



**ROHDE & SCHWARZ**

Test and Measurement  
Division

## Operating Manual

# SIGNAL ANALYZER

### **FSIQ3**

1119.5005.13

### **FSIQ7**

1119.5005.17

### **FSIQ26**

1119.6001.27

### **FSIQ40**

1119.6001.40

Printed in the Federal  
Republic of Germany



# Tabbed Divider Overview

## Contents

### Data Sheet

Safety Instructions  
Certificate of Quality  
EU Certificate of Conformity  
List of R&S Representatives

### Manuals for Signal Analyzer FSIQ

### Tabbed Divider

1	Chapter 1: Putting into Operation
2	Chapter 2: Getting Started
3	Chapter 3: Operation
4	Chapter 4: Functional Description
5	Chapter 5: Remote Control – Basics
6	Chapter 6: Remote Control – Commands
7	Chapter 7: Remote Control – Program Examples
8	Chapter 8: Maintenance and Hardware Interfaces
9	Chapter 9: Error Messages
10	Index





**Before putting the product into operation for the first time, make sure to read the following**



# Safety Instructions

Rohde & Schwarz makes every effort to keep the safety standard of its products up to date and to offer its customers the highest possible degree of safety. Our products and the auxiliary equipment required for them are designed and tested in accordance with the relevant safety standards. Compliance with these standards is continuously monitored by our quality assurance system. This product has been designed and tested in accordance with the EC Certificate of Conformity and has left the manufacturer's plant in a condition fully complying with safety standards. To maintain this condition and to ensure safe operation, observe all instructions and warnings provided in this manual. If you have any questions regarding these safety instructions, Rohde & Schwarz will be happy to answer them.

Furthermore, it is your responsibility to use the product in an appropriate manner. This product is designed for use solely in industrial and laboratory environments or in the field and must not be used in any way that may cause personal injury or property damage. You are responsible if the product is used for an intention other than its designated purpose or in disregard of the manufacturer's instructions. The manufacturer shall assume no responsibility for such use of the product.

The product is used for its designated purpose if it is used in accordance with its operating manual and within its performance limits (see data sheet, documentation, the following safety instructions). Using the products requires technical skills and knowledge of English. It is therefore essential that the products be used exclusively by skilled and specialized staff or thoroughly trained personnel with the required skills. If personal safety gear is required for using Rohde & Schwarz products, this will be indicated at the appropriate place in the product documentation.

## Symbols and safety labels

Observe operating instructions	Weight indication for units >18 kg	Danger of electric shock	Warning! Hot surface	PE terminal	Ground	Ground terminal	Attention! Electrostatic sensitive devices

Supply voltage ON/OFF	Standby indication	Direct current (DC)	Alternating current (AC)	Direct/alternating current (DC/AC)	Device fully protected by double/reinforced insulation

## Safety Instructions

Observing the safety instructions will help prevent personal injury or damage of any kind caused by dangerous situations. Therefore, carefully read through and adhere to the following safety instructions before putting the product into operation. It is also absolutely essential to observe the additional safety instructions on personal safety that appear in other parts of the documentation. In these safety instructions, the word "product" refers to all merchandise sold and distributed by Rohde & Schwarz, including instruments, systems and all accessories.

### Tags and their meaning

DANGER	This tag indicates a safety hazard with a high potential of risk for the user that can result in death or serious injuries.
WARNING	This tag indicates a safety hazard with a medium potential of risk for the user that can result in death or serious injuries.
CAUTION	This tag indicates a safety hazard with a low potential of risk for the user that can result in slight or minor injuries.
ATTENTION	This tag indicates the possibility of incorrect use that can cause damage to the product.
NOTE	This tag indicates a situation where the user should pay special attention to operating the product but which does not lead to damage.

These tags are in accordance with the standard definition for civil applications in the European Economic Area. Definitions that deviate from the standard definition may also exist. It is therefore essential to make sure that the tags described here are always used only in connection with the associated documentation and the associated product. The use of tags in connection with unassociated products or unassociated documentation can result in misinterpretations and thus contribute to personal injury or material damage.

### Basic safety instructions

1. The product may be operated only under the operating conditions and in the positions specified by the manufacturer. Its ventilation must not be obstructed during operation. Unless otherwise specified, the following requirements apply to Rohde & Schwarz products:  
prescribed operating position is always with the housing floor facing down, IP protection 2X, pollution severity 2, overvoltage category 2, use only in enclosed spaces, max. operation altitude max. 2000 m. Unless specified otherwise in the data sheet, a tolerance of  $\pm 10\%$  shall apply to the nominal voltage and of  $\pm 5\%$  to the nominal frequency.
2. Applicable local or national safety regulations and rules for the prevention of accidents must be observed in all work performed. The product may be opened only by authorized, specially trained personnel. Prior to performing any work on the product or opening the product, the product must be disconnected from the supply network. Any adjustments, replacements of parts, maintenance or repair must be carried out only by technical personnel authorized by Rohde & Schwarz. Only original parts may be used for replacing parts relevant to safety (e.g. power switches, power transformers, fuses). A safety test must always be performed after parts relevant to safety have been replaced (visual inspection, PE conductor test, insulation resistance measurement, leakage current measurement, functional test).
3. As with all industrially manufactured goods, the use of substances that induce an allergic reaction (allergens, e.g. nickel) such as aluminum cannot be generally excluded. If you develop an allergic reaction (such as a skin rash, frequent sneezing, red eyes or respiratory difficulties), consult a physician immediately to determine the cause.

## Safety Instructions

4. If products/components are mechanically and/or thermally processed in a manner that goes beyond their intended use, hazardous substances (heavy-metal dust such as lead, beryllium, nickel) may be released. For this reason, the product may only be disassembled, e.g. for disposal purposes, by specially trained personnel. Improper disassembly may be hazardous to your health. National waste disposal regulations must be observed.
5. If handling the product yields hazardous substances or fuels that must be disposed of in a special way, e.g. coolants or engine oils that must be replenished regularly, the safety instructions of the manufacturer of the hazardous substances or fuels and the applicable regional waste disposal regulations must be observed. Also observe the relevant safety instructions in the product documentation.
6. Depending on the function, certain products such as RF radio equipment can produce an elevated level of electromagnetic radiation. Considering that unborn life requires increased protection, pregnant women should be protected by appropriate measures. Persons with pacemakers may also be endangered by electromagnetic radiation. The employer is required to assess workplaces where there is a special risk of exposure to radiation and, if necessary, take measures to avert the danger.
7. Operating the products requires special training and intense concentration. Make certain that persons who use the products are physically, mentally and emotionally fit enough to handle operating the products; otherwise injuries or material damage may occur. It is the responsibility of the employer to select suitable personnel for operating the products.
8. Prior to switching on the product, it must be ensured that the nominal voltage setting on the product matches the nominal voltage of the AC supply network. If a different voltage is to be set, the power fuse of the product may have to be changed accordingly.
9. In the case of products of safety class I with movable power cord and connector, operation is permitted only on sockets with earthing contact and protective earth connection.
10. Intentionally breaking the protective earth connection either in the feed line or in the product itself is not permitted. Doing so can result in the danger of an electric shock from the product. If extension cords or connector strips are implemented, they must be checked on a regular basis to ensure that they are safe to use.
11. If the product has no power switch for disconnection from the AC supply, the plug of the connecting cable is regarded as the disconnecting device. In such cases, it must be ensured that the power plug is easily reachable and accessible at all times (length of connecting cable approx. 2 m). Functional or electronic switches are not suitable for providing disconnection from the AC supply. If products without power switches are integrated in racks or systems, a disconnecting device must be provided at the system level.
12. Never use the product if the power cable is damaged. By taking appropriate safety measures and carefully laying the power cable, ensure that the cable cannot be damaged and that no one can be hurt by e.g. tripping over the cable or suffering an electric shock.
13. The product may be operated only from TN/TT supply networks fused with max. 16 A.
14. Do not insert the plug into sockets that are dusty or dirty. Insert the plug firmly and all the way into the socket. Otherwise this can result in sparks, fire and/or injuries.
15. Do not overload any sockets, extension cords or connector strips; doing so can cause fire or electric shocks.
16. For measurements in circuits with voltages  $V_{rms} > 30 V$ , suitable measures (e.g. appropriate measuring equipment, fusing, current limiting, electrical separation, insulation) should be taken to avoid any hazards.
17. Ensure that the connections with information technology equipment comply with IEC 950/EN 60950.
18. Never remove the cover or part of the housing while you are operating the product. This will expose circuits and components and can lead to injuries, fire or damage to the product.

## Safety Instructions

19. If a product is to be permanently installed, the connection between the PE terminal on site and the product's PE conductor must be made first before any other connection is made. The product may be installed and connected only by a skilled electrician.
20. For permanently installed equipment without built-in fuses, circuit breakers or similar protective devices, the supply circuit must be fused in such a way that suitable protection is provided for users and products.
21. Do not insert any objects into the openings in the housing that are not designed for this purpose. Never pour any liquids onto or into the housing. This can cause short circuits inside the product and/or electric shocks, fire or injuries.
22. Use suitable overvoltage protection to ensure that no overvoltage (such as that caused by a thunderstorm) can reach the product. Otherwise the operating personnel will be endangered by electric shocks.
23. Rohde & Schwarz products are not protected against penetration of water, unless otherwise specified (see also safety instruction 1.). If this is not taken into account, there exists the danger of electric shock or damage to the product, which can also lead to personal injury.
24. Never use the product under conditions in which condensation has formed or can form in or on the product, e.g. if the product was moved from a cold to a warm environment.
25. Do not close any slots or openings on the product, since they are necessary for ventilation and prevent the product from overheating. Do not place the product on soft surfaces such as sofas or rugs or inside a closed housing, unless this is well ventilated.
26. Do not place the product on heat-generating devices such as radiators or fan heaters. The temperature of the environment must not exceed the maximum temperature specified in the data sheet.
27. Batteries and storage batteries must not be exposed to high temperatures or fire. Keep batteries and storage batteries away from children. If batteries or storage batteries are improperly replaced, this can cause an explosion (warning: lithium cells). Replace the battery or storage battery only with the matching Rohde & Schwarz type (see spare parts list). Batteries and storage batteries are hazardous waste. Dispose of them only in specially marked containers. Observe local regulations regarding waste disposal. Do not short-circuit batteries or storage batteries.
28. Please be aware that in the event of a fire, toxic substances (gases, liquids etc.) that may be hazardous to your health may escape from the product.
29. Please be aware of the weight of the product. Be careful when moving it; otherwise you may injure your back or other parts of your body.
30. Do not place the product on surfaces, vehicles, cabinets or tables that for reasons of weight or stability are unsuitable for this purpose. Always follow the manufacturer's installation instructions when installing the product and fastening it to objects or structures (e.g. walls and shelves).
31. Handles on the products are designed exclusively for personnel to hold or carry the product. It is therefore not permissible to use handles for fastening the product to or on means of transport such as cranes, fork lifts, wagons, etc. The user is responsible for securely fastening the products to or on the means of transport and for observing the safety regulations of the manufacturer of the means of transport. Noncompliance can result in personal injury or material damage.
32. If you use the product in a vehicle, it is the sole responsibility of the driver to drive the vehicle safely. Adequately secure the product in the vehicle to prevent injuries or other damage in the event of an accident. Never use the product in a moving vehicle if doing so could distract the driver of the vehicle. The driver is always responsible for the safety of the vehicle; the manufacturer assumes no responsibility for accidents or collisions.
33. If a laser product (e.g. a CD/DVD drive) is integrated in a Rohde & Schwarz product, do not use any other settings or functions than those described in the documentation. Otherwise this may be hazardous to your health, since the laser beam can cause irreversible damage to your eyes. Never try to take such products apart, and never look into the laser beam.





**Por favor lea imprescindiblemente antes de la primera puesta en funcionamiento las siguientes informaciones de seguridad**



## Informaciones de seguridad

Es el principio de Rohde & Schwarz de tener a sus productos siempre al día con los estándares de seguridad y de ofrecer a sus clientes el máximo grado de seguridad. Nuestros productos y todos los equipos adicionales son siempre fabricados y examinados según las normas de seguridad vigentes. Nuestra sección de gestión de la seguridad de calidad controla constantemente que sean cumplidas estas normas. Este producto ha sido fabricado y examinado según el comprobante de conformidad adjunto según las normas de la CE y ha salido de nuestra planta en estado impecable según los estándares técnicos de seguridad. Para poder preservar este estado y garantizar un funcionamiento libre de peligros, deberá el usuario atenerse a todas las informaciones, informaciones de seguridad y notas de alerta. Rohde&Schwarz está siempre a su disposición en caso de que tengan preguntas referentes a estas informaciones de seguridad.

Además queda en la responsabilidad del usuario utilizar el producto en la forma debida. Este producto solamente fue elaborado para ser utilizado en la industria y el laboratorio o para fines de campo y de ninguna manera deberá ser utilizado de modo que alguna persona/cosa pueda ser dañada. El uso del producto fuera de sus fines definidos o despreciando las informaciones de seguridad del fabricante queda en la responsabilidad del usuario. El fabricante no se hace en ninguna forma responsable de consecuencias a causa del maluso del producto.

Se parte del uso correcto del producto para los fines definidos si el producto es utilizado dentro de las instrucciones del correspondiente manual del uso y dentro del margen de rendimiento definido (ver hoja de datos, documentación, informaciones de seguridad que siguen). El uso de los productos hace necesarios conocimientos profundos y el conocimiento del idioma inglés. Por eso se deberá tener en cuenta de exclusivamente autorizar para el uso de los productos a personas peritas o debidamente minuciosamente instruidas con los conocimientos citados. Si fuera necesaria indumentaria de seguridad para el uso de productos de R&S, encontrará la información debida en la documentación del producto en el capítulo correspondiente.

### Símbolos y definiciones de seguridad

Ver manual de instrucciones del uso	Informaciones para maquinaria con un peso de > 18kg	Peligro de golpe de corriente	¡Advertencia! Superficie caliente	Conexión a conductor protector	Conexión a tierra	Conexión a masa conductora	¡Cuidado! Elementos de construcción con peligro de carga electrostática

potencia EN MARCHA/PARADA	Indicación Stand-by	Corriente continua DC	Corriente alterna AC	Corriente continua/alterna DC/AC	El aparato está protegido en su totalidad por un aislamiento de doble refuerzo

## Informaciones de seguridad

Tener en cuenta las informaciones de seguridad sirve para tratar de evitar daños y peligros de toda clase. Es necesario de que se lean las siguientes informaciones de seguridad concienzudamente y se tengan en cuenta debidamente antes de la puesta en funcionamiento del producto. También deberán ser tenidas en cuenta las informaciones para la protección de personas que encontrarán en otro capítulo de esta documentación y que también son obligatorias de seguir. En las informaciones de seguridad actuales hemos juntado todos los objetos vendidos por Rohde&Schwarz bajo la denominación de „producto“, entre ellos también aparatos, instalaciones así como toda clase de accesorios.

### Palabras de señal y su significado

PELIGRO	Indica un punto de peligro con gran potencial de riesgo para el usuario. Punto de peligro que puede llevar hasta la muerte o graves heridas.
ADVERTENCIA	Indica un punto de peligro con un potencial de riesgo mediano para el usuario. Punto de peligro que puede llevar hasta la muerte o graves heridas .
ATENCIÓN	Indica un punto de peligro con un potencial de riesgo pequeño para el usuario. Punto de peligro que puede llevar hasta heridas leves o pequeñas
CUIDADO	Indica la posibilidad de utilizar mal el producto y a consecuencia dañarlo.
INFORMACIÓN	Indica una situación en la que deberían seguirse las instrucciones en el uso del producto, pero que no consecuentemente deben de llevar a un daño del mismo.

Las palabras de señal corresponden a la definición habitual para aplicaciones civiles en el ámbito de la comunidad económica europea. Pueden existir definiciones diferentes a esta definición. Por eso se debiera tener en cuenta que las palabras de señal aquí descritas sean utilizadas siempre solamente en combinación con la correspondiente documentación y solamente en combinación con el producto correspondiente. La utilización de las palabras de señal en combinación con productos o documentaciones que no les correspondan puede llevar a malinterpretaciones y tener por consecuencia daños en personas u objetos.

### Informaciones de seguridad elementales

1. El producto solamente debe ser utilizado según lo indicado por el fabricante referente a la situación y posición de funcionamiento sin que se obstruya la ventilación. Si no se convino de otra manera, es para los productos R&S válido lo que sigue: como posición de funcionamiento se define principalmente la posición con el suelo de la caja para abajo , modo de protección IP 2X, grado de suciedad 2, categoría de sobrecarga eléctrica 2, utilizar solamente en estancias interiores, utilización hasta 2000 m sobre el nivel del mar.  
A menos que se especifique otra cosa en la hoja de datos, se aplicará una tolerancia de  $\pm 10\%$  sobre el voltaje nominal y de  $\pm 5\%$  sobre la frecuencia nominal.
2. En todos los trabajos deberán ser tenidas en cuenta las normas locales de seguridad de trabajo y de prevención de accidentes. El producto solamente debe de ser abierto por personal périto autorizado. Antes de efectuar trabajos en el producto o abrirlo deberá este ser desconectado de la corriente. El ajuste, el cambio de partes, la manutención y la reparación deberán ser solamente efectuadas por electricistas autorizados por R&S. Si se reponen partes con importancia para los aspectos de seguridad (por ejemplo el enchufe, los transformadores o los fusibles), solamente podrán ser sustituidos por partes originales. Despues de cada recambio de partes elementales para la seguridad deberá ser efectuado un control de

## Informaciones de seguridad

- seguridad (control a primera vista, control de conductor protector, medición de resistencia de aislamiento, medición de medición de la corriente conductora, control de funcionamiento).
3. Como en todo producto de fabricación industrial no puede ser excluido en general de que se produzcan al usarlo elementos que puedan generar alergias, los llamados elementos alergénicos (por ejemplo el níquel). Si se produjeran en el trato con productos R&S reacciones alérgicas, como por ejemplo urticaria, estornudos frecuentes, irritación de la conjuntiva o dificultades al respirar, se deberá consultar inmediatamente a un médico para averiguar los motivos de estas reacciones.
  4. Si productos / elementos de construcción son tratados fuera del funcionamiento definido de forma mecánica o térmica, pueden generarse elementos peligrosos (polvos de sustancia de metales pesados como por ejemplo plomo, berilio, níquel). La partición elemental del producto, como por ejemplo sucede en el tratamiento de materias residuales, debe de ser efectuada solamente por personal especializado para estos tratamientos. La partición elemental efectuada inadecuadamente puede generar daños para la salud. Se deben tener en cuenta las directivas nacionales referentes al tratamiento de materias residuales.
  5. En el caso de que se produjeran agentes de peligro o combustibles en la aplicación del producto que debieran de ser transferidos a un tratamiento de materias residuales, como por ejemplo agentes refrigerantes que deben ser repuestos en periodos definidos, o aceites para motores, deberán ser tenidas en cuenta las prescripciones de seguridad del fabricante de estos agentes de peligro o combustibles y las regulaciones regionales para el tratamiento de materias residuales. Cuiden también de tener en cuenta en caso dado las prescripciones de seguridad especiales en la descripción del producto.
  6. Ciertos productos, como por ejemplo las instalaciones de radiación HF, pueden a causa de su función natural, emitir una radiación electromagnética aumentada. En vista a la protección de la vida en desarrollo deberían ser protegidas personas embarazadas debidamente. También las personas con un bypass pueden correr peligro a causa de la radiación electromagnética. El empresario está comprometido a valorar y señalar áreas de trabajo en las que se corra un riesgo de exposición a radiaciones aumentadas de riesgo aumentado para evitar riesgos.
  7. La utilización de los productos requiere instrucciones especiales y una alta concentración en el manejo. Debe de ponerse por seguro de que las personas que manejen los productos estén a la altura de los requerimientos necesarios referente a sus aptitudes físicas, psíquicas y emocionales, ya que de otra manera no se pueden excluir lesiones o daños de objetos. El empresario lleva la responsabilidad de seleccionar el personal usuario apto para el manejo de los productos.
  8. Antes de la puesta en marcha del producto se deberá tener por seguro de que la tensión preseleccionada en el producto equivalga a la del la red de distribución. Si es necesario cambiar la preselección de la tensión también se deberán en caso dabo cambiar los fusibles correspondientes del producto.
  9. Productos de la clase de seguridad I con alimentación móvil y enchufe individual de producto solamente deberán ser conectados para el funcionamiento a tomas de corriente de contacto de seguridad y con conductor protector conectado.
  10. Queda prohibida toda clase de interrupción intencionada del conductor protector, tanto en la toma de corriente como en el mismo producto ya que puede tener como consecuencia el peligro de golpe de corriente por el producto. Si se utilizaran cables o enchufes de extensión se deberá poner al seguro, que es controlado su estado técnico de seguridad.
  11. Si el producto no está equipado con un interruptor para desconectarlo de la red, se deberá considerar el enchufe del cable de distribución como interruptor. En estos casos deberá asegurar de que el enchufe sea de fácil acceso y nabejo (medida del cable de distribución aproximadamente 2 m). Los interruptores de función o electrónicos no son aptos para el corte de la red eléctrica. Si los productos sin interruptor están integrados en construcciones o instalaciones, se deberá instalar el interruptor al nivel de la instalación.

## Informaciones de seguridad

12. No utilice nunca el producto si está dañado el cable eléctrico. Asegure a través de las medidas de protección y de instalación adecuadas de que el cable de eléctrico no pueda ser dañado o de que nadie pueda ser dañado por él, por ejemplo al tropezar o por un golpe de corriente.
13. Solamente está permitido el funcionamiento en redes de distribución TN/TT aseguradas con fusibles de como máximo 16 A.
14. Nunca conecte el enchufe en tomas de corriente sucias o llenas de polvo. Introduzca el enchufe por completo y fuertemente en la toma de corriente. Si no tiene en consideración estas indicaciones se arriesga a que se originen chispas, fuego y/o heridas.
15. No sobrecargue las tomas de corriente, los cables de extensión o los enchufes de extensión ya que esto pudiera causar fuego o golpes de corriente.
16. En las mediciones en circuitos de corriente con una tensión de entrada de  $U_{eff} > 30 \text{ V}$  se deberá tomar las precauciones debidas para impedir cualquier peligro (por ejemplo medios de medición adecuados, seguros, limitación de tensión, corte protector, aislamiento etc.).
17. En caso de conexión con aparatos de la técnica informática se deberá tener en cuenta que estos cumplan los requisitos de la EC950/EN60950.
18. Nunca abra la tapa o parte de ella si el producto está en funcionamiento. Esto pone a descubierto los cables y componentes eléctricos y puede causar heridas, fuego o daños en el producto.
19. Si un producto es instalado fijamente en un lugar, se deberá primero conectar el conductor protector fijo con el conductor protector del aparato antes de hacer cualquier otra conexión. La instalación y la conexión deberán ser efectuadas por un electricista especializado.
20. En caso de que los productos que son instalados fijamente en un lugar sean sin protector implementado, autointerruptor o similares objetos de protección, deberá la toma de corriente estar protegida de manera que los productos o los usuarios estén suficientemente protegidos.
21. Por favor, no introduzca ningún objeto que no esté destinado a ello en los orificios de la caja del aparato. No vierta nunca ninguna clase de líquidos sobre o en la caja. Esto puede producir corto circuitos en el producto y/o puede causar golpes de corriente, fuego o heridas.
22. Asegúrese con la protección adecuada de que no pueda originarse en el producto una sobrecarga por ejemplo a causa de una tormenta. Si no se verá el personal que lo utilice expuesto al peligro de un golpe de corriente.
23. Los productos R&S no están protegidos contra el agua si no es que exista otra indicación, ver también punto 1. Si no se tiene en cuenta esto se arriesga el peligro de golpe de corriente o de daños en el producto lo cual también puede llevar al peligro de personas.
24. No utilice el producto bajo condiciones en las que pueda producirse y se hayan producido líquidos de condensación en o dentro del producto como por ejemplo cuando se desplaza el producto de un lugar frío a un lugar caliente.
25. Por favor no cierre ninguna ranura u orificio del producto, ya que estas son necesarias para la ventilación e impiden que el producto se caliente demasiado. No pongan el producto encima de materiales blandos como por ejemplo sofás o alfombras o dentro de una caja cerrada, si esta no está suficientemente ventilada.
26. No ponga el producto sobre aparatos que produzcan calor, como por ejemplo radiadores o calentadores. La temperatura ambiental no debe superar la temperatura máxima especificada en la hoja de datos.

## Informaciones de seguridad

27. Baterías y acumuladores no deben de ser expuestos a temperaturas altas o al fuego. Guardar baterías y acumuladores fuera del alcance de los niños. Si las baterías o los acumuladores no son cambiados con la debida atención existirá peligro de explosión (atención celulas de Litio). Cambiar las baterías o los acumuladores solamente por los del tipo R&S correspondiente (ver lista de piezas de recambio). Baterías y acumuladores son deshechos problemáticos. Por favor tirenlos en los recipientes especiales para este fin. Por favor tengan en cuenta las prescripciones nacionales de cada país referente al tratamiento de deshechos. Nunca sometan las baterías o acumuladores a un corto circuito.
28. Tengan en consideración de que en caso de un incendio pueden escaparse gases tóxicos del producto, que pueden causar daños a la salud.
29. Por favor tengan en cuenta que en caso de un incendio pueden desprenderse del producto agentes venenosos (gases, líquidos etc.) que pueden generar daños a la salud.
30. No sitúe el producto encima de superficies, vehículos, estantes o mesas, que por sus características de peso o de estabilidad no sean aptas para él. Siga siempre las instrucciones de instalación del fabricante cuando instale y asegure el producto en objetos o estructuras (por ejemplo paredes y estantes).
31. Las asas instaladas en los productos sirven solamente de ayuda para el manejo que solamente está previsto para personas. Por eso no está permitido utilizar las asas para la sujecion en o sobre medios de transporte como por ejemplo grúas, carretillas elevadoras de horquilla, carros etc. El usuario es responsable de que los productos sean sujetados de forma segura a los medios de transporte y de que las prescripciones de seguridad del fabricante de los medios de transporte sean tenidas en cuenta. En caso de que no se tengan en cuenta pueden causarse daños en personas y objetos.
32. Si llega a utilizar el producto dentro de un vehículo, queda en la responsabilidad absoluta del conductor que conducir el vehículo de manera segura. Asegure el producto dentro del vehículo debidamente para evitar en caso de un accidente las lesiones u otra clase de daños. No utilice nunca el producto dentro de un vehículo en movimiento si esto pudiera distraer al conductor. Siempre queda en la responsabilidad absoluta del conductor la seguridad del vehículo y el fabricante no asumirá ninguna clase de responsabilidad por accidentes o colisiones.
33. Dado el caso de que esté integrado un producto de laser en un producto R&S (por ejemplo CD/DVD-ROM) no utilice otras instalaciones o funciones que las descritas en la documentación. De otra manera pondrá en peligro su salud, ya que el rayo laser puede dañar irreversiblemente sus ojos. Nunca trate de descomponer estos productos. Nunca mire dentro del rayo laser.

## Certified Quality System

**DIN EN ISO 9001 : 2000**  
**DIN EN 9100 : 2003**  
**DIN EN ISO 14001 : 1996**

**DQS REG. NO 001954 QM/ST UM**

### QUALITÄTSZERTIFIKAT

*Sehr geehrter Kunde,*

Sie haben sich für den Kauf eines Rohde & Schwarz-Produktes entschieden. Hiermit erhalten Sie ein nach modernsten Fertigungsmethoden hergestelltes Produkt. Es wurde nach den Regeln unseres Managementsystems entwickelt, gefertigt und geprüft.

Das Rohde & Schwarz Managementsystem ist zertifiziert nach:

DIN EN ISO 9001:2000  
DIN EN 9100:2003  
DIN EN ISO 14001:1996

### CERTIFICATE OF QUALITY

*Dear Customer,*

you have decided to buy a Rohde & Schwarz product. You are thus assured of receiving a product that is manufactured using the most modern methods available. This product was developed, manufactured and tested in compliance with our quality management system standards.

The Rohde & Schwarz quality management system is certified according to:

DIN EN ISO 9001:2000  
DIN EN 9100:2003  
DIN EN ISO 14001:1996

### CERTIFICAT DE QUALITÉ

*Cher Client,*

vous avez choisi d'acheter un produit Rohde & Schwarz. Vous disposez donc d'un produit fabriqué d'après les méthodes les plus avancées. Le développement, la fabrication et les tests respectent nos normes de gestion qualité.

Le système de gestion qualité de Rohde & Schwarz a été homologué conformément aux normes:

DIN EN ISO 9001:2000  
DIN EN 9100:2003  
DIN EN ISO 14001:1996



**ROHDE & SCHWARZ**





Certificate No.: 98091

This is to certify that:

Equipment type	Stock No.	Designation
FSIQ3	1119.5005.03/.13	Signal Analyzer
FSIQ7	1119.5005.07/.17	
FSIQ26	1119.6001.26/.27	
FSIQ40	1119.6001.40	
FSE-B13	1119.6499.02	Option: 1 dB Input Attenuator
FSIQB70	1119.6747.02	Option: DSP and IQ Memory Extension

complies with the provisions of the Directive of the Council of the European Union on the approximation of the laws of the Member States

- relating to electrical equipment for use within defined voltage limits  
(73/23/EEC revised by 93/68/EEC)
- relating to electromagnetic compatibility  
(89/336/EEC revised by 91/263/EEC, 92/31/EEC, 93/68/EEC)

Conformity is proven by compliance with the following standards:

EN61010-1 : 1993 + A2 : 1995  
EN50081-1 : 1992  
EN50082-2 : 1995

Affixing the EC conformity mark as from 1998

**ROHDE & SCHWARZ GmbH & Co. KG**  
**Mühldorfstr. 15, D-81671 München**

Munich, 2000-02-11

Central Quality Management FS-QZ / Becker





# Customer Support

## Technical support – where and when you need it

For quick, expert help with any Rohde & Schwarz equipment, contact one of our Customer Support Centers. A team of highly qualified engineers provides telephone support and will work with you to find a solution to your query on any aspect of the operation, programming or applications of Rohde & Schwarz equipment.

## Up-to-date information and upgrades

To keep your Rohde & Schwarz equipment always up-to-date, please subscribe to our electronic newsletter at

<http://www.rohde-schwarz.com/www/response.nsf/newsletterpreselection>

or request the desired information and upgrades via email from your Customer Support Center (addresses see below).

## Feedback

We want to know if we are meeting your support needs. If you have any comments please email us and let us know [CustomerSupport.Feedback@rohde-schwarz.com](mailto:CustomerSupport.Feedback@rohde-schwarz.com).

---

### USA & Canada

Monday to Friday (except US public holidays)

8:00 AM – 8:00 PM Eastern Standard Time (EST)

Tel. from USA 888-test-rsa (888-837-8772) (opt 2)

From outside USA +1 410 910 7800 (opt 2)

Fax +1 410 910 7801

E-mail [Customer.Support@rsa.rohde-schwarz.com](mailto:Customer.Support@rsa.rohde-schwarz.com)

### East Asia

Monday to Friday (except Singaporean public holidays)

8:30 AM – 6:00 PM Singapore Time (SGT)

Tel. +65 6 513 0488

Fax +65 6 846 1090

E-mail [Customersupport.asia@rohde-schwarz.com](mailto:Customersupport.asia@rohde-schwarz.com)

### Rest of the World

Monday to Friday (except German public holidays)

08:00 – 17:00 Central European Time (CET)

Tel. from Europe +49 (0) 180 512 42 42

From outside Europe +49 89 4129 13776

Fax +49 (0) 89 41 29 637 78

E-mail [CustomerSupport@rohde-schwarz.com](mailto:CustomerSupport@rohde-schwarz.com)





# Adressen/Addresses

## FIRMENSITZ/HEADQUARTERS

(Tel) Phone  
(Fax) Fax  
E-mail

Rohde & Schwarz GmbH & Co. KG  
Mühlendorfstraße 15 · D-81671 München  
Postfach 80 14 69 · D-81614 München

(Tel) +49 (89) 41 29-0  
(Fax) +49 89 4129-121 64  
info@rohde-schwarz.com

## WERKE/PLANTS

Rohde & Schwarz Messgerätebau GmbH  
Riedbachstraße 58 · D-87700 Memmingen  
Postfach 1652 · D-87686 Memmingen

(Tel) +49 (8331) 108-0  
(Fax) +49 (8331) 108-11 24  
info.rsdbm@rohde-schwarz.com

Rohde & Schwarz GmbH & Co. KG  
Werk Teisnach  
Kaikenrieder Straße 27 · D-94244 Teisnach  
Postfach 1149 · D-94240 Teisnach

(Tel) +49 (9923) 857-0  
(Fax) +49 (9923) 857-11 74  
info.rsdt@rohde-schwarz.com

Rohde & Schwarz GmbH & Co. KG  
Dienstleistungszentrum Köln  
Graf-Zeppelin-Straße 18 · D-51147 Köln  
Postfach 98 02 60 · D-51130 Köln

(Tel) +49 (2203) 49-0  
(Fax) +49 (2203) 49 51-229  
info.rsd@rohde-schwarz.com  
schwarz.com-service.rsd@rohde-schwarz.com

## TOCHTERUNTERNEHMEN/SUBSIDIARIES

Rohde & Schwarz Vertriebs-GmbH  
Mühlendorfstraße 15 · D-81671 München  
Postfach 80 14 69 · D-81614 München

(Tel) +49 (89) 41 29-137 74  
(Fax) +49 (89) 41 29-137 77  
customersupport@rohde-schwarz.com

Rohde & Schwarz International GmbH  
Mühlendorfstraße 15 · D-81671 München  
Postfach 80 14 60 · D-81614 München

(Tel) +49 (89) 41 29-129 84  
(Fax) +49 (89) 41 29-120 50  
info.rusis@rohde-schwarz.com

Rohde & Schwarz Engineering and Sales GmbH  
Mühlendorfstraße 15 · D-81671 München  
Postfach 80 14 29 · D-81614 München

(Tel) +49 (89) 41 29-137 11  
(Fax) +49 (89) 41 29-137 23  
info.rse@rohde-schwarz.com

R&S BICK Mobilfunk GmbH  
Fritz-Hahne-Str. 7 · D-31848 Bad Münder  
Postfach 2062 · D-31844 Bad Münder

(Tel) +49 (5042) 998-0  
(Fax) +49 (5042) 998-105  
info.rsbeck@rohde-schwarz.com

Rohde & Schwarz FTK GmbH  
Wendenschlossstraße 168, Haus 28  
D-12557 Berlin

(Tel) +49 (30) 658 91-122  
(Fax) +49 (30) 655 50-221  
info.ftk@rohde-schwarz.com

Rohde & Schwarz SIT GmbH  
Agastraße 3  
D-12489 Berlin

(Tel) +49 (30) 658 84-0  
(Fax) +49 (30) 658 84-183  
info.sit@rohde-schwarz.com

R&S Systems GmbH  
Graf-Zeppelin-Straße 18 · D-51147 Köln  
Postfach 98 02 60 · D-51130 Köln

(Tel) +49 (2203) 49-5 23 25  
(Fax) +49 (2203) 49-5 23 36  
info.rssys@rohde-schwarz.com

## ADRESSEN WELTWEIT/ADDRESSES WORLDWIDE

**Albania** siehe/see Austria

**Algeria** Rohde & Schwarz  
Bureau d'Alger  
5B Place de Laperrine  
16035 Hydra-Alger

(Tel) +213 (21) 48 20 18  
(Fax) +213 (21) 69 46 08

**Antilles (Neth.)** siehe / see Mexico

**Argentina** Precision Electronica S.R.L.  
Av. Pde Julio A. Roca 710 - 6° Piso  
1067 Buenos Aires

(Tel) +541 (14) 331 10 67  
(Fax) +541 (14) 334 51 11  
alberto.lombardi@prec-elec.com.ar

**Australia** Rohde & Schwarz (Australia) Pty. Ltd.  
Sales Support  
Unit 6  
2-8 South Street  
Rydalmere, N.S.W. 2116

(Tel) +61 (2) 88 45 41 00  
(Fax) +61 (2) 96 38 39 88  
sales@saus.rohde-schwarz.com

**Austria** Rohde & Schwarz-Österreich Ges.m.b.H.  
Am Europlatz 3  
Gebäude B  
1120 Wien

(Tel) +43 (1) 602 61 41-0  
(Fax) +43 (1) 602 61 41-14  
rs-austria@rsoe.rohde-schwarz.com

**Azerbaijan** Rohde & Schwarz Azerbaijan  
Liaison Office Baku  
ISR Plaza, 5th floor  
340 Nizami Str.  
370000 Baku

(Tel) +994 (12) 93 31 38  
(Fax) +994 (12) 93 03 14  
rs-azerbaijan@rsd.rohde-schwarz.com

**Bangladesh** BIL Consortium Ltd.  
Corporate Office  
House-33, Road-4, Block-F  
Banani, Dhaka-1213

(Tel) +880 (2) 881 06 53  
(Fax) +880 (2) 882 82 91

**Barbados** siehe / see Mexico

**Belarus** siehe/see Ukraine

**Belgium** Rohde & Schwarz Belgium N.V.  
Excelsiorlaan 31 Bus 1  
1930 Zaventem

(Tel) +32 (2) 721 50 02  
(Fax) +32 (2) 725 09 36  
info@rsb.rohde-schwarz.com

**Belize** siehe / see Mexico

**Bermuda** siehe/see Mexico

**Bosnia-Herzegovina** siehe/see Slovenia

**Brazil** Rohde & Schwarz Do Brasil Ltda.  
Av. Alfredo Egídio de Souza Aranha (Rod. Arlindo  
1° andar - Santo Amaro  
04726-170 Sao Paulo - SP

(Tel) +55 (11) 56 44 86 11  
(Fax) +55 (11) 56 44 86 25 (sales)  
(Fax) +55 (11) 56 44 86 36  
sales-brazil@rsdb.rohde-schwarz.com

**Brunei** George Keen Lee Equipment Pte Ltd.  
#11-01 BP Tower  
396 Alexandra Road  
Singapore 119954

(Tel) +656 276 06 26  
(Fax) +656 276 06 29  
gkleqpt@singnet.com.sg

**Bulgaria** Rohde & Schwarz  
Representation Office Bulgaria  
39, Fridtjof Nansen Blvd.  
1000 Sofia

(Tel) +359 (2) 96 343 34  
(Fax) +359 (2) 963 21 97  
rs-bulgaria@rsbg.rohde-schwarz

**Canada** Rohde & Schwarz Canada Inc.  
555 March Rd.  
Kanata, Ontario K2K 2M5

(Tel) +1 (613) 592 80 00  
(Fax) +1 (613) 592 80 09  
sales@rscanada.ca

**Chile** Dymeq Ltda.  
Av. Larrain 6666  
Santiago

(Tel) +56 (2) 339 20 00  
(Fax) +56 (2) 339 20 10  
dymeq@dymeq.com

**China** Rohde & Schwarz China Ltd.  
Representative Office Beijing  
6F, Parkview Center  
2 Jiangtai Road  
Chao Yang District  
Beijing 100016

(Tel) +86 (10) 64 31 28 28  
(Fax) +86 (10) 64 37 98 88  
info.rschina@rsbp.rohde-schwarz.com

Rohde & Schwarz China Ltd.  
Representative Office Shanghai  
Room 807-809, Central Plaza  
227 Huangpi North Road  
Shanghai 200003

(Tel) +86 (21) 63 75 00 18  
(Fax) +86 (21) 63 75 91 70  
May.Zhu@rsbp.rohde-schwarz.com

Rohde & Schwarz China Ltd.  
Representative Office Guangzhou  
Room 2903, Metro Plaza  
183 Tian He North Road  
Guangzhou 510075

(Tel) +86 (20) 87 55 47 58  
(Fax) +86 (20) 87 55 47 59  
Winnie.Lin@rsbp.rohde-schwarz.com

# Adressen/Addresses

<b>China</b>	Rohde & Schwarz China Ltd. Representative Office Chengdu Unit G, 28/F, First City Plaza 308 Shuncheng Avenue Chengdu 610017	(Tel) +86 (28) 86 52 76 06 (Fax) +86 (28) 86 52 76 10 sophia.chen@rsbp.rohde-schwarz.com	<b>Germany</b>	Zweigniederlassung Büro Bonn Josef-Wirmer-Straße 1-3 · D-53123 Bonn Postfach 140264 · D-53057 Bonn	(Tel) +49 (228) 918 90-0 (Fax) +49 (228) 25 50 87 info.rsv@rohde-schwarz.com
	Rohde & Schwarz China Ltd. Representative Office Xian Room 603, Jin Xin International No. 99 Heping Road Xian 710001	(Tel) +86 (29) 87 41 53 77 (Fax) +86 (29) 87 20 65 00 sherry.yu@rsbp.rohde-schwarz.com		Zweigniederlassung Nord, Geschäftsstelle Hamburg Vierenkamp 6 D-22423 Hamburg	(Tel) +49 (40) 38 61 83 - 00 (Fax) +49 (40) 38 61 83 - 20 info.rsv@rohde-schwarz.com
	Rohde & Schwarz China Ltd. Representative Office Shenzhen Room 1901, Central Business Building No. 88 Fuhua Yilu Futian District Shenzhen 518026	(Tel) +86 (755) 82 03 11 98 (Fax) +86 (755) 82 03 30 70 jessica.lia@rsbp.rohde-schwarz.com		Zweigniederlassung Mitte, Geschäftsstelle Köln Niederlasser Straße 33 · D-51147 Köln Postfach 900 149 · D-51111 Köln	(Tel) +49 (2203) 807-0 (Fax) +49 (2203) 807-650 info.rsv@rohde-schwarz.com
<b>Costa Rica</b>	siehe / see Mexico			Zweigniederlassung Süd, Geschäftsstelle München Mühlhordstraße 15 · D-81671 München Postfach 80 14 69 · D-81614 München	(Tel) +49 (89) 41 86 95-0 (Fax) +49 (89) 40 47 64 info.rsv@rohde-schwarz.com
<b>Croatia</b>	siehe/see Slovenia			Zweigniederlassung Süd, Geschäftsstelle Nürnberg Donaustraße 36 D-90451 Nürnberg	(Tel) +49 (911) 642 03-0 (Fax) +49 (911) 642 03-33 info.rsv@rohde-schwarz.com
<b>Cuba</b>	siehe / see Mexico			Zweigniederlassung Mitte, Geschäftsstelle Neu-Isenburg Siemensstraße 20 D-63263 Neu-Isenburg Postfach 16 51 D-63236 Neu-Isenburg	(Tel) +49 (6102) 20 07-0 (Fax) +49 (6102) 20 07 12 info.rsv@rohde-schwarz.com
<b>Cyprus</b>	Hinis Telecast Ltd. Agiou Thoma 18 Kiti Larnaca 7550	(Tel) +357 (24) 42 51 78 (Fax) +357 (24) 42 46 21 hinis@logos.cy.net	<b>Ghana</b>	Kop Engineering Ltd. P.O. Box 11012 3rd Floor Akai House, Osu Accra North	(Tel) +233 (21) 77 89 13 (Fax) +233 (21) 701 06 20 joblink@ghana.com
<b>Czech Republic</b>	Rohde & Schwarz Praha, s.r.o. Hadovka Office Park Evropská 2590/33c 16000 Praha 6	(Tel) +420 (2) 24 31 12 32 (Fax) +420 (2) 24 31 70 43 office@rscz.rohde-schwarz.com	<b>Greece</b>	Mercury S.A. 6, Loukianou Str. 10675 Athens	(Tel) +302 (10) 722 92 13 (Fax) +302 (10) 721 51 98 mercury@hol.gr
<b>Denmark</b>	Rohde & Schwarz Danmark A/S Ejby Industrivej 40 2600 Glostrup	(Tel) +45 (43) 43 66 99 (Fax) +45 (43) 43 77 44 rsdk@rsdk.rohde-schwarz.com	<b>Guatemala</b>	siehe/see Mexico	
<b>Egypt</b>	U.A.S. Universal Advanced Systems 31 Manshiet El-Bakry Street Heliopolis 11341 Cairo	(Tel) +20 (2) 455 67 44 (Fax) +20 (2) 256 17 40 an_uas@link.net	<b>Guiana</b>	siehe / see Mexico	
<b>El Salvador</b>	siehe/see Mexico		<b>Haiti</b>	siehe / see Mexico	
<b>Estonia</b>	Rohde & Schwarz Danmark A/S Estonian Branch Office Narva mnt. 13 10151 Tallinn	(Tel) +372 (6) 14 31 23 (Fax) +372 (6) 14 31 21 estonia@rsdk.rohde-schwarz.com	<b>Honduras</b>	siehe/see Mexico	
<b>Finland</b>	Rohde & Schwarz Finland Oy Taivaltie 5 01610 Vantaa	(Tel) +358 (207) 60 04 00 (Fax) +358 (207) 60 04 17 info@rsfin.rohde-schwarz.com	<b>Hong Kong</b>	Electronic Scientific Engineering 9/F North Somerset House Taikoo Place 979 King's Road, Quarry Bay Hong Kong	(Tel) +852 (25) 07 03 33 (Fax) +852 (25) 07 09 25 stephenchau@ese.com.hk
<b>France</b>	Rohde & Schwarz France Immeuble "Le Newton" 9-11, rue Jeanne Braconnier 92366 Meudon La Forêt Cédex	(Tel) +33 (0) 141 36 10 00 (Fax) +33 (0) 141 36 11 11 contact@rsf.rohde-schwarz.com	<b>Hungary</b>	Rohde & Schwarz Budapesti Iroda Váci út 169 1138 Budapest	(Tel) +36 (1) 412 44 60 (Fax) +36 (1) 412 44 61 rs-hungary@rshu.rohde-schwarz.com
	Niederlassung/Subsidiary Rennes 37 Rue du Bignon Bâtiment A 35510 Cesson Sévigné	(Tel) +33 (2) 99 51 97 00 (Fax) +33 (2) 99 51 98 77	<b>Iceland</b>	siehe/see Denmark	
<b>Germany</b>	Zweigniederlassungen der Rohde & Schwarz Vertriebs-GmbH/Branch offices of Rohde & Schwarz Vertriebs-GmbH		<b>India</b>	Rohde & Schwarz India Pvt. Ltd. 244, Okhla Industrial Estate Phase - III New Delhi 110 020	(Tel) +91 (11) 26 32 63 81 (Fax) +91 (11) 26 32 63 73 sales@rsindia.rohde-schwarz.com
	Zweigniederlassung Nord, Geschäftsstelle Berlin Ernst-Reuter-Platz 10 · D-10587 Berlin Postfach 100620 · D-10566 Berlin	(Tel) +49 (30) 34 79 48-0 (Fax) +49 (30) 34 79 48 48 info.rsv@rohde-schwarz.com		Rohde & Schwarz India Pvt. Ltd. Bangalore Office No. 24, Service Road, Domlur 2nd Stage Extension Bangalore - 560 071	(Tel) +91 (80) 535 23 62 (Fax) +91 (80) 535 03 61 rsindiab@rsnl.net
				Rohde & Schwarz India Pvt. Ltd. Hyderabad Office 302 & 303, Millennium Centre 6-3-1099/1100, Somajiguda Hyderabad - 500 016	(Tel) +91 (40) 23 32 24 16 (Fax) +91 (40) 23 32 27 32 rsindiah@nd2.dot.net.in

# Adressen/Addresses

<b>India</b>	Rohde & Schwarz India Pvt. Ltd. Mumbai Office B-603, Remi Bizcourt, Shah Industrial Estate, Off Veera Desai Road Andheri West Mumbai - 400 058	(Tel) +91 (22) 26 30 18 10 (Fax) +91 (22) 26 73 20 81 rsindiam@rsnl.net	<b>Kazakhstan</b>	Rohde & Schwarz Kazakhstan Representative Office Almaty Pl. Respubliki 15 480013 Almaty	(Tel) +7 (32) 72 67 23 54 (Fax) +7 (32) 72 67 23 46 rs-kazakhstan@rsd-rohde-schwarz.com
<b>Indonesia</b>	PT Rohde & Schwarz Indonesia Graha Paramita 5th Floor Jln. Denpasar Raya Blok D-2 Jakarta 12940	(Tel) +62 (21) 252 36 08 (Fax) +62 (21) 252 36 07 sales@rsbj.rohde-schwarz.com-services@rsbj.rohde-schwarz.com	<b>Kenya</b>	Excel Enterprises Ltd Dunga Road P.O.Box 42 788 Nairobi	(Tel) +254 (2) 55 80 88 (Fax) +254 (2) 54 46 79
<b>Iran</b>	Rohde & Schwarz Iran Liaison Office Tehran Groundfloor No. 1, 14th Street Khaled Eslamboli (Vozara) Ave. 15117 Tehran	(Tel) +98 (21) 872 42 96 (Fax) +98 (21) 871 90 12 alfred.korff@rsd.rohde-schwarz.com	<b>Korea</b>	Rohde & Schwarz Korea Ltd. 83-29 Nonhyun-Dong, Kangnam-Ku  Seoul 135-010	(Tel) +82 (2) 34 85 19 00 (Fax) +82 (2) 547 43 00 sales@rskor.rohde-schwarz.com-service@rskor.rohde-schwarz.com
<b>Ireland</b>	siehe/see United Kingdom		<b>Kuwait</b>	Group Five Trading & Contracting Co. Mezzanine Floor Al-Bana Towers Ahmad Al Jaber Street Sharq	(Tel) +965 (244) 91 72/73/74 (Fax) +965 (244) 95 28 jk_agarwal@yahoo.com
<b>Israel</b>	Eastronics Ltd. Measurement Products 11 Rozanis St. P.O.Box 39300 Tel Aviv 61392	(Tel) +972 (3) 645 87 77 (Fax) +972 (3) 645 86 66 david_hasky@easx.co.il	<b>Latvia</b>	Rohde & Schwarz Danmark A/S Latvian Branch Office Merkela iela 21-301 1050 Riga	(Tel) +371 (7) 50 23 55 (Fax) +371 (7) 50 23 60 latvia@rsdk.rohde-schwarz.com
	J.M. Moss (Engineering) Ltd. Communications Products 9 Oded Street P.O.Box 967 52109 Ramat Gan	(Tel) +972 (3) 631 20 57 (Fax) +972 (3) 631 40 58 jmoss@zahav.net.il	<b>Lebanon</b>	Rohde & Schwarz Liaison Office Riyadh P.O.Box 361 Riyadh 11411	(Tel) +966 (1) 465 64 28 Ext. 303 (Fax) +966 (1) 465 64 28 Ext. 229 chris.porzky@rsd.rohde-schwarz.com
<b>Italy</b>	Rohde & Schwarz Italia S.p.a. Centro Direzionale Lombardo Via Roma 108 20060 Cassina de Pecchi (MI)	(Tel) +39 (02) 95 70 41 (Fax) +39 (02) 95 30 27 72 rsi.info@rsi.rohde-schwarz.com		Netcom P.O.Box 55199 Op. Ex-Presidential Palace Horch Tabet Beirut	(Tel) +961 (1) 48 69 99 (Fax) +961 (1) 49 05 11 tohme.sayar@netcomm.tv
	Rohde & Schwarz Italia S.p.a. Via Tiburtina 1182 00156 Roma	(Tel) +39 (06) 41 59 81 (Fax) +39 (06) 41 59 82 70 rsi.info@rsi.rohde-schwarz.com	<b>Liechtenstein</b>	siehe/see Switzerland	
<b>Jamaica</b>	siehe / see Mexico		<b>Lithuania</b>	Rohde & Schwarz Danmark A/S Lithuanian Branch Office Lukiskiu 5-228 2600 Vilnius	(Tel) +370 (5) 239 50 10 (Fax) +370 (5) 239 50 11 lithuania@rsdk.rohde-schwarz.com
<b>Japan</b>	Rohde & Schwarz Japan K.K. Tokyo Office 711 Bldg., Room 501 (5th floor) 7-11-18 Nishi-Shinjuku Shinjuku-ku Tokyo 160-0023	(Tel) +81 (3) 59 25 12 88 (Fax) +81 (3) 59 25 12 90 scj.support@rsjp.rohde-schwarz.com	<b>Luxembourg</b>	siehe/see Belgium	
	Rohde & Schwarz Japan K.K. Shin-Yokohama Office KM Daiichi Bldg., 8F 2-13-13 Kouhoku-ku Yokohama-shi Kanagawa 222-0033	(Tel) +81 (4) 54 77 35 70	<b>Macedonia</b>	NETRA Sarski odred 7 1000 Skopje	(Tel) +389 (2) 329 82 30 (Fax) +389 (2) 317 74 88 netra@netra.com.sk
	Rohde & Schwarz Japan K.K. Osaka Office TEK Dai 2 Bldg., 8F 1-13-20 Esaka-shi Suita-shi Osaka-fu 564-0063	(Tel) +81 (6) 63 10 96 51	<b>Malaysia</b>	Rohde & Schwarz Malaysia Sdn Bhd Suite 10.04, Level 10, Wisma E&C No. 2 Lorong Dungun Kiri Damansara Heights 50490 Kuala-Lumpur	(Tel) +60 (3) 20 94 00 33 (Fax) +60 (3) 20 94 24 33 sales.malaysia@rohde-schwarz.com
<b>Jordan</b>	Jordan Crown Engineering & Trading Co. Jabal Amman, Second Circle Youssef Ezzideen Street P.O.Box 830414 Amman, 11183	(Tel) +962 (6) 462 17 29 (Fax) +962 (6) 465 96 72 jocrown@go.com.jo	<b>Malta</b>	Tektraco International Technology Ltd. 121, B'Kara Road San Gwann SGN 08	(Tel) +356 (21) 37 43 00 or 37 80 88 (Fax) +356 (21) 37 66 67 sales@tektraco.com
			<b>Mexico</b>	Rohde & Schwarz de Mexico S. de R.L. de C.V. German Centre Oficina 4-2-2 Av. Santa Fé 170 Col. Lomas de Santa Fé 01210 Mexico D.F.	(Tel) +52 (55) 85 03 99 13 (Fax) +52 (55) 85 03 99 16 latinoamerica@rsd-rohde-schwarz.com
			<b>Moldava</b>	siehe/see Austria	
			<b>Nepal</b>	ICTC Pvt. Ltd. Hattisar, Post Box No. 660 Kathmandu	(Tel) +977 (1) 443 48 95 (Fax) +977 (1) 443 49 37 ictc@mos.com.np

# Adressen/Addresses

<b>Netherlands</b>	Rohde & Schwarz Nederland B.V. Perkinsbaan 1 3439 ND Nieuwegein	(Tel) +31 (30) 600 17 00 (Fax) +31 (30) 600 17 99 info@rsn.rohde-schwarz.com	<b>Saudi Arabia</b>	Gentec Haji Abdullah Alireza & Co. Ltd. P.O.Box 43054 Riyadh	(Tel) +966 (1) 293 20 35 (Fax) +966 (1) 466 16 57 akanbar@gentec.com.sa
<b>New Zealand</b>	Nichecom 1 Lincoln Ave. Tawa, Wellington	(Tel) +64 (4) 232 32 33 (Fax) +64 (4) 232 32 30 rob@nichecom.co.nz	<b>Serbia-Montenegro</b>	Rohde & Schwarz Representative Office Belgrade Tose Jovanovica 7 11030 Beograd	(Tel) +381 (11) 305 50 25 (Fax) +381 (11) 305 50 24 rs-scg@rscs.rohde-schwarz.com
<b>Nicaragua</b>	siehe/see Mexico		<b>Singapore</b>	Rohde & Schwarz Regional Headquarters Singapore Pte. Ltd. 1 Kaki Bukit View #05-01/02 Techview Singapore 415 941	(Tel) +65 68 46 18 72 (Fax) +65 68 46 12 52
<b>Nigeria</b>	Ferrostaal Abuja Plot 3323, Barada Close P.O.Box 8513, Wuse Off Amazon Street Maitama, Abuja	(Tel) +234 (9) 413 52 51 (Fax) +234 (9) 413 52 50 fsabuja@rosecom.net		Rohde & Schwarz Systems & Communications Asia Pte Ltd Service 1 Kaki Bukit View #04-01/07 Techview Singapore 415 941	(Tel) +65 68 46 37 10 (Fax) +65 68 46 00 29 info@rssg.rohde-schwarz.com
<b>Norway</b>	Rohde & Schwarz Norge AS Enebakkeveien 302 B 1188 Oslo	(Tel) +47 (23) 38 66 00 (Fax) +47 (23) 38 66 01 firmapost@rsnor.rohde-schwarz.com	<b>Slovak Republic</b>	Specialne systémy a software, a.s. Svrčia ul. 3 841 04 Bratislava 4	(Tel) +421 (2) 65 42 24 88 (Fax) +421 (2) 65 42 07 68 3s@special.sk
<b>Oman</b>	Mustafa Sultan Science & Industry Co.LLC. Test & Measurement Products Way No. 3503 Building No. 241 Postal Code 112 Al Khuwair, Muscat	(Tel) +968 63 60 00 (Fax) +968 60 70 66 m-aziz@mustafasultan.com	<b>Slovenia</b>	Rohde & Schwarz Representative Office Ljubljana Tbilisjska 89 1000 Ljubljana	(Tel) +386 (1) 423 46 51 (Fax) +386 (1) 423 46 11 rs-slovenia@rssi.rohde-schwarz.com
<b>Pakistan</b>	Siemens Pakistan 23, West Jinnah Avenue Islamabad	(Tel) +92 (51) 227 22 00 (Fax) +92 (51) 227 54 98 reza.bokhary@siemens.com.pk	<b>South Africa</b>	Protea Data Systems (Pty.) Ltd. Communications and Measurement Division Private Bag X19 Bramley 2018	(Tel) +27 (11) 719 57 00 (Fax) +27 (11) 786 58 91 unicm@protea.co.za
<b>Panama</b>	siehe/see Mexico			Protea Data Systems (Pty.) Ltd. Cape Town Branch Unit G9, Centurion Business Park Bosmandam Road Milnerton Cape Town, 7441	(Tel) +27 (21) 555 36 32 (Fax) +27 (21) 555 42 67 unicm@protea.co.za
<b>Papua New Guinea</b>	siehe/see Australia		<b>Spain</b>	Rohde & Schwarz Espana S.A. Salcedo, 11 28034 Madrid	(Tel) +34 (91) 334 10 70 (Fax) +34 (91) 729 05 06 rses@rses.rohde-schwarz.com
<b>Paraguay</b>	siehe/see Argentina			Rohde & Schwarz Espana S.A. Av. Príncipe d'Astúries, 66 08012 Barcelona	(Tel) +34 (93) 415 15 68 (Fax) +34 (93) 237 49 95 bcn@rses.rohde-schwarz.com
<b>Philippines</b>	Rohde & Schwarz (Philippines) Inc. Unit 2301, PBCOM Tower 6795, Ayala Ave. cor. Herrera St. Makati City	(Tel) +63 (2) 753 14 44 (Fax) +63 (2) 753 14 56	<b>Sri Lanka</b>	Dynatel Communications (PTE) Ltd. 451/A Kandy Road Kelaniya	(Tel) +94 (112) 90 80 01 (Fax) +94 (112) 91 04 69 69 dynatel@dyanet.lk
<b>Poland</b>	Rohde & Schwarz SP.z o.o. Przedstawicielstwo w Polsce ul. Stawki 2, Pietro 28 00-193 Warszawa	(Tel) +48 (22) 860 64 94 (Fax) +48 (22) 860 64 99 rs-poland@rspl.rohde-schwarz.com	<b>Sudan</b>	SolarMan Co. Ltd. P.O.Box 11 545 North of Fraouq Cementry 6/7/9 Bldg. 16 Karthoum	(Tel) +249 (183) 47 31 08 (Fax) +249 (183) 47 31 38 solarman29@hotmail.com
<b>Portugal</b>	Rohde & Schwarz Portugal, Lda. Alameda Antonio Sergio 7-R/C - Sala A 2795-023 Linda-a-Velha	(Tel) +351 (21) 415 57 00 (Fax) +351 (21) 415 57 10 info@rspt.rohde-schwarz.com	<b>Sweden</b>	Rohde & Schwarz Sverige AB Flygfältsgatan 15 128 30 Skarpnäck	(Tel) +46 (8) 605 19 00 (Fax) +46 (8) 605 19 80 info@rss.rohde-schwarz.com
<b>Republic Dominican</b>	siehe/see Mexico		<b>Switzerland</b>	Roschi Rohde & Schwarz AG Mühlestr. 7 3063 Ittigen	(Tel) +41 (31) 922 15 22 (Fax) +41 (31) 921 81 01 support@roschi.rohde-schwarz.com
<b>Romania</b>	Rohde & Schwarz Representation Office Bucharest 89 Eroii Sanitari Bldv., sector 5 050472 Bucuresti	(Tel) +40 (21) 411 20 13 (Fax) +40 (21) 410 68 46 rs-romania@rsro.rohde-schwarz.com	<b>Syria</b>	Electro Scientific Office Baghdad Street Dawara Clinical Lab. Bldg P.O.Box 8162 Damascus	(Tel) +963 (11) 231 59 74 (Fax) +963 (11) 231 88 75 memo@hamshointl.com
<b>Russian Federation</b>	Rohde & Schwarz International GmbH 119180, Yakimanskaya nab., 2 Moscow	(Tel) +7 (095) 745 88 50 to 53 (Fax) +7 (095) 745 88 54 rs-russia@rsru.rohde-schwarz.com			
<b>Saudi Arabia</b>	Rohde & Schwarz International GmbH - Liaison Office Riyadh c/o Haji Abdullah Alireza Co. Ltd. P.O.Box 361 Riyadh 11411	(Tel) +966 (1) 293 2035 (Fax) +966 (1) 466 1657 chris.porzky@rsd.rohde-schwarz.com			

# Adressen/Addresses

<b>Taiwan</b>	Rohde & Schwarz Taiwan (Pvt.) Ltd. Floor 14, No. 13, Sec. 2, Pei-Tou Road Taipei 112	(Tel) +886 (2) 28 93 10 88 (Fax) +886 (2) 28 91 72 60 celine.tu@rstw.rohde-schwarz.com	<b>United Kingdom</b>	Rohde & Schwarz UK Ltd. 3000 Manchester Business Park Aviator Way Manchester M22 5TG	(Tel) +44 (870) 735 16 42 (Fax) +44 (1252) 81 14 77 sales@rsuk.rohde-schwarz.com
<b>Tanzania</b>	SSTL Group P.O. Box 7512 Dunga Street Plot 343/345 Dar Es Salaam	(Tel) +255 (22) 276 00 37 (Fax) +255 (22) 276 02 93 sstl@ud.co.tz	<b>Uruguay</b>	Aeromarine S.A. Cerro Largo 1497 11200 Montevideo	(Tel) +598 (2) 400 39 62 (Fax) +598 (2) 401 85 97 cs@aeromarine.com.uy
<b>Thailand</b>	Rohde & Schwarz International Thailand 2nd floor Gems Tower Bangrak, Suriyawong Bangkok 10600	(Tel) +66 (2) 200 07 29 (Fax) +66 (2) 267 00 79	<b>USA</b>	Rohde & Schwarz, Inc. Eastern Regional Office (US Headquarters) 8661A Robert Fulton Drive Columbia, MD 21046-2265	(Tel) +1 (410) 910 78 00 (Fax) +1 (410) 910 78 01 info@rsa.rohde-schwarz.com
	Schmidt Electronics (Thailand) Ltd. Messtechnik 202 Le Concorede Tower, 23rd Fl. Ratchadaphisek Rd. Huay kwang Bangkok 10320	(Tel) +66 (2) 69 41 47 05 (Fax) +66 (2) 69 41 47 06 salestm@schmidtelectronics.com		Rohde & Schwarz, Inc. Central Regional Office / Systems & EMI Products 8080 Tristar Drive Suite 120 Irving, TX 75063	(Tel) +1 (469) 713 53 00 (Fax) +1 (469) 713 53 01 info@rsa.rohde-schwarz.com
	TPP Operation Co. Ltd. Kommunikationstechnik 41/5 Mooban Tarinee Boromrajchonnee Road Talingchan Bangkok 10170	(Tel) +66 (2) 880 93 47 (Fax) +66 (2) 880 93 47		Rohde & Schwarz, Inc. R&D and Application Support 8905 SW Nimbus Ave Suite 240 Beaverton, OR 97008	(Tel) +1 (503) 403 47 00 (Fax) +1 (503) 403 47 01 info@rsa.rohde-schwarz.com
<b>Trinidad &amp; Tobago</b>	siehe/see Mexico	(Tel) (Fax)		Rohde & Schwarz, Inc. Western Regional Office 7700 Irvine Center Drive Suite 100 Irvine, CA 92618	(Tel) +1 (949) 885 70 00 (Fax) +1 (949) 885 70 01 info@rsa.rohde-schwarz.com
<b>Tunisia</b>	Teletek 71, Rue Alain Savary Residence Alain Savary (C64) Cit� el Khadra 1003 Tunis	(Tel) +216 (71) 77 33 88 (Fax) +216 (71) 77 05 53 teletek@gnet.tn		Rohde & Schwarz, Inc. Service & Calibration Center 8661A Robert Fulton Drive Columbia, MD 21046-2265	(Tel) +1 (410) 910 50 02 (Fax) +1 (410) 910 79 31 service.rsa@rsa.rohde-schwarz.com
<b>Turkey</b>	Rohde & Schwarz International GmbH Liaison Office Istanbul Bagdat Cad. 191/3, Arda Apt. B-Blok 81030 Selamicesme-Istanbul	(Tel) +90 (216) 385 19 17 (Fax) +90 (216) 385 19 18 nadir.guerelman@rsd.rohde-schwarz.com	<b>Vietnam</b>	Rohde & Schwarz Representative Office Vietnam Unit 807, 8/F, Schmidt Tower 239 Xuan Thuy Road Cau Giay District Hanoi	(Tel) +84 (4) 834 20 46
<b>Ukraine</b>	Rohde & Schwarz Representative Office Kiev 4, Patris Loumoumba ul. 01042 Kiev	(Tel) +38 (044) 268 60 55 (Fax) +38 (044) 268 83 64 rsbkiev@public.ua.net	<b>West Indies</b>	siehe/see Mexico	
<b>United Arab Emirates</b>	Rohde & Schwarz International GmbH Liaison Office Middle East Vertrieb P.O. Box 31156 Abu Dhabi	(Tel) +971 (2) 6335 670 (Fax) +971 (2) 6335 671 Dario Barisoni@rsd.rohde-schwarz.com			
	Rohde & Schwarz Bick Mobile Communication P.O.Box 17466 JAFZ, PPU ZG-07 Dubai	(Tel) +971 (4) 883 71 35 (Fax) +971 (4) 883 71 36			
	Rohde & Schwarz Emirates L.L.C. ESNAAD Premisses at Mussafah, P.O.Box 31156 Abu Dhabi	(Tel) +971 (2) 55 49 411 (Fax) +971 (2) 55 49 433 rsuaeam@emirates.net.ae			
<b>United Kingdom</b>	Rohde & Schwarz UK Ltd. Ancells Business Park Fleet Hampshire GU51 2UZ	(Tel) +44 (1252) 81 88 88 (sales)+44 (1252) 81 88 18 (service) (Fax) +44 (1252) 81 14 47 sales@rsuk.rohde-schwarz.com			





# Contents of Manuals for Signal Analyzer FSIQ

## Operating Manual FSIQ

The operating manual describes the following models and options:

- FSIQ3 20 Hz to 3,5 GHz
- FSIQ7 20 Hz to 7 GHz
- FSIQ3 20 Hz to 26,5 GHz
- FSIQ40 20 Hz to 40 GHz
  
- Option FSE-B8/9/10/11 Tracking Generator
- Option FSE-B13 1-dB Attenuator
- Option FSE-B15 Ethernet Adapter
- Option FSE-B17 Second IEC/IEEE Bus Interface
- Option FSIQ-B70 DSP and IQ Memory Extension

Option FSE-B21, External Mixer Output, is described in a separate manual.

The present operating manual contains comprehensive information about the technical data of the instrument, the setup and putting into operation of the instrument, the operating concept and controls as well as the operation of the FSIQ via the menus and via remote control. Typical measurement tasks for the FSIQ are explained using the functions offered by the menus and a selection of program examples.

In addition the operating manual gives information about maintenance of the instrument and about error detection listing the error messages which may be output by the instrument. It is subdivided into the data sheet plus 9 chapters:

- |                       |   |
|-----------------------|---|
| <b>The data sheet</b> | informs about guaranteed specifications and characteristics of the instrument.  |
| <b>Chapter 1</b>      | describes the control elements and connectors on the front and rear panel as well as all procedures required for putting the FSIQ into operation and integration into a test system.  |
| <b>Chapter 2</b>      | gives an introduction to typical measurement tasks of the FSIQ which are explained step by step.  |
| <b>Chapter 3</b>      | describes the operating principles, the structure of the graphical interface and offers a menu overview.  |
| <b>Chapter 4</b>      | forms a reference for manual control of the FSIQ and contains a detailed description of all instrument functions and their application.   |
| <b>Chapter 5</b>      | describes the basics for programming the FSIQ, command processing and the status reporting system.  |
| <b>Chapter 6</b>      | lists all the remote-control commands defined for the instrument. At the end of the chapter a alphabetical list of commands and a table of softkeys with command assignment is given. |
| <b>Chapter 7</b>      | contains program examples for a number of typical applications of the FSIQ.   |
| <b>Chapter 8</b>      | describes preventive maintenance and the characteristics of the instrument's interfaces.  |
| <b>Chapter 8</b>      | gives a list of error messages that the FSIQ may generate.  |
| <b>Chapter 9</b>      | contains a list of error messages.  |
| <b>Chapter 10</b>     | contains an index for the operating manual.   |

**Service Manual - Instrument**

The service manual - instrument informs on how to check compliance with rated specifications (performance test) and on the self tests.

**Service Manual**

The service manual is not delivered with the instrument but may be obtained from your R&S service department using the order number 1065.6016.24.

The service manual informs on instrument function, repair, troubleshooting and fault elimination. It contains all information required for the maintenance of FSIQ by exchanging modules. It contains information about the individual modules of FSIQ. This comprises the test and adjustment of the modules, fault detection within the modules and the interface description.

# Contents - Chapter 1 " Preparing for Operation "

## 1 Preparing for Operation

<b>Description of Front and Rear Panel Views .....</b>	<b>1.1</b>
Front View.....	1.1
Rear View .....	1.13
<b>Start-Up.....</b>	<b>1.20</b>
Unpacking the Instrument.....	1.20
Instrument Setup .....	1.20
Stand-alone Operation .....	1.20
19" Rack Installation.....	1.21
EMI Protection Measures .....	1.21
Connecting to AC Power .....	1.21
AC Power Line Fuses.....	1.21
Instrument On/Off.....	1.21
Battery-Powered Memory .....	1.22
<b>Functional Test .....</b>	<b>1.22</b>
<b>Controller Function.....</b>	<b>1.23</b>
<b>Connecting a Mouse.....</b>	<b>1.24</b>
<b>Connecting an External Keyboard .....</b>	<b>1.25</b>
<b>Connecting an External Monitor .....</b>	<b>1.26</b>
<b>Connecting an Output Device .....</b>	<b>1.28</b>
<b>Connecting a CD-ROM Drive .....</b>	<b>1.34</b>
<b>Firmware Update.....</b>	<b>1.36</b>
<b>Installing Windows NT Software .....</b>	<b>1.37</b>
<b>Options .....</b>	<b>1.38</b>
Option FSE-B17 – Second IEC/IEEE Interface .....	1.38
Installing the software.....	1.38
Operation.....	1.40
Option FSE-B5 - FFT Filter.....	1.41
Prerequisites .....	1.41
Enabling the option.....	1.41
Option FSE-B16 – Ethernet Adapter .....	1.42
Hardware Installation.....	1.42
Software Installation .....	1.43
Operation.....	1.47
NOVELL .....	1.47
MICROSOFT .....	1.47
Option FSIQB70 - DSP and IQ Memory Extension (2 X 512 K).....	1.54



# 1 Preparing for Operation

Chapter 1 describes the controls and connectors of the Spectrum Analyzer FSIQ by means of the front and rear view. Then follows all the information that is necessary to put the instrument into operation and connect it to the AC supply and to external devices.

A more detailed description of the hardware connectors and interfaces can be found in chapter 8. Chapter 2 provides an introduction into the operation of the FSIQ by means of typical examples of configuration and measurement; for the description of the concept for manual operation and an overview of menus refer to chapter 3.

For a systematic explanation of all menus, functions and parameters and background information refer to the reference part in chapter 4.

For remote control of the FSIQ refer to the general description of the SCPI commands, the instrument model, the status reporting system, and command description in chapter 5 and 6.

## Description of Front and Rear Panel Views

### Front View

**1**

Display Screen

|| see Chap. 3 and 4

**2**

Softkeys

|| see Chap. 3 and 4

### **3 USER**



Generate macros

|| see Chap. 4

### **4 MARKER**

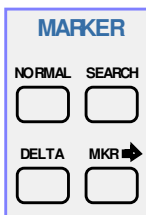

Select and set marker

|| see Chap. 4

NORMAL Select and set the marker

SEARCH Set and start the peak/min search

DELTA Select and set the delta markers

MKR ⇒ Set the active marker

### **5 FREQUENCY**

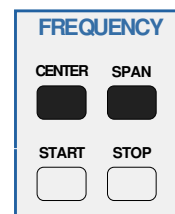

Define frequency axis in the active window

|| see Chap. 4

CENTER Set center frequency.

SPAN Set sweep width

START Set start frequency

STOP Set stop frequency

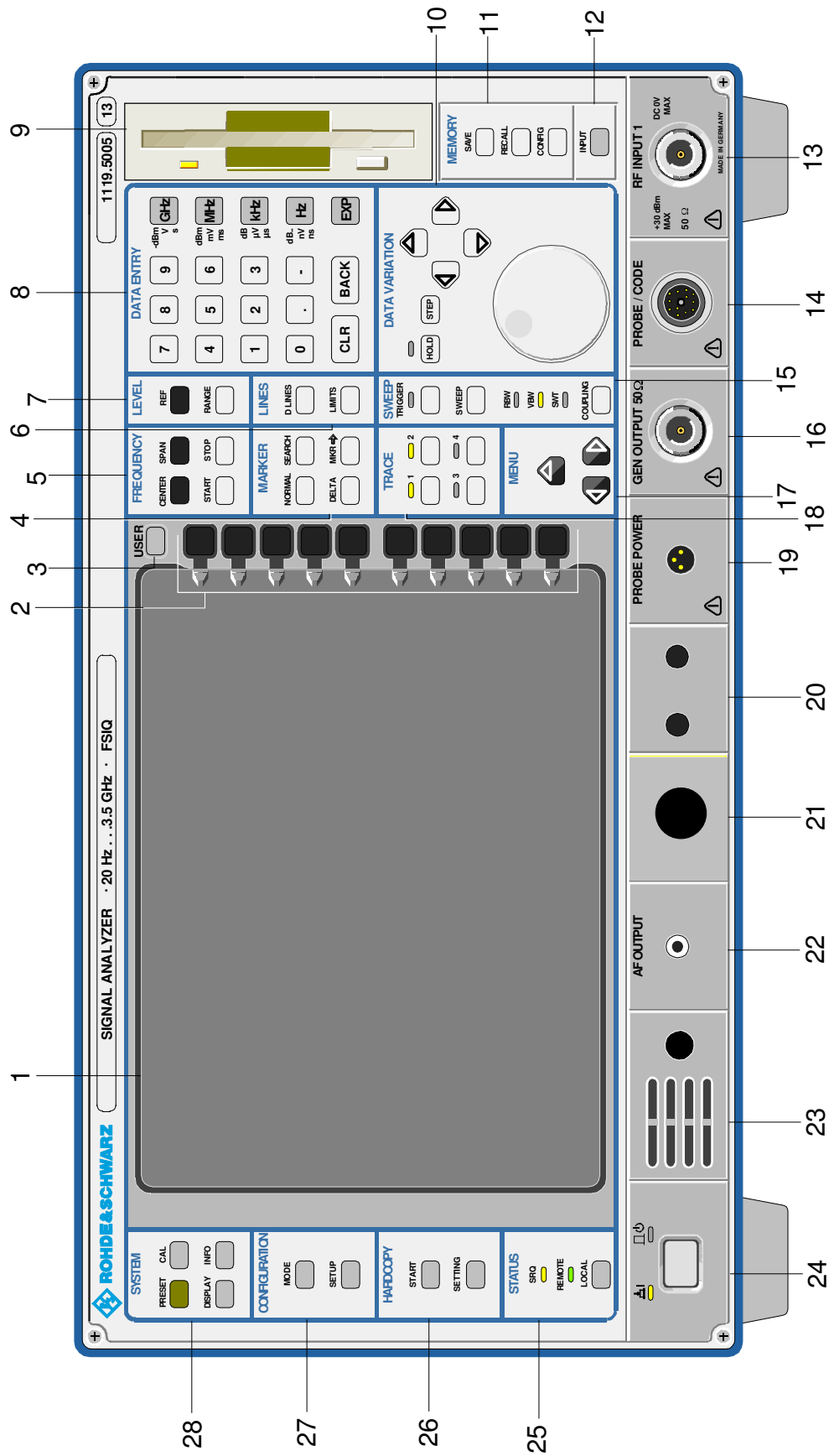
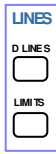

Fig. 1-1 Front View

**6 LINES**



Setup evaluation lines and tolerance limits  
 D LINES Setup evaluation lines (display lines)  
 LIMITS Definition and recall of tolerance limits

see Chap. 4

**7 LEVEL**

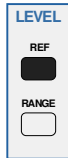

Define reference levels and display range in the active measurement window.  
 REF Set reference level (= max. display level)  
 RANGE Set range

see Chap. 4

**8 DATA ENTRY**

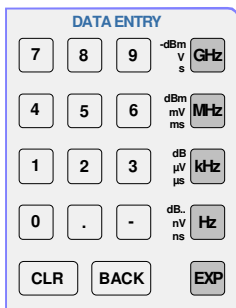

Keypad for data input  
 0...9 input numbers  
 . input decimal point  
 - change sign  
 CLR – close input field (for uncompleted or already closed inputs, the original entry is kept)  
 – erase the current entry in input field (beginning of an input)  
 – close message window (status, error and warning messages)  
 BACK erase last character input  
 GHz The units keys close the data input and define the multiplication factor for each basic unit.  
 -dBm V s  
 MHz dBm For dimension-less or alphanumeric inputs, the units keys have weight 1.  
 mV ms  
 kHz dB They behave, in this case, like the ENTER key.  
 μV μs  
 Hz dB  
 nV ns  
 EXP Append an exponent

see Chap. 3



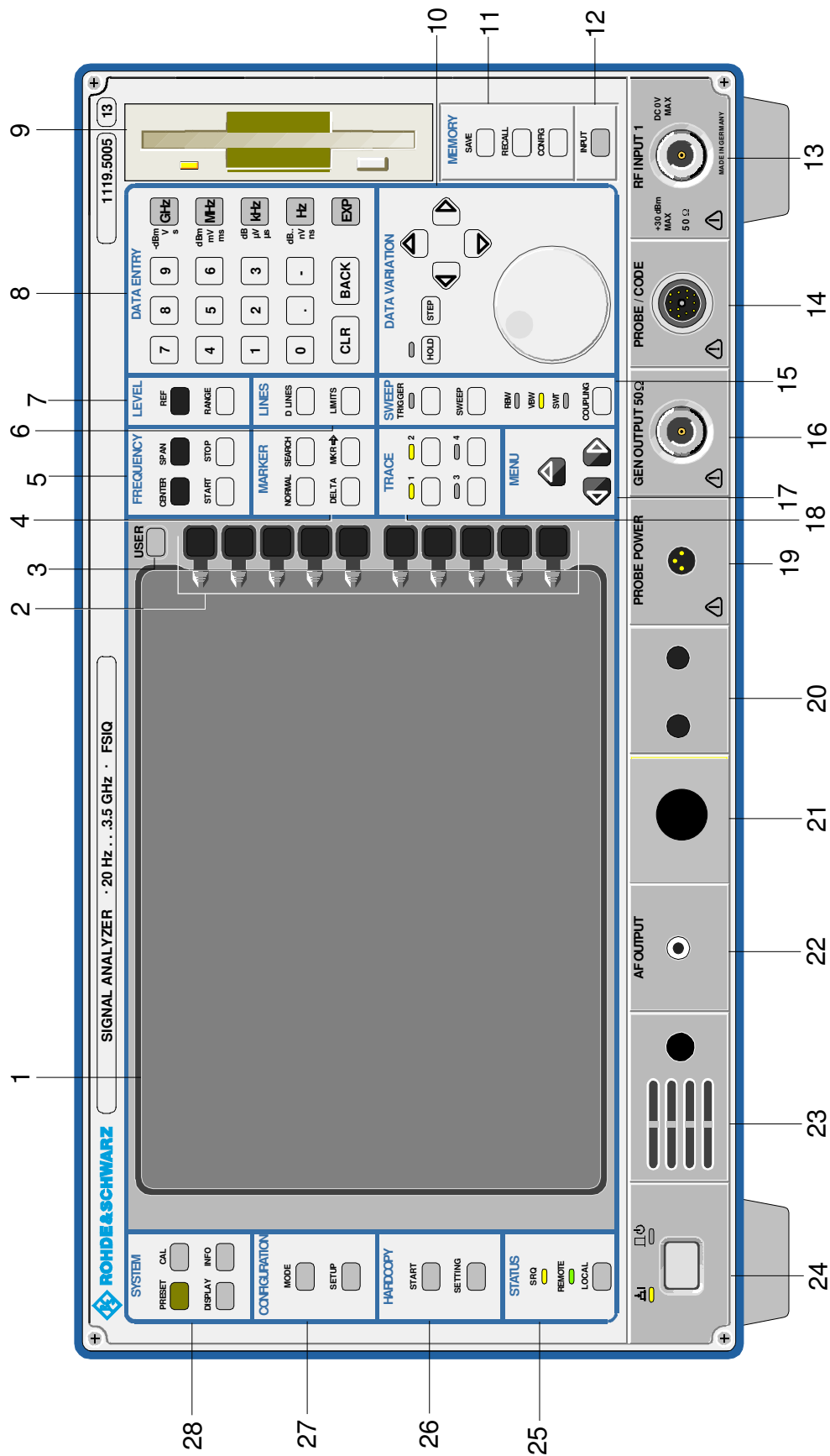
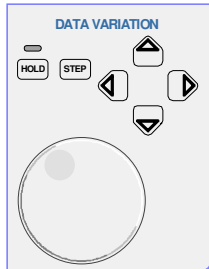

Fig. 1-1 Front View

9

3 1/2" diskette drive; 1.44 MByte

10 DATA VARIATION



Key group for entering data and for cursor movement

**HOLD** Disable control elements / overall control. The LED indicates the hold condition.

**STEP** Set step size for cursor keys and roll-key.

**Cursor keys** – Move the cursor within the input fields and tables.  
 – Vary the input value.  
 – Define the direction of movement for the roll-key.

**Roll-key** – Vary input values.  
 – Move markers and limits.  
 – Select letters in the help line editor.  
 – Move cursor in the tables

see Chap. 3

11 MEMORY

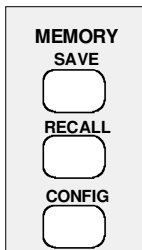

Memory media and file management

**SAVE** Save instrument data

**RECALL** Recall instrument data

**CONFIG** Configuration of memory media and data

see Chap. 4

12 INPUT

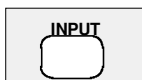

Set impedance and attenuation at the RF input.

see Chap. 4

13 RF INPUT 1

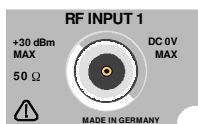

RF-Input 1



**Caution:**  
 The maximum DC voltage is 0 V, the maximum power is 1 W ( $\hat{=} 30$  dBm at  $\geq 10$  dB attenuation)

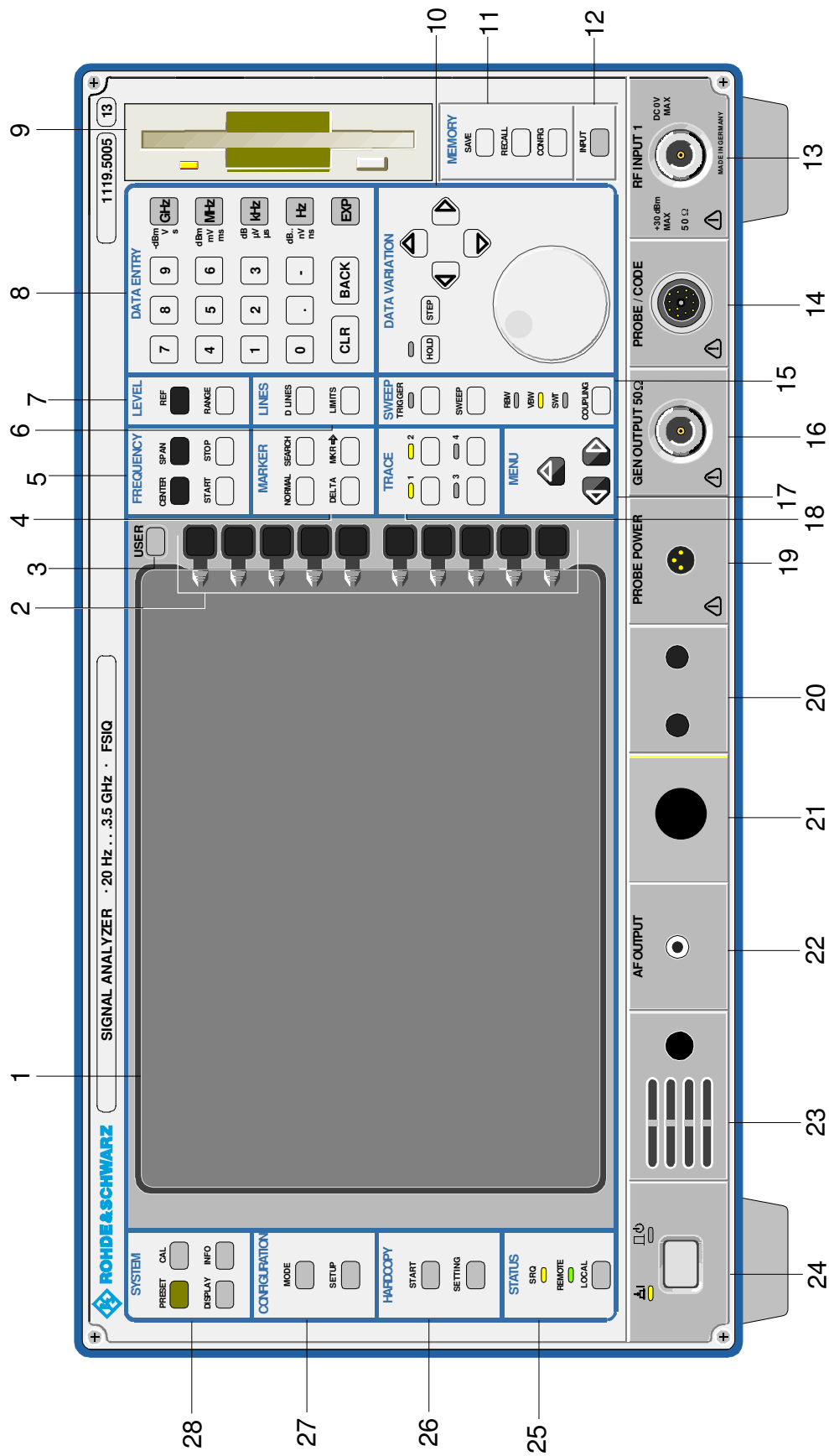

Fig. 1-1 Front View

**14 PROBE/CODE**



Power supply and coded socket for R&S accessories.(12-pin Tuchel)

**15 SWEEP**



Input sweep parameters

**TRIGGER** Set trigger source. The LED illuminates on valid trigger.

**SWEEP** Define the sweep mode parameters.

**COUPLING** Set coupled parameters. Resolution BandWidth (RBW), Video BandWidth (VBW) and SWEEP Time (SWT). The LEDs light indicating coupled parameters which are manually cancelled.

see Chap. 4

**16 GEN OUTPUT 50Ω**

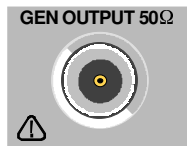



Generator output; N-connector

**17 MENU**



Menu-change keys

 Call main menu

 Change to left menu

 Change to right menu

see Chap. 3

**18 TRACE**

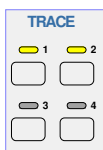

Select and activate measurement traces (Trace 1...4).  
The LEDs indicate traces turned on.

see Chap. 4

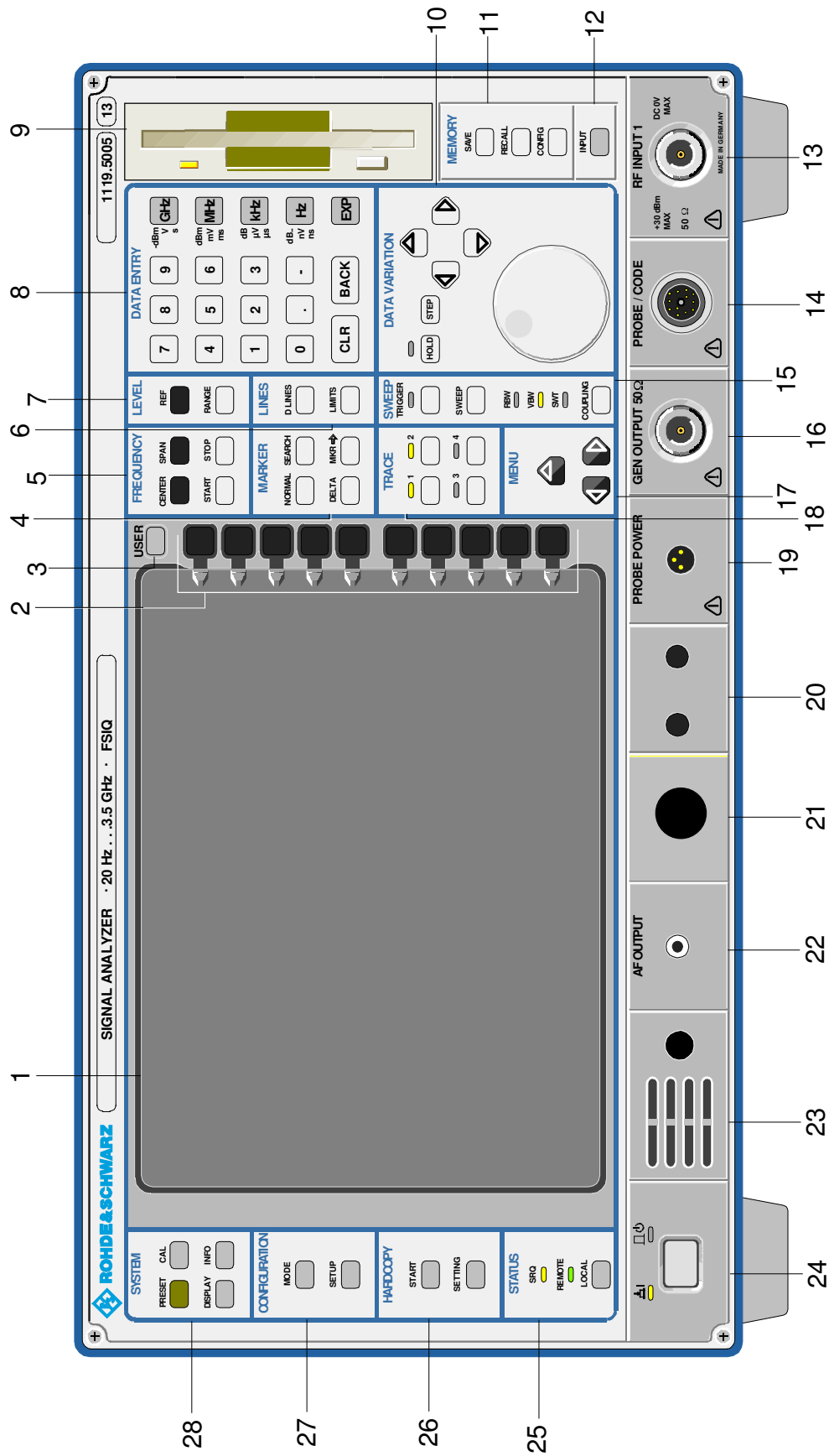

Fig. 1-1 Front View

**19 PROBE POWER**

Power supply connector (+15V / - 12.6V) for measurement accessories (probes)

see Chap. 8

**20**

Reserved for options

**21**

Reserved for options

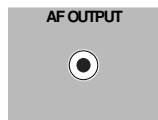
**22 AF OUTPUT**

AF output connector (head phones) (miniature phone jack)

see Chap. 8

**23**

Internal loudspeaker

The loudspeaker is disabled when the phone jack is inserted in the AF output.

see Chap. 8

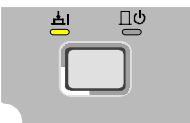
**24**

ON/STANDBY-switch

**Caution:**

*In standby mode, the AC line voltage is still present within the instrument.*

see Chap. 1

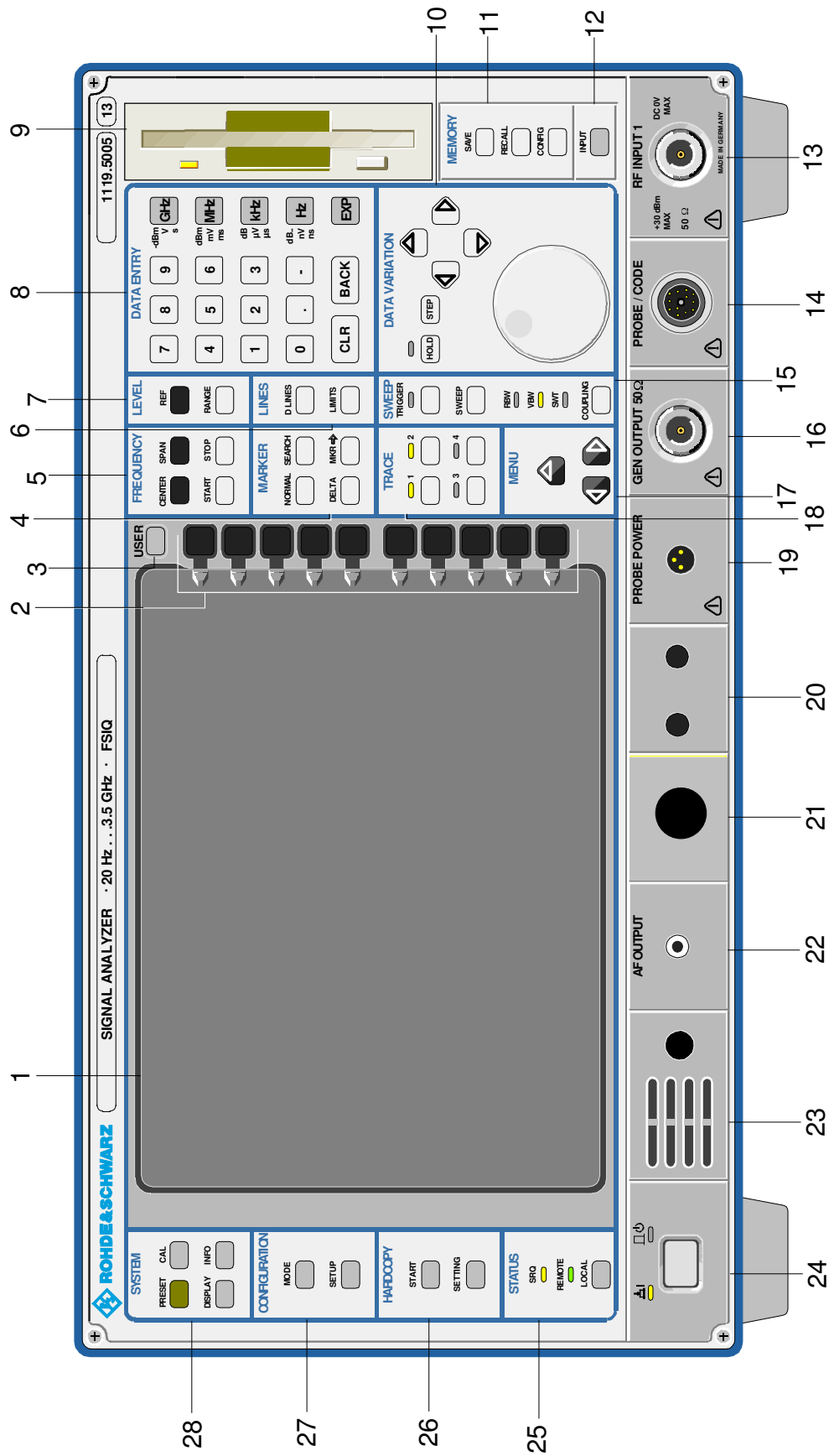
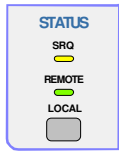

Fig. 1-1 Front View

**25 STATUS**



Indicators for remote control and switch for manual control.

see Chap. 4 and Chap. 5

**LOCAL** Switch from remote to manual control.  
 The LED SRQ indicates that a service request from the instrument is active on the IEC Bus.  
 The LED REMOTE indicates that the instrument is under remote control.

**26 HARDCOPY**



Printer control

see Chap. 4

**START** Start a print job with the setup defined in the SETTING menu.  
**SETTING** Configure the diagram, parameter list and measurement protocol outputs on the various output media.

**27 CONFIGURATION**

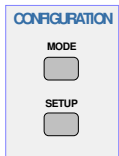

Select operational modes and define default settings

see Chap. 1 and Chap. 4

**MODE** Select mode  
**SETUP** Define configurations

**28 SYSTEM**

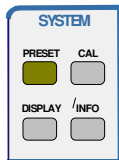

General instrument default settings

see Chap. 4

**PRESET** Recall instrument default settings  
**DISPLAY** Configure the display screen format  
**CAL** Calibrate the analyzer  
**INFO** – Information concerning instrument state and measurement parameters  
 – Call help functions



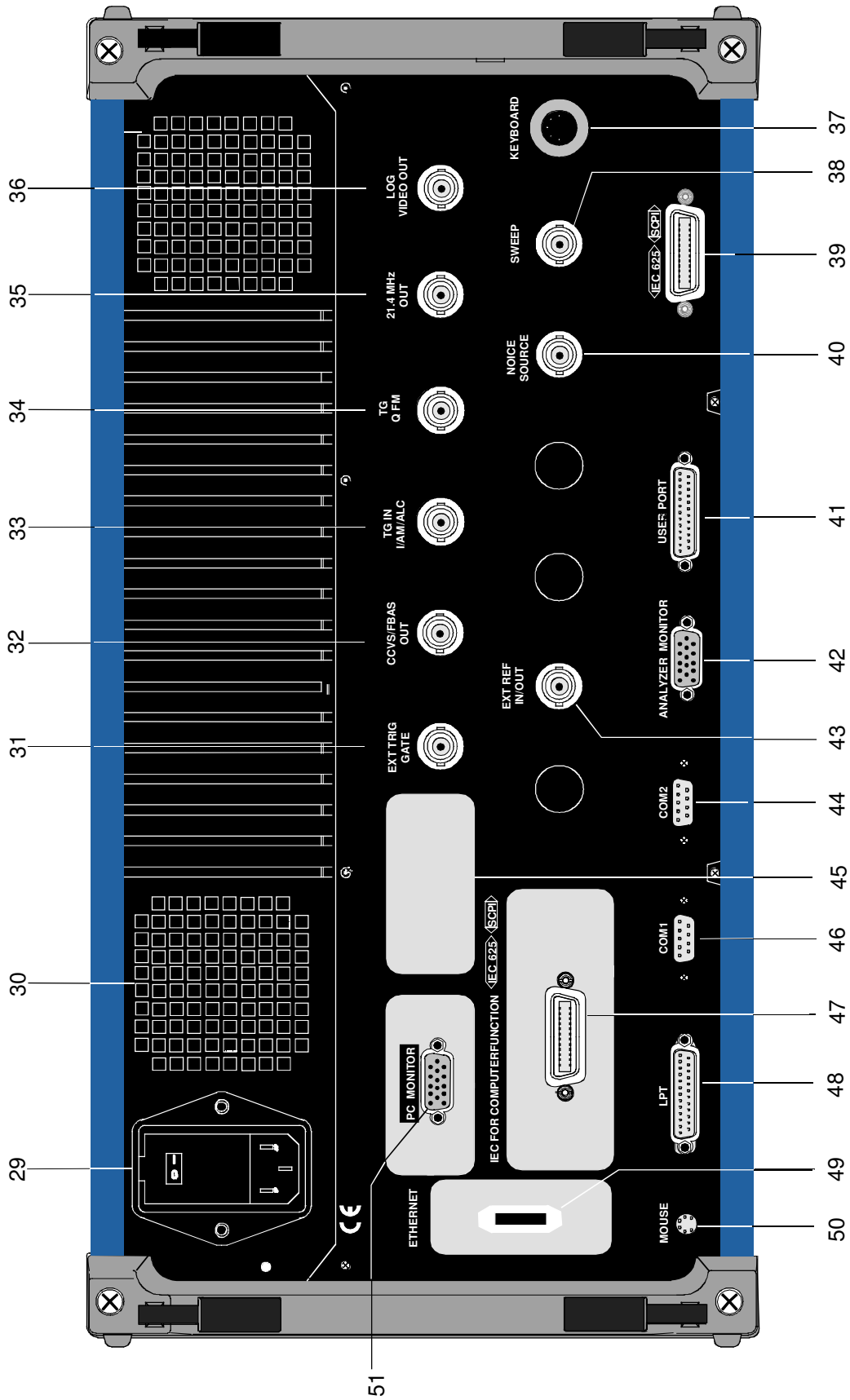
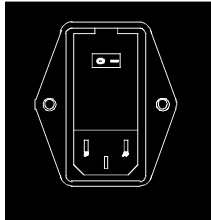

Fig. 1-2 Rear View

## Rear View

29



Power switch

see Chap. 1

Fuse holder

AC power connector

30

Power supply fans

## 31 EXT TRIG/GATE



Input connector for an external trigger or an external gate signal

see Chap. 2  
and  
Chap. 8

## 32 CCVS/FBAS OUT



Connector for external CCVS/FBAS monitor

see Chap. 8

## 33 TG IN I/AM/ALC



Signal input connector for external modulation of Tracking Generator (options FSE-B9 and FSE-B11)

see Chap. 8

## 34 TG IN Q/FM



Signal input connector for external modulation of Tracking Generator (options FSE-B9 and FSE-B11)

see Chap. 8

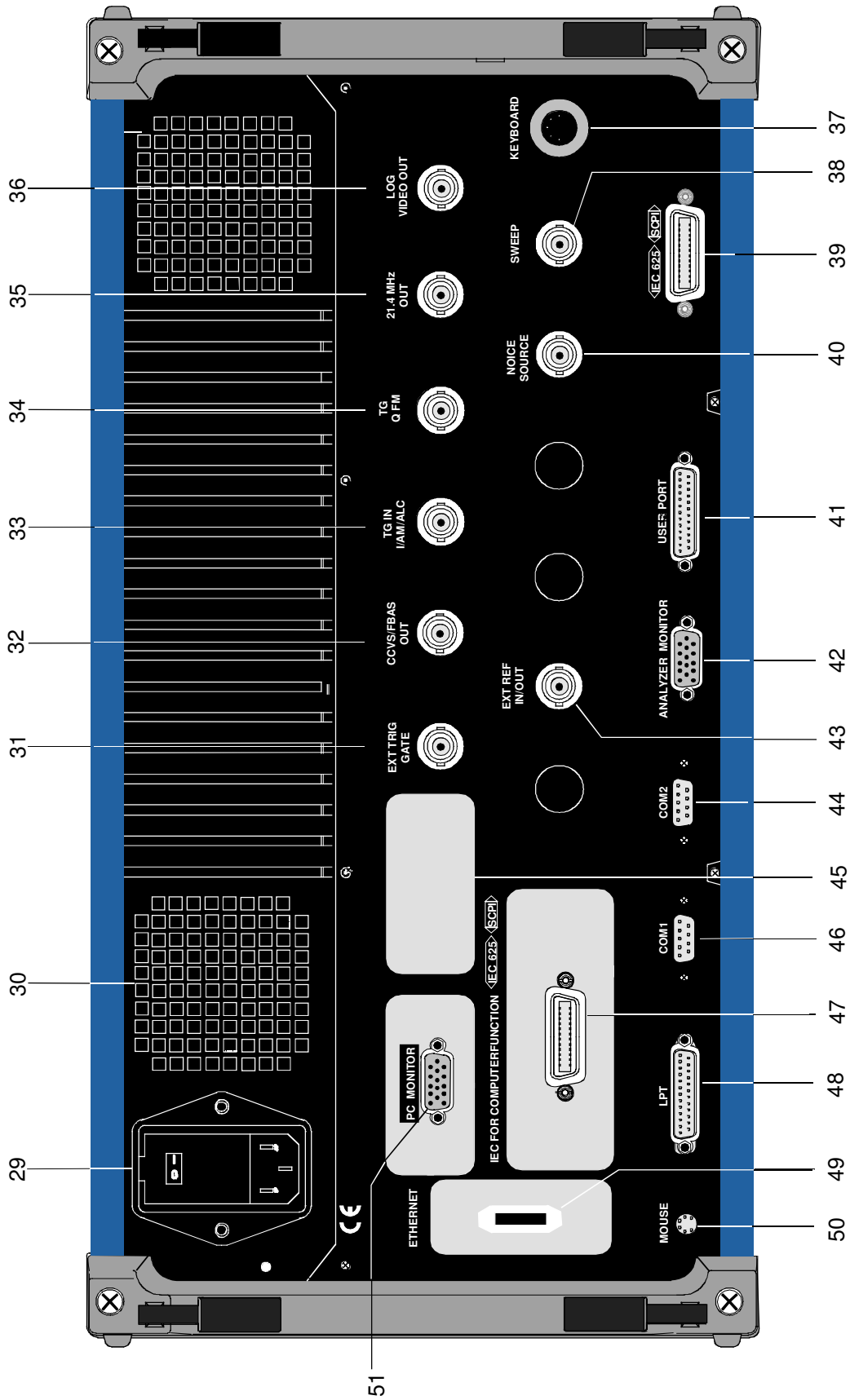

Fig. 1-2 Rear View

**35 21.4 MHZ OUT**

Output connector for 21.4 MHz IF

see Chap. 8

**36 LOG VIDEO OUT**

Output connector for a switchable noise source

see Chap. 8

**37 KEYBOARD**

Connector for an external keyboard  
(5-pin DIN socket)

see Chap. 1  
and  
Chap. 8

**38 SWEEP**

Output connector  
During a sweep, a sawtooth voltage is output which is  
proportional to frequency.

see Chap. 8

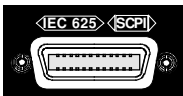
**39 <SCPI> IEC625**

IEC Bus-connector

see Chap. 8

**40 NOISE SOURCE**

Output connector for a switchable noise source

see Chap. 8

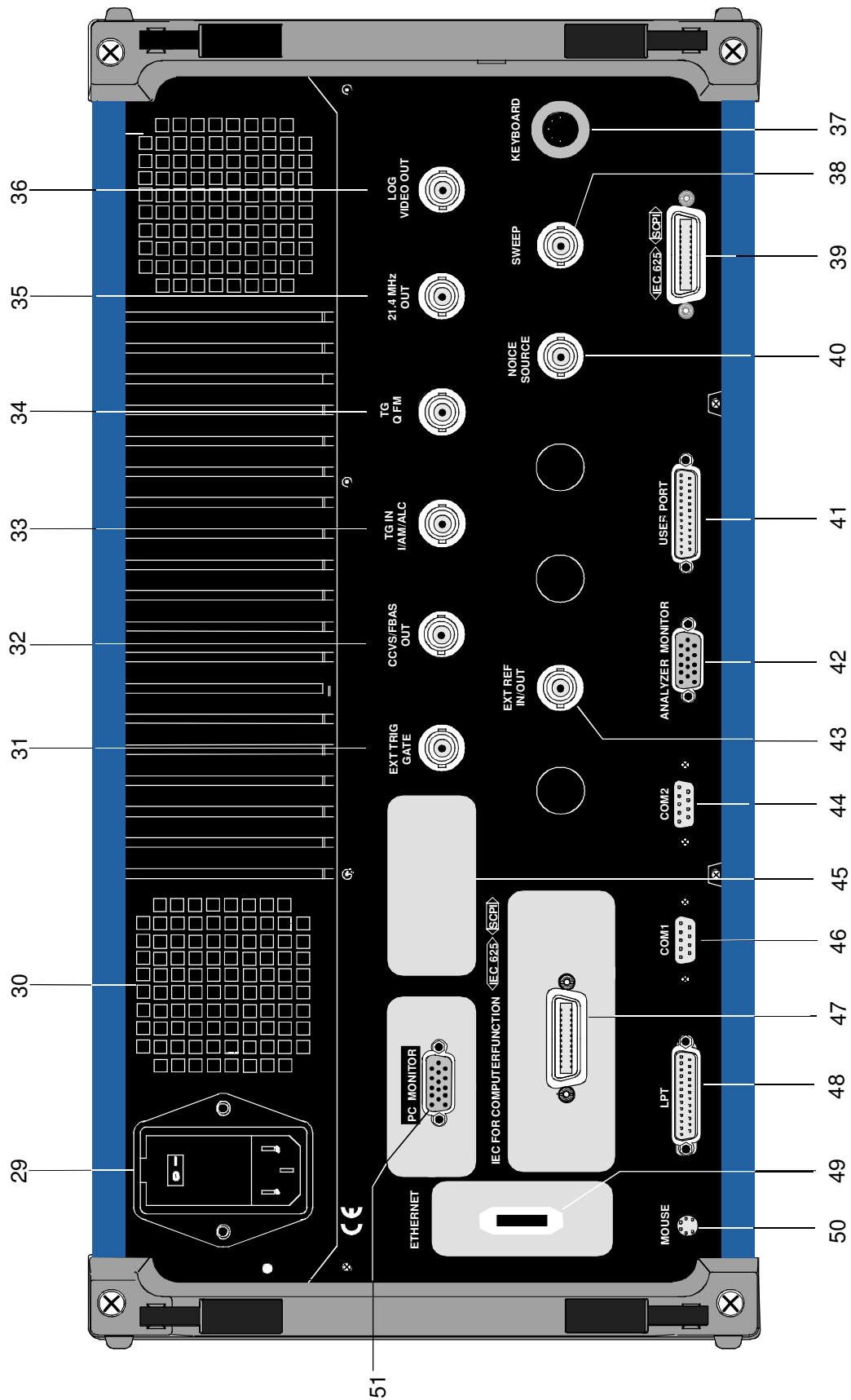
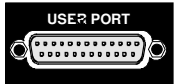

Fig. 1-2 Rear View

**41 USER**

User interface connector with configurable inputs and outputs (USER-PORT A and USER-PORT B)

see Chap. 8

**42 ANALYZER MONITOR**

Connector for an external VGA monitor

see Chap. 8

**43 EXT REF IN/OUT**

Input for external reference frequency (1 MHz to 16 MHz), can be switched to output 10 MHz.

see Chap. 4  
and  
Chap. 8

**44 COM2**

Connector for serial interface 2 (9-pin socket; COM2)

see Chap. 1  
and  
Chap. 8

**45**

Inputs / Outputs for options  
(cover plates for digital interface expansion)

**46 COM1**

Connector for serial interface 1 (9-pin socket; COM1)

see Chap. 1  
and  
Chap. 8

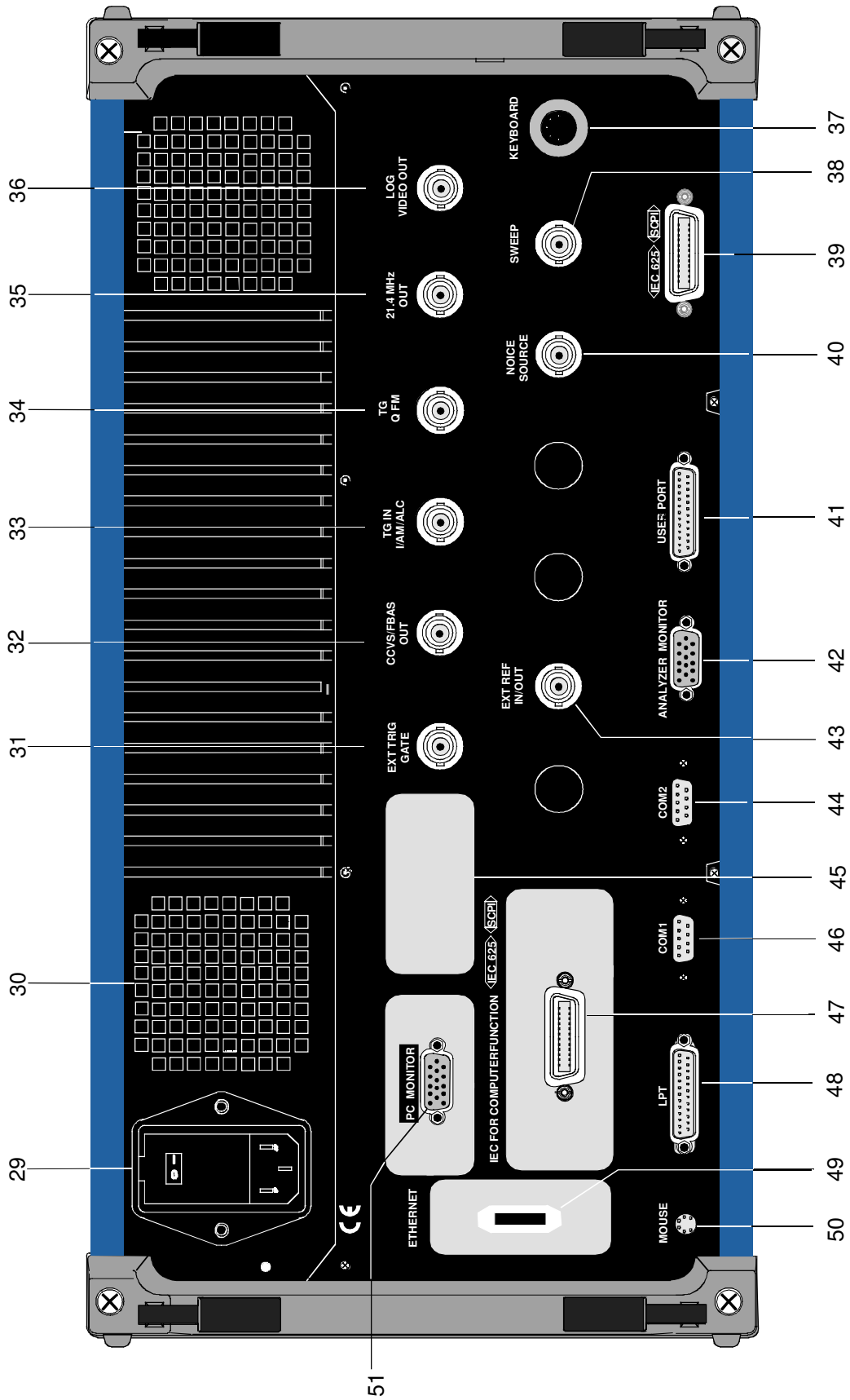
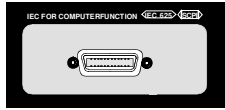
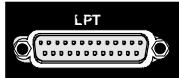

Fig. 1-2 Rear View

**47 IEC FOR COMPUTER FUNCTION <SCPI> IEC625**

IEC Bus-connector for computer function  
(option FSE-B16)

see Chap. 1  
and  
Chap. 8

**48 LPT**

Parallel interface connector  
(printer connector, Centronics compatible)

see Chap. 1  
and  
Chap. 8

**49 ETHERNET**

Connector for ethernet (option FSE-B16)

**50 MOUSE**

Connector for PS/2-Mouse

see Chap. 1  
and  
Chap. 8

**51 PC MONITOR**

Connector for an external PC-Monitor

see Chap. 1  
and  
Chap. 8



## Start-Up



### **Important Note:**

Before turning the instrument on, it must be observed that the following conditions are fulfilled:

- instrument covers are in place and all fasteners are tightened,
- fan openings are free from obstructions,
- signal levels at the input connectors are all within specified maximums,
- signal outputs are correctly connected and not overloaded.

**Non-observance may cause damage to the instrument .**

## Unpacking the Instrument

After the instrument has been removed from its packaging, insure that all deliverable items are present as follows:

- signal analyzer FSIQ
- AC power cable
- keyboard and mouse
- Windows NT operating manual
- this operating manual

Now check the instrument for visible mechanical damage. If damage is present, promptly inform the delivery firm that delivered the instrument. In case damage is found, retain the carton and the packing materials.

## Instrument Setup

### Stand-alone Operation

The instrument is designed for use under general laboratory conditions. The ambient conditions required at the operational site are as follows:

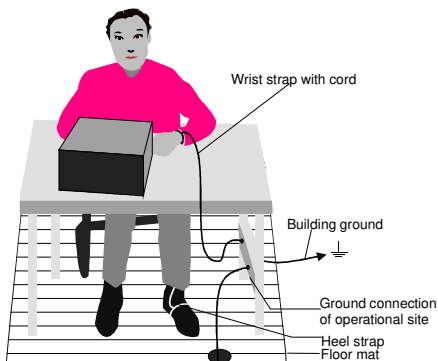

- The ambient temperature must be in the range recommended in the data sheet.
- All fan openings must be unobstructed and the air flow at the rear panel and at the side-panel perforations must not be obstructed. The distance to the wall should be at least 10 cm.
- The mounting surface should be flat.
- To avoid damage of electronic components of the DUT and the instrument, the operational site must be protected against electrostatic discharge.

For applications in the laboratory or on a work bench, it is recommended that the support feet on the bottom of the instrument be extended. For the LCD display, this provides the optimum viewing angle which typically ranges from perpendicular to the display front to approximately 30° below.

## 19" Rack Installation



### **Important Note:**

For rack installation, insure that the air flow at the side-panel perforations and the air exhaust at the rear panel are not obstructed.

The instrument may be mounted in a 19" rack by using the rack adapter kit ZZA-95 (order number: 396.4911.00). The installation instructions are included in the adapter kit.

## EMI Protection Measures

In order to prevent electromagnetic interference (EMI), the instrument may be operated only when all covers are correctly in place. Only adequately shielded signal and control cables may be used (see recommended accessories).

## Connecting to AC Power

The FSIQ is equipped with an AC voltage selection feature and will automatically set itself according to the applied AC voltage (range: 90 to 132 VAC and 180 to 265 VAC, 47 to 440 Hz). The AC power connector is located on the rear panel (see below).

- Connect the instrument to the AC power source using the AC power cable delivered with the instrument.

## AC Power Line Fuses

The FSIQ is protected by two fuses as specified on the power supply name-plate. The fuses are located in a removable fuse holder which is located between the AC power switch and the AC power connector (see below).

## Instrument On/Off

AC power switch on the rear panel

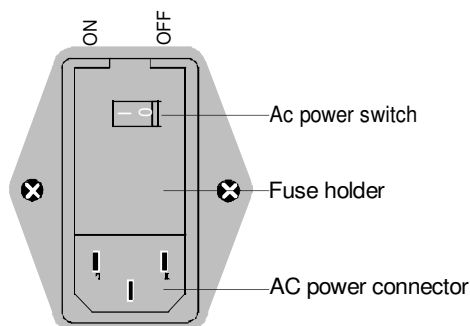

### **Power On/Off**

- Depress the AC Power Switch to the desired position ON/OFF.

After turn-on (position ON), the instrument is in the ready state (STANDBY) or in operation dependent upon the position of the ON/STANDBY switch located on the instrument front panel (see below).

**Note:** The AC power switch may remain ON continuously. Switching to OFF is only required when the instrument must be completely removed from the AC power source.

Switching to OFF (position OFF) removes all instrument circuitry from the AC power source.

ON/STANDBY switch on the front panel

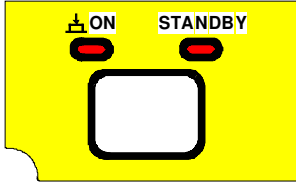

**Caution:**

*In standby mode, the AC power voltage is present within the instrument.*

**Standby**

- ON/STANDBY switch is not depressed.

The yellow LED (STANDBY) is illuminated. The DC power supply is supplied with power and the quartz oven is maintained at normal operating temperature.

**Operation**

- ON/STANDBY is depressed.

The green LED (ON) is illuminated. The instrument is ready for operation. All modules within the instrument are supplied with power.

## Battery-Powered Memory

The FSIQ is equipped with a battery-powered read/write memory (CMOS-RAM) where instrument settings are saved at power-off. After each power-on, the FSIQ is reloaded with the operational parameters which were active just prior to the last power-off (STANDBY or AC power OFF).

A lithium battery is used to supply power to the CMOS-RAM. When the battery is depleted (expected life is approx. 5 years), any data stored in CMOS-RAM will be lost. In this case, the factory standard setup is loaded at turn-on. For changing batteries please contact the representative of our company responsible for you.

## Functional Test

After turning on the AC power, the FSIQ returns the following message to the display screen:

```
Analyzer BIOS
Rev.x.y

Copyright
Rohde & Schwarz
Munich

Booting
```

After appearance of the above message, a self-test of the digital hardware is performed. Subsequently, the Windows NT controller boots and the instrument then starts measuring.

Any errors which occur in self-test are transferred as ASCII text to the printer interface (LPT). Thus, an error diagnosis can be carried out, even for serious failures.

A check of the data contents of the instrument is performed in self calibration (CAL, CAL TOTAL key). The individual results of the calibration (PASSED / FAILED) can be displayed in the calibration menu. With the aid of the built-in self-test functions (INFO key, SELFTEST soft key), the functional integrity of the instrument can be verified and/or defective modules can be localized.

## Controller Function

**Caution:**

*The drivers used in the integrated controller function are adapted to the measuring instrument. Only the settings described below should be resorted to. The existing driver software should be modified only with the update software released by Rohde&Schwarz.*

The instrument possesses an integrated Windows-NT controller. The user can switch between the measurement screen and the controller screen. When an external monitor is connected, the measurement function and the controller function can be displayed simultaneously (see section "Connecting an External Monitor"). The controller function is automatically booted on instrument power-up.

Windows NT operation is described in the supplied manual or in the online help of Windows NT.

### Login

Windows NT requires a login window in which the user is asked to identify himself by entering his name and password. An autologin comes as standard in the instrument, ie the login is performed automatically in the background. The user name used for this is "instrument" and the password is also "instrument" (in small letters).

To login under another name, call up the logout window in the task bar with START - SHUT DOWN. Mark the item "Close all programs and log on as a different user?" in the window and click YES while holding the SHIFT key down until the login window is displayed to enter the user identification. The password should be entered in the correct syntax including low-case and upper-case characters.

### Administrator identification

Some of the installations (eg CD-ROM drive) described below are possible only under the administrator login. This is indicated in the relevant window.

The administrator is an identification prescribed by Windows NT which in particular allows system settings which are disabled for the standard user.

The password for the administrator is 894129 for the instrument.

After an installation under the administrator identification, the "Service Pack X" of Windows NT is to be re-installed, see section "Installation of Windows NT Software".

On the power-up following an installation under the administrator identification, the NT login window is displayed (no autologin). The user name "Administrator" is indicated in the window. This entry is to be replaced by "instrument" and then "instrument" as password entered. An autologin is then possible.

### Changeover between measurement screen and controller screen

To call up the controller screen use key combination <ALT><SYSREQ> (US keyboard).

To return to the measurement screen, activate the window "R&S Analyzer Interface" on the controller.

### Logout

The instrument can be switched off (standby mode). Logging out of Windows NT is not necessary.

## Connecting a Mouse

**Caution:**

*The mouse may only be connected when the instrument is switched off (STANDBY). Otherwise, correct operation of the mouse and instrument cannot be guaranteed.*

The instrument has the facility to simplify operation by connecting a mouse to the rear-panel PS/2-mouse connector (MOUSE) for .

MOUSE



During measurement operation, soft keys, tables and data input fields may also be controlled via the mouse. For computer function, the mouse has the usual functions.

The control functions for the mouse during measurement operation are described in Chapter 3 in the section "Mouse Control of Further Display Elements". This section contains a list in which the screen display elements for mouse control of the corresponding soft keys and push buttons of the instrument are described. Chapter 8 contains the interface description.

After connection the mouse is automatically recognized. Special settings such as mouse cursor speed etc., can be performed in the Windows NT menu START - SETTINGS - CONTROL PANEL - MOUSE.

## Connecting an External Keyboard

**Caution:**

*The keyboard may only be connected when the instrument is switched off (STANDBY). Otherwise, correct operation of the keyboard cannot be guaranteed.*

The instrument is fitted with a rear-panel 5-contact DIN connector (KEYBOARD) for the connection of an external PC keyboard.



During measurement operations, the keyboard simplifies the input of commentary text, filenames, etc. For computer function, the keyboard has the usual functions.

Chapter 3, in section "External Keyboard Control", contains a list which describes the assignment of the instrument front-panel key functions to the key codes of the external keyboard as well as special key combinations used for quick operations. Chapter 8 contains the interface description.

After connection the keyboard is automatically recognized. The default setting is for the US keyboard. Special settings such as repetitional rate etc. can be performed in Windows NT menu START - SETTINGS - CONTROL PANEL - KEYBOARD.

## Connecting an External Monitor

**Caution:**

The monitor may only be connected when the instrument is switched off (STANDBY). Otherwise, the monitor may be damaged.

Do not modify the screen driver (display type) since this would disturb instrument operation.

- Notes:**
- When connecting the monitor to the PC MONITOR connector, the display of controller function can be adapted to the external screen (eg higher resolution) in the NT menu START-SETTING - CONTROL PANEL - DISPLAY PROPERTIES.
  - CHIPS (setting = both) should not be modified since otherwise switching between the external monitor and the instrument screen is not possible.

The instrument is fitted with a rear-panel connector PC MONITOR or ANALYZER MONITOR for the connection of an external monitor.



With an external monitor it is possible to have an enlarged display of the measurement screen (ANALYZER MONITOR connector) or of the controller screen (PC MONITOR connector). The measuring instrument and the Windows NT controller can be operated in parallel. The mouse and the keyboard are allocated to only one mode.

### Display of the measurement screen - Connection to ANALYZER MONITOR connector

**Connection**

After connecting the external monitor the measurement screen is displayed on both the external monitor and the instrument. Further settings are not necessary.

**Operation**

The instrument is operated as usual via its softkeys, the mouse and keyboard, etc..

**Toggle between measurement screen and controller screen**

Key combination <ALT><SYSREQ> is used to call up the controller. After call up, the mouse and keyboard are allocated to the controller function.

By activating the window "R&S Analyzer Interface" the user returns to the measurement screen and the mouse and keyboard are allocated to this screen.

### Display of the controller screen - Connection to PC MONITOR connector

**Connection**

After connecting the monitor external monitor operation should be selected.

Setting is performed in the *SETUP-GENERAL SETUP* menu (key group: *CONFIGURATION*, see in Chapter 4, the section "Presettings and Interface Configuration"):

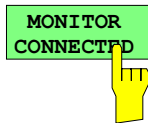
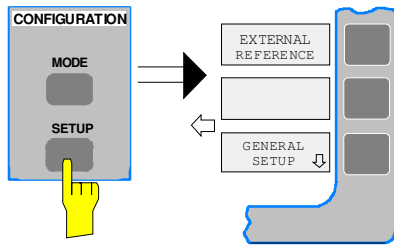

---

### Call *SETUP-GENERAL SETUP* menu

- Press the *SETUP* key in the *CONFIGURATION* field.

The *SETUP* menu is opened.

- 
- Press the *GENERAL SETUP* softkey.

The *GENERAL SETUP* submenu is opened and the current settings of the instrument parameters are displayed on the screen in the form of tables.

---

### Selecting the external monitor mode

- Press the *MONITOR CONNECTED* softkey.

The softkey is in color to indicate that the external monitor mode is activated. The external monitor displays the controller screen.

### Operation

The controller function is operated as usual with the mouse and keyboard. The measuring instrument (displayed on the instrument screen) can be operated with both the softkeys and keys of the instrument.

### Toggle between screens

By activating (clicking) the window "R&S Analyzer Interface" at the controller the mouse and keyboard are allocated to the measurement screen. The mouse and keyboard are allocated to the controller when the window is deactivated.



## Connecting an Output Device



**Caution:**

The output device may be connected only when the instrument is switched off (STANDBY)

- Notes:**
- The installation of some printer drivers is possible only under the administrator identification (see section "Controller Function").
  - After the installation, the "Service Pack X" of Windows NT is to be re-installed, see "New Installation of Windows NT Software".
  - To ensure that the instrument performs an autologin, the user identification is to be reset to "instrument" after the next power-up, see section "Controller Function".

The instrument provides an option for connecting up to three different output devices to allow printing a hard copy of the display screen.

The interfaces can also be used for printing in the controller mode. The output formats "WMF" (Windows Metafile) and "Clipboard" are preset. A large number of output devices can be connected under Windows NT after installing suitable printer drivers.

The output devices supported by the instrument can be found in the selection box *DEVICE/LANGUAGE* in the *HARDCOPY –SETTINGS DEVICE1/2* menu (see in Chapter 4, the section "Documentation of Measurement Results"). To print out via the COM interface, the latter must be assigned the controller function in the *SETUP - GENERAL SETUP* menu (owner = OS)..

Chapter 8 contains the interface description of the connectors.

The interface connectors are located on the rear panel:

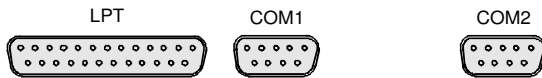

After connection of the output device to the appropriate interface connector, the configuration of the interface as well as the output device must be entered and the output device must be assigned to the interface.

### 1. Configuration of the interface

LPT1                      Interface LPT1 cannot be configured.

**Note:**                    *An external CM-ROM drive can be connected to this interface. If this interface is allocated, one of the serial interfaces can be used for the printout.*

COM1/COM2            The configuration of serial interfaces COM1 and COM2 can be performed in the Windows NT menu *START - SETTINGS - CONTROL PANEL - PORTS*. The parameters *COM PORTS BAUDRATE, BITS, PARITY, STOPBITS, HW/SW-HANDSHAKE* determine the transmission parameters of the interface They must agree with the specifications of the output device (see the operating manual for the output device).

### 2. Selection and installation of the printer driver

The selection and installation of the printer driver, the assignment to the interface and the setting of most of the printer-specific parameters (eg paper size) is performed under Windows NT in the *START - SETTINGS - PRINTER* menu.

### 3. Configuration of the connected output device

The configuration of the connected output device and the assignment to the interface takes place in the *HARDCOPY DEVICE-SETTINGS DEVICE1/2* menu (key group: *HARDCOPY*, see in Chapter 4, the section "Selection and Configuration of the Output Device "). The configuration of up to two output devices (*DEVICE1* and *DEVICE2*) may be entered, of which, at least one must be activated for printing.

- The parameter *DEVICE/LANGUAGE* determines which output device is to be used.
- The parameter *PRINT TO FILE* determines if the output is in the form of a file.
- The parameter *ORIENTATION* sets the page format to horizontal or vertical (portrait).

Selecting the type of printer automatically sets the parameters *PRINT TO FILE* and *ORIENTATION* to values which correspond to a standard mode with this output device. Other printer-dependent parameters such as *FORMFEED*, *PAPERFEED* etc., can be modified under Windows NT in the printer properties window (*START/SETTINGS/PRINTER/SETTINGS/....*).

Table 1-1 shows the standard factory settings for the two output devices.

The factory settings of *DEVICE 1* correspond to output format "WMF" (Windows Metafile), printing is performed in a file. WMF is a common format which is used for the import of hardcopies (eg measurement windows) to other Windows applications that support this format (eg WinWord).

The factory setting of *DEVICE 2* is "Clipboard". In this setting the printout is copied to the Windows NT clipboard. Most of Windows applications support the clipboard. The clipboard content can be directly inserted in a document via *EDIT - PASTE*.

Table 1-1 Factory settings for *DEVICE 1* and *DEVICE 2* in the *HARDCOPY-DEVICE SETTINGS* menu.

Parameter	Parameter Name	<i>DEVICE 1 Settings</i>	<i>DEVICE 2 Settings</i>
Output Device	DEVICE/LANGUAGE	WINDOWS METAFILE	CLIPBOARD
Output	PRINT TO FILE	YES	---
Paper Format	ORIENTATION	---	---

In the following example, a HP DeskJet 660C printer is connected to interface LPT1 and configured as *DEVICE2* of the instrument to output hardcopies of the measurement screen.

---

**Switch off device.**

---

**Connect printer to interface LPT1.**

---

**Switch on device.**

**Select printer driver under Windows NT**

- Press key combination <ALT> <SYSREQ>  
The Windows NT screen is displayed.



- In the Start menu press first "Setting" and then "Printers".  
The printer window is opened.

- Double-click symbol "Add Printer".  
The "Add Printer Wizard" window is opened. This window leads through the following printer driver installation.

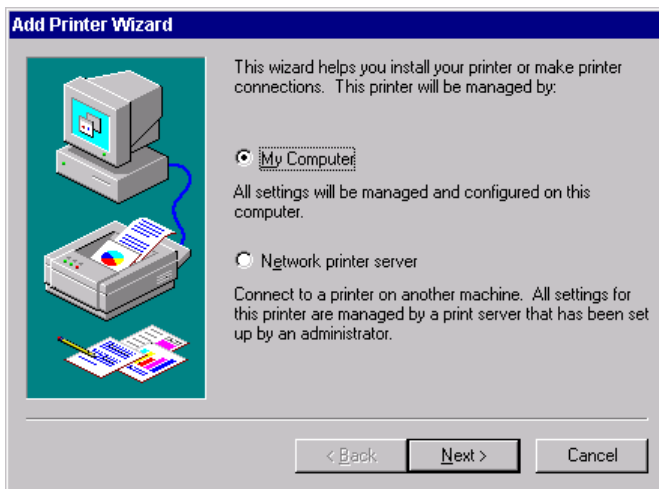

- Click first "My computer" and then "Next".  
The available ports are displayed.



- Select LPT1 port.  
The selection is marked by a tick.

- Click "Next".  
The available printer drivers are displayed. The left-hand selection table indicates the manufacturers and the right-hand one the available printer drivers.

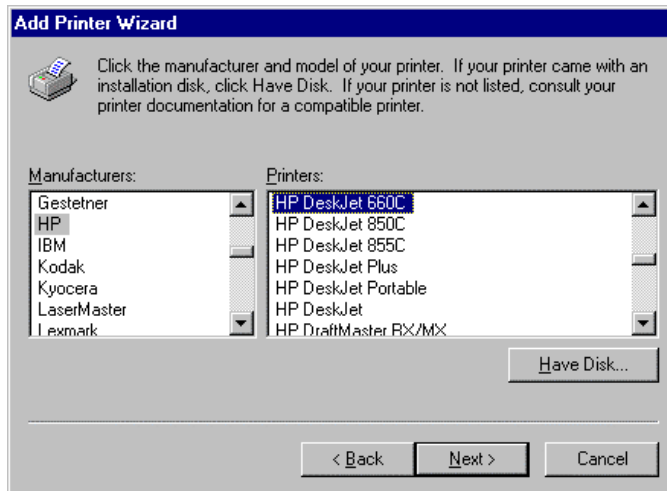

- Mark "HP" in selection table "Manufacturers" and "HP DeskJet 660C" in selection table "Printers".

**Note:** *If the desired type of output device is not shown in this list, it means that it is not supported by Windows NT.*

- Click "Next".

The entry field for the printer name is displayed.

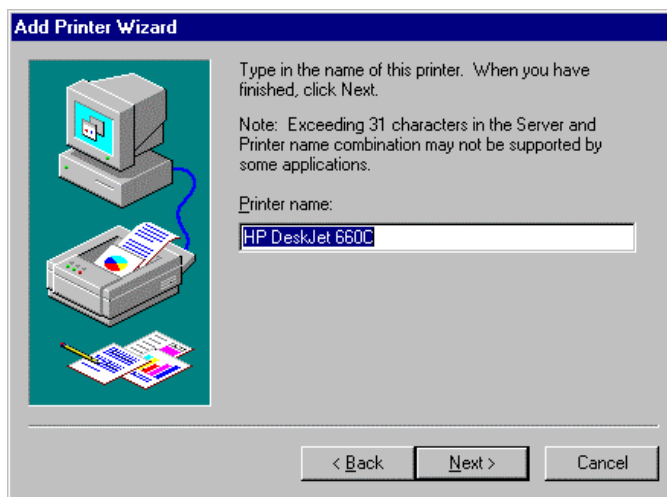

- The printer name can be modified in the entry field "Printer name" (max. 60 characters).

If one or more printers are already installed, a query is displayed in this window to ask if the printer last installed as default printer should be selected for the Windows NT applications (Do you want your Windows-based programs to use this printer as default printer?) "No" is preset.

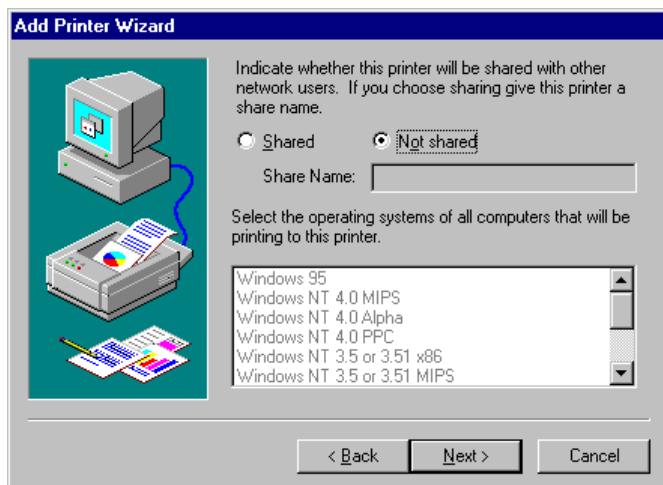

- Click "Next".

A query is displayed for providing the printer in the network. This query is irrelevant when installing a local printer. The answer "Not shared" is preset.

- Click "Next".

The window for starting a test page is displayed. The test page is for checking if the installation was successful.



- Switch on printer.
- Click Yes (recommended)".
- Click "Finish".

A test page is printed out if the installation was successful.

If the test page is not printed out or not completely, the Windows NT online help offers troubleshooting instructions under the entry "Printer Trouble Shooting".

**Note:**

If after clicking "Finish" the user is asked to specify the path for the printer driver, this printer installation should be performed under the administrator identification (see section "Controller Function").

The instrument has to be configured with this printer for the printout of the measurement screen.

**Configuring HP DeskJet 660C.**

- Click button "R&S Analyzer Interface".  
The measurement screen is displayed.

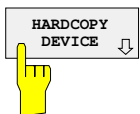
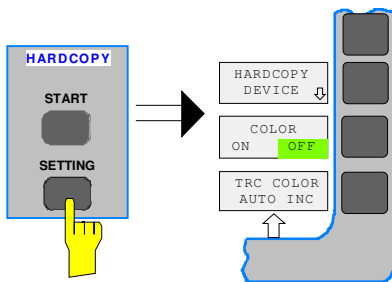

- Press the *SETTINGS* key in the *HARDCOPY* field.  
The *SETTING* menu is opened.

HARDCOPY DEVICE SETTINGS	
Device1	WINDOWS METAFILE
Print to File	YES
Orientation	---
Device2	CLIPBOARD
Print to File	---
Orientation	---

- Press the *HARDCOPY DEVICE* softkey.  
The *HARDCOPY DEVICE* submenu is opened and the current settings of the two possible output devices are displayed on the screen in the form of tables.

- Press *SETTING DEVICE2*.  
Line *DEVICE2* is marked with the selection bar.

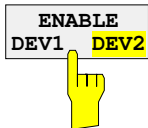
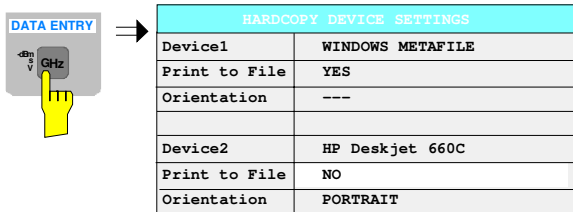
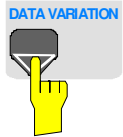
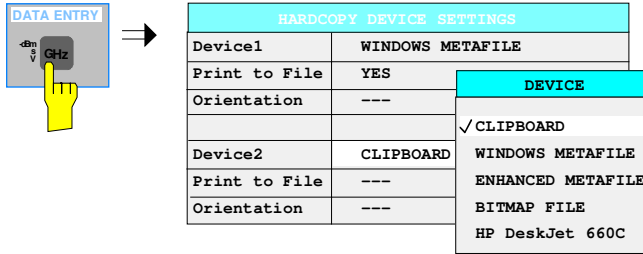

- Press one of the unit keys.

The selection box *DEVICE* is displayed on the screen. The current selection is marked by a tick and highlighted by the selection bar.

- Press cursor key until the entry *HP DeskJet 600C* is highlighted by the selection bar.

- Press one of the unit keys.

The selection box *DEVICE* is closed and *HP DeskJet 660C* is entered in line *DEVICE2*.

**Note:**

Selecting the type of printer automatically sets the parameters *PRINT TO FILE* and *ORIENTATION* to values which correspond to a standard mode with this output device. Other printer-dependent parameters such as *PAPERSIZE*, can be modified under Windows NT in the printer properties window (*START/SETTINGS/PRINTER/SETTINGS*)..

**Switch on printer.**

- Press *ENABLE* softkey until *DEV2* is marked on the second softkey line.

Printing can then be started with the *START* key in the *HARDCOPY* menu.

**Return to main menu**

- Press the menu key several times.

**Note:** After the installation, the "Service Pack X" of Windows NT is to be re-installed, see "New Installation of Windows NT Software".

## Connecting a CD-ROM Drive



**Caution:**

The CD-ROM may only be connected when the instrument is switched off (STANDBY). If this is not observed correct operation of the CD-ROM and the instrument cannot be guaranteed.

- Notes:**
- The installation of a CD-ROM is possible only under the administrator identification (see section "Controller Function").
  - After the installation, the "Service Pack X" of Windows NT is to be re-installed, see "New Installation of Windows NT Software".
  - To ensure that the instrument performs an autologin, the user identification is to be reset to "instrument" after the next power-up, see section "Controller Function",

The instrument is fitted with a rear-panel interface LPT1 for the connection of a CD-ROM drive.

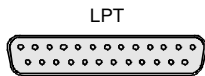

The following CD-ROM drives are supported:

- MICROSOLUTIONS BACKPACK External CD-ROM.
- FREECOM IQ DRIVE
- ADAPTEC Parallel SCSI Adapter + SCSI CD-ROM

After connection, the CD-ROM drive is to be installed under Windows NT.

---

**Switch off device.**

---

Connect CD-ROM drive to interface LPT1 of the instrument and to AC power source.

---

**Switch on device.**

---

**Administrator identification**

- Press key combination <ALT> <SYSREQ>

The Windows NT screen is displayed.

- 
- Call the logout window with "Shut Down" in the "Start" menu.

- Mark entry "Shut down and log on as a different user".

- Press Shift key and click button "Yes" at the same time.

The login window is displayed.

- Enter "administrator" under "name" and "894129" under "password", confirm entry with "OK".

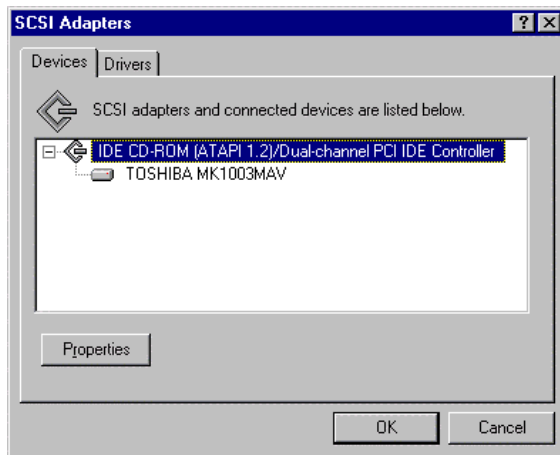

### Select driver under Windows NT

- In the Start menu press first "Setting" and then "Control Panel".

The system control window is opened.

- Double-click symbol "SCSI Adapters".

The "SCSI Adapters" window is opened.

- Click "Driver" index card and then button "Add".

The list of installed drivers is displayed.

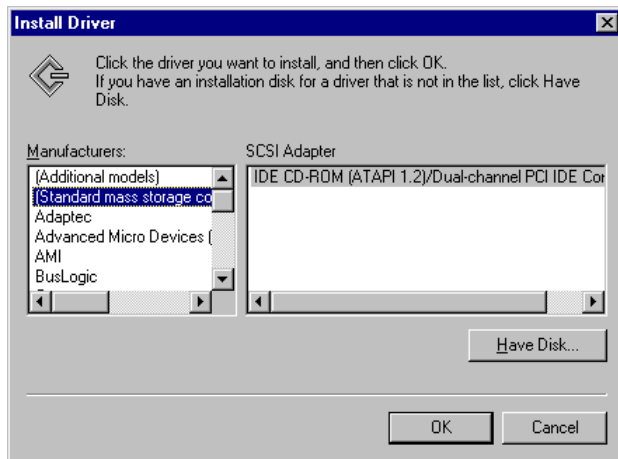

- Click "Have Disk".

This window leads through the following installation.

**Note:** After the installation, the "Service Pack X" of Windows NT is to be re-installed, see "New Installation of Windows NT Software".



## Firmware Update

The installation of a new firmware version can be performed using the built-in diskette drive and does not require opening the spectrum analyzer. The firmware update kit contains several diskettes. The installation program is called up in the *CONFIGURATION - SETUP* menu.

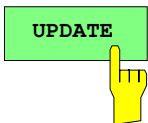
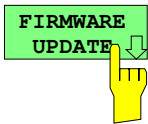
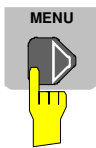
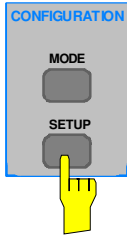

The installation can be cancelled.



---

***Insert diskette 1 into the drive.***

---

***Call SETUP-GENERAL SETUP menu***

- Press the *SETUP* key in the *CONFIGURATION* field.

The *SETUP* menu is opened.

---

- Change to the right-hand menu using the menu key.
- 

- Press the *FIRMWARE UPDATE* softkey.

The submenu is opened.

---

- Press the *UPDATE* softkey.

The installation program starts and leads the user through the remaining steps of the update.

---

- Press the *RESTORE* softkey.

The previous firmware version is restored.

## Installing Windows NT Software

The driver software and the system settings of Windows NT are exactly adapted to the measurement functions of the instrument. Correct operation of the instrument can therefore be guaranteed only if the software and hardware used is released or offered by Rohde & Schwarz.

The use of other software or hardware may cause malfunctioning or failures in the functions of the instrument.

A current list of released software can be obtained from your nearest Rohde&Schwarz agency (see list of addresses).

After each software installation requiring the administrator identification, it is necessary to re-install the "Service Pack X" of Windows NT (also with administrator identification; see section "Controller Function"):

---

### ***Re-installing Service Pack X***

- In the Start menu press first "Setting" and then "Run".

The entry window is opened.

- 
- Enter "C:\SPX\I386\UPDATE" into the command line and start installation with "OK".

The following window leads through the installation.

## Options

- Notes:**
- Option FSE-B13, 1 dB Attenuator, is described in Chapter 4, Section "Level Display/RF Input"
  - Options FSE-B8 to B12, Tracking Generator, are described in Chapter 4, Section "Tracking Generator"

### Option FSE-B17 – Second IEC/IEEE Interface

- Notes:**
- The installation of option FSE-B17 is possible only under the administrator identification (see section "Controller Function").
  - After the installation, the "Service Pack X" of Windows NT is to be re-installed, see "New Installation of Windows NT Software".
  - To ensure that the instrument performs an autologin, the user identification is to be reset to "instrument" after the next power-up, see section "Controller Function".

Besides the instrument external devices can also be controlled via the IEC/IEEE bus using the optional 2nd bus interface FSE-B17 and the computer function for instrument. The interface software permits IEC/IEEE-bus commands to be included in user programs. The installation instructions are enclosed with the option.

### Installing the software

The operating software is already installed and need not be loaded from the driver diskettes which serve as backup diskettes.

The driver must be loaded on the start-up of Windows NT. To do this, enter the type of board, configure the board and enter the parameters for the connected equipment. If the option is factory fitted, all this has been done in the factory.

The following parameters may not be changed after selection on configuration of the board:

```
Board Type .....AT-GPIB/TNT
Base I/O Address .....02C0h
Interrupt Level .....3
DMA Channel .....5
Enable Auto Serial Polling ...No
```

For further parameters, refer to manual for the board.

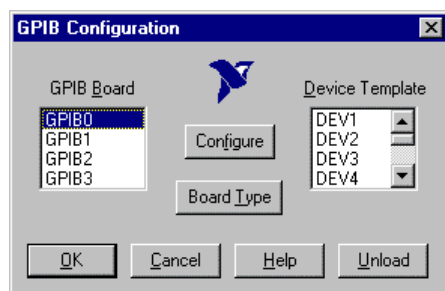

#### Selecting the board type

- Click "Start" in the task bar.
- Click consecutively "Settings", "Control Panel" and "GPIB" in this sequence.

The "GPIB Configuration" menu for selecting the board type and configuring the board is opened.

- Click button "Board Type".

The "Board Type" menu for selecting the board type is opened.

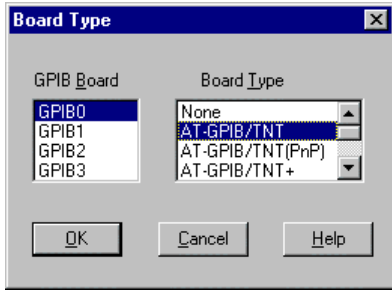

- Mark "GPIB0" in the "GPIB Board" list.
  - Mark "AT-GPIB/TNT" in the "Board Type" list.
  - Confirm the selection with "OK".
- The "GPIB Configuration" menu is displayed again.

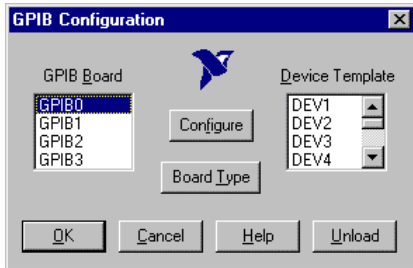

- Click button "Configure".
- The "GPIB0 (AT-GPIB/TNT)" menu for configuring the board is opened.

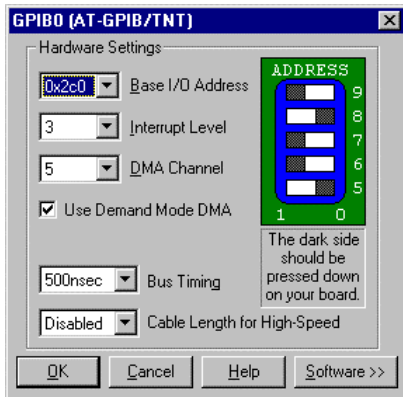

- ### Configuring the board
- Set "3" in the "Interrupt Level" list.
  - Click button "Software".
- The menu is extended.

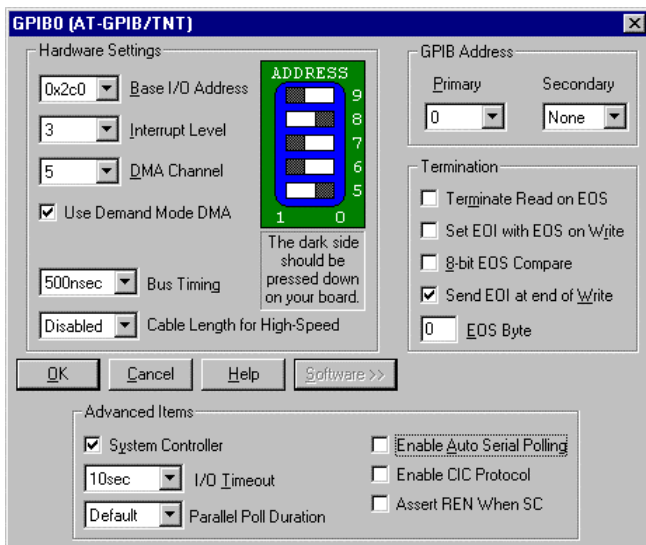

- Deactivate (= no tick) "Enable Auto Serial Polling" in the "Advanced Items" field.
- Quit the menu with "OK".

The "GPIB Configuration" menu is displayed again.

**Note:**  
*The settings of the following parameters should not be no longer modified.*

```

Board Type ..... AT-GPIB/TNT
Base I/O Address ..... 02C0h
Interrupt Level ..... 3
DMA Channel ..... 5
Enable Auto Serial Polling .. No
    
```

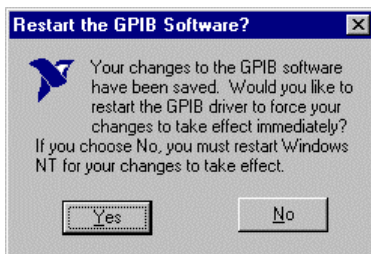
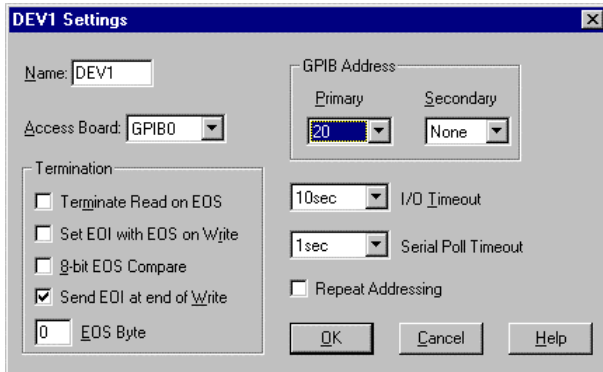
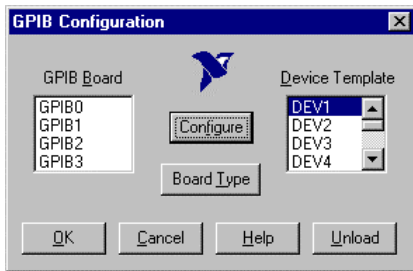

### Setting the parameters for the connected equipment

- Mark the instrument in the "Device Template" list and confirm selection with "OK".

The "DEV.. Settings" menu is opened.

- Perform the settings for the selected unit in the "DEV.. Settings" menu.

The logic name for the instrument is preset with DEV1 and address 20. See board manual for further units.

**Note:** When assigning logic names to connected equipment note that these names do not correspond to the directory names under DOS.

- Terminate setting with "OK".

The query asking if the GPIB software should be re-started is displayed.

- Select "No".

- Re-start controller with Start-Restart in the task bar.

After the controller has been re-started, the settings for the GPIB interface are effective.

**Note:** After the installation, the "Service Pack X" of Windows NT is to be re-installed, see "New Installation of Windows NT Software".

## Use of DOS Programs

When using DOS programs, driver GPIB-NT.COM should be loaded. For this to take place, the line `device=C:\PROGRA~1\NATION~1\GPIB\NI488\DosWin16\Gpib-nt.com` has to be activated in the file `C:\WINNT\SYSTEM32\CONFIG.NT`. If the option is factory fitted, this line will have been entered in the factory.

## Operation

The second IEC/IEEE-bus interface corresponds physically to that of the instrument (see Chapter 8). If the instrument is to be controlled via the IEC/IEEE bus, a bus cable must be plugged to both bus connectors. The interface can be driven under DOS/WINDOWS3.1/95/NT by R&S software (FS-K3, Order No. 1057.3028.02, etc.) or by user-written software. The handling of IEC/IEEE-bus commands in user programs is described in the manual for the card.

The files are in directory `C:\Program Files\National Instrument\GPIB\NI488`.

## Option FSE-B5 - FFT Filter

Option FFT Filter FSE-B5 is a firmware option. It has to be enabled by a keyword.

### Prerequisites

1. Keywords  
The keyword is printed on a label which is part of the equipment supplied and has to be stuck to the rear of FSIQ.
2. Hardware  
The modification state of module DIGITAL IF has to be either  $\text{MODIF INDEX} > 5$  or  $\text{MODIF INDEX} = 5$  and  $\text{HW CODE} \geq 6$ . The modification state can be checked in the module list *INSTALLED COMPONENTS* in menu *INFO HARDWARE+OPTIONS*.
3. Firmware  
The modification state of the firmware has to be  $\geq 1.62$ . The modification state can be checked in table *FIRMWARE VERSION* in menu *INFO FIRMWARE VERSIONS*.

### Enabling the option

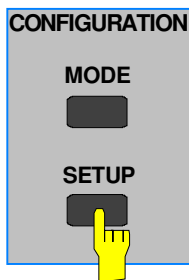

- Call up menu *SETUP* by pressing the *SETUP* key.

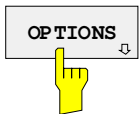

- Call up submenu *OPTIONS* by pressing the *OPTIONS* softkey.  
Table *FIRMWARE OPTIONS* is displayed, listing the installed options.

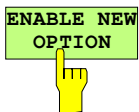

- Activate the entry field by pressing the *ENABLE NEW OPTION* soft key.

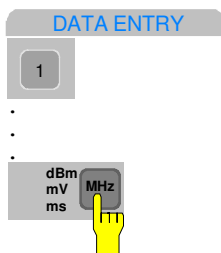

- Enter the 10-digit keyword via the numeric keypad and terminate the entry by pressing one of the unit keys.  
Now option FFT filter is listed in table *FIRMWARE OPTIONS*.

**Note:** Message 'option key invalid' indicates an invalid entry.

## Option FSE-B16 – Ethernet Adapter

With the option Ethernet Adapter FSE-B16, the device can be connected to an Ethernet-LAN (local area network). It is possible to transmit data via the network and to use the network printer. The adapter operates with a 10 MHz Ethernet in line with standards IEEE 802.3 10Base2 (Thin Ethernet, CheaperNet, BNC-Net) (B16 model 03) or 10Base5 (Thick Ethernet) (B16 model 02).

### Hardware Installation



**Caution:**

*Prior to installation contact the network administrator, especially in case of complex LAN installations since mistakes in cabling might have influence the whole network.*

If the adapter is installed at the factory, it is preconfigured. In case of retrofitting, refer to the installation instructions. The hardware settings must not be modified since the functions of the device could otherwise be impaired.

The following parameters are factory-set:

I/O Addr. 300,      IRQ 5,      MEM D0000

The connection with the network depends on the connectors used in the network.

### BNC (Thin Ethernet, CheaperNet; FSE-B16 Var. 03)

#### Connection

The device is looped into the LAN segment via rear-panel 2 BNC connectors.

If a cable is not connected to one of the BNC connectors, this BNC connector has to be terminated with 50 Ohm. BNC T connectors must not be used.

#### Network traffic



Note that the network traffic is disturbed if a segment is interrupted.

#### Requirements

Thin Ethernet segment requirements have to be complied with:

- maximum segment length of 185 m
- minimum distance between the connectors of 0.5 m
- maximum of 30 connectors per segment.

If components that comply with enhanced requirements are exclusively used (Ethernet Adapter FSE-B16 complies with the enhanced requirements):

- maximum length of segment of 300 m
- maximum number of connectors of 100

With repeaters used:

- maximum total length of the network of 900 m containing a
- maximum of 3 segments
- maximum of two repeaters between two connectors

## AUI (Thick Ethernet; FSE B16 Var. 02)

<b>Connection</b>	The device is connected to the LAN segment using a transceiver cable (DB-15 AUI connector, not part of the equipment supplied) which is connected to the rear panel and to the transceiver.
<b>Network traffic</b>	The connection does not conflict with the network traffic. The device can also be disconnected from the network without any problems but make sure that data are not being transmitted.
<b>Requirements</b>	<p>The Thick Ethernet segment requirements have to be taken into account.</p> <ul style="list-style-type: none"> <li>- The maximum segment length should be 500 m and the distance between the connectors should at least be 2.5 m.</li> <li>- A maximum of 100 connectors may be used in a segment.</li> </ul> <p>With repeaters used,</p> <ul style="list-style-type: none"> <li>- the total length of the network must not be more than 2500 m containing</li> <li>- a maximum of 3 segments.</li> <li>- There should be no more than two repeaters between two connectors.</li> </ul> <p>If other network components are used, these conditions may vary.</p>

## RJ45 (UTP, 10BaseT, Western Connector)

<b>Connection</b>	The device is connected to the LAN segment using a RJ45 cable (not part of the equipment supplied) which is connected to the rear panel and to the network hub of the LAN segment.
<b>Network traffic</b>	This connection does not conflict with the network traffic. The device can also be disconnected from the network without any problems but make sure that data are not being transmitted.
<b>Requirements</b>	<p>Since RJ45 is not a bus but a star topology no special requirements have to be taken into account for the connection.</p> <p>The LAN requirements should be considered in the installation.</p>

## Software Installation

Data transmission within the network is by means of data blocks, the so-called packets. Besides user data other information, the so-called protocol data (transmitter, receiver, type of data, order) are transmitted. The drivers corresponding to the protocol have to be installed to process protocol information. A network operating system is required for network services (data transmission, directory services, printing in the network) and thus has to be installed.



## Calling up Configuration Menu for Network Settings

- Click "Start" in the task bar.
- Click consecutively "Settings", "Control Panel" and "Network".

The "Network" configuration menu for network settings is opened.

## Registering the Identification

**Note:** It is important for the computer name to be unique in the network..

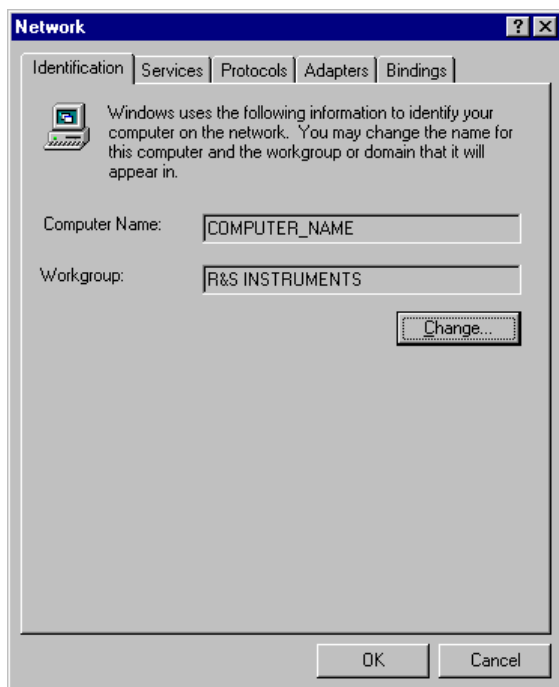

- Select "Identification".
- Confirm computer and workgroup names with "OK" or enter new names in submenu "Change".

## Installation and Configuration of the Driver for the Network Adapter

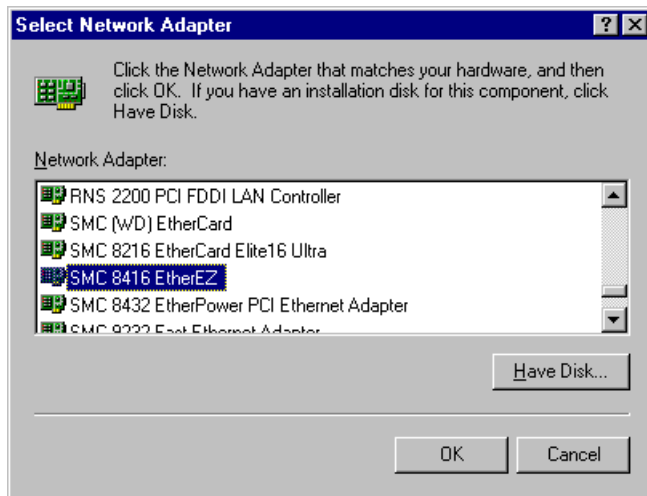

- Select "Adapter".
- Click "Add" and mark network driver "SMC 8416 EtherEZ" and select with "OK".  
The query "Files.." is displayed.

- Answer it by clicking "Continue".  
The "SMCEthernet Card Setup" window is displayed.

- Close the window with "OK".  
Some files are copied and the network adapter is displayed under "Network Adapters".  
The entry "MS Loopback Adapter" refers to a driver which ensures instrument control and should not be modified.

**Note:** *The network adapter settings must not be modified since this may cause problems to the instrument.*

## Installation of Network Protocols

**Note:** *The network administrator knows which protocols are to be used..*

- Select "Protocol".
- Click "Add", mark the desired protocol and select with "OK".  
This operation has to be performed several times when several protocols are selected.

- Execute the installation by clicking "Continue".

**Note:** *If a protocol requires further settings, they can be performed with "Properties" after marking the corresponding entry. If further settings are not possible, this field is gray.*

## Installation of Network Services

To utilize the resources of the network it is necessary to install the corresponding services.

**Note:** The network administrator knows which services are to be used.

- 
- Select "Services".
  - Click "Add", mark the desired service and select with "OK".

This operation has to be performed several times when several services are selected.

Some services are pre-installed and can be cleared with "Remove" if they are not needed.

- 
- Execute the installation by clicking "Continue".

**Note:** If a service requires further settings, they can be performed with "Properties" after marking the corresponding entry. If further settings are not possible, this field is gray.

## Terminating the Installation

- 
- Quit the "Network" configuration menu for network settings with "OK".

The settings are checked and processed. Missing information is queried.

- 
- Answer the query "You must shutdown..." with "Yes".

The settings are valid after computer restart.

**Note:** After the installation, the "Service Pack X" of Windows NT is to be re-installed, see "New Installation of Windows NT Software".

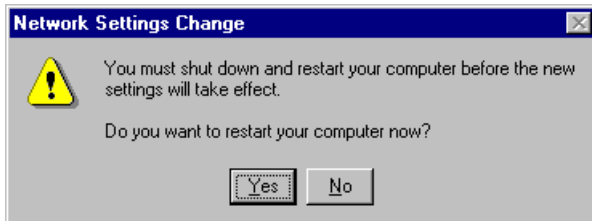

## Examples of Configurations

Network	Protocols	Services	Notes
NOVELL Netware	NWLink IPX/SPX Compatible Transport	Client Service for NetWare	The "Frame Type" used under "Protocols - Properties" should be set.
IP networks (FTP, TELNET, WWW, GOPHER, etc.)	TCP/IP Protocol	Simple TCP/IP Services	An "IP Address" unambiguous in the network should be set under "Protocols - Properties".
MICROSOFT network	NetBEUI Protocol or TCP/IP Protocol	Workstation Server	A name unambiguous in the network should be registered under "Identification - Computer Name".

## Operation

After installing the network operating system it is possible to transfer data between the device and other computers and to use printers in the network. A precondition for network operation is the authorization to use network resources. Resources may be access to the file directories of other computers or the use of a central printer. The network or server administrator will grant the authorizations. The network name of the resource and the corresponding authorization are required. Passwords protect the resources against improper use. A user name is normally assigned to every authorized user. The user also has a password. Resources may then be assigned to the user. The type of access, i.e. whether data are only read or also written as well as a shared access to data has to be defined. Other types are possible depending on the network operating system.

## NOVELL

Operating system NETWARE from NOVELL is as server-supported system. Data transfer between the individual workstations is not possible. Data transfer is between workstation computers and a central computer, the server. This server provides storage capacity and the connection to the network printers. Like under DOS, the data on a server are organized in directories and are offered to the workstation as virtual drives. A virtual drive on a workstation is like a hard disk and data can be processed accordingly. This is called drive mapping. Also network printers can be addressed as normal printers.

Network operating system NOVELL is available in two forms: NETWARE 3 and NETWARE 4 NDS. In the previous version NETWARE 3, each server manages its own resources itself and is independent. A user has to be managed separately on each server. For NOVELL 4 NDS, all resources are managed in the NDS (NOVELL DIRECTORY SERVICE). The user only has to log in once and gains access to the resources released for him. The individual resources and the user are managed as objects in a hierarchical tree (NDS TREE). The position of the object in the tree is called CONTEXT for NETWARE and must be known in order to access the resources.

## MICROSOFT

For MICROSOFT, data can be transferred between workstations (peer-to-peer) but also between workstations and servers. The servers can provide access to individual files as well as the connection to network printers. Like under DOS, the data on a server are organized in directories and are offered to the workstation as virtual drives. A virtual drive on a workstation is like a hard disk and data can be processed accordingly. This is called drive mapping. Also network printers can be addressed as normal printers. A connection to DOS, WINDOWS FOR WORKGROUPS, WINDOWS95, WINDOWS NT is possible.

## Installing a user

After the network software has been installed, the instrument logs with an error message during the next start-up since there is no user "Instrument" (= user identification for NT autologin) in the network. It is therefore necessary to install a user which should be the same for Windows NT and for the network. The network administrator is responsible for the installation of new users in the network.

**Note:** *The installation of new users is possible only under the administrator identification (see section "Controller Function").*

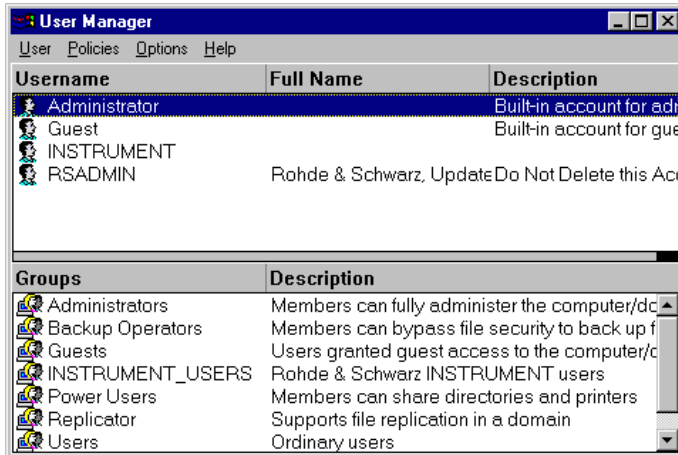

- Click "Start" in the task bar.
- Click consecutively "Programs" "Administrative Tools (Common)" and "User Manager".

The "User Manager" menu is opened.

- Click "User" and select "New User".

The menu "New User" for entering user data is opened.

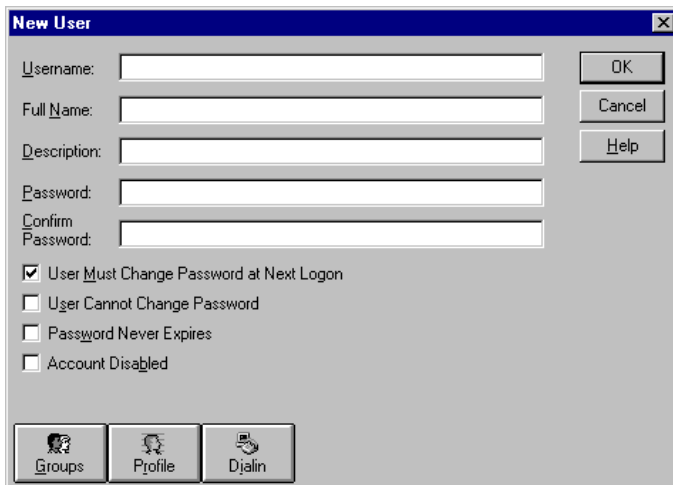

- Fill in the lines "Username", "Password" and "Confirm Password" and confirm the entry with OK.

The user data should correspond to the network settings.

### Only NOVELL network: Configure NOVELL Client

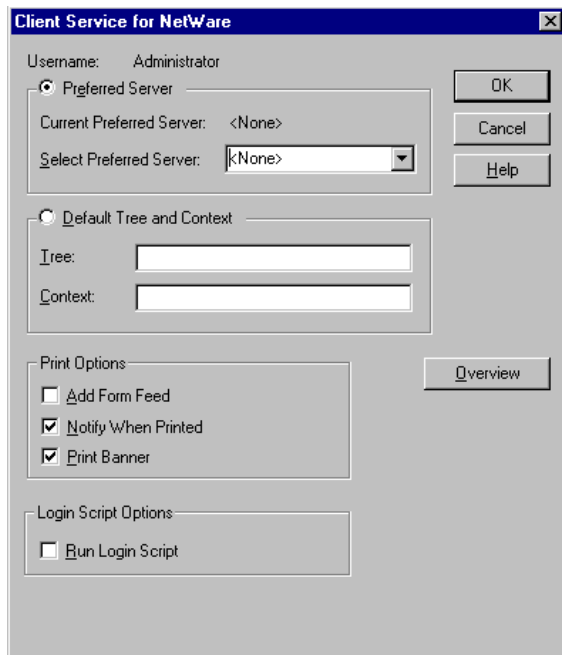

- Click "Start" in the task bar.
- Click consecutively "Settings", "Control Panel", "CSNW".

#### NOVELL 3.x

- Click "Preferred Server".
- Under "Select Preferred Server" select the NOVELL server for which the user has been installed.

#### NOVELL 4.x

- Click "Default Tree and Context" .
- Enter the NDS Tree under "Tree" and, under "Context", the hierarchical path for which the user has been installed.

**Note:** *These specifications can be obtained from the network administrator.*

### Login in the Network

Network login is automatically performed with the operating system login. A prerequisite is that the user name and the password are the same under Windows NT and in the network.

### Use of Network Drives

- Click "Start" in the task bar.
- Click consecutively "Programs" and "Windows NT Explorer".
- Click "Network" line in the "All Directories" list.

A list of available network drives is displayed.

- Click "Tools" and "Map Network Drive".  
In the list "Shared Directories:" the network paths available in the network are displayed.
- Mark the desired network path.

- Select the drive under "Drive:"
- Activate "Reconnect at Logon:" if the link is to be automatically established at each unit start.
- Connect the network path to the selected drive with "OK".

The user name and the password are queried. The drive is then displayed in the "All Directories" list of Explorer.

**Note:** Only drives for which an authorization is available may be connected.

---

Disconnect link:

- Click "Tools" and "Disconnect Network Drive" in Explorer.
- Select under "Drive:" the drive whose connection is to be removed.
- Disconnect link with "OK". The query should be answered with "Yes".

## Printing on a Network Printer

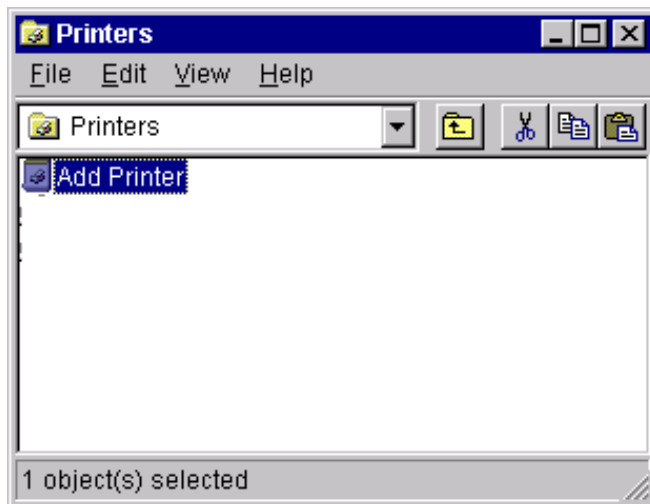

---

### Select printer driver under Windows NT

- Press key combination <ALT> <SYSREQ>  
The Windows NT screen is displayed.
- 
- In the Start menu press first "Setting" and then "Printers".  
The printer window is opened.

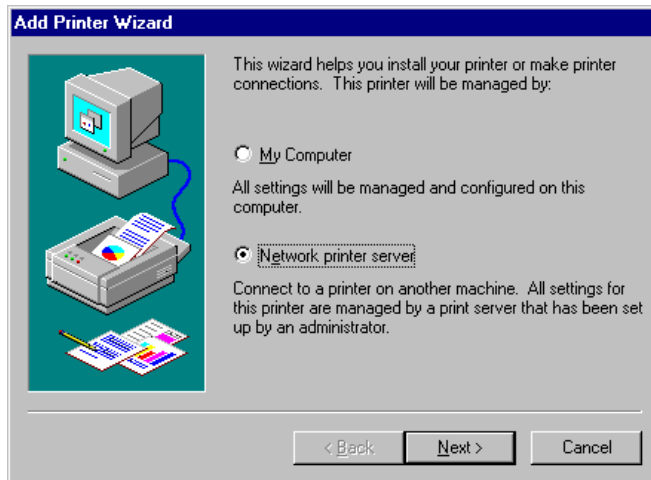

- Double-click line "Add Printer".

The "Add Printer Wizard" window is opened. This window leads through the following printer driver installation.

- Click first "Network Printer Source" and then "Next".

The list of available network printers is displayed.

- Mark the printer and select with "OK".

The available printer drivers are displayed. The left-hand selection table indicates the manufacturers and the right-hand one the available printer drivers.

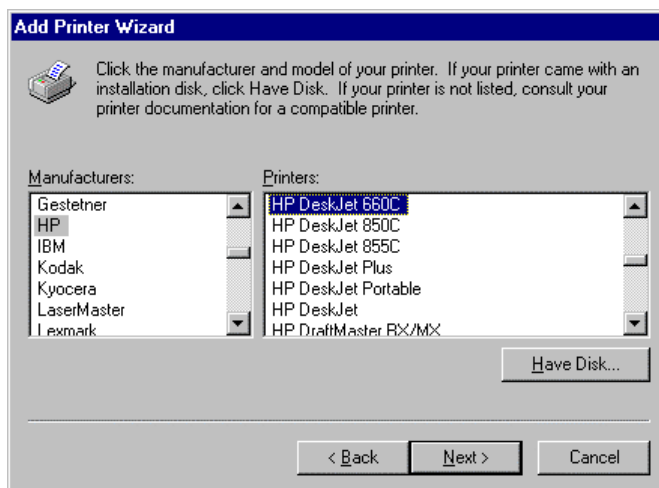

- Mark the manufacturer in selection table "Manufacturers" and then the printer driver in selection table "Printers".





- Click "Next".

The window for starting a test page is displayed. The test print is for checking if the installation was successful.

- Switch on printer.
- Click Yes (recommended)".
- Click "Finish".

A test page is printed out if the installation was successful.

If the test page is not printed out or not completely, the Windows NT online help offers troubleshooting instructions under the entry "Printer Trouble Shooting".

The instrument has to be configured with this printer for the printout of the measurement screen. This configuration is described in this chapter in the section "Connecting an Output Device".

## Server Function

With the server function data can be provided on the instrument for use in other computers. This is possible only in the MICROSOFT network. The server function is released after network installation as standard. If this is not required, it should be deactivated, see "Installation of Network Services".

The availability of instrument data in the network is controlled by releases. The release is a property of a file or of a directory. To grant a release, the object is to be marked in "Windows NT Explorer" and pressed by the right-hand mouse key. The release is performed under Properties -> Sharing by selecting "Shared As". Other computers can then access these objects with the names allocated under "Share Name". The online help gives further information on the network operation.

## TCP/IP

The TCP/IP protocol allows files to be transmitted between different computer systems. A program running on both computers is required to control the data transfer. The same operating or file system need not be used by the two partners. A file transfer is possible between DOS/WINDOWS and UNIX, for example. One partner has to be configured as host the other as client or vice versa. The system performing several processes at the same time (UNIX) will normally be the host. The usual file transfer program used for TCP/IP is FTP (File Transfer Protocol). An FTP host is installed as standard on most of the UNIX systems.

After installing the TCP/IP services, a terminal link can be established with "Start" - "Programs" - "Accessories" - "Telnet" or a data transmission with FTP using "Start" - "Run" "ftp" - "OK". Thus, all controller systems can be accessed which support these universal protocols (UNIX, VMS, ...).

Further information is given in the NT online help which can be called up with "Help".

**FTP**

For a complete description of the functions and commands see the FTP documentation.

**Establishing a connection**

➤ Click "Start" and then "Run" in the task bar.

The program is started with the DOS command

```
FTP
```

The following command sets up the connection:

```
OPEN <xx.xx.xx.xx>
```

xx.xx.xx.xx = IP address, e.g. 89.0.0.13

**File transmission**

To transmit a file to the target system, the following command is used:

```
PUT <file name>
```

file name = name of file e.g. DATA.TXT.

To call a file from the target system, the following command is used:

```
GET<file name>
```

file name = name of file e.g. SETTING.DAT.

```
TYPE B
```

allows the transmission of files in the BINARY format, no conversion is performed.

```
TYPE A
```

allows the transmission of files in the ASCII format. Thus, control characters are converted so that the text files can be read on the target system, too.

**Examples:**

```
PUT C:\AUTOEXEC.BAT
```

sends the AUTOEXEC.BAT file to the target system.

```
LCD DATA
```

changes to subdirectory DATA in the computer function.

```
CD SETTING
```

changes to the subdirectory SETTING on the target system.

**Changing directories**

The command

```
LCD <path>
```

changes the directory as the corresponding DOS command.

```
LDIR
```

lists the directory.

These commands refer to the computer function of the instrument. If the 'L' preceding the commands is omitted, they apply to the target system.

## **Option FSIQB70 - DSP and IQ Memory Extension (2 X 512 K)**

FSIQB70 is a hardware option. FSIQ has to be equipped with this option to enable the installation of future firmware options such as option FSIQK71, Code Domain Power Measurement for IS95.

Moreover, option FSIQB70 is the prerequisite for a R&S demo software used for the CDP measurement on W-CDMA signals (NTT DoCoMo and 3GPP downlink).

Apart from this, FSIQB70 has no effect on the operation of the unit.

## Contents - Chapter 2 "Getting Started"

### 2 Getting Started

<b>Level and Frequency Measurements</b> .....	<b>2.1</b>
Measurement Task.....	2.2
Important Spectrum Analyzer Functions .....	2.2
Sweep, Level and Frequency Measurements – Example 1 .....	2.2
Sweep, Level and Frequency Measurements – Example 2 .....	2.7
Level Measurement Accuracy .....	2.9
<b>Measurement of Harmonic Separation</b> .....	<b>2.10</b>
Measurement Task.....	2.10
Important Spectrum Analyzer Functions .....	2.11
Measurement Procedure - Harmonic Separation – Example 1 .....	2.12
Measurement Procedure - Harmonic Separation – Example 2.....	2.16
Measurement Procedure - Harmonic Separation – Example 3.....	2.20
<b>Measurement of Intermodulation Distortions</b> .....	<b>2.24</b>
Measuring Task .....	2.24
Important Spectrum-Analyzer Functions .....	2.25
Measurement.....	2.26
<b>Time-domain Measurements with Pulsed Signals</b> .....	<b>2.31</b>
Measuring Task .....	2.31
Important Spectrum Analyzer Functions .....	2.31
Measurement.....	2.32



## 2 Getting Started

Chapter 2 presents basic measurements performed by a signal analyzer to provide fast and easy access to the operation of the instrument.

Before starting any measurement with the FSIQ, please note the instructions given in chapter 1 for putting the instrument into operation. In chapters 3 you will find detailed information on customizing the instrument and the display.

For a systematic explanation of all menus, functions and parameters and background information refer to the reference part in chapter 4.

In the following description, each step is explained in detail using the FSIQ so that the instrument can be immediately used without the need for learning all of the available functions. The described measurement applications are:

- Measurement of the level and frequency of a sine wave signal.
- Measurement of harmonics.
- Measurement of third order intermodulation and determination of the intercept point.
- Zero span measurement of a pulsed signal.

All of the following examples assume the standard settings for the analyzer. These are set with the *PRESET* key in the *SYSTEM* key field. The most important standard settings are shown in Table 2-1. A complete listing of standard settings can be found in chapter 4.

Table 2-1 Important PRESET settings

Parameter	Parameter name	Setting			
		FSIQ3	FSIQ7	FSIQ26	FSIQ40
Mode	Mode	Analyzer	Analyzer	Analyzer	Analyzer
Center frequency	Center Frequency	1.75 GHz	3.5 GHz	13.25 GHz	20 GHz
Active Freq. Meas. Range	Span	3.5 GHz	7 GHz	26.5 GHz	40 GHz
Reference Level	Ref Level	- 20 dBm	- 20 dBm	- 20 dBm	- 20 dBm
RF Attenuation	RF ATT	10 dB	10 dB	10 dB	10 dB
Level Display Range	Level Range	100 dB	100 dB	100 dB	100 dB
Resolution Bandwidth	Res Bw	3 MHz	3 MHz	3 MHz	3 MHz
Video Bandwidth	Video Bw	3 MHz	3 MHz	3 MHz	3 MHz
Sweep Time	Sweep Time	5 ms	5 ms	150 ms	225 ms
Trigger	Trigger	free run	free run	free run	free run

## Level and Frequency Measurements

### Measurement Task

The determination of the level and frequency of a signal is one of the most frequently encountered measurement tasks typically performed by a spectrum analyzer. Usually, for the measurement of an unknown signal, the PRESET settings are initially selected. If levels above +30 dBm are expected or possible, then a power attenuator must be inserted ahead of the analyzer input. Without attenuation, these signal levels might damage or destroy the input attenuator or the input mixer.

## Important Spectrum Analyzer Functions

Important parameters for level and frequency measurements are the settings for the *CENTER FREQUENCY*, the selection of the active measurement frequency range (*SPAN*) and the *MARKER* functions.

### Sweep, Level and Frequency Measurements – Example 1

In this example, a signal with a frequency of 200 MHz and a level of -10 dBm are applied to the RF INPUT of the analyzer. The selection of the center frequency and the active frequency range takes place manually.

The necessary setup functions are performed almost without exception by the fixed-function keys. The menus which appear with a key can, for the most part, be ignored. In this manner, fast, key-oriented operation is possible.

The following setup steps are performed:

1. Reset the instrument.
2. Apply the test signal.
3. Set the center frequency to 200 MHz.
4. Reduce the active measurement frequency range (*SPAN*) to 1 MHz.
5. Measure the level and frequency using the marker.
6. Optimize the measurement dynamic range and reduce the level measurement error.
7. Measure the frequency with the internal frequency counter

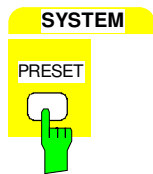

---

#### 1. Reset the instrument.

- Press the *PRESET* key.
- 

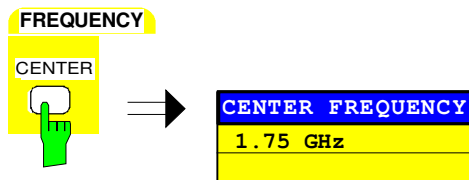

---

#### 2. Connect the test signal to the RF INPUT located on the instrument front panel.

---

#### 3. Set the center frequency to 200 MHz.

- Press the *CENTER* key in the *FREQUENCY* key field.

The input field for center frequency appears on the display screen.

---

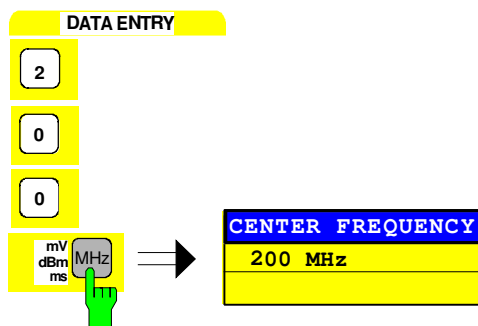

- Enter *200* via the numeric keypad and terminate with the *MHz* key.

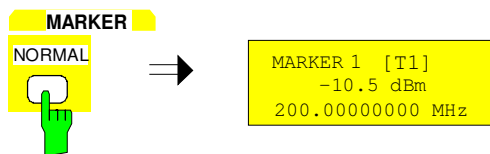
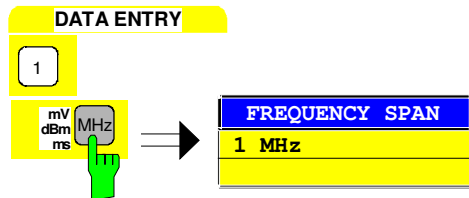

#### 4. Reduce the measurement frequency range (SPAN) to 1 MHz.

- Press the *SPAN* key in the *FREQUENCY* key field.

- Enter *1* via the numeric keypad and terminate with the *MHz* key.

**Note:** In conjunction with the change in measurement frequency range (*SPAN*), the resolution bandwidth (*RES BW*), video bandwidth (*VIDEO BW*) and sweep time (*SWEEP TIME*) are set to new values since they are defined as coupled functions in the standard *PRESET* settings.

#### 5. Measure level and frequency using the marker and read the resulting values on the display screen.

- Press the *NORMAL* key in the *MARKER* key field.

The marker jumps to the largest signal peak shown on the display screen.

**Note:** When the marker is switched on for the first time, it automatically performs the *PEAK SEARCH* function as demonstrated in this example.

If a marker was already active, the *SEARCH* key in the *MARKER* key field must be pressed in order to set the currently active marker to the displayed signal maximum.

The level and frequency measured by the marker can be read in the marker field at the upper edge of the display screen. (see Fig. 2-1).

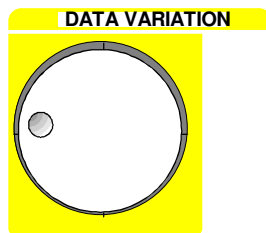

- Using the roll-key, the marker can be moved along the measured curve.

The corresponding level and frequency values appear in the marker field.



Fig. 2-1 shows the measured curve on the display screen over a 1 MHz range as well as the marker level and frequency values.

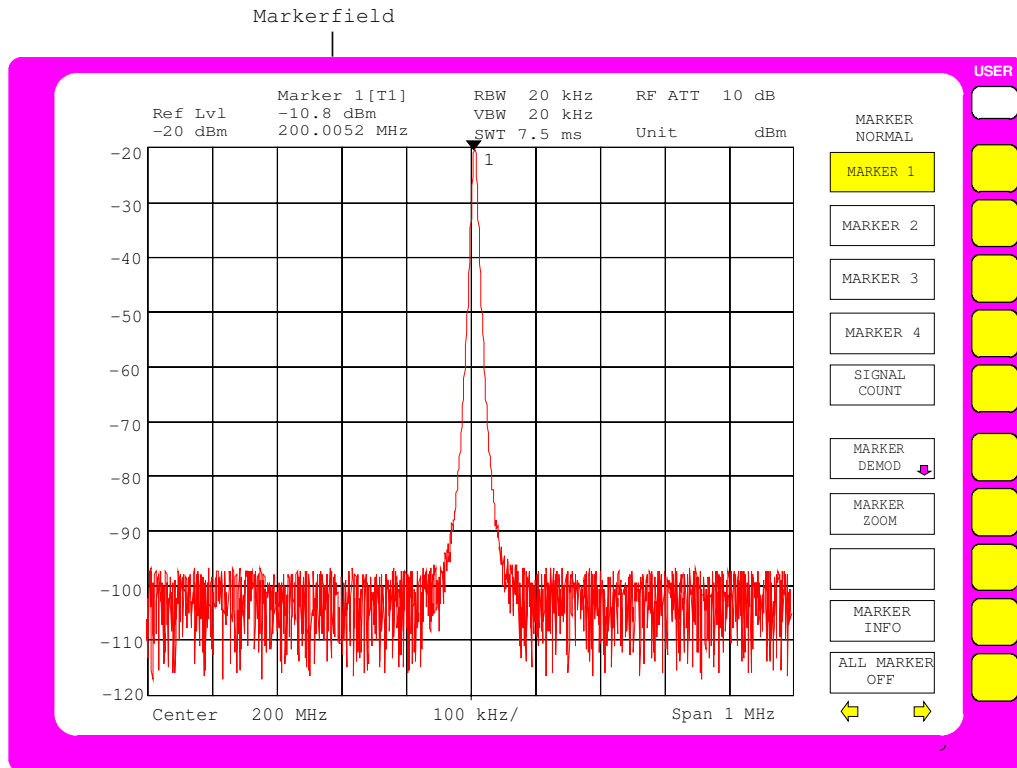
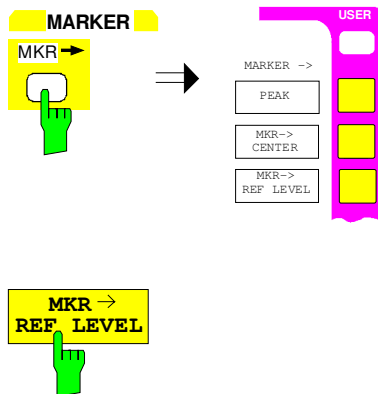

Fig. 2-1 200-MHz signal. The measured values are displayed in the marker field.

At low signal-to-noise ratios, the level measurement accuracy can be improved by an optimum selection of the FSIQ parameters. The accuracy of the frequency display can also be enhanced by applying the internal frequency counter.



**6. Optimize the dynamic range and reduce the level measurement error.**

- Press the *MKR*→ key in the *MARKER* key field. The *MARKER-MKR*→ menu is opened.

- Press *MKR* → *REF LEVEL* softkey. The reference level (REF LEVEL) is reduced to the signal level.

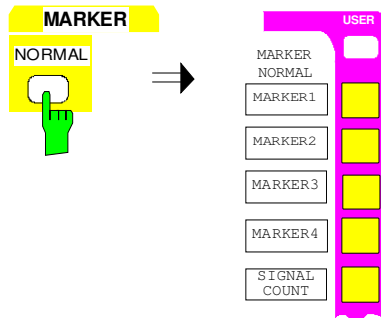

### 7: Determine the exact frequency with the internal frequency counter.

**Note:** The frequency counter measures the frequency of the marked signal with the selected counter resolution and at the accuracy of the internal frequency reference. A frequency measurement made using the marker is, however, limited by the number of horizontal display points and the applicable resolution bandwidth.

- Press the *NORMAL* key in the *MARKER* key field.  
The *MARKER NORMAL* menu is opened.

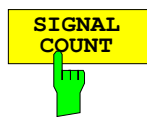

- Press the *SIGNAL COUNT* softkey.

The internal frequency counter is now active and measures the signal frequency with the *PRESET* resolution. The resolution is to be increased to 10 Hz.

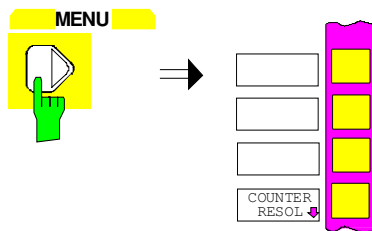

- Press the menu change key .  
The supplementary menu is opened.

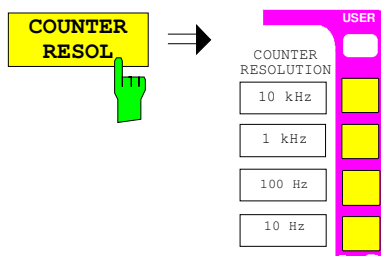

- Press the *COUNTER RESOL* softkey.  
The *COUNTER RESOLUTION* sub-menu is opened.

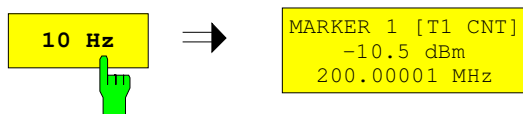

- Press the *10 Hz* softkey.  
The desired frequency resolution (10 Hz) is now selected.  
In the marker field, the item [CNT] indicates that the counter is active (see Fig. 2-2).

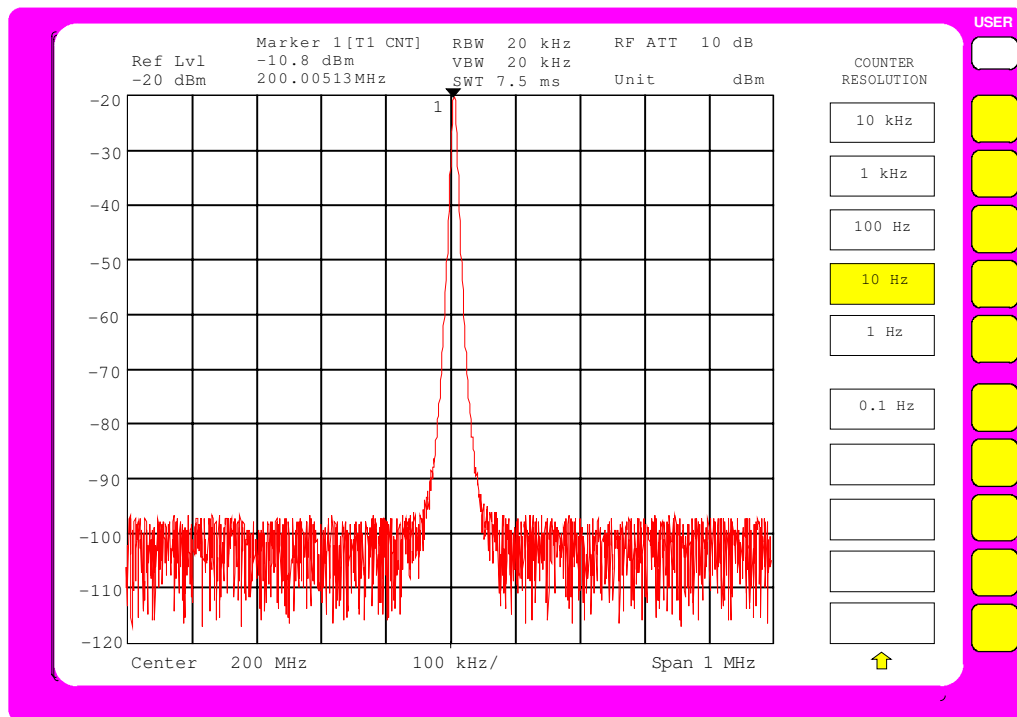

Fig. 2-2 Frequency measurement using the internal frequency counter.

## Sweep, Level and Frequency Measurements – Example 2

The zoom function (*MARKER ZOOM*) operates much faster than the manual input of center frequency and measurement frequency range, and permits the measurement frequency range displayed on the screen to be as narrow as desired.

As in Example 1, a signal with a frequency of 200 MHz and a level of -10 dBm is applied to the analyzer RF INPUT.

The following setup steps are performed:

1. Reset the instrument.
2. Apply the signal.
3. Zoom in on the signal.
4. Measure the level and frequency with the marker.
5. Optimize the dynamic range and reduce the level measurement error.
6. Measure the frequency with the internal frequency counter.

Steps 1 to 2 and 4 to 6 correspond to steps 1 to 2 and 5 to 7, respectively, of Example 1. Step 3 replaces the manual input of center frequency and measurement frequency range. (steps 3 and 4).

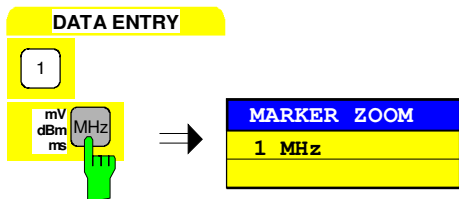
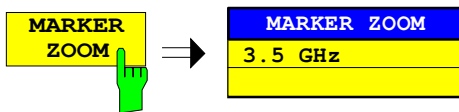
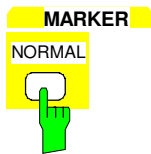

See steps 1 and 2 of example 1

1. **Reset the instrument to standard settings.**
2. **Connect the test signal to the analyzer RF INPUT.**

### 3. Zoom in on the signal.

- Press the *NORMAL* key in the *MARKER* key field .

The marker moves to the largest signal displayed on the screen. In this example, it is the signal at 200 MHz. (PEAK SEARCH function, see step 5 in Example 1).

- Press the *MARKER ZOOM* softkey.

The input field for the measurement frequency range appears on the display screen.

- Enter 1 via the numeric keypad and terminate with the *MHz* key.

After entry of the measurement frequency range, the marked signal is counted and then used as the new center frequency. At the same time, the entered measurement frequency range is set.

**Note:** In conjunction with the active measurement frequency range (SPAN) change, the resolution bandwidth (RES BW), video bandwidth (VIDEO BW) and sweep time (SWEEP TIME) are also set to new values since they are defined as coupled functions in the standard PRESET settings.

See steps 5 to 7 of example 1:

4. **Read the values for level and frequency as measured by the marker.**
5. **Optimize the dynamic range and reduce the level measurement error.**
6. **Determine the frequency with the internal frequency counter.**

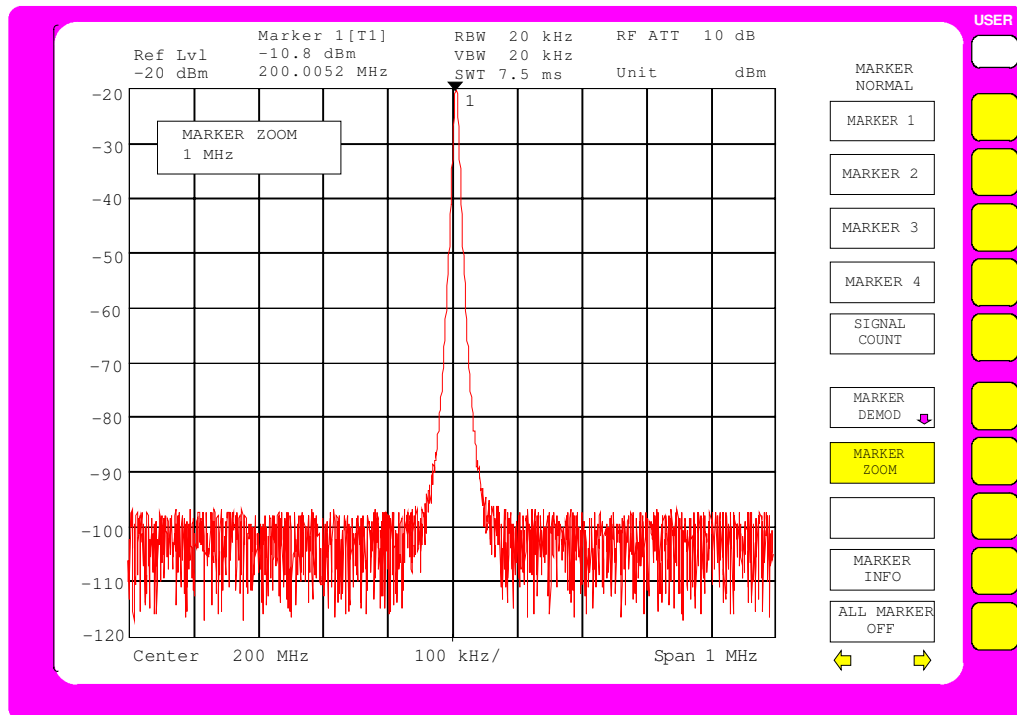

Fig. 2-3 The MARKER ZOOM function requires the entry of the measurement frequency range (span)

## Level Measurement Accuracy

The level measurement accuracy of an analyzer is influenced by the following parameters:

- RF attenuator (*RF-ATT*)
- IF amplification
- Resolution bandwidth (*RES BW*)
- Display range (*LEVEL RANGE*)
- Display linearity (*SCALE FIDELITY*)

The error in a level measurement for the FSIQ is < 1 dB for frequencies up to 1 GHz and < 1.5 dB for frequencies from 1 GHz to 3.5 GHz. This specification includes all of the above mentioned influential factors. The frequency characteristics of the pertinent modules (RF divider, front end) are stored individually in memory on each module. The FSIQ initializing routines read out the corresponding values during execution immediately after the analyzer is turned on and corrects the frequency characteristics during the sweep. Any errors in the attenuation settings, the filter bandwidth or the video rectifier are corrected after calling the built-in calibration routines. For calibration purposes, the FSIQ has an internal 120 MHz calibration source which is switched internally to the RF INPUT.

The measurement accuracy is guaranteed only after running the calibration routines. It should be noted, however, that the individual parameters are so stable that a calibration need only be performed, after approximately 15 minutes warm-up time, for larger temperature variations. Normally, a weekly calibration is more than adequate.

## Measurement of Harmonic Separation

### Measurement Task

The measurement of signal harmonics is a frequently occurring task which can be optimally performed by a spectrum analyzer. In general, all signals will contain harmonics to some degree. Harmonics are especially critical in high-power transmitters, e.g., in radio transmitters, where a significant radiated harmonic component may interfere with the reception of other radio services. Generally, non-linear device characteristics create harmonics which are often selectively reduced through the use of low-pass filters. Since the spectrum analyzer also has non-linear characteristics, e.g., at the first mixer, it is necessary to exercise caution during a measurement to insure that the spurious harmonics generated by the analyzer do not influence the measurement results. If necessary, the fundamental frequency must be selectively attenuated with respect to the harmonics by insertion of an appropriate high-pass filter.

For harmonic-content measurements, the achievable measurement dynamic range is dependent upon the k2 intercept of the spectrum analyzer. The k2 intercept point is defined as the fictitious first-mixer input level where the levels of the first harmonic and of the fundamental frequency are equal. In practice, this level cannot be applied to the mixer since, to do so, would cause its destruction. However, using the k2 intercept point concept, the achievable measurement dynamic range for the harmonics of a Unit Under Test (UUT) can be calculated with relative simplicity.

As can be seen in Fig.2-4, the harmonic level is reduced by 20 dB when the level at the fundamental frequency is reduced by 10 dB.

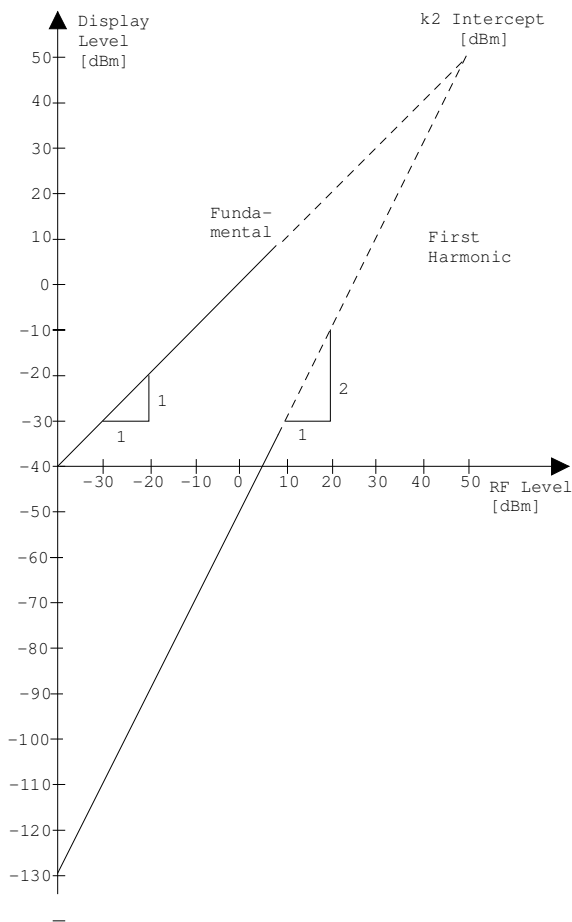

Fig.2-4 Theoretical display curve of fundamental and first harmonic with a k2 intercept of 50 dBm.

From the linear equations and the given intercept point, the following formula can be derived for the achievable harmonic separation  $a_{k2}$  in dB:

$$a_{k2} = IP2 - P_e \quad (1)$$

$a_{k2}$  = harmonic separation  
 $P_e$  = mixer level/dBm  
 $IP2$  = k2 intercept point

The formula for the internally produced level  $P_1$  at the first harmonic in dBm is:

$$P_1 = 2 \cdot P_e - IP2 \quad (2)$$

The lower harmonic measurement limit is dictated by the noise figure of the spectrum analyzer. Through adequate averaging with the video filter, the UUT harmonic level which is to be measured should be at least 4 dB over the noise figure so that the measurement error caused by the input noise is less than 1 dB.

From the above, the following rules for the measurement of large harmonic separations can be derived:

- Select an IF bandwidth as narrow as possible in order to reduce the noise figure.
- Select the RF attenuation as high as required so that the necessary harmonic separation can still be measured.

**Note:** *The mixer amplitude is the applied RF level reduced by the selected RF attenuation. The low distortion (LOW DISTORTION function) mode of the analyzer automatically sets the optimum RF attenuation for the best harmonic separation.*

The maximum harmonic separation is achieved when the harmonics level is equal to the inherent noise level of the receiver. The corresponding level at the mixer according to (2) is:

$$P_e [dBm] = \frac{P_{noise} / dBm + IP2}{2}$$

For a 30 Hz resolution bandwidth, (noise level < -140 dB,  $IP2 = 50$  dBm), this level is -45 dBm. Therefore, according to (1), the maximum measurable harmonic separation is 95 dB less 4 dB minimum signal-to-noise ratio.

## Important Spectrum Analyzer Functions

In addition to frequency and level settings, the harmonic separation measurement requires, above all, the delta markers. Also, the MRK→CF STEP SIZE function (marker frequency = center frequency step-width) is used in order to quickly measure the individual harmonics with the cursor keys.

There are several methods to measure harmonic content:

- The measurement of fundamental and harmonic signals in one measurement frequency range.
- The individual measurement of the harmonic separation in a narrow measurement frequency range. This method is preferred when high harmonic separation is to be measured (requires large dynamic range and, thus, narrow resolution bandwidth) or the frequency of the fundamental is very high, i.e., a very wide measurement frequency range is necessary.
- The measurement of fundamental and harmonics in two independent windows on the display screen (SPLIT SCREEN mode).

Example 1 describes the measurement of fundamental and harmonics in one measurement frequency range.

Example 2 describes the measurement of harmonic separation in separate measurement frequency ranges.

Example 3 shows the measurement of fundamental and harmonics in two independent windows on the display screen.

## Measurement Procedure - Harmonic Separation – Example 1

The analyzer 10 MHz reference signal is used at the input signal. The connector EXT REF IN/OUT on the rear panel is connected to the analyzer front-panel RF INPUT. Since the output level is 7 dBm, the reference level must be set to 10 dBm.

The following setup steps are performed:

1. Reset the instrument.
2. Set the reference level to 10 dBm.
3. Connect the rear-panel 10 MHz reference signal to the analyzer input RF INPUT.
4. Set the start frequency to 5 MHz.
5. Set the stop frequency to 55 MHz.
6. Smooth the displayed noise with the video bandwidth.
7. Measure the fundamental signal with the marker.
8. Measure the harmonic separation with the delta marker.
9. Measure the separation of remaining harmonics.

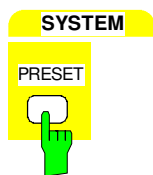

---

### 1. Reset the analyzer.

- Press the *PRESET* key.

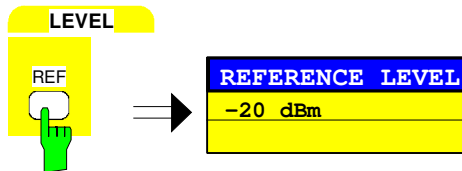



---

### 2. Set the reference level to 10 dBm.

- Press *REF* key in the *LEVEL* key field.

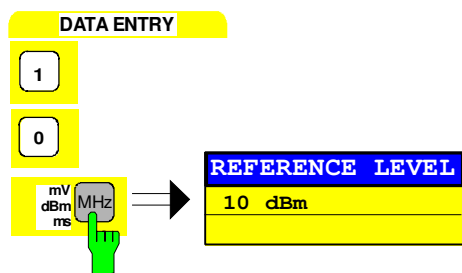
The entry field for the reference level appears on the display screen.



- Enter 10 via the numeric keypad and terminate with the *dBm* key.

---

### 3. Connect the 10 MHz-reference signal (output EXT REF IN/OUT) to the analyzer RF INPUT.



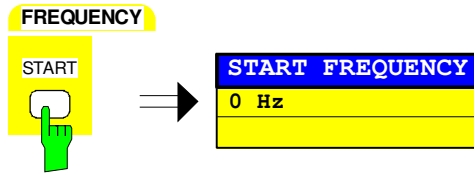

**4. Set the start frequency to 5 MHz**

- Press the *START* key in the *FREQUENCY* key field. The entry window for the start frequency appears on the display screen.

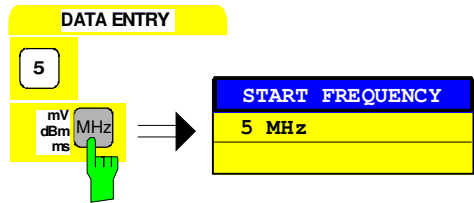

- Enter 5 via the numeric keypad and terminate with the *MHz* key.

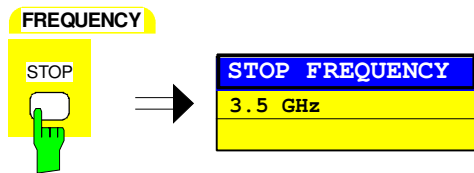

**5. Set the stop frequency to 55 MHz**

- Press the *STOP* key in the *FREQUENCY* key field. The entry window for the stop frequency appears on the display screen.

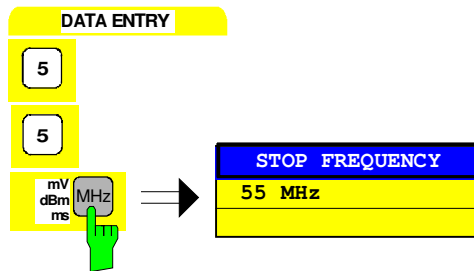

- Enter 55 via the numeric keypad and terminate with the *MHz* key.

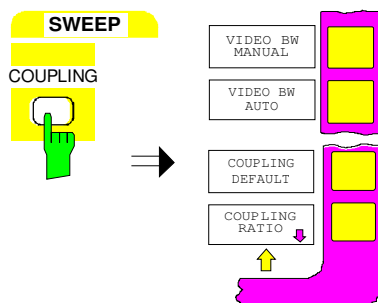

**6. Smooth the displayed noise with the video bandwidth**

- Press the *COUPLING* key in the *SWEEP* key field.

The *SWEEP-COUPLING* menu is opened.

The video bandwidth can now be either automatically coupled to the resolution bandwidth or manually entered.

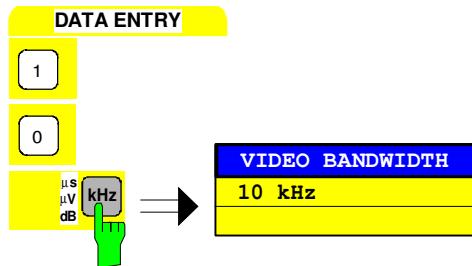
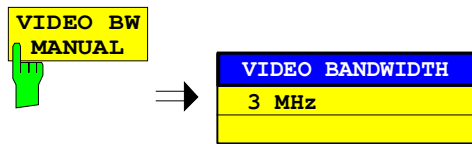
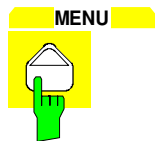
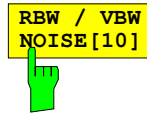
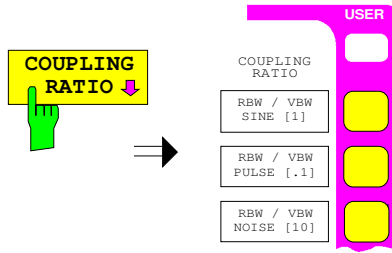

either:

**Automatic coupling of the video bandwidth to the measurement frequency range**

- Press the *COUPLING RATIO* softkey.

The sub-menu for setting the automatic coupling of bandwidths to the measurement frequency range is opened.

- Press the *RBW / VBW NOISE [10]*.

The video bandwidth is set to a factor of 10 less than the resolution bandwidth. This smooths the displayed noise.

- Press the menu change key .

The *COUPLING RATIO* submenu is closed.

or:

**Manual input of the video bandwidth**

- Press the *VIDEO BW MANUAL* softkey.

The entry field for the video bandwidth appears on the display screen.

- Enter 10 via the numeric keypad and terminate with the *kHz* key.

The analyzer displays the fundamental as well as the first to third harmonics (see Fig.2-5).

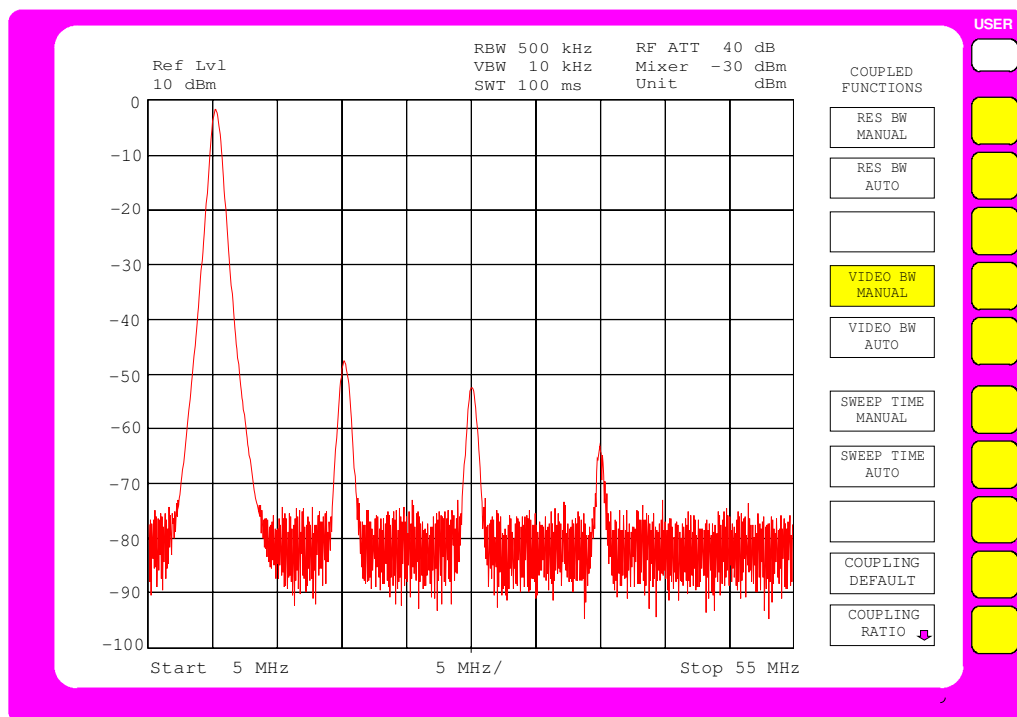

Fig.2-5 The fundamental and harmonics to 55 MHz



**7. Measure the fundamental with the marker.**

- Press the *NORMAL* key in *MARKER* key field.

The marker appears at the fundamental peak (see also level and frequency measurement step 5 of the *PEAK SEARCH* function).

The measured values can be read at the upper left of the display screen.



**8: Activate the delta marker and measure the harmonic separation**

- Press the *DELTA* key in the *MARKER* key field

The delta marker is active and appears on the fundamental.

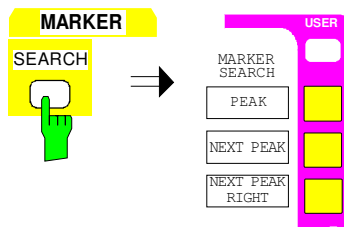

- Press the *SEARCH* key in the *MARKER* key group .  
The *SEARCH-MARKER* menu is opened.



- Press the *NEXT PEAK RIGHT* softkey.

The delta marker jumps to the first harmonic and measures the difference between the harmonic and the fundamental. The measured values can be read at the upper left of the display screen. In this example, the harmonic separation is approx. 40 dB (see Fig.2-6).



**9. Measure the separation of additional harmonics**

- Press the *NEXT PEAK RIGHT* softkey.

The delta marker jumps to the next highest harmonic. The measured value can be read as before.

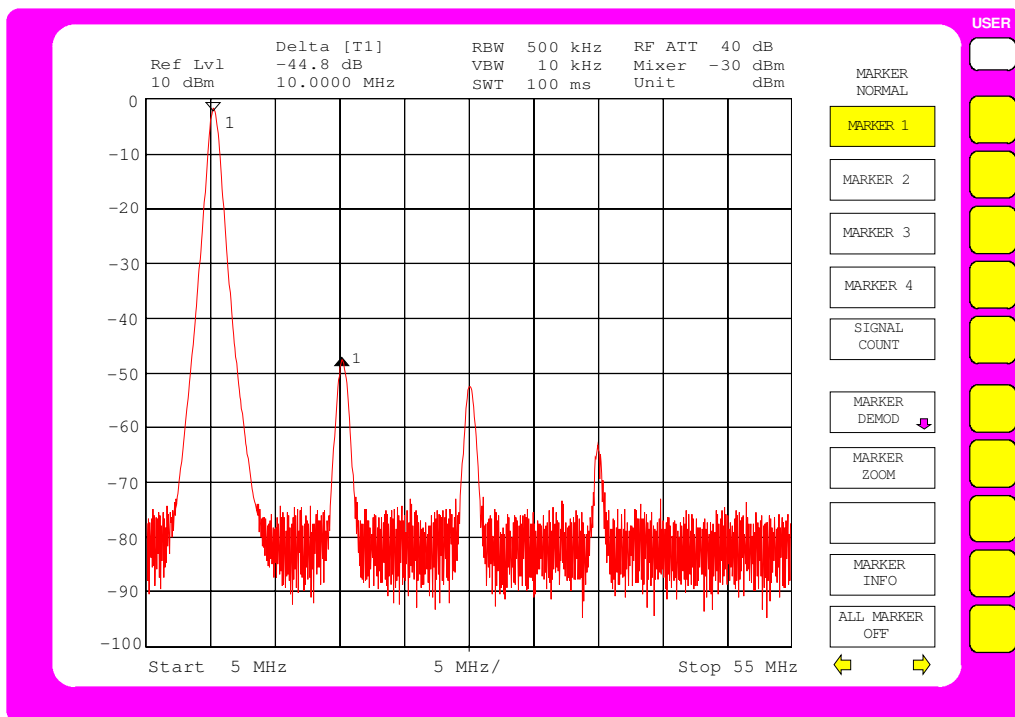

Fig.2-6 First harmonic separation: approx. 40 dB referred to the fundamental

## Measurement Procedure - Harmonic Separation – Example 2

In example 2, the fundamental frequency of the test signal and the separation of the individual harmonics are measured. The reference to the fundamental is established with the REFERENCE FIXED marker, and the movement from harmonic to harmonic is performed with the MKR→ CF STEP SIZE and step keys. This method is recommended when the highest dynamic range is to be achieved.

The following measurement steps are carried out:

1. Reset the instrument.
2. Set the reference level to 10 dBm.
3. Connect the rear-panel 10 MHz reference signal (connector EXT REF IN/OUT) to the analyzer input RF INPUT.
4. Set the start frequency to 5 MHz.
5. Set the stop frequency to 55 MHz.
6. Smooth the displayed noise with the video bandwidth.
7. Measure the fundamental signal with the marker.
8. Reduce the measurement frequency range (ZOOM function):
9. Set the frequency step size to the fundamental frequency.
10. Save the reference value (REFERENCE FIXED)
11. Measure the separation to the first harmonic.
12. Measure the separations to the remaining harmonics.

---

**Set the analyzer according to Example 1 up to and including "Measure the fundamental with the marker" (steps 1 to 7).**

---

### **8. Reduce the measurement frequency range.**

- Press the *NORMAL* key in the *MARKER* key field .  
The *MARKER-NORMAL* menu is opened.

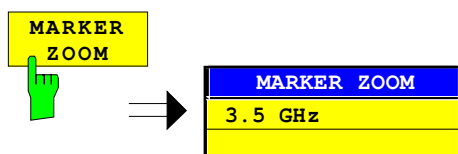
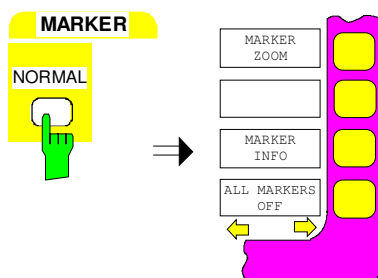

- Press the *MARKER ZOOM* softkey.  
The entry field for the measurement frequency range appears on the display screen.

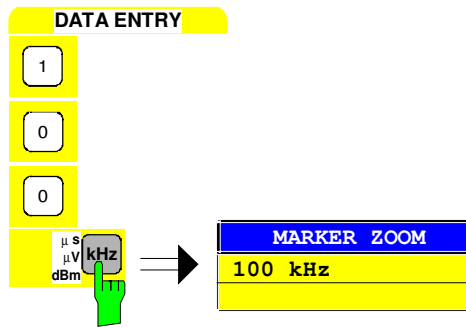

➤ Enter 100 via the numeric keypad and terminate with the kHz key.

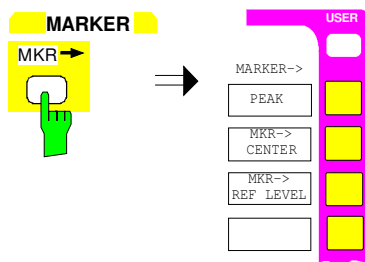

**9. Set the frequency step size to the fundamental frequency**

➤ Press the MKR → key in the MARKER key field  
The MARKER-MKR → menu is opened.

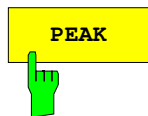

➤ Press the PEAK softkey.

The marker appears at peak of the fundamental signal.



➤ Press the MKR → CF STEP SIZE softkey.

The step size used when setting the center frequency with the cursor keys is set equal to the marker frequency.

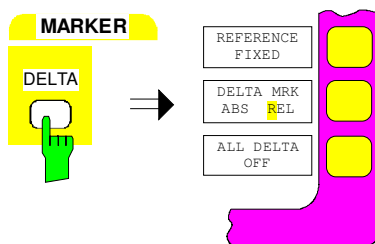

**10. Fix reference value**

➤ Press the DELTA key in the MARKER key field.  
The DELTA-MARKER menu is opened.



➤ Press the REFERENCE FIXED softkey.

The position of the marker is now a curve-independent reference for the delta measurement, even when the actual reference point is not visible on the display screen.

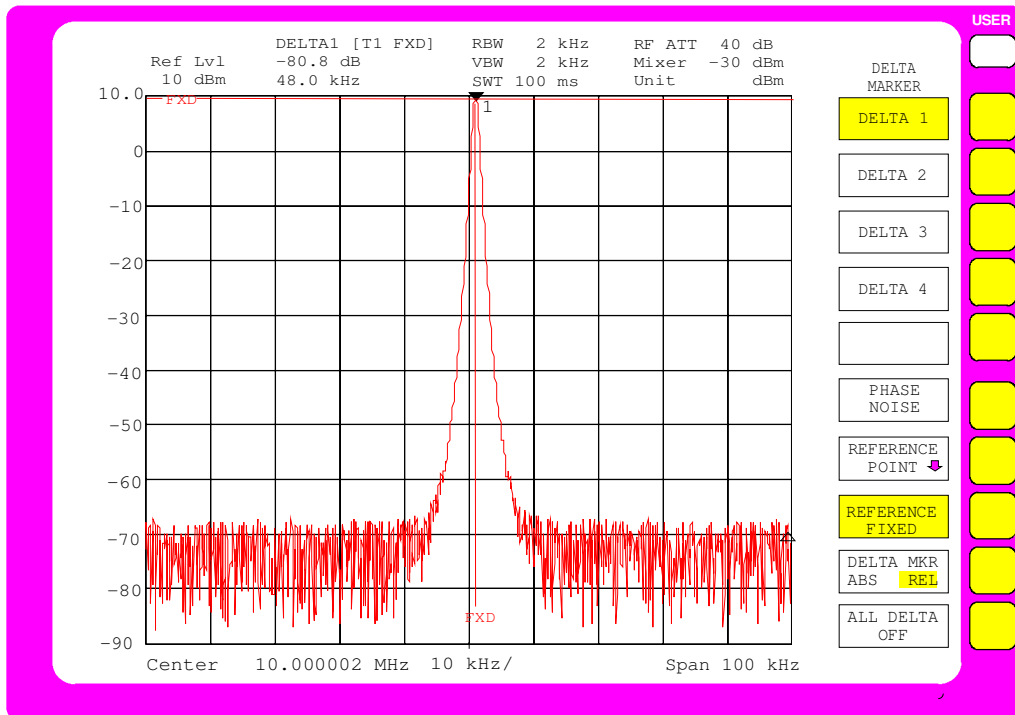
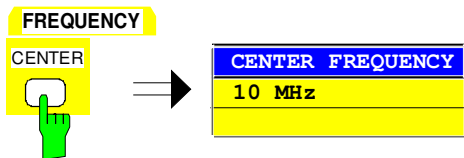

Fig. 2-7 Fundamental with REFERENCE FIXED marker



**11. Measure the harmonic**

- Press the *CENTER* key in the *FREQUENCY* key field.

The entry field for the center frequency appears on the display screen.

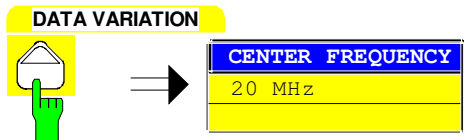

- Press the cursor key  in the *DATA VARIATION* key field.

The center frequency is increased by one step (= fundamental frequency).

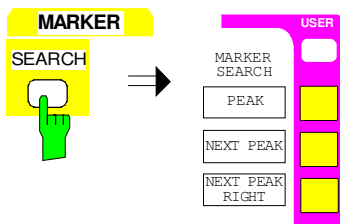

- Press the *SEARCH* key in the *MARKER* key field.

The *SEARCH-MARKER* menu is opened.

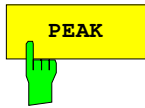

- Press the *PEAK* softkey.

The delta marker appears at the first harmonic and measures the separation from harmonic to fundamental. The measured value is displayed in the marker field at the upper left of the display screen (see Fig. 2-8).

## 12. Measure the separation of additional harmonics

- Repeat all of step 11.

The center frequency is once again increased by the frequency of the fundamental. The delta marker thus appears at the next harmonic.

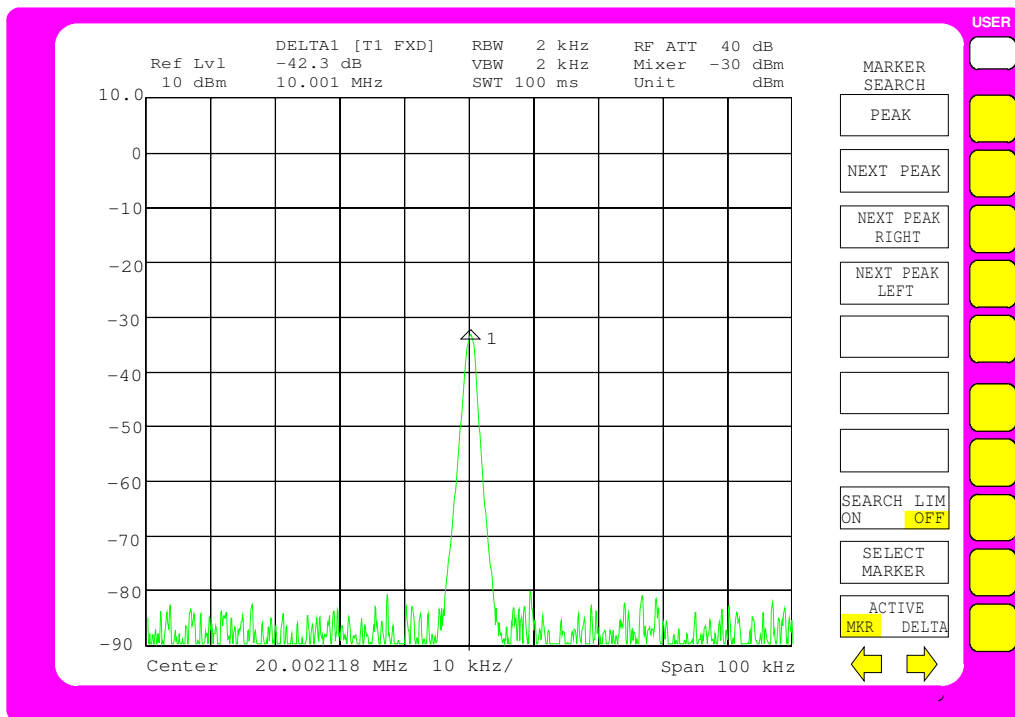

Fig. 2-8 Measurement of the first harmonic

**Note:** The spurious harmonics generated internal to the analyzer can be easily recognised by switching in additional RF attenuation. When an additional 10 dB attenuation is inserted, the displayed level of harmonics generated by the analyzer will be reduced by 10 dB, however, harmonics from the UUT will remain unchanged. This assumes that the receiver noise is substantially below the displayed level.



## Measurement Procedure - Harmonic Separation – Example 3

The measurement of fundamental and harmonics can also be performed in two independent windows on the display screen (SPLIT-SCREEN mode). This mode permits the simultaneous presentation of the fundamental and harmonics with higher resolution and dynamic range.

The following measurement steps are carried out:

1. Reset the instrument.
2. Set the reference level to 10 dBm.
3. Connect the rear-panel 10 MHz reference signal (connector EXT REF IN/OUT) to the analyzer input RF INPUT.
4. Set the start frequency to 5 MHz.
5. Set the stop frequency to 55 MHz.
6. Smooth the displayed noise with the video bandwidth.
7. Measure the fundamental signal with the marker.
8. Reduce the measurement frequency range (ZOOM function):
9. Set the frequency step size to the fundamental frequency.
10. Set the display to two measurement windows.
11. Uncouple the window settings.
12. Measure the harmonic separation.

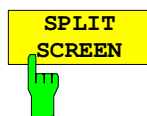
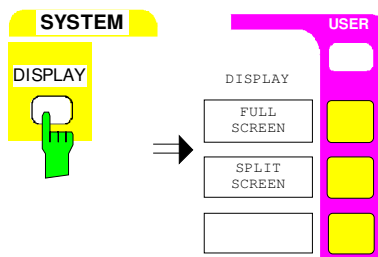

---

**Set the analyzer according to Example 2 up to and including " Set the frequency step size to the fundamental frequency" (steps 1 to 9).**

---

### 10. Set the display to two uncoupled measurement windows.

- Press the *DISPLAY* key in the *SYSTEM* key field.  
The *SYSTEM DISPLAY* menu is opened.

- 
- Press the *SPLIT SCREEN* softkey.

Two windows are displayed simultaneously on the display screen (see Fig.2-9). The upper measurement window is called Screen A and the lower is called Screen B. At the initial turn-on, both measurement windows are coupled, i.e., changes in settings such as frequency or levels take place in both windows.

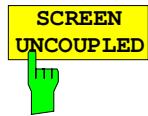
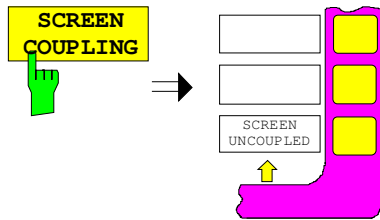

**11. Uncouple the window settings**

- Press the *SCREEN COUPLING* softkey.  
The *SCREEN COUPLING* sub-menu is opened.

- Press the *SCREEN UNCOUPLED* softkey .

The settings for each measurement window can now be selected independently. The entry is assigned to either *ACTIVE SCREEN A* or *ACTIVE SCREEN B* as selected by the softkey in the main menu window.

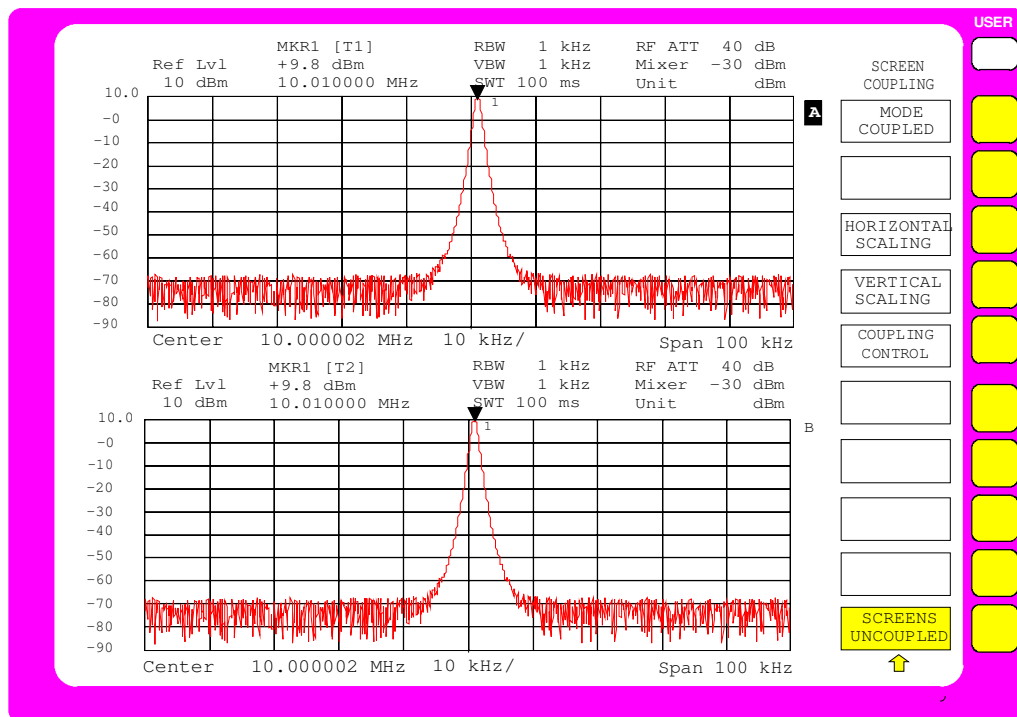
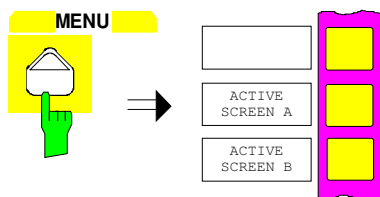

Fig.2-9 SPLIT-SCREEN Mode



**12. Measure the harmonic in the lower measurement window SCREEN B.**

- Press the menu change key .  
The main menu is opened.



- Press the *ACTIVE SCREEN B* softkey.

The following entries are now valid for the lower window which is used to measure the harmonic separation.

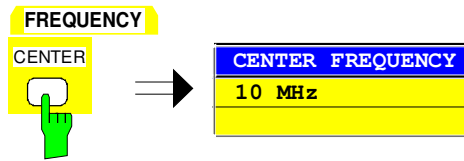

- Press the *CENTER* key in the *FREQUENCY* key field.

The entry field for the center frequency appears on the display screen.

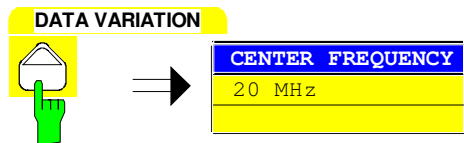

- Press the cursor key  in the *DATA VARIATION* key field.

The center frequency is increased by one step. (= fundamental frequency).

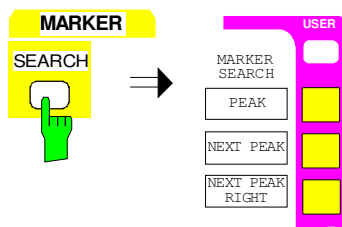

- Press the *SEARCH* key in the *MARKER* key field.

The *SEARCH-MARKER* menu is opened.

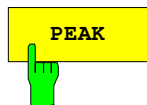

- Press the *PEAK* softkey.

A marker appears at the first harmonic and measures the level of the harmonic. The measured value is displayed in the marker field at the upper left of the second measurement window (see Fig.2-10).

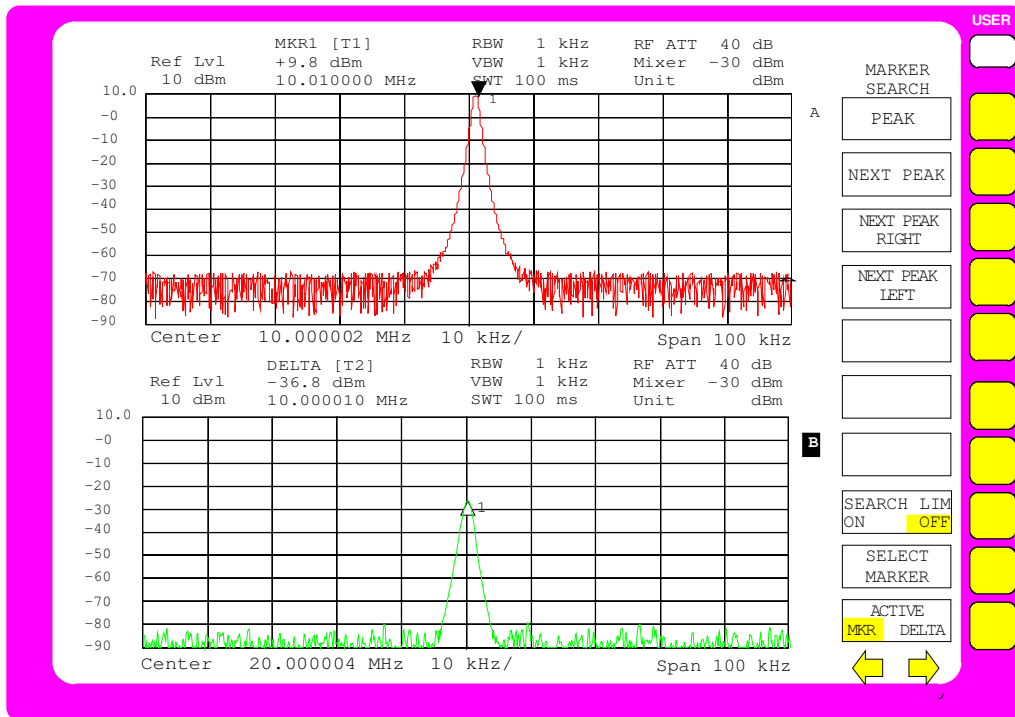

Fig.2-10 Alternate representation of fundamental and first harmonic

## Measurement of Intermodulation Distortions

### Measuring Task

If several signals are applied to a transmission quadripole with a non-linear characteristic, intermodulation products occur at its output due to addition and subtraction of the signals. The non-linear characteristic causes harmonics of the information signals to occur, which are mixed up at the characteristic. The low-order mixture products are particularly significant since they have the highest levels and are close to the information signals. The third-order intermodulation product causes the most significant distortions. In case of two-tone modulation it is the mixture product of the first information signal and the first harmonic of the second information signal.

The frequencies of the spurious signals occur with an offset of the information signals above and below the information signals. Fig. 2-11 shows the intermodulation products  $P_{S1}$  and  $P_{S2}$ , which are obtained from the two information signals  $P_{N1}$  and  $P_{N2}$ .

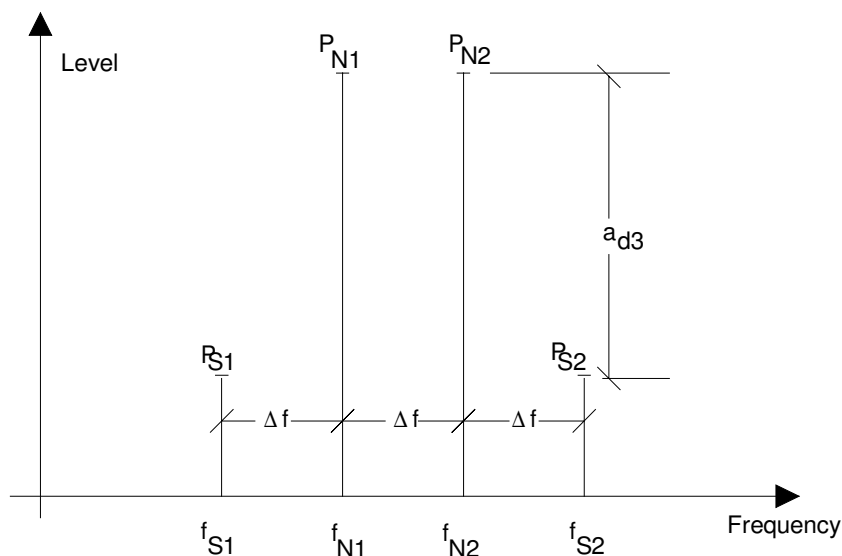

Fig. 2-11 Intermodulation products  $P_{S1}$  and  $P_{S2}$

The intermodulation product at  $f_{S2}$  is obtained by mixture of the first harmonic of the information signal  $P_{N2}$  with the signal  $P_{N1}$ , the intermodulation product at  $f_{S1}$  by mixture of the first harmonic of the information signal  $P_{N1}$  with the signal  $P_{N2}$ .

$$f_{S1} = 2 \times f_{N1} - f_{N2} \quad (1)$$

$$f_{S2} = 2 \times f_{N2} - f_{N1} \quad (2)$$

The level of the spurious products depends on the level of the information signals. If both information signals are increased by 1 dB, the level of the spurious responses increases by 3 dB. I.e., the offset  $a_{d3}$  of the spurious responses decreases by 2 dB. This is illustrated by Fig.2-12.

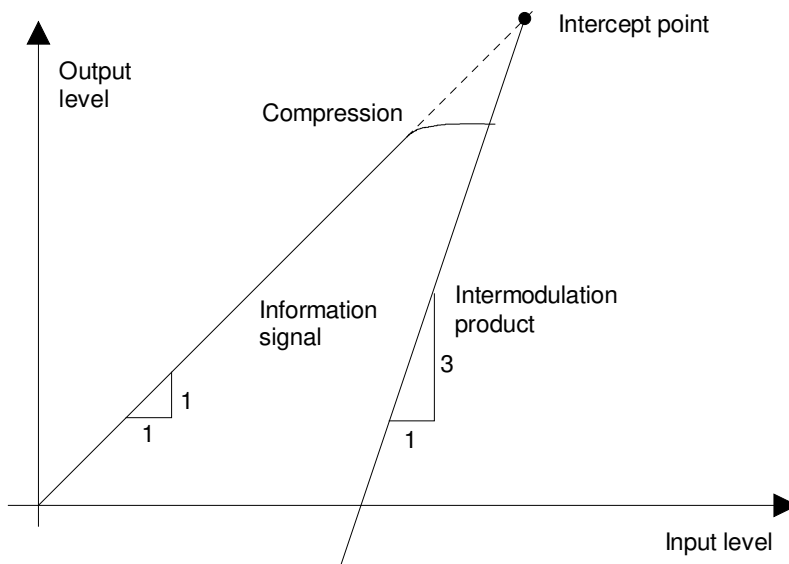

Fig.2-12 Dependence of the spurious product level from the level of the information signals

The information signals at the output of a four-terminal network increase as the input level increases as long as the input level is in the linear range. If the level changes by 1 dB at the input, it also changes by 1 dB at the output. At a specified input level the quadripole compresses and the output level does not increase any more. The third-order intermodulation products increase three times as fast as the information signals. The intercept point is the fictitious level where both lines intersect. It cannot be measured directly since the wanted level is limited by the maximum output power of the quadripole. It can however be calculated from the known gradients of the lines and the measured intermodulation offset  $a_{D3}$  with a given level using the following formula:

$$IP3 = \frac{a_{D3}}{2} + P_N \quad (3)$$

If, e.g., the intermodulation offset is 60 dB and the input level  $P_N$  is -20 dBm, the third-order intercept  $IP3$  is calculated as follows:

$$IP3 = \frac{60}{2} + (-20\text{dBm}) = 10\text{dBm}. \quad (4)$$

## Important Spectrum-Analyzer Functions

Correct setting of the RF attenuation is particularly important for intermodulation measurements. In the FSIQ, the attenuation can be set automatically according to the reference level. There are three coupling methods:

- RF ATTEN AUTO
- ATTEN AUTO LOW DIST
- ATTEN AUTO LOW NOISE

The coupling mode ATTEN AUTO LOW DIST is recommended to be used for measurement of intermodulation distortions since the intrinsic spurious products are minimized.

## Measurement

In the following, measurement of the third-order intercept of an amplifier is described, by way of example.

Two signal generators with the frequencies  $f_1$  and  $f_2$  supply signals to the amplifier via a power divider. The output of the device under test is connected to the RF input of the FSIQ. The level of the two signal generators is the same and is selected such that the DUT is not overloaded.

$f_1 = 99.5$  MHz

$f_2 = 100.5$  MHz

Level at amplifier input = -20 dBm with  $f_1$  and  $f_2$

Test setup:

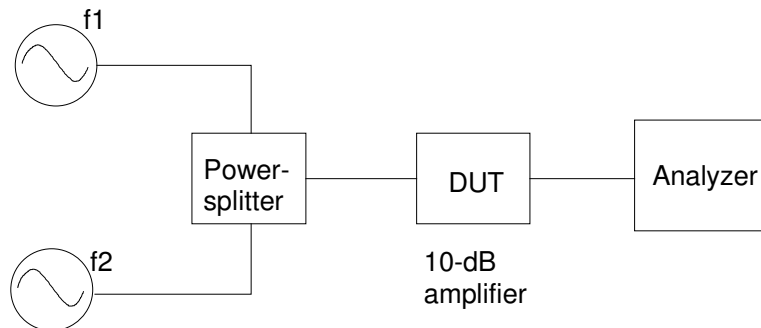

The following measurement steps are carried out:

1. Reset the FSIQ.
2. Set the center frequency to 100 MHz.
3. Set the frequency-display range to 5 MHz (SPAN function).
4. Set the reference level to -10 dBm.
5. Set the resolution bandwidth to 10 kHz.
6. Set the RF attenuation for low-distortion mode.
7. Measure the intercept point using the markers.
8. Calculate IP3 from the measured offset and the signal level according to (4)

*Cf. measurement example Level and Frequency Measurements (steps 1 to 3)*

1. *Reset the instrument.*
2. *Set the center frequency to 100 MHz.*
3. *Set the frequency-display range to 5 MHz.*

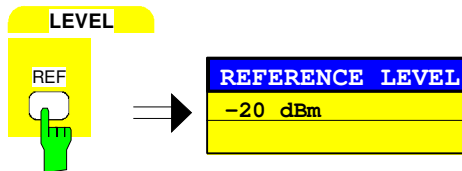

#### 4. Set the reference level to -10 dBm

- Press the *REF* key in the *LEVEL* key field.

The entry window for the reference level is displayed.

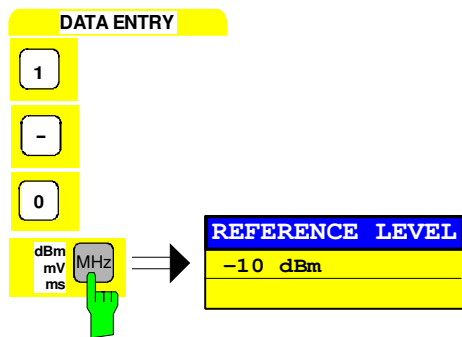

- Enter *-10* via the numeric keypad in the entry field and terminate the entry by pressing the *dBm* key.

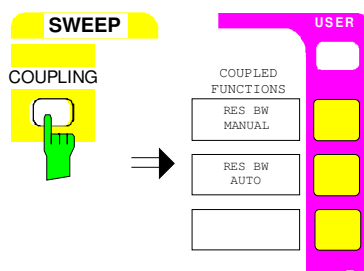

#### 5. Set the resolution bandwidth to 10 kHz

- Press the *COUPLING* key in the *SWEEP* key field.

The *SWEEP-COUPLING* menu is opened.

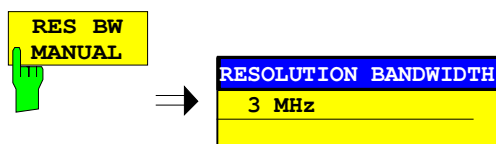

- Press the *RES BW MANUAL* softkey.

The entry field for the resolution bandwidth is displayed.



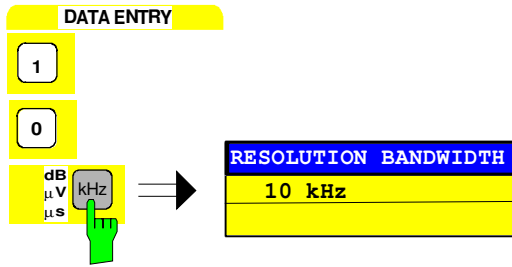

- Enter 10 in the entry field via the numeric keypad and terminate the entry by pressing the kHz key.

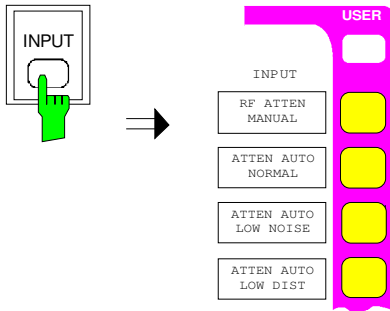

**6. Set low-distortion mode**

- Press the *INPUT* key  
The *INPUT* menu is opened.

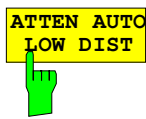

either

- Press the *ATTEN AUTO LOW DIST* softkey.  
The low-distortion mode is selected. Thus, the combination of input attenuation and IF gain is selected such that the internal intermodulation products are the smallest possible and the intermodulation-free range is as large as possible.

The FSIQ shows the measuring diagram in Fig.2-13

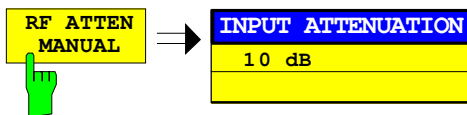

or

- Press the *RF ATTEN MANUAL* softkey.  
The entry window for the RF attenuation is displayed.

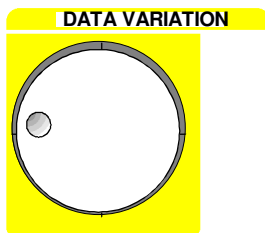

- Vary the RF attenuation using the roll-key.  
If the amplitude of the IM products doesn't change, the existing setting is sufficient (see Fig.2-13)

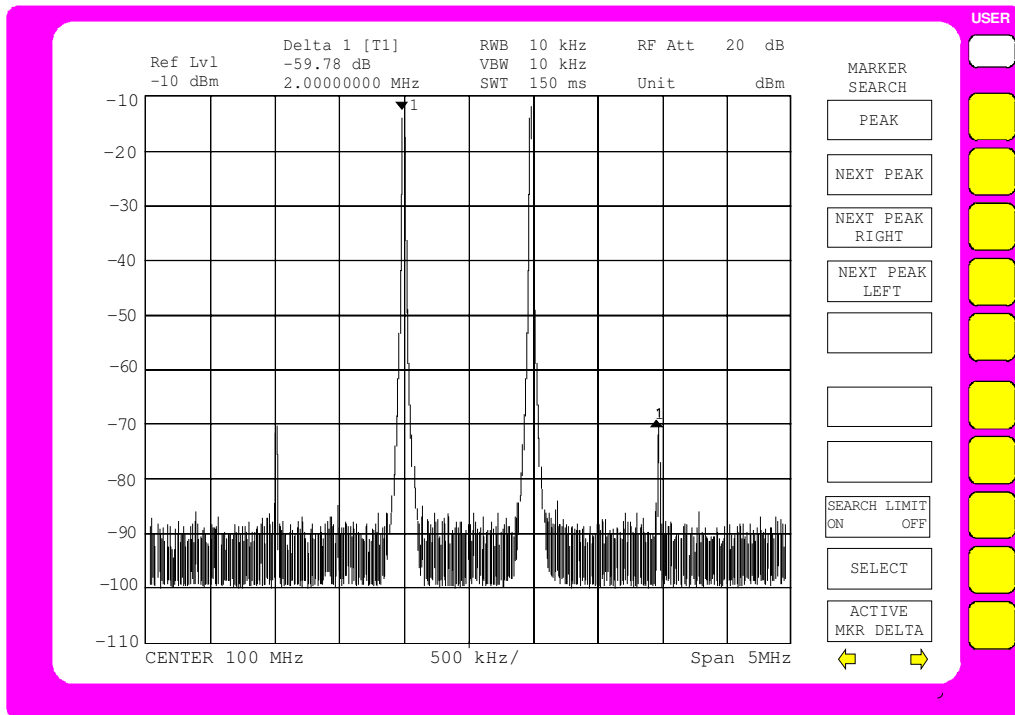

Fig.2-13 Measuring diagram in low distortion mode



**7. Measure the intercept point using the markers**

- Press the *NORMAL* key in the *MARKER* key field.

The marker appears on the fundamental (see also level and frequency measurement step 5, PEAK SEARCH function).

The measured values can be read off at the upper left of screen.



- Press the *DELTA* key in the *MARKER* key field.

The delta marker is active. It appears on the fundamental.

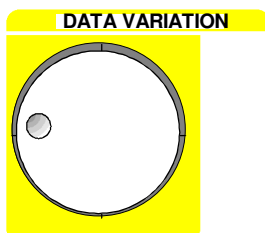

either

- Move the marker to an intermodulation product using the roll-key (see Fig.2-13).

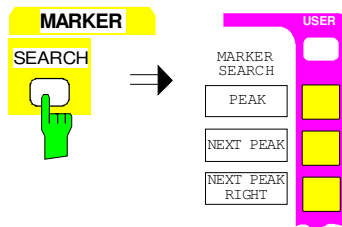

or

- Press the *SEARCH* key of the *MARKER* keys.  
The *SEARCH-MARKER* menu is opened.

- Press the *NEXT PEAK RIGHT* softkey until the delta marker appears on one of the IM products (see Fig.2-13).

**8. Calculate IP3 from the measured offset and the signal level according to (4)**

In the example, an intermodulation ratio of approx. 60 dB at a level of -10 dBm was measured. IP3 is thus:

$$IP3 = 60 \text{ dB}/2 + (-10\text{dBm}) = 20 \text{ dBm}$$

## Time-domain Measurements with Pulsed Signals

### Measuring Task

A lot of systems which handle pulsed signals do not only require measurement of the pulse width and the pulse repetition rate which can be derived from the spectrum but also assess the rise and fall time as well as the power ramping during the pulse. In particular, modern digital mobile radio systems which, like GSM e.g., employ the TDMA method, require the power to be measured versus time over a wide dynamic range.

Time-domain measurements are performed using the spectrum analyzer with ZERO SPAN selected. The analyzer operates as fix-tuned receiver on the set center frequency such that the signal power versus time is displayed.

### Important Spectrum Analyzer Functions

Trigger functions such as video trigger and sweep settings such as blanking of the measured value (GAP SWEEP) are of particular importance for time-domain measurements. The pretrigger function of the GAP SWEEP just enables measurement of rise times since it allows for representation of measurements prior to the trigger point. The GAP function, which enables cutout of a part of the pulse signal on the screen at high time resolution. During the GAP time, the sweep and thus data acquisition at the time marked by the "GAP" line is interrupted and thus the pulse is not completely displayed (the part which is not important for this measurement is blanked) (see Fig. 2-14).

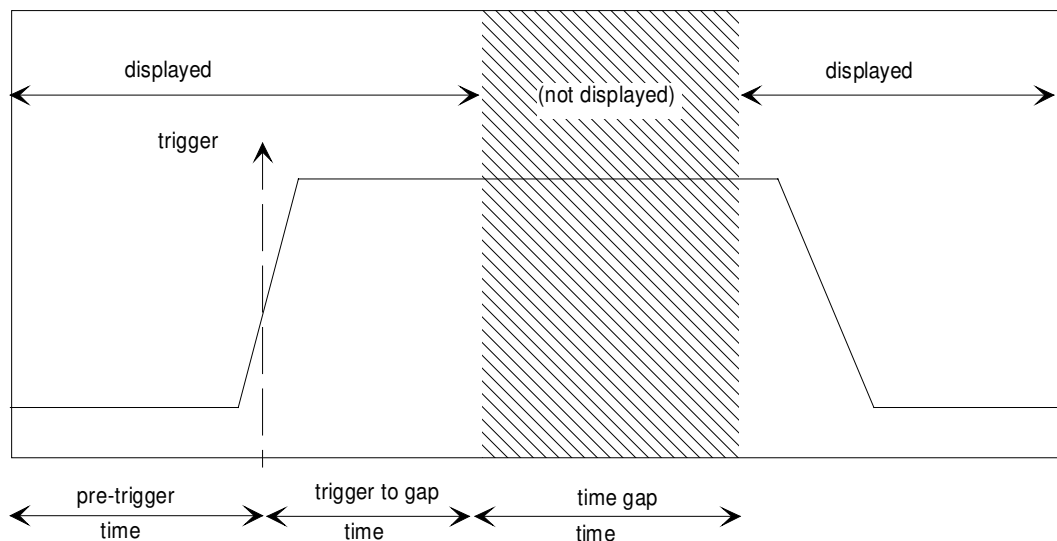

Fig. 2-14 Parameters of Gap Sweep

**Note:** If the pretrigger time and the trg-to-gap time is 0 s, the gap time function has the same effect as a delayed trigger.

## Measurement

This example shows the measurement of the rise and fall times as well as the power ramping during the pulse.

The signal generator SME with built-in pulse modulation source SME-B4 is used as signal source. A signal generator providing for pulse modulation in conjunction with an external pulse generator may be used, instead.

Settings on the signal generator:

Frequency	900 MHz
Level	-5 dBm
Modulation	Pulse
Pulse width	ca. 600 $\mu$ s
Pulse frequency	ca. 500 Hz

The following measuring steps are made:

1. Reset the instrument.  
The video bandwidth is thus set to 3 MHz.
2. Set the center frequency to 900 MHz.
3. Set the frequency display range to zero span.
4. Set the reference level to 0 dBm.
5. Set the resolution bandwidth to 2 MHz.
6. Set the sweep time to 1 ms.
7. Connect the RF output of the SME to the RF input of the FSIQ.
8. Set the video trigger.
9. Set the sweep time to 100  $\mu$ s.
10. Set the trigger points.
11. Activate the gap sweep.

---

***comp. measuring example - level and frequency measurement (steps 1 to 3)***

- 1. Set the instrument to the default state. I.e., the video bandwidth is set to 3 MHz.***
- 2. Set the center frequency to 900 MHz.***
- 3. Set the frequency-display range to zero span.***

**Note:** With first calling of the zero span following preset, a resolution bandwidth of 1 MHz is automatically set. Apart from that, switching on the zero span always causes that resolution bandwidth to be set that was last set in zero span.

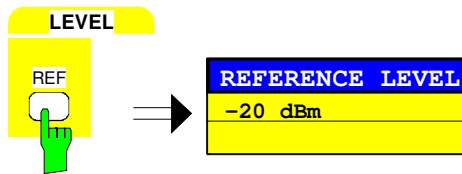

**4. Set the reference level to 0 dBm.**

- Press the *REF* key in the *LEVEL* key field.  
The entry field for the reference level appears on the display screen.

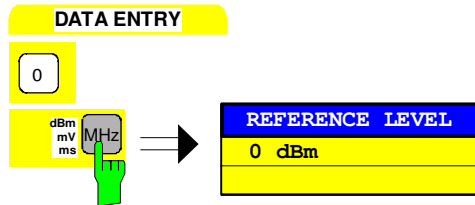

- Enter *0* in the entry field via the numeric keypad and terminate the entry by pressing the *MHz/ms* key.

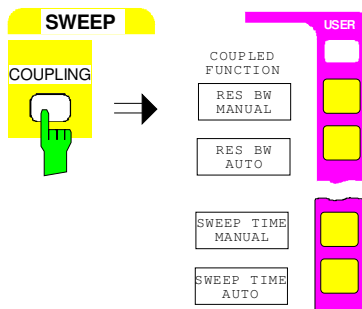

**5. Set the resolution bandwidth to 2 MHz**

- Press the *COUPLING* key in the *SWEEP* key field.  
The *SWEEP-COUPLING* menu is opened.

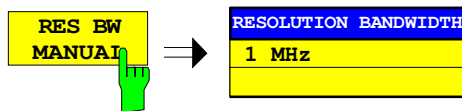

- Press the *RES BW MANUAL* soft key.  
The entry field for the resolution bandwidth appears on the display screen.

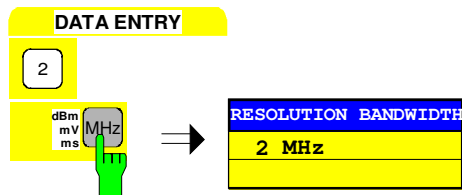

- Enter *2* via the numeric key pad and terminate the entry by pressing the *MHz* key.

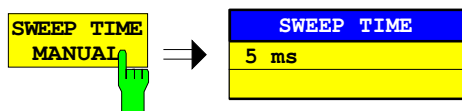

**6. Set the sweep time to 1 ms**

- Press the *SWEEP TIME MANUAL* softkey.  
The entry field for the sweep time is opened.

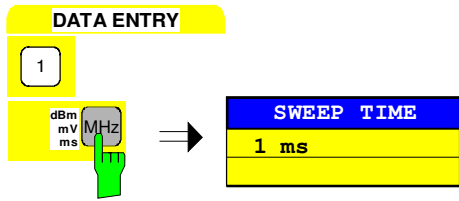

- Enter 1 in the entry field via the numeric keypad and terminate the entry by pressing the MHz key.

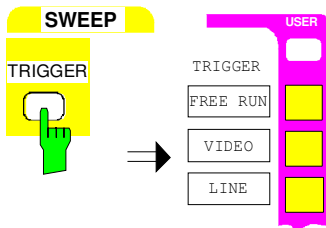

- 7. Connect the RF output of the SME to the RF input of the FSIQ.

8. Initiate triggering by means of the display voltage (video trigger)

- Press the TRIGGER key in the SWEEP key field  
The TRIGGER menu is opened.

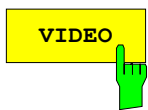

- Press the VIDEO softkey.  
A dashed horizontal line is displayed which marks the trigger level.

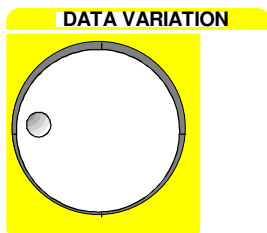

- Set the trigger level using the roll key such that a triggered display is obtained.  
(see Fig. 2-15)

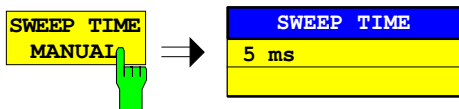

- 9. Set the sweep time to 100 μs
- Press the SWEEP TIME MANUAL softkey.  
The window for entering the sweep time is opened.

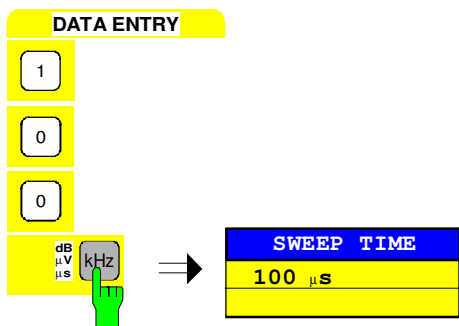

- Enter 100 via the numeric keypad and terminate the entry by pressing the kHz/μs key.

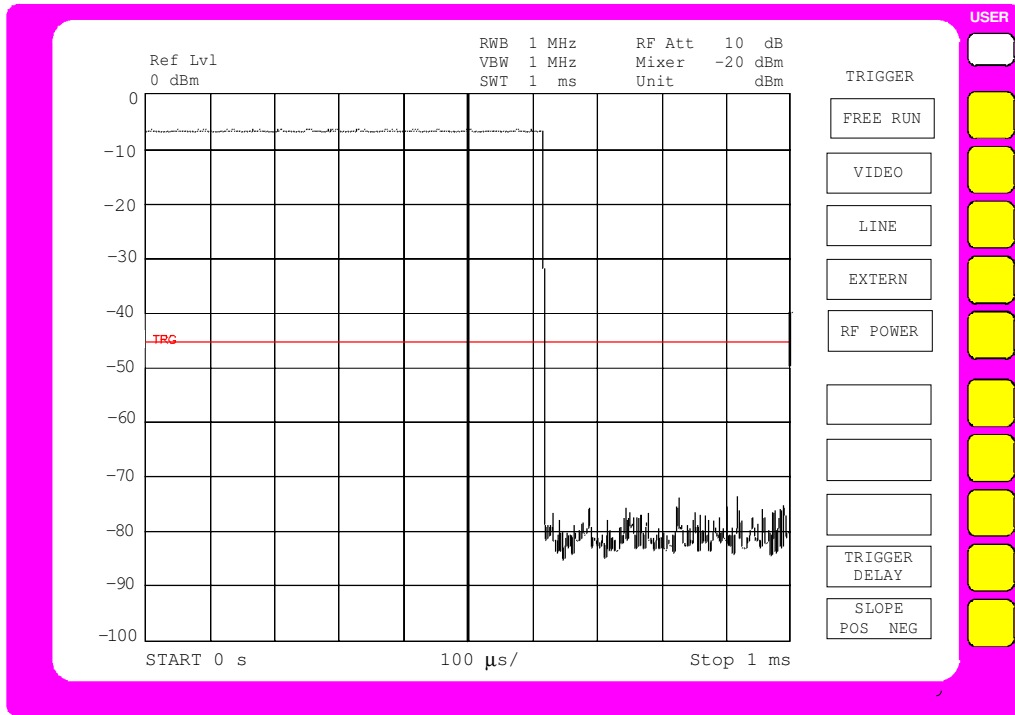
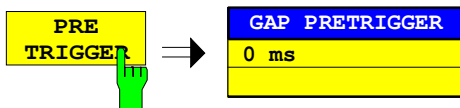
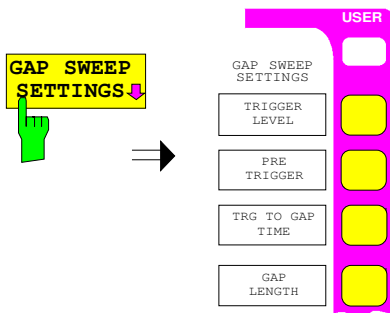
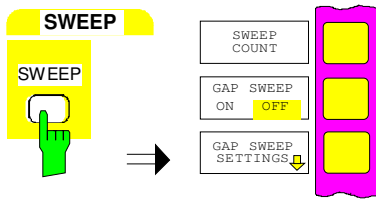

Fig. 2-15 Representation of pulse sequence with video trigger



**10. Set the trigger points.**

➤ Press the *SWEEP* key in the *SWEEP* keyfield.  
The *SWEEP* menu is opened.

➤ Press the *GAP SWEEP SETTINGS* softkey.  
The *GAP SWEEP SETTINGS* submenu for setting the trigger points is opened.

➤ Press the *PRE TRIGGER* softkey.  
The entry field for the pretrigger is opened.



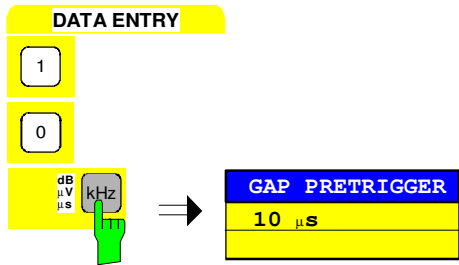

- Enter 10 via the numeric keypad in the entry field and terminate the entry by pressing the kHz/μs key.

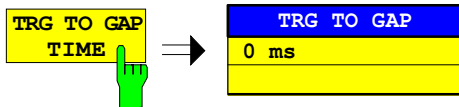

- Press the TRG TO GAP softkey. The entry field for the trigger-to-gap-time is opened.

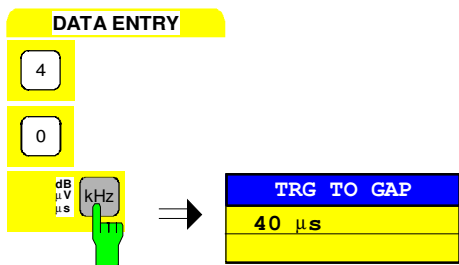

- Enter 40 via the numeric keypad in the entry field and terminate the entry by pressing the kHz/μs key.

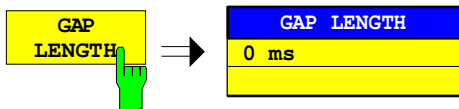

- Press the GAP LENGTH softkey. The entry field for the length of the time gap is opened.

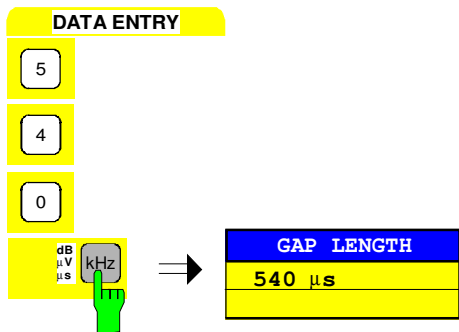

- Enter 540 in the entry field via the numeric keypad and terminate the entry by pressing the kHz/μs key.

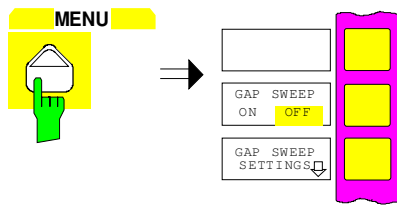

**11. Activate the measurement with mask-out of measured value**

- Press the menu change key.  
The right supplementary menu is opened.



- Press the *GAP SWEEP ON/OFF* key.  
The measurement with blanking of measured value is activated. The measurement results are shown in Fig. 2-16

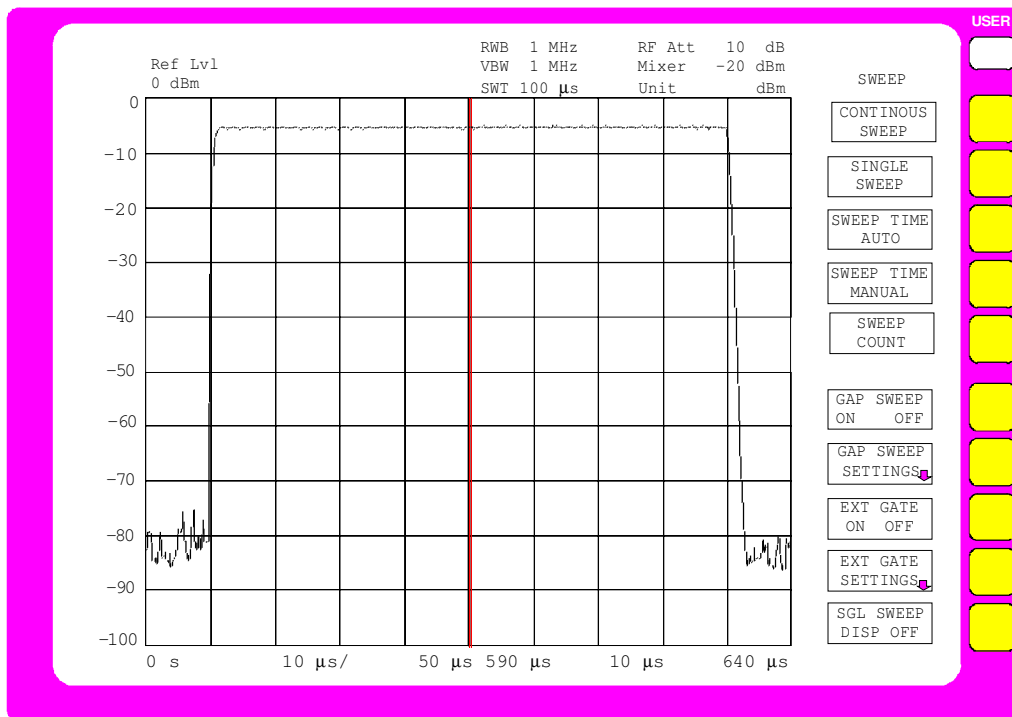

Fig. 2-16 Measured-value blanking for simultaneous display of rising and falling edge of a pulse signal. The position of the gap is indicated by the thick vertical line. The gap time is indicated via the double label 50  $\mu$ s and 590  $\mu$ s in the time axis.



## Contents - Chapter 3 "Manual Operation"

### 3 Manual Operation

<b>The Screen</b> .....	<b>3.2</b>
Diagram Area .....	3.3
Full Screen.....	3.9
Split Screen .....	3.9
Softkey Area .....	3.10
Changing the Menu .....	3.11
<b>Setting the Parameters</b> .....	<b>3.13</b>
Data Entry.....	3.13
Numeric Keypad on the Front Panel .....	3.13
Roll-key and Cursor Keys.....	3.14
Entry Windows.....	3.15
Setting Up the Entry Window .....	3.15
Editing of Numeric Parameters .....	3.16
Editing of Alphanumeric Parameters.....	3.17
Help Line Editor .....	3.17
Table Entry .....	3.18
Shifting Mode.....	3.18
Editing Mode.....	3.19
<b>Disabling the Control Elements - HOLD Key</b> .....	<b>3.20</b>
<b>Setting the Stepsize - STEP Key</b> .....	<b>3.21</b>
<b>Mouse and External Keyboard Control</b> .....	<b>3.22</b>
External Keyboard Control.....	3.22
Data Entry Windows with Mouse Control .....	3.23
Mouse Control of Further Display Elements.....	3.24
<b>Menu Overview</b> .....	<b>3.25</b>
System Key Group.....	3.25
Configuration Key Group .....	3.27
Hardcopy Key Group .....	3.33
Frequency Key Group.....	3.34
Level Key Group, Input Key.....	3.36
Marker Key Group .....	3.38
Lines Key Group .....	3.42
Trace Key Group .....	3.43
Sweep Key Group.....	3.44
Memory Key Group.....	3.47
User Key Group.....	3.49



## 3 Manual Operation

Chapter 3 provides an overview of the operating concept and the basic steps of manual operation of the FSIQ. This includes a description of the screen, of the control of menus and of the setting of parameters. An overview of the menus will be listed at the end of this chapter.

The functions of the menus are described in detail in Chapter 4. Chapter 2 contains a short introduction on step-by-step simple measurements. The remote control of the instrument is described in Chapters 5, 6 and 7

The operation of the signal analyzer is menu-controlled via keys and softkeys. The setting of the instrument and test parameters in the menus is made either directly via softkeys or by entry of values in entry fields and by selection in tables. The operating mode and the screen mode is selected via the softkeys.

If required, data entry windows and tables are superimposed on the screen.

After switching on the instrument a message about the BIOS version installed is displayed for a few seconds (e.g. "Analyzer BIOS Rev. 1.2").

The results of the self test is displayed next.

```
MAINPROCESSOR
SELFTEST STARTING ...
TESTING CMOS ...
DMA CHANNEL ...
INTERRUPTS ...
NMI ...
BASE MEMORY ...
EXTENDED MEMORY ...
HD CAPACITY ...
INIT FLOPPY DRIVE ...
INIT HD ...

SELFTEST DONE,
SYSTEM IS BOOTING ...
```

Subsequently, the Windows NT controller boots and the instrument then starts measuring. The type of measurement which was activated prior to last switch-off is performed, as long as no other instrument configuration was selected via *AUTO RECALL* in the *MEMORY RECALL* menu. While the measurement is being performed other menus and measuring modes can be entered simultaneously. The measurement results and the settings of the parameters are displayed on the screen.

## The Screen

The screen informs continuously on the results and parameters of the selected measuring functions. It shows the assignment of the softkeys and menus, which are required for setting the measuring parameters. The display of test results, the softkey labeling and the type of menu depend on the selected measuring function.

The screen is subdivided into two areas:

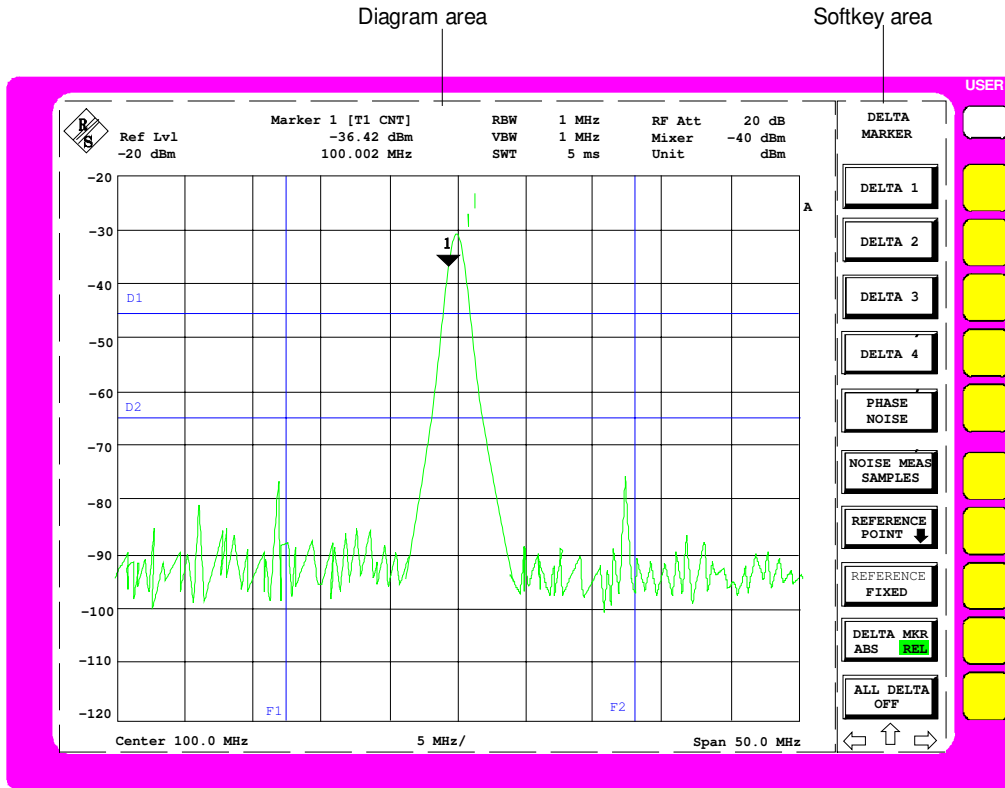

Fig. 3-1 Subdivision of screen

### Diagram area

This area contains the measuring diagrams and other measured-value information as well as the parameters and status information which are important for analysis of the results.

In addition, message fields, entry windows and tables may be shown in this area.

### Softkey area

This area contains the instrument functions which can be selected via the softkeys. The softkey area is not superimposed by other graphics.

### Diagram Area

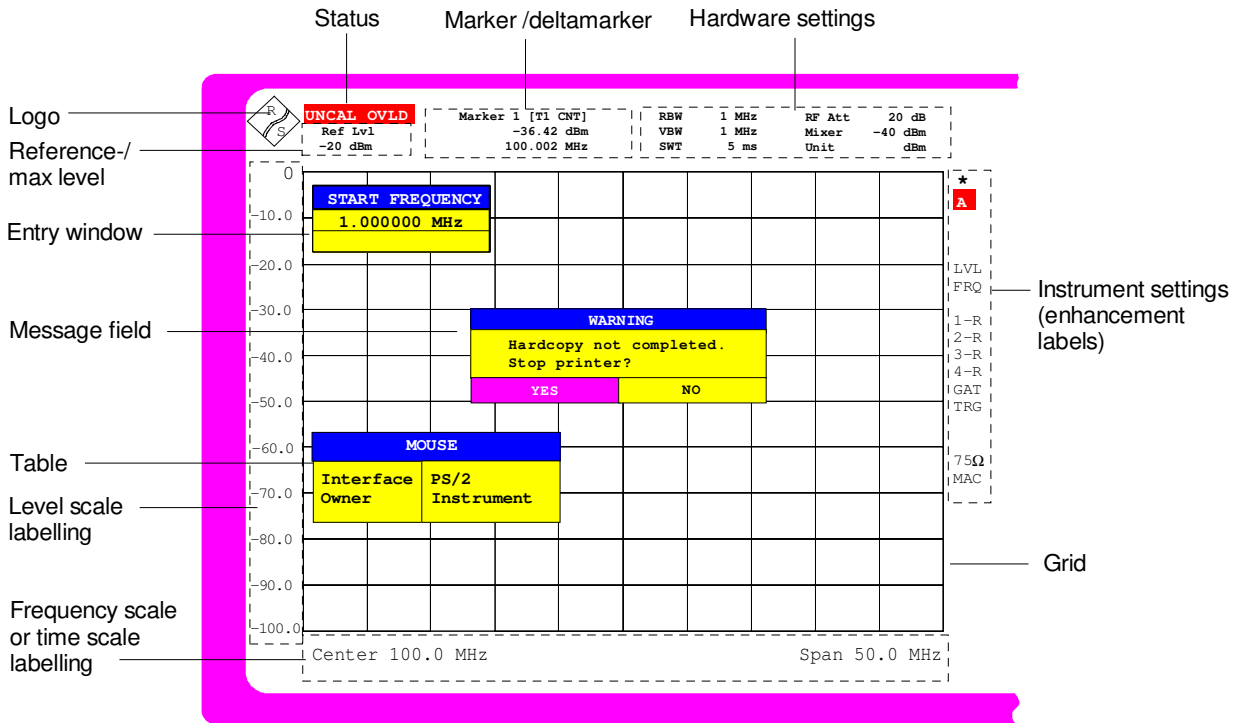

Fig. 3-2 Subdivision of the FSIQ screen in analyzer mode (without measuring diagram)

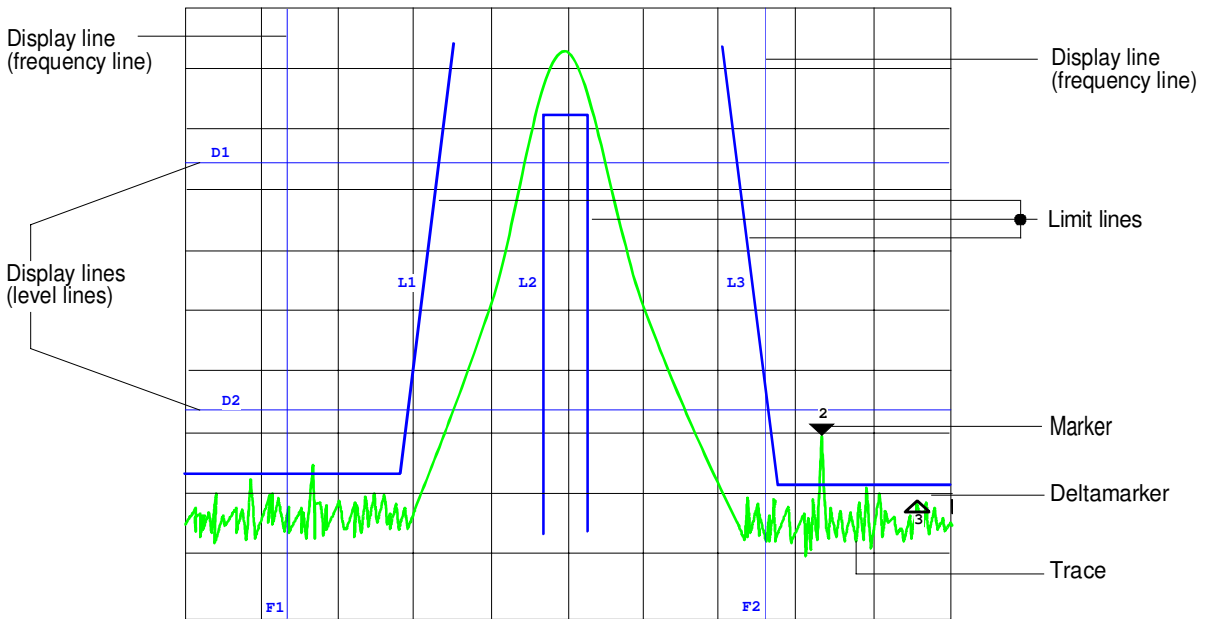

Fig. 3-3 Measuring diagram



The following graphic elements are displayed in the diagram area:

### Status information

Hint at irregularity (e.g. UNCAL)

In addition the status display displays MAX / REF LVL, if the maximum level and the reference level have different values .

UNCAL	<p>"UNCAL" is indicated under the following circumstances:</p> <ul style="list-style-type: none"> <li>• no valid calibration data (Status CALIBRATION FAILED in table CAL RESULTS), may occur after a cold start following a firmware update ⇒ Total calibration</li> <li>• correction data are switched off (menu CAL, CAL CORR OFF). ⇒ switch on CAL CORR ON or PRESET</li> <li>• Sweep time too short for current instrument settings (span, resolution bandwidth, video band width). ⇒ increase sweep time</li> <li>• resolution bandwidth too small for set symbol rate (Vector Analysis: digital demodulation) . ⇒ increase resolution bandwidth</li> </ul>
OVL	<p>„Overload“ is indicated when the input mixer is overloaded ⇒ Increase input attenuation</p>
IFOVL	<p>„IF Overload“ is indicated when overload occurs after the input mixer. ⇒ Increase reference level</p>
DIFOVL	<p>„Digital IF Overload“ is indicated when the digital resolution filter is overloaded. ⇒ Increase reference level</p>
ExtRef	<p>„External Reference“ is indicated when the instrument is set to <i>REFERENCE EXT</i> (menu <i>SETUP</i>), but the reference signal is missing at the rear panel connector. ⇒ Check input signal of external reference</p>
LO unl	<p>„LO unlock“ is indicated when the 1st LO is unlocked (moduleerror).</p>
LO Lvl	<p>„LO Level“ is indicated when the output level of the 1st LO is too small (module error).</p>
LO LvlD	<p>„LO Level Digital IF“ is indicated when the output level of the oscillator of module Digital IF is too small (module error).</p>
OCXO	<p>„OCXO cold“ is indicated when the crystal oscillator has not yet reached its operating temperature. This indication vanishes after a few minutes after switch on.</p>
UNLD	<p>'Underload' is indicated when the analyzer is not in its optimal dynamic range. In this case the measuring accuracy is not optimal. This indication is only output in vector analyzer operating mode. ⇒ Decrease reference level</p>

**Marker/Deltamarker** This label displays the position of the last selected marker or deltamarker in the x and y-directions and the marker/deltamarker index. As additional information, 2 fields in square brackets are provided which contain the curve which the marker is assigned to and the active measuring function of the marker indicated. The measuring function of the markers in the second field is indicated by the following abbreviations:

CNT frequency counter active  
 TRK signal track active  
 NOI noise measurement active

The marker text has the same color as the trace which the marker is assigned to. If, for example, the active marker is assigned to trace 1, and trace 1 is yellow, the marker text will be yellow, too.

### Hardware settings

#### Analyzer mode

RBW Indication of the set resolution bandwidth.  
 VBW Indication of the set video bandwidth.  
 SWT Indication of the set sweep time.  
 RF Att Indication of the set RF attenuation.  
 Mixer Indication of the user set level at the input mixer (only when level differs from standard settings) (= level of the reference level REF LVL).  
 Unit Indication of the level unit of the measuring results and the associated setting and test parameters in full length. This label is particularly important for selection of units with more than 4 digits, since they can only be indicated as dB\* in the other labels (except for marker).

#### Tracking generator mode

Only available with one of the options FSE-B8/9/10/11  
 TG Lvl Indication of the set output level of the tracking generator

#### Vector Analyzer mode

CF Indication of the set center frequency  
 SR Indication of the symbol rate  
 Demod Indication of the switched on demodulator.  
 Standard Indication of the set standard (e.g. GSM)

**Grid** X-axis: frequency or time,  
 Y-axis: level

**Instrument settings**  
 (Enhancement Labels)

Indication of user instrument settings which influence the measuring result and which are not immediately obvious when viewing the measured values.

- \* The current instrument setting does not correspond to the one which applied when one of the displayed curves had been stored. This occurs under the following circumstances:
  - The instrument setting is modified while a sweep is being performed.
  - The instrument setting is modified in SINGLE SWEEP mode subsequent to the end of the sweep and no new sweep is started.
  - The instrument setting is modified after setting the trace to VIEW.

The display is retained until the cause is eliminated by the user. I.e., either a new sweep is started (SINGLE SWEEP mode), or the trace of interest is switched to BLANK (all cases).
- A** Identification for screen A. Screen A is activated for the entry of test parameters.
- B** Identification for screen B. Screen B is activated for the entry of test parameters.
- C** If, in the Vector Analyzer mode, the inphase and quadrature signal is displayed in the measurement window A, the window is subdivided into two diagrams. The upper diagram is marked with an A and the bottom one with C.
- D** If, in the Vector Analyzer mode, the inphase and quadrature signal is displayed in the measurement window B, the window is subdivided into two diagrams. The upper diagram is marked with an B and the bottom one with D.
- LN** The automatic setting of the input attenuation is set to ATTEN LOW NOISE .
- LD** The automatic setting of the input attenuation is set to ATTEN LOW DISTORTION.
- NOR** Normalization is activated; high accuracy (only with one of the options FSE-B8/9/10/11).
- APP** Normalization is activated; medium accuracy (only with one of the options FSE-B8/9/10/11).
- TDF** A antenna correction factor (*TRANSDUCER FACTOR*) is switched on.
- TDS** A set of antenna correction factors (*TRANSDUCER SETS*) is switched on.
- LVL** A level offset  $\neq 0$  dB has been set. A level offset of the installed tracking generator (option) leads to the same display.
- FRQ** A frequency offset  $\neq 0$  Hz has been set.
- SGL** The sweep is set to SINGLE SWEEP.

<b>1-&lt;n&gt;</b>	Subtraction Trace 1 - Trace <n> active (<n>: numeric value) or subtraction Trace 1 - Reference Line active (<n>: R)
<b>2-&lt;n&gt;</b>	Subtraction Trace 2 - Trace <n> active (<n>: numeric value) or subtraction Trace 1 - Reference Line active (<n>: R)
<b>3-&lt;n&gt;</b>	Subtraction Trace 3 - Trace <n> active (<n>: numeric value) or subtraction Trace 1 - Reference Line active (<n>: R)
<b>4-&lt;n&gt;</b>	Subtraction Trace 4 - Trace <n> active (<n>: numeric value) or subtraction Trace 1 - Reference Line active (<n>: R)
<b>&lt;n&gt;AP</b>	For trace <n> (n = 1 to 4) the detector is set to AUTOPEAK.
<b>&lt;n&gt;MA</b>	For trace <n> (n = 1 to 4) the detector is set to MAX PEAK.
<b>&lt;n&gt;MI</b>	For trace <n> (n = 1 to 4) the detector is set to MIN PEAK.
<b>&lt;n&gt;SA</b>	For trace <n> (n = 1 to 4) the detector is set to SAMPLE.
<b>&lt;n&gt;AV</b>	For trace <n> (n = 1 to 4) the detector is set to AVERAGE.
<b>&lt;n&gt;RM</b>	For trace <n> (n = 1 to 4) the detector is set to RMS.
<b>GAT</b>	The frequency sweep is controlled via the <i>EXT TRIG/GATE</i> input of the instrument.
<b>TRG</b>	The instrument is not triggered in <i>FREE RUN</i> mode.
<b>EXT</b>	The unit is configured for operation with external reference
<b>75 Ω</b>	The input impedance of the unit is set to 75 Ω.
<b>MAC</b>	Macro recording active.
<b>PRN</b>	A printer output is active. PRN overwrites the enhancement label MAC.
<b>&lt;n&gt;VIEW</b>	Trace <n> (n = 1 to 4) is set to VIEW
<b>&lt;n&gt;AVG</b>	Trace <n> (n = 1 to 4) is set AVERAGE
<b>MIX</b>	The external mixer output is switched on (option FSE-B21).
<b>SID</b>	External mixer output: SIGNAL ID is switched on (option FSE-B21).
<b>AID</b>	External mixer output: AUTO ID is switched on (option FSE-B21).

<b>Frequency axis labeling</b>	Display of the x-scaling.
<code>{123.4 ms/Div }</code>	The distance between two grid lines is displayed in this label.
<code>{Center 1.2345678901234 GHz }</code>	The set center frequency or start frequency is displayed in this label depending on whether the keys CENTER/SPAN or START/STOP were last pressed.
<code>{Start 1.2345678901234 GHz }</code>	If span = 0 Hz, the center frequency is always displayed.
<code>{Span 1.2345678901234 GHz }</code>	The set frequency range ( <i>SPAN</i> ) or the stop frequency is displayed, depending on whether the keys CENTER/SPAN or START/STOP were last pressed.
<code>{Stop 1.2345678901234 GHz }</code>	If span = 0 Hz, the trigger moment ( <i>PRETRIGGER</i> ) is displayed.
<code>{Trigger 1.234 ms }</code>	
<b>Optional labeling</b>	Optional indication of date, time and comment.
<code>{14.Jun 97 12:13 }</code>	
<b>Level axis labeling</b>	Display of the y-scaling.
<b>Entry window</b>	The data entry window is superimposed in the diagram area, if required.
<b>Reference level/ Max. level</b>	Display of the set reference level or combined display of maximum level and reference level .
<b>Limit lines</b>	Limit lines are used to mark level curves or spectral distributions which must not be exceeded or dropped below.
<b>Traces 1 to 4</b>	Up to 4 traces can be displayed simultaneously.
<b>Display lines</b>	Utilities for trace analysis.

The FSIQ provides two display modes:

- Full Screen: 1 window, all traces are displayed in one window.
- Split Screen: 2 windows, traces, grid and labels are distributed on the two windows.

## Full Screen

In the full-screen mode, the settings and measurements are performed in the active visible window. All indications on the screen refer to this window. The designation (SCREEN A or SCREEN B) is inserted as enhancement label A or B on the right diagram margin.

Switching between the windows is by means of *DISPLAY* key. The current measurement is terminated when its window is blanked out.

Switching from split-screen to full-screen mode is performed in menu *SYSTEM DISPLAY*.

## Split Screen

In Split Screen mode, the screen is divided into two halves.

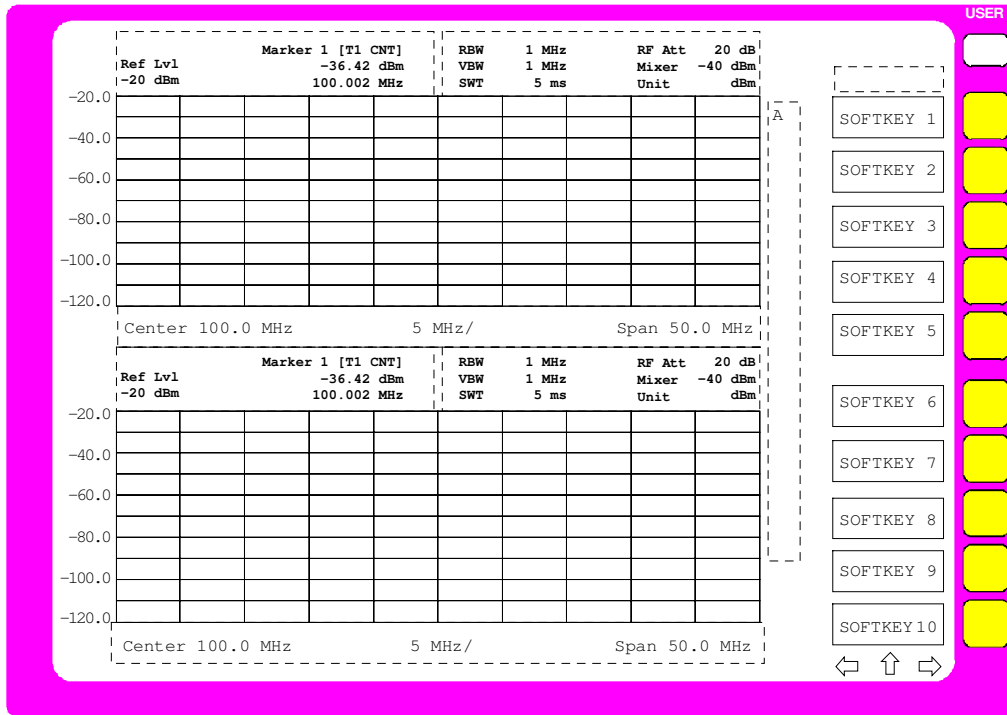

Fig. 3-4 Subdivision of the screen in Split Screen mode

The upper half is assigned Screen A, the lower one Screen B. The settings for measurement can be selected independently for both screens. E.g., a spectrum may be displayed in Screen A and a time amplitude in the time range is displayed in Screen B. The window for entry of the measuring parameters or the marker operation is selected using the *DISPLAY* key.

The indications which are valid only for one window appear in the margin of the associated diagram. Indications which are valid for the two windows are displayed between the diagrams.

The assignment of traces to the windows is fixed and cannot be modified.

Table 3-1 Assignment of traces to windows with split screen in the signal or vector analyzer mode

Trace 1:	upper (screen A)	Trace 3:	upper (screen A)
Trace 2:	lower (screen B)	Trace 4:	lower (screen B)

The two windows can be subdivided into two measurement diagrams. This applies to separate display of measurement values, eg to the display of the inphase and quadrature signal in vector analysis. Screen A is divided into diagrams A and C, screen B is divided in diagrams B and D.

## Softkey Area

The setup of the softkey area is independent of the operating mode. It consists of the following graphic elements:

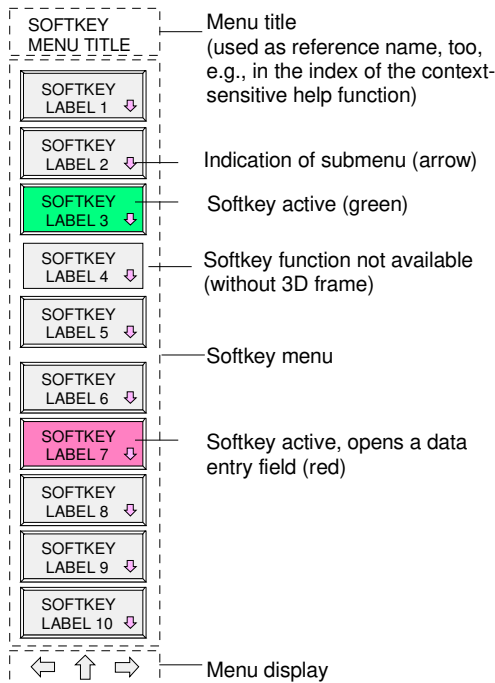

Fig. 3-5 Setup of the softkey area

The softkeys have different functions depending on the instrument state. Therefore, their labeling can be varied. The function and current state of the softkeys is indicated in the label by different texts and colors. The color assignment is factory-set as follows:

Table 3-2 Factory-set color assignment of soft keys

Softkey color	Meaning
gray	Softkey switched off
green	Softkey switched on
red	Softkey switched on and data entry active

These colors can be changed by the user as desired in the *SYSTEM DISPLAY-CONFIG DISPLAY* menu.

A softkey is switched on or off by pressing the respective hardkey. If a mouse is connected to the instrument, the softkey label on the display can be selected using the mouse, alternatively.

If instrument functions depend on **options**, the associated softkeys may be completely masked out, if the options are not fitted. If instrument functions are not available temporarily due to different **operating modes**, the corresponding softkeys are disabled. Actuating the softkey has no function then. In this case, the softkey is represented "plane", i.e., without 3D effect.

## Changing the Menu

With manual control, the FSIQ can be operated via the front-panel keys, the external keyboard or with a mouse.

Operation is menu-controlled. Various **softkey menus** are displayed depending on the instrument status. The individual menus constitute the so-called menu tree. The top menu (the root of the menu tree) is always called by means of a keystroke. The individual softkeys are then used to branch into further menus (submenus).

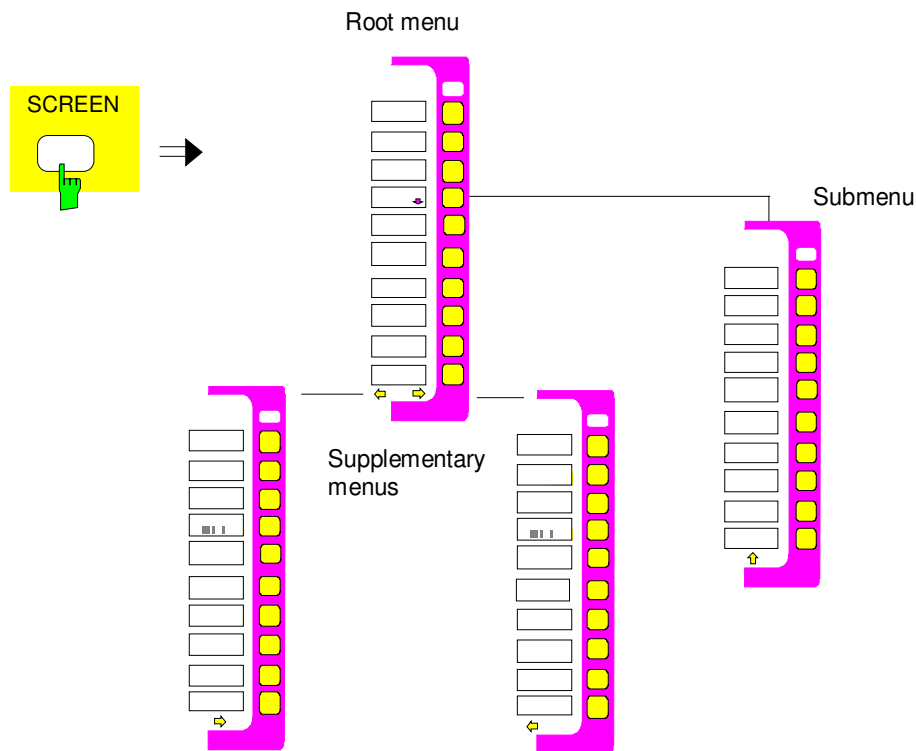

Fig. 3-6 Theory of menu selection

Each softkey menu consists of max. 30 softkeys, 10 softkeys being arranged in a main menu, 10 in a left-hand supplementary menu and 10 in a right-hand supplementary menu. In contrast to empty main menus, empty supplementary menus are not displayed. Arrows at the lower edge of the softkey area indicate whether a supplementary menu exists or not.



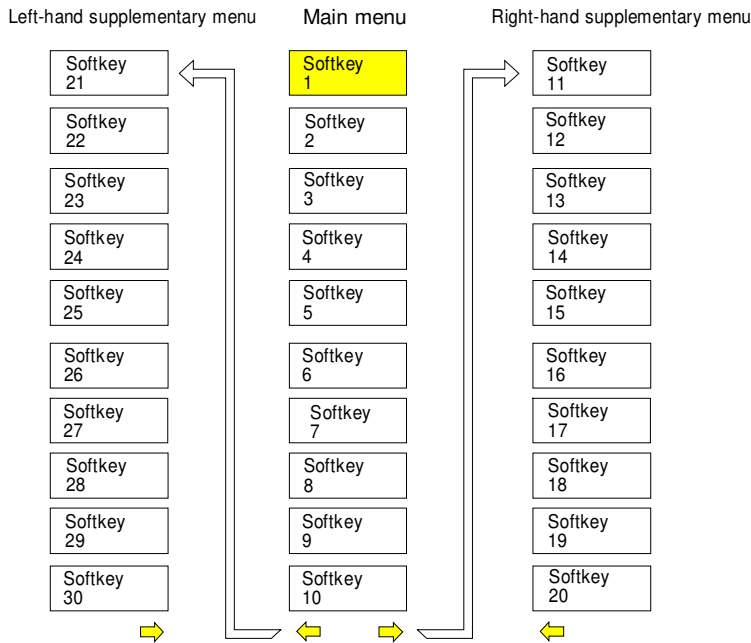

Fig. 3-7 Switching between main menu and supplementary menu

The menu arrows help to orient inside the menu tree.

**Examples:** This menu has a right-hand and a lefthand supplementary menu. It is the root menu since there is no arrow.

Only a right-hand supplementary menu or the upper menu can be accessed from this menu.

**MENU**

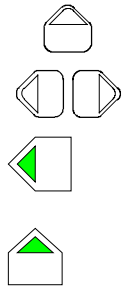

The MENU keys allow for selecting the main menu and the supplementary menus. If a mouse is connected to the instrument, the menu arrows can be selected to enter the respective menus. The MENU keys have the following functions:

When this key is pressed, the FSIQ enters the left-hand supplementary menu.

This key is pressed to call the upper menu which is located in the next higher hierarchical level in the menu tree. Several menus provide for automatic change, i.e., return to the next higher menu is caused automatically after pressing a softkey.

The right-hand supplementary menu is selected by pressing this key. A supplementary menu cannot be selected from another supplementary menu but only via the main menu.

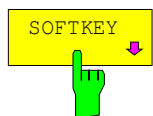

The labelling of all softkeys which call a submenu includes an arrow. Selection of a submenu is always effected via a softkey.

The softkeys are masked out in remote mode and during macro processing.

## Setting the Parameters

### Data Entry

Instrument parameters can be entered in an entry window or in a table via the numeric keypad on the front panel (*DATA ENTRY*), an external keyboard and the roll-key.

The numeric keypad *DATA ENTRY* is provided for entry of numeric parameters (e.g., the start frequency). The roll-key is used for fast incrementing or decrementing of numeric parameters with a defined step size.

It is advisable to use the external keyboard for definition of alphanumeric parameters (e.g., file names) since the front panel does not allow for entry of letters.

### Numeric Keypad on the Front Panel

The keys are assigned the following functions:



Number keys



Changes the sign of the mantissa or exponent of a numeric parameter. A "-" is inserted at the cursor position in case of an alphanumeric parameter.



Inserts a decimal point "." at the cursor position in the numeric string.

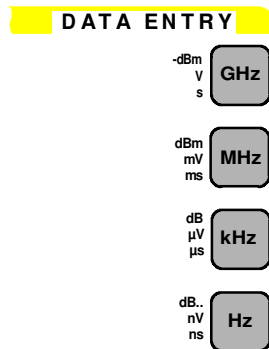

Provide the numeric value entered with the selected unit and terminate the entry.

The unit keys are all assigned the value "1" if quantities are indicated without dimensions in order to prevent faulty operations. The unit keys thus adopt the function of an ENTER key. The same applies for an alphanumeric entry field.



Adds an exponent (E-xx) to the end of the numeric string.



Deletes the character left to the cursor with numeric entry. After entry has been terminated it allows for toggling between the current parameter and the previous value (UNDO function).



Exit from the entry window and removal from screen prior or subsequent to entry. Complete deletion of the entry string just being entered during numeric entry. Deletion of the system messages or warnings which are displayed in an individual field.

### Roll-key and Cursor Keys

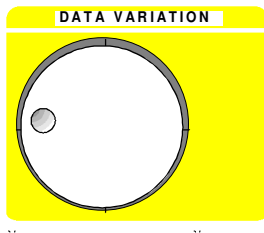



The roll-key has various functions.

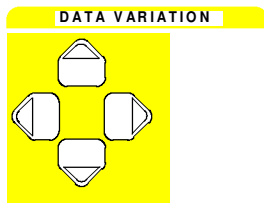

- With numeric entry, the instrument parameter is incremented (turning clockwise) or decremented (turning counterclockwise) at a defined step size. The step size may be equal to or smaller (e.g., 1/10) than the step size being defined for the cursor keys (see description of the *STEP* key).
- In tables, the roll-key can be used to shift the cursor horizontally or vertically when no entry window is open. The direction (horizontal/vertical) is switched over using the cursor keys.
- The roll-key is used with the help-line editor to select the individual letters.
- It can be used to shift markers, display lines, limit lines etc.

The roll-key provides an acceleration algorithm, i.e., the variation step size increases with increasing rotational speed.

### Cursor keys:



With numeric entry, the keys  or  are used to increase or decrease the instrument parameter by the selected step size. The keys are disabled With alphanumeric entry, the keys are used to toggle between the editing line and the help line editor.

The keys  and  are used to shift the cursor inside the entry window to reach a particular position in the number string.

In tables, the cursor keys are used to shift the cursor between the lines and columns of the table.

## Entry Windows

### Setting Up the Entry Window

The instrument parameters are not entered at the location where the parameter is displayed but in an individual entry window.

The entry window is called by a softkey or a hardkey and is used for definition of numeric or alphanumeric instrument parameters (START FREQUENCY by way of example):

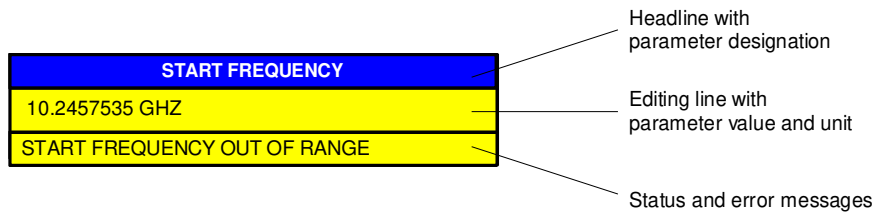

Fig. 3-8 Setup of an entry window

Subsequent to calling the entry window the current parameter value including the unit is displayed in the editing line. Status and error messages which refer to the current entry are displayed in the third and (optionally) fourth line.

The entry window is displayed in the left upper edge of the active measuring window with the default setting. When a mouse is connected to the instrument, open entry windows can be shifted to any position on the screen provided that they do not cover the softkey line. The new position is valid until measuring window is selected. The data entry window is represented transparent or non-transparent, as required.

Alphanumeric parameters are displayed as a simple character string in the editing line. Numeric parameters which consist of mantissa, exponent and unit are set up as follows:

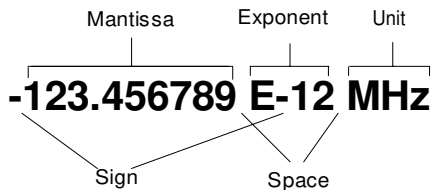

Fig. 3-9 Setup of numeric parameters

**Mantissa:** The first character is the sign of the mantissa, the positive sign is not displayed. The actual numeric value follows. The number of digits depends on the instrument parameter. The cursor may be shifted to the first digit of the mantissa at maximum, however, it may not precede the sign. The decimal point can be set as required.

**Exponent:** The exponent is separated from mantissa by a space character. The sign field of the exponent follows the "E", the positive sign "+" being not displayed similar to the representation of the mantissa. The cursor skips the "E" and the sign field. Two characters are fixed for the exponent value.

**Unit:** The unit (not represented in editing mode) is separated from the exponent by a space character.

The number of digits which can be entered for each instrument parameter is limited by the width of the input field only, but not by the amount which is physically enabled. (Example: Levels should be indicated with two decimals. The user may, however, enter as many decimals as desired - the entered value is rounded accordingly).

There are two types of entry windows:

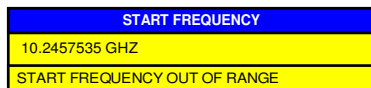

The editing line of the entry window for numeric parameters allows for display of up to 24 characters. Horizontal scrolling is not possible in the editing line.

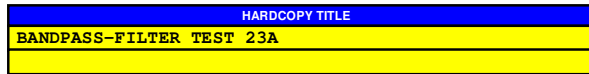









The editing line of the entry window for alphanumeric parameters allows for display of up to 60 characters (cf. display section). Maximum 256 characters may be entered. Horizontal scrolling is possible.

## Editing of Numeric Parameters

### Calling the entry window:

- Subsequent to calling the entry window, the current value of the numeric parameter including the unit is displayed in inverted color. The cursor is not displayed in this state. The transparent data entry window has no background color.
- The entry window is closed upon pressing the key CLR.

### Editing mode:



- Pressing a number, sign or decimal point key causes the value and unit to be deleted. The new value is output left-justified. The individual characters are entered in insert mode. If the maximum amount of characters for the mantissa or the exponent has been entered, no further entry is possible (no horizontal scrolling). If characters are positioned to the right of the cursor, they are shifted right when reaching the maximum length and get lost.
- Pressing the keys DATA VARIATION  or  causes normal representation of the current value. The unit is no longer displayed and the cursor precedes the first digit of the mantissa () or follows the last digit entered (). The DATA VARIATION keys  and  change the numeric value of the cursor.
- Pressing the DATA VARIATION keys  or  or the roll-key causes the original parameter value to be restored and modified according to the defined step size for this parameter.
- The data management of the instrument stores the previous value of a parameter in addition to the current value. The BACK key allows for toggling between these two values.

### Termination and abortion of entry:

- The editing mode is terminated by pressing a unit key. The validity of the new parameter value is checked and accepted for the instrument setting. If an error occurs, a corresponding error message is displayed in the status line of the editing field, e.g., "Out of range", "Value adjusted", etc.
- Editing of a parameter can be aborted by pressing the key CLR. The original parameter is then displayed again. The entry window is closed by pressing the CLR key again.
- Pressing a key or softkey subsequent to starting the entry causes the entry to be aborted and the entry window to be closed. If the same softkey which has opened the entry window is activated during entry, the original value is restored and displayed.

## Editing of Alphanumeric Parameters

Generally, the regulations for numeric parameters analogously apply for alphanumeric parameters. Note the exceptions given below:

- Alphanumeric parameters are not displayed with a unit.
- The four unit keys adopt the function of the ENTER key.
- Horizontal scrolling is possible in the editing line.
- Incrementing or decrementing cannot be effected via the keys ,  or the roll-key.
- Pressing the sign key causes a "-" character to be inserted at the cursor position, the decimal point key causes insertion of a point ".".
- The exponent key has no function.

## Help Line Editor

The help line editor allows for labelling or text entries to be made without an external keyboard being required. In this case, a field containing letters and special characters is added to the standard entry window. The help line editor is displayed automatically if no external keyboard is provided and an entry window for alphanumeric entry is opened.

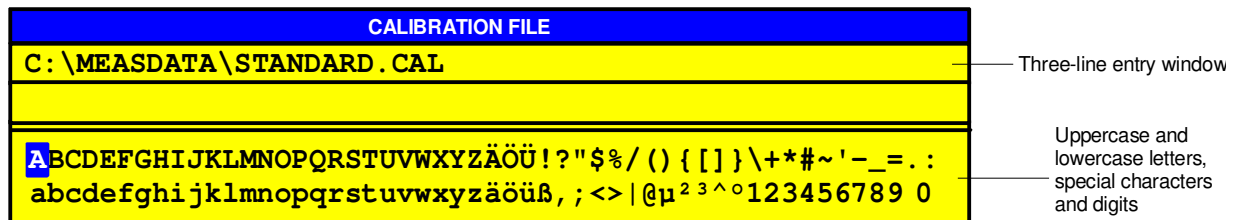



Fig. 3-10 Help line editor

- The keys  and  are used to toggle between the editing line and the help line editor.
- The cursor can be positioned to the required character in the help line editor using the cursor keys and the roll-key.
- A character is entered in the editing line by pressing any of the unit keys.
- If the cursor is already located in the editing line, pressing a unit key terminates data entry.

## Table Entry

The FSIQ uses numerous tables for indication and configuration of instrument parameters. The tables differ very much in the number of lines, columns and inscriptions and have a different functionality.

Tables are represented in a non-transparent form. The size is predefined and cannot be modified. If a mouse is connected, the tables may be shifted on the display without covering the softkeys. Tables can be superimposed by entry windows or suchlike.

Tables are mostly coupled to a softkey menu which provides further functions for editing table entries, e.g., deletion of tables, copying lines or columns, marking of table elements, restoring of default states etc. Another kind of tables is exclusively used for indication of instrument parameters and cannot be edited.

The definition of individual tables and the operation of particular editing functions can be looked up in the reference section with the description of the corresponding softkey menu.

The basic concept of operation is, however, the same for all tables. A differentiation is made between shifting mode and editing mode.

## Shifting Mode

This mode is active subsequent to opening a table. The **cursor** is shifted between the table elements by means of the cursor keys. The table element which is below the cursor is represented in inverted color.

TRANSDUCER SET			
	Name	Unit	
	Antenna	dB $\mu$ V/m	
	Ant_Cab2	dB $\mu$ V/m	
	Ant_Pre	dB $\mu$ V/m	
✓	Ant_Cab1	dB $\mu$ V/m	
	Probeset	dB $\mu$ A	
	—		

Cursor

Fig. 3-11 Shifting mode

## Editing Mode

A table element which is marked by a cursor can be edited as follows:

- by pressing one of the unit keys on the front panel or the *ENTER* key on the external keyboard.
- by a double-click of the mouse on the table element. If the clicked element is not yet marked by the cursor, the letter is positioned on the element, additionally.
- For numeric or alphanumeric instrument parameters, the editing operation may be started by entry of any number or letter on the front panel or on the external keyboard.

The data entry window, the selection list or the toggle editor are provided for this purpose.

After the editing operation has been terminated, the table enters the shifting mode again. The cursor is positioned automatically on the next table element.



## Disabling the Control Elements - HOLD Key

The individual softkeys have the following functions:

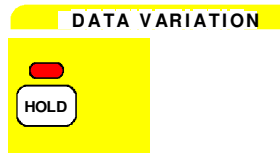

The functions of the *HOLD* menu allow for disabling individual control elements or the complete instrument control. The LED above the *HOLD* key indicates that either the function *LOCK DATA* or *LOCK ALL* has been activated. The control can be enabled again by successively pressing the two *UNLOCK* softkeys in any order.

Switching off the instrument resets control such that the instrument can be normally operated again after subsequent switch-on.



After selecting the two *UNLOCK* softkeys, the instrument keyboard is enabled again. The LED above the *HOLD* key goes out.





Selection of softkey *LOCK DATA* causes the roll-key to be disabled in order to prevent a parameter from being varied by mistake.



Selection of *LOCK ALL* softkey disables the complete front panel (including the *PRESET* key and roll-key, not including the *UNLOCK* softkeys), the mouse and all keys of the external keyboard. Exit from the *HOLD* menu is no longer possible. Control is enabled again by actuating the two *UNLOCK* softkeys.

## Setting the Stepsize - STEP Key

A number of numeric instrument parameters allow for step-by-step incrementing or decrementing the value in the editing line of the entry window using the keys  or  or the roll-key. The stepsize used with the cursor keys can be specified for the selected parameters in the *STEP* menu.

- Notes:**
- It is not possible to set the stepsize by all of the numeric parameters.
  - An extended *STEP* menu is available by some parameters. The extra functions are described by the respective parameter.
  - Setting the step size has no effect on the roll-key (the resolution of the roll-key is higher than that of the step size function)

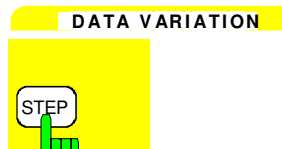

The *STEP* key opens the *STEP* menu for entry of the stepsize.

The stepsize of an instrument parameter can only be varied when this parameter is edited in an entry window.

The softkeys in the *STEP* menu are disabled if no instrument parameter is being varied or if the parameter being edited does not support stepsize variation (as is the case by all of the alphanumeric parameters).

The key  leads to exit from the *STEP* menu and automatic return to the previously active menu.



The softkey *STEPSIZE AUTO* causes the stepsize for the corresponding instrument parameter to be set automatically and be continuously varied with varying instrument settings (in accordance with other parameters).

### Example:

The stepsize of the *CENTER* frequency depends on the selected span.



The softkey *STEPSIZE NORMAL* calls an entry window for definition of a stepsize by the user. The parameter whose stepsize is varied, is displayed in the headline of the entry window:

START FREQUENCY	STEPSIZE
100 kHz	

The stepsize remains constant until a new value is entered or until the *STEPSIZE AUTO* softkey is activated. It is no longer coupled to other instrument parameters.

# Mouse and External Keyboard Control

## External Keyboard Control

The connection of an external keyboard provides additional characters for the entry (letters and special characters). It is permitted to use both, front panel keys and the external keyboard, for control. The number, cursor and sign keys have the same effect as the corresponding front panel keys. A few keys of the external keyboard provide an extended functionality with entries or tables which is described in the following table. The table shows the external keyboard key combinations through which the functions of the front panel keys can be emulated.

**Note:** The key combination <ALT> <SYSREQ> switches between the instrument display screen and the controller display screen

Table 3-3 Front Panel Keyboard Emulation

FSIQ front panel keys	Key assignments for the external keyboard
Soft keys: SK1 SK2 SK3 SK4 SK5 SK6 SK7 SK8 SK9 SK10	F1 F2 F3 F4 F5 F6 F7 F8 F9 F10
Menu select: Menu left Menu right Menu up	CTRL ← CTRL → CTRL ↑
Cursor control: Cursor left Cursor right Cursor up Cursor down	← → ↑ ↓
Roll-key: Turn left Turn right	SHIFT ↑ SHIFT ↓
Numeric keys: 0 to 9	0 to 9
Units keys: GHz... MHz... kHz... Hz...	ALT-G ALT-M ALT-K <ENTER>
Edit keys: Clear Backspace	<ESC> BACK
Misc. data entry keys: Exponent "Exp" Sign "+/-" Decimal point".	ALT-E - .
Hold key: Hold	SHIFT-F1
User menu: User	SHIFT-F2
System keys: Preset Cal Display Info	SHIFT-F4 ALT-F12 ALT-F10 SHIFT-F5
Configuration key group: Mode Setup	ALT-F2 SHIFT-F8

FSIQ front panel keys	Key assignments for the external keyboard
Hardcopy key group: Start Settings	SHIFT-F6 SHIFT-F9
Status key group : Local	SHIFT-F3
Frequency key group: Start Stop CenterCenter Span	CTRL-F7 CTRL-F8 CTRL-F9 CTRL-F10
Level key group: Ref Range Input Cal	CTRL-F11 CTRL-F12 ALT-F11 ALT-F12
Marker key group : Normal Search Delta → Mkr	CTRL-F1 CTRL-F2 CTRL-F3 CTRL-F4
Lines key group : Display Limit	CTRL-F5 CTRL-F6
Traces key group : 1 2 3 4	ALT-1 ALT-2 ALT-3 ALT-4
Sweep key group : -- -- -- Coupl. Sweep Trigger	ALT-F3 ALT-F4 ALT-F5 ALT-F6 ALT-F7 ALT-F8
Memory key group: Save Recall Config	SHIFT-F10 SHIFT-F11 SHIFT-F12
Data entry key group : Step	SHIFT-F7
Letters and special characters	A to Z (ext.) a to z (ext.) Special characters (ext.)
Edit key	Delete
Cursor control	Home End Page up Page down

## Data Entry Windows with Mouse Control

With a mouse being connected, additional functions are provided in the entry windows. Therefore, buttons are displayed in the entry window.

Essentially, the definitions which have been made for all types of entry window also apply for mouse control. However, note the following deviations:

- The so-called close-button is displayed on the left margin of the headline. Selecting this button via the mouse aborts the entry and closes the entry window. This corresponds to the function of the CLR key with manual control.
- In the numeric entry window, two buttons (↕) are displayed on the left margin of the editing line. Simply clicking the buttons causes the parameter in the editing line to be incremented or decremented (similar to the keys ⬆ / ⬇ or the roll-key with manual control).
- The cursor can be positioned in the entry line by clicking a character using the mouse.
- A character in the letter window of the help line editor can be selected by a single click. A double click copies the character from the letter window into the editing line.
- Open entry windows can be shifted across the complete screen using the mouse; they must not, however, be superimposed on the softkey line. Shifting is performed by clicking the headline and pushing the mouse while the mouse-key is being pressed.

**Example:** Numeric entry window with mouse control

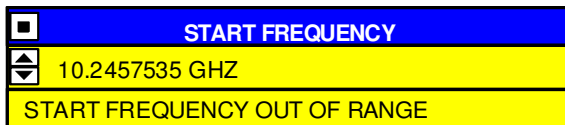

## Mouse Control of Further Display Elements

All display and control elements (enhancement labels, soft keys, function fields, display and limit lines) which can be displayed on the display screen can also be controlled by the mouse. Each soft key or key is assigned to a display element.

Double-clicking an display or control element opens the corresponding softkey menu. The assignment of softkeys/keys to display elements is shown in the following table.

Klicking the right mouse key call all softkey menus one after the other.

Table 3-4 Mouse Control of Display Elements

Display element for mouse control.	Assigned soft key or key
Display field for Soft Key 1 to Soft Key 10	Soft Key 1 to Soft Key 10
Display field for menu arrow: right/center/left	Key right/center/left supplementary menu
Enhancement labels * PA PS UNS LVL FRQ 1-x 2-x 3-x 4-x  TRG DC 75Ω MAC	-- SETUP key SETUP key COUPLING key REF key CENTER key TRACE 1 key TRACE 2 key TRACE 3 key TRACE 4 key  TRIGGER key INPUT key INPUT key USER key
Status display UNCAL OVLD ERR	CAL key REF key INFO key
Display fields above the diagram  Ref. Level / Max Level Marker RBW VBW SWT RF Att Mixer Unit	REF key NORMAL key COUPLING key COUPLING key COUPLING key INPUT key INPUT key REF key
Display fields below the diagram  Start Stop Center Span Trigger /Div	START key STOP key CENTER key SPAN key TRIGGER key --

# Menu Overview

## System Key Group

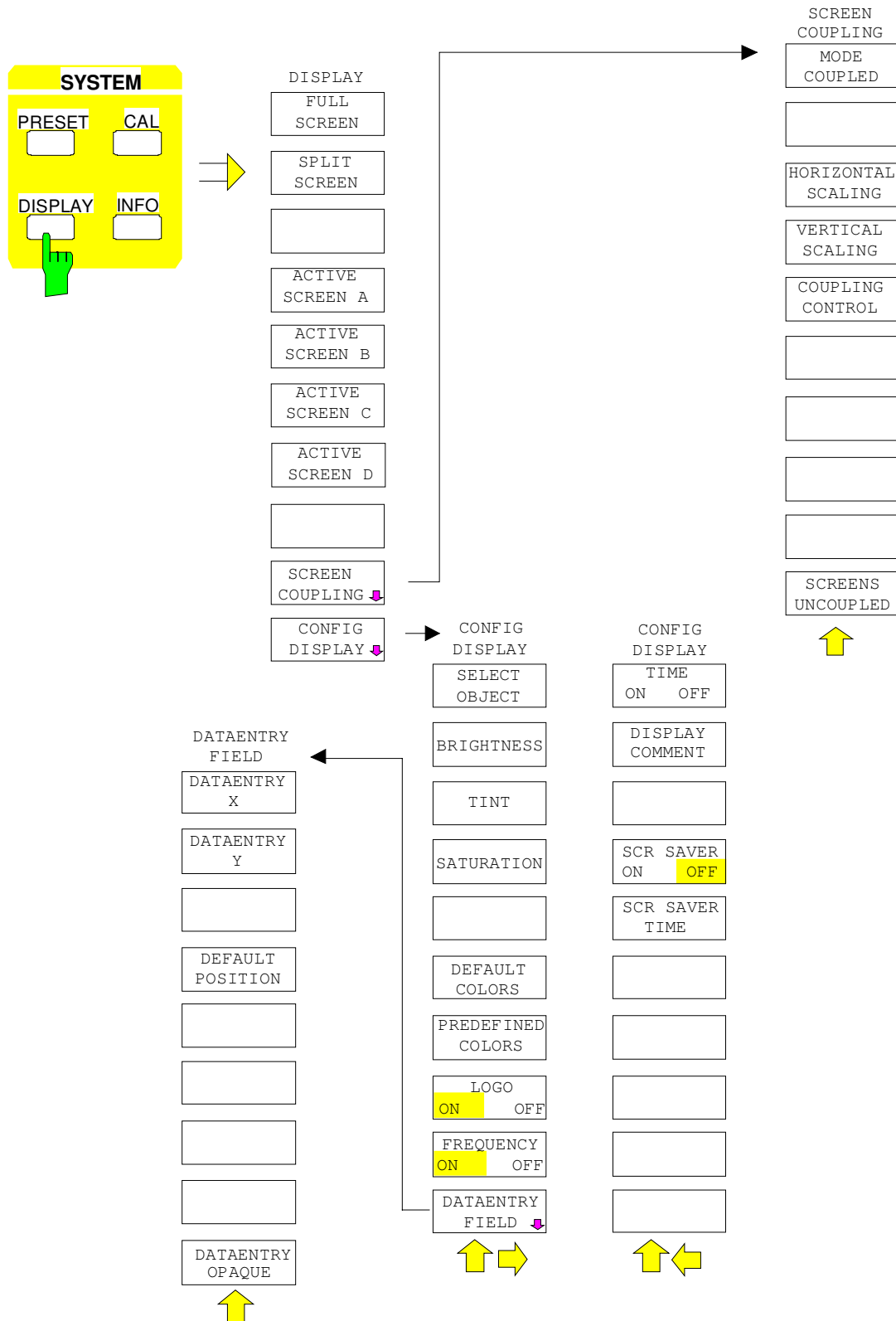

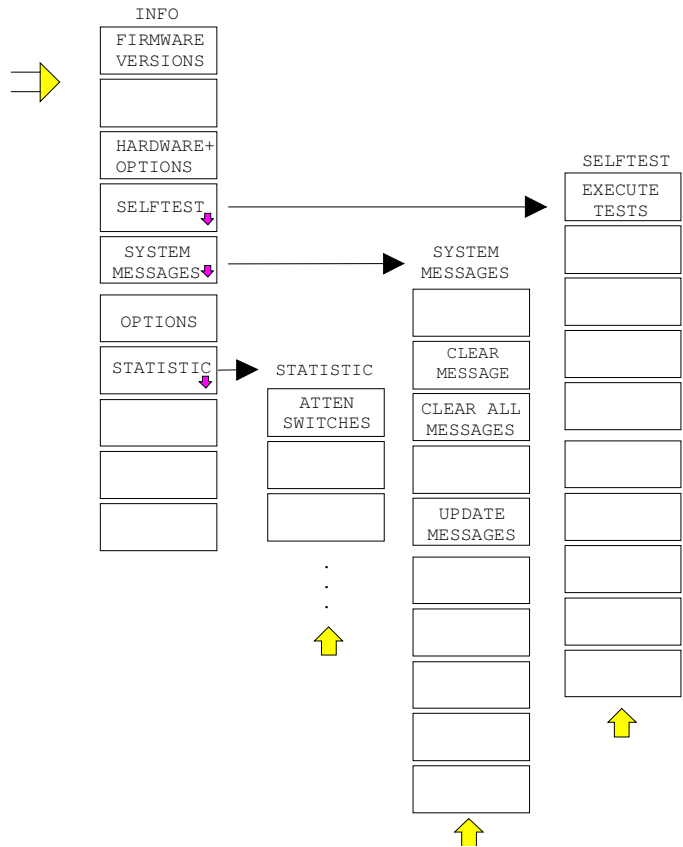
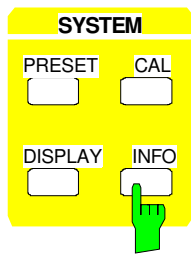
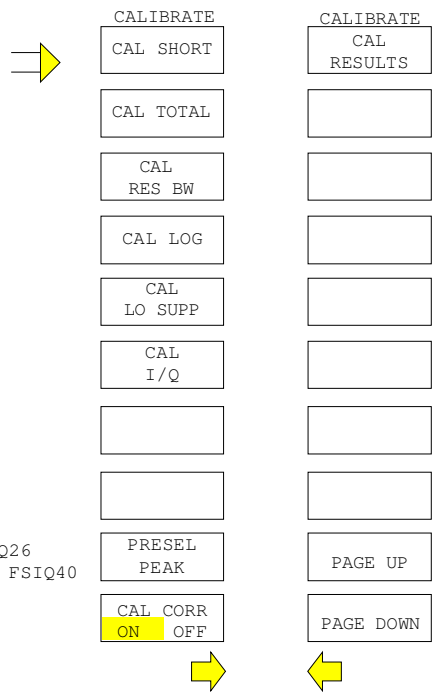
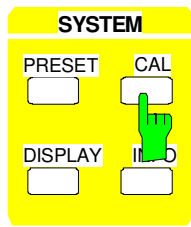

### Configuration Key Group

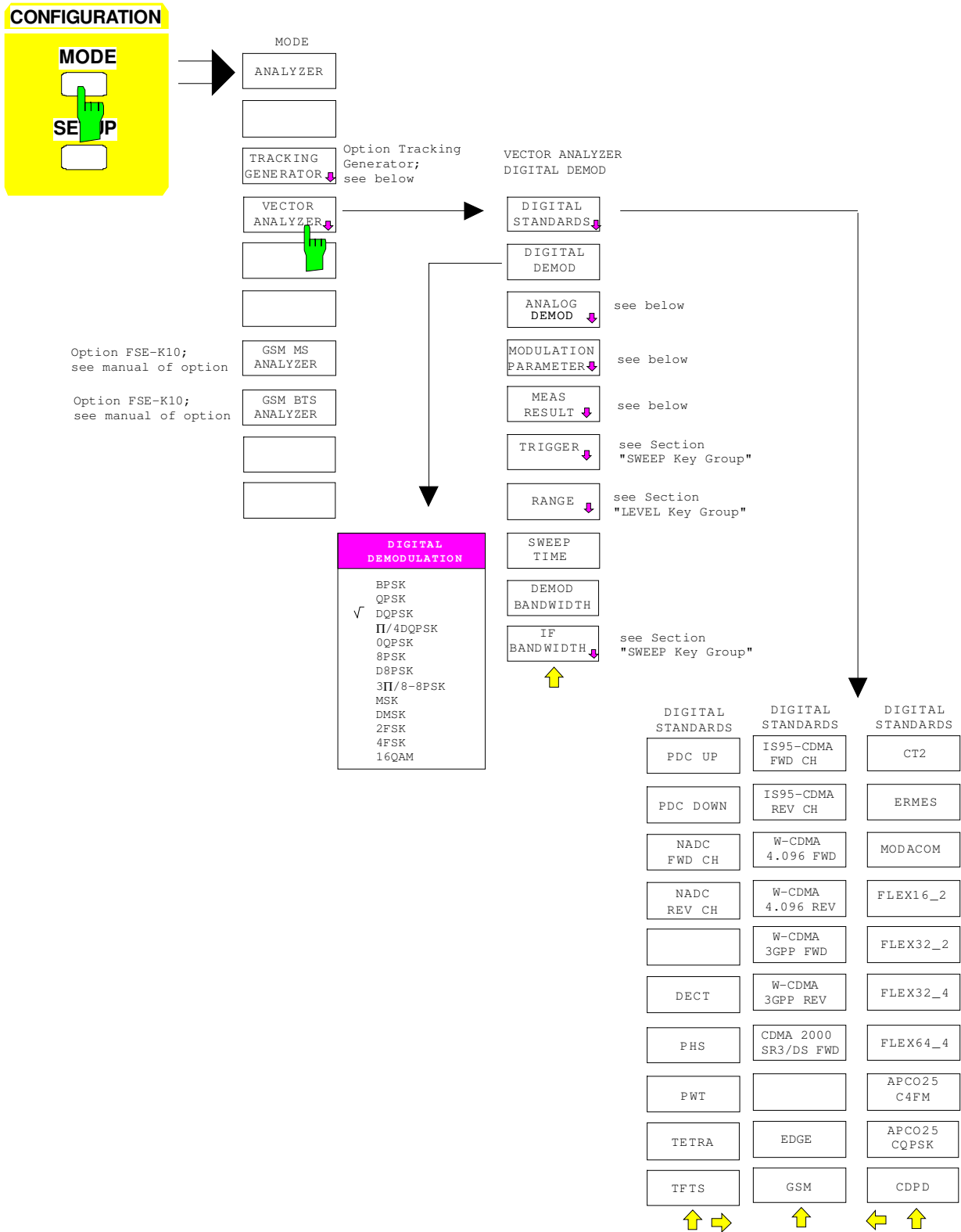



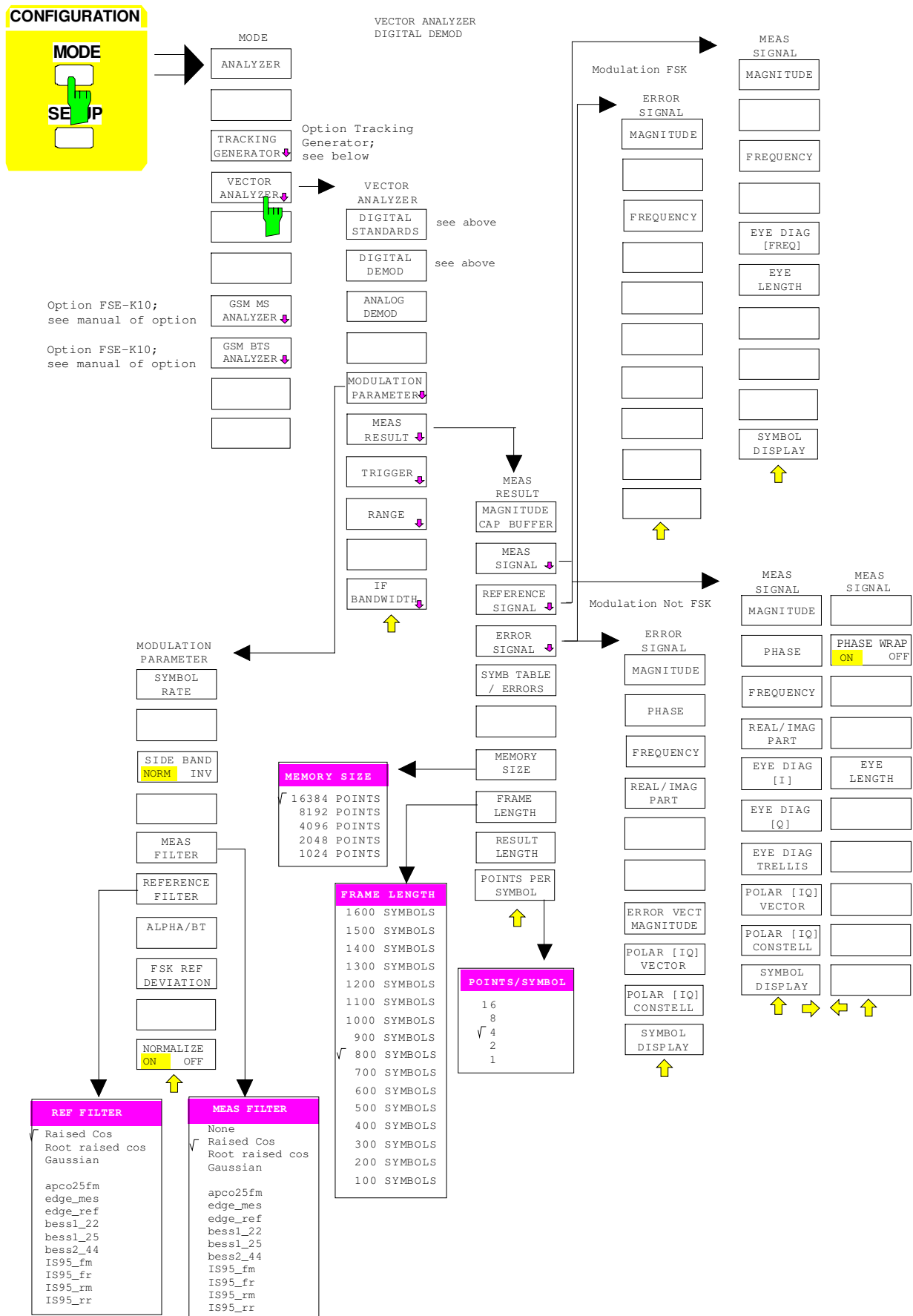

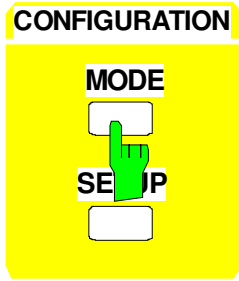

Option Tracking Generator; see below

Option FSE-K10; see manual of option

Option FSE-K11; see manual of option

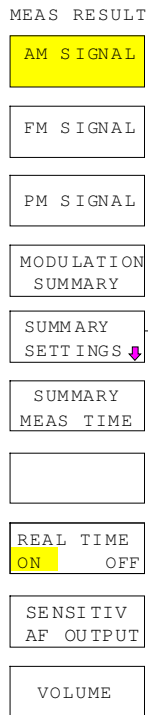
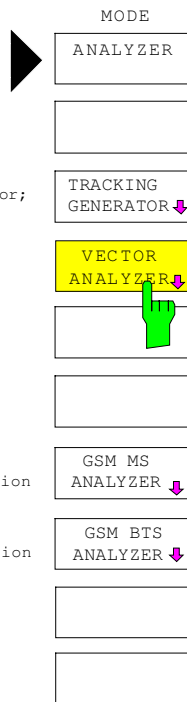

VECTOR ANALYZER  
ANALOG DEMOD / REAL TIME ON

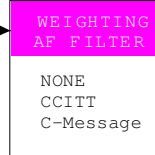
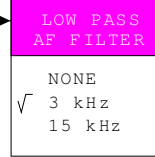
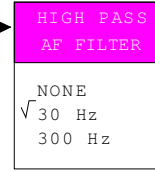
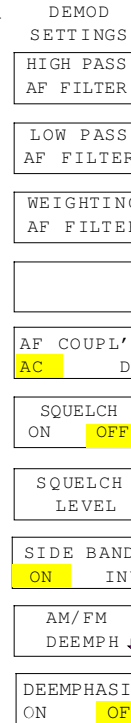
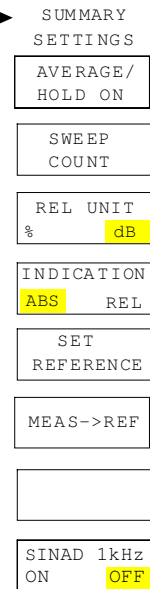
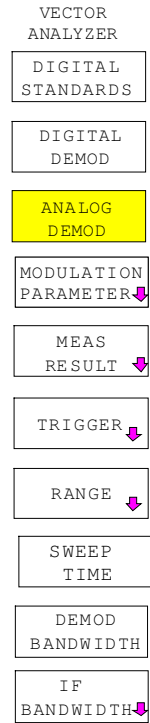

AM/FM DEEMPHASIS

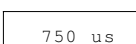

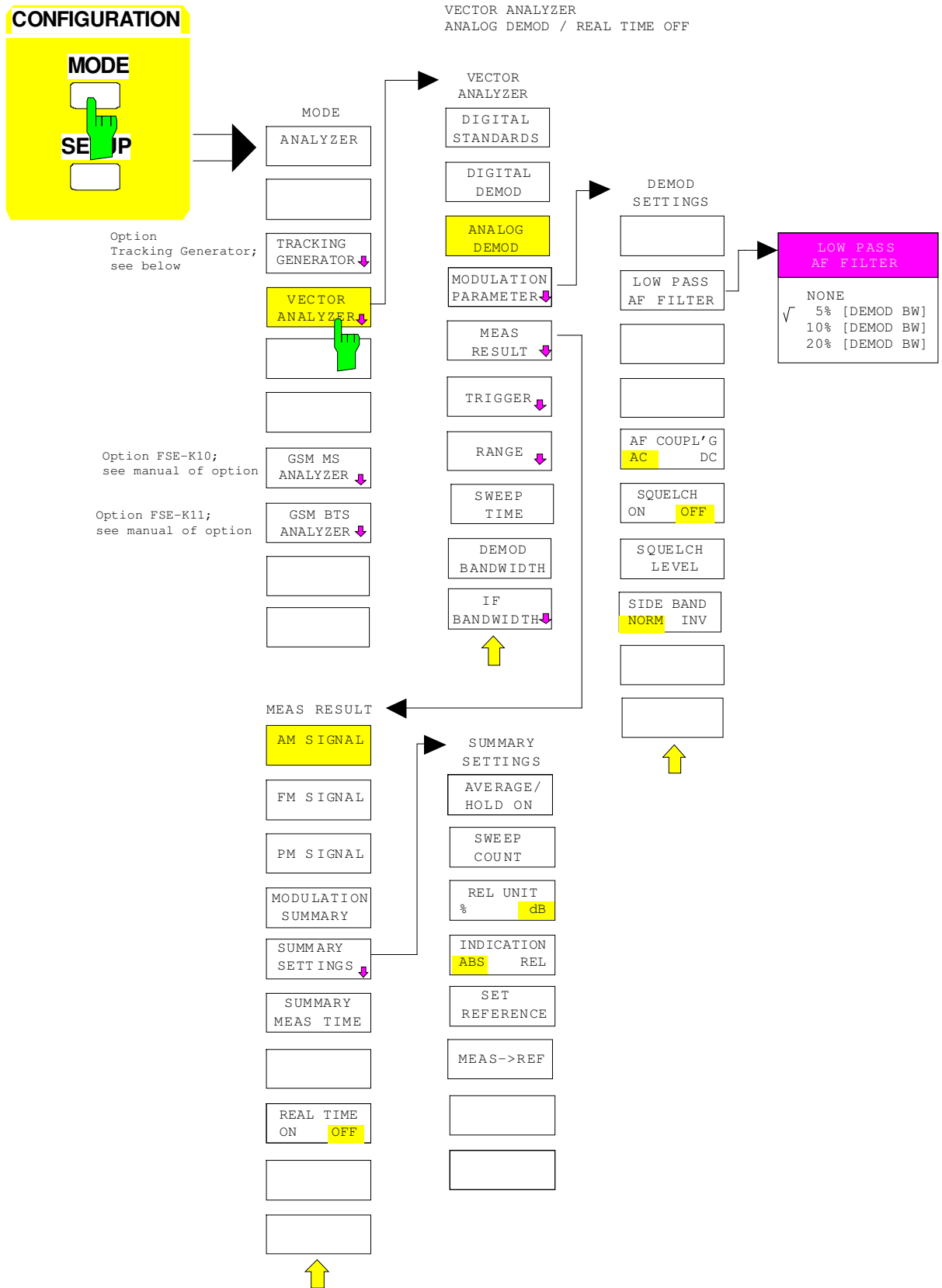

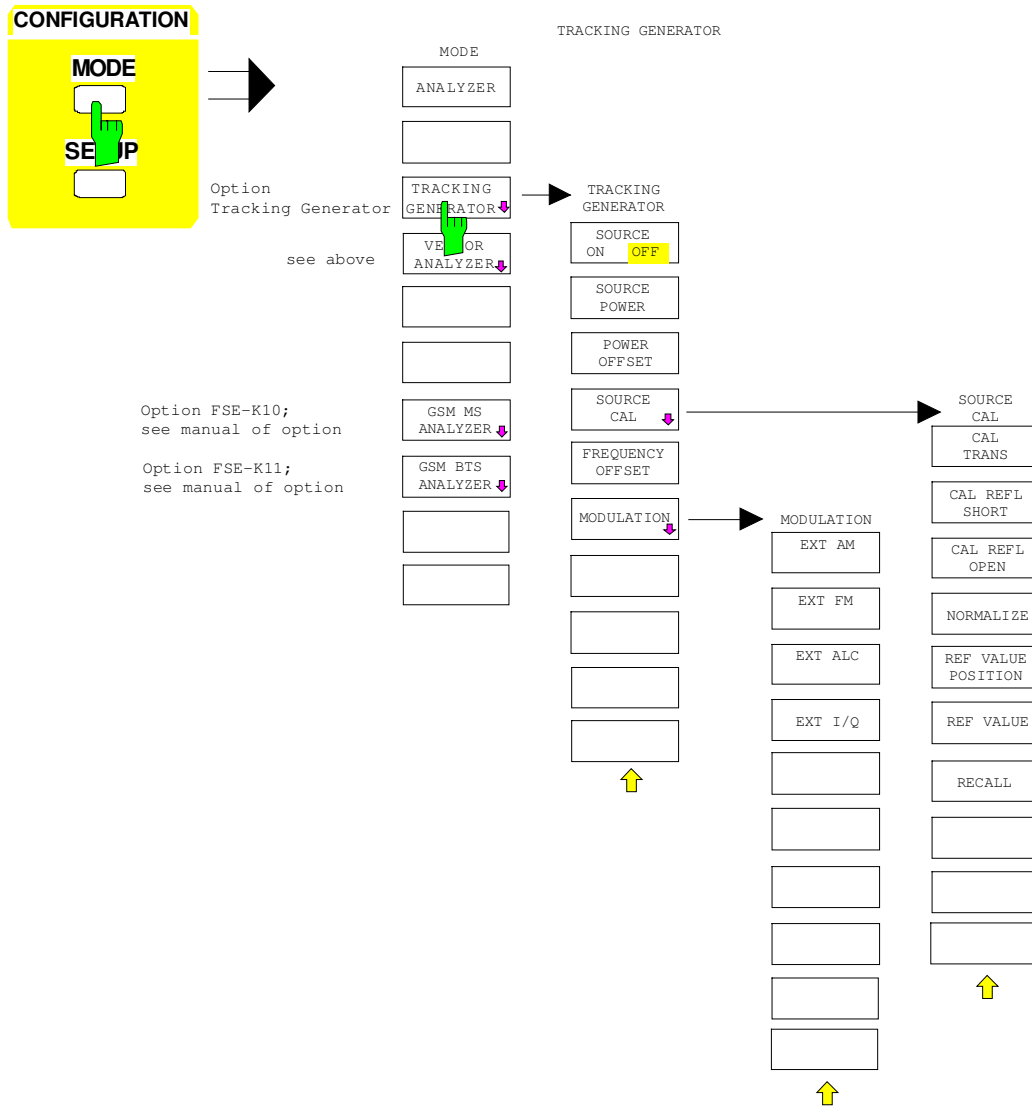

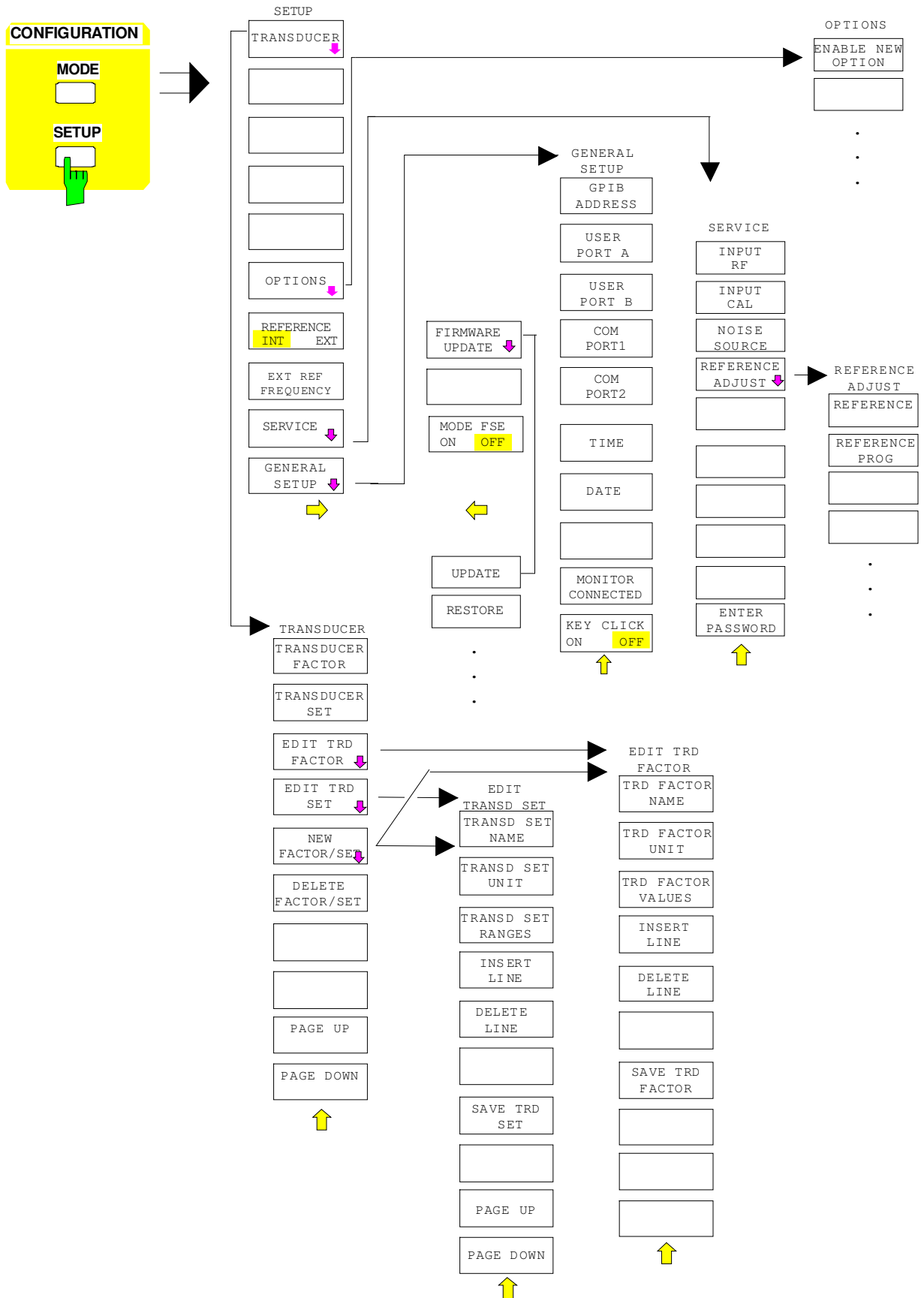

### Hardcopy Key Group

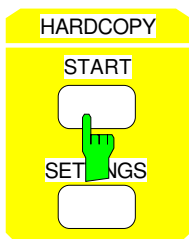
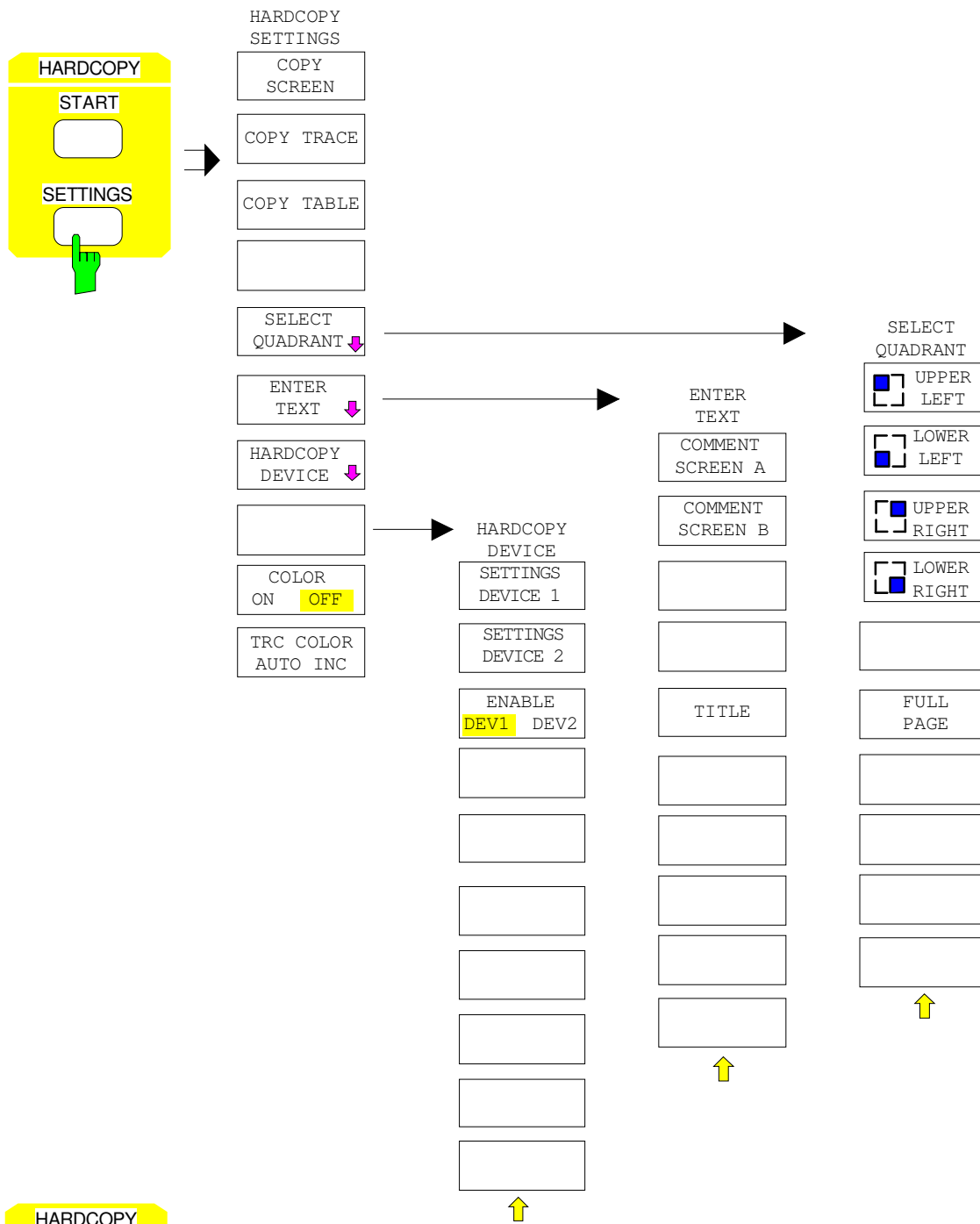

without softkey menu

Frequency Key Group

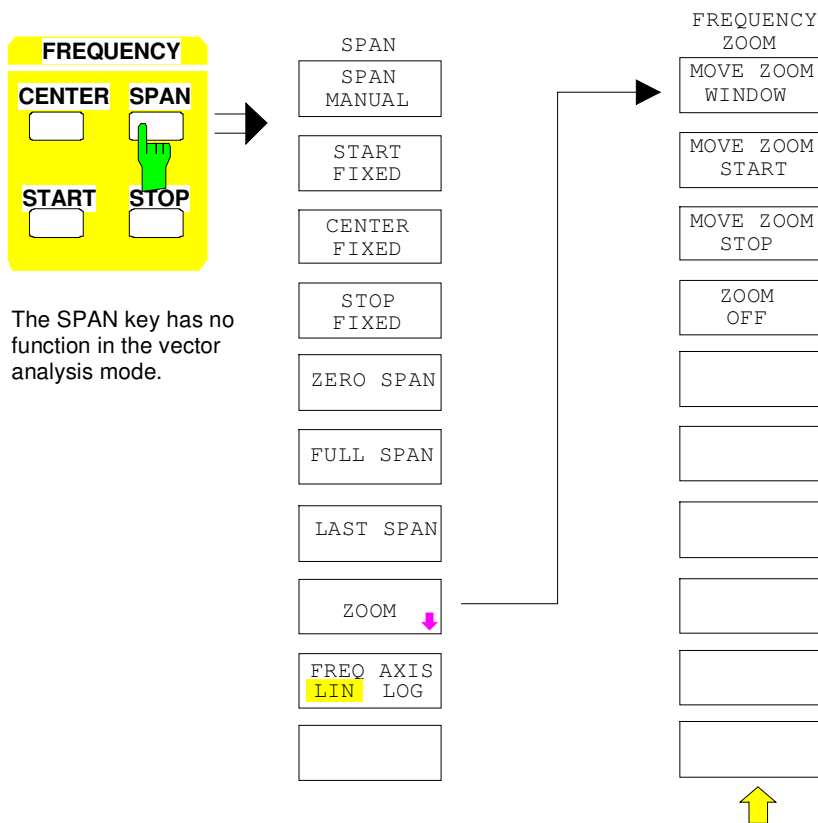
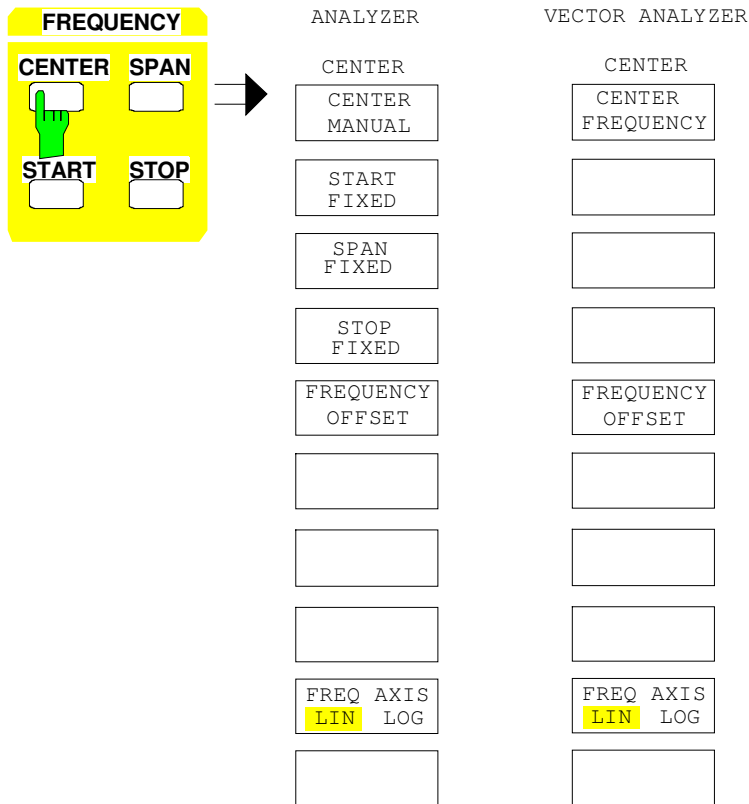

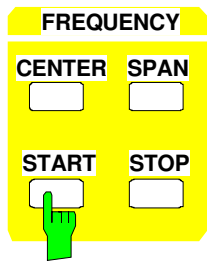

The START key has no function in vector analysis mode.

- START FREQ
- START MANUAL
- CENTER FIXED
- SPAN FIXED
- STOP FIXED
- 
- 
- 
- 
- FREQ AXIS
- LIN LOG
- 

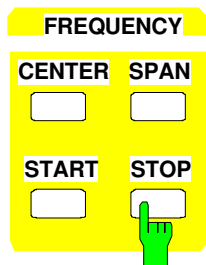

The STOP key has no function in vector analysis mode.

- STOP FREQ
- STOP MANUAL
- START FIXED
- CENTER FIXED
- SPAN FIXED
- 
- 
- 
- 
- FREQ AXIS
- LIN LOG
-



Level Key Group, Input Key

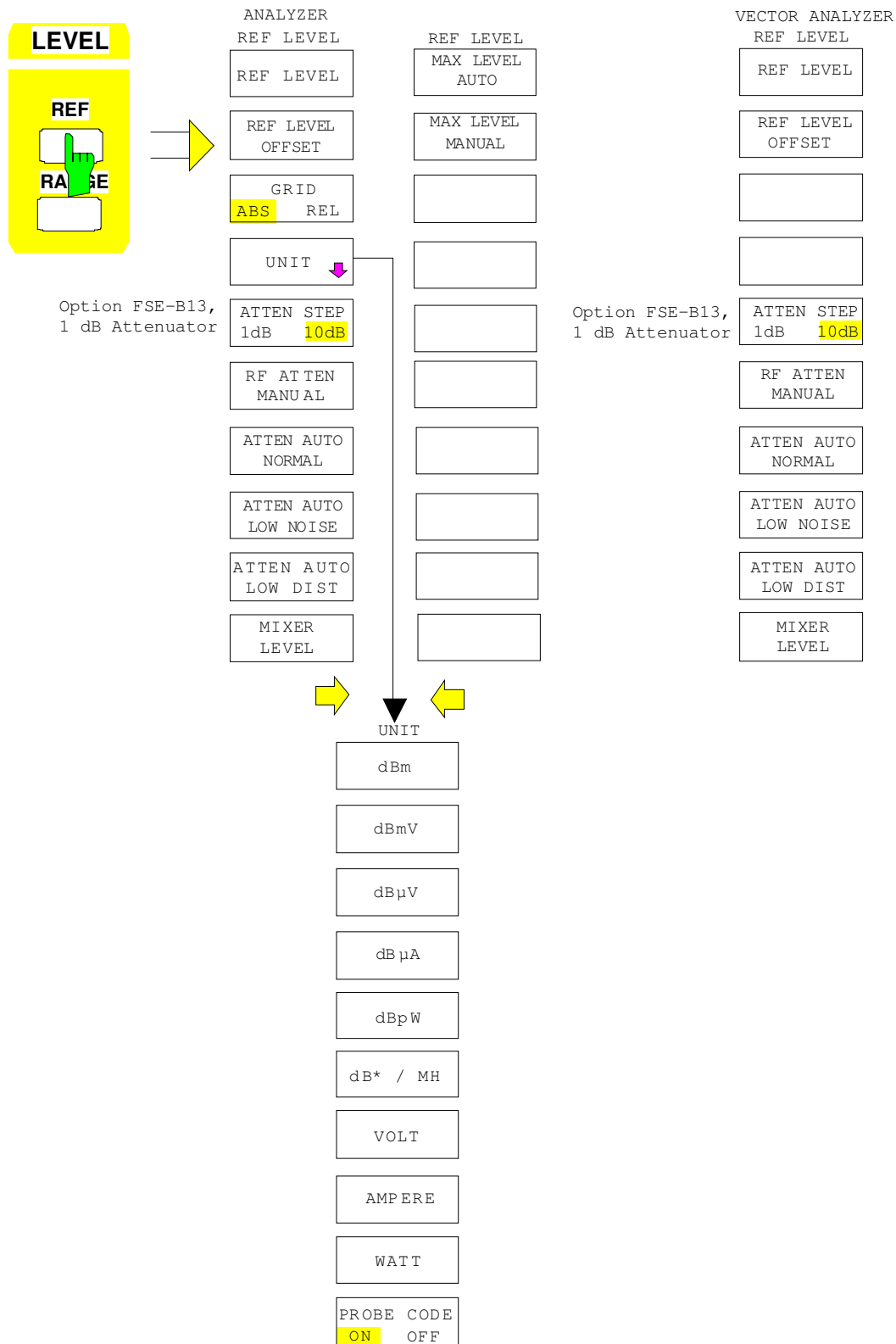

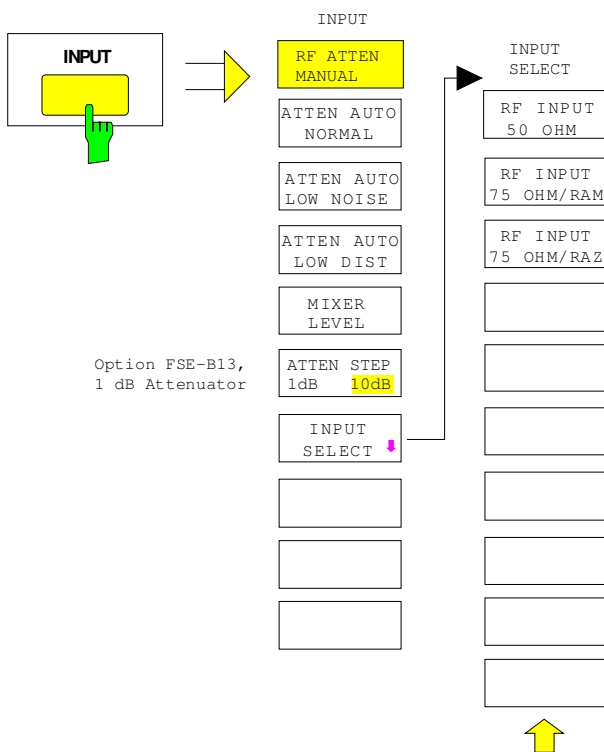
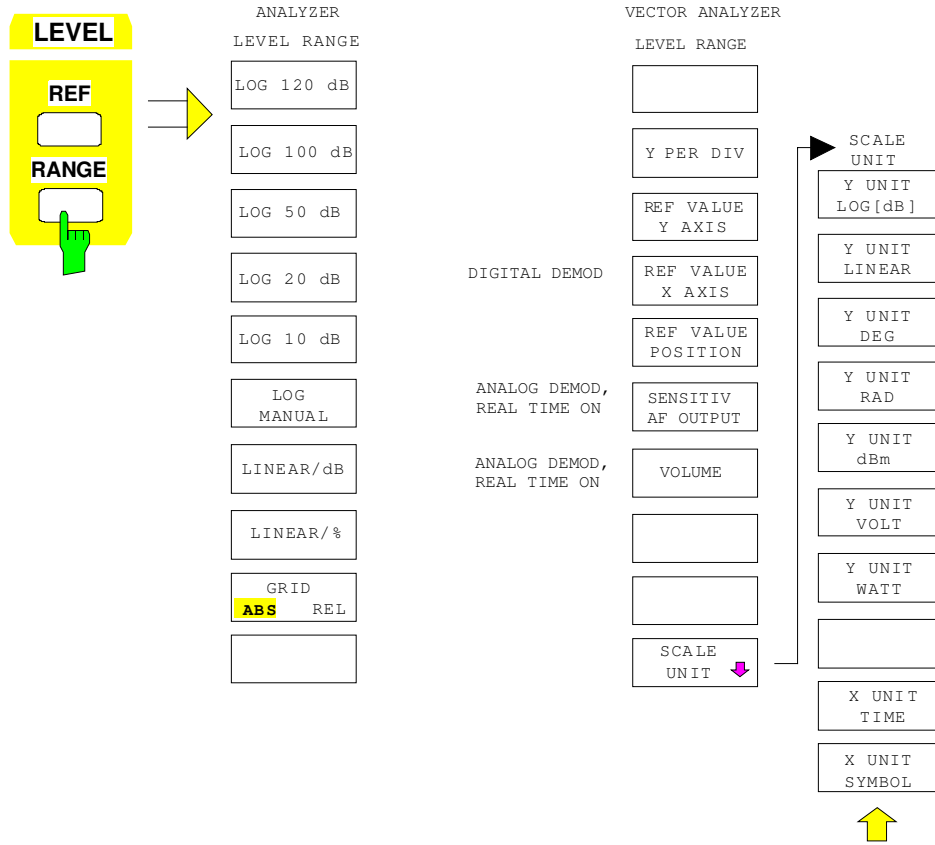

Marker Key Group

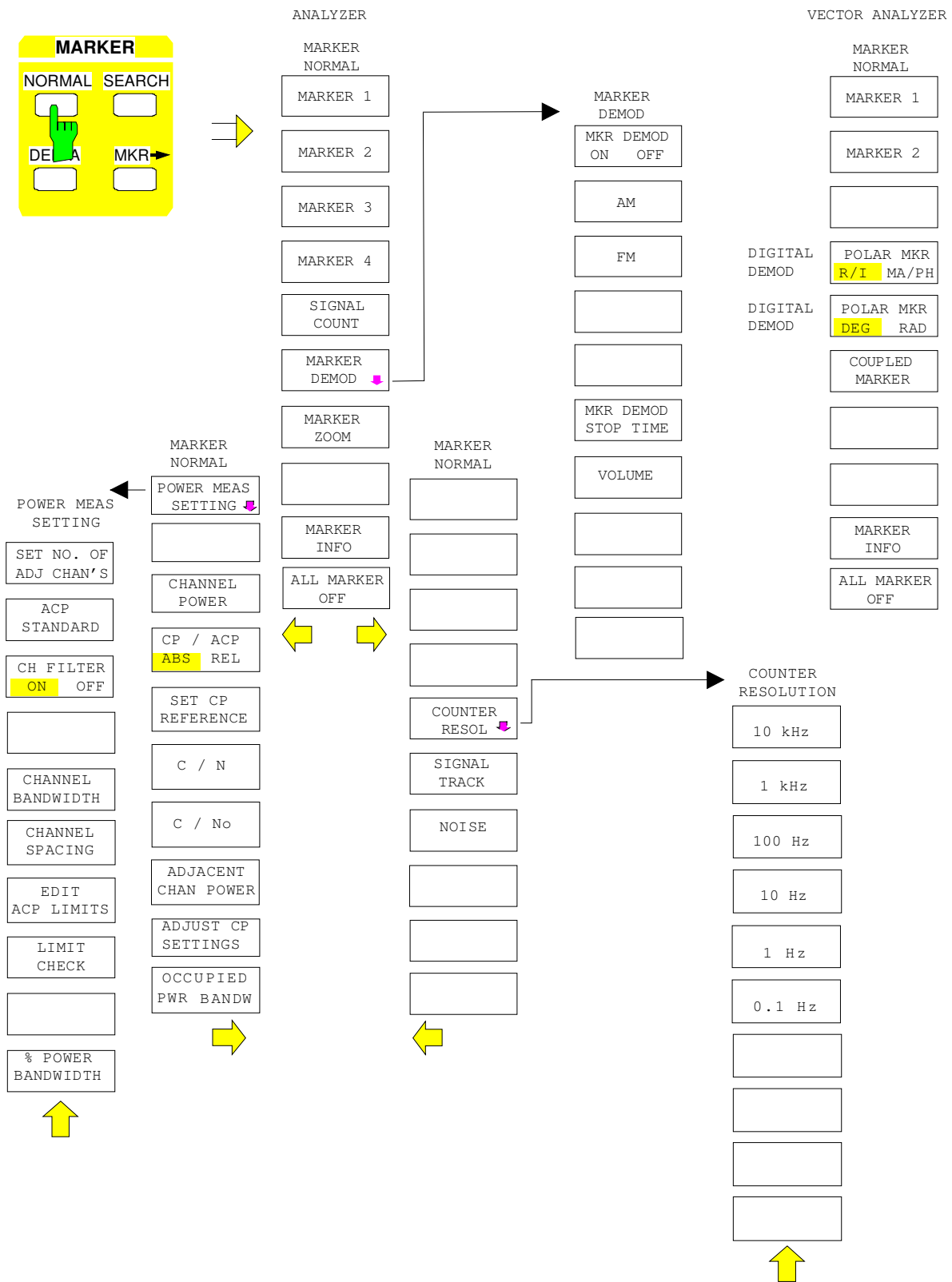

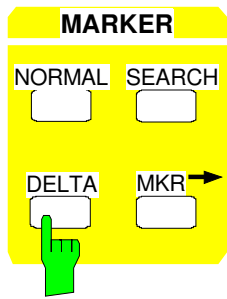

ANALYZER  
DELTA  
MARKER

- DELTA 1
- DELTA 2
- DELTA 3
- DELTA 4
- PHASE NOISE
- 
- REFERENCE POINT
- REFERENCE FIXED
- DELTA MKR  
ABS **REL**
- ALL DELTA OFF



VECTOR ANALYZER  
DELTA  
MARKER

- DELTA 1
- DELTA 2
- 
- 
- 
- 
- 
- DELTA MKR  
ABS **REL**
- ALL DELTA OFF

- REFERENCE POINT
- REF POINT LEVEL
- REF POINT LVL OFFSET
- REF POINT FREQUENCY
- REF POINT TIME
- 
- 
- 
- 
- 



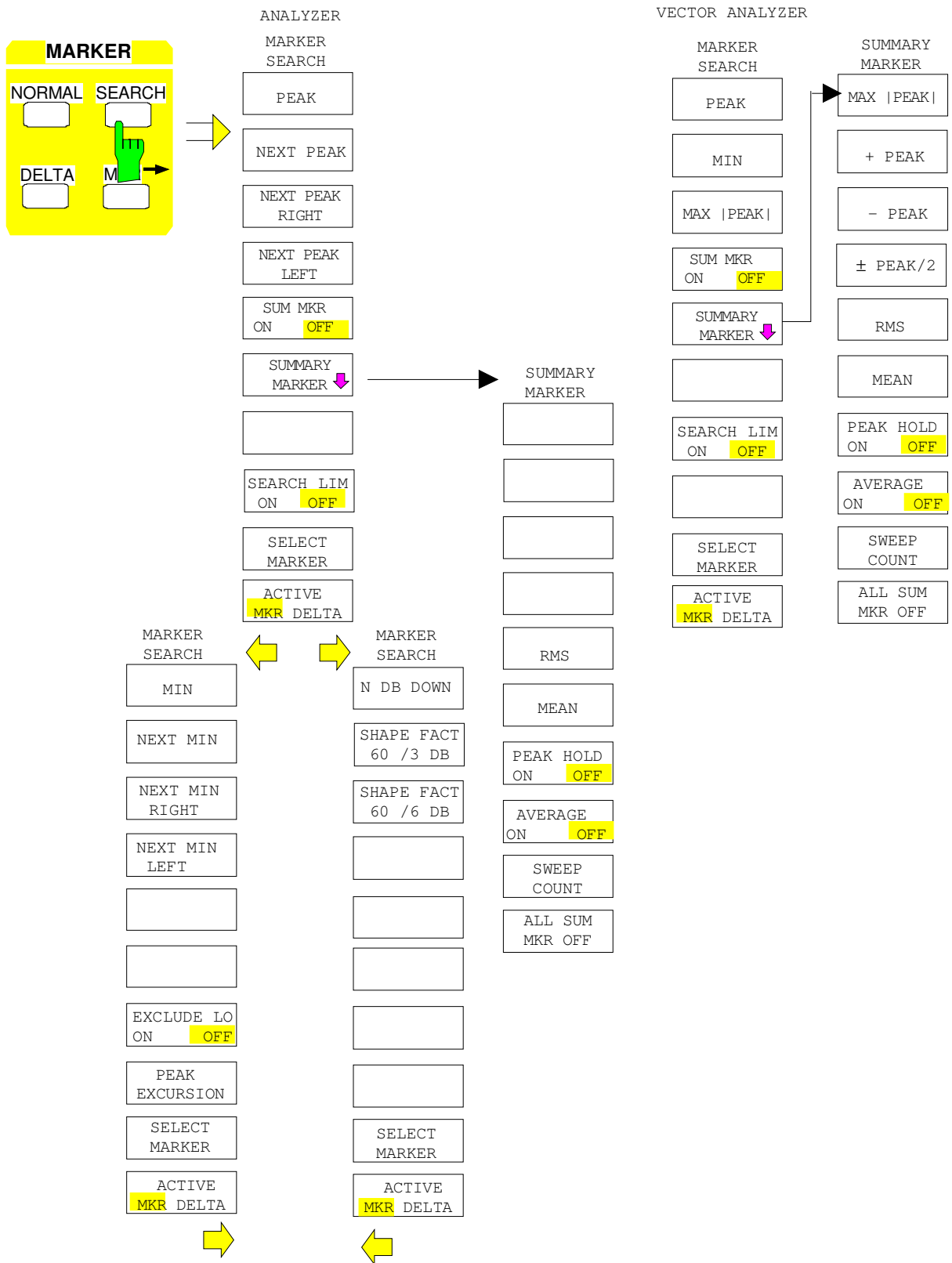

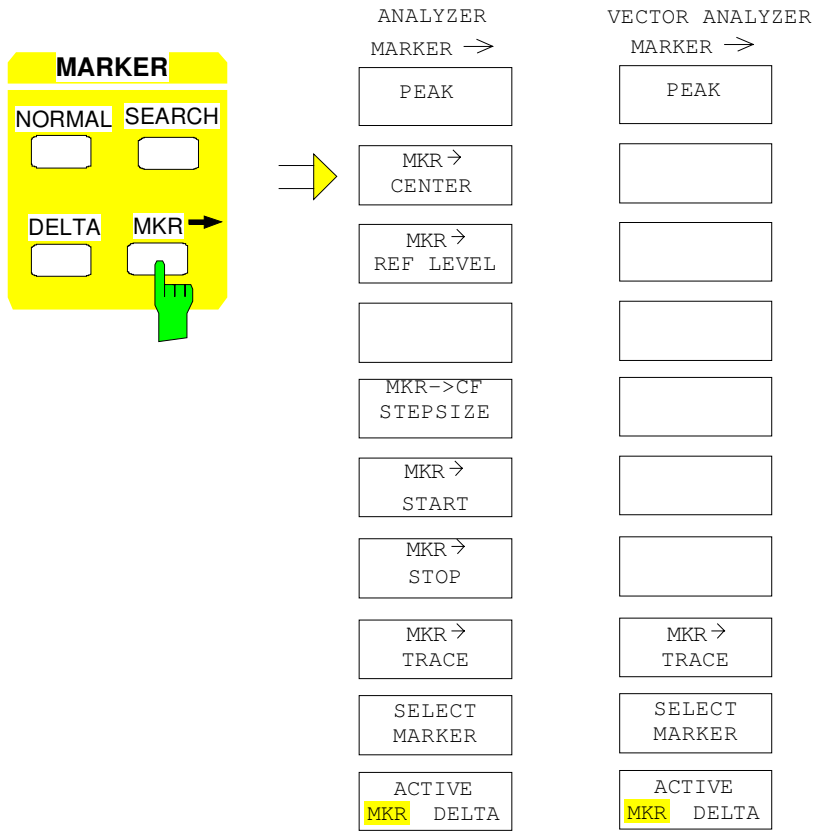

### Lines Key Group

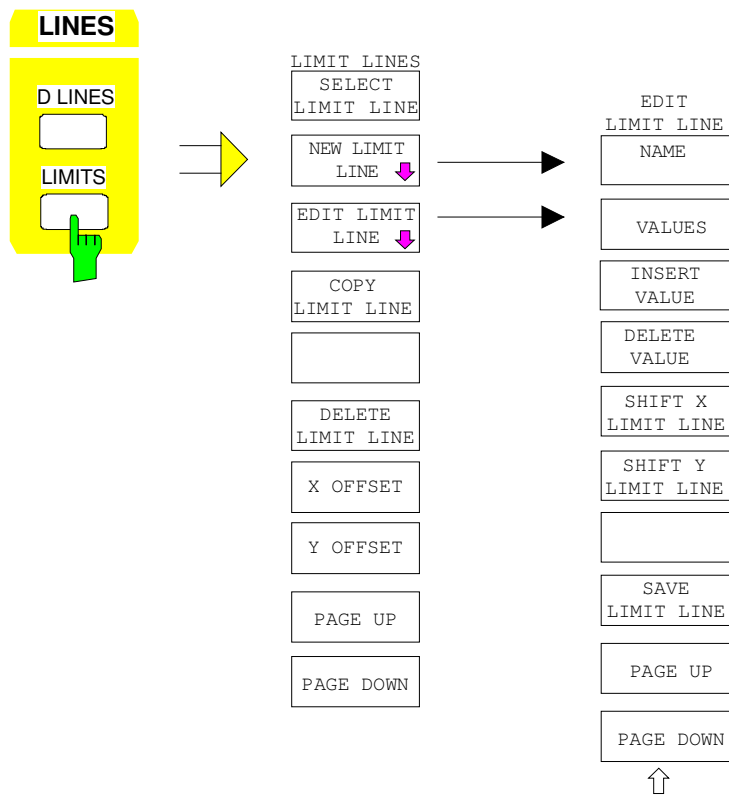
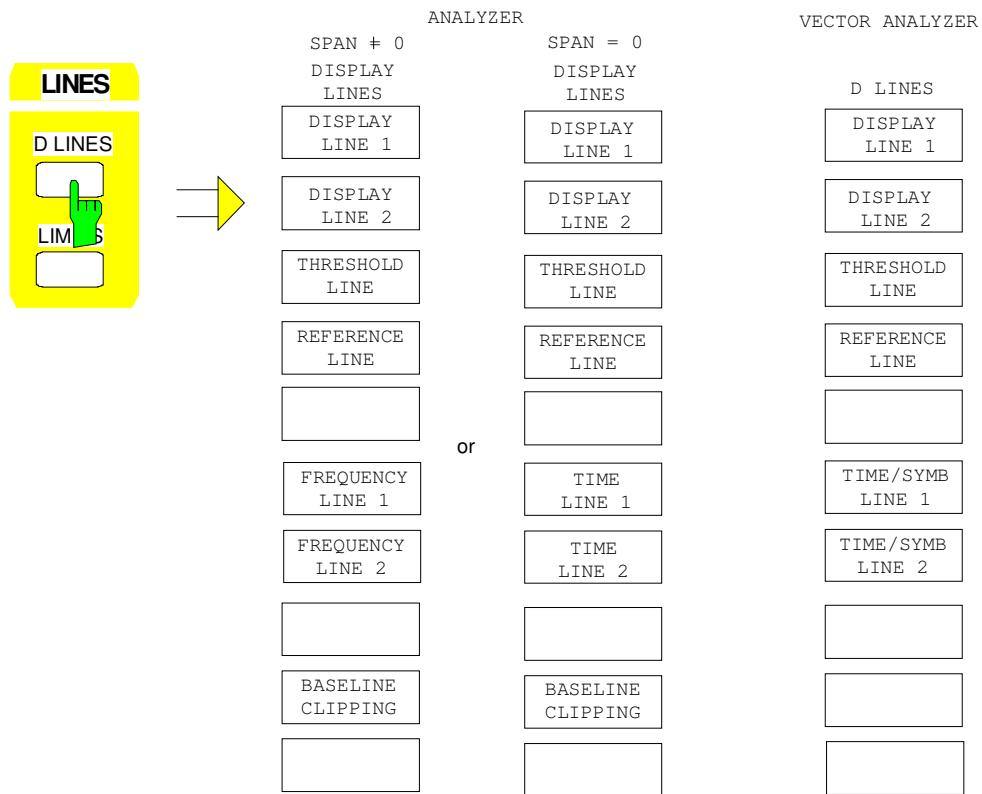

### Trace Key Group

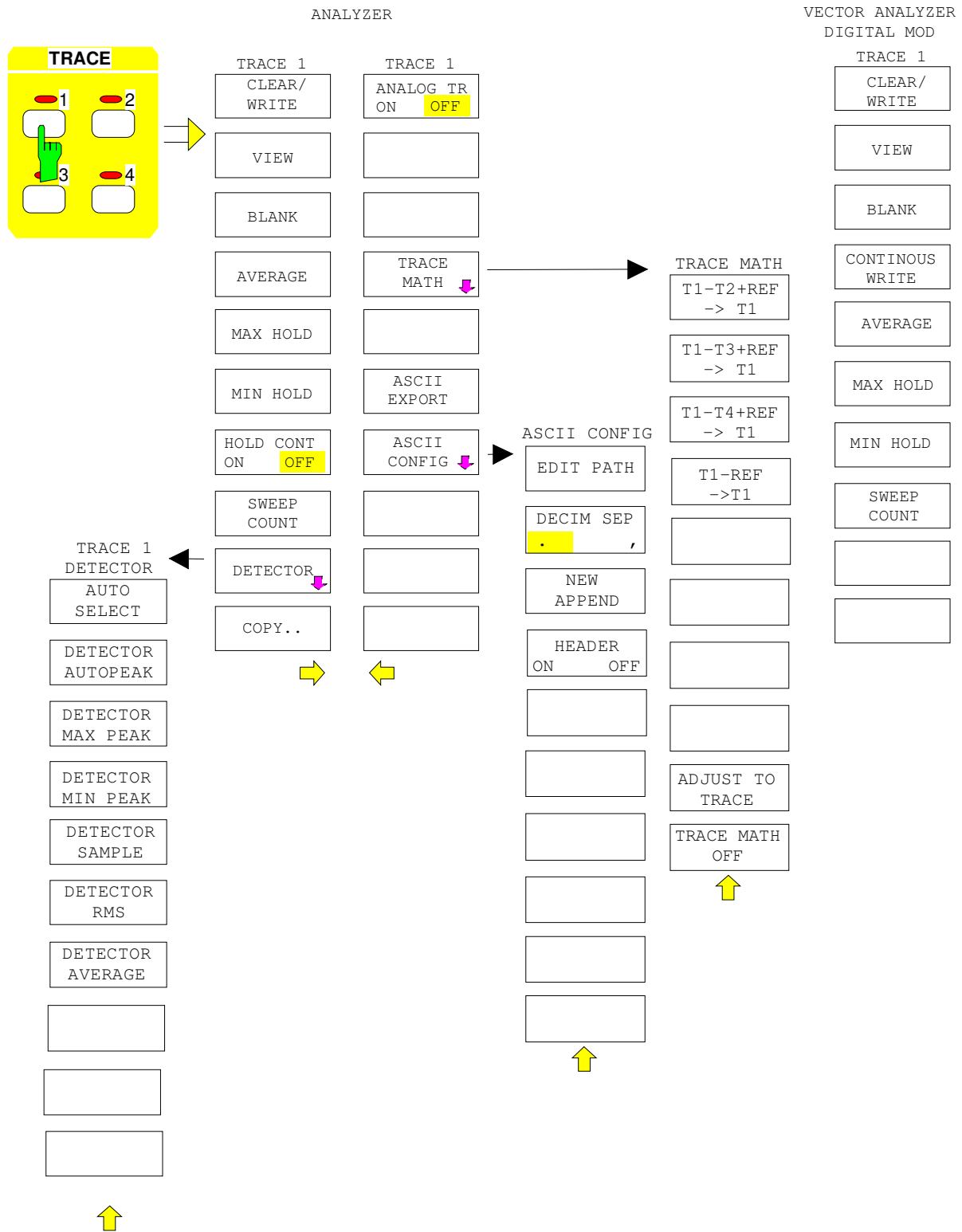



### Sweep Key Group

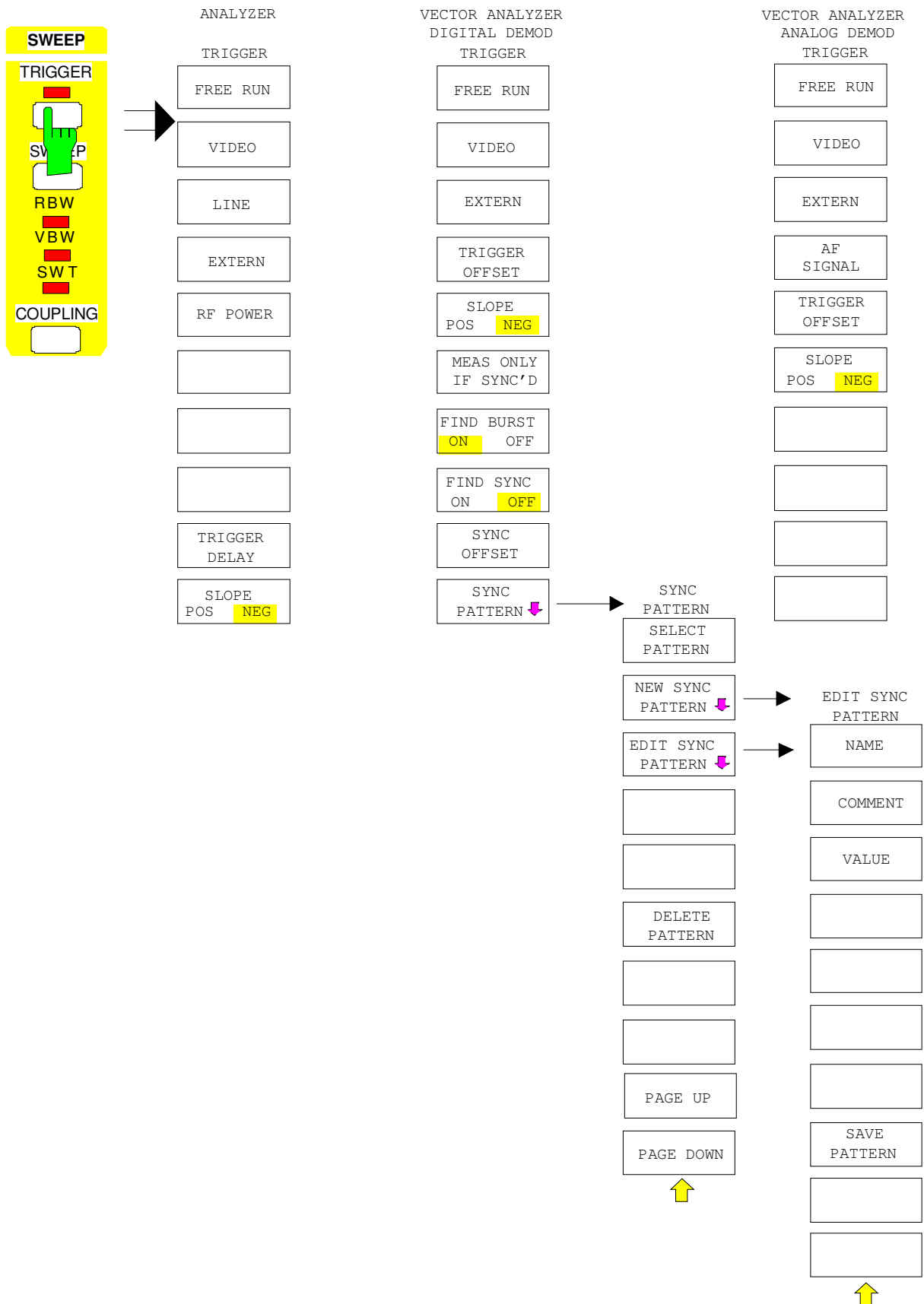

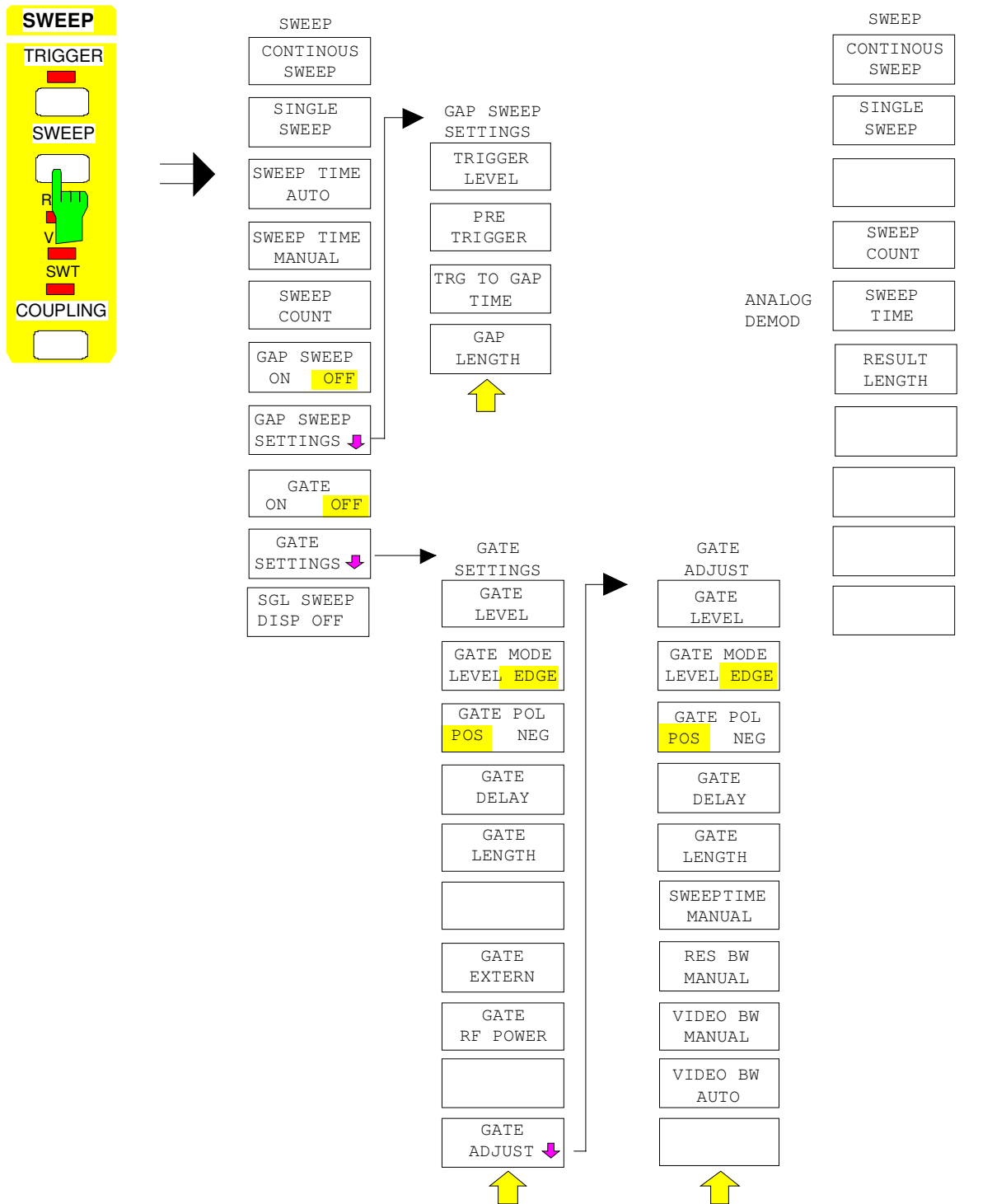

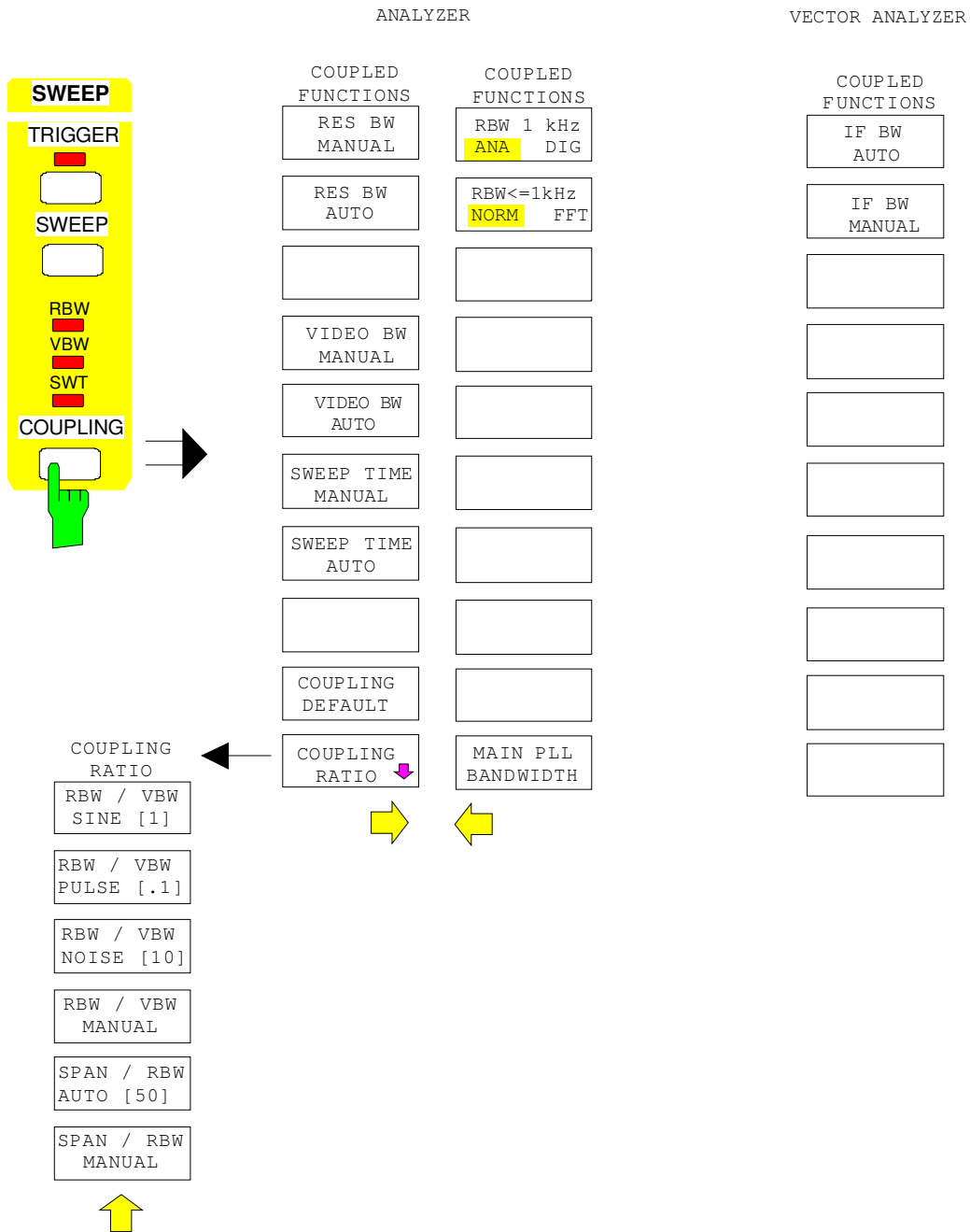

### Memory Key Group

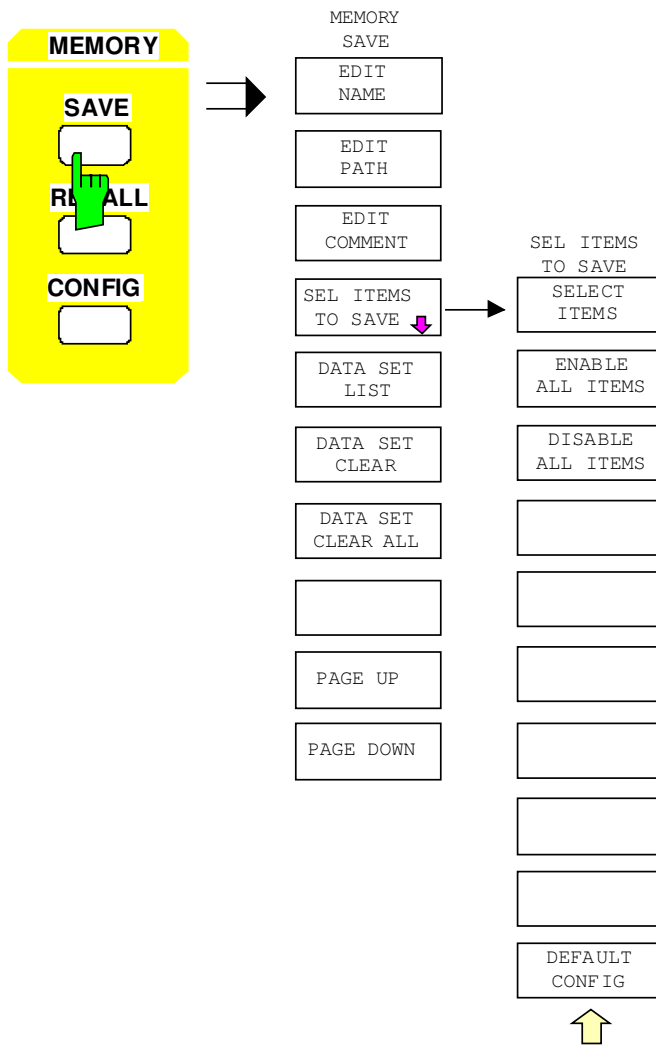

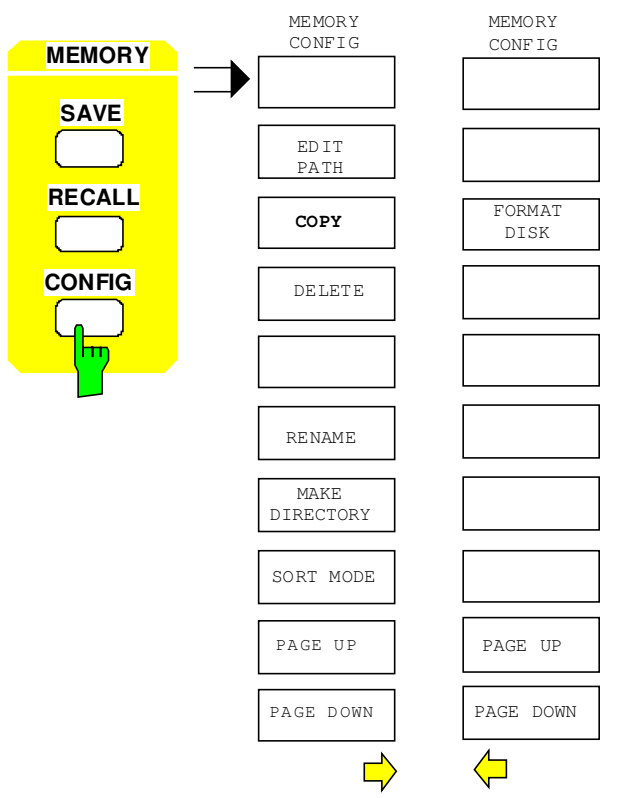
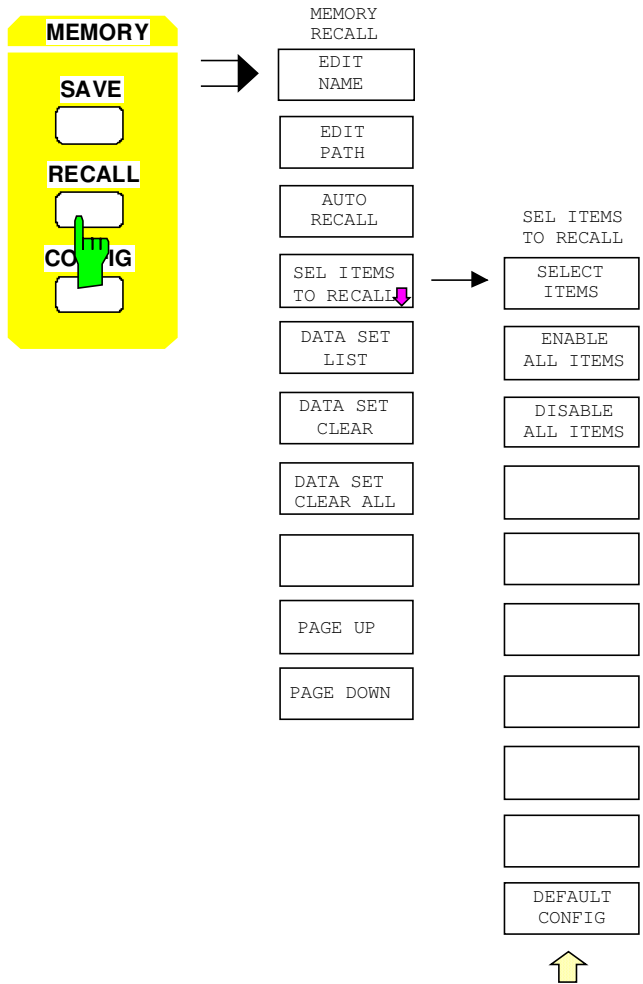

### User Key Group

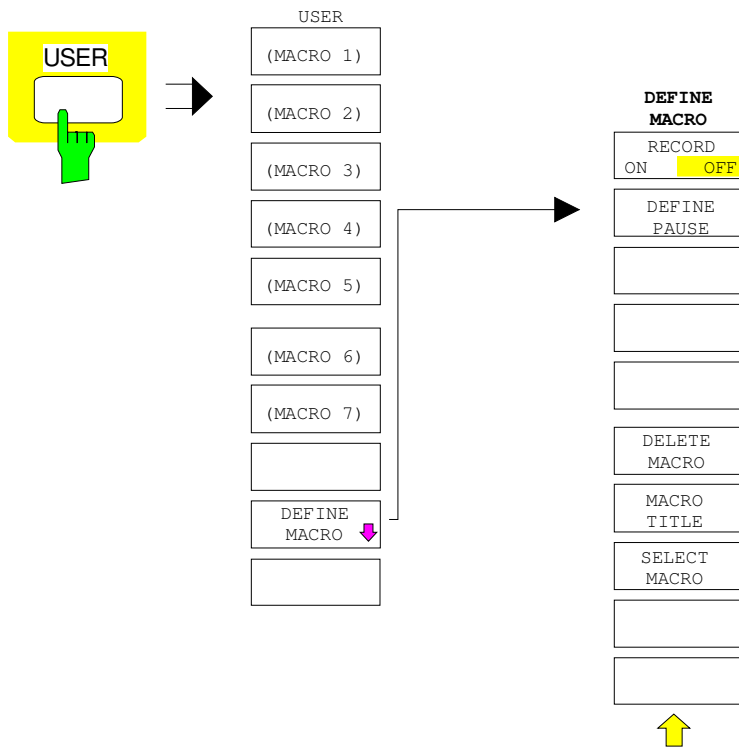



## Contents - Chapter 4 "Instrument Functions"

### 4 Instrument Functions

<b>General Configuration – SYSTEM and CONFIGURATION Key Groups</b> .....	<b>4.2</b>
FSIQ Initial Configuration – PRESET Key .....	4.2
Display Configuration – DISPLAY Key .....	4.3
Display Screen Mode Selection.....	4.4
Measurement Window Coupling .....	4.5
Display Screen Configuration .....	4.6
FSIQ Calibration – CAL Key.....	4.9
Calibration Function Calls.....	4.10
Calibration Results .....	4.12
Instrument Status and Measurement Parameters – INFO Key.....	4.13
Firmware Versions .....	4.13
Hardware Configuration and Options .....	4.14
Self Test .....	4.15
System Messages .....	4.16
Statistics Function for Input Attenuator Switching .....	4.17
Mode Selection – MODE Key .....	4.18
Preliminary Setup and Interface Configuration – SETUP Key.....	4.20
Using Transducers .....	4.20
Activating Transducer Factors and Transducer Sets .....	4.21
New Entry and Editing of Transducer Factors.....	4.23
New Entry and Editing of Transducer Sets.....	4.27
Enabling Firmware Options .....	4.31
External Reference Oscillator.....	4.31
Service Functions.....	4.32
Programming the Interface Configuration and Time .....	4.34
IEC Bus Address Selection .....	4.34
User Port Configuration.....	4.35
Serial Interface Configuration .....	4.36
Setting Date and Time.....	4.38
Connecting the External Monitor .....	4.39
Switching the Beeper ON/OFF .....	4.39
Firmware Update.....	4.40
Compatibility to FSE Instrument Family .....	4.40
<b>Status Display-Remote/Manual Control – STATUS Key Group</b> .....	<b>4.41</b>
<b>Measurement Documentation – HARDCOPY Key Group</b> .....	<b>4.42</b>
Printing Data – START Key .....	4.42
Printing Configuration – SETTINGS Key .....	4.44
Selection of Displayed Elements and Colour Settings .....	4.45
Selection of Hardcopy Format.....	4.46
Entry of Comment Text .....	4.47
Selection and Configuration of the Output Device .....	4.48
<b>Saving and Recalling Data Sets – MEMORY Key Group</b> .....	<b>4.50</b>
Configuration of Memory – CONFIG Key .....	4.52
Saving Data Sets – SAVE Key .....	4.54
Selecting the Data Set for Storage.....	4.55
Selecting the Data subset for Storage.....	4.57
Recalling of Data Sets – RECALL Key .....	4.58
Selecting the Data Set for Recalling.....	4.59
Building a Data Set.....	4.61



<b>Macros – USER Key</b> .....	<b>4.62</b>
Fundamentals.....	4.62
Starting Macros.....	4.63
Defining Macros.....	4.64
<b>Analyzer Mode</b> .....	<b>4.66</b>
Frequency and Span Selection – <i>FREQUENCY</i> Key Group.....	4.67
Start Frequency – <i>START</i> Key.....	4.67
Stop Frequency – <i>STOP</i> Key.....	4.69
Center Frequency – <i>CENTER</i> Key.....	4.70
Center Frequency Step Size.....	4.72
Frequency Span – <i>SPAN</i> Key.....	4.74
Display Zoom.....	4.76
Level Display and RF Input Configuration – <i>LEVEL</i> Key Group.....	4.77
Reference Level – <i>REF</i> key.....	4.77
Display Units.....	4.79
Level Range – <i>RANGE</i> Key.....	4.82
RF Input Configuration – <i>INPUT</i> Key.....	4.83
Option 1 dB Attenuator - FSE-B13.....	4.86
Marker Functions – <i>MARKER</i> Key Group.....	4.88
Main Markers– <i>NORMAL</i> Key.....	4.88
LF Demodulation.....	4.92
Frequency Measurement.....	4.94
Noise Power Density Measurement.....	4.95
Channel Power Measurements.....	4.96
Marker Step Size.....	4.109
Delta Markers – <i>DELTA</i> Key.....	4.110
Phase Noise Measurement.....	4.113
Delta-Marker Step Size - <i>STEP</i> Key.....	4.114
Search Functions – <i>SEARCH</i> Key.....	4.115
Summary Marker.....	4.120
Instrument Parameter Changes via Markers – <i>MKR</i> → Key.....	4.123
Setup of Display and Limit Lines – <i>LINES</i> Key Field.....	4.125
Display Lines – <i>D LINES</i> Key.....	4.125
Limit Lines – <i>LIMITS</i> Key.....	4.129
Limit Line Selection.....	4.130
Entry and Editing of Limit Lines.....	4.133
Trace Selection and Setup – <i>TRACE</i> Key Group.....	4.138
Measurement Function Selection - <i>TRACE 1 to 4</i> key.....	4.138
Detector Selection.....	4.143
Quasi Analog Display.....	4.146
Mathematical Functions for Traces.....	4.147
Trace Export.....	4.148
Sweep Control – <i>SWEEP</i> Key Group.....	4.152
Coupled Settings – <i>COUPLING</i> Key.....	4.152
Setting and Coupling the Coupling Resolution, Video Bandwidth and Sweep Time.....	4.153
Sweep Coupling Ratio.....	4.158
Sweep Trigger – <i>TRIGGER</i> Key.....	4.160
Sweep Setup – <i>SWEEP</i> Key.....	4.162
Gated Sweep.....	4.164
Sweep Blanking – Gap Sweep.....	4.170

<b>Vector Analyzer Mode .....</b>	<b>4.174</b>
Selecting the Operating Mode .....	4.175
Analog Demodulation Methods.....	4.177
Selecting the Modulation Parameters .....	4.181
Selecting the Audio Signal.....	4.186
Triggering with Analog Demodulation - Softkey TRIGGER or Hardkey TRIGGER...	4.194
Setting the Display Range and the Scaling - Softkey RANGE or Hardkey RANGE..	4.196
Sweep Menu with Analog Demodulation - Softkey SWEEP TIME or Hardkey SWEEP4.	199
Digital Demodulation Methods.....	4.202
Diagram for signal processing.....	4.202
Symbol Mapping.....	4.203
Phase Shift Keying (PSK).....	4.203
Differential PSK .....	4.205
Frequency Shift Keying (FSK) .....	4.206
Minimum Shift Keying (MSK), CDPD .....	4.207
Quadrature Amplitude Modulation (QAM) .....	4.207
Selecting the Digital Demodulators .....	4.208
Standard Settings .....	4.209
Selecting Modulation Parameters for Digital Demodulation .....	4.211
Selecting Measurement Results for Digital Demodulation .....	4.216
Magnitude of Capture Buffer .....	4.216
Measurement of Reference Signal .....	4.217
Measurement of Modulation Errors .....	4.224
Symbol Table and Table of Modulation Errors .....	4.227
Selecting Memory Size, Demodulation Length and Display Range .....	4.231
Frequency Settings- FREQUENCY Key Group.....	4.234
Setting the Frequency - CENTER Key .....	4.234
Setting the Frequency Span - START, STOP, and SPAN Key .....	4.234
Setting the Level Display and Configuring the RF Input .....	4.235
Setting the Reference Level .....	4.235
Setting the Display Range and Scaling - RANGE Key .....	4.237
Configuration of RF Input in Vector Signal Analysis.....	4.240
MARKER Key Group .....	4.241
Main Marker - <i>NORMAL</i> Key.....	4.241
Delta Marker - <i>DELTA</i> Key.....	4.244
Search Functions (Marker Search menu) - <i>SEARCH</i> Key.....	4.245
The Summary Marker.....	4.247
Varying Instrument Settings by means of Markers - <i>MKR</i> →Key .....	4.250
Setup of Display and Limit Lines – <i>LINES</i> Key Field .....	4.251
Display Lines – <i>D LINES</i> Key .....	4.251
Limit Lines – <i>LIMITS</i> Key .....	4.253
Limit Line Selection .....	4.254
Entry and Editing of Limit Lines .....	4.257
Selection and Setting of Traces - <i>TRACE</i> Key Group .....	4.261
<i>SWEEP</i> Key Group.....	4.264
Setting the Analog Bandwidth - <i>COUPLING</i> Key .....	4.264
Sweep Setup - <i>SWEEP</i> Key.....	4.265
Triggering Data Storage - <i>TRIGGER</i> Key .....	4.266

---

<b>Tracking Generator Option .....</b>	<b>4.277</b>
Tracking Generator Settings.....	4.278
Transmission Measurement.....	4.279
Calibration of Transmission Measurement.....	4.279
Normalization.....	4.281
Reflection Measurement.....	4.285
Calibration of Reflection Measurement .....	4.285
Functioning of Calibration .....	4.286
Frequency-Converting Measurements .....	4.287
External Modulation of Tracking Generator.....	4.288

## 4 Instrument Functions

All functions of the spectrum analyzer are explained in detail in this chapter.

The instrument functions for general settings, printout and data management are described at the beginning of this chapter – key groups *SYSTEM*, *CONFIGURATION*, *HARDCOPY*, *MEMORY* and the *USER* key.

The sequence of the following key groups depends on their appearance on the front panel: key groups *FREQUENCY*, *LEVEL*, *MARKER*, *LINES*, *TRACE*, *SWEEP* and the *INPUT* key.

All options that provide an additional operating mode and are not supplied with a separate manual are described at the end of the chapter.

The different softkeys of a menu are described from top to bottom and from the left to the right side menu. The submenus are marked by an indentation or displayed in a separate section. The whole path (key - softkey - ...) is indicated in the line above the menu display.

An overview of the menus is given in chapter 3 which also contains the description of the operating concept.

For fast lookup a list of softkeys with the associated IEC/IEEE-bus commands is given at the end of Chapter 6.

An index at the end of the handbook serves as further help for the user.

## General Configuration – *SYSTEM* and *CONFIGURATION* Key Groups

### FSIQ Initial Configuration – *PRESET* Key

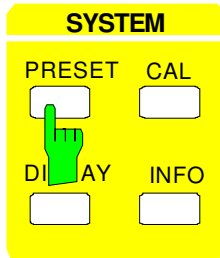

Using the *PRESET* key, the FSIQ can be brought to a predefined initial state equivalent to the state after power on. All previous settings are deleted if they were not previously saved in memory. Returning to the *PRESET* state is not critical with regard to an arbitrary signal which may still be present at the input as long as the signal is within the specified voltage range.

**Note:** *The initial state set by the PRESET key can be adapted to arbitrary applications using the AUTO RECALL function. This function implies that the AUTO RECALL dataset is loaded upon pressing the PRESET key. For further information refer to section "Saving and Recalling Data Sets".*

Pressing the *PRESET* key, causes the FSIQ to enter its initial state according to the following table:

Table 4-1 Initial State of FSIQ

Parameter	Setting				
	FSIQ3	FSIQ7	FSIQ26	FSIQ40	
Mode	analyzer	Analyzer	analyzer	analyzer	
Center Frequency	1.75 GHz	3.5 GHz	13.25 GHz	20 GHz	
Center Frequency Step	350 MHz	700 MHz	2,65 GHz	4 GHz	auto, 0.1×Span
Span	3.5 GHz	7 GHz	26.5 GHz	40 GHz	
RF Attenuation	10 dB	10 dB	10 dB	10 dB	auto
Ref Level	-20 dBm	-20 dBm	-20 dBm	- 20 dBm	
Level Range	100 dB log	100 dB log	100 dB log	100 dB log	
Detector	auto peak	auto peak	auto peak	auto peak	
Sweep Time	5 ms	5 ms	150 ms	225 ms	auto
Resolution Bandwidth	3 MHz	3 MHz	3 MHz	3 MHz	auto
Video Bandwidth	3 MHz	3 MHz	3 MHz	3 MHz	auto
Sweep	cont	cont	cont	cont	
Trigger	free run	free run	free run	free run	
Trace	1	1	1	1	clr write
Trace	2, 3, 4	2, 3, 4	2, 3, 4	2, 3, 4	blnk

## Display Configuration – DISPLAY Key

The display of the measurement results on the FSIQ display screen takes place in either one or two measurement windows. In some cases, the two windows can be subdivided into two diagrams each, e.g. for the representation of the inphase and quadrature signal in the vector analyzer mode.

If only one window is used, this window fills the complete display screen. Two measurement windows are always placed over each other. The axes labelling and measurement settings are defined independently in each measurement window.

When two measurement windows are used, the settings can be chosen to be either coupled or fully independent from each other. The measurement procedure is always sequential.

New instrument settings can only be entered in the active measurement window. This window is marked on the upper right corner of the grid. Coupled settings are changed simultaneously in both windows at the time of entry.

The entry of the measurement parameters for each of the two windows can be either independent from one another using numerical inputs, or by graphical definition of the span through the use of level and frequency lines. The former case, e.g., may be used for harmonic or frequency converter measurements, and the latter case, for a zoom display of a frequency or level segment.

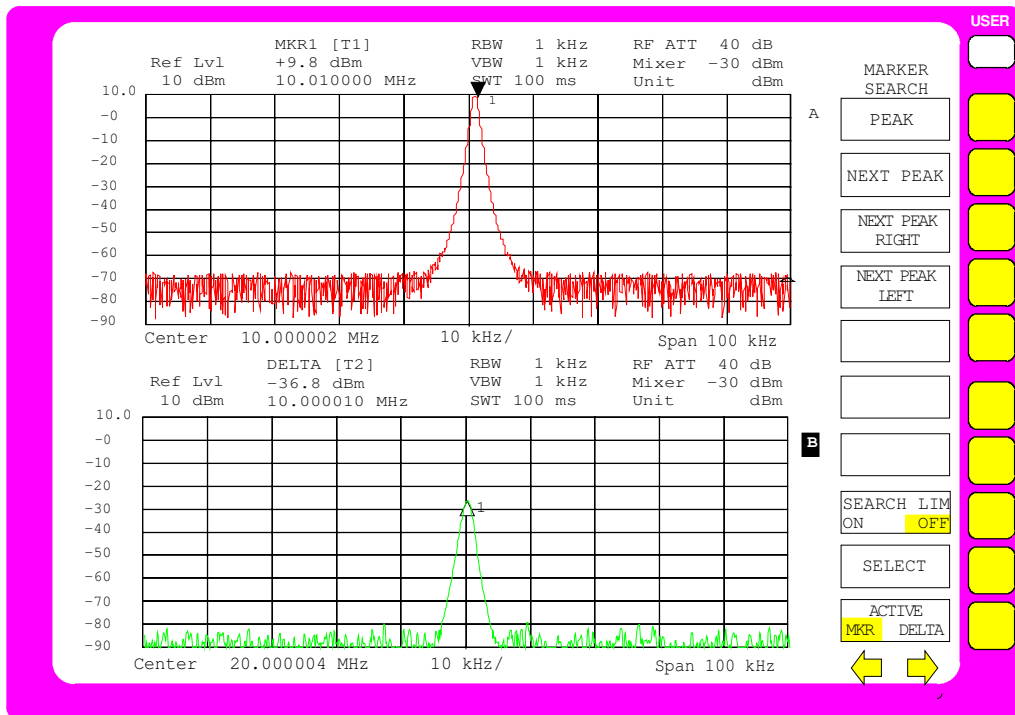
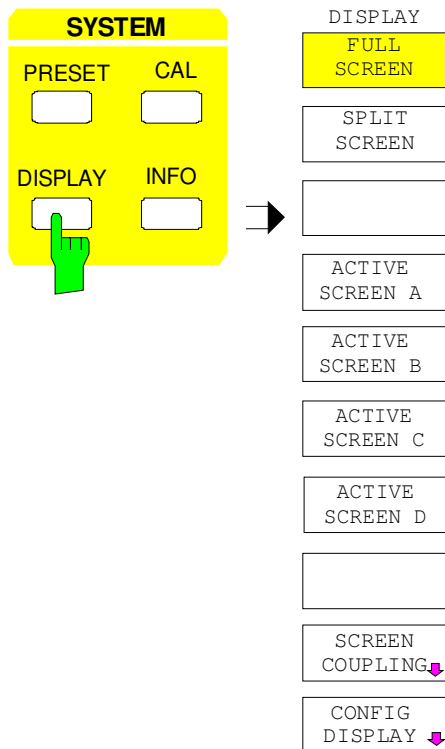

Fig. 4-1 Split screen mode, screens uncoupled

SYSTEM DISPLAY menu:



The *DISPLAY* key calls a menu which is used to configure the display screen and to select the active measurement window in SPLIT-SCREEN mode.

### Display Screen Mode Selection

SYSTEM DISPLAY menu:

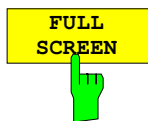

The *FULL SCREEN* softkey configures the display screen to one measurement window. This is the default setting of the FSIQ.

In this mode, the *ACTIVE SCREEN A / ACTIVE SCREEN B* and *SCREEN COUPLING* softkeys are not used.



The *SPLIT SCREEN* softkey sets the display screen to show two measurement windows. The upper window is called *SCREEN A*, the lower is called *SCREEN B*.



If *SPLIT SCREEN* display is activated, the *ACTIVE SCREEN A* and *ACTIVE SCREEN B* softkeys are used to activate either window A or window B.

The entry of new settings is only possible for the active window.

.  
. .  
. .

When switching back to *FULL SCREEN* mode, the active measurement window is displayed.

If, in addition, the two windows are both subdivided into two diagrams, the *ACTIVE SCREEN A/B* softkeys activate the upper diagram, *ACTIVE SCREEN C/D* the lower diagram in each window.

## Measurement Window Coupling

For the most part, the settings for the two windows can be either independently performed or coupled to one another. In many cases, when changes are made in one window (e.g., the reference level) it is desirable to also make the corresponding changes in the second window. The measurement window parameters which are to be coupled may be selected in the *SCREEN COUPLING* menu.

*SYSTEM DISPLAY-SCREEN COUPLING* submenu:

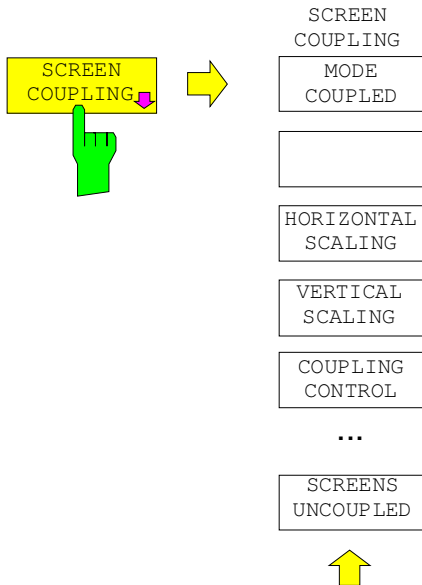

The *SCREEN COUPLING* softkey calls a sub-menu in which the coupling between the two measurement windows *SCREEN A* and *SCREEN B* can be defined. This coupling is only effective when both windows are displayed (*SPLIT SCREEN*).

In the default setting, all of the items which are selectable are also coupled.

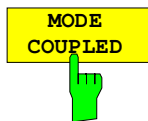

The *MODE COUPLED* softkey switches the coupling of the operating mode (Analyzer, Vector Analyzer) on/off.



The *HORIZONTAL SCALING* softkey switches the coupled scaling of the horizontal axes on and off. In the frequency domain, the center frequency and the frequency span are identical. In the time domain, the sweep time for both windows is the same.



The *VERTICAL SCALING* softkey switches the coupled scaling of the vertical axes on and off. For a level measurement, this means that the reference level and the vertical resolution (*LEVEL RANGE*) are set to the same values in both windows.

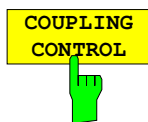

The *COUPLING CONTROL* softkey switches the coupling of the trigger and gate parameters and of SWEEP COUNT and SWEEP SINGLE/CONTINUOUS on/off.

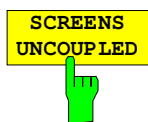

The *SCREENS UNCOUPLED* softkey switches all of the possible couplings between the measurement windows to off.



## Display Screen Configuration

SYSTEM DISPLAY-CONFIG DISPLAY submenu:

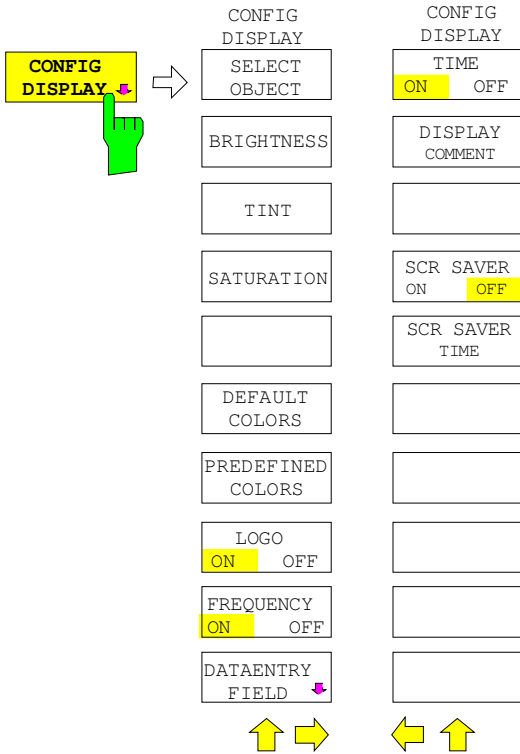

The *CONFIG DISPLAY* softkey calls a submenu and its supplementary menu, in which the selection of color and brightness for the individual elements on the display screen takes place. The actual selection of the elements takes place in the corresponding menu table.

The color assignment of the softkeys is coupled with the color assignment of other display elements.

Changing for example the color of *SOFTKEY STATE OFF* causes the color of the table background to be changed at the same time. The same applies to *SOFTKEY STATE DATA ENTRY* and display lines, and to *SOFTKEY STATE ON* and enhancement labels.

In the supplementary menu, date, time and a diagram label can be displayed on the screen.

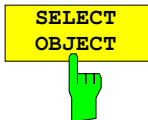

The *SELECT OBJECT* softkey activates the SELECT DISPLAY OBJECT table, with which a graphics element can be selected. After selection, the brightness, tint and saturation of the selected element can be changed using the softkeys of the same name. The color changes can be seen immediately on the display screen.

SELECT DISPLAY OBJECT	
√	TRACE 1
	TRACE 2
	TRACE 3
	TRACE 4
	MARKER
	GRID
	SOFTKEY STATE ON
	SOFTKEY STATE DATA ENTRY
	SOFTKEY STATE OFF
	SOFTKEY SHADE
	TEXT
	TITLE
	BACKGROUND



The *BRIGHTNESS* softkey activates the entry of the brightness of the color for the selected element. The range of input values is 0 to 100%.

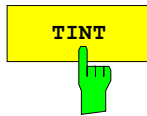

The *TINT* softkey activates the entry of the color tint of the selected element. The entered value is related to a continuous color spectrum ranging from red (0%) to blue (100%).

The *TINT* function is not available for monochrome (black/white) displays.



The *SATURATION* softkey activates the entry of the color saturation for the selected element.

The range of inputs is from 0 to 100%.

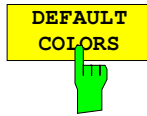

The *DEFAULT COLORS* softkey restores the default settings for brightness, color tint and color saturation for all display screen elements.

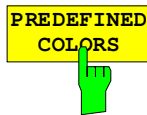

The *PREDEFINED COLORS* softkey activates a table, with which the predefined colors for the display screen elements can be selected.

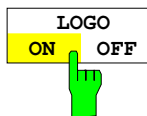

The *LOGO* softkey switches the Rohde & Schwarz company logo displayed in the upper left corner of the display screen on or off.

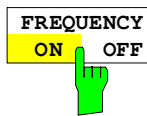

The *FREQUENCY* softkey switches the displaying of frequency information on the screen on and off.

ON Frequency information is displayed.

OFF Frequency information is not outputted to the display. This can be used for example to protect confidential data.

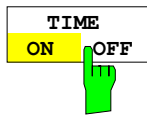

The *TIME* softkey switches on or off the display of date and time at the lower edge of the diagram.

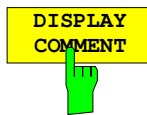

The *DISPLAY COMMENT* softkey activates the entry of a label comprising a maximum of 50 characters. This label is displayed at the lower edge of the diagram.

Pressing the softkey again causes the label to be switched off. The stored text, however, is not deleted.

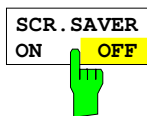

The *SCR. SAVER* softkey is used to switch on/off the screen saver for the display.

After the elapse of the response time (*SCR. SAVER TIME*) the display is completely switched off, ie including backlighting.

The screen saver is deactivated by pressing any key or by sending the corresponding IEEE/IEC bus command.



The *SCR. SAVER TIME* softkey activates the entry of the time for the screen saver to respond. The response time is entered in minutes between 1 to 100 minutes.

SYSTEM DISPLAY-CONFIG DISPLAY DATAENTRY FIELD Untermenü:

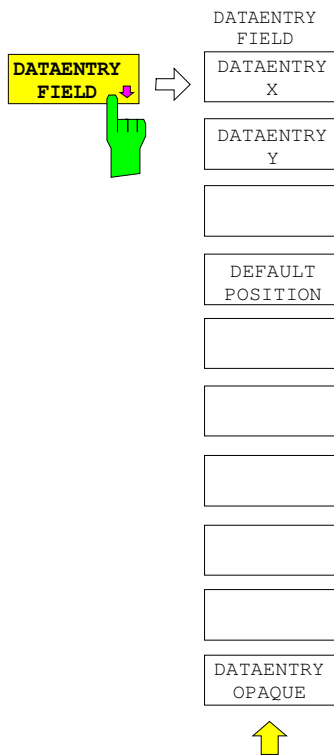

The *DATAENTRY FIELD* softkey displays a submenu used to specify the position and characteristics of the data entry field.

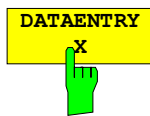

The *DATAENTRY X* softkey shifts the position of the data entry field horizontally.

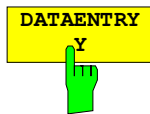

The *DATAENTRY Y* softkey shifts the position of the data entry field vertically.



The *DEFAULT POSITION* softkey positions the data entry field automatically. In general, its position is the upper left edge of the grid on the active screen.

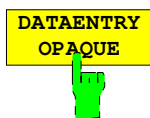

The *DATAENTRY OPAQUE* softkey sets the data entry windows to opaque. This means that entry windows are underlaid with the background color for tables and that diagrams and traces behind an entry window can no longer be seen.

## FSIQ Calibration – CAL Key

The FSIQ maintains its high measurement accuracy through the application of numerous self-calibration techniques. The *CAL* hard key provides a series of calibration functions which allow not only the calibration of the complete instrument, but also calibration functions which are specifically applicable to the measurement requirements of relevant instrument sections.

The measurement settings of the FSIQ are saved and, after calibration, completely restored. The calibration data valid before calibration are saved and, in case of a calibration abort, restored.

A window shows the progress of the calibration while it is running. ABORT can be used to abort the calibration at any time.

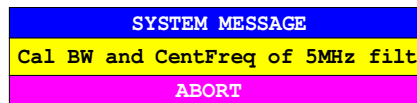

SYSTEM CAL menu:

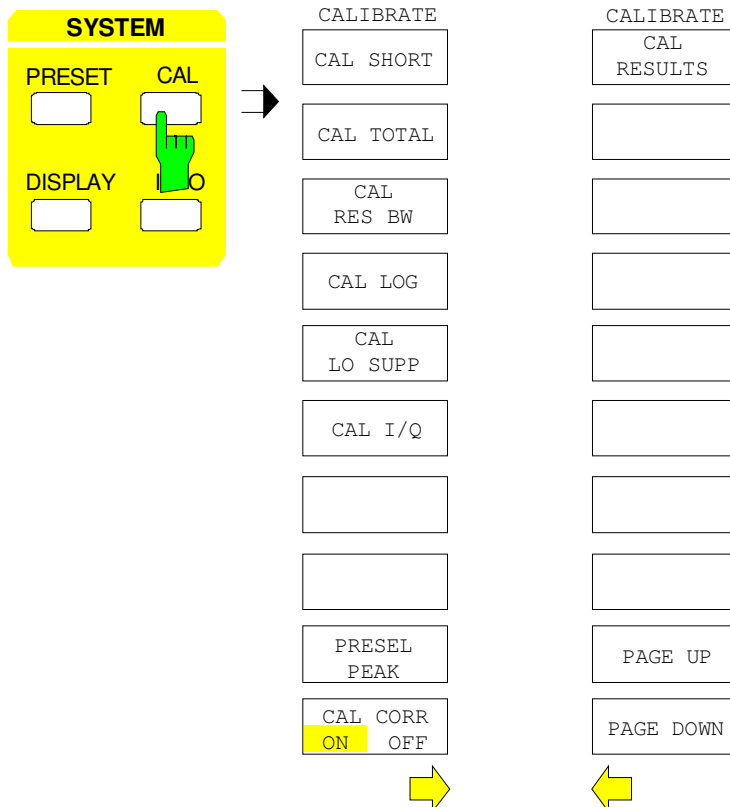

The *CAL* key displays a menu with the available calibration functions.

## Calibration Function Calls

SYSTEM CAL menu:



The *CAL SHORT* softkey starts a short calibration, in which the absolute gain of the analyzer as well as the gain errors of the selected bandwidth are corrected.



The *CAL TOTAL* softkey starts a complete calibration of the analyzer including additional partial calibrations shown in the menu.

*UNCAL* is displayed in the status line if calibration cannot be successfully completed or if the correction data are disabled (*CAL CORR* softkey= *OFF*).



The *CAL RES BW* softkey starts the correction of the center frequency, the bandwidth and the gain of the resolution filter.



The *CAL LOG* softkey starts the calibration of the linearity of the logarithmic amplifier.



The *CAL LO SUPP* softkey calibrates the compensation of the first oscillator at low frequencies. After calibration, the display of the internal oscillator at the frequency 0 Hz is very small.

It is recommended that the calibration be performed whenever sensitive measurements are to be made at low frequencies.



The *CAL I/Q* softkey calibrates the gain and phase error of the I/Q demodulator.



The *PRESEL PEAK* softkey optimizes the tuning of the preselector for input signals in the frequency range above 7 GHz.

This calibration should be used whenever signal levels in the frequency range above 7 GHz are to be measured and high accuracy is desired.

If a marker is not active when the *PRESEL PEAK* softkey is pressed, marker 1 is activated as the reference marker and placed on the signal maximum in the active trace. Otherwise the active marker is used.

The following window is displayed on the screen while the peaking function is running. The function can be aborted at any time using the *ABORT* line. In this case, the correction value determined at the factory is restored.

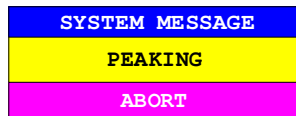

The input signal's signal-to-noise ratio must be at least 10dB in order that the peaking function runs properly. Otherwise, the preselector may be set incorrectly, which would cause level errors by subsequent measurements.

If the instrument setting (start/stop frequency, sweep time) is changed after *PRESEL PEAK* has been called, the correction value for the preselector determined by the function is no longer used. Instead, the correction value determined at the factory is restored.

The softkey is only available by those FSIQ models which have an input frequency range above 7 GHz.



The *CAL CORR ON/OFF* softkey switches the calibration data on/off.

ON The status message depends upon the results of the total calibration

OFF The message *UNCAL* appears in the FSIQ status line.

## Calibration Results

SYSTEM CAL menu:



The *CAL RESULTS* softkey in the right-hand supplementary menu calls the *CALIBRATION RESULTS* table, which shows the correction data found during calibration.

The *CALIBRATION RESULTS* table contains the following information:  
page 1:

- date and time of the last total calibration
- overall results of the total calibration
- list of the calibration procedures according to function/module, including the correction values, the measured results and the individual results for each of the calibration procedures

The results for the individual calibration procedures are categorised and displayed as follows:

PASSED calibration successful without restrictions  
 CHECK deviations larger than expected, however, corrections could be performed  
 FAILED deviations too large, no corrections were possible  
 ABORTED calibration aborted

CALIBRATION RESULTS				
CALIBRATION: PASSED				
Last cal total: 05.Jun 1997 16:24:54				
Calibration of IF Filters PASSED				
IF GAIN Adjust PASSED				
Bandwidth:				
Filter	Cal Val [Hz]	DAC Val	State	
1kHz	2.806e+01	1679	PASSED	
2kHz	1.603e+01	2887	PASSED	
3kHz	-6.012e+00	3238	PASSED	
5kHz	-1.002e+01	3514	PASSED	
10kHz	1.804e+02	3703	PASSED	
20kHz	3.607e+02	3801	PASSED	
30kHz	8.417e+02	3831	PASSED	
50kHz	1.403e+03	3743	PASSED	
100kHz	1.804e+03	3698	PASSED	
200kHz	3.607e+03	3606	PASSED	
300kHz	8.417e+03	3516	PASSED	
500kHz	1.403e+04	3329	PASSED	
1MHz	2.806e+04	2881	PASSED	

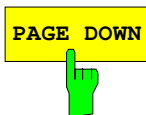

The *PAGE UP* and *PAGE DOWN* softkeys can be used to page through the table of calibration results.

## Instrument Status and Measurement Parameters – INFO Key

SYSTEM INFO menu:

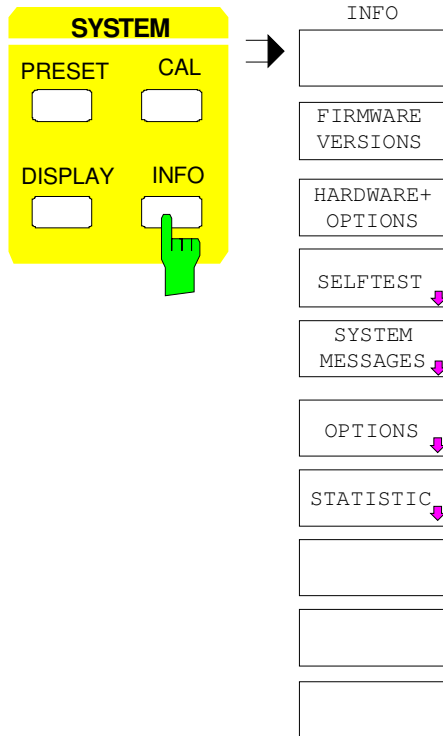

The *INFO* key is used to request general information concerning the instrument. These include:

- firmware version
- installed hardware and hardware options
- modification level of the individual modules
- self-test results with the option of calling self-test functions
- list of generated system messages
- installed firmware and hardware options.
- Statistical evaluations

## Firmware Versions

SYSTEM INFO menu:



The *FIRMWARE VERSIONS* softkey opens two tables, which provide the following informations:

- Table *MODEL* displays the exact instrument model.

MODEL	
FSIQ	26

- In the *FIRMWARE VERSION* table, the version of each software component installed in the instrument is listed. The versions of programmable logic devices are also included if the firmware version of the device can be determined.

FIRMWARE VERSION	
BIOS	1.2
ANALYZER	1.80
SERIAL NUMBER	101379/005



## Hardware Configuration and Options

SYSTEM INFO menu:

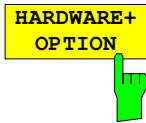

The *HARDWARE+OPTIONS* softkey opens two tables in which the modules (INSTALLED COMPONENTS) installed in the instrument are listed.

- Table *MODEL* lists the instrument name and model:

MODEL
FSIQ 26

- Table *INSTALLED COMPONENTS* consists of four columns:  
 COMPONENT name of module  
 MODEL INDEX model number of the module  
 MODIF INDEX main modification index of the module  
 HW CODE secondary modification index of the module

These lists contain only the modules which are actually present in the instrument, i.e., the modules which were identified by the module recognition software.

INSTALLED COMPONENTS			
COMPONENT	MODEL INDEX	MODIF INDEX	HW CODE
Main Processor	4	n/a	0
Graphic Board	4	n/a	0
I/O Board	4	n/a	0
FRAC SYN	4	0	4
RF Module	4	0	4
2nd IF Converter	3	2	2
LOPhase	3	4	17
Detector	4	0	2
IF Filter	3	2	3
Digital IF	2	0	2
I/Q Demod (B7)	2	3	2

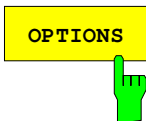

The *OPTIONS* softkey opens two tables listing the options installed. The standard FSIQ is equipped with options FSE-B4, FSE-B5 and FSE-B7

FIRMWARE OPTIONS		
DESIGNATION	TYPE	CODE
FFT	B5	1938496289

**Note:** New firmware options can be enabled in the *SETUP* menu.

HARDWARE OPTIONS	
DESIGNATION	CODE
Low Phase Noise & OCXO	B4

## Self Test

SYSTEM INFO-SELFTEST submenu:

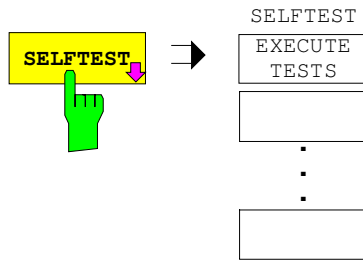

The *SELFTEST* softkey opens a submenu with which the self test can be started.

The instrument has extensive self test functions which comprehensively test instrument functionality. In case of a fault, the instrument can locate a defective module on its own. The self test sequence is described in more detail in the service manual instrument (supplied with the FSIQ).

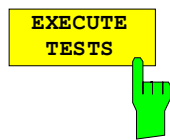

The *EXECUTE TESTS* softkey starts the test of the complete instrument. During the self test a window is displayed:



The functions are tested in the following order:

1. Modules main CPU, digital motherboard, graphics and the interfaces
2. Reference frequency conditioning, the synthesizer modules and all LO signals
3. All RF, IF and signal-weighting modules

If no failure occurs during the execution of the self test, the following message is displayed when the complete self test is finished:



If a failure occurs during the execution of the self test, the self test is immediately aborted and a message indicating the defective module and the defective function is displayed:

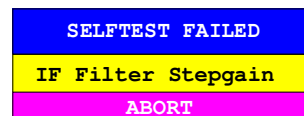

Further testing should be performed by an R&S service department.

### System Messages

The *SYSTEM MESSAGES* softkey opens a submenu including a table in which the generated system messages are displayed. The most recent messages are at the top of the list.

The following information is presented:

- NO Device specific three digit error code (shown as XXX in the figure)
- MESSAGE Brief description of the reason for the message
- DATE/TIME Date and time of occurrence of the message

The messages that have occurred since the last call to the *SYSTEM MESSAGES* menu are marked by an asterix "\*".

*SYSTEM INFO-SYSTEM MESSAGES* submenu:

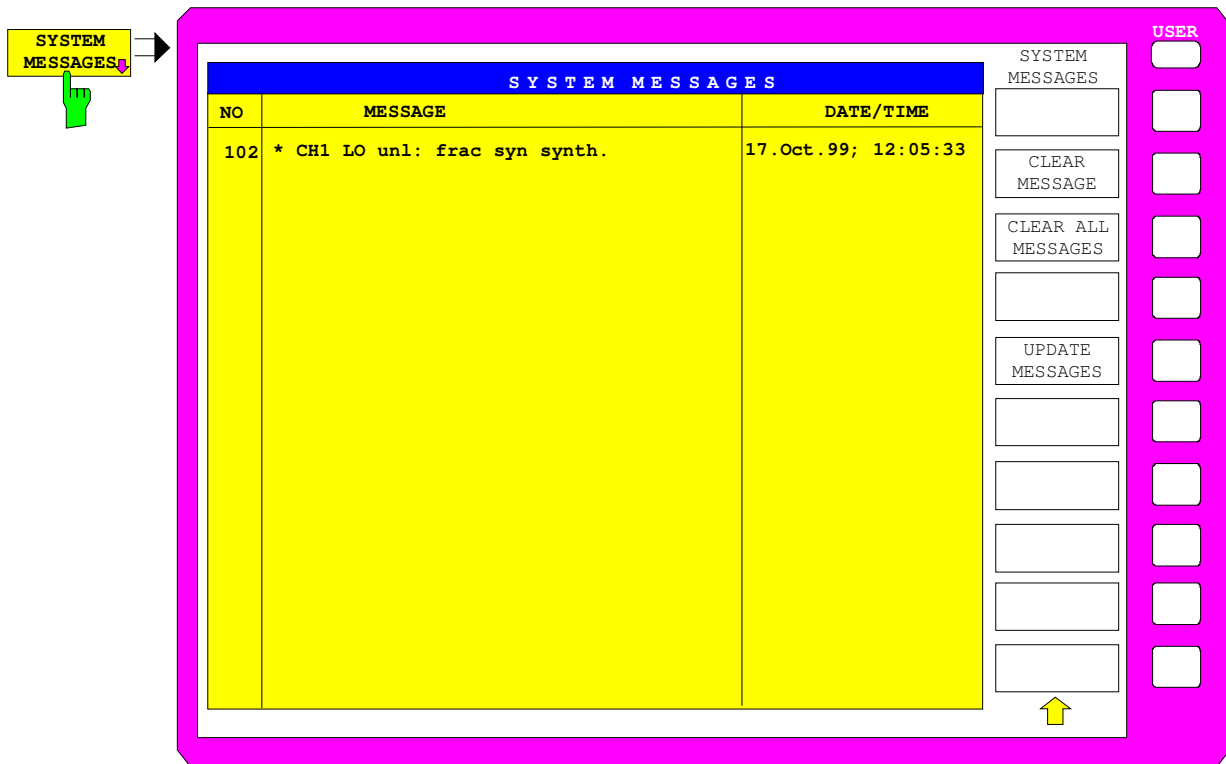

The *CLEAR MESSAGE* softkey deletes the message just selected. All subsequent messages are shifted automatically one line upwards so that no empty lines exist. When the last message has been deleted, the selection bar also disappears.



The *CLEAR ALL MESSAGES* softkey deletes all messages.



The *UPDATE MESSAGES* softkey causes all newly arrived messages to be entered at the top of the table. At this time, all messages previously indicated as "new" are displayed as "old" messages

### Statistics Function for Input Attenuator Switching

SYSTEM INFO menu:

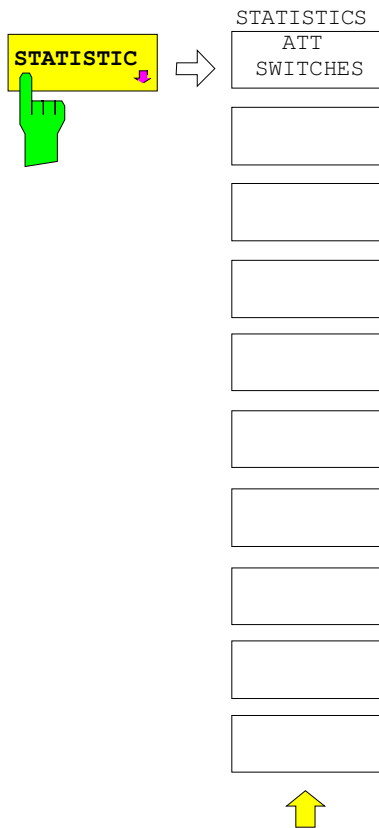

The *STATISTICS* softkey calls a submenu for indication of device statistics.

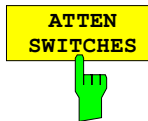

The *ATT SWITCHES* softkey displays various tables listing the mechanical switches and attenuators fitted in the instrument, plus the number of switching operations for the respective switch or attenuator.

INPUT ATTENUATOR	
Date	5 Aug 1999
Calibration Input	6
10 dB	121
20 dB	217
30 dB	137

## Mode Selection – *MODE* Key

The FSIQ can be operated in one of several modes, each of which is different with respect to functionality and control. The differences in control, however, consist not only in the enabling/disabling of additional softkeys within existing softkey menus, but rather in the fact that existing menus are completely replaced by new menus and menu trees which are tailored to the functional requirements. In the simultaneous application of two measurement diagrams, two modes may also simultaneously enabled. Each mode can be assigned to a measurement window.

### CONFIGURATION MODE menu

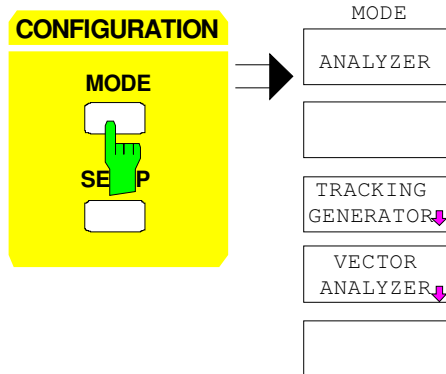

The *MODE* key opens the menu for selection of the mode.

Herein, the modes can be selected according to the available FSIQ options.

- Analyzer
- Tracking Generator and
- Vector Signal Analysis



The *ANALYZER* softkey selects the *ANALYZER* mode.

This mode is the default setting of the FSIQ.

The functions provided correspond to those of a conventional spectrum analyzer. The analyzer measures the frequency spectrum of the test signal over the selected frequency range with the selected resolution and sweep time, or, for a fixed frequency, displays the waveform of the video signal.



The *TRACKING GENERATOR* softkey selects the operating mode Scalar Network Analysis.

The softkey is only available if FSIQ is equipped with one of the following options: FSE-B8/B9/B10 and B11. For a detailed description of operation see Section 'Option Tracking Generator'.

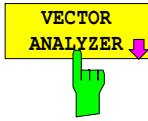

Softkey *VECTOR ANALYZER* selects the vector analysis mode.

In the vector analyzer mode the FSIQ is automatically set to a fixed frequency (center frequency) since vector analysis can only be carried out on one frequency.

The IF signal is digitized by the selected resolution bandwidth after filtering and mixed into the baseband by a digital mixer. Further processing is via digital signal processors which display the time characteristic of the amplitude or phase. As an option, the baseband can also be demodulated and the demodulated signal can be displayed. Principally any type of modulation (digital and analog) can be processed.

The functions of the analyzer mode are supplemented by the vector analysis functions which are described in detail in Section 'Vector Analyzer Mode'.

## Preliminary Setup and Interface Configuration – *SETUP* Key

CONFIGURATION SETUP menu:

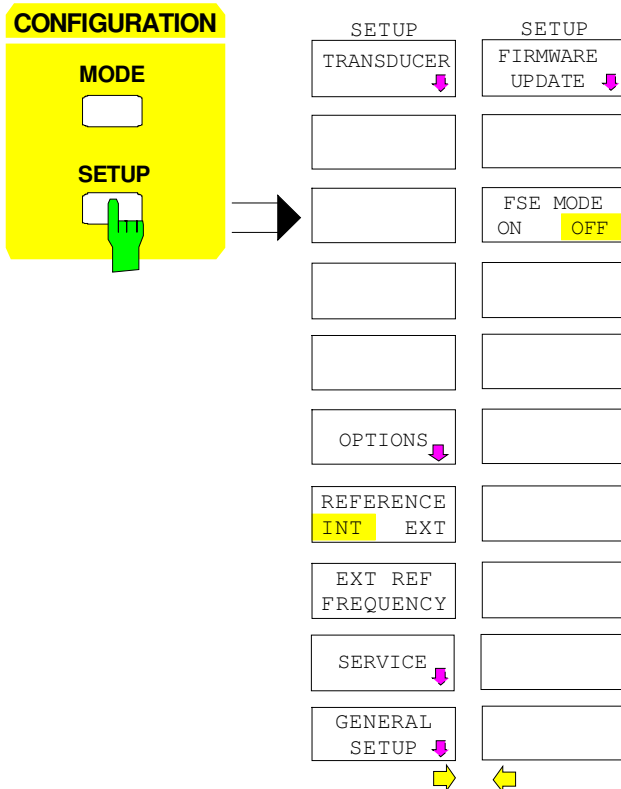

The *SETUP* key opens the menu for configuration of the FSIQ.

The *TRANSUDUCER* softkey opens a submenu to consider the characteristics of transducers in the test result.

The *OPTIONS* softkey allows the enabling of firmware options (Application Firmware Modules).

The *REFERENCE INT/EXT* and *EXTERNAL REF FREQUENCY* softkey determine the reference to be used.

The *SERVICE* softkey provides special setup functions which, although not necessary in normal use, are useful in instrument service.

The *GENERAL SETUP* softkey opens a submenu for all the general settings such as date and time as well as the configuration of the device interfaces.

The *FIRMWARE UPDATE* softkey opens a submenu for the installation of a firmware update.

The *FSE MODE* softkey determines whether the FSIQ is FSE-compatible after preset.

### Using Transducers

A transducer is often connected ahead of FSIQ both during the measurement of useful signals and EMI and converts the useful or interference variable such as field strength, current or RFI voltage into a voltage across 50 Ohm. Transducers with a frequency-independent transducer factor can be coded in 10-dB steps together with the unit at connector *PROBE CODE*. They are supplied at the same time by this connector. Transducers such as antennas, probes or current probes mostly have a frequency-dependent transducer factor which can be stored in FSIQ and automatically has the correct unit during level measurement.

If a transducer is switched on it is considered as part of the unit during the measurement, ie the measured values are displayed in the correct unit and magnitude. When working with two measurement windows, the transducer is always assigned to two windows.

FSIQ distinguishes between **transducer factor** and **transducer set**. A transducer factor takes the frequency response of a single transfer element, eg an antenna into consideration. A transducer set can summarize different transducer factors in several subranges (several transducer factors at the same time), eg an antenna, a cable and a diplexer.

A transducer factor consists of max. 50 reference values defined with frequency, transducer factor and the unit. For the measurement between frequency values linear or logarithmic interpolation of the transducer factor can be chosen.

Several factors can be compiled in a transducer set provided that all factors have the same unit or unit "dB". The frequency range covered by a set can be subdivided into max. 10 subranges (each with up to 4 transducer factors) which follow each other without a gap, ie the stop frequency of a subrange is the start frequency of the next subrange.

The transducer factors used in a subrange have to fully cover the subrange.

The definition of a transducer set is recommended if different transducers are used in the frequency range to be measured or if a cable attenuation or an amplifier has to be taken into consideration.

If a transducer set is defined during a frequency sweep, the latter can be stopped at the interface between two transducer ranges and the user is asked to exchange the transducer.

The following message informs the user that the limit has been reached:

*TDS Range # reached, CONTINUE / BREAK*

He can continue the sweep by confirming the message (*CONTINUE*) or he can switch off the transducer (*BREAK*).

With the automatic switchover of the transducer used, the frequency sweep is not interrupted.

**Note:** *Transducers cannot be used in vector analyzer mode.*

## Activating Transducer Factors and Transducer Sets

The *TRANSDUCER* softkey opens a submenu in which already defined transducer factors or sets can be activated or deactivated, new transducer factors or sets can be generated or existing transducer factors or sets can be edited. Tables with the defined transducer factors and sets are displayed. The table (factor or set) in which a transducer is active is set.

By switching on the transducers all the level settings and outputs are automatically made in the unit of the transducer. A change of the unit in menu *LEVEL REF* is no longer possible as FSIQ together with the transducer used is regarded as a measuring instrument. Only if the transducer has the unit dB, can the original unit at FSIQ be maintained and changed.

**Note:** *If one of the units dB $\mu$ V, dB $\mu$ V/m, dB $\mu$ A, or dB $\mu$ A/m is selected, the LEVEL REF key (see UNIT-submenu) can be used to switch to the corresponding units referred to the bandwidth, i.e. dB $\mu$ V/MHz, dB $\mu$ V/mMHz, dB $\mu$ A/MHz, dB $\mu$ A/mMH.*

If a transducer factor is active, TDF is displayed in the column of the enhancement labels and TDS if the transducer set is active.

After switching off all the transducers, FSIQ continues to use the unit which was selected before a transducer was switched on.

In the analyzer mode, an active transducer for a sweep is uniquely calculated for each point displayed after its setting and added to the result of the level measurement during the sweep. If the sweep range is changed, the correction values are recalculated. If several measured values are combined, only a single value is taken into consideration.

If an active transducer factor/set is not defined over the whole sweep or scan range during the measurement, the missing values are replaced by zero.



CONFIGURATION SETUP Menu

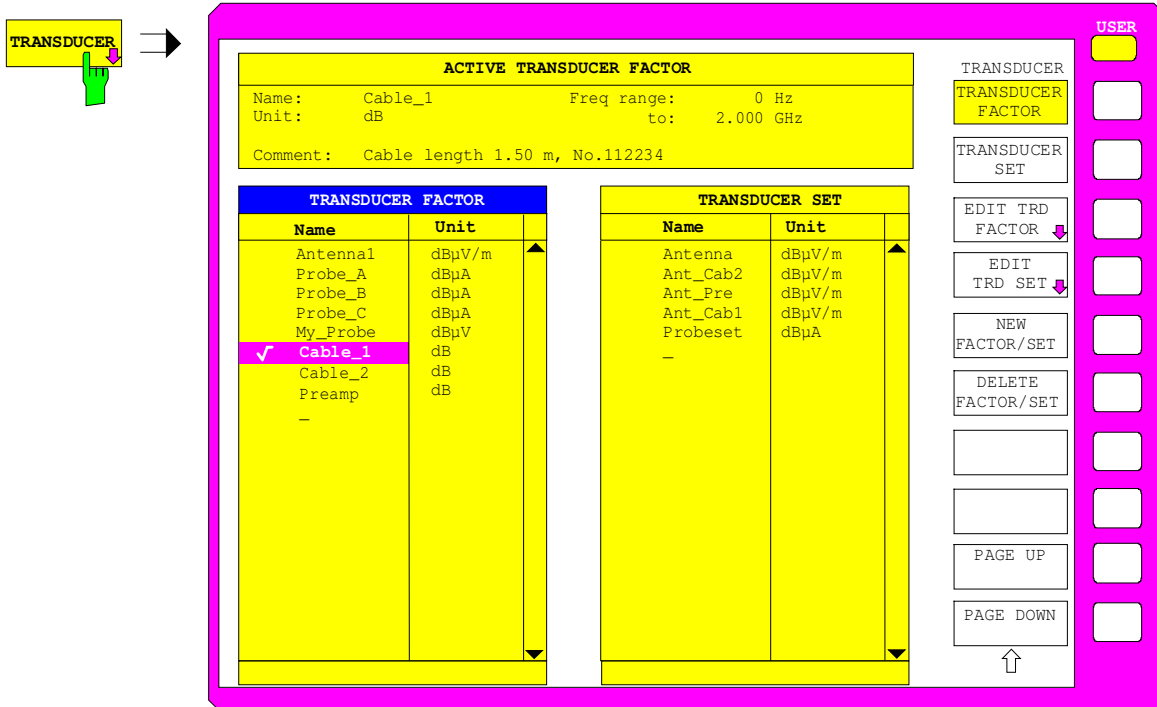

The upper table *ACTIVE TRANSDUCER FACTOR / SET* indicates the active transducer factor or the set with the associated name, frequency range and unit. If no factor or set is active, *none* is displayed in the table. Additional information can be entered in a comment line. If a transducer factor is active, the selected interpolation is displayed in addition, if a set is active, the break setting is displayed.

The left table *TRANSDUCER FACTOR* comprises all the defined factors with name and unit. If the number of defined transducer factors exceeds the number of possible lines in the table, the table will be scrolled.

The right table *TRANSDUCER SET* comprises all the defined transducer sets with the corresponding information.

Only one set or transducer can be activated. An already active transducer factor or set is switched off automatically if another one is switched on. An activated transducer factor or set is marked with a check sign.

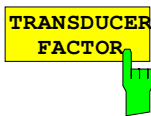

The *TRANSDUCER FACTOR* softkey sets the selection bar to the position of the active transducer factor. If no transducer factor is switched on, the bar is positioned to the first line of the table.

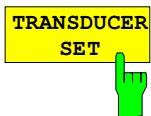

The *TRANSDUCER SET* softkey sets the selection bar to the position of the active transducer set. If no transducer set is switched on, the bar is set to the first line of the table.

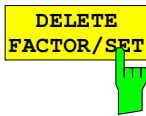

The *DELETE FACTOR/SET* softkey deletes the marked factor or set. To avoid deletion by mistake, deletion has to be confirmed.

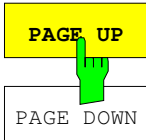
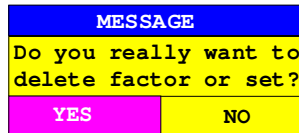

The *PAGE UP* and *PAGE DOWN* softkeys are used to scroll in large tables which cannot fully be displayed on the screen.

## New Entry and Editing of Transducer Factors

A transducer factor is characterized by

- reference values with frequency and transducer factor (*Values*)
- the unit of the transducer factor (*Unit*) and
- the name (*Name*) to distinguish between the different factors.

During the entry, FSIQ checks the transducer factor according to specific rules that have to be met to ensure trouble-free operation.

- The frequencies for the reference values always have to be entered in ascending order. Otherwise, the entry is not accepted and the following message is displayed:

*Frequency Sequence!*

- The entered frequencies do not necessarily have to be set at FSIQ, as only the values for the frequency display range are considered for a set sweep or scan. The minimum frequency for a reference value is 0 Hz, the maximum frequency 200 GHz.
- The minimum or maximum value for a transducer factor is -200 dB or 200 dB. The unit "dB" means that the transducer factor is always logarithmic and has nothing to do with the physical transducer factor, which, for example, establishes the relationship between field strength and voltage into 50 Ohm. If the minimum or maximum value is exceeded, FSIQ signals:

*Min Level -200 dB or*

*Max Level 200 dB.*

- Amplifiers have a negative transducer factor, attenuation values have to be entered as a positive transducer factor.

**Note:** *A unit activated by switching on the transducer has priority over a coded unit of the connected probe.*

*With the exception of dB\*/MHz, the softkeys for the unit in the menu under key LEVEL REF are inoperative with the transducer switched on.*

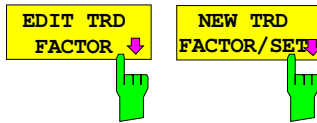

The *EDIT TRD FACTOR* and *NEW FACT/SET* softkeys both open the submenu for editing and entering new transducer factors. A precondition for the *NEW FACTOR/SET* softkey is that the selection bar is located in the table when the table *TRANSDUCER FACTOR* is called up.

FREQUENCY	TDF/dB . .	FREQUENCY	TDF/dB . .
20.0000 MHz	25.5		
25.0000 MHz	23.8		
30.0000 MHz	20.5		
40.0000 MHz	19.8		
50.0000 MHz	20.0		
60.0000 MHz	19.5		
70.0000 MHz	19.1		
80.0000 MHz	18.2		

The table with the data of the marked factor (the *EDIT TRD FACTOR* softkey) or an empty table is displayed in which the following entries are preset (the *NEW FACTOR/SET* softkey):

- Unit: dB
- Interpolation: LIN for linear frequency scaling  
LOG for logarithmic frequency scaling

The characteristics of the factor can be entered in the header field of the table, the frequency and the transducer factor in the columns of the table.

- Name* Entry of the name
- Unit* Selection of unit
- Interpolation* Selection of interpolation
- Comment* Entry of a comment
- FREQUENCY* Entry of the frequency of the reference points
- TDF/dB* Entry of the transducer factor.

An overwritten transducer factor remains stored in the background as long as the edited factor is stored with the *SAVE TRD FACTOR* softkey or until the table is closed. A factor overwritten by mistake can be restored by leaving the entry.

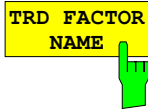

The *TRD FACTOR NAME* softkey activates the entry of the transducer factor characteristics in the header field of the table.

**Name - Entry of name**

A maximum of 8 characters is permissible for the name. The characters have to comply with the convention of DOS file names. The unit automatically stores all transducer factors with the extension .TDS.

If an existing name is changed, the factor stored under the previous name is retained and will not be overwritten automatically with the new name. The previous factor can be deleted at a later time, using *DELETE FACTOR/SET*. Thus, factors can be copied.

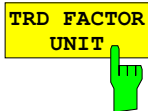

**Unit - Selection of unit**

The unit of the transducer factor is selected from a selection box activated by the *TRD FACTOR UNIT* softkey.

FACTOR UNIT
dB
dBm
dB $\mu$ V
dB $\mu$ V/m
dB $\mu$ A
dB $\mu$ A/m
✓ dB $\rho$ W
dB $\rho$ T

The default setting is dB.

**Interpolation - Selection of interpolation**

Linear or logarithmic interpolation can be carried out between the frequency reference points of the table. Selection is via the ENTER key which is toggled between LIN and LOG (toggle function).

The following diagrams indicate the effect of the interpolation on the calculated characteristic:

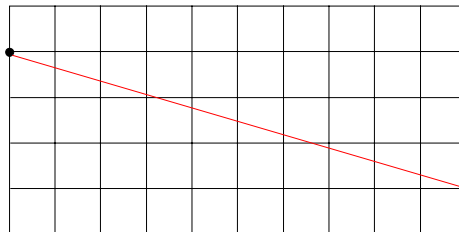

Fig. 4-2 inear frequency axis and linear interpolation

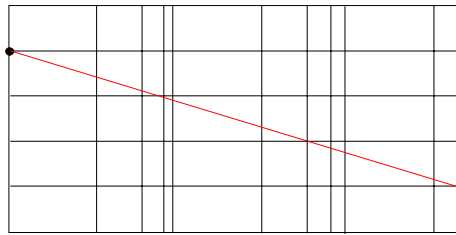

Fig. 4-3 Logarithmic frequency axis and logarithmic interpolation

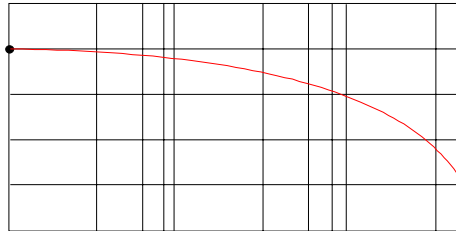

Fig. 4-4 Logarithmic frequency axis and linear interpolation

**Comment - Entry of a comment**

The comment can be freely selected. It can have a maximum number of 50 characters.

TRD FACTOR  
VALUES



The *TRD FACTOR VALUES* softkey activates the entry for the reference values of the transducer factor.

The selection bar marks the first reference value. The desired reference values have to be entered in ascending frequency sequence. After entering the frequency the selection bar automatically jumps to the corresponding level value.

After entering the first reference value the table can be edited. The two *INSERT LINE* and *DELETE LINE* softkeys are displayed. Individual values are changed at a later time by marking the field and by entering the new value.

INSERT  
LINE



The *INSERT LINE* softkey inserts a free line above the marked reference value. When entering a new reference value into this line watch out for the ascending frequency sequence.

DELETE  
LINE



The *DELETE LINE* softkey deletes the marked reference value (the whole line). The following reference values move up.

SAVE TRD  
FACTOR



The *SAVE TRD FACTOR* softkey saves the changed table in a file on the internal hard disk.

If a transducer factor with the same name already exists, a corresponding query is performed beforehand.

If the factor to be newly saved is currently switched on, the new values will immediately be valid. If a transducer set is switched on comprising the factor, the values will only be used when the set is switched on next time.

### New Entry and Editing of Transducer Sets

A transducer set is characterized by:

- maximum 10 ranges (*Ranges*) in which different transducer factors can be active
- the combination of several transducer factors per range (*Factor*)
- a transducer-set name (*Name*)

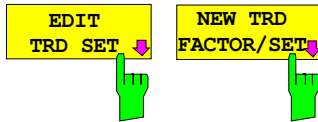

The *EDIT TRD SET* and *NEW FACTOR/SET* softkeys both open the submenu for editing and entering new transducer factors. A precondition for the *NEW FACTOR/SET* softkey is that the selection bar is located in the table *TRANSDUCER SET*.

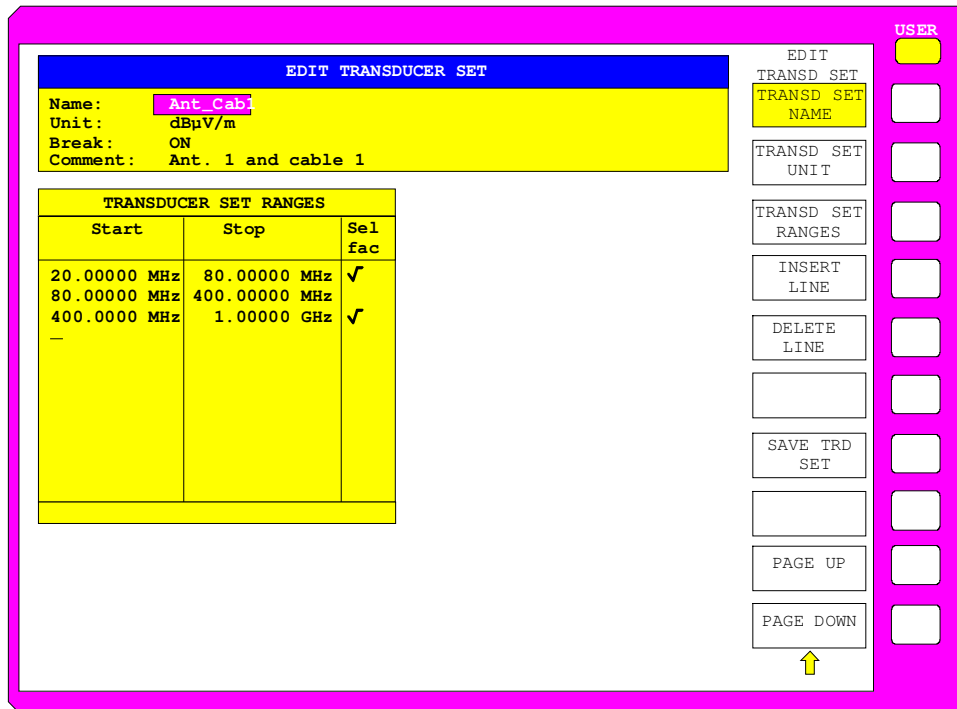

The table with the data of the marked set (the *EDIT TRD SET* softkey) or an empty table in which the following entries are preset (the *NEW FACTOR/SET* softkey) is displayed:

Unit: dB  
 Break: NO

The characteristics of the set can be entered in the header field of the table, the subranges in the columns of the set.

- Name* Entry of the name
- Unit* Selection of unit
- Break* Activating the query when changing the subrange
- Comment* Entry of a comment
- Start* Entry of the start frequency of the subrange
- Stop* Entry of the stop frequency of the subrange
- Sel Fac* Selection of the transducer factors for the subrange

An overwritten transducer set remains stored in the background as long as the edited factor is stored with the *SAVE TRD SET* softkey or until the table is closed. A set overwritten by mistake can be restored by leaving the entry.

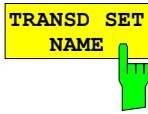

The *TRD SET NAME* softkey activates the entry of the transducer set characteristics in the header field of the table.

**Name - Entry of name**

A maximum of 8 characters is permissible for the name. The characters have to comply with the convention of DOS file names. The unit automatically stores all transducer sets with the extension .TDS.

If an existing name is changed, the set stored under the previous name is retained and will not be overwritten automatically with the new name. The previous set can be deleted at a later time using *DELETE FACTOR/SET*. Thus, sets can be copied.

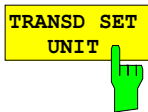

**Unit - Selection of unit**

The unit of the transducer set is selected from a selection box activated by the *TRANSD SET UNIT* softkey.

The unit should be selected prior to the entry as it determines the settable transducer factors. The preset unit for new sets is "dB". The unit can no longer be changed when editing a set as the set of selected transducer factors will otherwise become inconsistent.

SET UNIT
dB
dBm
dB $\mu$ V
dB $\mu$ V/m
dB $\mu$ A
dB $\mu$ A/m
✓ dB $\rho$ W
dB $\rho$ T

**Break - Activation of query when changing a subrange**

The sweep can be stopped if the user changes the subrange and selects a new subrange of the transducer. A message informs the user that the limit has been attained. He can continue the sweep or switch off the transducer. The interruption is activated by setting Break to ON. Selection is by the ENTER key which toggles between ON and OFF (toggle function).

**Comment - Entry of a comment**

The comment can be freely selected. It can have a maximum number of 50 characters.

TRANSD SET  
RANGES



Softkey *TRANSD SET RANGES* activates the entry of subranges and the associated transducer factors. The selection bar marks the frequency values last active.

**Start - Entry of start frequency of subrange**

**Stop - Entry of stop frequency of subrange**

The individual subranges have to be linked without a gap. That is why the start frequency is already defined from the second subrange (= stop frequency of previous range).

After entering the first frequency value the table can be edited. The two *INSERT LINE* and *DELETE LINE* softkeys are displayed. Some values are changed at a later time by marking the field and by entering the new value. It should be noted that both the stop frequency of a particular subrange and the start frequency of the subsequent subrange are changed to the same extent.

**Sel fac- Selection of factors for the subrange**

A check sign in column *Sel Fac* (select factor) indicates whether one or several transducer factors were selected for the subrange.

The permissible transducer factors for the marked subrange can be selected in a selection box. Only factors matching with the unit of the set and fully covering the selected subrange are permissible.

After each change of range limits, FSIQ thus checks the factor list and, if required, rebuilds it.

After reducing the start frequency or increasing the stop frequency of a range it may happen that the factors defined for this range no longer fully cover the range. These factors are deleted for this range when the transducer factor table is opened next time.

A maximum of 4 transducer factors can be switched on at the same time in each subrange. If none of them is switched on, 0 dB is assumed as a factor for the whole subrange.

SELECT TRANSDUCER FACTOR		
Name	Unit	
✓ Antenna1	dB $\mu$ V/m	▲
Probe_A	dB $\mu$ V/m	
Probe_B	dB $\mu$ V/m	
Probe_C	dB $\mu$ V/m	
My_Probe	dB	
✓ Cable_1	dB	
Cable_2	dB	
✓ Preamp	dB	
		▼

Press ENTER to (de)select



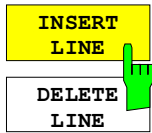

The *INSERT LINE* softkey inserts a free line above the marked subrange.  
 The *DELETE LINE* softkey deletes the marked subrange (whole line). The following subranges move up.  
 In both cases FSIQ checks that the ranges follow each other without a gap.



The *SAVE TRD SET* softkey saves the changed table in a file on the internal hard disk. If a transducer name with the same name already exists, a corresponding query is performed beforehand:

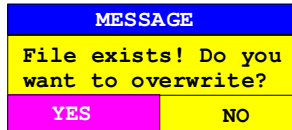

After pressing ENTER, the data set is overwritten on the hard disk. If the saved set is switched on, the new values will be used immediately.

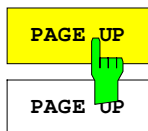

The *PAGE UP* and *PAGE DOWN* softkeys set the table to the next or previous page.  
 The softkeys are locked during selection of factors in the right table.

## Enabling Firmware Options

CONFIGURATION SETUP menu:

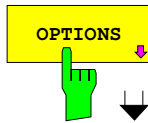

The *OPTIONS* softkey opens a submenu for entering keywords for new firmware options (Application Firmware Modules). Options which are already available are indicated in a table that is opened when the menu is called.

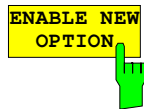

The *ENABLE OPTION* softkey activates the entry of a keyword for a firmware option.

One or several keywords may be specified in the entry field. When a valid keyword is entered, the message *OPTION KEY OK* appears in the info line and the option is written into the *FIRMWARE OPTIONS* table.

The *FIRMWARE OPTIONS* table can also be displayed using the *FIRMWARE OPTIONS* softkey in the *INFO* menu.

If a keyword is invalid the message *OPTION KEY INVALID* is displayed in the info line.

## External Reference Oscillator

In general, the FSIQ can generate all internal oscillators from either the internal or an external reference oscillator. A 10 MHz quartz-controlled oscillator is used as the internal reference. A reference oscillator output is also available at the rear panel via the *EXT REF IN/OUT* connector.

This output can be used, e.g., to synchronize other instruments to the FSIQ. This connector can also be converted to an input connector for application of an external frequency standard. The FSIQ requires that the frequency of the external standard be entered so that the internal oscillators can be synchronized to it.

CONFIGURATION SETUP Menu:

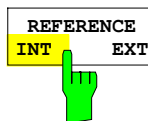

The *REFERENCE INT EXT* softkey switches between the internal and external references.



The *EXT REF FREQUENCY* softkey activates the entry of the frequency of the external source. Range of input values is 1 MHz to 16 MHz in 1 MHz steps.

## Service Functions

The service menu offers a variety of additional function which are used in maintenance and/or trouble shooting. The service functions are not necessary for normal measurements, however, incorrect use can impair the functionality and/or data integrity of the FSIQ. Therefore, many of the functions can only be used after entering a password.

CONFIGURATION SETUP menu:

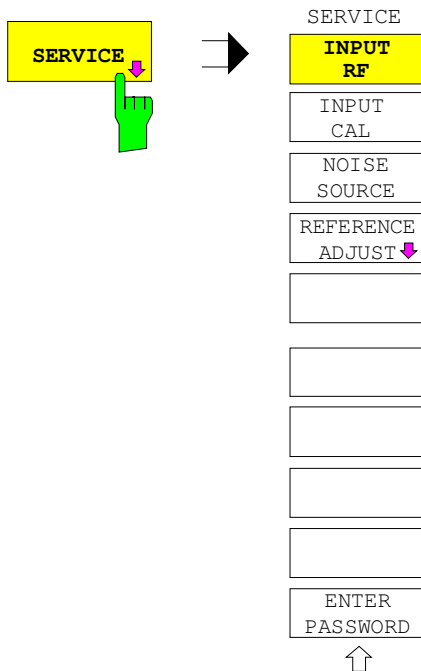

The *SERVICE* softkey calls the service submenu.

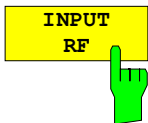

The *INPUT RF* and *INPUT CAL* softkeys are mutually exclusive selection switches. Only one switch can be active at any one time. They switch the input to the FSIQ between the *INPUT RF* connector (normal position) and the internal calibration source (120 MHz, -40 dBm).

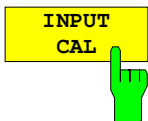

After *PRESET*, *RECALL* or FSIQ power on, the *INPUT RF* is always selected.

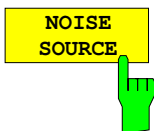

The *NOISE SOURCE* softkey switches on a noise source which is connected to the *NOISE SOURCE* connector on the instrument's rear panel.

The dc voltages on the connector are described in Chapter 8.

CONFIGURATION SETUP SERVICE menu:

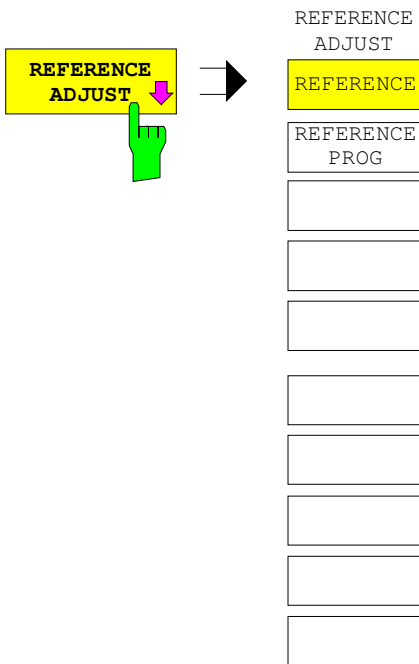

The *REFERENCE ADJUST* softkey opens a submenu used to adjust the frequency precision of the reference oscillator. The value should be modified only after the frequency precision was checked and found to be erroneous (setting range 0 to 4095).

For more information about how to perform the adjustment of the frequency precision refer to service manual instrument (delivered with the FSIQ).

The modified reference value is preserved when the menu is closed.

The current adjustment value can be permanently stored in an EEPROM in the instrument.

**Caution:** *As the specifications of the whole instrument depend directly on the setting of the reference oscillator (frequency precision), storing incorrect adjustment values should be avoided.*

**Note:** *If no adjustment value has been stored (REFERENCE PROG softkey) before the analyzer is switched off and on again, the factory-set value of the reference frequency or the value that has been programmed last will be used.*

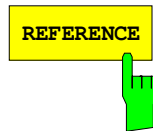

The *REFERENCE* softkey adjusts the frequency precision of the reference oscillator.

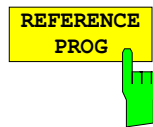

The *REFERENCE PROG* softkey stores the current adjustment value in an EEPROM in the instrument.



The *ENTER PASSWORD* softkey allows the entry of a password.

The FSIQ contains a variety of service functions which, if incorrectly used, can impair the functionality of the analyzer. These functions are normally not accessible and are only usable after the entry of a password (*ENTER PASSWORD*).

## Programming the Interface Configuration and Time

The *GENERAL SETUP* softkey branches to a sub-menu in which the basic setup of general instrument parameters may be performed. The current settings are displayed in tabular form on the display screen where they may then be edited.

*CONFIGURATION SETUP* menu:

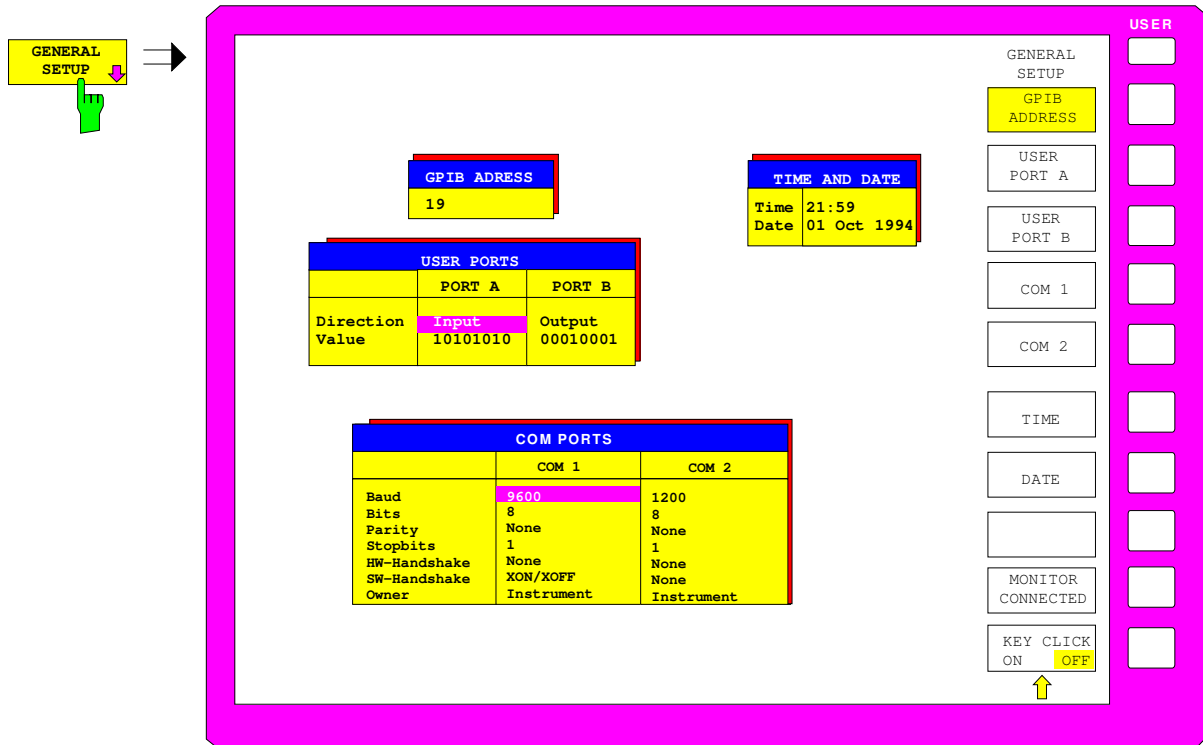

## IEC Bus Address Selection

*CONFIGURATION SETUP-GENERAL SETUP* submenu:



The *GPIB ADDRESS* softkey activates the entry of the IEC Bus address. Permitted addresses are 0 through 31. The default setting is address 20.

## User Port Configuration

The instrument provides two parallel interfaces, each of which is 8 bits wide. Over these ports, arbitrary bit patterns can be output or input. The interfaces are designated *USER PORT A* and *USER PORT B*.

*CONFIGURATION SETUP-GENERAL SETUP* submenu:

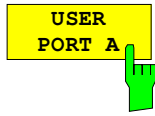

The *USER PORT A* and *USER PORT B* softkeys activate the columns PORT A and PORT B, respectively, in the USERPORTS table for entry of the parameters for both of the parallel interfaces in the instrument. Because the two interfaces are configured in the same manner, how to configure an interface is described in the following using *USER PORT A*.

The following parameters need to be configured in the table:

*Direction*                      Direction of data transmission  
*Value*                              Indication/entry of current value

USERPORTS		
	PORT A	PORT B
<b>Direction</b>	INPUT	OUTPUT
<b>Value</b>	10101010	

### **Direction – Direction of data transmission**

The *DIRECTION* parameter determines in which direction the interface transmits data.

*INPUT*      read operation  
*OUTPUT*    write operation

DIRECTION
✓ INPUT
OUTPUT

### **Value – Indication/Entry of current value**

The *VALUE* parameter shows the current value of the data at the port for data input as well as for data output. The displayed data is in binary format with the least significant bit (LSB) on the right.

If the port is configured as an *OUTPUT* then, the displayed value can be edited. Data entry must also be in binary format (i.e., only the digits 0 and 1 are accepted).

VALUE
00010001

## Serial Interface Configuration

CONFIGURATION SETUP-GENERAL SETUP submenu:

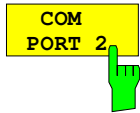
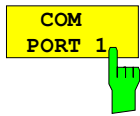

The *COM PORT 1* and *COM PORT 2* softkeys activate the columns COM1 and COM2, respectively, for entry of the serial interface parameters. Since the two interfaces are configured in the same manner, how to configure an interface is described in the following using *COM PORT 1*.

The following parameters need to be configured in the table:

<i>Baud rate</i>	data transmission rate
<i>Bits</i>	number of data bits
<i>Parity</i>	bit parity check
<i>Stop bits</i>	number of stop bits
<i>HW-Handshake</i>	hardware handshake protocol
<i>SW-Handshake</i>	software handshake protocol
<i>Owner</i>	assignment to the measuring instrument or computer

COM PORTS		
	COM 1	COM 2
Baud	9600	1200
Bits	8	8
Parity	None	None
Stopbits	1	1
HW-Handshake	None	None
SW-Handshake	XON/XOFF	None
Owner	Instrument	Instrument

**Note:** A serial interface (COM1 or COM2) cannot be used for another purpose if a mouse is connected to it.

### Baud – Data transmission rate

Allowed are the indicated values between 110 and 19200 baud. The default setting is 9600 baud.

BAUD RATE
19200
✓ 9600
4800
1200
600
300
110

### Bits – Number of data bits per word

For the transmission of text without German umlauts (Ä, ä, Ü, ü, Ö, ö) and special characters, 7 bits are adequate. For binary data as well as text with special characters or umlauts, 8 bits must be selected (default setting).

BITS
✓ 7
8

**Parity – Bit parity check***NONE* no parity check (default setting)*EVEN* even parity check*ODD* odd parity check

PARITY
NONE
✓ EVEN
ODD

**Stop bits – Number of stop bits**

Available are 1 and 2. The default setting is 1 stop bit.

STOPBITS
✓ 1
2

**HW-Handshake – Hardware handshake protocol**

The integrity of data transmission can be improved through the use of a hardware handshake protocol which effectively prevents uncontrolled transmission of data and the resulting possible loss of data bytes. In the hardware handshaking procedure, additional interface lines are used to transmit acknowledge signals with which the data transmission can be controlled and, if necessary, stopped until the receiver is ready to receive data again.

A prerequisite for handshaking is, however, that the interface lines (DTR and RTS) are provided between sender and receiver. For a simple, 3-wire connection, this is not the case and hardware handshake cannot be realized here.

Default setting is *NONE*.

HW-HANDSHAKE
None
✓ DTR/RTS

**SW-Handshake – Software handshake protocol**

Besides the hardware handshake procedure using interface lines, it is also possible to achieve the same effect by using a software handshake protocol. Here, control bytes are transmitted in addition to the normal data bytes. These control bytes can be used, as necessary, to stop data transmission until the receiver is ready to receive data again.

In contrast to hardware handshaking, software handshaking can be realized even for a simple, 3-wire connection.

One limitation is, however, present in software handshaking. Software handshaking cannot be used for the transmission of binary data since, the control characters XON and XOFF require bit combinations that are also used for binary data transmission.

Default setting is *NONE*.

SW-HANDSHAKE
None
✓ XON/XOFF



**Owner – Assignment of the interface**

The serial interface can be assigned alternatively to the instrument measurement section or the computer section.

- INSTRUMENT The interface is assigned to the instrument measurement section. Outputs to the interface from the computer are not possible and, so to say, land nowhere.
- OS The interface is assigned to the computer section. It cannot be used by the instrument measurement section. This means that hardcopy or remote control of the instrument via the interface is not possible. An attempt to start a print job via the interface results in an error message.

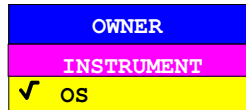

**Setting Date and Time**

CONFIGURATION SETUP-GENERAL SETUP submenu:



The *TIME* softkey activates the entry of time for the internal real time clock . In the corresponding dialog box, the time is partitioned into two input fields so that hours and minutes can be entered independently.

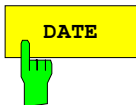
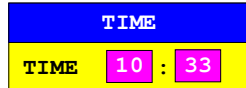

The *DATE* softkey activates the entry of the date of the internal real-time clock. In the corresponding dialog box, the date is partitioned into 3 input fields so that day, month and year can be input separately.



For the selection of the month, pressing a units key opens a list of abbreviations wherein the desired month can be selected.

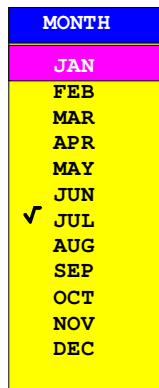

## Connecting the External Monitor

Submenu *CONFIGURATION SETUP-GENERAL SETUP*:



The *MONITOR CONNECTED* softkey informs the unit that an external monitor is available at PC MONITOR connector. The external monitor displays the Windows NT mask.

## Switching the Beeper ON/OFF

*CONFIGURATION SETUP-GENERAL SETUP* submenu:



The *KEY CLICK ON/OFF* softkey switches the beeper on or off. The beeper acknowledges each key stroke with a beep.

## Firmware Update

The installation of a new firmware version can be performed using the built-in diskette drive. The firmware update kit contains several diskettes. The installation program is called up in the *SETUP* menu.

*CONFIGURATION SETUP* sidemenu:

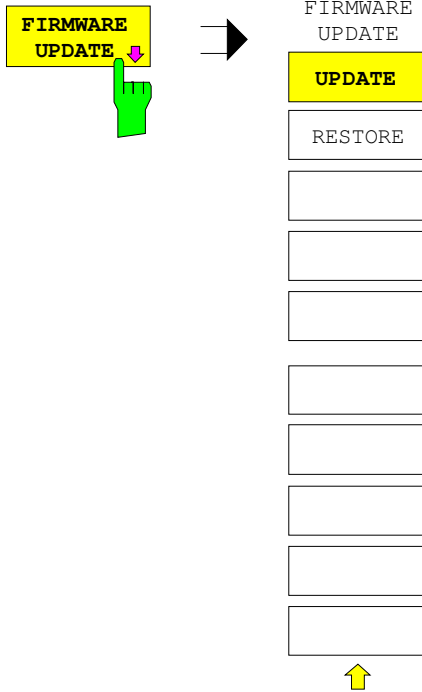

The *FIRMWARE UPDATE* softkey opens the submenu for the installation of a new firmware version.

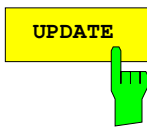

The *UPDATE* softkey starts the installation program and leads the user through the remaining steps of the update.



The *RESTORE* softkey restores the previous firmware version

## Compatibility to FSE Instrument Family

*CONFIGURATION SETUP* sidemenu:

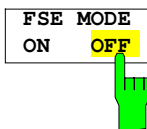

The *FSE MODE ON/OFF* softkey determines whether the FSIQ is FSE-compatible after a preset. Following a preset, the FSIQ has not the same settings as an FSE. With compatibility, the FSIQ has the same default settings as FSE after a preset.

## Status Display-Remote/Manual Control – *STATUS* Key Group

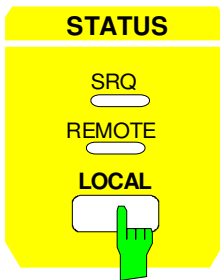

The *SRQ* LED, the *REMOTE* LED and the *LOCAL* key are contained in the *STATUS* key group.

- The *SRQ* LED indicates that a service request from the instrument has been asserted on the IEC Bus.
- The *REMOTE* LED indicates that the instrument is under remote control.
- The *LOCAL* key switches the instrument from remote to manual control, with the assumption that the remote controller has not previously set the LOCAL LOCKOUT function.

A change in the control mode consists of:

- **Enabling the Front Panel Keys**

Under remote control, the soft-key menu is turned off and all keys, with the exception of *PRESET* and *LOCAL*, are disabled. Returning to manual mode enables all inactive keys. The soft key menu which is displayed is the main menu of the current mode.

- **Turning off the *REMOTE* LED**

- **Generating the message *OPERATION COMPLETE***

If, at the time of pressing the *LOCAL* key, the synchronisation mechanism via *\*OPC*, *\*OPC?* or *\*WAI* is active, the currently running measurement procedure is aborted and synchronisation is achieved by setting the corresponding bits in the registers of the status reporting system.

- **Setting Bit 6 (User Request) of the Event Status Register**

With a corresponding configuration of the status reporting system, this bit immediately causes the generation of a service request (*SRQ*) which is used to inform the software that the user wishes to return to front-panel control. This information can be used, e.g., to interrupt the control program so that the user can make necessary manual corrections to instrument settings. This bit is set each time the *LOCAL* key is pressed and is independent of whether or not the instrument is under remote or manual control.

- The *LOCAL* key aborts a running macro. The continuation of the macro is not possible.

## Measurement Documentation – *HARDCOPY* Key Group

### Printing Data – *START* Key

The instrument uses the printer function of Windows NT to output hardcopies. Any printer supported by Windows NT can be used. In addition, the instrument permits data output in the usual data formats WMF, EWMF and BMP which enable hardcopies to be directly inserted into other documents. Network printers can be used if the instrument is connected to a network.

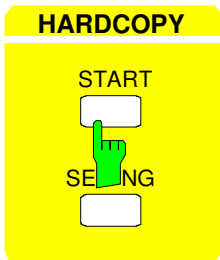

The *START* key initiates the printing of measurement/ instrument status data. The instrument can distinguish between two different output devices, each of which may be individually configured, e.g., a laser printer and a ink jet printer. All documents are printed on the output device which is currently active.

Pressing the *HARDCOPY START* key initiates the print job. The printer parameters defined under Windows NT and in the *HARDCOPY SETTINGS* menu are used for setting up the printer configuration. After pressing the *START* key, all of the display items to be printed are written to the printer buffer of Windows NT. Since the printer runs in the background, the instrument may be operated immediately after pressing the *START* key.

With *COPY SCREEN* selected in menu *HARDCOPY SETTINGS*, all the diagrams with traces and status displays are printed as they occur on the screen. Softkeys, open tables and data entry fields are not printed out. Function *COPY TRACE* allows to print out individual traces. With *COPY TABLE* tables can be printed out.

If output device *CLIPBOARD* is active in menu *HARDCOPY SETTINGS*, submenu *HARDCOPY DEVICE*, the clipboard can be used to directly transfer hardcopies to Windows applications. The copy is written in the clipboard by pressing *HARDCOPY START*. The user can then change to another Word document and insert the clipboard content into the document via the menu EDIT - PASTE by using the key combination CTRL+V.

If the *PRINT TO FILE* option in the *HARDCOPY DEVICE* submenu of the *HARDCOPY SETTINGS* menu is selected then, upon pressing *HARDCOPY START*, the file name to which the output data are to be written is requested. For this an entry field is opened for entering the file name. If no external keyboard is connected, the help line editor is activated.

If the *START* key is pressed again during an active print job, a second output can be released which can also be joined to the printer queue. Any number of print jobs can be released consecutively.

Current print jobs can be aborted only by canceling the entries in the Windows NT printer queue. After starting the print a printer symbol is displayed in the task bar near the time indication.



A double-click on this symbol opens a window containing the entries of the printer queue. The relevant print order can be cancelled by marking it with the mouse and pressing the DEL key.

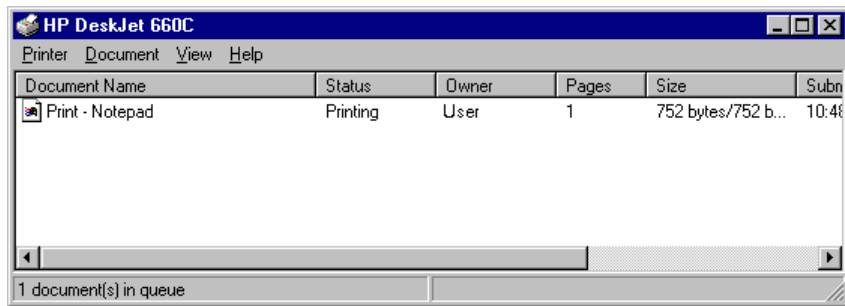

While a print job is in progress, problems may occur in the output device. If, while printing, the output device issues a PAPER OUT message, i.e., no more paper is available, the user will be prompted by the following message

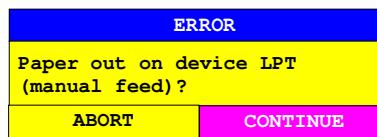

to load paper into the output device. The print job will then be either continued (CONTINUE selected) or aborted (ABORT selected).

Switchover between b/w and colored printouts is possible with softkey *COLOR ON/OFF* provided that the printer connected is able to output such prints. The colors of the printout correspond exactly to those of the screen, ie a red trace will be output in red.

To change the colors of the objects on the printout, the screen colors have to be changed correspondingly in menu *DISPLAY*, submenu *CONFIG DISPLAY*. One exception is the color of the background and the color of the diagrams. The output background is always white irrespective of the screen color and the diagrams are always black.

If several traces are to be output one after the other on the same sheet different colors can be chosen for each trace with the aid of softkey *TRC COLOR AUTO INC* (Trace Color Auto Increment).

On most b/w printers, a better printout of the color screen is obtained on hardcopies if the color information is converted into gray shades. For this, the color output in menu *HARDCOPY SETTINGS* is to be activated (COLOR ON).

## Printing Configuration – *SETTINGS* Key

*HARDCOPY SETTINGS* menu:

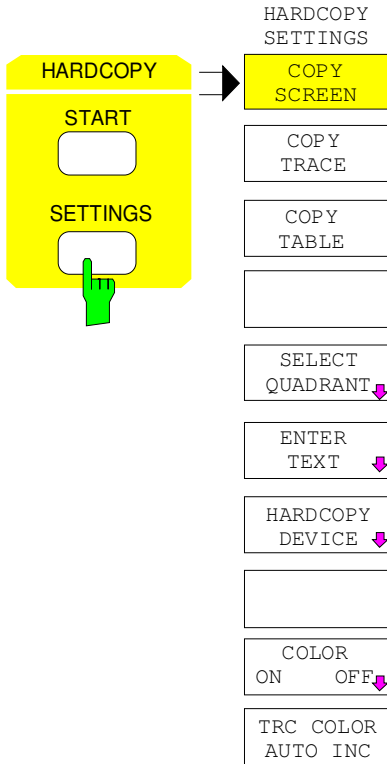

The *SETTINGS* key opens the menu to define the output configuration for diagrams and measurement curves to the various output channels, e.g., printer, plotter or files.

The recommended procedure for configuring the output data is as follows:

- Configure the desired output device and select the interface over which the output is to take place by using Windows NT and the *HARDCOPY DEVICE* softkey.
- Select the display items to be printed via the *COPY SCREEN*, *COPY TRACE* softkeys.
- Select between coloured and b/w printouts via softkeys *COLOR ON/ OFF* and *TRC COLOR AUTO INC*
- Enter commentary applicable to the diagram or add a title for the overall print-out by using the *ENTER TEXT* softkey.
- Select the page format (*QUADRANT*, *FULL PAGE*) through use of the *SELECT QUADRANT* softkey.

The *COPY SCREEN*, *COPY TRACE* and *COPY TABLE* softkeys are selection switches, i.e., only one function can be enabled at any one time. The push buttons are used for selection only and do not initiate a print job. The actual printing of data is initiated by the *HARDCOPY START* key.

## Selection of Displayed Elements and Colour Settings

*HARDCOPY SETTINGS* menu:

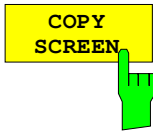

With softkey *COPY SCREEN* the output of test results is selected.

All the diagrams, traces, markers, marker lists, display lines, limit lines etc. are printed out as long as they are displayed on the screen. All the softkeys, tables and open data entry fields are not printed out. Moreover, comments, title, date, and time entered at the bottom margin of the printout are output. The logo appears at the top left of the printout.

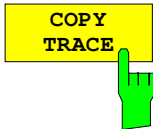

Using the *COPY TRACE* softkey, all curves visible on the display screen are printed out without auxiliary information. Specifically, no markers or display lines are printed.

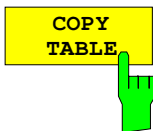

Using the *COPY TABLE* softkey, all tables visible on the display screen are printed out.

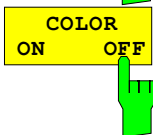

The *COLOR ON/OFF* softkey selects a coloured or b/w printout.

After having changed the printer driver or the hardcopy device (in submenu, *HARDCOPY SETTINGS*) the softkey is automatically switched to *ON*. One exception is printer driver HP PCL4 which only supports b/w printouts. In this case, the softkey cannot be operated.

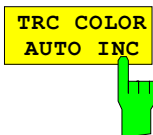

The *TRC COLOR AUTO INC* softkey automatically switches the colours of the traces on to the next printout. On the second printout, trace 1 has the colour of trace 2, trace 2 the colour of trace 3 etc. The fourth printout starts with the first colour. With the softkey switched off, the colours of the traces are reset to their original state.

When changing the printer driver or the hardcopy device (both in submenu *HARDCOPY SETTINGS*) as well as the selection b/w printout (softkey *COLOR ON/OFF* in position *OFF*), softkey *TRC COLOR AUTO INC* is switched off.



## Selection of Hardcopy Format

HARDCOPY SETTINGS-SELECT QUADRANT submenu:

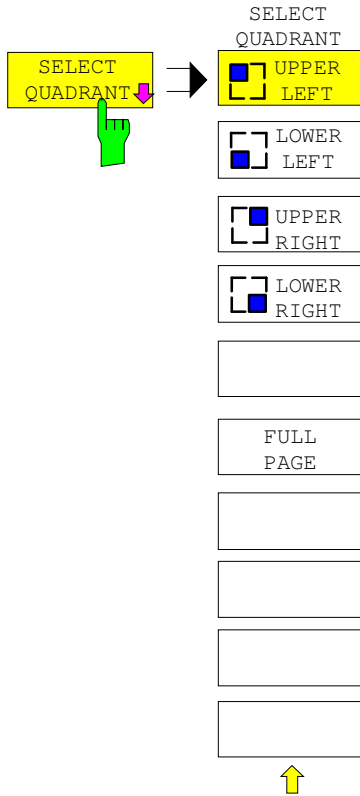

The *SELECT QUADRANT* softkey calls the the submenu for selection of *QUADRANT*the location of the display screen graphics on the printed page.

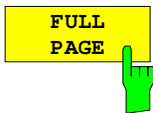

The *FULL PAGE* softkey switches quadrant printing off, i.e., printing now takes place at full size. The information as to which quadrant was last selected is also lost. *FULL PAGE* is the default setting.

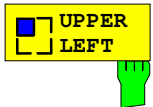

The *UPPER LEFT*, *LOWER LEFT* as well as *UPPER RIGHT*, *LOWER RIGHT* softkeys select the page quadrants where the printed data will be positioned. In this case, the actual size of the data printed on the page is reduced to 25% of normal size. This reduction is independent of how the graphics are distributed on the display screen. Thus, for two measurement windows (*SPLIT SCREEN*), both measurement diagrams shown on the display are placed in the chosen quadrant. Thus, up to a maximum of 8 measurement windows can be printed on one page. (4 print commands for a *SPLIT SCREEN* display, each to a different quadrant)

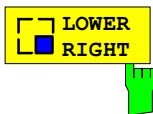
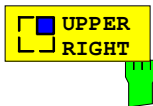
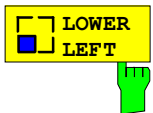

### Entry of Comment Text

HARDCOPY SETTINGS-ENTER TEXT submenu:



The *ENTER TEXT* softkey calls the submenu for editing the commentary for the individual windows. The comment text appears in the print-out, but does not appear on the display screen.

If a comment is not to appear on the printout, it has to be deleted. By pressing *PRESET*, all comments will be deleted.

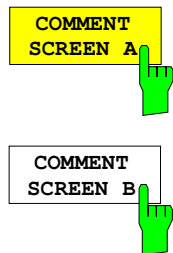

The *COMMENT SCREEN A* softkey opens an entry field in which a comment of two lines (60 characters per line) can be entered pertinent to the applicable window. If the user enters more than 60 characters, the excess characters appear on the second line on the print-out. Note: at any point, a manual line-feed can be forced by entering the @ character. The commentary is printed below the corresponding diagram. The *COMMENT SCREEN B* key has the same effect in measurement window 2.

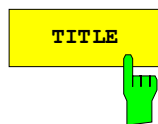

The *TITLE* softkey activates a single line entry box for entering a title for the complete print-out with a maximum of 60 characters.

## Selection and Configuration of the Output Device

The instrument permits two different output devices to be configured. One of the devices is defined as the active device and can be used for hardcopies.

The installation and configuration of these output devices is mainly done under Windows NT and is valid for all Windows applications (see Chapter 1, section "Connecting an Output Device"). The active device and the settings which concern only the output of hardcopies are selected in menu *HARDCOPY DEVICE*.

*HARDCOPY SETTINGS* submenu:

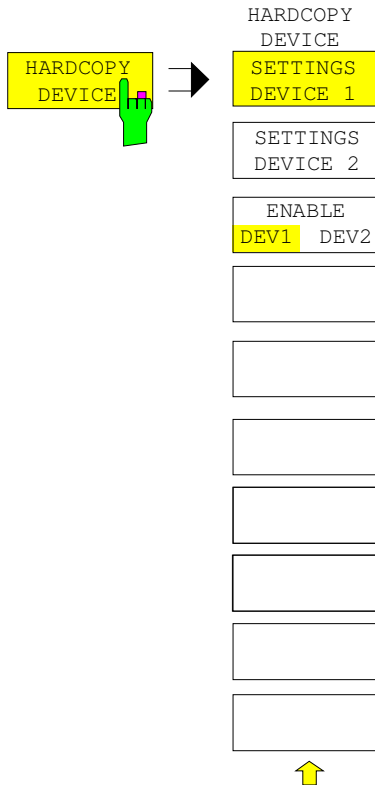

The *HARDCOPY DEVICE* softkey switches to the sub-menu which is used for the selection/configuration of the two output devices.

When the sub-menu is called, the corresponding table is simultaneously displayed. The *SETTINGS DEVICE 1* softkey is active and the selection bar is located at the *DEVICE1* line in the corresponding column of the table.

HARDCOPY DEVICE SETTINGS	
Device1	WINDOWS METAFILE
Print to File	YES
Orientation	---
Device2	CLIPBOARD
Print to File	---
Orientation	---



After calling the menu, the *SETTINGS DEVICE 1* softkey is active and permits the selection and configuration of the output device *DEVICE 1*. The *SETTINGS DEVICE 2* softkey is used to configure *DEVICE 2*.



The actual selection of the active output device takes place with the *ENABLE DEV1 DEV2* softkey in the *HARDCOPY DEVICE* sub-menu.

## Device

The selection of the output device/language for DEVICE 1 and DEVICE 2 is made in this line.

HARDCOPY DEVICE SETTINGS	
Device1	WINDOWS METAFILE
Print to File	YES
Orientation	---
Device2	CLIPBOARD
Print to File	---
Orientation	---

DEVICE
✓ CLIPBOARD
WINDOWS METAFILE
ENHANCED METAFILE
BITMAP FILE
HP DeskJet 660C

Three file formats and the Windows NT clipboard are always available, even if a printer has not yet been installed under Windows NT. All installed printers are listed below in alphabetic order.

The printer installation is described in Chapter 1, section 1.6.

**CLIPBOARD** When "Clipboard" is selected the hardcopies are copied to the Windows NT clipboard. This permits to obtain a printout of high quality which can be directly inserted into other Windows applications (menu EDIT | PASTE or key combination CTRL+V). The lines 'Print to File', 'Orientation' and 'GPIB Address' are deactivated.

## WINDOWS METAFILE and ENHANCED METAFILE

WMF and EWMF are vector graphics formats which can be imported by most graphics and editing programs. EMF is recommended for recent Windows32 applications.

**BITMAP FILE** BMP is a bitmap format which can also be imported by most programs.

When WMF, EWMF and BMP are selected, the line "Print to File" is automatically set to ON and line "Orientation" deactivated.

## Print to File

With "Print to File" ON, the printout is directed to a file. In this case the user is prompted to enter a file name on calling up *HARDCOPY START*.

*Note: This setting is coupled to the corresponding setting under Windows NT.*

## Orientation

In this line, the print format of the output page is set to either vertical (= PORTRAIT) or horizontal (= LANDSCAPE).



The *ENABLE DEV1 / DEV2* softkey determines the active output device. The default output device is DEVICE 1, i.e., all output takes place on DEVICE 1.

## Saving and Recalling Data Sets – *MEMORY* Key Group

The keys in the *MEMORY* group call the following functions:

- Functions for management of storage media (*CONFIG*). Included are among others functions for listing files, formatting storage media, copying, and deleting/rename files.
- Storage/loading functions for storing (*SAVE*) instrument settings such as instrument configurations (measurement/display settings, etc.) and measurement results from working memory to permanent storage media, or to load (*RECALL*) stored data into working memory.

The FSIQ is capable of internally storing complete instrument settings with instrument configurations and measurement data in the form of data sets. The respective data are stored on the internal hard disk or, if selected, on a floppy. The hard-disk and floppy-disk drives are assigned logical names as usual in PC applications:

floppy disk	A:
hard disk	C:

In addition to the saving and recalling of complete instrument settings, it is also possible to save/recall subsets of settings. Configuration data and measurement values are stored in separate files. These files have the same name as the data set but however have a different extension. A data set thus consists of several files which have the same name but different extensions (see Table 4-2).

When saving or loading a data set, the subsets which are to be saved or loaded can be selected in the corresponding menus. This makes it easy to reconstruct specific instrument settings.

When saving and loading data via the *SAVE* and *RECALL* menus, data subsets are selected in a table in the sub-menu *SEL ITEMS TO SAVE/RECALL*. The relationship between the designations in the table and the contents of the data subsets is shown in Table 4-2.

The saved files of the data sets can be copied from one storage medium (e.g. drive C:) to another storage medium (e.g. drive A:) or to another directory using the functions found in the *MEMORY CONFIG* menu. File names and extensions must however not be changed. The relationship between the data subsets and the extensions is shown in Table 4-2.

Table 4-2 Relationship between extensions, contents and designations of data subsets

	Extension	Contents	Designation in the table SEL ITEMS TO SAVE/RECALL
Configuration data:	.SET	current settings of the measurement hardware and the related title, if present	HARDWARE SETTINGS
	.LIN	data-point tables for the active limit lines	LINES
	.LIA	all limit lines	ALL LINES
	.CFG	current configuration of general instrument parameters	GENERAL SETUP
	.HCS	configuration for hardcopy output	HARDCOPY
	.TCI	Tracking generator settings (only with option FSE-B8/9/10/11)	SOURCE CAL
	.TS1 .TS2	Settings for source calibration (only with option FSE-B8/9/10/11)	SOURCE CAL
	.TC1 .TC2	Correction data for source calibration (only with option FSE-B8/9/10/11)	SOURCE CAL
	.TS	active transducer set	TRANSDUCER
	.TSA	all transducer sets	ALL TRANSDUCER
	.TF	transducer factor	TRANSDUCER
	.TFA	all transducer factors	ALL TRANSDUCER
	.COL	user-defined color settings	COLOR SETUP
	Measurement results:	.TR1...4	measurement data trace 1 to trace 4

## Configuration of Memory – CONFIG Key

MEMORY CONFIG menu:

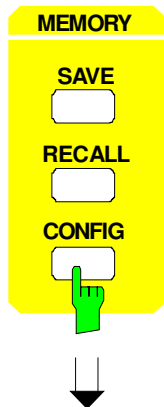

The CONFIG key opens a menu for managing storage media and files.

Table *Drive Management* displays the name and label of the storage medium as well as the available storage area.

Table *File Management* displays the files of the current directory and indicates if any subdirectories are present.

If a directory name is selected, the FSIQ automatically changes to this directory. Selection of the entry '..' moves the FSIQ to the next higher directory level.

**Note:** It is not possible to change menus as long as a file operation is running.

DRIVE MANAGEMENT		
DRIVE:	HARDDISK C:	FREE MEM: 394:510.336

  

FILE MANAGEMENT			
FILE NAME	DATE	TIME	SIZE
..			
✓ SETTING1.DRW	10.MAY.93	10:25:18	68.175 kB
SETTING2.DRW	15.MAY.93	13:08:27	73.283 kB
SETTING3.DRW	17.MAY.93	08:15:21	174.315 kB
SETTING4.DRW	28.MAY.93	17:05:42	1.236812 MB

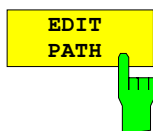

The EDIT PATH softkey activates the input of the directory which will be used in subsequent file operations.

The new path is included in the FILE MANAGEMENT table.

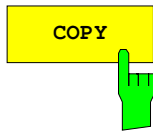

The *COPY* softkey activates the input of the destination of the copy operation.

By entering a predefined disk drive (e.g. C:), a file can also be copied to another storage medium. The files/directories selected by the cursor are copied after the input is confirmed by pressing the *ENTER* key.

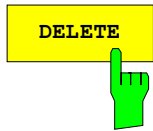

The *DELETE* softkey deletes the selected files.

To prevent accidental deletion of data, confirmation by the user is requested.

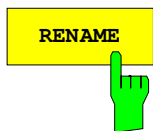

The *RENAME* softkey activates the entry of a new name for the selected file or directory.

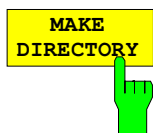

The *MAKE DIRECTORY* softkey creates directories/sub-directories. Sub-directories are recommended for sorting files on the storage medium so that the structure is easier to comprehend.

The entry of an absolute path name (e.g.; "USER\MEAS") as well as the path relative to the current directory (e.g., "..\MEAS") is possible.

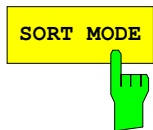

The *SORT MODE* softkey activates the selection of the criteria according to which the files listed in the *FILE MANAGEMENT* table may be sorted.

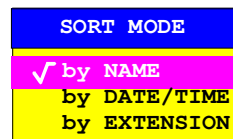

Directory names are located at the top of the list after the entry for the next higher directory level ("..").

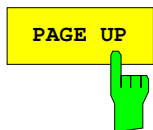

The *PAGE UP* or *PAGE DOWN* softkey sets the *FILE MANAGEMENT* table to the next or the previous page.

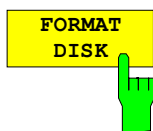
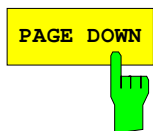

The *FORMAT DISK* softkey formats diskettes located in drive A:.

To prevent accidental destruction of diskette data, confirmation by the user is requested.



## Saving Data Sets – SAVE Key

The *SAVE* key activates a menu which contains all functions necessary for saving instrument data.

- Entry of the name of the data set which should be saved. Confirmation of the entry initiates a save operation to store the data set.

Data set names may contain both alphabetical and numeric characters, in the simplest case only numbers. The simplest example for the input of a data set name is illustrated by the following key strokes:

<SAVE> <1> <units key>

- Entry of the directory in which the data set should be saved
- Input of data set description
- Selection of the data subsets to be saved (sub-menu SEL ITEMS TO SAVE)
- Indication of all available data sets
- Deletion of all available data sets

MEMORY SAVE menu

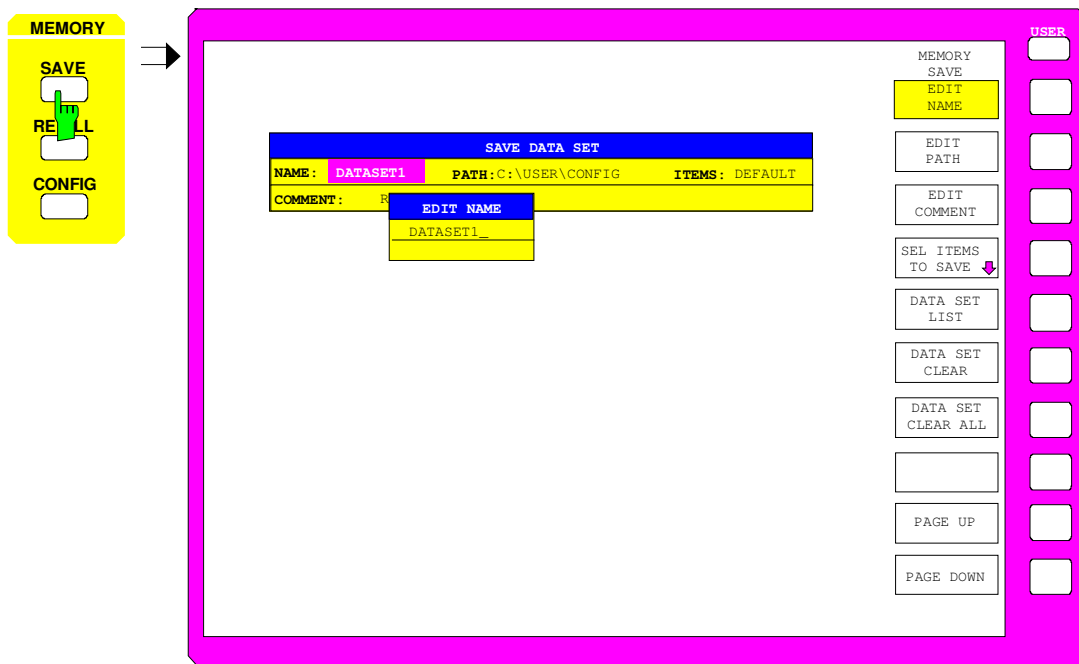

The *SAVE DATA SET* table shows the current settings regarding the data set:

<i>Name</i>	name of data set
<i>Path</i>	directory in which the data set will be saved
<i>Items</i>	indicates whether the default selection of the data subset (DEFAULT) or a user-defined selection (SELECTED) will be saved
<i>Comment</i>	Commentary regarding the data set

The *EDIT NAME* softkey for entering the name of the data set to be saved is activated automatically.

## Selecting the Data Set for Storage

MEMORY SAVE menu:

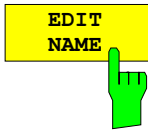

The *EDIT NAME* softkey activates the entry of the name of the data set to be saved.

Data entry is concluded by pressing one of the units keys which initiates a save operation to store the data set.

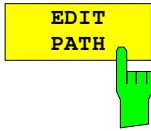

The *EDIT PATH* softkey activates the input of a directory name where the data sets are to be stored.

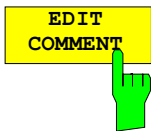

The *EDIT COMMENT* softkey activates the entry of commentary concerning the current data set. A total of 60 characters are available for this purpose.

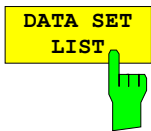

The *DATA SET LIST* softkey opens the *DATA SET LIST/CONTENTS* table. In addition, the *DATA SET CLEAR* and *DATA SET CLEAR ALL* softkeys are displayed.

DATA SET LIST	DATA SET CONTENTS	
DATASET1	CONTENTS	
DATASET2	✓ GENERAL SETUP	✓ COLOR SETUP
DATASET3	✓ HW-SETTINGS	✓ HARD COPY
	TRACE 1	MACROS
	TRACE 2	
	TRACE 3	
	TRACE 4	
	✓ ACTIVE LINES	✓ ACTIVE TRANSDUCER
	ALL LINES	ALL TRANSDUCER
	COMMENT	
	GSM_MASK	

The *DATA SET LIST* column lists all of the data sets which are stored in the selected directory.

The *CONTENTS* and *COMMENT* lines in the *DATA SET CONTENTS* column indicate the saved data subsets and the commentary for the currently selected data set.

**Note:** The current instrument configuration can be easily stored under the name of an existing data set:

- Press a units key after selecting a data set

The name and the selection of the data subsets for the currently selected data set will be placed in the SAVE DATA SET table. The DATA SET LIST table is closed and, instead, the entry field for the EDIT NAME function with the name of the selected data set is opened.

- Press a units key.

The current instrument configuration is saved as a data set under this name.

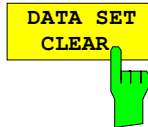

The DATA SET CLEAR softkey deletes the marked data set.

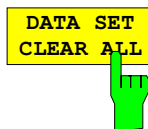

The DATA SET CLEAR ALL softkey deletes all data sets in the current directory.

Since, in this case, all available data sets are lost, confirmation by the user is required.

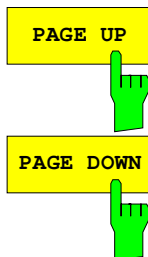

The PAGE UP or PAGE DOWN softkey sets the DATA SET LIST table to the next or previous page.

### Selecting the Data subset for Storage

The *SEL ITEMS TO SAVE* softkey opens a sub-menu for selection of the data subsets.

*MEMORY SAVE-SELECT ITEMS TO SAVE* sub-menu:

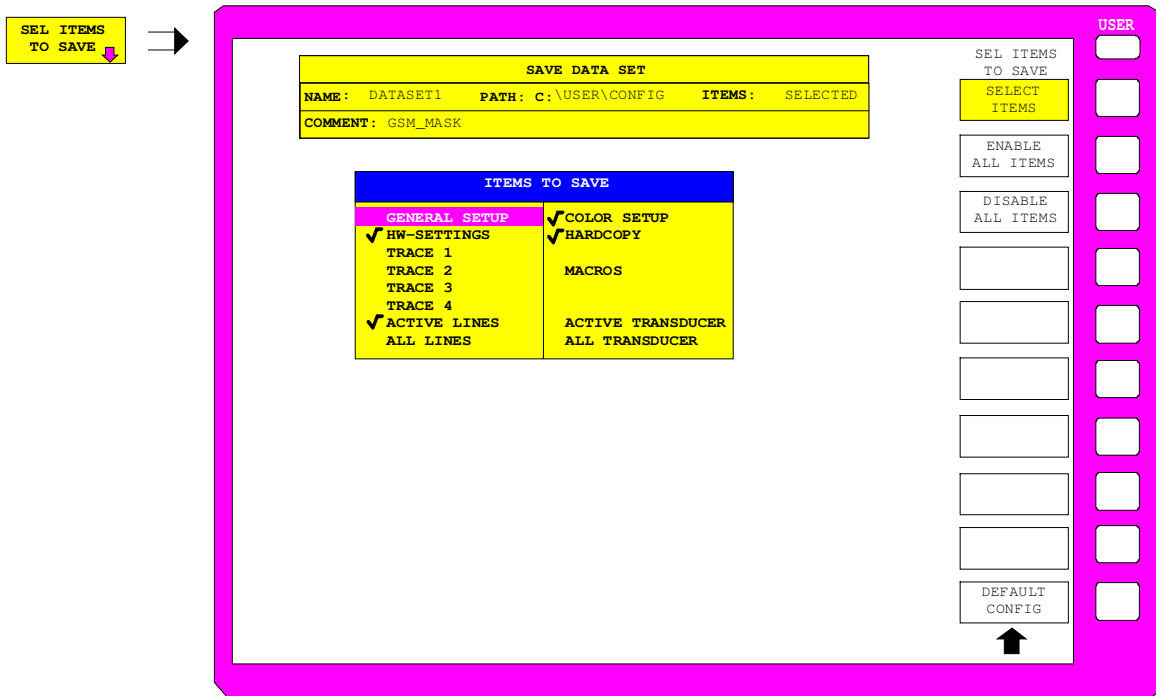

The *ITEMS TO SAVE* table displays the selectable data subsets:

<i>General Setup</i>	current configuration of general instrument parameters
<i>HW-Settings</i>	current measurement hardware settings
<i>Trace1...4</i>	measurement data trace 1 to trace 4
<i>Active Lines</i>	active limit lines
<i>All Lines</i>	all limit lines
<i>Color Setup</i>	user-defined color settings
<i>Hardcopy Setup</i>	configuration for hardcopy output
<i>Macros</i>	macros
<i>Active Transducer</i>	active transducer
<i>All Transducer</i>	all transducer

SELECT ITEMS



The *SELECT ITEMS* softkey moves the selection bar to the first line, left column of the table.

ENABLE ALL ITEMS



The *ENABLE ALL ITEMS* softkey marks all entries in the *ITEMS TO SAVE* table.

DISABLE ALL ITEMS



The *DISABLE ALL ITEMS* softkey unmarks all entries in the *ITEMS TO SAVE* table.

DEFAULT CONFIG



The *DEFAULT CONFIG* softkey establishes the default selection of the data subset to be saved and outputs *DEFAULT* in the *ITEMS* field of the *SAVE DATA SET* table.

## Recalling of Data Sets – *RECALL* Key

The *RECALL* key activates a menu which contains all functions necessary for recalling data sets.

- Entry of the name of the data set which should be recalled. Confirmation of the entry initiates a load operation to recall the data set.
- Entry of the directory in which the data set is stored
- Display of data set description
- Selection of a data set which will be automatically loaded upon power-up
- Indication of all available data sets
- Deletion of all available data sets
- Selection of the data subsets which should be loaded (configurations, measurement and calibration data, sub-menu *SEL ITEMS TO RECALL*)

Any settings not restored when data subsets are loaded will remain unchanged in the instrument. During recall operations, the FSIQ recognises which data subsets are present in the recalled data set and offers only the corresponding settings for selection in the *SELECT ITEM* sub-menu.

A new instrument data set can be easily constructed from several existing data sets: the desired data subsets are selected and recalled out of various data sets in several *RECALL* operations. When the desired configuration is completed, the new data set can be saved under a new name.

*MEMORY RECALL* menu:



The *RECALL DATA SET* table shows the current settings regarding the data set:

<i>Name</i>	name of data set
<i>Path</i>	directory in which the data set is located
<i>Items</i>	indicates whether the default selection of the data subset (DEFAULT) or a user-defined selection (SELECTED) will be loaded
<i>Comment</i>	commentary regarding the data set

The *EDIT NAME* softkey for entering the name of the data set to be loaded is activated automatically.

## Selecting the Data Set for Recalling

MEMORY RECALL menu:

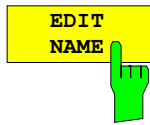

The *EDIT NAME* softkey activates the entry of a data set name. The data input is terminated by pressing one of the units keys which simultaneously initiates the data set recall operation.

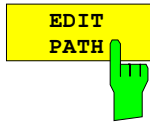

The *EDIT PATH* softkey activates the entry of a directory name in which the data set is located.

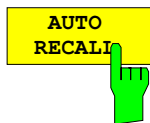

The *AUTO RECALL* softkey activates the selection of a data set which is automatically loaded when the instrument is powered on. To this end the table *DATA SET LIST/CONTENT* is opened (analog to *DATA SET LIST*).

DATA SET LIST	AUTO RECALL SET CONTENT
DATASET1	CONTENTS
DATASET2	GENERAL SETUP ✓ COLOR SETUP
DATASET3	✓ HW-SETTINGS ✓ HARDCOPY
	TRACE 1
	TRACE 2
	TRACE 3
	TRACE 4
	✓ LINES ✓ TRANSDUCER
	COMMENT
	GSM_MASK

The *DATA SET LIST* column displays all data sets present in the selected directory.

The *CONTENTS* and *COMMENT* lines in the *AUTO RECALL CONTENTS* column indicate the saved data subsets and the commentary for the currently selected data set.

In addition to the data sets stored by the user, the data set *FACTORY*, which specifies the settings of the instrument before it was last switched off (Standby), is always present.

If a data set other than *FACTORY* is chosen then, at the time of instrument power on, the available data subsets of the selected data set are recalled. The data subsets which are not present in this data set are taken from the *FACTORY* data set.

**Note:** The specified data set is also loaded upon *PRESET* if *AUTO RECALL* is active. The preset settings can thus be arbitrarily modified.

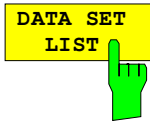

see Chapter "Saving Data Sets"

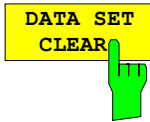

see Chapter "Saving Data Sets"



see Chapter "Saving Data Sets"

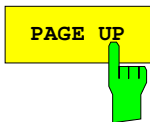

The *PAGE UP* or *PAGE DOWN* softkey sets the *DATA SET LIST* table to the next or previous page.

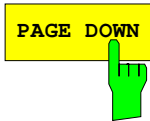

### Building a Data Set

The *SEL ITEMS TO RECALL* softkey opens a sub-menu to select data subsets.

*MEMORY RECALL-SELECT ITEMS TO RECALL* sub-menu:

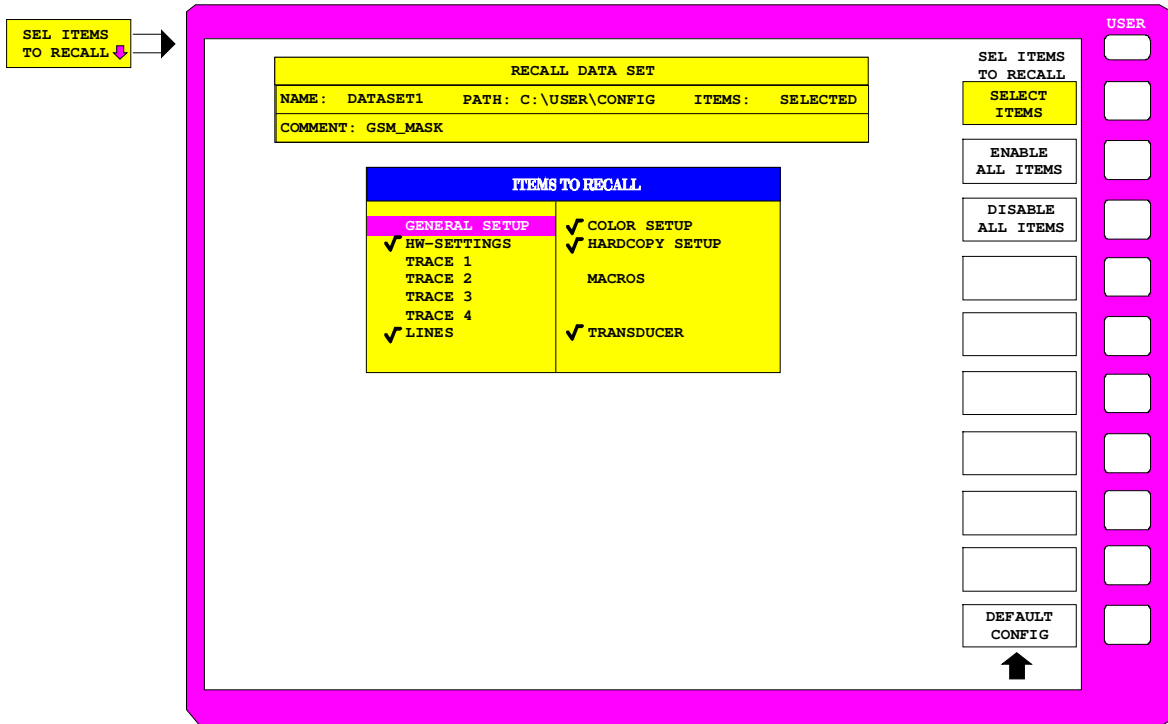

The *ITEMS TO RECALL* table displays the selectable data subsets:

<i>General Setup</i>	current configuration of general instrument parameters
<i>HW-Settings</i>	current measurement hardware settings
<i>Trace1...4</i>	measurement data trace 1 to trace 4
<i>Lines</i>	data point tables for the active limit lines
<i>Color Setup</i>	user-defined color settings
<i>Hardcopy Setup</i>	configuration for hardcopy output
<i>Macros</i>	macros
<i>Transducer</i>	transducer factor, transducer set



The *SELECT ITEMS* softkey activates the *ITEMS TO RECALL* table and sets the selection bar to the first line, left column of the table.

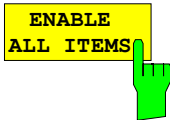

The *ENABLE ALL ITEMS* softkey marks all entries in the *ITEMS TO RECALL* table.

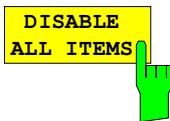

The *DISABLE ALL ITEMS* softkey unmarks all entries in the *ITEMS TO RECALL* table.

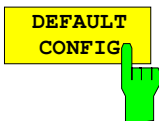

The *DEFAULT CONFIG* softkey establishes the default selection of the data subset to be recalled and outputs *DEFAULT* in the *ITEMS* field of the *RECALL DATA SET* table.



## Macros – USER Key

The FSIQ menus are so designed that the analyzer can be easily applied to most of the usual measurement tasks with a minimum number of key operations. However, the *USER* menu also permits a tailored adaptation of any necessary setup and measurement functions needed for special applications. Here, a sequence of key operations, which may occur repeatedly, can be listed in the *USER* menu as a key macro, then stored in memory and recalled as required by the application.

### Fundamentals

Macros are defined as arbitrary key sequences which need to be defined only once and then can be recalled as often as desired. Through the use of macros, often-needed measurement functions or instrument setups, which may require a large number of key operations, can be easily performed. The writing of macros is possible only under manual control. Macro generation is not possible under remote control (e.g. via the IEC Bus interface).

A total of 7 different macros can be programmed and assigned to the individual softkeys of the *USER* menu. Each macro has a title (arbitrarily defined by the user ) which is also used as a label for the corresponding softkey. To indicate that a macro has not yet been programmed, the soft-key label appears in parenthesis (e.g. (MACRO 1)). After a key-sequence macro has been defined, the parenthesis are removed and the softkey is replaced by the title specified by the user.

A macro is executed by pressing the corresponding softkey.

During execution of macros, the key actions are repeated in exactly the **same sequence** as they were programmed. The sequential execution of a macro may be interrupted by using the PAUSE instruction. As soon as a macro is interrupted, adjustments on the Unit Under Test (UUT) may be made, etc. The interrupted macro is allowed to continue by pressing *CONTINUE* in the message window and is aborted by pressing ABORT.

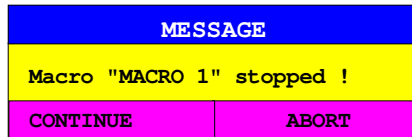

A running macro can be aborted by pressing the *LOCAL* key. At this time, the following message is displayed:

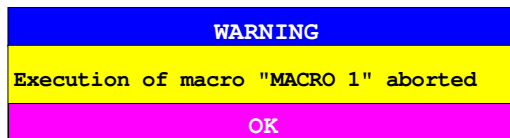

During the time a macro is executing, manual operations on the instrument are not possible, and the soft-key panel is disabled. After interruption or conclusion of a macro, the applicable soft-key panel is enabled (i.e., menu state at the conclusion of the macro).

## Starting Macros

USER menu

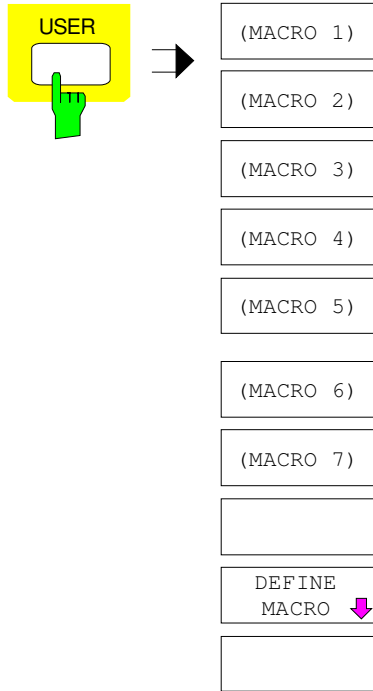

The USER key opens a menu for selection and starting of macros. The macros can be defined in the *DEFINE MACRO* submenu.

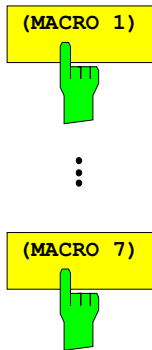

The *MACRO 1* to *7* softkeys start the execution of the macros.

## Defining Macros

In the *DEFINE MACRO* menu, all necessary softkeys needed for macro management are available. Included are functions for starting and ending macro programming, editing of a macro title, etc.

### USER DEFINE MACRO menu

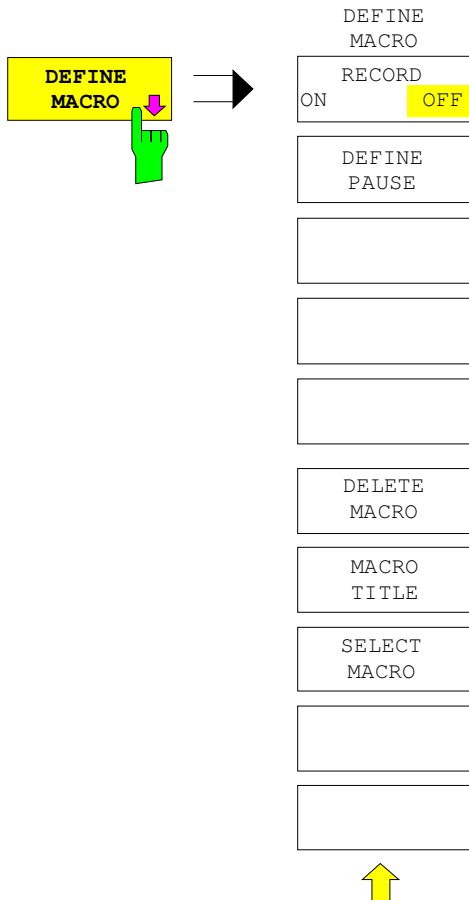

The *DEFINE MACRO* softkey calls the sub-menu to define the macros.

The *SELECT MACRO* softkey is active and opens the box to select the macro to be edited. In case no selection is made, *MACRO 1* is automatically selected.

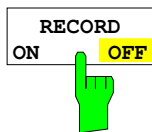

The *RECORD ON/OFF* starts or stops the recording of the macro.

**ON** All key actions are recorded until the softkey is changed to *OFF*. To indicate that macro record is enabled, the enhancement label **MAC** is displayed.

The number of actions which can be stored in a macro is limited. If the limit is exceeded, the error message "Macro too long. Recording aborted" is output and the recording operation is aborted, however, the actions already recorded do remain stored.

**OFF** The recording is stopped. The key actions are stored under the macro chosen by the *SELECT MACRO* softkey.

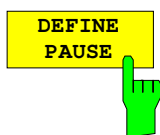

The *DEFINE PAUSE* softkey inserts a pause instruction into the macro sequence which is being recorded. A running macro will pause when it reaches this instruction, at which point settings on the unit under test could for example be made. *CONTINUE* in the message window is used to continue the macro execution.

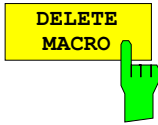

The *DELETE MACRO* softkey deletes the macro which was previously selected by the *SELECT MACRO* softkey. The softkey of the deleted title now carries its default label (*MACRO X*, X = macro number)

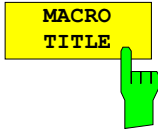

The *MACRO TITLE* softkey activates the entry of the title for the selected macro .

Because the macro title is used for labelling the corresponding softkey, a maximum of only 20 characters is allowed. All text after the 10<sup>th</sup> character is written to the second line. However, entering the character @ forces a new line at any point in the softkey title.

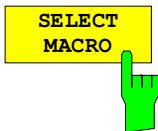

The *SELECT MACRO* softkey open the selection box with a list of all 7 macros. All soft-key functions of this menu are related to this macro.

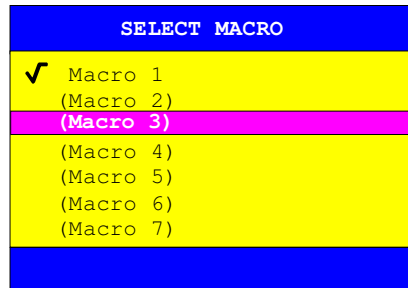

## Analyzer Mode

The analyzer mode is activated in the *CONFIGURATION MODE* menu (see also Section 'Mode Selection - *MODE* Key')

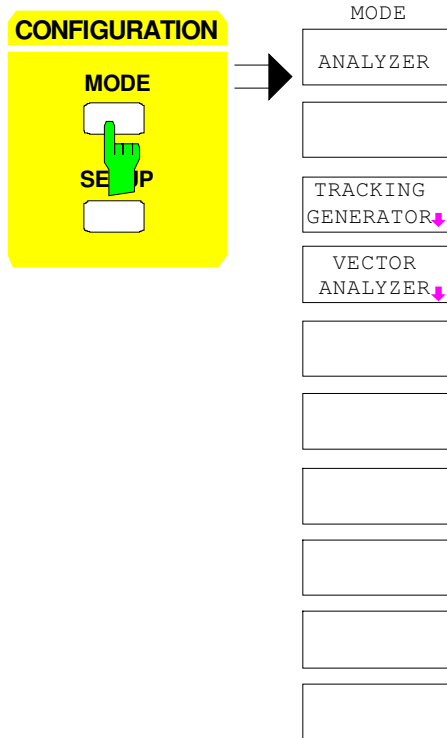

The *ANALYZER* softkey selects the *ANALYZER* mode.

This mode is the default setting of the FSIQ.

The functions provided correspond to those of a conventional spectrum analyzer. The analyzer measures the frequency spectrum of the test signal over the selected frequency range with the selected resolution and sweep time, or, for a fixed frequency, displays the waveform of the video signal.

**Note:** *If two displays (screen A and screen B) are opened after switch-on of signal analysis, the analyzer mode is only set for the display activated for entry (marked at the top right corner of diagram). For the other display, the previous settings remain valid. Storage and display of measured values is sequential: first in the upper and then in the lower display.*

## Frequency and Span Selection – FREQUENCY Key Group

The *FREQUENCY* key group is used to specify the frequency axis of the active measurement window. The frequency axis can be defined either by the start and stop frequency or by the center frequency and span. For the case when two measurement windows (*SPLIT-SCREEN*) are displayed simultaneously, data entered are always related to the window selected in the *SYSTEM-DISPLAY* menu.

After pressing one of the keys *CENTER*, *SPAN*, *START* or *STOP*, the value of the corresponding parameter can be defined in the appropriate dialog window. At the same time, a softkey menu appears, which allows selecting the optional parameters.

### Start Frequency – START Key

*FREQUENCY* – *START* menu:

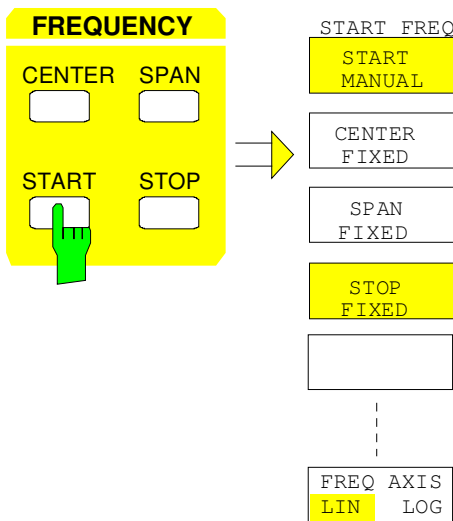

The *START* key opens a menu which displays the various options for setting the start frequency of the sweep. The *START MANUAL* softkey is automatically active and opens the entry window for manual input of the start frequency. At the same time, the coupling of the parameters is set to *STOP FIXED*

The *STOP FIXED*, *SPAN FIXED* and *CENTER FIXED* softkeys are mutually exclusive selection switches. Only one of these switches may be active at any one time. The frequency coupling selected by the softkeys defines which of the dependent parameters stop frequency, center frequency and span is to remain constant when a change in the start frequency is made.

The *FREQ AXIS LIN/LOG* softkey switches between linear and logarithmic scaling of the frequency axis.



The *START MANUAL* softkey activates manual entry of the start frequency.

The allowed range of values for the start frequency is:

$$0 \text{ Hz} \leq f_{\text{start}} \leq f_{\text{max}} - \text{minspan}/2$$

$f_{\text{start}}$  start frequency  
 minspan smallest selectable span)  
 $f_{\text{max}}$  max. frequency

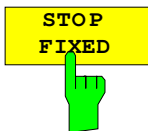

If the *STOP FIXED* key is active, the stop frequency remains constant when the start frequency is changed. The center frequency is adjusted to the new frequency range. *STOP FIXED* coupling is the default setting.

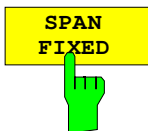

If the *SPAN FIXED* softkey is active, the span remains constant when the start frequency is changed. The stop frequency is adjusted to the new frequency range.

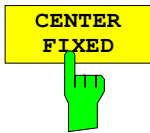

If the *CENTER FIXED* softkey is active, the center frequency remains constant when the start frequency is changed. The stop frequency is adjusted to the new frequency range.



The *FREQ AXIS LIN/LOG* softkey switches between linear and logarithmic scaling of the frequency axis.

When the log scale is used, the following restrictions apply:

- For the start/stop frequency ratio the following holds:

$$\frac{\text{Stopfrequency}}{\text{Startfrequency}} \geq 1.4$$

At ratios below 1.4, a linear frequency scale is automatically selected.

- Up to five decades can be set.

$$\frac{\text{Stopfrequency}}{\text{Startfrequency}} \leq 10^5$$

When the start or stop frequency is changed, the stop or start frequency is adapted to the settable range, as required.

- A frequency offset is not allowed.
- The *CHANNEL POWER*, *C/N*, *C/N0*, *ADJACENT CHAN POWER* and *OCCUPIED PWR BANDW* measurements are disabled.

**Note:** *The function of a limit line is influenced by the FREQ AXIS LIN/LOG setting at the time of the definition.*

*Limit lines are entered as tabulated values (level and frequency). Most regulations and standards prescribe the linking of values by straight lines both for the linear and logarithmic display. When the limit line is defined with the desired frequency scale selected, this is automatically taken into account (linear interpolation).*

*To be able to use the correct limit values among the tabulated values after a scale switchover, the limit line is recalculated after the switchover.*

### Stop Frequency – STOP Key

FREQUENCY – STOP menu:

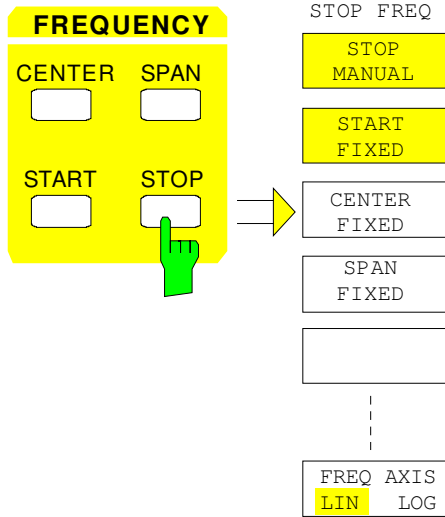

The **STOP** key opens a menu which displays the various options for setting the stop frequency of the sweep .

The **STOP MANUAL** softkey is automatically active and opens the entry window for manual input of the stop frequency. At the same time, parameter coupling is set to **START FIXED**.

The **START FIXED**, **CENTER FIXED** and **SPAN FIXED** softkeys are mutually exclusive selection switches. Only one switch can be active at any one time. The softkeys are used to select the frequency coupling. The frequency coupling defines which of the dependent parameters start frequency, center frequency or span is to remain constant when the stop frequency is changed.



The **STOP MANUAL** softkey activates the manual entry window for the stop frequency.

The allowed range of values for the stop frequency is:

$$\text{minspan} \leq f_{\text{stop}} \leq f_{\text{max}}$$

$f_{\text{stop}}$  stop frequency  
 minspan smallest selectable span (10Hz)  
 $f_{\text{max}}$  max. frequency



If the **START FIXED** softkey is active, the start frequency remains constant when the stop frequency is changed. The center frequency is adjusted to the new frequency range. The **START FIXED** coupling is the default setting.



If the **CENTER FIXED** softkey is active, the center frequency remains constant when the stop frequency is changed. The start frequency is adjusted to the new frequency range.

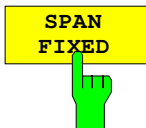

If the **SPAN FIXED** softkey is active, the span remains constant when the stop frequency is changed. The start frequency is adjusted to the new frequency range.



The **FREQ AXIS LIN/LOG** softkey switches between linear and logarithmic scaling of the frequency axis (see **START** key).



### Center Frequency – CENTER Key

FREQUENCY – CENTER menu:

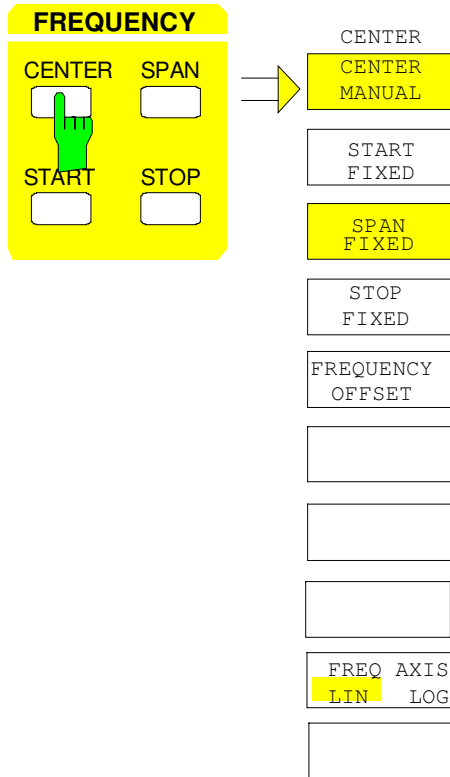

The *CENTER* softkey opens a menu which displays the various options for setting the center frequency of the sweep.

The *CENTER MANUAL* softkey is automatically active and opens the entry window for manual input of the center frequency. At the same time, the coupling of the parameters is set to *SPAN FIXED*.

The *START FIXED*, *STOP FIXED* and *SPAN FIXED* softkeys are mutually exclusive selection switches. Only one switch can be active at any one time. The softkeys are used to select the frequency coupling. The frequency coupling defines which of the dependent parameters start frequency, stop frequency or span remains constant when the center frequency is changed.



The *CENTER MANUAL* softkey activates the manual entry window for entering the center frequency.

The allowed range of values for the center frequency is:

for the frequency domain (span > 0):

$$0 \text{ Hz} \leq f_{\text{center}} \leq f_{\text{max}} - \text{minspan}/2$$

and for the time domain (span = 0)

$$0 \text{ Hz} \leq f_{\text{center}} \leq f_{\text{max}}$$

- $f_{\text{center}}$  center frequency
- $\text{minspan}$  smallest selectable span (10Hz)
- $f_{\text{max}}$  max. frequency

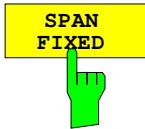

If the *SPAN FIXED* softkey is active, the span remains constant when the center frequency is changed. The start and stop frequency are adjusted to the new frequency range. *SPAN FIXED* coupling is the default setting.

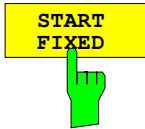

If the *START FIXED* softkey is active, the start frequency remains constant when the center frequency is changed. The span is adjusted to the new frequency range.

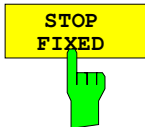

If the *STOP FIXED* softkey is active, the stop frequency remains constant when the center frequency is changed. The span is adjusted to the new frequency range.



The *FREQUENCY OFFSET* softkey activates the entry window for an arithmetical frequency offset which is added to the frequency axis labelling. The allowable range of input values is -100 GHz to 100 GHz. The default setting is 0 Hz.



The *FREQ AXIS LIN/LOG* softkey switches between linear and logarithmic scaling of the frequency axis (see *START* key).

### Center Frequency Step Size

The *STEP* key in the *DATA VARIATION* key group opens a menu for setting the step size of the center frequency. The step size can be coupled to the span (frequency domain) or the resolution bandwidth (time domain) or it can be manually set to a fixed value.

In order to change the step size, the entry window for the center frequency must already be active. After pressing the *STEP* key, the *CENTER STEP* menu appears. The softkeys are presented according to the selected domain (frequency or time).

The softkeys are mutually exclusive selection switches. Only one switch can be active at any one time.

Control is returned to the *FREQUENCY CENTER* menu via the menu key .

*DATA VARIATION - STEP* menu      for span ≠ 0      for span = 0

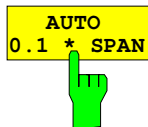
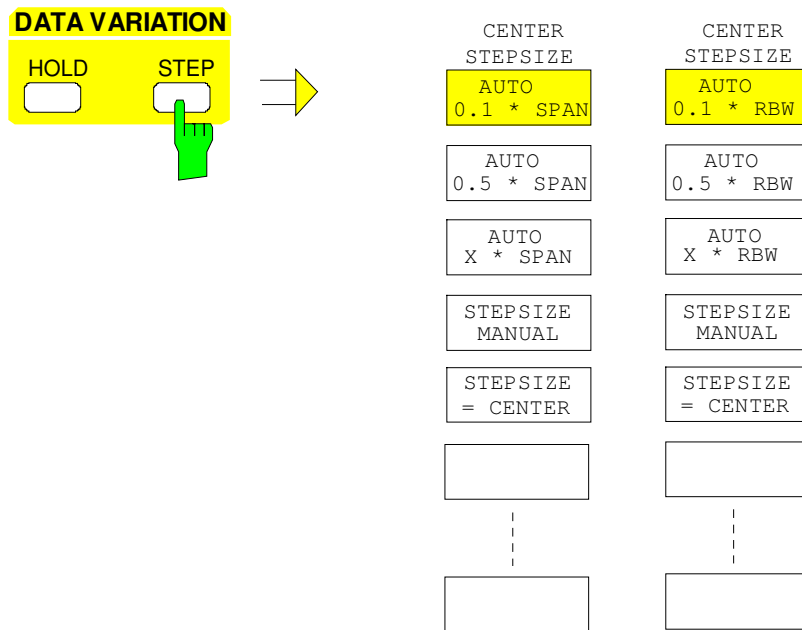

Frequency domain: The *AUTO 0.1 \* SPAN* softkey sets the step size of the center frequency entry to 10% of the span.



Time domain: The *AUTO 0.1 \* RBW* softkey sets the step size of the center frequency entry to 10% of the resolution bandwidth

*AUTO 0.1 \* RBW* is the default setting.

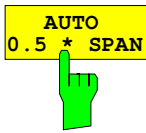

Frequency domain: The *AUTO 0.5 \* SPAN* softkey sets the step size of the center frequency entry to 50% of the span.

Time domain: The *AUTO 0.5 \* RBW* softkey sets the step size of the center frequency entry to 50% of the resolution bandwidth

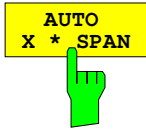
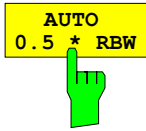

Frequency domain: The *AUTO X \* SPAN* softkey activates the entry of the factor defining the center frequency step size as a % of span.

Time domain: The *AUTO X \* RBW* softkey activates the entry of the factor defining the center frequency step size as a % of the resolution bandwidth.

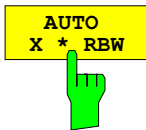

Values between 1 and 100% in steps of 1% are acceptable. The default setting is 10%.



The *STEPSIZE MANUAL* softkey activates the entry window for the input of a fixed step size.

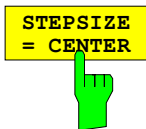

The *STEPSIZE = CENTER* softkey sets the step size coupling to *MANUAL* and the step size to a value equal to the center frequency. This function is especially useful during measurements of the signal harmonic content, because, when entering the center frequency, the center frequency of another harmonic is selected with each stroke of the *STEP* key.

### Frequency Span – SPAN Key

FREQUENCY – SPAN menu:

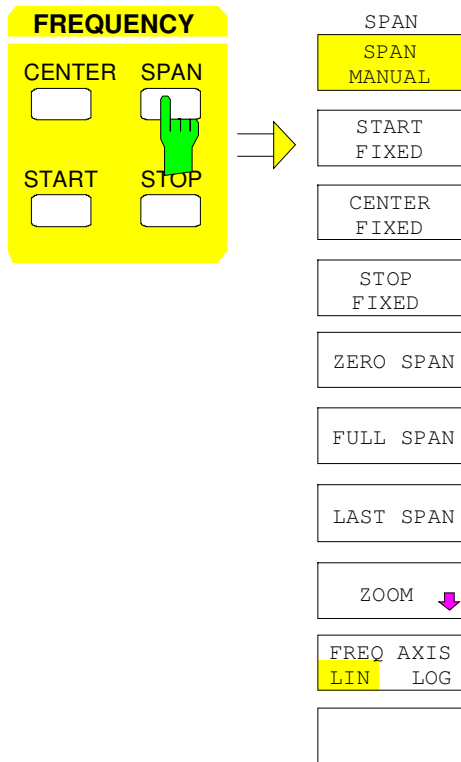

The *SPAN* key opens a menu which displays various options for the selection of sweep span.

The *SPAN MANUAL* softkey is automatically active and opens the entry window for manual input of the span. At the same time, the parameter coupling is set to *CENTER FIXED*.

The *START FIXED*, *CENTER FIXED* and *STOP FIXED* softkeys are mutually exclusive selection switches. Only one switch can be active at any one time. The frequency coupling is selected with these softkeys. The frequency coupling defines which of the dependent parameters start frequency, center frequency or stop frequency is to remain constant when the span is changed



The *SPAN MANUAL* softkey activates the manual entry of the span.

The allowed range of input values for span are:  
time domain (span = 0):

0 Hz

frequency domain (span > 0):

$$\text{minspan} \leq f_{\text{span}} \leq f_{\text{max}}$$

$f_{\text{span}}$  frequency span  
 minspan smallest selectable span (10Hz)  
 $f_{\text{max}}$  max. frequency

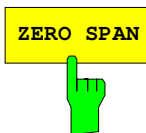

The *ZERO SPAN* softkey sets the span value to 0 Hz. The x axis becomes the time axis. The axis labelling corresponds to the sweep time (on the left, 0 ms, on the right, the current sweep time (SWT)).

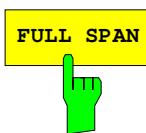

The *FULL SPAN* softkey sets the span value to the maximum span of the FSIQ.



The *LAST SPAN* softkey switches the instrument between a detailed measurement (given: center frequency and span) mode and an overview measurement (*FULL SPAN*) mode.

The *FULL SPAN* softkey modifies the center frequency as well as the selected span. The *LAST SPAN* softkey cancels this change.



If the *START FIXED* softkey is activated, the start frequency remains constant when the span is changed. The center and stop frequency are adjusted to the new span.



If the *CENTER FIXED* softkey is activated, the center frequency remains constant when the span is changed. The center and stop frequency are adjusted to the new span. The *CENTER FIXED* coupling is the default setting.



If the *STOP FIXED* softkey is activated, the stop frequency remains constant when the span is changed. The center and start frequency are adjusted to the new span.

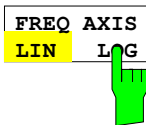

The *FREQ AXIS LIN/LOG* softkey switches between linear and logarithmic scaling of the frequency axis (see *START* key).

## Display Zoom

FREQUENCY SPAN- ZOOM submenu:

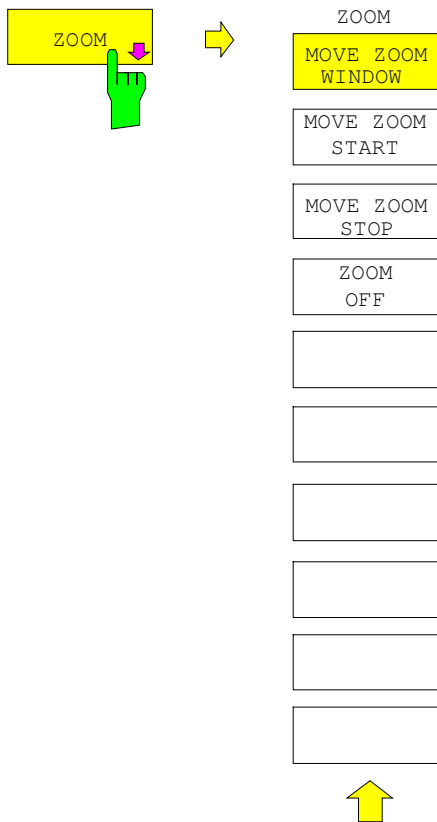

The *ZOOM* softkey activates the zoom mode and opens a sub-menu to define the zoom span.

Two frequency lines, which show and define the frequency range to be zoomed, appear in the active measurement window when the zoom mode is switched on. The default setting is a zoom span of 10% to the left and 10% to the right of the center frequency. The zoomed display is shown in the second measurement window.

The settings for the second measurement window are taken from the original window. The second measurement window thus becomes the active measurement window and its settings can now be changed.

If only one window is active when the zoom function is selected, *SPLIT SCREEN* mode is automatically switched on.

The zoom span can be edited by using the softkeys of the sub-menu to change the position of the frequency lines.

The softkey *ZOOM OFF* switches off the zoom.



The *MOVE ZOOM WINDOW* softkey shifts the full zoom window. The window can be shifted until the upper frequency line has reached the stop frequency or the lower frequency line has reached the start frequency of the original window.



The *MOVE ZOOM START* softkey shifts the lower frequency line. Thus, the start frequency of the zoomed display can be modified. The frequency line can be shifted down to the start frequency of the original window or up to the upper frequency line (= zero span).



The *MOVE ZOOM STOP* softkey shifts the upper frequency line. Thus, the stop frequency of the zoomed display can be modified. The frequency line can be shifted up to the stop frequency of the original window or down to the lower frequency line (= zero span).

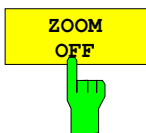

The *ZOOM OFF* softkey switches the zoom function off and then returns control to the main menu.

The frequency lines for indicating the zoom range are deleted, *SPLIT SCREEN* mode remains active, the settings of both measurement windows are retained and the coupling of the two measurement windows is cancelled.

## Level Display and RF Input Configuration – LEVEL Key Group

The *REF* and *RANGE* keys are used to set the reference level (= maximum RF input level, = overload limit), the maximum level (= upper grid level) , and the display range of the active window. The *INPUT* key sets the characteristics of the RF input (input impedance and input attenuation).

### Reference Level – REF key

In addition to the reference level (maximum RF input level), the FSIQ provides a function to define a maximum level (uppermost grid line on the display):

For a spectrum analyzer, the upper boundary of the measurement diagram (maximum level) is also the limit of its dynamic range (reference level). This means, that a signal which goes beyond the upper grid line also overdrives the analyzer.

For compensation of frequency or antenna characteristics, transducer factors can be applied to increase the signal level. In this case, the calculated values can be above the reference level without actually being physically applied to the instrument. In order to display these signals on the grid, an upper grid level which is different from the reference level of the analyzer can be entered.

LEVEL REF menu:

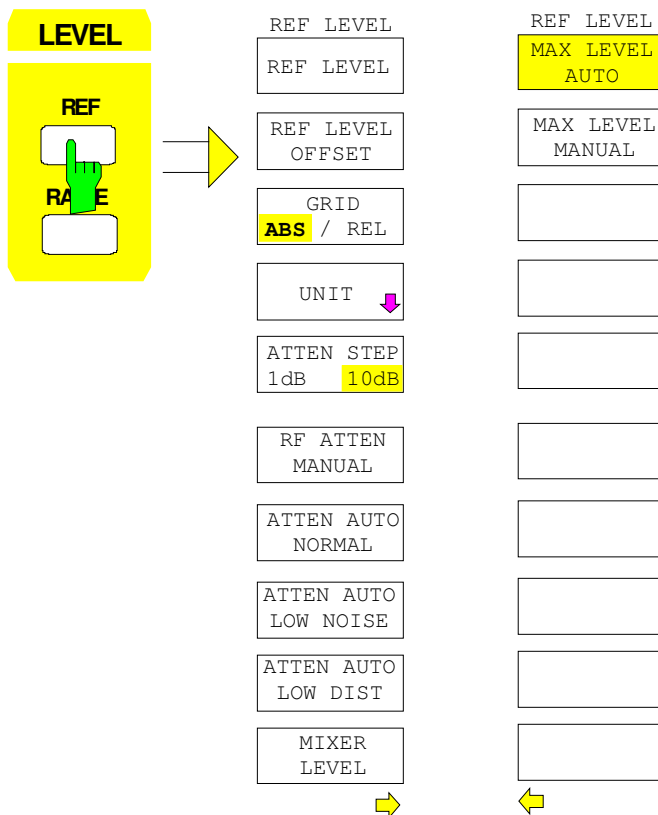

The *REF* key opens a menu to set the reference level and the input attenuation for the active measurement window .

The *REF LEVEL* soft key is automatically active with the menu called up and opens the entry window for manual input of the reference level.

At the same time various settings concerning the level and the attenuation display can be made.

The functions for setting the attenuation are identical to those under the *INPUT* key and are described in Section "Configuration of the RF Input - INPUT Key". Softkey *ATTEN STEP 10dB/1dB* is only available when the FSIQ is equipped with option FSE-B13, 1dB attenuator (see 'Option 1 dB Attenuator - FSE-B13' at the end of this Section.)





The *REF LEVEL* soft key activates the entry of the reference level. The input is made in the currently active units (dBm, dB $\mu$ V, etc.).

If the *MAX LEVEL MANUAL* softkey is active, a change of the reference level causes an equal amount of change in maximum level. Thus, the separation between the overload limit of the analyzer to the upper grid edge remains the same. Thus, with only one entry, it is possible to make a change to the display and simultaneously to perform an adjustment to the amplifier.



The *REF LEVEL OFFSET* soft key activates the entry of an arithmetic offset ( $\pm 200$  dB in 0,1 dB steps) to the level. The offset is added to the measured level dependent upon the selected units. The scaling of the y axis is changed accordingly.

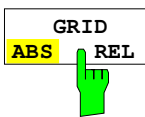

The *GRID ABS/REL* soft key switches between absolute and relative scaling of the level axis. *GRID ABS* is the default setting.

For absolute scaling the labelling of the level lines is referenced to the absolute value of the reference level.

For relative scaling, the upper line of the grid is always at 0 dB and the scale units are in dB. In contrast, the reference level is always displayed in the set units (dBm, dB $\mu$ V,..).

The soft key is not displayed for setting *LIN / %* (linear scaling, labelling in %) in the *LEVEL-RANGE* menu since the % unit itself implies a relative scale.

The *MAX LEVEL MANUAL* and *MAX LEVEL AUTO* soft keys are mutually exclusive selection switches. Only one switch can be active at one time. The soft keys are used to select whether reference level and maximum level are identical or not:



When *MAX LEVEL AUTO* soft key is active, the reference level and maximum level are identical.

In this case, the reference level is displayed above the upper left corner of the grid in the corresponding function field.

*MAX LEVEL AUTO* is the default setting.

If the *MAX LEVEL MANUAL* soft key was active prior to pressing the *MAX LEVEL AUTO* soft key, the upper boundary of the grid is set to the reference level.

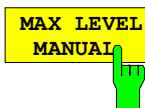

The *MAX LEVEL MANUAL* soft key activates the entry of the maximum level. The range of input values is  $\pm 200$ dBm with 0.1 dB resolution.

If the *MAX LEVEL MANUAL* soft key is activated, the maximum level is displayed in addition to the reference level to the right above the grid.

## Display Units

In general, a spectrum analyzer measures the signal voltage at the RF input. The level display is calibrated in rms values of an unmodulated sine wave signal. In the initial state, the level is displayed at a power of 1 milliwatt (= dBm). Via the known input resistance of  $50\Omega$ , a conversion can be made to other units. The units dBm, dB $\mu$ V, dB $\mu$ A, dBpW, V, A and W are directly convertible and can be selected in the *REF UNIT* menu.

Units dB./MHz have a special status. They are applicable for broadband pulse signals. The measured pulse voltage or the pulse current is referred to 1 MHz bandwidth. This conversion is not useful for narrowband or sinewave signals.

If the antenna coded connector on the front panel is used, the coded unit there determines the possible display units. Connecting to the coded connector deactivates the settings of the *UNIT* menu.

By certain codings it is nevertheless possible to select a conversion of the unit in the menu. The dependencies between the unit of the antenna coded connector and the unit which is to be selected for the display are given in the soft key description.

The default coding defined by the connector can be switched off using the *PROBE CODE ON/OFF* soft key. In this case, the unit can be set with the corresponding unit soft keys (dBm, dB $\mu$ V, ...) even if a coded connector is plugged in. The coded entries in the connector are then ignored.

**Note:** *The units dB $\mu$ V/m and dB $\mu$ A/m can only be set via the unit of a transducer or via the unit of the coded connector.*

LEVEL REF UNIT submenu:

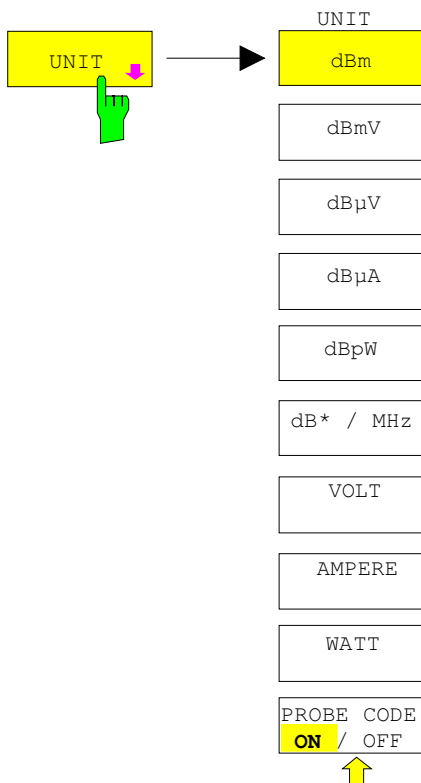

The *UNIT* soft key opens a sub-menu in which the desired units for the level axis can be selected and the coding of the antenna coded connector can be switched on and off.

The selected units are valid for both displays when two measurement windows are displayed.

The unit soft keys are mutually exclusive selection switches. Only one of these switches may be active at any one time.

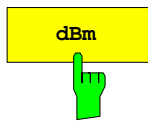

The *dBm*, *dBμV*, *dBmV*, *dBμA*, *dBpW* soft keys set the display units to the corresponding logarithmic units. The *dBm* unit is the default unit in analyzer mode.

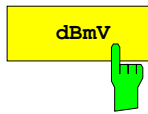

The units *dBm*, *dBμV*, *dBmV*, *dBμA* cannot be selected when the coded antenna connector or the used transducer defines a unit.

Only for coding dB, the conversion to the desired units is permitted.

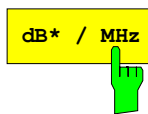
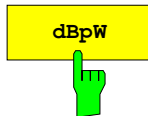
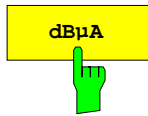
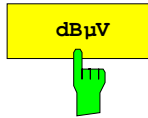

The *dB\*/MHz* softkey activates/disactivates the display of results in units relative to the bandwidth. Those units can be derived from the logarithmic units *dBμV*, *dBμV/m*, *dBμA* and *dBμA/m*.

This leads to the following relative units:

- dBmV* ⇒ *dBmV/MHz*
- dBμV* ⇒ *dBμV/MHz*
- dBμV/m* ⇒ *dBμV/mMHz*
- dBμA* ⇒ *dBμA/MHz*
- dBμA/m* ⇒ *dBμA/mMHz*

Switching over is possible also if a coded antenna connector or a transducer fixes the unit to be used.

Conversion to 1 MHz is via the pulse bandwidth of the selected resolution bandwidth  $B_{imp}$  according to the following equation (example for *dBμV*) :

$$P / (dB\mu V / MHz) = 20 \cdot \log \frac{B_{imp} / MHz}{1MHz} + P / (dB\mu V),$$

where P = display level

The *dBμV/MHz* unit can be combined with the following coded connector or transducer units

- dB (the unit *dBμV/MHz* remains )
- $\mu V/m$  (yields the display unit *dBμV/mMHz*)

analogous for *dBμA/MHz*:

- dB and  $\mu A$  (the unit *dBμA/MHz* remains)

Other combinations are not allowed.

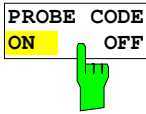
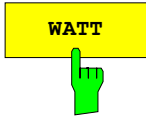
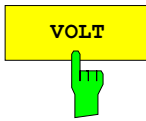

The *VOLT*, *AMPERE*, *WATT* soft keys set the display units to the corresponding linear units.

The units *VOLT*, *AMPERE*, *WATT* cannot be selected when the coded antenna connector or the transducer table defines one of the following as units:

$\mu\text{V/m}$   
 $\mu\text{A}$

For coding dB, the conversion to the desired units is permitted.

The *PROBE CODE ON/OFF* soft key enables or disables the units defined by the coded connector.

### Level Range – RANGE Key

LEVEL RANGE menu:

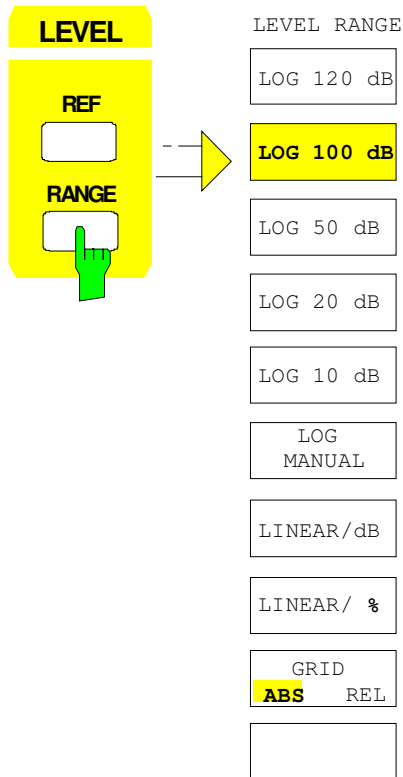

The *RANGE* key calls a menu in which the range, linear or logarithmic the display scale, absolute or relative and the level units for the active window can be selected.

The display range of the analyzer can be set in 10 dB steps from 10 to 200 dB. The default setting is 100 dB.

The most often used settings (120 dB, 100 dB, 50 dB, 20 dB and 10 dB) are each directly selectable by a soft key.

All other ranges are chosen with the *LOG MANUAL* soft key.

After pressing the *RANGE* key, the *LOG MANUAL* entry window is enabled if the display range is not set to *LIN*.



The *LOG MANUAL* soft key activates the entry of the level display range. Display ranges from 10 to 200 dB are allowed in 10-dB steps. Values which are not permissible are rounded to the next valid number.

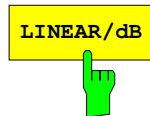

The *LINEAR/dB* soft key switches the display range of the analyzer to linear scaling. The horizontal lines are labelled according to the selection *GRID ABS/REL* in dB\* or \*.



The *LINEAR/%* soft key switches the display range of the analyzer to linear scaling. The horizontal lines are labelled in %. The grid is divided into decades.

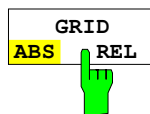

The *GRID ABS/REL* soft key switches between absolute and relative scaling of the level axis. *GRID ABS* is the default setting.

**ABS** The labelling of the level lines is referenced to the absolute value of the reference level.

**REL** The upper line of the grid is always at 0 dB and the scale units are in dB. In contrast, the reference level is always displayed in the set units (dBm, dBμV,..).

The soft key is not displayed for setting *LIN / %* (linear scaling, labelling in %) since the % unit itself implies a relative scale.

### RF Input Configuration – INPUT Key

In addition to manual entry of the input attenuation, the FSIQ provides an option which allows the RF attenuation, dependent on the selected reference level, to be automatically set. Thus, it is guaranteed that an optimum combination of RF attenuation and IF amplification is always used. For the automatic selection process, three modes are provided. The *AUTO LOW NOISE* mode selects the amplification/attenuation combination so that the display of noise on the FSIQ is at a minimum. The signal/noise ratio is maximised. The *AUTO LOW DISTORTION* mode is tuned for minimisation of the internally generated interference products. This causes, however, a lower signal/noise ratio. The *ATTEN AUTO NORMAL* mode is a compromise between low noise and low distortion.

INPUT menu:

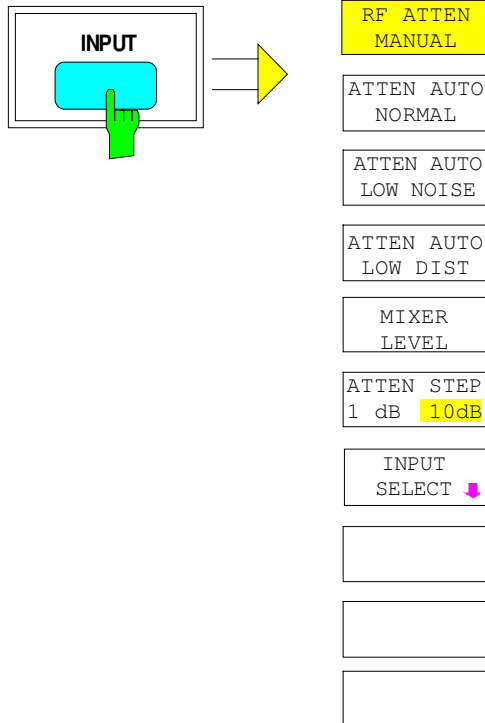

The *INPUT* key opens the menu for configuring the RF input. It contains the input attenuator and mixer level for matching the RF input to the input signal.

The *RF ATTEN MANUAL*, *ATTEN AUTO NORMAL*, *ATTEN AUTO LOW NOISE* and *ATTEN AUTO LOW DIST* soft keys are mutually exclusive selection switches. Only one can be active at any one time.

Softkey *ATTEN STEP 10dB/1dB* is only available when the FSIQ is equipped with option FSE-B13, 1dB attenuator (see 'Option 1 dB Attenuator - FSE-B13' at the end of this Section.)

The *INPUT SELECT* soft key calls a submenu for selection of the input impedance.

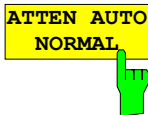

The *RF ATTEN MANUAL* soft key activates the entry of an attenuation factor independent of the reference level.

The attenuation can be modified in 10 dB steps between 0 and 70 dB.

Other inputs will be rounded to the next higher integer value.

If the defined reference level cannot be set for the given RF attenuation, the reference level will be adjusted accordingly and the warning "Limit reached" will be output.



The *ATTEN AUTO NORMAL* soft key sets the RF attenuation automatically independent of the selected reference level.



The *ATTEN AUTO LOW NOISE* soft key sets the RF attenuation always 10dB lower than in the *RF ATTEN AUTO* mode. Therefore, for 10 dB RF attenuation, the maximum reference level is -10 dBm. For reference levels which are lower, at least 10 dB is always set (see above).

Setting Low Noise means that the indicated inherent noise level is low. This setting is recommended if signals with a low level have to be measured as the highest S/N ratio is then obtained.



The *ATTEN AUTO LOW DIST* soft key sets the RF attenuation 10 dB higher than in *RF ATT AUTO* mode. This means that for 10 dB RF attenuation, the maximum reference level is -30 dBm (-40 dBm at the mixer).

This setting is recommended whenever a small signal is to be measured in the presence of larger signals. Here, the intermodulation-free range of the FSIQ is large and the internal distortion products are minimised.



The *MIXER LEVEL* soft key activates the entry of the maximum mixer level attainable for a given reference level. At the same time it enables soft keys *ATTEN AUTO LOW NOISE* and *ATTEN AUTO LOW DIST*.

Range of input values is -10 to -100 dBm

INPUT INPUT SELECT submenu:

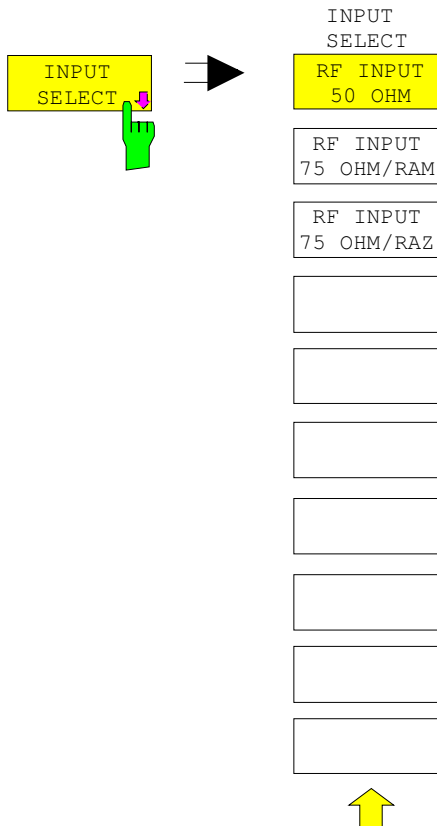

The *INPUT SELECT* soft key calls a submenu for selection of the input impedance of the RF input.

The basic setting is 50 Ohm. By connecting an impedance converter RAM or RAZ ahead, the 50-Ohm input can be transformed to 75 Ohm. FSIQ automatically takes the corresponding correction values for the level display into account.

The soft keys used to select the input impedance are selection switches. Only one of them can be active at any one time

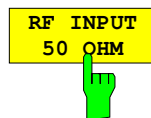

The *RF INPUT 50 OHM* soft key sets the input impedance to 50 Ohm (= default setting). All level indications are referenced to 50 Ohm.

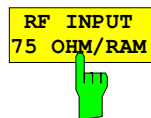

The *RF INPUT 75 OHM/RAM* soft key sets the input impedance of the FSIQ to 75 Ohm including the matching element RAM. All level indications are referenced to 75 Ohm.



The *RF INPUT 75 OHM/RAZ* soft key sets the input impedance of the FSIQ to 75 Ohm including the matching element RAZ. All level indications are referenced to 75 Ohm.



### Option 1 dB Attenuator - FSE-B13

The option 1 dB Attenuator FSE-B13 is used to set the attenuator with a step size of 1 dB up to an upper limit frequency of 7 GHz.

The attenuator with 1 dB stepping is connected in series after the main attenuator.

#### Instruments with an Upper Limit Frequency of up to 7 GHz

The optional attenuator is in the signal path for all settable frequencies in instruments with a maximum upper limit frequency of 7 GHz. When it is activated, it is used without any restriction for setting the input attenuation or the reference level.

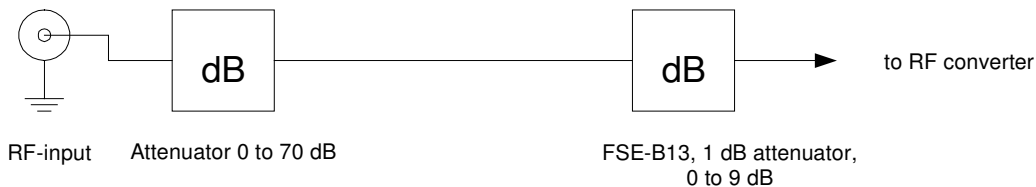

#### Instruments with an Upper Limit Frequency of more than 7 GHz

In instruments with an upper limit frequency of more than 7 GHz a diplexer is placed before the optional attenuator for separating the frequency ranges  $\leq 7\text{GHz}$  and  $> 7\text{ GHz}$ . The optional attenuator is in the signal path only for frequencies  $\leq 7\text{ GHz}$ .

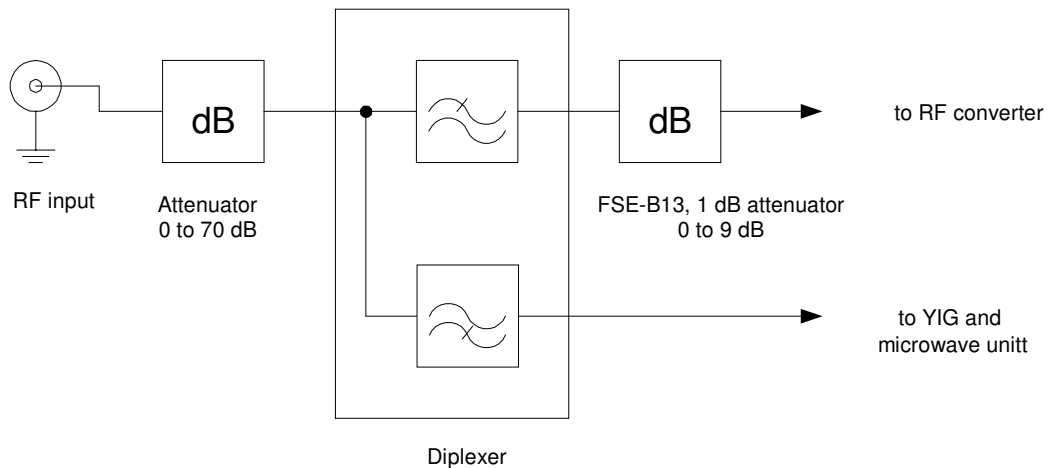

On changing the frequency range for the stop frequency, the attenuator can be set as follows:

**Instrument setting: ATTENUATOR AUTO**

- After switching from  $F_{\text{stop}} \leq 7$  GHz to  $F_{\text{stop}} > 7$  GHz the reference level is re-calculated provided the attenuation previously set contained 1 dB steps. A warning is not displayed.
- After switching from  $F_{\text{stop}} > 7$  GHz to  $F_{\text{stop}} \leq 7$  GHz the reference level is re-calculated. A warning is not displayed.

**Instrument setting: ATTENUATOR MANUAL**

- After switching from  $F_{\text{stop}} \leq 7$  GHz to  $F_{\text{stop}} > 7$  GHz, the attenuation is rounded off to a value divisible by 10 provided the attenuation previously set contained 1 dB steps. A warning is displayed:

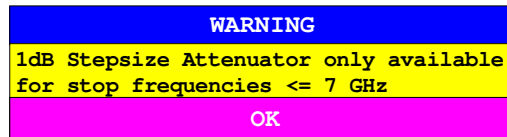

- After switching from  $F_{\text{stop}} > 7$  GHz to  $F_{\text{stop}} \leq 7$  GHz the current value of the input attenuation is maintained.

The 1 dB attenuator is inactive as default. In this case the attenuation can be set only in 10 dB steps, ie the attenuation of the optional attenuator is fixed at 0 dB.

The optional attenuator is activated either in the INPUT menu or in the REF LEVEL menu (the two settings are equivalent):

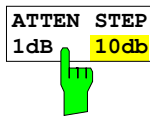

The *ATTEN STEP* 1dB/10dB softkey switches between the 10 dB step and 1 dB step settings.

After activating the optional attenuator with the *ATTEN STEP 10dB/1dB* softkey, setting in 1 dB steps is possible, the total attenuation is divided into

- a 10 dB contribution from the main attenuator and
- a residual contribution of 0 to 9 dB from the optional attenuator.

The attenuation setting range in the instrument remains to be 0 to 70 dB, it is **not** extended by the optional attenuator.

After a reset the attenuator step size is automatically set to 10 dB.

## Marker Functions – *MARKER* Key Group

The markers are used for marking points on measurement curves, reading out measurement values and for quickly selecting a display screen segment. Preselected measurement routines can be called by pressing a key in the marker menu. The FSIQ provides four markers and four delta markers per measurement window. The currently activated marker can be shifted with the cursor keys, the roll-key or the softkeys. The softkeys are defined according to the type of display representation selected (frequency or time domain).

The marker which can be moved by the user is defined as the **active marker**.

Examples:

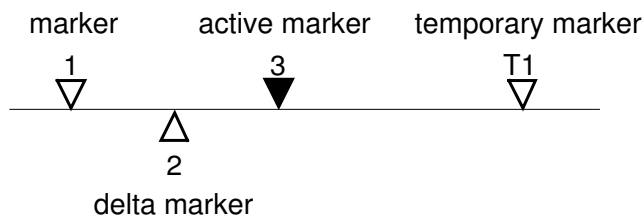

The measurement values of the active marker (also called **marker values**) are displayed in the marker field. In the **marker info list**, the measurement values from all enabled markers are sorted in ascending order. The marker info list can be switched off with the *MARKER INFO* softkey so that only the values for the active marker are shown.

The summary markers have a special function. They read out the rms or average value of the current trace or the trace averaged over several sweeps in the marker info list. These markers are not displayed.

### Main Markers– *NORMAL* Key

The *NORMAL* key calls a menu which contains all standard functions. The current state of the markers is indicated by a colored illumination of the softkeys. If no marker is enabled prior to pressing the *NORMAL* key, *MARKER 1* will be enabled as the reference marker and a peak search on the measurement curve is carried out (assumption: at least one measurement curve is active). Otherwise, the peak search is omitted and the entry window for the reference marker is activated.

The marker field at the upper left of the display screen shows the marker location (here, frequency), the level and the currently selected measurement curve.

```
MARKER 1 [T1]
-27.5 dBm
123.4567 MHz
```

MARKER NORMAL menu:

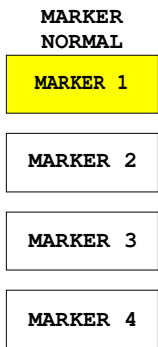
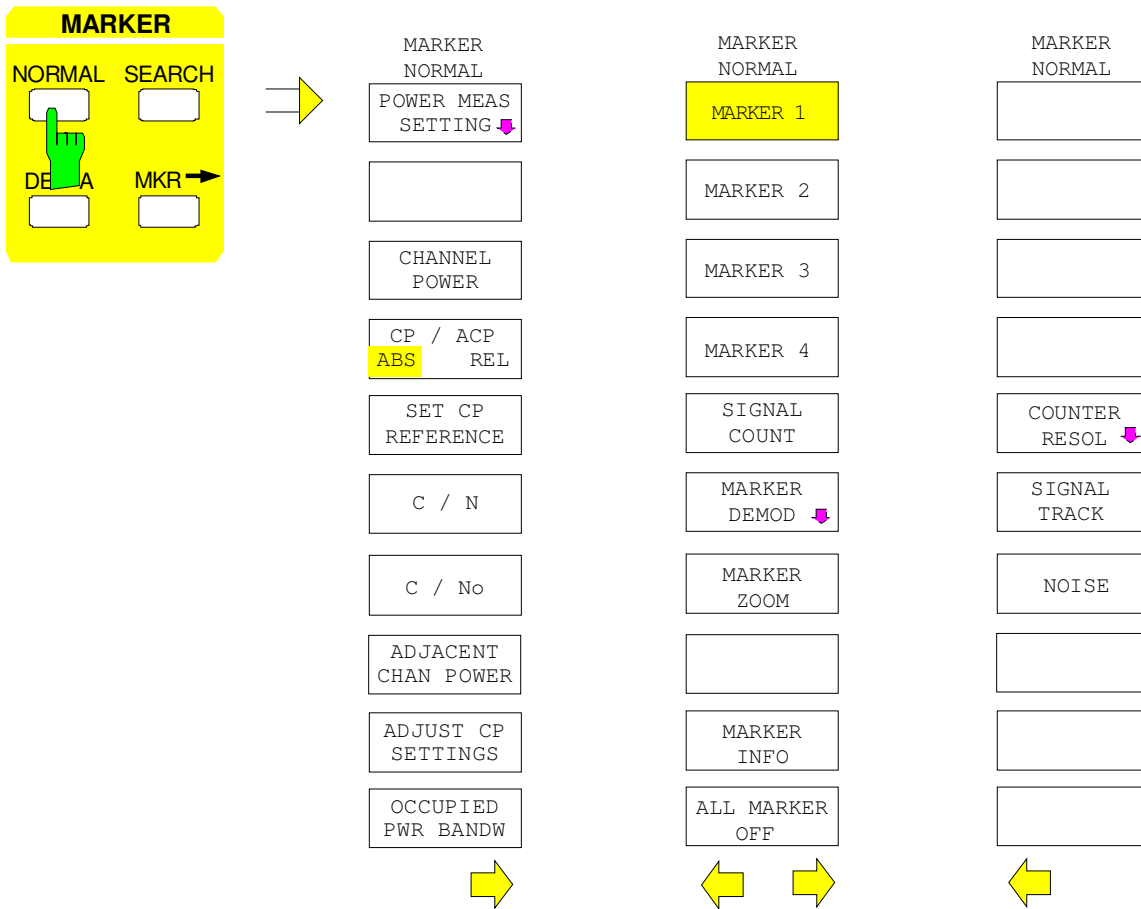

The *MARKER 1* to *MARKER 4* softkeys switch the corresponding marker on/off or activate it as the reference marker. If the marker is activated as a reference marker, an entry field for manually setting the position of the reference marker is opened simultaneously. If the marker is disabled, the softkey is not illuminated. Enabled markers and the reference marker are indicated by illuminating the corresponding softkeys in different colors. (In the instrument default state, the active reference marker is displayed in red and enabled markers are displayed in green.)

**Operating example:**

*MARKER 1* is shown as the reference marker by the colored background illumination. *MARKER 2* through *MARKER 4* are turned off.

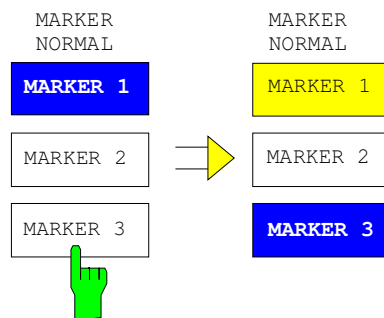

Pressing the *MARKER 3* softkey switches *MARKER 3* on and it becomes the reference marker. The previous reference marker remains enabled and the softkey remains illuminated. However, the entry mode for this marker is not now active. Instead, the entry window for *MARKER 3* is opened and the position of *MARKER 3* can be shifted.

<b>MARKER 3</b>
123.4567 MHz

The information in the marker field also changes to describe the new reference marker.

MARKER 3 [T1]
-27.5 dBm
23.4567891 MHz

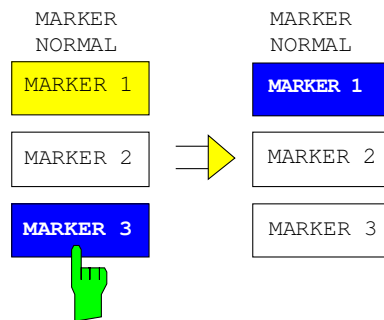

Pressing the current reference marker (*MARKER 3*) softkey again switches *MARKER 3* off. If at least one marker is enabled, the marker with the smallest number will be selected as the new reference marker (in the example, *MARKER 1*). Switching off the last active marker also deletes all delta markers.

When several measurement curves (traces) are being displayed, the marker is set to the maximum value (peak) of the active curve which has the lowest number (1 to 4). In case a marker is already located there, it will be set to the frequency of the next highest level (next peak).

When the split screen display mode is active, the marker will be placed in the active window (for *SCREEN A*: trace 1 or 3, for *SCREEN B*: trace 2 or 4). Since markers are attached to a measurement curve, the marker can only be enabled when at least one curve in the corresponding window is visible .

If a measurement curve is turned off, the corresponding markers and marker functions are also erased. If the curve is switched on again (*VIEW, CLR/WRITE;..*), these markers along with coupled functions will be restored to their original positions. A prerequisite for the restoration of the marker positions is that individual markers have not been used on another measurement curve or that the sweep data (start/stop frequency for span > 0 or sweep time for span = 0) have not been changed.

If a marker (or, delta marker) necessary for a marker function is not available, it will be automatically checked whether or not the enabling of the corresponding marker is possible (see above). If this is not the case, a warning is issued.

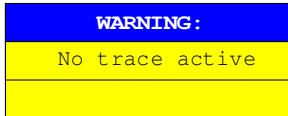

The activation of the desired marker function is then not possible.

On the other hand, if the marker can be enabled, a peak search is automatically performed. Thereafter, the desired marker function can be executed.

*MARKER NORMAL* menu:



The *ALL MARKER OFF* softkey switches off all markers (reference and delta markers). Similarly, it switches off all functions and displays correlated with the markers/delta markers (signal count, signal track, marker zoom, N dB down, shape factor, marker list and marker info).

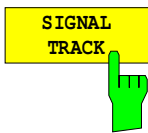

After each sweep, the *SIGNAL TRACK* softkey starts a search for the maximum signal level on the display screen (*PEAK SEARCH*) and then sets the center frequency to this signal (*MARKER -> CENTER*).

If a threshold line is enabled, only signals above the threshold level are considered. If no signal is over the threshold, the center frequency remains constant until a signal is available which is over the threshold.

If no marker is switched to the active trace, the next unused marker is automatically activated and positioned by the peak search routine.

In order to reduce the search range, it is possible to apply the *SEARCH LIMIT ON/OFF* function (see section: "Search Functions"). If the center frequency is changed, the position of the frequency line relative to the center frequency remains the same, ie its absolute position is correspondingly changed.

The softkey is only available in the frequency domain (spectrum) display mode (span > 0.)

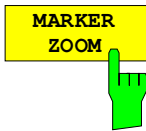

The *MARKER ZOOM* softkey expands the area around the active marker. With the zoom function, more details of the spectrum can be seen. The desired display range can be defined in an entry window.

The following sweep is stopped at the position of the reference marker. The frequency of the signal is counted and the measured frequency becomes the new center frequency. The zoomed display is then configured and the new settings are used by the FSIQ for further measurements.

As long as switching to the new frequency display range has not yet taken place, pressing the softkey will abort the procedure.

If no marker is activated when the softkey is pressed, then *MARKER 1* is automatically activated and set to the highest peak in the measurement window.

If an instrument setting is changed after selection of *MARKER ZOOM*, the function is aborted.

The *MARKER ZOOM* softkey is only available in the frequency domain (span > 0).



The *MARKER INFO* softkey opens the display of several markers within the grid. In the upper right corner of the grid, a maximum of 4 markers/delta markers with the marker symbols  $\Delta/\nabla$ , marker number (1 to 4), position and measurement value are listed. For the output of the marker position, the number or displayed characters will be limited as required.

If the number of lines available is not enough for all the enabled markers and delta markers, first the markers and then the delta markers are entered into the info list

In the *SPLIT SCREEN* display, the info list is partitioned into 2 partial lists and assigned to the corresponding measurement window (*SCREEN A* and *SCREEN B*). The info list for *SCREEN A* contains the markers which are assigned to trace 1 or trace 3. The info list for *SCREEN B* contains the markers which are assigned to trace 2 and trace 4.

For the two measurement windows, it is not possible to turn the *MARKER INFO* function selectively on/off .

## LF Demodulation

The FSIQ provides demodulators for AM and FM signals. With these demodulators, a displayed signal can be identified acoustically through the use of the internal loudspeaker or with external headphones. The frequency at which the demodulation is enabled is coupled to the markers. The sweep stops at the frequency determined by the set marker for the selected time and the RF signal is demodulated.

During a measurement in the time domain (span = 0) the demodulation is switched on continuously.

MARKER NORMAL-MARKER DEMOD submenu:

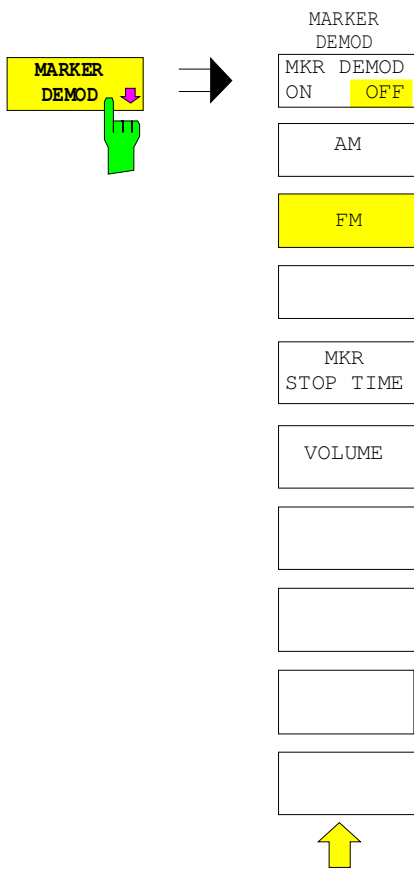

The *MARKER DEMOD* softkey calls a sub-menu in which the type of demodulation desired, the duration of the demodulation and the loudness may be selected

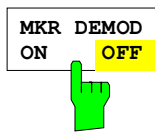

The *MKR DEMOD ON/OFF* softkey switches the demodulation on/off. When the demodulation is on, the sweep is stopped at all marker frequencies, assuming the signal is over the threshold, and the signal is demodulated for the duration of the defined stop time. A total of four stopping points (four markers) can be programmed.

If no marker is set when the demodulation is switched on, the FSIQ switches the first marker on (*MARKER 1*) and sets it to the largest signal.



The *MKR STOP TIME* softkey activates the entry window for setting the stop time.

The FSIQ stops the sweep at the marker or the marker for the duration of the defined stop time and then switches the demodulation on (see also *MKR DEMOD ON/OFF*).

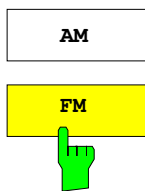

The *AM* and *FM* are selection switches of which only one can be activated at any one time. They are used to set the desired demodulation type, FM or AM. The default setting is AM.



The *VOLUME* soft key opens the entry window for setting the loudness. The volume can be set between 0 and 100%.



## Frequency Measurement

In order to perform an exact determination of the frequency of a signal, the FSIQ is equipped with an internal frequency counter. The frequency counter measures the frequency of the RF signal at the intermediate frequency. Using the value found at the intermediate frequency, the FSIQ calculates the frequency of the RF signal by applying the known frequency conversion relationships.

The frequency measurement error depends only upon the accuracy of the frequency standard used (external or internal reference). Although the FSIQ always operates with a synchronous sweep, independent from the set span, the frequency counter delivers a more exact frequency measurement than a measurement performed with a marker. This is explained by the following:

- The marker measures only the position of the pixel on the measurement curve (trace) and infers therefrom the frequency of the signal. The trace, however, contains only a limited number of pixels. Each pixel, depending upon the selected span, may contain many measurement values which, as a consequence, causes a limitation in the frequency resolution.
- The resolution with which the frequency can be measured is proportional to the measurement time. For measurement time reasons, the bandwidth is normally held as wide as possible and the sweep time is set as short as possible. This results in a loss of frequency resolution.

For the measurement with the frequency counter, the sweep is stopped at the reference marker, the frequency is counted with the desired resolution and then the sweep is allowed to continue (see also Chapter 2, "Measurement Examples").

*MARKER NORMAL* menu:

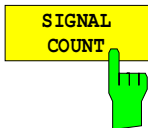

The *SIGNAL COUNT* softkey switches the frequency counter on/off.

The frequency is counted at the position of the reference marker. The sweep stops at the reference marker until the frequency counter has delivered a result. The time required for a frequency measurement depends on the selected frequency resolution. The resolution is set in the *COUNTER RESOL* sub-menu.

If no marker is enabled when the *SIGNAL COUNT* softkey is pressed, *MARKER 1* is switched on and set at the largest signal.

In addition, the *SIGNAL COUNT* function is displayed in the marker field on the display screen with [T x CNT].

Switching the *SIGNAL COUNT* function off is accomplished by pressing the softkey once again.

**Note:** For digital resolution filters (RBW < 1kHz or softkey RBW 1kHz set to DIG), a analog prefilter of 2 kHz is active.

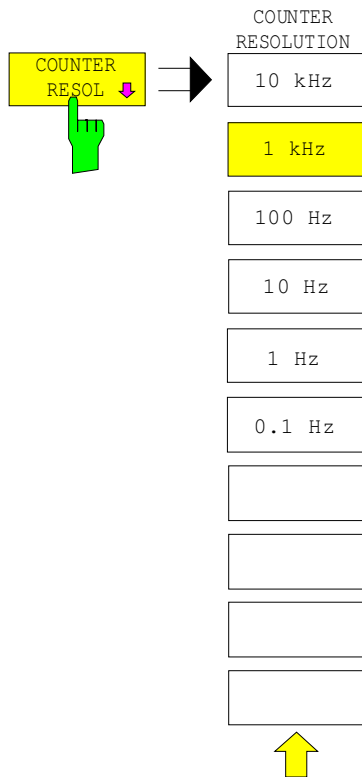

The *COUNTER RESOL* softkey in the right-hand supplementary menu opens a sub-menu in which the resolution of the frequency counter can be defined. The value can be selected between 0.1 Hz and 10 kHz.

The time which the frequency counter requires for a measurement is proportional to the selected resolution. For example, a 1 Hz resolution will require approximately one second measurement time. In order to prevent slowing the sweep time unnecessarily, it is recommended that the frequency resolution be set as low as possible.

## Noise Power Density Measurement

*MARKER NORMAL* menu:

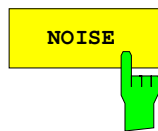

The *NOISE* softkey located in the right-hand supplementary menu switches the noise measurement on/off.

During a noise measurement, the noise power density is measured at the position of the reference marker. The display takes place in the marker field dependent upon the vertical units in dBx/Hz (for logarithmic scale) or in V/Hz, A/Hz or W/Hz for linear scales. The correction factors for the selected bandwidth and the conversion of the IF logarithmic converter are automatically taken into consideration.

The measurement should be performed by the sampling detector which allows displaying the effective value of the noise power.

In order to produce a smoother noise display, neighboring points (symmetrical to measurement frequency) on the measurement curve are averaged.

In the time domain display, an average of the measurement values takes place in time (after each sweep).

## Channel Power Measurements

A modulated carrier is almost always used (exception e.g.,: SSB-AM) for high-frequency transmission of information. As a result carrier modulation with information, the modulated carrier now occupies a frequency spectrum which is defined by the modulation, the transmission data rate and the filtering of the signal. Each carrier is assigned, within a transmission band, to a channel corresponding to these parameters. In order to make error-free transmission possible, each transmitter must adhere to the specified transmission parameters. Among others, these are:

- output power,
- occupied bandwidth, i.e., the bandwidth within which a defined percentage of the power must be contained and
- power output in the neighboring channels.

Using the power measurement function, the FSIQ is capable of measuring all the specified parameters with high precision and at high speed.

The settings for the power measurements are performed in the left-hand supplementary menu *MARKER NORMAL*.

*MARKER NORMAL* menu:

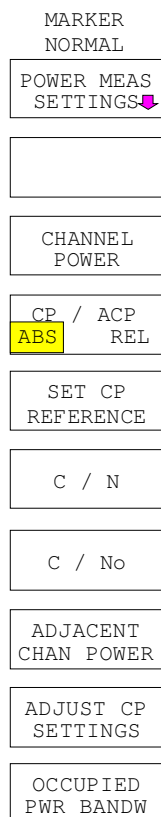

The following measurements can be made:

- channel power (*CHANNEL POWER*)
- signal / noise power (*C/N*)
- signal / noise power density (*C/No*)
- adjacent channel power (*ADJACENT CHAN POWER*)
- occupied bandwidth (*OCCUPIED PWR BANDWIDTH*)

The channel power and the adjacent channel power can be measured either relative (*CP/ACP REL*) to the power in the utilised channel or in absolute terms (*CP/ACP ABS*).

Channel configuration is via sub menu *POWER MEAS SETTINGS*.

The above mentioned power measurements can be carried out alternately.

### Channel Configuration

For all power measurements, a specified channel configuration is assumed which is, e.g. oriented on a specific radio communications system.

The channel configuration is defined by the nominal channel frequency (= center frequency of the FSIQ), the channel bandwidth (*CHANNEL BANDWIDTH*) and the channel spacing (*CHANNEL SPACING*).

The channel is indicated on the display screen by vertical lines located at a half-channel bandwidth to the left and to the right of the channel frequency.

For the adjacent channel power measurement, the adjacent channels are also indicated by vertical lines. The lines of the utilised channel are labelled with CO for easier recognition.

Depending on the radio communication service, the power of the 1<sup>st</sup> alternate channel and/or 2<sup>nd</sup> alternate channel can be measured in addition (softkey *SET NO.OF ADJ CHAN'S*).

With the *ACP STANDARD* softkey, the channel configuration can be set automatically according to the regulations of different digital mobile-radio standards.

For some standards, the channel power has to be evaluated by means of a root-cosine filter corresponding to the transmit filter. This filter is switched on automatically if the corresponding standards are selected but can be switched off manually (softkey *CH FILTER ON/OFF*).

*MARKER NORMAL - POWER MEAS SETTINGS* submenu:

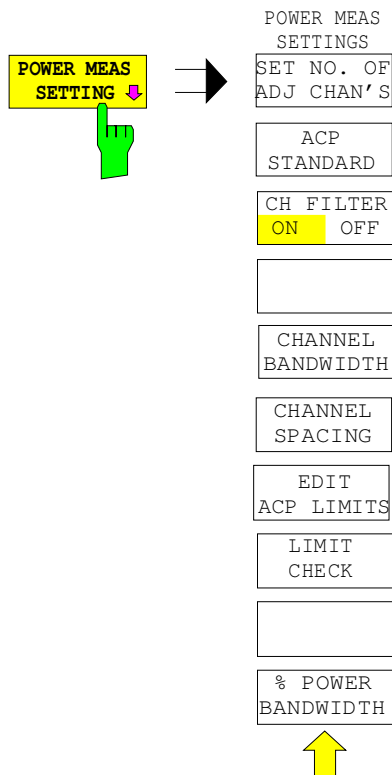

The *POWER MEAS SETTINGS* softkey calls the sub-menu for the definition of the channel configuration.

The *SET NO. OF ADJ CHAN'S* softkey activates the input of number  $\pm n$  adjacent channels to be considered for adjacent channel power measurement

The individual powers are indicated separately. Example  $n=3$ :

CH0 Pwr	-20.00	dBm
ACP UP	-45.23	dBm
ACP LOW	-52.11	dBm
ALT1 UP	-60.04	dBm
ALT1 LOW	-61.00	dBm
ALT2 UP	-63.34	dBm
ALT2 LOW	-64.00	dBm

1, 2 or 3 adjacent channels are possible. ALT1 and ALT2 (Alternate Channel Power) indicate the channel power at  $\pm 2 \times$  channel spacing and  $\pm 3 \times$  channel spacing from the center of the channel.

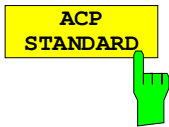

The *ACP STANDARD* softkey activates the selection of a digital mobile-radio standard. The parameters for the adjacent channel power measurement are set according to the regulations of the selected standard.

ACP STANDARD	The following standards can be selected:
NONE	NADC (IS-54 B)
NADC	TETRA
TETRA	PDC (RCR STD-27)
PDC	PHS (RCR STD-28)
PHS	CDPD
CDPD	CDMA800FWD
CDMA800FWD	CDMA800REV
CDMA800REV	CDMA1900REV
CDMA1900FWD	CDMA1900FWD
CDMA1900REV	W-CDMA FWD
W-CDMA FWD	W-CDMA REV
W-CDMA REV	W-CDMA 3GPP FWD
W-CDMA 3GPP FWD	W-CDMA 3GPP REV
W-CDMA 3GPP REV	CDMA2000 Multi Carrier
CDMA2000 MC	CDMA2000 Direct Sequence
CDMA2000 DS	

If the full dynamic range of the analyzer is to be utilized for the W-CDMA measurement (for a power measurement in this standard), the RF attenuation has to be set to 0 dB.

However this is not done automatically to avoid damaging the analyzer input. Instead, a window displaying the following note is shown if one of the W-CDMA standards is selected: 'Attention: For higher dynamic range use *RF ATTEN MANUAL=0dB*.

The selection of a standard influences the following parameters:

- channel spacing
- channel bandwidth
- modulation filter
- resolution bandwidth
- video bandwidth
- detector

Trace Maths and Trace Averaging are switched off.

The reference level is not influenced by automatic matching. It has to be set for an optimum dynamic range so that the signal maximum is in the vicinity of the reference level.

The basic setting *ACP STANDARD NONE*.

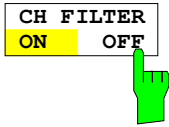

The *CH FILTER ON/OFF* softkey switches a modulation filter for the channel power and adjacent channel power measurement on or off.

When selecting the digital mobile-radio standards NADC and TETRA using the *ADC STANDARD* softkey, the softkey is automatically set to ON. When the other standards are selected, weighting is not selectable and the softkey is not available.

**CH FILTER ON** The channel bandwidth is defined by the filter weighting alone. Therefore, the *CHANNEL BANDWIDTH* softkey cannot be operated.

The activated modulation filter influences the channel and adjacent channel power measurement.

Within the definition range of the filter, the individual pixels are weighted with the calculated filter attenuation as a function of the spacing to the channel center. The weighted display points are then added to the total channel power.

**CH FILTER OFF** No modulation filter is switched on.

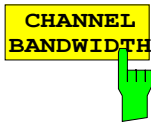

The *CHANNEL BANDWIDTH* softkey opens an entry window for setting the channel bandwidth for the transmission channel and the corresponding adjacent channels.

For all channels, the default setting is 14 kHz.

ACP CHANNEL BW	
CHAN	BANDWIDTH
CH	14 kHz
ADJ	14 kHz
ALT1	14 kHz
ALT2	14 kHz

**Note:** *If the bandwidth of one channel is changed, the new value is also assigned to all subsequent channels in the table. The bandwidths for the individual channels can be set independently, however, by overwriting the table from the top to the bottom.*

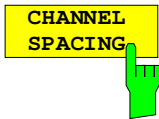

The *CHANNEL SPACING* softkey opens a table for defining the channel spacing. The channel spacing is the spacing of the center frequency of a given channel relative to the center of the transmission channel.

The default setting for channel spacing is 20 kHz.

CHANNEL SPACING	
CHAN	SPACING
ADJ	20 kHz
ALT1	40 kHz
ALT2	60 kHz

**Note:** *Channel spacings can be selected separately for each channel. If a spacing value is changed in the table, the following values are changed automatically.*

EDIT  
ACP LIMITS



The *EDIT ACP LIMITS* opens a table for defining the limits for ACP-measurement.

ACP LIMITS			
CHAN	CHECK	LOWER CHANNEL LIMIT	UPPER CHANNEL LIMIT
ADJ	✓	-50 dB	-50 dB
ALT1	✓	-60 dB	-60 dB
ALT2			

The limit values are defined either in units of dB (for *CP/ACP REL*) or in dBm (for *CP/ACP ABS*).

**Note:** *Measured values that exceed one of the limits are marked with an preceding asterisk.*

LIMIT  
CHECK



The *LIMIT CHECK* softkey switches on or off the limit check of the ACP measurement.

% POWER  
BANDWIDTH



The *% POWER BANDWIDTH* softkey opens an entry window for defining the percentage of the power with respect to the total power in the displayed frequency range. This defines the occupied bandwidth (percent of the total power).

The permitted range is 10 % - 99,9 %

### Channel Power Measurement

The *CHANNEL POWER* measurement is performed by an integration of the measurement points within the channel bandwidth. The channel is marked by two vertical lines to the left and to the right of the center frequency as defined by the channel bandwidth (see Fig. 4-5).

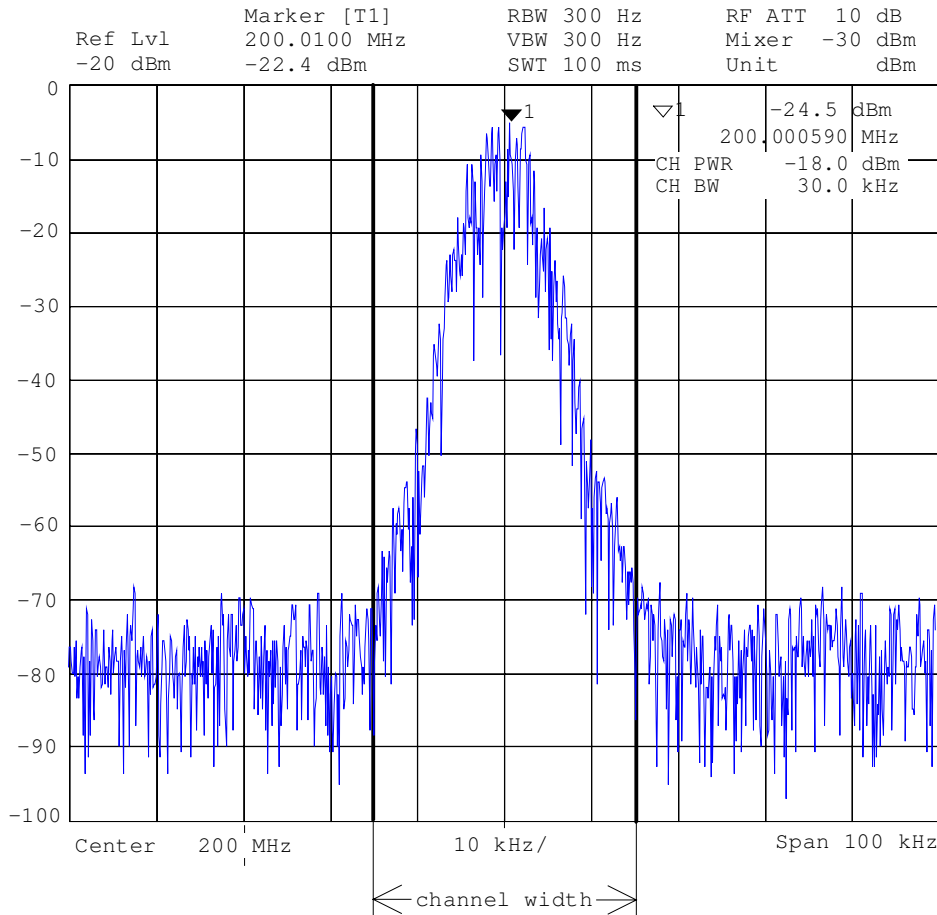
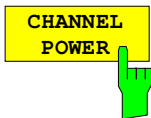

Fig. 4-5 Determination of the channel width

MARKER NORMAL menu:



The *CHANNEL POWER* softkey initiates the calculation of the power in the measurement channel. The display takes place in the units of the y axis, e.g., in dBm, dB $\mu$ V.

The calculation is performed by summing the power at the pixels within the specified channel.

The measurement is either absolute or relative to a reference power (see the *CP/ACP ABS/ REL* softkey).



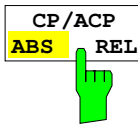

The *CP/ACP ABS/REL* softkey (Channel Power/Adjacent Channel Power Absolute /Relative) switches between an absolute and relative display of the power measured in the channel or adjacent channel.

Channel power measurement

**CP ABS** The absolute value of the power is displayed in the unit of the Y axis, eg in dBm, dBV.

**CP REL** The power of a freely selected channel is measured. This power is set in relation to the power of a reference channel. The reference channel power is selected beforehand using the *SET CP REFERENCE* softkey, ie:

1. Declare the power in the currently measured channel as the reference value using the *SET CP REFERENCE* softkey.
2. Set the channel of interest by changing the channel frequency (FSIQ center frequency).

In case of linear scale of the Y axis the relative power ( $CP/CP_{ref}$ ) of the new channel is displayed in addition to the reference channel. In case of dB scale, the logarithmic ratio  $20 \times \log (CP/CP_{ref})$  is displayed.

Thus, the relative channel power measurement can also be used for universal adjacent channel power measurements.

**Example:**

Measurement of the 1597-QCDMA adjacent channel power. The useful channel and the adjacent channels have different bandwidths (1.23 MHz or 30 kHz).

Adjacent channel power measurement

The power of the adjacent channels is measured. The reference value is the power of the useful channels (see measurement of the adjacent channel power). The useful channel is marked by two vertical lines that are labelled with C0.

**ACP ABS** The powers of the useful channel and of the adjacent channels are displayed as absolute values in the unit of the Y axis.

**ACP REL** The logarithmic ratio  $20 \times \log (CP/CP_0)$  of the powers of the adjacent channels to the useful channel is displayed

The softkey is not available for *OCCUPIED PWR BANDWIDTH*, *C/N* and *C/N0*

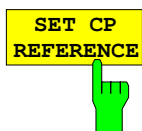

For an activated *CHANNEL POWER* power measurement, the *SET CP REFERENCE* softkey sets the reference value to the currently measured channel power.

## Signal / Noise Power Measurement

MARKER NORMAL menu:

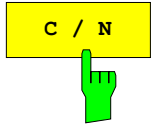

The  $C/N$  (Carrier to Noise) softkey calculates the ratio of carrier power to noise power and the power of interference signals in the channel defined under *POWER MEAS SETTING*. For the measurement, a marker must be set to the carrier of interest.

The unit of  $C/N$  is dB when the display is logarithmic. When the display is linear,  $C/N$  is shown without a unit.

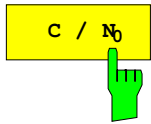

The  $C/N_0$  softkey starts the  $C/N_0$  measurement.

In contrast to the  $C/N$  measurement,  $C/N_0$  calculates the ratio of carrier power to noise and interference signals based on a 1 Hz bandwidth in the channel defined under *POWER MEAS SETTING*.

The unit of  $C/N_0$  is dB/Hz when the display is logarithmic and 1/Hz when the display is linear.

### Measurement procedure:

1. Activate a marker and position it to the peak of the carrier signal (e.g., with the *Marker -> Peak* softkey).
2. Select With the desired frequency range (channel) with the *FREQUENCY CENTER* and *CHANNEL BANDWIDTH (POWER MEAS SETTING sub-menu)* softkeys.
3. Press the  $C/N$  or  $C/N_0$  softkey. The marker is set to reference fixed and activates each measurement. It must be observed that the carrier is either located outside of the measurement channel or turned off at the UUT (Unit Under Test).
4. Press the *ADJUST CP SETTINGS* softkey to active the default settings with modified channel parameters.

The measurement values for  $C/N$  or  $C/N_0$  are displayed in the marker info field.

**Notes:** – If no carrier marker was set, only  $N$  or  $N_0$  with the appropriate units is displayed.  
 – Is the carrier located inside the measurement channel,  $C/C+N$  or  $C/C+N_0$  will be displayed

**Example:**

The signal-to-noise ratio of the carrier ( $f = 199.9$  MHz) in the channel with  $+100$  kHz separation from  $200$  MHz (channel center frequency) is to be measured. The channel bandwidth is  $150$  kHz.

1. Using the *CENTER* key, set the center frequency to the channel center frequency  $200$  MHz.
2. Using the *SPAN* key, set the span, e.g., to  $1$  MHz (carrier must be visible).
3. Using the *MARKER NORMAL* key, activate *MARKER 1* (If Marker 1 was not yet active, the function *MARKER*→*PEAK* is automatically executed. In this case, skip step 4.)
4. Using the *MARKER*→*PEAK* key, set *MARKER 1* on the carrier (assumption: the  $200$  MHz carrier has the highest level in the selected span).
5. Press the *MARKER NORMAL* key and change to the left-hand supplementary menu.
6. Using the *POWER MEAS SETTING* softkey, call the sub-menu for defining the measurement channel.
7. Using the *CHANNEL BANDWIDTH*: softkey, set the bandwidth to  $150$  kHz (The channel spacing does not need to be entered for this measurement). Then press  $\uparrow$  menu change key.
8. Using the *C/N* softkey, start the C/N measurement. In the marker info field, the outputs *CHANNEL CENTER*, *CHANNEL BANDWIDTH* as well as the corresponding C/N measurement values appear. *MARKER 1* is also set to reference fixed.
9. Using the *ADJUST CP SETTINGS* softkey, activate the default settings with modified channel parameters (channel bandwidth =  $150$  kHz) for the correct C/N measurement (span =  $2 \times$  channel bandwidth =  $300$  kHz, RBW =  $3$  kHz, VBW =  $10$  kHz, detector: sampling).

Two vertical lines mark the channel  $200$  MHz  $\pm 75$  kHz in which the noise measurement is performed (see Fig.4-6). The reference value is the measurement from *MARKER 1* (Reference Fixed).

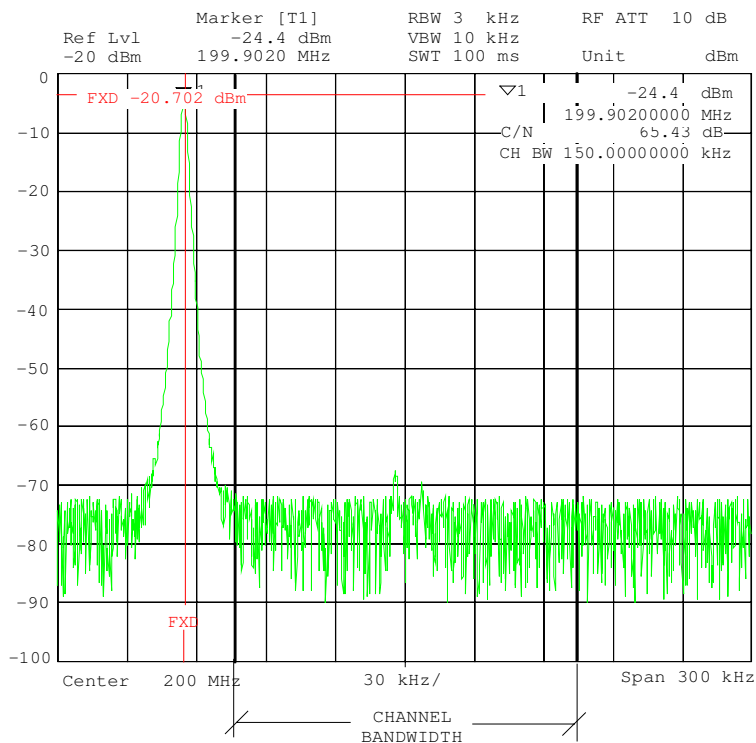
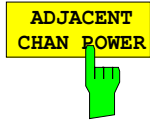

Fig.4-6 Example: measurement of the signal/noise power

### Adjacent Channel Power

MARKER NORMAL menu:



The *ADJACENT CHAN POWER* softkey starts the measurement of the adjacent channel power.

The *ADJACENT CHAN POWER* measures the power which the transmitter delivers to the two adjacent channels (upper channel , lower channel). The measurement values are displayed according to the setting of the *CH/ACD ABS/REL* softkey as absolute values in the scale of the X axis (see Fig.) or as a logarithmic ratio of adjacent channel to useful channel in dB ( $20 \times \log (CP/CP_0)$ ).

If the power of the other neighbouring channels is to be measured in addition to the adjacent channel power, the number of adjacent channels can be extended (on one side only) using *SET NO. OF ADJ CHAN'S* in the submenu *POWER MEAS SETTINGS*.

A prerequisite for the correct measurement of the adjacent channel power is the correct setting of the FSIQ center frequency, the channel bandwidth and the channel spacing.

The *CHANNEL SPACING* and *CHANNEL BANDWIDTH* are defined in the *POWER MEAS SETTINGS* sub-menu.

For an activated measurement of adjacent channel power, the analyzer itself optimally sets all other values (span, resolution bandwidth, detector, etc.) after the *ADJUST CP SETTINGS* softkey is pressed. The carrier power in the utilised channel, the power (absolute or relative to the utilised channel) in the upper and lower adjacent channels as well as the largest of the two power values and the channel raster with channel spacing and bandwidth are displayed as the result of the measurement. The C0 lines mark the bandwidth of the carrier channel. Other unlabelled frequency lines mark the adjacent channels (see Fig.4-7). With *SET NO. OF ADJ CHAN'S 2* selected, the other two neighbouring channels (1st Alternate Channels) are displayed as well, with *SET NO. OF ADJ CHAN'S 3* selected, an additional channel each (2nd Alternate Channels).

The measurement values are updated and displayed until the *ADJACENT CHAN POWER* softkey is pressed again and the measurement of the adjacent channel power is stopped.

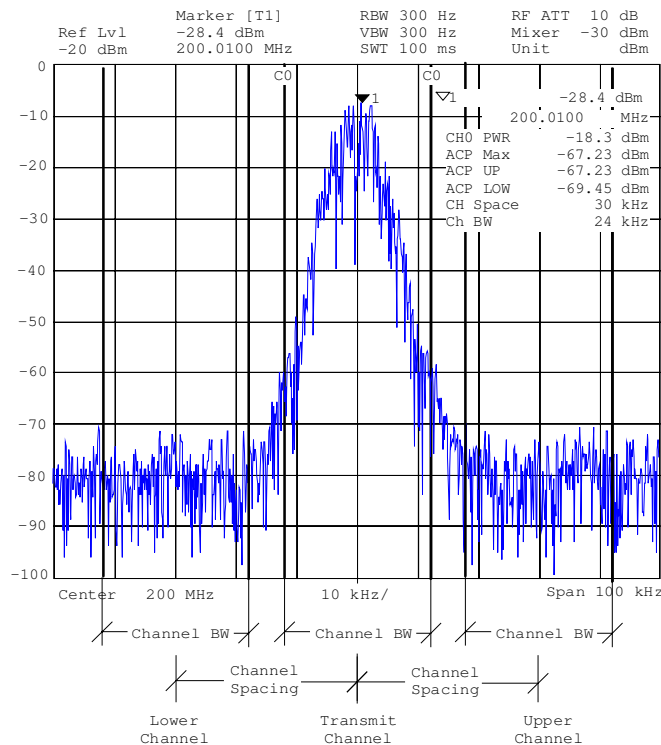

Fig.4-7 Measurement of the adjacent channel power.

If the limit check is activated for ACP measurements, the result of the limit check (PASSED/FAILED) is displayed as well as an asterisk preceding each measured ACP power that exceeded one of the limits.

**Note:** The limit check is activated and the limits are defined in the *POWER MEAS SETTINGS* menu.

## Occupied Bandwidth Measurement

An important characteristic of a modulated signal is the bandwidth which it occupies. The occupied bandwidth must be limited in a radio communications system so that disturbance-free transmission in adjacent channels is possible. The occupied bandwidth is defined as the bandwidth in which a defined percentage of the total transmitter power is contained. The percentage of the power can be set between 10 and 99% in the FSIQ.

MARKER NORMAL menu:

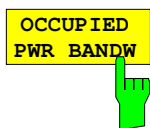

The *OCCUPIED PWR BANDW* (occupied power bandwidth) softkey starts the measurement for determining the occupied bandwidth.

In the spectrum display mode, the bandwidth is determined in which a predefined percentage of the power in the displayed bandwidth is contained. (selectable in the *POWER MEAS SETTINGS* sub-menu with the : % *POWER BANDWIDTH* softkey). The occupied bandwidth is output to the marker display field and marked on the measurement curve with temporary markers.

## Measurement principle:

For example, the bandwidth is to be found in which 99% of the signal power is contained. The routine calculates first the total power of all displayed points (pixels) of the measurement curve. In the next step, the measurement points from the right edge of the measurement curve are integrated until 0.5% of the total power is reached. Then the FSIQ integrates, in an analog fashion, from the left edge of the measurement curve until 0.5% of the power is reached. The delta marker is positioned at this point. Thus, 99% of the power is located between the two markers. The difference between the two frequency markers is the occupied bandwidth which is displayed in the marker info field.

A prerequisite for the correct operation of the measurement is that **only** the signal to be measured is visible on the display screen of the FSIQ. An additional signal would falsify the measurement.

In order to be able to perform correct power measurements, especially for noisy signals, and thus to achieve the correct occupied bandwidth, the selection of the following parameters should be observed:

RBW	<< occupied bandwidth ( $\leq$ approx. 1/20 of the occupied bandwidth, for voice communications, typ. 300 Hz or 1 kHz)
VBW	$\geq 3 \times$ RBW
detector	sampling
span	$\geq 2$ to $3 \times$ occupied bandwidth

According to the application or other measurement guidelines, it may be necessary or reasonable to average a definite number of sweeps in order to achieve a usable value for the occupied bandwidth.

This is provided by the *TRACE* (1...4) key group and the averaging function. With the *SWEEP COUNT* softkey, the number of averages is defined.

Some measurement instructions (e.g. PDC, RCR, STD-27B) require the occupied bandwidth to be measured by means of a peak detector. In this case, the detector of the FSIQ must be corrected appropriately.

## Parameters for Channel Power Measurements / Configuration

For the correct measurement of channel power, C/N, C/N0, adjacent channel power and occupied bandwidth, it is recommended that an automatic optimisation of the analyzer settings be performed after enabling the corresponding measurement and selecting the channel configuration (channel power settings).

MARKER NORMAL menu:

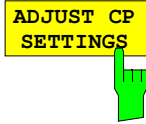

The *ADJUST CP SETTINGS* softkey optimises automatically the settings of the analyzer for the selected power measurement (see below).

Thus, all relevant analyzer settings for a power measurement within a defined frequency range (channel bandwidth) are optimally set including:

- span
- resolution bandwidth
- video bandwidth
- detector

dependent upon the channel configuration (channel bandwidth and, if needed, channel spacing).

The trace mathematical functions and trace averaging are switched off.

The reference level is not influenced by the automatic optimisation routine. The reference level is to be so adjusted that the signal maximum is located near the reference level.

The optimisation is performed only once, however, if necessary, the instrument settings may be changed later.

### Span

The span should cover at least the frequency range that is to be observed. For measurements of channel power, C/N and C/N0, this is the channel bandwidth. For adjacent channel power measurements, this is the utilised channel bandwidth and the adjacent channels located within the channel spacing.

If the span is large compared to the observed frequency band(s), then only a few points on the measurement curve are available for the measurement.

The *ADJUST CP SETTINGS* softkey sets the span as follows:

$2 \times$ channel bandwidth		for channel power, C/N, C/No
	or	
$2 \times$ channel spacing + channel width		for adjacent channel power
$4 \times$ channel bandwidth		for adjacent channel power and NO. OF ADJ CHAN'S 2
$6 \times$ channel spacing + channel width		for adjacent channel power and NO. OF ADJ CHAN'S 3

For measurements of the occupied bandwidth, the span is not influenced.

## Resolution bandwidth (RBW)

In order to achieve acceptable speed as well as the necessary selection (to suppress spectral components outside of the frequency range to be measured and, especially the adjacent channels), the resolution bandwidth should not be chosen too broad or too narrow.

If the resolution bandwidth is too narrow, the measurement speed becomes very slow and it is possible that relative spectral components are not displayed (due to the sampling detector necessary for power measurements and the finite number of points).

On the other hand, the resolution bandwidth should not be so broad that, due to insufficient selection, spectral components outside of the observed frequency range (from adjacent channel) falsify the measurement results.

The *ADJUST CP SETTINGS* softkey sets the resolution bandwidth (RBW) dependent upon the channel bandwidth as follows:

$RBW \leq 1/40$  of the channel bandwidth. The largest possible RBW, with due regard to the 1, 2, 3, 5 step size and the requirement  $RBW \leq 1/40$  will be selected.

The RBW is not influenced by measurements of the occupied bandwidth.

**Video bandwidth (VBW)** Since a power measurement of the noise components is also necessary (otherwise, errors occur due to the logarithmic characteristics of the spectrum analyzer), the video bandwidth should be chosen substantially larger than the resolution bandwidth.

The *ADJUST CP SETTINGS* softkey adjusts the video bandwidth (VBW) dependent upon the channel bandwidth as follows:

$VBW \geq 3 * RBW$ . The smallest VWB with regard to the available 1, 2, 3, 5 step size is selected.

**Grid scale** The *ADJUST CP SETTINGS* softkey sets the grid scale to the 100-dB range. Thereby, a wide dynamic range in channel power measurements is achieved.

**Detector** The *ADJUST CP SETTINGS* softkey selects the sampling detector. The sampling detector is to be selected, above all, for correct power measurements of noisy signals within the observed frequency range.

## Marker Step Size

*DATA VARIATION* – *STEP* menu:

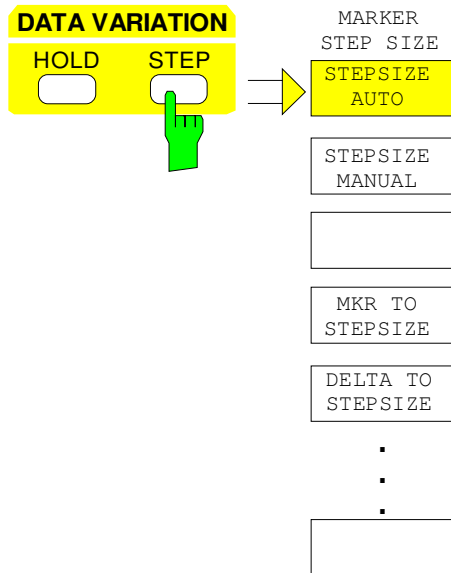

The *STEP* key in the *DATA VARIATION* key group opens a menu to match the marker step size to each individual application. In order to change the step size, the marker entry mode must already be active.

Control is returned to the *MARKER NORMAL* menu via the menu key .



The *STEPSIZE AUTO* softkey sets the marker step size to *AUTO*. In this case, the step size is exactly 10% of the grid. A one-raster movement of the roll-key corresponds to one pixel.

*STEPSIZE AUTO* is the default setting.





The *STEPSIZE MANUAL* softkey activates the entry window for defining a fixed value for the marker step size.

Pressing the step key shifts the marker position by the selected step size. The resolution of the roll-key is always one pixel per raster.



The *MKR TO STEPSIZE* softkey sets the marker step size to the current marker frequency or marker time.

In the frequency domain, this function is well suited to harmonic measurements. The marker is set to the largest signal using the peak search function. After activation of the *MKR TO STEPSIZE* function, the marker is set to the corresponding harmonic of the signal each time the cursor key  or  is pressed when entering the marker position (see also Chapter 2, "Measurement Examples").



The *DELTA TO STEPSIZE* softkey sets the marker step size to the difference between the reference marker and the last active delta marker.

The softkey is only available when at least one delta marker is enabled.



### Delta Markers – DELTA Key

The delta markers are used to measure a level or frequency referred to a reference marker. They are always referenced to the marker whose position was last changed. A delta marker is displayed as an empty  $\triangle$  symbol. The reference marker is displayed as a filled  $\blacktriangledown$  symbol.

MARKER DELTA menu:

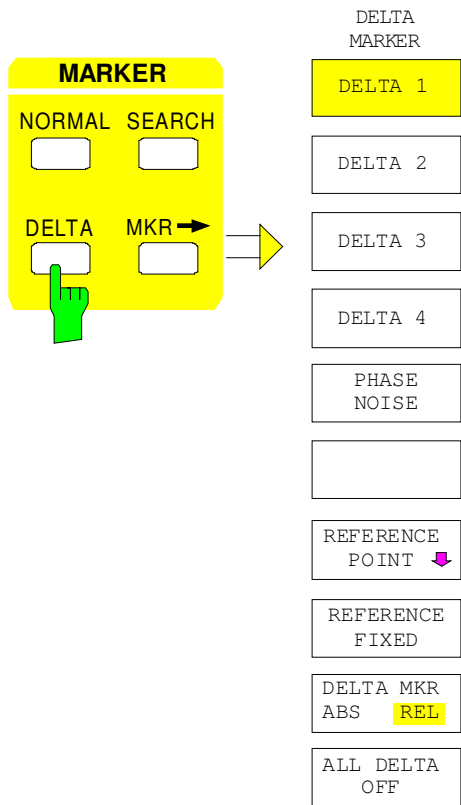

The *DELTA* key switches a delta marker on and calls the menu for its control. If no marker is enabled, *MARKER 1* is automatically activated when the delta marker is switched on. The delta marker activated to entry mode is shown on the display screen as a filled  $\blacktriangle$  symbol.

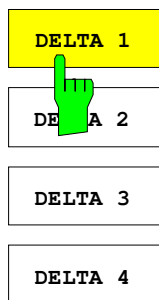

The *DELTA 1 to 4* softkeys are used to enable delta markers 1...4. The control of the delta markers corresponds to that of the markers. After a delta marker has been enabled, all entries are now applicable to this marker. The main marker must be activated anew if its position is to be changed.

The delta marker field on the display screen contains the delta marker number, the difference frequency from the delta marker to reference marker and the level difference between the active delta markers and reference markers.

The indicated differences are, in general, referred to the reference marker. If the *PHASE NOISE* or *REFERENCE FIXED* functions are enabled, the reference values under *REFERENCE POINT* are applicable.

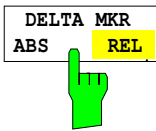

The *DELTA ABS REL* softkey switches between relative and absolute entry modes for the delta-marker frequency.

In the *REL* position, the delta marker frequency is entered relative to the reference marker. In this case, the entry mode for the delta-marker frequencies is also relative.

In the *ABS* position, the entry of the delta-marker frequency is in terms of absolute frequency.

The default setting is *REL*.



The *ALL DELTA OFF* softkey switches off all active delta markers and any associated functions (e.g. *REFERENCE FIXED*, *PHASE NOISE*).

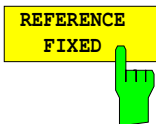

The *REFERENCE FIXED* softkey enables/disables relative measurements with respect to a fixed, measurement-curve-independent reference value.

The information in the delta-marker field on the display screen is referenced to this fixed reference value. For the generation of the marker lists using *MARKER INFO* list, the delta markers are also output relative to a fixed reference. In the lists, the *REFERENCE POINT* is tagged by the number of the reference marker (only one enabled)

When *REFERENCE FIXED* is enabled, the current settings of the reference marker become the reference values. If no marker is active, *MARKER 1* (with peak search) is activated. After transferring the reference values, all markers are deleted, and the active delta marker is set to the position of the reference value. Additional delta markers can be switched on.

The reference value can be subsequently changed

1. by shifting it in the *REFERENCE POINT* sub-menu.
2. by starting a search:

In the *MARKER NORMAL* menu the *REF POINT* is handled as a reference marker (even though it is not bound to the measurement curve). This means, that it will be shown as enabled and can also be changed in position. The co-ordinates of the *REF POINT* are overwritten by the marker values (they lie, by definition, on the measurement curve). Thus, it is possible, even for an enabled *REFERENCE FIXED*, to define a new reference point function with search functions.

The *REFERENCE FIXED* function is particularly useful for measurements which are performed relative to a reference signal that is not available during the whole measurement time (e. g. harmonics measurements, see chapter "Measurement Example").

MARKER DELTA- REFERENCE POINT submenu:

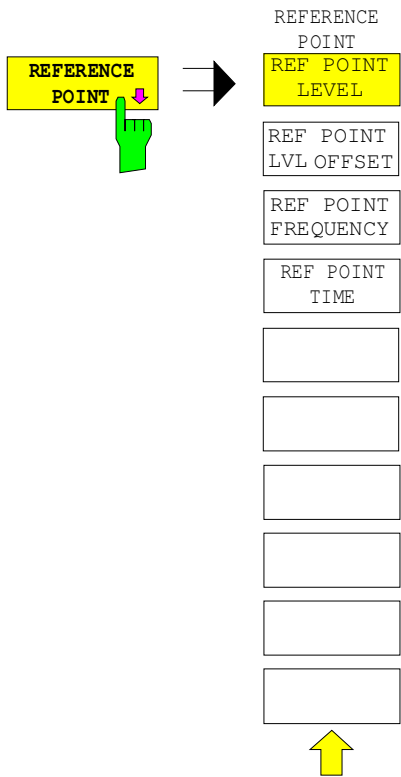

The *REFERENCE POINT* softkey opens a sub-menu in which the reference value the *REFERENCE FIXED* and *PHASE NOISE* functions can be modified.

The position of the reference value is indicated by two additional display lines (horizontal and vertical). In addition, an offset level may be defined which is added to each difference during output.

The softkey is only available when the *REFERENCE FIXED* or *PHASE NOISE* function is switched on.



The *REF POINT LEVEL* softkey activates an entry box for setting the reference level relevant to the *REFERENCE FIXED* or *PHASE NOISE* functions.

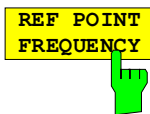

The *REF POINT FREQUENCY* softkey activates the entry box for the input of a reference frequency for the *REFERENCE FIXED* or *PHASE NOISE* functions.

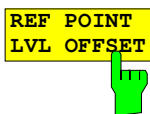

The *REF POINT LVL OFFSET* softkey activates the entry box for the entry of an additional offset level during output when the *REFERENCE FIXED* or *PHASE NOISE* functions are enabled.

The offset level is set to 0 dB when the *REFERENCE FIXED* or *PHASE NOISE* functions are switched on.



The *REF POINT TIME* softkey activates the entry box for the input of a reference time for the *REFERENCE FIXED* function in the time domain (span = 0).

The entry of a reference time for the *PHASE NOISE* function is not possible.

## Phase Noise Measurement

MARKER DELTA menu:

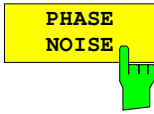

The *PHASE NOISE* softkey switches the *PHASE NOISE* function on/off.

Enabling the *PHASE NOISE* function causes the frequency and level of the reference marker to be transferred as reference values, that means, the *REFERENCE FIXED* function is activated.

The difference between this reference point and the active delta markers is determined. The correction factors for bandwidth and the logarithmic converter are automatically taken into consideration. The sampling detector is also enabled to allow the effective noise power to be displayed. The measured values are displayed in the delta marker field in units of dBc/Hz.

If several delta markers are enabled, only the measurement value output of the active marker is shown in the marker field. Using *MARKER INFO* and *MARKER LIST* the measurement data of all delta markers can be displayed.

If no marker is present when the *PHASE NOISE* function is enabled, *MARKER 1* is automatically switched on (peak search), and the marker values are saved as reference values. The reference value can be changed later in the *NORMAL* menu, *SEARCH* menu or *REFERENCE POINT* sub-menu (see *REFERENCE FIXED* softkey).

Turning on an additional marker causes the *PHASE NOISE* function to be disabled.

### Delta-Marker Step Size - *STEP* Key

*STEP-DELTA STEP* menu:

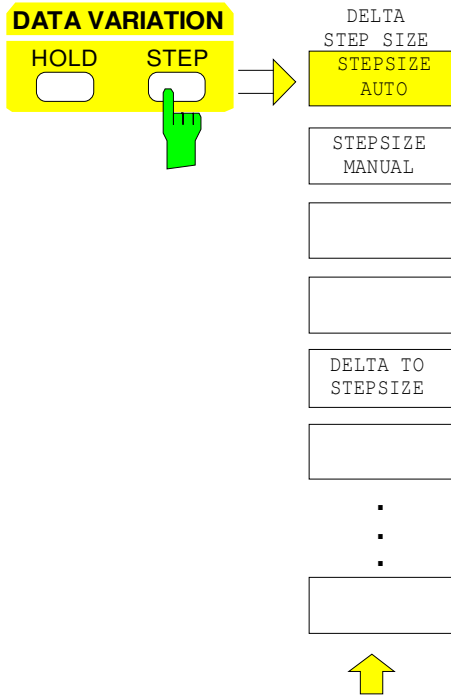

The *STEP* key in the *DATA VARIATION* key group opens a menu to match the step size of the individual delta markers to the specific application. In order to change the step size, the entry mode for a delta marker must already be active.

Control is returned to the *DELTA MARKER* menu via the menu key .

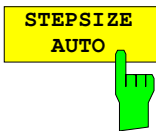

The *STEPSIZE AUTO* softkey sets the delta marker step size to *AUTO*. In this case, the step size of the delta marker is exactly 10% of the grid. The roll-key corresponds to 1/500, i.e., for each rotational pulse, the delta marker is shifted one pixel position.



The *STEPSIZE MANUAL* softkey permits the entry of a fixed value for the delta marker step size.

Pressing the step-key shifts the marker position by the selected step size. The roll-key resolution, however, always remains constant at 1 pixel.



The *DELTA TO STEPSIZE* softkey sets the delta marker step size to a quantity equal to the difference between the delta and reference markers.

The softkey is only presented when at least one delta marker is switched on.

### Search Functions – SEARCH Key

The FSIQ offers numerous functions useful for peak/min. peak searching. The search functions can be used for marker as well as delta marker functions.

The setups applicable to the available search functions are performed in the *MARKER-SEARCH* menu.

The search functions are always related to the currently active marker. If the *SEARCH* key is pressed while the marker entry mode is active, then all search functions are related to the current reference marker. If the entry mode of a delta marker is active, then the functions will be applied to the corresponding delta marker. For the case where no marker is active, *MARKER 1* will be automatically enabled (with peak search). The *ACTIVE MKR / DELTA* softkey allows toggling between the active marker and the active delta marker.

If the threshold line is turned on, the peak/min. search functions will only evaluate signals which have a level above/below the selected threshold. In addition, the search range can also be limited (*SEARCH LIM ON/OFF* softkey) by the frequency/time lines (*FREQUENCY LINE 1/2, TIME LINE 1/2*).

For all peak search functions, the first local oscillator is omitted at 0 Hz if it happens to be displayed.

In the time domain display, the summary markers can be activated and set in addition to the search functions in menu *MARKER-SEARCH*.

*MARKER SEARCH* menu:

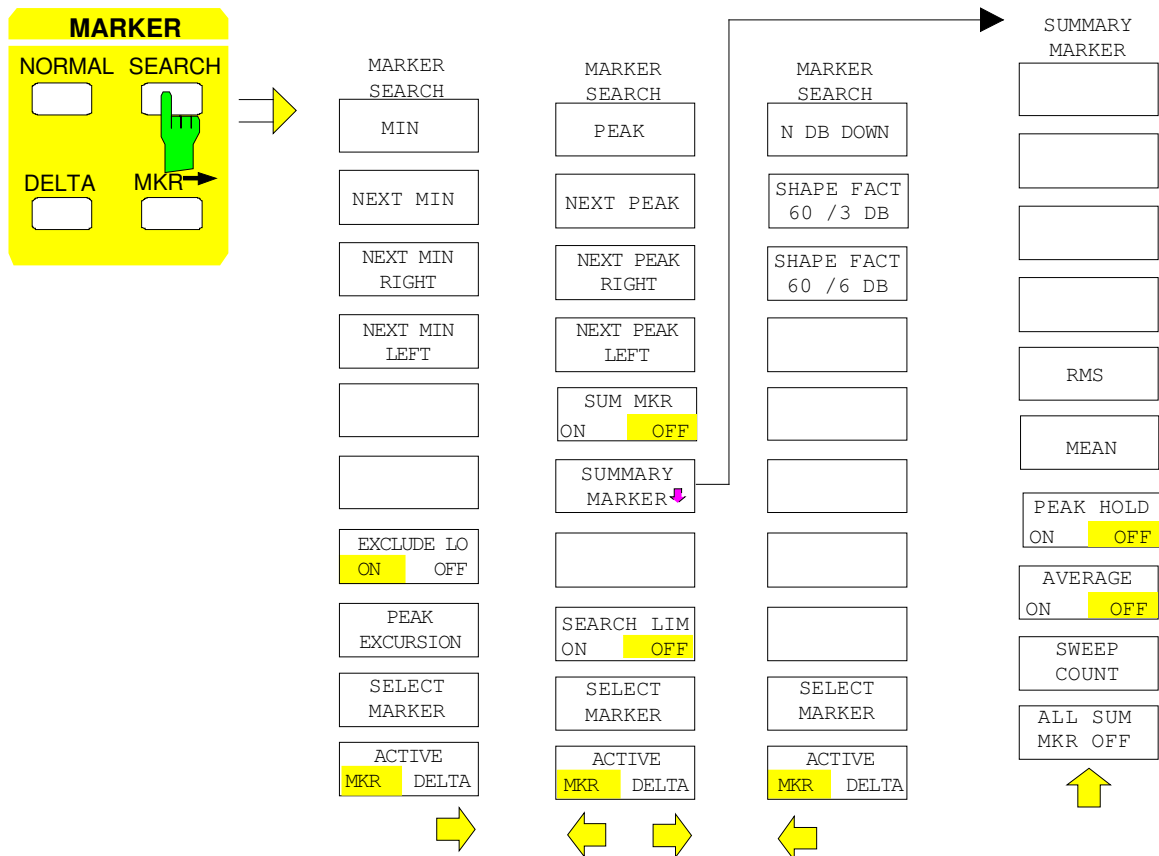

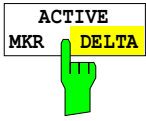

The *ACTIVE MKR / DELTA* softkey toggles between the active marker and the active delta marker.

If *DELTA* is illuminated, the following search functions are performed with the active delta marker.

**Note:** *Switching between marker and delta marker entry modes may also be performed using the NORMAL and DELTA keys.*



The *SELECT MARKER* softkey activates the selection of the marker/delta markers. The selection box lists the currently enabled markers/delta markers.

MARKER SELECT	DELTA SELECT
MARKER 1	✓ DELTA 1
MARKER 3	DELTA 2
MARKER 4	DELTA 3

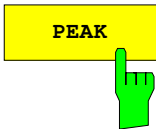

The *PEAK* softkey sets the active marker/delta marker to the maximum displayed value on the corresponding trace.



The *NEXT PEAK* softkey sets the active marker/delta marker to the next lower peak value on the corresponding curve.

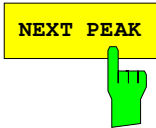

The *NEXT PEAK RIGHT* softkey sets the active marker to the next peak to the right of the current marker position.



The *NEXT PEAK LEFT* softkey sets the active marker to the next peak to the left of the current marker position.

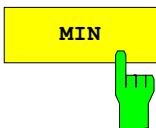

The *MIN* softkey sets the active marker to the lowest displayed peak on the corresponding measurement curve.

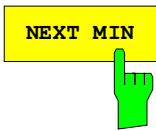

The *NEXT MIN* softkey sets the active marker to the next higher of the low peaks on the corresponding measurement curve.

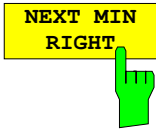

The *NEXT MIN RIGHT* softkey set the active marker to the next low peak to the right of the current marker position.

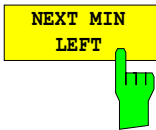

The *NEXT MIN LEFT* softkey sets the active marker to the next low peak to the left of the current marker position.

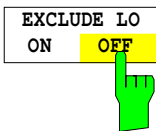

The *EXCLUDE LO ON/OFF* softkey switches between a restricted (*ON*) and an unrestricted search range (*OFF*).

**ON** Because of non-ideal input mixer, the first LO of any analyzer can be seen at 0 Hz. The search functions can possibly respond to this LO level, in particular in the preset setting (FULL SPAN). To avoid this, the search range is restricted according to the following formula:

$$\text{Search range} \geq 6 \times \text{resolution bandwidth}$$

**OFF** No restriction to the search range. The search functions find also signals below the frequency limit quoted above.

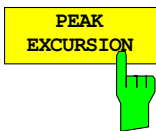

The *PEAK EXCURSION* softkey activates the entry box which sets the minimum amount a signal level must decrease/increase before it is recognised by the search functions (except *PEAK* and *MIN*) as a maximum or minimum.

Input values from 0 dB to 80 dB are allowed with a resolution of 0.1 dB.

The peak excursion is preset to 6 dB. This is completely sufficient for the functions *NEXT PEAK* (or *NEXT MIN*) as always the next smaller (or higher) signal is searched for.

Functions *NEXT PEAK LEFT* and *NEXT PEAK RIGHT* (or *NEXT MIN LEFT* and *NEXT MIN RIGHT*) search for the next relative maximum (or minimum) independent of the current signal amplitude.

As for wide bandwidths, the set 6-dB level change is already reached by the noise indication of the analyzer, the noise values are also identified as peak. In this case, *PEAK EXCURSION* has to be selected with a higher value than the difference between the highest and lowest noise indication values.

The following example shows the effect of different *PEAK EXCURSION* settings.



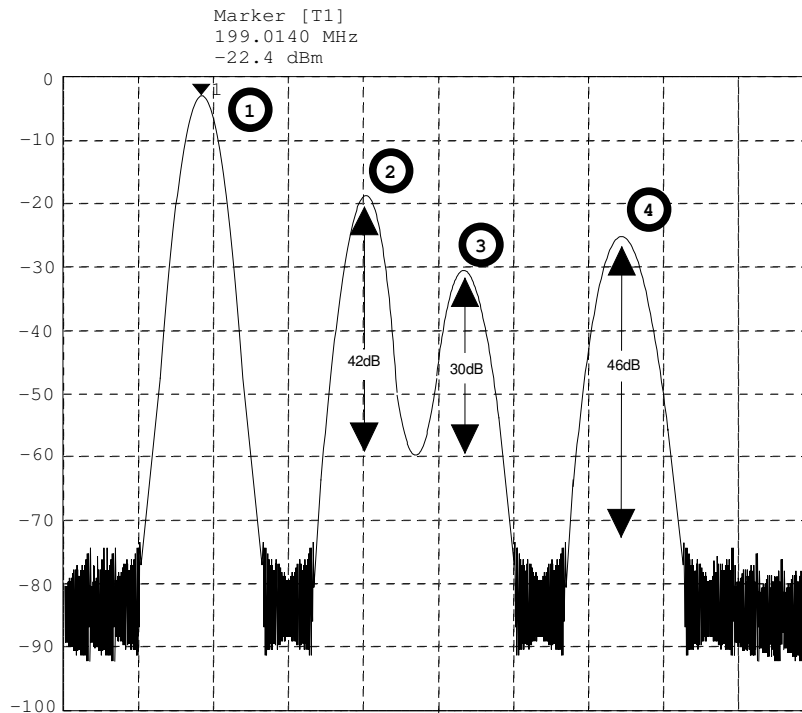

Fig. 4-8 Example for level measurements at different peak excursion settings

Maximum relative level change of the measured signals:

Signal 2:	42dB
Signal 3:	30dB
Signal 4:	46dB

Setting **Peak Excursion 40dB** causes signal 2 and 4 to be detected with *NEXT PEAK* or *NEXT PEAK RIGHT*. Signal 3 is not detected since it is only decreased by 30 dB before the level rises again.

Order of signals found:

PEAK:	Signal 1
NEXT PEAK:	Signal 2
NEXT PEAK:	Signal 4

or

PEAK:	Signal 1
NEXT PEAK RIGHT:	Signal 2
NEXT PEAK RIGHT:	Signal 4

Setting **Peak Excursion 20dB** causes signal 3 to be detected since its highest level change of 30 dB is now higher than the set peak excursion.

Order of signals found:

PEAK: Signal 1  
 NEXT PEAK: Signal 2  
 NEXT PEAK: Signal 4  
 NEXT PEAK: Signal 3

or

PEAK: Signal 1  
 NEXT PEAK RIGHT: Signal 2  
 NEXT PEAK RIGHT: Signal 3  
 NEXT PEAK RIGHT: Signal 4

Setting **Peak Excursion 6dB** recognizes all the signals, *NEXT PEAK RIGHT* does not work as required.

Order of signals found:

PEAK: Signal 1  
 NEXT PEAK: Signal 2  
 NEXT PEAK: Signal 4  
 NEXT PEAK: Signal 3

or

PEAK: Signal 1  
 NEXT PEAK RIGHT: Marker in noise between signal 1 and signal 2  
 NEXT PEAK RIGHT: Marker in noise between signal 1 and signal 2

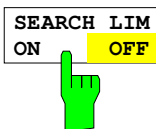

The *SEARCH LIMIT ON/OFF* softkey switches between a limited (*ON*) and unlimited (*OFF*) search range.

For peak and min. search functions, the search range can also be limited by the frequency and time lines (*FREQUENCY LINE 1, 2/TIME LINE 1, 2*). If *SEARCH LIMIT = ON*, the appropriate signal level will only be searched for between the specified frequency/time lines.

The default setting is *SEARCH LIMIT = OFF*.

When only one line is enabled, frequency/time line 1 is defined as the lower limit and the upper limit is defined by the stop frequency. If frequency/time line 2 turned on, then it determines the upper limit.

For the case in which no line is active the search range is unlimited.

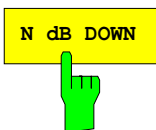

The *N dB DOWN* softkey automatically activates the temporary markers T1 and T2 which are located n dB below the active reference marker. The marker T1 is located to the left, the marker T2 is located to the right of the reference marker. The value n can be entered in an entry window. The default value is 6 dB.

The frequency difference between the two temporary markers is shown in the level output field on the display screen.

If, e.g., due to the noise level, it is not possible to find the frequency difference for the n dB value, a broken line is displayed in the level output field.

Entry mode is switched to the reference marker for the case in which the delta maker entry mode is to be active. The position of the reference marker can be changed in the usual way (numeric input, step-keys, roll-key, peak search, etc.).

Pressing the *N dB DOWN* softkey again switches the function off, however, the entry function for the reference marker remains turned on.

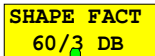
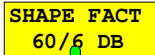
The *SHAPE FACT 60/3dB* and *SHAPE FACT 60/6dB* softkeys activate the automatic measurement of the form factor for the displayed signals.

For this purpose, four temporary markers are used. The markers T1 to T4 indicate, in increasing order, the 3 dB/6 dB positions below the reference marker level.

In the level output field, the relationship between the two frequency differences  $\Delta f_{60dB} / \Delta f_{3dB}$  and  $\Delta f_{60dB} / \Delta f_{6dB}$  are displayed

The display of the measurement value takes place in the marker field. When the level differences cannot be determined, the measurement value is marked as invalid. The update of the shape-factor display takes place at the end of sweep.

The entry mode is switched to the reference marker if the delta marker entry mode is to be active. The position of the reference marker can be changed in the usual way (numeric input, step-keys, roll-key, peak search, etc.).

The *SHAPE FACTOR* function is turned off by pressing *SHAPE FACTOR* softkey once again, or by enabling another marker.

The *SHAPE FACTOR* function is available only in the frequency domain.

## Summary Marker

The summary markers are available for measurements in the time domain (SPAN = 0).

Unlike the markers and delta markers, the *summary markers* are not used to mark the pixels of a trace. They activate a measurement of the rms value (*RMS*) or of the average value (*MEAN*) of the whole trace. The result is displayed in the marker info field.

The measured values are either updated after every sweep or averaged according to a defined number of sweeps (*AVERAGE ON/OFF* and *SWEEP COUNT*). In case of maximum peak evaluation (*PEAK HOLD ON*) the measured values are held until the occurrence of the next higher value.

Example:

Marker info field switched on with summary marker: *MEAN*, *AVERAGE ON* and *PEAK HOLD ON*

MEAN HOLD	2.33 Watt
MEAN AV	2.29 Watt

The evaluation range can be limited with the function *SEARCH LIMITS ON* and the time lines (*TIME LINE1,2*), eg when measuring the average power of a sampled signal from the beginning to the end of a burst.

With the summary marker switched on, the sampling detector is activated (*TRACE-DETECTOR-AUTO*).

*MARKER SEARCH* menu

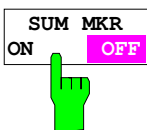

The *SUM MKR* softkey activates the summary marker

The measurement, rms or average value and the settings for maximum peak evaluation and averaging is selected in the submenu *SUMMARY MARKER*.

The softkey is only available in the time domain.

## MARKER SEARCH menu

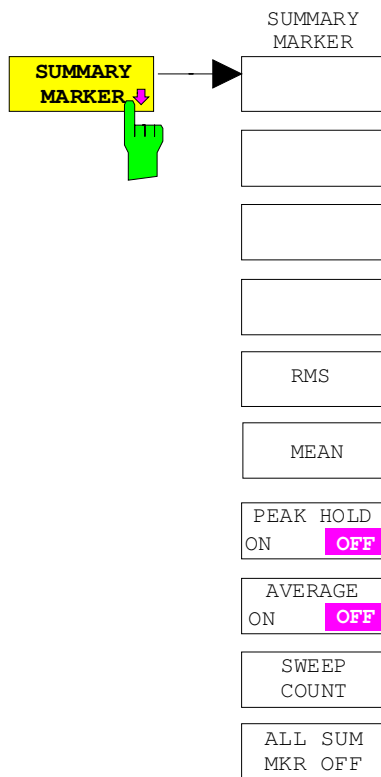

The *SUMMARY MARKER* softkey calls up the submenu for selecting the summary marker measurements.

The softkey is only available in the time domain.

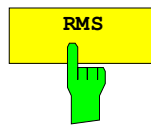

The *RMS* softkey selects the measurement of the rms value of the signal per sweep.

In case of maximum peak evaluation the highest rms value since the activation of *PEAK HOLD ON* is displayed.

In case of *AVERAGE ON* the rms values of a trace are averaged and displayed over several sweeps.

The number of sweeps is set with the *SWEEP COUNT* softkey. If *PEAK HOLD = ON* is active at the same time, the display is held until the occurrence of the next higher average value.

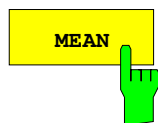

The *MEAN* softkey selects the measurement of the average value of the signal per sweep.

Thus, the mean power can be measured, for example during a GSM burst.

In case of maximum peak evaluation, the highest average value since the activation of *PEAK HOLD ON* is displayed.

In case of *AVERAGE ON*, the average values of a trace are averaged and displayed over several sweeps.

The number of sweeps is set with the *SWEEP COUNT* softkey. If *PEAK HOLD = ON* is active at the same time, the display is held until the occurrence of the next higher average value.

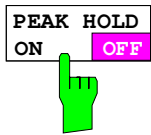

The *PEAK HOLD ON/OFF* softkey switches the maximum peak evaluation on and off.

For all active summary markers, the displays are updated after each sweep only if higher values have occurred.

The measured values can be reset by switching the *PEAK HOLD ON / OFF* softkey on and off again.

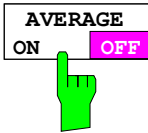

The *AVERAGE ON/OFF* softkey switches the averaging of the summary markers on and off.

The measured values can be reset by switching the *AVERAGE HOLD ON / OFF* softkey on and off again.



The *SWEEP COUNT* softkey activates the entry of the number of sweeps in the *SINGLE SWEEP* mode.

The permissible range of values is 0 to 32767.

In case of *AVERAGE ON*:

If an averaging has been selected, *SWEEP COUNT* also determines the number of measurements required for averaging.

*SWEEP COUNT* = 0     10 measured values are required for running averaging.

*SWEEP COUNT* = 1     No averaging is carried out.

*SWEEP COUNT* > 1     An averaging is carried out over the set number of measured values.

In the *CONTINUOUS SWEEP* mode averaging is performed until the number of sweeps set under *SWEEP COUNT* is attained and then running averaging is performed.

The maximum peak evaluation is infinite independent of the entry under *SWEEP COUNT*.

**Note:** This setting is equivalent to the settings of the number of sweeps of menus *TRACE* and *SWEEP-SWEEP*.



The *ALL SUM MKR OFF* softkey switches all the summary markers off.

### Instrument Parameter Changes via Markers – MKR → Key

MARKER MKR →menu:

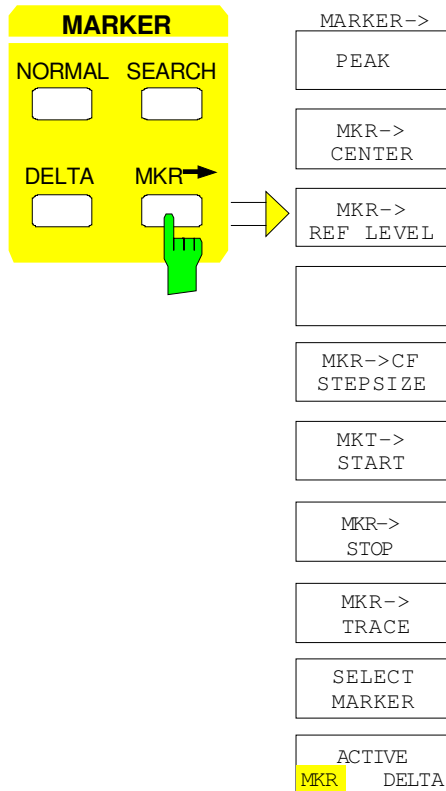

The *MKR →* menu offers functions through which instrument parameters can be changed with the aid of the currently active marker. Exactly as in the *SEARCH* menu, these functions can also be applied to the delta markers.

The choice between marker and delta marker is made according to the currently active frequency entry mode for the marker/delta marker. If no entry mode is active, the marker with the lowest number will be activated as the reference marker.



The *ACTIVE MKR /DELTA* softkey toggles between the active marker and the active delta marker.

If *DELTA* is illuminated, the following marker functions are carried out with the active delta marker.

**Note:** *Switching between marker and delta marker can also be done with the NORMAL and DELTA keys.*



To simplify control, the *PEAK* search function (see section "Search Functions - *SEARCH* Key") is also available in the *MRK →* menu. Thus, the most important functions *MARKER → PEAK*, *MKR → CENTER* and *MKR → REF LEVEL* can be selected in one menu.

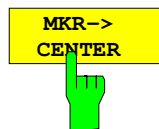

The *MKR → CENTER* softkey sets the center frequency for the current marker/delta marker .

The softkey is not available in the time domain.

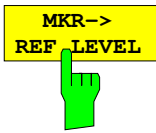

The *MKR→REF LEVEL* softkey sets the reference level to that of the current marker.



The *MKR→CF STEPSIZE* softkey sets the step size for the center frequency entry mode to the current marker frequency, and also sets step-size adaptation to *MANUAL*. The *CF STEP SIZE* remains at this value until the center frequency entry mode in the STEP menu is switched from *MANUAL* to *AUTO* again.

The *MKR→CF STEPSIZE* function is, above all, helpful in the measurement of harmonics with large dynamic range (narrow bandwidth and narrow span).

The softkey is not available in the time domain.



The *MKR→START* softkey sets the start frequency to the current marker frequency.

The softkey is not available in the time domain.



The *MKR→STOP* softkey sets the stop frequency to the current marker frequency.

The softkey is not available in the time domain.

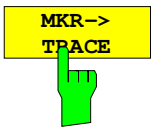

The *MKR→TRACE* softkey opens a selection window through which the marker can be set to a new measurement curve. The traces available for selection appear in the window.

SELECT TRACE	
	TRACE1
✓	TRACE2
	TRACE3
	TRACE4

## Setup of Display and Limit Lines – *LINES* Key Field

### Display Lines – *D LINES* Key

Display lines are aids which, similar to markers, make the evaluation of measurement curve data more convenient. The function of display lines is similar to that of a movable scale which can be used to measure absolute and differential values on measurement curves.

In addition, the display lines can also be used to limit the range of search for marker functions.

The FSIQ provides four different types of display lines:

- two horizontal threshold lines for setting levels or for defining level search ranges – Display Line 1/2,
- two vertical frequency/time lines for indicating frequencies/times or for determining frequency or time search ranges – Frequency/Time Line 1/2,
- a threshold line which, for example, sets the search threshold for maximum levels (Peak Search) – Threshold Line
- a reference line which serves as the basis for mathematical correlation between measurement curves – Reference Line

For purposes of clarity, each line is annotated on the right side of the display diagram by the following abbreviations:

D1	Display Line 1	T1	Time Line 1
D2	Display Line 2	T2	Time Line 2
F1	Frequency Line 1	TH	Threshold Line
F2	Frequency Line 2	REF	Reference Line

The lines for level, threshold and reference are displayed as continuous, horizontal lines over the full width of the diagram. They are movable in the y-direction.

The lines for frequency and time are displayed as vertical, continuous lines over the total height of the diagram. They are movable in the x-direction.

For measurement operations in two separate windows, (Split Screen-Modus), the display lines are available independently in both windows. In the currently active window, the display lines can be activated and/or shifted. Lines previously defined in the currently inactive window remain unchanged.

The *LINES-D LINES* menu, used for switching on and setting the display lines, is dedicated to the chosen display in the active measurement window (span or time). For the display of a spectrum (span  $\neq$  0), the *FREQUENCY LINE 1* and *FREQUENCY LINE 2* softkeys appear, For the time display (span = 0), the *TIME LINE 1* and *TIME LINE 2* softkeys are displayed.



**Note:** The softkeys for setting and switching the display lines on and off operate similar to a three-position switch:

Initial condition: The line is switched off (softkey has grey background)

1<sup>st</sup> press: The line is switched on (softkey has red background) and data entry is activated. The position of the display line can be adjusted by using the roll-key, the step keys or through direct numerical inputs via the data-entry keypad. If some other arbitrary function is requested, the data-entry keypad is disabled. In this case, the display line remains switched on (softkey has green background).

2<sup>nd</sup> press: The display line is switched off (softkey has grey background).

Initial condition: The line is switched on (softkey has green background)

1<sup>st</sup> press: The line is switched on (softkey has red background) and data entry is activated. The position of the display line can be adjusted by using the roll-key, the step keys or through direct numerical inputs via the data-entry keypad. If any other arbitrary function is requested, the data-entry keypad is disabled. In this case, the display line remains switched on (softkey has green background).

2<sup>nd</sup> press: The display line is switched off (softkey has grey background).

Menu *LINES-D-LINES*

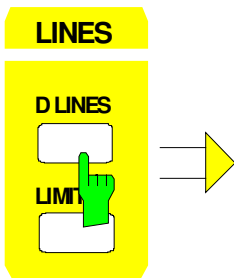

for Span ≠ 0

for Span = 0

for Span ≠ 0	or:	for Span = 0
DISPLAY LINES		DISPLAY LINES
DISPLAY LINE 1		DISPLAY LINE 1
DISPLAY LINE 2		DISPLAY LINE 2
THRESHOLD LINE		THRESHOLD LINE
REFERENCE LINE		REFERENCE LINE
FREQUENCY LINE 1		TIME LINE 1
FREQUENCY LINE 2		TIME LINE 2
BASELINE CLIPPING		BASELINE CLIPPING

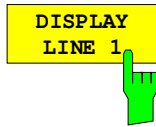

The *DISPLAY LINE 1/2* softkeys switch the display lines on/off and activate the entry of the line location.

The display lines mark the selected levels in the measurement window.

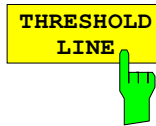
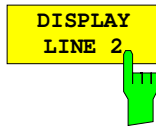

The *THRESHOLD LINE* softkey switches the threshold line on/off and activates the entry of the line location.

The threshold line is a display line which defines a threshold value. This threshold value serves as a lower search limit for maximums/minimums in the marker functions (*MAX PEAK*, *MIN PEAK*, *NEXT PEAK* etc.). For signal tracking (*SIGNAL TRACK function*), this threshold value defines the lower search limit (see section "Marker Functions").

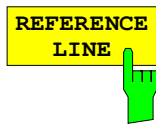

The *REFERENCE LINE* softkey switches the reference line on/off and activates the entry of the line position.

The reference line serves as the basis for mathematical correlation between measurement curve data (see section "Mathematical Operations on Measurement Curves")

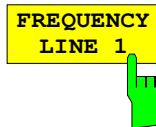

The *FREQUENCY LINE 1/2* softkeys switch the frequency lines 1/2 on/off and activate the entry of the line locations.

The frequency lines mark the selected frequencies in the measurement window or define search ranges (see section "Marker Functions").

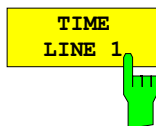
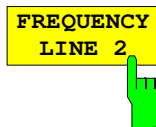

The *TIME LINE 1/2* softkeys switch the time lines 1/2 on/off and activate the entry of line locations.

The time lines mark the selected times or define the search range (see section "Marker Functions").

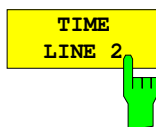



The *BASELINE CLIPPING* softkey switches on or off the *BASELINE CLIPPING* function and allows a limit value to be entered.

The *BASELINE CLIPPING* function is for blanking measured values (for example noise) which are below a preset threshold.

If the *BASELINE CLIPPING* function is active and a measured value is below the preset threshold, the value is set to a lower boundary (-400 dBm). Measured values above the clipping level are not changed.

**Note:** *It is advisable not to combine the BASELINE CLIPPING function with the AUTOPEAK detector.*

*If the set clipping value is within the displayed noise band (AUTOPEAK detector), activation of the CLIPPING function and the resulting clipping of the MIN PEAK values will lead to a drastic enlargement of the displayed noise band.*

## Limit Lines – *LIMITS* Key

Limit lines are used to define amplitude curves or spectral distribution boundaries on the display screen which are not to be exceeded. They indicate, for example, the upper limits for interference radiation or spurious waves which are permissible from a Unit Under Test (UUT). For transmission of information in TDMA (e.g., GSM), the amplitude of the bursts in a time slot must adhere to a curve which must fall within a specified tolerance band. The lower and upper limits may each be specified by a limit line. Then, the amplitude curve can be controlled either visually or automatically for any violations of the upper or lower limits (GO/NOGO test).

The FSIQ instrument supports up to 300 limit lines, each of which may have a maximum of 50 data points. For each limit line, the following characteristics must be defined:

- The name of the limit line. The limit line data are stored under this name and can be examined in the table *LIMIT LINES*.
- The domain in which the limit line is to be used. Here, a distinction is made between the time domain (span = 0 Hz) and the frequency domain (span > 0 Hz).
- The reference of the interpolation points to the X-axis. The limit line may be specified either for absolute frequencies or times or for frequencies which are related to the set center frequency and times related to the time on the left edge of the diagram.
- The reference of the interpolation points to the Y-axis. The limit line can be selected either for absolute levels or voltages or referred to the set maximum level (Ref Lvl or Max Lvl). If the reference line is switched on, it is used as reference when relative setting has been selected.
- The type of limit line (upper or lower limit). With this information and the active limit checking function (*LIMIT CHECK*), the FSIQ checks for compliance with each limit.
- The limit line units to be used. The units of the limit line must be compatible with the level axis in the active measurement window.
- The measurement curve (trace) to which the limit line is assigned. For the FSIQ, this defines the curve to which the limit is to be applied when several traces are simultaneously displayed.
- For each limit line, a margin can be defined which serves as a threshold for automatic evaluation.
- In addition, commentary can be written for each limit line, e.g., a description of the application.

In the *LINES LIMIT* menu, the compatible limit lines can be enabled in the *LIMIT LINES* table. The *SELECTED LIMIT LINE* display field provides information concerning the characteristics of the marked limit lines. New limit lines can be specified and edited in the *NEW LIMIT LINE* and *EDIT LIMIT LINE* sub-menus, respectively.

LINES LIMIT menu

The screenshot shows the 'LIMIT LINES' menu. On the left, a yellow sidebar contains 'LINES', 'D LINES', and 'LIMITS'. A green hand icon points to 'LIMITS'. The main display area has a pink border and contains the following elements:

- SELECTED LIMIT LINE** (yellow header):
 

Name:	GSM22UP	Limit:	LOWER
Domain:	FREQUENCY	X-Axis:	LOG
Unit:	dB	X-Scaling:	ABSOLUTE
Comment:	Line 1	Y-Scaling:	RELATIVE
- LIMIT LINES** (blue header):
 

NAME	COMPATIBLE	LIMIT	CHECKTRACE	MARGIN
GSM22UP		off	1	0 dB
✓ LP1GHz	✓	on	1	0 dB
✓ LP1GHz		off	1	0 dB
MIL461A		off	2	-10 dB
- Buttons** (right side):
  - LIMIT LINES
  - SELECT LIMIT LINE (yellow)
  - NEW LIMIT LINE
  - EDIT LIMIT LINE
  - COPY LIMIT LINE
  - DELETE LIMIT LINE
  - X OFFSET
  - Y OFFSET
  - PAGE UP
  - PAGE DOWN
- USER** (top right): A vertical column of 10 buttons.
- Footer** (bottom): Press ENTER to activate / deactivate Limit Line

Limit Line Selection

The *SELECTED LIMIT LINES* table provides information about the characteristics of the marked limit line :

<i>Name</i>	name
<i>Domain</i>	frequency or time
<i>Limit</i>	upper/lower limit
<i>X-Axis</i>	linear or logarithmic interpolation
<i>X-Scaling</i>	absolute or relative frequencies/times
<i>Y-Scaling</i>	absolute or relative Y-units
<i>Unit</i>	vertical scale
<i>Comment</i>	commentary

The characteristics of the limit line are set in the *EDIT LIMIT LINE (=NEW LIMIT LINE)* sub-menu.



The *SELECT LIMIT LINE* softkey activates the *LIMIT LINES* table and the selection bar jumps to the uppermost name in the table.

The following informations are offered in the columns of the table:

<i>Name</i>	Enable the limit line.
<i>Compatible</i>	Indicates if the limit line is compatible with the measurement window of the given trace.
<i>Limit Check</i>	Activate automatic violation check for upper/lower limits.
<i>Trace</i>	Select the measurement curve to which the limit is assigned.
<i>Margin</i>	Define margin.

**Name and Compatible - Enabling limit lines**

A maximum of 8 limit lines can be enabled at any one time. A check mark at the left edge of a cell indicates that this limit line is enabled. A limit line can only be enabled when it has a check mark in the *Compatible* column, i.e., only when the horizontal display (time or frequency) and vertical scales are **identical** to those of the display in the measurement window.

Lines with the unit dB are compatible to all dB(..) settings of the Y-axis. If the trace assigned to a line is not switched on, the line is displayed in the window the trace would be displayed in.

Example:

In split screen mode, trace 2 is assigned measuring window B. A line assigned to trace 2 is always displayed in measurement window B.

If the scale of the y-axis or the domain (frequency or time axis) are changed, all non-compatible limit lines are automatically switched off in order to avoid misinterpretation. The limit lines must be enabled anew when the original display is re-displayed.

**Limit Check - Activate automatic limit violation check**

When *LIMIT CHECK ON* is activated, a GO/NOGO test is performed. In the center of the diagram, a display window appears which indicates the results of the limit check test:

LIMIT CHECK: PASSED No violations of active limits.

LIMIT CHECK: FAILED One or more active limit lines were violated. The message contains the names of the limit lines which were violated or whose margins were not complied with.

LIMIT CHECK: MARGIN The margin of at least one active limit lines was not complied with, however, no limit line was violated. The message contains the names of the limit lines whose margins were not complied with.

The following example shows three active limit lines:

```
LIMIT CHECK: FAILED
LINE VHF_MASK: Failed
LINE UHF2MASK: Margin
```

A check for violations of limit lines takes place only if the limit line of the assigned measurement curve (trace) is enabled.

If *LIM CHECK* is set to *OFF* for all active limit lines, then the limit line check is not executed and the display window is activated.

**Trace - Select the measurement curve to which the limit line is assigned.**

The selection of the measurement curve (trace) takes place in an entry window. Allowed are the integer entries 1, 2, 3 or 4. The default setting is trace 1. If the selected limit line is not compatible with the assigned measurement curve, then the limit line is disabled. (display and limit check).

**Margin - Setting a margin.**

The margin is defined as the signal-level distance to the limit line. When the limit line is defined as an upper limit, the margin means that the level is below the limit line. When the limit line is defined as a lower limit, the margin means that the level is above the limit line. The default setting is 0 dB (i.e., no margin).

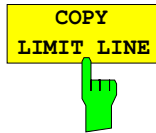

The *COPY LIMIT LINE* softkey copies the data file describing the marked limit line and saves it under a new name. In this way, a new limit line can be easily generated by parallel translation or editing of an existing limit line. The name can be arbitrarily chosen and input via an entry window (max. of 8 characters).



Pressing the *DELETE LIMIT LINE* softkey erases the selected limit line. Before deletion, a message appears requesting confirmation.

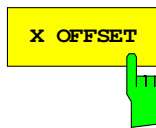

The *X OFFSET* softkey is used to horizontally shift a limit line which has been specified for relative frequencies or times (X-axis). The softkey opens an entry window, where the value for shifting may be entered numerically or via the roll-key.

**Note:** When changing the start or stop frequencies, the line on the display is only retained, if *SPAN FIXED* is set.



The *Y OFFSET* softkey is used to vertically shift a limit line, which has relative values for the Y-axis (levels or linear units such as volt). The softkey opens an entry window where the value for shifting may be entered numerically or via the roll-key.



Pressing the *PAGE UP* softkey sets the limit line table to the next page.



Pressing the *PAGE DOWN* softkey sets the limit line table to the previous page.

## Entry and Editing of Limit Lines

A limit line is characterized by

- its name
- the assignment of domain (frequency or time)
- the scaling in absolute or relative times or frequencies
- linear or logarithmic interpolation
- the vertical unit
- the vertical scaling
- the definition of the limit line as either upper or lower limit.
- the data points for frequency/time and level

At the time of entry, the FSIQ immediately checks that all limit lines are in accordance with certain guidelines. These guidelines must be observed if specified operation is to be guaranteed.

- The frequencies/times for each data point must be entered in ascending order, however, for any single frequency/time, two data points may be input (vertical segment of a limit line).

The data points are allocated in order of ascending frequency/time. Gaps are not allowed. If gaps are desired, two separate limit lines must be defined and then both enabled.

- The entered frequencies/times must not necessarily be selectable in FSIQ. A limit line may also exceed the specified frequency or time domains. The minimum frequency for a data point is 0 Hz, the maximum frequency is 200 GHz. For the time domain representation, negative times may also be entered. The allowable range is -1000 s to +1000 s.
- The minimum/maximum value for a limit line is -200 dB to +200 dB for the logarithmic or  $10^{-20}$  to  $10^{+20}$  or -99.9% to +999.9% for the linear amplitude scales.



LINES LIMIT-EDIT LIMIT LINE menu

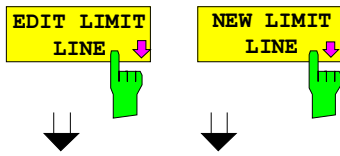

The *EDIT LIMIT LINE* and *NEW LIMIT LINE* softkeys both call the *EDIT LIMIT LINE* sub-menu used for editing limit lines. In the table heading, the characteristics of the limit line can be entered. The data points for frequency/time and level values are entered in the columns.

- Name* Enter name.
- Domain* Select domain.
- Unit* Select units.
- X-Axis* Selection of interpolation
- X-Scaling* Entry of absolute or relative values for the X-axis
- Y-Scaling* Entry of absolute or relative values for the Y-axis
- Limit* Select upper/lower limit.
- Comment* Enter comments.
- Time/Frequency* Enter time/frequency for the data points.
- Limit/dBm* Enter magnitudes for the data points.

EDIT LIMIT LINE TABLE	
Name:	Limit_22
Domain:	FREQUENCY
Unit:	dBuV/m
X-Axis:	LOG
X-Scaling:	ABSOLUTE
Y-Scaling:	ABSOLUTE
Limit:	UPPER
Comment:	Limit 22
FREQUENCY	LIMIT/dBuV/m
30.000 MHz	30.0000
230.000 MHz	30.0000
230.000 MHz	37.0000
1.000 GHz	37.0000

Press ENTER to edit field.

EDIT LIMIT LINE

NAME

VALUES

INSERT VALUE

DELETE VALUE

SHIFT X LIMIT LINE

SHIFT Y LIMIT LINE

SAVE LIMIT LINE

PAGE UP

PAGE DOWN

↑

USER

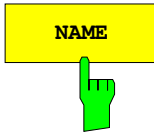

The *NAME* softkey enables the entry of characteristics in the table heading.

#### **Name - Enter name**

A maximum of 8 characters are permitted for each name. All names must be compatible with the MS DOS conventions for file names. The instrument stores all limit lines with the .LIM extension.

#### **Domain - Select time or frequency domain**

A change in domain (frequency/time) is only permitted when the data point table is empty. The default setting is frequency.

#### **X-Axis - Indication of interpolation**

Linear or logarithmic interpolation can be carried out between the frequency reference points of the table. Selection is via the ENTER key which is toggled between LIN and LOG (toggle function).

#### **Scaling - selection of absolute or relative scaling**

The limit line can either be scaled in absolute (frequency or time) or relative units. Any of the unit keys may be used to toggle between *ABSOLUTE* and *RELATIVE*, the cursor must be positioned in the *X-Scaling* or the *Y-Scaling* line

*X-Scaling ABSOLUTE* The frequencies or times are interpreted as absolute physical units.

*X-Scaling RELATIVE* In the data point table, the frequencies are referred to the currently set center frequency. In time domain mode, the left boundary of the diagram constitutes the reference.

*Y-Scaling ABSOLUTE* The limit values refer to absolute levels or voltages.

*Y-Scaling RELATIVE* The limit values refer to the reference level (Ref Level) or, in case a reference line is set, to the reference line.  
Limit values with the units dB or % are always relative values.

The *RELATIVE* scaling is always suitable, if masks for bursts are to be defined in the time domain, or if masks for modulated signals are required in the frequency domain.

An X-offset with half the sweep time may be entered in order to shift the mask in the time domain into the center of screen.

**Unit - Select the vertical scale units for the limit line**

The selection of units takes place in a selection box. The default setting is dBm.

UNITS	
VERTICAL SCALE	
	dB
✓	dBm
	%
	dBuV
	dBmV
	dBuA
	dBpW
	V
	A
	W
	dBuV/MHz
	dBmV/MHz
	dBuA/MHz

**Limit - Select upper/lower limit**

A limit line can be defined as either an upper or lower limit.

**Comment - Enter comments**

Comments are arbitrary, however, they must be less than 40 characters long.

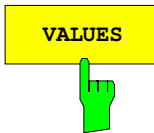

The *VALUES* softkey activates the entry of the data points in the table columns *Time/Frequency* and *Limit/dB*. Which table columns appear depends upon the *Domain* selection in the table heading.

The desired frequency/time data points are entered in ascending order (two repeated frequencies/time values are permitted).

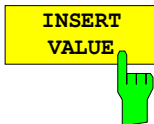

The *INSERT VALUE* softkey creates an empty line above the current cursor position where a new data point may be entered. However, during the entry of new values, it is necessary to observe an ascending order for frequency/time.

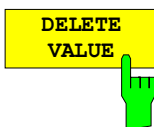

The *DELETE VALUE* softkey erases the data point (complete line) at the cursor position. All succeeding data points are shifted down accordingly.

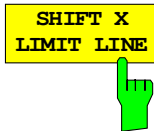

The *SHIFT X LIMIT LINE* softkey calls an entry window where the complete limit line may be shifted parallel in the horizontal direction.

The shift takes place according to the horizontal scale:

- in the frequency domain in Hz, kHz, MHz or GHz
- in the time domain in ns,  $\mu$ s, ms or s

In this manner, a new limit line can be easily generated based upon an existing limit line which has been shifted horizontally and stored (*SAVE LIMIT LINE* softkey) under a new name (*NAME* softkey).

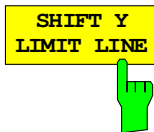

The *SHIFT Y LIMIT LINE* softkey calls an entry window where the complete limit line may be shifted parallel in the vertical direction.

The shift takes place according to the vertical scale:

- for logarithmic units, relative, in dB
- for linear units, as a factor

In this manner, a new limit line can be easily generated based upon an existing limit line which has been shifted vertically and stored (*SAVE LIMIT LINE* softkey) under a new name (*NAME* softkey).

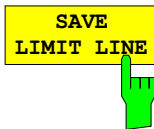

The *SAVE LIMIT LINE* softkey stores the currently edited limit line. The name can be entered in an input window (max. 8 characters)

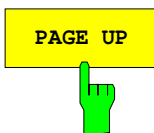

Pressing the *PAGE UP* softkey displays the next page of data points.

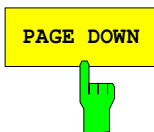

Pressing the *PAGE DOWN* softkey displays the previous page of data points.

## Trace Selection and Setup –TRACE Key Group

The FSIQ is capable of displaying up to four separate traces at the same time. A trace consists of a maximum of 500 pixels on the horizontal axis (frequency or time). If there are more measurement values than pixels available, then several measurement values are collected together in one pixel.

The traces are selected using keys 1 to 4 of the *TRACES* key group. When two measurement windows (*SPLIT SCREEN*) are displayed, traces 1 and 3 are assigned to the upper (*SCREEN A*) and traces 2 and 4 are assigned to the lower (*SCREEN B*) measurement window.

The traces can be individually enabled for a measurement and, after the measurement is completed, held fixed. Traces which are not enabled remain dark.

For each trace, the type of display is selectable. The traces can be overwritten (*CLEAR/WRITE* mode) at each measurement, averaged (*AVERAGE* mode) over several measurements, or a maximum/minimum value from several measurements can be determined and displayed.

Individual detectors are selectable for the various traces. The auto-peak detector displays maximum and minimum values connected by a vertical line. The max-peak detector and min-peak detector display the maximum value/minimum value of the level within a pixel. The sampling detector displays the instantaneous value of the level at a pixel. The rms detector displays the power (rms value) of the measured values within a pixel, the average detector the average value.

## Measurement Function Selection - TRACE 1 to 4 key

The trace functions are partitioned as follows:

- type of trace display (*CLEAR/WRITE*, *VIEW* and *BLANK*)
- evaluation of the trace as a whole (*AVERAGE*, *MAX HOLD* and *MIN HOLD*)
- evaluation of the individual pixels of a trace (*AUTOPEAK*, *MAX PEAK*, *MIN PEAK*, *SAMPLE*, *RMS* and *AVERAGE*)

TRACE 1 menu

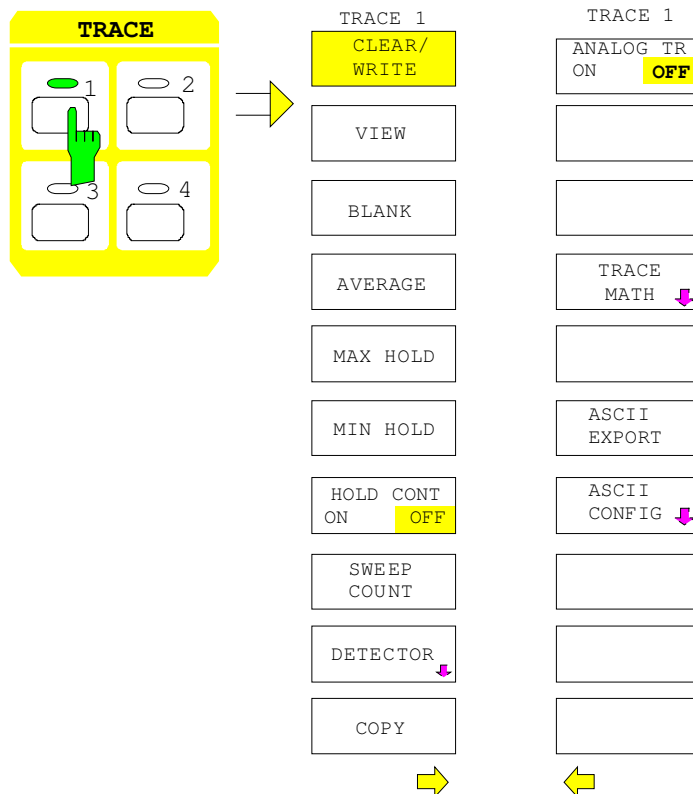

The *TRACE* keys 1...4 call a menu which presents the options for the selected trace.

In this menu, the method to be used for compressing the measurement data in the frequency or time domain to the 500 representable points of the display is determined.

At the beginning of the measurement, each trace can be displayed either completely new or based on previous measurement results.

Traces can be displayed, blanked and copied.

By applying mathematical functions, the traces can also be corrected.

The measurement detector for each of the display types may be chosen either directly or selected automatically by the FSIQ.

All activated traces are marked with a LED at the corresponding key (here, *TRACE 1*). The default setting is *TRACE 1* with *CLEAR / WRITE* selected. The remaining traces 2...4 are switched off (*BLANK*). For the split screen display, the selection of the trace automatically selects the corresponding screen for entry.

The *CLEAR/WRITE*, *MAX HOLD*, *MIN HOLD*, *AVERAGE*, *VIEW*, and *BLANK* are mutually exclusive selection switches.

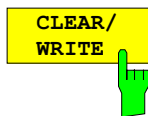

The *CLEAR/WRITE* softkey activates the clear/write display mode.

The trace is displayed without additional trace evaluation. The trace memory is overwritten by each sweep. If more than one data point falls within a pixel, the trace is displayed in bar form with the maximum and minimum values in a pixel connected. In the clear/write display mode, all the available detectors are selectable. The autopeak detector is selected in the default mode (detector to *AUTO*).

After each *CLEAR/WRITE* softkey action, the FSIQ clears the selected trace memory and starts the measurement anew.

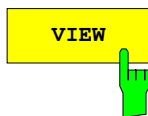

The *VIEW* softkey freezes the current contents of the trace memory and displays them on the display screen.

If the trace data were formed through *MAX HOLD*, *MIN HOLD* or *AVERAGE*, the sweep is restarted and the trace contents are cleared, after switching to these trace modes.

If a trace is frozen by *VIEW*, the instrument settings can be modified without modifying the displayed trace. The fact that the trace and the current instrument setting do not agree anymore is indicated by an enhancement label "\*" at the right edge of the grid. The initial instrument setting can be restored using the *ADJUST TO TRACE* softkey in the *TRACE MATH* sub-menu.

If *LEVEL RANGE* or *REF LEVEL* is changed in the *VIEW* display mode, the FSIQ adjusts the measurement data to the changed display range. Thus, an amplitude zoom can be performed after the measurement so that details of the trace can be seen better.

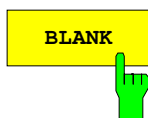

The *BLANK* softkey removes the trace from the display screen. However, the trace data remain stored in memory and can be displayed again by *VIEW*. The markers for the blanked trace are also erased. If the trace is activated again (with *VIEW*, *CLEAR / WRITE*, *MAX HOLD*, *MIN HOLD*, *AVERAGE*) the markers will be restored to their original positions.

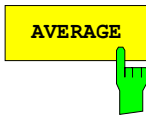

The *AVERAGE* softkey enables the trace averaging function. The average is taken from several foregoing measurements. The average can be calculated for each available detector. In case the detector is automatically selected by the FSIQ, the sampling detector is chosen.

After enabling the averaging mode, the first trace is recorded in *CLEAR/WRITE* mode with the selected detector. After the second sweep, the average is then formed for each succeeding sweep. Here, the average is formed over the samples/pixels, i.e., according to the LIN or LOG setting, over amplitudes or levels.

The average always starts anew when one of the *AVERAGE* softkeys is pressed. The trace memory is also cleared. This is also the case when the trace is switched from the setting *AVERAGE* to *VIEW* or *BLANK*

### Description of the averaging procedure:

Averaging is carried out using the pixels which are derived from the measurement value samples. These pixels may in some cases be comprised of several combined measurement values. This means that the average is formed over linear amplitude values when the level display is linear and over levels when the level display is logarithmic. Because of this, the trace must be measured anew when changing between the LIN and LOG display mode. The settings *CONT/SINGLE SWEEP* and the running average apply to the average display analogously.

Two calculation procedures are available for averaging. For *SWEEP COUNT*= 0, a running average is calculated according to the following equation:

$$\text{TRACE} = \frac{9 \cdot \text{TRACE} + \text{MEAS\_VALUE}}{10}$$

Because of the distribution of the weighting between the new measurement value and the trace average, the measurement history has essentially no influence on the displayed trace after around 10 sweeps have taken place. For this setting, the signal noise is effectively reduced without the need for restarting the averaging process even if the signal is changed.

If, for *SWEEP COUNT* a value >1 is entered, the averaging takes place over the selected number of sweeps. In this case, the displayed trace is determined during averaging according to the following equation:

$$\text{TRACE} = \frac{(n-1) \cdot \text{TRACE} + \text{MEAS\_VALUE}}{n}$$

where n is the number of the current sweep (n = 2 ... *SWEEP COUNT*). For the first sweep, an average is not calculated. The measurement values are stored directly in trace memory. With growing n, the displayed trace is increasingly smoothed since more individual trace data are available for averaging. The average trace is stored in trace memory after the defined number of sweeps. Until this number of sweeps is reached, a preliminary average is displayed.

After completion of averaging, ie if the averaging length defined with *SWEEP COUNT* is attained, a running averaging is continued with *CONTINUOUS SWEEP* according to the following formula:

$$\text{Trace} = \frac{(N-1) \cdot \text{Trace}_{\text{old}} + \text{meas. value}}{N}, \text{ where } \begin{array}{l} \text{Trace} = \text{new trace} \\ \text{Trace}_{\text{old}} = \text{old trace} \\ N = \text{SWEEP COUNT} \end{array}$$

The display "Sweep 200 of 200" then remains constant until a new start is made.

In *SINGLE SWEEP* mode, *SWEEP START* initiates n single sweeps. The sweeps are stopped as soon as the selected number of sweeps is reached. The number of the current sweep and the total number of sweeps are shown in the display: "Sweep 3 of 200".



The *SWEEP COUNT* softkey activates the entry of the number of sweeps, over which an average is to be calculated.

The permitted range for SWEEP COUNT is 0 through 32767. For 0, the FSIQ performs a running average over 10 sweeps. For 1, no averaging takes place.

The default setting is 10 sweeps. The programming naturally influences the sweep duration. The number of sweeps which are used in the averaging process or the averaging time are valid **for all 4 traces**.

**Note :** *The setting of the SWEEP COUNT in the trace menu is equivalent to the setting in the sweep menu.*



The *MAX HOLD* softkey activates the max hold mode.

In this display mode, the FSIQ saves for each sweep the largest of the previously stored/currently measured values in the trace memory. The detector is set automatically to *MAX PEAK*. In this way, the maximum value of a signal can be determined over several sweeps.

This is especially useful in the measurement of modulated or pulsed signals. The signal spectrum is filled at each sweep until all signal components have been captured.

By pressing of the *MAX HOLD* softkey again, the trace memory is cleared and the maximum value accumulation begins anew.

If *MAX HOLD* is enabled, a new start is made after clearing the trace memory for each frequency change, (start frequency, stop frequency, center frequency or frequency span), a reference level change or switching between linear/logarithmic scales.

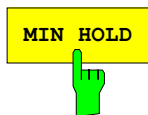

The *MIN HOLD* softkey activates the min hold mode.

In this display mode, the FSIQ saves for each sweep the smallest of the previously stored/currently measured values in the trace memory. The detector is set automatically to *MIN PEAK*. In this way, the minimum value of a signal can be determined over several sweeps. This function is, e.g., useful in making an unmodulated carrier in a mix of signals visible. Noise, interference signals or modulated signals are suppressed by the *MIN HOLD* function while a CW signal maintains a constant level.

Pressing the *MIN HOLD* softkey clears the trace memory and the minimum value function starts anew.



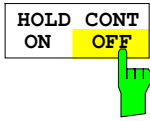

The *HOLD CONT* softkey defines whether the traces in the average mode and min hold/max hold mode are reset after some definite parameter changes.

OFF The traces are reset after some definite parameter changes.

ON This mechanism is switched off.

In general, parameter changes require a restart of the measurement before results are evaluated (e. g. with markers). For those changes that are known to require a new measurement (e. g. modification of the span), the trace is automatically reset so that erroneous evaluations of previous results are avoided.

This mechanism can be switched off for those exceptional cases where the described behavior is unwelcome.

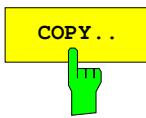

The *COPY* softkey copies the contents of the display screen for the current trace to another trace memory. A table appears in which the desired copy procedure can be selected.

COPY TRACE 1 TO	
✓	TRACE 2
	TRACE 3
	TRACE 4

For only one window, the selected trace can be copied to any of the other trace memories since here, all four traces are displayed in one diagram with the same frequency boundaries.

In the split screen display, this is only possible as long as the frequencies of screen A and screen B are identical. If this is not the case, the selected trace can only be copied to the corresponding trace memory, i.e., trace 1 to trace 3 and trace 2 to trace 4 or vice versa. In this case, only the available trace is displayed.

After copying, the contents of the destination memory are lost. The destination memory now changes automatically to view mode with the new data.

## Detector Selection

The FSIQ detectors are realised by pure digital techniques . The detectors available are the max-peak detector which delivers the maximum value from a number of sample values, the min-peak detector which delivers the minimum value from a number of sample values and the sampling detector. The sampling detector can transfer the sampled data without modification or can perform a data reduction by suppressing non-displayable values. For the peak detectors, the current value is compared with the maximum/minimum levels of the previously sampled data. When the number of samples defined by the instrument settings is reached, the samples are collected into the available pixels. Thus, each of the 500 pixels of the display represents 1/500 of the sweep range and contains, in compressed form, all of the individual measurements (frequency samples) in this sub-range. Even though the recording rate is high, there are no recording gaps thanks to the internal pipeline structure. According to the trace display mode, an optimised detector is automatically applied. Since the peak detectors and the sample detector are connected in parallel, a single sweep is sufficient for recording and displaying four traces with four detectors.

### Peak value detectors (*MAX PEAK / MIN PEAK*)

Peak value detectors are implemented by digital comparators, which determine the largest of all positive (max peak) or the smallest of all negative (min peak) peak values of the levels measured at the different frequencies which are displayed in one of the 500 pixels. This is repeated for each pixel so that, for wide frequency spans and inspite of the limited display resolution, a large number of measurements can be taken into consideration for the display of the spectrum.

### *AUTOPEAK* detector

The *AUTOPEAK* detector combines the two peak detectors. The max-peak detector and min-peak detector determine the maximum and minimum level at a displayed test point at the same time and display it as a common measurement value. The maximum and minimum level at a frequency point are joined with a vertical line.

### *SAMPLE* detector

The *SAMPLE* detector transfers all sampled data without further evaluation and either displays them directly or, for reasons of speed (short sweep times), first writes them into a memory and subsequently processes them.

Data reduction, i.e., summing of measurement values of neighbouring frequencies or time samples is not performed here. If, during a sweep, more measurement values are generated than can be displayed, measurement values will be lost. Discrete signals can thus be lost

Therefore, the sampling detector can only be recommended for a ratio of span-to-resolution bandwidth of up to approximately 250. It is thereby guaranteed that no signal will be suppressed (example: span 1 MHz --> min. bandwidth 5 kHz).

## RMS detector

The rms detector forms the rms value of the measured values within a pixel.

To this effect FSIQ uses the linear display voltage after the envelope detection. The linear values are squared, summed and the sum is divided through the number of samples (= root mean square). In case of logarithmic display, the logarithm is then formed from the square sum. In case of linear display the root mean square is displayed directly. Each pixel thus corresponds to the power of the measured values summed up in the pixel.

The rms detector supplies the power of the signal independent of the waveform (CW carrier, modulated carrier, white noise or pulse signal). The correction factors required by other detectors for the power measurement of the different signal classes are omitted.

## Average detector

The average detector forms the average value of measured values within a pixel.

To this effect, FSIQ uses the linear display voltage after the envelope detection. The linear sample values are summed up and the sum is divided by the number of measurement samples (= linear average value). In case of logarithmic display, the logarithm is then formed from the average value. In case of linear display the average value is displayed directly. Each pixel thus corresponds to the average value of the measured values summed up in the pixel.

The average detector supplies the average value of the signal independent of the waveform (CW carrier, modulated carrier, white noise or pulse signal).

**Note:** *During a sweep, the FSIQ switches the first oscillator in steps which are smaller than approximately 1/10 of the bandwidth. This guarantees that the level of a signal is correctly measured. For narrow bandwidths and wide spans, a very large number of measurement values are generated. The number of frequency steps is, however, always a multiple of 500 (= number of displayable points). In the sampling mode, only every  $n^{\text{th}}$  value is displayed. The quantity  $n$  depends upon the number of measurement values, i.e. on the span, resolution bandwidth and the measurement rate.*

TRACE 1-DETECTOR submenu

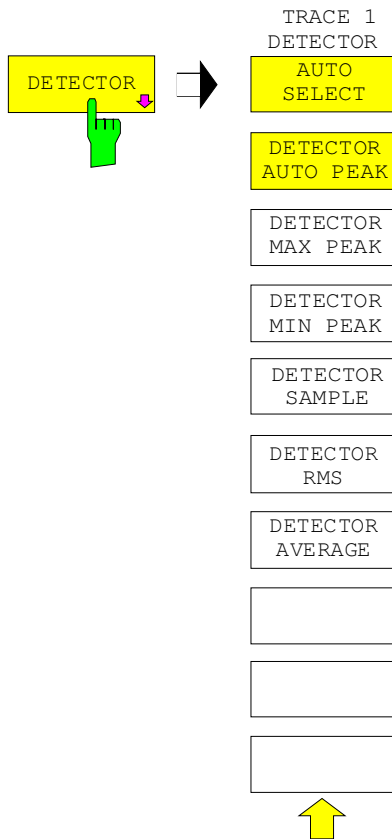

The *DETECTOR* softkey opens a submenu to select the detector.

The detector type may be independently selected for each trace. Mode *AUTO SELECT* sets the best suitable detector for the type of trace display (Clear Write, Max Hold oder Min Hold).

The softkeys are mutually exclusive selection switches.



The *AUTO SELECT* softkey (= default) selects the optimum detector dependent upon the trace mode (clear write, max hold, min hold).

<u>Trace-mode</u>	<u>Detector</u>
Clear/Write	Autopeak
Average	Sample
Max Hold	Max Peak
Min Hold	Min Peak



The *DETECTOR AUTOPEAK* softkey selects the autopeak detector.

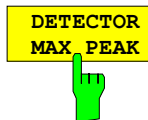

The *DETECTOR MAX PEAK* softkey selects the max peak detector. It is recommended if pulse-shaped signals are to be measured.



The *DETECTOR MIN PEAK* softkey selects the min peak detector. Weak sinewave signals become clearly visible in noise by using this detector. For a composite signal made up of sinewave and pulse signals the pulse signals are suppressed.



The *DETECTOR SAMPLE* softkey selects the sample detector.

It is used if uncorrelated signals like noise are to be measured. The power can be determined by means of fixed correction factors for evaluation and the log amplifier.

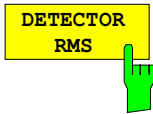

The *DETECTOR RMS* softkey activates the rms detector.

The rms detector supplies the power of the signal independent of the waveform. To this effect the root mean square of all sampled level values is formed during the sweep of a pixel. The sweep time thus determines the number of averaged values so that the trace can be better averaged with increasing sweep time. The rms detector is thus an alternative for averaging over several sweeps (see *TRACE AVERAGE*).

In the time domain ( $SPAN = 0$ ), the rms detector is only available for sweep times  $\geq 5$  ms. Moreover, the combination of the rms detector with the pretrigger function and the gaped sweep function is not permissible.

The video bandwidth has to be set to at least 10 times the resolution bandwidth (RBW) so that the rms value of the signal is not invalidated by video filtering.

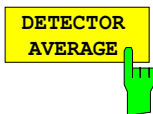

The *DETECTOR AVERAGE* softkey activates the average detector.

In contrast to the rms detector, the average detector supplies the linear average of all sampled level values during the sweep of a pixel.

The same restrictions as those of the rms detector apply (see above).

## Quasi Analog Display

Normally, measurement points are displayed interconnected by a continuous line. This leads to a continuous curve which is erased and rewritten for each new sweep. However, in the domain of analog measurement technology, display screen persistence leads to statistical emphasis which is related to the relative frequency of occurrence of a signal. Thus, on the display screen, frequently occurring events appear much brighter than rarely occurring curve segments.

Using the *ANALOG TRACE* function, the characteristics of an analog display are simulated. In this case, a measurement value is displayed as a single pixel on the display screen. This pixel is reset only by explicitly clearing the trace with *CLEAR / WRITE*. The overwriting of several sweeps is now possible and a frequency-of-occurrence distribution of the measurement values can be observed.

*TRACE 1* side menu



The *ANALOG TR ON/OFF* softkey enables/disables the *ANALOG TRACE* function for each trace.

The measurement is always made with the selected detector.

## Mathematical Functions for Traces

TRACE 1-TRACE MATH submenu:

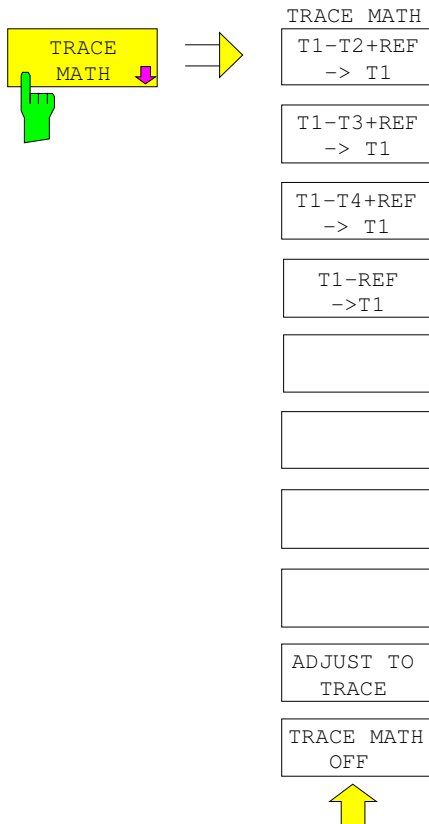

The *TRACE MATH* softkey opens a sub-menu in which a differential curve for the selected trace is calculated.

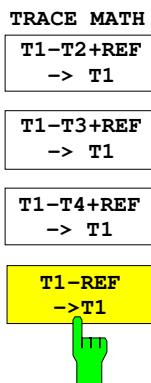

The *T1-T2+REF*, *T1-T3+REF*, *T1-T3+REF* and *T1-REF* softkeys subtract the corresponding traces and add the set level to the difference. If the reference line is switched on (see key D LINES), the level value of the reference line instead of the reference level is added to the difference. Thus, the differential curve can be positioned anywhere on the screen by shifting the reference line. The difference of the two traces with respect to the reference line is displayed.

The *T1-REF* softkey subtracts the level of the reference line from the trace level.

To indicate that the trace has been obtained by a differential curve, a corresponding enhancement label is displayed at the right margin of the measurement value diagram (1-2, 1-3, 1-4, 1-R). In *TRACE 1* main menu, the *TRACE MATH* softkey is on a coloured background to show that the function is being used.

**Important:** For a display with two measurement windows, not all combinations are allowed if the sweep data for screen A and screen B are not the same. Only the traces allowed in the screen can be combined (in screen A, only trace 1 with trace 3; in screen B, only trace 2 with trace 4).

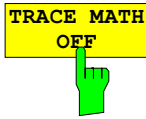

The *TRACE MATH OFF* softkey switches the enabled differential curve off. The softkey is only available when a conversion function is enabled.



The *ADJUST TO TRACE* softkey restores the original instrument settings when the corresponding trace is set to *VIEW* and the current instrument settings are different than those of the trace data.

If a trace is frozen with *VIEW*, changes in the instrument settings can be made without influencing the trace. An asterisk ( \* ) at the edge of the display screen indicates that the current instrument settings are different than those in effect when the trace was recorded. In this case, the *ADJUST TO TRACE* softkey is presented with which the original instrument setting can be restored.

### Trace Export

*TRACE* menu:



In analyzer mode, the *ASCII EXPORT* softkey stores the corresponding trace in a file with ASCII format.

Upon pressing the *ASCII EXPORT* softkey, a file name can be entered. The default name is *TRACE.DAT*. Then the measured data of the trace are stored. The function can be configured in the *ASCII CONFIG* submenu.

*TRACE* menu:

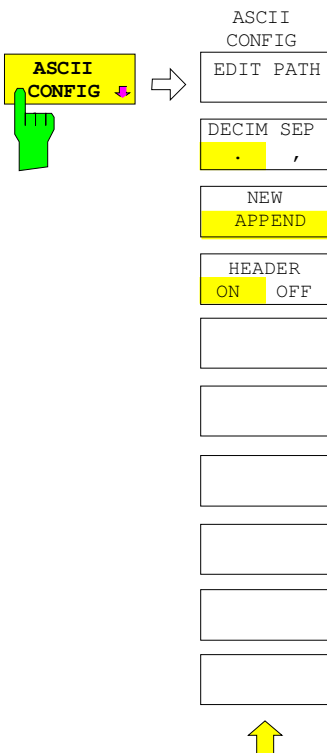

The *ASCII CONFIG* softkey calls a submenu for various settings for the *TRACE ASCII EXPORT* function.



The *EDIT PATH* softkey defines the directory in which the file is to be stored.

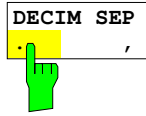

The *DECIM SEP* softkey selects the separator for the ASCII file: '.' (decimal point) or ',' (comma). Different language versions of analysis programs may require different notations of the decimal point. .

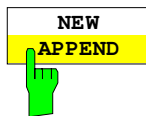

The *APPEND NEW* softkey defines whether output data are to be written to an existing file or a new file.

- With *APPEND*, the data are added to an existing file.
- With *NEW*, either a new file is generated or an existing file is overwritten by storage of the data.

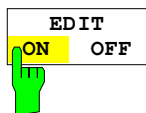

The *HEADER ON/OFF* softkey defines whether important instrument settings should be stored at the beginning of the file.

### Structure of the ASCII file:

The file consists of the header containing important scaling parameters and a data section containing the trace data.

The data of the file header consist of three columns, each separated by a semicolon: parameter name; numeric value; basic unit

The data section starts with the keyword " Trace <n> " (<n> = number of stored trace), followed by the measured data in one or several columns (depending on measurement) which are also separated by a semicolon.

This format can be read in from spreadsheet calculation programs, eg MS-Excel. It is necessary to define ',' as a separator.



	Content of file	Description
<b>File header</b>	Type;FSEA30;	Instrument model
	Version;1.91;	Firmware version
	Date;01.Jul 1999;	Date of data set storage
	Mode;Spectrum;	Instrument mode
	Start;10000;Hz	Start/stop of the display range.
	Stop;100000;Hz	Unit: Hz for span > 0, s for span = 0,
	Center Freq;55000;Hz	Center frequency
	Span;90000;Hz	Frequency range (0 Hz with zero span)
	Freq Offset;0;Hz	Frequency offset
	x-Axis;LIN;	Scaling of x axis linear (LIN) or logarithmic (LOG)
	y-Axis;LOG;	Scaling of y axis linear (LIN) or logarithmic (LOG)
	Ref.Level;-30;dBm	Reference level
	Level Offset;0;dB	Level offset
	Max Level	Maximum level
	Level Range;100;dB	Display range in y direction. Unit: dB with x axis LOG, % with x axis LIN
	RF Att;20;dB	Input attenuation
	RBW;100000;Hz	Resolution bandwidth
VBW;30000;Hz	Video bandwidth	
SWT;0.005;s	Sweep time	
Trace Mode;AVERAGE;	Display mode of trace: CLR/WRITE,AVERAGE,MAXHOLD,MINHOLD	
Detector;SAMPLE;	Detector set: AUTOPEAK,MAXPEAK,MINPEAK,AVERAGE, RMS,SAMPLE	
Sweep Count;20;	Number of sweeps set	
<b>Data section of the file</b>	Trace 1;;	Selected trace
	x-Unit;Hz;	Unit of x values: Hz with span > 0; s with span = 0; dBm/dB with statistics measurements
	y-Unit;dBm;	Unit of y values: dB*/V/A/W depending on the selected unit with y axis LOG or % with y axis LIN
	Values;500;	Number of test points
	10000;-10.3;-15.7	Measured values: <x value>, <y1>, <y2>
	10180;-11.5;-16.9	<y2> being available only with detector AUTOPEAK and containing in this case the smallest of the two measured values for a test point.
	10360;-12.0;-17.4	
...;...;		

**Example:**

```

Type;FSIQ13;
Version;1.91;
Date;20.Sep 1999;
Mode;Spectrum;
Start;0.000000;Hz
Stop;3500000000.000000;Hz
Center Freq;1750000000.000000;Hz
Span;3500000000.000000;Hz
Freq Offset;0.000000;Hz
x-Axis;LIN;
y-Axis;LOG;
Level Range;100.000000;dB
Ref. Level;-20.000000;dBm
Level Offset;0.000000;dBm
Max. Level;-20.000000;dBm
RF Att;10.000000;dB
RBW;3000000.000000;Hz
VBW;3000000.000000;Hz
SWT;0.005000;s
Trace Mode;CLR/WRITE;
Detector;AUTOPEAK;
Sweep Count;0;
TRACE 1:
x-Unit;Hz;
y-Unit;dBm;
Values;500;
0.000000;-44.465958;-60.190887
7014028.056112;-49.233063;-81.451668
14028056.112224;-75.692101;-101.811501
21042084.168337;-75.147057;-101.229843
28056112.224449;-75.114517;-95.358429
35070140.280561;-71.769005;-100.755981
...

```

If all traces are to be stored in one file with the header information stored only once, the following procedure is recommended:

[TRACE 1] [MENU ⇒][ASCII CONFIG]	
[ASCII CONFIG] [NEW]	Generate new file
[ASCII CONFIG] [HEADER ON]	with header
[TRACE 1] [MENU ⇒][ASCII EXPORT]	Store trace 1 with header
[TRACE 2] [MENU ⇒][ASCII CONFIG]	
[ASCII CONFIG] [APPEND]	Append to end of file
[ASCII CONFIG] [HEADER OFF]	without header
[TRACE 2] [MENU ⇒][ASCII EXPORT]	Write trace 2 to file
[TRACE 3] [MENU ⇒][ASCII EXPORT]	Write trace 3 to file
[TRACE 4] [MENU ⇒][ASCII EXPORT]	Write trace 4 to file

## Sweep Control – SWEEP Key Group

Using the *SWEEP* key group, the parameters are entered which determine the sweep characteristics. These are the coupled functions resolution bandwidth, video bandwidth and sweep time (*COUPLING* key), the trigger used for starting the sweep (*TRIGGER* key) and the type of sweep (*SWEEP* key).

## Coupled Settings – COUPLING Key

The *COUPLING* key calls a menu for entering the sweep parameters resolution bandwidth (*RBW*), video bandwidth (*VBW*) and sweep time (*SWT*). The parameters can be set dependent upon the span (stop - start frequency), coupled to each other or arbitrarily defined by the user. The settings for the split screen display mode are valid only for the window which is active for entries.

The FSIQ offers the resolution bandwidths 1 Hz to 10 MHz in 1, 2, 3, 5 steps:

The FSIQ resolution bandwidths up to 1 kHz have been implemented using digital filters with Gaussian characteristics. They behave like analog filters. The 1-kHz filter has been implemented both as a decoupled quartz filter and as a digital filter. One of the two filter types can be selected. The bandwidths from 2 kHz to 30 kHz have been implemented using decoupled quartz filters, the bandwidths between 50 kHz and 5 MHz using decoupled LC filters. These filters consist of 5 circuits, their shape factor is < 12, typ. 9.5.

The 10-MHz filter is a critically coupled LC filter.

For bandwidths up to about 1 kHz, the FFT-algorithm, as compared to other filter methods with identical settings, offers clear advantages with respect to the measurement time. This is due to the fact that for analog filters the time required for a given display range is proportional to  $(\text{Span}/\text{RBW})^2$ . The FFT-algorithm reduces that time to a value proportional to  $(\text{Span}/\text{RBW})$ .

FFT-filters are provided for bandwidths between 1 Hz and 1 kHz as an alternative to the analog filters.

The video bandwidths are available in 1/2/3/5 steps between 1 Hz and 10 MHz. They can be set independent of the resolution bandwidth. Video bandwidths between 1 Hz and 10 kHz are available for resolution bandwidths up to 1 kHz and video bandwidths between 1 Hz and 10 MHz are available for resolution bandwidths greater than or equal to 2 kHz. The video filters are used to smooth the traces. Small video bandwidths in relation to the resolution bandwidth average out noise peaks pulse-like signals such that only the average value of the signals is displayed. A large video bandwidth in relation to the resolution bandwidth is therefore recommended when measuring pulsed signals ( $\text{VBW} \geq 10 \times \text{RBW}$ ) so that the amplitude of pulses can be measured correctly.

## Setting and Coupling the Coupling Resolution, Video Bandwidth and Sweep Time

SWEEP COUPLING menu

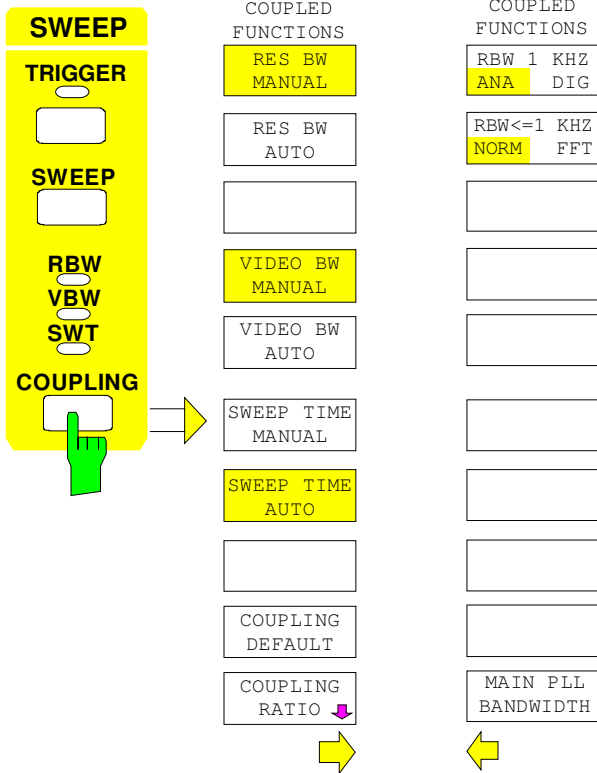

The *COUPLING* key calls a menu and a supplementary menu for setting the resolution bandwidth, video bandwidth, sweep time and their couplings.

The various *AUTO* softkeys are used to couple the functions. The coupling ratios are selected in the *COUPLING RATIO* sub-menu.

The various *MANUAL* softkeys request that the respective parameter be entered in the entry window. This parameter is not coupled to the other parameters.

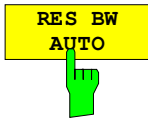

The *RES BW AUTO* softkey couples the resolution bandwidth to the selected span. Changing the span causes automatic compensation of the resolution bandwidth.

Automatic coupling of resolution bandwidth to span is always recommended when, for the measurement problem on hand, a favorable setting of the resolution bandwidth in relation to the selected span is desired.

The coupling ratio is set in the *COUPLING RATIO* sub-menu.

The coupling is indicated by illumination of the softkey and the active *RBW* LED.

The *RES BW AUTO* softkey is only available in the frequency domain (span > 0 Hz). The softkey is blanked in the time domain.

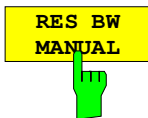

The *RES BW MANUAL* softkey activates the manual entry mode for the resolution bandwidth.

The lower limit of the bandwidth is 1 Hz.

For numerical inputs, the values are always rounded to the next valid bandwidth. For roll-key or the UP/DOWN key inputs, the bandwidth is adjusted in steps either upwards or downwards.

For manual input of the resolution bandwidth (coupling off), on the front panel remains off.



The *VIDEO BW AUTO* softkey couples the video bandwidth of the FSIQ to the resolution bandwidth. If the resolution bandwidth is changed, the video bandwidth is automatically adjusted.

The coupling of the video bandwidth is always recommended when the maximum sweep time for a selected resolution bandwidth is to be achieved. Lower video bandwidths require longer sweep times due to the longer settling time. Wider bandwidths reduce the signal/noise ratio.

The coupling ratio is set in the *COUPLING RATIO* menu.

The coupling is indicated by illumination of the softkey and the lighted *VBW* LED on the front panel.

The coupling of the video bandwidth to the resolution filter is also permitted for display in the time domain (span = 0).



The *VIDEO BW MANUAL* softkey activates the manual input mode for the video bandwidth.

The video bandwidth is selectable in 1/2/3/5 steps between 1 Hz and 10 MHz. For bandwidths up to 1 kHz, the maximum video bandwidth is 10 kHz, for larger resolution bandwidths, there is no restriction to the video bandwidth.

For numerical inputs, rounding is made to the next possible bandwidth. For roll-key or UP/DOWN entries, the bandwidth is switched in steps either downwards or upwards.

For manual input, the video bandwidth (coupling disabled) *VBW* LED on the front panel is turned off.



The *SWEEP TIME AUTO* softkey couples the sweep time to the span, video bandwidth (VBW) and resolution bandwidth (RBW). For a change in span, the resolution bandwidth or the video bandwidth is automatically matched to the sweep time. The FSIQ always selects the fastest sweep time which is possible without falsifying the level display.

The coupling is indicated by illumination of the softkey and turning on the *SWT* LED.

The softkey is only available in the frequency domain (span > 0 Hz). The softkey is blanked in the time domain.



The *SWEEP TIME MANUAL* softkey activates the manual input mode for the sweep time. At the same time, the coupling of the sweep is canceled and the *SWT LED* is turned off. Other couplings (*VIDEO BW*, *RES BW*) remain in effect.

In the frequency domain (span > 0 Hz) and for resolution bandwidths  $\geq 1$  kHz, the allowed sweep times range from 5 ms through 16000 s in steps of 5% of the sweep time at maximum. The digital resolution filters from 10 Hz to 1 kHz allow a minimum sweep time of 20 ms.

If an FFT-filter is used the sweep time is fixed by the display range and resolution bandwidth selected and therefore can not be set.

For displays in the time domain (span = 0 Hz), the range of sweep times 1  $\mu$ s to 2500 s is selectable in steps of 5% of the sweep time at maximum.

For numerical inputs, rounding is made to the next possible sweep time. For roll-key or UP/DOWN entries, the sweep time is switched in steps either downwards or upwards.

If the selected sweep time is too small for the selected span and bandwidth, measurement errors will occur. This happens because the available settling time for the resolution filter or the video filter is too short. In this case, the FSIQ outputs *UNCAL* on the display

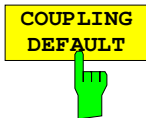

The *COUPLING DEFAULT* softkey sets all coupled functions to *AUTO*. In addition, the ratio *RBW / VBW* is set to *SINE [1]* and the ratio *SPAN/RBW* is set to 50 in the *COUPLING RATIO* submenu (default setting, *COUPLING RATIO* softkey not illuminated).

The relevant softkeys are then illuminated.

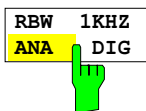

The *RBW 1kHz ANA/DIG* softkey enables either the analog quartz filter (*ANA*) or the digital filter (*DIG*) for the instrument's resolution bandwidth of 1 kHz. In the default setting, the instrument uses the analog IF filter for the 1-kHz bandwidth.

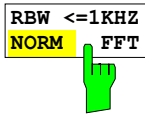

The *RBW<=1kHz NORM/FFT* softkey switches between fixed filter and FFT-filter.

*NORM* For resolution bandwidths up to 1 kHz fixed IF-filters are used.

*FFT* An FFT is performed. To this end, the filtered IF-signal is digitalized by the 3-kHz resolution filters and then transformed into the spectral domain via FFT. The transformation range is equal to the selected display range but covers 4 kHz at maximum. If the display range is larger than the transformation range, several subsequent transformations are performed, the results are appended to each other in the spectral domain. This compensates for the frequency response of the 3-kHz preselection filter so that the amplitude response within the transformation range is offset. A flattop window serves as a window in the time domain so that a high amplitude precision with good selection is achieved.

Span:

- minimum display range: 50× resolution bandwidth selected

- maximum display range:

Resolution bandwidths > 20 Hz: 2 MHz (500 FFT-transf./sweep at maximum)

Resolution bandwidths < 20 Hz: Reduction to 125 kHz at 1 Hz resolution bandwidth

Level display range: 100 dB at max. A larger display range implies that the trace is tilted at -100 dB from the reference level.

Sweep time: fixed by the bandwidth selected and the display range.  
(Reason: an FFT-filter represents a block transformation). The sweep time can not be changed (softkey inactive).

Detector All settings of the sample detector are fixed, no other detector can be selected (softkeys inactive)

Video bandwidth not defined for FFT-transf. so that it can not be set (softkeys inactive).

Compared to fixed filters, FFT-filters lead to markedly reduced sweep times. For a display range of 50 kHz and a resolution bandwidth of 100 Hz, e. g., the sweep time is reduced from 25 s to 520 ms. FFT-filters are particularly suitable for stationary signals (sinusoidal signals or signals that are continuously modulated in time). For burst signals (TDMA) or pulses, fixed filters should be preferred. The FFT is a block transformation so that the result depends on the time relation between the dataset to be transformed and the burst or pulse signal. A 'gated sweep' measurement for TDMA signals is therefore not provided if FFT-filters are used.



The *MAIN PLL BANDWIDTH* softkey opens a selection window for setting the PLL control bandwidth.

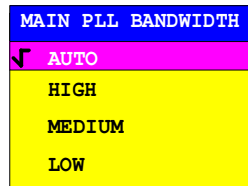

The first local oscillator is synchronized with the PLL control bandwidth. The control bandwidth determines the characteristic of the phase noise. A medium or high control bandwidth improves the phase noise for frequency differences smaller than 10 kHz to the carrier, whereas a low control bandwidth improves the phase noise for frequency differences larger than 100 kHz to the carrier. If the control bandwidth is set unfavorably, the phase noise is deteriorated.

The PLL bandwidth is set in the AUTO mode depending on the RBW and SPAN according to the following tables:

MAIN PLL BANDWIDTH	SPAN ≤ 100 kHz and RBW < 3kHz	SPAN > 100 kHz or RBW ≥ 3kHz
HIGH	X	
MEDIUM		X
LOW		

The setting is chosen such that the phase noise for small spans with small resolution bandwidth near the carrier is optimized.

For measurements with small span but with a relatively large frequency difference to the carrier (>100kHz), the automatic bandwidth setting deteriorates the phase noise relative to the optimal setting. The *MAIN PLL BANDWIDTH* softkey allows to by-pass this automatic setting. Optimal settings are, as a function of the carrier difference @:

MAIN PLL BANDWIDTH	@ ≤ 10 kHz	10 kHz < @ < 100 kHz	@ ≥ 100 kHz
HIGH	X		
MEDIUM		X	
LOW			X

If a larger control bandwidth is needed due to the sweep velocity, the processor automatically increases the control bandwidth as far as necessary.



## Sweep Coupling Ratio

*SWEEP COUPLING-COUPLING RATIO* submenu:

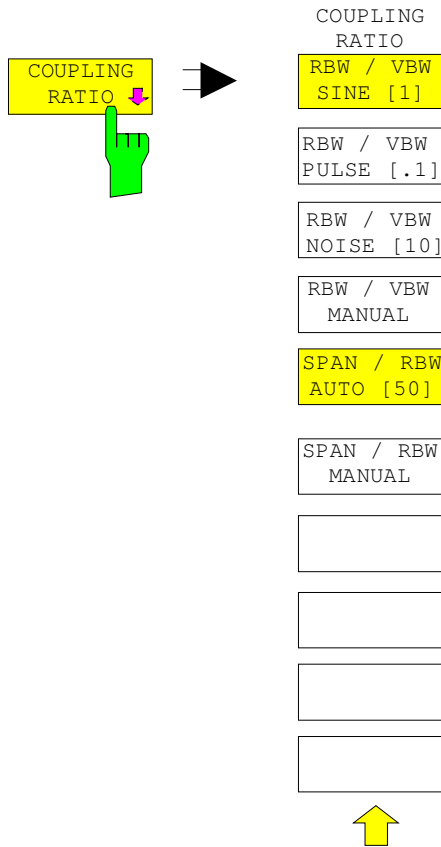

The *COUPLING RATIO* softkey opens a sub-menu in which the coupling ratio between resolution bandwidth, video bandwidth and the span can be defined.

These settings are effective only for the selected parameters in ...*AUTO* of the main menu.

The softkeys *RBW/VBW PULSE*, *RBW/VBW SINE*, *RBW/VBW NOISE*, *RBW/VBW MANUAL* are selection keys. Only one softkey can be enabled (illuminated) at any one time.

The same is valid for the softkeys *SPAN/RWB AUTO [50]* and *SPAN/RWB MANUAL*.

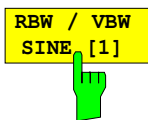

The *RBW / VBW SINE [1]* softkey always sets the video bandwidth equal to the resolution bandwidth.

This is the default setting for the coupling ratio resolution bandwidth to video bandwidth.

This coupling ratio is recommended when sine-wave signals are to be measured.

This setting is only effective for the *VBW AUTO* selection in the main menu.

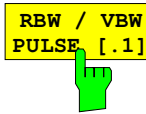

The *RBW / VBW PULSE* softkey sets the following coupling ratio:

video bandwidth = 10 x resolution bandwidth

or

video bandwidth = 10 MHz (= maximum video bandwidth).

This coupling ratio is always to be recommended when the amplitude of pulsed signal shape is to be measured. The IF filter characteristics alone determine the pulse shape. No additional weighting takes place via the video filter.

This setting is only effective for the *VBW AUTO* selection in the main menu.

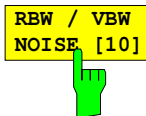

The *RBW / VBW NOISE* softkey sets the following coupling ratio:

video bandwidth = resolution bandwidth/10

With this setting, noise and pulsed signals are suppressed in the video section. For noise signals, the FSIQ displays the average value.

This setting is only effective for the *VBW AUTO* selection in the main menu.

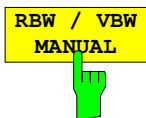

The *RBW / VBW MANUAL* softkey activates the entry of the coupling ratio for resolution bandwidth to video bandwidth.

The ratio of resolution bandwidth to video bandwidth can be set in the range from 0,001 to 1000.

This setting is only effective for the *VBW AUTO* selection in the main menu.

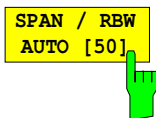

The *SPAN / RBW AUTO [50]* softkey sets the following coupling:

resolution bandwidth = span/50

This coupling corresponds to the default state.

This setting is only effective for the *RBW AUTO* selection in the main menu.



The *SPAN / RBW MANUAL* softkey activates the manual entry mode for the coupling of resolution bandwidth and span.

The ratio of span to resolution bandwidth can be in the range from 1 to 10000.

This setting is only effective for the *RBW AUTO* selection in the main menu.

## Sweep Trigger – TRIGGER Key

*SWEEP TRIGGER* menu:

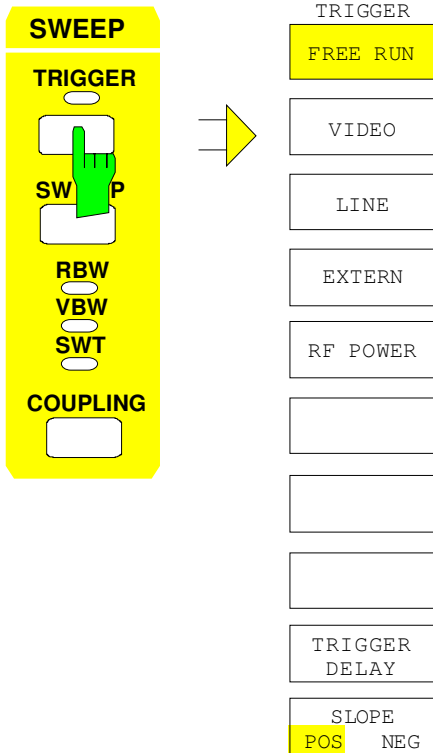

The *TRIGGER* key opens a menu for selection of the various trigger sources and the trigger polarity. The active trigger mode is indicated by illumination of the corresponding softkey.

For triggering modes in which the trigger threshold can be entered, the corresponding entry window is activated and, if appropriate, a horizontal trigger line is displayed.

The *FREE RUN*, *VIDEO*, *LINE*, *EXTERN* and *RF-POWER* softkeys are selection switches. Only one key can be enabled at any one time (illuminated). For sweep operations controlled by a gate signal, the *FREE RUN* setting is the only setting possible.

If triggering has taken place, the trigger LED is turned on at the beginning of the sweep and then turned off at the end of sweep.

To indicate that the FSIQ is set for triggering (= not free run), the enhancement label **TRG** is shown on the display. If two measurement windows are displayed, TRG appears next to the window which is configured for triggering.



The *FREE RUN* softkey activates the free-run sweep mode (default setting).

In free-run sweep mode there is no triggering at the start of sweep.

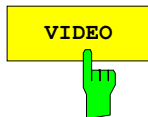

The *VIDEO* softkey activates triggering by the displayed voltage.

For the video triggering mode, a level line showing the trigger threshold is displayed. Using the level line, the threshold can be adjusted with the roll-key or the UP/DOWN keys.

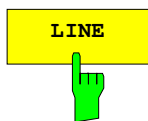

The *LINE* softkey activates triggering derived from the mains (line) frequency. The power supply generates a trigger pulse at the line frequency which is used to trigger a new sweep.

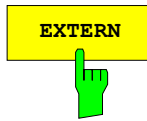

The *EXTERN* softkey activates triggering via an external voltage (-5V...+5V) at the input connector *EXT TRIGGER/GATE* on the rear panel.

The trigger threshold can be set in an entry window within a range of -5V...+5V.

External triggering in the sweep mode "gated sweep" (*SWEEP SWEEP-GATE ON*) is not possible, because the *EXT TRIG/GATE* connector is used to control the sweep. The softkey is not illuminated in these modes.

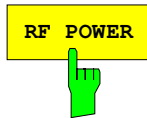

The *RF POWER* softkey activates triggering of the measurement via signals which are outside the measurement channel.

The FSIQ uses a level detector at the intermediate frequency. The detector threshold is approximately -20 dBm at the input mixer. This means that the actual trigger level at the RF input is approx. -20 dBm plus the set RF attenuation.

The bandwidth at the intermediate frequency is approximately 60 MHz for model FSIQ3, approx. 160 MHz for FSIQ7, FSIQ26 and FSIQ40. Triggering takes place when the trigger threshold is exceeded within a 100 MHz bandwidth about the selected frequency. Thus, the measurement of noise emissions, e.g., for pulsed carriers, is possible. The carrier itself is suppressed via the selected resolution filter.



The *TRIGGER DELAY* softkey activates the entry window for delay time or a pretrigger.

The triggering is delayed or advanced relative to the trigger signal by the entered delay time. The delay time can be set in the range from -100 s to 100 s (default = 0 s).

**Note:** A negative delay time (pretrigger) can be set in the time domain (*SPAN < 0 Hz*) only. The maximum permissible range and the maximum resolution of the pretrigger is limited by the set sweep time:

*max. range = - 499/500 x sweep time*

*max. resolution = sweep time/500.*

*Pretriggering is not possible when the rms or the average detector is activated.*



The *SLOPE POS/NEG* softkey selects the trigger slope.

The sweep starts after a positive or negative edge of the trigger signal. The selected setting is illuminated.

The selection is valid for all trigger modes with the exception of *FREE RUN*.

The default mode is *SLOPE POS*.

## Sweep Setup – SWEEP Key

*SWEEP SWEEP* menu:

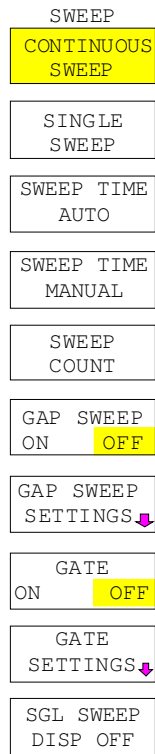
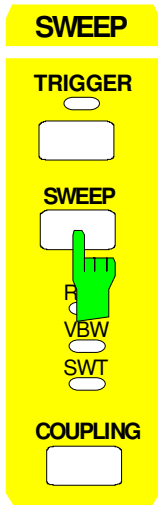

The *SWEEP* key calls a menu in which the type of sweep (sweep mode) is determined. In split screen mode, the entries are valid only for the active measurement window.

In the menu, continuous or single sweep mode, gap-sweep settings or the external gate function can be selected.

The *CONTINUOUS SWEEP* and *SINGLE SWEEP* softkeys are selection switches. Only one softkey can be active (illuminated) at any one time.



The *CONTINUOUS SWEEP* softkey sets the continuous sweep mode. This means, that the sweep takes place continuously according to the trigger conditions.

In case of split screen display with different settings in each measurement window, screen A is swept first and then screen B. After pressing the softkey, the sweep is initialized and restarted.

*CONTINUOUS SWEEP* is the default setting of FSIQ.



The *SINGLE SWEEP* softkey starts a series of n sweeps according to the triggering definition. The number of sweeps, n, is determined by the *SWEEP COUNT* softkey.

In split screen display mode, the spans of each window are swept sequentially. If a displayed curve is averaged, the span is swept n times (n = sweep count). For n = 0, a single sweep takes place.

To indicate that the FSIQ is set for single sweep, the enhancement label **SGL** is shown on the display.

SWEPTIME  
AUTO

SWEPTIME  
MANUAL

The *SWEPTIME AUTO* and *SWEPTIME MANUAL* softkeys activate the automatic or manual selection of the sweep time. These functions are identical to the entries in the *COUPLING* menu (see section "Setting and Coupling the Coupling Resolution, Video Bandwidth and Sweep Time").

SGL SWEEP  
DISP OFF



The *SGL SWEEP DISP OFF* softkey switches off the display during a single sweep. The trace is displayed when the sweep has terminated.

SWEEP  
COUNT



The *SWEEP COUNT* softkey activates the entry of the number of sweeps performed by the FSIQ after the start of a single sweep. If trace average, max hold or min hold is switched on, this also fixed the number of averaging or minimum/maximum search procedures.

Example:

[TRACE1: MAX HOLD]

[SWEEP: SWEEP COUNT: {10} ENTER]

[SINGLE SWEEP]

The FSIQ performs the max hold function over 10 sweeps.

The permissible range for the sweep count is 0 through 32767. For sweep count = 0 or 1, a sweep is performed. For trace averaging (*AVERAGE*), sweep count = 0 and continuous sweep, the FSIQ performs a running average over 10 sweeps in average mode. For sweep count = 1, no averaging takes place.

The default setting totals 10 sweeps.

**Note:** *The setting for the number of sweeps in the TRACE menu is equivalent to the setting in the SWEEP menu. In SINGLE SWEEP mode, the measurement is stopped after reaching the chosen number of sweeps.*

### Gated Sweep

By using a gate in sweep mode and stopping the measurement while the gate signal is inactive, the spectrum for pulsed carriers can be displayed without overlaid frequency components caused by the on/off switching procedure. Similarly, the spectrum can also be examined for an inactive carrier. The sweep can be controlled by an external gate or by the internal power trigger.

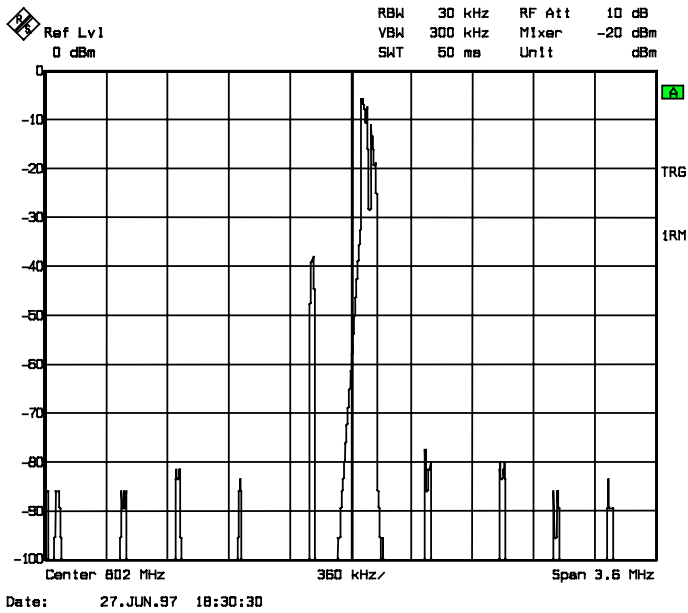

Fig. 4-9 Pulsed signal GATE

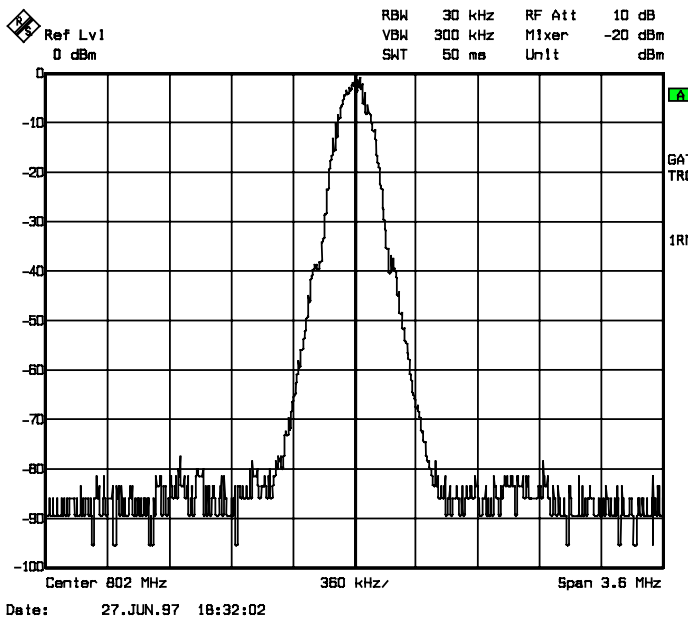
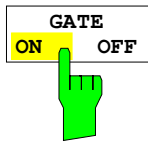

Fig 4-10 TDMA-signal with GATE ON

The 'gated sweep' mode is activated by the *GATE ON/OFF* softkey. The setting of the mode takes place in the *GATE SETTINGS* sub-menu.

SWEEP SWEEP menu:



The *GATE ON / OFF* softkey switches the sweep mode with an internal or external gate on/off.

When *GATE ON* is selected, a signal applied to the rear panel connector *EXT TRIGGER/GATE* or the internal RF power detector controls the sweep of the analyzer. The sweep can be stopped and then continued. A switch from an edge triggered to a level triggered mode can also be made.

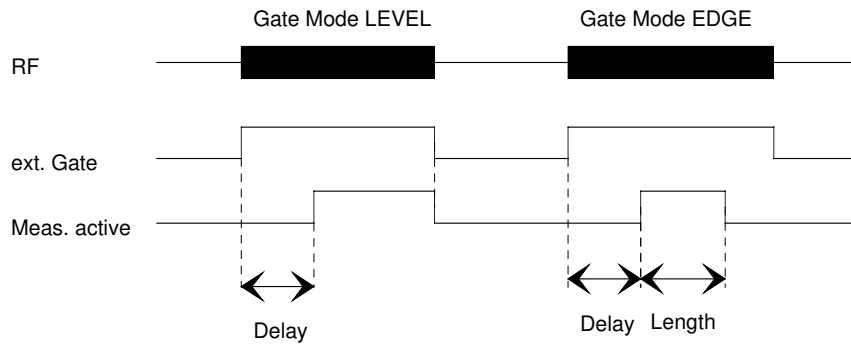

Fig. 4-11 Interaction of the parameters *GATE MODE*, *GATE DELAY* and *GATE LENGTH*

The softkey is only available in the frequency domain (span > 0).

*GATE ON* is only possible when the trigger mode is set to *FREE RUN* (*SWEEP TRIGGER* menu).

To indicate that the FSIQ is set for sweep mode with external gate, the enhancement label *GAT* is shown on the display. *GAT* appears next to the window which is configured for sweep mode with external gate.



SWEEP SWEEP-GATE SETTINGS sub-menu:

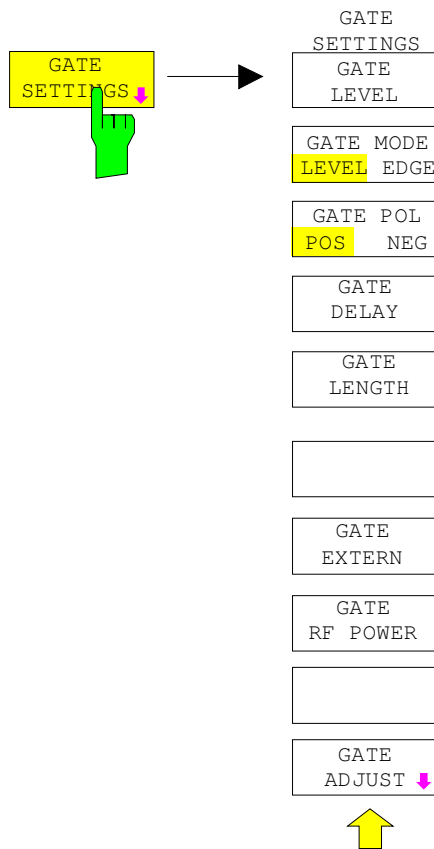

In the *GATE SETTINGS* sub-menu, all settings are made which are necessary for 'gated sweep' operation.

On switching to the time domain, the *GATE DELAY* and *GATE LENGTH* times are displayed by horizontal time lines which allow simple adjustment of the gate time.

The softkeys *GATE EXTERN* and *GATE RF POWER* provide alternative settings, only one of them can be active at one time.



The *GATE LEVEL* softkey activates the entry window for defining the threshold value of the external gate signal.

The threshold can be set between -5V and +5V.

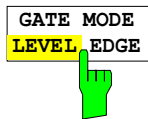

The *GATE MODE LEVEL/EDGE* softkey selects the trigger mode. The sweep mode *GATE* can be operated either as level or as edge triggered.

For level triggering, the *GATE LENGTH* softkey is deactivated and can not be used.



The *GATE POL* softkey determines the polarity of the *GATE* control line.

If level triggering with *GATE POL POS* is set, the sweep is stopped when the gate signal is a logic '0' (input signal < gate level) at the *EXT TRIGGER/GATE* input and then, when the gate signal goes to a logic '1', the sweep is continued after a delay time of *GATE DELAY*.

For edge triggering and a change from '0' to '1', i.e., the positive edge of the *EXT TRIGGER/GATE* input signal, the sweep is continued after a delay of *GATE DELAY* for a duration which was set by the *GATE LENGTH* softkey.



The *GATE DELAY* softkey activates the entry window for setting the delay time between the gate signal and the continuation of the sweep.

Thus, e.g., delays between the gate signal and the stabilization of an RF carrier can be taken into consideration.

For the gate delay time, values can be selected between 1  $\mu$ s and 100 s. The resolution is dependent upon the absolute value of the delay time:

Gate delay	Resolution
0 - 500 $\mu$ s	1 $\mu$ s
0.5 - 5 ms	5 $\mu$ s
5 - 50 ms	50 $\mu$ s
50 - 500 ms	500 $\mu$ s
0.5 - 5 s	5 ms
5 - 50 s	50 ms
50 - 100 s	500 ms

In the time domain, a time line is displayed separated from the trigger point by the gate delay time. This simplifies the adjustment of the necessary delay time.

The values for *GATE DELAY* and *GATE LENGTH* are displayed by two time lines. The duration of the active sweep for span > 0 (continuation of sweep: *GATE DELAY* line, stopping of sweep: *GATE LENGTH* line) is described by these two lines. A change in parameters causes a shift of the corresponding line position. After switching to span > 0, the selected times for the gated sweep are effective.

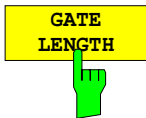

For edge triggering, the *GATE LENGTH* softkey activates the entry window for defining the FSIQ sweep duration.

*GATE LENGTH* can be set to values between 1  $\mu$ s and 100 s. The resolution is dependent upon the absolute value of the gate length:

Gate length	Resolution
0 - 500 $\mu$ s	1 $\mu$ s
0.5 - 5 ms	5 $\mu$ s
5 - 50 ms	50 $\mu$ s
50 - 500 ms	500 $\mu$ s
0.5 - 5 s	5 ms
5 - 50 s	50 ms
50 - 100 s	500 ms

In the time domain (*ZERO SPAN*), a time line is displayed separated from the *GATE DELAY* time by the *GATE LENGTH* time.

The softkey is only available for the *GATE MODE EDGE* setting (edge triggering). It is disabled for the *GATE MODE LEVEL* setting (level triggering).



The *GATE EXTERN* softkey selects a signal applied to the *EXT TRIGGER/GATE* connector on the rear panel of the instrument as a gate source.

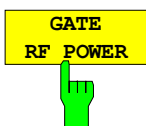

The *GATE RF POWER* softkey selects the internal RF power detector as a gate source.

## Setting the Gate Times

*SWEEP SWEEP- GATE SETTINGS - GATE ADJUST* submenu:

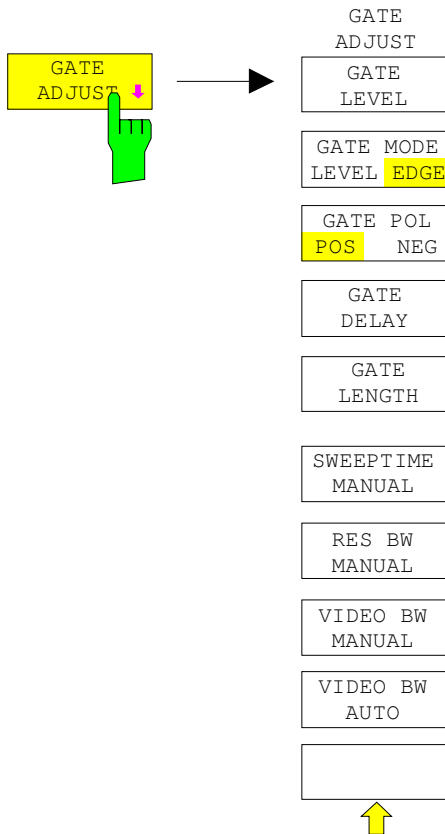

The *GATE ADJUST* softkey opens a submenu comprising all softkeys that are used to set the parameters relevant for the 'gated sweep' function.

On pressing this softkey, the display is switched to the time domain (zero span setting) so that all necessary times can be checked by means of cursor lines.

The values for Res BW, Video BW and sweep time are taken from the corresponding settings in the frequency domain.

To make sure that the times can be set correctly corresponding to the conditions in the frequency domain, the settings for the resolution bandwidth and the video bandwidth should not be changed.

The sweep time must be selected such that, e. g., a full burst is displayed. It usually differs from the sweep time in the frequency range.

Finally, *GATE DELAY* and *GATE LENGTH* can be used to set the times in such a way that the desired section in the spectral range is covered.

On quitting the submenu, the original settings in the frequency range are restored so that the measurement can be directly performed with the required parameters.

### Measurement example:

The modulation spectrum of a GSM or PCS1900 signal to be measured using the 'gated sweep' function. The signal is generated by the test sender SME03. Its RF-output is directly connected to the RF input of the FSIQ.

#### Settings on the SME03:

FREQ:	802 MHz
Level:	0 dBm: Return
Digital Mod:	Select: GMSK: Select
Source:	Select: PRBS: Select: Return
Level Attenuation:	Select: 60 dB: Return

The SME03 provides a GMSK-modulated TDMA-signal (GSM)

Operation steps on the FSIQ:

[PRESET]  
 [CENTER: {802} MHz]  
 [SPAN {3.6} MHz]  
 [REF LVL: {0} dBm: RF ATTEN MANUAL: {10} dB]  
 [COUPLING: RES BW MANUAL: {30} kHz]  
 [TRACE 1: DETECTOR: RMS]  
 [SWEEP: SWEEPTIME MANUAL: {50} ms;  
 GATE ON  
 GATE SETTINGS: GATE MODE EDGE: GATE POL POS: GATE RF POWER  
  
 GATE ADJUST: SWEEPTIME MANUAL {1} ms: GATE DELAY {300} μs:  
 GATE LENGTH: {250} μs]

**Note:** [KEY] Menu called by the KEY. All indications inside the bracket refer to this menu.  
 {Number} Numeric value to be entered for the corresponding parameter  
 SOFTKEY Softkey used to select a parameter or enter a value.

The following figure shows the screen display for gate parameter setting: The vertical lines for gate delay (GL) and gate length (GL) can be adapted to the burst signal by entering numbers of by means of the rollkey.

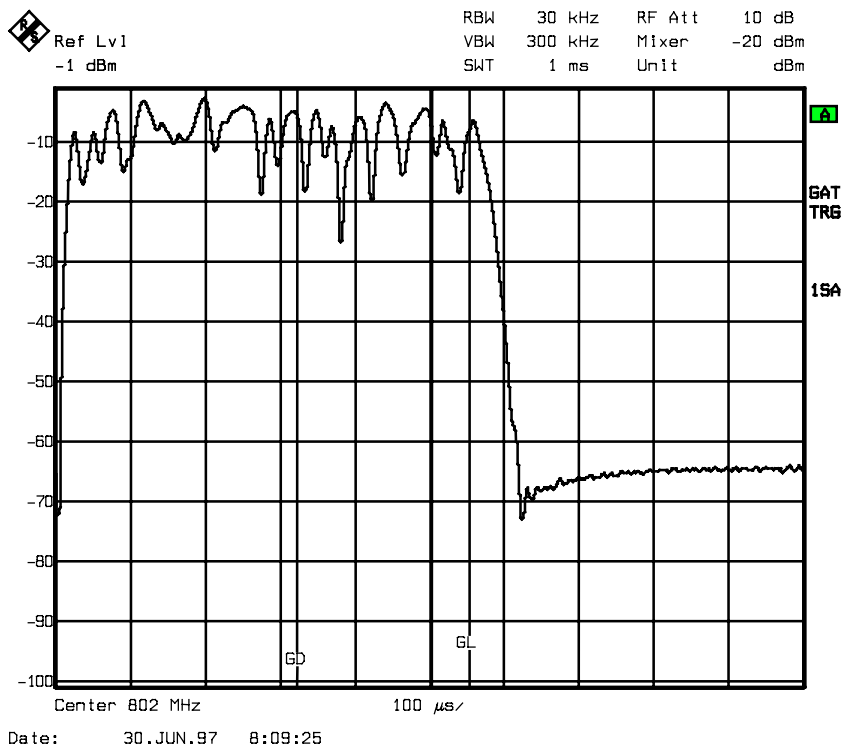

Fig. 4-12 Setting the GATE DELAY and GATE LENGTH times in the time domain using the GD and GL lines

On quitting the menu GATE ADJUST, the FSIQ returns to spectral representation.

### Sweep Blanking – Gap Sweep

For measurements in the time domain, the *GAP SWEEP* function offers a high degree of flexibility with regard to the display of measurement data. With the *PRE TRIGGER* softkey, it is possible to display measurements taken before the trigger time. With the *GAP TIME* softkey, the measurements within a predefined time range can be blanked. Thus, it is possible to display the rising and falling edge of a signal with high resolution on a single diagram.

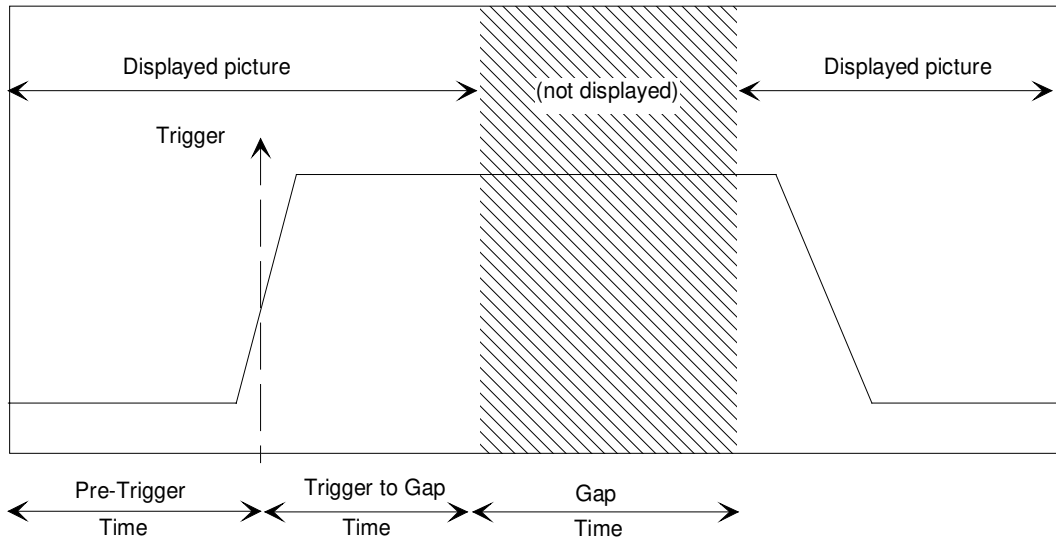

Fig 4-13 Trace blanking in sweep mode.– Gap Sweep

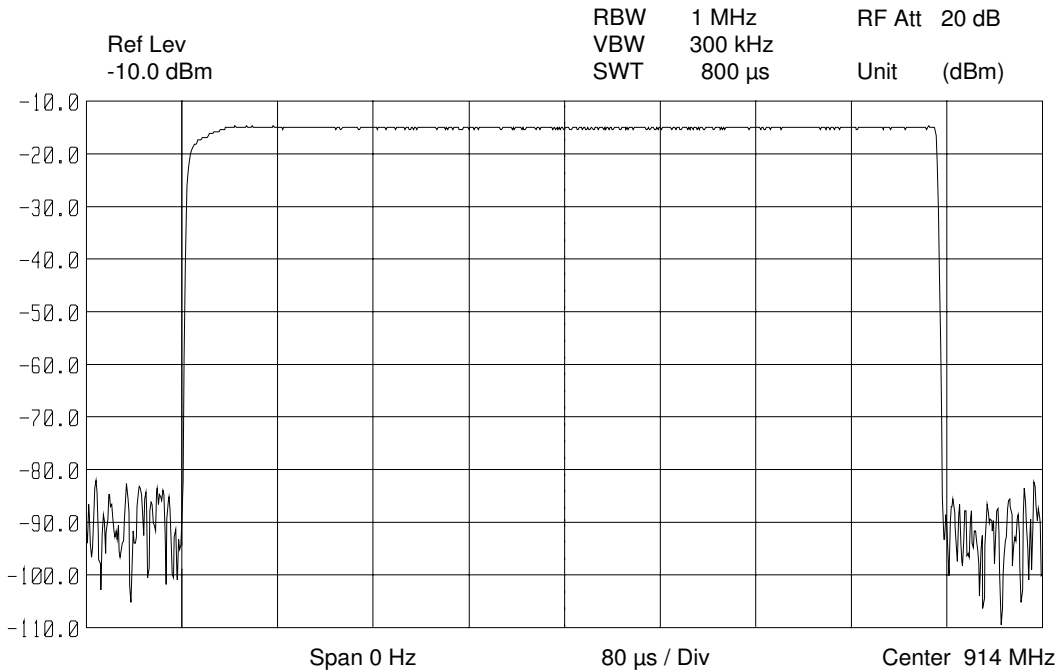

Fig. 4-14 Display of a burst without gaps

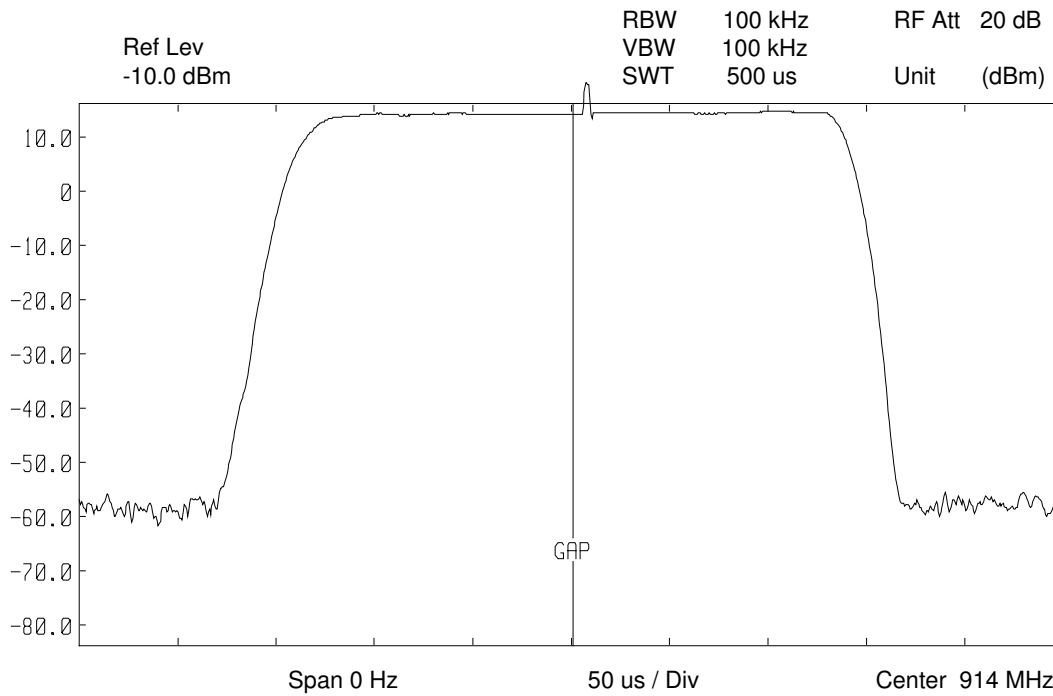

Fig. 4-15 Display of a burst with a gap

The *GAP SWEEP* measurement is activated by the *GAP SWEEP ON/OFF* softkey. The mode settings are made in the *GAP SWEEP SETTINGS* sub-menu.

SWEEP SWEEP menu:



The *GAP SWEEP ON/OFF* softkey switches the *GAP SWEEP* measurement on/off.

The softkey is available only in the time domain.

*SWEEP SWEEP-GAP SWEEP SETTINGS* sub-menu:

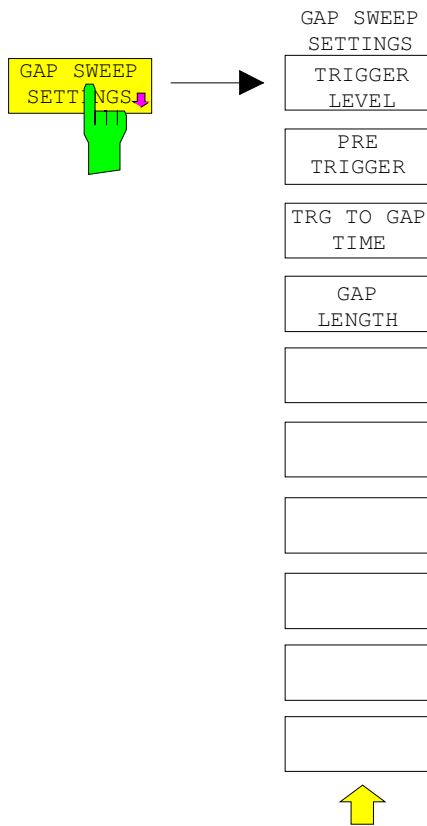

The *GAP SWEEP SETTINGS* softkey opens a sub-menu in which the parameters for the gap can be selected.

The trigger time corresponds to  $t = 0$ . Events occurring before the trigger time are displayed in negative time.



The *TRIGGER LEVEL* softkey activates the entry window for trigger level.

This function corresponds to the setting in the trigger menu.



The *PRE TRIGGER* softkey activates the entry window for the pre-trigger time. The pre-trigger time defines the separation between the left edge of the grid and the trigger time ( $t = 0$ ).

At the same time the gap sweep is switched on (exception : entry  $t = 0$ )

The minimum pre-trigger time is  $-100$  s, the maximum pre-trigger time depends on the sweep time and the trigger to gap time (max = 100 s). The maximum resolution is 50 ns.

The *PRE TRIGGER* value can be entered in the frequency domain (span  $> 0$ ) as well as in the time domain and *GAP SWEEP OFF* mode. It is, however, only effective when the *GAP SWEEP* measurement is enabled.



The *TRG TO GAP TIME* softkey opens an entry window for defining the distance between the trigger time and the beginning of the gap.

The *TRIGGER TO GAP TIME* range is from 0 to 100 s with a resolution of 50 ns. The length of the gap is defined by *GAP LENGTH*. If the *GAP LENGTH* is 0 s, the entered value of *TRG TO GAP TIME* is only stored.

The *TRG TO GAP TIME* value can be entered in the frequency domain (span > 0) as well as in the time domain and for the *GAP SWEEP OFF* mode. It has an effect on the measurement only after the *GAP SWEEP ON* is switched on.

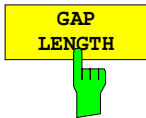

The *GAP LENGTH* softkey activates the entry window for defining the gap within which the measurement values are to be blanked.

The beginning of the gap is defined by *TRG TO GAP TIME*.

*GAP LENGTH* can be set to values between 150 ns and 100 s in 1/2/3/5 steps. The resolution is dependent upon the absolute value of the gap length:

Gap length	Resolution
150 ns - 50 $\mu$ s	50 ns
50 - 500 $\mu$ s	500 ns
0.5 - 5 ms	5 $\mu$ s
5 - 50 ms	50 $\mu$ s
50 - 500 ms	500 $\mu$ s
0.5 - 5 s	5 ms
5 - 50 s	50 ms
50 - 100 s	500 ms

The *GAP LENGTH* value can be entered in the frequency domain (span > 0) as well as in the time domain and for the *GAP SWEEP OFF* mode. It has an effect on the measurement only after the *GAP SWEEP ON* is switched on.



## Vector Analyzer Mode

The Vector Signal Analyzer in the FSIQ allows the analysis of analog and digital modulations. For this purpose, the FSIQ samples the IF signal which is band-limited by the resolution bandwidth (RBW) and mixes it into the complex baseband. The real and imaginary section of the signal is then digitally filtered and further processed in digital signal processors. The complex baseband contains the whole signal information which can be evaluated according to the different criteria.

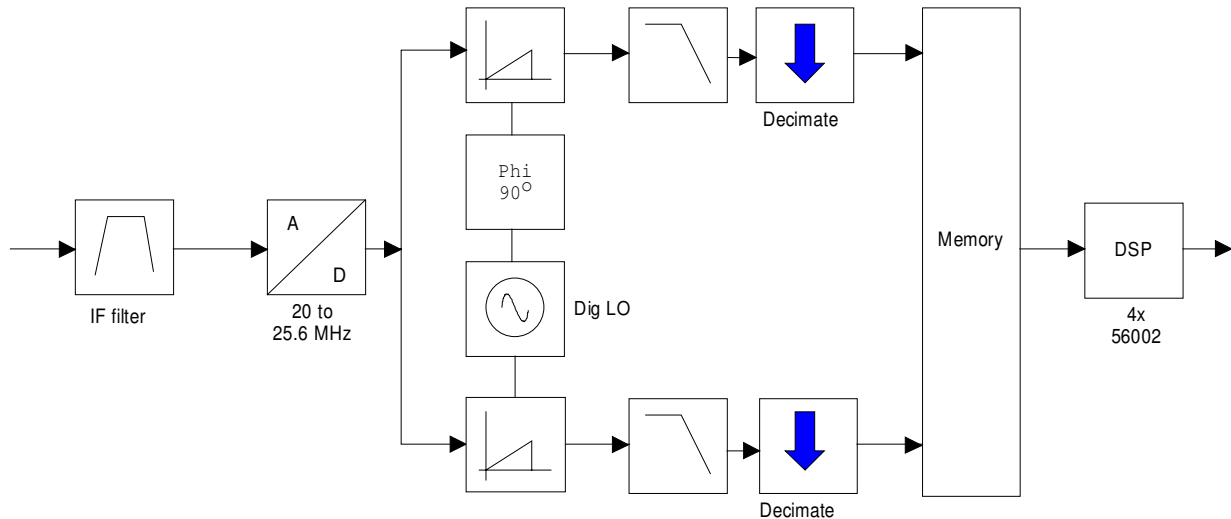

Fig. 4-16 Block diagram of FSIQ vector signal analyzer

Three types of analysis are distinguished in the vector signal analyzer:

- In the analog demodulation mode, the amplitude (AM), frequency (FM) or phase (PM) demodulated signal is represented as a function of time. Alternatively, display of a table containing the numerical demodulation parameters can be selected (*RESULT DISPLAY*).
- For digitally modulated signals, the most commonly used demodulators are available to evaluate the modulation parameters.
- In the *DIGITAL DEMODULATION* mode, the magnitude of the non-demodulated signal can also be displayed (*MAGNITUDE CAP BUFFER*).

The vector analyzer mode is activated in the *CONFIGURATION MODE* menu (See section: "Selecting the Operating Mode" - *MODE* key)

## Selecting the Operating Mode

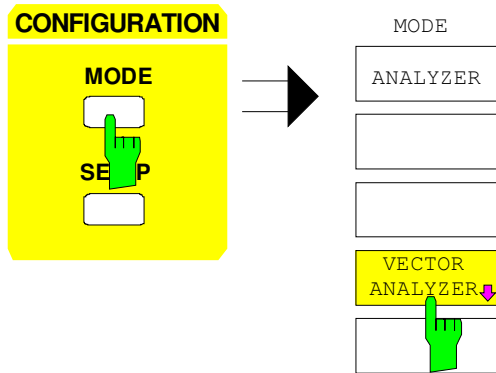

The *MODE* key calls up the menu for selecting the operating mode.

The type of analysis is selected in the *VECTOR ANALYZER* sub menu.

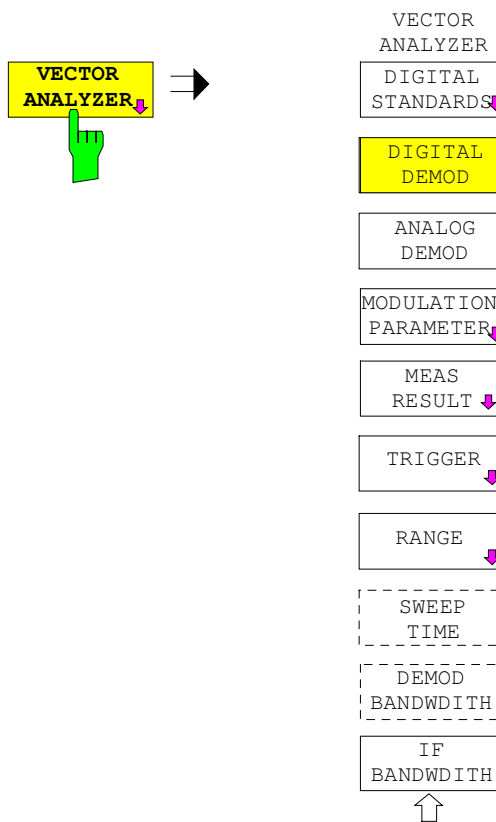

The *VECTOR ANALYZER* softkey calls up a submenu. The specific settings for the vector analyzer are entered into this submenu.

The menu for the test parameter settings lying below these keys (*FREQUENCY*, *LEVEL*, *MARKER*, *TRACE*, *COUPLING*, *TRIGGER*) are adapted to the specific capabilities of the vector signal analyzer.

The *DIGITAL STANDARDS*, *DIGITAL DEMOD* and *ANALOG DEMOD* softkeys are selectors with which the required type of analysis is set.

The *MODULATION PARAMETER* softkey sets the required modulation parameters for the demodulation of digitally modulated signals.

The *MEAS RESULT* softkey calls up a submenu in which the required evaluation of the selected type of analysis is set. For digital demodulation, for example, this is the evaluation of the signal itself or the reference signal, I/Q or vector errors etc.

The *TRIGGER* softkey calls up a menu equal to the *SWEEP TRIGGER* menu.

The *RANGE* softkey calls up the same menu called by the *RANGE* key in the *LEVEL* key group.

The *IF BANDWIDTH* softkey calls up a submenu in which the analog IF Bandwidth is set.

**Note:** *If two displays (screen A and screen B) are opened after switch-on of the vector signal analysis, the vector analyzer mode is only set for the display activated for entry (marked at the top right corner of diagram). For the other display, the previous settings remain valid. Storage and display of measured values is sequential: first in the upper and then in the lower display.*

The configuration of the vector analysis is performed in four steps:

1. Setting the type of analysis: Analog demodulation of the signal (*ANALOG DEMOD*), general demodulation of digitally modulated signals (*DIGITAL DEMOD*) or setting as required by a specific transmission mode (*DIGITAL STANDARDS*, in this case, step no. 2 can be skipped).
2. Selecting the modulation parameters (*MODULATION PARAMETER*).
3. Selecting the required measurement results (*MEAS RESULT*).
4. Selecting the output format for measurement results (*RESULT DISPLAY*).

## Analog Demodulation Methods

With amplitude, frequency and phase demodulation, the FSIQ provides all demodulation methods which can be used for analog RF carrier modulation or which may impair a carrier. The bandwidth used for demodulation depends on the demodulation bandwidth selected. Make sure that the entire modulation spectrum is included in the demodulation bandwidth. Otherwise, signal distortions that impair the modulation will be caused by analog prefiltering with the IF filters of the FSIQ and digital filtering for suppression of aliasing products due to sampling or data reduction. Correct measurement of the modulation parameters will no longer be possible.

For correct demodulation make sure that only the signal to be analyzed is located within the demodulation bandwidth (*DEMOD BANDWIDTH*) of the FSIQ. Otherwise, the demodulation would be impaired by adjacent signals. Spectral components of adjacent signals should be at a distance of at least 1.285 times the (demodulation bandwidth)/2 from the center frequency (= carrier frequency).

Depending on the demodulation bandwidth set (*DEMOD BANDWIDTH*), two modes of demodulation are provided:

With *DEMOD BANDWIDTH* ≤ 200 kHz real-time (*REAL TIME ON*) or offline (*REAL TIME OFF*) demodulation can be selected, with *DEMOD BANDWIDTH* > 200 kHz only offline demodulation is possible.

Real-time and offline demodulation differ as follows:

- Real-time demodulation (*REAL TIME ON*)
  - The bandwidth of the demodulated signal can be reduced in the AF region using switchable highpass, lowpass or weighting filters (CCITT or C-message filter) to enable spurious modulation measurements for analog radio systems in line with the standard; moreover, deemphases can also be switched on for FM (and AM). A deemphasis, if switched on, has an effect on the audio signal (provided via loudspeaker or headphones connector) **and** on the result display or on the audio signal only. The switchable filters, however, always have an effect on the display and AF/loudspeaker output.
  - The demodulated signal can be monitored via the built-in loudspeaker or via the headphones output.
  - In addition, the demodulated signal (parts of it) or a summary of numerical modulation parameters can be displayed on the screen. With the aid of the split screen display, the demodulated signal and the summary of numerical modulation parameters can be displayed at the same time.
- Offline demodulation (*REAL TIME OFF*)
  - The demodulation is not carried out continuously, but in blocks, ie a data block is written into the memory and then demodulated and displayed:
  - The measurement result displayed on the screen is the time function of the demodulated AF signal and/or a summary of numerical modulation parameters.
  - The internal loudspeaker, the headphones output is switched off.
  - No highpass filters and no weighting filters can be activated. Deemphases cannot be switched on.
  - To restrict the noise bandwidth, AF lowpass filters can be selected, standardized to the demodulation bandwidth (cutoff frequency = 5, 10 or 25 % of demodulation bandwidth).

The two demodulation modes provided are designed for the following main applications:

- Real-time demodulation (*REAL TIME ON*) for demodulation bandwidths up to max. 200 kHz for modulation measurements to the standard on analog radio systems and also for monitoring.
- Offline demodulation (*REAL TIME OFF*), especially for measurement of transients (e.g. frequency settling of oscillators and synthesizers).

The following diagram shows the menus which permit to set the parameters and the result display with analog demodulation.

Menu: CONFIGURATION MODE - VECTOR ANALYZER - ANALOG DEMOD (with REAL TIME ON)

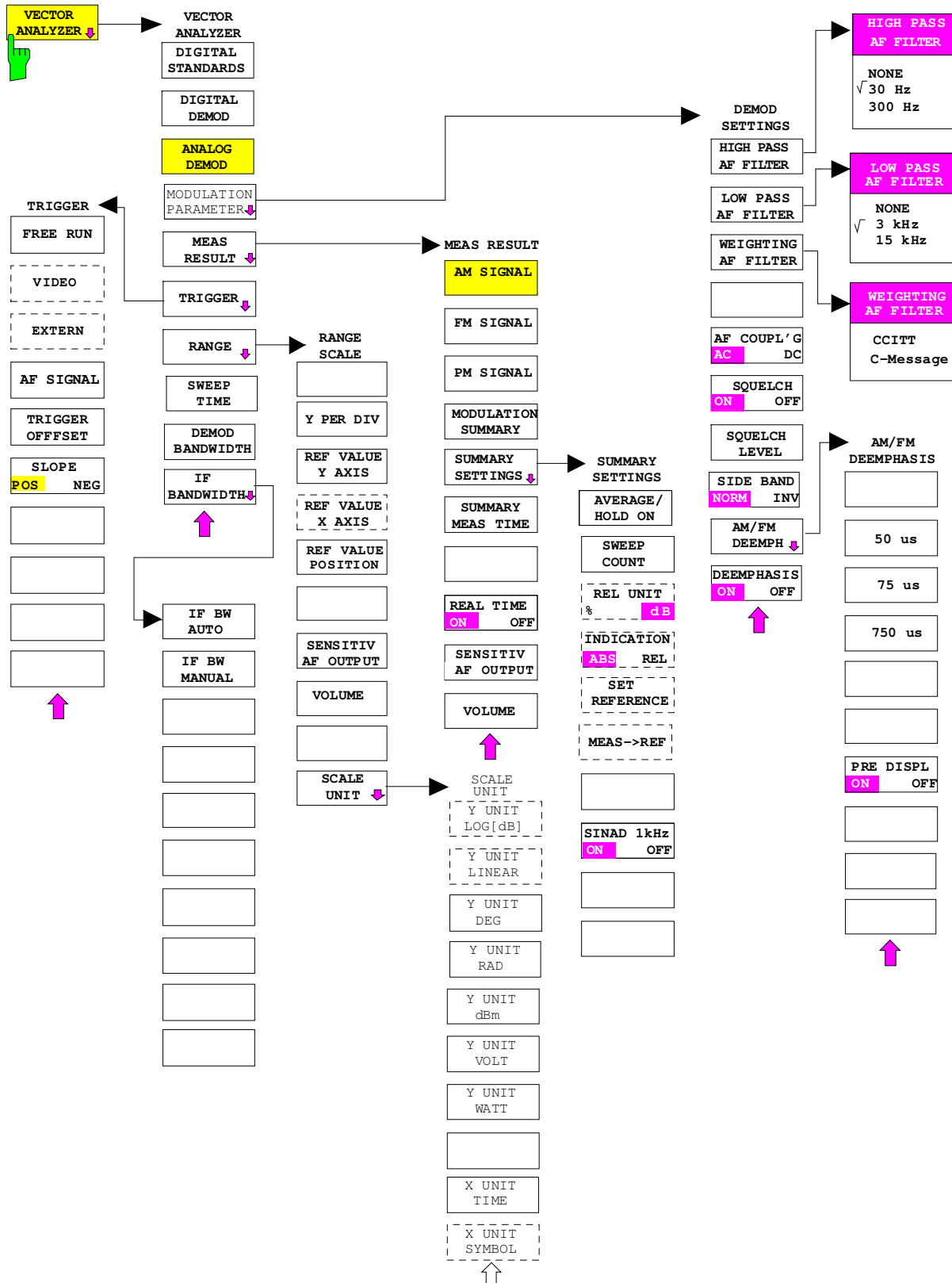
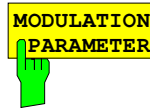

Fig. 4-17 Menu structure for setting the demodulation with analog-modulated signals



The *ANALOG DEMOD* softkey activates the analog demodulation mode. The demodulation (AM, FM and PM demodulation) is performed in parallel. The type of demodulation or display (AM, FM or PM or numerical display) is set under MEAS RESULT.



See section "Selecting the Modulation Parameters"

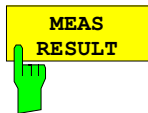

See section "Selecting the Audio Signal"

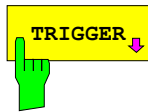

See section "Triggering with Analog Demodulation - Softkey *TRIGGER* or Hardkey *TRIGGER*"

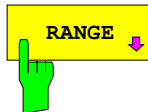

See section "Setting the Display Range and the Scaling - Softkey *RANGE* or Hardkey *RANGE*"



See section "Sweep Menu with Analog Demodulation - Softkey *SWEEP TIME* or Hardkey *SWEEP*"



The *DEMOD BANDWIDTH* softkey calls up a field for entering the demodulation bandwidth.

The spectrum to be demodulated should be located completely within this bandwidth, if possible (check in spectrum analyzer mode) in order to avoid demodulation distortions. Spurious signals outside the spectrum to be demodulated do not cause any demodulation errors if the frequency spacing with respect to the tuning frequency is  $(CENTER\ FREQUENCY) \pm \Delta f \geq 1.28 \times (DEMOD\ BANDWIDTH)/2$ .

The *DEMOD BANDWIDTH* can be set in steps of 1, 2, 3 and 5 in the range from 5 kHz to 5 MHz or, if different entries are made, it will be rounded off to the nearest possible step.

With FM demodulation the maximum deviation that can be measured is restricted to  $(0.4 \times DEMOD\ BANDWIDTH)$ .

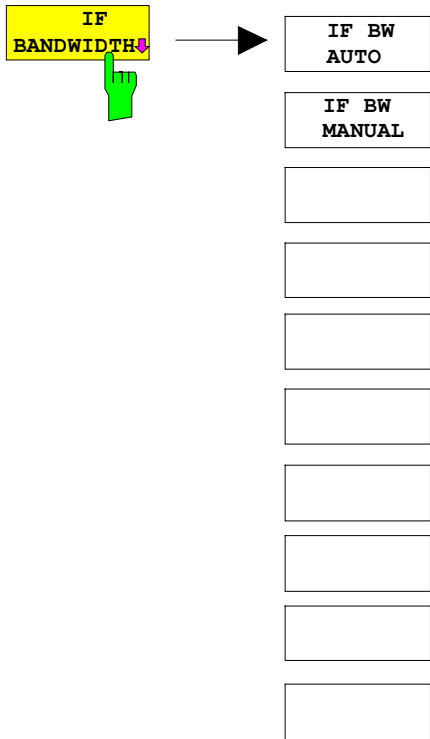

The *IF BANDWIDTH* softkey opens up a submenu where the bandwidth of the analog IF filters is set (corresponds to the resolution bandwidth in spectrum analyzer mode).



The *IF BW AUTO* softkey is used to set the IF bandwidth to the maximum possible value 10 MHz (irrespective of the demodulation bandwidth).

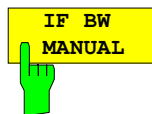

The *IF BW MANUAL* softkey permits to restrict the analog IF bandwidth specifically.

To avoid modulation distortions and errors it is recommended to set the IF bandwidth as large as possible (*IF BANDWIDTH*  $\geq 5 \times$  *DEMODO BANDWIDTH*).

If spurious signals are to be suppressed outside the useful modulation spectrum, *IF BW MANUAL* can be used to reduce the IF bandwidth down to a value equal to the demodulation bandwidth.

Possible input values:  $\geq$  *DEMODO BANDWIDTH*, 5 kHz to 10 MHz.

## Selecting the Modulation Parameters

Submenu: CONFIGURATION MODE - VECTOR ANALYZER - ANALOG DEMOD

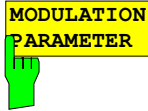

The *MODULATION PARAMETER* softkey calls up a submenu which permits to select the modulation parameters for analog demodulation.

Which menu is displayed depends on whether real-time demodulation is activated (*REAL TIME ON*) or not (*REAL TIME OFF*).

**REAL TIME ON:**

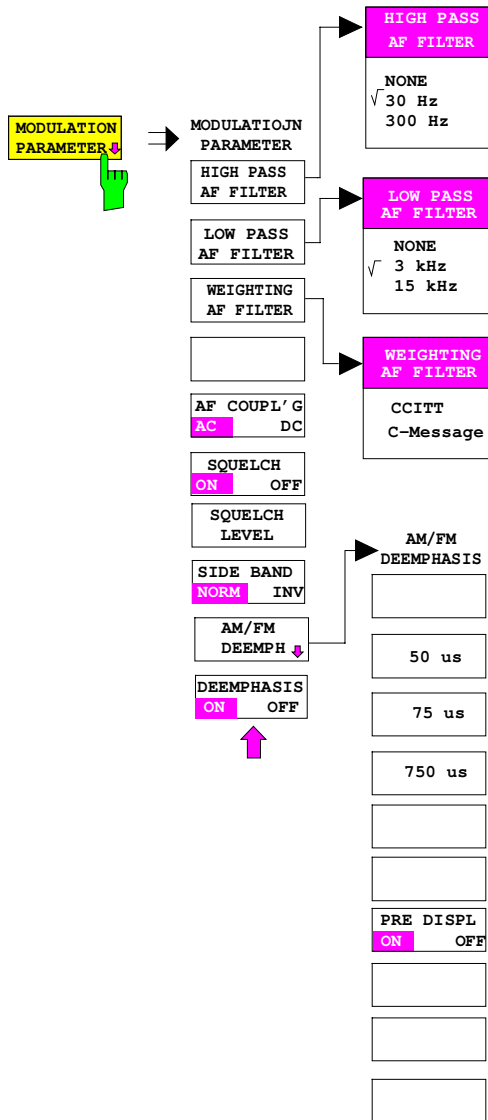

**REAL TIME OFF:**

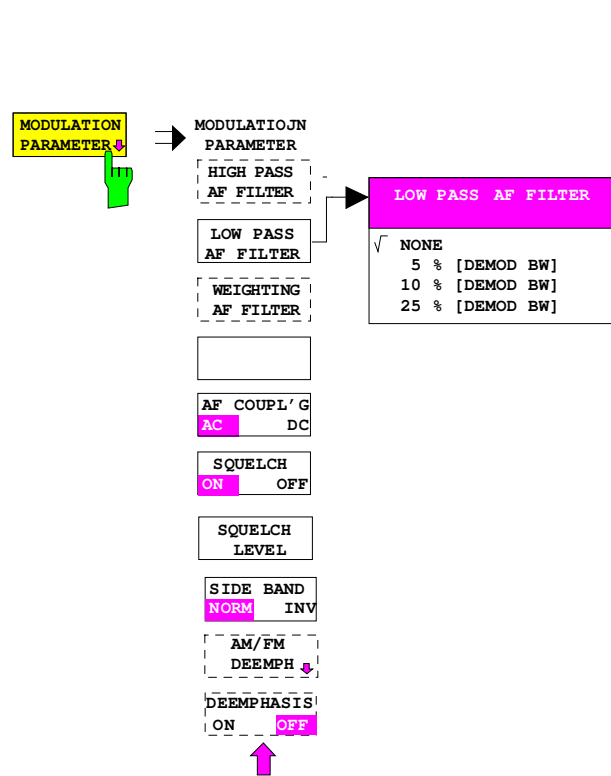

**Note:** The dashed softkeys cannot be activated in the operating mode selected



The possible selection of the filter depends on whether real-time demodulation is activated or not (*REAL TIME ON/OFF*).

**REAL TIME ON:**

The softkeys *HIGHPASS AF FILTER* and *LOW PASS AF FILTER* call up input fields which permit to select highpass or lowpass filters for restriction of the AF bandwidth.

HIGH PASS  
AF FILTER



LOW PASS  
AF FILTER



HIGH PASS  
AF FILTER  
NONE  
√ 30 Hz  
300 Hz

LOW PASS  
AF FILTER  
NONE  
√ 3 kHz  
15 kHz

If *REAL TIME ON* is activated, the opposite highpass and lowpass filters as well as standard weighting filters can be selected.

If AF filters are switched on, they act on the display and AF output or loudspeaker output.

The 3-dB cutoff frequencies are indicated for the highpass and lowpass filters.

1st-order highpass filters (6 dB/octave slope) and 2nd-order lowpass filters (12 dB/octave slope) are used.

WEIGHTING  
AF FILTER



The *WEIGHTING AF FILTER* softkey calls up the input field for selection of a standard weighting filter.

The CCITT filter (CCITT P.53) and the C-message filter are used as weighting filters according to US standard.

WEIGHTING  
AF FILTER  
CCITT  
C-Message

When one of the two weighting filters is activated, the demodulation bandwidth is automatically switched to 30 kHz. If the demodulation bandwidth is subsequently changed with active weighting filter, the latter is switched off.

**REAL TIME OFF:**

If *REAL TIME OFF* is selected, only lowpass filters can be activated for restriction of the noise bandwidth.

LOW PASS AF FILTER  
√ NONE  
5 % [DEMODO BW]  
10 % [DEMODO BW]  
25 % [DEMODO BW]

The filter bandwidth (-3 dB) can be selected in % of the demodulation bandwidth.

5, 10 or 25 % of the demodulation bandwidth are possible.

The filters are designed as 2nd-order Butterworth filters (12 dB/octave slope).

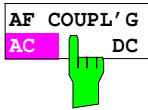

The *AF COUPL'G AC/DC* softkey switches the AF analysis stages after the demodulators to DC or AC voltage coupling.

FM:

With FM, AC coupling (*AF COUPL'G AC*) is achieved by determining the center frequency of the signal to be measured and correcting the demodulated signal accordingly.

With *AF COUPL'G DC* the center frequency of the FSIQ is assumed as the carrier frequency, and no frequency correction is performed. The AF signal is DC-coupled.

PM:

With PM, AC coupling (*AF COUPL'G AC*) is achieved by estimating both the frequency offset and the phase offset and setting them to zero.

Only with **REAL TIME OFF**:

With *AF COUPL'G DC*, if the center frequency of the signal to be measured deviates, the phase varies with a period corresponding to the difference between applied and set center frequency (0 to 360°).

If the frequency is consistent (e.g. in the case of synchronization to a common reference frequency) the phase is constant on an offset in the range from 0 to 360°. The PM demodulator is DC-coupled.

AM:

As a mere envelope demodulator, the AM demodulator is insensitive to frequency errors as long as carrier and sidebands are within the set frequency display range.

In the case of AC coupling (*AF COUPL'G AC*), the demodulated AF signal is standardized to the DC voltage (corresponds to the average carrier value) and the DC component is removed.

The amplitude of the AF signal is directly proportional to the AM modulation depth.

In the case of DC coupling (*AF COUPL'G DC*), the amplitude of the demodulated signal is proportional both to the AM depth and to the level, there is no standardization to the average carrier value. The measured value is displayed in absolute level units.

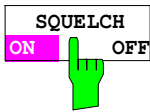
**REAL TIME ON:**

The *SQUELCH ON* softkey mutes the loudspeaker or headphones output provided that the level falls below a threshold that can be entered under *SQUELCH LEVEL*. The trace of the demodulated signal is also set to zero at this point in time. The muting circuit responds with a delay that is designed such that a signal modulated with  $\geq 30$  Hz AM does not cause the circuit to respond in a modulation low status.

Loudspeaker or headphones output are only active if real-time demodulation is selected.

**REAL TIME OFF:**

With *MEAS RESULT: AM-*, *FM SIGNAL* or *:PM SIGNAL* the frequency or phase deviation is set to zero when the value falls below the squelch. The muting circuit responds without delay, which is why it is suitable for transient measurements in particular.

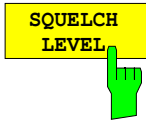

*SQUELCH LEVEL* permits to enter an absolute level in the unit dBm, below which the *SQUELCH* function is activated (only with *SQUELCH ON*).

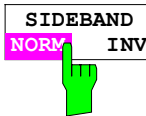

The softkey *SIDEBAND INV (INVERTED)* demodulates and inverts the signal received.

Thus, with FM or PM demodulation, a receive signal with increasing frequency at the FSIQ input leads to a falling AF signal.

Default status is *SIDEBAND NORM* (normal): A receive signal with increasing frequency at the FSIQ input leads to an increasing AF signal.

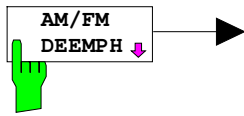

AM/FM  
DEEMPHASIS







PRE DISPL  
ON OFF







PRE DISPL  
ON OFF



**REAL TIME ON** only

The *DEEMPHASIS ON/OFF* softkey switches the demphasis selected under *AM/FM DEEMPHASIS* on or off.

In the default status, the deemphasis is switched off.

**REAL TIME ON** only

The *AM/FM DEEMPH* softkey opens the submenu in which a deemphasis can be selected for FM (or AM) demodulation (An AM deemphasis is prescribed in a few regulations for measurement of synchronous amplitude modulation on FM transmitters.).

Deemphases with the time constants 50  $\mu$ s, 75  $\mu$ s (used for radio broadcasting) and 750  $\mu$ s (used for radio communication) are provided.

If switched on, the deemphasis acts on the audio output.

**REAL TIME ON** only

The *50us*, *75 us* and *750 us* softkeys select the time constant of the deemphasis.

The default setting is 50  $\mu$ s.

**REAL TIME ON** only

The *PRE DISPL ON/OFF* softkey switches on or off the effect of the deemphasis to the result display.

Via the function *PRE DISP ON* (PRE DISPLAY ON) the effect of the deemphasis can also be extended to the result display to enable spurious modulation measurements complying with the standard.

To be able to measure the correct deviation of the signal applied in spite of the corrected audio signal, the active deemphasis can be switched off via *PRE DISP OFF* for the result display.

### Selecting the Audio Signal

Submenu: CONFIGURATION: MODE - VECTOR ANALYZER - ANALOG DEMOD

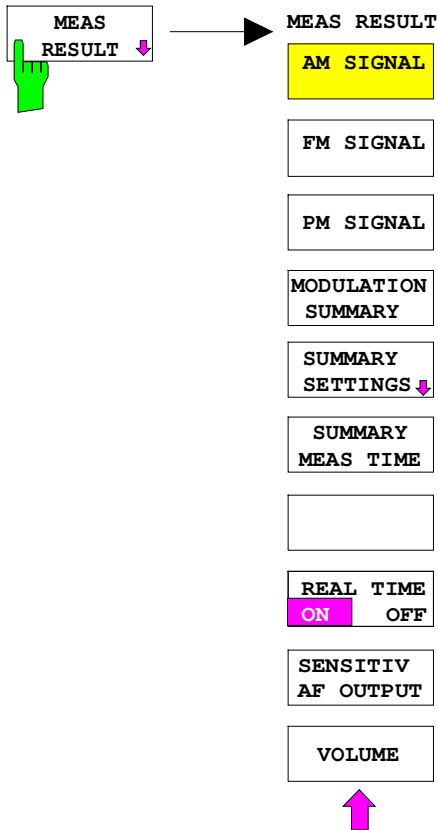

The *MEAS RESULT* softkey opens up a submenu for selection of the AM, FM, or PM demodulated audio signal (display and audio output).

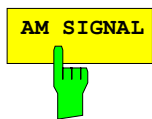

The *AM SIGNAL* softkey is used to display the AM-demodulated time signal provided that *MODULATION SUMMARY* is not active. If *MODULATION SUMMARY* is active, the modulation parameters will be numerically displayed with main signal AM (see *MODULATION SUMMARY*).

The AM-demodulated signal is applied to the audio output (if **REAL TIME ON**).

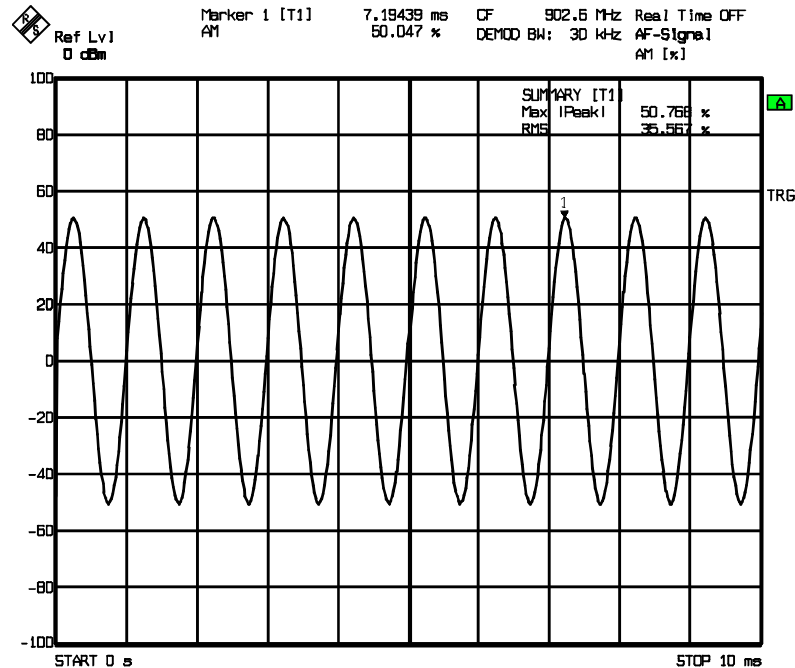

The *FM SIGNAL* softkey displays the FM-demodulated time signal provided that MODULATION SUMMARY is not active. If MODULATION SUMMARY is active, the modulation parameter will be numerically displayed with main signal FM (see MODULATION SUMMARY).

The FM-demodulated signal is present at the audio output (in the case of real-time demodulation).



The *PM SIGNAL* softkey displays the PM-demodulated time signal provided that MODULATION SUMMARY is not active. If MODULATION SUMMARY is active, the modulation parameter will be numerically displayed with main signal PM (see MODULATION SUMMARY).

In the case of **REAL TIME ON** the PM-demodulated signal is present at the audio output.

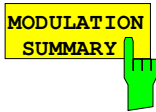

The *MODULATION SUMMARY* softkey (on/off switch) switches from the display of the audio signal versus time to the summary of the numeric modulation parameters.

Of the main signal in question the positive and negative peak modulation value, peak-to-peak value as well as the rms value are displayed with absolute display (see *SUMMARY SETTING*) (except for AM DC: the +-Pk/2 detector does not display the peak-to-peak value, but the average from positive and negative peak value).

Parallel to the main signal, the parameters of the remaining demodulators are also displayed, ie the absolute, arithmetic average from positive and negative peak value.

The following parameters of the demodulation main signal can be displayed in addition:

- SINAD value (1-kHz modulation frequency fixed)
- Audio frequency

In addition, the frequency error as well as the carrier power (to be more exact: power of the unmodulated carrier) and the configuration of the active AF filter and deemphasis are displayed.

**Example: AM signal/REAL TIME ON:**

Ref Lvl 10 dBm      CF 978.3 MHz      REAL TIME ON  
 DEMOD BW: 100 kHz      MOD SUMMARY AM  
 ANALOG DEMOD

MODULATION SUMMARY AM			
AM:	54.20 % +Pk	54.68 -Pk	
	54.44 % $\pm$ PK/2	33.3 % RMS	
SINAD 1 kHz:	35.1 dB		
AUDIO FREQ:	1.001 kHz		
FREQ ERROR:	101.1 Hz		
CARR PWR:	7.88 dBm		
FILTER:	HP 30 Hz	LP 3 kHz	DEEMPH OFF
FM:	1.031 kHz $\pm$ PK/2		
PM	1.011 rad $\pm$ PK/2		

**Example: AM signal/REAL TIME OFF:**

Ref Lvl 10 dBm      CF 978.3 MHz      REAL TIME OFF  
 DEMOD BW: 100 kHz      MOD SUMMARY AM  
 ANALOG DEMOD

MODULATION SUMMARY AM			
AM:	54.20 % +Pk	54.68 -Pk	
	54.44 % $\pm$ PK/2	33.3 % RMS	
SINAD 1 kHz:	--		
AUDIO FREQ:	1.001 kHz		
FREQ ERROR:	101.1 Hz		
CARR PWR:	7.88 dBm		
FILTER:	HP --	LP 10 % [DEMOM BW]	DEEMPH OFF
FM:	1.031 kHz $\pm$ PK/2		
PM	1.011 rad $\pm$ PK/2		

**Example: FM signal, relative measurement:**

In the case of relative measurement, the absolute arithmetic average from positive and negative peak value as well as the rms value of the main signal are also displayed. The separate display of positive and negative peak value is omitted. Instead, the reference value is additionally displayed as peak and rms value.

Ref Lvl 10 dBm  
 CF 978.3 MHz  
 DEMOD BW: 100 kHz  
 REAL TIME ON  
 MOD SUMMARY FM  
 ANALOG DEMOD

MODULATION SUMMARY FM			
FM RELATIV:	-45.21 dB $\pm$ PK/2	-58 dB RMS	
REF Deviation:	10.00 kHz Pk	7.07 kHz RMS	
SINAD 1 kHz:	OFF		
AUDIO FREQ:	1.001 kHz		
FREQ ERROR:	101.1 Hz		
CARR PWR:	7.88 dBm		
FILTER:	CCITT	DEEMPH 50us	PRE DISP ON
AM:	1.031 % $\pm$ PK/2		
PM	1.011 rad $\pm$ PK/2		

**Example: AVERAGE/ HOLD ON:**

Ref Lvl 10 dBm  
 CF 978.3 MHz  
 DEMOD BW: 100 kHz  
 REAL TIME ON  
 MOD SUMMARY FM  
 ANALOG DEMOD

MODULATION SUMMARY FM			
FM RELATIV:	-45.21 dB $\pm$ PK/2 HLD	-58 dB RMS AV	
REF Deviation:	10.00 kHz Pk HLD	7.07 kHz RMS AV	
SINAD 1 kHz:	OFF		
AUDIO FREQ:	1.001 kHz AV		
FREQ ERROR:	101.1 Hz AV		
CARR PWR:	7.88 dBm		
FILTER:	CCITT	DEEMPH 50us	PRE DISP ON
AM:	1.031 % $\pm$ PK/2		
PM	1.011 rad $\pm$ PK/2		



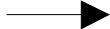
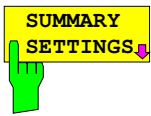

**SUMMARY SETTINGS**

AVERAGE/  
HOLD ON

SWEEP  
COUNT

REL UNIT  
% dB

INDICATION  
ABS REL

SET  
REFERENCE

MEAS->REF

SINAD 1kHz  
ON OFF

The *SUMMARY SETTINGS* softkey opens up the submenu for configuration of the summary of all numeric measured values.

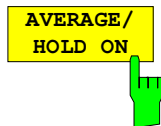

The *AVERAGE/HOLD ON* softkey permits to average all display values obtained in the number of sweeps defined under Sweep Count except for the Pk values with Single Sweep (the display *No of Measurements* appears in the modulation summary, *AV* is indicated after the units).

The Pk values are displayed in the Pk Hold mode (display *Hold* after the Pk units).

In the case of a restart, the Pk values and AV values are reset by means of Single Sweep or by switching *TRACE AVERAGE/HOLD ON* off and on.

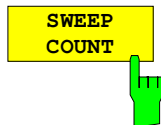

The *SWEEP COUNT* softkey sets the number of sweeps used to determine the average or PK Hold values (see also the corresponding softkey in analyzer mode)).



The *REL UNIT dB/%* softkey softkey selects the unit (% and dB) with relative display (*INDICATION REL*) .

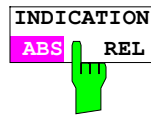

The *INDICATION ABS REL* softkey switches between absolute (*ABS*, default setting) and relative display (*REL*). The reference value for the relative display can be entered by means of *SET REFERENCE* or *MEAS→REF*.

Only the main signal can be displayed in relative mode, the other signals are indicated in absolute display in any case.

For relative indication, the default unit is dB and can be changed from dB to % via the softkey *REL UNIT%*.

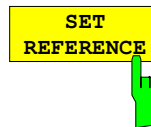

The *SET REFERENCE* softkey opens up a field for input of a reference modulation (for main signal).

The peak value of the modulation is to be entered. The rms reference value will then be peak value/ $\sqrt{2}$ .

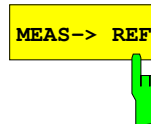

The *MEAS→REF* softkey is used to represent the current absolute measured values of the main modulation signal (+PK/2 and RMS) as reference values for the relative display.

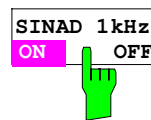

**REAL TIME ON** only.

The *SINAD 1 kHz ON* softkey activates the SINAD measurement for the main modulation signal.

Irrespective of the signal applied, the main modulation signal is compared with the main modulation signal which is filtered by a 1-kHz notch filter. The display unit is dB.

When a signal modulated with 1 kHz is applied, the SINAD value is thus displayed correctly. Default setting is *SINAD 1 kHz OFF*.

With **REAL TIME OFF** (no real-time demodulation) no SINAD measurement is possible, the softkey cannot be operated.

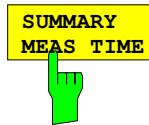
**REAL TIME ON** only.

The *SUMMARY MEAS TIME* softkey opens up a field for entering the measuring time (as well as the measured value update rate) for the numerical measured values of the modulation summary.

Default setting is 100 ms

Thus, with a stationary modulation frequency of 30 (typ. 20) Hz, peak values and rms value can be determined correctly.

The measured values are updated at least every 100 ms, ie max. 10x/s.

With a measuring time of 1 s and a stationary modulation frequency of up to 5 Hz peak values and rms values can be determined correctly.

The measured values are updated every second, ie max. 1x/s.

In both cases, the peak values are measured continuously, the time constant of the rms detector is adapted accordingly.

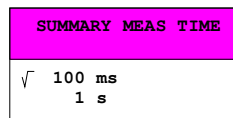

The *REAL TIME ON/OFF* softkey switches real time demodulation on or off.

For demodulation bandwidths  $\leq 200$  kHz, real-time demodulation can be switched on or off. (Off is default status).

Demodulation bandwidths  $> 200$  kHz do not allow real-time modulation.

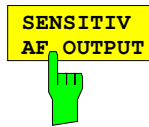
**REAL TIME ON** only.

The *SENSITIV AF OUTPUT* softkey sets the scaling of the AF output for real-time modulation. Depending on *MEAS RESULT* (AM, FM or PM signal), an input field appears, where the modulation amplitude is to be entered so that the dynamic range of the AF output is fully utilized.

(Peak voltage 1V):

m[%] FOR FULL SCALE SIGNAL
20
FM DEV FOR FULL SCALE SIGNAL
100
PM DEV FOR FULL SCALE SIGNAL
1

*SENSITIV AF OUTPUT* also has an effect on the volume of the loudspeaker and on the headphones output.

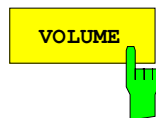
**REAL TIME ON** only

The *VOLUME* softkey sets the volume of the demodulated signal (loudspeaker and headphones output) according to the slope of the AF output.

With **REAL TIME OFF** (no real-time demodulation) the outputs are switched off.

**Note:** *If the modulation depth / deviation is very small, the scaling of the AF output (softkey SENSITIV AF OUTPUT) is to be matched to achieve a usable volume.*

*On the other hand, the modulation depth / deviation must not be greater than the full-scale setting under SENSITIV AF OUTPUT, or a distorted signal will be obtained at the loudspeaker/headphones output even with the volume reduced.*

Triggering with Analog Demodulation - Softkey TRIGGER or Hardkey TRIGGER

Submenu: CONFIGURATION MODE - VECTOR ANALYZER - ANALOG DEMOD

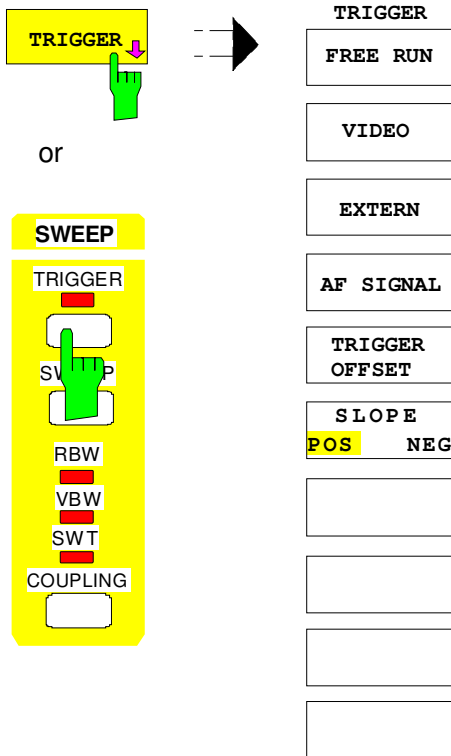

The TRIGGER softkey as well as the TRIGGER hardkey permit to call up the menu for setting the trigger.



The FREE RUN softkey activates a measurement without trigger. After a measurement has been terminated, data acquisition for a new measurement takes place immediately.

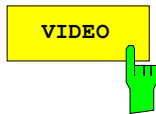

**REAL TIME OFF** only.

The VIDEO softkey starts the measurement by means of the video voltage of the analog path of the spectrum analyzer. For this purpose, the analog video voltage of the spectrum analyzer is analyzed parallel to the vector signal analyzer.

Video triggering is of particular use for frequency settling measurements on synthesizers.

Video triggering requires the trigger threshold to be entered. It is identical with the trigger threshold of the spectrum analyzer. The trigger threshold is entered numerically into the data input field in % of the last grid that was active in spectrum analysis mode.

The appropriate value for the trigger threshold can be determined in the spectrum analysis mode.

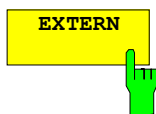

**REAL TIME OFF** only.

The EXTERN softkey activates triggering via an external voltage in the range from - 5 V to + 5 V at the BNC connector EXT TRIGGER / GATE (rear panel). Enter the desired value in the data input field.

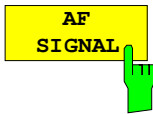

The *AF SIGNAL* softkey opens up a data input field where the level of the AF signal is entered as the trigger level for display of the time signal.

The AF trigger level is entered in %, Hz, deg or rad according to the current demodulation AM, FM or PM (in the case of AM DC in the current absolute level unit).

Triggering on the AF signal is similarly possible with **REAL TIME ON/OFF**.

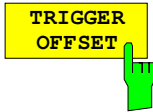

#### **REAL TIME OFF** only

The *TRIGGER OFFSET* softkey opens up an input window for entry of the desired offset with video trigger or external trigger (only with ).

The softkey cannot be operated with **REAL TIME ON** and **REAL TIME OFF** in conjunction with AF trigger.

The *trigger offset* is used to determine the start of data acquisition relative to the trigger event. Both positive values for a trigger delay and negative values for a pretrigger are permissible.

The input is made in absolute time irrespective of the scale selected for the X-axis.

Depending on the demodulation bandwidth, values from 1 $\mu$ s to at least 10 ms are permissible for positive values of the trigger offset (trigger delay). The value range for negative trigger offset values (pretrigger) depends on the sweep time and is maximally half the sweep time.



The *SLOPE POS/NEG* softkey determines the trigger edge for triggering y means of the video signal, AF signal or external trigger.

The measurement run is started on a positive or negative edge of the trigger signal. With free-running trigger (*FREE RUN*), the setting is not of any significance.

## Setting the Display Range and the Scaling - Softkey RANGE or Hardkey RANGE

The menu for setting the range differs from that in the signal analysis mode.

Submenu: *CONFIGURATION MODE - VECTOR ANALYZER - ANALOG DEMOD*

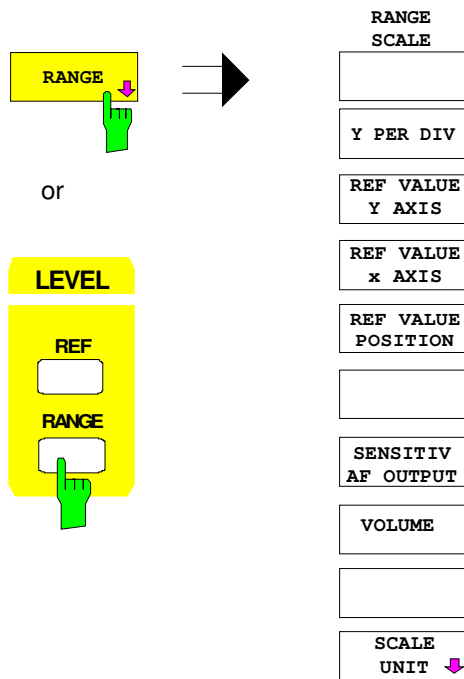

The *RANGE* softkey as well as the *RANGE* hardkey are used to call up a menu, which contains all the parameters important for the vertical axis (y-axis) and the horizontal axis of the screen display of the AF signal, such as reference values, scaling, etc.

In addition, with real-time demodulation, the slope of the AF output as well as the volume of the loudspeaker or headphones connector can be set here.

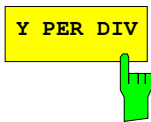

The *Y PER DIV* softkey indicates the vertical scaling in the current unit.

Hz or % are set for AM or FM, respectively. PM permits to choose between the units deg and rad (default status: rad).

For the relative value display of the modulation summary, it is possible to choose between % and dB (default setting dB).



The *REF VALUE Y AXIS* softkey prompts the user to enter the reference value for the Y-axis of the diagram.

The reference value is entered in the respective display unit (see *UNIT*).



The *REF VALUE POSITION* softkey opens up an input window, in which reference value positions deviating from the default setting are set.

*REF VALUE POSITION* determines the position of the reference value. It is normally 50 % when the AF signal is displayed.



The *SENSITIV AF OUTPUT* (sensitivity AF output) softkey is used to set the scaling of the AF output with real-time demodulation. Depending on *MEAS RESULT* (AM, FM, or PM signal), an input field appears, where the modulation amplitude is to be entered at which the dynamic range of the AF output is fully utilized.

(Peak voltage 1V):

m[%] FOR FULL SCALE SIGNAL
20
FM DEV FOR FULL SCALE SIGNAL
100
PM DEV FOR FULL SCALE SIGNAL
1

*SENSITIV AF OUTPUT* also affects the volume of the loudspeaker and the headphones output.

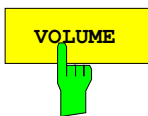

#### **REAL TIME ON** only

The *VOLUME* softkey sets the volume of the demodulated signal (loudspeaker and headphones output) according to the slope of the AF output.

With **REAL TIME OFF** (no real-time demodulation) the outputs are switched off.

**Note:** *If the modulation depth / deviation is very small, the scaling of the AF outputs (Softkey *SENSITIV AF OUTPUT*) is to be matched to achieve a usable volume.*

*On the other hand, the modulation depth / deviation must not be greater than the full-scale setting under *SENSITIV AF OUTPUT*, or a distorted signal will be obtained at the loudspeaker/headphones output even with reduced volume.*



Submenu: CONFIGURATION MODE - VECTOR ANALYZER - ANALOG DEMOD - RANGE

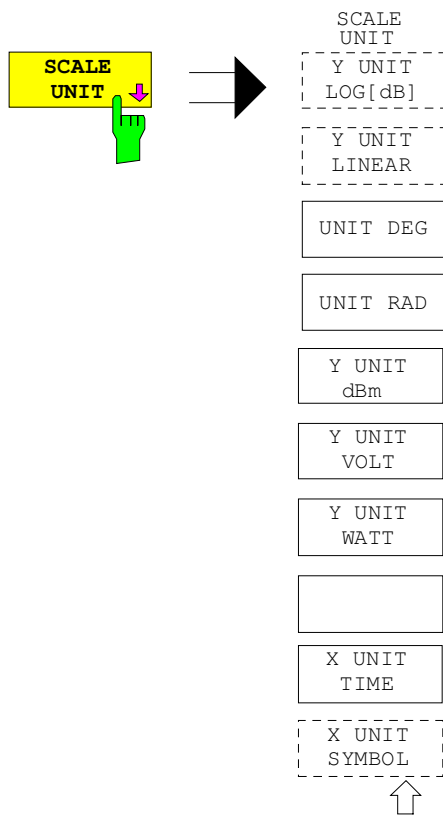

The *SCALE UNIT* softkey calls up a submenu for setting the unit of the Y-axis .

The units offered depend on the signal displayed. If a marker is switched on, the marker results are output in the current scale units.

With *ANALOG DEMODULATION*, the following Y-units are possible according to the type of modulation

AM: AM[%],

FM: Hz,

PM: rad (default setting) or deg.

(With AM and FM, the units cannot be selected).

With time display of the AM signal and *AF COUPL'G DC* selected, the AM-demodulated signal is not standardized, but scaled in absolute levels.

Possible units are dBm, V and W. The default unit is dBm.

## Sweep Menu with Analog Demodulation - Softkey SWEEP TIME or Hardkey SWEEP

Submenu: CONFIGURATION MODE - VECTOR ANALYZER - ANALOG DEMOD

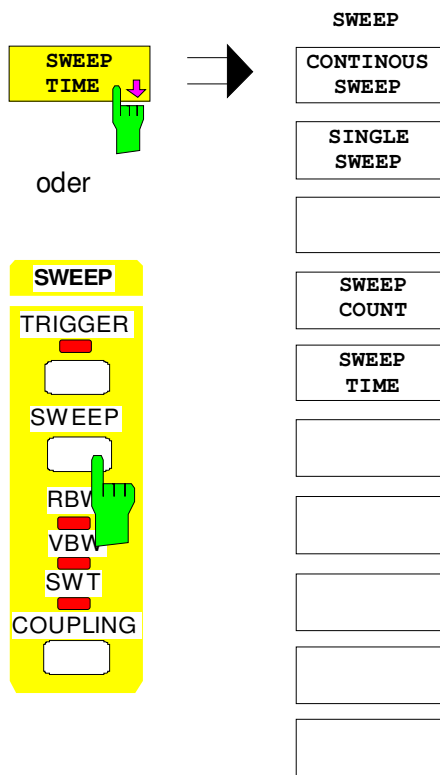

The *SWEEP* key calls up a menu, which permits to determine the type of measurement - single measurement or continuous measurement - and the length of the measurement results to be displayed in terms of time.



The *CONTINUOUS SWEEP* softkey starts a continuous measurement in accordance with the trigger condition and the selected test settings. Triggering is followed by data acquisition first and then by evaluation and display on the screen.

If, with split screen display, vector analysis mode is used for measurement in both windows, the data in the measurement RAM are used for both evaluations.

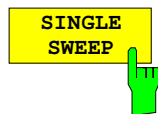

The *SINGLE SWEEP* softkey starts n measurements in accordance with the trigger settings. The number of measurement runs n is determined by means of *SWEEP COUNT*. The measurement stops after n measurements. It can be restarted by pressing the *SINGLE SWEEP* or *CONTINUOUS SWEEP* softkey again.

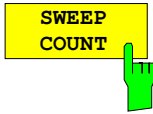

The *SWEEP COUNT* softkey opens up an input field in which the number of measurements is determined for the *SINGLE SWEEP*.

The number of measurements can be selected between 0 and 32767.

If averaging of the measured values is set (*AVG/HOLD ON*, *MODULATION MARKER: RMS* to be found under the *MARKER SEARCH* key), *SWEEP COUNT* also determines the number of measurements used for averaging.

If *SWEEP COUNT* = 0, 10 measured values are always used for floating averaging.

If *SWEEP COUNT* = 1, no averaging takes place.

If *SWEEP COUNT* > 1, the average is taken of the set number of measured values.



*SWEEP TIME* is used to define the time during which the demodulated signal is to be displayed.

The maximum time is determined by the demodulation bandwidth set and the buffer length for the demodulated signal, which is 5000 points with analog demodulation.

Thus, the following settable maximum time is obtained:

$$\text{SWEEP TIME}_{\max} = \frac{5000}{0.8 * (\text{DEMODO\_BW})} \text{ [s]}$$

A minimum of 10 points can be displayed, which means for the minimum settable time:

$$\text{SWEEP TIME}_{\min} = \frac{10}{0.8 * (\text{DEMODO\_BW})}$$

Example:

With Demod BW 1kHz, the maximum and minimum time scale is as follows:

$$\text{TIME/DIV}_{\max} = 6.25 \text{ s}$$

$$\text{TIME/DIV}_{\min} = 12.5 \text{ ms}$$

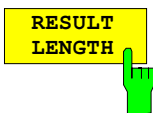

The *RESULT LENGTH* softkey cannot be operated with *ANALOG DEMODULATION*.

**Example: Measurement of amplitude modulation**

Measurement of a carrier modulated with 1 kHz, 50 % at 100 MHz, level 0 dBm

1. [PRESET] Default setting
2. [CENTER: 100 MHz] Frequency setting
3. [REF: REF LEVEL: +6 dBm] Level setting (the max. level of AM-modulated signals is 6 dB above the nominal level with 100 % AM).
4. [MODE: VECTOR ANALYSIS] Selection of vector analysis mode The FSIQ is in the analysis mode **DIGITAL DEMODULATION** (default setting).
5. [ANALOG DEMODULATION] Switch to analog demodulation. The AM-modulated signal appears on the display (display in the time domain, the default setting for [ANALOG DEMODULATION] is AM-SIGNAL). The demodulation bandwidth (analysis bandwidth) is 100 kHz in the default setting, i.e. audio signals up to max. 0.4\* demodulation bandwidth can be demodulated.
6. [DEMODO BW: 30 kHz] The demodulation bandwidth is changed eg to 30 kHz
7. [TRIGGER: AF SIGNAL 0%] Trigger setting to achieve a stable display. The display of the AF signal at the left edge of the screen starts at 0 %.
8. [SWEEP: SWEEPTIME 100 ms] Setting of the sweep time. The sweep time depends on the demodulation bandwidth and the sampling points provided (=5000 with analog demodulation). With a demodulation bandwidth of 30 kHz, the max. sweep time is 208 ms in the default setting.
9. [SEARCH: SUM MKR ON] Activating the summary marker for numeric trace evaluation.

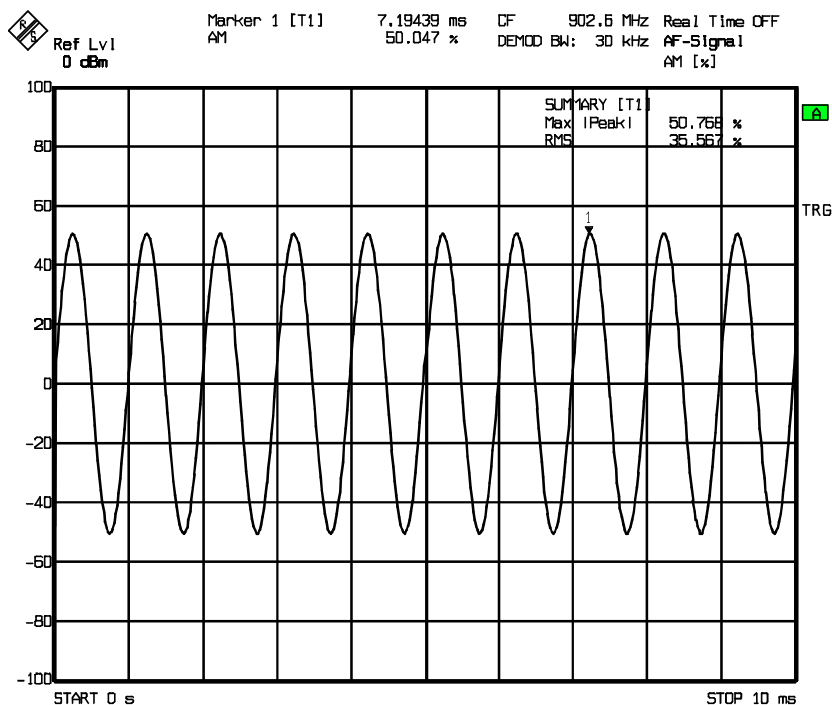

## Digital Demodulation Methods

### Diagram for signal processing

In modern mobile radio networks digital transmission methods are used to avoid the disadvantages of a transmission channel in mobile communication and to be able to serve more subscribers in the available frequency spectrum. The FSIQ offers all commonly used demodulators for digitally modulated signals. All modulation parameters for standard transmission methods can be loaded as required by the user. The FSIQ determines all relevant modulation parameters such as frequency, phase, amplitude and vector errors, etc. Measurements are carried out on continuous as well as pulsed signals such as TDMA signals. Bit patterns can be defined to be able to trigger to known bit sequences like preambles or midambles. The demodulator requires neither a coherent carrier nor a symbol clock for demodulation. It comprises matched filters and synchronizes automatically to the carrier and to the symbol clock. Furthermore, the demodulator can generate the ideal I/Q signal from the demodulated bit stream and thus determine the errors of the analyzed signal.

For a correct demodulation of digital signals, a number of modulation parameters in addition to the modulation mode has to be specified for the signal to be analyzed. The most important are the symbol rate and the input filter. And in addition, the frequency of the FSIQ (approx. 2% of the symbol rate) has to be tuned exactly to the frequency of the signal to be analyzed.

The bandwidth for demodulation is a function of the symbol rate and the selected oversampling method (*POINTS PER SYMBOL*). At least 4-fold oversampling is performed. If the number set under *POINTS PER SYMBOL* is reduced, fewer points are used in the display. The demodulation bandwidth for 1, 2 and 4 points per symbol is 3.125 times the symbol rate, with 8 points per symbol 6.5 times and for 16 points per symbol 13 times. It should be ensured that no modulation spectrum of adjacent signals is within the displayed range during demodulation, as this may introduce errors in the measurement of modulation parameters. If required, check for correct settings in the analyzer mode. The block diagram below shows the digital demodulator and its measurement capabilities:

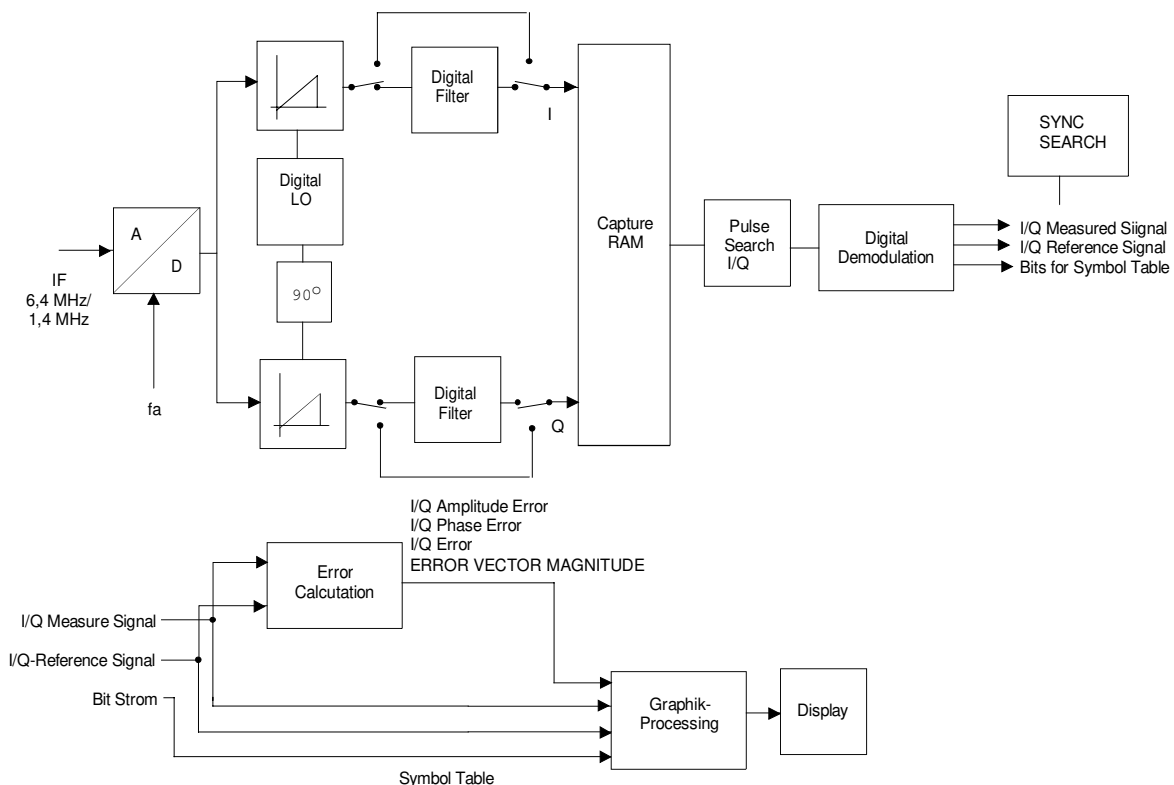

Fig. 4-18 Block diagram for signal processing during digital demodulation

### Symbol Mapping

The following types of symbol mapping are used for representing the results in the vector and constellation diagrams (PSK, MSK, QAM) and for the time/frequency representations with FSK modulation. The symbols are always in the binary code (MSB at left).

### Phase Shift Keying (PSK)

With these modulation types, the symbol represents the absolute phase of the received signal at the decision time. The following representations are given:

- a constellation diagram containing all symbols
- a table containing the symbol designations and the associated reference phases

With this type of phase modulation, transitions from any symbol to any other in the constellation diagram are permitted.

#### BPSK

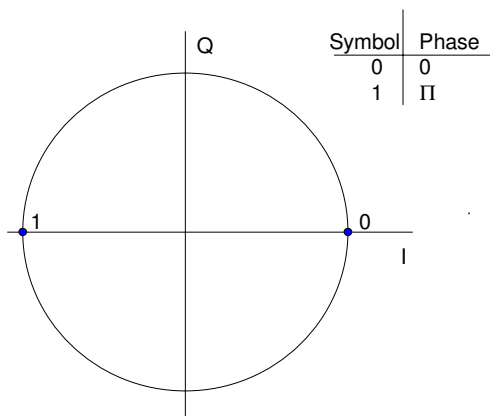

#### QPSK (WCDMA)

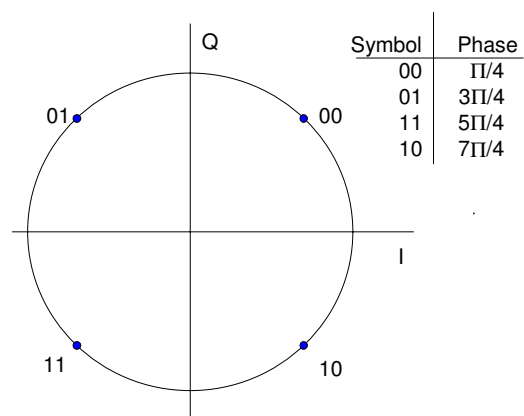

#### QPSK (QCDMA FWD; WCDMA; APCO25) OQPSK (QCDMA REV)

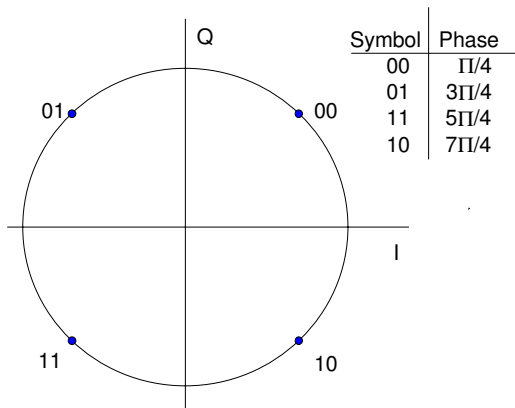

#### 8PSK

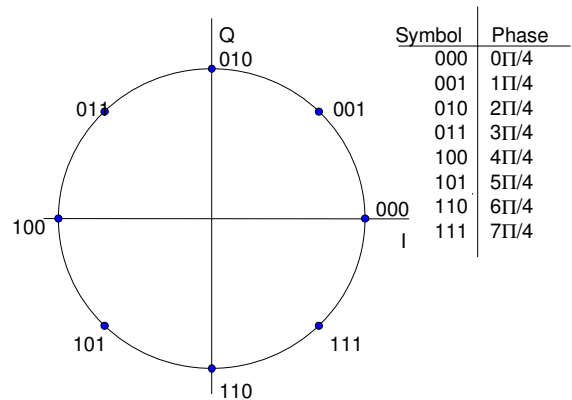

Fig. 4-19 Symbol mapping - phase shift keying

3PI/8-8PSK (EDGE)

For these modulation methods the digital information is **NOT** coded in the phase transitions but in the absolute position of the constellation diagram. The constellation diagram consists of 16 points. For each symbol transition, an offset of  $3\pi/8$  is inserted counterclockwise.

The symbol allocation in the constellation diagram is thus only valid for the first symbol of the data record.

Five symbol transitions with an offset of  $3\pi/8$  each is given as an example. The modulated symbol "111" remains constant.

This phase offset is taken into account during decoding and the display of symbols.

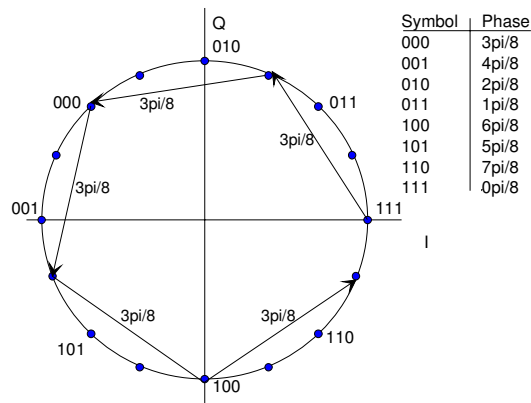

Fig. 4-20 Symbol mapping - Phase Shift Keying - EDGE

### Differential PSK

When using differential phase modulation, the symbol is the result of the phase difference between the current and the previous decision point. The absolute position of the pointer at the decision time is therefore not relevant. In the following diagrams, the phase transitions are shown, as examples, in the first quadrant, while the pointers point to the constellation point relevant for the current decision time. The signal is demodulated such that the decision times coincide with the constellation points. The following representations are given:

- a constellation diagram containing all permissible symbol transitions
- a table containing the symbol designations and the associated phase differences

The absolute phase of the signal is not relevant for the symbol decision.

### $\pi/4$ DQPSK

The positions of the permissible constellation points is as with 8PSK. With this technique, only the phase transitions given in the tables are permitted.

NADC, PDC, PHS, TETRA, APCO25, PWT

TFTS

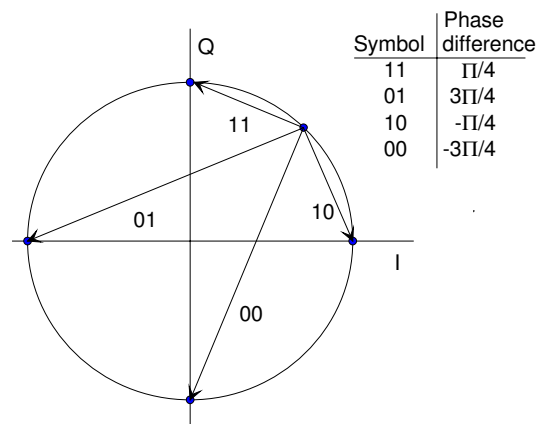
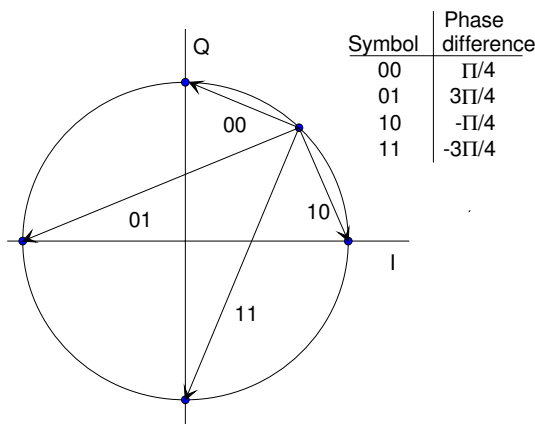

### D8PSK

The positions of the permissible constellation points is as with 8PSK. With this technique, transitions to all 8 constellation points possible are permitted.

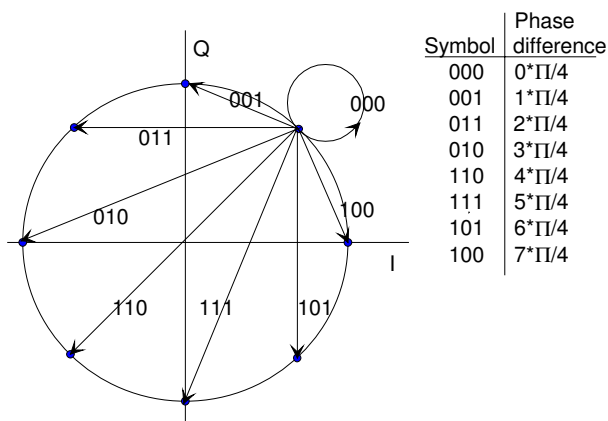

Fig. 4-21 Symbol mapping - differential phase modulation



### Frequency Shift Keying (FSK)

When working with FSK demodulation, a frequency/time diagram will be displayed instead of the constellation and vector diagrams. The symbol decision is based on the signal deviation at the decision times.

#### 2FSK (DECT, CT2; FLEX16\_2; FLEX32\_2)

With 2FSK, the symbol decision is taken by a simple frequency discriminator with the following decision threshold:

$$f_T = f_{mid}$$

$$\text{Symbol} = \begin{cases} "1" & \text{for } f_E \geq f_T \\ "0" & \text{for } f_E < f_T \end{cases}$$

$f_I$  = instantaneous frequency

$f_T$  = decision threshold

$f_{MID}$  = middle frequency of analyzer

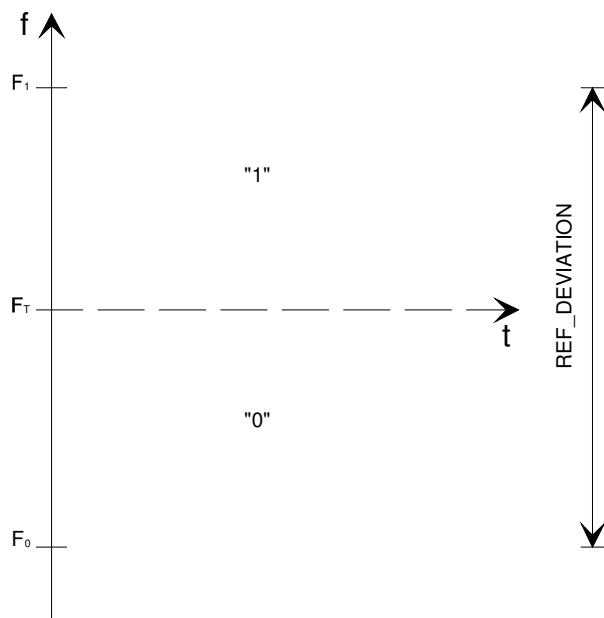

#### 4FSK (ERMES; MODACOM; APCO25; FLEX32\_4; FLEX64\_4)

With 4FSK the symbol decision is taken by a frequency discriminator using three decision thresholds derived from the operating parameter REF\_DEVIATION:

$$f_{T1} = f_{MID} - \frac{1}{3} \cdot \text{REF\_DEVIATION}$$

$$f_{T2} = f_{MID}$$

$$f_{T3} = f_{MID} + \frac{1}{3} \cdot \text{REF\_DEVIATION}$$

$$\text{Symbol} = \begin{cases} "11" & \text{for } f_E \geq f_{T3} \\ "10" & \text{for } f_{T2} \leq f_E < f_{T3} \\ "01" & \text{for } f_{T1} \leq f_E < f_{T2} \\ "00" & \text{for } f_E < f_{T1} \end{cases}$$

$f_I$  = instantaneous frequency

$f_{T1}, f_{T2}, f_{T3}$  = decision thresholds

$f_{MID}$  = middle frequency of analyzer

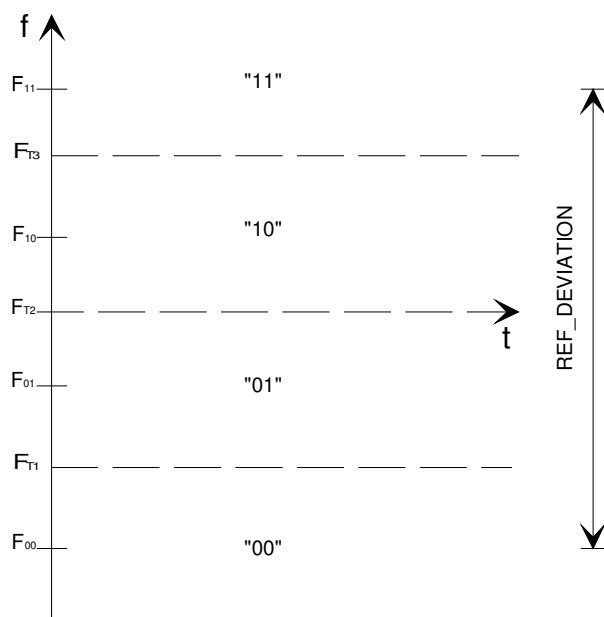

Fig. 4-22 Symbol mapping - FSK demodulation

## Minimum Shift Keying (MSK), CDPD

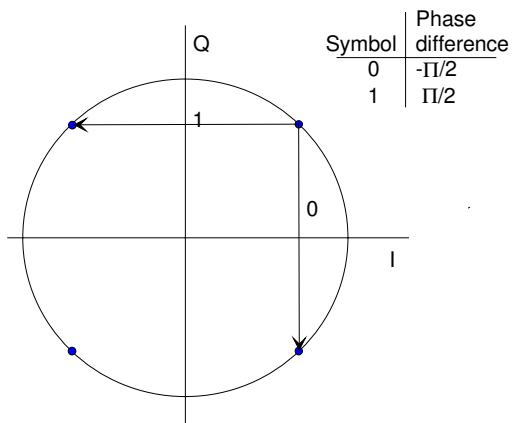

Fig. 4-23 Symbol mapping - minimum shift keying (MSK)

DMSK (and the derived GSMK) uses additional difference coding of two subsequent symbols. Static symbol mapping therefore does not exist.

## Quadrature Amplitude Modulation (QAM)

With the QAM technique, the symbols are counted linearly from right to left and from top to bottom (linear mapping).

**Note:** For reliable demodulation make sure the available symbols are utilized. If only some of the symbols or only the symbols in one quadrant are utilized, demodulation errors may occur.

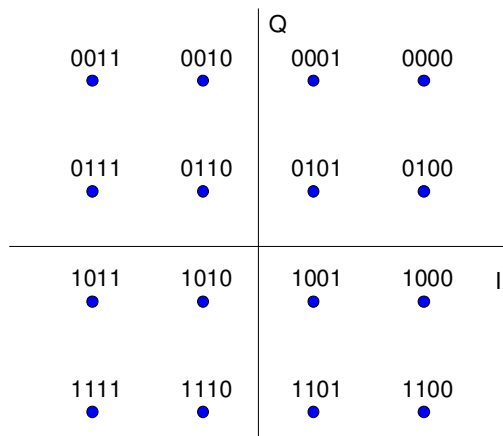
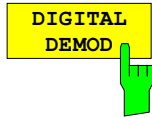

Fig. 4-24 Symbol mapping - 16QAM

## Selecting the Digital Demodulators

Submenu: CONFIGURATION MODE - VECTOR ANALYZER



The *DIGITAL DEMOD* softkey opens a list of all available demodulators .

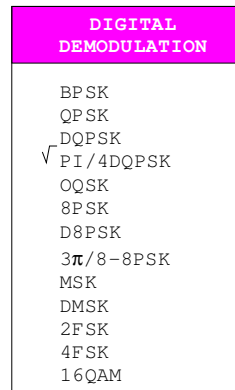

Demodulators are provided for the two-, four- and eight-level PSK modulation modes BPSK, QPSK and 8PSK. For QPSK and 8PSK demodulation, the demodulators for differential signals DQPSK and D8PSK can be selected additionally.

Demodulators are also available for the special versions of QPSK modulation, such as differential QPSK with  $\pi/4$  phase offset ( $\pi/4$ -DQPSK) and offset QPSK (OQPSK).

QPSK is used, for instance, by the IS95- CDMA for modulating signals from the base station to the mobile, OQPSK for signals from the mobile to the base station. The American TDMA system NADC (IS54) uses  $\pi/4$ -DQPSK for digital signal transmissions.

For higher-level modulation modes the demodulator for 16QAM is available. MSK (minimum shift keying) demodulators pertain to the group of continuous-phase demodulators. MSK with Gaussian filters (GMSK = Gaussian minimum shift keying) is used for the European mobile radio systems GSM and DCS1800 or PCS1900 in the USA. For correct bit detection for GSM, DCS 1800 and PCS 1900 and 1800 the MSK demodulator with additional differential decoding (DMSK) should be activated.

For FSK (frequency shift keying modulation, two-level (2FSK) and four-level (4FSK) demodulators can be selected.

2FSK modulation methods are used for instance for the digital cordless telephone to DECT standard, 4FSK for the paging system to ERMES standard.

### Standard Settings

To simplify the selection of parameters when standard transmission methods are used, standard setups are available in the FSIQ. All modulation parameters and the width of the display range are set automatically..

The following table shows available standards and respective settings.

For the GSM, DCS1800 and PCS 1900 standards the sync pattern GSM\_BTS0 with the associated synchronization offset of 61 symbols is preset in addition. When selecting the NADC standard, the instrument is set to the burst of the base station with a slot length of 162 symbols. When selecting the NADC FORWARD CH standard, the instrument is set to the non-burst signal of the base station with a slot length of 162 symbols. For the burst of the mobile station, the standard length NADC REVERSE CH must be set.

For the DECT standard the sync pattern of the fixed part DECT\_FP is preset, the sync offset is set to 0. When selecting the TETRA standard, the sync pattern Tetra\_1 is preset, the sync offset is preset to 122.

Sync pattern and sync offset become active by switching *FIND SYNC* (menu *SWEEP TRIGGER*) on.

**Note:** *The pager standards ERMES and FLEX (2FSK and 4FSK modulation) feature modulation filters with increased bandwidth ( $B \cdot T > 1$ ). This means that with normal oversampling (4 points per symbol) there is an intolerable bandwidth restriction which causes a distinctly higher demodulation error probability. Therefore the number of points per symbol is preset to 8 when the ERMES standard is selected and to 16 when the FLEX standard is selected.*

**Attention:** *In case of departures from the preset value (which may happen automatically when increasing the frame length or result length) there is a higher system error probability.*

#### Submenu: CONFIGURATION MODE - VECTOR ANALYZER

DIGITAL STANDARDS	DIGITAL STANDARDS	DIGITAL STANDARDS
PDC UP	IS95-CDMA FWD CH	CT2
PDC DOWN	IS95-CDMA REV CH	ERMES
NADC FWD CH	W-CDMA 4.096 FWD	MODACOM
NADC REV CH	W-CDMA 4.096 REV	FLEX16_2
	W-CDMA 3GPP FWD	FLEX32_2
DECT	W-CDMA 3GPP REV	FLEX32_4
PHS	CDMA 2000 SR3/DS FWD	FLEX64_4
PWT		APCO25 C4FM
TETRA	EDGE	APCO25 CQPSK
TFTS	GSM	CDPD

The *DIGITAL STANDARDS* softkey calls up a submenu of available standard setups.

If one of the following modulation parameters is modified, any digital standard that may be selected is switched off automatically:

- Symbol rate
- Measurement filter
- Reference filter
- $\alpha/BT$

Table 4-3 Standard settings

Modulation/ Standard	Symbol rate	Measurement filter	Reference filter	Alpha BT	Synchro- nization	Sync Pattern	SYNC OFFSET	Points/ symbol
IS95-CDMA FWD CH QPSK	1.2288 MHz	IS95_FM	IS95_FR	--	--	--	--	4
IS95-CDMA REV CH OQPSK	1.2288 MHz	IS95_FR	IS95_RR	--	--	--	--	4
W-CDMA 4.096 FWD QPSK	4.096 MHz	ROOT RAISED COS	RAISED COS	0.22	--	--	--	4
W-CDMA 4.096 REV QPSK	4.096 MHz	ROOT RAISED COS	RAISED COS	0.22	--	--	--	4
W-CDMA 3GPP FWD QPSK	3.84 MHz	ROOT RAISED COS	RAISED COS	0.22	--	--	--	4
W-CDMA 3GPP REV QPSK	3.84 MHz	ROOT RAISED COS	RAISED COS	0.22	--	--	--	4
CDMA 2000 SR3/DS FWD QPSK	3.6864 MHz	IS95_FM	IS95_FR	--	--	--	--	4
EDGE 8 $\pi$ /8-8PSK	270.833 Hz	EDGE_MES	EDGE_REF	--	BURST SEARCH	EDGE_BT0	61	4
GSM, (DCS1800, PCS 1900) MSK	270.833kHz	NONE	GAUSSIAN	0.3	BURST SEARCH	GSM_BTS0	61	4
NADC FWD CH*) $\pi$ /4 DQPSK	24.3 kHz	ROOT RAISED COS	RAISED COS	0.35	SYNC SEARCH	NADC_S1	0	4
NADC REV CH $\pi$ /4 DQPSK	24.3 kHz	ROOT RAISED COS	RAISED COS	0.35	BURST SEARCH	NADC_S1	8	4
PDC DOWN $\pi$ /4 DQPSK	21 kHz	ROOT RAISED COS	RAISED COS	0.5	SYNC SEARCH	PDC_S1	57	4
PDC UP $\pi$ /4 DQPSK	21 kHz	ROOT RAISED COS	RAISED COS	0.5	BURST SEARCH	PDC_S1	57	4
PHS $\pi$ /4 DQPSK	192 kHz	ROOT RAISED COS	RAISED COS	0.5	BURST SEARCH	PHS_DO1	32	4
CDPD MSK	19.2 kHz	NONE	GAUSSIAN	0.5	--	--	--	4
DECT 2-FSK	1152 kHz	NONE	GAUSSIAN	0.5	VIDEO TRIGGER + BURST SEARCH	DECT_FP	0	4
TETRA $\pi$ /4-DQPSK	18 kHz	ROOT RAISED COS	RAISED COS	0.35	BURST SEARCH	TETRA_1	122	4
CT2 2-FSK	72 kHz	NONE	GAUSSIAN	0.5	BURST SEARCH	CT2_CFP	0	4
ERMES 4-FSK	3.125 kHz	NONE	BESSEL 1_25	--	--	--	--	8
MODACOM 4-FSK	4.8 kHz	ROOT RAISED COS	RAISED COS	0.2	--	--	--	4
FLEX 16_2 (FLEX 1600) 2-FSK	1.6 kHz	NONE	BESSEL 2_44	--	--	--	--	16
FLEX 32_2 (FLEX 3200) 2-FSK	3.2 kHz	NONE	BESSEL 1_22	--	--	--	--	16
FLEX 32_4 (FLEX 3200 4-FSK	1.6 kHz	NONE	BESSEL 2_44	--	--	--	--	16
FLEX 64_4 (FLEX 6400) 4-FSK	3.2 kHz	NONE	BESSEL 1_22	--	--	--	--	16
PWT WCPE $\pi$ /4 DQPSK	562.5 kHz	ROOT RAISED COS	RAISED COS	0.5	BURST SEARCH	WCPE_FP1	0	4
TFTS $\pi$ /4 DQPSK**)	22.1 kHz	ROOT RAISED COS	RAISED COS	0.4	BURST SEARCH	TFTS_G1	0	
APCO25 C4FM	4.8 kHz	NONE	RAISED COS	0.2	--	--	--	8
APCO25 CQPSK	4.8 kHz	APCO25FM	RAISED COS	0.2	--	--	--	4

\*) The standard setting is matched to the slot of the NADC base station. As the base station doesn't burst, the FIND BURST function is disabled.

\*\*\*) When selecting the TFTS standard, the special bit decoding is made according to the TFTS standard.

The standard settings are called up by means of the DIGITAL STANDARD softkey.

## Selecting Modulation Parameters for Digital Demodulation

Submenu: *CONFIGURATION MODE - VECTOR ANALYZER*

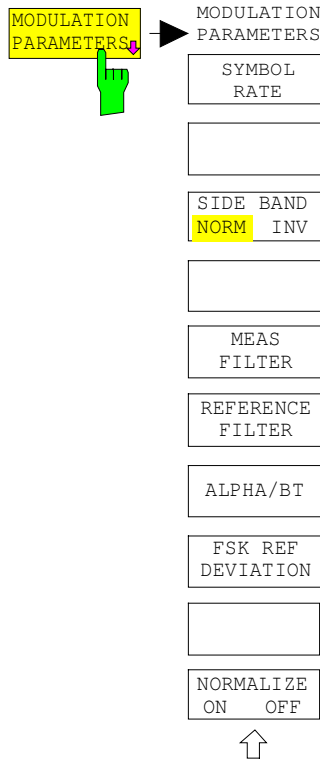

The *MODULATION PARAMETERS* softkey calls up a submenu for setting of the modulation parameters.

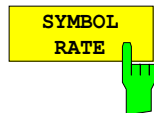

The *SYMBOL RATE* softkey opens a window for entering the symbol rate of the digitally modulated signal to be measured.

The symbol rate is a function of the bit rate determined via the modulation level and corresponds to the baud rate. With QPSK, for instance, the symbol rate corresponds to half the bit rate (= 2 bits per symbol). Symbols are only valid while the signal is evaluated by the receiver. The time of demodulation is the point of decision. The demodulator of the FSIQ uses the set symbol rate to find the points of decision.

To be able to select the correct symbols, the symbol rate has to be entered exactly. The more complex (high-level) the modulation method, the more critical the exact definition of the symbol rate. An inaccurately defined symbol rate causes demodulation errors. The settings below should also be observed for selecting the symbol rate:

- Maximum possible symbol rate is 7 MHz.
- The number of points per symbol is limited to 8 for symbol rates >200 kHz and to 4 for symbol rates >400 kHz.
- The demodulation bandwidth is limited to 8 MHz. If the symbol rate is set, the parameter ALPHA/BT may be adjusted accordingly.

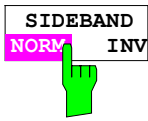

The *SIDE BAND NORM / INV (INVERTED)* demodulates and inverts the signal received.

Thus, with FSK demodulation, the frequency states are inverted, and, with non-FSK modulation, the I and Q signal are inverted.

Default status is *SIDE BAND NORM* (normal).

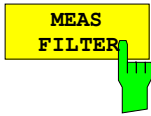

The *MEAS FILTER* softkey selects the input filter for the signal to be measured. The required filter is selected in a table:

MEAS FILTER
None
<input checked="" type="checkbox"/> Raised Cos
Root Raised Cos
Gaussian
apco25fm
edge_mes
edge_ref
bess1_22
bess1_25
bess2_44
is95_fm
is95_fr
is95_rm
is95_rr

Further information is given in the description of the *REFERENCE FILTER* softkey.

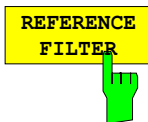

The *REFERENCE FILTER* softkey selects the filter for the ideal reference signal for detecting modulation errors at the baseband level. The required filter is selected in a table:

REFERENCE FILTER
<input checked="" type="checkbox"/> Raised Cos
Root Raised Cos
Gaussian
apco25fm
edge_mes
edge_ref
bess1_22
bess1_25
bess2_44
IS95_fm
IS95_fr
IS95_rm
IS95_rr

Predefined filters are the squarewave filter (only for setting *MEAS FILTER:NONE*), the raised cosine filter, the root raised cosine filter and the Gaussian filter. Cosine filters are generally used for PSK modulation, Gaussian filters by MSK and FSK modulators.

The filter parameters are set via *ALPHA/BT*.

The digital demodulator of FSIQ generates two signals at the I/Q level, the signal to be measured (*MEAS SIGNAL*) and the reference signal (*REFERENCE SIGNAL*).

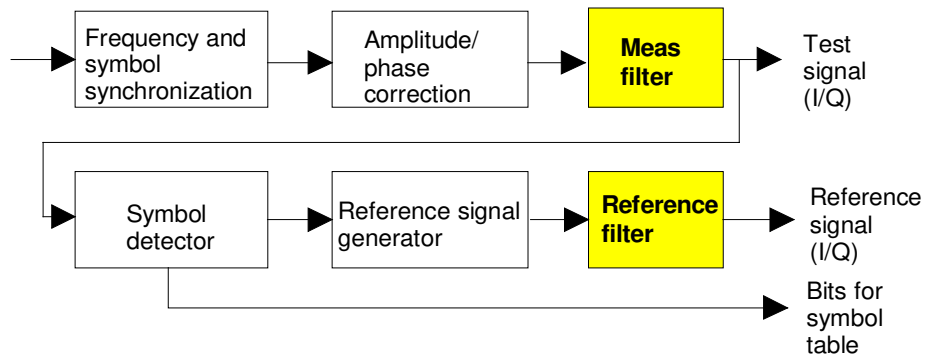

The signal to be measured is present at the RF input after demodulation. The reference signal is the signal that would be obtained in the case of an ideal RF signal. A separate filter is provided for the signal and the reference signal. For digital transmissions, filtering can be carried out at the transmitter or receiver end or be split up between both. The filter at the receiver is the measurement filter. The reference filter is used for the total system. Depending on the configuration of filters, the following combinations can be used:

Filters of transmission system		Filters to be selected	
Transmitter	Receiver	MEAS FILTER	REFERENCE FILTER
Root-raised cos	Root-raised cos	Root-raised cos	Raised cos
Raised Cos	none	none	Raised cos
Gaussian	none	none	Gaussian

If no modulation filter is provided in the transmitter, it may also be useful to employ a RAISED COS or GAUSSIAN filter as measurement filter.

However, the non-existing band limiting at the FSIQ input may cause unwanted aliasing products in the vector analyzer mode, which might impair the measurement. A measurement without reference filter is not possible!



ALPHA/BT

The *ALPHA/BT* softkey opens a window where the roll-off factor (*ALPHA*) for the cosine filters or the bandwidth/symbol period product *BT* for the Gaussian filters is entered.

If an input filter is used for demodulation or a filter for generating the reference signal, the filter characteristic has to be determined by means of *ALPHA/BT*. With Nyquist filters *ALPHA* has to be specified, with Gaussian filters the product of the symbol period *T* and bandwidth *B* (*BT*).

All filters are computed up to a length of 16 symbols. Permissible input values are 0.2 to 1 in steps of 0.05. The value for *ALPHA/BT* applies to the measurement and to the reference filter. Values for *ALPHA* or *BT* are determined by the digital transmission system. These values should be used for measurements with FSIQ as higher demodulation errors could otherwise occur.

*ALPHA* describes the transmission characteristic of a Nyquist filter (cosine filter). It is also designated as roll-off factor or bandwidth factor. The greater *ALPHA*, the greater is the bandwidth occupied by the digitally modulated signal relative to the theoretical minimum. In digital transmission systems typical bandwidth factors of 0.25 to 0.5 are used, ie the occupied bandwidth is 25% to 50% larger than the theoretical minimum. The bandwidth/time product *BT* describes the characteristic or the bandwidth factor of Gaussian filters.

FSK REF  
DEVIATION

The *FSK REF DEVIATION* softkey opens a window for entering the reference deviation for FSK demodulation.

FSK deviation is defined as the (unilateral) deviation from the center frequency occurring in the case of modulation with constant 0 or 1 sequences, ie the stationary value.

For 4FSK, the modulation deviation is the deviation from the center frequency for the bit sequences causing maximum frequency deviation.

The reference deviation is used for computing the deviation error in *NORMALIZE ON* mode

NORMALIZE	
ON	OFF

The *NORMALIZE ON/OFF* softkey has the following effect:

The measurement result in the vector and constellation diagram is always normalized to a circle, the radius of which corresponds to the mean distance between the center of the circle and the mid-points (of all groups of sampling values).

This circle is defined as a unit circle with the radius 1.

Softkey *NORMALIZE ON* shifts the center of the unit circle by the I/Q offset to the center for the group mid-points.

*NORMALIZE ON* is the default state:

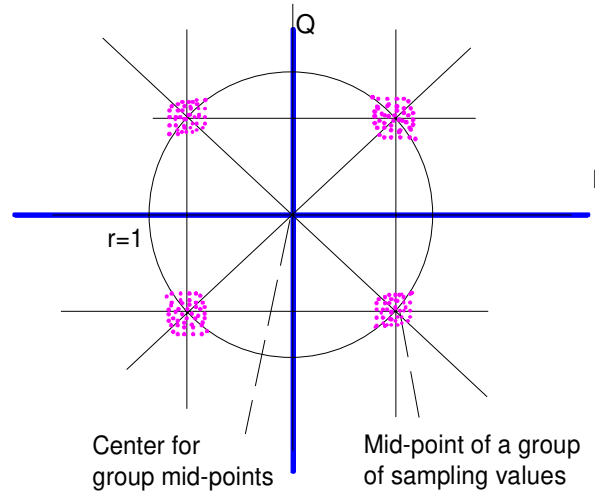
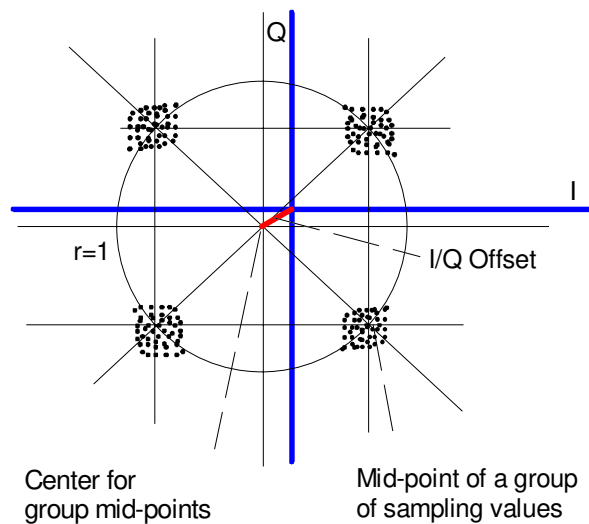

Diagram in the case of *NORMALIZE OFF*:



## Selecting Measurement Results for Digital Demodulation

After entering all modulation parameters the required measurement is selected using the *MEAS RESULT* softkey. The contents of the trace memory (magnitude), the demodulated measurement signal, the reference signal, i.e. the ideal signal derived from the measurement signal, or the error signal can be displayed as the measurement result. The I/Q error and the vector error are the two possible error signals. A table is available listing all errors together with the demodulated bits.

Submenu: *CONFIGURATION MODE - VECTOR ANALYZER*

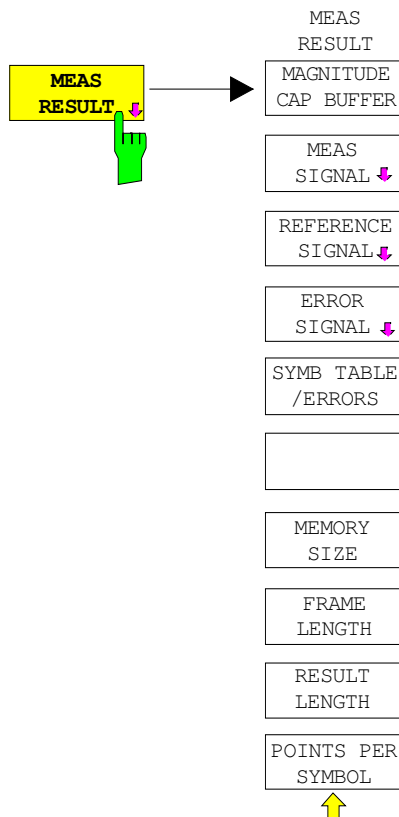

The *MEAS RESULT* softkey opens a submenu in which the different displays for the measured signal can be selected.

The *MAGNITUDE CAP BUFFER*, *MEAS SIGNAL*, *REFERENCE SIGNAL*, *ERROR SIGNAL* and *SYMB TABLE/ERRORS* softkeys are selection switches, i.e. only one of the measurement results offered can be selected per screen. If two screens are available, (split-screen mode) a different measurement result can be displayed in each screen.

When the measurement signal, the reference signal and the error signal are displayed, submenus are called up by the corresponding softkeys and the associated parameter can be set.

Moreover, softkeys are available for setting the memory size, the number of bits to be demodulated and displayed.

## Magnitude of Capture Buffer

The capture buffer is the memory comprising the samples that are entered during the storage of measured values. These samples are used for demodulation but are retained over the complete measurement. A reason for this is the loss in the dynamic range during the synchronization and demodulation of the signal. For synchronization, an interpolation between the samples is necessary, for example, for determining the symbol decision point accurately. Interpolation is always synonymous with a loss in the amplitude dynamic range. In case of synchronization, the signal has to be normalized. The normalization is also linked with a loss in the dynamic range.

When measuring the power ramping of a TDMA burst, a maximum dynamic range is required. This dynamic range is obtained when using the capture buffer for samples.

Submenu: CONFIGURATION MODE - VECTOR ANALYZER - MEAS RESULT

MAGNITUDE  
CAP\_BUFFER



The *MAGNITUDE CAP BUFFER* softkey indicates the magnitude of the signal in the capture buffer in the time domain.

The *MAGNITUDE CAP BUFFER* mode is therefore recommended in all cases where power ramping of TDMA bursts should be measured with a wide dynamic range. Timing will be accurate to less than or equal to half a clock period of the sampling unit

**Example:**

*A signal is sampled with 8 values per symbol. The maximum timing error of the TDMA burst synchronized to a bit sequence is 1/16, i.e. 6.25% of the symbol period.*

**Measurement of Reference Signal**

The FSIQ can display both the waveform of the measurement signal, which is derived from the samples in the baseband, and that of the reference signal. To this effect, the measurement signal is filtered and synchronized to the carrier and the symbol clock. The I/Q offset and the amplitude reduction of the signal is compensated prior to the display. The reference signal is generated from the demodulated bits by modulation down to the baseband. It is identical to the measurement signal freed of modulation errors and noise.

The output formats for the measurement signal and the reference signal are identical. The output formats are different for FSK demodulation and the other demodulation modes.

**Output formats for non-FSK demodulation:**

Submenu: CONFIGURATION MODE - VECTOR ANALYZER - MEAS RESULT

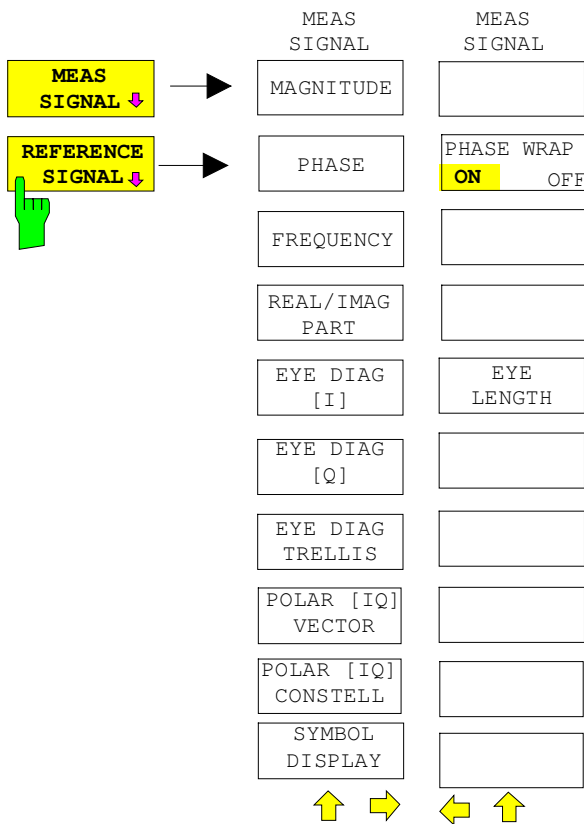

The *MEAS SIGNAL* and *REFERENCE SIGNAL* softkeys call up identical submenus. The output formats of the two signals can be selected there.

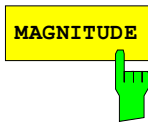

The *MAGNITUDE* softkey displays the magnitude of the demodulated measurement or reference signal, which is normalized to 1, as a function of time and symbol.

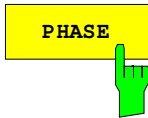

The *PHASE* softkey displays the phase of the measurement or reference signal.

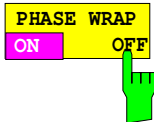

The *PHASE WRAP ON/OFF* softkey activates/deactivates a phase shift.

The phase of a signal can have very high values due to the modulation. Therefore, scaling should be very coarse to display the phase over many bits. FSIQ therefore offers the phase to be shifted by means of the *PHASE WRAP ON/OFF* softkey.

*ON* The FSIQ displays the phase in the range of  $\pm 180^\circ$ . If the phase exceeds  $+180^\circ$ , for example,  $360^\circ$  is subtracted from the phase value so that  $>-180^\circ$  is indicated. This avoids very high phase values to be displayed which would impair the reading accuracy.

*OFF* The phase is not shifted. It is displayed within the range of the Y axis. Phase values above or below this range are cut off at the diagram edges.

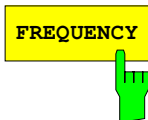

The *FREQUENCY* softkey displays the time or symbol-dependent frequency response of the signal, i.e., the frequency-demodulated signal. The softkey is only available for MSK demodulation.

The frequency display is suitable for measuring the frequency deviation by using the markers.



The *REALIMAG PART* softkey calls up the display of the real and imaginary parts of the measurement or reference signal in separate diagrams.

To this effect, the diagram is split up. The real part is displayed in the upper half whereas the imaginary part is displayed in the bottom half. The X axis (which is scaled in time units or symbols) is identical for the two diagrams.

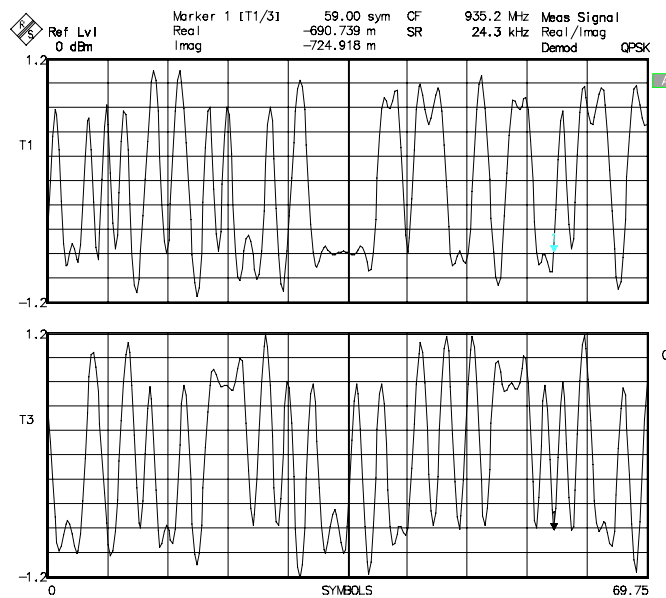

Fig. 4-25 Simultaneous display of inphase and quadrature component in a single diagram (here: screen A in split-screen display)



The *EYE DIAG [I]*, *EYE DIAG [Q]* and *EYE DIAG TRELLIS* softkeys select the various eye diagrams:

- eye diagram for the inphase signal,
- eye diagram for the quadrature signal and
- trellis diagram.

The eye diagram is the representation of inphase and quadrature signal (*EYE DIAG [I]* or *EYE DIAG [Q]*) as a function of time. It is triggered by the symbol clock at the points of decision. The display range of the eye diagram (number of states on the time axis) is determined by softkey *EYE LENGTH*.

The individual traces of the eye diagram are superimposed on each other until the number of symbols specified with *RESULT LENGTH* is attained. The successive traces are the continuation of the trace written last, i.e. the total trace is displayed in a folded form. To obtain a complete eye diagram, all the states of a signal have to be traced at least once. The number of eyes vertically corresponds to the number of modulation states less 1. The eye aperture is a measure for differentiating between two decision levels. A small eye apertures indicate a high, large eye apertures a small bit error rate.

The trellis diagram is used for representing the states of continuous-phase modulation methods (e.g. MSK). It indicates the phase versus time and permits also phases above  $\pm 180^\circ$  to be displayed. The trellis diagram is similar to the eye diagram in that measured traces are superimposed onto each other in the display until the number of symbols defined by *RESULT LENGTH* is attained.

For the FSIQ, the trellis diagram is particularly useful for testing MSK and GMSK modulation. The symbols are spaced by  $90^\circ$ . A phase shift of  $+90^\circ$  corresponds to logic 1, a shift of  $-90^\circ$  to logic 0. A rising phase edge therefore indicates a logic 1, a falling edge a logic 0. Same as with the eye diagram, the width of the trellis diagram is defined by *EYE LENGTH*. To obtain a clear display, a minimum of 5 symbols should be selected as display width.

The number of *POINTS PER SYMBOL* should be as high as possible to obtain a continuous trace in the eye diagram. 8 to 16 points are recommended.

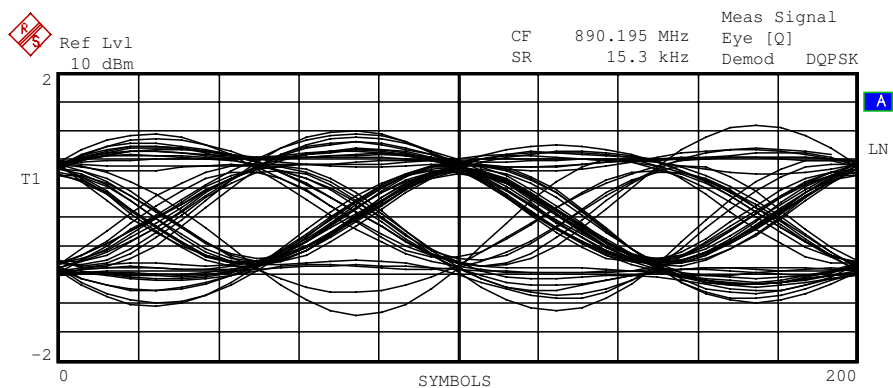
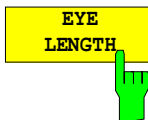
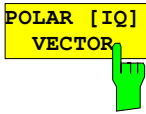

Fig. 4-26 Eye diagram over 200 symbols of a DQPSK-modulated signal.  
**Display range is five symbols.**



The *EYE LENGTH* softkey determines the display width of the eye diagram in symbols. The number of symbols is entered in the field.

At least one symbol length or two states are required for a complete eye. To be able to detect the errors particularly at the zero crossings, two to five symbols are recommended. The number of symbols is limited with *RESULT LENGTH*. In the case of *EYE LENGTH* = *RESULT LENGTH*, however, the signal versus time is displayed, the eyes are no longer visible.



The *POLAR [IQ] VECTOR* and *POLAR [IQ] CONSTELL* softkey display the trace in the form of a polar diagram. In the vector diagram, all the points are marked. In the constellation diagram only those at the points of decision.

In the I/Q diagram, the FSIQ displays the inphase component of the signal on the X axis, the quadrature component on the Y axis. Each trace represents a vector. The magnitude of the vector is the distance to the zero point, the phase is the angle between the positive X axis and the vector measured counterclockwise.

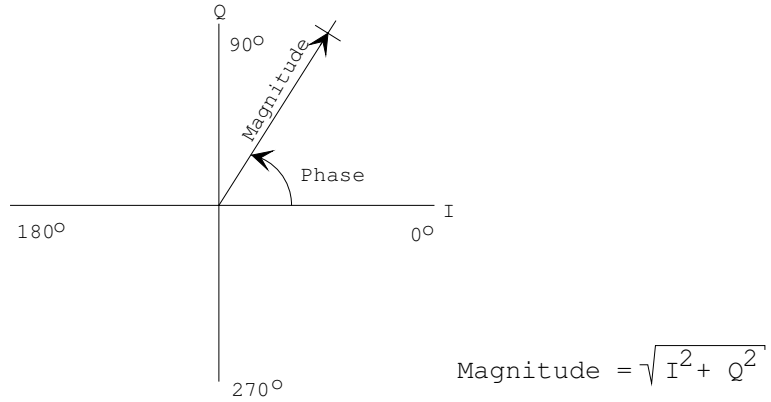

Fig. 4-27 Vector in the I/Q diagram

In the vector diagram the number of points between the points of decision is determined with *POINTS PER SYMBOL*. For instance, if 5 points per symbol have been selected, every 5th point is a symbol at the point of decision. The other four points are intermediate values. The points of decision can be marked by selecting *DOTS* under *SYMBOL DISPLAY*. The constellation diagram displays only the measurement values at the points of decision.

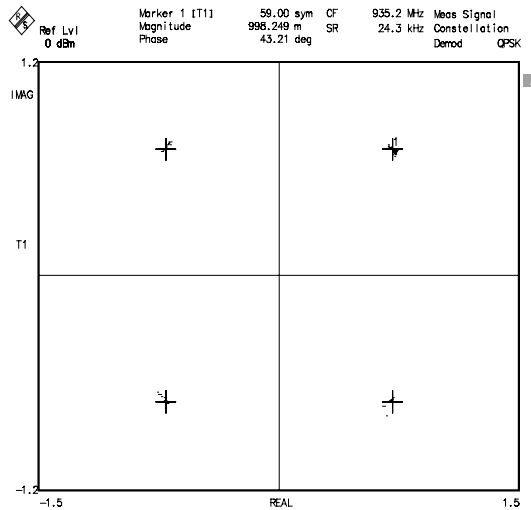
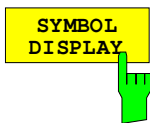
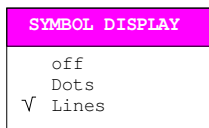

Fig. 4-28 Constellation diagram (example QPSK)





The *SYMBOL DISPLAY* softkey marks the symbol decision points in the displayed trace. The desired form of highlighting can be selected from the table. Points of decision can be marked by vertical lines or by means of dots.



With *off* selected, the points of decision are not marked. When *Dots* are selected, points are drawn on the trace and for *Lines*, (except for vector and constellation diagrams) vertical lines are drawn between the X axis and the trace.

For vector and constellation diagrams dots are inserted with *Dots* **and** *Lines*.

For the constellation diagram dots are also displayed even in the *off* mode.

This function is used for displaying the time characteristic of measurement results, e.g. as an I/Q characteristic or error signal.

**Output formats with FSK demodulation:**

Submenu: *CONFIGURATION MODE - VECTOR ANALYZER - MEAS RESULTS*

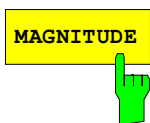
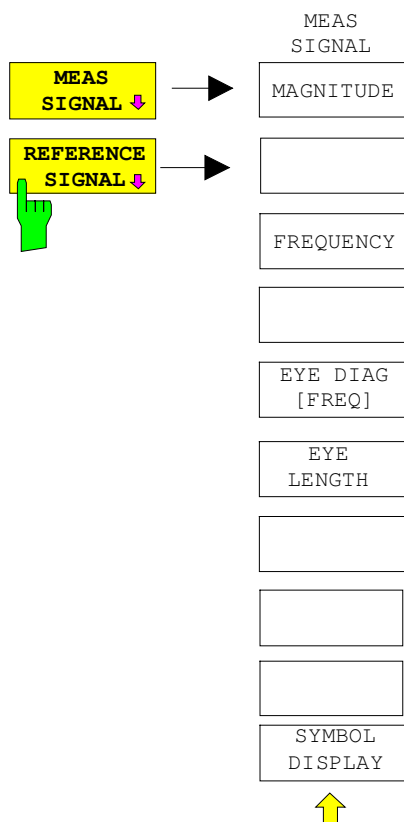

The *MAGNITUDE* softkey displays the magnitude of the demodulated measurement or reference signal as a function of time and symbol.

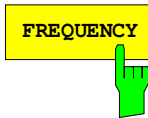

The *FREQUENCY* softkey displays the time- or symbol-dependent frequency response of the signal, i.e., the frequency-demodulated signal.

The frequency display is for instance suitable for measuring the frequency deviation by using the markers.



The *EYE DIAG [FREQ]* softkey displays the frequency-demodulated signal as a function of time. This signal is triggered by the symbol clock at the points of decision. The display range of the eye diagram (number of states on the time axis) is determined by *EYE LENGTH*.

The individual traces of the eye diagram are superimposed on each other until the number of symbols specified with *RESULT LENGTH* is attained. The successive traces are the continuation of the trace written last, i.e. the total trace is displayed in a folded form. To obtain a complete eye diagram, all the states of a signal have to be traced at least once. The number of eyes corresponds to the number of modulation states less 1. The eye aperture is a measure for differentiating between two decision levels. A small eye apertures indicate a high, large eye apertures a small bit error rate.

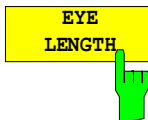

The *EYE LENGTH* softkey determines the display width of the eye diagram in symbols. The number of symbols is entered in the field.

At least one symbol length or two states are required for a complete eye. Two to five symbols are recommended however to detect the errors particularly at the zero crossings. The number of symbols is limited by *RESULT LENGTH*. In the case of *EYE LENGTH = RESULT LENGTH*, however, the signal versus time is displayed, the eyes are no longer visible.

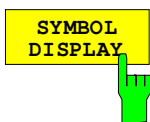

The *SYMBOL DISPLAY* softkey marks the symbol decision points in the displayed trace. The desired form of highlighting can be selected from the table. Points of decision can be marked by vertical lines or by dots..

SYMBOL DISPLAY
off
Dots
<input checked="" type="checkbox"/> Lines

With *off* selected, the points of decision are not highlighted. When *Dots* are selected, points are drawn on the trace and with *Lines* selected (except for vector and constellation diagrams), vertical lines are drawn between the X axis and the trace.

### Measurement of Modulation Errors

The FSIQ evaluates the modulation errors by comparing the measurement signal with the internally generated ideal reference signal. The output formats differ depending on whether FSK demodulation is selected or not. The different output formats of the error are selected by means of the *ERROR SIGNAL* softkey.

#### Non-FSK demodulation:

The modulation error of the measurement signal can be displayed separately, i.e. according to magnitude and phase, as I and Q error, error vector magnitude or, in polar diagrams, as vector or constellation diagram.

The magnitude and phase error are determined according to the following equations:

$$\text{Error signal magnitude} = \sqrt{I^2 + Q^2} - \sqrt{I_{\text{ref}}^2 + Q_{\text{ref}}^2} \text{ and}$$

$$\text{Error signal phase} = \arctan \frac{Q}{I} - \arctan \frac{Q_{\text{ref}}}{I_{\text{ref}}}, \text{ where}$$

the real and imaginary part of the error signal are given as follows

$$\text{Error signal real part} = I - I_{\text{ref}} \text{ and}$$

$$\text{Error signal imag part} = Q - Q_{\text{ref}}$$

The magnitude of the error vector (error vector magnitude) is

$$\text{EVM} = \sqrt{(I - I_{\text{ref}})^2 + (Q - Q_{\text{ref}})^2}$$

I, Q = measured I/Q component

I<sub>ref</sub>, Q<sub>ref</sub> = I/Q components ideally calculated from the bit sequence.

The following vector diagram indicates the different types of errors resulting from the measurement signal and the reference signal:

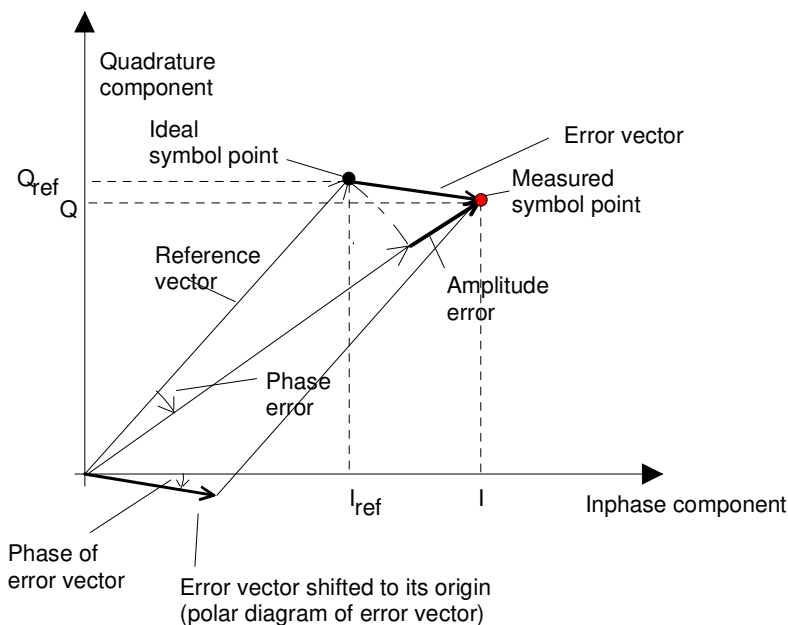
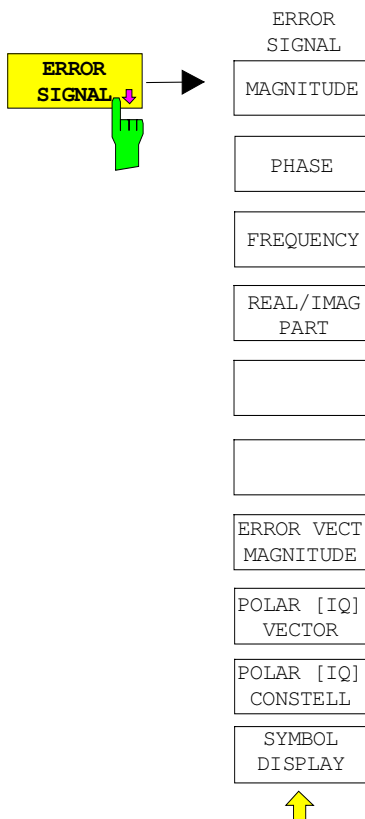

Fig. 4-29 Graphic display of modulation errors by means of a point of decision

Submenu: CONFIGURATION MODE - VECTOR ANALYZER - MEAS RESULT



The *ERROR SIGNAL* softkey opens the submenu for selecting the type of error to be displayed.

The following types of error representation are available

- amplitude error (MAGNITUDE)
- phase error (PHASE)
- frequency error (FREQUENCY)
- error if the real part (REAL/IMAG PART) and
- error of the imaginary part (REAL/IMAG PART)
- magnitude error (ERROR VECTOR MAGNITUDE)

For error representation the FSIQ compares all the points of the measurement and reference signal and displays them in the error diagram (except for *POLAR [IQ] CONSTELL*). Thus, the number of measurement results depends on the number of points per symbol. If only the errors are to be evaluated at the points of decision, the number of points per symbol has to be set to one.

To maintain the correct error for discontinuous transmission, e.g. for TDMA methods, make sure that only valid symbols are displayed. The result length and the trigger condition have to be set appropriately.



The *MAGNITUDE* softkey starts the point by point comparison of the magnitude of the measurement signal with the magnitude of the ideal signal. The difference of the two magnitudes is displayed..

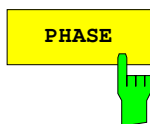

The *PHASE* softkey starts the point by point comparison of the phase of the measurement signal with the phase of the ideal signal. The difference of the two phases is displayed as phase error.

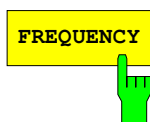

The *FREQUENCY* softkey displays the frequency error. The frequency response of the measurement signal is compared with that of the ideal reference signal and the difference between the two responses is displayed as a function of time and symbol. The softkey is only available for MSK demodulation .

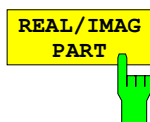

The *REAL/IMAG PART* softkey displays the error of the real and imaginary part in separate diagrams. To this effect, the measurement diagram is split up. The real part is displayed in the top half and the imaginary part in the bottom half. The X axis (time or symbols) is identical for the two diagrams.

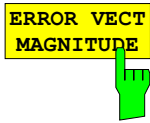

The *ERROR VECT MAGNITUDE* softkey displays the magnitude of the error vector versus time or symbols.

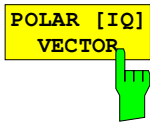

The *POLAR [IQ] VECTOR* and *POLAR [IQ] CONSTELL* softkeys display the error vector in the polar diagram. The error vector diagram and the error constellation diagram.

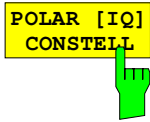

With these forms of representation, the points of decision are all shifted back to the origin and are laid on top of each other. The errors at the points of decision can thus be seen at a glance.

**FSK demodulation:**

Submenu: *CONFIGURATION MODE - VECTOR ANALYZER - MEAS RESULT*

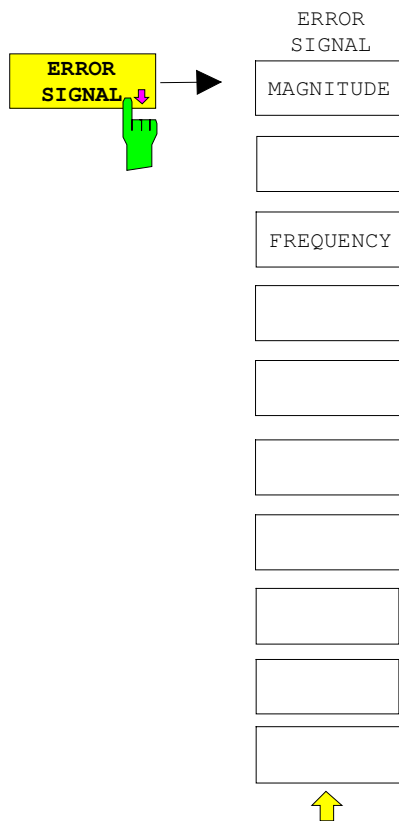

The *ERROR SIGNAL* softkey opens the submenu for selecting the type of error to be displayed.

The following quantities can be displayed:

- Magnitude error (MAGNITUDE)
- Frequency error (FREQUENCY)

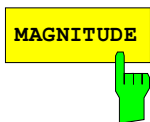

The *MAGNITUDE* softkey starts the point by point comparison of the measurement signal with the magnitude of the ideal signal. The difference of the two magnitudes is displayed.

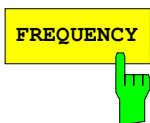

The *FREQUENCY* softkey displays the frequency error. The frequency response of the measurement signal is compared with that of the ideal reference signal and the difference between the two responses is displayed as a function of time and symbol.

## Symbol Table and Table of Modulation Errors

The symbol table and the table with modulation errors are indicated in the same display. In this case, the two tables are assigned to a trace. Similar to the trace display, the corresponding trace can be frozen (*VIEW*) or faded out (*BLANK*).

The range for the error calculation can be limited by means of the time lines (*TIME LINES 1/2*; *MARKER SEARCH* menu, *SEARCH LIM ON/OFF* menu).

If only one window is displayed, the symbol table is assigned to trace 1 and the error table to trace 2.

Submenu: *CONFIGURATION MODE - VECTOR ANALYZER - MEAS RESULT*

SYMB TABLE  
/ERRORS



The *SYMB TABLE / ERRORS* softkey displays a table of demodulated bits and a table of modulation errors of the measured signal.

The symbol table shows the demodulated bits of the signal. The number of bits is defined under *RESULT LENGTH* in the same menu. Bits can be related to the traces (in split screen mode) by means of the marker coupling. The marker on the trace and the associated symbol are marked at the same time.

The indicated modulation errors differ depending on whether FSK signals are demodulated or one of the other digital demodulators is active.

The following parameters are indicated as sum errors of the modulation (except with FSK demodulation):

- Frequency error
- Magnitude error
- Phase error
- Error vector magnitude
- I/Q offset
- I/Q imbalance and
- Amplitude droop
- Rho factor.

The FSIQ evaluates these errors within the result length or in a range limited by the vertical lines within the result length.

With FSK demodulation, the following parameters are indicated as sum errors of the modulation:

- Frequency error
- Magnitude error
- FSK deviation
- FSK deviation error

The entered reference deviation is indicated in addition (*FSK REF DEVIATION*).

Non-FSK demodulations:

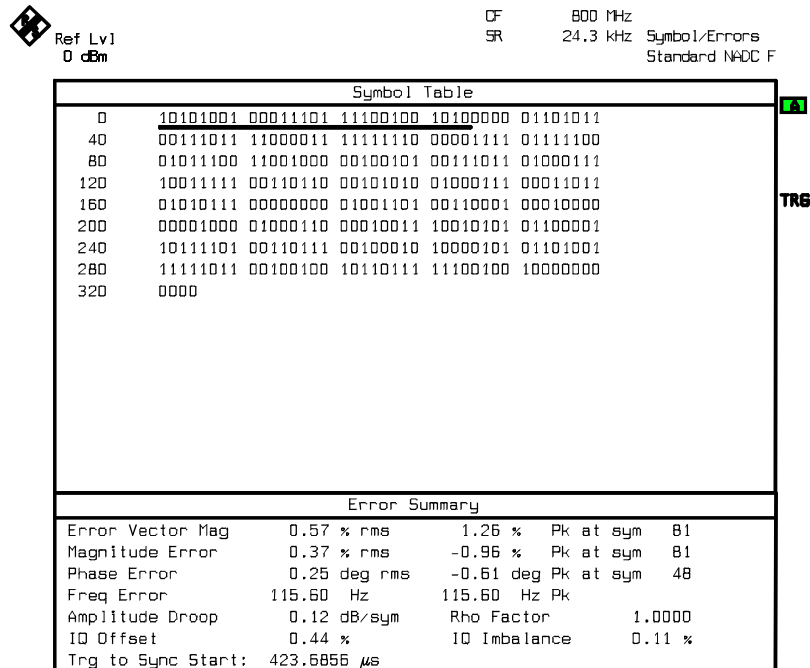

Fig. 4-30 Symbol table and table of sum errors (not FSK demodulation)

Description of errors as follows (**not FSK signals**):

**Magnitude error:** The magnitude error is the amplitude difference of the I/Q components of measurement signal and reference signal at the points of decision. For MSK modulations, all the points are considered in the calculation. It is a measure for the quality of the amplitude component of the modulated signal.

**Phase error:** The phase error is the phase difference of the I/Q components of measurement signal and reference signal at the points of decision. For MSK modulations, all the points are considered in the calculation.

**Vector error:** The error vector magnitude is the magnitude of the error vector which links the measured I and Q value in the complex plane to the ideal I and Q value at the points of decision. The error is calculated according to the following equation:

$$\text{Error vector magnitude (EVM)} = \sqrt{I_{\text{err}}^2 + Q_{\text{err}}^2}, \text{ where}$$

$I_{\text{err}}$  = error of the inphase signal and  
 $Q_{\text{err}}$  = error of the quadrature signal

**Frequency error :** The frequency error is the deviation of the FSIQ center frequency from the measured carrier frequency. It is derived from the frequency shift to be effected for synchronization to the carrier. The reference error of the FSIQ is also part of the frequency error.

**Amplitude droop:** The amplitude droop indicates the amplitude variation of the signal between the two symbols at the points of decision in dB. This parameter is very important for TDMA signals and is a measure for the quality of pulse modulation.

**I/Q offset:**

The I/Q offset is a measure for the LO feedthrough with analog I/Q modulators. It can be seen through a shift of the zero point in the constellation diagram. Without LO feedthrough (LO 100 % suppressed), the I/Q offset is zero. It is measured at the points of decision.

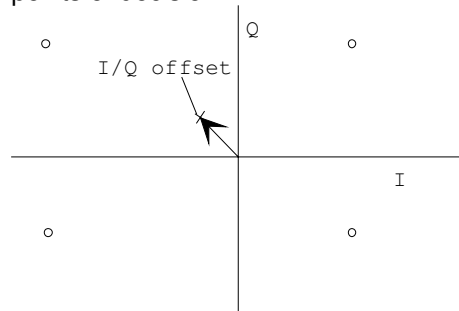

Fig. 4-31 Constellation diagram with I/Q offset

Amplitude and vector errors are given in %, phase errors in degrees (deg) or radian (rad). Prior to calculation, the measurement result is normalized in the vector or constellation diagram to a circle around the center of the group mid-points, the radius corresponding to the mean distance of all group mid-points to the center. This circle is defined as a unit circle with the radius 1 (see *NORMALIZE* function in the *MODULATION PARAMETER* menu)

Then, the errors at the points of decision are determined and the rms of the individual error values is calculated. Since the constellation diagram is normalized, the result is the rms value of the error in %.

**I/Q imbalance:**

The I/Q imbalance is a measure for the symmetry of the I/Q modulator to be measured. The I/Q gain error is the result of unequal gain factors in the I and Q path of the transmitter. The I/Q imbalance is calculated from the square root of the quotient of the vector magnitude for the wanted and interfering signals averaged over all points of decision:

$$\text{I/Q imbalance} = 100 * \sqrt{\sum_{i=1}^n \frac{|\text{Interference vector}|^2}{|\text{Signal vector}|^2}} \quad [\%]$$

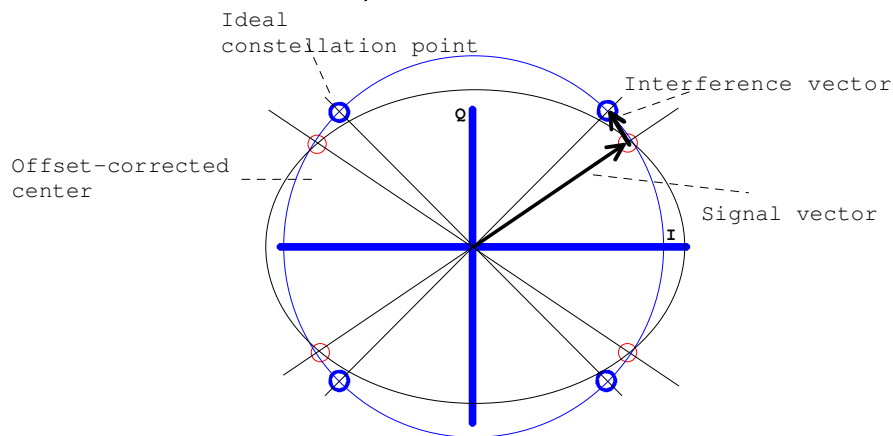

Fig. 4-32 Constellation diagram with I/Q imbalance



**Rho factor:** Similar to the error vector magnitude, the Rho factor is a measure for the quality of digital modulation. It is determined by measurement of the normalized correlated power between the measured signal and reference signal (IS95-CDMA to US standard IS-98) and is designated as waveform quality factor. The Rho factor can assume a maximum value of 1.0 (measured signal and reference signal are a 100% identical).

**FSK demodulation:**

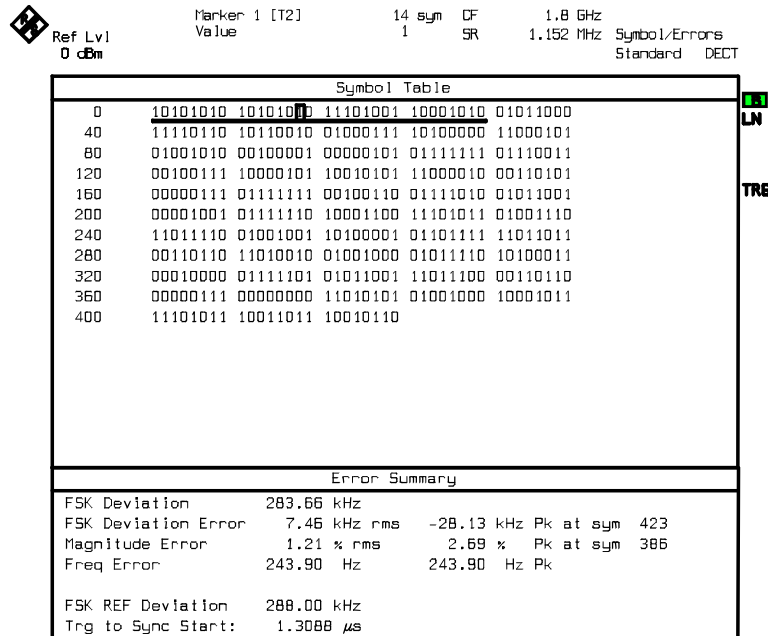

Fig. 4-33 Symbol table and table of sum errors (FSK demodulation)

The various errors and measured values have the following meaning (**FSK signals**):

**FSK deviation:** The FSK deviation is determined by the square difference between measurement and reference signal being minimized. The reference signal is based is formed on the basis of the known demodulated bits and modulation parameters. The frequency offset is determined separately and indicated under Freq Error. The frequency error is not considered in the indicated FSK deviation.

**FSK deviation error:** The FSK deviation error is the deviation difference between the measured signal and the reference signal, measured as an rms and peak value over all symbols. Frequency errors (frequency offset) are part of the indicated FSK deviation error.

Normalize ON The entered FSK reference deviation is used for scaling of the reference signal.

Normalize OFF The reference signal is automatically derived from the measurement signal on the basis of the known demodulated symbols and modulation parameters so as to ensure maximum agreement between measurement and reference signal.

**Magnitude error:** With FSK, the magnitude error is the deviation of the individual amplitudes of the AM envelope from the mean (rms) carrier amplitude, measured as an rms value over all symbols displayed and as a peak value normalized to the rms amplitude in %.

**Frequency error:** The frequency error is the deviation of the FSIQ center frequency from the measured carrier frequency. It is derived from the frequency shift to be effected for synchronization to the carrier. The reference error of the FSIQ is also part of the frequency error.

### Selecting Memory Size, Demodulation Length and Display Range

The size of the capture buffer containing the stored samples, the frame length to be demodulated and displayed and the number of points per symbol can be set to allow an adaptation to the measurement or to optimize the measurement speed.

At the beginning of a measurement, the FSIQ stores the samples into the capture buffer which can be selected between 1 and 16-k symbols. It then tries to find the suitable frame length for further processing according to the trigger condition (*FIND BURST*). The frame length to be displayed or used for error calculation is defined with *RESULT LENGTH*. It can be positioned within the frame length by synchronization sequence triggering (*FIND SYNC*).

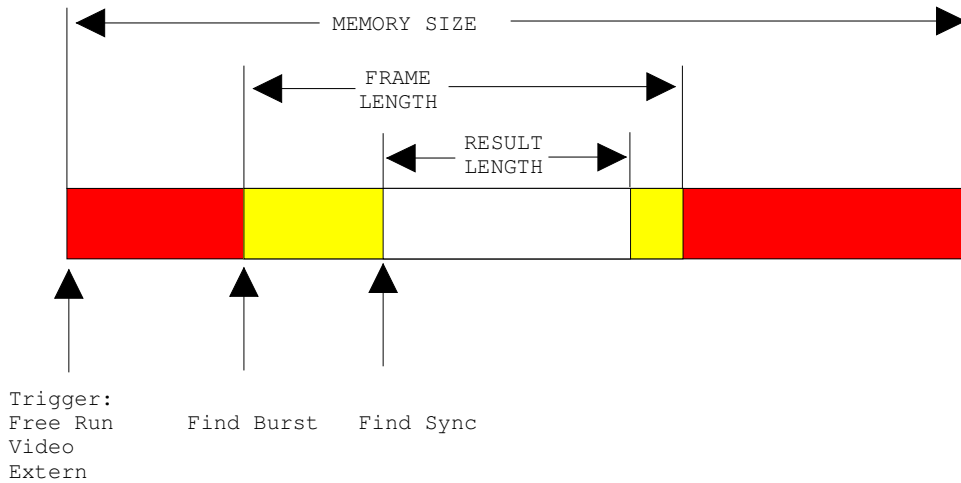

Finally, the number of points per symbol can be set. This number defines the maximum number of symbols that can be processed in the *FRAME LENGTH*.

#### Submenu *CONFIGURATION MODE - VECTOR ANALYZER - MEAS RESULT*

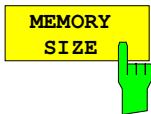

The *MEMORY SIZE* softkey calls up a table in which the number of samples saved in the capture buffer per measurement is determined. Within the memory size a burst, e.g. in the case of a TDMA signal, can be searched for (*FIND BURST* function).

MEMORY SIZE	
	16384 POINTS
√	8192 POINTS
	4096 POINTS
	2048 POINTS
	1024 POINTS

Only the symbols entered under *FRAME LENGTH* are used for demodulation.

For symbol rates > 1 MHz the data are stored in the memory without prior filtering and reduction. The maximum memory size is therefore reduced to 4096 points.

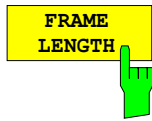

The *FRAME LENGTH* softkey calls up a table in which the number of symbols to be demodulated or evaluated is defined.

FRAME LENGTH	
1600	SYMBOLS
1500	SYMBOLS
1400	SYMBOLS
1300	SYMBOLS
1200	SYMBOLS
1100	SYMBOLS
1000	SYMBOLS
900	SYMBOLS
√ 800	SYMBOLS
700	SYMBOLS
600	SYMBOLS
500	SYMBOLS
400	SYMBOLS
300	SYMBOLS
200	SYMBOLS
100	SYMBOLS

With up to 4 points per symbol a maximum of 1600 symbols can be demodulated per measurement and their modulation parameters measured. With 8 points per symbol up to 800 symbols, and with 16 points per symbol up to 400 symbols can be handled.

With symbol rates  $>1$  MHz to  $\leq 1.20$  MHz a maximum of 500 symbols can be handled. This is due to the fact that the data are stored in the memory without prior reduction. The subsequent reduction limits the *FRAME LENGTH* in the specified frequency range.

The frame length markedly influences the time required for evaluating a measurement signal. It is therefore recommended to choose the frame length as short as possible. 400 symbols, for example, are sufficient for determining the phase error of a GSM burst as only 147 symbols are to be evaluated. The FSIQ automatically searches for the correct time domain by trigger functions *FIND BURST* and *FIND SYNC*.

The choice of the frame length influences the maximum number of points per symbol. With up to 400 symbols a maximum of 16 points, with  $>400$  up to 800 symbols a maximum of 8 points and with  $>800$  symbols a maximum of 4 points per symbol is possible.

**With symbol rates  $>1$  MHz to  $\leq 1.20$  MHz, the maximum number of symbols is 500!**

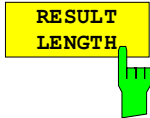

The *RESULT LENGTH* softkey opens a window for defining the number of symbols for display on the screen.

The maximum result length is identical to the frame length.

With the *FIND SYNC* function activated (synchronization to bit sequences in the signal), the maximum result length can be reduced (or the frame length increased).

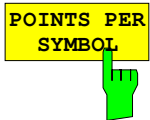

The *POINTS PER SYMBOL* softkey opens a window for entering the number of points per symbol.

1, 2, 4, 8 and 16 points per symbol can be selected. With one point per symbol, each point in the display corresponds to a symbol sampled at the time of decision. With  $n$  points per symbol, each  $n$ -th value is a point of decision. With 1 and 2 points per symbol, the FSIQ demodulates with 4 points per symbol for reasons of accuracy. Only one or two samples are output, however.

For up to 4 points per symbol, a frame length of max. 1600 symbols is possible, with 8 points per symbol a frame length of max. 800 symbols and with 16 points per symbol of max. 400 symbols.

In the case of MSK demodulation, the number of points per symbol influences the result of the error measurement as all the points are considered in the calculation. With all other demodulators, only the values measured at the points of decision are taken into account. For GSM (DCS1800 and PCS1900) less than 4 points per symbol should not be used.

The number of points per symbol largely influences the measurement speed attained during the evaluation of the signal. If high measurement rates are to be attained for automatic tests, for example, a low number of points per symbol is recommended.

## Frequency Settings- FREQUENCY Key Group

### Setting the Frequency - CENTER Key

In vector signal analysis, FSIQ is always set to a fixed frequency. The RF signal is analyzed by converting the signal into the complex baseband.

The frequency of FSIQ is set in the same way as in the spectrum analysis mode, i.e. with the *CENTER* key in the *FREQUENCY* key group.

*FREQUENCY CENTER* menu

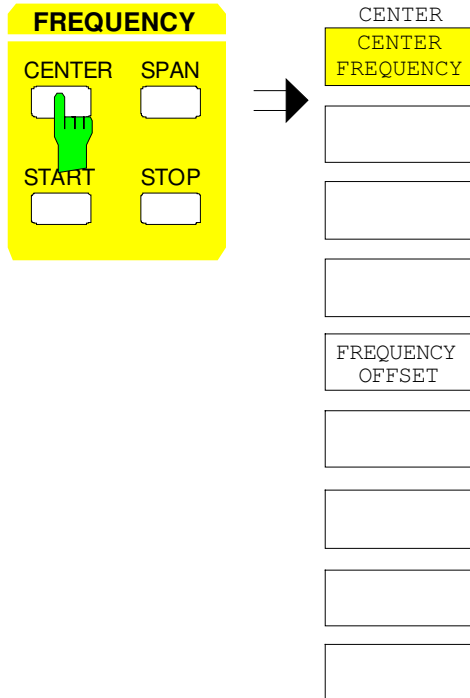

The *CENTER* key calls up the entry window for the center frequency .

For the demodulation of digitally modulated signals, the FSIQ frequency has to be accurately set to the frequency (carrier) of the signal to be measured so that synchronization to the carrier is possible. The required setting accuracy depends on the symbol rate and must not exceed 2% of the symbol rate.

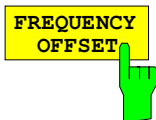

The *FREQUENCY OFFSET* softkey activates the input of a frequency offset which can be added to the frequency-axis labeling. The displayed frequency is shifted by the frequency offset. The range of values for the offset is -100 GHz to +100 GHz.

### Setting the Frequency Span - START, STOP, and SPAN Key

The *SPAN*, *START* and *STOP* keys are not assigned in vector signal analysis for the demodulation of digitally modulated signals since FSIQ is always set to a fixed frequency and the measurement results are displayed in the time domain. The analysis bandwidth by which the demodulation is performed is predefined by the symbol rate and the number of sampling points.

## Setting the Level Display and Configuring the RF Input

### Setting the Reference Level

With spectrum analysis (ANALYZER mode) of the FSIQ, the level applied to the RF input is always indicated on the display so that one can see the relationship between the setting of the reference level and the measurement results on the display.

With vector signal analysis, this only applies to operating mode *DIGITAL DEMODULATION*, *MAG CAP BUFFER*. In operating mode *DIGITAL DEMODULATION* with activated demodulation, e.g. when the demodulated signal is displayed this relationship is not obvious. That is why a strict distinction has to be made between setting the **reference value** which is an important reference point for the measured-value display and the **reference level** relating to the RF input.

To obtain a maximum dynamic range it is important for the signal level at the A/D converter to be close to the maximum level of the converter. The maximum level of the converter corresponds to the reference level (*REF LEVEL*) in the spectrum analysis mode. This means that a signal whose amplitude attains the reference level in the spectrum analysis mode is ideal for the vector analyzer mode. An important factor is the **sum level** within the IF bandwidth (=ANALOG BANDWIDTH in vector signal analysis mode) of the analyzer.

The reference level can be manually set by checking the signal level in the spectrum analysis mode against the set frequency (at the same IF bandwidth!) and by operating the vector analyzer with the same setting.

The FSET can perform this in vector signal analysis but also by a single automatic setting of the reference level.

Certain settings of the spectrum analysis mode such as center frequency, reference level and attenuation are taken over by the vector signal analysis. Parameters that are not affected are span (in vector signal analysis, the frequency span has a different meaning: it corresponds to the analysis bandwidth and is thus independent in the two operating modes), resolution bandwidth, ref. level offset as well as trace and trigger settings

The **reference value** (*REF VALUE*) of the vector signal analysis is the reference point for scaling the measured value. Apart from *DIGITAL DEMODULATION-RESULT DISPLAY-MAGNITUDE CAP BUFFER* it is decoupled from the setting of the reference level, i.e. a direct relationship cannot be determined.

With the **REF** key, the **reference level** can be set like in the spectrum analysis mode.

The **RANGE** key calls up a menu comprising all the settings required for scaling the measured value such as auto scaling (*AUTO SCALE*), scaling (Y per Div), reference values in the X and Y direction (*X/Y\_REF VALUE*) and the relative position of the reference value on the diagram (*REF VALUE POSITION*).

LEVEL REF Menu

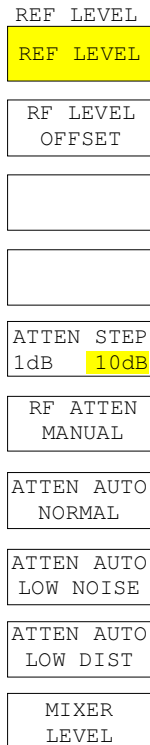
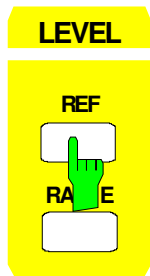

The REF key calls up the menu for setting the reference level and at the same time activates the level entry field.

Operation and softkey functions identical to analyzer mode:

- ATTEN STEP 1dB/10dB
- RF ATTEN MANUAL
- ATTEN AUTO NORMAL
- ATTEN AUTO LOW NOISE
- ATTEN AUTO LOW DIST
- MIXER LEVEL

Softkey *ATTEN STEP 1dB/10dB* is only available when the FSIQ is equipped with option FSE-B13, 1dB attenuator



The *REF LEVEL* softkey activates entry of the manual gain of the FSIQ. For a maximum dynamic range, it has to be ensured that the A/D converter is driven to its full range but not overdriven.

In the vector analyzer mode, this is indicated by the messages *IF OVLD* (overload) and *UNLD* (underrange) which inform on the dynamic range when measured data are read in.

When *IF OVLD* is displayed, the instrument or the A/D converter is overdriven during data read-in and entered data are invalid.

With *UNLD* displayed, the A/D converter is not sufficiently driven during data read-in (level <-6 dB of full range). Indicated values may have a reduced dynamic range, i.e. have a greater error.

For a correct level setting in the case of *IF OVLD*, reduce the REF LEVEL (continuous sweep mode) in sufficiently small steps (e.g. 2 dB) until the message disappears.

Proceed analogously for increasing the REF LEVEL when *UNLD* is displayed until the message disappears.

The maximum dynamic range is attained approx. 1 dB below the *OVLD* level.

The reference level can also be set to the test signal in the spectrum analysis mode at the same IF bandwidth as in the vector signal analysis mode (with *COUPLED: ANALOG BW AUTO* also 10 kHz) and vector signal analysis can then be selected again.



The *REF LEVEL OFFSET* softkey activates the entry of a level offset. It is added to the measured level, irrespective of the unit used. The scaling of the Y axis is changed accordingly. This function is used to take into account the effect of an external attenuator on the displayed values. The setting range is  $\pm 200$  dB in 0.1 dB steps.

### Setting the Display Range and Scaling - RANGE Key

The menu for setting the display range is different from that of the spectrum analysis mode.

LEVEL RANGE menu

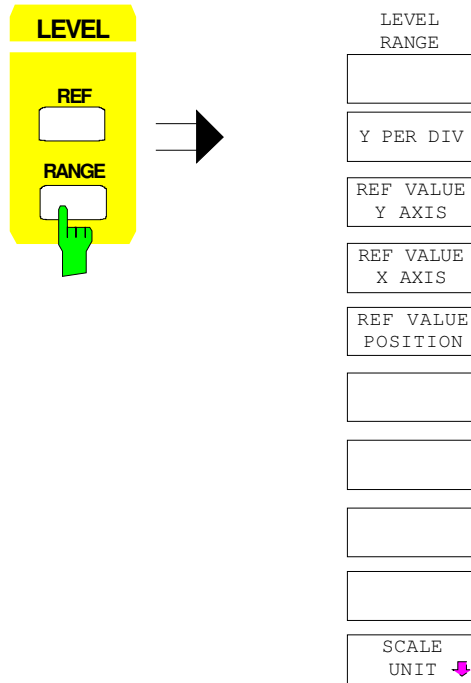

The *RANGE* key calls up a menu comprising all the important display parameters such as reference value, scaling etc.



The *Y PER DIV* softkey calls for the entry of the vertical scaling in the current unit.

For vector or constellation diagrams, the corresponding X scaling is linked with Y scaling:

$$X \text{ PER DIV} = 5/4 * (Y \text{ PER DIV})$$

Reason: The diagram has 400 x 500 points. In case of a free X scaling circles would be reproduced as ellipses.



The *REF VALUE Y AXIS* and *REF VALUE X AXIS* softkeys call for the entry of the reference value for the Y or X axis of the measurement diagram. The *REF VALUE X AXIS* softkey is only displayed if a polar diagram has been selected for the trace.



The reference value is entered in the corresponding unit of the diagram (See *UNIT*).



**Example 1:** Constellation diagram: y reference value: +1.20; x reference value: - 0,35  
(reference position: 50%)

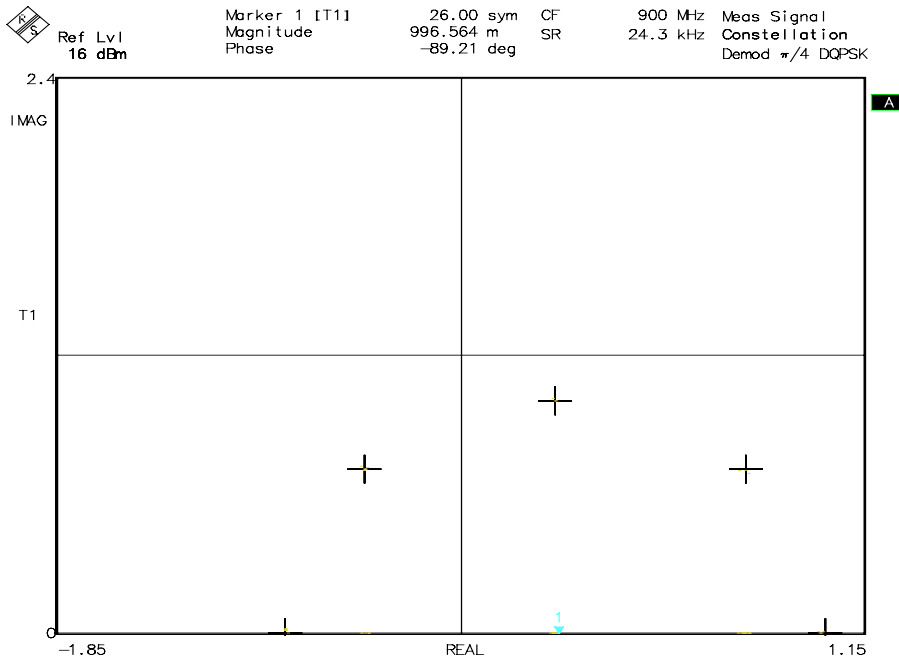

Fig. 4-33 Representation of the reference values in the constellation diagram

**Example 2:** Display of I and Q signals: Y reference value: -0.2 REF position: 50%

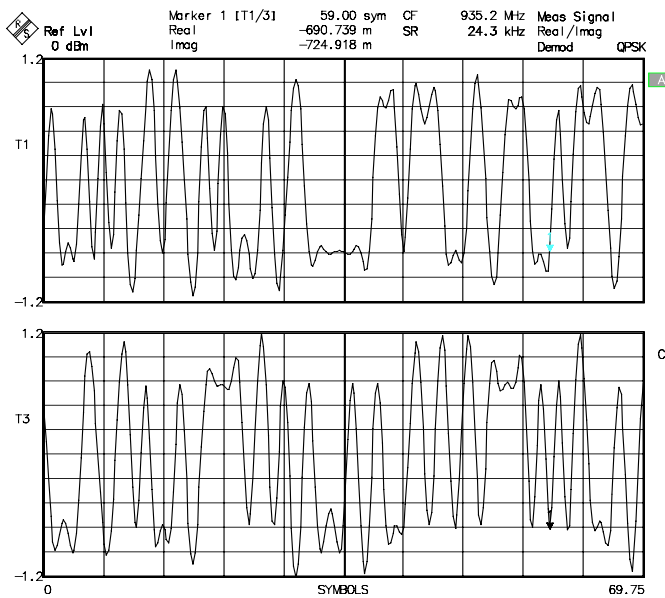
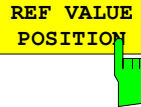

Fig. 4-34 Display of I and Q signals



The *REF VALUE POSITION* softkey opens a window for setting the reference positions diverging from the basic setting.

*REF VALUE POSITION* defines the position of the reference value. It normally lies at 100%, i.e. the maximum displayable Y value is also the reference value. It is best to use this setting for displaying the magnitude which is then the basic setting.

When, for example, the timing of I/Q signals or the phase spectrum is displayed it might be desirable to set the reference value to the center. The basic setting is thus 50% (also for polar diagrams).

Submenu: *LEVEL RANGE*

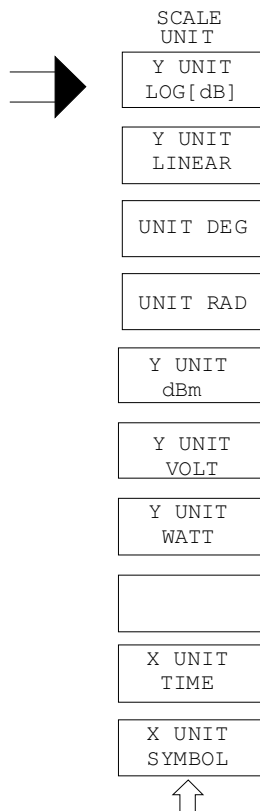
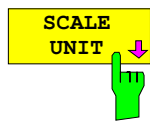

The *SCALE UNIT* softkey calls up a submenu in which the unit of the Y axis and the X axis are set.

The units offered depend on the setting of *RESULT DISPLAY* and *MEAS RESULT*.

The logarithmic unit dB (*Y UNIT [dB]*) or dimensionless linear units (*Y UNIT LINEAR*) are permissible for the Y axis.

*ERROR* and *MAGNITUDE* are displayed in the following units:

*Y UNIT LOG [dB]*: dB

*Y UNIT LINEAR* : %.

Errors of *REAL/IMAG PART* are always displayed in %.

Phase errors are displayed in DEG or RAD, frequency errors in Hz.

Units which are not allowed in the current operating mode are disabled.

In polar diagrams, the units for the X-axis and Y-axis are equal. The softkeys *X UNIT...* are suppressed.

The time representation, the units time (*X UNIT TIME*) or symbols (*X UNIT SYMBOLS*) can be used for the X-axis. The softkey for the X-axis unit are only shown in time representation.

If a marker is active, the marker values are read out in the current scale units.

**Only for *MEAS RESULT: MAGNITUDE CAP BUFFER*:**

Possible display units: *YUNIT LOG [dB]*, *YUNIT LINEAR*, *dBm*, *Volt* and *Watt*.

Table 4-4 Allocation table of selectable units or, in case of error display, of the displayed units in operating mode *DIGITAL DEMODULATION* depending on *RESULT DISPLAY* and *MEAS RESULT*

RESULT DISPLAY ----- MEAS RESULT	MAGNITUDE CAP BUFFER	MAGNI- TUDE	PHASE	FREQUENCY [with FSK and MSK only]	REAL/ IMAG PART	EYE DIAG	POLAR [IQ] VECTOR	POLAR [IQ] CONSTELL
MEAS SIGNAL	Y_UNIT LINEAR Y-UNIT LOG[dB] dBm VOLT WATT	Y_UNIT LINEAR Y-UNIT LOG[dB]	DEG/RAD	Hz	Y_UNIT LINEAR	Y_UNIT LINEAR	Y_UNIT LINEAR	Y_UNIT LINEAR
REFERENCE SIGNAL	--	like MEAS SIGNAL	like MEAS SIGNAL	like MEAS SIGNAL	like MEAS SIGNAL	like MEAS SIGNAL	like MEAS SIGNAL	like MEAS SIGNAL
ERROR SIGNAL	--	[%] [dB]	PHASE DEG/RAD	Hz	--	-	-	-
VECTOR ERROR	--	[%] [dB]	DEG/ RAD	--	[%]	-	[%]	[%]

### Configuration of RF Input in Vector Signal Analysis

This section is identical to that of the spectrum analysis mode.

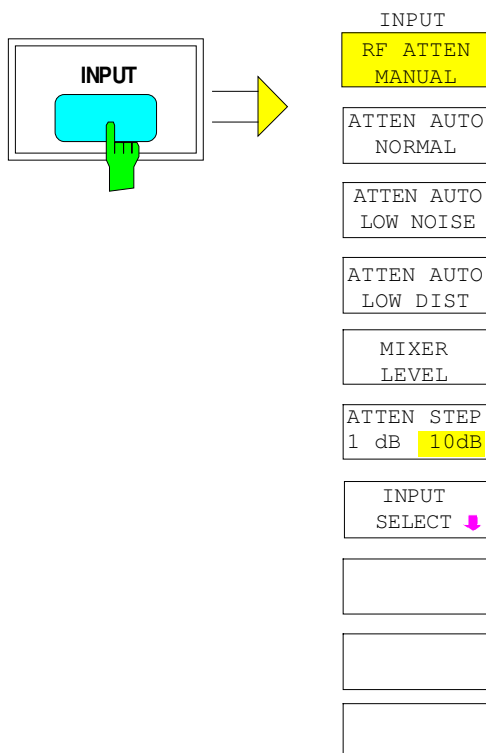

**Note:** The operating mode recommended for the vector analyzer input is *ATTEN AUTO NORMAL*. If *ATTEN AUTO LOW NOISE* is set (or for *MIXER LEVEL ≥ -30 dB*), the higher signal modulation occurring within the *IF*-bandwidth causes a nonlinear behavior in the *IF* branch. This leads to increased measurement errors, in particular for modulation types with a non-constant level (e.g. *PSK*).

## MARKER Key Group

In the vector analyzer mode markers may be used for highlighting points in a trace and for reading out measured values.

For detailed information see section 'Marker Function' in chapter 'Analyzer Mode'.

In the vector analyzer mode marker softkey functions depend on the selected measurement.

### Main Marker - *NORMAL* Key

The main markers and their functions are selected with the *NORMAL* key.

*MARKER NORMAL* menu

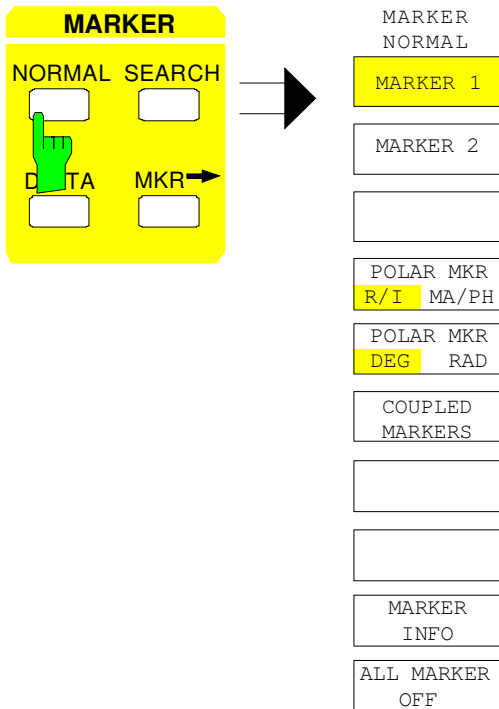

The *NORMAL* key calls up a menu comprising all standard marker functions.

Activated marker functions are indicated by a dark background of the softkeys. If no marker is activated when the *NORMAL* key is pressed, MARKER 1 is activated as a reference and set to the maximum value in the curve. (automatic switch-on of peak search function provided at least one trace is active; not with polar diagram). In all other cases the reference marker is activated but no automatic peak search is performed.

In the marker field the marker position (time), the measured value or values (in the case of a complex display) and the trace relevant for the marker (here [T1]) are displayed.

Example:

Marker display in the digital demodulation and I/Q display mode:

```
Marker 1 [T1/3] 22.3 μs
Real      0.998
Imag     -0.124
```

When the symbol table is displayed (softkey *SYMB TABLE/ERRORS* in submenu *MEAS RESULT*) the marker moves from symbol to symbol in the table. The position of the marker is indicated by a dark background and its numerical value in inverse video.

In the marker field, the marker position and the decimal value of the symbol are displayed.

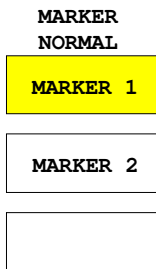

The *MARKER 1* and *MARKER 2* softkeys switch the respective marker on or off or define it as an entry marker (reference marker).

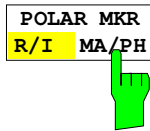

The *POLAR MARKER R/I / MA/PH* softkey selects magnitude and phase (*MA/PH*) or real and imaginary part (*R/I*) for the numeric result display in the polar diagram. When measured values are indicated versus time this softkey is disabled.

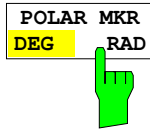

The *POLAR MARKER DEG/RAD* softkey selects the unit degree (*DEG*) or radiant (*RAD*) for indication of the phase of the marker in the respective diagram.

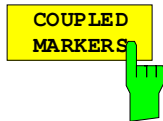

The *COUPLED MARKER* softkey couples markers (and delta markers) of different traces in the combined display mode *REAL/IMAG PAR*. In this case the X position of corresponding markers is identical. This allows complex marker values to be displayed which correspond to the polar display.

Marker 1 6.75 SYM [T1/3]  
 RE 0.895  
 IM 1.002

If several windows are displayed, the markers of **all** windows are coupled when the *COUPLED MARKERS* function is active.

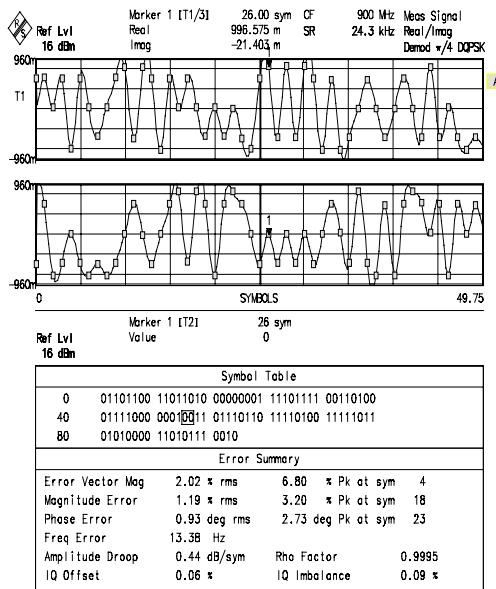

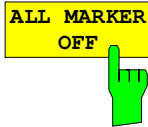

The *ALL MARKER OFF* softkey switches all markers including reference and delta markers off and closes the marker entry window. In addition the *MARKER INFO* softkey is switched off.



The *MARKER INFO* softkey allows several markers to be displayed in the grid, in addition to the display of marker information in the marker field of the diagram headline.

In the top right-hand corner of the grid the two markers or delta markers are displayed with symbols  $\nabla/\Delta$ , marker number (1, 2), position and measured value (may be complex). The number of symbols for specifying the marker position is limited in certain cases.

If there are not enough lines for displaying all active markers and delta markers, the markers are listed first and then the delta markers.

In the *SPLIT SCREEN* display this list is divided into two lists, one for *SCREEN A* and one for *SCREEN B*.

### Delta Marker - DELTA Key

MARKER DELTA menu

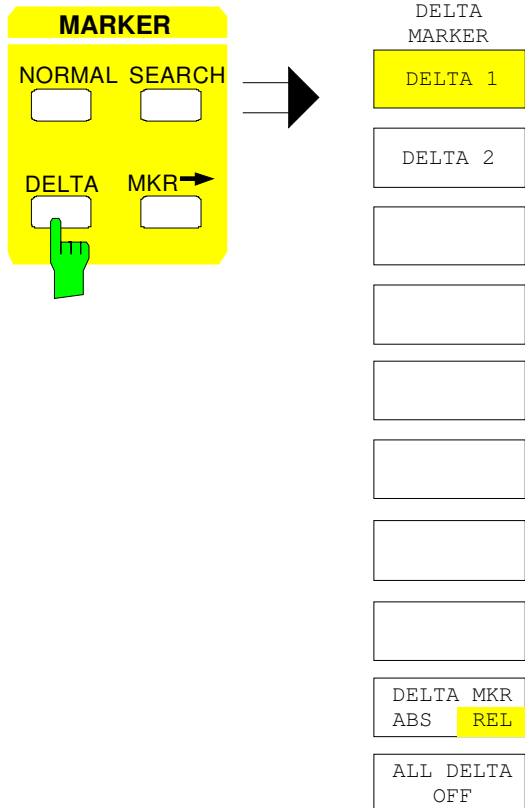

The *DELTA* key in the MARKER key group selects the delta markers.

Delta markers are always referenced to the active reference marker . When no marker is active, switching on a delta marker automatically activates marker 1. Delta markers are displayed as an unfilled symbol ▽. When the delta marker is active for entry, a filled symbol ▼ is displayed.

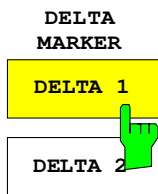

The *DELTA 1* and *DELTA 2* softkeys switch on delta markers 1 and 2.

Operation of delta markers is identical to that of markers. When a delta marker is switched on, all entries apply to the delta marker. For changing the position of the main marker, the main marker has to be reactivated. Displayed differences normally apply to the active reference marker.

In the delta marker field, the number of the delta marker, the time difference to the reference marker and the difference of measured values between the active delta marker and reference marker are displayed.



The *DELTA ABS / REL* softkey switches between absolute (*ABS*) and relative (*REL*) input of time of the delta marker.

Default setting is *REL* (input relative to the reference marker)



The *ALL DELTA OFF* softkey switches off all active delta markers and any associated functions.

### Search Functions (Marker Search menu) - SEARCH Key

The menus called up with *SEARCH* offer functions for a peak/min search and universal marker functions for overall evaluation of traces. The search functions can be used for markers and delta markers.

Important: With polar diagrams, peak/min. peak values refer to the vector length (with origin as reference), in all other cases to the Y deflection. In this diagram, summary markers cannot be switched on or are not displayed.

Functions in the *MARKER SEARCH* menu refer to the marker or delta marker active during entry. Switchover between the active marker and delta marker is possible with the *ACTIVE MKR DELTA* softkey.

If no marker is switched on when the *SEARCH* key is pressed, marker 1 is activated as reference marker (by means of peak search).

The search range can be limited by time lines (*TIME LINE 1/2*) switched on with *SEARCH LIM ON/OFF*. The limitation of the search range is valid for all the marker search functions including the *SUMMARY MARKERS* and for error calculation during *SYMB TABLE/ERRORS*.

The time lines are only visible for diagrams versus time, i.e. not for polar diagrams and for diagrams of *SYMB TABLE/ERRORS*. The limitation of the search range is valid for *SEARCH LIMITS ON* for all diagrams irrespective of whether the time lines are visible or not.

*MARKER SEARCH* menu

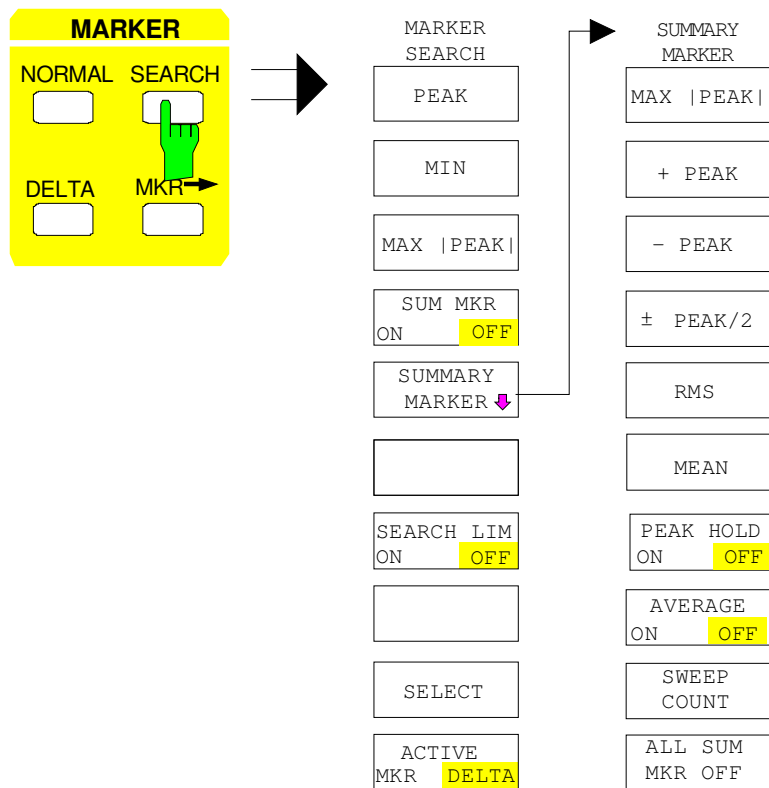

The search range can be limited by the time lines (*TIME LINE 1/2*) (softkey *SEARCH LIM ON/OFF*). The limitation of the search range extends to all marker search functions including the *SUMMARY MARKER* as well as to error calculation during *SYMB TABLE/ERRORS*.

The time lines are only visible for diagrams versus time, ie not for polar diagrams and for diagrams representing *SYMB TABLE/ERRORS* . The limitation of the search range during *SEARCH LIM ON* extends to all types of representation, irrespective of whether the time lines are visible or not.

The functions in the *MARKER SEARCH* menu refer to the marker or delta marker that is currently active for entries. Softkey *ACTIVE MKR DELTA* may be used to switch between the active marker and the active delta marker. If no marker is switched on before *SEARCH* is pressed, marker 1 will be activated as reference marker (with peak search).



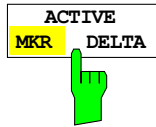

The *ACTIVE MKR / DELTA* softkey switches over between active marker and active delta marker.

With *DELTA* highlighted, subsequent search functions are carried out with the active delta marker.

**Note:** *Switchover between marker and delta marker entry is also possible with the NORMAL and DELTA keys.*



The *SELECT MARKER* softkey opens the table for selection of the marker or delta marker.

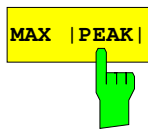

The *MAX /PEAK/* softkey sets the active marker or delta marker to the highest magnitude displayed (*PEAK* or *MIN*) in the associated curve.

For instance, the function searches for the maximum phase error of a signal, which may be positive or negative.

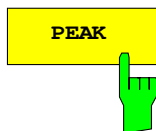

The *PEAK* softkey sets the active marker or delta marker to the highest value displayed in the associated measured curve.

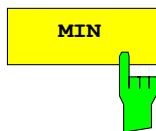

The *MIN* softkey sets the reference marker to the lowest value in the associated curve.

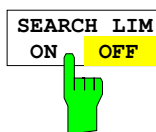

The *SEARCH LIMIT ON/OFF* switches between limited (ON) and unlimited (OFF) search range.

The search range can be limited by time lines (*TIME LINE1/2*) for peak- and min-search functions as well as for the summary markers.

If *SEARCH LIMIT* is ON, a search for the corresponding signals is only performed between the two lines.

If only one line is switched on, *TIME LINE 1* is valid as lower limit (the upper limit is the stop frequency), *TIME LINE 2* defines the upper limit value.

If no line is active, lines 1 and 2 are switched on automatically and positioned to 20 % and 80 % of the grid.

If the function is switched off, the lines continue to be switched on.

Time lines are not visible for polar diagrams and for Symb Table/Errors. The limitation of the search range, however, remains effective.

Default value is *SEARCH LIMIT OFF*.

## The Summary Marker

MARKER SEARCH menu

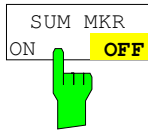

The *SUM MKR* softkey switches the display of the summary marker values in the marker info field on and off. The measured values are updated after every sweep end (in case of *AVG/HOLD OFF*).

If one trace is in *AVERAGE*, *MAX HOLD* or *MIN HOLD* mode, the summary markers for this trace cannot be switched on.

On the other hand, the summary markers are switched off if the trace functions *AVERAGE*, *MAX HOLD* or *MIN HOLD* are activated (only valid for the same trace).

The maximum and average values can be maintained or displayed for all summary markers by means of function *HOLD ON/OFF* or *AVERAGE ON/OFF* if Sweep Count >0.

Example:

Marker info field for :

Summary Marker: + *PEAK* and *MEAN* switched on, *PEAK HOLD ON* and *AVERAGE ON*:

```

▼1          63. sym
MAGN CAP   2.40 Watt
+PEAK HOLD 2.55 Watt
+PEAK AV   2.39 Watt
MEAN HOLD  2.33 Watt
MEAN AV    2.29 Watt
    
```

The measurement range can be restricted by means of the function *SEARCH LIMITS ON* and the time lines (*TIME LINE 1,2*).

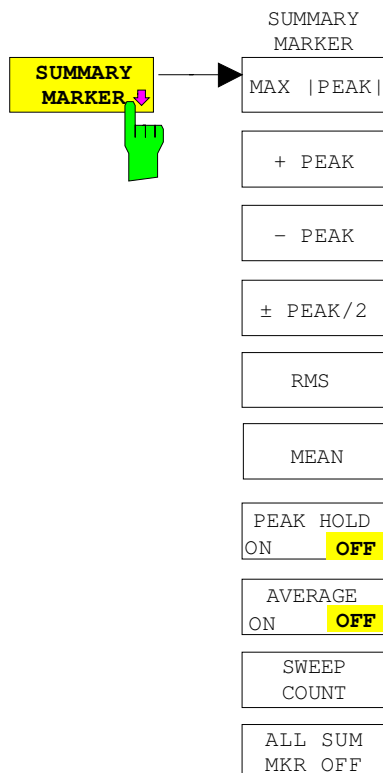

The *SUMMARY MARKER* softkey calls up the submenu for selecting the summary marker values to be displayed in the marker info field.

The measured values are updated for every sweep. (In case of setting *SYMB TABLE/ERRORS* the marker info field is not displayed).

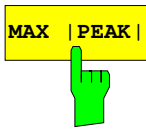

The *MAX /PEAK* softkey selects the measurement of the magnitude of the higher of the two peaks *+PEAK* and *-PEAK* per sweep.

The search range can be limited by means of function *SEARCH LIMITS ON*.

With the *PEAK HOLD* function activated, the highest peak value that has occurred since the activation of *PEAK HOLD* is displayed.

With the *AVERAGE* function activated, the highest peak values are averaged and displayed.

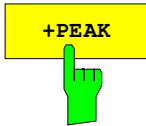

The *+PEAK* softkey selects the measurement of the positive peak value per sweep.

The search range can be limited with the function *SEARCH LIMITS ON*.

With the *PK Hold* function activated, the highest positive peak value that has occurred since the activation of *PEAK HOLD* is displayed.

With the *AVERAGE* function activated, the positive peak values are averaged and displayed.



The *-PEAK* softkey selects the measurement of the negative peak value per sweep.

The search range can be limited with the function *SEARCH LIMITS ON*.

With the peak hold function switched on, the highest negative peak value that has occurred since the activation of *PEAK HOLD* is displayed.

With the *AVERAGE* function switched on, the highest negative peaks are averaged and displayed.

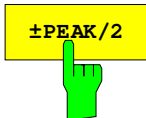

The *±PEAK* softkey selects the measurement of the average value of the positive and negative peak value per sweep.

The search range can be limited with the *SEARCH LIMITS ON* function.

With the peak hold function switched on, the highest average value that has occurred since the activation of *PEAK HOLD* is displayed.

With the *AVERAGE* function switched on, the average values of the positive and negative peak value (versus time) are averaged and displayed.

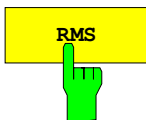

The *RMS* softkey selects the measurement of the rms value of the signal per sweep.

The search range can be limited with the *SEARCH LIMITS ON* function.

With the peak hold function switched on, the highest rms value that has occurred since the activation of the *PEAK HOLD* function is displayed.

With the *AVERAGE* function switched on, the rms values are averaged versus time and displayed.

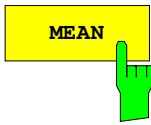

The MEAN softkey selects the measurement of the average value of the signal per sweep. Thus, the average carrier power can be measured during a GSM burst (during display of *MAGNITUDE CAP BUFFER*).

The search range can be limited with the *SEARCH LIMITS ON* function.

With the peak hold function switched on, the highest average value that has occurred since the activation of *PEAK HOLD* is displayed.

With the *AVERAGE* function switched on, the average values (of a trace) are averaged versus time and displayed.

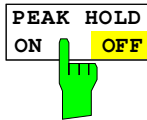

The *PEAK HOLD ON / OFF* softkey switches the peak hold function of the summary markers on or off.

All active summary markers are only updated after every sweep end if higher values have occurred.

The measured values can be reset by switching the *PEAK HOLD ON / OFF* softkey off and on again.

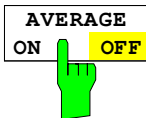

The *AVERAGE ON / OFF* softkey switches the averaging of the summary markers on or off.

The measured values can be reset by switching the *AVERAGE HOLD ON / OFF* softkey off and on again.



The *SWEEP COUNT* softkey activates the entry of the number of measurements (sweeps) in the *SINGLE SWEEP* mode.

The number of measurements can be selected between 0 and 32767.

If an averaging of measured values or the peak hold mode is set, *SWEEP COUNT* also determines the number of measurements required for averaging or maximum averaging.

*SWEEP COUNT* = 0      10 measured values are always required for a running averaging.

*SWEEP COUNT* = 1      no averaging is performed.

*SWEEP COUNT* > 1      averaging is performed over the set number of measured values.

In case of *CONTINUOUS SWEEP* the FSET (*AVERAGE ON*) performs an averaging until the number of sweeps set under *SWEEP COUNT* is attained and then performs a running averaging.

Maximum averaging is infinite irrespective of *SWEEP COUNT*.

**Note :** *This setting is equivalent to the settings in the menus TRACE and SWEEP-SWEEP.*



The *ALL SUM MKR OFF* softkey switches off the summary markers.

## Varying Instrument Settings by means of Markers - MKR→Key

MARKER MKR→ menu

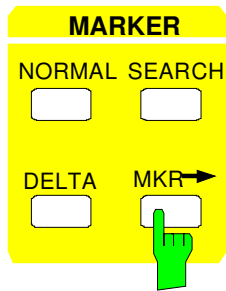

MARKER →

PEAK

MKR→  
TRACE

SELECT  
MARKER

ACTIVE  
MKR DELTA

The *MKR ->* key calls up a menu which offers functions for varying instrument parameters by means of the currently active marker. Same as in the *SEARCH* menu, the functions are also valid for the delta markers.

The selection of marker or delta marker depends on the currently active frequency entry for marker or delta marker. If no entry is active, the marker with the lowest number is activated as reference marker.

PEAK



To simplify operation, the *PEAK* search function is also available in the *Marker→* menu.

MKR →  
TRACE



The *MKR → TRACE* softkey opens a window in which the marker can be positioned on a new trace. Only selectable traces are displayed in the window.

SELECT  
MARKER



The *SELECT MARKER* softkey opens the table for selection of the marker or delta marker.

ACTIVE  
MKR DELTA



The *ACTIVE MKR / DELTA* softkey is used for switchover between active marker and delta marker.

With *DELTA* activated (highlighted), the following marker functions are carried out with the active delta marker.

**Note:** *Switchover between marker and delta marker entry is also possible by means of the NORMAL and DELTA keys.*

## Setup of Display and Limit Lines – *LINES* Key Field

### Display Lines – *D LINES* Key

Display lines are aids which, similar to markers, make the evaluation of measurement curve data more convenient. The function of display lines is similar to that of a movable scale which can be used to measure absolute and differential values on measurement curves.

In addition, the display lines can also be used to limit the range of search for marker functions.

In vector analyzer mode, the FSIQ provides four different types of display lines:

- two horizontal threshold lines for marking measurement values or for defining measurement value search ranges – Display Line 1/2,
- two vertical time lines for marking times or for defining time search ranges – Time Line 1/2,
- a threshold line which, for example, sets the search threshold for maximum values (Peak Search) – Threshold Line
- a reference line – Reference Line

For purposes of clarity, each line is annotated on the right side of the display diagram by the following abbreviations:

D1	Display Line 1	D2	Display Line 2
T1	Time Line 1	T2	Time Line 2
TH	Threshold Line	REF	Reference Line

The lines for level, threshold and reference are displayed as continuous, horizontal lines over the full width of the diagram. They are movable in the y-direction.

The lines for time are displayed as vertical, continuous lines over the total height of the diagram. They are movable in the x-direction.

For measurement operations in two separate windows, (Split Screen-Modus), the display lines are available independently in both windows. In the currently active window, the display lines can be activated and/or shifted. Lines previously defined in the currently inactive window remain unchanged.

**Note:** *The softkeys for setting and switching the display lines on and off operate similar to a three-position switch:*

*Initial condition: The line is switched off (softkey has grey background)*

*1<sup>st</sup> press: The line is switched on (softkey has red background) and data entry is activated. The position of the display line can be adjusted by using the roll-key, the step keys or through direct numerical inputs via the data-entry keypad. If some other arbitrary function is requested, the data-entry keypad is disabled. In this case, the display line remains switched on (softkey has green background).*

*2<sup>nd</sup> press: The display line is switched off (softkey has grey background).*

*Initial condition: The line is switched on (softkey has green background)*

*1<sup>st</sup> press: The line is switched on (softkey has red background) and data entry is activated. The position of the display line can be adjusted by using the roll-key, the step keys or through direct numerical inputs via the data-entry keypad. If any other arbitrary function is requested, the data-entry keypad is disabled. In this case, the display line remains switched on (softkey has green background).*

*2<sup>nd</sup> press: The display line is switched off (softkey has grey background).*

Menu *LINES-D-LINES*

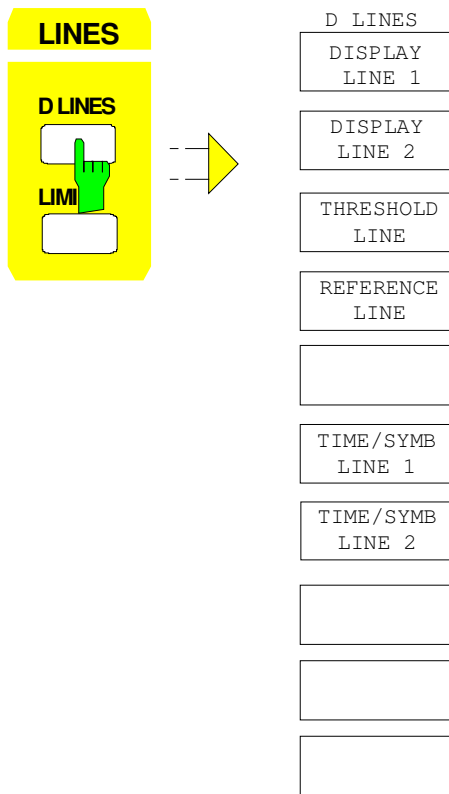

DISPLAY  
LINE 1



DISPLAY  
LINE 2



THRESHOLD  
LINE



REFERENCE  
LINE



TIME/SYMB  
LINE 1



TIME/SYMB  
LINE 2



The *DISPLAY LINE 1/2* softkeys switch the display lines on/off and activate the entry of the line location.

The display lines mark the selected levels in the measurement window.

The *THRESHOLD LINE* softkey switches the threshold line on/off and activates the entry of the line location.

The threshold line is a display line which defines a threshold value. This threshold value serves as a lower search limit for maximums/minimums in the marker functions (*MAX PEAK, MIN PEAK, NEXT PEAK* etc.).

The *REFERENCE LINE* softkey switches the reference line on/off and activates the entry of the line position.

The *TIME/SYMB LINE 1/2* softkeys switch the time lines 1/2 on/off and activate the entry of line locations.

The time lines mark the selected times or define the search range (see section "Marker Functions").

## Limit Lines – *LIMITS* Key

Limit lines are used to define amplitude curves or error boundaries on the display screen which are not to be exceeded. They indicate, for example, the upper limits for modulation errors which are permissible from a Unit Under Test (UUT). For transmission of information in TDMA (e.g. GSM), the amplitude of the bursts in a time slot must adhere to a curve which must fall within a specified tolerance band. The lower and upper limits may each be specified by a limit line. Then, the amplitude curve can be controlled either visually or automatically for any violations of the upper or lower limits (GO/NOGO test).

The FSIQ supports up to 300 limit lines, each of which may have a maximum of 50 data points. For each limit line, the following characteristics must be defined:

- The name of the limit line. The limit line can be specified for time units or symbols. Time units can be entered as absolute time or time in relation to set reference time. Symbols can be entered as absolute symbols or symbols in relation to set reference symbol
- The reference of the interpolation points to the X-axis. The limit line may be specified either for absolute times or for times which are related to the time on the left edge of the diagram.
- The reference of the interpolation points to the Y-axis. The limit line can be selected either for absolute levels or voltages or referred to the set maximum level (Ref Lvl). If the reference line is switched on, it is used as reference when relative setting has been selected.
- The type of limit line (upper or lower limit). With this information and the active limit checking function (*LIMIT CHECK* softkey), the FSIQ checks for compliance with each limit.
- The limit line units to be used. The units of the limit line must be compatible with the vertical axis in the active measurement window.
- The measurement curve (trace) to which the limit line is assigned. For the FSIQ, this defines the curve to which the limit is to be applied when several traces are simultaneously displayed.
- For each limit line, a margin can be defined which serves as a threshold for automatic evaluation.
- In addition, commentary can be written for each limit line, e.g., a description of the application.

In the *LINES LIMITS* menu, the compatible limit lines can be enabled in the *LIMIT LINES* table. The *SELECTED LIMIT LINE* display field provides information concerning the characteristics of the marked limit lines. New limit lines can be specified and edited in the *NEW LIMIT LINE* and *EDIT LIMIT LINE* sub-menus, respectively.



LINES LIMIT menu

SELECTED LIMIT LINE				
Name:	GSM22UP	Limit:	LOWER	
Domain:	TIME	X-Axis:	LOG	
Unit:	dB	X-Scaling:	ABSOLUTE	
Comment:	Line 1	Y-Scaling:	RELATIVE	

LIMIT LINES				
NAME	COMPATIBLE	LIMIT CHECK	TRACE	MARGIN
✓ GSM22UP	✓	off	1	0 dB
✓ GSM22LO	✓	on	1	0 dB

Press ENTER to activate / deactivate Limit Line

Limit Line Selection

The *SELECTED LIMIT LINES* table provides information about the characteristics of the marked limit line :

- Name* name
- Domain* time domain (unit: seconds or symbols)
- Unit* vertical unit
- Comment* commentary
- Limit* upper/lower limit
- X-Axis* linear or logarithmic interpolation
- X-Scaling* absolute or relative times
- Y-Scaling* absolute or relative Y-units

The characteristics of the limit line are set in the *EDIT LIMIT LINE (= NEW LIMIT LINE)* sub-menu.



The *SELECT LIMIT LINE* softkey activates the *LIMIT LINES* table and the selection bar jumps to the uppermost name in the table.

The columns contain the following information:

- Name* Enable the limit line.
- Compatible* Indicate whether the limit line is compatible with the measurement window of the given trace.
- Limit Check* Activate automatic violation check for upper/lower limits.
- Trace* Select the measurement curve to which the limit is assigned.
- Margin* Define margin.

**Name and Compatible - Enabling limit lines**

A maximum of 8 limit lines can be enabled at any one time. A check mark at the left edge of a cell indicates that this limit line is enabled. A limit line can only be enabled when it has a check mark in the *Compatible* column, i.e. only when the vertical scales are **identical** to those of the display in the measurement window.

Lines with the unit dB are compatible to all dB(..) settings of the Y-axis.

If the trace assigned to a line is not switched on, the line is displayed in the window the trace would be displayed in.

Example:

In split screen mode, trace 2 is assigned measuring window B. A line assigned to trace 2 is always displayed in measurement window B.

If the scale of the Y-axis is changed, all non-compatible limit lines are automatically switched off in order to avoid misinterpretation. The limit lines must be enabled anew when the original display is re-displayed.

**Limit Check - Activate automatic limit violation check**

When *LIMIT CHECK ON* is activated, a GO/NOGO test is performed. In the center of the diagram, a display window appears which indicates the results of the limit check test:

LIMIT CHECK: PASSED No violations of active limits.

LIMIT CHECK: FAILED One or more active limit lines were violated. The message contains the names of the limit lines which were violated or whose margins were not complied with.

LIMIT CHECK: MARGIN The margin of at least one active limit lines was not complied with, however, no limit line was violated. The message contains the names of the limit lines whose margins were not complied with.

The following example shows 2 active limit lines:

```
LIMIT CHECK: FAILED
LINE VHF_MASK: Failed
LINE UHF2MASK: Margin
```

A check for violations of limit lines takes place only if the limit line of the assigned measurement curve (trace) is enabled.

If *LIM CHECK* is set to *OFF* for all active limit lines, then the limit line check is not executed and the display window is activated.

**Trace - Select the trace to which the limit line is assigned.**

The selection of the measurement curve (trace) takes place in an entry window. Allowed are the integer entries 1, 2, 3 or 4. The default setting is trace 1. If the selected limit line is not compatible with the assigned measurement curve, then the limit line is disabled (display and limit check).

**Margin - Setting a margin.**

The margin is defined as the signal-level distance to the limit line. When the limit line is defined as an upper limit, the margin means that the level is below the limit line. When the limit line is defined as a lower limit, the margin means that the level is above the limit line. The default setting is 0 dB (i.e. no margin).

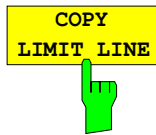

The *COPY LIMIT LINE* softkey copies the data file describing the marked limit line and saves it under a new name. In this way, a new limit line can be easily generated by parallel translation or editing of an existing limit line. The name can be arbitrarily chosen and input via an entry window (max. of 8 characters).



The *X OFFSET* softkey activates the entry of the value for horizontally shifting a limit line which has been specified for relative times (X-axis).



The *Y OFFSET* softkey activates the entry of the value for vertically shifting a limit line, which has relative values for the Y-axis (levels or linear units such as volt).



The *DELETE LIMIT LINE* softkey erases the selected limit line. Before deletion, a message appears requesting confirmation.

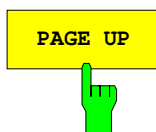

The *PAGE UP* softkey sets the limit line table to the next page.



The *PAGE DOWN* softkey sets the limit line table to the previous page.

## Entry and Editing of Limit Lines

A limit line is characterized by

- its name
- the unit of the time data points
- the vertical unit
- linear or logarithmic interpolation
- the scaling in absolute or relative times
- the vertical scaling
- the definition of the limit line as either upper or lower limit.
- the data points for time and level or modulation measurement values.

At the time of entry, the FSIQ immediately checks that all limit lines are in accordance with certain guidelines. These guidelines must be observed if specified operation is to be guaranteed.

- The times for each data point must be entered in ascending order, however, for any single time, two data points may be input (vertical segment of a limit line).

The data points are allocated in order of ascending time. Gaps are not allowed. If gaps are desired, two separate limit lines must be defined and then both enabled.

- The entered times must not necessarily be selectable in FSIQ. A limit line may also exceed the specified time domain and negative times may also be entered. The allowable range is -1000 s to +1000 s.
- The minimum/maximum value for a limit line is -200 dB to +200 dB for the logarithmic or  $10^{-20}$  to  $10^{+20}$  or -99.9% to + 999.9% for the linear amplitude scales.

LINES LIMIT-EDIT LIMIT LINE menu

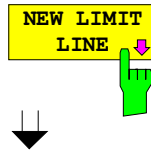
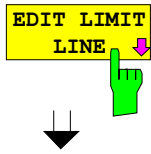

The *EDIT LIMIT LINE* and *NEW LIMIT LINE* softkeys both call the *EDIT LIMIT LINE* sub-menu used for editing limit lines. In the table heading, the characteristics of the limit line can be entered. The data points for time and level values are entered in the columns.

- Name* Enter name.
- x-Unit* Selection of unit.
- y-Unit* Selection of vertical unit.
- X-Axis* Selection of interpolation
- X-Scaling* Entry of absolute or relative values for the X-axis
- Y-Scaling* Entry of absolute or relative values for the Y-axis
- Limit* Select upper/lower limit.
- Comment* Enter comments.
- Time* Enter time for the data points.
- Limit/dB(..)* Enter magnitudes for the data points.

EDIT LIMIT LINE TABLE

Name: GSM\_MNM

x-Unit: s

y-Unit: dB

x-Axis: LOG

x-Scaling: RELATIVE

y-Scaling: RELATIVE

Limit: LOWER

Comment: GSM PWR VS TIME. VSA MODE

Time	LIMIT/dB
-271.380 us	-100 0000
-271.380 us	-1 000
271.380 us	-1 000
271.380 us	-100 0000

Press ENTER to edit field.

EDIT  
LIMIT LINE

NAME

VALUES

INSERT  
LINE

DELETE  
LINE

SHIFT X  
LIMIT LINE

SHIFT Y  
LIMIT LINE

SAVE  
LIMIT LINE

PAGE UP

PAGE DOWN

↑

USER

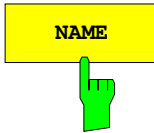

The *NAME* softkey enables the entry of characteristics in the table heading.

**Name - Enter name**

A maximum of 8 characters are permitted for each name. All names must be compatible with the MS DOS conventions for file names. The instrument stores all limit lines with the .LIM extension.

**x-Unit - Select the unit (TIME)**

Only time domain is available in vector analyzer mode. Possible units are s or Symb.

**y-Unit - Select the vertical unit for the limit line (LIMIT)**

The selection of the unit is made in the selection box. The default setting is dBm.

**X-Axis - Indication of interpolation**

Linear or logarithmic interpolation can be carried out between the reference points of the table. Selection is via the *ENTER* key which is toggled between *LIN* and *LOG* (toggle function).

**Scaling - Select absolute or relative scaling**

The limit line can either be scaled in absolute or relative units. Any of the unit keys may be used to toggle between *ABSOLUTE* and *RELATIVE*, the cursor must be positioned in the *X-Scaling* or the *Y-Scaling* line.

*X-Scaling ABSOLUTE*      The times are interpreted as absolute physical units.

*X-Scaling RELATIVE*      In the data point table, the times are referred to the left boundary of the diagram.

*Y-Scaling ABSOLUTE*      The limit values refer to absolute levels or voltages.

*Y-Scaling RELATIVE*      The limit values refer to the reference level (Ref Level) or, in case a reference line is set, to the reference line.  
Limit values with the units dB or % are always relative values.

The *RELATIVE* scaling is always suitable, if masks for bursts are to be defined.

An X-offset with half the sweep time may be entered in order to shift the mask into the center of screen.

**Limit - Select upper/lower limit**

A limit line can be defined as either an upper or lower limit.

**Comment - Enter comments**

Comments are arbitrary, however, they must be less than 40 characters long.

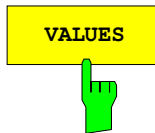

The *VALUES* softkey activates the entry of the data points in the table columns *Time* and *Limit/dB*.

The desired time data points are entered in ascending order (two repeated time values are permitted).

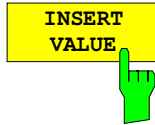

The *INSERT VALUE* softkey creates an empty line above the current cursor position where a new data point may be entered. However, during the entry of new values, it is necessary to observe an ascending order for time.



The *DELETE VALUE* softkey erases the data point (complete line) at the cursor position. All succeeding data points are shifted down accordingly.

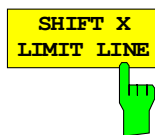

The *SHIFT X LIMIT LINE* softkey calls an entry window where the complete limit line may be shifted parallel in the horizontal direction.

The shift takes place according to the horizontal scale in ns,  $\mu$ s, ms or s

In this manner, a new limit line can be easily generated based upon an existing limit line which has been shifted horizontally and stored (*SAVE LIMIT LINE* softkey) under a new name (*NAME* softkey).



The *SHIFT Y LIMIT LINE* softkey calls an entry window where the complete limit line may be shifted parallel in the vertical direction.

The shift takes place according to the vertical scale:

- for logarithmic units, relative, in dB
- for linear units, as a factor

In this manner, a new limit line can be easily generated based upon an existing limit line which has been shifted vertically and stored (*SAVE LIMIT LINE* softkey) under a new name (*NAME* softkey).

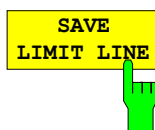

The *SAVE LIMIT LINE* softkey stores the currently edited limit line. The name can be entered in an input window (max. 8 characters)

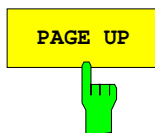

The *PAGE UP* softkey displays the next page of data points.

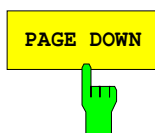

The *PAGE DOWN* softkey displays the previous page of data points.

## Selection and Setting of Traces - TRACE Key Group

The function of keys TRACE 1 to 4 in vector signal analysis is largely identical with the function in *ANALYZER* mode as long as traces are displayed. If numeric values or tables (e.g. *SYMBOL TABLE*) are displayed, they are also linked with a trace (some of the trace functions are not available then).

**Example:** In diagram *SYMB TABLE / ERRORS* the symbol table refers to trace 1 and the error table to trace 2 (not for *SPLIT SCREEN!*).

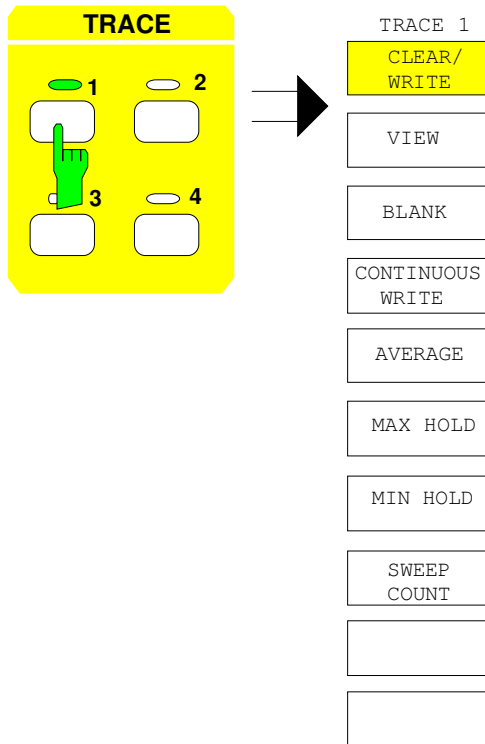

The TRACE keys 1 to 4 call up a menu in which the selected trace can be set.

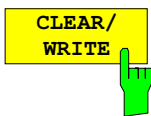

The *CLEAR/WRITE* softkey displays a new trace for each measurement or outputs a measured value. Values from previous measurements are deleted.

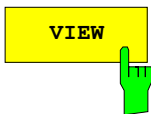

The *VIEW* softkey freezes the current contents of the trace memory and displays them. If the device setting is changed, the displayed trace does not change. The measurement data are then invalid with reference to the current setting. This is shown by the enhancement label "\*" at the right grid end.

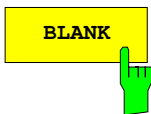

The *BLANK* softkey blanks the trace or the measured values on the display. They are internally stored so that they can be displayed again with the aid of *VIEW*. The markers linked to a trace are also deleted with *BLANK*, but restored after reactivating the trace with *VIEW* or *CLEAR/WRITE*.





The *CONTINUOUS WRITE* softkey outputs measured values for each sweep or displays a trace without clearing the previous measurements. This function can be useful for the display of the constellation or eye diagram, where test runs are required for in-depth information.

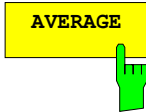

The *AVERAGE* softkey switches the trace averaging on. The average value is derived from several sweeps.

After switch-on of averaging, the first trace is written in the *CLEAR/WRITE mode*. Successive averaging is performed from the second sweep.

Averaging is restarted if the *AVERAGE* softkey is pressed. The trace memory is then deleted. This is also the case if the trace memory is set to *VIEW* or *BLANK* in the *AVERAGE* position.

If the *AVERAGE* function is active, the highest values are indicated for peak values (incl. *AMPLITUDE DROOP*) for the display of the error table. A square averaging is performed for RMS values. For all other displays a linear averaging is performed.

Switch-on of function *AVERAGE* on a trace where the summary markers are active results in a switch-off of summary markers.

On the other hand, summary markers cannot be activated on a trace if one of the *AVERAGE* (or *MAX HOLD* or *MIN HOLD*) functions is switched to this trace.

For description of average procedure see 'Traces - TRACE Key Group' in chapter 'Analyzer mode'.



The *SWEEP COUNT* softkey activates the entry of the number of sweeps required to perform the averaging.

The permissible range of values for the Sweep Count is 0 to 32767. In case of 0, the FSIQ carries out a running averaging over 10 sweeps in the Average mode. No averaging is performed in case of 1.

The default setting is 10 sweeps (Sweep Count = 0). Programming of course influences the sweep duration. The number of sweeps required for averaging or the average time are identical for all 4 traces.

**Note:** *This sweep number setting in the trace menu is equivalent to that of the sweep menu. If both averaging and hold functions of the summary markers or trace averaging (or MAX HOLD or MIN HOLD) are active on different traces, the SWEEP COUNT counter simultaneously refers to summary markers and trace averaging.*

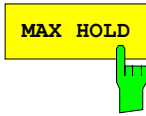

The *MAX HOLD* softkey activates peak-value averaging. For every sweep run, the FSIQ identifies the highest value and compares it with the current value. The highest of the two values is then stored in the updated trace memory. Thus, the maximum value of a signal can be evaluated over several test runs.

The trace memory is deleted by pressing the *MAX HOLD* softkey again. Peak-value averaging is started again.

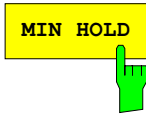

The *MIN HOLD* softkey activates minimum-value averaging. For every sweep run, the FSIQ identifies the smallest of the two values and compares it with the current value. The smallest of the two values is then stored in the updated trace memory. Thus, the minimum value of a signal can be evaluated over several test runs.

The trace memory is deleted by pressing the *MIN HOLD* softkey again. Minimum averaging is started again.

## SWEEP Key Group

### Setting the Analog Bandwidth - *COUPLING* Key

In the vector analysis mode, bandwidth limiting is not at the IF but in the baseband by means of digital filtering. The analog IF filters only serve for attenuating far off signals. The IF filters are set more broadly as required by the signal to be measured in order to increase the measurement accuracy. Thus, the measurement signal is less distorted by the amplitude and phase response of the IF filtering.

*SWEEP COUPLING* menu

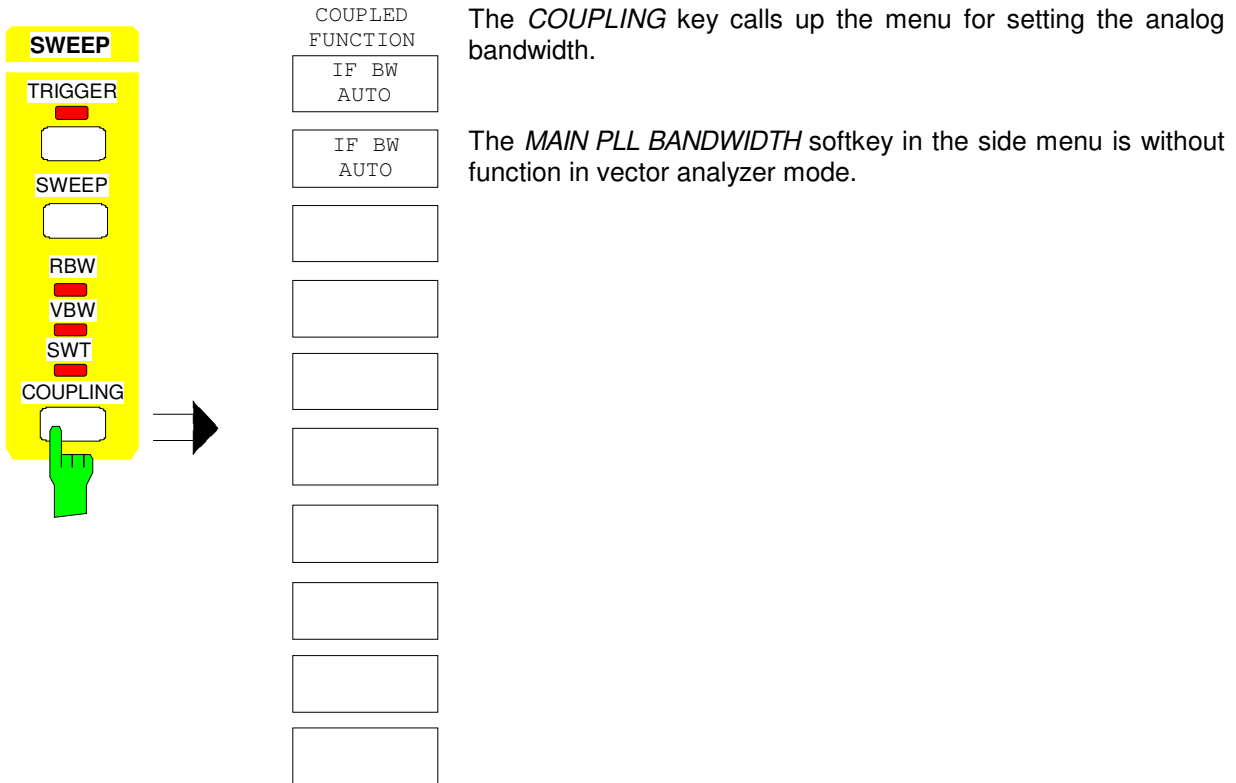

The *COUPLING* key calls up the menu for setting the analog bandwidth.

The *MAIN PLL BANDWIDTH* softkey in the side menu is without function in vector analyzer mode.

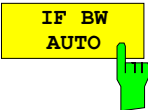

The *IF BW AUTO*, the *FSIQ* automatically sets the resolution bandwidth to the maximum 10-MHz bandwidth for digitally modulated signals.

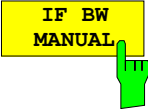

The *IF BW MANUAL* softkey opens a window for entering the bandwidth for the analog prefiltering.

With *IF BW MANUAL*, the *FSIQ* can be manually set. When the demodulators are used for digitally modulated signals, the minimum analog bandwidth corresponds to the set symbol rate. Since modulation errors increase when narrow analog bandwidths are selected because of the amplitude and phase distortions, *UNCAL* is displayed for analog bandwidths below 10 times the symbol rate.

Bandwidths below 1 kHz cannot be set as the smallest bandwidth implemented by analog filtering is 1 kHz. When a smaller bandwidth than permitted is set, the *FSIQ* signals:

*RBW out of range*

### Sweep Setup - SWEEP Key

Menu SWEEP SWEEP

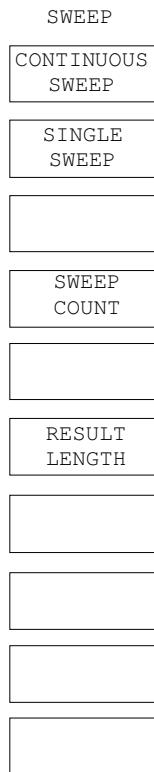
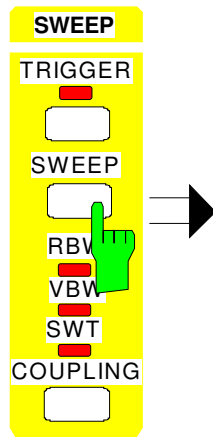

The *SWEEP* key calls up a menu in which the type of measurement - single or continuous measurement - and the measurement result length to be displayed in time or symbols are defined.



The *CONTINUOUS SWEEP* softkey starts a continuous measurement after defining the trigger condition and selected measurement settings. Following triggering, the measured values will be collected and then evaluated and displayed.

If, for split screen display, measurements in both windows are in the vector analysis mode, data in the measurement RAM are used for the two evaluations.

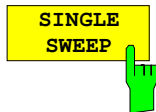

The *SINGLE SWEEP* softkey starts n measurements with the given trigger settings. The number of sweeps n is determined with *SWEEP COUNT*. The measurement is stopped after n measurements. It can be restarted by pressing *SINGLE SWEEP* again or by *CONTINUOUS SWEEP*.



The *SWEEP COUNT* softkey opens a window for entering the number of measurements for the single sweep

The number of measurements can be selected between 0 and 32767. With averaging of measured values set, *SWEEP COUNT* also determines the number of measurements required for averaging.

SWEEP COUNT = 0 10 measurements are used for a running averaging.

SWEEP COUNT = 1 no averaging is performed.

SWEEP COUNT >1 averaging is performed for the set number of measurements.

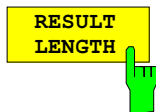

The *RESULT LENGTH* softkey defines the number of symbols or the time slot to be displayed. The maximum number of symbols that can be displayed is equal to the frame length.

## Triggering Data Storage - *TRIGGER* Key

The trigger in the vector analyzer mode determines the time from which data are stored in the result memory. For the demodulation of digitally modulated signals, the time reference can also be obtained by synchronization to a given bit sequence or, for TDMA signals, by searching for a burst in the result memory.

Menu: *SWEEP TRIGGER*

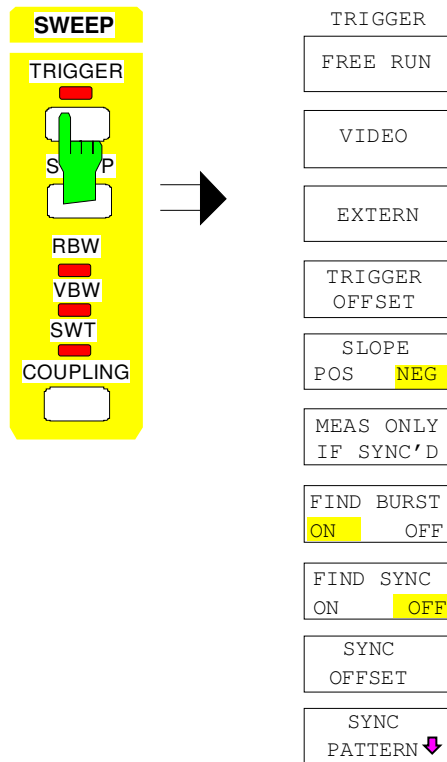

The *TRIGGER* key opens a menu in which the different trigger sources can be set and trigger slopes selected.



The *FREE RUN* softkey activates the measurement without trigger. After a measurement, the memory is prepared to store data for a new measurement.

The free-run mode is recommended if a continuously modulated signal is applied to the RF input or, for TDMA signals, the capture time is long enough to enter a full burst into the result memory.

The capture time is influenced by the memory size (max. 16384 points), the set symbol rate as well as the number of points per symbol.

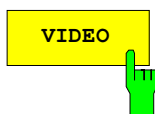

The *VIDEO* softkey starts the measurement by the video voltage of the analog path of the spectrum analyzer. Parallel to the vector signal analyzer, the analog video voltage of the spectrum analyzer is evaluated.

Video triggering calls for the entry of the trigger threshold. It is identical to the trigger threshold of the spectrum analyzer. The entry of the trigger threshold into the data window is numeric in % of the last grid which has been active in the analyzer mode.

To determine a suitable value for the trigger threshold it is possible to switch to the display *MAGNITUDE CAP BUFFER* or to measure the threshold in the analyzer mode.

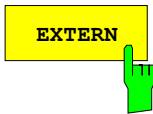

The *EXTERN* softkey activates triggering by means of an external voltage between -5 V to +5 V at the rear BNC connector *EXT TRIGGER / GATE*. The desired value is to be entered into the window.

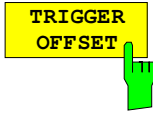

The *TRIGGER OFFSET* softkey opens a window for entering the desired offset.

With *TRIGGER OFFSET*, the start time for the data storage relative to the trigger event is determined. Both positive values (for a trigger delay) and negative values (for a pretrigger) are permitted.

Entry is in absolute time independent of the scaling of the X axis.

For positive values of the trigger offset (trigger delay), values from 1  $\mu$ s to at least 10 ms are permitted, depending on the symbol rate and the number of points per symbol. The range of values for negative trigger offsets (pretrigger) depends on the selected memory size and is not more than half the memory size.



Softkey *MEAS ONLY IF SYNC'D* sets the vector analyzer so that measurements are performed if synchronization to the selected sync pattern was possible.

The measured values are displayed and taken into account in the error analysis only if the set sync pattern is found. Bursts with a wrong sync pattern (sync not found) are ignored.

If an invalid sync pattern is found or if there is none, the measurement is halted and continued in the presence of a valid sync pattern.

This softkey is available only if *FIND SYNC = ON*.

The default setting is OFF. If the digital standard is changed, OFF is always activated.

#### Example:

An EDGE-compatible base station can send EDGE and GSM bursts at different times. The demodulator thus sees EDGE (8PSK) and GSM bursts (GMSK).

If GSM is activated in the vector analysis, the measurement and error analysis are disturbed by an EDGE burst. This can be prevented by activating softkey *MEAS ONLY IF SYNC'D*. The EDGE bursts are ignored in the error analysis.



The *SLOPE POS/NEG* softkey determines the trigger slope in case of triggering by means of the video signal or external trigger.

The sweep starts after a positive or negative slope of the trigger signal. With a free-running trigger the setting is irrelevant.

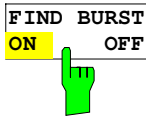

The *FIND BURST ON/OFF* softkey searches for a burst in the stored data (within the entered memory size), demodulates it within the entered frame length and displays it with the set result length.

The *FIND BURST* mode is particularly useful for TDMA signals if a burst is to be completely displayed (and would otherwise not be demodulated due to the mark-to-space ratio at the maximum settable frame length of 800 symbols). The time required for searching for a burst is determined with memory size. A burst must have a minimum length of 30 symbols to be identified.

Digital communication systems operating according to the TDMA access methods transmit or receive information in the form of bursts. The carrier power is only switched on for a certain time. The transmitter switches the carrier on if an information is to be transmitted and switches it off again.

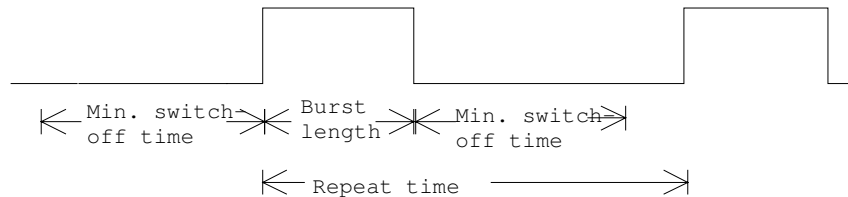

The carrier power is switched off between two bursts. With *FIND BURST*, the FSIQ searches for a complete burst, i.e. for a carrier that can be switched on **and** off. If no complete burst is found within the search time, the message *BURST NOT FOUND* is displayed.

If a trigger (video or extern) is used for the storage of the measured values, a negative trigger offset (pretrigger) is recommended so that a sufficiently long switch-off time of the carrier is available at the beginning of the search time.

The search time has at least to be as long as the burst length plus twice the switch-off time to ensure that the burst is found.

For a free-running trigger, set the length of the captured data (*MEMORY SIZE*) to a minimum (repeat time + 2 x switch-off time + burst length) so that the burst can be found.

The FSIQ centers the number of symbols (*FRAME LENGTH*) required for demodulation as well as the displayed symbols (*RESULT LENGTH*) to the center of the found burst (*FIND SYNC OFF*).

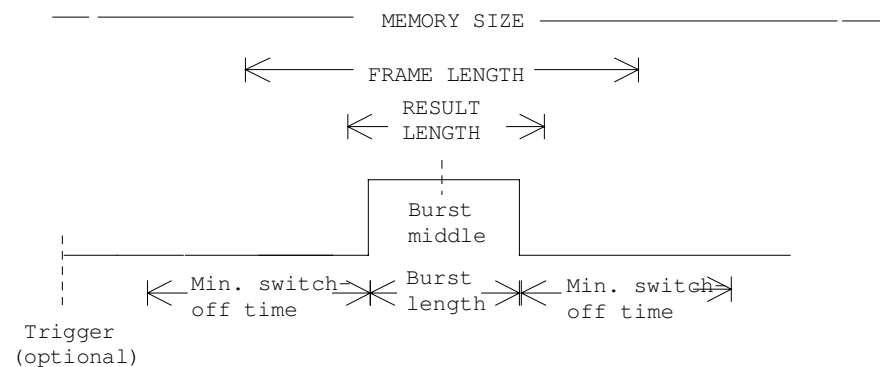

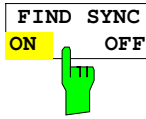

The *FIND SYNC ON*, softkey searches for a defined bit sequence (sync pattern) within the set frame length. The measurement result is displayed with the set result length with reference to the first symbol of the synchronization sequence.

If the synchronization sequence is not found, a result is still output according to the set result length. The message: *SYNC NOT FOUND* is then output.

Centering the burst on the middle of the picture cannot be carried out if the burst is found at the very beginning of the data set (of the memory size) and a **Result Length > Burst Length + 2×20 symbols** is set. A precondition for burst recognition is that before the rising edge measured values corresponding to at least 20 symbols are present in the current trace memory. In this case, the burst is represented from the first measured value in the trace memory.

If the consequent centering of the burst is indispensable for the user, the result length has to be reduced according to the above precondition.

In case of *FIND BURST ON* and *FIND SYNC ON*, the FSIQ only centers the frame length to the center of the burst while the result length is displayed from the beginning of the bit sequence (in case of *SYNC OFFSET 0*) or around the *SYNC OFFSET*.

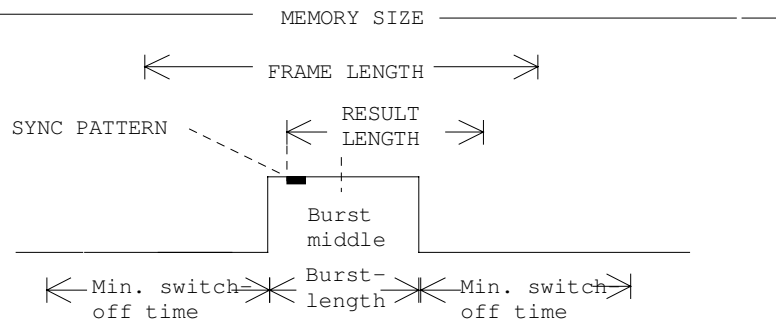



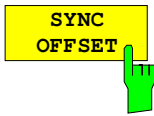

The *SYNC OFFSET* softkey opens a window for entering the offset in symbols.

*SYNC OFFSET* defines the display time prior to the synchronization sequence in *SYNC SEARCH*. It thus determines the position of the displayed trace or symbols (result length) within the demodulated signal (frame length). The modulated signal may have a preamble or a midamble. Depending on the configuration it is thus desirable to display the measurement signal from a synchronization sequence or prior to the synchronization sequence.

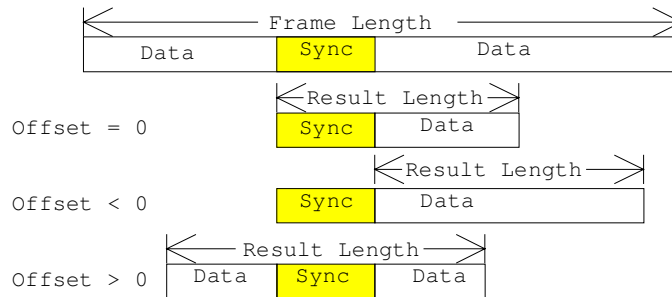

A positive or a negative offset can be set.

The minimum or maximum offset depends on the following parameters:

- frame length
- result length and
- position of the sync sequence in the burst

In order to find the sync sequence correctly regardless of its position within the burst and to obtain enough measured values for the diagram, the *FRAME LENGTH* for the *FIND SYNC* function should be set at least twice as large as the *RESULT LENGTH*.

Any offset can basically be entered provided that the measurement result is within the *FRAME LENGTH*. If the *FRAME LENGTH* is extended, a higher offset can be entered. If the *RESULT LENGTH* is extended, the maximum offset is reduced.

If an offset is set that is too large (i.e. that, together with the selected *FRAME LENGTH*, prevents the *RESULT LENGTH* combined with the determined sync sequence to be completely displayed), the error message *SYNC OFFSET INVALID !* appears on the screen.

In this case, either the *FRAME LENGTH* must be increased, or the sync offset must be adapted to the position of the sync sequence in the burst.

The frame buffer contains the data available for the evaluation (*FRAME LENGTH*).

The message "SYNC OFFSET INVALID" indicates that there are not enough data available for displaying the *RESULT LENGTH*.

The following examples explain how *FRAME LENGTH*, *SYNC OFFSET* and *FRAME LENGTH* are related.

**Example 1 (input signal without burst):**

Device settings:

- Input signal (without burst)
- FIND BURST off
- FIND SYNC on
- FRAME LENGTH = 400
- RESULT LENGTH = 200
- SYNC OFFSET = 0

The start of the frame buffer is at symbol -300 (with respect to the sync pattern), the FSIQ displays the results starting with symbol no. 0, but there are no more than 100 valid symbols in the file, 100 symbols of the result length are invalid because they are located outside the frame buffer.

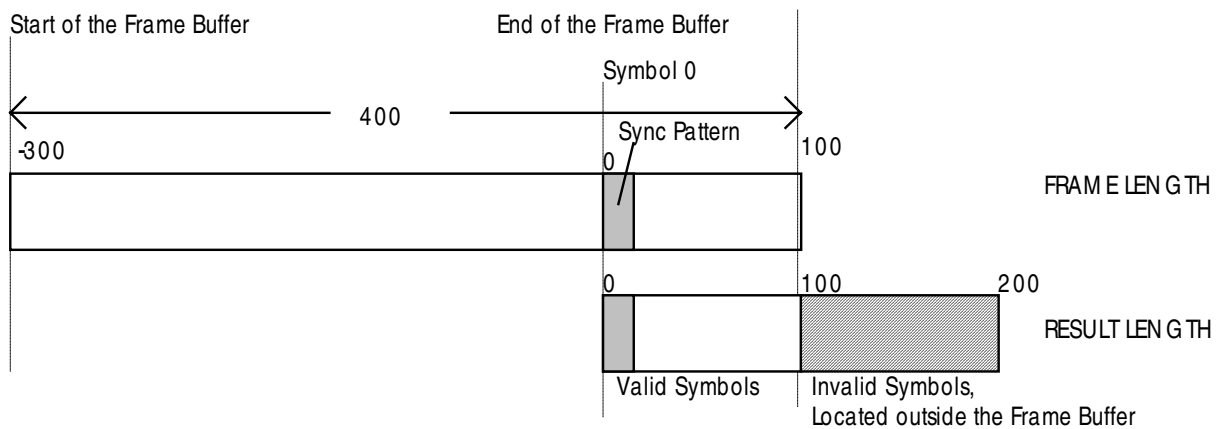

**Solution:** diminish result length to 100 symbols *or* extend frame length to 800 symbols.

**Example 2 (input signal with burst):**

Device settings:

- Input signal (burst length 100 symbols)
- FIND BURST on
- FIND SYNC on
- FRAME LENGTH = 400
- RESULT LENGTH = 200
- SYNC OFFSET = 0

After successful search of the burst, only the symbols inside the burst are marked as valid. The synchronization pattern is found in the burst (Symbol 0), the FSIQ displays starting with symbol no.0, but there are only 20 valid symbols in the burst, 180 symbols of the result length are invalid because they are located outside the burst.

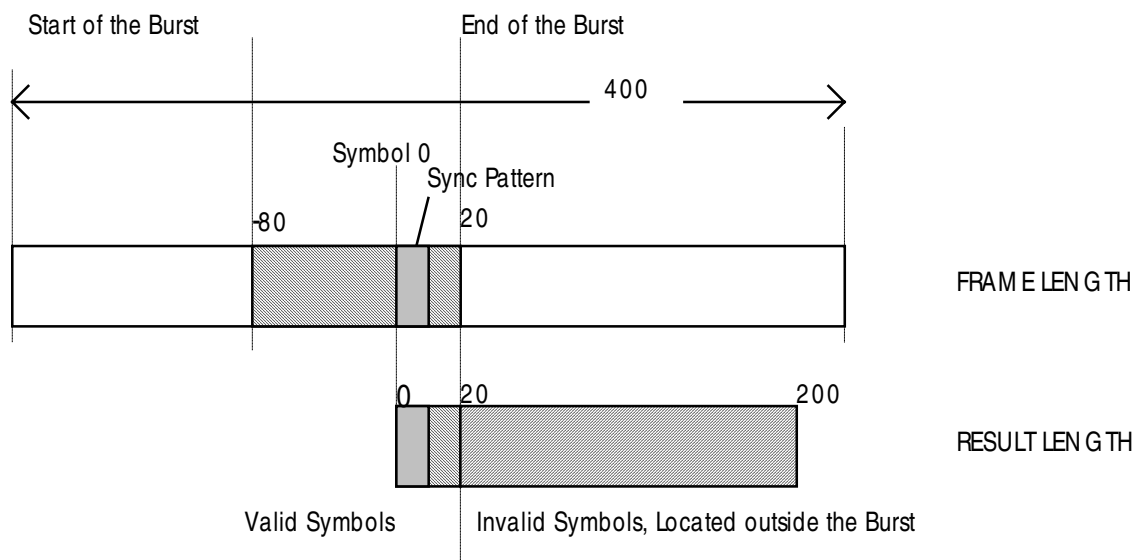

Solution: diminish result length to 20 symbols.

**Example 3 (input signal with burst):**

Device settings:

- Input signal (burst length 100 symbols)
- FIND BURST on
- FIND SYNC on
- FRAME LENGTH = 400
- RESULT LENGTH = 200
- SYNC OFFSET = 90

After successful search of the burst, only the symbols inside the burst are marked as valid.  
The synchronization pattern is found in the burst (Symbol 0), the FSIQ displays starting with symbol no. -90 up to +19, the beginning of the display range is located before the start of the burst !

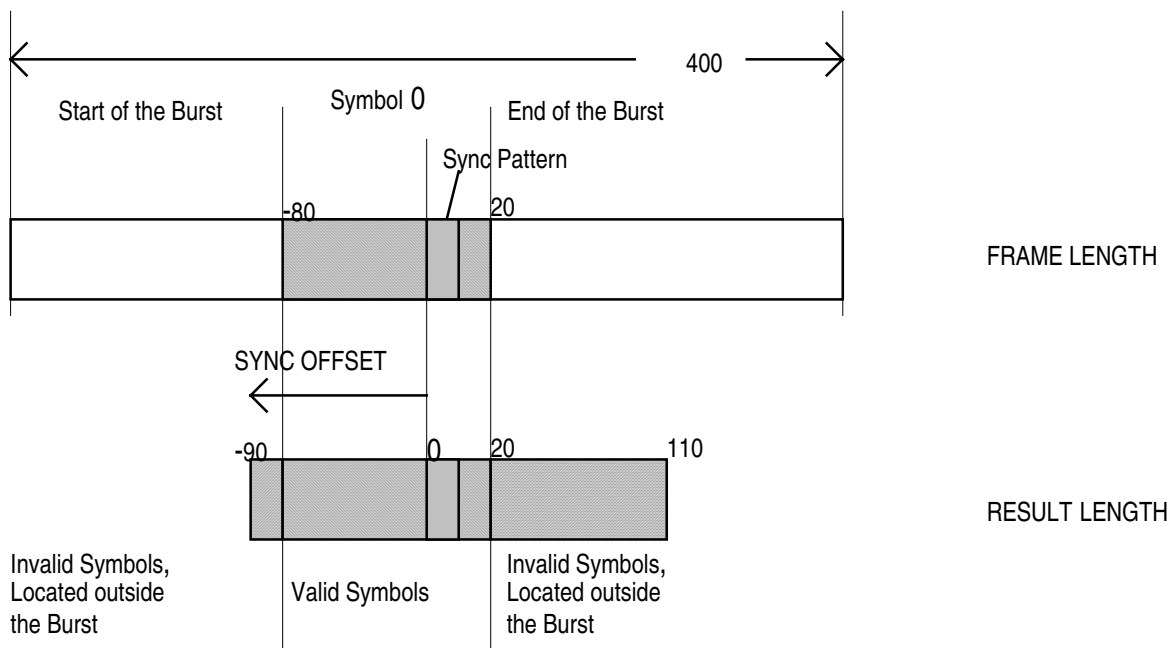

Solution: diminish result length to 100 symbols (= burst length)  
set sync offset to 80 (beginning of the burst lies 80 symbols before the sync-pattern).

Submenu: *SWEEP TRIGGER*

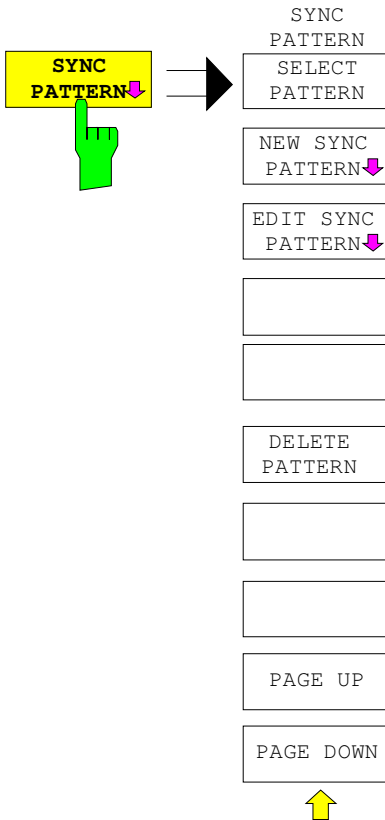

The *SYNC PATTERN* softkey calls up a submenu, allowing to select available patterns.

These patterns are displayed in the table *PATTERN NAME*. If a pattern is activated, the bit sequence of the selected pattern is displayed in the table *PATTERN VALUE*.

The synchronization pattern defines a bit sequence which is searched for in the signal to be demodulated. When the *FIND SYNC* function is activated, this bit sequence is used for synchronizing measurement results. The FSIQ demodulates the signal to be measured down to bit level and searches for this predefined sequence. The first symbol in the bit sequence is the reference time (for *SYNC OFFSET* = 0).

The bit sequence of digitally modulated signals often includes a preamble or midamble which is used on the one hand for assessing the channel impulse response and setting the channel equalizer in the receiver and on the other hand to synchronize the receiver. This bit sequence may be used in the FSIQ to find and display particular signal sections.

The maximum pattern length of the FSIQ is 200 bits . The number of symbols depends on the significance of the modulation method. With QPSK, for instance, 200 bits correspond to 100 symbols, with 16QAM to 50 symbols. The FSIQ always uses an integral multiple of the bits per symbol. Bits which are not multiples or exceed the maximum length are omitted.

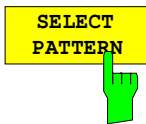

The *SELECT PATTERN* softkey marks the first field in the *PATTERN NAME* table.

The bit sequence of the selected pattern is displayed simultaneously with the *PATTERN VALUE* table.

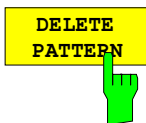

The *DELETE PATTERN* softkey clears the pattern marked by the cursor. To avoid the pattern being inadvertently deleted, a confirmation is required..

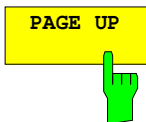

The *PAGE UP/PAGE DOWN* softkey causes the next/last page of the sync pattern table to be displayed.



Submenu: SWEEP TRIGGER - SYNC PATTERN

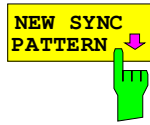
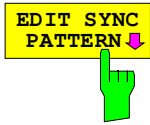

The *NEW PATTERN* and *EDIT PATTERN* softkeys call up the *EDIT SYNC PATTERN* submenu for generating sync pattern.

In the head line of the table the name and comment of the sync pattern to be edited or modified can be entered.

The sync pattern is entered or modified in the *VALUES* field, using the *DATA ENTRY* keys "0", "1" und ".".

EDIT SYNC PATTERN	
<b>GSM BTS0</b>	
COMMENT: GSM BTS COLOR CODE 0	
BIT No:	VALUE:
0	00100101110000100010010111
32	
64	
96	
128	

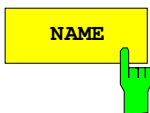

The *NAME* softkey activates the input of the name of the sync pattern. A maximum of eight characters can be entered. When the sync pattern is stored, the extension .PAT is automatically appended.

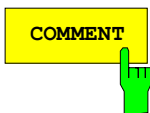

The *COMMENT* softkey activates the input of a comment for the sync pattern.

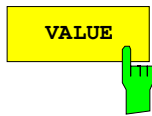

The *VALUE* softkey activates the input of the bit pattern of the sync pattern. The sync pattern may include "don't care bits" which are not considered when searching for the valid bit pattern.. The don't care bits are marked by an 'x' in the *VALUE* field.

The sync pattern has to start and end with a valid bit, a don't care bit can not be the first or last bit of the sync pattern.

During burst search, the sync pattern has to start and to end 10 symboles before the beginning and end of the burst, respectively.

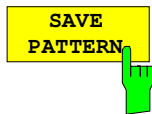
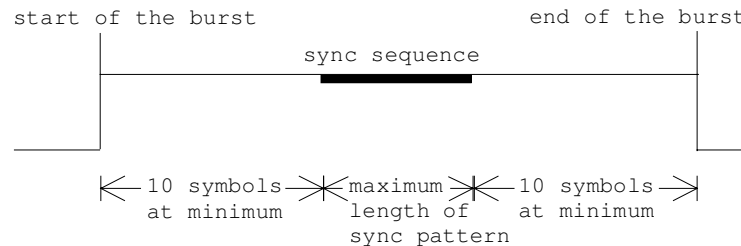

The *SAVE PATTERN* softkey stores a newly edited pattern under the current name.

## Tracking Generator Option

In the normal mode, the tracking generator sends a signal exactly at the input frequency of the instrument without a frequency offset.

For frequency-converting measurements it is possible to set a constant frequency offset of  $\pm 200$  MHz between the output signal of the tracking generator and the receive frequency of the instrument. Moreover, an I/Q modulation or AM and BB-FM modulation of the output signal can be carried out by using two analog input signals.

The output level is level-controlled and can be set in 0.1-dB steps in the range from -20 to 0 dBm, the level control can also be operated with external detectors. When the tracking generator is equipped with the optional attenuator, the setting range is extended from -90 dBm to 0 dBm.

The tracking generator can be used in all operating modes. The recording of test setup calibration values (SOURCE CAL) and the normalization with this correction values (*NORMALIZE*) is only possible in operating mode *ANALYZER MODE*.

*SYSTEM MODE* menu:

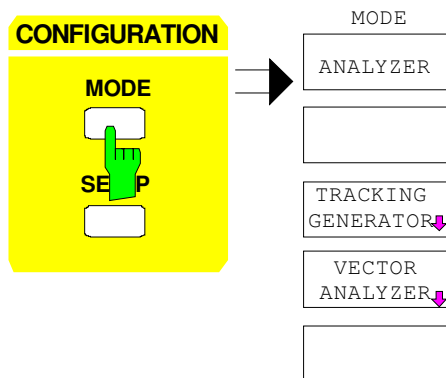

The *MODE* key activates the menu in which the submenu for setting the tracking generator can be selected in addition to different operating modes.



## Tracking Generator Settings

SYSTEM MODE menu:

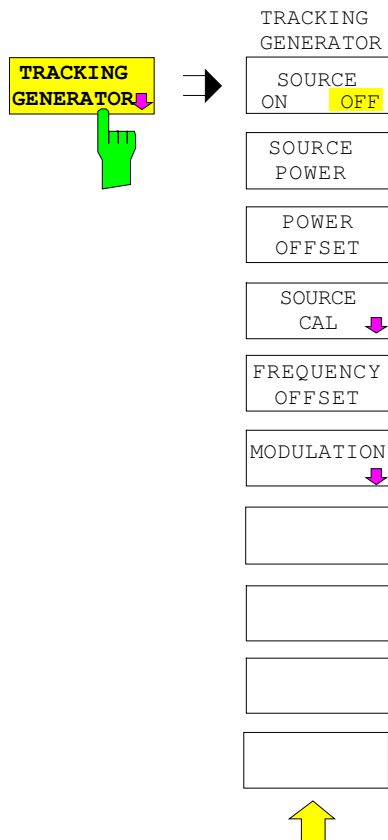

The *TRACKING GEN* softkey opens a menu for setting the functions of the tracking generator.

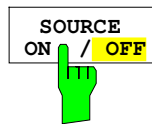

The *SOURCE ON/OFF* softkey switches the tracking generator on or off. Default setting is *OFF*

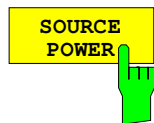

The *SOURCE POWER* softkey activates the input of the tracking generator output level.

The output level can be set in 0.1-dB steps from 0 dBm to -20 dBm. The setting range is extended to -90 dBm when the tracking generator is equipped with the optional attenuator FSE-B12.

If the tracking generator is off, it is automatically switched on by the *SOURCE PWR* softkey.

Default setting is -20 dBm.

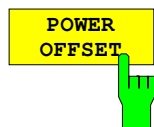

The *POWER OFFSET* softkey activates the input of a constant level offset of the tracking generator.

With this offset it is possible to consider attenuators or amplifiers at the output connector of the tracking generator during the input or output of output levels, for example.

The permissible setting range is -200 dB to +200 dB in 0.1-dB steps. Positive offsets apply to a subsequent amplifier and negative offsets to an attenuator. Default setting is 0 dB.

## Transmission Measurement

In this measurement, the transmission characteristic of a two-port network is measured. The built-in tracking generator serves as a signal source. The tracking generator is connected to the input connector of the DUT. The input of the instrument is fed from the output of the DUT.

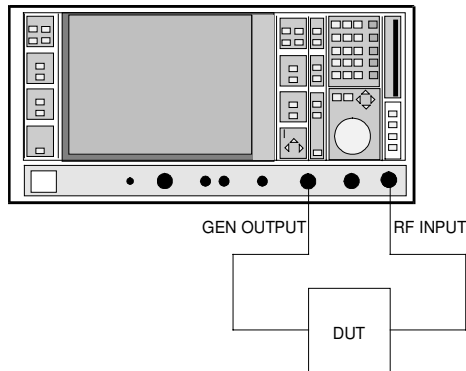
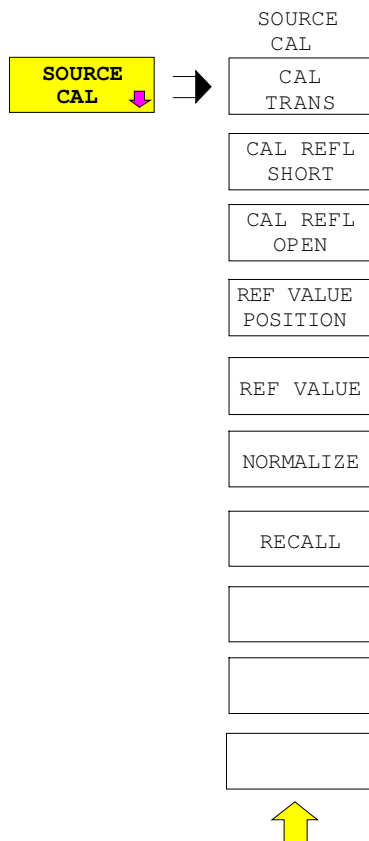

Fig. 4-35 Test setup for reflection measurements

A calibration can be carried out to compensate for the effects from the test setup (eg. frequency response of connecting cables).

## Calibration of Transmission Measurement

SYSTEM MODE-TRACKING GENERATOR menu:



The *SOURCE CAL* softkey opens a submenu comprising the calibration functions for the transmission and reflection measurement.

The calibration of the reflection measurement is described in section 2.13.3, its functioning in section 2.13.4 .

To carry out a calibration for transmission measurements the whole test setup is through-connected (THRU).

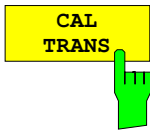

The *CAL TRANS* softkey triggers the calibration of the transmission measurement.

It starts a sweep that records a reference curve. This trace is then used to obtain the differences to the normalized values.

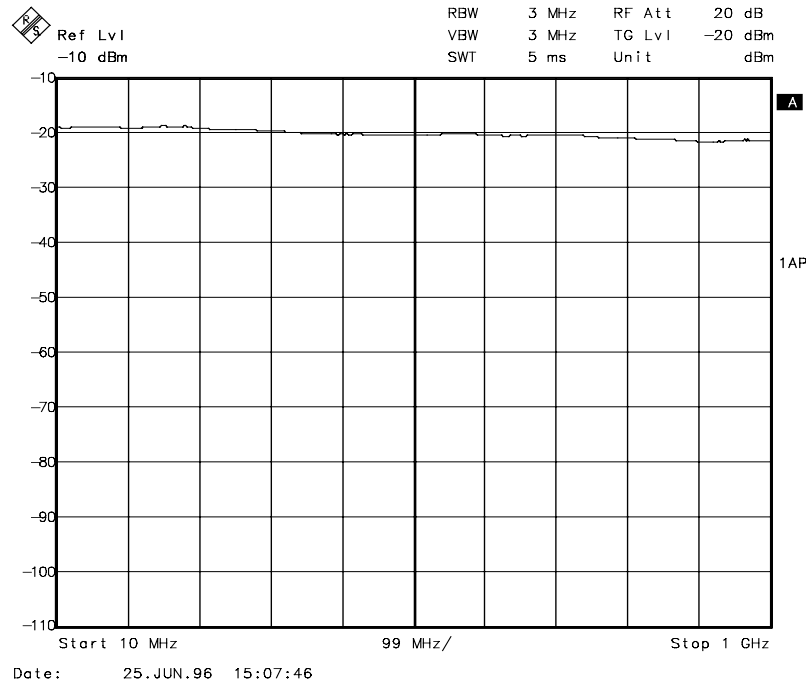
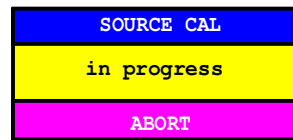
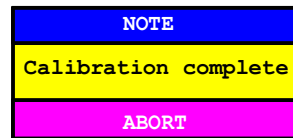

Fig. 4-36 Trace of a transmission calibration procedure

During the calibration sweep the following message is displayed:



After the calibration sweep the following message is displayed:



This message is cleared after approx. 3 seconds.

By storing and reloading the reference data set using the *SAVE* and *RECALL* softkeys in the key array *MEMORY* it is possible to store several calibration data sets and to switch between them without having to carry out a new calibration.

## Normalization

SYSTEM MODE-TRACKING GENERATOR -SOURCE CAL menu:

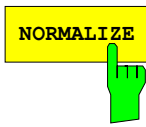

The *NORMALIZE* softkey switches the normalization on or off. The softkey is only offered if the memory contains a correction trace.

If no reference line is switched on when activating the normalization, all measured values are with reference to the top grid line. The effects of the test setup is corrected in such a way that the measured values are displayed at the top grid margin.

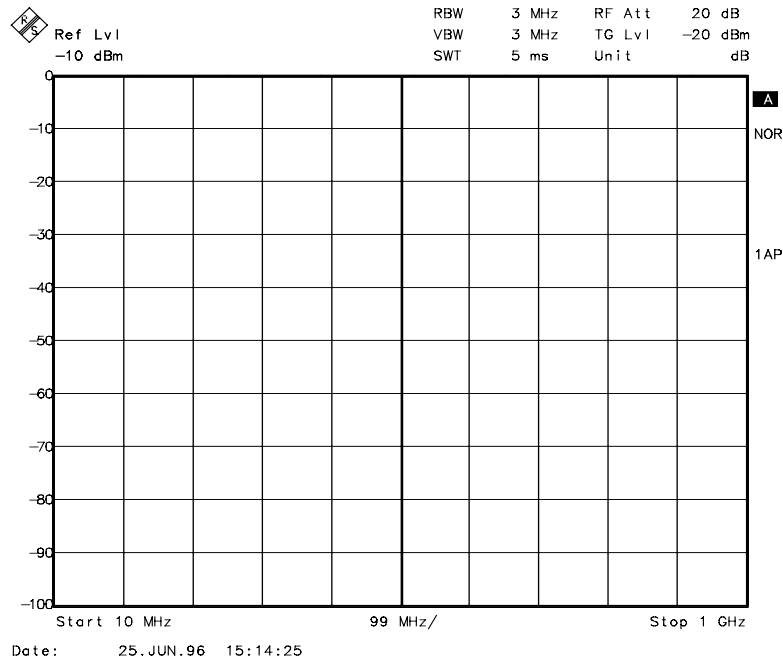
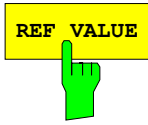

Fig. 4-37 Normalized display

In the *SPLIT SCREEN* setting, the normalization is switched on in the current window. Different normalizations can be active in the two measurement windows.

Normalization is aborted as soon as the operating mode *ANALYZER* is quit but can be switched on again as long as the reference trace stored in the memory has not been overwritten.





The *REF VALUE* softkey activates the input of a level value which is assigned to the reference line.

With normalization switched on, all measured values are displayed relative to the reference line, or if the latter is switched off relative to the top grid line which corresponds to 0 dB with default setting.

The value of *REF VALUE* is with reference to the actually active measurement window.

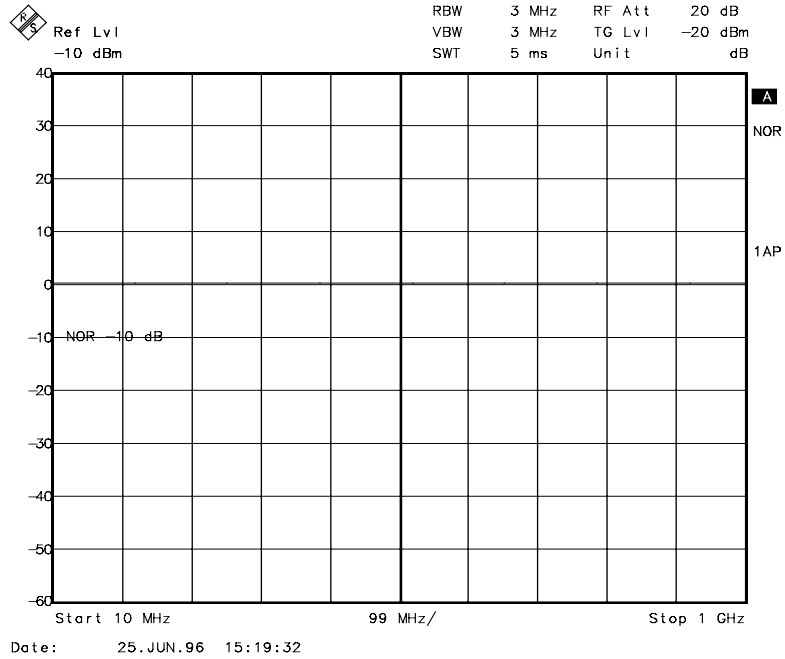

Fig. 4-39 Measurement with REF VALUE 20 dB Band REF VALUE POSITION 50%

If a 10dB-attenuator pad is measured, the reference line can be displayed with a nominal attenuation after calibration by entering *REF VALUE* -10 dB. Departures from this nominal value are then displayed with high resolution (eg 1dB/Div) and with the absolute attenuation (eg 1 dB below nominal value = 11 dB attenuation).

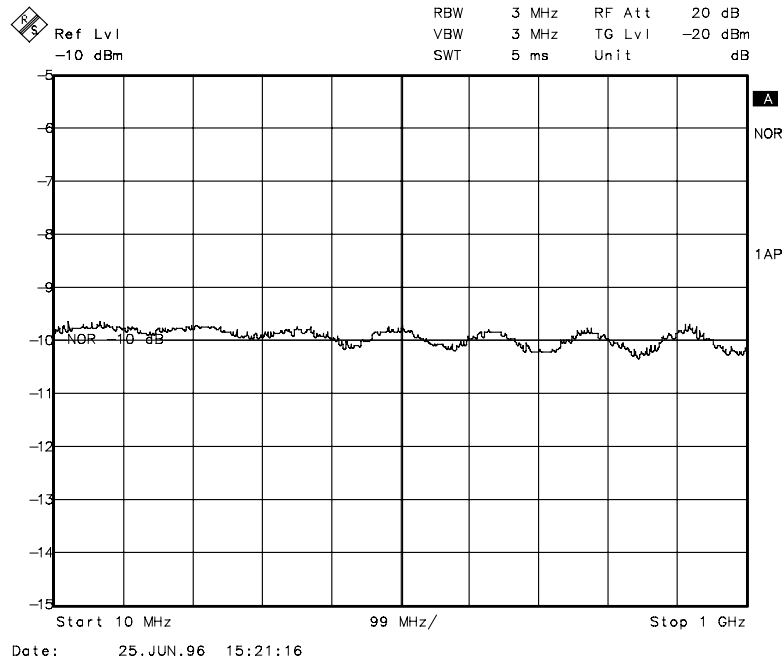
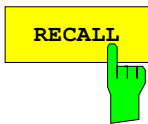

Fig. 4-40 Measurement of a 10dB attenuator pad with 1 dB / Div



The *RECALL* softkey restores the instrument setting with which the calibration was carried out.

This can be useful if the device setting was changed after calibration (eg center frequency setting, frequency deviation, reference level, etc. ).

The softkey is only offered if:

- the analyzer mode has been selected
- the memory contains a calibration data set.

## Reflection Measurement

Scalar reflection measurements can be carried out by means of a reflection-coefficient bridge.

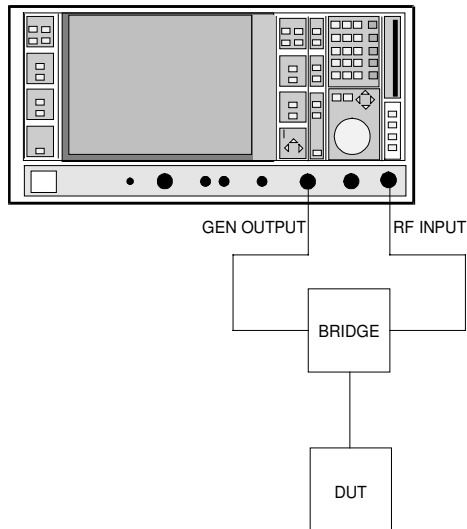

Fig. 4-41 Test setup for reflection measurements

## Calibration of Reflection Measurement

This calibration essentially corresponds to that of the transmission measurement.

*SYSTEM MODE-TRACKING-SOURCE CAL* submenu



The *CAL REFL OPEN* softkey starts the open-circuit calibration.

During calibration the following message is displayed

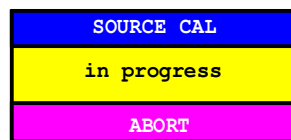

The *CAL REFL SHORT* softkey starts the short-circuit calibration.

If both calibrations (open circuit, short circuit) are carried out, the calibration curve is formed by averaging the two measurements and stored in the memory. The order of measurements is optional.

The completion of the calibration is indicated by

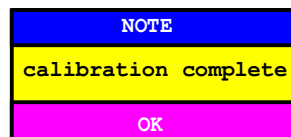

The display is cleared after 3 seconds.



## Functioning of Calibration

Independent of the selected measurement (transmission/reflection) the calibration performs a difference calculation of the current measured values to a reference curve. The hardware settings used for measuring the reference curve is also assigned to the reference data set.

With the normalization switched on, the device setting can largely be changed without stopping the normalization, ie the necessity to carry out a new normalization is reduced to a minimum.

To this effect, the reference data set (trace with 500 measured values) is also available as a table with 500 points (frequency/level).

Differences in level settings between the reference curve and the current device setting are calculated automatically. For small spans, a linear interpolation of the intermediate values is carried out. If the span is increased, the values at the left or right end of the reference data set are frozen until the set start or stop frequency is reached, ie the reference data set is extended by constant values.

An enhancement label is used to mark the different levels of measurement accuracy. This enhancement label is displayed at the right display margin when normalization is switched on and in case of an error from the reference setting. Three accuracy levels are defined:

Table 4-5 Measurement accuracy levels

Accuracy	Enhancement label	Reason/Limitation
High	NOR	No difference between reference setting and measurement
Medium	APP (approximation)	Change of the following settings: <ul style="list-style-type: none"> <li>• coupling (RBW, VBW, SWT)</li> <li>• reference level, RF attenuation</li> <li>• start or stop frequency</li> <li>• output level of tracking generator</li> <li>• frequency offset of tracking generator</li> <li>• detector (max peak, min peak, sample...)</li> </ul> Change of frequency: <ul style="list-style-type: none"> <li>• 500 frozen points at maximum within the set sweep limits (corresponds to a doubling of the span)</li> </ul>
-	Abortion of calibration	<ul style="list-style-type: none"> <li>• more than 500 frozen points within the set sweep limits (in case of span doubling)</li> </ul>

**Note:** At a reference level (REF LEVEL) of -10 dBm and at a tracking generator output level of the same value the instrument operates without a headroom. ie the instrument is in danger of being overloaded if a signal is applied whose amplitude is higher than the reference line. In this case, either the message "OVL" for overload is displayed in the status line or the display range is exceeded (upper limitation of trace = Overrange).

This overload can be avoided by two actions:

- Reducing the output level of the tracking generator (SOURCE POWER, SYSTEM-MODE-TRACKING GENERATOR menu)
- Increasing the reference level (REF LEVEL, LEVEL-REF menu)

## Frequency-Converting Measurements

For frequency-converting measurements (eg on converters) the tracking generator is able to set a constant frequency offset between the output frequency of the tracking generator and the receive frequency of the instrument. Up to an output frequency of 200 MHz the measurement can be carried out in inverted and normal position.

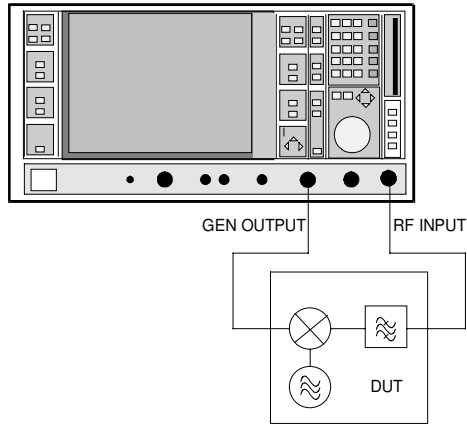
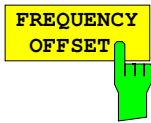

Fig. 4-42 Test setup for frequency-converting measurements

SYSTEM MODE-TRACKING GENERATOR menu:



The *FREQUENCY OFFSET* softkey activates the input of the frequency offset between the output signal of the tracking generator and the input frequency of the instrument. The permissible setting range is  $\pm 200$  MHz in 1-Hz steps.

The default setting is 0 Hz.

If a positive frequency offset is entered, the tracking generator generates an output signal above the receive frequency of the instrument. In case of a negative frequency offset it generates a signal below the receive frequency of the instrument. The output frequency of the tracking generator is calculated as follows:

Tracking generator frequency = receive frequency + frequency offset.

A frequency offset cannot be entered if an external I/Q or FM modulation is switched on. In this case, the *FREQUENCY OFFSET* softkey is blocked.

## External Modulation of Tracking Generator

SYSTEM MODE-TRACKING GENERATOR menu:

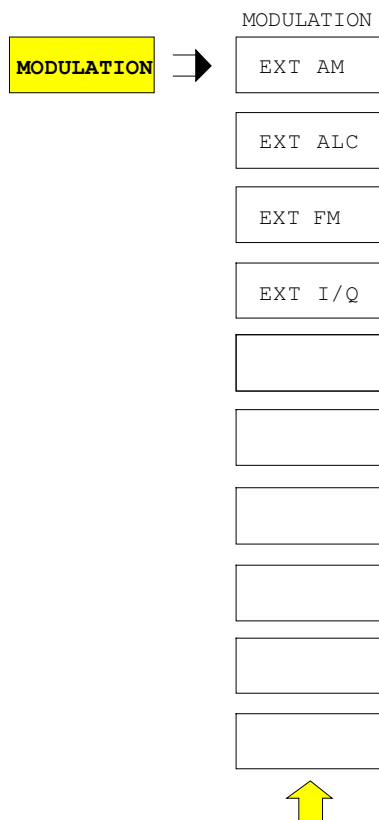

The *MODULATION* softkey opens a submenu for selecting the different modulation types.

The time characteristic of the output signal of the tracking generator can be influenced by means of externally fed-in signals (input voltage range -1 V to +1 V).

The functions for amplitude and frequency modulation and for external level control are always available.

The function IQ modulation is only available in models of tracking generators that are equipped with the IQ modulator (FSE-B9 and FSE-B11).

Two BNC connectors at the rear panel are available as signal inputs. Their function can be changed according to the modulation selected:

*TG-INPUT I / AM / ALC* and

*TG-INPUT Q / FM*

The types of modulation can partly be combined with each other and with the frequency offset function. The following table shows which types of modulation are possible at the same time and which can be combined with the frequency offset function.

Table 4-6 Simultaneous modes of modulation (tracking generator)

Modulation	Frequency offset	EXT AM	EXT ALC	EXT FM	EXT I/Q
Frequency offset		•	•	•	
EXT AM	•			•	
EXT ALC	•				
EXT FM	•	•			
EXT I/Q					

- modulations can be combined

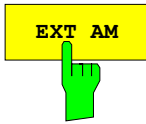

The *EXT AM* softkey activates an AM modulation of the tracking generator output signal.

The modulation signal is connected to the *TG-INPUT AM* connector. An input voltage of 1 V corresponds to 100% amplitude modulation.

Switching on an external AM deactivates the following functions:

- active external level control
- active I/Q modulation.



The *EXT ALC* softkey activates the external level control.

In case of external level control the output level of the tracking generator is determined from the signal of an external detector. The external detector has to supply a negative voltage in the range of -0.1 to -1 V which is applied to the *TG-INPUT ALC* connector. The setting of the output level is the same as that of the internal level control but the output level depends on the external detector.

Switching on an external level control deactivates the following functions:

- active external AM
- active I/Q modulation.

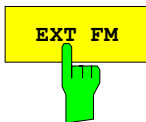

The *EXT FM* softkey activates the FM modulation of the tracking generator output signal.

The modulation frequency range is 100 kHz to 10 MHz, the deviation is approx. 10 MHz at an input voltage of 1 V.

The modulation signal is connected to the *TG-INPUT FM* connector.

Switching on an external FM deactivates the following function:

- active I/Q modulation.

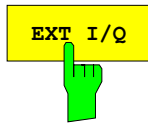

The *EXT I/Q* softkey is only offered with I/Q modulator option built-in. It activates the external I/Q modulation of the tracking generator (FSE-B9 and FSE B-11).

The signals for modulation are connected to the two input connectors *TG-INPUT IN* and *TG-INPUT Q* at the rear of the unit. The input voltage range is  $\pm 1$  V into  $50 \Omega$ .

Switching on an external I/Q modulation deactivates the following functions:

- active external AM
- active external level control
- active external FM or
- a level offset.

Functional description of quadrature modulator:

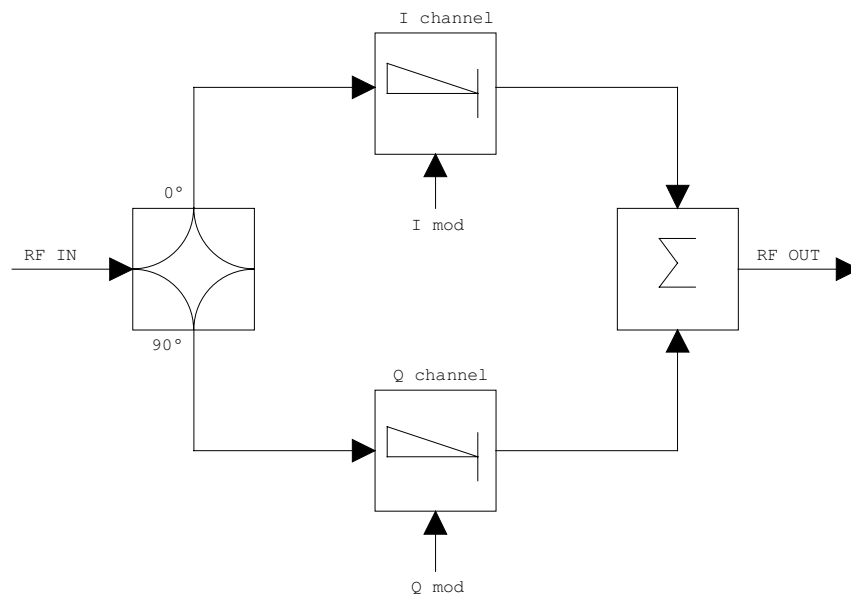

Fig. 4-43 I/Q modulation

I/Q modulation is performed by means of the built-in quadrature modulator. The RF signal is divided into the two orthogonal I and Q components (inphase and quadrature phase). Amplitude and phase are controlled in each path by the I and Q modulation signal. A RF output signal controllable in amplitude and phase is obtained by adding the two components.

# Contents - Chapter 5 "Remote Control - "Basics"

## 5 Remote Control - Basics

<b>Introduction</b> .....	<b>5.1</b>
<b>Brief Instructions</b> .....	<b>5.2</b>
<b>Switchover to Remote Control</b> .....	<b>5.3</b>
Indications during Remote Control .....	5.3
Remote Control via IEC Bus.....	5.4
Setting the Device Address .....	5.4
Return to Manual Operation .....	5.4
Remote Control via RS-232-Interface .....	5.5
Setting the Transmission Parameters .....	5.5
Return to Manual Operation .....	5.5
Limitations .....	5.5
Remote Control via RSIB Interface .....	5.6
Return to Manual Operation .....	5.6
<b>Messages</b> .....	<b>5.7</b>
IEE/IEEE-Bus Interface Messages .....	5.7
RSIB Interface Messages.....	5.7
Device Messages (Commands and Device Responses) .....	5.8
<b>Structure and Syntax of the Device Messages</b> .....	<b>5.9</b>
SCPI Introduction.....	5.9
Structure of a Command .....	5.9
Structure of a Command Line.....	5.12
Responses to Queries .....	5.12
Parameters .....	5.13
Overview of Syntax Elements.....	5.14
<b>Instrument Model and Command Processing</b> .....	<b>5.15</b>
Input Unit .....	5.15
Command Recognition .....	5.16
Data Set and Instrument Hardware .....	5.16
Status Reporting System .....	5.16
Output Unit.....	5.17
Command Sequence and Command Synchronization.....	5.17
<b>Status Reporting System</b> .....	<b>5.18</b>
Structure of an SCPI Status Register .....	5.18
Overview of the Status Registers .....	5.20
Description of the Status Registers .....	5.21
Status Byte (STB) and Service Request Enable Register (SRE) .....	5.21
IST Flag and Parallel Poll Enable Register (PPE).....	5.22
Event-Status Register (ESR) and Event-Status-Enable Register (ESE).....	5.22
STATUS:OPERation Register .....	5.23
STATUS:QUEStionable Register .....	5.24
STATUS QUEStionable:ACPLimit Register .....	5.25
STATUS QUEStionable:FREQuency Register.....	5.26
STATUS QUEStionable:LIMit Register .....	5.27
STATUS QUEStionable:LMARgin Register .....	5.28

STATus QUEStionable:POWer Register .....	5.29
STATus QUEStionable:SYNC Register .....	5.30
STATus QUEStionable:TRANsducer Register .....	5.31
Application of the Status Reporting Systems.....	5.32
Service Request, Making Use of the Hierarchy Structure .....	5.32
Serial Poll .....	5.32
Parallel Poll.....	5.32
Query by Means of Commands.....	5.33
Error-Queue Query.....	5.33
Resetting Values of the Status Reporting System.....	5.34

## 5 Remote Control - Basics

In this chapter you find:

- instructions how to put the FSIQ into operation via remote control,
- a general introduction to remote control of programmable instruments. This includes the description of the command structure and syntax according to the SCPI standard, the description of command execution and of the status registers,
- diagrams and tables describing the status registers used in the FSIQ.

In chapter 6, all remote control functions are described in detail. The subsystems are listed by alphabetical order according to SCPI. All commands and their parameters are listed by alphabetical order in the command list at the end of chapter 6.

Program examples for the FSIQ can be found in chapter 7.

The remote control interfaces and their interface functions are described in chapter 8.

### Introduction

The instrument is equipped with an IEC-bus interface according to standard IEC 625.1/IEEE 488.2 and two RS-232 interfaces. The connectors are located at the rear of the instrument and permits to connect a controller for remote control.

The internal controller function may also be used as a controller (see chapter 1, section "Controller function").

In addition, the instrument is equipped with an RSIB interface that allows instrument control by Windows applications WinWord and Excel or by Visual C++ and Visual Basic programs

The instrument supports the SCPI version 1994.0 (Standard Commands for Programmable Instruments). The SCPI standard is based on standard IEEE 488.2 and aims at the standardization of device-specific commands, error handling and the status registers (see section "SCPI Introduction").

This section assumes basic knowledge of IEC-bus programming and operation of the controller. A description of the interface commands is to be obtained from the relevant manuals. The RSIB interface functions are matched to the function interface for IEC/IEEE-bus programming from National Instruments. The functions supported by the DLLs are listed in chapter 8.

The requirements of the SCPI standard placed on command syntax, error handling and configuration of the status registers are explained in detail in the respective sections. Tables provide a fast overview of the commands implemented in the instrument and the bit assignment in the status registers. The tables are supplemented by a comprehensive description of every command and the status registers. Detailed program examples of the main functions are to be found in chapter 7.

The program examples for IEC-bus programming are all written in Quick BASIC.



## Brief Instructions

The short and simple operating sequence given below permits fast putting into operation of the instrument and setting of its basic functions. As a prerequisite, the IEC-bus address, which is factory-set to 20, must not have been changed.

1. Connect instrument and controller using IEC-bus cable.
2. Write and start the following program on the controller:

```
CALL IBFIND("DEV1", analyzer%)           'Open port to the instrument
CALL IBPAD(analyzer%, 20)                 'Inform controller about instrument address
CALL IBWRT(analyzer%, "*RST;*CLS")       'Reset instrument
CALL IBWRT(analyzer%, 'FREQ:CENT 100MHz') 'Set center frequency to 100 MHz
CALL IBWRT(analyzer%, 'FREQ:SPAN 10MHz') 'Set span to 10 MHz
CALL IBWRT(analyzer%, 'DISP:TRAC:Y:RLEV -10dBm') 'Set reference level to -10 dBm
```

The instrument now performs a sweep in the frequency range of 95 MHz to 105 MHz.

3. To return to manual control, press the *LOCAL* key at the front panel

## Switchover to Remote Control

On power-on, the instrument is always in the manual operating state ("LOCAL" state) and can be operated via the front panel.

It is switched to remote control ("REMOTE" state)

IEC-bus                as soon as it receives an addressed command from a controller.

RS-232                as soon as it receives a command from a controller.

RSIB                    as soon as it receives an addressed command from a controller.

During remote control, operation via the front panel is disabled. The instrument remains in the remote state until it is reset to the manual state via the front panel or via remote control interfaces. Switching from manual operation to remote control and vice versa does not affect the remaining instrument settings.

## Indications during Remote Control

Remote control mode is indicated by the LED "REMOTE" on the instrument's front panel. In this mode the softkeys, the function fields and the diagram labelling on the display are not shown.

**Note:** Command `SYSTem:DISPlay:UPDate ON` activates all indications during remote control to check the instrument settings.

## Remote Control via IEC Bus

### Setting the Device Address

In order to operate the instrument via the IEC-bus, it must be addressed using the set IEC-bus address. The IEC-bus address of the instrument is factory-set to 20. It can be changed manually in the *SETUP - GENERAL SETUP* menu or via IEC bus. Addresses 0 to 30 are permissible.

**Manually:** Call *SETUP - GENERAL SETUP* menu  
 Enter desired address in table *GPIB ADDRESS*  
 Terminate input using one of the unit keys (=ENTER).

**Via IEC bus:**

CALL IBFIND("DEV1", analyzer%)	'Open port to the instrument
CALL IBPAD(analyzer%, 20)	'Inform controller about old address
CALL IBWRT(analyzer%, "SYST:COMM:GPIB:ADDR 18")	'Set instrument to new address
CALL IBPAD(analyzer%, 18)	'Inform controller about new address

### Return to Manual Operation

Return to manual operation is possible via the front panel or the IEC bus.

**Manually:** Press the *LOCAL* key.

- Notes:**
- Before switchover, command processing must be completed as otherwise switchover to remote control is effected immediately.
  - The *LOCAL* key can be disabled by the universal command *LLO* (see chapter 8) in order to prevent unintentional switchover. In this case, switchover to manual mode is only possible via the IEC bus.
  - The *LOCAL* key can be enabled again by deactivating the *REN* line of the IEC bus (see chapter 8).

**Via IEC bus:** ...  
 CALL IBLOC(analyzer%) 'Set instrument to manual operation.  
 ...

## Remote Control via RS-232-Interface

### Setting the Transmission Parameters

To enable an error-free and correct data transmission, the parameters of the unit and the controller should have the same setting. Parameters can be manually changed in menu *SETUP-GENERAL SETUP* in table *COM PORT 1/2* or via remote control using the command `SYSTem:COMMunicate:SERial1|2:....`.

The transmission parameters of the interfaces COM1 and COM2 are factory-set to the following values: baudrate = 9600, data bits = 8, stop bits = 1, parity = NONE and owner = INSTRUMENT.

- Manually:**                    Setting interface COM1|2
- Call *SETUP-GENERAL SETUP* menu
  - Select desired baudrate, bits, stopbit, parity in table *COM PORT 1/2*.
  - Terminate input using one of the unit keys (=ENTER).

### Return to Manual Operation

Return to manual operation is possible via the front panel.

- Manually:**                    Press the *LOCAL* key.

**Note:**    *Before switchover, command processing must be completed as otherwise switchover to remote control is effected immediately.*

### Limitations

The following limitations apply if the unit is remote-controlled via the RS-232-C interface:

- No interface messages
- Only the Common Commands \*OPC? can be used for command synchronization, \*WAI and \*OPC are not available.
- Block data cannot be transmitted.

## Remote Control via RSIB Interface

To access the measuring instruments via the RSIB interface the DLLs should be installed in the corresponding directories:

- RSIB.DLL in Windows NT `system` directory or control application directory.
- RSIB32.DLL in Windows NT `system32` directory or control application directory.

On the measuring instrument the DLL is already installed in the corresponding directory.

The control is performed via one of the Windows applications WinWord or Excel or with Visual C++ or Visual Basic programs. The local link to the internal controller is established with the name '@local'. If a remote controller is used, the instrument IP address is to be indicated here.

**Via VisualBasic:**

internal controller:	ud = RSDLLibfind ('@local', ibsta, iberr, ibcntl)
remote controller:	ud = RSDLLibfind ('82.1.1.200', ibsta, iberr, ibcntl)

## Return to Manual Operation

The return to manual operation can be performed via the front panel (*LOCAL* key) or the RSIB interface.

**Manually:** Press the *LOCAL* key.

**Note:** *Before switchover, command processing must be completed as otherwise switchover to remote control is effected immediately.*

**Via RSIB:**

```
...  
ud = RSDLLibloc (ud, ibsta, iberr, ibcntl);  
...
```

## Messages

The messages transferred via the data lines of the IEC bus or the RSIB interface (see chapter 8) can be divided into two groups:

- **interface messages and**
- **device messages.**

For the RS-232 interface, no interface messages are defined.

## IEE/IEEE-Bus Interface Messages

Interface messages are transferred on the data lines of the IEC bus, the "ATN" control line being active. They are used for communication between controller and instrument and can only be sent by a controller which has the IEC-bus control. Interface commands can be subdivided into

- **universal commands and**
- **addressed commands.**

Universal commands act on all devices connected to the IEC bus without previous addressing, addressed commands only act on devices previously addressed as listeners. The interface messages relevant to the instrument are listed in chapter 8.

## RSIB Interface Messages

The RSIB interface enables the instrument to be controlled by Windows applications. The interface functions are matched to the function interface for IEC/IEEE-bus programming from National Instruments.

The functions supported by interface are listed in chapter 8.

## Device Messages (Commands and Device Responses)

Device messages are transferred on the data lines of the IEC bus, the "ATN" control line not being active. ASCII code is used. The device messages are more or less equal for the different interfaces. A distinction is made according to the direction in which they are sent on the IEC bus:

- **Commands** are messages the controller sends to the instrument. They operate the device functions and request informations.  
The commands are subdivided according to two criteria:
  1. According to the effect they have on the instrument:
    - Setting commands** cause instrument settings such as reset of the instrument or setting the center frequency.
    - Queries** cause data to be provided for output on the IEC-bus, e.g. for identification of the device or polling the marker.
  2. According to their definition in standard IEEE 488.2:
    - Common Commands** are exactly defined as to their function and notation in standard IEEE 488.2. They refer to functions such as management of the standardized status registers, reset and selftest.
    - Device-specific commands** refer to functions depending on the features of the instrument such as frequency setting. A majority of these commands has also been standardized by the SCPI committee (cf. Section 3.5.1).
- **Device responses** are messages the instrument sends to the controller after a query. They can contain measurement results, instrument settings and information on the instrument status (cf. Section 3.5.4).

Structure and syntax of the device messages are described in the following section. The commands are listed and explained in detail in chapter 6.

## Structure and Syntax of the Device Messages

### SCPI Introduction

SCPI (Standard Commands for Programmable Instruments) describes a standard command set for programming instruments, irrespective of the type of instrument or manufacturer. The goal of the SCPI consortium is to standardize the device-specific commands to a large extent. For this purpose, a model was developed which defines the same functions inside a device or for different devices. Command systems were generated which are assigned to these functions. Thus it is possible to address the same functions with identical commands. The command systems are of a hierarchical structure.

Fig. 5-1 illustrates this tree structure using a section of command system SOURce, which operates the signal sources of the devices. The other examples concerning syntax and structure of the commands are derived from this command system.

SCPI is based on standard IEEE 488.2, i.e. it uses the same syntactic basic elements as well as the common commands defined in this standard. Part of the syntax of the device responses is defined with greater restrictions than in standard IEEE 488.2 (see Section "Responses to Queries").

### Structure of a Command

The commands consist of a so-called header and, in most cases, one or more parameters. Header and parameter are separated by a "white space" (ASCII code 0 to 9, 11 to 32 decimal, e.g. blank). The headers may consist of several key words. Queries are formed by directly appending a question mark to the header.

**Note:** *The commands used in the following examples are not in every case implemented in the instrument.*

#### Common commands

Common commands consist of a header preceded by an asterisk "\*" and one or several parameters, if any.

Examples:

*RST	RESET, resets the device
*ESE 253	EVENT STATUS ENABLE, sets the bits of the event status enable register
*ESR?	EVENT STATUS QUERY, queries the contents of the event status register.



Device-specific commands

Hierarchy: Device-specific commands are of hierarchical structure (see Fig. 5-1). The different levels are represented by combined headers. Headers of the highest level (root level) have only one key word. This key word denotes a complete command system.

Example: `SENSe` This key word denotes the command system `SENSe`.

For commands of lower levels, the complete path has to be specified, starting on the left with the highest level, the individual key words being separated by a colon ":".

Example: `SENSe:FREQuency:SPAN:LINK START`

This command lies in the fourth level of the `SENSe` system. It determines which parameter remains unchanged when the span is changed. If `LINK` is set to `START`, the values of `CENTer` and `STOP` are adjusted when the span is changed.

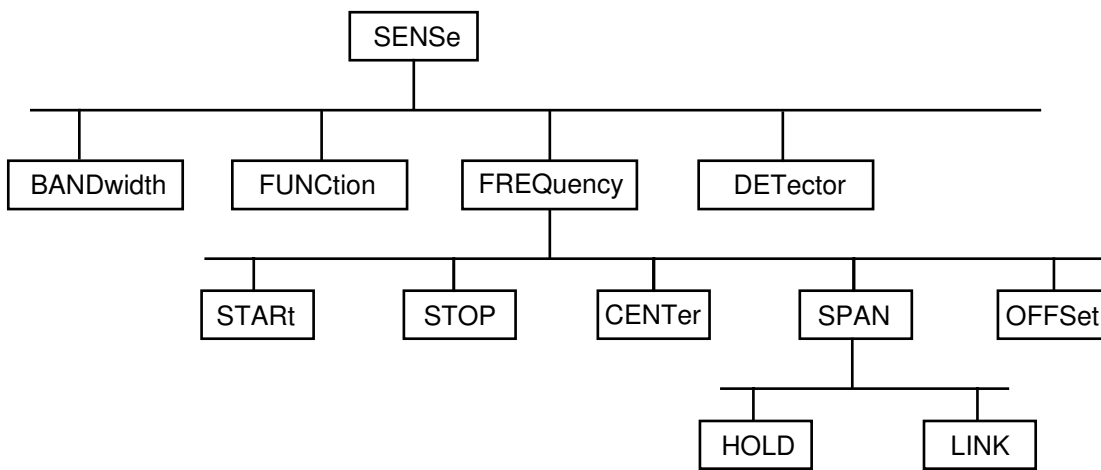

Fig. 5-1 Tree structure the SCPI command systems using the `SENSe` system by way of example

Some key words occur in several levels within one command system. Their effect depends on the structure of the command, that is to say, at which position in the header of a command they are inserted.

Example: `SOURce:FM:POLarity NORMal`

This command contains key word `POLarity` in the third command level. It defines the polarity between modulator and modulation signal.

`SOURce:FM:EXTernal:POLarity NORMal`

This command contains key word `POLarity` in the fourth command level. It defines the polarity between modulation voltage and the resulting direction of the modulation only for the external signal source indicated.

**Optional key words:** Some command systems permit certain key words to be optionally inserted into the header or omitted. These key words are marked by square brackets in the description. The full command length must be recognized by the instrument for reasons of compatibility with the SCPI standard. Some commands are considerably shortened by these optional key words.

**Example:** `[SENSe]:BANDwidth[:RESolution]:AUTO`

This command couples the resolution bandwidth of the instrument to other parameters. The following command has the same effect:

`BANDwidth:AUTO`

**Note:** *An optional key word must not be omitted if its effect is specified in detail by a numeric suffix.*

**Long and short form:** The key words feature a long form and a short form. Either the short form or the long form can be entered, other abbreviations are not permissible.

**Beispiel:** `STATus:QUESTionable:ENABle 1= STAT:QUES:ENAB 1`

**Note:** *The short form is marked by upper-case letters, the long form corresponds to the complete word. Upper-case and lower-case notation only serve the above purpose, the instrument itself does not make any difference between upper-case and lower-case letters.*

**Parameter:** The parameter must be separated from the header by a "white space". If several parameters are specified in a command, they are separated by a comma ",". A few queries permit the parameters MINimum, MAXimum and DEFault to be entered. For a description of the types of parameter, refer to Section 3.5.5.

**Example:** `SENSe:FREQuency:STOP? MAXimum`      **Response:** `3.5E9`  
This query requests the maximal value for the stop frequency.

**Numeric suffix:** If a device features several functions or features of the same kind, e.g. inputs, the desired function can be selected by a suffix added to the command. Entries without suffix are interpreted like entries with the suffix 1.

**Example:** `SYSTem:COMMunicate:SERial2:BAUD 9600`

This command sets the baudrate of the second serial interface.



## Parameters

Most commands require a parameter to be specified. The parameters must be separated from the header by a "white space". Permissible parameters are numerical values, Boolean parameters, text, character strings and block data. The type of parameter required for the respective command and the permissible range of values are specified in the command description (see Section 3.6).

**Numerical values** Numerical values can be entered in any form, i.e. with sign, decimal point and exponent. Values exceeding the resolution of the instrument are rounded up or down. The mantissa may comprise up to 255 characters, the exponent must lie inside the value range -32000 to 32000. The exponent is introduced by an "E" or "e". Entry of the exponent alone is not permissible. In the case of physical quantities, the unit can be entered. Permissible unit prefixes are G (giga), MA (mega), MOHM and MHZ are also permissible), K (kilo), M (milli), U (micro) and N (nano). If the unit is missing, the basic unit is used.

Example:

```
SENSe:FREQuency:STOP 1.5GHz = SENSe:FREQuency:STOP 1.5E9
```

**Special numerical** The texts MINimum, MAXimum, DEFault, UP and DOWN are interpreted as values special numerical values.

In the case of a query, the numerical value is provided.

Example: Setting command: `SENSe:FREQuency:STOP MAXimum`

Query: `SENSe:FREQuency:STOP?` Response: `3.5E9`

MIN/MAX MINimum and MAXimum denote the minimum and maximum value.

DEF DEFault denotes a preset value which has been stored in the EPROM. This value conforms to the default setting, as it is called by the \*RST command

UP/DOWN UP, DOWN increases or reduces the numerical value by one step. The step width can be specified via an allocated step command for each parameter which can be set via UP, DOWN.

INF/NINF INFINITY, Negative INFINITY (NINF) Negative INFINITY (NINF) represent the numerical values -9.9E37 or 9.9E37, respectively. INF and NINF are only sent as device responses.

NAN Not A Number (NAN) represents the value 9.91E37. NAN is only sent as device response. This value is not defined. Possible causes are the division of zero by zero, the subtraction of infinite from infinite and the representation of missing values.

**Boolean Parameters** Boolean parameters represent two states. The ON state (logically true) is represented by ON or a numerical value unequal to 0. The OFF state (logically untrue) is represented by OFF or the numerical value 0. 0 or 1 is provided in a query.

Example: Setting command: `DISPlay:WINDow:STATe ON`

Query: `DISPlay:WINDow:STATe?` Response: `1`

**Text** Text parameters observe the syntactic rules for key words, i.e. they can be entered using a short or long form. Like any parameter, they have to be separated from the header by a white space. In the case of a query, the short form of the text is provided.

Example: Setting command: `INPut:COUPling GROund`  
 Query: `INPut:COUPling?` Response `GRO`

**Strings** Strings must always be entered in quotation marks (' or ").

Example: `SYSTem:LANGUage "SCPI"` or  
`SYSTem:LANGUage 'SCPI'`

**Block data** Block data are a transmission format which is suitable for the transmission of large amounts of data. A command using a block data parameter has the following structure:

Example: `HEADer:HEADer #45168xxxxxxxx`

ASCII character # introduces the data block. The next number indicates how many of the following digits describe the length of the data block. In the example the 4 following digits indicate the length to be 5168 bytes. The data bytes follow. During the transmission of these data bytes all End or other control signs are ignored until all bytes are transmitted..

## Overview of Syntax Elements

The following survey offers an overview of the syntax elements.

- :** The colon separates the key words of a command.  
In a command line the colon after the separating semicolon marks the uppermost command level.
- ;** The semicolon separates two commands of a command line. It does not alter the path.
- ,** The comma separates several parameters of a command.
- ?** The question mark forms a query.
- \*** The asterisk marks a common command.
- "** Quotation marks introduce a string and terminate it.
- #** The double dagger ( #) introduces block data
- A "white space (ASCII-Code 0 to 9, 11 to 32 decimal, e.g.blank) separates header and parameter.

## Instrument Model and Command Processing

The instrument model shown in Fig. 5-2 has been made viewed from the standpoint of the servicing of IEC-bus commands. The individual components work independently of each other and simultaneously. They communicate by means of so-called "messages".

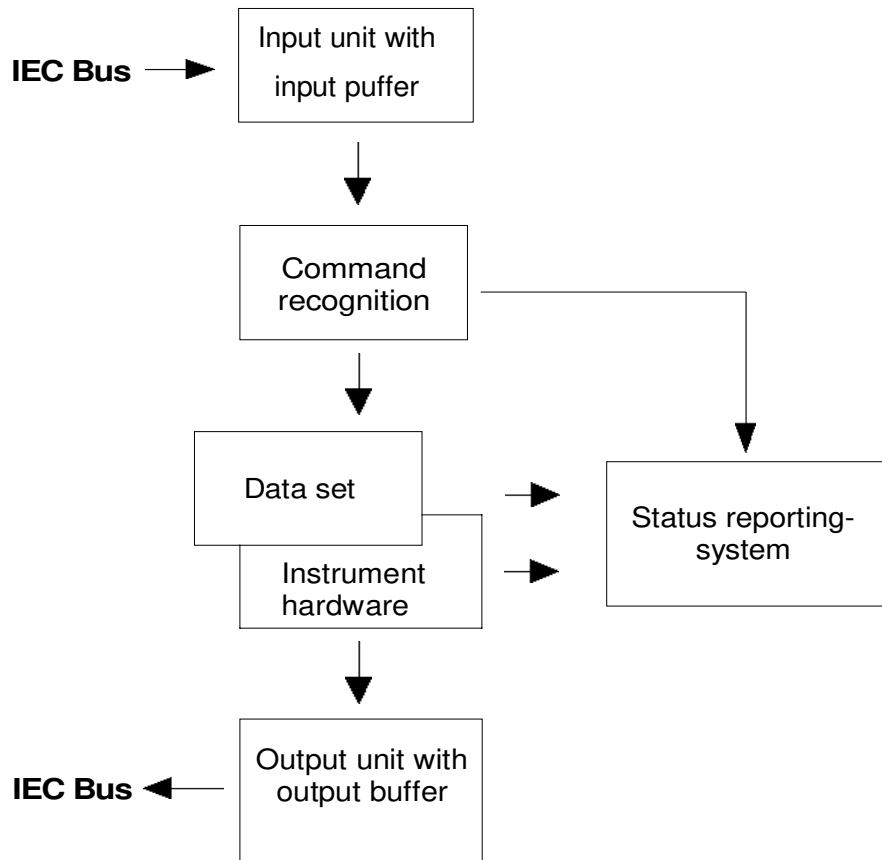

Fig. 5-2 Instrument model in the case of remote control by means of the IEC bus

### Input Unit

The input unit receives commands character by character from the IEC bus and collects them in the input buffer. The input buffer has a size of 256 characters. The input unit sends a message to the command recognition as soon as the input buffer is full or as soon as it receives a delimiter, <PROGRAM MESSAGE TERMINATOR>, as defined in IEEE 488.2, or the interface message DCL.

If the input buffer is full, the IEC-bus traffic is stopped and the data received up to then are processed. Subsequently the IEC-bus traffic is continued. If, however, the buffer is not yet full when receiving the delimiter, the input unit can already receive the next command during command recognition and execution. The receipt of a DCL clears the input buffer and immediately initiates a message to the command recognition.

## **Command Recognition**

The command recognition analyses the data received from the input unit. It proceeds in the order in which it receives the data. Only a DCL is serviced with priority, a GET (Group Execute Trigger), e.g., is only executed after the commands received before as well. Each recognized command is immediately transferred to the data set but without being executed there at once.

Syntactical errors in the command are recognized here and supplied to the status reporting system. The rest of a command line after a syntax error is analysed further if possible and serviced.

If the command recognition recognizes a delimiter or a DCL, it requests the data set to set the commands in the instrument hardware as well now. Subsequently it is immediately prepared to process commands again. This means for the command servicing that further commands can already be serviced while the hardware is still being set ("overlapping execution").

## **Data Set and Instrument Hardware**

Here the expression "instrument hardware" denotes the part of the instrument fulfilling the actual instrument function - signal generation, measurement etc. The controller is not included.

The data set is a detailed reproduction of the instrument hardware in the software.

IEC-bus setting commands lead to an alteration in the data set. The data set management enters the new values (e.g. frequency) into the data set, however, only passes them on to the hardware when requested by the command recognition. As this is always only effected at the end of a command line, the order of the setting commands in the command line is not relevant.

The data are only checked for their compatibility among each other and with the instrument hardware immediately before they are transmitted to the instrument hardware. If the detection is made that an execution is not possible, an "execution error" is signalled to the status reporting system. All alterations of the data set are cancelled, the instrument hardware is not reset. Due to the delayed checking and hardware setting, however, it is permissible to set impermissible instrument states within one command line for a short period of time without this leading to an error message. At the end of the command line, however, a permissible instrument state must have been reached again.

IEC-bus queries induce the data set management to send the desired data to the output unit.

## **Status Reporting System**

The status reporting system collects information on the instrument state and makes it available to the output unit on request. The exact structure and function are described in the following section.

## Output Unit

The output unit collects the information requested by the controller, which it receives from the data set management. It processes it according to the SCPI rules and makes it available in the output buffer. The output buffer has a size of 4096 characters. If the information requested is longer, it is made available "in portions" without this being recognized by the controller.

If the instrument is addressed as a talker without the output buffer containing data or awaiting data from the data set management, the output unit sends error message "Query UNTERMINATED" to the status reporting system. No data are sent on the IEC bus, the controller waits until it has reached its time limit. This behaviour is specified by SCPI.

## Command Sequence and Command Synchronization

What has been said above makes clear that all commands can potentially be carried out overlapping. Equally, setting commands within one command line are not absolutely serviced in the order in which they have been received.

In order to make sure that commands are actually carried out in a certain order, each command must be sent in a separate command line, that is to say, with a separate IBWRT()-call.

In order to prevent an overlapping execution of commands, one of commands \*OPC, \*OPC? or \*WAI must be used. All three commands cause a certain action only to be carried out after the hardware has been set and has settled. By a suitable programming, the controller can be forced to wait for the respective action to occur (cf. Table 5-1).

Table 5-1 Synchronisation using \*OPC, \*OPC? and \*WAI

Commnd	Action after the hardware has settled	Programming the controller
*OPC	Setting the operation-complete bit in the ESR	- Setting bit 0 in the ESE - Setting bit 5 in the SRE - Waiting for service request (SRQ)
*OPC?	Writing a "1" into the output buffer	Addressing the instrument as a talker
*WAI	Continuing the IEC-bus handshake	Sending the next command

An example as to command synchronization can be found in chapter 7 "Program Examples".





<b>CONDition part</b>	The CONDition part is directly written into by the hardware or the sum bit of the next lower register. Its contents reflects the current instrument status. This register part can only be read, but not written into or cleared. Its contents is not affected by reading.
<b>PTRansition part</b>	The Positive-TRansition part acts as an edge detector. When a bit of the CONDition part is changed from 0 to 1, the associated PTR bit decides whether the EVENT bit is set to 1. PTR bit =1: the EVENT bit is set. PTR bit =0: the EVENT bit is not set. This part can be written into and read at will. Its contents is not affected by reading.
<b>NTRansition part</b>	The Negative-TRansition part also acts as an edge detector. When a bit of the CONDition part is changed from 1 to 0, the associated NTR bit decides whether the EVENT bit is set to 1. NTR-Bit = 1: the EVENT bit is set. NTR-Bit = 0: the EVENT bit is not set. This part can be written into and read at will. Its contents is not affected by reading.  With these two edge register parts the user can define which state transition of the condition part (none, 0 to 1, 1 to 0 or both) is stored in the EVENT part.
<b>EVENT part</b>	The EVENT part indicates whether an event has occurred since the last reading, it is the "memory" of the condition part. It only indicates events passed on by the edge filters. It is permanently updated by the instrument. This part can only be read by the user. During reading, its contents is set to zero. In linguistic usage this part is often equated with the entire register.
<b>ENABLE part</b>	The ENABLE part determines whether the associated EVENT bit contributes to the sum bit (cf. below). Each bit of the EVENT part is ANDed with the associated ENABLE bit (symbol '&'). The results of all logical operations of this part are passed on to the sum bit via an OR function (symbol '+'). ENABLE-Bit = 0: the associated EVENT bit does not contribute to the sum bit ENABLE-Bit = 1: if the associated EVENT bit is "1", the sum bit is set to "1" as well. This part can be written into and read by the user at will. Its contents is not affected by reading.
<b>Sum bit</b>	As indicated above, the sum bit is obtained from the EVENT and ENABLE part for each register. The result is then entered into a bit of the CONDition part of the higher-order register. The instrument automatically generates the sum bit for each register. Thus an event, e.g. a PLL that has not locked, can lead to a service request throughout all levels of the hierarchy.
<b>Note:</b>	<i>The service request enable register SRE defined in IEEE 488.2 can be taken as ENABLE part of the STB if the STB is structured according to SCPI. By analogy, the ESE can be taken as the ENABLE part of the ESR.</i>

# Overview of the Status Registers

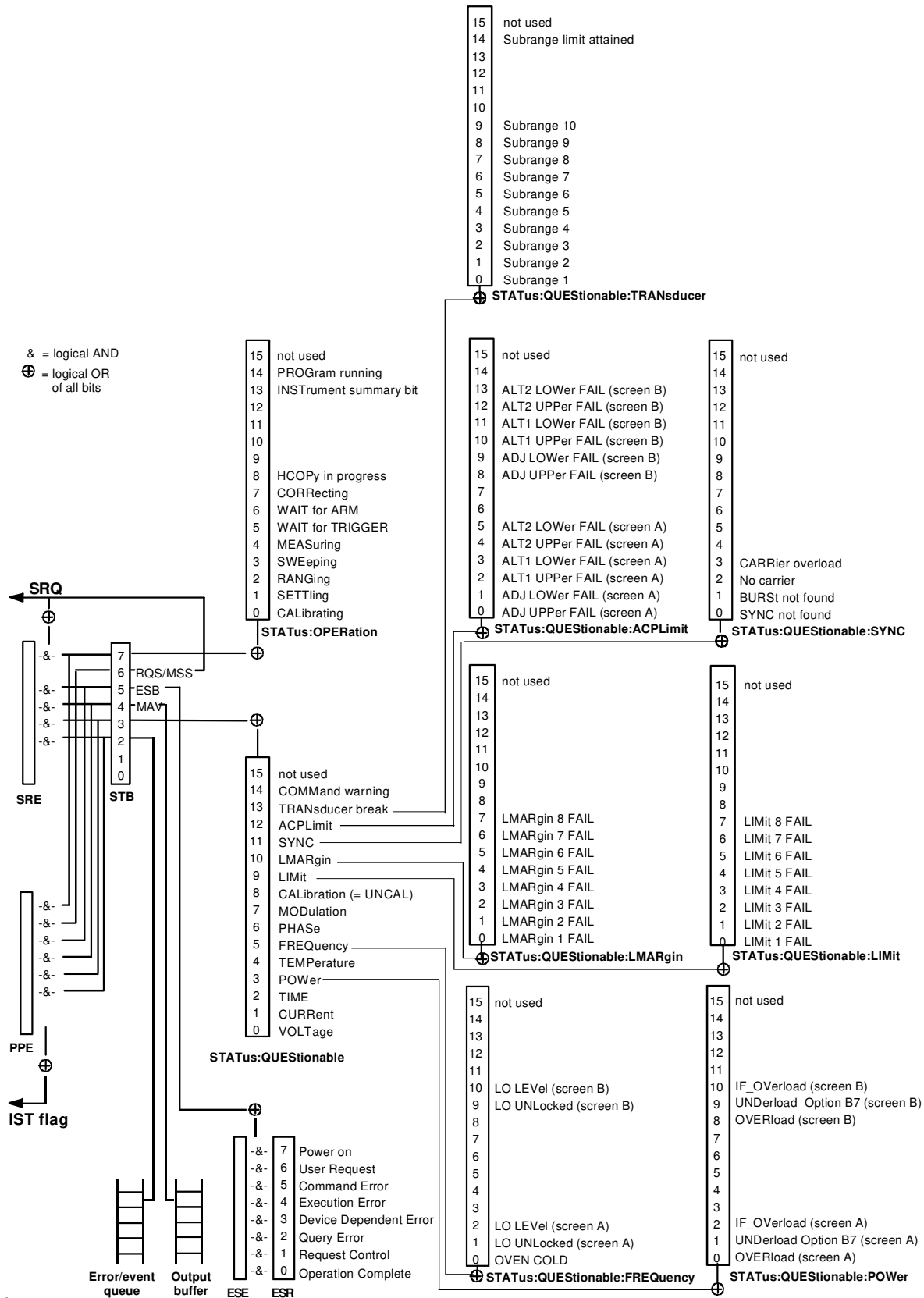

Fig. 5-3 Overview of the status registers

## Description of the Status Registers

### Status Byte (STB) and Service Request Enable Register (SRE)

The STB is already defined in IEEE 488.2. It provides a rough overview of the instrument status by collecting the pieces of information of the lower registers. It can thus be compared with the CONDITION part of an SCPI register and assumes the highest level within the SCPI hierarchy. A special feature is that bit 6 acts as the sum bit of the remaining bits of the status byte.

The STATUS BYTE is read out using the command "**\*STB?**" or a serial poll.

The STB implies the SRE. It corresponds to the ENABLE part of the SCPI registers as to its function. Each bit of the STB is assigned a bit in the SRE. Bit 6 of the SRE is ignored. If a bit is set in the SRE and the associated bit in the STB changes from 0 to 1, a Service Request (SRQ) is generated on the IEC bus, which triggers an interrupt in the controller if this is appropriately configured and can be further processed there.

The SRE can be set using command "**\*SRE**" and read using "**\*SRE?**".

Table 5-2 Meaning of the bits in the status byte

Bit No.	Meaning
2	<p><b>Error Queue not empty</b></p> <p>The bit is set when an entry is made in the error queue. If this bit is enabled by the SRE, each entry of the error queue generates a Service Request. Thus an error can be recognized and specified in greater detail by polling the error queue. The poll provides an informative error message. This procedure is to be recommended since it considerably reduces the problems involved with IEC-bus control.</p>
3	<p><b>QUESTIONable status sum bit</b></p> <p>The bit is set if an EVENT bit is set in the QUESTIONable-Status register and the associated ENABLE bit is set to 1. A set bit indicates a questionable instrument status, which can be specified in greater detail by polling the QUESTIONable-Status register.</p>
4	<p><b>MAV bit</b> (message available)</p> <p>The bit is set if a message is available in the output buffer which can be read. This bit can be used to enable data to be automatically read from the instrument to the controller (cf. chapter 7, program examples).</p>
5	<p><b>ESB bit</b></p> <p>Sum bit of the event status register. It is set if one of the bits in the event status register is set and enabled in the event status enable register. Setting of this bit implies an error or an event which can be specified in greater detail by polling the event status register.</p>
6	<p><b>MSS bit</b> (master status summary bit)</p> <p>The bit is set if the instrument triggers a service request. This is the case if one of the other bits of this registers is set together with its mask bit in the service request enable register SRE.</p>
7	<p><b>OPERation status register sum bit</b></p> <p>The bit is set if an EVENT bit is set in the OPERation-Status register and the associated ENABLE bit is set to 1. A set bit indicates that the instrument is just performing an action. The type of action can be determined by polling the OPERation-status register.</p>

### IST Flag and Parallel Poll Enable Register (PPE)

By analogy with the SRQ, the IST flag combines the entire status information in a single bit. It can be queried by means of a parallel poll or using command `"*IST?"`.

The parallel poll enable register (PPE) determines which bits of the STB contribute to the IST flag. The bits of the STB are ANDed with the corresponding bits of the PPE, with bit 6 being used as well in contrast to the SRE. The Ist flag results from the ORing of all results. The PPE can be set using commands `"*PRE"` and read using command `"*PRE?"`.

### Event-Status Register (ESR) and Event-Status-Enable Register (ESE)

The ESR is already defined in IEEE 488.2. It can be compared with the EVENT part of an SCPI register. The event status register can be read out using command `"*ESR?"`.

The ESE is the associated ENABLE part. It can be set using command `"*ESE"` and read using command `"*ESE?"`.

Table 5-3 Meaning of the bits in the event status register

Bit No.	Meaning
0	<b>Operation Complete</b> This bit is set on receipt of the command <code>*OPC</code> exactly when all previous commands have been executed.
1	<b>Request Control</b> This bit is set if the instrument requests the controller function. This is the case when hardcopy is outputted to a printer or a plotter via the IEC-bus.
2	<b>Query Error</b> This bit is set if either the controller wants to read data from the instrument without having send a query, or if it does not fetch requested data and sends new instructions to the instrument instead. The cause is often a query which is faulty and hence cannot be executed.
3	<b>Device-dependent Error</b> This bit is set if a device-dependent error occurs. An error message with a number between -300 and -399 or a positive error number, which denotes the error in greater detail, is entered into the error queue (cf. chapter 9, Error Messages).
4	<b>Execution Error</b> This bit is set if a received command is syntactically correct, however, cannot be performed for other reasons. An error message with a number between -200 and -300, which denotes the error in greater detail, is entered into the error queue (cf. chapter 9, Error Messages).
5	<b>Command Error</b> This bit is set if a command which is undefined or syntactically incorrect is received. An error message with a number between -100 and -200, which denotes the error in greater detail, is entered into the rror queue (cf. chapter 9, -Error Messages).
6	<b>User Request</b> This bit is set on pressing the <i>LOCAL</i> key.
7	<b>Power On</b> (supply voltage on) This bit is set on switching on the instrument.

## STATus:OPERation Register

In the CONDition part, this register contains information on which actions the instrument is being executing or, in the EVEnt part, information on which actions the instrument has executed since the last reading. It can be read using commands "STATus:OPERation:CONDition?" or "STATus:OPERation[:EVEnt]?".

Table 5-4 Meaning of the bits in the STATus.OPERation register

Bit No.	Meaning
0	<b>CALibrating</b> This bit is set as long as the instrument is performing a calibration.
1	<b>SETTLing</b> This bit is set as long as the new status is settling after a setting command. It is only set if the settling time is longer than the command processing time.
2	<b>RANGing</b> This bit is set as long as the instrument is changing a range (e.g. Autorange).
3	<b>SWEeping</b> This bit is set while the instrument is performing a sweep.
4	<b>MEASuring</b> This bit is set while the instrument is performing a measurement.
5	<b>WAIT for TRIGGER</b> This bit is set as long as the instrument is waiting for a trigger event.
6	<b>WAIT for ARM</b> This bit is set as long as the instrument is waiting for an arming event.
7	<b>CORRecting</b> This bit is set while the instrument is performing a correction.
8	<b>HardCOPy in progress</b> This bit is set while the instrument is printing a hardcopy.
9-12	Device dependent
13	<b>INSTrument Summary Bit</b> This bit is set when one or more logical instruments is reporting a status message.
14	<b>PROGram running</b> This bit is set while the instrument is performing a program.
15	This bit is always 0

The FSIQ supports bits 0 and 8.

## STATus:QUESTionable Register

This register comprises information about indefinite states which may occur if the unit is operated without meeting the specifications. It can be queried by commands `STATus:QUESTionable:CONDition?` and `STATus:QUESTionable[:EVENT]?`.

Table 5-5 Meaning of bits in STATus:QUESTionable register

Bit No.	Meaning
0	<b>VOLTage</b> This bit is set if a questionable voltage occurs.
1	<b>CURRent</b> This bit is set if a questionable current occurs.
2	<b>TIME</b> This bit is set if a questionable time occurs.
3	<b>POWer</b> This bit is set if a questionable power occurs (cf. also section "STATus:QUESTionable:POWerRegister")
4	<b>TEMPerature</b> This bit is set if a questionable temperature occurs.
5	<b>FREQuency</b> The bit is set if a frequency is questionable (cf. section "STATus:QUESTionable:FREQuency Register")
6	<b>PHASe</b> The bit is set if a phase value is questionable.
7	<b>MODulation</b> The bit is set if a modulation is performed questionably.
8	<b>CALibration</b> The bit is set if a measurement is performed uncalibrated ( $\hat{=}$ label "UNCAL")
9	<b>LIMit</b> (unit-dependent) This bit is set if a limit value is violated (see also section STATus:QUESTionable:LIMit Register)
10	<b>LMARgin</b> (unit-dependent) This bit is set if a margin is violated (see also section STATus:QUESTionable:LMARgin Register)
11	<b>SYNC</b> (unit-dependent) This bit is set if, during measurements with Option B7 (Signal Vector Analysis), the synchronization with midamble or a successful search for bursts cannot be performed (see also STATus:QUESTionable:SYNC Register)
12	<b>ACPLimit</b> (unit-dependent) This bit is set if a limit for the adjacent channel power measurement is violated (see also section STATus:QUESTionable:ACPLimit Register)
13	<b>TRANSDUCER break</b> This bit is set when the limit of the transducer set subrange is attained.
14	<b>COMMANd Warning</b> This bit is set if the instrument ignores parameters when executing a command.
15	This bit is always 0.

The FSIQ supports bits 3, 5, 7, 8, 9, 10, 11, 12 and 13.¹.

## STATus QUEStionable:ACPLimit Register

This register comprises information about the observance of limits during adjacent power measurements. It can be queried with commands 'STATus:QUEStionable:ACPLimit:CONDition?' and 'STATus:QUEStionable:ACPLimit[:EVENT]?'

Table 5-6 Meaning of bits in STATus:QUEStionable:ACPLimit register

Bit No.	Meaning
0	<b>ADJ UPPer FAIL(Screen A)</b> This bit is set if the limit is exceeded in the upper adjacent channel.
1	<b>ADJ LOWer FAIL (Screen A)</b> This bit is set if the limit is exceeded in the lower adjacent channel.
2	<b>ALT1 UPPer FAIL (Screen A)</b> This bit is set if the limit is exceeded in the upper 1st alternate channel.
3	<b>ALT1 LOWer FAIL (Screen A)</b> This bit is set if the limit is exceeded in the lower 1st alternate channel.
4	<b>ALT2 UPPer FAIL (Screen A)</b> This bit is set if the limit is exceeded in the upper 2nd alternate channel.
5	<b>ALT2 LOWer FAIL (Screen A)</b> This bit is set if the limit is exceeded in the lower 2nd alternate channel.
6	not used
7	not used
8	<b>ADJ UPPer FAIL (Screen B)</b> This bit is set if the limit is exceeded in the upper adjacent channel.
9	<b>ADJ LOWer FAIL (Screen B)</b> This bit is set if the limit is exceeded in the lower adjacent channel.
10	<b>ALT1 UPPer FAIL (Screen B)</b> This bit is set if the limit is exceeded in the upper 1st alternate channel.
11	<b>ALT1 LOWer FAIL (Screen B)</b> This bit is set if the limit is exceeded in the lower 1st alternate channel.
12	<b>ALT2 UPPer FAIL (Screen B)</b> This bit is set if the limit is exceeded in the upper 2nd alternate channel.
13	<b>ALT2 LOWer FAIL (Screen A)</b> This bit is set if the limit is exceeded in the lower 2nd alternate channel.
14	not used
15	This bit is always 0.



## STATUS QUESTIONABLE:FREQUENCY REGISTER

This register comprises information about the reference and local oscillator. It can be queried with commands `STATUS:QUESTIONABLE:FREQUENCY:CONDITION?` and `STATUS:QUESTIONABLE:FREQUENCY[:EVENT]?`.

Table 5-7 Meaning of bits in STATUS:QUESTIONABLE:FREQUENCY register

Bit No.	Meaning
0	<b>OVEN COLD</b> This bit is set if the reference oscillator has not yet attained its operating temperature. 'OCXO' will then be displayed.
1	<b>LO UNLocked (Screen A)</b> This bit is set if the local oscillator no longer locks. 'LO unl' will then be displayed.
2	<b>LO LEVEL (Screen A)</b> This bit is set if the level of the local oscillator is smaller than the nominal value. 'LO LVL' will then be displayed.
3	not used
4	not used
5	not used
6	not used
7	not used
8	not used
9	<b>LO UNLocked (Screen B)</b> This bit is set if the local oscillator no longer locks. 'LO unl' will then be displayed.
10	<b>LO LEVEL (Screen B)</b> This bit is set if the level of the local oscillator is smaller than the nominal value. 'LO LVL' will then be displayed.
11	not used
12	not used
13	not used
14	not used
15	This bit is always 0.

## STATus QUEStionable:LIMit Register

This register comprises information about the observance of limit lines. It can be queried with commands `STATus:QUEStionable:LIMit:CONDition?` and `STATus:QUEStionable:LIMit[:EVENT]?`.

Table 5-8 Meaning of bits in STATus:QUEStionable:LIMit register

Bit No.	Meaning
0	<b>LIMit 1 FAIL</b> This bit is set if limit line 1 is violated.
1	<b>LIMit 2 FAIL</b> This bit is set if limit line 2 is violated.
2	<b>LIMit 3 FAIL</b> This bit is set if limit line 3 is violated.
3	<b>LIMit 4 FAIL</b> This bit is set if limit line 4 is violated.
4	<b>LIMit 5 FAIL</b> This bit is set if limit line 5 is violated.
5	<b>LIMit 6 FAIL</b> This bit is set if limit line 6 is violated.
6	<b>LIMit 7 FAIL</b> This bit is set if limit line 7 is violated.
7	<b>LIMit 8 FAIL</b> This bit is set if limit line 8 is violated.
8	not used
9	not used
10	not used
11	not used
12	not used
13	not used
14	not used
15	This bit is always 0.

## STATus QUEStionable:LMARgin Register

This register comprises information about the observance of limit margins. It can be queried with commands `STATus:QUEStionable:LMARgin:CONDition?` and `"STATus:QUEStionable:LMARgin[:EVENT]?"`.

Table 5-9 Meaning of bits in STATus:QUEStionable:LMARgin register

Bit No.	Meaning
0	<b>LMARgin 1 FAIL</b> This bit is set if limit margin 1 is violated.
1	<b>LMARgin 2 FAIL</b> This bit is set if limit margin 2 is violated.
2	<b>LMARgin 3 FAIL</b> This bit is set if limit margin 3 is violated.
3	<b>LMARgin 4 FAIL</b> This bit is set if limit margin 4 is violated.
4	<b>LMARgin 5 FAIL</b> This bit is set if limit margin 5 is violated.
5	<b>LMARgin 6 FAIL</b> This bit is set if limit margin 1 is violated.
6	<b>LMARgin 7 FAIL</b> This bit is set if limit margin 7 is violated.
7	<b>LMARgin 8 FAIL</b> This bit is set if limit margin 8 is violated.
8	not used
9	not used
10	not used
11	not used
12	not used
13	not used
14	not used
15	This bit is always 0.

## STATus:QUESTionable:POWer Register

This register comprises all information about possible overloads of the unit.

It can be queried with commands `STATus:QUESTionable :POWer:CONDition?` and `"STATus :QUESTionable:POWer [:EVENT]?"`.

Table 5-10 Meaning of bits in STATus:QUESTionable:POWer register

Bit No.	Meaning
0	<b>OVERload</b> (Screen A) This bit is set if the RF input is overloaded. 'OVLD' will then be displayed.
1	<b>UNDERload</b> (Screen A) This bit is set if, during measurements in vector analyzer mode without capture buffer used, the lower level limit in the IF path is violated.
2	<b>IF_OVERload</b> (Screen A) This bit is set if the IF path is overloaded. 'IFOVLD' will then be displayed.
3	not used
4	not used
5	not used
6	not used
7	not used
8	<b>OVERload</b> (Screen B) This bit is set if the RF input is overloaded. 'OVLD' will then be displayed.
9	<b>UNDERload</b> (Screen B) This bit is set if, during measurements without capture buffer used, the lower level limit in the IF path is violated.
10	<b>IF_OVERload</b> (Screen B) This bit is set if the IF path is overloaded. 'IFOVLD' will then be displayed.
11	not used
12	not used
13	not used
14	not used
15	This bit is always 0.

## STATus QUESTionable:SYNC Register

This register comprises information about sync and burst events. It can be queried with commands `STATus:QUESTionable:SYNC:CONDition?` and `"STATus:QUESTionable:SYNC[:EVENT]?"`.

Table 5-11 Meaning of bits in STATus:QUESTionable:SYNC register

Bit No.	Meaning
0	<b>SYNC not found</b> This bit is set if the sync sequence of midamble was not found.
1	<b>BURSt not found</b> This bit is set if a burst was not found.
2	<b>No carrier</b> This bit is set if a signal was not found after starting the GSM/DCS/PCS mobile (option FSE-K10) or base station (option FSE-K11) test.
3	<b>Carrier overload</b> This bit is set if the sync sequence of midamble was not found after starting the GSM/DCS/PCS mobile (option FSE-K10) or base station (option FSE-K11) test.
4	not used
5	not used
6	not used
7	not used
8	not used
9	not used
10	not used
11	not used
12	not used
13	not used
14	not used
15	This bit is always 0.

## STATus QUESTionable:TRANsducer Register

This register indicates that a transducer hold point is attained (bit 15) and what range is to be swept next (bit 0 to 10). The sweep can be continued with command `INITiate2:CONMeasure`. It can be queried with commands `STATus:QUESTionable:TRANsducer:CONDition?` and `"STATus:QUESTionable:TRANsducer[:EVENT]?"`.

Table 5-12 Meaning of bits in STATus:QUESTionable:TRANsducer register

Bit No.	Meaning
0	<b>Range 1</b> This bit is set when subrange 1 is attained.
1	<b>Range 2</b> This bit is set when subrange 2 is attained.
2	<b>Range 3</b> This bit is set when subrange 3 is attained.
3	<b>Range 4</b> This bit is set when subrange 4 is attained.
4	<b>Range 5</b> This bit is set when subrange 1 is attained.
5	<b>Range 6</b> This bit is set when subrange 6 is attained.
6	<b>Range 7</b> This bit is set when subrange 7 is attained.
7	<b>Range 8</b> This bit is set when subrange 8 is attained.
8	<b>Range 9</b> This bit is set when subrange 9 is attained.
9	<b>Range 10</b> This bit is set when subrange 10 is attained.
10	<b>not used</b>
11	<b>not used</b>
12	<b>not used</b>
13	<b>not used</b>
14	<b>Subrange limit</b> This bit is set when the transducer is at the point of changeover from one range to another.
15	This bit is always 0.

## Application of the Status Reporting Systems

In order to be able to effectively use the status reporting system, the information contained there must be transmitted to the controller and further processed there. There are several methods which are represented in the following. Detailed program examples are to be found in chapter 7, Program Examples.

### Service Request, Making Use of the Hierarchy Structure

Under certain circumstances, the instrument can send a service request (SRQ) to the controller. Usually this service request initiates an interrupt at the controller, to which the control program can react with corresponding actions. As evident from Fig. 5-3, an SRQ is always initiated if one or several of bits 2, 3, 4, 5 or 7 of the status byte are set and enabled in the SRE. Each of these bits combines the information of a further register, the error queue or the output buffer. The corresponding setting of the ENABLE parts of the status registers can achieve that arbitrary bits in an arbitrary status register initiate an SRQ. In order to make use of the possibilities of the service request, all bits should be set to "1" in enable registers SRE and ESE.

Examples (cf. Fig. 5-3 and chapter 7, Program Examples, as well):

Use of command `"*OPC"` to generate an SRQ at the end of a sweep.

- Set bit 0 in the ESE (Operation Complete)
- Set bit 5 in the SRE (ESB)?

After its settings have been completed, the instrument generates an SRQ.

The SRQ is the only possibility for the instrument to become active on its own. Each controller program should set the instrument such that a service request is initiated in the case of malfunction. The program should react appropriately to the service request. A detailed example for a service request routine is to be found in chapter 7, Program Examples.

### Serial Poll

In a serial poll, just as with command `"*STB"`, the status byte of an instrument is queried. However, the query is realized via interface messages and is thus clearly faster. The serial-poll method has already been defined in IEEE 488.1 and used to be the only standard possibility for different instruments to poll the status byte. The method also works with instruments which do not adhere to SCPI or IEEE 488.2.

The quick-BASIC command for executing a serial poll is `"IBRSP()"`. Serial poll is mainly used to obtain a fast overview of the state of several instruments connected to the IEC bus.

### Parallel Poll

In a parallel poll, up to eight instruments are simultaneously requested by the controller by means of a single command to transmit 1 bit of information each on the data lines, i.e., to set the data line allocated to each instrument to logically "0" or "1". By analogy to the SRE register which determines under which conditions an SRQ is generated, there is a parallel poll enable register (PPE) which is ANDed with the STB bit by bit as well considering bit 6. The results are ORed, the result is then sent (possibly inverted) as a response in the parallel poll of the controller. The result can also be queried without parallel poll by means of command `"*IST"`.

The instrument first has to be set for the parallel poll using quick-BASIC command "IBPPC()". This command allocates a data line to the instrument and determines whether the response is to be inverted. The parallel poll itself is executed using "IBRPP()".

The parallel-poll method is mainly used in order to quickly find out after an SRQ which instrument has sent the service request if there are many instruments connected to the IEC bus. To this effect, SRE and PPE must be set to the same value. A detailed example as to the parallel poll is to be found in chapter 7, Program Examples.

## Query by Means of Commands

Each part of every status register can be read by means of queries. The individual commands are indicated in the detailed description of the registers. What is returned is always a number which represents the bit pattern of the register queried. Evaluating this number is effected by the controller program.

Queries are usually used after an SRQ in order to obtain more detailed information on the cause of the SRQ.

## Error-Queue Query

Each error state in the instrument leads to an entry in the error queue. The entries of the error queue are detailed plain-text error messages which can be looked at in the ERROR menu via manual control or queried via the IEC bus using command "SYSTem:ERRor?". Each call of "SYSTem:ERRor?" provides an entry from the error queue. If no error messages are stored there any more, the instrument responds with 0, "No error".

The error queue should be queried after every SRQ in the controller program as the entries describe the cause of an error more precisely than the status registers. Especially in the test phase of a controller program the error queue should be queried regularly since faulty commands from the controller to the instrument are recorded there as well.



## Resetting Values of the Status Reporting System

Table 5-13 comprises the different commands and events causing the status reporting system to be reset. None of the commands, except for \*RST and SYSTem:PRESet influences the functional instrument settings. In particular, DCL does not change the instrument settings.

Table 5-13 Resetting instrument functions

Event	Switching on supply voltage		DCL,SDC (Device Clear, Selected Device Clear)	*RST or SYSTem:PRESet	STATus:PRESet	*CLS
	Power-On-Status-Clear					
	0	1				
Clear STB,ESR	—	yes	—	—	—	yes
Clear SRE,ESE	—	yes	—	—	—	—
Clear PPE	—	yes	—	—	—	—
Clear EVENTt parts of the registers	—	yes	—	—	—	yes
Clear Enable parts of all OPERation and QUEStionable registers, Fill Enable parts of all other registers with "1".	—	yes	—	—	yes	—
Fill PTRansition parts with "1", Clear NTRansition parts	—	yes	—	—	yes	—
Clear error queue	yes	yes	—	—	—	yes
Clear output buffer	yes	yes	yes	1)	1)	1)
Clear command processing and input buffer	yes	yes	yes	—	—	—

1) Every command being the first in a command line, i.e., immediately following a <PROGRAM MESSAGE TERMINATOR> clears the output buffer.

# Contents - Chapter 6 "Remote Control - Description of Commands"

## 6 Description of Commands

<b>Notation</b> .....	<b>6.1</b>
<b>Common Commands</b> .....	<b>6.4</b>
<b>ABORt Subsystem</b> .....	<b>6.7</b>
<b>CALCulate Subsystem</b> .....	<b>6.7</b>
CALCulate:DELTamarker Subsystem .....	6.8
CALCulate:DLINe Subsystem .....	6.14
CALCulate:FEED Subsystem .....	6.18
CALCulate:FORMat Subsystem .....	6.19
CALCulate:LIMit Subsystem .....	6.20
CALCulate:MARKer Subsystem .....	6.35
CALCulate:MATH Subsystem .....	6.60
CALCulate:UNIT Subsystem .....	6.61
<b>CALibration Subsystem</b> .....	<b>6.62</b>
<b>CONFigure Subsystem</b> .....	<b>6.64</b>
CONFigure:BTS Subsystem.....	6.64
CONFigure:BURSt Subsystem.....	6.71
CONFigure:MS Subsystem .....	6.74
CONFigure:SPECTrum Subsystem.....	6.80
CONFigure:SPURious Subsystem .....	6.82
<b>DIAGnostic Subsystem</b> .....	<b>6.84</b>
<b>DISPlay Subsystem</b> .....	<b>6.86</b>
<b>FETCh Subsystem</b> .....	<b>6.96</b>
FETCh:BURSt Subsystem .....	6.96
FETCh:SPECTrum Subsystem .....	6.101
FETCh:SPURious Subsystem.....	6.104
FETCh:PTEMplate Subsystem.....	6.106
<b>FORMat Subsystem</b> .....	<b>6.107</b>
<b>HCOPy Subsystem</b> .....	<b>6.109</b>
<b>INITiate Subsystem</b> .....	<b>6.114</b>
<b>INPut Subsystem</b> .....	<b>6.115</b>
<b>INSTrument Subsystem</b> .....	<b>6.118</b>
<b>MMEMory Subsystem</b> .....	<b>6.120</b>
<b>OUTPut Subsystem</b> .....	<b>6.131</b>
<b>READ Subsystem</b> .....	<b>6.133</b>
READ:BURSt Subsystem .....	6.133
READ:SPECTrum Subsystem .....	6.141
READ:SPURious Subsystem .....	6.143

- SENSe Subsystem ..... 6.145**
  - SENSe:ADEMod Subsystem ..... 6.145
  - SENSe:AVERAge Subsystem ..... 6.147
  - SENSe:BANDwidth Subsystem ..... 6.149
  - SENSe:CORRection-Subsystem ..... 6.152
  - SENSe:DETEctor Subsystem ..... 6.162
  - SENSe:DDEMod Subsystem..... 6.163
  - SENSe:FILTEr Subsystem ..... 6.171
  - SENSe:FREQuency Subsystem..... 6.174
  - SENSe:MIXer - Subsystem ..... 6.178
  - SENSe:MSUMmary Subsystem ..... 6.182
  - SENSe:POWEr Subsystem ..... 6.184
  - SENSe:ROSCillator Subsystem ..... 6.187
  - SENSe:SWEEp Subsystem..... 6.188
- SOURce Subsystem ..... 6.192**
- STATus Subsystem ..... 6.194**
- SYSTEM Subsystem ..... 6.205**
- TRACe Subsystem..... 6.211**
- TRIGger Subsystem..... 6.213**
- UNIT Subsystem ..... 6.216**
  
- Alphabetical List of Commands ..... 6.217**
  
- Table of Softkeys with IEC/IEEE-Bus Command Assignment ..... 6.233**
  - Basic Instrument - Signal Analysis Mode ..... 6.233
    - FREQUENCY Key Group..... 6.233
    - LEVEL Key Group ..... 6.235
    - INPUT Key..... 6.236
    - MARKER Key Group..... 6.237
    - LINES Key Group..... 6.241
    - TRACE Key Group ..... 6.242
    - SWEEP Key Group ..... 6.244
  - Basic Instrument - General Device Settings..... 6.247
    - DATA VARIATION Key Group ..... 6.247
    - SYSTEM Key Group..... 6.247
    - CONFIGURATION Key Group..... 6.250
    - STATUS Key Group ..... 6.252
    - HARDCOPY Key Group..... 6.253
    - MEMORY Key Group ..... 6.254
    - USER Key ..... 6.256
  - Vektor-Signal Analysis Mode..... 6.257
    - CONFIGURATION Key Group - Digital Demodulation..... 6.257
    - CONFIGURATION Key Group - Analog Demodulation ..... 6.261
    - FREQUENCY Key Group..... 6.263
    - LEVEL Key Group ..... 6.263
    - INPUT Key..... 6.264
    - MARKER Key Group..... 6.265
    - LINES Key Group..... 6.267
    - TRACE Key Group ..... 6.268

SWEEP Key Group .....	6.269
TRIGGER Key - Digital Demodulation .....	6.269
TRIGGER Key - Analog Demodulation .....	6.270
Tracking Generator (Option FSE-B8 to B11).....	271
CONFIGURATION Key Group .....	271
GSM BTS Analysis (Option FSE-K11).....	6.272
CONFIGURATION Key Group .....	6.272
GSM MS Analysis (Option FSE-K10) .....	6.280
CONFIGURATION Key Group .....	6.280
External Mixer (Option FSE-B21) .....	6.288
INPUT Key Group.....	6.288



## 6 Description of Commands

### Notation

In the following sections, all commands implemented in the instrument are first listed in tables and then described in detail, separated according to the command system. The notation corresponds to the one of the SCPI standards to a large extent. The SCPI conformity information can be taken from the individual description of the commands.

#### Table of Commands

Command:	In the command column, the table provides an overview of the commands and their hierarchical arrangement (see indentations).
Parameter:	The parameter column indicates the requested parameters together with their specified range.
Unit:	The unit column indicates the basic unit of the physical parameters.
Remark:	In the remark column an indication is made on: <ul style="list-style-type: none"> <li>– whether the command does not have a query form,</li> <li>– whether the command has only one query form</li> <li>– whether this command is implemented only with a certain option of the instrument</li> </ul>

#### Indentations

The different levels of the SCPI command hierarchy are represented in the table by means of indentations to the right. The lower the level is, the farther the indentation to the right is. Please observe that the complete notation of the command always includes the higher levels as well.

Example: `SENSe:FREQuency:CENTer` is represented in the table as follows:

<code>SENSe</code>	first level
<code>:FREQuency</code>	second level
<code>:CENTer</code>	third level

#### Individual description

In the individual description, the complete notation of the command is given. An example for each command, the \*RST value and the SCPI information is written out at the end of the individual description.

The modes for which a command can be used are indicated by the following abbreviations:

A	Spectrum analysis
A-F	Spectrum analysis - frequency domain only
A-Z	Spectrum analysis - time domain only (zero span)
VA	Vector signal analysis
VA-D	Vector signal analysis - digital demodulation only
VA-A	Vector signal analysis - analog demodulation only
BTS	GSM BTS analysis (option FSE-K11)
MS	GSM MS analysis (option FSE-K10)

**Note:** *The spectrum analysis (analyzer) and vector signal analysis (vector analyzer) modes are implemented in the basic unit. For the other modes, the corresponding options are required.*

**Upper/lower case notation** Upper/lower case letters serve to mark the long or short form of the key words of a command in the description (see Chapter 5). The instrument itself does not distinguish between upper and lower case letters.

**Special characters |** A selection of key words with an identical effect exists for several commands. These key words are indicated in the same line, they are separated by a vertical stroke. Only one of these key words has to be indicated in the header of the command. The effect of the command is independent of which of the key words is indicated.

Example: `SENSe:FREQuency:CW|:FIXed`

The two following commands of identical meaning can be formed. They set the frequency of the constantly frequent signal to 1 kHz:

`SENSe:FREQuency:CW 1E3 = SENSe:FREQuency:FIXed 1E3`

A vertical stroke in indicating the parameters marks alternative possibilities in the sense of "or". The effect of the command is different, depending on which parameter is entered.

Example: Selection of the parameters for the command

`INPut:COUPling AC | DC`

If parameter AC is selected, only the AC content is fed through, in the case of DC, the DC as well as the AC content.

[ ] Key words in square brackets can be omitted when composing the header (cf. Chapter 5, Section "Optional Keywords"). The full command length must be accepted by the instrument for reasons of compatibility with the SCPI standards.

Parameters in square brackets can optionally be incorporated in the command or omitted as well.

{ } Parameters in braces can optionally be incorporated in the command either not at all, once or several times.

**Description of parameters** Due to the standardization, the parameter section of SCPI commands consists always of the same syntactical elements. SCPI has specified a series of definitions therefore, which are used in the tables of commands. In the tables, these established definitions are indicated in angled brackets (<...>) and will be briefly explained in the following (see also Chapter 5, Section "Parameters").

<Boolean> This indication refers to parameters which can adopt two states, "on" and "off". The "off" state may either be indicated by the keyword **OFF** or by the numeric value 0, the "on" state is indicated by **ON** or any numeric value other than zero. Parameter queries are always returned the numeric value 0 or 1.

<numeric\_value>  
<num>

These indications mark parameters which may be entered as numeric values or be set using specific keywords (character data).

The keywords given below are permitted:

MINimum This keyword sets the parameter to the smallest possible value.

MAXimum This keyword sets the parameter to the largest possible value.

DEFault This keyword is used to reset the parameter to its default value.

UP This keyword increments the parameter value.

DOWN This keyword decrements the parameter.

The numeric values associated to MAXimum/MINimum/DEFault can be queried by adding the corresponding keywords to the command. They must be entered following the quotation mark.

Example: `SENSe:FREQuency:CENTer? MAXimum`

returns the maximum possible numeric value of the center frequency as result.

<arbitrary block program data>

This keyword is provided for commands the parameters of which consist of a binary data block.



## Common Commands

The common commands are taken from the IEEE 488.2 (IEC 625-2) standard. Some commands have the same effect on different devices. The headers of these commands consist of an asterisk "\*" followed by three letters. Many common commands refer to the status reporting system which is described in detail in Chapter 5.

Command	Designation	Parameter	Remark
*CAL?	Calibration Query		query only
*CLS	Clear Status		no query
*ESE	Event Status Enable	0 to 255	
*ESR?	Standard Event Status Query	0 to 255	query only
*IDN?	Identification Query	<string>	query only
*IST?	Individual Status Query	0 to 255	query only
*OPC	Operation Complete		
*OPT?	Option Identification Query		query only
*PCB	Pass Control Back	0 to 30	no query
*PRE	Parallel Poll Register Enable	0 to 255	
*PSC	Power On Status Clear	0   1	
*RST	Reset		no query
*SRE	Service Request Enable	0 to 255	
*STB?	Status Byte Query		query only
*TRG	Trigger		no query
*TST?	Self Test Query		query only
*WAI	Wait to continue		no query

### \*CAL?

**CALIBRATION QUERY** triggers a calibration of the instrument and subsequently query the calibration status. Any responses > 0 indicate errors.

### \*CLS

**CLEAR STATUS** sets the status byte (STB), the standard event register (ESR) and the EVENT-part of the QUESTIONable and the OPERATION register to zero. The command does not alter the mask and transition parts of the registers. It clears the output buffer.

### \*ESE 0 to 255

**EVENT STATUS ENABLE** sets the event status enable register to the value indicated. Query \*ESE? returns the contents of the event status enable register in decimal form.

**\*ESR?**

**STANDARD EVENT STATUS QUERY** returns the contents of the event status register in decimal form (0 to 255) and subsequently sets the register to zero.

**\*IDN?**

**IDENTIFICATION QUERY** queries the instrument identification.

The instrument identification consists of the following elements which are separated by commas:

Manufacturer

Device (analyzer model)

Serial number of the instrument

Firmware version number

Example: "Rohde&Schwarz, FSIQ3, 825082/007, 2.05"

**\*IST?**

**INDIVIDUAL STATUS QUERY** returns the contents of the IST flag in decimal form (0 | 1). The IST flag is the status bit which is sent during a parallel poll (cf. Chapter 5).

**\*OPC**

**OPERATION COMPLETE** sets bit 0 in the event status register when all preceding commands have been executed. This bit can be used to initiate a service request (cf. Chapter 5).

**\*OPC?**

**OPERATION COMPLETE QUERY** writes message "1" into the output buffer as soon as all preceding commands have been executed (cf. Chapter 5).

**\*OPT?**

**OPTION IDENTIFICATION QUERY** queries the options included in the instrument and returns a list of the options installed. The options are separated from each other by means of commas.

Position	Option	
1		reserved
2	FSE-B4	Low Phase Noise & OCXO
3	FSE-B5	FFT-Filter
4		reserved
5	FSE-B7	Vector Signal Analysis
6	FSE-B8	Tracking Generator 3.5 GHz
7	FSE-B9	Tracking Generator 3.5 GHz with I/Q modulator
8	FSE-B10	Tracking Generator 7 GHz
9	FSE-B11	Tracking Generator 7 GHz with I/Q modulator
10	FSE-B12	Output Attenuator for Tracking Generator
11 to 18		reserved
19	FSE-B21	External Mixer Output

Example: 0, FSE-B4, 0, 0, FSE-B7, 0, 0, 0, FSE-B11, FSE-B12, 0, 0, 0, 0, 0, 0, 0, 0, 0, 0, 0

**Note:** The standard FSIQ is equipped with options FSE-B4, FSE-B6 and FSE-B7.

**\*PCB 0 to 30**

**PASS CONTROL BACK** indicates the controller address which the IEC-bus control is to be returned to after termination of the triggered action.

**\*PRE 0 to 255**

**PARALLEL POLL REGISTER ENABLE** sets parallel poll enable register to the value indicated. Query \*PRE? returns the contents of the parallel poll enable register in decimal form.

**\*PSC 0 | 1**

**POWER ON STATUS CLEAR** determines whether the contents of the ENABLE registers is maintained or reset in switching on.

\*PSC = 0 causes the contents of the status registers to be maintained. Thus a service request can be triggered in switching on in the case of a corresponding configuration of status registers ESE and SRE.

\*PSC  $\neq$  0 resets the registers.

Query \*PSC? reads out the contents of the power-on-status-clear flag. The response can be 0 or 1.

**\*RST**

**RESET** sets the instrument to a defined default status. The command essentially corresponds to pressing the [PRESET] key. The default setting is indicated in the description of the commands.

**\*SRE 0 to 255**

**SERVICE REQUEST ENABLE** sets the service request enable register to the value indicated. Bit 6 (MSS mask bit) remains 0. This command determines under which conditions a service request is triggered. Query \*SRE? reads the contents of the service request enable register in decimal form. Bit 6 is always 0.

**\*STB?**

**READ STATUS BYTE QUERY** reads out the contents of the status byte in decimal form.

**\*TRG**

**TRIGGER** triggers a measurement. This command corresponds to `INITiate:IMMediate` (cf. Section "TRIGger subsystem", as well).

**\*TST?**

**SELF TEST QUERY** triggers all selftests of the instrument and outputs an error code in decimal form.

**\*WAI**

**WAIT-to-CONTINUE** only permits the servicing of the subsequent commands after all preceding commands have been executed and all signals have settled (cf. Chapter 5 and ""OPC" as well).

## ABORt Subsystem

The ABORt subsystem contains the commands for aborting triggered actions. An action can be triggered again immediately after being aborted. All commands trigger events which is why they are not assigned any \*RST value.

COMMAND	PARAMETERS	UNIT	COMMENT
ABORt	--	--	no query

### ABORt

This command aborts a current measurement and resets the trigger system.

**Example:** "ABOR; INIT: IMM"

**Features:** \*RST value: 0  
SCPI: conforming

**Modes:** A, VA, BTS, MS

## CALCulate Subsystem

The CALCulate subsystem contains commands for converting instrument data, transforming and carrying out corrections. These functions are carried out subsequent to data acquisition, i.e., following the SENSE subsystem.

In the split-screen representation, a distinction is made between CALCulate1 and CALCulate2:

CALCulate1  $\hat{=}$  screen A;

CALCulate2  $\hat{=}$  screen B



**CALCulate<1|2>:DELTamarker<1 to 4>:MODE ABSolute | RELative**

This command switches over between relative and absolute input of frequency of the delta marker.

**Example:** "CALC:DELT:MODE ABS"  
**Features:** \*RST value: REL  
 SCPI: device-specific  
**Modes:** A, VA, BTS, MS

In the RELative mode, the frequency of the delta marker is programmed relative to the reference marker. In the ABSolute mode, the frequency is defined by the absolute values.

**CALCulate<1|2>:DELTamarker<1 to 4>:AOFF**

This command switches off all active delta markers.

**Example:** "CALC:DELT:AOFF"  
**Features:** \*RST value: -  
 SCPI: device-specific  
**Modes:** A, VA, BTS, MS

**CALCulate<1|2>:DELTamarker<1 to 4>:TRACe 1 to 4**

This command assigns the selected delta marker to the indicated measuring curve.

**Example:** "CALC:DELT3:TRAC 2"  
**Features:** \*RST value: -  
 SCPI: device-specific  
**Modes:** A, VA, BTS, MS

**CALCulate<1|2>:DELTamarker<1...4>:X 0 ... MAX (frequency | sweep time | symbols)**

This command positions the selected delta marker to the indicated frequency (span > 0) or time (span = 0). The query always returns the absolute value of frequency or time.

**Example:** "CALC:DELT:X 10.7MHz"  
**Features:** \*RST value: -  
 SCPI: device-specific  
**Modes:** A, VA, BTS, MS

The SYM unit is only valid in Vector Signal Analysis mode.

**CALCulate<1|2>:DELTamarker<1 to 4>:X:RELative?**

This command queries the frequency (span > 0) or time (span = 0) of the selected delta marker relative to the reference marker.

**Example:** "CALC:DELT:X:REL?"  
**Features:** \*RST value: -  
 SCPI: device-specific  
**Modes:** A, VA, BTS, MS

**CALCulate<1|2>:DELTamarker<1 to 4>:Y?**

This command queries the value of the selected marker.

**Example:** "CALC:DELT:Y?"

**Features:** \*RST value: -  
SCPI: device-specific

**Modes:** A, VA, BTS, MS

In complex presentations (vector signal analysis - polar diagrams), the real and the imaginary component as well as magnitude and phase are output separated by a comma.

**CALCulate<1|2>:DELTamarker<1 to 4>:MAXimum[:PEAK]**

This command positions the delta marker to the current maximum value in the trace memory.

**Example:** "CALC:DELT:MAX"

**Features:** \*RST value: -  
SCPI: device-specific

**Modes:** A, VA, BTS, MS

This command is an event which is why it is not assigned an \*RST value and has no query.

**CALCulate<1|2>:DELTamarker<1 to 4>:MAXimum:APEak**

This command positions the delta marker to the maximum absolute value of the trace.

**Example:** "CALC:DELT:MAX:APE"

**Features:** \*RST value: -  
SCPI: device-specific

**Modes:** VA

This command is an event which is why it is not assigned an \*RST value and has no query.

**CALCulate<1|2>:DELTamarker<1 to 4>:MAXimum:NEXT**

This command positions the delta marker to the next smaller maximum value in the trace memory.

**Example:** "CALC:DELT:MAX:NEXT"

**Features:** \*RST value: -  
SCPI: device-specific

**Modes:** A, BTS, MS

This command is an event which is why it is not assigned an \*RST value and has no query.

**CALCulate<1|2>:DELTamarker<1 to 4>:MAXimum:RIGHT**

This command positions the delta marker to the next smaller maximum value to the right of the current value (i.e., in ascending X direction) in the trace memory.

**Example:** "CALC:DELT:MAX:RIGH"

**Features:** \*RST value: -  
SCPI: device-specific

**Modes:** A, BTS, MS

This command is an event which is why it is not assigned an \*RST value and has no query.

**CALCulate<1|2>:DELTamarker<1 to 4>:MAXimum:LEFT**

This command positions the delta marker to the next smaller maximum value to the left of the current value (i.e., in descending X direction) in the trace memory.

**Example:** "CALC:DELT:MAX:LEFT"

**Features:** \*RST value: -  
SCPI: device-specific

**Modes:** A, BTS, MS

This command is an event which is why it is not assigned an \*RST value and has no query.

**CALCulate<1|2>:DELTamarker<1 to 4>:MINimum[:PEAK]**

This command positions the delta marker to the current minimum value in the trace memory.

**Example:** "CALC:DELT:MIN"

**Features:** \*RST value: -  
SCPI: device-specific

**Modes:** A, VA, BTS, MS

This command is an event which is why it is not assigned an \*RST value and has no query.

**CALCulate<1|2>:DELTamarker<1 to 4>:MINimum:NEXT**

This command positions the delta marker to the next higher minimum value in the trace memory.

**Example:** "CALC:DELT:MIN:NEXT"

**Features:** \*RST value: -  
SCPI: device-specific

**Modes:** A, BTS, MS

This command is an event which is why it is not assigned an \*RST value and has no query.

**CALCulate<1|2>:DELTamarker<1 to 4>:MINimum:RIGHT**

This command positions the delta marker to the next higher minimum value to the right of the current value (ie in ascending X direction).

**Example:** "CALC:DELT:MIN:RIGH"

**Features:** \*RST value: -  
SCPI: device-specific

**Modes:** A, BTS, MS

This command is an event which is why it is not assigned an \*RST value and has no query.

**CALCulate<1|2>:DELTamarker<1 to 4>:MINimum:LEFT**

This command positions the delta marker to the next higher minimum value to the left of the current value (ie in descending X direction).

**Example:** "CALC:DELT:MIN:LEFT"

**Features:** \*RST value: -  
SCPI: device-specific

**Modes:** A, BTS, MS

This command is an event which is why it is not assigned an \*RST value and has no query.



**CALCulate<1|2>:DELTamarker<1 to 4>:FUNCTION:FIXed[:STATe] ON | OFF**

This command switches the relative measurement to a fixed reference value on or off.

**Example:** "CALC:DELT:FUNC:FIX ON"

**Features:** \*RST value: OFF  
SCPI: device-specific.

**Modes:** A, VA-D, BTS, MS

The reference value is independent of the current trace.

**CALCulate<1|2>:DELTamarker<1 to 4>:FUNCTION:FIXed:RPOint:Y <numeric\_value>**

This command defines a new fixed reference value for the relative measurement.

**Example:** "CALC:DELT:FUNC:FIX:RPO:Y -10dBm"

**Features:** \*RST value: - (FUNCTION:FIXed[:STATe] is set to OFF)  
SCPI: device-specific

**Modes:** A, VA

The reference value is independent of the current trace.

**CALCulate<1|2>:DELTamarker<1 to 4>:FUNCTION:FIXed:RPOint:Y:OFFSet <numeric\_value>**

This command defines an additional level offset for the relative measurement.

**Example:** "CALC:DELT:FUNC:FIX:RPO:Y:OFFS 10dB"

**Features:** \*RST value: 0 dB  
SCPI: device-specific

**Modes:** A, VA

The level offset is included in the output of the level value.

**CALCulate<1|2>:DELTamarker<1 to 4>:FUNCTION:FIXed:RPOint:X <numeric\_value>**

This command defines the new fixed reference frequency, time or symbols for the relative measurement.

**Example:** "CALC:DELT:FUNC:FIX:RPO:X 10.7MHz"

**Features:** \*RST value: - (FUNCTION:FIXed[:STATe] is set to OFF)  
SCPI: device-specific

**Mode:** A

The reference value is independent of the current trace. With span = 0, the reference time, otherwise the reference frequency is defined.

**CALCulate<1|2>:DELTamarker<1 to 4>:FUNCTION:PNOise[:STATe] ON | OFF**

This command switches the measurement of the phase noise on or off.

**Example:** "CALC:DELT:FUNC:PNO ON"

**Features:** \*RST value: OFF  
SCPI: device-specific

**Mode:** A

When the phase noise is measured, the correction values for the bandwidth and the log amplifier are automatically considered. The measurement uses the reference values defined by FUNCTION:FIXed:RPOint:X or :Y.

**CALCulate<1|2>:DELTamarker<1 to 4>:FUNCtion:PNOise:RESult?**

This command queries the result of the phase noise measurement.

**Example:** "CALC:DELT:FUNC:PNO:RES?"

**Features:** \*RST value: -  
SCPI: device-specific

**Modes:** A, BTS, MS

This command is only a query which is why it is not assigned an \*RST value.

**CALCulate<1|2>:DELTamarker<1 to 4>:STEP[:INCRement] <numeric\_value>**

This command defines the delta marker step width.

**Example:** "CALC:DELT:STEP 10kHz" (frequency domain)  
"CALC:DELT:STEP 5ms" (time domain)

**Features:** \*RST value: - (STEP is set to AUTO)  
SCPI: device-specific

**Mode:** A

**CALCulate<1|2>:DELTamarker<1 to 4>:STEP:AUTO ON | OFF**

This command switches the automatic adaptation of the marker step width on or off.

**Example:** "CALC:DELT:STEP:AUTO OFF"

**Features:** \*RST value: ON  
SCPI: device-specific

**Mode:** A

With AUTO ON, the step width is 10% of the span.

## CALCulate:DLINe Subsystem

The CALCulate:DLINe subsystem checks the display lines in the instrument, i.e., the level, frequency and time lines (depending on the X-axis) as well as threshold and reference lines.

COMMAND	PARAMETERS	UNIT	COMMENT
CALCulate<1 2> :DLINe<1 2>	<numeric_value>	DBM   DB   DEG   RAD   S   HZ   PCT	
:STATe	<Boolean>		
:THReshold	<numeric_value>	DBM   DB   DEG   RAD   S   HZ   PCT	
:STATe	<Boolean>		
:CTHReshold	<numeric_value>	DBM   DB   DEG   RAD   S   HZ   PCT	
:STATe	<Boolean>		
:RLINe	<numeric_value>	DBM   DB   DEG   RAD   S   HZ   PCT	
:STATe	<Boolean>		
:FLINe<1 2>	<numeric_value>	HZ	
:STATe	<Boolean>		
:TLINe<1 2>	<numeric_value>	S   SYM	
:STATe	<Boolean>		

### CALCulate<1|2>:DLINe<1|2> MINimum to MAXimum (depending on current unit)

This command defines the position of the display line.

**Example:** "CALC:DLIN -20dBm"

**Features:** \*RST value: - (STATe to OFF)  
SCPI: device-specific

**Modes:** A, VA, BTS, MS

The display lines mark the given level in the display.

The units DEG, RAD, S, and HZ are only valid in operating mode Vector Signal Analysis.

### CALCulate<1|2>:DLINe<1|2>:STATe ON | OFF

This command switches the display line on or off.

**Example:** "CALC:DLIN2:STAT OFF"

**Features:** \*RST value: OFF  
SCPI: device-specific

**Modes:** A, VA, BTS, MS

**CALCulate<1|2>:THReshold** MINimum to MAXimum (depending on current unit)

This command defines the position of the thresholds.

**Example:** "CALC:THR -82dBm"

**Features:** \*RST value: - (STATe to OFF)  
SCPI: device-specific

**Modes:** A, VA, BTS, MS

For marker scan functions MAX PEAK, NEXT PEAK etc., the threshold serves as the lowest limit for maximum or minimum search.

The units DEG, RAD, S, and HZ are only valid in operating mode Vector Signal Analysis.

**CALCulate<1|2>:THReshold:STATe** ON | OFF

This command switches the threshold on or off.

**Example:** "CALC:THR:STAT ON"

**Features:** \*RST value: OFF  
SCPI: device-specific

**Modes:** A, VA, BTS, MS

**CALCulate<1|2>:CTHReshold** MINimum to MAXimum (depending on the current unit)

This command defines the position of a threshold line (base line), below which all measured values are cleared.

**Example:** "CALC:CTHR -82dBm"

**Features:** \*RST value: - (STATe to OFF)  
SCPI: device-specific

**Mode:** A, VA, BTS, MS

The units DEG, RAD, S, and HZ are only valid in operating mode Vector Signal Analysis.

**CALCulate<1|2>:CTHReshold:STATe** ON | OFF

This command is for switching on or off the threshold line (base line), below which all measured values are cleared.

**Example:** "CALC:CTHR:STAT ON"

**Features:** \*RST value: OFF  
SCPI: device-specific

**Mode:** A, VA, BTS, MS

**CALCulate<1|2>:RLINe** MINimum to MAXimum (depending on the current unit)

This command defines the position of the reference line.

**Example:** "CALC:RLIN -10dBm"  
**Features:** \*RST value: - (STATe to OFF)  
 SCPI: device-specific  
**Modes:** A, VA, BTS, MS

The reference line serves as a reference for the arithmetic operation of traces.

The units DEG, RAD, S, and HZ are only valid in operating mode Vector Signal Analysis.

**CALCulate<1|2>:RLINe:STATe** ON | OFF

This command switches the reference line on or off.

**Example:** "CALC:RLIN:STAT ON"  
**Features:** \*RST value: OFF  
 SCPI: device-specific  
**Modes:** A, VA, BTS, MS

**CALCulate<1|2>:FLINe<1|2>** 0 GHz to  $f_{\max}$ 

This command defines the position of the frequency lines.

**Example:** "CALC:FLIN2 120MHz "  
**Features:** \*RST value: - (STATe to OFF)  
 SCPI: device-specific  
**Modes:** A-F, VA, BTS, MS

The frequency lines mark the given frequencies in the display. Frequency lines are only valid for a SPAN >0.

**CALCulate<1|2>:FLINe<1|2>:STATe** ON | OFF

This command switches the frequency line on or off.

**Example:** "CALC:FLIN2:STAT ON"  
**Features:** \*RST value: OFF  
 SCPI: device-specific  
**Modes:** A-F, VA, BTS, MS

**CALCulate<1|2>:TLINe<1|2>** 0 to 1000s

This command defines the position of the time lines.

**Example:** "CALC:TLIN 10ms"

**Features:** \*RST value: - (STATe to OFF)  
SCPI: device-specific

**Modes:** A-Z, VA, BTS, MS

The time lines mark the given times in the display. Time lines are only valid for a SPAN = 0.

**CALCulate<1|2>:TLINe<1|2>:STATe** ON | OFF

This command switches the time line on or off.

**Example:** "CALC:TLIN2:STAT ON"

**Features:** \*RST value: OFF  
SCPI: device-specific

**Modes:** A-Z, VA, BTS, MS



## CALCulate:FORMat Subsystem

The CALCulate:FORMat subsystem determines further processing and conversion of measured data in operating mode vector signal analysis.

COMMAND	PARAMETERS	UNIT	COMMENT
CALCulate<1 2> :FORMat	MAGNitude   PHASe   UPHase   RIMag   FREQuency   IEYE   QEYE   TEYE   FEYE   COMP   CONS		Vector Signal Analysis
:FSK :DEViation :REFerence	<numeric_value>	HZ	Vector Signal Analysis

**CALCulate<1|2>:FORMat** MAGNitude | PHASe | UPHase | RIMag | FREQuency | IEYE | QEYE |  
TEYE | FEYE | COMP | CONS

This command defines the display of the traces.

**Example:** "CALC:FORM CONS"

**Features:** \*RST value: MAGNitude  
SCPI: conforming

**Mode:** VA-D

The parameters have the following meaning:

MAGNitude	Display of the magnitude in the time domain
PHASe   UPHase	Display of the phase in the time domain with or without ("unwrapped") limitation to $\pm 180^\circ$
RIMag	Display of the time characteristic of inphase and quadrature component
FREQuency	Display of the frequency response in the time domain
IEYE   QEYE	Eye diagram of the inphase or quadrature component
TEYE	Display of the trellis diagram
FEYE	Eye diagram of FSK modulation
COMP	Display of the polar vector diagram (complex)
CONS	Display of the polar vector diagram (constellation)

**CALCulate<1|2>:FSK:DEViation:REFerence** <numeric\_value>

This command defines the reference value of the frequency deviation for FSK modulation.

**Example:** "CALC:FSK:DEV:REF 20kHz"

**Features:** \*RST value: -  
SCPI: device-specific

**Mode:** VA-D



## CALCulate:LIMit Subsystem

The CALCulate:LIMit subsystem comprises the limit lines and the corresponding limit checks. Limit lines can be defined as upper and lower limit lines. The individual values of the limit lines correspond to the values of the X-axis (CONTRol) which have to have the same number.

COMMAND	PARAMETERS	UNIT	COMMENT
CALCulate<1 2> :LIMit<1 to 8> :TRACe :STATe :UNIT	<numeric_value> <Boolean> DBM   DBPW   WATT   DBUV   DBMV   VOLT   DBUA   AMPere   DB   DBUV_MHZ   DBMV_MHZ   DBUA_MHZ   DBUV_M   DBUA_M   DBUV_MMHZ   DBUA_MMHZ   DEG   RAD   S   HZ   PCT   UNITLESS	--	
CATalog? :CONTRol			query only
[:DATA] :DOMain :OFFSet :MODE :UNIT [:TIME]	<numeric_value>,<numeric_value>.. FREQuency   TIME <numeric_value> RELative   ABSolute S   SYM	HZ   S   SYM HZ   S   SYM	
:SHIFt :SPACing :UPPer	<numeric_value> LINear   LOGarithmic	HZ   S   SYM	Vector Signal Analysis
[:DATA] :STATe :OFFSet :MARGin :MODE :SHIFt :SPACing	<numeric_value>,<numeric_value>.. <Boolean> <numeric_value> <numeric_value> RELative   ABSolute <numeric_value> LINear   LOGarithmic	DBM   DB   DEG   RAD   S   HZ   PCT -- DB   DEG   RAD   S   HZ   PCT DB   DEG   RAD   S   HZ   PCT -- DB   DEG   RAD   S   HZ   PCT	
:LOWer			
[:DATA] :STATe :OFFSet :MARGin :MODE :SHIFt :SPACing	<numeric_value>,<numeric_value>.. <Boolean> <numeric_value> <numeric_value> RELative   ABSolute <numeric_value> LINear   LOGarithmic	DBM   DB   DEG   RAD   S   HZ   PCT -- DB   DEG   RAD   S   HZ   PCT DB   DEG   RAD   S   HZ   PCT -- DB   DEG   RAD   S   HZ   PCT	
:FAIL? :CLEar		--	query only
[:IMMEDIATE]	--	--	no query
:COMMeNt :COPY :NAME :DELeTe	<string> 1 to 8   < name> <string>		



**CALCulate<1|2>:LIMit<1...8>:UNIT** DBM | DBPW | WATT | DBUV | DBMV | VOLT | DBUA | AMPere | DB | DBUV\_MHZ | DBMV\_MHZ | DBUA\_MHZ | DBUV\_M | DBUA\_M | DBUV\_MMHZ | DBUA\_MMHZ | DEG | RAD | S | HZ | PCT | UNITLESS|

This command defines the unit of the selected limit line.

**Example:** "CALC:LIM:UNIT DBUV"

**Features:** \*RST value: DBM  
SCPI: device-specific

**Modes:** A, VA, BTS, MS

DBUV\_MHZ and DBUA\_MHZ denote the units DBUV/MHZ or DBUA/MHZ.

Upon selection of the unit DB the limit line is automatically switched to the relative mode. For units different from DB the limit line is automatically switched to the absolute mode.

The units DEG, RAD, S, HZ are available in the vector analysis mode only.

### CALCulate:LIMit:CATalog?

This command reads out the names of all limit lines stored on the harddisk.

**Example:** "CALC:LIM:CAT?"

**Feature:** \*RST value: -  
SCPI: device-specific

**Mode:** A, VA, BTS, MS

**CALCulate<1|2>:LIMit<1 to 8>:CONTrol[:DATA]** <numeric\_value>,<numeric\_value>..

This command defines the X-axis values (frequencies or times) of the upper or lower limit lines.

**Example:** "CALC:LIM:CONT 1MHz,30MHz,300MHz,1GHz"

**Features:** \*RST value: - (LIMit:STATe is set to OFF)  
SCPI: conforming

**Modes:** A, VA, BTS, MS

The number of values for the CONTROL axis and the corresponding UPPER- and/or LOWER limit lines have to be identical. Available units are HZ | S | SYM, SYM only for vector signal analyzer mode.

**CALCulate<1|2>:LIMit<1 to 8>:CONTrol:DOMain** FREQuency | TIME

This command defines the X-axis in the frequency or time domain.

**Example:** "CALC:LIM:CONT:DOM TIME"

**Features:** \*RST value: FREQuency  
SCPI: device-specific

**Modes:** A, VA, BTS, MS

**CALCulate<1|2>:LIMit<1 to 8>:CONTRol:OFFSet** <numeric\_value>

This command defines an offset for the X-axis value of the selected relative limit line in the frequency or time domain.

**Example:** "CALC:LIM:CONT:OFFS 100us"

**Features:** \*RST value: 0  
SCPI: device-specific

**Modes:** A, VA

**CALCulate<1|2>:LIMit<1 to 8>:CONTRol:MODE** RELative | ABSolute

This command selects the relative or absolute scaling for the X-axis of the selected limit line.

**Example:** "CALC:LIM:CONT:MODE REL"

**Features:** \*RST value: ABSolute  
SCPI: device-specific

**Modes:** A, VA, BTS, MS

Upon selection of RELative, the unit is switched to DB.

**CALCulate<1|2>:LIMit<1 to 8>:CONTRol:UNIT[:TIME]** S | SYM

This command defines the unit of the x-axis scaling of limit lines.

**Example:** "CALC:LIM:CONT:UNIT SYM"

**Features:** \*RST value: S  
SCPI: device-specific

**Mode:** VA

**CALCulate<1|2>:LIMit<1 to 8>:CONTRol:SHIFt** <numeric\_value>

This command shifts a limit line which has been specified for relative frequencies or times (X-axis).

**Example:** "CALC:LIM:CONT:SHIF 50kHz"

**Features:** \*RST value: --  
SCPI: device-specific

**Modes:** A, VA, BTS, MS

This command is an event which is why it is not assigned an \*RST value and has no query.

**CALCulate<1|2>:LIMit<1 to 8>:CONTRol:SPACing** LINear | LOGarithmic

This command makes a selection between linear and logarithmic interpolation for determining the limit line from the frequency points.

**Example:** "CALC:LIM:CONT:SPAC LIN"

**Features:** \*RST value: LIN  
SCPI: device-specific

**Modes:** A, VA, BTS, MS

**CALCulate<1|2>:LIMit<1 to 8>:UPPer[:DATA]** <numeric\_value>,<numeric\_value>..

This command defines the values for the upper limit lines.

**Example:** "CALC:LIM:UPP -10,0,0,-10"  
**Features:** \*RST value: - (LIMit:STATe is set to OFF)  
 SCPI: conforming  
**Modes:** A, VA, BTS, MS

The number of values for the CONTROL axis and the corresponding UPPER limit line have to be identical. If the measured values exceed the UPPER limit line, the limit check signals errors. The unit must be identical with the unit selected by CALC:LIM:UNIT.

The units DEG, RAD, S, and HZ are available in the vector signal analysis mode only.

**CALCulate<1|2>:LIMit<1 to 8>:UPPer:STATe** ON | OFF

This command defines the selected limit line as upper limit line.

**Example:** "CALC:LIM:UPPer:STAT ON"  
**Features:** \*RST value: OFF  
 SCPI: conforming  
**Modes:** A, VA, BTS, MS

The result of the limit check can be queried with CALCulate:LIMit<1 to 8>:FAIL?.

In analyzer and vector analyzer mode, the result of the limit check can be queried with CALCulate:LIMit<1 to 8>:FAIL?.

**CALCulate<1|2>:LIMit<1 to 8>:UPPer:OFFSet** <numeric\_value>

This command defines an offset for the Y-axis of the selected relative upper limit line.

**Example:** "CALC:LIM:UPP:OFFS 3dB"  
**Features:** \*RST value: 0  
 SCPI: device-specific  
**Modes:** A, VA

**CALCulate<1|2>:LIMit<1 to 8>:UPPer:MARGin** <numeric\_value>

This command defines the margin of the selected upper limit line.

**Example:** "CALC:LIM:UPP:MARG 10dB"  
**Features:** \*RST value: 0  
 SCPI: device-specific  
**Modes:** A, VA, BTS, MS

**CALCulate<1|2>:LIMit<1 to 8>:UPPer:MODE** RELative | ABSolute

This command selects the relative or absolute scaling for the Y-axis of the selected upper limit line.

**Example:** "CALC:LIM:UPP:MODE REL"  
**Features:** \*RST value: ABSolute  
 SCPI: device-specific  
**Modes:** A, VA, BTS, MS

**CALCulate<1|2>:LIMit<1 to 8>:UPPer:SHIFt** <numeric\_value>

This command shifts a limit line, which has relative values for the Y-axis (levels or linear units such as volt).

**Example:** "CALC:LIM:UPP:SHIF 20dB"

**Features:** \*RST value: --  
SCPI: device-specific

**Modes:** A, VA, BTS, MS

This command is an event which is why it is not assigned an \*RST value and has no query.

**CALCulate<1|2>:LIMit<1 to 8>:UPPer:SPACing** LINear | LOGarithmic

This command makes a selection between linear and logarithmic interpolation for the upper limit line.

**Example:** "CALC:LIM:UPP:SPAC LIN"

**Features:** \*RST value: LIN  
SCPI: device-specific

**Modes:** A, VA, BTS, MS

**CALCulate<1|2>:LIMit<1 to 8>:LOWer[:DATA]** <numeric\_value>,<numeric\_value>..

This command defines the values for the selected lower limit line.

**Example:** "CALC:LIM:LOW -30,-40,-40,-30"

**Features:** \*RST value: - (LIMit:STATe is set to OFF)  
SCPI: conforming

**Modes:** A, VA, BTS, MS

The number of values for the CONTROL axis and the corresponding LOWER limit line have to be identical. If the measured values violate the LOWER limit line, the limit check signals errors.

The unit must be identical with the unit selected by CALC:LIM:UNIT.

The units DEG, RAD, S, and HZ are available in the vector signal analysis mode only.

**CALCulate<1|2>:LIMit<1 to 8>:LOWer:STATe** ON | OFF

This command defines the selected limit line as lower limit line.

**Example:** "CALC:LIM:LOWer:STAT ON"

**Features:** \*RST value: OFF  
SCPI: conforming

**Modes:** A, VA, BTS, MS

The result of the limit check can be queried with CALCulate:LIMit:FAIL?.

**CALCulate<1|2>:LIMit<1 to 8>:LOWer:OFFSet** <numeric\_value>

This command defines an offset for the Y-axis of the selected relative lower limit line.

**Example:** "CALC:LIM:LOW:OFFS 3dB"

**Features:** \*RST value: 0  
SCPI: device-specific

**Modes:** A, VA

**CALCulate<1|2>:LIMit<1 to 8>:LOWer:MARGin** <numeric\_value>

This command defines the margin of the selected lower limit line.

**Example:** "CALC:LIM:LOW:MARG 10dB"

**Features:** \*RST value: 0  
SCPI: device-specific

**Modes:** A, VA, BTS, MS

**CALCulate<1|2>:LIMit<1 to 8>:LOWer:MODE** RELative | ABSolute

This command selects the relative or absolute scaling for the Y-axis of the selected lower limit line.

**Example:** "CALC:LIM:LOW:MODE REL"

**Features:** \*RST value: ABSolute  
SCPI: device-specific

**Modes:** A, VA, BTS, MS

**CALCulate<1|2>:LIMit<1 to 8>:LOWer:SHIFt** <numeric\_value>

This command shifts a limit line, which has relative values for the Y-axis (levels or linear units such as volt).

**Example:** "CALC:LIM:LOW:SHIF 20dB"

**Features:** \*RST value: --  
SCPI: device-specific

**Modes:** A, VA, BTS, MS

This command is an event which is why it is not assigned an \*RST value and has no query.

**CALCulate<1|2>:LIMit<1 to 8>:LOWer:SPACing** LINear | LOGarithmic

This command makes a selection between linear and logarithmic interpolation for the lower limit line.

**Example:** "CALC:LIM:LOW:SPAC LIN"

**Features:** \*RST value: LIN  
SCPI: device-specific

**Modes:** A, VA, BTS, MS

**CALCulate<1|2>:LIMit<1 to 8>:FAIL?**

This command queries the result of the limit check.

**Example:** "CALC:LIM:FAIL?"

**Features:** \*RST value: -  
SCPI: conforming

**Modes:** A, VA, BTS, MS

The result of the limit check responds with 0 in case of PASS and with 1 in case of FAIL.

**CALCulate<1|2>:LIMit<1 to 8>:CLEar[:IMMediate]**

This command deletes the result of the current limit check.

**Example:** "CALC:LIM:CLE"

**Features:** \*RST value: -  
SCPI: conforming

**Modes:** A, VA, BTS, MS

This command is an event which is why it is not assigned an \*RST value.

**CALCulate<1|2>:LIMit<1 to 8>:COMMent <string>**

This command defines a comment for the limit line selected.

**Example:** "CALC:LIM:COMM 'Upper limit for spectrum'"

**Features:** \*RST value: blank comment  
SCPI: device-specific

**Modes:** A, VA, BTS, MS

**CALCulate<1|2>:LIMit<1 to 8>:COPY 1 to 8 | <name>**

This command copies one limit line onto another one.

**Parameter:** 1 to 8 ::= number of the new limit line or, alternatively:  
<name> ::= name of the new limit line given as a string

**Example:** "CALC:LIM1:COPY 2"  
"CALC:LIM1:COPY 'GSM2'"

**Features:** \*RST value: --  
SCPI: device-specific

**Modes:** A, VA, BTS, MS

The name of the limit line may contain a maximum of 8 characters. This command is an "event" which is why it is not assigned an \*RST value and has no query.



**CALCulate<1|2>:LIMit<1 to 8>:NAME** <name of limit line>

This command assigns a name to a limit line numbered 1 to 8. If it doesn't exist previously, a limit line with this name is created.

**Example:** "CALC:LIM1:NAME 'GSM1' "

**Features:** \*RST value: 'REM1' to 'REM8' for lines 1 to 8  
SCPI: device-specific

**Modes:** A, VA, BTS, MS

The name of the limit line may contain a maximum of 8 characters.

**CALCulate<1|2>:LIMit<1 to 8>:DELeTe**

This command deletes the limit line selected.

**Examples:** "CALC:LIM1:DEL"

**Features:** \*RST value: --  
SCPI: device-specific

**Modes:** A, VA, BTS, MS

This command is an "event" which is why it is not assigned an \*RST value and has no query.

**CALCulate<1|2>:LIMit<1 to 8>:BURSt:PTEMplate?**

This command queries the result of the limit check for a power vs. time measurement.

**Parameter:** The result is displayed in character data form. Possible values are:  
PASSED limit not exceeded  
FAILED limit exceeded  
RUNNING measurement not completed

**Examples:** "CALC:LIM:BURS:PTEM?"

**Features:** \*RST value: --  
SCPI: device-specific

**Modes:** BTS, MS

This command is a query and therefore not assigned a \*RST value.

If no measurement has been carried out yet, a query error is triggered off. The numeric suffixes <1|2> or <1 to 8> are not significant for this command.

**CALCulate<1|2>:LIMit<1 to 8>:BURSt:POWer?**

This command queries the total result of the carrier power measurement.

**Parameter:** The result is displayed in character data form. Possible values are:  
 PASSED limit not exceeded  
 FAILED limit exceeded  
 ABORTED measurement aborted  
 RUNNING measurement not completed

**Examples:** "CALC:LIM:BURS:POW?"  
 Result: PASSED

**Features:** \*RST value: --  
 SCPI: device-specific

**Modes:** BTS, MS

This command is a query and therefore not assigned a \*RST value.

If the command is triggered off before the carrier power measurement was started for the first time, a query error results. The numeric suffixes <1|2> or <1 to 8> are not significant for this command.

**CALCulate<1|2>:LIMit<1 to 8>:SPECtrum:MODulation?** ARFCn | TXBand | RXBand | COMBined | DCSRx1800

This command queries the total result of the spectrum due to modulation measurement.

**Parameter:** The result is displayed in character data form. Possible values are:  
 PASSED limit not exceeded  
 FAILED limit exceeded  
 ABORTED measurement aborted  
 RUNNING measurement not completed

**Examples:** "CALC:LIM:SPEC:MOD? RXB"  
 Result: PASSED

**Features:** \*RST value: --  
 SCPI: device-specific

**Modes:** BTS, MS

ARFCn	ARFCN ± 1.8 MHz	TXBand	TX-band
RXBand	RX-band	COMBined	ARFCN ± 1.8 MHz / TX-band
DCSRx1800	RX-Band DCS 1800 (option FSE-K10 only)		

This command is a query and therefore not assigned a \*RST value.

The numeric suffixes <1|2> or <1 to 8> are not significant for this command.

**CALCulate<1|2>:LIMit<1 to 8>:SPECtrum:MODulation:FAILs?** ARFCn | TXBand | RXBand |  
COMBined | DCSRx1800

This command queries the number of limit violations of the spectrum due to modulation measurement.

**Examples:** "CALC:LIM:SPEC:MOD:FAIL? RXB"

**Features:** \*RST value: --  
SCPI: device-specific

**Modes:** BTS, MS

ARFCn ARFCN  $\pm$  1.8 MHz  
TXBand TX-band  
RXBand RX-band  
COMBined ARFCN  $\pm$  1.8 MHz / TX-band  
DCSRx1800 RX-Band DCS 1800 (option FSE-K10 only)

This command is a query and therefore not assigned a \*RST value  
The numeric suffixes <1|2> or <1 to 8> are not significant for this command.

**CALCulate<1|2>:LIMit<1 to 8>:SPECtrum:MODulation:EXCptions?** ARFCn | TXBand | RXBand |  
COMBined | DCSRx1800

This command queries the number of limit violations of the spectrum due to modulation measurement which are marked as exceptions.

**Examples:** "CALC:LIM:SPEC:MOD:EXC? RXB"

**Features:** \*RST value: --  
SCPI: device-specific

**Modes:** BTS, MS

ARFCn ARFCN  $\pm$  1.8 MHz  
TXBand TX-band  
RXBand RX-band  
COMBined ARFCN  $\pm$  1.8 MHz / TX-band  
DCSRx1800 RX-Band DCS 1800 (option FSE-K10 only)

This command is a query and therefore not assigned a \*RST value. The numeric suffixes <1|2> or <1 to 8> are not significant for this command.

**CALCulate<1|2>:LIMit<1 to 8>:SPECTrum:SWITching?**

This command queries the total result of the spectrum due to switching transients measurements.

**Parameter:** The result is displayed in character data form. Possible values are:

PASSED	limit not exceeded
FAILED	limit exceeded
ABORTED	measurement aborted
RUNNING	measurement not completed

**Examples:** "CALC:LIM:SPEC:SWIT?"  
Result: PASSED

**Features:** \*RST value: --  
SCPI: device-specific

**Modes:** BTS, MS

This command is a query and therefore not assigned a \*RST value. The numeric suffixes <1|2> or <1 to 8> are not significant for this command.

**CALCulate<1|2>:LIMit<1 to 8>:SPECTrum:SWITching:FAILs?**

This command queries the number of limit violations of the spectrum due to switching transient measurement.

**Examples:** "CALC:LIM:SPEC:SWIT:FAIL?"

**Features:** \*RST value: --  
SCPI: device-specific

**Modes:** BTS, MS

This command is a query and therefore not assigned a \*RST value. The numeric suffixes <1|2> or <1 to 8> are not significant for this command.

**CALCulate<1|2>:LIMit<1 to 8>:SPURious? TXBand | OTXBand | RXBand | IDLeband**

This command queries the total result of the spurious emissions measurement.

**Parameter:** The result is displayed in character data form. Possible values are:

PASSED	limit not exceeded
FAILED	limit exceeded
ABORTED	measurement aborted
RUNNING	measurement not completed

**Examples:** "CALC:LIM:SPUR? OTXB"  
Result: PASSED

**Features:** \*RST value: --  
SCPI: device-specific

**Modes:** BTS, MS

TXBand	TX-band
OTXBand	Not TX-band
RXBand	RX-band (option FSE-K11 only)
IDLeband	IDLeband (option FSE-K10 only)

This command is a query and therefore not assigned a \*RST value. The numeric suffixes <1|2> or <1 to 8> are not significant for this command.

**CALCulate<1|2>:LIMit<1 to 8>:SPURious:FAILs?** TXBand | OTXBand | RXBand | IDLeband

This command queries the number of limit violations of the spurious emissions measurement.

**Examples:** "CALC:LIM:SPUR:FAIL? OTXB"

**Features:** \*RST value: --  
SCPI: device-specific

**Modes:** BTS, MS

TXBand TX-band  
OTXBand Not TX-band  
RXBand RX-band (option FSE-K11 only)  
IDLeband IDLeband (option FSE-K10 only)

This command is a query and therefore not assigned a \*RST value. The numeric suffixes <1|2> or <1 to 8> are not significant for this command.

**CALCulate<1|2>:LIMit<1 to 8>:MARGin** 0 to 100DB

This command sets/changes the value of the margin (safe difference to the actual limit) for the limit check.

**Examples:** "CALC:LIM:MARG 6DB"

**Features:** \*RST value: 3DB  
SCPI: device-specific

**Modes:** BTS, MS

The numeric suffixes <1|2> or <1 to 8> are not significant for this command.

**CALCulate<1|2>:LIMit<1 to 8>:ACPpower[:STATe]** ON | OFF

This command switches on and off the limit check for adjacent channel power measurements. The commands `CALC:LIM:ACP:ACH:STAT` or `CALC:LIM:ACP:ALT:STAT` must be used in addition to specify whether the limit check is to be performed for the upper/lower adjacent channel or for the alternate adjacent channels.

**Examples:** "CALC:LIM:ACP ON"

**Features:** \*RST value: OFF  
SCPI: device-specific

**Modes:** A, VA

The numeric suffixes <1|2> or <1 to 8> are not significant for this command.

**CALCulate<1|2>:LIMit<1 to 8>:ACPpower:ACHannel** 0 to 100 dB, 0 to 100 dB

This command defines the limit for the upper/lower adjacent channel for adjacent channel power measurements.

**Parameter:** The first (second) numeric value is the limit for the upper (lower) adjacent channel.

**Examples:** "CALC:LIM:ACP:ACH 30DB, 30DB"

**Features:** \*RST value: 0 dB  
SCPI: device-specific

**Modes:** A, VA

The numeric suffixes <1|2> or <1 to 8> are not significant for this command.

**CALCulate<1|2>:LIMit<1 to 8>:ACPpower:ACHannel:STATe** ON | OFF

This command activates the limit check for the adjacent channel when adjacent channel power measurement is performed. Before, the limit check must be activated using `CALC:LIM:ACP ON`.

**Examples:** "CALC:LIM:ACP:ACH:STAT ON"

**Features:** \*RST value: OFF  
SCPI: device-specific

**Modes:** A, VA

The numeric suffixes <1|2> or <1 to 8> are not significant for this command.

**CALCulate<1|2>:LIMit<1 to 8>:ACPpower:ACHannel:RESult?**

This command queries the result of the limit check for the upper/lower adjacent channel when adjacent channel power measurement is performed.

**Parameter:** The result is returned in the form <result>, <result> where <result> = PASSED | FAILED, and where the first returned value denotes the lower, the second denotes the upper adjacent channel.

**Examples:** "CALC:LIM:ACP:ACH:RES?"

**Features:** \*RST value: --  
SCPI: device-specific

**Modes:** A, VA

This command is a query and therefore not assigned a \*RST value. If the power measurement of the adjacent channel is switched off, the command triggers a query error.

The numeric suffixes <1|2> or <1 to 8> are not significant for this command.

**CALCulate<1|2>:LIMit<1 to 8>:ACPpower:ALTErnate<1|2>** 0 to 100DB, 0 to 100 dB.

This command defines the limit for the first/second alternate adjacent channel for adjacent channel power measurements.

**Parameter:** The first (second) numeric value is the limit for the lower (upper) alternate adjacent channel. The numeric suffix after `ALTErnate<1|2>` denotes the first or the second alternate channel.

**Examples:** "CALC:LIM:ACP:ALT2 30DB 30DB"

**Features:** \*RST value: 0DB  
SCPI: device-specific

**Modes:** A, VA

The numeric suffixes <1|2> or <1 to 8> are not significant for this command.

**CALCulate<1|2>:LIMit<1 to 8>:ACPpower:ALTErnate<1|2>:STATe** ON | OFF

This command activates the limit check for the first/second alternate adjacent channel for adjacent channel power measurements. Before, the limit check must be activated using `CALC:LIM:ACP ON`.

**Examples:** "CALC:LIM:ACP:ALT2:STAT ON"

**Features:** \*RST value: OFF  
SCPI: device-specific

**Modes:** A, VA

The numeric suffixes <1|2> or <1 to 8> are not significant for this command.

**CALCulate<1|2>:LIMit<1 to 8>:ACPpower:ALTErnate<1|2>:RESult?**

This command queries the result of the limit check for the first/second alternate adjacent channel for adjacent channel power measurements.

**Parameter:** The result is returned in the form <result>, <result> where <result> = PASSED | FAILED and where the first (second) returned value denotes the lower (upper) alternate adjacent channel.

**Examples:** "CALC:LIM:ACP:ALT2:RES?"

**Features:** \*RST value: --  
SCPI: device-specific

**Modes:** A, VA

This command is a query and therefore not assigned a \*RST value. If the power measurement of the adjacent channel is switched off, the command triggers a query error.

The numeric suffixes <1|2> or <1 to 8> are not significant for this command.

## CALCulate:MARKer Subsystem

The CALCulate:MARKer subsystem checks the marker functions in the instrument.

COMMAND	PARAMETERS	UNIT	COMMENT
CALCulate<1 2>			
:MARKer<1 to 4>			
[:STATe]	<Boolean>	--	
:AOFF			no query
:TRACe	<numeric_value>	--	
:X	<numeric_value>	HZ   S   SYM	
:SLIMits			
[:STATe]	<Boolean>		
:COUNT	<Boolean>	--	
:RESolution	<numeric_value>	HZ	
:FREQuency?	--	--	query only
:COUPled			
[:STATe]	<Boolean>		
:SCOupled			
[:STATe]	<Boolean>		
:LOEXclude	<Boolean>		
:Y?	--	--	query only
:MAXimum			
[:PEAK]	--	--	no query
:APEak	--	--	no query, Vector Signal Analysis
:NEXT	--	--	no query
:RIGHT	--	--	no query
:LEFT	--	--	no query
:MINimum			
[:PEAK]	--	--	no query
:NEXT	--	--	no query
:RIGHT	--	--	no query
:LEFT	--	--	no query
:STEP			
[:INCRement]	<numeric_value>	HZ   S   SYM	
:AUTO	<Boolean>	--	
:PEXCursion	<numeric_value>	DB	
:READout	MPHase   RIMaginary		Vector Signal Analysis
:FUNction			
:NDBDown	<numeric_value>	DB	
:STATe	<Boolean>		
:RESult?	--	--	query only
:FREQuency?	--	--	query only
:ZOOM	<numeric_value>	HZ	no query
:NOISe			
[:STATe]	<Boolean>		
:RESult?	--	--	query only
:DEModulation			
:SElect	AM FM		
[:STATe]	<Boolean>		
:HOLDoff	<numeric_value>	S	
:SFACtor	<expr>		
:STATe	<Boolean>		
:RESult?	--	--	query only
:FREQuency?	--	--	query only







**CALCulate<1|2>:MARKer<1 to 4>:AOFF**

This command switches off all active markers.

**Example:** "CALC:MARK:AOFF"

**Features:** \*RST value: -  
SCPI: device-specific

**Modes:** A, VA, BTS, MS

This command is an event which is why it is not assigned an \*RST value and has no query.

**CALCulate<1|2>:MARKer<1 to 4>:TRACe 1 to 4**

This command assigns the selected marker (1 to 4) to the indicated test curve.

**Example:** "CALC:MARK3:TRAC 2"

**Features:** \*RST value -  
SCPI: device-specific

**Modes:** A, VA, BTS, MS

**CALCulate<1|2>:MARKer<1 to 4>:X 0 ... MAX (frequency | sweep time | symbols)**

This command positions the selected marker to the indicated frequency (span > 0) or time (span = 0).

**Example:** "CALC:MARK:X 10.7MHz"

**Features:** \*RST value: -  
SCPI: device-specific

**Modes:** A, VA, BTS, MS

The unit SYM is available only in the vector signal analysis mode.

**CALCulate<1|2>:MARKer<1 to 4>:X:SLIMits[:STATe] ON | OFF**

This command switches between a limited (ON) and unlimited (OFF) search range.

**Example:** "CALC:MARK:X:SLIM ON"

**features:** \*RST value: OFF  
SCPI: device-specific

**Modes:** A, VA

**CALCulate<1|2>:MARKer<1 to 4>:COUNT ON | OFF**

This command switches on or off the frequency counter at the marker position.

**Example:** "CALC:MARK:COUN ON"

**Features:** \*RST value: OFF  
SCPI: device-specific

**Mode:** A

**CALCulate<1|2>:MARKer<1 to 4>:COUNT:RESolution** 0.1 | 1 | 10 | 100 | 1000 | 10000 Hz

This command specifies the resolution of the frequency counter.

**Example:** "CALC:MARK:COUN:RES 1kHz"

**Features:** \*RST value: 1kHz  
SCPI: device-specific

**Mode:** A

The numeric suffix in MARKer<1 to 4> is not significant.

**CALCulate<1|2>:MARKer<1 to 4>:COUNT:FREQuency?**

This command queries the result of the frequency counter.

**Example:** "CALC:MARK:COUN:FREQ?"

**Features:** \*RST value: -  
SCPI: device-specific

**Modes:** A, BTS, MS

This command is only a query and thus has no \*RST value.

**CALCulate<1|2>:MARKer<1 to 4>:COUPled[:STATe]** ON | OFF

This command switches the coupling of markers on or off.

**Example:** "CALC:MARK:COUP ON"

**Features:** \*RST value: OFF  
SCPI: device-specific

**Modes:** VA

The numeric suffix in MARKer<1 to 4> is not significant.

**CALCulate<1|2>:MARKer<1 to 4>:LOEXclude** ON | OFF

This command switches the local oscillator suppression on or off.

**Example:** "CALC:MARK:LOEX ON"

**Features:** \*RST value: OFF  
SCPI: device-specific

**Mode:** A-F

The numeric suffixes 1|2 and 1 to 4 are not significant.

**CALCulate<1|2>:MARKer<1 to 4>:Y?**

This command queries the selected marker value.

**Example:** "CALC:MARK:Y?"

**Features:** \*RST value: -  
SCPI: device-specific

**Modes:** A, VA, BTS, MS

**CALCulate<1|2>:MARKer<1 to 4>:MAXimum[:PEAK]**

This command positions the marker to the current maximum value in the trace memory.

**Example:** "CALC:MARK:MAX"

**Features:** \*RST value: -  
SCPI: device-specific

**Modes:** A, VA, BTS, MS

This command is an event which is why it is not assigned an \*RST value and has no query.

**CALCulate<1|2>:MARKer<1 to 4>:MAXimum:APEak**

This command positions the marker to the maximum absolute value of the trace.

**Example:** "CALC:MARK:MAX:APE"

**Features:** \*RST value: -  
SCPI: device-specific

**Mode:** VA

This command is an event which is why it is not assigned an \*RST value and has no query.

**CALCulate<1|2>:MARKer<1 to 4>:MAXimum:NEXT**

This command positions the marker to the next lower maximum value in the trace memory.

**Example:** "CALC:MARK:MAX:NEXT"

**Features:** \*RST value: -  
SCPI: device-specific

**Modes:** A, BTS, MS

This command is an event which is why it is not assigned an \*RST value and has no query.

**CALCulate<1|2>:MARKer<1 to 4>:MAXimum:RIGHT**

This command positions the marker to the next smaller maximum value to the right of the current value (i.e., in ascending X direction) in the trace memory.

**Example:** "CALC:MARK:MAX:RIGH"

**Features:** \*RST value: -  
SCPI: device-specific

**Modes:** A, BTS, MS

This command is an event which is why it is not assigned an \*RST value and has no query.

**CALCulate<1|2>:MARKer<1 to 4>:MAXimum:LEFT**

This command positions the marker to the next smaller maximum value to the left of the current value (i.e., in descending X direction) in the trace memory.

**Example:** "CALC:MARK:MAX:LEFT"

**Features:** \*RST value: -  
SCPI: device-specific

**Modes:** A, BTS, MS

This command is an event which is why it is not assigned an \*RST value and has no query.

**CALCulate<1|2>:MARKer<1 to 4>:MINimum[:PEAK]**

This command positions the marker to the current minimum value in the trace memory.

**Example:** "CALC:MARK:MIN"

**Features:** \*RST value: -  
SCPI: device-specific

**Modes:** A, VA, BTS, MS

This command is an event which is why it is not assigned an \*RST value and has no query.

**CALCulate<1|2>:MARKer<1 to 4>:MINimum:NEXT**

This command positions the marker to the next higher minimum value in the trace memory.

**Example:** "CALC:MARK:MIN:NEXT"

**Features:** \*RST value: -  
SCPI: device-specific

**Modes:** A, BTS, MS

This command is an event which is why it is not assigned an \*RST value and has no query.

**CALCulate<1|2>:MARKer<1 to 4>:MINimum:RIGHT**

This command positions the marker to the next higher minimum value to the right of the current value (ie in ascending X direction).

**Example:** "CALC:MARK:MIN:RIGHT"

**Features:** \*RST value: -  
SCPI: device-specific

**Modes:** A, BTS, MS

This command is an event which is why it is not assigned an \*RST value and has no query.

**CALCulate<1|2>:MARKer<1 to 4>:MINimum:LEFT**

This command positions the marker to the next higher minimum value to the left of the current value (ie in descending X direction).

**Example:** "CALC:MARK:MIN:LEFT"

**Features:** \*RST value: -  
SCPI: device-specific

**Modes:** A, BTS, MS

This command is an event which is why it is not assigned an \*RST value and has no query.

**CALCulate<1|2>:MARKer<1 to 4>:STEP[:INCRement]** <numeric\_value>

This command defines the marker step width.

**Example:** "CALC:MARK:STEP 10kHz" (frequency domain)  
CALC:MARK:STEP 5ms" (time domain)

**Features:** \*RST value: - (STEP is set to AUTO)  
SCPI: device-specific

**Mode:** A

This command sets STEP:AUTO to OFF. The numeric suffix in MARKer<1 to 4> is not significant.

**CALCulate<1|2>:MARKer<1 to 4>:STEP:AUTO** ON | OFF

This command switches the automatic adaptation of the marker step width on or off.

**Example:** "CALC:MARK:STEP:AUTO OFF"

**Features:** \*RST value: ON  
SCPI: device-specific

**Mode:** A

With AUTO ON, the step width is 10% of the span. The numeric suffix in MARKer<1 to 4> is not significant.

**CALCulate<1|2>:MARKer<1 to 4>:PEXCursion** <numeric\_value>

This command defines the peak excursion.

**Example:** "CALC:MARK:PEXC 10dB"

**Features:** \*RST value: 6dB  
SCPI: device-specific

**Modes:** A, VA, BTS, MS

The numeric suffix in MARKer<1 to 4> is not significant.

**CALCulate<1|2>:MARKer<1 to 4>:READout** MPHase | RIMaginary

This command determines the type of the marker display.

**Example:** "CALC:MARK:READ RIM"

**Features:** \*RST value: -  
SCPI: device-specific

**Mode:** VA-D

The numeric suffix in MARKer<1 to 4> is not significant.

**CALCulate<1|2>:MARKer<1 to 4>:FUNCtion:NDBDown** <numeric\_value>

This command defines the "N dB Down" value.

**Example:** "CALC:MARK:FUNC:NDBD 3dB"

**Features:** \*RST value: 6dB  
SCPI: device-specific

**Mode:** A

The temporary markers T1 and T2 are positioned by n dB below the active reference marker. The frequency spacing of these markers can be queried with CALCulate:MARKer:FUNCtion:NDBDown:RESult?.

**CALCulate<1|2>:MARKer<1 to 4>:FUNCtion:NDBDown:STATe** ON | OFF

This command switches the "N dB Down" function on or off.

**Example:** "CALC:MARK:FUNC:NDBD:STAT ON"

**Features:** \*RST value: OFF  
SCPI: device-specific

**Modes:** A, BTS, MS

**CALCulate<1|2>:MARKer<1 to 4>:FUNCtion:NDBDown:RESult?**

This command queries the frequency spacing (bandwidth) of the "N dB Down" markers.

**Example:** "CALC:MARK:FUNC:NDBD:RES?"

**Features:** \*RST value: -  
SCPI: device-specific

**Modes:** A, BTS, MS

This command is only a query which is why it is not assigned an \*RST value.

**CALCulate<1|2>:MARKer<1 to 4>:FUNCtion:NDBDown:FREQUency?**

This command queries the frequencies of the "N dB Down" marker.

**Example:** "CALC:MARK:FUNC:NDBD:FREQ?"

**Features:** \*RST value: -  
SCPI: device-specific

**Modes:** A, BTS, MS

The two frequency values are separated by comma and indicated in ascending order. This command is only a query which is why it is not assigned an \*RST value.



**CALCulate<1|2>:MARKer<1 to 4>:FUNCTION:ZOOM <numeric\_value>**

This command defines the range to be enlarged around the active marker.

**Example:** "CALC:MARK:FUNC:ZOOM 1kHz"

**Features:** \*RST value: -  
SCPI: device-specific

**Mode:** A-F

The subsequent frequency sweep is stopped at the marker position and the frequency of the signal is counted. This frequency becomes the new center frequency, the zoomed span is then set. This command is an event which is why it is not assigned an \*RST value and has no query.

**CALCulate<1|2>:MARKer<1 to 4>:FUNCTION:NOISe[:STATe] ON | OFF**

This command switches the noise measurement on or off.

**Example:** "CALC:MARK:FUNC:NOIS ON"

**Features:** \*RST value: OFF  
SCPI: device-specific

**Mode:** A

The noise power density is measured at the position of the markers. The result can be queried with CALCulate:MARKer:FUNCTION:NOISe:RESult?.

**CALCulate<1|2>:MARKer<1 to 4>:FUNCTION:NOISe:RESult?**

This command queries the result of the noise measurement.

**Example:** "CALC:MARK:FUNC:NOIS:RES?"

**Features:** \*RST value: -  
SCPI: device-specific

**Modes:** A, BTS, MS

This command is an event which is why it is not assigned an \*RST value and has no query.

**CALCulate<1|2>:MARKer<1 to 4>:FUNCTION:DEModulation:SElect AM | FM**

This command selects the demodulation type.

**Example:** "CALC:MARK:FUNC:DEM:SEL FM"

**Features:** \*RST value: AM  
SCPI: device-specific

**Mode:** A

**CALCulate<1|2>:MARKer<1 to 4>:FUNction:DEModulation[:STATe]** ON | OFF

This command switches the demodulation on or off.

**Example:** "CALC:MARK:FUNC:DEM ON"

**Features:** \*RST value: OFF  
SCPI: device-specific

**Mode:** A

With demodulation switched on, the frequency sweep is stopped at the marker position and the signal is demodulated during the given stop time.

**CALCulate<1|2>:MARKer<1 to 4>:FUNction:DEModulation:HOLDoff** 10ms to 1000s

This command defines the duration of the stop time for the demodulation.

**Example:** "CALC:MARK:FUNC:DEM:HOLD 3s"

**Features:** \*RST value: - (DEModulation is set to OFF)  
SCPI: device-specific

**Mode:** A

With demodulation switched on, the frequency sweep is stopped at the marker position and the signal is demodulated during the given stop time.

**CALCulate<1|2>:MARKer<1 to 4>:FUNction:SFActor** (60dB/3dB) | (60dB/6dB)

This command defines the shape factor measurement 60dB/6dB or 60dB/3dB.

**Example:** "CALC:MARK:FUNC:SFA (60dB/3dB)"

**Features:** \*RST value: (60dB/6dB)  
SCPI: device-specific

**Modes:** A, BTS, MS

The temporary markers T1 to T4 are positioned in pairs by 60dB and by 3dB or 6dB below the active reference marker. The frequency spacing ratio of these markers - the shape factor - can be queried with `CALCulate:MARKer:FUNction:SFActor:RESult?`.

**CALCulate<1|2>:MARKer<1 to 4>:FUNction:SFActor:STATe** ON | OFF

This command switches the shape factor measurement on or off.

**Example:** "CALC:MARK:FUNC:SFA:STAT ON"

**Features:** \*RST value: OFF  
SCPI: device-specific

**Modes:** A, BTS, MS

**CALCulate<1|2>:MARKer<1 to 4>:FUNCTION:SFACtor:RESult?**

This command queries the result of the shape factor measurement.

**Example:** "CALC:MARK:FUNC:SFAC:RES?"

**Features:** \*RST value: -  
SCPI: device-specific

**Modes:** A, BTS, MS

This command is an event which is why it is not assigned an \*RST value and has no query.

**CALCulate<1|2>:MARKer<1 to 4>:FUNCTION:SFACtor:FREQuency?**

This command queries the frequencies of the shape factor measurement.

**Example:** "CALC:MARK:FUNC:SFAC:FREQ?"

**Features:** \*RST value: -  
SCPI: device-specific

**Modes:** A, BTS, MS

Four frequency values (at -60 dB, -6 or -3 dB, -6 or -3 dB, -60dB) are indicated in ascending order. They are separated by a comma. This command is only a query which is why it is not assigned an \*RST value.

**CALCulate<1|2>:MARKer<1 to 4>:FUNCTION:STRack[:STATe] ON | OFF**

This command switches the signal-track function on or off.

**Example:** "CALC:MARK:FUNC:STR ON"

**Features:** \*RST value: OFF  
SCPI: device-specific

**Mode:** A-F

With SIGNAL TRACK function activated, the maximum signal is determined after each frequency sweep and the center frequency of this signal is set. With drifting signals the center frequency follows the signal.

**CALCulate<1|2>:MARKer<1 to 4>:FUNCTION:ADEMod:AM[:RESult]? PPEak| MPEak| MIDDLE| RMS**

This command queries the results of the AM modulation measurement of the analog demodulation.

**Example:** "CALC:MARK:FUNC:ADEM:AM? PPE"

**Features:** \*RST value: -  
SCPI: device-specific

**Mode:** VA-A

PPEak Result of the measurement with detector +PK  
MPEak Result of the measurement with detector -PK  
MIDDLE Result of averaging  $\pm$ PK/2  
RMS Result of the measurement with detector RMS

In the modulation modes FM or PM query of the MIDDLE-result is possible only.

**CALCulate<1|2>:MARKer<1 to 4>:FUNCtion:ADEMod:FM[:RESult]?** PPEak | MPEak | MIDDLE | RMS | RDEV

This command queries the results of the FM modulation measurement of the analog demodulation.

**Example:** "CALC:MARK:FUNC:ADEM:FM? PPE"

**Features:** \*RST value: -  
SCPI: device-specific

**Mode:** VA-A

PPEak Result of the measurement with detector +PK  
MPEak Result of the measurement with detector -PK  
MIDDLE Result of averaging  $\pm PK/2$   
RMS Result of the measurement with detector RMS

In the modulation modes FM or PM query of the MIDDLE-result is possible only.

**CALCulate<1|2>:MARKer<1 to 4>:FUNCtion:ADEMod:PM[:RESult]?** PPEak| MPEak| MIDDLE| RMS

This command queries the results of the PM modulation measurement of the analog demodulation.

**Example:** "CALC:MARK:FUNC:ADEM:PM? PPE"

**Features:** \*RST value: -  
SCPI: device-specific

**Mode:** VA-A

PPEak Result of the measurement with detector +PK  
MPEak Result of the measurement with detector -PK  
MIDDLE Result of averaging  $\pm PK/2$   
RMS Result of the measurement with detector RMS

In the modulation modes FM or PM query of the MIDDLE-result is possible only.

**CALCulate<1|2>:MARKer<1 to 4>:FUNCtion:ADEMod:AFRequency[:RESult]?**

This command queries the audio frequency of the analog demodulation.

**Example:** "CALC:MARK:FUNC:ADEM:AFR? "

**Features:** \*RST value: -  
SCPI: device-specific

**Mode:** VA-A

**CALCulate<1|2>:MARKer<1 to 4>:FUNCtion:ADEMod:FERRor[:RESult]?**

This command queries the frequency error of the analog demodulation.

**Example:** "CALC:MARK:FUNC:ADEM:FERR? "

**Features:** \*RST value: -  
SCPI: device-specific

**Mode:** VA-A

**CALCulate<1|2>:MARKer<1 to 4>:FUNCTION:ADEMod:CARRier[:RESult]?**

This command queries the results of the carrier frequency measurement.

**Example:** "CALC:MARK:FUNC:ADEM:CARR?"

**Features:** \*RST value: -  
SCPI: device-specific

**Mode:** VA-A

**CALCulate<1|2>:MARKer<1 to 4>:FUNCTION:ADEMod:SINad[:STATe] ON | OFF**

This command switches the SINAD measurement on or off.

**Example:** "CALC:MARK:FUNC:ADEM:SIN ON"

**Features:** \*RST value: OFF  
SCPI: device-specific

**Mode:** VA-A

This command is valid only in the analog demodulation mode with Real Time ON.

**CALCulate<1|2>:MARKer<1 to 4>:FUNCTION:ADEMod:SINad:RESult?**

This command queries the results of the SINAD measurement.

**Example:** "CALC:MARK:FUNC:ADEM:SIN:RES?"

**Features:** \*RST value: -  
SCPI: device-specific

**Mode:** VA-A

This command is only a query and thus has no \*RST value assigned.

**CALCulate<1|2>:MARKer<1 to 4>:FUNCtion:DDEMod:RESult?** MERM | MEPK | MEPS | PERM | PEPK | PEPS | EVRM | EVPK | EVPS | IQOF | IQIM | ADR | FERR | RHO

This command queries the error measurement results of digital demodulation.

**Example:** "CALC:MARK:FUNC:DDEM:RES? EVRM"

**Features:** \*RST value: -  
SCPI: device-specific

**Mode:** VA-D

MERM	magnitude error in %rms	FERR	frequency error in Hz
MEPK	maximum of magnitude error in %pk	FEPK	maximum of frequency error in Hz
MEPS	symbol number by which the maximum of the magnitude error occurred	ADR	amplitude drop in dB/symbol
PERM	phase error in deg	RHO	Rho-Factor
PEPK	maximum of phase error in deg	DEV	FSK deviation in Hz
PEPS	symbol number by which the maximum of the phase error occurred		
EVRM	vector error in %rms	FSPK	maximum of FSK deviation error in Hz
EVPK	maximum of vector error in %pk	FSRM	FSK deviation error in Hz
EVPS	symbol number by which the maximum of the vector error occurred	FSPS	symbol number by which the maximum of error occurred
IQOF	I/Q-offset error in %	DTTS	trigger delay of synchronization
IQIM	I/Q Imbalance in %		

**CALCulate<1|2>:MARKer<1...4>:FUNCtion:POWer:SElect** ACPower | CPOWer | OBANdwidth | OBWidth | CN | CN0

This command selects the power measurement and switches it on.

**Example:** "CALC:MARK:FUNC:POW:SEL ACP"

**Features:** \*RST value: -  
SCPI: device-specific

**Mode:** A-F

ACPower	adjacent channel power measurement
CPOWer	channel power measurement
OBANdwidth   OBWidth	occupied bandwidth power measurement
CN	signal / noise power measurement
CN0	signal-/ noise power measurement based on 1Hz bandwidth

This command is an event which is why it is not assigned an \*RST value and query.

**CALCulate<1|2>:MARKer<1...4>:FUNCTION:POWer:RESult?** ACPower | CPOWer | OBANdwidth | OBWidth | CN | CN0

This command queries the results of the power measurement (see also CALCulate:MARKer:FUNCTION:POWer:SElect.)

**Example:** "CALC:MARK:FUNC:POW:RES? OBW"

**Features:** \*RST value: -  
SCPI: device-specific

**Modes:** A, VA, BTS, MS

**ACPower** adjacent channel power measurement; Results are output separated by commas in the following order: Power of main channel  
Power of lower adjacent channel 1  
Power of upper adjacent channel 1  
Power of lower adjacent channel 2  
Power of upper adjacent channel 2

...  
The number of results depends on the number of adjacent channels selected. With logarithmic scaling (RANGE LOG), the power is output in dBm, with linear scaling (RANGE LIN dB or LIN %) in W. If SENSE:POWer:ACHannel:MODE REL is selected, adjacent channel power is output in dB.

**CPOWer** channel power measurement  
With logarithmic scaling (RANGE LOG), the channel power is output in dBm, with linear scaling (RANGE LIN dB or LIN %) in W.

**OBANdwidth | OBWidth** occupied bandwidth power measurement  
The return value is the occupied bandwidth in Hz

**CN** signal / noise power measurement  
The return value is always in dB..

**CN0** signal-/ noise power measurement based on 1Hz bandwidth  
The return value is always in dB/Hz

This command is only a query which is why it is not assigned an \*RST value.

**CALCulate<1|2>:MARKer<1 to 4>:FUNCTION:POWer[:STATe]** OFF

This command switches the power measurement off.

**Example:** "CALC:MARK:FUNC:POW OFF"

**Features:** \*RST value: -  
SCPI: device-specific

**Modes:** A-F, VA-D

This command is an event which is why it is not assigned an \*RST value.

**CALCulate<1|2>:MARKer<1...4>:FUNCTION:POWER:PRESet** NADC | TETRA | PDC | PHS | CDPD | FWCDma | RWCDma | FW3Gppcdma | RW3Gppcdma | M2CDma | D2CDma | F8CDma | R8CDma | F19Cdma | R19Cdma | NONE

**Example:** "CALC:MARK:FUNC:POW:PRES NADC"

**Features:** \*RST value: -  
SCPI: device-specific

**Mode:** A-F

F8CDma	CDMA 800 forward
R8CDma	CDMA 800 reverse
F19Cdma	CDMA 1900 forward
R19Cdma	CDMA1900 reverse
M2CDma	CDMA 2000 Multi Carrier
D2CDma	CDMA 2000 Direct Sequence
FWCDma	W-CDMA, forward
RWCDma	W-CDMA, reverse
FW3Gppcdma	W-CDMA 3GPP forward
RW3Gppcdma	W-CDMA 3GPP reverse

The selection of a standard influences the parameters weighting filter, channel bandwidth and spacing, resolution and video bandwidth, as well as detector and sweep time.

**CALCulate<1|2>:MARKer<1 to 4>:FUNCTION:POWER:CFILter** ON | OFF

This command switches the weighting filter for the selected standard on or off.

**Example:** "CALC:MARK:FUNC:POW:CFIL ON"

**Features:** \*RST value: OFF  
SCPI: device-specific

**Mode:** A-F

**CALCulate<1|2>:MARKer<1 to 4>:FUNCTION:SUMMARY:STATe** ON | OFF

This command switches the messages selected by the summary marker (eg RMS and MEAN) on and off. One or several measurements can be selected with the commands listed in the following and then switched jointly on and off with `SUMMARY:STATe`.

**Example:** "CALC:MARK:FUNC:SUMM:STAT ON"

**Features:** \*RST value: OFF  
SCPI: device-specific

**Mode:** A-Z, VA



**CALCulate<1|2>:MARKer<1 to 4>:FUNction:SUMMary:MAXimum[:STATe] ON | OFF**

This command switches on or off the measurement of the maximum of the absolute value.

**Example:** "CALC:MARK:FUNC:SUMM:MAX ON"

**Features:** \*RST value: OFF  
SCPI: device-specific

**Mode:** VA

When the measurement is switched on, the summary marker is automatically activated (command `SUMMary:STATe` set to ON). When it is switched off, the summary marker remains switched on provided further measurements are selected. Otherwise the marker is switched off automatically.

**CALCulate<1|2>:MARKer<1 to 4>:FUNction:SUMMary:MAXimum:RESult?**

This command queries the results of the measurement of the maximum of the absolute value.

Results of average calculation and peak hold are queried with commands

`...:MAXimum:AVERage:RESult?` and `...:MAXimum:PHOLd:RESult?`.

**Example:** "CALC:MARK:FUNC:SUMM:MAX:RES?"

**Features:** \*RST value: -  
SCPI: device-specific

**Mode:** VA

This command is only a query and thus has no \*RST value assigned.

**CALCulate<1|2>:MARKer<1 to 4>:FUNction:SUMMary:MAXimum:AVERage:RESult?**

This command is used to query the results of the measurement of the maximum of the absolute value if the average is calculated using the command `CALCulate<1|2>:MARKer<1 to 4>:FUNction:SUMMary:AVERage`.

**Example:** "CALC:MARK:FUNC:SUMM:MAX:AVER:RES?"

**Features:** \*RST value: -  
SCPI: device-specific

**Mode:** VA

This command is only a query and thus has no \*RST value assigned.

**CALCulate<1|2>:MARKer<1 to 4>:FUNction:SUMMary:MAXimum:PHOLd:RESult?**

This command is used to query the results of the measurement of the maximum of the absolute value when the peak hold function is switched on with command `CALCulate<1|2>:MARKer<1 to 4>:FUNction:SUMMary:PHOLd`.

**Example:** "CALC:MARK:FUNC:SUMM:MAX:PHOL:RES?"

**Features:** \*RST value: -  
SCPI: device-specific

**Mode:** VA

This command is only a query and thus has no \*RST value assigned.

**CALCulate<1|2>:MARKer<1 to 4>:FUNction:SUMMary:PPEak[:STATe] ON | OFF**

This command switches on or off the measurement of the positive peak value if the calculation and.

**Example:** "CALC:MARK:FUNC:SUMM:PPE ON"

**Features:** \*RST value: OFF  
SCPI: device-specific

**Mode:** VA

When the measurement is switched on, the summary marker is automatically activated (command `SUMMary:STATe` set to ON). When it is switched off, the summary marker remains switched on provided further measurements are selected. Otherwise the marker is switched off automatically.

**CALCulate<1|2>:MARKer<1 to 4>:FUNction:SUMMary:PPEak:RESult?**

This command is used to query the result of the measurement of the positive peak value. Results of average calculation and peak hold are queried with commands `...:PPEak:AVERAge:RESult?` and `...:PPEak:PHOLd:RESult?`.

**Example:** "CALC:MARK:FUNC:SUMM:PPE:RES?"

**Features:** \*RST value: -  
SCPI: device-specific

**Mode:** VA

This command is only a query and thus has no \*RST value assigned.

**CALCulate<1|2>:MARKer<1 to 4>:FUNction:SUMMary:PPEak:AVERAge:RESult?**

This command is used to query the result of the measurement of the positive peak value if the average is calculated using the command `CALCulate<1|2>:MARKer<1 to 4>:FUNction:SUMMary:AVERAge`.

**Example:** "CALC:MARK:FUNC:SUMM:PPE:AVER:RES?"

**Features:** \*RST value: -  
SCPI: device-specific

**Mode:** VA

This command is only a query and thus has no \*RST value assigned.

**CALCulate<1|2>:MARKer<1 to 4>:FUNction:SUMMary:PPEak:PHOLd:RESult?**

This command is used to query the result of the measurement of the positive peak value if the peak hold function is switched on with command `CALCulate<1|2>:MARKer<1 to 4>:FUNction:SUMMary:PHOLd`.

**Example:** "CALC:MARK:FUNC:SUMM:PPE:PHOL:RES?"

**Features:** \*RST value: -  
SCPI: device-specific

**Mode:** VA

This command is only a query and thus has no \*RST value assigned.

**CALCulate<1|2>:MARKer<1 to 4>:FUNCtion:SUMMary:MPEak[:STATe] ON | OFF**

This command switches on or off the measurement of the negative peak value.

**Example:** "CALC:MARK:FUNC:SUMM:MPE ON"

**Features:** \*RST value: OFF  
SCPI: device-specific

**Mode:** VA

When the measurement is switched on, the summary marker is automatically activated (command `SUMMary:STATe` set to ON). When it is switched off, the summary marker remains switched on provided further measurements are selected. Otherwise the marker is switched off automatically.

**CALCulate<1|2>:MARKer<1 to 4>:FUNCtion:SUMMary:MPEak:RESult?**

This command queries the result of the measurement of the negative peak value. Results of average calculation and peak hold are queried with commands `...:MPEak:AVERage:RESult?` and `...:MPEak:PHOLd:RESult?`.

**Example:** "CALC:MARK:FUNC:SUMM:MPE:RES?"

**Features:** \*RST- value: -  
SCPI: device-specific

**Mode:** VA

This command is only a query and thus has no \*RST value assigned.

**CALCulate<1|2>:MARKer<1 to 4>:FUNCtion:SUMMary:MPEak:AVERage:RESult?**

This command queries the result of the measurement of the negative peak value if the average is calculated using the command `CALCulate<1|2>:MARKer<1 to 4>:FUNCtion:SUMMary:AVERage`.

**Example:** "CALC:MARK:FUNC:SUMM:MPE:AVER:RES?"

**Features:** \*RST- value: -  
SCPI: device-specific

**Mode:** VA

This command is only a query and thus has no \*RST value assigned.

**CALCulate<1|2>:MARKer<1 to 4>:FUNCtion:SUMMary:MPEak:PHOLd:RESult?**

This command queries the result of the measurement of the negative peak value if the peak hold function is switched on with command `CALCulate<1|2>:MARKer<1 to 4>:FUNCtion:SUMMary:PHOLd`.

**Example:** "CALC:MARK:FUNC:SUMM:MPE:RES?"

**Features:** \*RST- value: -  
SCPI: device-specific

**Mode:** VA

This command is only a query and thus has no \*RST value assigned.

**CALCulate<1|2>:MARKer<1 to 4>:FUNCtion:SUMMARY:MIDDLE[:STATe] ON | OFF**

This command switches on or off the measurement of the arithmetical mean between positive and negative peak value.

**Example:** "CALC:MARK:FUNC:SUMM:MIDD ON"

**Features:** \*RST value: OFF  
SCPI: device-specific

**Mode:** VA

When the measurement is switched on, the summary marker is automatically activated (command `SUMMARY:STATe` set to ON). When it is switched off, the summary marker remains switched on provided further measurements are selected. Otherwise the marker is switched off automatically.

**CALCulate<1|2>:MARKer<1 to 4>:FUNCtion:SUMMARY:MIDDLE:RESult?**

This command queries the result of the measurement of the arithmetical mean between positive and negative peak value. Results of average calculation and peak hold are queried with commands `...:MIDDLE:AVERAGE:RESult?` and `...:MIDDLE:PHOLD:RESult?`.

**Example:** "CALC:MARK:FUNC:SUMM:MIDD:RES? "

**Features:** \*RST- value: -  
SCPI: device-specific

**Mode:** VA

This command is only a query and thus has no \*RST value assigned

**CALCulate<1|2>:MARKer<1 to 4>:FUNCtion:SUMMARY:MIDDLE:AVERAGE:RESult?**

This command queries the result of the measurement of the arithmetical mean between positive and negative peak value if the average is calculated using the command `CALCulate<1|2>:MARKer<1 to 4>:FUNCtion:SUMMARY:AVERAGE`.

**Example:** "CALC:MARK:FUNC:SUMM:MIDD:AVER:RES? "

**Features:** \*RST- value: -  
SCPI: device-specific

**Mode:** VA

This command is only a query and thus has no \*RST value assigned

**CALCulate<1|2>:MARKer<1 to 4>:FUNCtion:SUMMARY:MIDDLE:PHOLD:RESult?**

This command queries the result of the measurement of the arithmetical mean between positive and negative peak value if the peak hold function is switched on using the command `CALCulate<1|2>:MARKer<1 to 4>:FUNCtion:SUMMARY:PHOLD`.

**Example:** "CALC:MARK:FUNC:SUMM:MIDD:PHOL:RES? "

**Features:** \*RST- value: -  
SCPI: device-specific

**Mode:** VA

This command is only a query and thus has no \*RST value assigned

**CALCulate<1|2>:MARKer<1 to 4>:FUNCTion:SUMMary:RMS[:STATe] ON | OFF**

This command switches on or off the measurement of the effective (rms) value of the total trace.

**Example:** "CALC:MARK:FUNC:SUM:RMS ON"

**Features:** \*RST value: OFF  
SCPI: device-specific

**Modes:** A-Z, VA

When the measurement is switched on, the summary marker is automatically activated (command `SUMMary:STATe` set to ON). When it is switched off, the summary marker remains switched on provided further measurements are selected. Otherwise the marker is switched off automatically.

**CALCulate<1|2>:MARKer<1 to 4>:FUNCTion:SUMMary:RMS:RESult?**

This command queries the result of the measurement of the mean value of the total trace. Results of average calculation and peak hold are queried with commands `...:RMS:AVERage:RESult?` and `...:RMS:PHOLd:RESult?..`

**Example:** "CALC:MARK:FUNC:SUMM:RMS:RES?"

**Features:** \*RST- value: -  
SCPI: device-specific

**Modes:** A-Z, VA

This command is only a query and thus has no \*RST value assigned.

**CALCulate<1|2>:MARKer<1 to 4>:FUNCTion:SUMMary:RMS:AVERage:RESult?**

This command queries the result of the measurement of the mean value of the total trace if the average is calculated using the command `CALCulate<1|2>:MARKer<1 to 4>:FUNCTion:SUMMary:AVERage`.

**Example:** "CALC:MARK:FUNC:SUMM:RMS:AVER:RES?"

**Features:** \*RST- value: -  
SCPI: device-specific

**Modes:** A-Z, VA

This command is only a query and thus has no \*RST value assigned.

**CALCulate<1|2>:MARKer<1 to 4>:FUNCTion:SUMMary:RMS:PHOLd:RESult?**

This command queries the result of the measurement of the mean value of the total trace if the peak hold function is switched on using the command `CALCulate<1|2>:MARKer<1 to 4>:FUNCTion:SUMMary:PHOLd`.

**Example:** "CALC:MARK:FUNC:SUMM:RMS:PHOL:RES?"

**Features:** \*RST- value: -  
SCPI: device-specific

**Modes:** A-Z, VA

This command is only a query and thus has no \*RST value assigned.

**CALCulate<1|2>:MARKer<1 to 4>:FUNCTion:SUMMary:MEAN[:STATe] ON | OFF**

This command switches on or off the measurement of the mean value of the total trace.

**Example:** "CALC:MARK:FUNC:SUMM:MEAN ON"

**Features:** \*RST value: OFF  
SCPI: device-specific

**Modes:** A-Z, VA

When the measurement is switched on, the summary marker is automatically activated (command `SUMMary:STATe` set to ON). When it is switched off, the summary marker remains switched on provided further measurements are selected. Otherwise the marker is switched off automatically.

**CALCulate<1|2>:MARKer<1 to 4>:FUNCTion:SUMMary:MEAN:RESult?**

This command queries the result of the measurement of the mean value of the total trace. Results of average calculation and peak hold are queried with commands `...:MEAN:AVERage:RESult?` and `...:MEAN:PHOLd:RESult?`.

**Example:** "CALC:MARK:FUNC:SUMM:MEAN:RES?"

**Features:** \*RST- value: -  
SCPI: device-specific

**Modes:** A-Z, VA

This command is only a query and thus has no \*RST value assigned.

**CALCulate<1|2>:MARKer<1 to 4>:FUNCTion:SUMMary:MEAN:AVERage:RESult?**

This command queries the result of the measurement of the mean value of the total trace if the average is calculated using the command `CALCulate<1|2>:MARKer<1 to 4>:FUNCTion:SUMMary:AVERage`.

**Example:** "CALC:MARK:FUNC:SUMM:MEAN:AVER:RES?"

**Features:** \*RST- value: -  
SCPI: device-specific

**Modes:** A-Z, VA

This command is only a query and thus has no \*RST value assigned.

**CALCulate<1|2>:MARKer<1 to 4>:FUNCTion:SUMMary:MEAN:PHOLd:RESult?**

This command queries the result of the measurement of the mean value of the total trace if the peak hold function is switched on using the command `CALCulate<1|2>:MARKer<1 to 4>:FUNCTion:SUMMary:PHOLd`.

**Example:** "CALC:MARK:FUNC:SUMM:MEAN:PHOL:RES?"

**Features:** \*RST- value: -  
SCPI: device-specific

**Modes:** A-Z, VA

This command is only a query and thus has no \*RST value assigned.

**CALCulate<1|2>:MARKer<1 to 4>:FUNCtion:SUMMary:PHOLd ON | OFF**

This command switches on or off the peak-hold function.

**Example:** "CALC:MARK:FUNC:SUMM:PHOL ON"

**Features:** \*RST value: OFF  
SCPI: device-specific

**Modes:** A-Z, VA

The peak-hold function is reset by switching off and on, again.

**CALCulate<1|2>:MARKer<1 to 4>:FUNCtion:SUMMary:AVERage ON | OFF**

This command switches the calculation of the average value on or off.

**Example:** "CALC:MARK:FUNC:SUMM:AVER ON"

**Features:** \*RST value: OFF  
SCPI: device-specific

**Modes:** A-Z, VA

The calculation of the average is reset by switching off and on, again.

**CALCulate<1|2>:MARKer<1 to 4>:FUNCtion:SUMMary:AOFF**

This command switches off all measuring functions.

**Example:** "CALC:MARK:FUNC:SUMM:AOFF"

**Features:** \*RST value: -  
SCPI: device-specific

**Modes:** A-Z, VA

This command is an "event" and therefore has no \*RST value assigned and no query.

**CALCulate<1|2>:MARKer<1 to 4>:FUNCtion:CENTer**

This command sets the center frequency to that of the current marker.

**Example:** "CALC:MARK:FUNC:CENT"

**Features:** \*RST value: -  
SCPI: device-specific

**Mode:** A-F

This command is an "event" and therefore has no \*RST value assigned and no query.

**CALCulate<1|2>:MARKer<1 to 4>:FUNCtion:CSTep**

This command sets the step width of the center frequency to the x-value of the current marker.

**Example:** "CALC:MARK:FUNC:CST"

**Features:** \*RST value: -  
SCPI: device-specific

**Mode:** A-F

This command is an "event" and therefore has no \*RST value assigned and no query.

**CALCulate<1|2>:MARKer<1 to 4>:FUNCtion:START**

This command sets the start frequency to the frequency of the current marker.

**Example:** "CALC:MARK:FUNC:STAR"

**Features:** \*RST value: -  
SCPI: device-specific

**Mode:** A-F

This command is an "event" which is why it is not assigned an \*RST value and has no query.

**CALCulate<1|2>:MARKer<1 to 4>:FUNCtion:STOP**

This command sets the stop frequency to the frequency of the current marker.

**Example:** "CALC:MARK:FUNC:STOP"

**Features:** \*RST value: -  
SCPI: device-specific

**Mode:** A-F

This command is an "event" which is why it is not assigned an \*RST value and has no query.

**CALCulate<1|2>:MARKer<1 to 4>:FUNCtion:MSTep**

This command sets the marker step width to the x-value of the current marker.

**Example:** "CALC:MARK:FUNC:MST"

**Features:** \*RST value: -  
SCPI: device-specific

**Modes:** A, VA

This command is an "event" which is why it is not assigned an \*RST value and has no query.

**CALCulate<1|2>:MARKer<1 to 4>:FUNCtion:REFerence**

This command sets the reference level to that of the current marker.

**Example:** "CALC:MARK:FUNC:REF"

**Features:** \*RST value: -  
SCPI: device-specific

**Modes:** A, VA

This command is an "event" and therefore has no \*RST value assigned and no query.



## CALCulate:MATH Subsystem

The CALCulate:MATH - subsystem allows to process data from the SENSE-subsystem in numeric expressions.

COMMAND	PARAMETERS	UNIT	COMMENT
CALCulate<1 2> :MATH<1 to 4> [:EXPRession] [:DEFine] :STATe	<expr> <Boolean>	-- --	

### CALCulate<1|2>:MATH<1 to 4>[:EXPRession][:DEFine] <expr>

This command defines the mathematical expression for relating traces and reference line. Command CALCulate:MATH:STATe switches the mathematical relation of traces on or off .

**Parameter:** <expr> ::= 'OP1 - OP2 [ + RLINE]'  
 OP1 ::= TRACE1 | TRACE2 | TRACE3 | TRACE4  
 OP2 ::= TRACE1 | TRACE2 | TRACE3 | TRACE4 | RLINE

**Examples:** "CALC:MATH1 (TRACE1 - TRACE3 + RLINE) "  
 "CALC:MATH4 (TRACE4 - RLINE) "

**Features:** \*RST value: -  
 SCPI: conforming

**Modes:** A, VA

The operand [ + RLINE ] may be used only if OP2 is different from RLINE. The numeric suffix in CALCULATE<1|2> is not significant. The numeric suffix in MATH<1 to 4> denotes the trace where the result of the mathematical operation is stored. The number must be identical to the number of the operand OP1.

### CALCulate<1|2>:MATH<1 to 4>:STATe ON | OFF

This command switches the mathematical relation of traces on or off.

**Example:** "CALC:MATH1:STAT ON"

**Features:** \*RST value: OFF  
 SCPI: conforming

**Modes:** A, VA

The numeric suffix in CALCULATE<1|2> is not significant. The numeric suffix in MATH<1 to 4> denotes the trace which the command refers to.

## CALCulate:UNIT Subsystem

The CALCulate:Unit subsystem defines the units for vector signal analyzer mode and power measurements.

COMMAND	PARAMETERS	UNIT	COMMENT
CALCulate<1 2> :X :UNIT :TIME :UNIT :ANGLE :POWER	S   SYM  DEG   RAD DBM   V   W   DB   PCT   UNITLESS   DBPW   WATT   DBUV   DBMV   VOLT   DBUA   AMPere DBUV_MHZ   DBMV_MHZ   DBUA_MHZ   DBUV_M   DBUA_M   DBUV_MMHZ   DBUA_MMHZ		Vector Signal Analysis  Vector Signal Analysis

### CALCulate<1|2>:X:UNIT:TIME S | SYM

This command selects seconds or symbols as an x-axis unit.

**Example:** "CALC:X:UNIT:TIME S"  
**Features:** \*RST value: S  
 SCPI: device-specific  
**Mode:** VA-D

### CALCulate<1|2>:UNIT:ANGLE DEG | RAD

This command selects the unit for angular measurement.

**Example:** "CALC:UNIT:ANGL DEG"  
**Features:** \*RST- value: RAD  
 SCPI: device-specific  
**Mode:** VA-D

### CALCulate<1|2>:UNIT:POWER DBM | V | W | DB | PCT | UNITLESS | DBPW | WATT | DBUV | DBMV | VOLT | DBUA | AMPere | DBUV\_MHZ | DBMV\_MHZ | DBUA\_MHZ | DBUV\_M | DBUA\_M | DBUV\_MMHZ | DBUA\_MMHZ

This command selects the unit for power.

**Example:** "CALC:UNIT:POW DBM"  
**Features:** \*RST value: \_  
 SCPI: device-specific  
**Modes:** A, VA

The units DEG, RAD, S, and HZ are available only in the vector analyzer mode.

DBUV\_MHZ and DBUA\_MHZ denote the units DBUV/MHZ or DBUA/MHZ.

## CALibration Subsystem

The commands of the CALibration subsystem perform instrument calibrations.

COMMAND	PARAMETERS	UNIT	COMMENT
CALibration			
[:ALL]?	--	--	query only
:BANDwidth			
[:RESolution]?	--	--	query only
:BWIDth			
[:RESolution]?	--	--	query only
:IQ?	--	--	query only / Vector Signal Analysis
:LDEtector?	--	--	query only
:LOSuppression?	--	--	query only
:PPEak?	--	--	query only
:SHORT?	--	--	FSIQ26/FSIQ40 only
:STATe	<Boolean>	--	query only

### CALibration[:ALL]?

This command performs a complete calibration of the instrument. A "0" is returned if the calibration was successful.

**Example:** "CAL?"

**Features:** \*RST value: -  
SCPI: conforming

**Modes:** A, VA, BTS, MS

### CALibration:BANDwidth | BWIDth[:RESolution]?

This command performs a calibration of the filter bandwidths. A "0" is returned if the calibration was successful.

**Example:** "CAL:BAND?"

**Features:** \*RST value: -  
SCPI: device-specific

**Modes:** A, VA, BTS, MS

### CALibration:IQ?

This command performs a calibration of the vector signal analyzer. A "0" is returned if the calibration was successful.

**Example:** "CAL:IQ?"

**features:** \*RST value: -  
SCPI: device-specific

**Modes:** VA, BTS, MS

**CALibration:LDETECTOR?**

This command performs a calibration of the log module's characteristic and of the detectors. A "0" is returned if the calibration was successful.

**Example:** "CAL:LDET?"  
**Features:** \*RST value: -  
 SCPI: device-specific  
**Modes:** A, VA, BTS, MS

**CALibration:LOSuppression?**

This command performs a calibration of the local oscillator suppression. . A "0" is returned if the calibration was successful.

**Example:** "CAL:LOS?"  
**Features:** \*RST value: -  
 SCPI: device-specific  
**Modes:** A, VA, BTS, MS  
**Modes:** E, A, VA

**CALibration:PPEAK?**

This command performs a calibration of the tracking YIG filter (preselector peaking). A "0" is returned if the calibration was successful.

**Example:** "CAL:PPE?"  
**Features:** \*RST value: -  
 SCPI: device-specific  
**Modes:** A

This command is only valid by the models FSIQ26 and FSIQ40.

**CALibration:SHORT?**

This command performs a short calibration. A "0" is returned if the calibration was successful.

**Example:** "CAL:SHOR?"  
**Features:** \*RST value: -  
 SCPI: device-specific  
**Modes:** A, VA, BTS, MS

**CALibration:STATe ON | OFF**

This command determines whether (ON) or not (OFF) the current calibration data are taken into consideration.

**Example:** "CAL:STAT OFF"  
**Features:** \*RST value: -  
 SCPI: conforming  
**Modes:** A, VA, BTS, MS

## CONFigure Subsystem

The CONFigure subsystem contains commands for configuring complex measurement tasks, like those provided by the options GSM BTS Analyzer (FSE-K11) or GSM MS Analyzer (FSE-K10). The CONFigure subsystem is closely linked to the functions of the FETCH and READ subsystems, where the measurement cycles are started and/or the results of the measurements are queried.

### CONFigure:BTS Subsystem

This subsystem provides the commands for configuring the GSM BTS Analyzer mode (Option FSE-K11) for analyzing the behavior of base stations corresponding to the standards P-GSM, E-GSM, R-GSM, DCS1800 or PCS1900.

COMMAND	PARAMETERS	UNIT	COMMENT
CONFigure			
[:BTS]			Option FSE-K11
:MEASurement			
:ARFCn	<numeric_value>	--	
:AUTO	ONCE		no query
:LIMit			
:PPEak	<numeric_value>	DEG	
:PRMS	<numeric_value>	DEG	
:FREQuency	<numeric_value>	ppm	
:STANdard	<Boolean>		
:POWer			
:CLASs	<numeric_value>   M1   M2   M3	--	
:COUPled	<Boolean>		
:STATic	<numeric_value>	--	
:DYNamic	<numeric_value>	--	
:EXPEcted	<numeric_value>	DBM	
:LIMit	<numeric_value>	DBM	
:SINGle			
[:STATe]	<Boolean>		
:CLEar	--		no query
:CHANnel			
:SLOT	<numeric_value>	--	
:AUTO	ONCE		no query
:TSC	<numeric_value>	--	
:AUTO	<Boolean>		no query
:SFH	<Boolean>		
:NETWork			
[:TYPE]	PGSM   PGSM900   EGSM   EGSM900   DCS   GSM1800   PCS   GSM1900   RGSM   RGSM900		
:PHASe	1 2[,PLUS]		
:COSiting	<Boolean>		
:TXSupp	<Boolean>		
:PRESet	--		no query
:SWEeptime	STANdard   AUTO		

**CONFigure[:BTS]:MEASurement?**

This command queries which measurement is currently set.

PFERror           Phase-/Frequency Error  
 POWer            Carrier Power  
 PTEMplate        Power v. Time  
 MODulation       Modulation Spectrum  
 SWITching        Transient Spectrum  
 SPURious         Spurious

**Example:**       "CONF:MEAS?"

**Answer:** "PFER"

**Features:**     \*RST-value: -  
 SCPI:            device-specific

**Mode:**         BTS, MS

**CONFigure[:BTS]:ARFCn <numeric\_value>**

This command selects the number of the transmission channel of the base station.

**Parameter:**    <numeric\_value>::=    1 to 124               (P-GSM phase I/II)  
   0 to 124, 975 to 1023   (E-GSM)  
   0 to 124, 955 to 1023   (R-GSM)  
   512 to 885              (DCS1800 phase I/II/II+)  
   512 to 810              (PCS1900)

**Example:**       "CONF:ARFC 67"

**Features:**     \*RST value:    1       (P-GSM phase I/II)  
   0       (E-GSM; R-GSM)  
   512    (DCS1800 phase I/II/II+)  
   512    (PCS1900)  
 SCPI:            device-specific

**Mode:**         BTS

**CONFigure[:BTS]:ARFCn:AUTO ONCE**

This command is used to search for the channel number of the transmission channel of the base station automatically. This requires only one channel to be active.

**Example:**       "CONF:ARFC:AUTO ONCE"

**Features:**     \*RST value:    --  
 SCPI:            device-specific

**Mode:**         BTS

This command is an event and thus has no query and no \*RST value assigned.

**CONFigure[:BTS]:LIMit:PPEak <numeric\_value>**

This command determines the phase error limits in degrees for the phase/frequency measurement (peak value).

**Example:**       "CONF:LIM:PPE 66"

**Feature:**      \*RST value:    depending on standard  
 SCPI:            device-specific

**Mode:**         BTS

**CONFigure[:BTS]:LIMit:PRMS <numeric\_value>**

This command determines the phase error limits in degrees for the phase/frequency measurement (mean value).

**Example:** "CONF:LIM:PRMS 22"  
**Feature:** \*RST value: depending on standard  
 SCPI: device-specific  
**Mode:** BTS

**CONFigure[:BTS]:LIMit:FREQuency <numeric\_value>**

This command determines the frequency error limits in ppm for the phase/frequency measurement.

**Example:** "CONF:LIM:FREQ 36"  
**Feature:** \*RST value: depending on standard  
 SCPI: device-specific  
**Mode:** BTS

**CONFigure[:BTS]:LIMit:STANdard ON | OFF**

This command switches between user-defined (OFF) and standard-defined (ON) limit values.

**Example:** "CONF:LIM:STAN ON"  
**Feature:** \*RST value: ON  
 SCPI: device-specific  
**Mode:** BTS

**CONFigure[:BTS]:POWer:CLASs <numeric\_value> | M1 | M2 | M3**

This command defines the power class of the base station.

**Parameter:** <numeric\_value> ::= 1 to 8 (P-GSM phase I/II, E-GSM, R-GSM)  
 ::= 1 to 4 (PCS1900, DCS1800 phase I/II/II+)  
 M1, M2, M3 ::= Power Classes for Micro BTS  
**Example:** "CONF:POW:CLAS 4"  
**Features:** \*RST value: 4 (P-GSM phase I/II, E-GSM, R-GSM)  
 1 (DCS1800, PCS1900)  
 SCPI: device-specific  
**Mode:** BTS

**CONFigure[:BTS]:POWer:COUPled** ON | OFF

This command switches between user-defined (OFF) and standard-defined (ON) level values.

**Example:** "CONF:POW:COUP ON"  
**Feature:** \*RST value: ON  
 SCPI: device-specific  
**Mode:** BTS

**CONFigure[:BTS]:POWer:STATic** 0 to 6

This command defines the static power control level of the base station.

**Example:** "CONF:POW:STAT 3"  
**Features:** \*RST value: 0  
 SCPI: device-specific  
**Mode:** BTS

**CONFigure[:BTS]:POWer:DYNamic** 0 to 15

This command defines the dynamic power control level of the base station.

**Example:** "CONF:POW:DYN 5"  
**Features:** \*RST value: 0  
 SCPI: device-specific  
**Mode:** BTS

**CONFigure[:BTS]:POWer:EXPected** <numeric\_value>

This command enters directly the rated output level of the base station specified by the manufacturer.

**Example:** "CONF:POW:EXP 43DBM"  
**Features:** \*RST value: 46 dBm (P-GSM phase I/II, E-GSM, R-GSM)  
 43 dBm (DCS1800, PCS1900)  
 SCPI: device-specific  
**Mode:** BTS

**CONFigure[:BTS]:POWer:LIMit** <numeric\_value>

This command defines the level for the selection of level-dependent limit lines.

**Example:** "CONF:POW:LIM 65DBM"  
**Feature:** \*RST value: depending on standard  
 SCPI: device-specific  
**Mode:** BTS

This command is only available for the setting `CONFigure[:BTS]:POWer:COUPled OFF`.



**CONFigure[:BTS]:POWer:SINGle[:STATe] ON | OFF**

This command switches single measurement of carrier power on and off.

**Example:** "CONF:POW:SING ON"  
**Feature:** \*RST value: OFF  
 SCPI: device-specific  
**Mode:** BTS

**CONFigure[:BTS]:POWer:SINGle:CLEAr**

This command clears the table containing the single-step carrier power measurements.

**Example:** "CONF:POW:SING:CLE"  
**Feature:** \*RST value: --  
 SCPI: device-specific  
**Mode:** BTS

This command is an event and has therefore neither \*RST value nor query.

**CONFigure[:BTS]:CHANnel:SLOT 0 to 7**

This command selects the slot number within a transmission frame of the base station.

**Example:** "CONF:CHAN:SLOT 3"  
**Features:** \*RST value: 0  
 SCPI: device-specific  
**Mode:** BTS

On changing the slot number, the number of the midamble (TSC) is automatically adapted to the slot.

**CONFigure[:BTS]:CHANnel:SLOT:AUTO ONCE**

This command automatically searches for the slot number within a transmission frame of the base station. This requires only one slot to be active.

**Example:** "CONF:CHAN:SLOT:AUTO ONCE"  
**Features:** \*RST value: --  
 SCPI: device-specific  
**Mode:** BTS

This command is an event and thus has no query and no \*RST value assigned.

**CONFigure[:BTS]:CHANnel:SFH ON | OFF**

This command defines whether the base station uses slow frequency hopping or not.

**Example:** "CONF:CHAN:SFH ON"  
**Features:** \*RST value: OFF  
 SCPI: device-specific  
**Mode:** BTS

This command is available only when spurious or transient spectrum measurement is selected. The settings for spurious measurement are independent from those selected for transient spectrum.

**CONFigure[:BTS]:CHANnel:TSC:AUTO** ON | OFF

This command couples the midamble (training sequence TSC\_0 to 7) to the slot, i.e. if the slot number is changed the training sequence in the ON state is automatically adapted. In the OFF state, the training sequence set is conserved even if the slot number is changed.

**Example:** "CONF:CHAN:TSC:AUTO ON"

**Features:** \*RST value: ON  
SCPI: device-specific

**Mode:** BTS

**CONFigure[:BTS]:CHANnel:TSC** 0 to 7

This command selects the midamble (training sequence TSC\_0 to 7) of the active slot.

**Example:** "CONF:CHAN:TSC 3"

**Features:** \*RST value: 0  
SCPI: device-specific

**Mode:** BTS

**CONFigure[:BTS]:NETWork[:TYPE]** PGSM | PGSM900 | EGSM |EGSM900 | DCS |GSM1800 | PCS|GSM1900 | RGSM | RGSM900

This command selects the standard type according to which the base station will work.

**Example:** "CONF:NETW DCS"

**Features:** \*RST value: GSM  
SCPI: device-specific

**Mode:** BTS

**CONFigure[:BTS]:NETWork:PHASe** 1|2 [,PLUS]

This command selects the phase of the standard according to which the base station will work.

**Example:** "CONF:NETW:PHAS 2"

**Features:** \*RST value: 1  
SCPI: device-specific

**Mode:** BTS

**CONFigure[:BTS]:COSiting** ON | OFF

This command selects whether the base station has the "cositing" feature.

**Example:** "CONF:COS ON"

**Features:** \*RST value: OFF  
SCPI: device-specific

**Mode:** BTS

This command is available only if spurious emission measurement is selected.

**CONFigure[:BTS]:TXSupp** ON | OFF

This command defines that an additional carrier suppression of min. 20dB is taken into account for the measurement. If there is already suppression, a more sensitive setting of the instrument is selected.

**Example:** "CONF:TXS ON"

**Features:** \*RST value: OFF  
SCPI: device-specific

**Mode:** BTS

For measurements in the RX-band the value is automatically set to ON.

**CONFigure[:BTS]:PRESet**

This command resets the parameters for the standard selected to their default values (DEFAULT SETTINGS).

**Example:** "CONF:PRES"

**Features:** \*RST value: --  
SCPI: device-specific

**Mode:** BTS

This command is an event and has thus no query and no \*RST value assigned.

**CONFigure[:BTS]:SWEeptime** STANdard | AUTO

This command selects the sweep-time computing mode for the spurious measurement:

**Example:** "CONF:SWE:STAN AUTO"

**Feature:** \*RST value: STANdard  
SCPI: device-specific

**Mode:** BTS

STANdard The computation of the sweep time is based on a worst-case estimation

AUTO The sweep time is reduced by a factor of 8 (assuming all slots are on).

## CONFigure:BURSt Subsystem

This subsystem provides the commands for configuring the measurements in the GSM BTS Analyzer mode (option FSE-K11) or GSM MS Analyzer mode (option FSE-K10) which are performed on individual bursts. (carrier power, phase/frequency error, power vs. time).

COMMAND	PARAMETERS	UNIT	COMMENT
CONFigure			
:BURSt			Option FSE-K11 or FSE-K10
:PFERror			
[:IMMediate]	--	--	no query
:COUnT	<numeric_value>	--	
:POWer			
[:IMMediate]	--	--	
:COUnT	<numeric_value>	--	
:CONdITION	NORMal   EXTReme		
:PTEmplate			
[:IMMediate]	--	--	no query
:COUnT	<numeric_value>	--	
:SELect	FULL   TOP   RISing   FALLing		
:REFerence			
:AUTO	<Boolean>		no query

### CONFigure:BURSt:PFERror[:IMMediate]

This command selects measurement of the phase and frequency error of the base station or mobile.

**Example:** "CONF: BURS: PFER"

**Features:** \*RST value: --  
SCPI: device-specific

**Modes:** BTS, MS

This command is an event and thus has no query and no \*RST value assigned.

### CONFigure:BURSt:PFERror:COUnT 1 to 1000

This command sets the number of bursts used for the determination of average and maximum value.

**Example:** "CONF: BURS: PFER: COUN 100"

**Features:** \*RST value: 500 (GSM/DCS1800 Phase I)  
200 otherwise  
SCPI: device-specific

**Modes:** BTS, MS

**CONFigure:BURSt:POWer[:IMMediate]**

This command selects measurement of the average carrier power of the base station or mobile.

**Example:** "CONF: BURS: POW"  
**Features:** \*RST value: --  
 SCPI: device-specific  
**Modes:** BTS, MS

This command is an event and thus has no query and no \*RST value assigned.

**CONFigure:BURSt:POWer:COUNt 1 to 1000**

This command sets the number of bursts used for the determination of measured values.

**Example:** "CONF: BURS: POW: COUN 100"  
**Features:** \*RST value: 500 (GSM/DCS1800 phase I)  
 200 otherwise  
 SCPI: device-specific  
**Modes:** BTS, MS

**CONFigure:BURSt:POWer:CONDition NORMal | EXTReMe**

This command defines the conditions for power measurement.

**Example:** "CONF: BURS: POW: COND EXTR"  
**Features:** \*RST value: NORMal  
 SCPI: device-specific  
**Modes:** BTS, MS

**CONFigure:BURSt:PTEMplate[:IMMediate]**

This command selects measurement of power of the base station or mobile vs. time.

**Example:** "CONF: BURS: PTEM"  
**Features:** \*RST value: --  
 SCPI: device-specific  
**Modes:** BTS, MS

This command is an event and thus has no query and no \*RST value assigned.

**CONFigure:BURSt:PTEMPlate:COUNT** 1 to 1000

This command defines the number of bursts used for determining the measured value.

**Example:** "CONF: BURS: PTEM: COUN 100"  
**Features:** \*RST value: 500 (GSM/DCS1800 phase I)  
200 otherwise  
SCPI: device-specific  
**Modes:** BTS, MS

**CONFigure:BURSt:PTEMPlate:SELEct** FULL | TOP | RISing | FALLing

This command defined the burst section to be measured.

**Example:** "CONF: BURS: PTEM: SEL TOP"  
**Features:** \*RST value: FULL  
SCPI: device-specific  
**Modes:** BTS, MS

**CONFigure:BURSt:REFerence:AUTO** ON | OFF

This command switches between automatic and user-activated preview of power versus time. When switched to AUTO, the preview is always performed, when switched to OFF it is omitted. Note: see  
READ: BURSt: REF: IMM

**Example:** "CONF: BURS: REF: AUTO ON"  
**Feature:** \*RST value: AUTO  
SCPI: device-specific  
**Mode:** BTS, MS

## CONFigure:MS Subsystem

This subsystem provides the commands for configuring the GSM MS Analyzer mode (Option FSE-K10) for analyzing the behavior of mobiles corresponding to the standards P-GSM, E-GSM, R-GSM, DCS1800 or PCS1900.

COMMAND	PARAMETERS	UNIT	COMMENT
CONFigure [:MS]			Option FSE-K10
:MEASurement			
:ARFCn	<numeric_value>	--	
:AUTO	ONCE		no query
:LIMit			
:PPEak	<numeric_value>	DEG	
:PRMS	<numeric_value>	DEG	
:FREQuency	<numeric_value>	ppm	
:STANdard	<Boolean>		
:POWer	<Boolean>		
:CLASs			
:COUPled	<numeric_value>	--	
:LEVel	<numeric_value>	--	
:LIMit	<numeric_value>	DBM	
:EXPEcted	<numeric_value>	DBM	
:SINGle			
[:STATe]	<Boolean>	--	
:CLEar	--		no query
:SMALI	<Boolean>		
:CHANnel			
:SFH	<Boolean>		
:TSC	<numeric_value>		
:NETWork		--	
[:TYPE]	PGSM   PGSM900   EGSM   EGSM900   DCS   GSM1800   PCS   GSM1900   RGSM   RGSM900		
:PHASe	1   2[, PLUS]		
:TXSupp	<Boolean>		
:PRESet	--		no query
:SWEeptime	STANdard   AUTO		

### CONFigure[:MS]:MEASurement?

This command queries which measurement is currently set.

PFERror           Phase-/Frequency Error  
 POWer            Carrier Power  
 PTEMplate        Power v. Time  
 MODulation       Modulation Spectrum  
 SWITching        Transient Spectrum  
 SPURious         Spurious

**Example:**       "CONF:MEAS?"  
 answer: "PFER"

**Features:**     \*RST value: -  
 SCPI:            device specific

**Mode:**         MS

**CONFigure[:MS]:ARFCn** <numeric\_value>

This command selects the number of the transmission channel of the mobile.

**Parameter:** <numeric\_value>::= 1 to 124 (P-GSM phase I/II)  
 0 to 124, 975 to 1023 (E-GSM)  
 0 to 124, 955 to 1023 (R-GSM)  
 512 to 885 (DCS1800 phase I/II/II+)  
 512 to 810 (PCS1900)

**Example:** "CONF:ARFC 67"

**Features:** \*RST value: 1 (P-GSM phase I/II)  
 0 (E-GSM; R-GSM)  
 512 (DCS1800 phase I/II/II+)  
 512 (PCS1900)  
 SCPI: device-specific

**Mode:** MS

**CONFigure[:MS]:ARFCn:AUTO** ONCE

This command selects automatically the transmission channel of the mobile.

**Example:** "CONF:ARFC:AUTO ONCE"

**Features:** \*RST value: -  
 SCPI: device-specific

**Mode:** MS

**CONFigure[:MS]:LIMit:PPEak** <numeric\_value>

This command determines the phase error limits in degrees for the phase/frequency measurement (peak value).

**Example:** "CONF:LIM:PPE 66"

**Feature:** \*RST value: depending on standard  
 SCPI: device-specific

**Mode:** MS

**CONFigure[:MS]:LIMit:PRMS** <numeric\_value>

This command determines the phase error limits in degrees for the phase/frequency measurement (mean value).

**Example:** "CONF:LIM:PRMS 22"

**Feature:** \*RST value: depending on standard  
 SCPI: device-specific

**Mode:** MS



**CONFigure[:MS]:LIMit:FREQuency** <numeric\_value>

This command determines the frequency error limits in ppm for the phase/frequency measurement.

**Example:** "CONF:LIM:FREQ 36"  
**Feature:** \*RST value: depending on standard  
 SCPI: device-specific  
**Mode:** MS

**CONFigure[:MS]:LIMit:STANdard** ON | OFF

This command switches between user-defined (OFF) and standard-defined (ON) limit values.

**Example:** "CONF:LIM:STAN ON"  
**Feature:** \*RST value: ON  
 SCPI: device-specific  
**Mode:** MS

**CONFigure[:MS]:POWer:CLASs** <numeric\_value>

This command defines the power class of the mobile.

**Parameter:** <numeric\_value> ::= 1 to 5 (P-GSM phase I)  
 2 to 5 (P-GSM phase II)  
 2 to 5 (E-GSM; R-GSM)  
 1 to 2 (DCS1800 phase I)  
 1 to 3 (DCS1800 phase II/II+)  
 1 to 3 (PCS1900)  
**Example:** "CONF:POW:CLAS 4"  
**Features:** \*RST value: 2 (P-GSM phase I/II, E-GSM, R-GSM)  
 1 (DCS1800, PCS1900)  
 SCPI: device-specific  
**Mode:** MS

**CONFigure[:MS]:POWer:COUPlEd** ON | OFF

This command switches between user-defined (OFF) and standard-defined (ON) level values.

**Example:** "CONF:POW:COUP ON"  
**Feature:** \*RST value: ON  
 ON standard  
 OFF user-defined  
 SCPI: device-specific  
**Mode:** MS

**CONFigure[:MS]:POWER:LEVEL** 0 to 31

This command defines the power control level of the mobile.

**Example:** "CONF:POW:LEV 5"

**Features:** \*RST value: 2 (P-GSM Phase I/II, E-GSM, R-GSM)  
0 (DCS1800, PCS1900)  
SCPI: device-specific

**Mode:** MS

**CONFigure[:MS]:POWER:LIMit** <numeric\_value>

This command defines the level for the selection of level-dependent limit lines.

**Example:** "CONF:POW:LIM 65DBM"

**Feature:** \*RST value: depending on standard  
SCPI: device-specific

**Mode:** MS

This command is only available for the setting `CONFigure[:MS]:POWER:COUpled OFF`.

**CONFigure[:MS]:POWER:EXPected** <numeric\_value>

This command enters directly the rated output level of the mobile.

**Example:** "CONF:POW:EXP 43DBM"

**Features:** \*RST value: 46 dBm (P-GSM phase I/II, E-GSM; R-GSM)  
43 dBm (DCS1800, PCS1900)  
SCPI: device-specific

**Mode:** MS

**CONFigure[:MS]:POWER:SINGle[:STATe]** ON | OFF

This command switches single measurement of carrier power on and off.

**Example:** "CONF:POW:SING ON"

**Feature:** \*RST value: OFF  
SCPI: device-specific

**Mode:** MS

**CONFigure[:MS]:POWER:SINGle:CLEar**

This command clears the table containing the single-step carrier power measurements.

**Example:** "CONF:POW:SING:CLE"

**Feature:** \*RST value: --  
SCPI: device-specific

**Mode:** MS

This command is an event and has therefore neither \*RST value nor query.

**CONFigure[:MS]:POWer:SMAL** ON | OFF

This command switches the limits for spurious measurement in the RGSM range. It is only available for phase 2+.

**Example:** "CONF:POW:SMAL ON"  
**Feature:** \*RST value: OFF  
 SCPI: device-specific  
**Mode:** MS

**CONFigure[:MS]:CHANnel:SFH** ON | OFF

This command switches slow-frequency hopping on or off.

**Example:** "CONF:CHAN:SFH ON"  
**Feature:** \*RST value: OFF  
 SCPI: device-specific  
**Mode:** MS

**CONFigure[:MS]:CHANnel:TSC** 0 to 7

This command selects the midamble used by the mobile.

**Parameter:** 0 to 7 (training sequence for the Normal Burst)  
**Example:** "CONF:CHAN:TSC 3"  
**Features:** \*RST value: 0  
 SCPI: device-specific  
**Mode:** MS

**CONFigure[:MS]:NETWork[:TYPE]** PGSM | PGSM900 | EGSM |EGSM900 | DCS |GSM1800 | PCS|GSM1900 | RGSM | RGSM900

This command selects the standard type according to which the mobile will work.

**Example:** "CONF:NETW DCS"  
**Features:** \*RST value: GSM  
 SCPI: device-specific  
**Mode:** MS

**CONFigure[:MS]:NETWork:PHASe** 1 | 2 [,PLUS]

This command selects the phase of the standard according to which the mobile will work.

**Example:** "CONF:NETW:PHAS 2"  
**Features:** \*RST value: 1  
 SCPI: device-specific  
**Mode:** MS

**CONFigure[:MS]:TXSupp** ON | OFF

This command defines that an additional carrier suppression of min. 20dB is taken into account for the measurement. If there is already suppression, a more sensitive setting of the instrument is selected.

**Example:** "CONF:TXS ON"

**Features:** \*RST value: OFF  
SCPI: device-specific

**Mode:** MS

For measurements in the RX-band the value is automatically set to ON.

**CONFigure[:MS]:PRESet**

This command resets the parameters for the standard selected to their default values (DEFAULT SETTINGS).

**Example:** "CONF:PRES"

**Features:** \*RST value: --  
SCPI: device-specific

**Mode:** MS

This command is an event and has thus no query and no \*RST value assigned.

**CONFigure[:MS]:SWEeptime** STANdard | AUTO

This command selects the sweep-time computing mode for the spurious measurement:

**Example:** "CONF:SWE AUTO"

**Feature:** \*RST value: STANdard  
SCPI: device-specific

**Mode:** MS

STANdard The computation of the sweep time is based on a worst-case estimation

AUTO The sweep time is reduced by a factor of 8 (assuming all slots are on).

## CONFigure:SPECTrum Subsystem

This subsystem provides the commands for configuring the measurements in the GSM BTS Analyzer mode (FSE-K11) or in the GSM MS Analyzer mode (FSE-K10) used to determine the power of the spectral contributions due to modulation and switching (modulation spectrum, transient spectrum).

COMMAND	PARAMETERS	UNIT	COMMENT
CONFigure			
:SPECTrum			
:MODulation			
[:IMMediate]	--	--	no query, Option FSE-K11 or FSE-K10
:COUNT	<numeric_value>	--	Option FSE-K11 or FSE-K10
:RANGe	ARFCn   TXBand   RXBand   COMBined   DCSRx1800		Option FSE-K11 or FSE-K10
:TGATe	<Boolean>		Option FSE-K11
:SWITching			Option FSE-K11 or FSE-K10
[:IMMediate]	--	--	no query
:COUNT	<numeric_value>	--	

### CONFigure:SPECTrum:MODulation[:IMMediate]

This command selects measurement of the spectrum due to modulation.

**Example:** "CONF:SPEC:MOD"

**Features:** \*RST value: --  
SCPI: device-specific

**Modes:** BTS, MS

This command is an event and has thus no query and no \*RST value assigned.

### CONFigure:SPECTrum:MODulation:COUNT 1 to 1000

This command sets the number of bursts used for determining the average and maximum values.

**Example:** "CONF:SPEC:MOD:COUN 100"

**Features:** \*RST value: 500 (GSM/DCS1800 phase I)  
200 otherwise  
SCPI: device-specific

**Modes:** BTS, MS

**CONFigure:SPECTrum:MODulation:RANGe** ARFCn | TXBand | RXBand | COMBined | DCSRx1800

This command selects the frequency range for the measurement.

**Example:** "CONF:SPEC:MOD:RANG TXB"

**Features:** \*RST value: ARFCn  
SCPI: device-specific

**Modes:** BTS, MS

ARFCn ARFCN  $\pm$  1.8 MHz  
TXBand TX-Band  
RXBand RX-Band  
COMBined ARFCN  $\pm$  1.8 MHz / TX-Band  
DCSRx1800 RX band DCS 1800 (option FSE-K10 only)

**CONFigure:SPECTrum:MODulation:TGATe** ON | OFF

This command switches on or off the operating mode gating for the TX band. For TGATe OFF, 8 active slots are presumed.

**Example:** "CONF:SPEC:MOD:TGAT ON"

**Features:** \*RST value: OFF  
SCPI: device-specific

**Mode:** BTS

**CONFigure:SPECTrum:SWITching[:IMMediate]**

This command selects measurement of the spectrum due to switching transients.

**Example:** "CONF:SPEC:SWIT"

**Features:** \*RST value: --  
SCPI: device-specific

**Modes:** BTS, MS

This command is an event and has thus no query and no \*RST value assigned.

**CONFigure:SPECTrum:SWITching:COUNT** 1 to 1000

This command defines the number of bursts used for determining the average and maximum values.

**Example:** "CONF:SPEC:SWIT:COUN 100"

**Features:** \*RST value: 500 (GSM/DCS1800 phase I)  
200 otherwise  
SCPI: device-specific

**Modes:** BTS, MS

## CONFigure:SPURious Subsystem

This subsystem provides commands for configuring the measurements in the GSM BTS (FSE-K11) or GSM MS (FSE-K10) Analyzer mode used for measuring the power of spurious emissions.

COMMAND	PARAMETERS	UNIT	COMMENT
CONFigure :SPURious			
[:IMMediate]	--	--	no query, Option FSE-K11, FSE-K10
:COUNT	<numeric_value>	--	Option FSE-K11, FSE-K10
:RXBand	<numeric_value>	--	Option FSE-K11
:RANGe	TXBand   OTXBand   RXBand   IDLeband   COMBined	--	Option FSE-K11, FSE-K10
:STEP<1..26>	<Boolean>	--	Option FSE-K11, FSE-K10
:COUNT?			query only
:ANTenna	CONDUCTed   RADiated		Option FSE-K10

### CONFigure:SPURious[:IMMediate]

This command selects measurement of spurious emissions.

**Example:** "CONF:SPUR"

**Features:** \*RST value: --  
SCPI: device-specific

**Modes:** BTS, MS

This command is an event and has thus no query and no \*RST value assigned.

### CONFigure:SPURious:COUNT 1 to 1000

This command sets the number of bursts used for determining the average and maximum values.

**Example:** "CONF:SPUR:COUN 100"

**Features:** \*RST value: 500 (GSM/DCS1800 phase I)  
200 otherwise  
SCPI: device-specific

**Modes:** BTS, MS

The number of bursts in measurements of the RX band is set by command CONFigure:SPURious:RANGe:RXBand (FSE K11 only).

### CONFigure:SPURious:COUNT:RXBand 1 to 1000

This command sets the number of bursts used for determining the average and maximum values in measurements of the RX band.

**Example:** "CONF:SPUR:COUN:RXB 100"

**Features:** \*RST value: 1  
SCPI: device-specific

**Modes:** BTS

**CONFigure:SPURious:RANGe** TXBand | OTXBand | RXBand | IDLeband | COMBined

This command selects the frequency range used for the measurement.

<b>Example:</b>	"CONF:SPUR:RANG OTX"
<b>Features:</b>	*RST value: TXB SCPI: device-specific
<b>Modes:</b>	BTS, MS
TXBand	TX-Band
OTXBand	Not TX-Band
RXBand	RX-Band (option FSE-K11 only)
IDLeband	Idle band (option FSE-K10 only)
COMBined	TX-Band $\pm$ 2 MHz (option FSE-K11 only)

**CONFigure:SPURious:STEP<1...26>** ON | OFF

This command selects a subband of the selected band for a spurious measurement.

Each band is divided up into 1 to max. 26 subbands, which are selected by the numerical suffix following STEP. A subband is selected for measurement by setting ON.

<b>Example:</b>	"CONF:SPUR:STEP24 ON"
<b>Feature:</b>	*RST value: ON SCPI: device-specific
<b>Mode:</b>	BTS, MS

**CONFigure:SPURious:STEP:COUNT?**

This command queries the number of subbands of the currently selected band for a spurious measurement.

<b>Example:</b>	"CONF:SPUR:STEP:COUNT?"
<b>Feature:</b>	*RST value: - SCPI: device-specific
<b>Mode:</b>	BTS, MS

This command is a query and has therefore no \*RST value assigned.

**CONFigure:SPURious:ANTenna** CONDUCTed | RADiated

This command selects the features of the measurement of spurious emissions.

<b>Example:</b>	"CONF:SPUR:ANT RAD"
<b>Feature:</b>	*RST value: COND SCPI: device-specific
<b>Mode:</b>	MS



## DIAGnostic Subsystem

The DIAGnostic subsystem contains the commands which support instrument diagnostics for maintenance, service and repair. In accordance with the SCPI standard, all of these commands are device-specific.

COMMAND	PARAMETERS	UNIT	COMMENT
DIAGnostic :SERVice :INPut [:SElect]	CALibration   RF	--	
:FUNction	<numeric_value>,>numeric_value>	--	no query
:NSOurce	<Boolean>	--	
:INFO :CCOunt :ATTenuation<1 to 3>?			query only

### DIAGnostic:SERVice:INPut[:SElect] CALibration | RF

This command toggles between the RF input on the front panel and the internal 120-MHz reference signal.

**Example:** "DIAG:SERV:INP CAL"

**Features:** \*RST value: RF  
SCPI: device-specific

**Modes:** A, VA

### DIAGnostic:SERVice:FUNction <numeric\_value>,<numeric\_value>...

This command activates a service function.

**Example:** "DIAG:SERV:FUNC 2,0,2,12,1"

**Features:** \*RST value: -  
SCPI: device-specific

**Modes:** A, VA

The service function is selected via five parameters: functional group number, board number, function number, parameter 1 and parameter 2.

See service manual 1065.6016.24.

### DIAGnostic:SERVice:NSOurce ON | OFF

This command switches the 28-V supply at the rear connector of the noise source on and off.

**Example:** "DIAG:SERV:NSO ON"

**Features:** \*RST value: OFF  
SCPI: device-specific

**Modes:** A, VA

**DIAGnostic:INFO:CCOunt:ATTenuation<1 | 2 | 3>?**

This command queries the cycle counters of the attenuators. The suffix selects the attenuator:

1: Basic Instrument                    2: Tracking Generator   3: FSE-B13

The result is output as a list of values separated by a ','. The list starts with the date.

**Example:**                    "DIAG:INFO:CCO:ATT?"

**Features:**                    \*RST value:    --  
                                  SCPI:            device-specific

**Modes:**                    A, VA, MS, BTS

This command is a query and has therefore no \*RST value assigned.

# DISPlay Subsystem

The DISPlay subsystem controls the selection and presentation of textual and graphic information as well as of trace data on the display.

The displays in the split-screen mode are assigned to WINDOW 1 (screen A) or 2 (screen B).

COMMAND	PARAMETERS	UNIT	COMMENT
DISPlay			
:FORMat	SINGle   SPLit		
:PROgram			
[:MODE]	<Boolean>		
:ANNotation			
:FREQuency	<Boolean>		
:LOGO	<Boolean>		
:CMAP<1 to 13>			
:DEFault			
:HSL	0 to 100,0 to 100,0 to 100		
:PDEFined	BLAck   BLUE   BROWn   GREen   CYAN   RED   MAGen ta   YELLow   WHITE   DGRAY   LGRAY   LBLUe   LGREen   LCYan   LRED   LMAGen ta		
[:WINDow<1 2>]			
:TEXT			
[:DATA]	<string>		
:STATe	<Boolean>		
:TIME	<Boolean>		
:MINFo	<Boolean>		
:TRACe<1 to 4>			
:X			
[:SCALE]			Vector Signal Analy sis
:RVALue	<numeric_value>		
:ZOOM	<Boolean>		
[:FREQuency]			
:START	<numeric_value>	HZ	
:STOP	<numeric_value>	HZ	
:CENTer	<numeric_value>	HZ	
:SPACing	LINear   LOGarith mic	--	
:Y			
[:SCALE]	<numeric_value>	DB	
:MODE	ABSolute   RELati ve		
:RLEVel	<numeric_value>	DBM	
:OFFSet	<numeric_value>	DB	
:RVALue	<numeric_value>	DBM DB HZ  DEG RAD	
:AUTO	<Boolean>		
:RPOSITION	<numeric_value>	PCT	Vector Signal Analy sis
:PDIVision	<numeric_value>	DBM DB HZ  DEG RAD	Vector Signal Analy sis
:SPACing	LINear LOGarith mic PERCent	--	

COMMAND	PARAMETERS	UNIT	COMMENT
DISPlay			
[:WINDow<1 2>]			
:TRACe<1...4>			
:MODE	WRITe VIEW AVERAge  MAXHold MINHold FRESults	--	
:CWRIte	<Boolean>	--	Vector Signal Analysis
:ANALog	<Boolean>	--	
:HCONTinuous	<Boolean>	--	
[:STATe]	<Boolean>	--	
:SYMBol	DOTS   BARS   OFF		Vector Signal Analysis
:EYE			
COUNT	<numeric_value>	SYM	Vector Signal Analysis
:PSAVe			
[:STATe]	<Boolean>		
HOLDoff	<numeric_value>		

**DISPlay:FORMat** SINGLE | SPLit

This command switches the test result display between FULL SCREEN and SPLIT SCREEN.

- Example:** "DISP:FORM SPL"
- Features:** \*RST value: SINGLE  
SCPI: device-specific
- Modes:** A, VA

**DISPlay:PROGram[:MODE]** ON | OFF

This command switches the display between the measuring instrument and the computer function.

- Example:** "DISP:PROG ON"
- Features:** \*RST value: OFF  
SCPI: device-specific
- Modes:** A, VA, BTS, MS

**DISPlay:ANNotation:FREQuency** ON | OFF

This command switches the x-axis annotation on or off.

- Example:** "DISP:ANN:FREQ OFF"
- Features:** \*RST value: ON  
SCPI: conforming
- Modes:** A, VA, BTS, MS

**DISPlay:LOGO** ON | OFF

This command switches the factory logo on the screen on or off.

- Example:** "DISP:LOGO OFF"
- Features:** \*RST value: ON  
SCPI: device-specific
- Modes:** A, VA, BTS, MS

**DISPlay:CMAP<1 to 13>:DEFault**

This command resets the screen colors of the instrument to their default settings.

**Example:** "DISP:CMAP:DEF"  
**Features:** \*RST value: --  
 SCPI: conforming  
**Modes:** A, VA, BTS, MS

This command is an event and has thus no query and no \*RST value assigned. The numeric suffix in CMAP<1 to 13> is not significant.

**DISPlay:CMAP<1 to 13>:HSL <hue>,<sat>,<lum>**

This command defines the color table of the instrument.

**Parameter:** hue = TINT  
 sat = SATURATION  
 lum = BRIGHTNESS  
 The value range is 0.0 to 100.0 for all parameters.

**Example:** "DISP:CMAP2:HSL 0.3,0.8,1.0"  
**Features:** \*RST value: --  
 SCPI: conforming  
**Modes:** A, VA, BTS, MS

To each numeric suffix of CMAP is assigned one or several picture elements which can be modified by varying the corresponding color setting. The following assignment applies:

CMAP1	Trace 1	CMAP8	Softkey State Data Entry
CMAP2	Trace 2	CMAP9	Softkey State OFF
CMAP3	Trace 3	CMAP10	Softkey Shade
CMAP4	Trace 4	CMAP11	Text
CMAP5	Marker	CMAP12	Title
CMAP6	Grid	CMAP13	Background
CMAP7	Softkey State On		

The values set are not changed by \*RST.

**DISPlay:CMAP<1 to 13>:PDEFined** BLACK | BLUE | BROWn | GREen | CYAN | RED | MAGenta |  
 YELLow | WHITe | DGRAY | LGRAY | LBLUe | LGREen |  
 LCYan | LRED | LMAGenta

This command defines the color table of the instrument using predefined color values. To each numeric suffix of CMAP is assigned one or several picture elements which can be modified by varying the corresponding color setting. The same assignment as for DISPlay:CMAP<1 to 13>:HSL applies.

**Example:** "DISP:CMAP2:PDEF GRE"  
**Features:** \*RST value: --  
 SCPI: conforming  
**Modes:** A, VA, BTS, MS

The values set are not changed by \*RST.

**DISPlay[:WINDow<1|2>]:MINFo** ON | OFF

This command switches the marker info list on the screen on or off.

**Example:**           "DISP:MINF ON"  
**Features:**        \*RST value:   OFF  
                       SCPI:           device-specific  
**Modes:**           A, VA, BTS, MS

**DISPlay[:WINDow<1|2>]:TEXT[:DATA]** <string>

This command defines a comment (max. 50 characters) which can be displayed on the screen.

**Example:**           "DISP:TEXT "signal/noise power measurement"  
**Features:**        \*RST value:   "" (empty)  
                       SCPI:           conforming  
**Modes:**           A, VA, BTS, MS

The numeric suffix in WINDow<1|2> is not significant.

**DISPlay[:WINDow<1|2>]:TEXT:STATe** ON | OFF

This command switches on or off the screen display of the comment.

**Example:**           "DISP:TEXT:STAT ON"  
**Features:**        \*RST value:   OFF  
                       SCPI:           conforming  
**Modes:**           A, VA, BTS, MS

The numeric suffix in WINDow<1|2> is not significant.

**DISPlay[:WINDow<1|2>]:TIME** ON | OFF

This command switches on or off the screen display of date and time.

**Example:**           "DISP:TIME ON"  
**Features:**        \*RST value:   OFF  
                       SCPI:           device-specific  
**Modes:**           A, VA, BTS, MS

The numeric suffix in WINDow<1|2> is not significant.

**DISPlay[:WINDow<1|2>]:TRACe<1 to 4>:X[:SCALE]:RVALue** <numeric\_value>

This command defines the reference value for the X-axis of the measuring diagram.

**Example:**           "DISP:TRAC:X:RVAL 20SYM"  
**Features:**        \*RST value:   -  
                       SCPI:           device-specific  
**Mode:**           VA-D

**DISPlay[:WINDow<1|2>]:TRACe<1 to 4>:X[:SCALe]:ZOOM ON | OFF**

This command displays the zoomed current frequency range in the opposite window of the split screen representation.

**Example:**           "DISP:TRAC:X:ZOOM ON"

**Features:**        \*RST value:    OFF  
                  SCPI:            device-specific

**Mode:**            A-F

The numeric suffix in TRACe<1 to 4> is not significant.

**DISPlay[:WINDow<1|2>]:TRACe<1 to 4>:X[:SCALe]:ZOOM[:FREQuency]:STARt <numeric\_value>**

This command defines the start frequency of the zoomed display range. The value must lie between start and stop frequency of the original range.

**Example:**           "DISP:TRAC:X:ZOOM:STAR 100MHZ"

**Features:**        \*RST value:    -- (depending on the current frequency setting)  
                  SCPI:            device-specific

**Mode:**            A-F

The numeric suffix in TRACe<1 to 4> is not significant.

**DISPlay[:WINDow<1|2>]:TRACe<1 to 4>:X[:SCALe]:ZOOM[:FREQuency]:STOP <numeric\_value>**

This command defines the stop frequency of the zoomed display range. The value must lie between start and stop frequency of the original range.

**Example:**           "DISP:TRAC:X:ZOOM:STOP 200MHZ"

**Features:**        \*RST value:    -- (depending on the current frequency setting)  
                  SCPI:            device-specific

**Mode:**            A-F

The numeric suffix in TRACe<1 to 4> is not significant.

**DISPlay[:WINDow<1|2>]:TRACe<1 to 4>:X[:SCALe]:ZOOM[:FREQuency]:CENTer <numeric\_value>**

This command shifts the zoomed frequency range to the specified center frequency.

**Example:**           "DISP:TRAC:X:ZOOM:CENT 1GHZ"

**Features:**        \*RST value:    -- (depending on the current frequency setting)  
                  SCPI:            device-specific

**Mode:**            A-F

The numeric suffix in TRACe<1 to 4> is not significant.

**DISPlay[:WINDow<1|2>]:TRACe<1 to 4>:X:SPACing** LINear | LOGarithmic

This command toggles between linear and logarithmic display.

**Example:** "DISP:TRAC:X:SPAC LIN"

**Features:** \*RST value: LOGarithmic  
SCPI: conforming

**Mode:** A

The numeric suffix in TRACe<1 to 4> is not significant.

**DISPlay[:WINDow<1|2>]:TRACe<1 to 4>:Y[:SCALe]** 10dB to 200dB

This command defines the display range of the Y-axis (level axis) with logarithmic scaling (DISP:TRAC:Y:SPAC LOG).

**Example:** "DISP:TRAC:Y 110dB"

**Features:** \*RST value: 100dB  
SCPI: device-specific

**Mode:** A

For linear scaling, (DISP:TRAC:Y:SPAC LIN | PERC) the display range is fixed and cannot be set. The numeric suffix in TRACe<1 to 4> is not significant.

**DISPlay[:WINDow<1|2>]:TRACe<1 to 4>:Y[:SCALe]:MODE** ABSolute | RELative

This command defines the scale of the y-axis (absolute or relative).

**Example:** "DISP:TRAC:Y:MODE REL"

**Features:** \*RST value: ABS  
SCPI: device-specific

**Mode:** A

As long as SYSTem:DISPlay is set to OFF, this command does not directly influence the screen. The numeric suffix in TRACe<1 to 4> is not significant.

**DISPlay[:WINDow<1|2>]:TRACe<1 to 4>:Y[:SCALe]:RLEVEL** -200dBm to 200dBm

This command defines the reference level.

**Example:** "DISP:TRAC:Y:RLEV -60dBm"

**Features:** \*RST value: -20dBm  
SCPI: conforming

**Modes:** A, VA

The numeric suffix in TRACe<1 to 4> is not significant.



**DISPlay[:WINDow<1|2>]:TRACe<1 to 4>:Y[:SCALe]:RLEVel:OFFSet** -200dB to 200dB

This command defines the offset of the reference level.

**Example:** "DISP:TRAC:Y:RLEV:OFFS -10dB"

**Features:** \*RST value: 0dB  
SCPI: conforming

**Modes:** A, VA

The numeric suffix in TRACe<1 to 4> is not significant.

**DISPlay[:WINDow<1|2>]:TRACe<1 to 4>:Y[:SCALe]:RVALue** <numeric\_value>

This command defines the reference value for the y-axis of the measurement diagram.

This defines the upper limit of the display range, the corresponding parameters of the manual control vary according to the measurement mode.

In the spectrum analysis mode the setting corresponds to the parameter MAX LEVEL.

In the vector signal analysis mode the setting corresponds to the parameter REFERENCE VALUE Y AXIS.

IF option tracking generator is fitted and the normalization in the analyzer mode is activated, the value corresponds to the parameter REFERENCE VALUE.

**Example:** "DISP:TRAC:Y:RVAL -20dBm" (spectrum analysis)  
"DISP:TRAC:Y:RVAL +1.20" (vector signal analysis)  
"DISP:TRAC:Y:RVAL 0" (tracking generator)

**Features:** \*RST value: - coupled to reference level  
0 (vector signal analysis)  
0 dB (tracking generator with active normalization)  
SCPI: device specific

**Modes:** A, VA

The numeric suffix in TRACe<1 to 4> is not significant.

**DISPlay[:WINDow<1|2>]:TRACe<1 to 4>:Y[:SCALe]:RVALue:AUTO** ON | OFF

This command defines whether the reference value for the y-axis of the measured diagram is coupled to the reference level (default) or can be set independently.

**Example:** "DISP:TRAC:Y:RVAL:AUTO ON"

**Features:** \*RST value: ON  
SCPI: device-specific

**Mode:** A

This command is available in the analyzer mode only. The numeric suffix in TRACe<1 to 4> is not significant.

**DISPlay[:WINDow<1|2>]:TRACe<1 to 4>:Y[:SCALE]:RPOsition** 0 to 100PCT

This command defines the position of the reference value.

**Example:** "DISP:TRAC:Y:RPOS 50PCT"  
**Features:** \*RST value: 100PCT (tracking generator)  
 50PCT (vector analyzer)  
 SCPI: conforming  
**Modes:** A, VA

The numeric suffix in TRACe<1 to 4> is not significant. This command is only valid in conjunction with option Tracking Generator or in vector analyzer mode.

**DISPlay[:WINDow<1|2>]:TRACe<1 to 4>:Y[:SCALE]:PDIVision** <numeric\_value>

This command defines the scaling of the Y-axis in the current unit.

**Example:** "DISP:TRAC:Y:PDIV +1.20"  
**Features:** \*RST value: -  
 SCPI: conforming  
**Mode:** VA

The numeric suffix in TRACe<1 to 4> is not significant.

**DISPlay[:WINDow<1|2>]:TRACe<1 to 4>:Y:SPACing** LINear | LOGarithmic | PERCent

This command toggles between linear and logarithmic display.

**Example:** "DISP:TRAC:Y:SPAC LIN"  
**Features:** \*RST value: LOGarithmic  
 SCPI: conforming  
**Mode:** A

The linear display can be LIN/% (PERCent) or LIN/dB (LINear). The numeric suffix in TRACe<1 to 4> is not significant.

**DISPlay[:WINDow<1|2>]:TRACe<1 to 4>:MODE** WRITe | VIEW | AVERAge | MAXHold | MINHold

This command defines the type of display and the evaluation of the traces.

**Example:** "DISP:TRAC3:MODE MAXH"  
**Features:** \*RST value: WRITe for TRACe1, STATe OFF for TRACe2 to 4  
 SCPI: device-specific  
**Modes:** A, VA, BTS, MS

**DISPlay[:WINDow<1|2>]:TRACe<1 to 4>:MODE:CWRite** ON | OFF

This command selects continuous display of the measured values (continuous write).

**Example:** "DISP:TRAC3:MODE:CWR ON"  
**Features:** \*RST value: OFF  
 SCPI: device-specific  
**Mode:** VA

**DISPlay[:WINDow<1|2>]:TRACe<1 to 4>:MODE:ANALog** ON | OFF

This command selects continuous display of the measured values in the analyzer mode (analog trace).

**Example:** "DISP:TRAC3:MODE:ANAL ON"

**Features:** \*RST value: OFF  
SCPI: device-specific

**Mode:** A

**DISPlay[:WINDow<1|2>]:TRACe<1 to 4>:MODE:HCONTinuous** ON | OFF

This command defines whether the traces in the min hold/max hold mode are reset after some definite parameter changes.

**Example:** "DISP:TRAC3:MODE:HCON ON"

**Features:** \*RST value: OFF  
SCPI: device-specific

**Mode:** A

OFF The traces are reset after some definite parameter changes.

ON This mechanism is switched off.

In general, parameter changes require a restart of the measurement before results are evaluated (e.g. with markers). For those changes that are known to require a new measurement (e.g. modification of the span), the trace is automatically reset so that erroneous evaluations of previous results are avoided. This mechanism can be switched off for those exceptional cases where the described behavior is unwelcome.

**DISPlay[:WINDow<1|2>]:TRACe<1 to 4>[:STATe]** ON | OFF

This command switches the display of the corresponding trace on or off.

**Example:** "DISP:TRAC3 ON"

**Features:** \*RST value: ON for TRACe1, OFF for TRACe2 to 4  
SCPI: conforming

**Modes:** A, VA, BTS, MS

**DISPlay[:WINDow<1|2>]:TRACe<1 to 4>:SYMBol** DOTS | BARS | OFF

This command determines the display of the points of decision on the trace.

**Example:** "DISP:TRAC:SYMB BARS"

**Features:** \*RST value: OFF  
SCPI: device-specific

**Mode:** VA-D

**DISPlay:WINDow<1|2>:TRACe<1 to 4>:EYE:COUNT** 1 to Result Length

This command determines the display range of the eye diagram in symbols.

**Example:** "DISP:TRAC:EYE:COUNT 5"

**Features:** \*RST value: 2  
SCPI: device-specific

**Mode:** VA-D

**DISPlay:PSAVe[:STATe]** ON | OFF

This command switches the screen saver mode on or off.

**Example** "DISP:PSAV ON"

**Features:** \*RST value: OFF  
SCPI: device-specific

**Modes:** A, VA, BTS, MS

**DISPlay:PSAVe:HOLDoff** <numeric\_value>

This command determines the time after which the screen saver is switched on. Values are input in minutes, the valid range is 1 to 100 minutes.

**Example:** "DISP:PSAV:HOLD 10"

**Features:** \*RST value: 1  
SCPI: device-specific

**Modes:** A, VA, BTS, MS

## FETCh Subsystem

The FETCh subsystem contains commands for reading out results of complex measurement tasks like those provided by options GSM BTS Analyzer, FSE-K11, or GSM MS Analyzer, FSE-K10. The FETCh-subsystem is closely linked to the functions of the CONFigure and READ-subsystems, where the measurement sequences are configured, the measurements are started and their results are queried.

### FETCh:BURSt Subsystem

This subsystem provides the commands for reading out results of measurements in the GSM BTS (option FSE-K11) or GSM MS (option FSE-K10) Analyzer mode, which are performed on individual bursts (Carrier Power, Phase/Frequency Error) without starting the measurement by themselves.

COMMAND	PARAMETERS	UNIT	COMMENT
FETCh			Option FSE-K11 or FSE-K10
:BURSt			
:PERRor			
:RMS			
:STATus?			query only
:AVERage?	--		query only
:MAXimum?	--		query only
:PEAK			
:STATus?			query only
:AVERage?	--		query only
:MAXimum?	--		query only
:FERRor			
:STATus?			query only
:AVERage?	--		query only
:MAXimum?	--		query only
:POWer	--		
[:IMMEDIATE]?	--		query only
:ALL?	--		query only

#### FETCh:BURSt:PERRor:RMS:STATus?

This command reads out the status of the RMS-measurement of the phase error taken over the selected number of bursts.

0: failed, 1: passed

**Example:** "FETC:BURS:PERR:RMS:STAT?"

**Features:** \*RST value: --  
SCPI: device-specific

**Modes:** BTS, MS

If no measurement has been performed yet, a query error results.

This command is a query and has therefore no \*RST value assigned.

It is available only when measurement of the phase/frequency error is selected (see CONFigure:BURSt:PFERRor).

**FETCh:BURSt:PERRor:RMS:AVERAge?**

This command reads out the average of the RMS-measurement of the phase error taken over the selected number of bursts.

**Example:** "FETC:BURS:PERR:RMS:AVER?"

**Features:** \*RST value: --  
SCPI: device-specific

**Modes:** BTS, MS

If no measurement has been performed yet, a query error results.  
This command is a query and has therefore no \*RST value assigned.  
It is available only when measurement of the phase/frequency error is selected (see `CONFigure:BURSt:PFERror`).

**FETCh:BURSt:PERRor:RMS:MAXimum?**

This command reads out the maximum of the RMS-measurement of the phase error for the selected number of bursts.

**Example:** "FETC:BURS:PERR:RMS:MAX?"

**Features:** \*RST value: --  
SCPI: device-specific

**Modes:** BTS, MS

If no measurement has been performed yet, a query error results.  
This command is a query only and therefore has no \*RST value assigned. It is available only when measurement of the phase/frequency error is selected (see `CONFigure:BURSt:PFERror`).

**FETCh:BURSt:PERRor:PEAK:STATus?**

This command reads out the status of the peak measurement of the phase error taken over the selected number of bursts.

0: failed, 1: passed

**Example:** "FETC:BURS:PERR:PEAK:STAT?"

**Features:** \*RST value --  
SCPI: device-specific

**Modes:** BTS, MS

If no measurement has been performed yet, a query error results.  
This command is a query only and therefore has no \*RST value assigned. It is available only if measurement of the phase/frequency error is selected (see `CONFigure:BURSt:PFERror`).

**FETCh:BURSt:PERRor:PEAK:AVERage?**

This command reads out the average of the peak measurement of the phase error taken over the selected number of bursts.

**Example:** "FETC:BURS:PERR:PEAK:AVER?"

**Features:** \*RST value: --  
SCPI: device-specific

**Modes:** BTS, MS

If no measurement has been performed yet, a query error results.

This command is a query only and therefore has no \*RST value assigned. It is available only if measurement of the phase/frequency error is selected (see `CONFigure:BURSt:PFERror`).

**FETCh:BURSt:PERRor:PEAK:MAXimum?**

This command reads out the maximum of the peak measurement of the phase error for the selected number of bursts.

**Example:** "FETC:BURS:PERR:PEAK:MAX?"

**Features:** \*RST value: --  
SCPI: device-specific

**Modes:** BTS, MS

If no measurement has been performed yet, a query error results.

This command is a query only and therefore has no \*RST value assigned. It is available only when measurement of the phase/frequency error is selected (see `CONFigure:BURSt:PFERror`).

**FETCh:BURSt:FERRor:STATus?**

This command reads out the status of the measurement of the frequency error taken over the selected number of bursts.

0: failed, 1: passed

**Example:** "FETC:BURS:FERR:STAT?"

**Features:** \*RST value: --  
SCPI: device specific

**Modes:** BTS, MS

If no measurement has been performed yet, a query error results.

This command is a query only and therefore has no \*RST value assigned. It is available only if measurement of the phase/frequency error is selected (see `CONFigure:BURSt:PFERror`).

**FETCh:BURSt:FERRor:AVERage?**

This command reads out the average of the measurement of the frequency error taken over the selected number of bursts.

**Example:** "FETC:BURS:FERR:AVER?"  
**Features:** \*RST value: --  
 SCPI: device-specific  
**Modes:** BTS, MS

If no measurement has been performed yet, a query error results.  
 This command is a query only and therefore has no \*RST value assigned. It is available only if measurement of the phase/frequency error is selected (see CONFigure:BURSt:PFERror).

**FETCh:BURSt:FERRor:MAXimum?**

This command reads out the maximum frequency error measured over the selected number of bursts.

**Example:** "FETC:BURS:FERR:MAX?"  
**Features:** \*RST value: --  
 SCPI: device-specific  
**Modes:** BTS, MS

If no measurement has been performed yet, a query error results.  
 This command is a query only and therefore has no \*RST value assigned. It is available only if measurement of the phase/frequency error is selected (see CONFigure:BURSt:PFERror).

**FETCh:BURSt:POWer[:IMMediate]?**

This command reads out the result of the last step performed during the measurement of the output power of the base station or mobile.

**Parameter:** The result is output as an ASCII string in the following format:  
 <Static Power Ctrl>,<Dyn Power Ctrl>,<Rat-Level>,<Act-Level>,<Delta>,<Status>  
 with

<Static Power Ctrl>: current static power control level  
 <Dyn Power Ctrl>: current dynamic power control level  
 <Rat-Level>: Rated value for the current power control level acc. to standard dBm  
 <Act-Level>: measured power in dBm  
 <Delta>: Difference between the measured power and the power at the previous static/dynamic power control level.  
 <Status>: Result of limit check in character data form:  
 PASSED no limits exceeded  
 FAILED limit exceeded

**Example:** "FETC:BURS:POW?"  
 Result: 0,0,43,44.1,0,PASSED  
**Features:** \*RST value: --  
 SCPI: device-specific

**Modes:** BTS, MS

If no measurement has been performed yet, a query error results.  
 This command is a query only and therefore has no \*RST value assigned. It is available only if measurement of the phase/frequency error is selected (see CONFigure:BURSt:PFERror).



**FETCh:BURSt:POWer:ALL?**

This command reads out the results of all individual steps during the measurement of the output power of the base station or mobile.

**Parameter:** The result is output as an ASCII string in the following format:

<Static Power Ctrl>,<Dyn Power Ctrl>,<Rat-Level>,<Act-Level>, <Delta>,<Status>

with

<Static Power Ctrl>: current static power control level  
 <Dyn Power Ctrl>: current dynamic power control level  
 <Rat-Level>: Rated value for the current power control level acc. to standard dBm  
 <Act-Level>: measured power in dBm  
 <Delta>: Difference between the measured power and the power at the previous static/dynamic power control level.  
 <Status>: Result of limit check in character data form:  
 PASSED no limits exceeded  
 FAILED limit exceeded

**Example:** "FETC:BURSt:POW:ALL?"  
 Result:  
 0,0,43,44.1,0,PASSED,1,0,41,42.5,1.6,PASSED,1,1,35,32.5,5.6,FAILED

**Features:** \*RST value: --  
 SCPI: device-specific

**Modes:** BTS, MS

If no measurement has been performed yet, a query error results.  
 This command is a query only and therefore has no \*RST value assigned. It is available only if measurement of the phase/frequency error is selected (see `CONFigure:BURSt:PFERror`).

## FETCh:SPECTrum Subsystem

This subsystem provides the commands for reading out results of measurements in the GSM BTS (FSE-K11) or GSM MS (FSE-K10) Analyzer mode, used to measure the power of the spectral contributions due to modulation and switching (modulation spectrum, transient spectrum) without first restarting a new measurement.

COMMAND	PARAMETERS	UNIT	COMMENT
FETCh			Option FSE-K11 or FSE-K10
:SPECTrum			
:MODulation			
[:ALL]?	ARFCn   TXBand   RXBand   COMBined   DCSRx1800		query only
:REFerence?			query only
:SWITChing			
[:ALL]?	--		query only
:REFerence?			query only

### FETCh:SPECTrum:MODulation[:ALL]? ARFCn | TXBand | RXBand | COMBined | DCSRx1800

This command reads out the result of the measurement of the modulation spectrum of the base station or mobile.

**Parameter:** The result is output as a list of partial result strings separated by ',' in the following (ASCII) format:

```
<Index>,<Freq1>,<Freq2>,<Level>,<Limit>, <Abs/Rel>,<Status> [,
<Index>,<Freq1>,<Freq2>,<Level>,<Limit>, <Abs/Rel>,<Status>]...
```

where the parts between '['...''] denote a partial result string that can be repeated n times.

<Index>: 0, if the partial result string characterizes a measurement range  
current number <>0,  
if the partial result string characterizes a single  
limit excess.

<Freq1>: Start frequency of the measurement range or  
frequency where the limit line is exceeded

<Freq2>: Start frequency of the measurement range or  
frequency exceeding the measurement range. The value of  
<Freq2> is equal to the value of <Freq1>, if either the  
measurement is performed in the time domain or if the  
partial result string contains a limit excess.

<Level>: Measured maximum level of the partial range or  
measured level at the test point.

<Limit>: Limit in the partial range or at the test point

<Abs/Rel>: ABS <Level> and <Limit> are in absolute units (dBm)  
REL <Level> and <Limit> are in relative units (dBm)

<Status>: Result of the limit check in character data form:  
PASSED no limit exceeded  
FAILED limit exceeded  
MARGIN margin exceeded  
EXC limit excess marked as an exception

The frequencies <Freq1> and <Freq2> are always absolute i. e. not referred to the carrier frequency.

**Example:** "FETC:SPEC:MOD? TXB"  
**Result:** 0,890E6,915E6,-87.4,-108.0,ABS,FAILED,  
 1,893.2E6,893.2E6,-83.2,-108.0,ABS,FAILED,  
 2,895.7E6,895.7E6,-87.4,-108.0,ABS,FAILED

**Features:** \*RST value: --  
 SCPI: device-specific

**Modes:** BTS, MS

ARFCn ARFCN ± 1.8 MHz  
 TXBand TX-Band  
 RXBand RX-Band  
 COMBined ARFCN ± 1.8 MHz / TX-Band (option FSE-K11 only)  
 DCSRx1800 RX band DCS 1800 (option FSE-K10 only)

If no measurement has been performed yet, a query error results.  
 This command is a query only and therefore has no \*RST value assigned. It is available only if measurement of the modulation spectrum is selected (see CONFigure:SPECTrum:MODulation).

**FETCh:SPECTrum:MODulation:REference?**

This command reads out the result of the premeasurement.

**Parameter:** The result is output as a list of partial result strings separated by ',' in the following (ASCII) format:

<Level1>,<Level2>,<RBW>  
 <Level1>: measured level  
 <Level2>: level corrected by means of the bandwidth  
 <RBW>: bandwidth

**Example:** "FETC:SPEC:MOD:REF?"  
**Result:** 36.2,43.2,30000

**Features:** \*RST value: --  
 SCPI: device-specific

**Modes:** BTS, MS

If no measurement has been performed yet, a query error results.  
 This command is a query only and therefore has no \*RST value assigned. It is available only if measurement of the modulation spectrum is selected (see CONFigure:SPECTrum:MODulation).

**FETCh:SPECTrum:SWITching[:ALL]?**

This command reads out the result of the measurement of the transient spectrum of the base station or mobile.

**Parameter:** The result is output as a list of partial result strings separated by ',' as for the command `FETCh:SPECTrum:MODulation[:ALL]?`.

**Example:** "FETC:SPEC:SWIT?"  
**Result:** 0,833.4E6,833.4E6,37.4,-36.0,ABS,MARGIN,  
 1,834.0E6,834.0E6,-35.2,-36.0,ABS,FAILED,  
 2,834.6E6,834.6E6,-74.3,-75.0,REL,FAILED  
 0,835.0E6,835.0E6,-65,0,-60.0,REL,PASSED

**Features:** \*RST value: --  
 SCPI: device-specific

**Modes:** BTS, MS

If no measurement has been performed yet, a query error results.

This command is a query only and therefore has no \*RST value assigned. It is available only if measurement of the transient spectrum is selected (see `CONFigure:SPECTrum:SWITching`).

**FETCh:SPECTrum:SWITching:REFerence?**

This command queries the result of the premeasurement

**Parameter:** The result is output as a list of partial result strings separated by ',' in the following (ASCII) format:

<Level1>,<Level2>,<RBW>  
 <Level1>: measured level  
 <Level2>: level corrected by means of the bandwidth  
 <RBW>: bandwidth

**Example:** "FETC:SPEC:SWIT:REF?"  
**Result:** 43.2,43.2,300000

**Features:** \*RST value --  
 SCPI: device specific

**Modes:** BTS, MS

If no measurement has been performed yet, a query error results.

This command is a query only and therefore has no \*RST value assigned. It is available only if measurement of the transient spectrum is selected (see `CONFigure:SPECTrum:SWITching`).

## FETCh:SPURious Subsystem

This subsystem provides the commands for reading out results of measurements in the GSM BTS (FSE-K11) or GSM MS (FSE-K10) Analyzer mode which are used to determine spurious emissions, without first restarting a new measurement.

COMMAND	PARAMETERS	UNIT	COMMENT
FETCh :SPURious [:ALL]? :STEP?	TXBand   OTXBand   RXBand   IDLeband --		Option FSE-K11 or FSE-K10  query only  query only

### FETCh:SPURious[:ALL]? TXBand | OTXBand | RXBand | IDLeband

This command reads out the results of the measurement of spurious emissions of the base station or mobile which is performed in the LIST mode.

**Parameter:** The result is output as a list of partial result strings separated by ',' in the following (ASCII) format:

<Index>,<Freq1>,<Freq2>,<Level>,<Limit>, <Abs/Rel>,<Status> [,  
<Index>,<Freq1>,<Freq2>,<Level>,<Limit>, <Abs/Rel>,<Status>]...

where the parts between '['...']' denote a partial result string that can be repeated n times.

<Index>: 0, if the partial result string characterizes a measurement range  
current number <>0,  
if the partial result string characterizes a single  
limit excess.

<Freq1>: Start frequency of the measurement range or  
frequency where the limit line is exceeded

<Freq2>: Start frequency of the measurement range or  
frequency exceeding the measurement range. The value of  
<Freq2> is equal to the value of <Freq1>, if either the  
measurement is performed in the time domain or if the  
partial result string contains a limit excess.

<Level>: Measured maximum level of the partial range or  
measured level at the test point.

<Limit>: Limit in the partial range or at the test point

<Abs/Rel>: ABS <Level> and <Limit> are in absolute units (dBm)  
REL <Level> and <Limit> are in absolute units (dBm)

<Status>: Result of the limit check in character data form:  
PASSED no limit exceeded  
FAILED limit exceeded  
MARGIN margin exceeded

**Example:** "FETC:SPUR? TXB"  
**Result:** 0,890E6,915E6,-87.4,-108.0,ABS,FAILED,  
 1,893.2E6,893.2E6,-83.2,-108.0,ABS,FAILED,  
 2,895.7E6,895.7E6,-87.4,-108.0,ABS,FAILED

**Features:** \*RST value: --  
 SCPI: device-specific

**Modes:** BTS, MS

TXBand TX-band  
 OTXBand Not TX-band  
 RXBand RX-band (option FSE-K11 only)  
 IDLeband Idle band (option FSE-K10 only)

If no measurement has been performed yet, a query error results.

This command is a query only and therefore has no \*RST value assigned. It is available only if measurement of the spurious emissions is selected (see CONFigure:SPURious).

### FETCh:SPURious:STEP?

This command reads out the result of the last single step of the measurement of spurious emissions performed in the STEP mode.

**Parameter:** The result is output as a list of partial result strings separated by ',' as for the command FETCh:SPURious[:ALL]?

**Example:** "FETC:SPUR:STEP?"  
**Result:** 0,890E6,915E6,-87.4,-108.0,ABS,FAILED,  
 1,893.2E6,893.2E6,-83.2,-108.0,ABS,FAILED,  
 2,895.7E6,895.7E6,-87.4,-108.0,ABS,FAILED

**Features:** \*RST value: --  
 SCPI: device-specific

**Modes:** BTS, MS

If no measurement has been performed yet, a query error results.

This command is a query only and therefore has no \*RST value assigned. It is available only if measurement of the spurious emissions is selected (see CONFigure:SPURious).

## FETCh:PTEMplate Subsystem

This subsystem provides the commands for reading out results of measurements in the GSM BTS (FSE-K11) or GSM MS (FSE-K10) Analyzer mode which are used to determine the carrier power of , power versus time measurement without first restarting a new measurement.

COMMAND	PARAMETER	UNIT	COMMENT
FETCh :PTEMplate :REFerence?			Option FSE-K11, FSE-K10  query only

### FETCh:PTEMplate:REFerence?

This command reads out the results of the premeasurement

**Parameter:** The result is output as a list of partial result strings separated by ',' in the following (ASCII) format:

<Level1>,<Level2>,<RBW>

<Level1>: measured level

<Level2>: level corrected by means of the bandwidth

<RBW>: bandwidth

**Example:** "FETCh:PTEM:REF?"  
Result: 43.2,43.2,1000000

**Features:** \*RST value: --  
SCPI: devicespecific

**Modes:** BTS, MS

If no measurement has been performed yet, a query error results.

This command is a query only and therefore has no \*RST value assigned. It is available only if measurement of Power versus Time is selected (see CONFigure:BURSt:PTEMplate).





**FORMat:DEXPort:DSEParator POINt|COMMA**

This command determines the decimal separator (decimal point or comma) for the output of the measurement data in ASCII format. Thus, evaluation programmes (i.e. MS-Excel) of different language versions are supported.

**Example:**           "FORM:DEXP:DSEP POIN  
**Features:**        \*RST value:    POINT  
                  SCPI:            device specific  
**Modes:**            A, VA, BTS, MS

**FORMat:DEXPort:HEADer[:STATe] ON|OFF**

This command determines if the output file starts with a header (start frequency, sweep time, detector, .. = ON) or not. OFF = only measurement data is output.

**Example:**           "FORM:DEXP:HEAD OFF  
**Features:**        \*RST value:    ON  
                  SCPI:            device specific  
**Modes:**            A, VA, BTS, MS

**FORMat:DEXPort:APPend[:STATe] ON|OFF**

This command determines if the output file is overwritten or the data is added to the end of the file.

**Example:**           "FORM:DEXP:APP OFF  
**Features:**        \*RST value:    ON  
                  SCPI:            device-specific  
**Modes:**            A, VA, BTS, MS

## HCOPY Subsystem

The HCOpy subsystem controls the output of display information for documentation purposes on output devices or files.

COMMAND	PARAMETERS	UNIT	COMMENT
HCOPY			
:ABORt	--		no query
:DESTination<1 2>	'SYST:COMM:PRIN'  'SYST:COMM:CLIP'   'MMEM'		no query
:DEvice			
:COLor	<Boolean>		
:LANGUage<1 2>	WMF   GDI   EWMF   BMP		
[:IMMediate<1 2>]	--		no query
:ITEM			
:ALL			no query
:FFEed<1 2>			
:STATe	<Boolean>		
:LABEL			
:TEXT	<string>		
:PFEed<1 2>			
:STATe	<Boolean>		
:WINDow<1 2>			
:TABLE			
:STATe	<Boolean>		
:TEXT	<string>		
:TRACe			
:STATe	<Boolean>		
:CAINcrement	<Boolean>		
:PAGE			
:DIMensions			
:QUADrant<1 to 4>			no query
:FULL			no query
:ORientation<1 2>	LANDscape   PORTrait		

### HCOPY:ABORt

This command aborts a running hardcopy output.

**Example:** "HCOP : ABOR "

**Features:** \*RST value: -  
SCPI: conforming

**Modes:** A, VA, BTS, MS

This command is an event which is why it is not assigned an \*RST value and no query.

**HCOPY:DESTination<1|2> <string>**

This command selects the device for outputting the hardcopy. The availability of the parameters depends on the selected data format (see command `HCOPY:DEVIce:LANGuage`).

**Parameter:** <string>::= 'MMEM' |  
'SYST:COMM:PRIN' |  
'SYST:COMM:CLIP'

**Example:** "HCOP:DEST2 'MMEM' "

**Features:** \*RST value: -  
SCPI: conforming

**Modes:** A, VA, BTS, MS

This command is an event which is why it is not assigned an \*RST value and no query.

- 'MMEM' creates a file for the hardcopy output. Command `MMEM:NAME <file_name>` defines the file name. All formats can be selected for `HCOPY:DEVIce:LANGuage`.
- 'SYST:COMM:PRIN' directs the hardcopy to the printer. The printer is selected with command `SYSTEM:COMMunicate:PRINter:SElect`. `GDI` should be selected for `HCOPY:DEVIce:LANGuage`.
- 'SYST:COMM:CLIP' directs the hardcopy to the clipboard. `EWMF` should be selected for `HCOPY:DEVIce:LANGuage`.

**HCOPY:DEVIce:COLor ON|OFF**

This command selects between color and monochrome hardcopy of the screen.

**Example:** "HCOP:DEV:COL ON"

**Features:** \*RST value: OFF  
SCPI: conforming

**Modes:** A, VA, BTS, MS

**HCOPY:DEVIce:LANGuage<1|2> WMF|EWMF|GDI|BMP**

This command determines the data format of the printout.

**Example:** "HCOP:DEV:LANG WMF"

**Features:** \*RST value: -  
SCPI: conforming

**Modes:** A, VA, BTS, MS

- WMF and EWMF (WINDOWS Metafile and Enhanced Metafile Format) Data formats for output files which can at a later time be integrated in corresponding programs for documentation purposes.
- BMP (Bitmap) Data format for output files.
- GDI (Graphics Device Interface) Default format for the output to a printer configured under Windows. For the output file the printer driver configured under Windows is used and thus a printer-specific format is generated.

**HCOPY[:IMMEDIATE<1|2>]**

This command starts a hardcopy output.

**Example:** "HCOP "

**Features:** \*RST value: -  
SCPI: conforming

**Modes:** A, VA, BTS, MS

HCOP [1] starts the hardcopy output to device 1 (default), HCOP2 starts the output to device 2. This command is an event which is why it is not assigned an \*RST value and has no query.

**HCOPY:DEVICE:ITEM:ALL**

This command selects the complete screen to be output.

**Example:** "HCOP:DEV:ITEM:ALL"

**Features:** \*RST value: OFF  
SCPI: conforming

**Modes:** A, VA, BTS, MS

The hardcopy output is always provided with comments, title, time and date. As an alternative to the whole screen, only traces (commands 'HCOPY:DEVICE:WINDOW:TRACE:STATE ON') or tables (command 'HCOPY:DEVICE:WINDOW:TABLE:STATE ON') can be output.

**HCOPY:DEVICE:ITEM:FFEEd<1|2>:STATE ON|OFF**

The command adds a form feed command to the hardcopy output of the screen.

**Example:** "HCOP:DEV:ITEM:FFE2:STAT ON"

**Features:** \*RST value: OFF  
SCPI: conforming

**Modes:** A, VA, BTS, MS

**HCOPY:DEVICE:ITEM:LABEL:TEXT <string>**

This command defines the title of the screen with a maximum of 60 characters.

**Example:** "HCOP:DEV:ITEM:LAB:TEXT 'My Title' "

**Features:** \*RST value: OFF  
SCPI: conforming

**Modes:** A, VA, BTS, MS

**HCOPY:DEVIce:ITEM:PFEed<1|2>:STATe ON|OFF**

This command adds a paper feed command to the hardcopy output of the screen (ON).

**Example:** "HCOP:DEV:ITEM:PFE2:STAT ON"

**Features:** \*RST value: OFF  
SCPI: device-specific

**Modes:** A, VA, BTS, MS

**HCOPY:DEVIce:ITEM:WINDow<1|2>:TABLe:STATe ON | OFF**

This command selects the output of the currently displayed tables (ON).

**Example:** "HCOP:DEV:ITEM:WIND:TABL:STAT ON"

**Features:** \*RST value: OFF  
SCPI: device-specific

**Modes:** A, VA, BTS, MS

The command `HCOPY:DEVIce:ITEM:WINDow<1|2>:TABLe:STATe OFF` same as command `HCOPY:DEVIce:ITEM:ALL` enables the output of the whole screen.

**HCOPY:DEVIce:ITEM:WINDow<1|2>:TEXT <string>**

This command defines the comment text for printout to trace 1 or 2 with a maximum of 100 characters.

**Example:** "HCOP:DEV:ITEM:WIND2:TEXT 'comment' "

**Features:** \*RST value: -  
SCPI: device-specific

**Modes:** A, VA, BTS, MS

**HCOPY:DEVIce:ITEM:WINDow<1|2>:TRACe:STATe ON | OFF**

This command selects the output of the currently displayed trace (ON).

**Example:** "HCOP:DEV:ITEM:WIND:TRACe:STAT ON"

**Features:** \*RST value: OFF  
SCPI: device-specific

**Modes:** A, VA, BTS, MS

The command `HCOPY:DEVIce:ITEM:WINDow<1|2>:TRACe:STATe OFF` same as command `HCOPY:DEVIce:ITEM:ALL` enables the output of the whole screen.

**HCOPY:DEVIce:ITEM:WINDow<1|2>:TRACe:CAINcrement ON | OFF**

The command automatically changes the colour of the currently displayed trace after printout (ON).

**Example:** "HCOP:DEV:ITEM:WIND:TRACe:CAIN ON"

**Features:** \*RST value: OFF  
SCPI: device-specific

**Modes:** A, VA, BTS, MS

The automatic change of colour of the trace allows outputting to a plotter of several traces of the same diagram. For a better distinction, the colour of the trace is changed ("Color Auto Increment").

**HCOPY:PAGE:DIMensions:QUADrant<1 to 4>**

The command defines the quadrant which is allocated to the screen output.

**Example:** "HCOP:PAGE:DIM:QUAD1"

**Features:** \*RST value: -  
SCPI: conforming

**Modes:** A, VA, BTS, MS

The quadrants are defined as QUAD1 at the top right, QUAD2 at the top left, QUAD3 at the bottom left and QUAD4 at the bottom right. This command is an event which is why it is not assigned an \*RST value and has no query.

**HCOPY:PAGE:DIMensions:FULL**

This command defines that the full screen is to be printed out.

**Example:** "HCOP:PAGE:DIM:FULL"

**Features:** \*RST value: -  
SCPI: device-specific

**Modes:** A, VA, BTS, MS

This command is an event which is why it is not assigned and \*RST value and has no query.

**HCOPY:PAGE:ORientation<1|2> LANDscape | PORTRait**

The command selects the format of the output (portrait and landscape) (hardcopy unit 1 or 2).

**Example:** "HCOP:PAGE:ORI LAND"

**Features:** \*RST value: -  
SCPI: conforming

**Modes:** A, VA, BTS, MS

## INITiate Subsystem

The INITiate subsystem checks the initialization of the trigger subsystem. In the split-screen representation, a distinction is made between INITiate1 (screen A) and INITiate2 (screen B)

COMMAND	PARAMETERS	UNIT	COMMENT
INITiate<1 2> :CONTInuous :CONMeas [:IMMediate] :DISPlay	<boolean> -- -- <boolean>	-- -- -- --	no query no query

### INITiate<1|2>:CONTInuous ON | OFF

This command determines if the trigger system is continuously initiated ("Free Run").

**Example:** "INIT:CONT OFF"

**Features:** \*RST value: ON  
SCPI: conforming

**Modes:** A, VA, BTS, MS

Setting "INITiate:CONTInuous ON" corresponds to function SWEEP CONTInuous, ie the sweep of the analyzer is cyclically repeated. The setting "INITiate:CONTInuous OFF" corresponds to function SWEEP SINGLE.

### INITiate<1|2>:CONMeas

This command continues the sweep from the current sweep position.

**Example:** "INIT:CONM"

**Features:** \*RST value: -  
SCPI: device-specific

**Modes:** A, VA, BTS, MS

This command is an event and therefore has no \*RST value and no query.

Sweeps are stopped, for example, in the case of transducer sets between the different transducer factors.

### INITiate<1|2>[:IMMediate]

The command initiates a new sweep or starts a single sweep.

**Example:** "INIT"

**Features:** \*RST value: -  
SCPI: conforming

**Modes:** A, VA, BTS, MS

This command is an event which is why it is not assigned an \*RST value and has no query.

### INITiate<1|2>:DISPlay ON | OFF

This command switches the display on or off during a single sweep.

**Example:** "INIT:DISP OFF"

**Features:** \*RST value: ON  
SCPI: device-specific

**Modes:** A, VA, BTS, MS

## INPut Subsystem

The INPut subsystem checks the input features of the instrument. In the split-screen representation, a distinction is made between INPut1 (screen A) and INPut2 (screen B).

COMMAND	PARAMETERS	UNIT	COMMENT
INPut<1 2>			
:ATTenuation	<numeric_value>	DB	
:AUTO	<Boolean>	--	
:MODE	NORMal   LNOise LDISortion	--	
:STEPsize	1   10	dB	Option 1-dB attenuator
:UPORt<1 2>			
[:VALue]?	--	--	query only
:STATe	<Boolean>	--	
:IMPedance	50   75	OHM	
:CORRection	RAM   RAZ		
:MIXer	<numeric_value>	DBM	

### INPut<1|2>:ATTenuation 0 to 70 dB

This command programs the input attenuator.

**Example:** "INP:ATT 40dB"

**Features:** \*RST value: - (AUTO is set to ON)  
SCPI: conforming

**Modes:** A, VA

The attenuation of the input calibration line can be programmed in steps of 10 dB. If the attenuation is programmed directly, the coupling to the reference level is switched off.

### INPut<1|2>:ATTenuation:AUTO ON | OFF

This command automatically couples the input attenuation to the reference level.

This command automatically couples the input attenuation to the reference level (analyzer).

**Example:** "INP:ATT:AUTO ON"

**Features:** \*RST value: ON  
SCPI: conforming

**Modes:** A, VA

### INPut<1|2>:ATTenuation:AUTO:MODE NORMal | LNOise | LDISortion

This command optimizes the coupling of the input attenuation to the reference level to high sensitivity or to high intermodulation immunity.

**Example:** "INP:ATT:AUTO:MODE LDIS"

**Features:** \*RST value: ON  
SCPI: device-specific

**Modes:** A, VA

For LNOise, the input attenuator value is set 10 dB lower than for INPut:ATTenuation:AUTO:MODE NORMal, for LDISortion it is set 10 dB higher.



**INPut<1|2>:ATTenuation:STEPsize 1dB | 10dB**

This command defines the attenuator stepsize.

**Example:** "INP:ATT:STEP 1dB"

**Features:** \*RST value: 10dB  
SCPI: device-specific

**Mode:** A, VA, BTS, MS

This command is only available in conjunction with option FSE-B13, 1-dB attenuator.

**INPut<1|2>:UPORt<1|2>[:VALue]?**

This command queries the control lines of the user ports.

**Example:** "INP:UPOR2?"

**Features:** \*RST value: -  
SCPI: device-specific

**Modes:** A, VA, BTS, MS

This command is a query command which is why it is not assigned an \*RST value.

**INPut<1|2>:UPORt<1|2>:STATe ON | OFF**

This command toggles the control lines of the user ports between INPut and OUTPut.

**Example:** "INP:UPOR2:STAT ON"

**Features:** \*RST value: ON  
SCPI: device-specific

**Modes:** A, VA, BTS, MS

With ON, the user port is switched to INPut, with OFF to OUTPut.

**INPut<1|2>:IMPedance 50 | 75**

This command sets the nominal input impedance of the instrument.

**Example:** "INP:IMP 75"

**Features:** \*RST value: 50  
SCPI: conforming

**Modes:** A, VA, BTS, MS

Switching the input impedance to 75  $\Omega$  includes the matching elements RAM or RAZ selected by the command `INPut:IMPedance:CORRection`.

**INPut<1|2>:IMPedance:CORRection** RAM | RAZ

This command selects the matching element for 75  $\Omega$  input impedance.

**Example:** "INP:IMP:CORR RAM"

**Features:** \*RST value: - (INPut:IMPedance = 50  $\Omega$ )  
SCPI: device-specific

**Modes:** A, VA, BTS, MS

**INPut<1|2>:MIXer** -10 to -100 dBm

This command defines the nominal mixer level of the instrument.

**Example:** "INP:MIX -30"

**Features:** \*RST value: -  
SCPI: device-specific

**Modes:** A, VA

# INSTRument Subsystem

The INSTRument subsystem selects the operating mode of the unit either via text parameters or fixed numbers. In the split-screen representation, a distinction is made between INSTRument1 (screen A) and INSTRument2 (screen B).

COMMAND	PARAMETERS	UNIT	COMMENT
INSTRument<1 2> [:SElect]  :NSElect :COUPle	SANalyzer   DDEMod   ADEMod   BSGM   MSGM  <numeric_value> NONE   MODE   X   Y   CONTrol   XY   XCONtrol   YCONtrol   ALL		Vector Signal Analysis FSE-K11 or FSE-K10,

## INSTRument<1|2>[:SElect] SANalyzer | DDEMod | ADEMod | BSGM | MSGM

This command switches between the operating modes by means of text parameters.

**Parameter:**      SANalyzer:      spectrum analysis  
                          DDEMod:            vector signal analysis, digital demodulation  
                          ADEMod:            vector signal analysis, analog demodulation  
                          BSGM:              GSM BTS analysis  
                          MSGM:              GSM MS analysis

**Example:**            "INST DDEM"

**Features:**          \*RST value:      SANalyzer  
                          SCPI:              conforming

**Modes:**              A, VA, BTS, MS

Switchover to BSGM is only possible in conjunction with option FSE-K11, GSM BTS Analyzer  
 Switchover to MSGM is only possible in conjunction with option FSE-K10, GSM MS Analyzer

## INSTRument<1|2>:NSElect 1 to 5

This command switches between the two modes by means of numbers.

**Example:**            "INST:NSEL 2"

**Features:**          \*RST value:      1  
                          SCPI:              conforming

**Modes:**              A, VA, BTS, MS

1:                      spectrum analysis  
 2:                      vector signal analysis, digital demodulation  
 3:                      vector signal analysis, analog demodulation  
 4:                      GSM BTS analysis  
 5:                      GSM MS analysis

Switchover to 4 is only possible in conjunction with option FSE-K11, GSM BTS Analyzer  
 Switchover to 5 is only possible in conjunction with option FSE-K10, GSM MS Analyzer

**INSTRUMENT<1|2>:COUPLE** NONE | MODE | X | Y | CONTROL | XY | XCONTROL | YCONTROL | ALL

This command defines the coupling between the two measurement windows screen A and B.

**Example:** "INST:COUP NONE"

**Features:** \*RST value: ALL  
SCPI: device specific

**Modes:** A, VA

NONE no coupling.

MODE the operating mode of the two screens is coupled.

X or Y the scaling of the x- or y axis of the two screens is coupled.

CONTROL the trigger and gate parameter ,and the sweep parameters SINGLE/ CONTInous and COUNT of the two screens are coupled.

XY the scaling of the x- and y-axis of the two screens are coupled.

XCONTROL bzw. YCONTROL the trigger and gate parameter, and the sweep parameters SINGLE CONTInous/ COUNT of the two screens are coupled.

ALL the scaling of the x- or y axis the trigger and gate parameter and the sweep parameters SINGLE/ CONTInous/ COUNT of the two screens are coupled.

# MMEMory Subsystem

The MMEMory (mass memory) subsystem provides commands which allow for access to the storage media of the instrument and for storing and loading various instrument settings.

The NAME command stores the HCOPY outputs in a file.

The various drives can be addressed via the mass storage unit specifier <msus> using the conventional DOS syntax. The internal hard disk is addressed by "C:", the floppy-disk drive installed by "A:".

The file names <file\_name> are indicated as string parameters with the commands being enclosed in quotation marks. They correspond to the DOS conventions.

DOS file names consist of max. 8 ASCII characters and an extension of up to three characters separated from the file name by a colon "." Both, the colon and the extension are optional. The colon is not part of the file name. DOS file names do not differ between uppercase and lowercase notation. All letters and digits are permitted as well as the special characters "\_", "^", "\$", "~", "!", "#", "%", "&", "-", "{", "}", "(", ")", "@", and "'". Reserved file names are CLOCK\$, CON, AUX, COM1 to COM4, LPT1 to LPT3, NUL and PRN.

The two characters "\*" and "?" have the function of so-called "wildcards", i.e., they are variables for selection of several files. The question mark "?" replaces exactly one character which may be any, the asterisk means any of the remaining characters in the file name. "\*. \*" thus means all files in a directory.

COMMAND	PARAMETERS	UNIT	COMMENT
MMEMory			
:CATalog	<string>		
:CDIRectory	<directory_name>	--	
:COPY	<file_name>,<file_name>	--	no query
:DATA	<file name>[,<block>]	--	
:DELete	<file_name>	--	no query
:INITialize	<msus>	--	no query
:LOAD			
:STATe	1,<file_name>	--	no query
:AUTO	1,<file_name>	--	no query
:MDIRectory	<directory_name>	--	no query
:MOVE	<file_name>,<file_name>	--	no query
:MSIS	<msus>	--	
:NAME	<file_name>	--	
:RDIRectory	<directory_name>	--	no query
:STORe			
:STATe	1,<file_name>	--	no query
:TRACe	<numeric_value>,<file_name>		no query
:CLEar			
:STATe	1,<file_name>	--	no query
:ALL			no query

COMMAND	PARAMETERS	UNIT	COMMENT
MMEMemory :SElect [:ITEM] :GSEtup :HWSEttings :TRACE<1 to 4> :LINes [:ACTive] :ALL :CSEtup :HCOPY :MACROs :SCData :TRANsducer [:ACTive] :ALL :CVL [:ACTive] :ALL :ALL :NONE :DEFault :COMMeNt	<Boolean> <Boolean> <Boolean> <Boolean> <Boolean> <Boolean> <Boolean> <Boolean> <Boolean> <Boolean> <Boolean> <Boolean> <Boolean> <Boolean> <Boolean> -- -- -- <string>		Option Tracking Generator          no query no query no query

**MMEMemory:CATalog?** <string>

This command is for read-out of the current directory. A mask, eg "\*.bat", can be defined so that only files with "bat" as extension are selected.

**Parameter:** <string>::= DOS file name

**Example:** "MME:CAT 'rem?.lin' "

**Characteristics:** \*RST value: -  
SCPI: conformal

**Modes:** A, VA, BTS, MS

**MMEMemory:CDIRectory** <directory\_name>

This command changes the current directory.

**Parameter:** <directory\_name>::= DOS path name

**Example:** "MME:CDIR 'C:\USER\DATA' "

**Features:** \*RST value: -  
SCPI: conforming

**Modes:** A, VA, BTS, MS

In addition to the path name, the indication of the directory may contain the drive name. The path name complies with the DOS conventions.

**MMEMory:COpy** <file\_source>,<file\_destination>

This command copies the files indicated.

**Parameter:** <file\_source>,<file\_destination> ::= <file\_name>  
<file\_name> ::= DOS file name

**Example:** "MMEM:COpy 'C:\USER\DATA\SETUP.CFG', 'A:' "

**Features:** \*RST value: -  
SCPI conforming

**Modes:** A, VA, BTS, MS

The indication of the file name may include the path and the drive. The file names and path information must be in accordance with the DOS conventions. This command is an event which is why it is not assigned an \*RST value and has no query.

**MMEMory:DATA** <file\_name>[,<block data>]

This command writes block data to the specified file.

**Syntax:** MMEMory:DATA <file\_name>,<block data>  
MMEMory:DATA? <file\_name>

**Example:** "MMEM:DATA? 'TEST01.HCP' "  
"MMEM:DATA 'TEST01.HCP', #217This is the file"

**Features:** \*RST value: -  
SCPI: conforming

**Modes:** A, VA, BTS, MS

Each <block> starts with the character '#', followed by the value stating the length of the length information. This is followed by one or several characters for the length information; then come the data themselves. The end character must be set to EOI to ensure correct data transmission.

**MMEMory:DELeTe** <file\_name>

This command deletes the files indicated.

**Parameter:** <file\_name> ::= DOS file name

**Example:** "MMEM:DEL 'TEST01.HCP' "

**Features:** \*RST value: -  
SCPI: conforming

**Modes:** A, VA, BTS, MS

The indication of the file name contains the path and, optionally, the drive. Indication of the path corresponds to the DOS conventions. The file name includes indication of the path and may also include the drive. The path name corresponds to the DOS conventions. This command is an event which is why it is not assigned an \*RST value and has no query.

**MMEMory:INITialize 'A:'**

This command formats the disk in drive A.

**Example:** "MMEM:INIT 'A:' "

**Features:** \*RST value: -  
SCPI: conforming

**Modes:** A, VA, BTS, MS

Formatting deletes all data stored on the floppy disk. This command is an event which is why it is not assigned an \*RST value and has no query.

**MMEMory:LOAD:STATe 1,<file\_name>**

This command loads instrument settings from files.

**Parameter:** <file\_name> ::= DOS file name without extension

**Example:** "MMEM:LOAD:STAT 1, 'A:TEST' "

**Features:** \*RST value: -  
SCPI: conforming

**Modes:** A, VA, BTS, MS

The contents of the file is loaded and set as new instrument state. The file name includes indication of the path and may also include the drive. The path name corresponds to the DOS conventions. This command is an event which is why it is not assigned an \*RST value and has no query.

**MMEMory:LOAD:AUTO 1,<file\_name>**

This command defines which device setting is automatically loaded after the instrument is switched on.

**Parameter:** <file\_name> ::= DOS file name without extension;  
FACTORY denotes the data set previously in the instrument

**Example:** "MMEM:LOAD:AUTO 1, 'C:\USER\DATA\TEST' "

**Features:** \*RST value: -  
SCPI: device-specific

**Modes:** A, VA, BTS, MS

The contents of the file are read after switching on the instrument and used to define the new device state. The file name includes indication of the path and may also include the drive. The path name corresponds to the DOS conventions. This command is an event which is why it is not assigned an \*RST value and has no query.



**MMEMory:MDIRectory** <directory\_name>

This command creates a new directory.

**Parameter:** <directory\_name> ::= DOS path name

**Example:** "MMEM:MDIR 'C:\USER\DATA' "

**Features:** \*RST value: -  
SCPI: device-specific

**Modes:** A, VA, BTS, MS

The file name includes indication of the path and may also include the drive. The path name corresponds to the DOS conventions. This command is an event which is why it is not assigned an \*RST value and has no query.

**MMEMory:MOVE** <file\_source>,<file\_destination>

This command renames existing files.

**Parameter:** <file\_source>,<file\_destination> ::= <file\_name>  
<file\_name> ::= DOS file name

**Example:** "MMEM:MOVE 'TEST01.CFG' , 'SETUP.CFG' "

**Features:** \*RST value: -  
SCPI: conforming

**Modes:** A, VA, BTS, MS

The file name includes indication of the path and may also include the drive. The path name corresponds to the DOS conventions. This command is an event which is why it is not assigned an \*RST value and has no query.

**MMEMory:MSIS** 'A:' | 'C:'

This command changes to the drive indicated.

**Example:** "MMEM:MSIS 'A:' "

**Features:** \*RST value: "C:"  
SCPI: conforming

**Modes:** A, VA, BTS, MS

The drive may be the internal hard disk C: or the floppy-disk drive A:. The drive is indicated according to the DOS conventions.

**MMEMory:NAME** <file\_name>

This command specifies a file which is printed or plotted to.

**Parameter:** <file\_name> ::= DOS filename

**Example:** "MMEM:NAME 'PLOT1.HPG' "

**Features:** \*RST value: -  
SCPI: conforming

**Modes:** A, VA, BTS, MS

The file name includes indication of the path and may also include the drive. The file name and path information correspond to the DOS conventions. The output to the printer is routed into a file using the command "HCOP:DEST 'MMEM'".

**MMEMory:RDIRECTory** <directory\_name>

This command deletes the directory indicated.

**Parameter:** <directory\_name> ::= DOS path name

**Example:** "MMEM:RDIR 'C:\TEST' "

**Features:** \*RST value: -  
SCPI: device-specific

**Modes:** A, VA, BTS, MS

The directory name includes indication of the path and may also include the drive. The path name corresponds to the DOS conventions. This command is an event which is why it is not assigned an \*RST value and has no query.

**MMEMory:STORE:STATE** 1,<file\_name>

This command stores the current instrument setting in a file.

**Parameter:** <file\_name> ::= DOS file name without extension

**Example:** "MMEM:STOR:STAT 1, 'TEST' "

**Features:** \*RST value: -  
SCPI: conforming

**Modes:** A, VA, BTS, MS

The current instrument state is stored as a file. The file name includes indication of the path and may also include the drive. The path name corresponds to the DOS conventions. This command is an event which is why it is not assigned an \*RST value and has no query.

**MMEMory:STORE:TRACe** 1 to 4,<file\_name>

This command stores the selected trace (1 to 4) in ASCII format in a file.

**Parameter:** 1 to 4 := selected trace 1 to 4  
<file\_name> := DOS file name

**Example:** "MMEM:STOR:TRAC 3, 'A:\TEST.ASC' "

**Features:** \*RST value: -  
SCPI: device-specific

**Modes:** A, VA, BTS, MS

The file name includes indication of the path and may also include the drive. The file name and path information correspond to the DOS conventions. This command is an event which is why it is not assigned an \*RST value and has no query.

**MMEMory:CLEar:STATe** 1,<file\_name>

This command deletes the instrument setting denoted by <file\_name>.

**Parameter:** <file\_name> ::= DOS file name without extension

**Example:** "MMEM:CLE:STAT 1, 'TEST' "

**Features:** \*RST value: -  
SCPI: device-specific

**Modes:** A, VA, BTS, MS

The device data set specified is deleted. The file name includes indication of the path and may also include the drive. The path name corresponds to the DOS conventions. This command is an event which is why it is not assigned an \*RST value and has no query.

**MMEMory:CLEar:ALL**

This command deletes all instrument settings in the current directory.

**Example:** "MMEM:CLE:ALL"

**Features:** \*RST value: -  
SCPI: device-specific

**Modes:** A, VA, BTS, MS

This command is an "event" which is why it is not assigned an \*RST value and has no query.

**MMEMory:SElect[:ITEM]:GSETup** ON | OFF

This command includes the data of the general setup in the list of data subsets of a device setting to be stored/loaded.

**Example:** "MMEM:SEL:GSET ON"  
**Features:** \*RST value: OFF  
 SCPI: device-specific  
**Modes:** A, VA, BTS, MS

**MMEMory:SElect[:ITEM]:HWSettings** ON | OFF

This command includes the hardware settings in the list of data subsets of a device setting to be stored/loaded.

**Example:** "MMEM:SEL:HWS ON"  
**Features:** \*RST value: ON  
 SCPI: device-specific  
**Modes:** A, VA, BTS, MS

Level and frequency lines are stored with this command as well.

**MMEMory:SElect[:ITEM]:TRACe<1 to 4>** ON | OFF

This command includes the data of the selected trace in the list of data subsets of a device setting to be stored/loaded.

**Example:** "MMEM:SEL:TRACE3 ON"  
**Features:** \*RST value: OFF for all Traces  
 SCPI: device-specific  
**Modes:** A, VA, BTS, MS

**MMEMory:SElect[:ITEM]:LINES[:ACTive]** ON | OFF

This command includes the active limit lines in the list of data subsets of a device setting to be stored/loaded.

**Example:** "MMEM:SEL:LIN ON"  
**Features:** \*RST value: ON  
 SCPI: device-specific  
**Modes:** A, VA, BTS, MS

Upon `MMEM:LOAD` the limit lines which are not currently active but contained in the data set are restored as well.

**MMEMory:SElect[:ITEM]:LINES:ALL** ON | OFF

This command includes all limit lines in the list of data subsets of a device setting to be stored/loaded.

**Example:** "MMEM:SEL:LIN:ALL ON"

**Features:** \*RST value: ON  
SCPI: device-specific

**Modes:** A, VA, BTS, MS

This command includes selection of the active limit lines.

**MMEMory:SElect[:ITEM]:CSETup** ON | OFF

This command includes the current color setting in the list of partial datasets of a device setting to be stored/loaded.

**Example:** "MMEM:SEL:CSET ON"

**Features:** \*RST value: ON  
SCPI: device-specific

**Modes:** A, VA, BTS, MS

**MMEMory:SElect[:ITEM]:HCOPY** ON | OFF

This command includes the hardcopy settings in the list of data subsets of a device setting to be stored/loaded.

**Example:** "MMEM:SEL:HCOPY ON"

**Features:** \*RST value: ON  
SCPI: device-specific

**Modes:** A, VA, BTS, MS

**MMEMory:SElect[:ITEM]:MACRos** ON | OFF

This command includes the keyboard macros in the list of data subsets of a device setting to be stored/loaded.

**Example:** "MMEM:SEL:MACRos ON"

**Features:** \*RST value: OFF  
SCPI: device-specific

**Modes:** A, VA, BTS, MS

**MMEMory:SElect[:ITEM]:SCData** ON | OFF

This command includes the tracking generator calibration data in the list of data subsets of a device setting to be stored/loaded.

**Example:** "MMEM:SEL:SCData ON"

**Features:** \*RST value: OFF  
SCPI: device-specific

**Modes:** A, VA

This command only available in conjunction with the option Tracking Generator.

**MMEMory:SElect[:ITEM]:TRANsducer[:ACTive]** ON | OFF

This command includes the active transducer factors and set in the list of data subsets of a device setting to be stored/loaded.

**Example:** "MMEM:SEL:TRAN ON"

**Features:** \*RST value: ON  
SCPI: device-specific

**Modes:** A, VA, BTS, MS

Upon `MMEM:LOAD` the transducer factors and sets which are not currently active but contained in the data set are restored as well.

**MMEMory:SElect[:ITEM]:TRANsducer:ALL** ON | OFF

This command includes all transducer factors and sets in the list of data subsets of a device setting to be stored/loaded.

**Example:** "MMEM:SEL:TRAN:ALL ON"

**Features:** \*RST value: ON  
SCPI: device-specific

**Modes:** A, VA, BTS, MS

This command is an event and therefore has no \*RST value assigned.

**MMEMory:SElect[:ITEM]:CVL[:ACTive]** ON | OFF

This command includes the active conversion loss table into the list of data subrecords to be stored / loaded for a device setup.

**Example:** "MMEM:SEL:CVL ON"

**Features:** \*RST value: OFF  
SCPI: device-specific

**Modes:** A, VA, BTS, MS

This command is available only in conjunction with option External Mixer Output, FSE-B21.

**MMEMory:SElect[:ITEM]:CVL:ALL** ON | OFF

This command includes all conversion loss table into the list of data subrecords to be stored / loaded for a device setup.

**Example:** "MMEM:SEL:CVL ON"

**Features:** \*RST value: OFF  
SCPI: device-specific

**Modes:** A, VA, BTS, MS

This command is available only in conjunction with option External Mixer Output, FSE-B21.

**MMEMory:SElect[:ITEM]:ALL**

This command includes all data subsets in the list of data subsets of a device setting to be stored/loaded.

**Example:** "MMEM:SEL:ALL"  
**Features:** \*RST value: --  
SCPI: device-specific  
**Modes:** A, VA, BTS, MS

This command is an event and therefore has no \*RST value assigned.

**MMEMory:SElect[:ITEM]:NONE**

This command deletes all data subsets in the list of data subsets of a device setting to be stored/loaded.

**Example:** "MMEM:SEL:NONE"  
**Features:** \*RST value: --  
SCPI: device-specific  
**Modes:** A, VA, BTS, MS

This command is an event and therefore has no \*RST value assigned.

**MMEMory:SElect[:ITEM]:DEfault**

This command sets the default list of the data subsets of a device setting to be stored/loaded.

**Example:** "MMEM:SEL:DEfault"  
**Features:** \*RST value: --  
SCPI: device-specific  
**Modes:** A, VA, BTS, MS

This command is an event and therefore has no \*RST value assigned.

**MMEMory:COMMent <string>**

This command defines a comment for a device setting to be stored.

**Example:** "MMEM:COMM 'Setup for GSM measurement' "  
**Features:** \*RST value: blank comment  
SCPI: device-specific  
**Modes:** A, VA, BTS, MS

## OUTPut Subsystem

The OUTPut subsystem checks the output features of the instrument. In conjunction with option tracking generator, in the split screen mode, a distinction is made between OUTPut1 (screen A) and OUTPut2 (screen B).

COMMAND	PARAMETERS	UNIT	COMMENT
OUTPut<1 2> [:STATe]	<boolean>	--	Option Tracking Generator
:UPORt<1 2> [:VALue]	<binary>	--	
:STATe	<boolean>	--	
:AF :SENSitivity	<numeric_value>	PCT   HZ   KHZ   DEG   RAD	Vector Signal Analysis

### OUTPut<1|2>[:STATe] ON | OFF

This command switches the tracking generator on or off.

**Example:** "OUTP ON"

**Features:** \*RST value: -  
SCPI: conforming

**Modes:** A, VA

This command is only valid in conjunction with one of the options tracking generator.

### OUTPut<1|2>UPORt<1|2>[:VALue] #B00000000 to #B11111111

This command sets the control lines of the user ports.

**Example:** "OUTP:UPOR2 #B10100101"

**Features:** \*RST value: -  
SCPI: device-specific

**Modes:** A, VA, BTS, MS

User port 1 or 2 is written with the given binary pattern. If the user port is programmed to INPut instead of OUTPut, the output value is temporarily stored.

### OUTPut<1|2>UPORt<1|2>:STATe ON | OFF

This command switches the control line of the user ports between INPut and OUTPut.

**Example:** "OUTP:UPOR:STAT ON"

**Features:** \*RST value: OFF  
SCPI: device-specific

**Modes:** A, VA, BTS, MS

With ON, the user port is switched to OUTPut, with OFF to INPut.



**OUTPut<1|2>AF:SENSitivity <numeric\_value>**

This command changes the sensitivity of the AF-output.

**Parameter:** <numeric\_value> ::= 0.1 PCT to 100 PCT for AM  
0.1 KHZ to 100 KHZ for FM  
0.0 1RAD to 10 RAD for PM

**Example:** "OUTP:AF:SENS 20PCT"

**Features:** \*RST value: 100 % for AM  
100 kHz for FM  
10 rad for PM  
SCPI: device-specific

**Mode:** VA-A

## READ Subsystem

The READ-subsystem contains commands for starting complex measurement tasks such as those provided by options GSM BTS Analyzer (FSE-K11) or GSM MS Analyzer (FSE-K10), and for querying the results subsequently. The READ-subsystem is closely linked to the functions of the CONFigure- and FETCh-subsystems, where the measurement sequences are configured or the results are queried without restarting a new measurement.

### READ:BURSt Subsystem

This subsystem provides the commands for starting measurements in the GSM BTS Analyzer mode (option FSE-K11), which are performed on individual bursts (carrier power, phase/frequency error), and for reading out the results subsequently.

COMMAND	PARAMETERS	UNIT	COMMENT
READ			
:BURSt			Option FSE-K11 or FSE-K10
:PERRor			
:RMS			query only
:STATus?			query only
:AVERAge?	--		query only
:MAXimum?	--		
:PEAK			query only
:STATus?			query only
:AVERAge?	--		query only
:MAXimum?	--		
:FERRor			query only
:STATus?			query only
:AVERAge?	--		query only
:MAXimum?	--		query only
:POWer?	--		query only; FSE-K11 only
:STATic?	--		query only; FSE-K11 only
:DYNamic?	--		query only; FSE-K10 only
:LEVel?	--		query only
:REFerence			
[:IMMediate]?	--		query only<

#### READ:BURSt:PERRor:RMS:STATus?

This command starts the measurement of the phase and frequency error of the base station or mobile and reads out the status of the RMS-measurement of the phase error taken over the selected number of bursts.

0: failed, 1: passed

**Example:** "READ:BURSt:PERRor:RMS:STATus?"

**Features:** \*RST value: --  
SCPI: device-specific

**Modes:** BTS, MS

When the measurement is started the instrument automatically assumes the SINGLE mode. An ongoing measurement can be aborted via the command `ABORT`. Further results of the phase/frequency error measurement can be then queried without restart of the measurement via the `FETCh:BURSt`-subsystem.

This command is a query only and therefore has no \*RST value assigned. It is available only if measurement of the phase/frequency error is selected (see `CONFigure:BURSt:PFERror`).

**READ:BURSt:PERRor:RMS:AVERage?**

This command starts the measurement of the phase and frequency error of the base station or mobile and reads out the average of the RMS-measurement of the phase error taken over the selected number of bursts.

**Example:** "READ: BURS: PERR: RMS: AVER?"

**Features:** \*RST value: --  
 SCPI: device-specific

**Modes:** BTS, MS

When the measurement is started the instrument automatically assumes the SINGLE mode. An ongoing measurement can be aborted via the command `ABORT`. Further results of the phase/frequency error measurement can be then queried without restart of the measurement via the `FETCH: BURSt`-subsystem.

This command is a query only and therefore has no \*RST value assigned. It is available only if measurement of the phase/frequency error is selected (see `CONFigure: BURSt: PFERror`).

**READ:BURSt:PERRor:RMS:MAXimum?**

This command starts the measurement of the phase and frequency error of the base station or mobile and reads out the maximum of the RMS-measurement of the phase error for the selected number of bursts.

**Example:** "READ: BURS: PERR: RMS: MAX?"

**Features:** \*RST value: --  
 SCPI: device-specific

**Modes:** BTS, MS

When the measurement is started the instrument automatically assumes the SINGLE mode. An ongoing measurement can be aborted via the command `ABORT`. Further results of the phase/frequency error measurement can be then queried without restart of the measurement via the `FETCH: BURSt`-subsystem.

This command is a query only and therefore has no \*RST value assigned. It is available only if measurement of the phase/frequency error is selected (see `CONFigure: BURSt: PFERror`).

**READ:BURSt:PERRor:PEAK:STATus?**

This command starts the measurement of the phase and frequency error of the base station or mobile and reads out the status of the peak measurement of the phase error taken over the selected number of bursts.

0: failed, 1: passed

**Example:** "READ: BURS: PERR: PEAK: STAT?"

**Features:** \*RST value: --  
 SCPI: device-specific

**Modes:** BTS, MS

When the measurement is started the instrument automatically assumes the SINGLE mode. An ongoing measurement can be aborted via the command `ABORT`. Further results of the phase/frequency error measurement can be then queried without restart of the measurement via the `FETCH: BURSt`-subsystem.

This command is a query only and therefore has no \*RST value assigned. It is available only if measurement of the phase/frequency error is selected (see `CONFigure: BURSt: PFERror`).

**READ:BURSt:PERRor:PEAK:AVERAge?**

This command starts the measurement of the phase and frequency error of the base station or mobile and reads out the maximum of the peak measurement of the phase error taken over the selected number of bursts.

**Example:** "READ: BURS: PERR: PEAK: AVER?"

**Features:** \*RST value: --  
SCPI: device-specific

**Modes:** BTS, MS

When the measurement is started the instrument automatically assumes the SINGLE mode. An ongoing measurement can be aborted via the command `ABORT`. Further results of the phase/frequency error measurement can be then queried without restart of the measurement via the `FETCH: BURSt`-subsystem.

This command is a query only and therefore has no \*RST value assigned. It is available only if measurement of the phase/frequency error is selected (see `CONFigure: BURSt: PFERror`).

**READ:BURSt:PERRor:PEAK:MAXimum?**

This command starts the measurement of the phase and frequency error of the base station or mobile and reads out the maximum of the peak measurement of the phase error for the selected number of bursts.

**Example:** "READ: BURS: PERR: PEAK: MAX?"

**Features:** \*RST value: --  
SCPI: device-specific

**Modes:** BTS, MS

When the measurement is started the instrument automatically assumes the SINGLE mode. An ongoing measurement can be aborted via the command `ABORT`. Further results of the phase/frequency error measurement can be then queried without restart of the measurement via the `FETCH: BURSt`-subsystem.

This command is a query only and therefore has no \*RST value assigned. It is available only if measurement of the phase/frequency error is selected (see `CONFigure: BURSt: PFERror`).

**READ:BURSt:FERRor:STATus?**

This command starts the measurement of the phase and frequency error of the base station or mobile and reads out the status of the frequency error taken over the selected number of bursts.

0: failed, 1: passed

**Example:** "READ: BURS: FERR: STAT?"

**Features:** \*RST value: --  
SCPI: device-specific

**Modes:** BTS, MS

When the measurement is started the instrument automatically assumes the SINGLE mode. An ongoing measurement can be aborted via the command `ABORT`. Further results of the phase/frequency error measurement can be then queried without restart of the measurement via the `FETCH: BURSt`-subsystem.

This command is a query only and therefore has no \*RST value assigned. It is available only if measurement of the phase/frequency error is selected (see `CONFigure: BURSt: PFERror`).

**READ:BURSt:FERRor:AVERage?**

This command starts the measurement of the phase and frequency error of the base station or mobile and reads out the average of the frequency error taken over the selected number of bursts.

**Example:** "READ: BURS: FERR: AVER?"

**Features:** \*RST value: --  
SCPI: device-specific

**Modes:** BTS, MS

When the measurement is started the instrument automatically assumes the SINGLE mode.

An ongoing measurement can be aborted via the command `ABORT`. Further results of the phase/frequency error measurement can be then queried without restart of the measurement via the `FETCH: BURSt-subsystem`.

This command is a query only and therefore has no \*RST value assigned. It is available only if measurement of the phase/frequency error is selected (see `CONFigure: BURSt: PFERror`).

**READ:BURSt:FERRor:MAXimum?**

This command starts the measurement of the phase and frequency error of the base station or mobile and reads out the maximum of the frequency error for the selected number of bursts.

**Example:** "READ: BURS: FERR: MAX?"

**Features:** \*RST value: --  
SCPI: device-specific

**Modes:** BTS, MS

When the measurement is started the instrument automatically assumes the SINGLE mode.

An ongoing measurement can be aborted via the command `ABORT`. Further results of the phase/frequency error measurement can be then queried without restart of the measurement via the `FETCH: BURSt-subsystem`.

This command is a query only and therefore has no \*RST value assigned. It is available only if measurement of the phase/frequency error is selected (see `CONFigure: BURSt: PFERror`).

**READ:BURSt:POWer?**

This command starts the measurement of the maximum output power of the base station or mobile and reads out the result.

Measurement of the maximum output power marks the beginning of a measurement cycle where subsequently the limits of the static and dynamic power control levels are checked step by step (READ:BURSt:STATic? or READ:BURSt:DYNamic?).

**Parameter:** The result is read out as an ASCII string in the following format:

<Static Power Ctrl>,<Dyn Power Ctrl>,<Rat-Level>,<Act-Level>, <Delta>,<Status>

<Static Power Ctrl>: 0

<Dyn Power Ctrl>: 0

<Rat-Level>: rated value for the current power control level acc.  
to standard in dBm

<Act-Level>: measured power in dBm

<Delta>: 0

<Status>: result of limit check in character data form:  
PASSED no limits exceeded  
FAILED limit exceeded

**Example:** "READ:BURSt:POW?"

Result: 0,0,43,44.1,0,PASSED

**Features:** \*RST value: --

SCPI: device-specific

**Modes:** BTS, MS

When the measurement is started any ongoing measurement cycle is aborted.

An ongoing measurement can be aborted with the command `ABORT`. This command is a query only and has therefore no \*RST value assigned. It is available only when measurement of the maximum carrier power is selected (see `CONFigure:BURSt:POWer`).

**READ:BURSt:POWer:STATic?**

This command increases the static power control level for the measurement by one step, measures the output power of the base station and reads out the result.

If the command `READ:BURSt:POWer:STATic?` is repeated after the maximum static power control level is reached, the measurement sequence is terminated and the result of the maximum static power control level is read out again. In this case the value 'FINISHED' indicating the status is read out. Before the status value 'FINISHED' is read out, the value 'RUNNING' is output if the total result of the limit check is queried via `CALCulate<1|2>:LIMit<1 to 8>:BURSt:POWer?`.

**Parameter:** The result is read out as an ASCII string in the following format:

<Static Power Ctrl>,<Dyn Power Ctrl>,<Rat-Level>,<Act-Level>, <Delta>,<Status>

- <Static Power Ctrl>: current static power control level
- <Dyn Power Ctrl>: current dynamic power control level
- <Rat-Level>: rated value for the current power control level acc.  
to standard in dBm
- <Act-Level>: measured power in dBm
- <Delta>: difference between the measured power and the power  
at the previous static power control level.
- <Status>: result of the limit check in character data form:  
PASSED no limit exceeded  
FAILED limit exceeded  
FINISHED measurement sequence terminated

**Example:** "READ:BURSt:POWer:STATic?"  
Result: 1,0,41,42.5,1.6,PASSED

**Features:** \*RST value: --  
SCPI: device-specific

**Mode:** BTS

The command `ABORt` terminates an ongoing measurement and resets the static and dynamic power control level to 0.

This command is only a query and therefore has no \*RST value assigned. It is available only if measurement of the maximum carrier power is selected. (see `CONFigure:BURSt:POWer`).

**READ:BURSt:POWer:DYNamic?**

This command increases the dynamic power control level for the measurement by one step, measures the output power of the base station and reads out the result.

Once the maximum dynamic power control level is reached the command is accepted only after the static power control level is increased by one step.

Note that the command is no longer accepted after the measurement sequence is terminated which implies that the static power control level was read out again with `READ:BURSt:POWer:STATic?` after the maximum value was reached and marked with the 'FINISHED' status.

**Parameter:** The result is read out as an ASCII string in the following format:

<Static Power Ctrl>,<Dyn Power Ctrl>,<Rat-Level>,<Act-Level>, <Delta>,<Status>

<Static Power Ctrl>: current static power control level

<Dyn Power Ctrl>: current dynamic power control level

<Rat-Level>: rated value for the current power control level acc.  
to standard in dBm

<Act-Level>: measured power in dBm

<Delta>: difference between the measured power and the power  
at the previous dynamic power control level.

<Status>: result of the limit check in character data form:  
PASSED no limit exceeded  
FAILED limit exceeded

**Example:** "READ:BURSt:POWer:DYN?"  
Result: 1,3,35,32.5,5.6,FAILED

**Features:** \*RST value: --  
SCPI: device-specific

**Mode:** BTS

The command `ABORt` terminates an ongoing measurement and resets the static and dynamic power control level to 0.

This command is only a query and therefore has no \*RST value assigned. It is available only if measurement of the maximum carrier power is selected. (see `CONFigure:BURSt:POWer`).



**READ:BURSt:POWer:LEVel?**

This command increases the power control level for the measurement by one step, measures the output power of the mobile and reads out the result.

Note that the command is no longer accepted after the measurement sequence is terminated which implies that the power control level was read out again with `READ:BURSt:POWer:LEVel?` after the maximum value was reached and marked with the 'FINISHED' status.

**Parameter:** The result is read out as an ASCII string in the following format:

<0>, <Power Ctrl Level>,<Rat-Level>,<Act-Level>, <Delta>,<Status>

<0>: always 0

<Power Ctrl Level>: current power control level

<Rat-Level>: rated value for the current power control level acc. to standard in dBm

<Act-Level>: measured power in dBm

<Delta>: difference between the measured power and the power at the previous power control level.

<Status>: result of the limit check in character data form:  
 PASSED no limit exceeded  
 FAILED limit exceeded

**Example:** `"READ:BURSt:POW:LEV?"`  
 Result: 0,3,35,32.5,5.6,FAILED

**Features:** \*RST value: --  
 SCPI: device-specific

**Mode:** MS

The command `ABORt` terminates an ongoing measurement and resets the power control level to 0.

This command is only a query and therefore has no \*RST value assigned. It is available only if measurement of the maximum carrier power is selected. (see `CONFigure:BURSt:POWer`).

**READ:BURSt:REFerence[:IMMediate]?**

This command starts the premeasurement and as a result provides the measured level in dBm.

**Example:** `"READ:BURSt:REF?"`

**Feature:** \*RST value: --  
 SCPI: device-specific

**Mode:** MS, BTS

This is a query command only and therefore has no \*RST value.

## READ:SPECTrum Subsystem

This subsystem provides the commands for starting measurements in the GSM BTS (option FSE-K11) and GSM MS (option FSE-K10) Analyzer mode, which are used to measure the power of the spectral components due to modulation and switching (modulation spectrum, transient spectrum), and for reading out the results subsequently.

COMMAND	PARAMETERS	UNIT	COMMENT
READ			
:SPECTrum			Option FSE-K11 or FSE-K10
:MODulation			
[:ALL]?	--		query only
:SWITching			
[:ALL]?	--		query only

### READ:SPECTrum:MODulation[:ALL]?

This command starts the measurement of the modulation spectrum of the base station or mobile and reads out the result. The measurement is performed in the currently set frequency range.

**Parameter:** The result is read out as a list of partial ASCII result strings separated by ',' in the following format:

```
<Index>,<Freq1>,<Freq2>,<Level>,<Limit>,<Abs/Rel>,<Status> [,
<Index>,<Freq1>,<Freq2>,<Level>,<Limit>,<Abs/Rel>,<Status>]...
```

where the part set in '['...]' characterizes a partial result string which can be repeated n times.

<Index>:           0,           if the partial result string characterizes a measurement range.  
                  current number <>0,  
                  if the partial result string characterizes a single limit excess.

<Freq1>:           Start frequency of the measurement range or frequency where the limit is exceeded.

<Freq2>:           Stop frequency of the measurement range or frequency where the measured range is exceeded. The value of <Freq2> is equal to the value of <Freq1>, if either the measurement is performed in the time domain or the partial result string contains a limit excess.

<Level>:           Measured maximum level of the partial range or measured level at the test point.

<Limit>:           Limit in the partial range or at the test point.

<Abs/Rel>:         ABS <Level> and <Limit> are in absolute units (dBm)  
                  REL <Level> and <Limit> are in relative units (dBm)

<Status>:         Result of the limit check in character data form:  
                  PASSED no limit exceeded  
                  FAILED limit exceeded  
                  MARGIN margin exceeded  
                  EXC    limited excess characterized as an exception

The frequencies <Freq1> and <Freq2> are always absolute and not referred to the carrier frequency.

**Example:** "READ:SPEC:MOD?"  
**Result:** 0,890E6,915E6,-87.4,-108.0,ABS,FAILED,  
 1,893.2E6,893.2E6,-83.2,-108.0,ABS,FAILED,  
 2,895.7E6,895.7E6,-87.4,-108.0,ABS,FAILED

**Features:** \*RST value: --  
 SCPI: device-specific

**Modes:** BTS, MS

The command `ABORT` aborts an ongoing measurement.

This command is only a query and therefore has no \*RST value assigned. It is available only if measurement of the modulation spectrum is selected. (see `CONFIGure:SPECTrum:MODulation`).

### READ:SPECTrum:SWITching[:ALL]?

This command starts the measurement of the transient spectrum of the base station or mobile and reads out the result.

**Parameter:** The result is read out as a list of partial ASCII result strings separated by ',' in the format used for `READ:SPECTrum:MODulation[:ALL]?`.

**Example:** "READ:SPEC:SWIT?"  
**Result:** 0,833.4E6,833.4E6,37.4,-36.0,ABS,MARGIN,  
 1,834.0E6,834.0E6,-35.2,-36.0,ABS,FAILED,  
 2,834.6E6,834.6E6,-74.3,-75.0,REL,FAILED  
 0,835.0E6,835.0E6,-65,0,-60.0,REL,PASSED

**Features:** \*RST value: --  
 SCPI: device-specific

**Modes:** BTS, MS

The command `ABORT` aborts an ongoing measurement.

This command is only a query and therefore has no \*RST value assigned. It is available only if measurement of the transient spectrum is selected. (see `CONFIGure:SPECTrum:SWITChing`).

## READ:SPURious Subsystem

This subsystem provides the commands for starting measurements in the GSM BTS (option FSE-K11) and GSM MS (option FSE-K10) Analyzer mode, which are used to measure the power of spurious emissions, and for reading out the results subsequently.

COMMAND	PARAMETERS	UNIT	COMMENT
READ :SPURious [:ALL]? :STEP?			Option FSE-K11 or FSE-K10 query only query only

### READ:SPURious[:ALL]?

This command starts the measurement of the spurious emissions of the base station or mobile and reads out the result. The measurement is performed in the currently set frequency range.

**Parameter:** The result is read out as a list of partial ASCII result strings separated by ',' in the following format:

```
<Index>,<Freq1>,<Freq2>,<Level>,<Limit>,<Abs/Rel>,<Status> [,
<Index>,<Freq1>,<Freq2>,<Level>,<Limit>,<Abs/Rel>,<Status>]...
```

where the part set in '['...]' characterizes a partial result string which can be repeated n times.

<Index>: 0, if the partial result string characterizes a measurement range.  
current number <>0,  
if the partial result string characterizes a single limit excess.

<Freq1>: Start frequency of the measurement range or frequency where the limit is exceeded.

<Freq2>: Stop frequency of the measurement range or frequency where the measured range is exceeded. The value of <Freq2> is equal to the value of <Freq1>, if either the measurement is performed in the time domain or the partial result string contains a limit excess.

<Level>: Measured maximum level of the partial range or measured level at the test point.

<Limit>: Limit in the partial range or at the test point.

<Abs/Rel>: ABS <Level> and <Limit> are in absolute units (dBm)  
REL <Level> and <Limit> are in absolute units (dBm)

<Status>: Result of the limit check in character data form:  
PASSED no limit exceeded  
FAILED limit exceeded  
MARGIN margin exceeded

**Example:** "READ:SPUR?"  
Result: 0,890E6,915E6,-87.4,-108.0,ABS,FAILED,  
1,893.2E6,893.2E6,-83.2,-108.0,ABS,FAILED,  
2,895.7E6,895.7E6,-87.4,-108.0,ABS,FAILED



## SENSe Subsystem

The SENSe subsystem is itself divided up into several subsystems. The commands of these subsystems directly control device-specific settings, they do not refer to the signal characteristics of the measurement signal.

The SENSe subsystem controls the essential parameters of the analyzer and vector analyzer. In accordance with the SCPI standard, it is for this reason optional, which means that it is not necessary to include the SENSe node in command sequences.

In the split-screen representation, a distinction is made between SENSe1 and SENSe2:

SENSe1  $\hat{=}$  screen A;

SENSe2  $\hat{=}$  screen B

## SENSe:ADEMod Subsystem

This subsystem controls the parameters for analog demodulation.

COMMAND	PARAMETERS	UNIT	COMMENT
[SENSe<1 2>] :ADEMod :AF :COUPling :SQUelch [:STATe] :LEVel :SBANd :RTIME	AC   DC  <Boolean> <numeric_value> NORMal   INVerse <Boolean>	DBM	Vector Signal Analysis

### [SENSe<1|2>:]ADEMod:AF:COUPling AC | DC

This command selects coupling of the AF-branch.

**Example:** "ADEM:AF:COUP DC"

**Features:** \*RST value: AC  
SCPI: device-specific

**Mode:** VA-A

### [SENSe<1|2>:]ADEMod:SQUelch[:STATe] ON | OFF

This command switches the squelch for the audio branch on or off.

**Example:** "ADEM:SQU ON"

**Features:** \*RST value: OFF  
SCPI: device-specific

**Mode:** VA-A

**[SENSe<1|2>:]ADEMod:SQUelch:LEVel** 30 to -150 dBm

This command defines the switching threshold for the squelch referred to the measured signal.

**Example:** "ADEM:SQU -10DBM"  
**Features:** \*RST value: -40dBm  
SCPI: device-specific  
**Mode:** VA-A

**[SENSe<1|2>:]ADEMod:SBANd** NORMal | INVerse

This command selects the side band for the demodulation.

**Example:** "ADEM:SBAN INV"  
**Features:** \*RST value: NORMal  
SCPI: device-specific  
**Mode:** VA-A

**[SENSe<1|2>:]ADEMod:RTIME** ON | OFF

This command selects whether the demodulation performed in real time or in blocks.

**Example:** "ADEM:RTIM ON"  
**Features:** \*RST value: ON  
SCPI: device-specific  
**Mode:** VA-A

## SENSe:AVERage Subsystem

The SENSe:AVERage subsystem calculates the average of the data acquired. A new test result is obtained from various successive measurements. The amount of test points and the axis reference of the new result correspond to those of the original measurements.

COMMAND	PARAMETERS	UNIT	COMMENT
[SENSe<1 2>] :AVERage			
:COUNT	<numeric_value>	--	
:AUTO	<Boolean>	--	
[:STATe]	<Boolean>	--	
:TYPE	MAXimum   SCALar	--	

### [SENSe<1|2>:]AVERage:COUNT 0 to 32767

The command specifies the number of measurements which are combined.

**Example:** "AVER:COUNT 16"

**Features:** \*RST value: 0  
SCPI: conforming

**Modes:** A. VA-D

### [SENSe<1|2>:]AVERage:COUNT:AUTO ON | OFF

AUTO ON selects a suitable number of :COUNT for the respective type of measurement.

**Example:** "AVER:COUNT:AUTO ON"

**Features:** \*RST value: OFF  
SCPI: conforming

**Modes:** A. VA-D

### [SENSe<1|2>:]AVERage[:STATe] ON | OFF

The command switches on or off the average function.

**Example:** "AVER OFF"

**Features:** \*RST value: OFF  
SCPI: conforming

**Modes:** A, VA, BTS, MS



**[SENSe<1|2>:]AVERAge:TYPE** MAXimum | MINimum | SCALar

The command selects the type of average function.

**Example:** "AVER:TYPE SCAL"

**Features:** \*RST value: SCALar  
SCPI: conforming

**Modes:** A, VA, BTS, MS

The following average functions have been defined:

MAXimum (MAX HOLD):  $AVG(n) = MAX(X_1 \text{ to } .X_n)$

MINimum (MIN HOLD):  $AVG(n) = Min(X_1 \text{ to } .X_n)$

SCALar (AVERAGE):  $AVG(n) = \frac{1}{n} \times \sum_{i=1}^n xi$

## SENSe:BANDwidth Subsystem

This subsystem controls the setting of the instrument's filter bandwidths. Both groups of commands (BANDwidth and BWIDth) perform the same functions.

COMMAND	PARAMETERS	UNIT	COMMENT
:BANDwidth			
[:RESolution]	<numeric_value>	HZ	
:AUTO	<Boolean>	--	
:MODE	ANALog DIGital	--	
:FFT	<Boolean>	--	Option FFT filter
:RATio	<numeric_value>	--	
:VIDeo	<numeric_value>	HZ	
:AUTO	<Boolean>	--	
:RATio	<numeric_value>   SINE   PULSe   NOISe	--	
:DEMod	<numeric_value>	HZ	Vector Signal Analysis
:PLL	AUTO   HIGH   MEDium   LOW		
:BWIDth			
[:RESolution]	<numeric_value>	HZ	
:AUTO	<Boolean>	--	
:MODE	ANALog DIGital	--	
:FFT	<Boolean>	--	Option FFT filter
:RATio	<numeric_value>	--	
:VIDeo	<numeric_value>	HZ	
:AUTO	<Boolean>	--	
:RATio	<numeric_value>   SINE   PULSe   NOISe	--	
:DEMod	<numeric_value>	HZ	Vector Signal Analysis
:PLL	AUTO   HIGH   MEDium   LOW		

[SENSe<1|2>:]BANDwidth|BWIDth[:RESolution] 1 Hz to 10 MHz

This command defines the analyzer's resolution bandwidth.

**Example:** "BAND 1MHz"

**Features:** \*RST value: - (AUTO is set to ON)  
SCPI: conforming

**Modes:** A, VA, BTS, MS

The values for the resolution bandwidth are rounded in 1 | 2 | 3 | 5 steps.

In the GSM BTS/MS ANALYZER mode with option FSE-K11/K10, the command is available for POWER vs. TIME measurement. In this case, the parameters DEFault (bandwidth setting according to GSM standard), 300KHZ and 1MHZ are permitted.

**[SENSe<1|2>:]BANDwidth|BWIDTH[:RESolution]:AUTO** ON | OFF

This command either automatically couples the resolution bandwidth of the instrument to the span or cancels the coupling.

**Example:** "BAND:AUTO OFF"

**Features:** \*RST value: ON  
SCPI: conforming

**Modes:** A, VA

The automatic coupling matches the resolution bandwidth to the currently set span according to the relationship between span and resolution bandwidth.

**[SENSe<1|2>:]BANDwidth|BWIDTH[:RESolution]:MODE** ANALog | DIGital

This command toggles between analog and digital resolution filters for the 1-kHz bandwidth.

**Example:** "BAND:MODE DIG"

**Features:** \*RST value: ANALog  
SCPI: device-specific

**Mode:** A

Depending on the bandwidth, the resolution filters are automatically toggled between digital filters (<1kHz) and analog filters (>1kHz). The 1-kHz bandwidth is present in the instrument as a digital filter and as an analog filter and can be toggled using this command. If the analog filter is selected for the bandwidth 1kHz, the FFT-filtering for bandwidths ≤ 1kHz is switched off.

**[SENSe<1|2>:]BANDwidth|BWIDTH[:RESolution]:MODE:FFT** ON | OFF

This command toggles the digital filters used for bandwidths ≤ 1 kHz between ordinary mode and FFT-filter mode.

**Example:** "BAND:MODE:FFT ON"

**Features:** \*RST value: OFF  
SCPI: device-specific

**Mode:** A

The filter bandwidth of 1 kHz is switched to digital filtering for both ON and OFF. This command is only available in conjunction with option FFT Filter.

**[SENSe<1|2>:]BANDwidth|BWIDTH[:RESolution]:RATio** 0.0001 to 1

This command defines the ratio resolution bandwidth (Hz) / span (Hz).

**Example:** "BAND:RAT 0.1"

**Features:** \*RST value: -- (AUTO is set to ON)  
SCPI: conforming

**Modes:** A, VA, R

The ratio to be entered is reciprocal to the ratio Span/RBW used in manual control.

**[SENSe<1|2>:]BANDwidth|BWIDth:VIDeo** 1Hz to 10MHz

This command defines the instrument's video bandwidth.

**Example:** "BAND:VID 10kHz"  
**Features:** \*RST value: - (AUTO is set to ON)  
 SCPI: conforming  
**Mode:** A

The values for the video bandwidth are rounded in 1 | 2 | 3 | 5 steps.

**[SENSe<1|2>:]BANDwidth|BWIDth:VIDeo:AUTO** ON | OFF

This command either automatically couples the instrument's video bandwidth to the resolution bandwidth or cancels the coupling.

**Example:** "BAND:VID:AUTO OFF"  
**Features:** \*RST value: ON  
 SCPI: conforming  
**Mode:** A

**[SENSe<1|2>:]BANDwidth|BWIDth:VIDeo:RATIO** 0.001to 1000 | SINE | PULSE | NOISE

This command defines the ratio video bandwidth (Hz) / resolution bandwidth (Hz).

**Parameter:** The parameters SINE, PULSE and NOISE may be used as synonyms for the following values:  
 SINE: 1  
 PULSE: 10  
 NOISE: 0.1  
**Example:** "BAND:VID:RAT 10"  
**Features:** \*RST value: - (AUTO is set to ON)  
 SCPI: conforming  
**Modes:** A, VA

The ratio to be entered is reciprocal to the ratio RBW/VBW used in manual control.

**[SENSe<1|2>:]BANDwidth|BWIDth:DEMod** 5kHz to 200kHz (Real Time on) | 5kHz to 5MHz (Real Time off)

This command defines the demodulation bandwidth of the instrument for analog demodulation.

**Example:** "BAND:DEM 100KHZ"  
**Features:** \*RST value: 10KHZ  
 SCPI: device-specific  
**Mode:** VA-A

The values for the demodulation bandwidth are rounded in steps of 1 | 2 | 3 | 5.

**[SENSe<1|2>:]BANDwidth|BWIDth:PLL** AUTO | HIGH | MEDIUM | LOW

This command defines the bandwidth of the main PLL of the instrument synthesizer.

**Example:** "BAND:PLL HIGH"  
**Features:** \*RST value: AUTO  
 SCPI: device-specific  
**Mode:** A

## SENSe:CORRection-Subsystem

The SENSe:CORRection-subsystem controls the correction of measured results by means of frequency-dependent correction factors (e. g. for antenna or cable attenuation).

It also controls calibration and normalization during operation with the option Tracking Generator .

COMMAND	PARAMETERS	UNIT	COMMENT
[SENSe<1 2>] :CORRection			option Tracking Generator
:METHod	TRANsmission   REFLexion		
:COLLect			
[ACQuire]	THRough   OPEN		no query
[:STATe]	<Boolean>		
:RECall			no query
:TRANsducer			
:CATalog?			query only
:ACTive?			query only
:SELect	<name>		
:UNIT	<string>		
:SCALing	LINear   LOGarithmic		
:COMMeNT	<string>		
:DATA	<freq> , <level> ..	HZ , --	
[:STATe]	<Boolean>		
:DELete	--	--	no query
:TSET			
:CATalog?			query only
:ACTive?			query only
:SELect	<name>		
:UNIT	<string>		
:BREak	<Boolean>		
:COMMeNT	<string>		
:RANGe<1 to 10>	<freq> , <freq> , <name> ..	HZ, HZ, --	
[:STATe]	<Boolean>		
:DELete	--	--	no query
:LOSS			option FSE-K11 or FSE-K10
:INPut			
[MAGNitude]	<numeric_value>	DB	
:RXGain			option FSE-K11 or FSE-K10
:INPut			
[MAGNitude]	<numeric_value>	DB	
:CVL			option external mixer output
:CATalog?			query only
:SELect	<file_name>		
:MIXer	<string>		
:SNUMber	<string>		
:BAND	A Q U V E W F D G Y J		
:TYPE	ODD   EVEN   EODD		
:PORTs	2   3		
:BIAS	<numeric_value>	A	
:COMMeNT	<string>		
:DATA	<freq> , <level> ..	HZ , DB	
:CLEar	--	--	no query

**[SENSe<1|2>:]CORRection[:STATe] ON | OFF**

This command activates/deactivates normalization of the measurement results.

**Example:** "CORR ON "

**Features:** \*RST value: OFF  
SCPI: conforming

**Mode:** A

This command is only valid in conjunction with option Tracking Generator.

**[SENSe<1|2>:]CORRection:METhod TRANsmission | REFLExion**

This command selects the kind of measurement with active tracking generator (transmission/reflexion).

**Example:** "CORR:METH TRAN "

**Features:** \*RST value: TRANsmission  
SCPI: device specific

**Mode:** A

This command is only valid in conjunction with option Tracking Generator.

**[SENSe<1|2>:]CORRection:COLLect[:ACQuire] THRough | OPEN**

This command selects the kind of measurement for the reference values of the normalization (response calibration).

**Example:** "CORR:COLL THR "

**Features:** \*RST value:  
SCPI: conforming

**Mode:** A

THRough "TRANsmission" mode: calibration with direct connection between tracking generator and device input.

"REFLExion" mode: calibration with short circuit at the input

OPEN only valid in "REFLExion" mode:calibration with open input

This command is an event which is why it is not assigned an \*RST value an a query. It is only valid in conjunction with option Tracking Generator.

**[SENSe<1|2>:]CORRection:RECall**

This command restores the instrument setting that was valid for the measurement of the reference data.

**Example:** "CORR:REC "

**Features:** \*RST value: -  
SCPI: conforming

**Mode:** A

This command is an event which is why it is not assigned an \*RST value and a query. It is only valid in conjunction with option Tracking Generator.

**[SENSe<1|2>:]CORRection:TRANsducer:CATalog?**

This command reads out the names of all transducer factors stored on the harddisk.

**Example:** "CORR:TRAN:CAT?"  
**Feature:** \*RST value: -  
 SCPI: device-specific  
**Mode:** A

**[SENSe<1|2>:]CORRection:TRANsducer:ACTive?**

This command reveals the active transducer factor. If no transducer factor is switched on, a void string will be output.

**Example:** "CORR:TRAN:ACT?"  
**Feature:** \*RST value: -  
 SCPI: device-specific  
**Mode:** A

**[SENSe<1|2>:]CORRection:TRANsducer:SELect <name>**

This command selects the transducer factor designated by <name>. If <name> does not exist yet, a new transducer factor is created.

**Parameter:** <name>::= Name of the transducer factor in string data form with a maximum of 8 characters.  
**Example:** "CORR:TRAN:SEL 'FACTOR1'"  
**Features:** \*RST value: -  
 SCPI: device-specific  
**Mode:** A

This command must be sent prior to the subsequent commands for modifying/activating transducer factors.

**[SENSe<1|2>:]CORRection:TRANsducer:UNIT <string>**

This command defines the unit of the transducer factor selected.

**Parameter:** <string>::= 'DB' | 'DBM' | 'DBMV' | 'DBUV' | 'DBUV/M' | 'DBUA' | 'DBUA/M' | 'DBPW' | 'DBPT'  
**Example:** "CORR:TRAN:UNIT 'DBUV'"  
**Features:** \*RST value: 'DB'  
 SCPI: device-specific  
**Mode:** A

Prior to this command, the command SENS:CORR:TRAN:SEL must be sent.

**[SENSe<1|2>:]CORRection:TRANsdruceR:SCALIng** LINear | LOGarithmic

This command defines whether the frequency scaling of the transducer factor is linear or logarithmic.

**Example:** "CORR:TRAN:SCAL LOG"

**Features:** \*RST value: LINear  
SCPI: device-specific

**Mode:** A

Prior to this command, the command `SENS:CORR:TRAN:SEL` must be sent.

**[SENSe<1|2>:]CORRection:TRANsdruceR:COMMeNt** <string>

This command defines the comment for the selected transducer factor.

**Example:** "CORR:TRAN:COMM 'FACTOR FOR ANTENNA' "

**Features:** \*RST value " (empty comment)  
SCPI: device specific

**Mode:** A

Prior to this command, the command `SENS:CORR:TRAN:SEL` must be sent.

**[SENSe<1|2>:]CORRection:TRANsdruceR:DATA** <freq>,<level>..

This command defines the test points for the selected transducer factor. The values are entered as a series of frequency/level pairs. The frequencies must be in ascending order.

**Example:** "CORR:TRAN:TRANsdruceR:DATA 1MHZ,-30,2MHZ,-40"

**Features:** \*RST value: -  
SCPI: device-specific

**Mode:** A

Prior to this command, the command `SENS:CORR:TRAN:SEL` must be sent. The level values are sent as dimensionless numbers; the unit is specified by means of the command `SENS:CORR:TRAN:UNIT`.

**[SENSe<1|2>:]CORRection:TRANsdruceR[:STATe]** ON | OFF

This command switches the selected transducer factor on or off.

**Example:** "CORR:TRAN ON"

**Features:** \*RST value: OFF  
SCPI: device-specific

**Mode:** A

Prior to this command, the command `SENS:CORR:TRAN:SEL` must be sent.



**[SENSe<1|2>:]CORRection:TRANsducer:DELeTe**

This command deletes the selected transducer factor.

**Example:** "CORR:TRAN:DEL"

**Features:** \*RST value: -  
SCPI: device-specific

**Mode:** A

This command is an event and therefore has no \*RST value.

Prior to this command, the command SENS:CORR:TRAN:SEL must be sent.

**[SENSe<1|2>:]CORRection:TSET:CATalog?**

This command polls the names of all transducer factors stored on the harddisk.

**Parameter:** none

**Example:** "CORR:TSET:CAT?"

**Mode:** A

**Feature:** \*RST value: -  
SCPI: device-specific

**[SENSe<1|2>:]CORRection:TSET:ACTive?**

This command reveals the active transducer set. If no transducer set is switched on, a void string will be output.

**Example:** "CORR:TSET:ACT?"

**Feature:** \*RST value: -  
SCPI: device-specific

**Mode:** A

**[SENSe<1|2>:]CORRection:TSET:SELeCt <name>**

This command selected the transducer set designated by <name>. If <name> does not exist yet, a new set is created.

**Parameter:** <name>::= name of the transducer set in string data form with a maximum of 8 characters.

**Example:** "CORR:TSET:SEL 'SET1'"

**Features:** \*RST value: -  
SCPI: device-specific

**Mode:** A

This command must be sent prior to the subsequent commands for changing/activating the transducer sets.

**[SENSe<1|2>:]CORRection:TSET:UNIT** 'DB' | 'DBM' | 'DBUV' | 'DBUV/M' | 'DBUA' | 'DBUA/M' | 'DBPW' | 'DBPT'

This command defines the unit of the selected transducer sets. When assigning transducer factors to the set, only factors which are compatible to the selected unit, i. e. factors with the same unit or the unit dB, are allowed.

**Example:** "CORR:TSET:UNIT 'DBUV' "

**Features:** \*RST value: 'DB'  
SCPI: device-specific

**Mode:** A

Prior to this command, the command `SENS:CORR:TSET:SEL` must be sent.

**[SENSe<1|2>:]CORRection:TSET:BREReak ON | OFF**

This command defines if the sweep is to be stopped on changeover from range to another.

**Example:** "CORR:TSET:BREReak ON"

**Features:** \*RST value: OFF  
SCPI: device-specific

**Mode:** A

Prior to the above command, the command `SENS:CORR:TSET:SEL` must be sent.

**[SENSe<1|2>:]CORRection:TSET:COMMeNT <string>**

This command defines the comment for the selected transducer set.

**Example:** "CORR:TSET:COMMeNT 'SET FOR ANTENNA' "

**Features:** \*RST value: " (empty comment)  
SCPI: device specific

**Mode:** A

Prior to this command, the command `SENS:CORR:TSET:SEL` must be sent.

**[SENSe<1|2>:]CORRection:TSET:RANGe<1 to 10> <freq>,<freq>,<name>..**

This command defines a partial range of the selected transducer set. The partial range is determined by its start and stop frequencies plus a list of names of the assigned transducer factors. The ranges 1 to 10 must be sent in ascending order.

**Parameter:** <freq>,<freq>::= start frequency, stop frequency of the range  
<name>...::= list of names for the assigned transducer factors.  
The individual names must be characterized by single quotation marks (') and separated by commas.

**Example:** "CORR:TRAN:TSET:RANG 1MHZ,2MHZ,'FACTOR1','FACTOR2' "

**Features:** \*RST value: -  
SCPI: device-specific

**Mode:** A

Prior to this command, the command `SENS:CORR:TSET:SEL` must be sent.

**[SENSe<1|2>:]CORRection:TSET[:STATe] ON | OFF**

This command switches the selected transducer set on or off.

**Example:** "CORR:TSET ON"

**Features:** \*RST value: OFF  
SCPI: device-specific

**Mode:** A

Prior to this command, the command `SENS:CORR:TSET:SEL` must be sent.

**[SENSe<1|2>:]CORRection:TSET:DELeTe**

This command deletes the selected transducer set.

**Example:** "CORR:TSET:DEL"

**Features:** \*RST value: -  
SCPI: device-specific

**Mode:** A

This command is an event and thus has no \*RST value assigned.

Prior to this command, the command `SENS:CORR:TSET:SEL` must be sent.

**[SENSe<1|2>:]CORRection:LOSS:INPut[:MAGNitude] <numeric\_value>**

This command announces to the instrument a possibly needed external attenuation of the input signal, so that it is taken into account later when the level is set.

**Parameter:** <numeric\_value>::= value of external attenuation in dB.

**Example:** "CORR:LOSS:INP 30DB "

**Features:** \*RST value: 20dB  
SCPI: device-specific

**Modes:** BTS, MS

The external attenuation must be selected such that the input power of the analyzer does not exceed 27 dBm.

**[SENSe<1|2>:]CORRection:RXGain:INPut[:MAGNitude] <numeric\_value>**

This command announces to the instrument a possibly needed preamplification in the RX-band (RX BAND GAIN), so that it is taken into account later when the measured values are read out.

**Parameter:** <numeric\_value>::= value of the amplification in dB.

**Example:** "CORR:RXG:INP 30DB "

**Features:** \*RST value: 0 dB  
SCPI: device-specific

**Modes:** BTS, MS

**[SENSe<1|2>:]CORRection:CVL:CATalog?**

This command polls the names of all conversion-loss tables stored on the harddisk.

**Example:** "CORR:CVL:CAT?"

**Feature:** \*RST value: -  
SCPI: device-specific

**Mode:** A

This command is only valid in conjunction with option External Mixer Output, FSE-B21.

**[SENSe<1|2>:]CORRection:CVL:SElect <file\_name>**

This command selects the Conversion Loss Table designated with <file\_name>. If <file\_name> is not available, a new Conversion Loss Table will be created.

**Parameter:** <file\_name>::= Name of Conversion Loss Table as string data with a maximum of 8 characters

**Example:** "CORR:CVL:SEL 'LOSS\_TAB' "

**Features:** \*RST value: -  
SCPI: device-specific

**Mode:** A

This command must be sent prior to the subsequent commands used to change/activate the Conversion Loss files. It is only valid in conjunction with option External Mixer Output, FSE-B21.

**[SENSe<1|2>:]CORRection:CVL:MIXer <string>**

This command defines the type designation of the mixer in the Conversion Loss Table.

**Parameter:** <string>::= Type designation of mixer with a maximum of 16 characters

**Example:** "CORR:CVL:MIX 'FSE\_Z60' "

**Features:** \*RST value: -  
SCPI: device-specific

**Mode:** A

Command `SENS:CORR:CVL:SEL` must be sent prior to this command. This command is only valid in conjunction with option External Mixer Output, FSE-B21.

**[SENSe<1|2>:]CORRection:CVL:SNUMber <string>**

This command defines the serial number of the mixer in the Conversion Loss Table.

**Parameter:** <string>::= Serial number of mixer with a maximum of 16 characters

**Example:** "CORR:CVL:SNUM '123.4567' "

**Features:** \*RST value: -  
SCPI: device-specific

**Mode:** A

Command `SENS:CORR:CVL:SEL` must be sent prior to this command. This command is only valid in conjunction with option External Mixer Output, FSE-B21.

**[SENSe<1|2>:]CORRection:CVL:BAND** A|Q|U|V|E|W|F|D|G|Y|J

This command defines the waveguide band in the Conversion Loss Table.

**Example:** "CORR:CVL:BAND E"

**Features:** \*RST value: -  
SCPI: device-specific

**Mode:** A

Command `SENS:CORR:CVL:SEL` must be sent prior to this command. This command is only valid in conjunction with option External Mixer Output, FSE-B21.

**[SENSe<1|2>:]CORRection:CVL:TYPE** ODD | EVEN | EODD

This command defines the type of harmonic in the Conversion Loss Table.

**Example:** "CORR:CVL:TYPE EODD"

**Features:** \*RST value: -  
SCPI: device-specific

**Mode:** A

Command `SENS:CORR:CVL:SEL` must be sent prior to this command. This command is only valid in conjunction with option External Mixer Output, FSE-B21.

**[SENSe<1|2>:]CORRection:CVL:PORTs** 2 | 3

This command defines the type of mixer in the Conversion Loss Table.

**Example:** "CORR:CVL:PORT 3"

**Features:** \*RST value: -  
SCPI: device-specific

**Mode:** A

Command `SENS:CORR:CVL:SEL` must be sent prior to this command. This command is only valid in conjunction with option External Mixer Output, FSE-B21.

**[SENSe<1|2>:]CORRection:CVL:BIAS** <numeric\_value>

This command defines the bias current in the Conversion Loss Table.

**Example:** "CORR:CVL:BIAS 7mA"

**Features:** \*RST value: -  
SCPI: device-specific

**Mode:** A

Command `SENS:CORR:CVL:SEL` must be sent prior to this command. This command is only valid in conjunction with option External Mixer Output, FSE-B21.

**[SENSe<1|2>:]CORRection:CVL:COMMeNt** <string>

This command defines the comment in the Conversion Loss Table.

**Parameter:** <string>:= Comment of mixer with a maximum of 60 characters

**Example:** "CORR:CVL:COMMENT 'MIXER FOR BAND U' "

**Features:** \*RST value: -  
SCPI: device-specific

**Mode:** A

Command `SENS:CORR:CVL:SEL` must be sent prior to this command. This command is only valid in conjunction with option External Mixer Output, FSE-B21.

**[SENSe<1|2>:]CORRection:CVL:DATA** <freq>,<level>..

This command defines the reference values of the selected Conversion Loss Tables. The values are entered as a result of frequency/level pairs. The frequencies have to be sent in ascending order.

**Example:** "CORR:CVL:DATA 1MHZ,-30DB,2MHZ,-40DB"

**Features:** \*RST value: -  
SCPI: device-specific

**Mode:** A

Command `SENS:CORR:CVL:SEL` must be sent prior to this command. This command is only valid in conjunction with option External Mixer Output, FSE-B21.

**[SENSe<1|2>:]CORRection:CVL:CLEAr**

This command deletes the selected Conversion Loss Table.

**Example:** "CORR:CVL:CLE "

**Features:** \*RST value: -  
SCPI: device-specific

**Mode:** A

This command is an event which is why it is not assigned an \*RST value.

Command `SENS:CORR:CVL:SEL` must be sent prior to this command. This command is only valid in conjunction with option External Mixer Output, FSE-B21.

## SENSe:DETECTOR Subsystem

The SENSe:DETECTOR subsystem controls the recording of measurement values via the type of detector selected for each trace.

COMMAND	PARAMETERS	UNIT	COMMENT
[SENSe<1 2>] :DETECTOR<1to4> [:FUNCTION]  :AUTO	APEAK   NEGATIVE   POSITIVE   SAMPLE   RMS   AVERAGE  <Boolean>	--	

**[SENSe<1|2>]:DETECTOR<1 to 4>[:FUNCTION] APEAK | NEGATIVE | POSITIVE | SAMPLE | RMS | AVERAGE**

This command switches the detector for recording of the measured value.

**Example:** "DET POS "

**Features:** \*RST value: APEAK  
SCPI: conforming

**Mode:** A

The value "APEAK" (AutoPeak) displays both the positive peak value and the negative peak value when noise is present. The positive peak value is displayed when one signal is present. The trace is selected by means of the numeric suffix after DETECTOR.

**[SENSe<1|2>]:DETECTOR<1 to 4>[:FUNCTION]:AUTO ON | OFF**

This command either couples the detector to the current trace setting or turns coupling off.

**Example:** "DET:AUTO OFF "

**Features:** \*RST value: ON  
SCPI: conforming

**Mode:** A

The trace is defined by the numeric suffix at DETECTOR.

## SENSe:DDEMod Subsystem

This subsystem controls the parameters for digital demodulation.

COMMAND	PARAMETERS	UNIT	COMMENT
[SENSe<1 2>] :DDEMod			Vector Signal Analysis
:FORMat	QPSK   PSK   MSK   QAM   FSK		
:SBANd	NORMal   INVerse		
:QPSK			
:FORMat	NORMal   DIFFerential   OFFSet   DPI4		
:PSK			
:NSTate	2   8		
:FORMat	NORMal   DIFFerential   N3Pi8		
:MSK			
:FORMat	TYPE1   TYPE2   NORMal   DIFFerential		
:QAM			
:NSTate	16		
:FSK			
:NSTate	2   4		
:SRATe	<numeric_value>	HZ	
:TIMe	<numeric_value>	SYM	
:PRATe	1   2   4   8   16		
:FILTer			
:MEASurement	OFF   RCOSine   RRCosine   GAUSSian   B22   B25   B44   QFM   FM95   QFR   FR95   QRM   RM95   QRR   RR95   A25Fm   EMES   EREF		
:REFerence	RCOSine   RRCosine   GAUSSian   B22   B25   B44   QFM   FM95   QFR   FR95   QRM   RM95   QRR   RR95   A25Fm   EMES   EREF		
:ALPHa	<numeric_value>		
:NORMalize	<Boolean>		
:PRESet	GSM   TETRa   DCS1800   PCS1900   PHS   PDCup   PDCDown   APCO25CQPSK   APCO25C4FM   CDPD   DECT   CT2   ERMes   MODacom   PWT   TFTS   F16   F322   F324   F64   FQCDma   F95Cdma   RQCDma   R95Cdma   FNADc   RNADc   EDGe   BPSK18   GMSK18   QPSK18   GMSK36   FWCDma   FCDMa4096   RWCDma   RCDMa4096   FW3Gppcdma   RW3Gppcdma   CDMA2000		
:SEARch			
:PULSe			
:STATe	<Boolean>		
:SYNC			
:CATalog?			query only
:SELeCt	<string>		
:OFFSet	<numeric_value>	SYM	
:PATtern	<string>		
:STATe	<Boolean>		
:NAME	<string>		
:COMMeNt	<string>		
:DATA	<string>		
:DELete			
:MONLy	<Boolean>		
:TIMe	<numeric value>	SYM	
:TCAPture			Vector Signal Analysis
:LENGth	<numeric_value>		



**[SENSe<1|2>:]DDEMod:FORMat** QPSK | PSK | MSK | QAM | FSK

This command selects the digital demodulation type.

**Example:** "DDEM:FORM QPSK"  
**Features:** \*RST value: MSK  
SCPI: device-specific  
**Mode:** VA-D

**[SENSe<1|2>:]DDEMod:SBANd** NORMal | INVerse

This command selects the sideband for the demodulation.

**Example:** "DDEM:SBAN INV"  
**Features:** \*RST value: NORMal  
SCPI: device-specific  
**Mode:** VA-D

**[SENSe<1|2>:]DDEMod:QPSK:FORMat** NORMal | DIFFerential | OFFSet | DPI4

This command determines the specific demodulation type for QPSK.

**Example:** "DDEM:QPSK:FORM DPI4"  
**Features:** \*RST value: -  
SCPI: device-specific  
**Mode:** VA-D

**[SENSe<1|2>:]DDEMod:PSK:NSTate** 2 | 8

This command determines the specific demodulation type for PSK.

**Example:** "DDEM:PSK:NST 2"  
**Features:** \*RST value: -  
SCPI: device-specific  
**Mode:** VA-D

Value 2 (i.e. PSK2) corresponds to BPSK demodulation, value 8 the 8PSK demodulation.

**[SENSe<1|2>:]DDEMod:PSK:FORMat** NORMal | DIFFerential | N3Pi8

This command determines the specific demodulation type for PSK.

**Example:** "DDEM:PSK:FORM DIFF"  
**Features:** \*RST value: -  
SCPI: device-specific  
**Mode:** VA-D

**[SENSe<1|2>:]DDEMod:MSK:FORMat** TYPE1 | TYPE2 | NORMAl | DIFFerential

This command determines the specific demodulation type for MSK.

**Example:** "DDEM:MSK:FORM TYPE2"

**Features:** \*RST value: TYPE2 | DIFFerential  
SCPI: device-specific

**Mode:** VA-D

TYPE1 | NORMAl corresponds to MSK demodulation, TYPE2 | DIFFerential corresponds to DMSK demodulation.

**[SENSe<1|2>:]DDEMod:QAM:NSTate** 16

This command determines the specific demodulation type for QAM.

**Example:** "DDEM:QAM:NST 16"

**Features:** \*RST value: 16  
SCPI: device-specific.

**Mode:** VA-D

**[SENSe<1|2>:]DDEMod:FSK:NSTate** 2 | 4

This command determines the specific demodulation type for FSK.

**Example:** "DDEM:FSK:NST 2"

**Features:** \*RST- value: -  
SCPI: device-specific

**Mode:** VA-D

The parameter 2 corresponds to the demodulation type 2FSK, the parameter 4 to the demodulation type 4FSK.

**[SENSe<1|2>:]DDEMod:SRATe** 160 Hz ...7 MHz

This command defines the symbol rate.

**Example:** "DDEM:SRAT 18kHz"

**Features:** \*RST value: 270.833333kHz  
SCPI: device-specific

**Mode:** VA-D

**[SENSe<1|2>:]DDEMod:TIME** 1 to Frame Length

The command determines the number of displayed symbols (result length).

**Example:** "DDEM:TIME 80"

**Features:** \*RST value: 147  
SCPI: device-specific

**Mode:** VA-D

**[SENSe<1|2>:]DDEMod:PRATe** 1 | 2 | 4 | 8 | 16

This command determines the number of points per symbol.

**Example:** "DDEM:PRAT 8"  
**Features:** \*RST value: 4  
 SCPI: device-specific  
**Mode:** VA-D

**[SENSe<1|2>:]DDEMod:FILTer:MEASurement** OFF | RCOSine | RRCosine | GAUSSian | B22 | B25 | B44 | QFM | FM95 | QFR | FR95 | QRM | RM95 | QRR | RR95 | A25Fm | EMES | EREF

This command selects the input filter for the test signal.

B22	Bessel 22
B25	Bessel 25
B44	Bessel 44
QFM or FM95	IS95-CDMA fm
QFR or FR95	IS95-CDMA fr
QRM or RM95	IS95-CDMA rm
QRR or RR95	IS95-CDMA rr
A25Fm	APCO 25 fm
EMES	EDGE mes
EREF	EDGE ref

**Example:** "DDEM:FILT:MEAS RCOS"  
**Features:** \*RST value: OFF  
 SCPI: device-specific  
**Mode:** VA-D

**[SENSe<1|2>:]DDEMod:FILTer:REFerence** RCOSine | RRCosine | GAUSSian | B22 | B25 | B44 | QFM | FM95 | QFR | FR95 | QRM | RM95 | QRR | RR95 | A25Fm | EMES | EREF

This command selects the input filter for the reference signal.

**Example:** "DDEM:FILT:REF RCOS"  
**Features:** \*RST value: GAUSSian  
 SCPI: device-specific  
**Mode:** VA-D

**[SENSe<1|2>:]DDEMod:FILTer:ALPHA** 0.2 to 1

This command determines the filter characteristic (ALPHA/BT). Step width is 0.05.

**Example:** "DDEM:FILT:ALPH 0.5"  
**Features:** \*RST value: 0.3  
 SCPI: device-specific  
**Mode:** VA-D

**[SENSe<1|2>:]DDEMod:NORMalize ON | OFF**

This command switches normalizing of the unit circle on or off using IQ offset.

**Example:** "DDEM:NORM OFF"  
**Features:** \*RST value: ON  
 SCPI: device-specific  
**Mode:** VA-D

**[SENSe<1|2>:]DDEMod:SEARch:PULSe:STATe ON | OFF**

This command switches the signal burst search on or off.

**Example:** "DDEM:SEAR:PULS:STAT OFF"  
**Features:** \*RST value: ON  
 SCPI: device-specific  
**Mode:** VA-D

**[SENSe<1|2>:]DDEMod:SEARch:SYNC:CATalog?**

This command polls the names of all sync-file data sets stored on the harddisk.

**Example:** "DDEM:SEAR:SYNC:CAT?"  
**Feature:** \*RST value: -  
 SCPI: device-specific  
**Mode:** VA-D

**[SENSe<1|2>:]DDEMod:SEARch:SYNC:SElect <string>**

This command selects a predefined sync file. A file that has been set previously by the command DDEM:SEARch:SYNC:PATTern becomes invalid.

**Example:** "DDEM:SEAR:SYNC:SEL "PATT\_1"  
**Feature:** \*RST value: ""  
 SCPI: device-specific  
**Mode:** VA-D

**[SENSe<1|2>:]DDEMod:SEARch:SYNC:OFFSet <numeric\_value>**

This command defines the offset of the display with reference to the synchronization sequence.

**Example:** "DDEM:SEAR:SYNC:OFFS 10SYM"  
**Features:** \*RST value: 0 SYM  
 SCPI: device-specific  
**Mode:** VA-D

**[SENSe<1|2>:]DDEMod:SEARch:SYNC:PATTern** <string>

This command defines the synchronization sequence. A file that has been set previously by the command `DDEM:SEARch:SYNC:SELEct` becomes invalid.

**Example:** `"DDEM:SEAR:SYNC:PATT "1101001"`

**Features:** \*RST value: ""  
SCPI: device-specific

**Mode:** VA-D

**[SENSe<1|2>:]DDEMod:SEARch:SYNC:STATe** ON | OFF

This command switches the search for a synchronization sequence on or off.

**Example:** `"DDEM:SEARch:SYNC:STAT ON"`

**Features:** \*RST value: OFF  
SCPI: device-specific

**Mode:** VA-D

**[SENSe<1|2>:]DDEMod:SEARch:SYNC:NAME** <string>

This command selects a sync file to be edited or entered anew.

**Example:** `"DDEM:SEAR:SYNC:NAME "PATT_NEW"`

**Feature:** \*RST value: ""  
SCPI: device-specific

**Mode:** VA-D

**[SENSe<1|2>:]DDEMod:SEARch:SYNC:COMment** <string>

This command defines a comment on a sync file. This sync file must be previously selected by the command `DDEM:SEARch:SYNC:NAME`.

**Example:** `"DDEM:SEAR:SYNC:COMM "PATTERN FOR PPSK"`

**Feature:** \*RST value: ""  
SCPI: device-specific

**Mode:** VA-D

**[SENSe<1|2>:]DDEMod:SEARch:SYNC:DATA** <string>

This command defines a synchronization pattern for the sync file. This sync file must be previously selected by the command `DDEM:SEARch:SYNC:NAME`.

**Example:** `"DDEM:SEAR:SYNC:DATA "1101001"`

**Feature:** \*RST value: ""  
SCPI: device-specific

**Mode:** VA-D

**[SENSe<1|2>:]DDEMod:SEARch:SYNC:DELeTe** <string>

This command deletes a synchronization pattern on the hard disk. This sync file must be previously selected by the command `DDEM:SEARch:SYNC:NAME`.

**Example:**            `"DDEM:SEAR:SYNC:DEL"`

**Features:**        \*RST-value:     ""  
                      SCPI:            device-specific

**Mode:**            VA-D

**[SENSe<1|2>:]DDEMod:SEARch:SYNC:MONLy** ON | OFF

For setting ON, this command sets the analyzer so that the measured values are displayed and taken into account in the error analysis only if the set sync pattern is found. Bursts with a wrong sync pattern (sync not found) are ignored.

**Example:**            `"DDEM:SEAR:SYNC:MONL ON"`

**Features:**        \*RST value:     OFF  
                      SCPI:            device specific

**Mode:**            VA-D

**[SENSe<1|2>:]DDEMod:SEARch:TIME** 100 to 1600

This command determines the number of symbols required for demodulation (frame length). The values > 800 are only permissible if the number of points per symbol is <16, the values > 1600 only if the number of points per symbol is <8. Step width is 100.

**Example:**            `"DDEM:SEAR:TIME 800"`

**Features:**        \*RST value:     400  
                      SCPI:            device-specific

**Mode:**            VA-D

**[SENSe<1|2>:]DDEMod:PRESet** GSM | EDGE | TETRA | PHS | PDCup | PDCDown | APCO25CQPSK | APCO25C4FM | CDPD | DECT | CT2 | ERMes | MODacom | PWT | TETS | F16 | F322 | F324 | F64 | FQCDma | F95Cdma | RQCDma | R95Cdma | FNADc | RNADc | FWCDma | FCDMa4096 | RWCDma | RCDMa4096 | FW3Gppcdma | RW3Gppcdma | CDMA2000

This command selects an automatic setting of all modulation parameters according to a standard transmission method.

**Example:** "DDEM:PRES TETR"

**Features:** \*RST value: FWCDma  
SCPI: device-specific

**Mode:** VA-D

APCO25CQPSK	APCO25 Continuous Phase QPSK
APCO25C4FM	APCO25Continuous Phase 4FM
F16	FLEX 1600 - 2FSK
F322	FLEX 3200 - 2FSK,
F324	FLEX 3200 - 4FSK
F64	FLEX 6400 - 4FSK
FNADc	Forward NADC
RNADc	Reverse NADC
FQCDma or F95Cdma	Forward CDMA acc. to IS95 Standard
RQCDma or R95Cdma	Reverse CDMA acc. to IS95 Standard
FWCDma or FCDMa4096	Forward W-CDMA
RWCDma or RCDMa4096	Reverse W-CDMA
FW3Gppcdma	Forward W-CDMA 3GPP
RW3Gppcdma	Reverse W-CDMA 3GPP
CDMA2000	CDMA 2000

**[SENSe<1|2>:]TCAPture:LENGth** 1024 | 2048 | 4096 | 8192 | 16384

This command determines the number of sampling points that are written into the memory for each measurement (memory size).

**Example:** "TCAP:LENG 1024"

**Features:** \*RST value: 16384  
SCPI: device-specific

**Mode:** VA-D

## SENSe:FILTer Subsystem

The SENSe:FILTer subsystem selects the filters in the video signal path. This subsystem is active only in the Vector Signal Analysis mode

COMMAND	PARAMETERS	UNIT	COMMENT
[SENSe<1 2>] :FILTer			Vector Signal Analyzer
:HPASs			
[:STATe]	<Boolean>	--	
:FREQuency	<numeric_value>	HZ	
:LPASs			Vector Signal Analyzer
[:STATe]	<Boolean>	--	
:FREQuency	<numeric_value>	HZ   PCT	
:CCITt			
[:STATe]	<Boolean>	--	
:CMESsage			
[:STATe]	<Boolean>	--	
:DEMPHasis			
[:STATe]	<Boolean>	--	
:TCONstant	<numeric_value>	S	
:LINK	DISPlay   AUDio		

### [SENSe<1|2>]:FILTer:HPASs[:STATe] ON | OFF

This command activates the high-pass filter in the AF-branch for analog demodulation.

**Example:** "FILT:HPAS ON"

**Features:** \*RST value: OFF  
SCPI: conforming

**Mode:** VA-A

### [SENSe<1|2>]:FILTer:HPASs:FREQuency 30 Hz | 300 Hz

In the Vector Signal Analysis mode with analog demodulation, this command defines the frequency limit of the high-pass filter in the AF-branch. For REAL TIME ON absolute frequencies are entered, for REAL TIME OFF, the frequencies are entered relative to the demodulation bandwidth.

**Example:** "FILT:HPAS:FREQ 300HZ"

**Features:** \*RST value: - (STATe = OFF)  
SCPI: conforming

**Mode:** VA-A



**[SENSe<1|2>:]FILTer:LPASs[:STATe]** ON | OFF

This command activates the low-pass filter in the AF-branch with analog demodulation.

**Example:** "FILT:LPAS ON"

**Features:** \*RST value: OFF  
SCPI: conforming

**Mode:** VA-A

On switching to ON, a bandwidth of 3 kHz for REAL TIME ON and a bandwidth of 5 PCT for REAL TIME OFF is set automatically.

**[SENSe<1|2>:]FILTer:LPASs:FREQuency** <numeric\_value>

This command defines the frequency limit of the low-pass filter in the NF-branch for analog demodulation.

**Parameter:** <numeric\_value> ::= 3 kHz | 15 kHz for REAL TIME ON  
5 PCT | 10 PCT | 25 PCT for REAL TIME OFF

**Example:** "FILT:LPAS:FREQ 3KHZ" for REAL TIME ON  
"FILT:LPAS:FREQ 25PCT" for REAL TIME OFF

**Features:** \*RST value: - (STATe = OFF)  
SCPI: conforming

**Mode:** VA-A

**[SENSe<1|2>:]FILTer:CCITt[:STATe]** ON | OFF

This command activates the weighting filter according to CCITT-recommendation in the AF-branch for analog demodulation.

**Example:** "FILT:CCIT ON"

**Features:** \*RST value: OFF  
SCPI: conforming

**Mode:** VA-A

**[SENSe<1|2>:]FILTer:CMESsage[:STATe]** ON | OFF

This command activates the C-message weighting filter according to CCITT-recommendation in the AF-branch for analog demodulation.

**Example:** "FILT:CMES ON"

**Features:** \*RST value: OFF  
SCPI: conforming

**Mode:** VA-A

This command is valid only with REAL TIME OFF.

**[SENSe<1|2>:]FILTer:DEMPHasis[:STATe]** ON | OFF

This command activates the selected de-emphasis for analog demodulation.

**Example:** "FILT:DEMP ON"  
**Features:** \*RST value: OFF  
 SCPI: conforming  
**Mode:** VA-A

**[SENSe<1|2>:]FILTer:DEMPHasis:TCONstant** 50US | 75US | 750US

This command sets the time constant of the de-emphasis for analog demodulation.

**Example:** "FILT:DEMP:TCON 75US"  
**Features:** \*RST value: 50us  
 SCPI: conforming  
**Mode:** VA-A

**[SENSe<1|2>:]FILTer:DEMPHasis:LINK** DISPlay | AUDio

For analog demodulation, this command selects whether the de-emphasis set is to be active in the audio branch only or in addition for the display of measured values.

**Example:** "FILT:DEMP:LINK DISP"  
**Features:** \*RST value: AUDio  
 SCPI: device-specific  
**Mode:** VA-A  
 AUDio De-emphasis effective in the audio branch only  
 DISPlay De-emphasis effective in the audio branch and in the display of measured values

## SENSe:FREQuency Subsystem

The SENSe:FREQuency subsystem defines the frequency axis of the active display. The frequency axis can either be defined via the start/stop frequency or via the center frequency and span.

COMMAND	PARAMETERS	UNIT	COMMENT
[SENSe<1 2>] :FREQuency			
:CENTer	<numeric_value>	HZ	
:LINK	START   STOP   SPAN	--	
:STEP	<numeric_value>	HZ	
:LINK	SPAN   RBW   OFF	--	
:FACTOR	<numeric_value>	PCT	
:SPAN	<numeric value>	HZ	
:FULL	--	--	
:LINK	CENTER   START   STOP	--	
:START	<numeric_value>	HZ	
:LINK	CENTER   STOP   SPAN	--	
:STOP	<numeric_value>	HZ	
:LINK	CENTER   START   SPAN	--	
:MODE	CW   FIXed   SWEep	--	
:OFFSet	<numeric_value>	HZ	

### [SENSe<1|2>:]FREQuency:CENTer 0 GHz to $f_{max}$

This command defines the center frequency of the analyzer.

**Example:** "FREQ:CENT 100MHz"

**Features:** \*RST value:  $f_{max} / 2$   
SCPI: conforming

**Modes:** A, VA, MS, BTS

The automatic coupling of the parameters is set to SPAN FIXED.

### [SENSe<1|2>:]FREQuency:CENTer:LINK START | STOP | SPAN

This command defines the coupling of the center frequency to the start, stop frequency or the frequency span.

**Example:** "FREQ:CENT:LINK STAR"

**Features:** \*RST value: SPAN  
SCPI: device-specific

**Mode:** A

**[SENSe<1|2>:]FREQUency:CENTer:STEP** 0 to  $f_{\max}$ 

This command defines the step width of the center frequency.

**Example:** "FREQ:CENT:STEP 120MHz"

**Features:** \*RST value: - (AUTO 0.1 × SPAN is switched on)  
SCPI: conforming

**Modes:** A, VA, BTS, MS

**[SENSe<1|2>:]FREQUency:CENTer:STEP:LINK** SPAN | RBW | OFF

This command couples the step width of the center frequency to span (span >0) or to the resolution bandwidth (span = 0) or cancels the couplings.

**Example:** "FREQ:CENT:STEP:LINK SPAN"

**Features:** \*RST value: SPAN  
SCPI: device-specific

**Modes:** A, BTS, MS

**[SENSe<1|2>:]FREQUency:CENTer:STEP:LINK:FACTor** 1 to 100 PCT

This command couples the step width of the center frequency with a factor to the span (span >0) or to the resolution bandwidth (span = 0).

**Example:** "FREQ:CENT:STEP:LINK:FACT 20PCT"

**Features:** \*RST value: - (AUTO 0.1 × SPAN is switched on)  
SCPI: device-specific

**Modes:** A, BTS, MS

**[SENSe<1|2>:]FREQUency:SPAN** 0 GHz to  $f_{\max}$ 

This command defines the frequency span of the analyzer.

**Example:** "FREQ:SPAN 10MHz"

**Features:** \*RST value:  $f_{\max}$   
SCPI: conforming

**Mode:** A

The automatic coupling of the parameters is set to CENTER FIXED.

**[SENSe<1|2>:]FREQuency:SPAN:FULL**

This command sets the maximum frequency span of the analyzer.

**Example:** "FREQ:SPAN:FULL"

**Features:** \*RST value: -  
SCPI: conforming

**Mode:** A

This command is an event which is why it is not assigned an \*RST value and has no query.

**[SENSe<1|2>:]FREQuency:SPAN:LINK CENTER | START | STOP**

This command defines the coupling for frequency-span changes.

**Example:** "FREQ:SPAN:LINK STOP"

**Features:** \*RST value: CENTER  
SCPI: conforming

**Mode:** A

**[SENSe<1|2>:]FREQuency:START 0 GHz to  $f_{\max}$** 

This command defines the start frequency of the analyzer.

**Example:** "FREQ:STAR 20MHz"

**Features:** \*RST value: 0  
SCPI: conforming

**Mode:** A

The automatic coupling of the parameters is set to STOP FIXED.

**[SENSe<1|2>:]FREQuency:START:LINK CENTER | STOP | SPAN**

This command defines the coupling for start-frequency changes.

**Example:** "FREQ:STAR:LINK SPAN"

**Features:** \*RST value: STOP  
SCPI: device-specific

**Mode:** A

**[SENSe<1|2>:]FREQuency:STOP 0 GHz to  $f_{\max}$** 

This command defines the stop frequency of the scan in receiver mode or the stop frequency of the analyzer.

**Example:** "FREQ:STOP 2000MHz"

**Features:** \*RST value:  $f_{\max}$   
SCPI: conforming

**Mode:** A

The automatic coupling of the parameters is set to START FIXED.

**[SENSe<1|2>:]FREQUency:STOP:LINK** CENTER | START | SPAN

This command defines the coupling for stop-frequency changes.

**Example:** "FREQ:STOP:LINK SPAN"

**Features:** \*RST value: START  
SCPI: device-specific

**Mode:** A

**[SENSe<1|2>:]FREQUency:MODE** CW | FIXed | SWEEp

This command switches between frequency (SWEEp) and time (CW | FIXed) domain in the analyzer mode.

**Example:** "FREQ:MODE SWE"

**Features:** \*RST value: CW  
SCPI: conforming

**Mode:** A

For CW and FIXed, the frequency setting is via command `FREQUency:CENTer`. In the SWEEp mode, the setting is via commands `FREQUency:START`, `STOP`, `CENTER` and `SPAN`.

**[SENSe<1|2>:]FREQUency:OFFSet** <numeric\_value>

This command defines the frequency offset of the instrument.

**Example:** "FREQ:OFFS 1GHZ"

**Features:** \*RST value: 0 Hz  
SCPI: conforming

**Modes:** A, VA

## SENSe:MIXer - Subsystem

The SENSe:MIXer subsystem controls the settings of the external mixer. It is only active in Analyzer mode (INSTRument SANalyzer). The suffix in SENSe<1|2> is not significant in this subsystem.

COMMAND	PARAMETERS	UNIT	COMMENT
[SENSe<1 2>:] :MIXer			
[:STATe]	<Boolean>	--	
:BLOCK	<Boolean>		
:PORTs	2   3		
:SIGNal	OFF   ON   AUTO		
:THReshold	<numeric_value>		
:HARMonic	<numeric_value>	--	Only query in band lock on
:TYPE	ODD   EVEN   EODD		Not in band lock off
:BAND	A Q U V E W F D G Y J		Not in band lock off
:LOSS			
[:LOW]	<numeric_value>	DB	
:HIGH	<numeric_value>	DB	Not in band lock off
:TABLE	<file_name>		
:BIAS	<numeric_value>	A	
:LIMit			
[:MAX]	<numeric_value>	A	Not in band lock on
:MIN	<numeric_value>	A	Not in band lock on

### [SENSe<1|2>:]MIXer[:STATe] ON | OFF

This command activates or shuts off the external mixer.

Example: "MIX ON"

**Features:** \*RST value: OFF  
SCPI: device-specific

**Mode:** A

This command is available only in conjunction with option FSE-B21, External Mixer Output.

### [SENSe<1|2>:]MIXer:BLOCK ON | OFF

This command activates the BAND LOCK ON or BAND LOCK OFF mode.

Example: "MIX:BLOC ON"

**Features:** \*RST value: OFF  
SCPI: device-specific

**Mode:** A

This command is available only if the external mixer (option FSE-B21) is switched on.

**[SENSe<1|2>:]MIXer:PORTs 2 | 3**

This command activates the 2- or 3-port mixer. In the BAND LOCK ON mode, the command refers to the active band selected with `SENSe:MIXer:HARMonic:BAND`.

**Example:** `"MIX:PORT 3"`

**Features:** \*RST value: 2  
SCPI: device-specific

**Mode:** A

This command is available only if the external mixer (option FSE-B21) is switched on.

**[SENSe<1|2>:]MIXer:SIGNal ON | OFF | AUTO**

This command activates the Signal ID or Auto ID mode.

**Example:** `"MIX:SIGN ON"`

**Features:** \*RST value: OFF  
SCPI: device-specific

**Mode:** A

This command is available only if the external mixer (option FSE-B21) is switched on.

**[SENSe<1|2>:]MIXer:THReshold 0.1 to 100 dB**

This command sets the level threshold for auto ID.

**Example:** `"MIX:THR 20"`

**Features:** \*RST value: 10  
SCPI: device-specific

**Mode:** A

The command is available only if the external mixer (option FSE-B21) is switched on.

**[SENSe<1|2>:]MIXer:HARMonic <numeric\_value>**

With BAND LOCK OFF, this command sets the nth harmonic. The command may be a query with BAND LOCK ON.

**Parameter:** <numeric\_value> := 2..X; X: depending on the LO

**Example:** `"MIX:HARM 5"`

**Features:** \*RST value: 2  
SCPI: conforming

**Mode:** A

The command is available only if the external mixer (option FSE-B21) is switched on.



**[SENSe<1|2>:]MIXer:HARMonic:TYPE** ODD | EVEN | EODD

With BAND LOCK ON, this command sets the type of harmonic.

**Example:** "MIX:HARM:TYPE EODD"

**Features:** \*RST value: EVEN  
SCPI: device-specific

**Mode:** A

The command is available only if the external mixer (option FSE-B21) is switched on.

**[SENSe<1|2>:]MIXer:HARMonic:BAND** A|Q|U|V|E|W|F|D|G|Y|J

With BAND LOCK ON, this command sets the active band.

**Example:** "MIX:HARM:BAND E"

**Features:** \*RST value: U  
SCPI: device-specific

**Mode:** A

The command is available only if the external mixer (option FSE-B21) is switched on.

**[SENSe<1|2>:]MIXer:LOSS[:LOW]** <numeric\_value>

This command sets the conversion loss of the mixer.

**Example:** "MIX:LOSS -12DB"

**Features:** \*RST value: 0 dB  
SCPI: conforming

**Mode:** A

The command is available only if the external mixer (option FSE-B21) is switched on.

**[SENSe<1|2>:]MIXer:LOSS:HIGH** <numeric\_value>

With BAND LOCK ON, this command sets the conversion loss of the mixer for higher harmonics in bands with two harmonics (band A: even harmonics, band Q: odd harmonics).

**Example:** "MIX:LOSS:HIGH -14DB"

**Features:** \*RST value: 0 dB  
SCPI: device-specific

**Mode:** A

The command is available only if the external mixer (option FSE-B21) is switched on.

**[SENSe<1|2>:]MIXer:LOSS:TABLE** <file\_name>

This command sets a conversion loss table.

**Parameter:** <file\_name> := DOS file name

**Example:** "MIX:LOSS:table 'mix\_1' "

**Features:** \*RST value: no table set  
SCPI: device-specific

**Mode:** A

The command is available only if the external mixer (option FSE-B21) is switched on.

**[SENSe<1|2>:]MIXer:BIAS** <numeric\_value>

This command sets the bias current.

**Example:** "MIX:BIAS 7mA"

**Features:** \*RST value: 0 A  
SCPI: conforming

**Mode:** A

The command is available only if the external mixer (option FSE-B21) is switched on.

**[SENSe<1|2>:]MIXer:BIAS:LIMit[:MAX]** <numeric\_value>

This command sets the maximum limit of the bias current.

**Example:** "MIX:BIAS:LIM 7mA"

**Features:** \*RST value: +10mA  
SCPI: conforming

**Mode:** A

The command is available only if the external mixer (option FSE-B21) is switched on.

**[SENSe<1|2>:]MIXer:BIAS:LIMit:MIN** <numeric\_value>

This command sets the minimum limit of the bias current.

**Example:** "MIX:BIAS:LIM:MIN -8mA"

**Features:** \*RST value: -10 mA  
SCPI: conforming

**Mode:** A

The command is available only if the external mixer (option FSE-B21) is switched on.

## SENSe:MSUMmary Subsystem

This subsystem controls the modulation summary setting for analog demodulation.

COMMAND	PARAMETERS	UNIT	COMMENT
[SENSe<1 2>] :MSUMmary :AHOLd [:STATe] :MODE :RUNit :REFerence :AUTO :MTIME	<Boolean> ABSolute   RELative PCT   DB <numeric_value> ONCE <numeric_value>	PCT   HZ   DEG   RAD    S	Vector Signal Analysis    no query

[SENSe<1|2>:]MSUMmary:AHOLd[:STATe] ON | OFF

This command switches on the average/peak hold mode.

**Example:** "MSUM:AHOL ON"

**Features:** \*RST value: OFF  
SCPI: device-specific

**Mode:** VA-A

[SENSe<1|2>:]MSUMmary:MODE ABSolute | RELative

This command selects the absolute or relative indication of the summary marker values.

**Example:** "MSUM:MODE REL"

**Features:** \*RST value: ABSolute  
SCPI: device-specific

**Mode:** VA-A

[SENSe<1|2>:]MSUMmary:RUNit PCT | DB

This command selects the relative unit of the summary marker in the relative result display.

**Example:** "MSUM:RUN DB"

**Features:** \*RST value: DB  
SCPI: device-specific

**Mode:** VA-A

[SENSe<1|2>:]MSUMmary:REFerence <numeric\_value>

This command selects the reference modulation.

**Parameter:** <numeric\_value> := 0.001 PCT to 1000 PCT for AM  
0.1 HZ to 10 MHZ for FM  
0.0001 RAD to 1000 RAD for PM

**Example:** "MSUM:REF 50PCT"

**Features:** \*RST value: 100 PCT for AM  
100 KHZ for FM  
10 RAD for PM  
SCPI: device-specific

**Mode:** VA-A

**[SENSe<1|2>:]MSUMmary:REFerence:AUTO ONCE**

This command sets the current absolute measured values of the main modulation signal as reference values for the relative indication.

**Example:** "MSUM:REF:AUTO ONCE"

**Features:** \*RST value: --  
SCPI: device-specific

**Mode:** VA-A

This command is an event and has therefore no query and no \*RST value assigned.

**[SENSe<1|2>:]MSUMmary:MTIME 0.1 s | 1 s**

This command selects the measurement time for the summary markers.

**Example:** "MSUM:MTIM 100US"

**Features:** \*RST value: 0.1S  
SCPI: device-specific

**Mode:** VA-A

## SENSe:POWer Subsystem

This subsystem controls the setting of the instrument's power measurements.

COMMAND	PARAMETER	UNIT	COMMENT
[SENSe<1 2>] :POWer			
:ACHannel			
:SPACing			
[:UPPer]	<numeric_value>	HZ	
:ACHannel	<numeric_value>	HZ	
:ALternate<1 2>	<numeric_value>	HZ	
:ACPairs	1   2   3		
:BANDwidth			
[:CHANnel]	<numeric_value>	HZ	
:ACHannel	<numeric_value>	HZ	
:ALternate<1 2>	<numeric_value>	HZ	
:BWIDth			
[:CHANnel]	<numeric_value>	HZ	
:ACHannel	<numeric_value>	HZ	
:ALternate<1 2>	<numeric_value>	HZ	
:MODE	ABSolute   RELative		
:REFerence			
:AUTO	ONCE		no query
:PRESet	ACPower   CPOWer   OBANdwidth   OBWidth   CN   CN0		
:BANDwidth	<numeric_value>	PCT	
:BWIDth	<numeric_value>	PCT	

### [SENSe<1|2>:]POWer:ACHannel:SPACing[:UPPer] 0 Hz to 1000 MHz

This command defines the channel spacing of adjacent channel to carrier.

**Example:** "POW:ACH:SPAC 28kHz"

**Features:** \*RST value: 24 kHz  
SCPI: conforming

**Mode:** A-F

### [SENSe<1|2>:]POWer:ACHannel:SPACing:ACHannel 0 Hz to 1000 MHz

This command defines the channel spacing of adjacent channel to carrier. This command has the same effect as POW:ACH:SPAC.

**Example:** "POW:ACH:SPAC:ACH 338kHz"

**Features:** \*RST value: 24 kHz  
SCPI: device-specific

**Mode:** A-F

**[SENSe<1|2>:]POWer:ACHannel:SPACing:ALTErnate<1|2>** 0 Hz ... 1000 MHz

This command defines the spacing of the first (ALTErnate1) or the second alternate adjacent channel (ALTErnate2) relative to the carrier signal.

**Example:** "POW:ACH:SPAC:ALT1 99kHz"

**Features:** \*RST value: 24 kHz  
SCPI: device-specific

**Mode:** A-F

**[SENSe<1|2>:]POWer:ACHannel:ACPairs** 1 | 2 | 3

This command sets the number of adjacent channels (upper and lower channel in pairs).

**Example:** "POW:ACH:ACP 3"

**Features:** \*RST value: 1  
SCPI: device-specific

**Mode:** A-F

**[SENSe<1|2>:]POWer:ACHannel:BANDwidth|BWIDth[:CHANnel]** 0 Hz to 1000 MHz

This command sets the channel bandwidth of the radio communication system.

**Example:** "POW:ACH:BWID 30kHz"

**Features:** \*RST value: 24 kHz  
SCPI: device-specific

**Mode:** A-F

If the channel bandwidth of the adjacent channel is changed the bandwidths of all alternate adjacent channels are automatically set to the same value.

**[SENSe<1|2>:]POWer:ACHannel:BANDwidth|BWIDth:ACHannel** 0 Hz to 1000 MHz

This command defines the channel bandwidth of the adjacent channel of the radio transmission system.

**Example:** "POW:ACH:BWID:ACH 30kHz"

**Features:** \*RST value: 24 kHz  
SCPI: device-specific

**Mode:** A-F

If the channel bandwidth of the adjacent channel is changed the bandwidths of all alternate adjacent channels are automatically set to the same value.

**[SENSe<1|2>:]POWER:ACHannel:BANDwidth|BWIDth|ALternate<1|2>** 0 Hz to 1000 MHz

This command defines the channel bandwidth of the first/second alternate adjacent channel of the radio transmission system.

**Example:** "POW:ACH:BWID:ALT2 30kHz"

**Features:** \*RST value: 24 kHz  
SCPI: device-specific

**Mode:** A-F

If the channel bandwidth of the alternate adjacent channel no. 1 is changed the bandwidth of the alternate adjacent channel no. 2 is automatically set to the same value.

**[SENSe<1|2>:]POWER:ACHannel:MODE** ABSolute | RELative

This command toggles between absolute and relative measurement.

**Example:** "POW:ACH:MODE REL"

**Features:** \*RST value: ABSolute  
SCPI: device-specific

**Mode:** A-F

For the relative measurement the reference value is set to the currently measured channel power by command POW:ACH:REF:AUTO ONCE.

**[SENSe<1|2>:]POWER:ACHannel:REFerence:AUTO** ONCE

This command sets the reference value to the currently measured channel power.

**Example:** "POW:ACH:REF:AUTO ONCE"

**Features:** \*RST value: -  
SCPI: device-specific

**Mode:** A-F

This command is an event which is why it is not assigned an \*RST value and has no query.

**[SENSe<1|2>:]POWER:ACHannel:PRESet** ACPower | CPOWER | OBANdwidth|OBWidth | CN | CN0

This command selects the type of power measurement.

**Example:** "POW:ACH:REF:PRESet ACP"

**Features:** \*RST value: -  
SCPI: device-specific

**Mode:** A-F

**[SENSe<1|2>:]POWER:BANDwidth|BWIDth** 0 to 100PCT

This command defines the percentage of the power with respect to the total power.

**Example:** "POW:BWID 95PCT"

**Features:** \*RST value: 99PCT  
SCPI: device-specific

**Mode:** A-F

This value defines the occupied bandwidth (measurement POW:ACH:PRESet OBW).

## SENSe:ROSCillator Subsystem

This subsystem controls the reference oscillator. The suffix in SENSE<1|2> is not significant in this subsystem.

COMMAND	PARAMETERS	UNIT	COMMENT
[SENSe<1 2>] :ROSCillator			
:SOURce	INTernal   EXTernal	--	
:EXTernal			
:FREQuency	<numeric_value>	HZ	
[:INTernal]			
:TUNe	<numeric_value>		
:SAVe			no query

### [SENSe<1|2>]:ROSCillator:SOURce INTernal | EXTernal

This command controls selection of the reference oscillator.

**Example:** "ROSC:SOUR EXT"

**Features:** \*RST value: –  
SCPI: conforming

**Modes:** A, VA, BTS, MS

If the external reference oscillator is selected, the reference signal must be connected to the rear panel of the instrument. \*RST has no influence on this setting.

### [SENSe<1|2>]:ROSCillator:EXTernal:FREQuency 1MHz to 16MHz

This command defines the frequency of the external reference oscillator.

**Example:** "ROSC:EXT:FREQ 5MHz"

**Features:** \*RST value: 10MHz  
SCPI: conforming

**Modes:** A, VA, BTS, MS

The value of the external reference frequency (1MHz to 16MHz) is rounded in steps of 1MHz.

### [SENSe<1|2>]:ROSCillator[:INTernal]:TUNe 0 to 4095

This command defines the value for the tuning of the internal reference oscillator.

**Example:** "ROSC:TUN 128"

**Features:** \*RST value: –  
SCPI: device-specific

**Modes:** A, VA, BTS, MS

The reference oscillator should be tuned only if an error has been detected in the frequency accuracy check. After PRESET or switching on the instrument, the saved value of the reference frequency is restored.

### [SENSe<1|2>]:ROSCillator[:INTernal]:TUNe:SAVe

This command saves the new value for the tuning of the internal reference oscillator. The factory-set value in the EEPROM is overwritten.

**Example:** "ROSC:TUN:SAV"

**Features:** \*RST value: –  
SCPI: device-specific

**Modes:** A, VA, BTS, MS



## SENSe:SWEEp Subsystem

This subsystem controls the sweep parameters.

COMMAND	PARAMETERS	UNIT	COMMENT
[SENSe<1 2>] :SWEEp			
:TIME	<numeric_value>	S	
:AUTO	<Boolean>	--	
:COUNT	<numeric_value>	--	
:EGATE	<Boolean>	--	
:LEVEL	<numeric_value>	V	
:TYPE	LEVEL   EDGE	--	
:POLarity	POSitive   NEGative	--	
:HOLDoff	<numeric_value>	S	
:LENGth	<numeric_value>	S	
:SOURce	EXTernal   RFPower	--	
:GAP	<Boolean>	--	
:PRETrigger	<numeric_value>	S	
:TRGTogap	<numeric_value>	S	
:LENGth	<numeric_value>	S	
:SPACing	LINear   LOGarithmic		

### [SENSe<1|2>:]SWEEp:TIME <numeric\_value>

This command defines the duration of the sweep.

The allowed value range depends on the selected domain and, for frequency domain, on the set resolution bandwidth (see Chapter 4, Softkey SWEEP TIME MANUAL).

**Example:** "SWE:TIME 10s"

**Features:** \*RST value - (AUTO is set to ON)  
SCPI: conforming

**Modes:** A, VA-A

If SWEEp:TIME is directly programmed, automatic coupling is switched off.

### [SENSe<1|2>:]SWEEp:TIME:AUTO ON | OFF

This command switches the automatic coupling of the sweep time for the frequency span or bandwidth settings.

**Example:** "SWE:TIME:AUTO ON"

**Features:** \*RST value: ON  
SCPI: conforming

**Mode:** A

If SWEEp:TIME is directly programmed, automatic coupling is switched off.

**[SENSe<1|2>:]SWEep:COUNT** 0 to 32767

This command defines the number of sweeps started with single sweep.

**Example:** "SWE:COUNT 64"  
**Features:** \*RST value: 0  
 SCPI: conforming  
**Modes:** A, VA-D

This parameter defines the number of sweeps or the number of averaging procedures. In the average mode, the value 0 defines a running averaging of measurement data over 10 sweeps.

**[SENSe<1|2>:]SWEep:EGATe** ON | OFF

This command controls the sweep with the external gate signal.

**Example:** "SWE:EGAT ON"  
**Features:** \*RST value: OFF  
 SCPI: device-specific  
**Mode:** A

**[SENSe<1|2>:]SWEep:EGATe:LEVel** -5V to +5V

This command determines the threshold for the external gate signal.

**Example:** "SWE:EGAT:LEV 3V"  
**Features:** \*RST value: 2V  
 SCPI: device-specific  
**Mode:** A

If `SWEep:TIME` is directly programmed, automatic coupling is switched off.

**[SENSe<1|2>:]SWEep:EGATe:TYPE** LEVel | EDGE

This command sets the type of triggering (level or edge) by the external gate signal.

**Example:** "SWE:EGAT:TYPE EDGE"  
**Features:** \*RST value: EDGE  
 SCPI: device-specific  
**Mode:** A

Parameter `EGATe:LENGth` is not used for level triggering.

**[SENSe<1|2>:]SWEep:EGATe:POLarity** POSitive | NEGative

This command determines the polarity of the external gate signal.

**Example:** "SWE:EGAT:POL POS"  
**Features:** \*RST value: POSitive  
 SCPI: device-specific  
**Mode:** A

**[SENSe<1|2>:]SWEep:EGATe:HOLDoff** 0 to 100s

This command defines the delay time between the external gate signal and the continuation of the sweep.

**Example:** "SWE:EGAT:HOLD 100us"  
**Features:** \*RST value: 0s  
 SCPI: device-specific  
**Mode:** A

The values for the delay time can be set in steps 1, 2, 3 and 5.

**[SENSe<1|2>:]SWEep:EGATe:LENGth** 0 to 100s

In case of edge triggering, this command determines the time interval in which the instrument sweeps.

**Example:** "SWE:EGAT:LENG 10ms"  
**Features:** \*RST value: 0s  
 SCPI: device-specific  
**Modes:** A

The values for the delay time can be set in steps 1, 2, 3 and 5.

**[SENSe<1|2>:]SWEep:EGATe:SOURce** EXTernal | RFPower

This command toggles between external gate signal and RF power signal.

**Example:** "SWE:EGAT:SOUR RFP"  
**Features:** \*RST value: EXTernal  
 SCPI: device-specific  
**Mode:** A

**[SENSe<1|2>:]SWEep:GAP** ON | OFF

This command controls the operating mode GAP SWEEP.

**Example:** "SWE:GAP ON"  
**Features:** \*RST value: OFF  
 SCPI: device-specific  
**Mode:** A-Z

Operating mode GAP SWEEP for measurements in the time domain controls the display of measured values. Measured values can be blanked for a defined time range (GAP).

**[SENSe<1|2>:]SWEep:GAP:PRETrigger** 0 to 100s

This command defines the evaluation time for measured values before the pretrigger time (resolution: 50 ns).

**Example:** "SWE:GAP:PRET 100us"  
**Features:** \*RST value: 0s  
 SCPI: device-specific  
**Mode:** A

**[SENSe<1|2>:]SWEep:GAP:TRGTogap** 0 to 100s

This command defines the time between the pretrigger time and the beginning of the gap (trigger-to-gap time) (resolution: 50 ns).

**Example:** "SWE:GAP:TRGT 50us"  
**Features:** \*RST value: 0s  
 SCPI: device-specific  
**Mode:** A

**[SENSe<1|2>:]SWEep:GAP:LENGth** 0 to 100s

This command defines the gap length.

**Example:** "SWE:GAP:LENG 400us"  
**Features:** \*RST value: 0s  
 SCPI: device-specific  
**Mode:** A

The gap length can be programmed from 0 to 100s in steps of 1, 2, 3 and 5.

**[SENSe<1|2>:]SWEep:SPACing** LINear | LOGarithmic

This command toggle between linear and logarithmic sweep.

**Example:** "SWE:SPAC LOG"  
**Features:** \*RST value: LIN  
 SCPI: conforming  
**Modes:** A,

The frequency axis is set to linear or logarithmic scaling accordingly.

## SOURce Subsystem

The SOURce subsystem controls the output signals of the analyzer when the option Tracking Generator is installed (FSE-B8 to FSE-B11). In the split screen mode, a distinction is made between SOURce1 (screen A) and SOURce2 (screen B).

COMMAND	PARAMETERS	UNIT	COMMENT
SOURce<1 2> :AM :STATe :DM :STATe :FM :STATe :FREQuency :OFFSet :POWer :ALC :SOURce [:LEVel] [:IMMediate] [:AMPLitude] :OFFSet	<Boolean> <Boolean> <Boolean> <numeric_value> INTERNAL   EXTERNAL <numeric_value> <numeric_value>	   HZ    DBM DB	Option Mitlaufgenerator

### SOURce<1|2>:AM:STATe ON | OFF

This command switches on or off the external amplitude modulation of the tracking generator.

**Example:** "SOUR:AM:STAT ON "

**Features:** \*RST-value: OFF  
SCPI: conforming

**Modes:** A, VA

External ALC and external I/Q-modulation is switched off, if active. This command is only valid in conjunction with option Tracking Generator.

### SOURce<1|2>:DM:STATe ON | OFF

This command switches on or off the external delta modulation of the tracking generator.

**Example:** "SOUR:DM:STAT ON "

**Features:** \*RST-value: OFF  
SCPI: conforming

**Modes:** A, VA

External AM, external ALC, external FM and external frequency offset are switched off, if active. This command is only valid in conjunction with option Tracking Generator.

### SOURce<1|2>:FM:STATe ON | OFF

This command switches on or off the external frequency modulation of the tracking generator.

**Example:** "SOUR:FM:STAT ON "

**Features:** \*RST-value: OFF  
SCPI: conforming

**Modes:** A, VA

External AM, external I/Q-modulation and frequency offset are switched off, if active. This command is only valid in conjunction with option Tracking Generator.

**SOURce<1|2>:FREQUency:OFFSet** -200MHz to 200MHz

This command defines a frequency offset of the tracking generators to the current instrument frequency.

**Example:** "SOUR:FREQ:OFFS "

**Features:** \*RST-value: 0 Hz  
SCPI: conforming

**Modes:** A, VA

External delta modulation is switched off, if active. This command is only valid in conjunction with option Tracking Generator.

**SOURce<1|2>:POWER:ALC:SOURce** INTernal | EXTernal

This command switches on or off the external level control (ALC).

**Example:** "SOUR:POW:ALC:SOUR INT "

**Features:** \*RST- value: INT  
SCPI: conforming

**Modes:** A, VA

External AM and external delta modulation are switched off, if active. This command is only valid in conjunction with option Tracking Generator.

**SOURce<1|2>:POWER[:LEVel][:IMMediate][:AMPLitude]** -20dBm to 0dBm / Option FSE-B12: -90dBm to 0dBm

This command defines the level of the tracking generator.

**Example:** "SOUR:POW -20dBm"

**Features:** \*RST- value:  
SCPI: conforming

**Modes:** A, VA

This command is only valid in conjunction with option Tracking Generator.

**SOURce<1|2>:POWER[:LEVel][:IMMediate]:OFFSet** -200dB to +200dB

This command defines a level offset for the tracking generator.

**Example:** "SOUR:POW:OFFS -10dB"

**Features:** \*RST- value: 0dB  
SCPI: conforming

**Modes:** A, VA

This command is only valid in conjunction with option Tracking Generator.

# STATus Subsystem

The STATus subsystem contains the commands for the status reporting system (see Chapter 5, Section "Status Reporting System"). \*RST does not influence the status registers.

COMMAND	PARAMETERS	UNIT	COMMENT
STATus			
:OPERation			
[:EVENT]?	--	--	
:CONDition?	--	--	
:ENABle	0 to 65535	--	
:PTRansition	0 to 65535	--	
:NTRansition	0 to 65535	--	
:PRESet	--	--	
:QUESTionable			
[:EVENT]?	--	--	
:CONDition?	--	--	
:ENABle	0 to 65535	--	
:PTRansition	0 to 65535	--	
:NTRansition	0 to 65535	--	
:POWer			
[:EVENT]?	--	--	
:CONDition?	--	--	
:ENABle	0 to 65535	--	
:PTRansition	0 to 65535	--	
:NTRansition	0 to 65535	--	
:LIMit			
[:EVENT]?	--	--	
:CONDition?	--	--	
:ENABle	0 to 65535	--	
:PTRansition	0 to 65535	--	
:NTRansition	0 to 65535	--	
:LMARgin			
[:EVENT]?	--	--	
:CONDition?	--	--	
:ENABle	0 to 65535	--	
:PTRansition	0 to 65535	--	
:NTRansition	0 to 65535	--	
:SYNC			
[:EVENT]?	--	--	
:CONDition?	--	--	
:ENABle	0 to 65535	--	
:PTRansition	0 to 65535	--	
:NTRansition	0 to 65535	--	
:ACPLimit			
[:EVENT]?	--	--	
:CONDition?	--	--	
:ENABle	0 to 65535	--	
:PTRansition	0 to 65535	--	
:NTRansition	0 to 65535	--	

COMMAND	PARAMETERS	UNIT	COMMENT
STATus			
:QUEStionable	--	--	
:FREQuency	--	--	
[:EVENT]?	0 to 65535	--	
:CONDition?	0 to 65535	--	
:ENABle	0 to 65535	--	
:PTRansition	--	--	
:NTRansition	--	--	
:TRANsducer			
[:EVENT]?	--	--	
:CONDition?	--	--	
:ENABle	0 to 65535	--	
:PTRansition	0 to 65535	--	
:NTRansition	0 to 65535	--	
:QUEue?	--	--	
[:NEXT]?	--	--	

**STATus:OPERation[:EVENT]?**

This command queries the contents of the EVENT section of the STATus:OPERation register.

**Example:** "STAT:OPER?"

**Features:** \*RST value: –  
SCPI: conforming

**Modes:** A, VA, BTS, MS

The contents of the EVENT section is deleted with readout.

**STATus:OPERation:CONDition?**

This command queries the CONDition section of the STATus:OPERation register.

**Example:** "STAT:OPER:COND?"

**Features:** \*RST value: –  
SCPI: conforming

**Modes:** A, VA, BTS, MS

Readout does not delete the contents of the CONDition section. The value returned reflects the current hardware status.

**STATus:OPERation:ENABle 0 to 65535**

This command sets the bits of the ENABle section of the STATus:QUEStionable register.

**Example:** "STAT:OPER:ENAB 65535"

**Features:** \*RST value: –  
SCPI: conforming

**Modes:** A, VA, BTS, MS

The ENABle register selectively enables the individual events of the associated EVENT section for the sum bit in the status byte.



**STATus:OPERation:PTRansition 0 to 65535**

This command sets the edge detectors of all bits of the STATus:OPERation register from 0 to 1 for the transitions of the CONDition bit.

**Example:** "STAT:OPER:PTR 65535"

**Features:** \*RST value: –  
SCPI: conforming

**Modes:** A, VA, BTS, MS

**STATus:OPERation:NTRansition 0 to 65535**

This command sets the edge detectors of all bits of the STATus:OPERation register from 1 to 0 for the transitions of the CONDition bit.

**Example:** "STAT:OPER:NTR 65535"

**Features:** \*RST value: –  
SCPI: conforming

**Modes:** A, VA, BTS, MS

**STATus:PRESet**

This command resets the edge detectors and ENABLE parts of all registers to a defined value. All PTRansition parts are set to FFFFh, i.e., all transitions from 0 to 1 are detected. All NTRansition parts are set to 0, i.e., a transition from 1 to 0 in a CONDition bit is not detected. The ENABLE part of the STATus:OPERation and STATus:QUESTionable registers are set to 0, i.e., all events in these registers are not passed on.

**Example:** "STAT:PRES"

**Features:** \*RST value: –  
SCPI: conforming

**Modes:** A, VA, BTS, MS

**STATus:QUESTionable[:EVENT]?**

This command queries the contents of the EVENT section of the STATus:QUESTionable register.

**Example:** "STAT:QUES?"

**Features:** \*RST value: –  
SCPI: conforming

**Modes:** A, VA, BTS, MS

Readout deletes the contents of the EVENT section.

**STATus:QUESTionable:CONDition?**

This command queries the CONDition section of the STATus:QUESTionable register.

**Example:** "STAT:QUES:COND?"

**Features:** \*RST value: –  
SCPI: conforming

**Modes:** A, VA, BTS, MS

Readout does not delete the contents of the CONDition section.

**STATus:QUESTIONable:ENABLE** 0 to 65535

This command sets the bits of the ENABLE section of the STATus-QUESTIONable register.

**Example:** "STAT:QUES:ENAB 65535"

**Features:** \*RST value: –  
SCPI: conforming

**Modes:** A, VA, BTS, MS

The ENABLE register selectively enables the individual events of the associated EVENT section for the sum bit in the status byte.

**STATus:QUESTIONable:PTRansition** 0 to 65535

This command sets the edge detectors of all bits of the STATus:OPERation register from 0 to 1 for the transitions of the CONDition bit.

**Example:** "STAT:QUES:PTR 65535"

**Features:** \*RST value: –  
SCPI: conforming

**Modes:** A, VA, BTS, MS

**STATus:QUESTIONable:NTRansition** 0 to 65535

This command sets the edge detectors of all bits of the STATus:OPERation register from 1 to 0 for the transitions of the CONDition bit.

**Example:** "STAT:QUES:NTR 65535"

**Features:** \*RST value: –  
SCPI: conforming

**Modes:** A, VA, BTS, MS

**STATus:QUESTIONable:POWer[:EVENT]?**

This command queries the contents of the EVENT section of the STATus:QUESTIONable:POWer register.

**Example:** "STAT:QUES?"

**Features:** \*RST value: –  
SCPI: conforming

**Modes:** A, VA, BTS, MS

Readout deletes the contents of the EVENT section.

**STATus:QUESTIONable:POWer:CONDition?**

This command queries the content of the CONDition section of the STATus:QUESTIONable:POWer register.

**Example:** "STAT:QUES:COND?"

**Features:** \*RST value: –  
SCPI: conforming

**Modes:** A, VA, BTS, MS

Readout does not delete the contents of the CONDition section.

**STATus:QUESTIONable:POWer:ENABle 0 to 65535**

This command sets the bits of the ENABle section of the STATus:QUESTIONable:POWer register.

**Example:** "STAT:QUES:ENAB 65535"

**Features:** \*RST value: –  
SCPI: conforming

**Modes:** A, VA, BTS, MS

The ENABle register selectively enables the individual events of the associated EVENT section for the sum bit in the status byte.

**STATus:QUESTIONable:POWer:PTRansition 0 to 65535**

This command sets the edge detectors of all bits of the STATus:QUESTIONable:POWer register from 0 to 1 for the transitions of the CONDition bit.

**Example:** "STAT:QUES:PTR 65535"

**Features:** \*RST-value: –  
SCPI: conforming

**Modes:** A, VA, BTS, MS

**STATus:QUESTIONable:POWer:NTRansition 0 to 65535**

This command sets the edge detectors of all bits of the STATus:QUESTIONable:POWer register from 1 to 0 for the transitions of the CONDition bit.

**Example:** "STAT:QUES:NTR 65535"

**Features:** \*RST value: –  
SCPI: conforming

**Modes:** A, VA, BTS, MS

**STATus:QUESTIONable:LIMit[:EVENT]?**

This command queries the contents of the EVENT section of the STATus:QUESTIONable:LIMit register.

**Example:** "STAT:QUES?"

**Features:** \*RST value: –  
SCPI: device-specific

**Modes:** A, VA, BTS, MS

Readout deletes the contents of the EVENT section.

**STATus:QUESTIONable:LIMit:CONDition?**

This command queries the contents of the CONDition section of the STATus:QUESTIONable:LIMit register.

**Example:** "STAT:QUES:COND?"

**Features:** \*RST value: –  
SCPI: device-specific

**Modes:** A, VA, BTS, MS

Readout does not delete the contents of the CONDition section.

**STATus:QUESTIONable:LIMit:ENABLE 0 to 65535**

This command sets the bits of the ENABLE section of the STATus:QUESTIONable register.

**Example:** "STAT:QUES:ENAB 65535"

**Features:** \*RST value: –  
SCPI: device-specific

**Modes:** A, VA, BTS, MS

The ENABLE register selectively enables the individual events of the associated EVENT section for the sum bit in the status byte.

**STATus:QUESTIONable:LIMit:PTRansition 0 to 65535**

This command sets the edge detectors of all bits of the STATus:QUESTIONable:LIMit register from 0 to 1 for the transitions of the CONDition bit.

**Example:** "STAT:QUES:PTR 65535"

**Features:** \*RST value: –  
SCPI: device-specific

**Modes:** A, VA, BTS, MS

**STATus:QUESTIONable:LIMit:NTRansition 0 to 65535**

This command sets the edge detectors of all bits of the STATus:QUESTIONable:LIMit register from 1 to 0 for the transitions of the CONDition bit.

**Example:** "STAT:QUES:NTR 65535"

**Features:** \*RST value: –  
SCPI: device-specific

**Modes:** A, VA, BTS, MS

**STATus:QUESTIONable:LMARgin[:EVENT]?**

This command queries the contents of the EVENT section of the STATus:QUESTIONable:LMARgin register.

**Example:** "STAT:QUES?"

**Features:** \*RST value: –  
SCPI: device-specific

**Modes:** A, VA, BTS, MS

Readout deletes the contents of the EVENT section.

**STATus:QUESTIONable:LMARgin:CONDition?**

This command queries the contents of the CONDition section of the STATus:QUESTIONable:LMARgin register.

**Example:** "STAT:QUES:COND?"

**Features:** \*RST value: –  
SCPI: device-specific

**Modes:** A, VA, BTS, MS

Readout does not delete the contents of the CONDition section.

**STATus:QUESTIONable:LMARgin:ENABLE 0 to 65535**

This command sets the bits of the ENABLE section of the STATus:QUESTIONable:LMARgin register.

**Example:** "STAT:QUES:ENAB 65535"

**Features:** \*RST value: –  
SCPI: device-specific

**Modes:** A, VA, BTS, MS

The ENABLE register selectively enables the individual events of the associated EVENT section for the sum bit in the status byte.

**STATus:QUESTIONable:LMARgin:PTRansition 0 to 65535**

This command sets the edge detectors of all bits of the STATus:QUESTIONable:LMARgin register from 0 to 1 for the transitions of the CONDition bit.

**Example:** "STAT:QUES:PTR 65535"

**Features:** \*RST value: –  
SCPI: device-specific

**Modes:** A, VA, BTS, MS

**STATus:QUESTIONable:LMARgin:NTRansition 0 to 65535**

This command sets the edge detectors of all bits of the STATus:QUESTIONable:LMARgin register from 1 to 0 for the transitions of the CONDition bit.

**Example:** "STAT:QUES:NTR 65535"

**Features:** \*RST value: –  
SCPI: device-specific

**Modes:** A, VA, BTS, MS

**STATus:QUESTIONable:SYNC[:EVENT]?**

This command queries the contents of the EVENT section of the STATus:QUESTIONable:SYNC register.

**Example:** "STAT:QUES?"

**Features:** \*RST value: –  
SCPI: device-specific

**Modes:** A, VA, BTS, MS

Readout deletes the contents of the EVENT section.

**STATus:QUESTIONable:SYNC:CONDition?**

This command queries the contents of the CONDition section of the STATus:QUESTIONable:SYNC register.

**Example:** "STAT:QUES:COND?"

**Features:** \*RST value: –  
SCPI: device-specific

**Modes:** A, VA, BTS, MS

Readout does not delete the contents of the CONDition section.

**STATus:QUESTIONable:SYNC:ENABLE** 0 to 65535

This command sets the bits of the ENABLE section of the STATus:QUESTIONable: SYNC register.

**Example:** "STAT:QUES:ENAB 65535"

**Features:** \*RST value: –  
SCPI: device-specific

**Modes:** A, VA, BTS, MS

The ENABLE register selectively enables the individual events of the associated EVENT section for the sum bit in the status byte.

**STATus:QUESTIONable:SYNC:PTRansition** 0 to 65535

This command sets the edge detectors of all bits of the STATus:QUESTIONable: SYNC register from 0 to 1 for the transitions of the CONDition bit.

**Example:** "STAT:QUES:PTR 65535"

**Features:** \*RST value: –  
SCPI: device-specific

**Modes:** A, VA, BTS, MS

**STATus:QUESTIONable:SYNC:NTRansition** 0 to 65535

This command sets the edge detectors of all bits of the STATus:QUESTIONable: SYNC register from 1 to 0 for the transitions of the CONDition bit.

**Example:** "STAT:QUES:NTR 65535"

**Features:** \*RST value: –  
SCPI: device-specific

**Modes:** A, VA, BTS, MS

**STATus:QUESTIONable:ACPLimit[:EVENT]?**

This command queries the contents of the EVENT section of the STATus:QUESTIONable:ACPLimit register.

**Example:** "STAT:QUES:ACPL?"

**Features:** \*RST value: –  
SCPI: device-specific

**Modes:** A, VA, BTS, MS

Readout deletes the contents of the EVENT section.

**STATus:QUESTIONable:ACPLimit:CONDition?**

This command queries the contents of the CONDition section of the STATus:QUESTIONable:ACPLimit register.

**Example:** "STAT:QUES:ACPL:COND?"

**Features:** \*RST value: –  
SCPI: device-specific

**Modes:** A, VA, BTS, MS

Readout does not delete the contents of the CONDition section.

**STATus:QUESTIONable:ACPLimit:ENABLE 0 to 65535**

This command sets the bits of the ENABLE section of the STATus:QUESTIONable:ACPLimit register.

**Example:** "STAT:QUES:ACPL:ENAB 65535"

**Features:** \*RST value: –  
SCPI: device-specific

**Modes:** A, VA, BTS, MS

The ENABLE register selectively enables the individual events of the associated EVENT section for the sum bit in the status byte.

**STATus:QUESTIONable:ACPLimit:PTRansition 0 to 65535**

This command sets the edge detectors of all bits of the STATus:QUESTIONable: ACPLimit register from 0 to 1 for the transitions of the CONDition bit.

**Example:** "STAT:QUES:ACPL:PTR 65535"

**Features:** \*RST value: –  
SCPI: device-specific

**Modes:** A, VA, BTS, MS

**STATus:QUESTIONable:ACPLimit:NTRansition 0 to 65535**

This command sets the edge detectors of all bits of the STATus:QUESTIONable: ACPLimit register from 1 to 0 for the transitions of the CONDition bit.

**Example:** "STAT:QUES:ACPL:NTR 65535"

**Features:** \*RST value: –  
SCPI: device-specific

**Modes:** A, VA, BTS, MS

**STATus:QUESTIONable:FREQuency[:EVENT]?**

This command queries the contents of the EVENT section of the STATus:QUESTIONableFREQuency register.

**Example:** "STAT:QUES:FREQ?"

**Features:** \*RST value: –  
SCPI: device-specific

**Modes:** A, VA, BTS, MS

Readout deletes the contents of the EVENT section.

**STATus:QUESTIONable:FREQuency:CONDition?**

This command queries the contents of the CONDition section of the STATus:QUESTIONable:FREQuency register.

**Example:** "STAT:QUES:FREQ:COND?"

**Features:** \*RST value: –  
SCPI: device-specific

**Modes:** A, VA, BTS, MS

Readout does not delete the contents of the CONDition section.

**STATus:QUESTIONable:FREQUENCY:ENABLE** 0 to 65535

This command sets the bits of the ENABLE section of the STATus:QUESTIONable:FREQUENCY register.

**Example:** "STAT:QUES:FREQ:ENAB 65535"

**Features:** \*RST value: –  
SCPI: device-specific

**Modes:** A, VA, BTS, MS

The ENABLE register selectively enables the individual events of the associated EVENT section for the sum bit in the status byte.

**STATus:QUESTIONable:FREQUENCY:PTRANSITION** 0 to 65535

This command sets the edge detectors of all bits of the STATus:QUESTIONable:FREQUENCY register from 0 to 1 for the transitions of the CONDITION bit.

**Example:** "STAT:QUES:FREQ:PTR 65535"

**Features:** \*RST value: –  
SCPI: device-specific

**Modes:** A, VA, BTS, MS

**STATus:QUESTIONable:FREQUENCY:NTRANSITION** 0 to 65535

This command sets the edge detectors of all bits of the STATus:QUESTIONable:FREQUENCY register from 1 to 0 for the transitions of the CONDITION bit.

**Example:** "STAT:QUES:FREQ:NTR 65535"

**Features:** \*RST value: –  
SCPI: device-specific

**Modes:** A, VA, BTS, MS

**STATus:QUESTIONable:TRANSDUCER[:EVENT]?**

This command queries the contents of the EVENT section of the STATus:QUESTIONable:TRANSDUCER register.

**Example:** "STAT:QUES:TRAN?"

**Features:** \*RST value: –  
SCPI: device-specific

**Modes:** A, VA, BTS, MS

Readout deletes the contents of the EVENT section.

**STATus:QUESTIONable:TRANSDUCER:CONDITION?**

This command queries the contents of the CONDITION section of the STATus:QUESTIONable:FREQUENCY register.

**Example:** "STAT:QUES:TRAN:COND?"

**Features:** \*RST value: –  
SCPI: device-specific

**Modes:** A, VA, BTS, MS

Readout does not delete the contents of the CONDITION section.



**STATus:QUEStionable:TRANsducer:ENABle 0 to 65535**

This command sets the bits of the ENABle section of the STATus:QUEStionable:TRANsducer register.

**Example:** "STAT:QUES:TRAN:ENAB 65535"

**Features:** \*RST value: –  
SCPI: device-specific

**Modes:** A, VA, BTS, MS

The ENABle register selectively enables the individual events of the associated EVENT section for the sum bit in the status byte.

**STATus:QUEStionable:TRANsducer:PTRansition 0 to 65535**

This command sets the edge detectors of all bits of the STATus:QUEStionable:TRANsducer register from 0 to 1 for the transitions of the CONDition bit.

**Example:** "STAT:QUES:TRAN:PTR 65535"

**Features:** \*RST value: –  
SCPI: device-specific

**Modes:** A, VA, BTS, MS

**STATus:QUEStionable:TRANsducer:NTRansition 0 to 65535**

This command sets the edge detectors of all bits of the STATus:QUEStionable:TRANsducer register from 1 to 0 for the transitions of the CONDition bit.

**Example:** "STAT:QUES:TRAN:NTR 65535"

**Features:** \*RST value: –  
SCPI: device-specific

**Modes:** A, VA, BTS, MS

**STATus:QUEue[:NEXT]?**

This command queries the earliest entry to the error queue, thus deleting it.

**Example:** "STAT:QUE?"

**Features:** \*RST value: –  
SCPI: conforming

**Modes:** A, VA, BTS, MS

Positive error numbers indicate device-specific errors, negative error numbers are error messages defined by SCPI (cf. Chapter 9). If the error queue is empty, the error number 0, "no error", is returned. This command is identical with the command SYSTem:ERRor.

## SYSTEM Subsystem

This subsystem comprises a series of commands for general functions.

COMMAND	PARAMETERS	UNIT	COMMENT
SYSTem			
:COMMunicate			
:GPIB			
[:SELF]			
:ADDRes	0 to 30	--	
:RTERminator	LFEoi   EOI		
:RDEVice<1 2>			
:ADDRes	0 to 30	--	
:SERial<1 2>			
:CONTrol			
:DTR	IBFull   OFF		
:RTS	IBFull   OFF		
[:RECeive]		--	
:BAUD	<numeric_value>	--	
:BITS	7   8		
:PARity			
[:TYPE]	EVEN   ODD   NONE	--	
:SBITs	1   2		
:PACE	XON   NONE	--	
:PRINter1 2>			
:ENUMerate			
[:NEXT]?			query only
:FIRSt?			query only
:SElect	<printer_name>		
:DATE	<num>, <num>, <num>	--	
:DISPlay			
:UPDate	ON   OFF		
:ERRor?	--		query only
:PASSword		--	
[:CENable]	<string>		no query
:PRESet	--		no query
:COMPatible	FSE   OFF		
:SET	<block>	--	
:SPEaker<1 2>		--	
:VOLume	<numeric_value>	--	
:TIME	0 to 23, 0 to 59, 0 to 59	--	
:VERSIon?	--		query only
:BINFo?	--		query only

### SYSTem:COMMunicate:GPIB[:SELF]:ADDRes 0 to 30

This command changes the IEC/IEEE-bus address of the unit.

**Example:** "SYST:COMM:GPIB:ADDR 18"

**Features:** \*RST value: - (no influence on this parameter)  
SCPI: conforming

**Modes:** A, VA, BTS, MS

**SYSTem:COMMunicate:GPIB[:SELF]:RTERminator** LFEOI | EOI

This command changes the delimiter.

**Example:** "SYST:COMM:GPIB:RTER EOI"

**Features:** \*RST value: LFEOI  
SCPI: device-specific

**Modes:** A, VA, BTS, MS

The instrument contains a DMA-channel for communication via IEC-bus. This ensures maximum speed for the transfer of commands and data. The parser for command decoding integrated in the instrument is, however, only activated by the delimiter when the command is completely transferred. In order to make this possible for the transfer of binary data, too (e. g. trace data which are retransferred into the instrument), the delimiter recognition must be switched to the EOI signal prior to the transfer. Output of binary data from the instrument does not require such a switching.

**SYSTem:COMMunicate:GPIB:RDEvice<1|2>:ADDRess** 0 to 30

This command changes the IEC/IEEE-bus address of the unit which is selected as hardcopy device 1 or 2, provided that the IEC/IEEE-bus interface of this unit is set as an interface.

**Example:** "SYST:COMM:GPIB:RDEV2:ADDR 5"

**Features:** \*RST value: 4  
SCPI: conforming

**Modes:** A, VA, BTS, MS

**SYSTem:COMMunicate:SERial<1|2>:CONTrol:DTR** IBFull | OFF  
**SYSTem:COMMunicate:SERial<1|2>:CONTrol:RTS** IBFull | OFF

These commands switch the hardware handshake procedure for the given serial interface off (OFF) or on (IBFull).

**Examples:** "SYST:COMM:SER:CONT:DTR OFF"  
"SYST:COMM:SER2:CONT:RTS IBF"

**Features:** \*RST value: OFF  
SCPI: conforming

**Modes:** A, VA, BTS, MS

The two commands have the same meaning. SERial1 and SERial 2 correspond to device COM1 and COM2, respectively.

**SYSTem:COMMunicate:SERial<1|2>[:RECeive]:BAUD** 75 | 150 | 300 | 600 | 1200 | 2400 | 9600

This command sets the transmission speed for the given serial interface.

**Example:** "SYST:COMM:SER:BAUD 2400"

**Features:** \*RST value: 9600  
SCPI: conforming

**Modes:** A, VA, BTS, MS

SERial1 and SERial 2 correspond to device interface COM1 and COM2, respectively. Permissible values are 75 Baud, 150 Baud, 300 Baud, 600 Baud, 1200 Baud, 2400 Baud, 4800 Baud, 9600 Baud.

**SYSTEM:COMMunicate:SERial<1|2>[:RECeive]:BITS 7 | 8**

This command defines the number of data bits per data word for the given serial interface.

**Example:** "SYST:COMM:SER2:BITS 7"

**Features:** \*RST value: 8  
SCPI: conforming

**Modes:** A, VA, BTS, MS

SERial1 and SERial 2 correspond to device interface COM1 and COM2, respectively.

**SYSTEM:COMMunicate:SERial<1|2>[:RECeive]:PARity[:TYPE] EVEN | ODD | NONE**

This command defines the parity check for the given serial interface.

**Example:** "SYST:COMM:SER:PAR EVEN"

**Features:** \*RST value: NONE  
SCPI: conforming

**Modes:** A, VA, BTS, MS

SERial1 and SERial 2 correspond to device interface COM1 and COM2, respectively. Permissible values are:

EVEN even parity  
ODD odd parity  
NONE no parity check.

**SYSTEM:COMMunicate:SERial<1|2>[:RECeive]:SBITS 1|2**

This command defines the number of stopbits per data word for the given serial interface.

**Example:** "SYST:COMM:SER:SBITS 2"

**Features:** \*RST value: 1  
SCPI: conforming

**Modes:** A, VA, BTS, MS

SERial1 and SERial 2 correspond to device interface COM1 and COM2, respectively.

**SYSTEM:COMMunicate:SERial<1|2>[:RECeive]:PACE XON | NONE**

This command switches on or off the software handshake for the given serial interface.

**Example:** "SYST:COMM:SER:PACE XON"

**features:** \*RST value: NONE  
SCPI: conforming

**Modes:** A, VA, BTS, MS

SERial1 and SERial 2 correspond to device interface COM1 and COM2, respectively.

**SYSTEM:COMMunicate:PRINter<1|2>:ENUMerate:FIRSt?**

This command queries the name of the first printer (in the list of printers) under Windows NT.

The names of other installed printers can be queried with command `SYSTEM:COMMunicate:PRINter:ENUMerate:NEXT?`.

If no printer is configured an empty string is output. The numeric suffix in `PRINter<1|2>` is not significant.

**Example:**           `"SYST:COMM:PRIN:ENUM:FIRS?"`

**Features:**        \*RST value:     -  
                      SCPI:             device-specific

**Modes:**            A, VA, BTS, MS

**SYSTEM:COMMunicate:PRINte<1|2>r:ENUMerate:NEXT?**

This command queries the name of the next printer installed under Windows NT.

This command can only be sent after command `SYSTEM:COMMunicate:PRINter:ENUMerate:FIRSt?`.

An empty string is output after all printer names have been output. The numeric suffix in `PRINter<1|2>` is not significant.

**Example:**           `"SYST:COMM:PRIN:ENUM:NEXT?"`

**Features:**        \*RST value:     -  
                      SCPI:             device-specific

**Modes:**            A, VA, BTS, MS

**SYSTEM:COMMunicate:PRINter<1|2>:SElect <printer\_name>**

This command selects one of the printers installed under Windows NT.

The name of the first printer is queried with `FIRSt?`. After that the names of other installed printers can be queried with `NEXT?`. The numeric suffix in `PRINter<1|2>` selects the device.

**Parameter:**        <printer\_name> ::=     string which has been queried with commands `SYSTEM:COMMunicate :PRINter:ENUMerate:FIRSt?` and `NEXT?`.

**Example:**           `"SYST:COMM:PRIN:SEL `HP_DESKJET660`"`

**Features:**        \*RST value:     -  
                      SCPI:             device-specific

**Modes:**            A, VA, BTS, MS

**SYSTEM:DATE 1980 to 2099, 1 to 12, 1 to 31**

This command is used to enter the date for the internal calendar.

**Example:**           `" SYST:DATE 1994,12,1"`

**Features:**        \*RST value:     -  
                      SCPI:             conforming

**Modes:**            A, VA, BTS, MS

The sequence of entry is year, month, day.

**SYSTEM:DISPlay:UPDate** ON | OFF

This command switches on or off the update of all display elements.

**Example:** " SYST:DISP:UPD ON  
**Features:** \*RST value: OFF  
 SCPI: device specific  
**Modes:** A, VA, BTS, MS

**SYSTEM:ERRor?**

This command queries the earliest entry to the error queue, thus deleting it. .

**Example:** "SYST:ERR?"  
**Features:** \*RST value: –  
 SCPI: conforming  
**Modes:** A, VA, BTS, MS

Positive error numbers indicate device-specific errors, negative error numbers are error messages defined by SCPI (cf. Chapter 9). If the error queue is empty, the error number 0, "no error", is returned. This command is identical with the command `STATus:QUEue:NEXT?`. This command is a query which is why it is not assigned an \*RST value.

**SYSTEM:PASSword[:CENable]** <string>

This command enables access to the service functions by means of the password.

**Example:** "SYST:PASS 'XXXX'"  
**Features:** \*RST value: –  
 SCPI: conforming  
**Modes:** A, VA, BTS, MS

This command is an event which is why it is not assigned an \*RST value and has no query.

**SYSTEM:PRESet**

This command triggers an instrument reset.

**Example:** "SYST:PRES"  
**Features:** \*RST value: –  
 SCPI: conforming  
**Modes:** A, VA, BTS, MS

The effect of this command corresponds to that of the *PRESET* key with manual control or to the \*RST command.

**SYSTEM:PRESet:COMPAtible** FSE | OFF

This command determines whether the unit is FSE-compatible after a preset. Following a preset, an FSIQ is not in the same mode as an FSE. With compatibility, FSIQ has the same default settings as FSE after a preset.

**Example:** "SYST:PRES:COMP FSE"  
**Features:** \*RST value: OFF  
 SCPI: device-specific  
**Mode:** A, VA, BTS, MS

**SYSTem:SET <block>**

The query `SYSTem:SET?` causes the data of the current instrument setting to be transmitted to the controller in binary form (SAVE function). The data can be read back into the instrument (RECALL function) by means of command `SYSTem:SET <block>`. If the data records are stored on the instrument harddisk with `SAVE/RECALL (MMEMory:STORe bzw. MMEMory:LOAD)`, it is possible to store the data in an external computer by means of `SYSTem:SET`.

**Example:**           `"SYST:SET "`  
**Features:**        \*`RST` value:   –  
                       `SCPI`:           conforming  
**Modes:**            A, VA, BTS, MS

The receive terminator has to be set to EOI to ensure reliable transfer of data (setting `SYST:COMM:GPIB:RTER EOI`).

**SYSTem:SPEaker<1|2>:VOLume 0 to 1**

This command sets the volume of the built-in loudspeaker for demodulated signals. The numeric suffix selects the measurement window.

**Example:**           `"SYST:SPE:VOL 0.5"`  
**Features:**        \*`RST` value:   0  
                       `SCPI`:           device-specific  
**Modes:**            A

The value 0 is the lowest volume, the value 1 is the highest volume.

**SYSTem:TIME 0 to 23, 0 to 59, 0 to 59**

This command sets the internal clock.

**Example:**           `"SYST:TIME 12,30,30"`  
**Features:**        \*`RST` value:   –  
                       `SCPI`:           conforming  
**Modes:**            A, VA, BTS, MS

The sequence of entry is hour, minute, second.

**SYSTem:VERSion?**

This command queries the number of the `SCPI` version, which is relevant for the instrument.

**Example:**           `"SYST:VERS?"`  
**Features:**        \*`RST` value:   –  
                       `SCPI`:           conforming  
**Modes:**            A, VA, BTS, MS

This command is a query which is why it is not assigned an \*`RST` value.

**SYSTem:BINFo?**

This command queries all present modules with variant, main index and subordinate index. Entries are separated by commas.

Return format: `module1, model1, main index1, subordinate index1, module2, model 2, main index2, subordinate index2, module3,...,moduleN, modelN, main indexN, subordinate indexN`

**Example:**           `"SYST:BINF?"`  
**Features:**        \*`RST` value:   –  
                       `SCPI`:           device-specific  
**Modes:**            A, VA, BTS, MS

## TRACe Subsystem

The TRACe subsystem controls access to the instrument's internal trace memory.

COMMAND	PARAMETERS	UNIT	COMMENT
TRACe [:DATA]	TRACE1   TRACE2   TRACE3   TRACE4, <block> <numeric_value>...	-	
:COPY	TRACE1 TRACE2 TRACE3 TRACE4, TRACE1 TRACE2 TRACE3 TRACE4		

**TRACe[:DATA]** TRACE1| TRACE2| TRACE3| TRACE4, <block> | <numeric\_value>

This command transfers trace data from the controller to the instrument, the query reads trace data out of the instrument.

**Example:**           "TRAC TRACE1, "+A\$     (A\$: data list in the current format)  
                      "TRAC? TRACE1"

**Features:**        \*RST value:     -  
                      SCPI:           conforming

**Modes:**           A, VA, BTS, MS

The trace data are transferred in the current format (corresponding to the command FORMat ASCii|REAL). The device-internal trace memory is addressed using the trace names 'TRACE1' to 'TRACE4'.

The parameter of the query is the trace name TRACE1 to TRACE4, it indicates which trace memory will be read out.

The transfer of trace data from the controller to the instrument takes place by indicating the trace name and then the data to be transferred. In ASCII format, these data are values separated by commas. If the transfer takes place using the format real (REAL 32), the data are transferred in block format (see FORMat subsystem).

Saving and recalling trace data together with the device settings to/from the device-internal hard disk or to/from a floppy is controlled via the commands "MMEMory:STORe:STATe" and "MMEMory:LOAD:STATe" respectively. Trace data are selected with "MMEMory:SELEct[:ITEM]:ALL" or "MMEMory:SELEct[:ITEM]:TRACe". Trace data in ASCII format (ASCII FILE EXPORT) are exported with the command "MMEM:STORe:TRACe".

The transfer format for the trace data depends on the instrument setting

### Analyzer mode (span >0 and zero span):

500 results are output in the unit selected for display.

**Note:**     With AUTO PEAK detector, only positive peak values can be read out.  
              Trace data can be read into instrument with logarithmic display only in dBm, with linear display only in volts.

FORMAT REAL,32 is to be used as format for binary transmission.



**Vector analyzer mode, digital demodulation**

The number of data transferred (except for the symbol table) is determined by the following formula

$$\text{number of results} = \text{result length} * \text{points per symbol}$$

Max. 6400 results can be transferred (for example result length 1600, points per symbol 4).

In all cartesian diagrams (MAGNITUDE CAP BUFFER, MAGNITUDE, PHASE, FREQUENCY, REAL/IMAG, EYE[I], EYE[Q], ERROR VECT MAGNITUDE) test data are transferred in the unit selected for display.

FORMAT REAL,32 is to be used for binary transmission.

**Note:** *In the case of the eye pattern, results are simply superimposed in the display, ie the EYE representation is the same as the REAL/IMAG representation.*

In the polar diagrams (POLAR CONSTELL, POLAR VECTOR) the real and the imaginary component are transferred as a pair for each result.

FORMAT REAL,32 is to be used for binary transmission.

With the SYMB TABLES / ERRORS setting, the displayed symbols can be read out as traces. Trace assignment is as follows:

Full screen	Trace 1
Split screen, screen A:	Trace 1
Split screen, screen B:	Trace 2

One byte (8 bits) is read out for each symbol.

FORMAT UINT,8 is to be used for binary transmission.

**Vector analyzer mode, analog demodulation**

The number of results transferred depends on the SWEEP TIME and DEMOD BW settings. Max. 5000 and min. 10 points are available. The unit for the results depends on the selected demodulation:

AM	unit %
FM	unit Hz
PM	unit rad or deg

FORMAT REAL,32 is to be used for binary data transmission.

**TRACe:COPY** TRACe:COPY TRACE1| TRACE2| TRACE3| TRACE4 ,  
TRACE1| TRACE2| TRACE3| TRACE4

This command copies data from one trace to another. The second operand designates the source, the first operand the destination of the data to be copied.

**Example:** "TRAC:COPY TRACE1,TRACE2"

**Features:** \*RST value:  
SCPI: conforming

**Modes:** A, VA, BTS, MS

This command is an event and therefore has no query and no \*RST value assigned.



**TRIGger<1|2>[:SEQuence]:LEVel:AF -120 to +120PCT**

This command defines the level of the demodulated trigger source.

**Example:** "TRIG:LEV:AF 50PCT"  
**Features:** \*RST value: 0 PCT  
 SCPI: device specific  
**Mode:** VA-A

**TRIGger<1|2>[:SEQuence]:HOLDoff -100 to 100s**

This command defines the length of the trigger delay.

**Example:** "TRIG:HOLD 500us"  
**Features:** \*RST value: 0s  
 SCPI: conforming  
**Modes:** A, VA

A negative delay time (pretrigger) can be set in the time domain (SPAN < 0 Hz) only. The maximum permissible range and the maximum effective resolution of the pretrigger are limited by the set sweep time (max range= - 499/500 x sweep time; max. resolution = sweep time/500). Pretriggering is not possible when the rms or the average detector is activated.

**TRIGger<1|2>[:SEQuence]:SLOPe POSitive | NEGative**

This command selects the slope of the trigger signal.

**Example:** "TRIG:SLOP NEG"  
**Features:** \*RST value: POSitive  
 SCPI: conforming  
**Modes:** A, VA, BTS, MS

The selected trigger slope applies to all trigger signal sources.

**TRIGger<1|2>[:SEQuence]:SYNChronize:ADJust:FRAMe -100μs to 100s**

This command defines the correction value for the time offset between the frame trigger and the midamble of the slot selected. The value set is corrected by means of the calculated offsets of the other slots and used as a base value for the correction of all slots.

This correction value is necessary in order to conserve the exact time relation between the trigger event and the midamble of the slot in question in cases where there is no midamble triggering.

**Example:** "TRIG:SYNC:ADJ:FRAM 30us"  
**Features:** \*RST value: -- (depending on the slot selected)  
 SCPI: device-specific  
**Modes:** BTS

The numeric suffix in TRIGger<1|2> is not significant.

**TRIGger<1|2>[:SEQuence]:SYNChronize:ADJust:FRAMe:AUTO ONCE**

This command determines once the correction value for the time offset between the frame trigger and the midamble of the slot selected. The value set is corrected by means of the calculated offsets of the other slots and used as a base value for the correction of all slots.

This correction value is necessary in order to conserve the exact time relation between the trigger event and the midamble of the slot in question in cases where there is no midamble triggering.

**Example:** "TRIG:SYNC:ADJ:FRAMe:AUTO ONCE"

**Features:** \*RST value: --  
SCPI: device-specific

**Modes:** BTS

The numeric suffix in TRIGger<1|2> is not significant.

**TRIGger<1|2>[:SEQuence]:SYNChronize:ADJust:SLOT -100µs to 100s**

This command defines the correction value for the time offset between the frame trigger and the midamble of the slot selected, without influencing the correction values of the other slots.

This correction value is necessary in order to conserve the exact time relation between the trigger event and the midamble of the slot in question in cases where there is no midamble triggering. The value set is corrected by means of the calculated offsets of the other slots and used as a base value for the correction of all slots.

**Example:** "TRIG:SYNC:ADJ:SLOT 30us"

**Features:** \*RST value: -- (depending on slot selected)  
SCPI: device-specific

**Modes:** BTS

The numeric suffix in TRIGger<1|2> is not significant.

**TRIGger<1|2>[:SEQuence]:SYNChronize:ADJust:SLOT:AUTO ONCE**

This command defines the correction value for the time offset between the frame trigger and the midamble of the slot selected. The value set is corrected by means of the calculated offsets of the other slots and used as a base value for the correction of all slots.

This correction value is necessary in order to conserve the exact time relation between the trigger event and the midamble of the slot in question in cases where there is no midamble triggering.

**Example:** "TRIG:SYNC:ADJ:SLOT:AUTO ONCE"

**Features:** \*RST value: --  
SCPI: device-specific

**Modes:** BTS

The numeric suffix in TRIGger<1|2> is not significant.

**TRIGger<1|2>[:SEQuence]:SYNChronize:SOURce FRAME | TSC**

This command defines the trigger reference point for measurements in the time domain (carrier power, power vs. time). The frame trigger of the base station or mobile may be selected as well as the relation to the midamble (TSC) of the slot to be measured.

**Example:** "TRIG:SYNC:SOURce TSC"

**Features:** \*RST value: FRAME  
SCPI: device-specific

**Modes:** BTS, MS

The numeric suffix in TRIGger<1|2> is not significant.

## UNIT Subsystem

The UNIT subsystem is used to switch the basic unit of setting parameters. In split screen mode, a distinction is made between UNIT1 (screen A) and UNIT2 (screen B).

COMMAND	PARAMETERS	UNIT	COMMENT
UNIT<1 2> :POWer         :PROBe	DBM   DBPW   WATT   DBUV   DBMV   VOLT   DBUA   AMPere V   W   DB   PCT   UNITLESS   DBUV_MHZ   DBMV_MHZ   DBUA_MHZ   DBUV_M   DBUA_M   DBUV_MMHZ   DBUA_MMHZ  <Boolean>		

**UNIT<1|2>:POWer** DBM | DBPW | WATT | DBUV | DBMV | VOLT | DBUA | AMPere | V | W | DB | PCT | UNITLESS | DBUV\_MHZ | DBMV\_MHZ | DBUA\_MHZ | DBUV\_M | DBUA\_M | DBUV\_MMHZ | DBUA\_MMHZ

This command selects the default unit for input and output.

**Example:** "UNIT:POW DBUV"

**Features:** \*RST value: DBM  
SCPI: conforming

**Mode:** A

**UNIT<1|2>:PROBe** ON | OFF

This command determines whether the coding of a probe which is connected to the front panel is taken into consideration (ON) or not (OFF).

**Example:** "UNIT:PROB OFF"

**Features:** \*RST value: ON  
SCPI: device-specific

**Mode:** A

## Alphabetical List of Commands

In the following, all remote-control commands are listed with their parameters and page numbers. Generally, they are arranged alphabetically according to the keywords of the command.

Command	Parameter	Page
ABORt		6.7
CALCulate<1 2>:CTHReshold	MIN to MAX (depending on current unit)	6.15
CALCulate<1 2>:CTHReshold:STATe	ON   OFF	6.15
CALCulate<1 2>:DELTamarker<1 to 4>:AOFF		6.9
CALCulate<1 2>:DELTamarker<1 to 4>:FUNction:FIXed:RPOint:X	<numeric_value>	6.12
CALCulate<1 2>:DELTamarker<1 to 4>:FUNction:FIXed:RPOint:Y		6.12
CALCulate<1 2>:DELTamarker<1 to 4>:FUNction:FIXed:RPOint:Y:OFFSet	<numeric_value>	6.12
CALCulate<1 2>:DELTamarker<1 to 4>:FUNction:FIXed[:STATe]	ON   OFF	6.12
CALCulate<1 2>:DELTamarker<1 to 4>:FUNction:PNOise:RESult?		6.13
CALCulate<1 2>:DELTamarker<1 to 4>:FUNction:PNOise[:STATe]	ON   OFF	6.12
CALCulate<1 2>:DELTamarker<1 to 4>:MAXimum:APEak		6.10
CALCulate<1 2>:DELTamarker<1 to 4>:MAXimum:LEFT		6.11
CALCulate<1 2>:DELTamarker<1 to 4>:MAXimum:NEXT		6.10
CALCulate<1 2>:DELTamarker<1 to 4>:MAXimum[:PEAK]		6.10
CALCulate<1 2>:DELTamarker<1 to 4>:MAXimum:RIGHT		6.10
CALCulate<1 2>:DELTamarker<1 to 4>:MINimum:LEFT		6.11
CALCulate<1 2>:DELTamarker<1 to 4>:MINimum:NEXT		6.11
CALCulate<1 2>:DELTamarker<1 to 4>:MINimum[:PEAK]		6.11
CALCulate<1 2>:DELTamarker<1 to 4>:MINimum:RIGHT		6.11
CALCulate<1 2>:DELTamarker<1 to 4>:MODE	ABSolute   RELative	6.9
CALCulate<1 2>:DELTamarker<1 to 4>[:STATe]	ON   OFF	6.8
CALCulate<1 2>:DELTamarker<1 to 4>:STEP:AUTO	ON   OFF	6.13
CALCulate<1 2>:DELTamarker<1 to 4>:STEP[:INCRement]	<numeric value>	6.13
CALCulate<1 2>:DELTamarker<1 to 4>:TRACe	1 to 4	6.9
CALCulate<1 2>:DELTamarker<1 to 4>:X:RELative?		6.9
CALCulate<1 2>:DELTamarker<1 to 4>:Y?		6.10
CALCulate<1 2>:DELTamarker<1...4>:X	0 to MAX (frequency   sweep time   symbols)	6.9
CALCulate<1 2>:DLINe<1 2>	MIN to MAX (depending on current unit)	6.14
CALCulate<1 2>:DLINe<1 2>:STATe	ON   OFF	6.14
CALCulate<1 2>:FEED	'XTIM:DDEM:MEAS'   'XTIM:DDEM:REF'   'XTIM:DDEM:ERR:MPH'   'XTIM:DDEM:ERR:VECT'   'XTIM:DDEM:SYMB'   'XTIM:AM'   'XTIM:FM'   'XTIM:PM'   'XTIM:AMSummary'   'XTIM:FMSummary'   'XTIM:PMSummary'	6.18
CALCulate<1 2>:FLINe<1 2>	0 GHz to $f_{max}$	6.16
CALCulate<1 2>:FLINe<1 2>:STATe	ON   OFF	6.16
CALCulate<1 2>:FORMat	MAGNitude   PHASe   UPHase   RIMag   FREQuency   IEYE   QEYE   TEYE   FEYE   COMP   CONS	6.19

<b>Command</b>	<b>Parameter</b>	<b>Page</b>
CALCulate<1 2>:FSK:DEVIation:REFerence	<numeric_value>	6.19
CALCulate<1 2>:LIMit<1 to 8>:ACPowEr:ACHannel	0 to 100 dB, 0 to 100 dB	6.33
CALCulate<1 2>:LIMit<1 to 8>:ACPowEr:ACHannel:RESult?		6.33
CALCulate<1 2>:LIMit<1 to 8>:ACPowEr:ACHannel:STATe	ON   OFF	6.33
CALCulate<1 2>:LIMit<1 to 8>:ACPowEr:ALTErnate<1 2>	0 to 100 DB, 0 to 100 DB	6.34
CALCulate<1 2>:LIMit<1 to 8>:ACPowEr:ALTErnate<1 2>:STATe	ON   OFF	6.34
CALCulate<1 2>:LIMit<1 to 8>:ACPowEr[:STATe]	ON   OFF	6.32
CALCulate<1 2>:LIMit<1 to 8>:BURSt:POWEr?		6.29
CALCulate<1 2>:LIMit<1 to 8>:BURSt:PTEmpLete?		6.28
CALCulate<1 2>:LIMit<1 to 8>:CLEar[:IMMediate]		6.27
CALCulate<1 2>:LIMit<1 to 8>:COMMEnt	<string>	6.27
CALCulate<1 2>:LIMit<1 to 8>:CONTRol[:DATA]	<numeric_value>,<numeric_value>. .	6.22
CALCulate<1 2>:LIMit<1 to 8>:CONTRol:DOMain	FREQuency   TIME	6.22
CALCulate<1 2>:LIMit<1 to 8>:CONTRol:MODE	RELative   ABSolute	6.23
CALCulate<1 2>:LIMit<1 to 8>:CONTRol:OFFset	<numeric_value>	6.23
CALCulate<1 2>:LIMit<1 to 8>:CONTRol:SHIFt	<numeric_value>	6.23
CALCulate<1 2>:LIMit<1 to 8>:CONTRol:SPACing	LINear < LOGarithmic	6.23
CALCulate<1 2>:LIMit<1 to 8>:CONTRol:UNIT[:TIME]	S   SYM	6.23
CALCulate<1 2>:LIMit<1 to 8>:COPIY	1 to 8   <name>	6.27
CALCulate<1 2>:LIMit<1 to 8>:DELEte		6.28
CALCulate<1 2>:LIMit<1 to 8>:FAIL?		6.27
CALCulate<1 2>:LIMit<1 to 8>:LOWer[:DATA]	<numeric_value>	6.25
CALCulate<1 2>:LIMit<1 to 8>:LOWer:MARGin	<numeric_value>	6.26
CALCulate<1 2>:LIMit<1 to 8>:LOWer:MODE	RELative   ABSolute	6.26
CALCulate<1 2>:LIMit<1 to 8>:LOWer:OFFset	<numeric_value>	6.26
CALCulate<1 2>:LIMit<1 to 8>:LOWer:SHIFt	<numeric_value>	6.26
CALCulate<1 2>:LIMit<1 to 8>:LOWer:SPACing	LINear   LOGarithmic	6.26
CALCulate<1 2>:LIMit<1 to 8>:LOWer:STATe	ON   OFF	6.25
CALCulate<1 2>:LIMit<1 to 8>:MARGin	0 to 100DB	6.32
CALCulate<1 2>:LIMit<1 to 8>:NAME	1 to 8   <string>	6.28
CALCulate<1 2>:LIMit<1 to 8>:SPEctrum:MODulation:EXCEptions?	ARFCn   TXBand   RXBand   COMBined   DCSRx1800	6.30
CALCulate<1 2>:LIMit<1 to 8>:SPEctrum:MODulation:FAILs?	ARFCn   TXBand   RXBand   COMBined   DCSRx1800	6.30
CALCulate<1 2>:LIMit<1 to 8>:SPEctrum:MODulation?	ARFCn   TXBand   RXBand   COMBined   DCSRx1800	6.29
CALCulate<1 2>:LIMit<1 to 8>:SPEctrum:SWITChing:FAILs?		6.31
CALCulate<1 2>:LIMit<1 to 8>:SPEctrum:SWITChing?		6.31
CALCulate<1 2>:LIMit<1 to 8>:SPURious:FAILs?	TXBand   OTXBand   RXBand   IDLeband	6.32
CALCulate<1 2>:LIMit<1 to 8>:SPURious?	ARFCn   TXBand   RXBand   IDLeband	6.31
CALCulate<1 2>:LIMit<1 to 8>:STATe	ON   OFF	6.21
CALCulate<1 2>:LIMit<1 to 8>:TRACe	1 to 4	6.21
CALCulate<1 2>:LIMit<1 to 8>:UPPEr[:DATA]	<numeric_value>,<numeric_value>. .	6.24
CALCulate<1 2>:LIMit<1 to 8>:UPPEr:MARGin	<numeric_value>	6.24
CALCulate<1 2>:LIMit<1 to 8>:UPPEr:MODE	RELative   ABSolute	6.24
CALCulate<1 2>:LIMit<1 to 8>:UPPEr:OFFset	<numeric_value>	6.24

Command	Parameter	Page
CALCulate<1 2>:LIMit<1 to 8>:UPPer:SHIFt	<numeric_value>	6.25
CALCulate<1 2>:LIMit<1 to 8>:UPPer:SPACing	LINear   LOGarithmic	6.25
CALCulate<1 2>:LIMit<1 to 8>:UPPer:STATe	ON   OFF	6.24
CALCulate<1 2>:LIMit<1..8>:UNIT	DBM   DBPW   WATT   DBUV   DBMV   VOLT   DBUA   AMPere   DB   DBUV_MHZ   DBMV_MHZ   DBUA_MHZ   DBUV_M   DBUA_M   DBUV_MHZ   DBUA_MHZ   DEG   RAD   S   HZ   PCT   UNITLESS	6.22
CALCulate<1 2>:MARKer<1 to 4>:AOFF		6.38
CALCulate<1 2>:MARKer<1 to 4>:COUNT	ON   OFF	6.38
CALCulate<1 2>:MARKer<1 to 4>:COUNT:FREQuency?		6.39
CALCulate<1 2>:MARKer<1 to 4>:COUNT:RESolution	0.1   1   10   100   1000   10000 Hz	6.39
CALCulate<1 2>:MARKer<1 to 4>:COUPled[:STATe]	ON   OFF	6.39
CALCulate<1 2>:MARKer<1 to 4>:FUNCTion:ADEMod:AFREquency[:RESult]?		6.47
CALCulate<1 2>:MARKer<1 to 4>:FUNCTion:ADEMod:AM[:RESult]?	PPEak   MPEak   MIDDLE   RMS	6.46
CALCulate<1 2>:MARKer<1 to 4>:FUNCTion:ADEMod:CARRier[:RESult]?		6.48
CALCulate<1 2>:MARKer<1 to 4>:FUNCTion:ADEMod:FERRor[:RESult]?		6.47
CALCulate<1 2>:MARKer<1 to 4>:FUNCTion:ADEMod:FM[:RESult]?	PPEak   MPEak   MIDDLE   RMS   RDEV	6.47
CALCulate<1 2>:MARKer<1 to 4>:FUNCTion:ADEMod:PM[:RESult]?	PPEak   MPEak   MIDDLE   RMS	6.47
CALCulate<1 2>:MARKer<1 to 4>:FUNCTion:ADEMod:SINad:RESult?		6.48
CALCulate<1 2>:MARKer<1 to 4>:FUNCTion:ADEMod:SINad[:STATe]	ON   OFF	6.48
CALCulate<1 2>:MARKer<1 to 4>:FUNCTion:CENTer:	ON   OFF	6.58
CALCulate<1 2>:MARKer<1 to 4>:FUNCTion:CSTep:	ON   OFF	6.58
CALCulate<1 2>:MARKer<1 to 4>:FUNCTion:DDEMod:RESult?	MERM   MEPK   MEPS   PERM   PEPEK   PEPS   EVRM   EVPK   EVPS IQOF   IQIM  ADR   FERR   RHO	6.49
CALCulate<1 2>:MARKer<1 to 4>:FUNCTion:DEModulation:HOLDoff	10ms to 1000s	6.45
CALCulate<1 2>:MARKer<1 to 4>:FUNCTion:DEModulation:SElect	AM   FM	6.44
CALCulate<1 2>:MARKer<1 to 4>:FUNCTion:DEModulation[:STATe]	ON   OFF	6.45
CALCulate<1 2>:MARKer<1 to 4>:FUNCTion:MSTep		6.59
CALCulate<1 2>:MARKer<1 to 4>:FUNCTion:NDBDown	<numeric_value>	6.43
CALCulate<1 2>:MARKer<1 to 4>:FUNCTion:NDBDown:FREQuency?		6.43
CALCulate<1 2>:MARKer<1 to 4>:FUNCTion:NDBDown:RESult?		6.43
CALCulate<1 2>:MARKer<1 to 4>:FUNCTion:NDBDown:STATe	ON   OFF	6.43
CALCulate<1 2>:MARKer<1 to 4>:FUNCTion:NOISe:RESult?		6.44
CALCulate<1 2>:MARKer<1 to 4>:FUNCTion:NOISe[:STATe]	ON   OFF	6.44
CALCulate<1 2>:MARKer<1 to 4>:FUNCTion:POWER:CFILter	ON   OFF	6.51
CALCulate<1 2>:MARKer<1 to 4>:FUNCTion:POWER:PRESet	NADC   TETRA   PDC   PHS   CDPD   FWCDMA   RWCDMA   FW3Gppcdma   RW3Gppcdma   M2CDma   D2CDma   F8CDma   R8CDma   F19Cdma   R19Cdma   NONE	6.51
CALCulate<1 2>:MARKer<1 to 4>:FUNCTion:POWER:RESult?	ACPower   CPOWER   OBANdwidth   OBWidth   CN   CN0	6.50
CALCulate<1 2>:MARKer<1 to 4>:FUNCTion:POWER:SElect?	ACPower   CPOWER   OBANdwidth   OBWidth   CN   CN0	6.49
CALCulate<1 2>:MARKer<1 to 4>:FUNCTion:POWER[:STATe]	OFF	6.50
CALCulate<1 2>:MARKer<1 to 4>:FUNCTion:REFerence:	ON   OFF	6.59



Command	Parameter	Page
CALCulate<1 2>:MARKer<1 to 4>:FUNctio:n:SFAcTOr	(60dB/3dB)   (60dB/6dB)	6.45
CALCulate<1 2>:MARKer<1 to 4>:FUNctio:n:SFAcTOr:FREQUency?		6.46
CALCulate<1 2>:MARKer<1 to 4>:FUNctio:n:SFAcTOr:RESult?		6.46
CALCulate<1 2>:MARKer<1 to 4>:FUNctio:n:SFAcTOr:STATe	ON   OFF	6.45
CALCulate<1 2>:MARKer<1 to 4>:FUNctio:n:STARt		6.59
CALCulate<1 2>:MARKer<1 to 4>:FUNctio:n:STOP		6.59
CALCulate<1 2>:MARKer<1 to 4>:FUNctio:n:STRack[:STATe]	ON   OFF	6.46
CALCulate<1 2>:MARKer<1 to 4>:FUNctio:n:SUMMery:AOff		6.58
CALCulate<1 2>:MARKer<1 to 4>:FUNctio:n:SUMMery:AVERage	ON   OFF	6.58
CALCulate<1 2>:MARKer<1 to 4>:FUNctio:n:SUMMery:MAXimum:AVERage:RES?		6.52
CALCulate<1 2>:MARKer<1 to 4>:FUNctio:n:SUMMery:MAXimum:PHOLd:RESult?		6.52
CALCulate<1 2>:MARKer<1 to 4>:FUNctio:n:SUMMery:MAXimum:RESult?		6.52
CALCulate<1 2>:MARKer<1 to 4>:FUNctio:n:SUMMery:MAXimum[:STATe]	ON   OFF	6.52
CALCulate<1 2>:MARKer<1 to 4>:FUNctio:n:SUMMery:MEAN:AVERage:RESult?		6.57
CALCulate<1 2>:MARKer<1 to 4>:FUNctio:n:SUMMery:MEAN:PHOLd:RESult?		6.57
CALCulate<1 2>:MARKer<1 to 4>:FUNctio:n:SUMMery:MEAN:RESult?		6.57
CALCulate<1 2>:MARKer<1 to 4>:FUNctio:n:SUMMery:MEAN[:STATe]	ON   OFF	6.57
CALCulate<1 2>:MARKer<1 to 4>:FUNctio:n:SUMMery:MIDdle:AVERage:RESult?		6.55
CALCulate<1 2>:MARKer<1 to 4>:FUNctio:n:SUMMery:MIDdle:PHOLd:RESult?		6.55
CALCulate<1 2>:MARKer<1 to 4>:FUNctio:n:SUMMery:MIDdle:RESult?		6.55
CALCulate<1 2>:MARKer<1 to 4>:FUNctio:n:SUMMery:MIDdle[:STATe]	ON   OFF	6.55
CALCulate<1 2>:MARKer<1 to 4>:FUNctio:n:SUMMery:MPEak:AVERage:RESult?		6.54
CALCulate<1 2>:MARKer<1 to 4>:FUNctio:n:SUMMery:MPEak:PHOLd:RESult?		6.54
CALCulate<1 2>:MARKer<1 to 4>:FUNctio:n:SUMMery:MPEak:RESult?		6.54
CALCulate<1 2>:MARKer<1 to 4>:FUNctio:n:SUMMery:MPEak[:STATe]	ON   OFF	6.54
CALCulate<1 2>:MARKer<1 to 4>:FUNctio:n:SUMMery:PHOLd	ON   OFF	6.58
CALCulate<1 2>:MARKer<1 to 4>:FUNctio:n:SUMMery:PPEak:AVERage:RESult?		6.53
CALCulate<1 2>:MARKer<1 to 4>:FUNctio:n:SUMMery:PPEak:PHOLd:RESult?		6.53
CALCulate<1 2>:MARKer<1 to 4>:FUNctio:n:SUMMery:PPEak:RESult?		6.53
CALCulate<1 2>:MARKer<1 to 4>:FUNctio:n:SUMMery:PPEak[:STATe]	ON   OFF	6.53
CALCulate<1 2>:MARKer<1 to 4>:FUNctio:n:SUMMery:RMS:AVERage:RESult?		6.56
CALCulate<1 2>:MARKer<1 to 4>:FUNctio:n:SUMMery:RMS:PHOLd:RESult?		6.56
CALCulate<1 2>:MARKer<1 to 4>:FUNctio:n:SUMMery:RMS:RESult?		6.56
CALCulate<1 2>:MARKer<1 to 4>:FUNctio:n:SUMMery:RMS[:STATe]	ON   OFF	6.56
CALCulate<1 2>:MARKer<1 to 4>:FUNctio:n:SUMMery:STATe	ON   OFF	6.51
CALCulate<1 2>:MARKer<1 to 4>:FUNctio:n:ZOOM	<numeric_value>	6.44
CALCulate<1 2>:MARKer<1 to 4>:LOEXclude	ON   OFF	6.39
CALCulate<1 2>:MARKer<1 to 4>:MAXimum:APeak		6.40
CALCulate<1 2>:MARKer<1 to 4>:MAXimum:LEFT		6.40
CALCulate<1 2>:MARKer<1 to 4>:MAXimum:NEXT		6.40
CALCulate<1 2>:MARKer<1 to 4>:MAXimum[:PEAK]		6.40
CALCulate<1 2>:MARKer<1 to 4>:MAXimum:RIGHT		6.40
CALCulate<1 2>:MARKer<1 to 4>:MINimum:LEFT		6.41
CALCulate<1 2>:MARKer<1 to 4>:MINimum:NEXT		6.41
CALCulate<1 2>:MARKer<1 to 4>:MINimum[:PEAK]		6.41
CALCulate<1 2>:MARKer<1 to 4>:MINimum:RIGHT		6.41
CALCulate<1 2>:MARKer<1 to 4>:PEXCursion	<numeric_value>	6.42

Command	Parameter	Page
CALCulate<1 2>:MARKer<1 to 4>:READout	MPHase   RIMaginary	6.42
CALCulate<1 2>:MARKer<1 to 4>[:STATe]	ON   OFF	6.37
CALCulate<1 2>:MARKer<1 to 4>:STEP:AUTO	ON   OFF	6.42
CALCulate<1 2>:MARKer<1 to 4>:STEP[:INCRement]	<numeric_value>	6.42
CALCulate<1 2>:MARKer<1 to 4>:TRACe	1 to 4	6.38
CALCulate<1 2>:MARKer<1 to 4>:X	0 to MAX (frequency   sweep time   symbols)	6.38
CALCulate<1 2>:MARKer<1 to 4>:X:SLIMits[:STATe]	ON   OFF	6.38
CALCulate<1 2>:MARKer<1 to 4>:Y?		6.39
CALCulate<1 2>:MATH<1 to 4>[:EXPRession][:DEFine]	<expr>	6.60
CALCulate<1 2>:MATH<1 to 4>:STATe	ON   OFF	6.60
CALCulate<1 2>:RLIne	MIN to MAX (depending on current unit)	6.16
CALCulate<1 2>:RLIne:STATe	ON   OFF	6.16
CALCulate<1 2>:THReshold	MIN to MAX (depending on current unit)	6.15
CALCulate<1 2>:THReshold:STATe	ON   OFF	6.15
CALCulate<1 2>:TLIne<1 2>	0 to 1000s	6.17
CALCulate<1 2>:TLIne<1 2>:STATe	ON   OFF	6.17
CALCulate<1 2>:UNIT:ANGLe	DEG   RAD	6.61
CALCulate<1 2>:UNIT:POWer	DBM   V   W   DB   PCT   UNITLESS   DBPW   WATT   DBUV   DBMV   VOLT   DBUA   AMPere   DBUV_MHZ   DBMV_MHZ   DBUA_MHZ   DBUV_M   DBUA_M   DBUV_MMHZ   DBUA_MMHZ	6.61
CALCulate<1 2>:X:UNIT:TIME	S   SYM	6.61
CALibration[:ALL]		6.62
CALibration:BANDwidth  BWIDth[:RESolution]?		6.62
CALibration:IQ?		6.62
CALibration:LDETEctor?		6.63
CALibration:LOSUPpression?		6.63
CALibration:PPEak?		6.63
CALibration:SHORT?		6.63
CALibration:STATe	ON   OFF	6.63
CONFigure:BURSt:PFERror:COUNT	1 to 1000	6.71
CONFigure:BURSt:PFERror[:IMMEDIATE]		6.71
CONFigure:BURSt:POWer:CONDition	NORMal   EXTReme	6.72
CONFigure:BURSt:POWer:COUNT	1 to 1000	6.72
CONFigure:BURSt:POWer[:IMMEDIATE]		6.72
CONFigure:BURSt:PTEMplate:COUNT	1 to 1000	6.73
CONFigure:BURSt:PTEMplate[:IMMEDIATE]		6.72
CONFigure:BURSt:PTEMplate:SELect	FULL   TOP   RISing   FALLing	6.73
CONFigure:BURSt:REFerence:AUTO	ON   OFF	6.73
CONFigure:SPECTrum:MODulation:COUNT	1 to 1000	6.80
CONFigure:SPECTrum:MODulation[:IMMEDIATE]		6.80
CONFigure:SPECTrum:MODulation:RANGe	ARFCn   TXBand   RXBand   COMBined   DCSRx1800	6.81
CONFigure:SPECTrum:MODulation:TGATE	ON   OFF	6.81

Command	Parameter	Page
CONFigure:SPECtrum:SWITching[:IMMediate]		6.81
CONFigure:SPECtrum:SWITching:COUNT	1 to 1000	6.81
CONFigure:SPURious:ANTenna	CONDUCTed   RADiated	6.83
CONFigure:SPURious:COUNT	1 to 1000	6.82
CONFigure:SPURious:COUNT:RXBand	1 to 1000	6.82
CONFigure:SPURious[:IMMediate]		6.82
CONFigure:SPURious:RANGe	TXBand   OTXBand   RXBand   IDLeband   COMBined	6.83
CONFigure:SPURious:STEP	ON   OFF	6.83
CONFigure:SPURious:STEP:COUNT?		6.83
CONFigure[:BTS]:ARFCn	1 to 124 (P-GSM phase I/II) 0 to 124, 975 to 1023 (E-GSM) 0 to 124, 955 to 1023 (R-GSM) 512 to 885 (DCS1800 phase I/II/II+) 512 to 810 (PCS1900)	6.65
CONFigure[:BTS]:ARFCn:AUTO	ONCE	6.65
CONFigure[:BTS]:CHANnel:SFH	ON   OFF	6.68
CONFigure[:BTS]:CHANnel:SLOT	0 to 7	6.68
CONFigure[:BTS]:CHANnel:SLOT:AUTO	ONCE	6.68
CONFigure[:BTS]:CHANnel:TSC	0 to 7	6.69
CONFigure[:BTS]:CHANnel:TSC:AUTO	ON   OFF	6.69
CONFigure[:BTS]:COSiting	ON   OFF	6.69
CONFigure[:BTS]:LIMit:FREQuency	<numeric_value>	6.66
CONFigure[:BTS]:LIMit:PPEak	<numeric_value>	6.65
CONFigure[:BTS]:LIMit:PRMS	<numeric_value>	6.66
CONFigure[:BTS]:LIMit:STANdard	ON   OFF	6.66
CONFigure[:BTS]:MEASurement?		6.65
CONFigure[:BTS]:NETWork:PHASe	1   2 [,PLUS]	6.69
CONFigure[:BTS]:NETWork[:TYPE]	PGSM   PGSM900   EGSM  EGSM900   DCS  GSM1800   PCS   GSM1900   RGSM   RGSM900	6.69
CONFigure[:BTS]:POWer:CLASs	1 to 8   1 to 4   M1   M2   M3	6.66
CONFigure[:BTS]:POWer:COUPled	ON   OFF	6.67
CONFigure[:BTS]:POWer:DYNamic	0 to 15	6.67
CONFigure[:BTS]:POWer:EXPEcted	<numeric_value>	6.67
CONFigure[:BTS]:POWer:LIMit	<numeric_value>	6.67
CONFigure[:BTS]:POWer:SINGle:CLEar		6.68
CONFigure[:BTS]:POWer:SINGle[:STATe]	ON   OFF	6.68
CONFigure[:BTS]:POWer:STATic	0 to 6	6.67
CONFigure[:BTS]:PRESet		6.70
CONFigure[:BTS]:SWEeptime	STANdard   AUTO	6.70
CONFigure[:BTS]:TXSupp	ON   OFF	6.70
CONFigure[:MS]:ARFCn	1 to 124 (P-GSM phase I/II) 0 to 124, 975 to 1023 (E-GSM) 0 to 124, 955 to 1023 (R-GSM) 512 to 885 (DCS1800 phase I/II/II+) 512 to 810 (PCS1900)	6.75
CONFigure[:MS]:ARFCn:AUTO	ONCE	6.75
CONFigure[:MS]:CHANnel:SFH	ON   OFF	6.78
CONFigure[:MS]:CHANnel:TSC	0 to 7	6.78
CONFigure[:MS]:LIMit:FREQuency	<numeric_value>	6.76

Command	Parameter	Page
CONFigure[:MS]:LIMit:PPEak	<numeric_value>	6.75
CONFigure[:MS]:LIMit:PRMS	<numeric_value>	6.75
CONFigure[:MS]:LIMit:STANdard	ON   OFF	6.76
CONFigure[:MS]:MEASurement?		6.74
CONFigure[:MS]:NETWork:PHASe	1   2 [,PLUS]	6.78
CONFigure[:MS]:NETWork[:TYPE]	PGSM   PGSM900   EGSM   EGSM900   DCS   GSM1800   PCS   GSM1900   RGSM   RGSM900	6.78
CONFigure[:MS]:POWer:CLASs	1 to 8   1 to 4   M1   M2   M3	6.76
CONFigure[:MS]:POWer:COUPled	ON   OFF	6.76
CONFigure[:MS]:POWer:EXPEcted	<numeric_value>	6.77
CONFigure[:MS]:POWer:LEVel	0 to 31	6.77
CONFigure[:MS]:POWer:LIMit	<numeric_value>	6.77
CONFigure[:MS]:POWer:SINGle:CLEar		6.77
CONFigure[:MS]:POWer:SINGle:STATe	ON   OFF	6.77
CONFigure[:MS]:POWer:SMALI	ON   OFF	6.78
CONFigure[:MS]:PRESet		6.79
CONFigure[:MS]:SWEeptime	STANdard   AUTO	6.79
CONFigure[:MS]:TXSupp	ON   OFF	6.79
DIAGnostic:INFO:CCOunt:ATTenuation<1 2 3>?		6.85
DIAGnostic:SERVice:FUNCTion	numeric_value>,<numeric_value>...	6.84
DIAGnostic:SERVice:INPut[:SElect]	CALibration   RF	6.84
DIAGnostic:SERVice:NSOource	ON   OFF	6.84
DISPlay:ANNotation:FREQuency	ON   OFF	6.87
DISPlay:CMAP<1 to 13>:DEFault		6.88
DISPlay:CMAP<1 to 13>:HSL	0.0 to 100.0 (tint), 0.0 to 100.0 (saturation), 0.0 to 100.0 (brightness)	6.88
DISPlay:CMAP<1 to 13>:PDEFined	BLACK   BLUE   BROWN   GREEN   CYAN   RED   MAGenta   YELLOW   WHITE   DGRAY   LGRAY   LBLUE   LGREEN   LCYan   LRED   LMAGenta	6.88
DISPlay:FORmat	SINGle   SPLit	6.87
DISPlay:LOGO	ON   OFF	6.87
DISPlay:PROGram[:MODE]	ON   OFF	6.87
DISPlay:PSAVe:HOLDoff		6.95
DISPlay:PSAVe[:STATe]	ON   OFF	6.95
DISPlay[:WINDow<1 2>]:MINFo	ON   OFF	6.89
DISPlay[:WINDow<1 2>]:TEXT[:DATA]	<string>	6.89
DISPlay[:WINDow<1 2>]:TEXT:STATe	ON   OFF	6.89
DISPlay[:WINDow<1 2>]:TIME	ON   OFF	6.89
DISPlay[:WINDow<1 2>]:TRACe<1 to 4>:EYE:COUNT	1 to Result Length	6.95
DISPlay[:WINDow<1 2>]:TRACe<1 to 4>:MODE	WRITE   VIEW   AVERage   MAXHold   MINHold	6.93
DISPlay[:WINDow<1 2>]:TRACe<1 to 4>:MODE:ANALog	ON   OFF	6.94
DISPlay[:WINDow<1 2>]:TRACe<1 to 4>:MODE:CWRite	ON   OFF	6.93
DISPlay[:WINDow<1 2>]:TRACe<1 to 4>:MODE:HCONtinuous	ON   OFF	6.94
DISPlay[:WINDow<1 2>]:TRACe<1 to 4>[:STATe]	ON   OFF	6.94
DISPlay[:WINDow<1 2>]:TRACe<1 to 4>:SYMBOL	DOTS   BARS   OFF	6.94

Command	Parameter	Page
DISPlay[:WINDow<1 2>]:TRACe<1 to 4>:X[:SCALe]:RVALue	<numeric_value>	6.89
DISPlay[:WINDow<1 2>]:TRACe<1 to 4>:X[:SCALe]:ZOOM	ON   OFF	6.90
DISPlay[:WINDow<1 2>]:TRACe<1 to 4>:X[:SCALe]:ZOOM[:FREQuency]:CENTer	<numeric_value>	6.90
DISPlay[:WINDow<1 2>]:TRACe<1 to 4>:X[:SCALe]:ZOOM[:FREQuency]:START	<numeric_value>	6.90
DISPlay[:WINDow<1 2>]:TRACe<1 to 4>:X[:SCALe]:ZOOM[:FREQuency]:STOP	<numeric_value>	6.90
DISPlay[:WINDow<1 2>]:TRACe<1 to 4>:X:SPACing	LINear   LOGarithmic	6.91
DISPlay[:WINDow<1 2>]:TRACe<1 to 4>:Y[:SCALe]	10dB to 200dB	6.91
DISPlay[:WINDow<1 2>]:TRACe<1 to 4>:Y[:SCALe]:MODE	ABSolute   RELative	6.91
DISPlay[:WINDow<1 2>]:TRACe<1 to 4>:Y[:SCALe]:PDIVision	<numeric_value>	6.93
DISPlay[:WINDow<1 2>]:TRACe<1 to 4>:Y[:SCALe]:RLEVel	-200dBm to 200dBm	6.91
DISPlay[:WINDow<1 2>]:TRACe<1 to 4>:Y[:SCALe]:RLEVel:OFFSet	-200dB to 200dB	6.92
DISPlay[:WINDow<1 2>]:TRACe<1 to 4>:Y[:SCALe]:RPOStion	0 to 100 PCT	6.93
DISPlay[:WINDow<1 2>]:TRACe<1 to 4>:Y[:SCALe]:RVALue	<numeric_value>	6.92
DISPlay[:WINDow<1 2>]:TRACe<1 to 4>:Y[:SCALe]:RVALue:AUTO	ON   OFF	6.92
DISPlay[:WINDow<1 2>]:TRACe<1 to 4>:Y:SPACing	LINear   LOGarithmic   PERCent	6.93
FETCh:BURSt:FERRor:AVERAge?		6.99
FETCh:BURSt:FERRor:MAXimum?		6.99
FETCh:BURSt:FERRor:STATus?		6.98
FETCh:BURSt:PERRor:PEAK:AVERAge?		6.98
FETCh:BURSt:PERRor:PEAK:MAXimum?		6.98
FETCh:BURSt:PERRor:PEAK:STATus?		6.97
FETCh:BURSt:PERRor:RMS:AVERAge?		6.97
FETCh:BURSt:PERRor:RMS:MAXimum?		6.97
FETCh:BURSt:PERRor:RMS:STATus?		6.96
FETCh:BURSt:POWer:ALL?		6.100
FETCh:BURSt:POWer[:IMMediate]?		6.99
FETCh:PTEMplate:REFerence?	TXBand	6.106
FETCh:SPECTrum:MODulation[:ALL]?	ARFCn   TXBand   RXBand   COMBined   DCSRx1800	6.101
FETCh:SPECTrum:MODulation:REFerence?	TXBand	6.102
FETCh:SPECTrum:SWITChing[:ALL]?		6.103
FETCh:SPECTrum:SWITChing:REFerence?	TXBand	6.103
FETCh:SPURious[:ALL]?	TXBand OTXBand   RXBand   IDLeband	6.104
FETCh:SPURious:STEP?		6.105
FORMat[:DATA]	ASCIi   REAL   UINt [,32]	6.107
FORMat:DEXPort:APPend[:STATe]	ON   OFF	6.108
FORMat:DEXPort:DSEParator	POINt COMMa	6.108
FORMat:DEXPort:HEADer[:STATe]	ON   OFF	6.108
HCOPY:ABORt		6.109
HCOPY:DEStination<1 2>	'MMEM'   'SYSt:COMM:PRIN'   'SYSt:COMM:CLIP'	6.110
HCOPY:DEVice:COLor	ON   OFF	6.110
HCOPY:DEVice:ITEM:ALL		6.111
HCOPY:DEVice:ITEM:FFEed<1 2>:STATe	ON   OFF	6.111
HCOPY:DEVice:ITEM:LABel:TEXT	<string>	6.111
HCOPY:DEVice:ITEM:PFEed<1 2>:STATe	ON   OFF	6.112
HCOPY:DEVice:ITEM:WINDow<1 2>:TABLe:STATe	ON   OFF	6.112

Command	Parameter	Page
HCOPY:DEVICE:ITEM:WINDOW<1 2>:TEXT	<string>	6.112
HCOPY:DEVICE:ITEM:WINDOW<1 2>:TRACE:CAINcrement	ON   OFF	6.113
HCOPY:DEVICE:ITEM:WINDOW<1 2>:TRACE:STATE	ON   OFF	6.112
HCOPY:DEVICE:LANGUAGE<1 2>	WMF   EWMF   GDI   BMP	6.110
HCOPY[:IMMEDIATE]		6.111
HCOPY:PAGE:DIMENSIONS:FULL		6.113
HCOPY:PAGE:DIMENSIONS:QUADRANT<1 to 4>		6.113
HCOPY:PAGE:ORIENTATION<1 2>	LANDscape   PORTrait	6.113
INITiate<1 2>:CONMeas		6.114
INITiate<1 2>:CONTInuous	ON   OFF	6.114
INITiate<1 2>:DISPlay	ON   OFF	6.114
INITiate<1 2>[:IMMEDIATE]		6.114
INPut<1 2>:ATTenuation	0 to 70dB	6.115
INPut<1 2>:ATTenuation:AUTO	ON   OFF	6.115
INPut<1 2>:ATTenuation:AUTO:MODE	NORMal   LNOise   LDISTorsion	6.115
INPut<1 2>:ATTenuation:STEPsize	1dB   10dB	6.116
INPut<1 2>:IMPedance	50   75	6.116
INPut<1 2>:IMPedance:CORRection	RAM   RAZ	6.117
INPut<1 2>:MIXer	-10 to -100 dBm	6.117
INPut<1 2>:UPOrT<1 2>:STATE	ON   OFF	6.116
INPut<1 2>:UPOrT<1 2>[:VALue]		6.116
INSTrument<1 2>:NSElect	1to 5	6.118
INSTrument<1 2>[:SElect]	SANalyzer   DDEMod   ADEMod   BGSM   MGSM	6.118
MMEMemory:CATalog?	<string>	6.121
MMEMemory:CDIRectory	directory name	6.121
MMEMemory:CLear:ALL		6.126
MMEMemory:CLear:STATE	1,path	6.126
MMEMemory:COMMeNt	<string>	6.130
MMEMemory:COpy	path, file name	6.122
MMEMemory:DATA	<file name>,<block data>	6.122
MMEMemory:DELeTe	path, file name	6.122
MMEMemory:INITialize	'A.'	6.123
MMEMemory:LOAD:AUTO	1,path	6.123
MMEMemory:LOAD:STATE	path, file name	6.123
MMEMemory:MDIRectory	path	6.124
MMEMemory:MOVE	path, file name	6.124
MMEMemory:MSIS	'A.'   'C.'	6.124
MMEMemory:NAME	path, file name	6.125
MMEMemory:RDIRectory	directory name	6.125
MMEMemory:SElect[:ITEM]:ALL		6.130
MMEMemory:SElect[:ITEM]:CSEtUp	ON   OFF	6.128
MMEMemory:SElect[:ITEM]:CVL[:ACTIve]	ON   OFF	6.129
MMEMemory:SElect[:ITEM]:CVL:ALL	ON   OFF	6.129
MMEMemory:SElect[:ITEM]:DEFault		6.130
MMEMemory:SElect[:ITEM]:GSEtUp	ON   OFF	6.127
MMEMemory:SElect[:ITEM]:HCOPY	ON   OFF	6.128
MMEMemory:SElect[:ITEM]:HWSettiNGs	ON   OFF	6.127

<b>Command</b>	<b>Parameter</b>	<b>Page</b>
MMEemory:SElect[:ITEM]:LINES[:ACTive]	ON   OFF	6.127
MMEemory:SElect[:ITEM]:LINES:ALL	ON   OFF	6.128
MMEemory:SElect[:ITEM]:MACRos	ON   OFF	6.128
MMEemory:SElect[:ITEM]:NONE		6.130
MMEemory:SElect[:ITEM]:SCData	ON   OFF	6.128
MMEemory:SElect[:ITEM]:TRACe<1 to 4>	ON   OFF	6.127
MMEemory:SElect[:ITEM]:TRANsdncer[:ACTive]	ON   OFF	6.129
MMEemory:SElect[:ITEM]:TRANsdncer:ALL	ON   OFF	6.129
MMEemory:STORe:STATe	path, file name	6.125
MMEemory:STORe:TRACe	1 to 4, path	6.126
OUTPut:AF:SENSitivity	0.1 PCT to 100 PCT for AM 0.1 KHZ to 100 KHZ for FM 0.0 1RAD to 10 RAD for PM	6.132
OUTPut[:STATe]	ON   OFF	6.131
OUTPut:UPOrt<1 2>:STATe	ON   OFF	6.131
OUTPut:UPOrt<1 2>[:VALue]	#B00000000 to #B11111111	6.131
READ:BURSt:FERRor:AVERAge?		6.136
READ:BURSt:FERRor:MAXimum?		6.136
READ:BURSt:FERRor:STATus?		6.135
READ:BURSt:PERRor:PEAK:AVERAge?		6.135
READ:BURSt:PERRor:PEAK:MAXimum?		6.135
READ:BURSt:PERRor:PEAK:STATus?		6.134
READ:BURSt:PERRor:RMS:AVERAge?		6.134
READ:BURSt:PERRor:RMS:MAXimum?		6.134
READ:BURSt:PERRor:RMS:STATus?		6.133
READ:BURSt:POWer:DYNamic?		6.139
READ:BURSt:POWer:POWer:LEVel?		6.140
READ:BURSt:POWer:STATic?		6.138
READ:BURSt:POWer?		6.137
READ:BURSt:REFerence[:IMMEDIATE?]		6.140
READ:SPECTrum:MODulation[:ALL]?		6.141
READ:SPECTrum:SWITChing[:ALL]?		6.142
READ:SPURious[:ALL]?		6.143
READ:SPURious:STEP?		6.144
[SENSe<1 2>:]ADEMod:AF:COUPling	AC   DC	6.145
[SENSe<1 2>:]ADEMod:RTIME	ON   OFF	6.146
[SENSe<1 2>:]ADEMod:SBANd	NORMal   INVerse	6.146
[SENSe<1 2>:]ADEMod:SQUelch:LEVel	30 to -150 dBm	6.146
[SENSe<1 2>:]ADEMod:SQUelch[:STATe]	ON   OFF	6.145
[SENSe<1 2>:]AVERAge:AUTO	ON   OFF	6.147
[SENSe<1 2>:]AVERAge:COUNt	0 to 256	6.147
[SENSe<1 2>:]AVERAge[:STATe]	ON   OFF	6.147
[SENSe<1 2>:]AVERAge:TYPE	MAXimum   SCALar	6.148
[SENSe<1 2>:]BANDwidth BWIDth:DEMod	5 kHz to 200 kHz (Real Time on) 5 kHz to 5 MHz (Real Time off)	6.151
[SENSe<1 2>:]BANDwidth BWIDth:PLL	AUTO   HIGH   MEDIUM   LOW	6.151
[SENSe<1 2>:]BANDwidth BWIDth[:RESolution]	1Hz to 10MHz	6.149
[SENSe<1 2>:]BANDwidth BWIDth[:RESolution]:AUTO	ON   OFF	6.150

Command	Parameter	Page
[SENSe<1 2>:]BANDwidth BWiDth[:RESolution]:MODE	ANALog   DIGital	6.150
[SENSe<1 2>:]BANDwidth BWiDth[:RESolution]:MODE:FFT	ON   OFF	6.150
[SENSe<1 2>:]BANDwidth BWiDth[:RESolution]:RATio	0.0001 to 1	6.150
[SENSe<1 2>:]BANDwidth BWiDth:VIDeo	1Hz to 10MHz	6.151
[SENSe<1 2>:]BANDwidth BWiDth:VIDeo:AUTO	ON   OFF	6.151
[SENSe<1 2>:]BANDwidth BWiDth:VIDeo:EXTErnal[:STATe]	ON   OFF	6.151
[SENSe<1 2>:]BANDwidth BWiDth:VIDeo:RATio	0.001 to 1000   SINE   PULSE   NOISE	6.151
[SENSe<1 2>:]CORRection:COLLect[:ACQuire]	THROUGH   OPEN	6.153
[SENSe<1 2>:]CORRection:CVL:Band	A Q U V E W F D G Y J	6.160
[SENSe<1 2>:]CORRection:CVL:BIAS	<numeric_value>	6.160
[SENSe<1 2>:]CORRection:CVL:CATalog?		6.159
[SENSe<1 2>:]CORRection:CVL:CLear		6.161
[SENSe<1 2>:]CORRection:CVL:COMMeNT	<string>	6.161
[SENSe<1 2>:]CORRection:CVL:DATA	<freq>,<level>..	6.161
[SENSe<1 2>:]CORRection:CVL:MIXer	<string>	6.159
[SENSe<1 2>:]CORRection:CVL:PORTs	2   3	6.160
[SENSe<1 2>:]CORRection:CVL:SELect	<file_name>	6.159
[SENSe<1 2>:]CORRection:CVL:SNUMber	<string>	6.159
[SENSe<1 2>:]CORRection:CVL:TYPE	ODD   EVEN   EODD	6.160
[SENSe<1 2>:]CORRection:LOSS:INPut[:MAGNitude]	<value of ext. attenuation in dB>	6.158
[SENSe<1 2>:]CORRection:METhod	TRANsmiSSion   REFLEXion	6.153
[SENSe<1 2>:]CORRection:RECall		6.153
[SENSe<1 2>:]CORRection:RXGain:INPut[:MAGNitude]	<value of the amplification in dB>	6.158
[SENSe<1 2>:]CORRection[:STATe]	ON   OFF	6.153
[SENSe<1 2>:]CORRection:TRANSDUCer:ACTive?		6.154
[SENSe<1 2>:]CORRection:TRANSDUCer:CATalog?		6.154
[SENSe<1 2>:]CORRection:TRANSDUCer:COMMeNT	<string>	6.155
[SENSe<1 2>:]CORRection:TRANSDUCer:DATA	<freq>,<level>..	6.155
[SENSe<1 2>:]CORRection:TRANSDUCer:DELeTe		6.156
[SENSe<1 2>:]CORRection:TRANSDUCer:SCALing	LINear   LOGarithmic	6.155
[SENSe<1 2>:]CORRection:TRANSDUCer:SELect	<name>	6.154
[SENSe<1 2>:]CORRection:TRANSDUCer[:STATe]	ON   OFF	6.155
[SENSe<1 2>:]CORRection:TRANSDUCer:UNIT	<string>	6.154
[SENSe<1 2>:]CORRection:TSET:ACTive?		6.156
[SENSe<1 2>:]CORRection:TSET:BReak	ON   OFF	6.157
[SENSe<1 2>:]CORRection:TSET:CATalog?		6.156
[SENSe<1 2>:]CORRection:TSET:COMMeNT	<string>	6.157
[SENSe<1 2>:]CORRection:TSET:DELeTe		6.158
[SENSe<1 2>:]CORRection:TSET:RANGe<1 to 10>	<freq>,<freq>,<name>..	6.157
[SENSe<1 2>:]CORRection:TSET:SELect	<name>	6.156
[SENSe<1 2>:]CORRection:TSET:UNIT	<string>	6.157
[SENSe<1 2>:]CORRection:TSET[:STATe]	ON   OFF	6.158
[SENSe<1 2>:]DDEMod:FiLTER:ALPHA	0.2 to 1	6.166
[SENSe<1 2>:]DDEMod:FiLTER:MEASurement	OFF   RCOSine   RRCosine   GAUSSian   B22   B25   B44   QFM   FM95   QFR   FR95   QRM   RM95   QRR   RR95   A25Fm   EMES   EREF	6.166



Command	Parameter	Page
[SENSe<1 2>:]DDEMod:FiLTeR:REFeRence	RCOSine   RRCosine   GAUSSian   B22   B25   B44   QFM   FM95   QFR   FR95   QRM   RM95   QRR   RR95   A25Fm   EMES   EREF	6.166
[SENSe<1 2>:]DDEMod:FORMat	QPSK   PSK   MSK   QAM   FSK	6.164
[SENSe<1 2>:]DDEMod:FSK:NState	2   4	6.165
[SENSe<1 2>:]DDEMod:MSK:FORMat	TYPE1   TYPE2   NORMal   DIFFerential	6.165
[SENSe<1 2>:]DDEMod:NORMalize	ON   OFF	6.167
[SENSe<1 2>:]DDEMod:PRATe	1   2   4   8   16	6.166
[SENSe<1 2>:]DDEMod:PRESet	GSM   EDGe   NADC   TETRa   PHS   PDCup   PDCDown   APCO25CQPSK   APCO25C4FM   CDPD   DECT   CT2   ERMes   MODacom   PWT   TFTS   F16   F322   F324   F64 F64   FQCDma   F95Cdma   RQCDma   R95Cdma   FNADc   RNADc   FWCDma   FCDMa4096   RWCDma   RCDMa4096   FW3Gppcdma   RW3Gppcdma   CDMA2000	6.170
[SENSe<1 2>:]DDEMod:PSK:FORMat	NORMal   DIFFerential   N3Pi8	6.164
[SENSe<1 2>:]DDEMod:PSK:NState	2   8	6.164
[SENSe<1 2>:]DDEMod:QAM:NState	16	6.165
[SENSe<1 2>:]DDEMod:QPSK:FORMat	NORMal   DIFFerential   OFFSet   DPI4	6.164
[SENSe<1 2>:]DDEMod:SBANd	NORMal   INVerse	6.164
[SENSe<1 2>:]DDEMod:SEARch:PULSe:STATe	ON   OFF	6.167
[SENSe<1 2>:]DDEMod:SEARch:SYNC:CATalog?		6.167
[SENSe<1 2>:]DDEMod:SEARch:SYNC:COMMeNt	<string>	6.168
[SENSe<1 2>:]DDEMod:SEARch:SYNC:DATA	<string>	6.168
[SENSe<1 2>:]DDEMod:SEARch:SYNC:DELeTe	<string>	6.169
[SENSe<1 2>:]DDEMod:SEARch:SYNC:MONLy	ON   OFF	6.169
[SENSe<1 2>:]DDEMod:SEARch:SYNC:NAME	<string>	6.168
[SENSe<1 2>:]DDEMod:SEARch:SYNC:OFFSet	<numeric_value>	6.167
[SENSe<1 2>:]DDEMod:SEARch:SYNC:PATTeRn	<string>	6.168
[SENSe<1 2>:]DDEMod:SEARch:SYNC:SELeCt	<string>	6.167
[SENSe<1 2>:]DDEMod:SEARch:SYNC:STATe	ON   OFF	6.168
[SENSe<1 2>:]DDEMod:SEARch:TIME	100 to 1600	6.169
[SENSe<1 2>:]DDEMod:SRATe	160 Hz to 7 MHz	6.165
[SENSe<1 2>:]DDEMod:TIME	1 to Frame Length	6.165
[SENSe<1 2>:]DETEctor<1 to 4>:FUNCTioN	APEak   NEGative   POSitive   SAMPlE   RMS   AVERage	6.162
[SENSe<1 2>:]DETEctor<1 to 4>:FUNCTioN:AUTO	ON   OFF	6.162
[SENSe<1 2>:]FiLTeR:CCITt[:STATe]	ON   OFF	6.172
[SENSe<1 2>:]FiLTeR:CMESsage[:STATe]	ON   OFF	6.172
[SENSe<1 2>:]FiLTeR:DEMPHasis:LiNK	DISPlay   AUDio	6.173
[SENSe<1 2>:]FiLTeR:DEMPHasis[:STATe]	ON   OFF	6.173
[SENSe<1 2>:]FiLTeR:DEMPHasis:TCONStant	<numeric_value>	6.173
[SENSe<1 2>:]FiLTeR:HPASs:FREQUency	30 Hz   300 HZ	6.171
[SENSe<1 2>:]FiLTeR:HPASS[:STATe]	ON   OFF	6.171
[SENSe<1 2>:]FiLTeR:LPASs:FREQUency	3 kHz   15 kHz (real time on) 5PCT 10PCT 25PCT (real time off)	6.172

Command	Parameter	Page
[SENSe<1 2>:]FILTer:LPASs[:STATe]	ON   OFF	6.172
[SENSe<1 2>:]FREQuency:CENTer	0 GHz to $f_{max}$	6.174
[SENSe<1 2>:]FREQuency:CENTer:LINK	START   STOP   SPAN	6.174
[SENSe<1 2>:]FREQuency:CENTer:STEP	0 to $f_{max}$	6.175
[SENSe<1 2>:]FREQuency:CENTer:STEP:LINK	SPAN   RBW   OFF	6.175
[SENSe<1 2>:]FREQuency:CENTer:STEP:LINK:FACTor	1 to 100 PCT	6.175
[SENSe<1 2>:]FREQuency:MODE	CW FIXed   SWEep	6.177
[SENSe<1 2>:]FREQuency:OFFSet	<numeric_value>	6.177
[SENSe<1 2>:]FREQuency:SPAN	0 GHz to $f_{max}$	6.175
[SENSe<1 2>:]FREQuency:SPAN:FULL		6.176
[SENSe<1 2>:]FREQuency:SPAN:LINK	CENTer   STOP   SPAN	6.176
[SENSe<1 2>:]FREQuency:START	0 GHz to $f_{max}$	6.176
[SENSe<1 2>:]FREQuency:START:LINK	CENTer   STOP   SPAN	6.176
[SENSe<1 2>:]FREQuency:STOP	0 GHz to $f_{max}$	6.176
[SENSe<1 2>:]FREQuency:STOP:LINK	CENTer   START   SPAN	6.177
[SENSe<1 2>:]MIXer:BIAS	<numeric_value>	6.181
[SENSe<1 2>:]MIXer:BIAS:LIMit[:MAX]	<numeric_value>	6.181
[SENSe<1 2>:]MIXer:BIAS:LIMit:MIN	<numeric_value>	6.181
[SENSe<1 2>:]MIXer:BLOCK	ON   OFF	6.178
[SENSe<1 2>:]MIXer:HARMonic	2..X; X: depending on the LO	6.179
[SENSe<1 2>:]MIXer:HARMonic:BAND	A   Q   U   V   E   W   F   D   G   Y   J	6.180
[SENSe<1 2>:]MIXer:HARMonic:TYPE	ODD   EVEN   EODD	6.180
[SENSe<1 2>:]MIXer:LOSS:HIGH	<numeric_value>	6.180
[SENSe<1 2>:]MIXer:LOSS[:LOW]	<numeric_value>	6.180
[SENSe<1 2>:]MIXer:LOSS:TABLE	<file_name>	6.181
[SENSe<1 2>:]MIXer:PORTs	2   3	6.179
[SENSe<1 2>:]MIXer:SIGNal	ON   OFF   AUTO	6.179
[SENSe<1 2>:]MIXer[:STATe]	ON   OFF	6.178
[SENSe<1 2>:]MIXer:THReshold	0.1 to 100 dB	6.179
[SENSe<1 2>:]MSUMmary:AHOLD[:STATe]	ON   OFF	6.182
[SENSe<1 2>:]MSUMmary:MODE	ABSolute   RELative	6.182
[SENSe<1 2>:]MSUMmary:MTIME	0.1 s   1 s	6.183
[SENSe<1 2>:]MSUMmary:REFerence	<numeric_value>	6.182
[SENSe<1 2>:]MSUMmary:RUNit	PCT   DB	6.182
[SENSe<1 2>:]POWer:ACHannel:ACPairs	1 to 3	6.185
[SENSe<1 2>:]POWer:ACHannel:BANDwidth BWIDth:ACHannel	0 to 1000MHz	6.185
[SENSe<1 2>:]POWer:ACHannel:BANDwidth BWIDth:ALTernate<1 2>	0 to 1000MHz	6.186
[SENSe<1 2>:]POWer:ACHannel:BANDwidth BWIDth[:CHANnel]	0 to 1000 MHz	6.185
[SENSe<1 2>:]POWer:ACHannel:MODE	ABSolute   RELative	6.186
[SENSe<1 2>:]POWer:ACHannel:PRESet	ACPowEr   CPOWer   OBANdwidth   OBWidth   CN   CNO	6.186
[SENSe<1 2>:]POWer:ACHannel:REFerence:AUTO	ONCE	6.186
[SENSe<1 2>:]POWer:ACHannel:SPACing:ACHannel	0 to 1000 MHz	6.184
[SENSe<1 2>:]POWer:ACHannel:SPACing:ALTernate<1 2>	0 to 1000 MHz	6.185
[SENSe<1 2>:]POWer:ACHannel:SPACing[:UPPer]	0 to 1000 MHz	6.184
[SENSe<1 2>:]POWer:BANDwidth BWIDth	0 to 100 PCT	6.186
[SENSe<1 2>:]ROSCillator:EXTernal:FREQuency	1 MHz to 16 MHz	6.187
[SENSe<1 2>:]ROSCillator[:INTernal]:TUNE	0 to 4095	6.187

Command	Parameter	Page
[SENSe<1 2>:]ROSCillator[:INTernal]:TUNe:SAVe		6.187
[SENSe<1 2>:]ROSCillator:SOURce	INTernal   EXTernal	6.187
[SENSe<1 2>:]SWEep:COUNT	0 to 32767	6.189
[SENSe<1 2>:]SWEep:EGATe	ON   OFF	6.189
[SENSe<1 2>:]SWEep:EGATe:HOLDoff	0 to 100s	6.190
[SENSe<1 2>:]SWEep:EGATe:LENGth	0 to 100s	6.190
[SENSe<1 2>:]SWEep:EGATe:LEVel	-5V to +5V	6.189
[SENSe<1 2>:]SWEep:EGATe:POLarity	POSitive   NEGative	6.190
[SENSe<1 2>:]SWEep:EGATe:SOURce	EXTernal   RFPower	6.190
[SENSe<1 2>:]SWEep:EGATe:TYPE	LEVel   EDGE	6.189
[SENSe<1 2>:]SWEep:GAP	ON   OFF	6.190
[SENSe<1 2>:]SWEep:GAP:LENGth	0 to 100s	6.191
[SENSe<1 2>:]SWEep:GAP:PRETrigger	0 to 100s	6.191
[SENSe<1 2>:]SWEep:GAP:TRGTogap	0 to 100s	6.191
[SENSe<1 2>:]SWEep:TIME	<numeric_value>	6.188
[SENSe<1 2>:]SWEep:TIME:AUTO	ON   OFF	6.188
[SENSe<1 2>:]TCAPture:LENGth	1024   2048   4096   8192   16384	6.170
SOURce:AM:STATe	ON   OFF	6.192
SOURce:DM:STATe	ON   OFF	6.192
SOURce:FREQuency:OFFSet	-200 MHz to 200 MHz	6.193
SOURce:POWer:ALC:SOURce	INTernal   EXTernal	6.193
SOURce:POWer[:LEVel][:IMMediate][:AMPLitude]	20dBm to 0dBm / Option FSE-B12: -90dBm to 0dBm	6.193
SOURce:POWer[:LEVel][:IMMediate]:OFFSet	-200 dB to +200 dB	6.193
STATus:OPERation:CONDition?		6.195
STATus:OPERation:ENABle	0 to 65535	6.195
STATus:OPERation[:EVENT]?		6.195
STATus:OPERation:NTRansition	0 to 65535	6.196
STATus:OPERation:PTRansition	0 to 65535	6.196
STATus:PRESet		6.196
STATus:QUESTionable:ACPLimit:CONDition?		6.201
STATus:QUESTionable:ACPLimit:ENABle	0 to 65535	6.202
STATus:QUESTionable:ACPLimit[:EVENT]?		6.201
STATus:QUESTionable:ACPLimit:NTRansition	0 to 65535	6.202
STATus:QUESTionable:ACPLimit:PTRansition	0 to 65535	6.202
STATus:QUESTionable:CONDition?		6.196
STATus:QUESTionable:ENABle	0 to 65535	6.197
STATus:QUESTionable[:EVENT]?		6.196
STATus:QUESTionable:NTRansition	0 to 65535	6.197
STATus:QUESTionable:PTRansition	0 to 65535	6.197
STATus:QUESTionable:FREQuency:CONDition?		6.202
STATus:QUESTionable:FREQuency:ENABle	0 to 65535	6.203
STATus:QUESTionable:FREQuency[:EVENT]?		6.202
STATus:QUESTionable:FREQuency:NTRansition	0 to 65535	6.203
STATus:QUESTionable:FREQuency:PTRansition	0 to 65535	6.203
STATus:QUESTionable:LIMit:CONDition?		6.198
STATus:QUESTionable:LIMit:ENABle	0 to 65535	6.199

Command	Parameter	Page
STATus:QUEStionable:LIMit[:EVENT]?		6.198
STATus:QUEStionable:LIMit:NTRansition	0 to 65535	6.199
STATus:QUEStionable:LIMit:PTRansition	0 to 65535	6.199
STATus:QUEStionable:LMARgin:CONDition?		6.199
STATus:QUEStionable:LMARgin:ENABle	0 to 65535	6.200
STATus:QUEStionable:LMARgin[:EVENT]?		6.199
STATus:QUEStionable:LMARgin:NTRansition	0 to 65535	6.200
STATus:QUEStionable:LMARgin:PTRansition	0 to 65535	6.200
STATus:QUEStionable:POWer:CONDition?		6.197
STATus:QUEStionable:POWer:ENABle	0 to 65535	6.198
STATus:QUEStionable:POWer[:EVENT]?		6.197
STATus:QUEStionable:POWer:NTRansition	0 to 65535	6.198
STATus:QUEStionable:POWer:PTRansition	0 to 65535	6.198
STATus:QUEStionable:SYNC:CONDition?		6.200
STATus:QUEStionable:SYNC:ENABle	0 to 65535	6.201
STATus:QUEStionable:SYNC[:EVENT]?		6.200
STATus:QUEStionable:SYNC:NTRansition	0 to 65535	6.201
STATus:QUEStionable:SYNC:PTRansition	0 to 65535	6.201
STATus:QUEStionable:TRANsducer:CONDition?		6.203
STATus:QUEStionable:TRANsducer:ENABle	0 to 65535	6.204
STATus:QUEStionable:TRANsducer:NTRansition	0 to 65535	6.204
STATus:QUEStionable:TRANsducer:PTRansition	0 to 65535	6.204
STATus:QUEStionable:TRANsducer[:EVENT]?		6.203
STATus:QUEue[:NEXT]?		6.204
SYSTem:BINFo?		6.210
SYSTem:COMMunicate:GPIB:RDEvice<1 2>:ADDRes	0 to 30	6.206
SYSTem:COMMunicate:GPIB[:SELF]:ADDRes	0 to 30	6.205
SYSTem:COMMunicate:GPIB[:SELF]:RTERminator	LFEOI   EOI	6.206
SYSTem:COMMunicate:PRINter<1 2>:ENUMerate:FIRSt?		6.208
SYSTem:COMMunicate:PRINter<1 2>:ENUMerate:NEXt?		6.208
SYSTem:COMMunicate:PRINter<1 2>:SElect	<printer_name>	6.208
SYSTem:COMMunicate:SERial<1 2>:CONTRol:DTR	IBFull   OFF	6.206
SYSTem:COMMunicate:SERial<1 2>:CONTRol:RTS	IBFull   OFF	6.206
SYSTem:COMMunicate:SERial<1 2>[:RECeive]:BAUD	<numeric_value>	6.206
SYSTem:COMMunicate:SERial<1 2>[:RECeive]:BITS	7   8	6.207
SYSTem:COMMunicate:SERial<1 2>[:RECeive]:PACE	XON   NONE	6.207
SYSTem:COMMunicate:SERial<1 2>[:RECeive]:PARity[:TYPE]	EVEN   ODD   NONE	6.207
SYSTem:COMMunicate:SERial<1 2>[:RECeive]:SBITS	1   2	6.207
SYSTem:DATE	1980 to 2099, 1 to 12, 1 to 31	6.208
SYSTem:ERRor?		6.209
SYSTem:PASSword[:CENable]	'password'	6.209
SYSTem:PRESet		6.209
SYSTem:PRESet:COMPatible	FSE   OFF	6.209
SYSTem:SET	<block>	6.210
SYSTem:SPEaker<1 2>:VOLume	0 to 1	6.210
SYSTem:TIME	0 to 23, 0 to 59, 0 to 59	6.210
SYSTem:UPDate	ON   OFF	6.209
SYSTem:VERSion?		6.210

<b>Command</b>	<b>Parameter</b>	<b>Page</b>
SYSTem:VERSion?		6.210
TRACe:COPI	TRACE1   TRACE2   TRACE3   TRACE4 ,TRACE1   TRACE2   TRACE3   TRACE4	6.212
TRACe[:DATA]	TRACE1   TRACE2   TRACE3   TRACE4, <block>   <numeric_value>	6.211
TRIGger<1 2>[:SEQuence]:HOLDoff	-100 to 100 s	6.214
TRIGger<1 2>[:SEQuence]:LEVel:AF	-120 to +120PCT	6.214
TRIGger<1 2>[:SEQuence]:LEVel[:EXTernal]	-5.0 V to +5.0 V	6.213
TRIGger<1 2>[:SEQuence]:LEVel:VIDeo	0 to 100 PCT	6.213
TRIGger<1 2>[:SEQuence]:SLOPe	POSitive   NEGative	6.214
TRIGger<1 2>[:SEQuence]:SOURce	IMMediate   LINE   EXTernal   VIDeo   RFPower   AF	6.213
TRIGger<1 2>[:SEQuence]:SYNChronize:ADJust:FRAMe	-100µs to 100 s	6.214
TRIGger<1 2>[:SEQuence]:SYNChronize:ADJust:FRAMe:AUTO	ONCE	6.215
TRIGger<1 2>[:SEQuence]:SYNChronize:ADJust:SLOT	-100µs to 100 s	6.215
TRIGger<1 2>[:SEQuence]:SYNChronize:ADJust:SLOT:AUTO	ONCE	6.215
TRIGger<1 2>[:SEQuence]:SYNChronize:SOURce	FRAMe   TSC	6.215
UNIT<1 2>:POWer	DBM   DBPW   WATT   DBUV   DBMV   VOLT   DBUA   AMP   DB   PCT   UNITLESS   DBUV_MHZ   DBMV_MHZ   DBUA_MHZ   DBUV_M   DBIA_M   DBUV_MMHZ   DBUA_MMHZ	6.216
UNIT<1 2>:PROBe	ON   OFF	6.216

## Table of Softkeys with IEC/IEEE-Bus Command Assignment

### Basic Instrument - Signal Analysis Mode

#### FREQUENCY Key Group

<b>START</b>	
START MANUAL	[SENSe<1 2>:]FREQuency:START <num_value>
CENTER FIXED	[SENSe<1 2>:]FREQuency:START:LINK CENTER
SPAN FIXED	[SENSe<1 2>:]FREQuency:START:LINK SPAN
STOP FIXED	[SENSe<1 2>:]FREQuency:START:LINK STOP
START AT FREQ LINE	[SENSe<1 2>:]FREQuency:START:FLINe[:STATe] ON   OFF
FREQ AXIS LIN LOG	[SENSe<1 2>:]SWEep:SPACing LIN   LOG
<b>STOP</b>	
STOP MANUAL	[SENSe<1 2>:]FREQuency:STOP <num_value>
START FIXED	[SENSe<1 2>:]FREQuency:STOP:LINK START
CENTER FIXED	[SENSe<1 2>:]FREQuency:STOP:LINK CENTER
SPAN FIXED	[SENSe<1 2>:]FREQuency:STOP:LINK SPAN
SPAN FIXED	[SENSe<1 2>:]FREQuency:STOP:LINK SPAN
STOP AT FREQ LINE	[SENSe<1 2>:]FREQuency:STOP:FLINe[:STATe] ON   OFF
FREQ AXIS LIN LOG	[SENSe<1 2>:]SWEep:SPACing LIN   LOG
<b>CENTER</b>	
CENTER MANUAL	[SENSe<1 2>:]FREQuency:CENTer <num_value>
START FIXED	[SENSe<1 2>:]FREQuency:CENTer:LINK START
SPAN FIXED	[SENSe<1 2>:]FREQuency:CENTer:LINK SPAN

STOP FIXED	[SENSe<1 2>:]FREQuency:CENTer:LINK STOP
FREQUENCY OFFSET	[SENSe<1 2>:]FREQuency:OFFSet <num_value>
FREQ AXIS LIN LOG	[SENSe<1 2>:]SWEep:SPACing LIN   LOG
<b>STEP</b>	
AUTO 0.1 * SPAN	[SENSe<1 2>:]FREQuency:CENTer:STEP:LINK SPAN; [SENSe<1 2>:]FREQuency:CENTer:STEP:LINK:FACTor 10PCT
or	
AUTO 0.1 * RBW	[SENSe<1 2>:]FREQuency:CENTer:STEP:LINK RBW; [SENSe<1 2>:]FREQuency:CENTer:STEP:LINK:FACTor 10PCT
AUTO 0.5 * SPAN	[SENSe<1 2>:]FREQuency:CENTer:STEP:LINK SPAN; [SENSe<1 2>:]FREQuency:CENTer:STEP:LINK:FACTor 50PCT
or	
AUTO 0.5 * RBW	[SENSe<1 2>:]FREQuency:CENTer:STEP:LINK RBW; [SENSe<1 2>:]FREQuency:CENTer:STEP:LINK:FACTor 50PCT
AUTO X * SPAN	[SENSe<1 2>:]FREQuency:CENTer:STEP:LINK SPAN; [SENSe<1 2>:]FREQuency:CENTer:STEP:LINK:FACTor <num_value>
or	
AUTO X * RBW	[SENSe<1 2>:]FREQuency:CENTer:STEP:LINK RBW; [SENSe<1 2>:]FREQuency:CENTer:STEP:LINK:FACTor <num_value>
STEPSIZE MANUAL	[SENSe<1 2>:]FREQuency:CENTer:STEP <num_value>
STEPSIZE = CENTER	no corresponding IEC/IEEE-bus command
<b>SPAN</b>	
SPAN MANUAL	[SENSe<1 2>:]FREQuency:SPAN <num_value>
START FIXED	[SENSe<1 2>:]FREQuency:SPAN:LINK START
CENTER FIXED	[SENSe<1 2>:]FREQuency:SPAN:LINK CENTER
STOP FIXED	[SENSe<1 2>:]FREQuency:SPAN:LINK STOP
ZERO SPAN	[SENSe<1 2>:]FREQuency:SPAN 0HZ or [SENSe<1 2>:]FREQuency:MODE CW   FIXed
FULL SPAN	[SENSe<1 2>:]FREQuency:SPAN:FULL
LAST SPAN	no corresponding IEC/IEEE-bus command
ZOOM	DISPlay[:WINDow<1 2>]:TRACe<1...4>:X[:SCALe]:ZOOM ON  OFF
MOVE ZOOM WINDOW	DISPlay[:WINDow<1 2>]:TRACe<1...4>:X[:SCALe]:ZOOM[:FREQuency]:CENTER <num_value>

MOVE ZOOM START	DISPlay[:WINDow<1 2>]:TRACe<1...4>:X[:SCALe]:ZOOM[:FREQuency]:START <num_value>
MOVE ZOOM STOP	DISPlay[:WINDow<1 2>]:TRACe<1...4>:X[:SCALe]:ZOOM[:FREQuency]:STOP <num_value>
ZOOM OFF	DISPlay[:WINDow<1 2>]:TRACe<1...4>:X[:SCALe]:ZOOM OFF
FREQ AXIS LIN LOG	[SENSe<1 2>]:SWEep:SPACing LIN   LOG

### LEVEL Key Group

<b>REF</b>	
REF LEVEL	DISPlay[:WINDow<1 2>]:TRACe<1...4>:Y[:SCALe]:RLEVel <num_value>
REF LEVEL OFFSET	DISPlay[:WINDow<1 2>]:TRACe<1...4>:Y[:SCALe]:RLEVel:OFFSet <num_value>
GRID ABS/REL	DISPlay[:WINDow<1 2>]:TRACe<1...4>:Y[:SCALe]:MODE ABSolute RELative
UNIT	--
dBm	CALCulate<1 2>:UNIT:POWer DBM
dBmV	CALCulate<1 2>:UNIT:POWer DBMV
dB $\mu$ V	CALCulate<1 2>:UNIT:POWer DBUV
dB $\mu$ A	CALCulate<1 2>:UNIT:POWer DBUA
dBpW	CALCulate<1 2>:UNIT:POWer DBPW
dB*/MHz	CALCulate<1 2>:UNIT:POWer DBUV_MHZ CALCulate<1 2>:UNIT:POWer DBUA_MHZ CALCulate<1 2>:UNIT:POWer DBMV_MHZ
VOLT	CALCulate<1 2>:UNIT:POWer VOLT
AMPERE	CALCulate<1 2>:UNIT:POWer AMPere
WATT	CALCulate<1 2>:UNIT:POWer WATT
PROBE CODE ON / OFF	UNIT<1 2>:PROBe ON   OFF
ATTEN STEP MANUAL	INPut<1 2>:ATTenuation:STEPsize 1 10 (nur mit Option FSE-B13)
RF ATTEN MANUAL	INPut<1 2>:ATTenuation <num_value>



ATTEN AUTO NORMAL	INPut<1 2>:ATTenuation:AUTO:MODE NORMAl; INPut<1 2>:ATTenuation:AUTO ON
ATTEN AUTO LOW NOISE	INPut<1 2>:ATTenuation:AUTO:MODE LNOise; INPut<1 2>:ATTenuation:AUTO ON
ATTEN AUTO LOW DIST	INPut<1 2>:ATTenuation:AUTO:MODE LDISTortion; INPut<1 2>:ATTenuation:AUTO ON
MIXER LEVEL	INPut<1 2>:MIXer <num_value>
MAX LEVEL AUTO	DISPlay[:WINDow<1 2>]:TRACe<1...4>:Y[:SCALe]:RVALue:AUTO ON
MAX LEVEL MANUAL	DISPlay[:WINDow<1 2>]:TRACe<1...4>:Y[:SCALe]:RVALue:AUTO OFF; DISPlay[:WINDow<1 2>]:TRACe<1...4>:Y[:SCALe]:RVALue <num_value>
<b>RANGE</b>	
LINEAR/%	DISPlay[:WINDow<1 2>]:TRACe<1...4>:Y:SPACing PERCent
LINEAR/dB	DISPlay[:WINDow<1 2>]:TRACe<1...4>:Y:SPACing LINear
LOG MANUAL	DISPlay[:WINDow<1 2>]:TRACe<1...4>:Y:SPACing LOGarithmic; DISPlay[:WINDow<1 2>]:TRACe<1...4>:Y[:SCALe] <num_value>

## INPUT Key

<b>INPUT</b>	
RF ATTEN MANUAL	INPut<1 2>:ATTenuation <num_value>
ATTEN AUTO NORMAL	INPut<1 2>:ATTenuation:AUTO:MODE NORMAl; INPut<1 2>:ATTenuation:AUTO ON
ATTEN AUTO LOW NOISE	INPut<1 2>:ATTenuation:AUTO:MODE LNOise; INPut<1 2>:ATTenuation:AUTO ON
ATTEN AUTO LOW DIST	INPut<1 2>:ATTenuation:AUTO:MODE LDISTortion; INPut<1 2>:ATTenuation:AUTO ON
MIXER LEVEL	INPut<1 2>:MIXer <num_value>
INPUT SELECT	--
RF INPUT 50 OHM	INPut<1 2>:IMPedance 50
RF INPUT 75 OHM/RAM	INPut<1 2>:IMPedance:CORRection RAM
RF INPUT 75OHM/RAZ	INPut<1 2>:IMPedance:CORRection RAZ

## MARKER Key Group

<b>NORMAL</b>	
MARKER 1..4	CALCulate<1 2>:MARKer<1...4>[:STATE] ON   OFF; CALCulate<1 2>:MARKer<1...4>:X <num_value>; CALCulate<1 2>:MARKer<1...4>:Y?
SIGNAL COUNT	CALCulate<1 2>:MARKer<1...4>:COUNT ON   OFF; CALCulate<1 2>:MARKer<1...4>:COUNT:FREQuency?
MARKER DEMODO	
MKR DEMOD ON/OFF	CALCulate<1 2>:MARKer<1...4>:FUNctioN:DEModulation[:STATE] ON   OFF
AM	CALCulate<1 2>:MARKer<1...4>:FUNctioN:DEModulation:SElect AM
FM	CALCulate<1 2>:MARKer<1...4>:FUNctioN:DEModulation:SElect FM
MKR STOP TIME	CALCulate<1 2>:MARKer<1...4>:FUNctioN:DEModulation:HOLDoFF <num_value>
VOLUME	SYStem:SPeaker<1 2>:VOLume <num_value>
MARKER ZOOM	CALCulate<1 2>:MARKer<1...4>:FUNctioN:ZOOM <num_value>
MARKER INFO	DISPlay:WINDow<1 2>:MINfo ON   OFF (indication)
ALL MARKER OFF	CALCulate<1 2>:MARKer<1...4>:AOFF
POWER MEAS SETTINGS	--
SET NO OF ADJ CHAN'S	[SENSe<1 2>:]POWer:ACHannel:ACPairs <num_value>
ACP STANDARD	CALCulate<1 2>:MARKer<1...4>:FUNctioN:POWer:PRESet NADC  TETRA  PDC  PHS  CDPD  FWCDma   RWCDma  F8CDma  R8CDma  F19Cdma  R19Cdma   FW3Gppcdma   RW3Gppcdma   M2CDma   D2CDma   NONE
CH FILTER ON/OFF	CALCulate<1 2>:MARKer<1...4>:FUNctioN:POWer:CFILter ON   OFF
CHANNEL BANDWIDTH	[SENSe<1 2>:]POWer:ACHannel:BANDwidth BWIDth[:CHANnel] <num_value> [SENSe<1 2>:]POWer:ACHannel:BANDwidth BWIDth:ACHannel <num_value> [SENSe<1 2>:]POWer:ACHannel:BANDwidth BWIDth:ALTernate<1 2> <num_value>
CHANNEL SPACING	[SENSe<1 2>:]POWer:ACHannel:SPACing[:UPPer] <num_value> [SENSe<1 2>:]POWer:ACHannel:SPACing:ACHannel <num_value> [SENSe<1 2>:]POWer:ACHannel:SPACing:ALTernate<1 2> <num_value>
EDIT ACP LIMITS	CALCulate<1 2>:LIMit<1...8>:ACPoweR:ACHannel <num_value>,<num_value> CALCulate<1 2>:LIMit<1...8>:ACPoweR:ACHannel:STATe ON   OFF CALCulate<1 2>:LIMit<1...8>:ACPoweR:ALTernate<1 2> <num_val>,<num_val> CALCulate<1 2>:LIMit<1...8>:ACPoweR:ALTernate<1 2>:STATe ON   OFF
LIMIT CHECK	CALCulate<1 2>:LIMit:ACPoweR[:STATE] ON   OFF CALCulate<1 2>:LIMit<1...8>:ACPoweR:ACHannel:RESult? CALCulate<1 2>:LIMit<1...8>:ACPoweR:ALTernate<1 2>:RESult?
% POWER BANDWIDTH	[SENSe<1 2>:]POWer: BANDwidth BWIDth <num_value>

CHANNEL POWER	CALCulate<1 2>:MARKer<1...4>:FUNction:POWer:SElect CPower; CALCulate<1 2>:MARKer<1...4>:FUNction:POWer:RESult? CPower; CALCulate<1 2>:MARKer<1...4>:FUNction:POWer[:STATe] OFF
CP/ACP ABS/REL	[SENSe<1 2>:]POWer:ACHannel:MODE ABSolute RELative
SET CP REFERENCE	[SENSe<1 2>:]POWer:ACHannel:REFerence:AUTO ONCE
C/N	CALCulate<1 2>:MARKer<1...4>:FUNction:POWer:SElect CN; CALCulate<1 2>:MARKer<1...4>:FUNction:POWer:RESult? CN; CALCulate<1 2>:MARKer<1...4>:FUNction:POWer[:STATe] OFF
C/No	CALCulate<1 2>:MARKer<1...4>:FUNction:POWer:SElect CN0; CALCulate<1 2>:MARKer<1...4>:FUNction:POWer:RESult? CN0; CALCulate<1 2>:MARKer<1...4>:FUNction:POWer[:STATe] OFF
ADJACENT CHAN POWER	CALCulate<1 2>:MARKer<1...4>:FUNction:POWer:SElect ACPower; CALCulate<1 2>:MARKer<1...4>:FUNction:POWer:RESult? ACPower; CALCulate<1 2>:MARKer<1...4>:FUNction:POWer[:STATe] OFF
ADJUST CP SETTINGS	[SENSe<1 2>:]POWer:ACHannel:PRESet ACPower CPower OBANdwidth OBWidth CN CN0
OCCUPIED PWR BANDW	CALCulate<1 2>:MARKer<1...4>:FUNction:POWer:SElect OBANdwidth   OBWidth CALCulate<1 2>:MARKer<1...4>:FUNction:POWer:RESult? OBANdwidth  OBWidth CALCulate<1 2>:MARKer<1...4>:FUNction:POWer[:STATe] OFF
COUNTER RESOL	CALCulate<1 2>:MARKer<1...4>:COUNT:RESolution <num_value>
SIGNAL TRACK	CALCulate<1 2>:MARKer<1...4>:FUNction:STRack[:STATe] ON   OFF
NOISE	CALCulate<1 2>:MARKer<1...4>:FUNction:NOISE[:STATe] ON   OFF; CALCulate<1 2>:MARKer<1...4>:FUNction:NOISE:RESult?
<b>STEP</b>	
STEP SIZE AUTO	CALCulate<1 2>:MARKer<1...4>:STEP:AUTO ON   OFF
STEP SIZE MANUAL	CALCulate<1 2>:MARKer<1...4>:STEP[:INCRement] <num_value>
MKR TO STEP SIZE	CALCulate<1 2>:MARKer<1...4>:FUNction:MSTep
DELTA TO STEP SIZE	--

<b>DELTA</b>	
DELTA 1...4	CALCulate<1 2>:DELTamarker<1...4>[:STATE] ON   OFF CALCulate<1 2>:DELTamarker<1...4>:X <num_value> CALCulate<1 2>:DELTamarker<1...4>:X:RELative? CALCulate<1 2>:DELTamarker<1...4>:Y?
PHASE NOISE	CALCulate<1 2>:DELTamarker<1...4>:FUNctioN:PNOise[:STATE] ON   OFF CALCulate<1 2>:DELTamarker<1...4>:FUNctioN:PNOise:RESult?
REFERENCE POINT	--
REF POINT LEVEL	CALCulate<1 2>:DELTamarker<1...4>:FUNctioN:FIXed:RPOint:Y <num_value>
REF POINT LVL OFFSET	CALCulate<1 2>:DELTamarker<1...4>:FUNctioN:FIXed:RPOint:Y:OFFSet <num_value>
REF POINT FREQUENCY	CALCulate<1 2>:DELTamarker<1...4>:FUNctioN:FIXed:RPOint:X <num_value>
REF POINT TIME	CALCulate<1 2>:DELTamarker<1...4>:FUNctioN:FIXed:RPOint:X <num_value>
REFERENCE FIXED	CALCulate<1 2>:DELTamarker<1...4>:FUNctioN:FIXed[:STATE] ON   OFF
DELTA MKR ABS REL	CALCulate<1 2>:DELTamarker<1...4>:MODE ABSolute   RELative
ALL DELTA OFF	CALCulate<1 2>:DELTamarker<1...4>:AOFF
<b>STEP</b>	
STEP SIZE AUTO	CALCulate<1 2>:DELTamarker<1...4>:STEP:AUTO ON   OFF
MANUAL STEP SIZE	CALCulate<1 2>:DELTamarker<1...4>:STEP[:INCRement] <num_value>
DELTA TO STEP SIZE	--
<b>SEARCH</b>	
PEAK	CALCulate<1 2>:MARKer<1...4>:MAXimum[:PEAK] CALCulate<1 2>:DELTamarker<1...4>:MAXimum[:PEAK]
NEXT PEAK	CALCulate<1 2>:MARKer<1...4>:MAXimum:NEXT CALCulate<1 2>:DELTamarker<1...4>:MAXimum:NEXT
NEXT PEAK RIGHT	CALCulate<1 2>:MARKer<1...4>:MAXimum:RIGHT CALCulate<1 2>:DELTamarker<1...4>:MAXimum:RIGHT
NEXT PEAK LEFT	CALCulate<1 2>:MARKer<1...4>:MAXimum:LEFT CALCulate<1 2>:DELTamarker<1...4>:MAXimum:LEFT
SUM MKR ON/OFF	CALCulate<1 2>:MARKer<1...4>:FUNctioN:SUMMery[:STATE] ON   OFF

SUMMARY MARKER	
RMS	CALCulate<1 2>:MARKer<1...4>:FUNction:SUMMary:RMS[:STATe] ON   OFF CALCulate<1 2>:MARKer<1...4>:FUNction:SUMMary:RMS:RESult? CALCulate<1 2>:MARKer<1...4>:FUNction:SUMMary:RMS:AVERage:RESult? CALCulate<1 2>:MARKer<1...4>:FUNction:SUMMary:RMS:PHOLd:RESult?
MEAN	CALCulate<1 2>:MARKer<1...4>:FUNction:SUMMary:MEAN[:STATe] ON   OFF CALCulate<1 2>:MARKer<1...4>:FUNction:SUMMary:MEAN:RESult? CALCulate<1 2>:MARKer<1...4>:FUNction:SUMMary:MEAN:AVERage:RESult? CALCulate<1 2>:MARKer<1...4>:FUNction:SUMMary:MEAN:PHOLd:RESult?
PEAK HOLD ON/OFF	CALCulate<1 2>:MARKer<1...4>:FUNction:SUMMary:PHOLd ON   OFF
AVERAGE ON/OFF	CALCulate<1 2>:MARKer<1...4>:FUNction:SUMMary:AVERage ON   OFF
SWEEP COUNT	[SENSe<1 2>:]SWEep:COUNT <num_value>
ALL SUM MKR OFF	CALCulate<1 2>:MARKer<1...4>:FUNction:SUMMary:AOFF
SEARCH LIM ON/OFF	CALCulate<1 2>:MARKer<1...4>:X:SLIMits[:STATe] ON   OFF
SELECT MARKER	no corresponding IEC/IEEE-bus command
ACTIVE MKR/DELTA	no corresponding IEC/IEEE-bus command
MIN	CALCulate<1 2>:MARKer<1...4>:MINimum[:PEAK] CALCulate<1 2>:DELTAmarker<1...4>:MINimum[:PEAK]
NEXT MIN	CALCulate<1 2>:MARKer<1...4>:MINimum:NEXT CALCulate<1 2>:DELTAmarker<1...4>:MINimum:NEXT
NEXT MIN LEFT	CALCulate<1 2>:MARKer<1...4>:MINimum:LEFT CALCulate<1 2>:DELTAmarker<1...4>:MINimum:LEFT
NEXT MIN RIGHT	CALCulate<1 2>:MARKer<1...4>:MINimum:RIGHT CALCulate<1 2>:DELTAmarker<1...4>:MINimum:RIGHT
EXCLUDE LO ON/OFF	CALCulate<1 2>:MARKer<1...4>:LOEXclude ON   OFF
PEAK EXCURSION	CALCulate<1 2>:MARKer<1...4>:PEXCursion <num_value>
N dB DOWN	CALCulate<1 2>:MARKer<1...4>:FUNction:NDBDown <num_value> CALCulate<1 2>:MARKer<1...4>:FUNction:NDBDown:STATe ON   OFF CALCulate<1 2>:MARKer<1...4>:FUNction:NDBDown:RESult? CALCulate<1 2>:MARKer<1...4>:FUNction:NDBDown:FREQuency?
SHAPE FACT 60/3 dB	CALCulate<1 2>:MARKer<1...4>:FUNction:SFACTOR (60dB/3dB) CALCulate<1 2>:MARKer<1...4>:FUNction:SFACTOR:STATe ON   OFF CALCulate<1 2>:MARKer<1...4>:FUNction:SFACTOR:RESult? CALCulate<1 2>:MARKer<1...4>:FUNction:SFACTOR:FREQuency?
SHAPE FACT 60/6 dB	CALCulate<1 2>:MARKer<1...4>:FUNction:SFACTOR (60dB/6dB) CALCulate<1 2>:MARKer<1...4>:FUNction:SFACTOR:STATe ON   OFF CALCulate<1 2>:MARKer<1...4>:FUNction:SFACTOR:RESult? CALCulate<1 2>:MARKer<1...4>:FUNction:SFACTOR:FREQuency?

<b>MKR-&gt;</b>	
PEAK	CALCulate<1 2>:MARKer<1...4>:MAXimum[:PEAK] CALCulate<1 2>:DELTamarker<1...4>:MAXimum[:PEAK]
MKR-> CENTER	CALCulate<1 2>:MARKer<1...4>:FUNction:CENTer
MKR-> REF LEVEL	CALCulate<1 2>:MARKer<1...4>:FUNction:REFerence
MKR-> CF STEPSIZE	CALCulate<1 2>:MARKer<1...4>:FUNction:CSTep
MKR-> START	CALCulate<1 2>:MARKer<1...4>:FUNction:START
MKR-> STOP	CALCulate<1 2>:MARKer<1...4>:FUNction:STOP
MKR-> TRACE	CALCulate<1 2>:MARKer<1...4>:TRACe <num_value> CALCulate<1 2>:DELTamarker<1...4>:TRACe <num_value>

### LINES Key Group

<b>D LINES</b>	
DISPLAY LINE 1/2	CALCulate<1 2>:DLINe<1 2>:STATe ON   OFF; CALCulate<1 2>:DLINe<1 2> <num_value>
THRESHOLD LINE	CALCulate<1 2>:THReshold ON   OFF; CALCulate<1 2>:THReshold <num_value>
REFERENCE LINE	CALCulate<1 2>:RLINe:STATe ON   OFF; CALCulate<1 2>:RLINe <num_value>
FREQUENCY LINE 1/2	CALCulate<1 2>:FLINe<1 2>:STATe ON   OFF; CALCulate<1 2>:FLINe<1 2> <num_value>
or	
TIME LINE 1/2	CALCulate<1 2>:TLINe<1 2>:STATe ON   OFF; CALCulate<1 2>:TLINe<1 2> <num_value>
BASELINE CLIPPING	CALCulate<1 2>:CTHReshold:STATe ON   OFF CALCulate<1 2>:CTHReshold <num_value>

<b>LIMITS</b>	
SELECT LIMIT LINE	CALCulate<1 2>:LIMit<1...8>:NAME <string>; CALCulate<1 2>:LIMit<1...8>:STATe ON   OFF
NEW LIMIT LINE	s. EDIT LIMIT LINE
NAME	CALCulate<1 2>:LIMit<1...8>:NAME <string>
VALUES	no corresponding IEC/IEEE-bus command

INSERT VALUE	no corresponding IEC/IEEE-bus command
DELETE VALUE	no corresponding IEC/IEEE-bus command
SHIFT X LIMIT LINE	CALCulate<1 2>:LIMit<1...8>:CONTRol:SHIFt <num_value>
SHIFT Y LIMIT LINE	CALCulate<1 2>:LIMit<1...8>:UPPer:SHIFt <num_value> CALCulate<1 2>:LIMit<1...8>:LOWer:SHIFt <num_value>
SAVE LIMIT LINE	automatically executed during IEC/IEEE-bus operation
EDIT LIMIT LINE	CALCulate<1 2>:LIMit<1...8>:UNIT DBM  DBPW  WATT  DBUV  VOLT DBUA  AMPere  DB  DBUV_MHZ  DBUA_MHZ  UNITLESS CALCulate<1 2>:LIMit<1...8>:COMMENT 'string' CALCulate<1 2>:LIMit<1...8>:TRACe <num_value> CALCulate<1 2>:LIMit<1...8>:CONTRol[:DATA] <num_value>, <num_value>.. CALCulate<1 2>:LIMit<1...8>:CONTRol:DOMain FREQUency TIME CALCulate<1 2>:LIMit<1...8>:CONTRol:OFFset <num_value> CALCulate<1 2>:LIMit<1...8>:CONTRol:MODE RELative   ABSolute CALCulate<1 2>:LIMit<1...8>:CONTRol:SPACing LINear   LOGarithmic CALCulate<1 2>:LIMit<1...8>:UPPer[:DATA] <num_value>, <num_value>.. CALCulate<1 2>:LIMit<1...8>:UPPer:STATe ON   OFF CALCulate<1 2>:LIMit<1...8>:UPPer:OFFset <num_value> CALCulate<1 2>:LIMit<1...8>:UPPer:MARGin <num_value> CALCulate<1 2>:LIMit<1...8>:UPPer:MODE RELative   ABSolute CALCulate<1 2>:LIMit<1...8>:UPPer:SPACing LINear   LOGarithmic CALCulate<1 2>:LIMit<1...8>:LOWer[:DATA] <num_value>,<num_value>.. CALCulate<1 2>:LIMit<1...8>:LOWer:STATe ON   OFF CALCulate<1 2>:LIMit<1...8>:LOWer:OFFset <num_value> CALCulate<1 2>:LIMit<1...8>:LOWer:MARGin <num_value> CALCulate<1 2>:LIMit<1...8>:LOWer:MODE RELative   ABSolute CALCulate<1 2>:LIMit<1...8>:LOWer:SPACing LINear   LOGarithmic CALCulate<1 2>:LIMit<1...8>:FAIL? CALCulate<1 2>:LIMit<1...8>:CLEAr[:IMMediate]
COPY LIMIT LINE	CALCulate<1 2>:LIMit<1...8>:COPY 1...8   <name>
DELETE LIMIT LINE	CALCulate<1 2>:LIMit<1...8>:DELeTe
X OFFSET	CALCulate<1 2>:LIMit<1...8>:CONTRol:OFFset <num_value>
Y OFFSET	CALCulate<1 2>:LIMit<1...8>:UPPer:OFFset <num_value> CALCulate<1 2>:LIMit<1...8>:LOWer:OFFset <num_value>

**TRACE Key Group**

<b>TRACE 1</b>	
CLEAR/ WRITE	DISPlay[:WINDow<1 2>]:TRACe<1...4>:MODE WRITE
VIEW	DISPlay[:WINDow<1 2>]:TRACe<1...4>:MODE VIEW
BLANK	DISPlay[:WINDow<1 2>]:TRACe<1...4>[:STATe] OFF
AVERAGE	DISPlay[:WINDow<1 2>]:TRACe<1...4>:MODE AVERAge or [SENSE<1 2>:]AVERAge:MODE SCALe

MAX HOLD	DISPlay[:WINDow<1 2>]:TRACe<1...4>:MODE MAXHold or [SENSe<1 2>:]AVERAge:MODE MAX
MIN HOLD	DISPlay[:WINDow<1 2>]:TRACe<1...4>:MODE MINHold or [SENSe<1 2>:]AVERAge:MODE MIN
HOLD CONT ON/OFF	DISPlay[:WINDow<1 2>]:TRACe<1...4>:MODE:HCONTinuous ON   OFF
SWEEP COUNT	[SENSe<1 2>:]SWEep:COUNT <num_value>
DETECTOR	--
AUTO SELECT	[SENSe<1 2>:]DETEctor<1...4>[:FUNction]:AUTO ON   OFF
DETECTOR AUTOPEAK	[SENSe<1 2>:]DETEctor<1...4>[:FUNction] APEak
DETECTOR MAX PEAK	[SENSe<1 2>:]DETEctor<1...4>[:FUNction] POSitive
DETECTOR MIN PEAK	[SENSe<1 2>:]DETEctor<1...4>[:FUNction] NEGative
DETECTOR SAMPLE	[SENSe<1 2>:]DETEctor<1...4>[:FUNction] SAMPlE
DETECTOR RMS	[SENSe<1 2>:]DETEctor<1...4>[:FUNction] RMS
DETECTOR AVERAGE	[SENSe<1 2>:]DETEctor<1...4>[:FUNction] AVERAge
COPY..	TRACe:COpy TRACE1  TRACE2  TRACE3  TRACE4 , TRACE1  TRACE2  TRACE3  TRACE4
ANALOG TR ON/OFF	DISPlay[:WINDow<1 2>]:TRACe<1...4>:MODE:ANALog ON   OFF
TRACE MATH	--
T1-T2/T3/T4 +REF ->T1	CALCulate<1 2>:MATH<1...4>:STATe ON CALCulate<1 2>:MATH<1...4>[:EXPRession][:DEFine] <expr>
T1-REF ->T1	CALCulate<1 2>:MATH<1...4>:STATe ON CALCulate<1 2>:MATH<1...4>[:EXPRession][:DEFine] <expr>
ADJUST TO TRACE	no corresponding IEC/IEEE-bus command
TRACE MATH OFF	CALCulate<1 2>:MATH<1...4>:STATe OFF
ASCII EXPORT	MMEMory:STORe:TRACe 1...4,<path>
ASCII CONFIG	--
EDIT PATH	the path is included in command MMEMory:STORe:TRACe
DECIM SEP . ,	FORMat:DEXport:DSEPARATOR POINT COMMA



NEW  
APPEND

FORMat:DEXPort:APPend[:STATE] ON | OFF

HEADER  
ON OFF

FORMat:DEXPort:HEADer[:STATE] ON | OFF

## SWEEP Key Group

### COUPLING

RES BW  
MANUAL

[SENSe<1|2>:]BANDwidth|BWIDth[:RESolution] <num\_value>

RES BW  
AUTO

[SENSe<1|2>:]BANDwidth|BWIDth[:RESolution]:AUTO ON | OFF

VIDEO BW  
MANUAL

[SENSe<1|2>:]BANDwidth|BWIDth:VIDeo <num\_value>

VIDEO BW  
AUTO

[SENSe<1|2>:]BANDwidth|BWIDth:VIDeo:AUTO ON | OFF

SWEEP TIME  
MANUAL

[SENSe<1|2>:]SWEep:TIME <num\_value>

SWEEP TIME  
AUTO

[SENSe<1|2>:]SWEep:TIME:AUTO ON | OFF

COUPLING  
DEFAULT

[SENSe<1|2>:]BANDwidth|BWIDth[:RESolution]:AUTO ON;  
[SENSe<1|2>:]BANDwidth|BWIDth:VIDeo:AUTO ON;  
[SENSe<1|2>:]SWEep:TIME:AUTO ON

COUPLING  
RATIO

[SENSe<1|2>:]BANDwidth|BWIDth[:RESolution]:RATio 0.02  
[SENSe<1|2>:]BANDwidth|BWIDth:VIDeo:RATio SINE

RBW / VBW  
SINE [1]

[SENSe<1|2>:]BANDwidth|BWIDth:VIDeo:RATio SINE

RBW / VBW  
PULSE [.1]

[SENSe<1|2>:]BANDwidth|BWIDth:VIDeo:RATio PULSE

RBW / VBW  
NOISE [10]

[SENSe<1|2>:]BANDwidth|BWIDth:VIDeo:RATio NOISE

RBW / VBW  
MANUAL

[SENSe<1|2>:]BANDwidth|BWIDth:VIDeo:RATio <num\_value>

SPAN / RBW  
AUTO [50]

[SENSe<1|2>:]BANDwidth|BWIDth[:RESolution]:RATio 0.02

SPAN / RBW  
MANUAL

[SENSe<1|2>:]BANDwidth|BWIDth[:RESolution]:RATio <num\_value>

RBW 1kHz  
ANA/DIG

[SENSe<1|2>:]BANDwidth|BWIDth[:RESolution]:MODE ANALog | DIGital

RBW <=1kHz  
FFT/NORM

[SENSe<1|2>:]BANDwidth|BWIDth[:RESolution]:MODE:FFT ON | OFF

MAIN PLL  
BANDWIDTH

[SENSe<1|2>:]BANDwidth|BWIDth:PLL AUTO|HIGH|MEDIum|LOW

### TRIGGER

FREE RUN	TRIGger<1 2>[:SEquence]:SOURce IMMEDIATE
VIDEO	TRIGger<1 2>[:SEquence]:SOURce VIDEO TRIGger<1 2>[:SEquence]:LEVel:VIDeo <num_value>
LINE	TRIGger<1 2>[:SEquence]:SOURce LINE
EXTERN	TRIGger<1 2>[:SEquence]:SOURce EXTernal TRIGger<1 2>[:SEquence]:LEVel[:EXTernal] -5.0...+5.0V
RF POWER	TRIGger<1 2>[:SEquence]:SOURce RFPower
TRIGGER DELAY	TRIGger<1 2>[:SEquence]:HOLDoff <num_value>
SLOPE POS/NEG	TRIGger<1 2>[:SEquence]:SLOPe POSitive NEGative
<b>SWEEP</b>	
CONTINUOUS SWEEP	INITiate<1 2>:CONTinuous ON; INITiate[:IMMEDIATE]
SINGLE SWEEP	INITiate<1 2>:CONTinuous OFF; INITiate[:IMMEDIATE]
SWEEP TIME AUTO	[SENSe<1 2>:]SWEep:TIME:AUTO ON   OFF
SWEEP TIME MANUAL	[SENSe<1 2>:]SWEep:TIME <num_value>
SWEEP COUNT	[SENSe<1 2>:]SWEep:COUNT <num_value>
GAP SWEEP ON/OFF	[SENSe<1 2>:]SWEep:GAP ON   OFF
GAP SWEEP SETTINGS	--
TRIGGER LEVEL	TRIGger<1 2>[:SEquence]:LEVel:VIDeo <num_value>
PRE TRIGGER	[SENSe<1 2>:]SWEep:GAP:PRETrigger <num_value>
TRG TO GAP TIME	[SENSe<1 2>:]SWEep:GAP:TRGTogap <num_value>
GAP LENGTH	[SENSe<1 2>:]SWEep:GAP:LENGth <num_value>
GATE ON / OFF	[SENSe<1 2>:]SWEep:EGATE ON   OFF

GATE SETTINGS	--
GATE LEVEL	[SENSe<1 2>:]SWEep:EGATe:LEVel <num_value>
GATE MODE LEVEL/EDGE	[SENSe<1 2>:]SWEep:EGATe:TYPE LEVel   EDGE
GATE POL POS/NEG	[SENSe<1 2>:]SWEep:EGATe:POLarity POSitive   NEGative
GATE DELAY	[SENSe<1 2>:]SWEep:EGATe:HOLDoff <num_value>
GATE LENGTH	[SENSe<1 2>:]SWEep:EGATe:LENGth <num_value>
GATE EXTERN	[SENSe<1 2>:]SWEep:EGATe:SOURce EXTernal
GATE RF POWER	[SENSe<1 2>:]SWEep:EGATe:SOURce RFPower
GATE ADJUST	
GATE LEVEL	[SENSe<1 2>:]SWEep:EGATe:LEVel <num_value>
GATE MODE LEVEL/EDGE	[SENSe<1 2>:]SWEep:EGATe:TYPE LEVel   EDGE
GATE POL POS/NEG	[SENSe<1 2>:]SWEep:EGATe:POLarity POSitive   NEGative
GATE DELAY	[SENSe<1 2>:]SWEep:EGATe:HOLDoff <num_value>
GATE LENGTH	[SENSe<1 2>:]SWEep:EGATe:LENGth <num_value>
SWEEP TIME MANUAL	[SENSe<1 2>:]SWEep:TIME <num_value>
RES BW MANUAL	[SENSe<1 2>:]BANDwidth BWIDth[:RESolution] <num_value>
VIDEO MANUAL	[SENSe<1 2>:]BANDwidth BWIDth:VIDeo <num_value>
VIDEO AUTO	[SENSe<1 2>:]BANDwidth BWIDth:VIDeo:AUTO ON   OFF
SGL SWEEP DISP OFF	INITiate<1 2>:DISPlay ON   OFF INITiate[:IMMEDIATE]

## Basic Instrument - General Device Settings

### DATA VARIATION Key Group

<b>HOLD</b>	
UNLOCK	no corresponding IEC/IEEE-bus command
LOCK DATA	no corresponding IEC/IEEE-bus command
LOCK ALL	no corresponding IEC/IEEE-bus command
<b>STEP</b>	if needed, the step width is entered in the subsystem of the corresponding parameter.
STEPSIZE AUTO	--
STEPSIZE MANUAL	--

### SYSTEM Key Group

<b>DISPLAY</b>	
FULL SCREEN	DISPlay:FORmat SINGle
SPLIT SCREEN	DISPlay:FORmat SPLit
ACTIVE SCREEN A	The screen is selected via the numeric suffix of the individual commands.
SCREEN COUPLING	--
MODE COUPLED	INSTRument<1 2>:COUPle MODE
HORIZONTAL SCALING	INSTRument<1 2>:COUPle X
VERTICAL SCALING	INSTRument<1 2>:COUPle Y
COUPLING CONTROL	INSTRument<1 2>:COUPle CONTrol
SCREENS UNCOUPLED	INSTRument<1 2>:COUPle NONE   ALL

CONFIG DISPLAY	--
SELECT OBJECT	--
BRIGHTNESS	DISPlay:CMAP:HSL <hue>,<sat>,<lum>
TINT	DISPlay:CMAP<1...13>:HSL <hue>,<sat>,<lum>
SATURATION	DISPlay:CMAP<1...13>:HSL <hue>,<sat>,<lum>
DEFAULT COLORS	DISPlay:CMAP<1...13>:DEFault
PREDEFINED COLORS	DISPlay:CMAP<1...13>:PDEFined BLACK  BLUE  BROWn  GREen  CYAN  RED   MAGenta  YELLow  WHITe  DGRAY  LGRAY  LBLUe  LGREen  LCYan  LRED  LMAGenta
LOGO ON/OFF	DISPlay:LOGO ON   OFF
FREQUENCY ON/OFF	DISPlay:ANNotation:FREQuency ON   OFF
DATA ENTRY FIELD	--
DATAENTRY X	no corresponding IEC/IEEE-bus command
DATAENTRY Y	no corresponding IEC/IEEE-bus command
DEFAULT POSITION	no corresponding IEC/IEEE-bus command
DATAENTRY OPAQUE	no corresponding IEC/IEEE-bus command
TIME ON OFF	DISPlay[:WINDow<1 2>]:TIME ON   OFF
DISPLAY COMMENT	DISPlay[:WINDow<1 2>]:TEXT[:DATA] <string> DISPlay[:WINDow<1 2>]:TEXT:STATE ON   OFF
SCR.SAVER ON OFF	DISPlayPSAVer[:STATE] ON   OFF
SCR.SAVER TIME	DISPlayPSAVer:HOLDoff <num_value>
<b>CAL</b>	
CAL SHORT	CALibration:SHORT?
CAL TOTAL	CALibration[:ALL]?
CAL RES BW	CALibration:BANDwidth BWIDth[:RESolution]?

CAL LOG	CALibration:LDEtector?
CAL LO SUPP	CALibration:LOSuppression?
CAL I/Q	CALibration:IQ?
CAL CORR ON/OFF	CALibration:STATE ON   OFF
CAL RESULTS	no corresponding IEC/IEEE-bus command
PRESEL PEAK	CALibration:PPEak?
<b>INFO</b>	
FIRMWARE VERSION	*IDN?
HARDWARE+ OPTIONS	*OPT? SYSTem:BINFo?
SELFTEST	*TST?
EXECUTE TEST	*TST?
SYSTEM MESSAGES	SYSTem:ERRor?
CLEAR MESSAGE	SYSTem:ERRor?
CLEAR ALL MESSAGES	--
UPDATE MESSAGES	--
OPTIONS	*OPT?
STATISTIC	--
ATT SWITCHES	DIAGnostic:INFO:CCount:ATTenuation<1 2 3>

## CONFIGURATION Key Group

<b>MODE</b>	The sub menus are described under the associated operating modes.
ANALYZER	INSTRument<1 2>[:SElect] SANalyzer INSTRument<1 2>:NSElect 1
TRACKING GENERATOR	OUTPut[:STATe] ON   OFF
VECTOR ANALYZER	INSTRument<1 2>[:SElect] ADEMod   DDEMod INSTRument<1 2>:NSElect 2   3
GSM MS ANALYZER	INSTRument<1 2>[:SElect] MGSM INSTRument<1 2>:NSElect 5
GSM BTS ANALYZER	INSTRument<1 2>[:SElect] BGSM INSTRument<1 2>:NSElect 4
<b>SETUP</b>	
TRANSDUCER	--
TRANSDUCER FACTOR	[SENSe<1 2>:]CORRection:TRANSDucer:SElect <name> [SENSe<1 2>:]CORRection:TRANSDucer[:STATe] ON   OFF
TRANSDUCER SET	[SENSe<1 2>:]CORRection:TSET:SElect <name> [SENSe<1 2>:]CORRection:TSET[:STATe] ON   OFF
EDIT TRD FACTOR	[SENSe<1 2>:]CORRection:TRANSDucer:SCALing LINear LOGarithmic[SENSe<1 2>:]CORRection:TRANSDucer:COMMENT <string>
TRD FACTOR NAME	[SENSe<1 2>:]CORRection:TRANSDucer:SElect <name>
TRD FACTOR UNIT	[SENSe<1 2>:]CORRection:TRANSDucer:UNIT <string>
TRD FACTOR VALUES	[SENSe<1 2>:]CORRection:TRANSDucer:DATA <freq>,<level>..
INSERT LINE	no corresponding IEC/IEEE-bus command
DELETE LINE	no corresponding IEC/IEEE-bus command
SAVE TRD FACTOR	automatically executed during IEC/IEEE-bus operation
EDIT TRD SET	[SENSe<1 2>:]CORRection:TSET:BREak ON   OFF [SENSe<1 2>:]CORRection:TSET:COMMENT <string>
TRANSD SET NAME	[SENSe<1 2>:]CORRection:TSET:SElect <name>
TRANSD SET UNIT	[SENSe<1 2>:]CORRection:TSET:UNIT <string>

TRANS D SET RANGES	[SENSe<1 2>:]CORRection:TSET:RANGe<1...10> <freq>,<freq1>,<name>..
INSERT LINE	no corresponding IEC/IEEE-bus command
DELETE LINE	no corresponding IEC/IEEE-bus command
SAVE TRD SET	automatically executed during IEC/IEEE-bus operation
NEW FACT/SET	see EDIT TRD FACTOR or EDIT TRD SET
DELETE FACTOR/SET	[SENSe<1 2>:]CORRection:TRANSDucer:DELeTe [SENSe<1 2>:]CORRection:TSET:DELeTe
OPTIONS	no corresponding IEC/IEEE-bus command
REFERENCE INT/EXT	[SENSe<1 2>:]ROSCillator:SOURce INTernal EXTernal
EXT REF FREQUENCY	[SENSe<1 2>:]ROSCillator:EXTernal:FREQuency <num_value>
SERVICE	--
INPUT RF	DIAGnostic:SERvice:INPut[:SElect] RF
INPUT CAL	DIAGnostic:SERvice:INPut[:SElect] CALibration
NOISE SOURCE	DIAGnostic:SERvice:NSourCe ON   OFF
REFERENCE ADJUST	--
REFERENCE	[SENSe<1 2>:]ROSCillator:[INTernal:]TUNe <num_value>
REFERENCE PROG	[SENSe<1 2>:]ROSCillator:[INTernal:]TUNe:SAVe
SERVICE FUNCTION	DIAGnostic:SERvice:FUNCTion <num_value>,<num_value>...
ENTER PASSWORD	SYSTem:PASSword[:CENable] <string>
GENERAL SETUP	--
GPIB ADDRESS	SYSTem:COMMunicate:GPIB[:SELF]:ADDRess 0...30
USER PORT A/B	INPut<1 2>:UPORt<1 2>[:VALue]? INPut<1 2>:UPORt<1 2>:STATe ON   OFF OUTPut<1 2>:UPORt<1 2>:STATe ON   OFF OUTPut<1 2>:UPORt<1 2>[:VALue] <Binary>



COM PORT 1/2	<p>SYSTem:COMMunicate:SERial&lt;1 2&gt;:CONTrol:DTR IBFull   OFF</p> <p>SYSTem:COMMunicate:SERial&lt;1 2&gt;:CONTrol:RTS IBFull   OFF</p> <p>SYSTem:COMMunicate:SERial&lt;1 2&gt;[:RECeive]:BAUD &lt;numeric_value&gt;</p> <p>SYSTem:COMMunicate:SERial&lt;1 2&gt;[:RECeive]:BITS 7   8</p> <p>SYSTem:COMMunicate:SERial&lt;1 2&gt;[:RECeive]:PARity[:TYPE] EVEN  ODD  NONE</p> <p>SYSTem:COMMunicate:SERial&lt;1 2&gt;[:RECeive]:SBIIts 1 2</p> <p>SYSTem:COMMunicate:SERial&lt;1 2&gt;[:RECeive]:PACE XON   NONE</p>
TIME	SYSTem:TIME 0...23, 0...59, 0...59
DATE	SYSTem:DATE <num>, <num>, <num>
MONITOR CONNECTED	no corresponding IEC/IEEE-bus command
KEY CLICK ON/OFF	no corresponding IEC/IEEE-bus command
MODE FSE ON/OFF	SYSTem:PRESet:COMPatible OFF   FSE

**STATUS Key Group**

<b>LOCAL</b>	device message "Go to LOCAL (GTL)"
--------------	------------------------------------

## HARDCOPY Key Group

START	HCOPY[:IMMEDIATE<1 2>]
SETTINGS	
COPY SCREEN	HCOPY:ITEM:ALL
COPY TRACE	HCOPY:ITEM:WINDOW<1 2>:TRACE:STATE ON   OFF
COPY TABLE	HCOPY:ITEM:WINDOW<1 2>:TABLE:STATE ON   OFF
SELECT QUADRANT	--
UPPER LEFT	HCOPY:PAGE:DIMENSIONS:QUADRANT 1
LOWER LEFT	HCOPY:PAGE:DIMENSIONS:QUADRANT 2
UPPER RIGHT	HCOPY:PAGE:DIMENSIONS:QUADRANT 3
LOWER RIGHT	HCOPY:PAGE:DIMENSIONS:QUADRANT 4
FULL PAGE	HCOPY:PAGE:DIMENSIONS:FULL
ENTER TEXT	--
COMMENT SCREEN A/B	HCOPY:ITEM:WINDOW<1 2>:TEXT <string>
TITLE	HCOPY:ITEM:LABEL:TEXT <string>
HARDCOPY DEVICE	HCOPY:DEVICE:LANGUAGE WMF EMMF   BMP   GDI
SETTINGS DEVICE 1/2	HCOPY:DESTINATION<1 2> <string> MMEMORY:NAME <file_name> HCOPY:ITEM:FFEEED<1 2>:STATE ON   OFF HCOPY:PAGE:ORIENTATION<1 2> LANDSCAPE   PORTRAIT
ENABLE DEV1/DEV2	the numeric suffix after HCOpy:IMMEDIATE denotes the first or second device.
COLOR ON/OFF	HCOPY:DEVICE:COLOR ON   OFF
TRC COLOR AUTO INC	HCOPY:ITEM:WINDOW<1 2>:TRACE:CAINCREMENT ON   OFF

## MEMORY Key Group

<b>CONFIG</b>	
EDIT PATH	MMEemory:MSIS <device> MMEemory:CDIRectory <directory_name>
DELETE	MMEemory:DELeTe <file_name> MMEemory:RDIRectory <directory_name>
FORMAT DISK	MMEemory:INITialize <msus>
MAKE DIRECTORY	MMEemory:MDIRectory <directory_name>
RENAME	MMEemory:MOVE <file_source>,<file_destination>
SORT MODE	no corresponding IEC/IEEE-bus command
COPY	MMEemory:COpy <file_source>,<file_destination>
<b>SAVE</b>	
EDIT NAME	MMEemory:STORe:STATe 1,<file_name>
EDIT PATH	the path is included in the file name.
EDIT COMMENT	MMEemory:COMMeNt <string>
SELECT ITEMS TO SAVE	--
SELECT ITEMS	MMEemory:SElect[:ITEM]:GSETup ON   OFF MMEemory:SElect[:ITEM]:HWSettings ON   OFF MMEemory:SElect[:ITEM]:TRAcE<1...4> ON   OFF MMEemory:SElect[:ITEM]:LINES[:ACTive] ON   OFF MMEemory:SElect[:ITEM]:LINES:ALL ON   OFF MMEemory:SElect[:ITEM]:CSETup ON   OFF MMEemory:SElect[:ITEM]:HCOpy ON   OFF MMEemory:SElect[:ITEM]:MACROs ON   OFF MMEemory:SElect[:ITEM]:SCData ON   OFF MMEemory:SElect[:ITEM]:TRANsducer[:ACTive] ON   OFF MMEemory:SElect[:ITEM]:TRANsducer:ALL ON   OFF MMEemory:SElect[:ITEM]:CVL[:ACTive] ON   OFF MMEemory:SElect[:ITEM]:CVL:ALL ON   OFF
ENABLE ALL ITEMS	MMEemory:SElect[:ITEM]:ALL
DISABLE ALL ITEMS	MMEemory:SElect[:ITEM]:NONE
DEFAULT CONFIG	MMEemory:SElect[:ITEM]:DEfauLt
DATA SET LIST	--

DATA SET CLEAR	MMEemory:CLEar:STATe 1,<file_name>
DATA SET CLEAR ALL	MMEemory:CLEar:ALL
<b>RECALL</b>	
EDIT NAME	MMEemory:LOAD:STATe 1,<file_name>
EDIT PATH	the path is included in the file name.
AUTO RECALL	MMEemory:LOAD:AUTO 1,<file_name>
SELECT ITEMS TO RECALL	--
SELECT ITEMS	MMEemory:SElect[:ITEM]:GSEtup ON   OFF MMEemory:SElect[:ITEM]:HWSettings ON   OFF MMEemory:SElect[:ITEM]:TRACe<1...4> ON   OFF MMEemory:SElect[:ITEM]:LINEs[:ACTIve] ON   OFF MMEemory:SElect[:ITEM]:LINEs:ALL ON   OFF MMEemory:SElect[:ITEM]:CSEtup ON   OFF MMEemory:SElect[:ITEM]:HCOPY ON   OFF MMEemory:SElect[:ITEM]:CDATa ON   OFF MMEemory:SElect[:ITEM]:MACROs ON   OFF MMEemory:SElect[:ITEM]:SCData ON   OFF MMEemory:SElect[:ITEM]:TRANSDUCER[:ACTIve] ON   OFF MMEemory:SElect[:ITEM]:TRANSDUCER:ALL ON   OFF MMEemory:SElect[:ITEM]:CVL[:ACTIve] ON   OFF MMEemory:SElect[:ITEM]:CVL:ALL ON   OFF
ENABLE ALL ITEMS	MMEemory:SElect[:ITEM]:ALL
DISABLE ALL ITEMS	MMEemory:SElect[:ITEM]:NONE
DEFAULT CONFIG	MMEemory:SElect[:ITEM]:DEFault
DATA SET LIST	--
DATA SET CLEAR	MMEemory:CLEar:STATe 1,<file_name>
DATA SET CLEAR ALL	MMEemory:CLEar:ALL

## USER Key

<b>USER</b>	
MACRO 1...7	no corresponding IEC/IEEE-bus command
DEFINE MACRO	no corresponding IEC/IEEE-bus command
RECORD ON/OFF	no corresponding IEC/IEEE-bus command
DEFINE PAUSE	no corresponding IEC/IEEE-bus command
DELETE MACRO	no corresponding IEC/IEEE-bus command
MACRO TITLE	no corresponding IEC/IEEE-bus command
SELECT MACRO	no corresponding IEC/IEEE-bus command

## Vektor-Signal Analysis Mode

### CONFIGURATION Key Group - Digital Demodulation

MODE	--
VECTOR ANALYZER	--
DIGITAL STANDARD	
PDC UP	[SENSe<1 2>:]DDEMod:PRESet PDCup
PDC DOWN	[SENSe<1 2>:]DDEMod:PRESet PDCDown
NADC FWD CH	[SENSe<1 2>:]DDEMod:PRESet FNADc
NADC REV CH	[SENSe<1 2>:]DDEMod:PRESet RNADc
DECT	[SENSe<1 2>:]DDEMod:PRESet DECT
PHS	[SENSe<1 2>:]DDEMod:PRESet PHS
PWT	[SENSe<1 2>:]DDEMod:PRESet PWT
TETRA	[SENSe<1 2>:]DDEMod:PRESet TETRa
TFTS	[SENSe<1 2>:]DDEMod:PRESet TFTS
IS-95 CDMA FWD CH	[SENSe<1 2>:]DDEMod:PRESet F95Cdma   FQCDma
IS-95 CDMA REV CH	[SENSe<1 2>:]DDEMod:PRESet R95Cdma   RQCDma
W-CDMA 4.096 FWD	[SENSe<1 2>:]DDEMod:PRESet FCDMA4096   FWCDma
W-CDMA 4.096 REV	[SENSe<1 2>:]DDEMod:PRESet RCDMA4096   RWCDma
W-CDMA 3GPP FWD	[SENSe<1 2>:]DDEMod:PRESet FW3Gppcdma
W-CDMA 3GPP REV	[SENSe<1 2>:]DDEMod:PRESet RW3Gppcdma
CDMA 2000 SR3/DS FWD	[SENSe<1 2>:]DDEMod:PRESet CDMA2000
EDGE	[SENSe<1 2>:]DDEMod:PRESet EDGe
GSM	[SENSe<1 2>:]DDEMod:PRESet GSM   DCS1800   PCS1900

CT2	[SENSe<1 2>:]DDEMod:PRESet CT2
ERMES	[SENSe<1 2>:]DDEMod:PRESet ERMes
MODACOM	[SENSe<1 2>:]DDEMod:PRESet MODacom
FLEX16_2	[SENSe<1 2>:]DDEMod:PRESet F16
FLEX32_2	[SENSe<1 2>:]DDEMod:PRESet F322
FLEX32_4	[SENSe<1 2>:]DDEMod:PRESet F324
FLEX64_4	[SENSe<1 2>:]DDEMod:PRESet F64
APCO25 C4FM	[SENSe<1 2>:]DDEMod:PRESet APCO25C4FM
APCO25 CQPSK	[SENSe<1 2>:]DDEMod:PRESet APCO25CQPSK
CDPD	[SENSe<1 2>:]DDEMod:PRESet CDPD
DIGITAL DEMODO	<pre> INSTRument[:SElect] DDEMod [SENSe&lt;1 2&gt;:]DDEMod:FORMat QPSK   PSK   MSK  QAM   FSK [SENSe&lt;1 2&gt;:]DDEMod:QPSK:FORMat NORMal   DIFFerential   OFFSet   DPI4 [SENSe&lt;1 2&gt;:]DDEMod:PSK:NState 2   8 [SENSe&lt;1 2&gt;:]DDEMod:PSK:FORMat NORMal   DIFFerential   N3Pi8 [SENSe&lt;1 2&gt;:]DDEMod:MSK:FORMat TYPE1   TYPE2   NORMal   DIFFerential [SENSe&lt;1 2&gt;:]DDEMod:QAM:NState 16 [SENSe&lt;1 2&gt;:]DDEMod:FSK:NState 2   4  CALCulate&lt;1 2&gt;:MARKer&lt;1...2&gt;:FUNctIon:DDEMod:RESult? MERM  MEPK  MEPS  PERM  PEPK  PEPS  EVRM  EVPK  EVPS  IQOF  IQIM  ADR  FERR  DEV  FSRM  FSPK  FSPS  RHO  FEPK                     </pre>
MODULATION PARAMETERS	--
SYMBOL RATE	[SENSe<1 2>:]DDEMod:SRate <num_value>
SIDE BAND NORM INV	[SENSe<1 2>:]DDEMod:SBAND NORMal INVerse
MEAS FILTER	[SENSe<1 2>:]DDEMod:FILTer:MEASurement OFF   RCOSine   RRCosine   GAUSSian   B22   B25   B44   QFM FM95   QFR FR95   QRM RM95   QRR RR95   A25Fm   EMES   EREF
REFERENCE FILTER	[SENSe<1 2>:]DDEMod:FILTer:REFerence RCOSine   RRCosine   GAUSSian   B22   B25   B44   QFM FM95   QFR FR95   QRM RM95   QRR RR95   A25Fm   EMES   EREF
ALPHA/BT	[SENSe<1 2>:]DDEMod:FILTer:ALPHa <num_value>
FSK REF DEVIATION	CALCulate<1 2>:FSK:DEVIation:REFerence <num_value>
NORMALIZE ON / OFF	[SENSe<1 2>:]DDEMod:NORMalize ON   OFF

MEAS RESULT	--
MAGNITUDE CAP BUFFER	CALCulate<1 2>:FEED `TCAP'
MEAS SIGNAL	CALCulate<1 2>:FEED `XTIM:DDEM:MEAS'
MAGNITUDE	CALCulate<1 2>:FORMat MAGNitude
PHASE	CALCulate<1 2>:FORMat PHASe
FREQUENCY	CALCulate<1 2>:FORMat FREQuency
REAL/IMAG PART	CALCulate<1 2>:FORMat RIMag
EYE DIAG [FREQ]	CALCulate<1 2>:FORMat FEYE
EYE DIAG [I]	CALCulate<1 2>:FORMat IEYE
EYE DIAG [Q]	CALCulate<1 2>:FORMat QEYE
EYE DIAG TRELLIS	CALCulate<1 2>:FORMat TEYE
POLAR [IQ] VECTOR	CALCulate<1 2>:FORMat COMP
POLAR [IQ] CONSTELL	CALCulate<1 2>:FORMat CONS
SYMBOL DISPLAY	DISPlay[:WINDow<1 2>]:TRACe<1...4>:SYMBol DOTS   BARS  OFF
PHASE WRAP ON/OFF	CALCulate<1 2>:FORMat PHASe   UPHase
EYE LENGTH	DISPlay[:WINDow<1 2>]:TRACe<1...4>:EYE:COUNT <num_value>
REFERENCE SIGNAL	CALCulate<1 2>:FEED `XTIM:DDEM:REF'
MAGNITUDE	CALCulate<1 2>:FORMat MAGNitude
PHASE	CALCulate<1 2>:FORMat PHASe
FREQUENCY	CALCulate<1 2>:FORMat FREQuency
REAL/IMAG PART	CALCulate<1 2>:FORMat RIMag
EYE DIAG [FREQ]	CALCulate<1 2>:FORMat FEYE
EYE DIAG [I]	CALCulate<1 2>:FORMat IEYE



EYE DIAG [Q]	CALCulate<1 2>:FORMat QEYE
EYE DIAG TRELLIS	CALCulate<1 2>:FORMat TEYE
POLAR [IQ] VECTOR	CALCulate<1 2>:FORMat COMP
POLAR [IQ] CONSTELL	CALCulate<1 2>:FORMat CONS
SYMBOL DISPLAY	DISPlay[:WINDow<1 2>]:TRACe<1...4>:SYMBol DOTS   BARS  OFF
PHASE WRAP ON/OFF	CALCulate<1 2>:FORMat PHASE   UPHase
EYE LENGTH	DISPlay[:WINDow<1 2>]:TRACe<1...4>:EYE:COUNT <num_value>
ERROR SIGNAL	CALCulate<1 2>:FEED `XTIM:DDEM:ERR:MPH`  CALCulate<1 2>:MARKer<1...2>:FUNCTion:DDEMod:RESult? MERM  MEPK  MEPS  PERM  PEPK  PEPS  EVRM  EVPK  EVPS  IQOF  IQIM  ADR  FERR  DEV  FSRM  FSPK  FSPS  RHO  FEPK
MAGNITUDE	CALCulate<1 2>:FORMat MAGNitude
PHASE	CALCulate<1 2>:FORMat PHASE
FREQUENCY	CALCulate<1 2>:FORMat FREQuency
REAL/IMAG PART	CALCulate<1 2>:FORMat RIMag
ERROR VECT MAGNITUDE	CALCulate<1 2>:FORMat MAGNitude CALCulate<1 2>:FEED `XTIM:DDEM:ERR:VECT`
POLAR [IQ] VECTOR	CALCulate<1 2>:FORMat COMP CALCulate<1 2>:FEED `XTIM:DDEM:ERR:VECT`
POLAR [IQ] CONSTELL	CALCulate<1 2>:FORMat CONS CALCulate<1 2>:FEED `XTIM:DDEM:ERR:VECT`
SYMBOL DISPLAY	DISPlay[:WINDow<1 2>]:TRACe<1...4>:SYMBol DOTS   BARS   OFF CALCulate<1 2>:MARKer<1...2>:FUNCTion:DDEMod:RESult? MERM  MEPK  MEPS PERM  PEPK  PEPS  EVRM  EVPK  EVPS  IQOF  IQIM  ADR  FERR  DEV FSRM  FSPK  FSPS  RHO  FEPK
SYMB TABLE / ERRORS	CALCulate<1 2>:FEED `XTIM:DDEM:SYMB`
MEMORY SIZE	[SENSe<1 2>:]TCAPture:LENGth 1024   2048   4096   8192   16384
FRAME LENGTH	[SENSe<1 2>:]DDEMod:SEARch:TIME <num_value>
RESULT LENGTH	[SENSe<1 2>:]DDEMod:TIME <num_value>
POINTS PER SYMBOL	[SENSe<1 2>:]DDEMod:PRATe 1  2  4  8  16
TRIGGER	see section "SWEEP - TRIGGER"

RANGE	see section "LEVEL - RANGE"
IF BANDWIDTH	--
IF BW AUTO	[SENSe<1 2>:]BANDwidth BWIDth:RESolution:AUTO ON   OFF
IF BW MANUAL	[SENSe<1 2>:]BANDwidth BWIDth:RESolution <num_value>

### CONFIGURATION Key Group - Analog Demodulation

<b>MODE</b>	--
VECTOR ANALYZER	--
ANALOG DEMODO	INSTRument<1 2>[:SELect] ADEMod
MODULATION PARAMETER	--
HIGH PASS AF FILTER	SENSe<1 2>:FILTer:HPASs[:STATe] ON   OFF SENSe<1 2>:FILTer:HPASs:FREQuency <num_value>
LOW PASS AF FILTER	SENSe<1 2>:FILTer[:LPASs][:STATe] ON   OFF SENSe<1 2>:FILTer[:LPASs]:FREQuency <num_value>
WEIGHTING AF FILTER	SENSe<1 2>:FILTer:CCITt[:STATe] ON   OFF SENSe<1 2>:FILTer:CMESsage[:STATe] ON   OFF
AF COUPL'G AC DC	SENSe<1 2>:ADEMod:AF:COUPLing AC DC
SQUELCH ON OFF	SENSe<1 2>:ADEMod:SQUElch[:STATe] ON   OFF
SQUELCH LEVEL	SENSe<1 2>:ADEMod:SQUElch:LEVel <num_value>
SIDE BAND NORM INV	SENSe<1 2>:ADEMod:SBANd NORMal INVerse
AM/FM DEEMPH	SENSe<1 2>:FILTer:DEMPHasis:TCONstant <num_value>
PRE DISPL ON OFF	SENSe<1 2>:FILTer:DEMPHasis:LINK DISPlay AUDio
MEAS RESULT	--
AM SIGNAL	CALCulate<1 2>:FEED `XTIM:AM`
FM SIGNAL	CALCulate<1 2>:FEED `XTIM:FM`
PM SIGNAL	CALCulate<1 2>:FEED `XTIM:PM`

MODULATION SUMMARY	<pre> CALCulate&lt;1 2&gt;:FEED `XTIM:AMSummary' CALCulate&lt;1 2&gt;:FEED `XTIM:FMSummary' CALCulate&lt;1 2&gt;:FEED `XTIM:PMSummary' CALCulate&lt;1 2&gt;:MARKer&lt;1...4&gt;:FUNction:ADEMod:AM[:RESult?]                                      PPEak   MPEak   MIDDLE   RMS CALCulate&lt;1 2&gt;:MARKer&lt;1...4&gt;:FUNction:ADEMod:FM[:RESult?]                                      PPEak   MPEak   MIDDLE   RMS   RDEV CALCulate&lt;1 2&gt;:MARKer&lt;1...4&gt;:FUNction:ADEMod:PM[:RESult?]                                      PPEak   MPEak   MIDDLE   RMS CALCulate&lt;1 2&gt;:MARKer&lt;1...4&gt;:FUNction:ADEMod:AFRequency[:RESult?] CALCulate&lt;1 2&gt;:MARKer&lt;1...4&gt;:FUNction:ADEMod:FERRor [:RESult?] CALCulate&lt;1 2&gt;:MARKer&lt;1...4&gt;:FUNction:ADEMod:SINad:RESult? CALCulate&lt;1 2&gt;:MARKer&lt;1...4&gt;:FUNction:ADEMod:CARRier[:RESult?]                 </pre>
SUMMARY SETTINGS	--
AVERAGE HOLD ON	SENSe<1 2>:MSUMmary:AHOLd[:STATE] ON   OFF
SWEEP COUNT	SENSe<1 2>:SWEep:COUNT <num_value>
RELUNIT DB %	SENSe<1 2>:MSUMmary:RUNit PCT   DB
INDICATION ABS REL	SENSe<1 2>:MSUMmary:MODE ABSolute   RELative
SET REFERENCE	SENSe<1 2>:MSUMmary:REFerence <num_value>
MEAS-> REF	SENSe<1 2>:MSUMmary:REFerence:AUTO ONCe
SINAD 1kHz ON OFF	<pre> CALCulate&lt;1 2&gt;:MARKer&lt;1...4&gt;:FUNction:ADEMod:SINad[:STATE] CALCulate&lt;1 2&gt;:MARKer&lt;1...4&gt;:FUNction:ADEMod:SINad:RESult?                 </pre>
SUMMARY MEAS TIME	SENSe<1 2>:MSUMmary:MTIME <num_value>
REAL TIME ON OFF	SENSe<1 2>:ADEMod:RTIME[:STATE] ON   OFF
SENSITIV AF OUTPUT	OUTPut<1 2>:AF:SENSitivity <num_value>
VOLUME	SYSTem:SPEaker<1 2>:VOLume <num_value>
DEMODO BANDWIDTH	SENSe<1 2>:BANDwidth BWIDth:DEMod <num_value>
DEEMPHASIS ON OFF	SENSe<1 2>:FILTer:DEMPHasis[:STATE] ON   OFF

### FREQUENCY Key Group

<b>CENTER</b>	[SENSe<1 2>:]FREQuency:CENTer <num_value>
CENTER FREQUENCY	[SENSe<1 2>:]FREQuency:CENTer <num_value>
FREQUENCY OFFSEt	[SENSe<1 2>:]FREQuency:OFFSet <num_value>

### LEVEL Key Group

<b>REF</b>	--
REF LEVEL	DISPlay[:WINDow<1 2>]:TRACe<1...4>:Y[:SCALE]:RLEVel <num_value>
REF LEVEL OFFSEt	DISPlay[:WINDow<1 2>]:TRACe<1...4>:Y[:SCALE]:RLEVel:OFFSet <num_value>
RF ATTEN MANUAL	INPut<1 2>:ATTenuation <num_value>
ATTEN AUTO NORMAL	INPut<1 2>:ATTenuation:AUTO:MODE NORMAL; INPut<1 2>:ATTenuation:AUTO ON
ATTEN AUTO LOW NOISE	INPut<1 2>:ATTenuation:AUTO:MODE LNOise; INPut<1 2>:ATTenuation:AUTO ON
ATTEN AUTO LOW DIST	INPut<1 2>:ATTenuation:AUTO:MODE LDISTortion; INPut<1 2>:ATTenuation:AUTO ON
MIXER LEVEL	INPut<1 2>:MIXer <num_value>
<b>RANGE</b>	--
Y PER DIV	DISPlay[:WINDow<1 2>]:TRACe<1...4>:Y[:SCALE]:PDIVision <num_value>
REF VALUE Y AXIS	DISPlay[:WINDow<1 2>]:TRACe<1...4>:Y[:SCALE]:RVALue <num_value>
REF VALUE X AXIS	DISPlay[:WINDow<1 2>]:TRACe<1...4>:X[:SCALE]:RVALue <num_value>
REF VALUE POSITION	DISPlay[:WINDow<1 2>]:TRACe<1...4>:Y[:SCALE]:RPOsition 0...100PCT
SCALE UNIT	--
Y UNIT LOG[dB]	CALCulate<1 2>:UNIT:POWer DB
Y UNIT LINEAR	CALCulate<1 2>:UNIT:POWer UNITLESS
Y UNIT DEG	CALCulate<1 2>:UNIT:ANGLE DEG

Y UNIT RAD	CALCulate<1 2>:UNIT:ANGLE RAD
Y UNIT DBM	CALCulate<1 2>:UNIT:POWER DBM
Y UNIT VOLT	CALCulate<1 2>:UNIT:POWER VOLT
Y UNIT WATT	CALCulate<1 2>:UNIT:POWER WATT
X UNIT TIME	CALCulate<1 2>:X:UNIT:TIME S
X UNIT SYMBOL	CALCulate<1 2>:X:UNIT:TIME SYMB
SENSITIV AF OUTPUT	OUTPut<1 2>:AF:SENSitivity <num_value>
VOLUME	SYSTem:SPEaker:VOLume <num_value>

**INPUT Key**

<b>INPUT</b>	
RF ATTEN MANUAL	INPut<1 2>:ATTenuation <num_value>
ATTEN AUTO NORMAL	INPut<1 2>:ATTenuation:AUTO:MODE NORMAl; INPut<1 2>:ATTenuation:AUTO ON
ATTEN AUTO LOW NOISE	INPut<1 2>:ATTenuation:AUTO:MODE LNOise; INPut<1 2>:ATTenuation:AUTO ON
ATTEN AUTO LOW DIST	INPut<1 2>:ATTenuation:AUTO:MODE LDISTortion; INPut<1 2>:ATTenuation:AUTO ON
MIXER LEVEL	INPut<1 2>:MIXer <num_value>
INPUT SELECT	--
RF INPUT 50 OHM	INPut<1 2>:IMPedance 50
RF INPUT 75 OHM/RAM	INPut<1 2>:IMPedance:CORRection RAM
RF INPUT 75OHM/RAZ	INPut<1 2>:IMPedance:CORRection RAZ

## MARKER Key Group

<b>NORMAL</b>	
MARKER 1..2	CALCulate<1 2>:MARKer<1...2>[:STATe] ON   OFF; CALCulate<1 2>:MARKer<1...2>:X <num_value>; CALCulate<1 2>:MARKer<1...2>:Y?
POLAR MARKER R/I / MA/PH	CALCulate<1 2>:MARKer<1...2>:READout MPHase   RIMaginary
POLAR MARKER DEG/ RAD	CALCulate<1 2>:UNIT:ANGLE DEG   RAD
COUPLED MARKER	CALCulate<1 2>:MARKer<1...2>:COUPled[:STATe] ON   OFF
MARKER INFO	DISPlay:WINDow<1 2>:MINFo ON   OFF (indication)
ALL MARKER OFF	CALCulate<1 2>:MARKer<1...2>:AOFF
<b>DELTA</b>	
DELTA 1/2	CALCulate<1 2>:DELTamarker<1...2>:AOFF
DELTA MKR ABS / REL	CALCulate<1 2>:DELTamarker<1...2>:MODE ABSolute   RELative
ALL DELTA OFF	CALCulate<1 2>:DELTamarker<1...2>[:STATe] ON   OFF CALCulate<1 2>:DELTamarker<1...2>:X <num_value> CALCulate<1 2>:DELTamarker<1...2>:Y?
<b>MARKER SEARCH</b>	
PEAK	CALCulate<1 2>:MARKer<1...2>:MAXimum[:PEAK] CALCulate<1 2>:DELTamarker<1...2>:MAXimum[:PEAK]
ACTIVE MKR / DELTA	--
MIN	CALCulate<1 2>:MARKer<1...2>:MINimum[:PEAK] CALCulate<1 2>:DELTamarker<1...2>:MINimum[:PEAK]
MAX  PEAK	CALCulate<1 2>:MARKer<1...2>:MAXimum:APEak CALCulate<1 2>:DELTamarker<1...2>:MAXimum:APEak
SUMMARY ON OFF	CALCulate<1 2>:MARKer<1...2>:FUNction:SUMMary[:STATe] ON   OFF
SUMMARY MARKER	--
MAX  PEAK	CALCulate<1 2>:MARKer<1...2>:FUNction:SUMMary:MAXimum[:STATe] ON   OFF CALCulate<1 2>:MARKer<1...2>:FUNction:SUMMary:MAXimum:RESult? CALCulate<1 2>:MARKer<1...2>:FUNction:SUMMary:MAXimum:AVERage:RESult? CALCulate<1 2>:MARKer<1...2>:FUNction:SUMMary:MAXimum:PHOLd:RESult?

+PEAK	CALCulate<1 2>:MARKer<1...2>:FUNction:SUMMary:PPEak[:STATe] ON   OFF CALCulate<1 2>:MARKer<1...2>:FUNction:SUMMary:PPEak:RESult? CALCulate<1 2>:MARKer<1...2>:FUNction:SUMMary:PPEak:AVERage:RESult? CALCulate<1 2>:MARKer<1...2>:FUNction:SUMMary:PPEak:PHOLd:RESult?
-PEAK	CALCulate<1 2>:MARKer<1...2>:FUNction:SUMMary:MPEak[:STATe] ON   OFF CALCulate<1 2>:MARKer<1...2>:FUNction:SUMMary:MPEak:RESult? CALCulate<1 2>:MARKer<1...2>:FUNction:SUMMary:MPEak:AVERage:RESult? CALCulate<1 2>:MARKer<1...2>:FUNction:SUMMary:MPEak:PHOLd:RESult?
±PEAK/2	CALCulate<1 2>:MARKer<1...2>:FUNction:SUMMary:MIDDLE[:STATe] ON   OFF CALCulate<1 2>:MARKer<1...2>:FUNction:SUMMary:MIDDLE:RESult? CALCulate<1 2>:MARKer<1...2>:FUNction:SUMMary:MIDDLE:AVERage:RESult? CALCulate<1 2>:MARKer<1...2>:FUNction:SUMMary:MIDDLE:PHOLd:RESult?
RMS	CALCulate<1 2>:MARKer<1...2>:FUNction:SUMMary:RMS[:STATe] ON   OFF CALCulate<1 2>:MARKer<1...2>:FUNction:SUMMary:RMS:RESult? CALCulate<1 2>:MARKer<1...4>:FUNction:SUMMary:RMS:AVERage:RESult? CALCulate<1 2>:MARKer<1...4>:FUNction:SUMMary:RMS:PHOLd:RESult?
MEAN	CALCulate<1 2>:MARKer<1...2>:FUNction:SUMMary:MEAN[:STATe] ON   OFF CALCulate<1 2>:MARKer<1...2>:FUNction:SUMMary:MEAN:RESult? CALCulate<1 2>:MARKer<1...4>:FUNction:SUMMary:MEAN:AVERage:RESult? CALCulate<1 2>:MARKer<1...4>:FUNction:SUMMary:MEAN:PHOLd:RESult?
PEAK HOLD ON / OFF	CALCulate<1 2>:MARKer<1...2>:FUNction:SUMMary:PHOLd ON   OFF
AVERAGE/HOLD ON / OFF	CALCulate<1 2>:MARKer<1...2>:FUNction:SUMMary:AVERage ON   OFF
SWEEP COUNT	[SENSe<1 2>:]SWEep:COUNT <num_value>
ALL SUM MKR OFF	CALCulate<1 2>:MARKer<1...2>:FUNction:SUMMary:AOFF
SEARCH LIMIT ON/OFF	CALCulate<1 2>:MARKer<1...2>:X:SLIMits[:STATe] ON   OFF
SELECT MARKER	--
<b>MKR -&gt;</b>	
PEAK	CALCulate<1 2>:MARKer<1...2>:MAXimum[:PEAK] CALCulate<1 2>:DELTAmarker<1...2>:MAXimum[:PEAK]
MKR → TRACE	CALCulate<1 2>:MARKer<1...4>:TRACe <num_value>
SELECT MARKER	--
ACTIVE MKR / DELTA	no corresponding IEC/IEEE-bus command

## LINES Key Group

<b>D LINES</b>	--
DISPLAY LINE 1/2	CALCulate<1 2>:DLINe<1 2>:STATe ON   OFF; CALCulate<1 2>:DLINe<1 2> <num_value>
REFERENCE LINE	CALCulate<1 2>:RLINe:STATe ON   OFF; CALCulate<1 2>:RLINe <num_value>
THRESHOLD LINE	CALCulate<1 2>:THReshold ON   OFF; CALCulate<1 2>:THReshold <num_value>
TIME/SYMB 1/2	CALCulate<1 2>:TLINe<1 2>:STATe ON   OFF; CALCulate<1 2>:TLINe<1 2> <num_value>
<b>LIMITS</b>	
SELECT LIMIT LINE	CALCulate<1 2>:LIMit<1...8>:NAME <string>; CALCulate<1 2>:LIMit<1...8>:STATe ON   OFF
NEW LIMIT LINE	s. EDIT LIMIT LINE
NAME	CALCulate<1 2>:LIMit<1...8>:NAME <string>
VALUES	no corresponding IEC/IEEE-bus command
INSERT VALUE	no corresponding IEC/IEEE-bus command
DELETE VALUE	no corresponding IEC/IEEE-bus command
SHIFT X LIMIT LINE	CALCulate<1 2>:LIMit<1...8>:CONTRol:SHIFt <num_value>
SHIFT Y LIMIT LINE	CALCulate<1 2>:LIMit<1...8>:UPPer:SHIFt <num_value> CALCulate<1 2>:LIMit<1...8>:LOWer:SHIFt <num_value>
SAVE LIMIT LINE	automatically executed during IEC/IEEE-bus operation



EDIT LIMIT LINE	<p>CALCulate&lt;1 2&gt;:LIMit&lt;1...8&gt;:UNIT DB  DBM   RAD   DEG   PCT   HZ   S   VOLT   WATT   UNITless</p> <p>CALCulate&lt;1 2&gt;:LIMit&lt;1...8&gt;:TRACe &lt;num_value&gt;</p> <p>CALCulate&lt;1 2&gt;:LIMit&lt;1...8&gt;:COMMeNt 'string'</p> <p>CALCulate&lt;1 2&gt;:LIMit&lt;1...8&gt;:CONTRol[:DATA] &lt;num_value&gt;,&lt;num_value&gt;..</p> <p>CALCulate&lt;1 2&gt;:LIMit&lt;1...8&gt;:CONTRol:DOMain FREQUency TIME</p> <p>CALCulate&lt;1 2&gt;:LIMit&lt;1...8&gt;:CONTRol:OFFset &lt;num_value&gt;</p> <p>CALCulate&lt;1 2&gt;:LIMit&lt;1...8&gt;:CONTRol:MODE RELative   ABSolute</p> <p>CALCulate&lt;1 2&gt;:LIMit&lt;1...8&gt;:CONTRol:UNIT[:TIME] S   SYM</p> <p>CALCulate&lt;1 2&gt;:LIMit&lt;1...8&gt;:CONTRol:SPACing LINear   LOGarithmic</p> <p>CALCulate&lt;1 2&gt;:LIMit&lt;1...8&gt;:UPPer[:DATA] &lt;num_value&gt;,&lt;num_value&gt;..</p> <p>CALCulate&lt;1 2&gt;:LIMit&lt;1...8&gt;:UPPer:STATe ON   OFF</p> <p>CALCulate&lt;1 2&gt;:LIMit&lt;1...8&gt;:UPPer:OFFset &lt;num_value&gt;</p> <p>CALCulate&lt;1 2&gt;:LIMit&lt;1...8&gt;:UPPer:MARGin &lt;num_value&gt;</p> <p>CALCulate&lt;1 2&gt;:LIMit&lt;1...8&gt;:UPPer:MODE RELative   ABSolute</p> <p>CALCulate&lt;1 2&gt;:LIMit&lt;1...8&gt;:UPPer:SPACing LINear   LOGarithmic</p> <p>CALCulate&lt;1 2&gt;:LIMit&lt;1...8&gt;:LOWer[:DATA] &lt;num_value&gt;,&lt;num_value&gt;..</p> <p>CALCulate&lt;1 2&gt;:LIMit&lt;1...8&gt;:LOWer:STATe ON   OFF</p> <p>CALCulate&lt;1 2&gt;:LIMit&lt;1...8&gt;:LOWer:OFFset &lt;num_value&gt;</p> <p>CALCulate&lt;1 2&gt;:LIMit&lt;1...8&gt;:LOWer:MARGin &lt;num_value&gt;</p> <p>CALCulate&lt;1 2&gt;:LIMit&lt;1...8&gt;:LOWer:MODE RELative   ABSolute</p> <p>CALCulate&lt;1 2&gt;:LIMit&lt;1...8&gt;:LOWer:SPACing LINear   LOGarithmic</p> <p>CALCulate&lt;1 2&gt;:LIMit&lt;1...8&gt;:FAIL?</p> <p>CALCulate&lt;1 2&gt;:LIMit&lt;1...8&gt;:CLEar[:IMMediate]</p>
COPY LIMIT LINE	CALCulate<1 2>:LIMit<1...8>:COpy 1...8   <name>
DELETE LIMIT LINE	CALCulate<1 2>:LIMit<1...8>:DELeTe
X OFFSET	CALCulate<1 2>:LIMit<1...8>:CONTRol:OFFset <num_value>
Y OFFSET	<p>CALCulate&lt;1 2&gt;:LIMit&lt;1...8&gt;:UPPer:OFFset &lt;num_value&gt;</p> <p>CALCulate&lt;1 2&gt;:LIMit&lt;1...8&gt;:LOWer:OFFset &lt;num_value&gt;</p>

### TRACE Key Group

TRACE	--
CLEAR/WRITE	DISPlay[:WINDow<1 2>]:TRACe<1...4>:MODE WRITe
VIEW	DISPlay[:WINDow<1 2>]:TRACe<1...4>:MODE VIEW
BLANK	DISPlay[:WINDow<1 2>]:TRACe<1...4>[:STATe] OFF
CONTINUOUS WRITE	DISPlay[:WINDow<1 2>]:TRACe<1...4>:MODE:CWRite ON   OFF
AVERAGE	DISPlay[:WINDow<1 2>]:TRACe<1...4>:MODE AVERAge or [SENSe<1 2>:]AVERAge:MODE SCALe
MAX HOLD	DISPlay[:WINDow<1 2>]:TRACe<1...4>:MODE MAXHold or [SENSe<1 2>:]AVERAge:MODE MAX
MIN HOLD	DISPlay[:WINDow<1 2>]:TRACe<1...4>:MODE MINHold or [SENSe<1 2>:]AVERAge:MODE MIN
SWEEP COUNT	[SENSe<1 2>:]SWEep:COUNT <num_value>

## SWEEP Key Group

<b>COUPLING</b>	--
IF BW AUTO	[SENSe<1 2>:]BANDwidth BWIDth[:RESolution]:AUTO ON   OFF
IF BW MANUAL	[SENSe<1 2>:]BANDwidth BWIDth[:RESolution] <num_value>
MAIN PLL BANDWIDTH	[SENSe<1 2>:]BANDwidth BWIDth:PLL AUTO HIGH MEDIum LOW
<b>SWEEP</b>	
CONTINUOUS SWEEP	INITiate<1 2>:CONTInuous ON; INITiate[:IMMediate]
SINGLE SWEEP	INITiate<1 2>:CONTInuous OFF; INITiate[:IMMediate]
SWEEP COUNT	[SENSe<1 2>:]SWEep:COUNT <num_value>
RESULT LENGTH	[SENSe<1 2>:]DDEMod:TIME <num_value>

## TRIGGER Key - Digital Demodulation

<b>TRIGGER</b>	
FREE RUN	TRIGGer<1 2>[:SEquence]:SOURce IMMEDIATE
VIDEO	TRIGGer<1 2>[:SEquence]:SOURce VIDEo TRIGGer<1 2>[:SEquence]:LEVel:VIDEo <num_value>
EXTERN	TRIGGer<1 2>[:SEquence]:SOURce EXTErnal TRIGGer<1 2>[:SEquence]:LEVel:EXTErnal <num_value>
TRIGGER OFFSET	TRIGGer<1 2>[:SEquence]:HOLDoff <num_value>
SLOPE POS NEG	TRIGGer<1 2>[:SEquence]:SLOPe POSitive NEGative
MEAS ONLY IF SYNC'D	[SENSe<1 2>:]DDEMod:SEARch:SYNC:MONLy ON   OFF
FIND BURST ON OFF	[SENSe<1 2>:]DDEMod:SEARch:PULSe:STATe ON   OFF
FIND SYNC ON OFF	[SENSe<1 2>:]DDEMod:SEARch:SYNC:STATe ON   OFF
SYNC OFFSET	[SENSe<1 2>:]DDEMod:SEARch:SYNC:OFFSet <num_value>
SYNC PATTERN	--

SELECT PATTERN	[SENSe<1 2>:]DDEMod:SEARCh:SYNC:SElect <pattern_name>
NEW SYNC PATTERN	[SENSe<1 2>:]DDEMod:SEARCh:SYNC:PATtern <string>
NAME	[SENSe<1 2>:]DDEMod:SEARCh:SYNC:NAME <pattern_name>
COMMENT	[SENSe<1 2>:]DDEMod:SEARCh:SYNC:COMment <string>
VALUE	[SENSe<1 2>:]DDEMod:SEARCh:SYNC:DATA <string> [SENSe<1 2>:]DDEMod:SEARCh:SYNC:PATtern <string> (the pattern is set in the instrument and automatically saved under the name remote.pat)
SAVE PATTERN	automatically executed during IEC/IEEE-bus operation (see above, command [SENSe<1 2>:]DDEMod:SEARCh:SYNC:PATtern <string>)
EDIT SYNC PATTERN	[SENSe<1 2>:]DDEMod:SEARCh:SYNC:PATtern <string>
DELETE PATTERN	[SENSe<1 2>:]DDEMod:SEARCh:SYNC:DElete

### TRIGGER Key - Analog Demodulation

<b>TRIGGER</b>	
FREE RUN	TRIGger<1 2>[:SEquence]:SOURce IMMEDIATE
VIDEO	TRIGger<1 2>[:SEquence]:SOURce VIDEo TRIGger<1 2>[:SEquence]:LEVel:VIDEo <num_value>
EXTERN	TRIGger<1 2>[:SEquence]:SOURce EXTernal TRIGger<1 2>[:SEquence]:LEVel[:EXTernal] -5.0...+5.0V
AF SIGNAL	TRIGger<1 2>[:SEquence]:SOURce AF TRIGger<1 2>[:SEquence]:LEVel:AF -120...+120PCT
SLOPE POS/NEG	TRIGger<1 2>[:SEquence]:SLOPe POSitive NEGative
TRIGGER OFFSET	TRIGger<1 2>[:SEquence]:HOLDoff <num_value>

## Tracking Generator (Option FSE-B8 to B11)

## CONFIGURATION Key Group

<b>MODE</b>	
TRACKING GEN	--
SOURCE ON/OFF	OUTPut<1 2>[:STATe] ON   OFF
SOURCE POWER	SOURce:POWer[:LEVel][:IMMediate][:AMPLitude] <num_value>
POWER OFFSET	SOURce:POWer[:LEVel][:IMMediate]:OFFSet <num_value>
SOURCE CAL	--
CAL TRANS	[SENSe<1 2>:]CORRection:METhod TRANSmisSion [SENSe<1 2>:]CORRection:COLLect[:ACQuire] THRUgh
CAL REFL SHORT	[SENSe<1 2>:]CORRection:METhod REFLExion [SENSe<1 2>:]CORRection:COLLect[:ACQuire] THRUgh
CAL REFL OPEN	[SENSe<1 2>:]CORRection:METhod REFLExion [SENSe<1 2>:]CORRection:COLLect[:ACQuire] OPEN
NORMALIZE	[SENSe<1 2>:]CORRection[:STATe] ON   OFF
REF VALUE POSITION	DISPlay[:WINDow<1 2>]:TRACe<1...4>:Y[:SCALE]:RPOSITION 0...100PCT
REF VALUE	DISPlay[:WINDow<1 2>]:TRACe<1...4>:Y[:SCALE]:RVALUE <num_value>
RECALL	[SENSe<1 2>:]CORRection:RECall
FREQUENCY OFFSET	SOURce:FREQuency:OFFSet <num_value>
MODULATION	--
EXT AM	SOURce:AM:STATe ON   OFF
EXT ALC	SOURce:POWer:ALC:SOURce INTernal   EXTernal
EXT FM	SOURce:FM:STATe ON   OFF
EXT I/Q	SOURce:DM:STATe ON   OFF

## GSM BTS Analysis (Option FSE-K11)

### CONFIGURATION Key Group

<b>MODE</b>	
GSM BTS ANALYZER	INSTRument<1 2>[:SElect] BGSM
SETTINGS	--
EXTERNAL ATTEN	[SENSe<1 2>:]CORRection:LOSS:INPut[:MAGNitude] <num_value>
ARFCN / FREQUENCY	--
ARFCN	CONFIgure[:BTS]:ARFCn <num_value>
ARFCN AUTOSELECT	CONFIgure[:BTS]:ARFCn:AUTO ONCE
FREQUENCY	SENSe<1 2>:FREQUency:CENTer <num_value>
POWER SETTINGS	--
EXTERNAL ATTEN	SENSe<1 2>:CORRection:LOSS:INPut[:MAGNitude] <num_value>
NOMINAL OUTPUT PWR	CONFIgure[:BTS]:POWer:EXPEcted <num_value>
POWER CLASS	CONFIgure[:BTS]:POWer:CLASs <num_value>   M1   M2   M3
STATIC PWR CTRL LEVEL	CONFIgure[:BTS]:POWer:STATic <num_value>
DYNAM PWR CTRL LEVEL	CONFIgure[:BTS]:POWer:DYNamic <num_value>
LIMIT/PWR COUPLED	CONFIgure[:BTS]:POWer:COUPled ON   OFF
SIGNAL POWER	CONFIgure[:BTS]:POWer:EXPEcted <num_value>
LIMIT LINE REF POWER	CONFIgure[:BTS]:POWer:LIMit <num_value>
LIMIT MARGIN	CALCulate<1 2>:LIMit<1...8>:MARGIn <num_value>
SLOT NO.	--
SLOT NO.	CONFIgure[:BTS]:CHANnel:SLOT 0...7
SLOT NO. AUTOSELECT	CONFIgure[:BTS]:CHANnel:SLOT:AUTO ONCE

MIDAMBLE	CONFigure[:BTS]:CHANnel:TSC 0...7 CONFigure[:BTS]:CHANnel:TSC:AUTO ON   OFF
TRIGGER	--
FREE RUN	TRIGger<1 2>[:SEquence]:SOURce IMMEDIATE
EXTERN	TRIGger<1 2>[:SEquence]:SOURce EXTERNAL TRIGger<1 2>[:SEquence]:LEVel[:EXternal] -5.0...+5.0V
SLOPE POS NEG	TRIGger<1 2>[:SEquence]:SLOPe POSitive NEGative
TRIGGER ADJUST	--
FRAME COARSE	TRIGger<1 2>[:SEquence]:SYNChronize:ADJust:FRAME <num_value>
FRAME FINE	TRIGger<1 2>[:SEquence]:SYNChronize:ADJust:FRAME <num_value>
AUTO FRAME ADJUST	TRIGger<1 2>[:SEquence]:SYNChronize:ADJust:FRAME:AUTO ONCE
SLOT ADJUST	TRIGger<1 2>[:SEquence]:SYNChronize:ADJust:SLOT <num_value>
AUTO SLOT ADJUST	TRIGger<1 2>[:SEquence]:SYNChronize:ADJust:SLOT:AUTO ONCE
TRIGGER LEVEL	TRIGger<1 2>[:SEquence]:LEVel[:EXternal] <num_value>
SLOPE POS NEG	TRIGger<1 2>[:SEquence]:SLOPe POSitive NEGative
DEFAULT SETTINGS	CONFigure[:BTS]:PRESet
P-GSM 900	CONFigure[:BTS]:NETWork[:TYPE] PGSM   PGSM900
GSM 1800 (DCS 1800)	CONFigure[:BTS]:NETWork[:TYPE] DCS   GSM1800
GSM 1900 (PCS 1900)	CONFigure[:BTS]:NETWork[:TYPE] PCS   GSM1900
R-GSM 900	CONFigure[:BTS]:NETWork[:TYPE] RGSM   RGSM900
R-GSM 900	CONFigure[:BTS]:NETWork[:TYPE] RGSM
PHASE I	CONFigure[:BTS]:NETWork:PHASe 1
PHASE II	CONFigure[:BTS]:NETWork:PHASe 2
PHASE II+	CONFigure[:BTS]:NETWork:PHASe 2, PLUS
PHASE/FREQ ERROR	CONFigure:BURSt:PFERror[:IMMEDIATE]

SINGLE	INITiate<1 2>:CONTinuous OFF; INITiate[:IMMediate] READ:BURSt:PERRor:RMS:STATus? READ:BURSt:PERRor:RMS:AVErAge? READ:BURSt:PERRor:RMS:MAXimum? READ:BURSt:PERRor:PEAK:STATus? READ:BURSt:PERRor:PEAK:AVErAge? READ:BURSt:PERRor:PEAK:MAXimum? READ:BURSt:FERRor:STATus? READ:BURSt:FERRor:AVErAge? READ:BURSt:FERRor:MAXimum?
CONTINUOUS	INITiate<1 2>:CONTinuous ON; INITiate[:IMMediate] FETCh:BURSt:PERRor:RMS:STATus? FETCh:BURSt:PERRor:RMS:AVErAge? FETCh:BURSt:PERRor:RMS:MAXimum? FETCh:BURSt:PERRor:PEAK:STATus? FETCh:BURSt:PERRor:PEAK:AVErAge? FETCh:BURSt:PERRor:PEAK:MAXimum? FETCh:BURSt:FERRor:STATus? FETCh:BURSt:FERRor:AVErAge? FETCh:BURSt:FERRor:MAXimum?
NO. OF BURSTS	--
SET MANUAL	CONFigure:BURSt:PFERRor:COUNT <num_value>
SET TO STANDARD	--
ARFCN / FREQUENCY	see sub menu SETTINGS
POWER SETTINGS	see sub menu SETTINGS
X UNIT SYMB TIME	CALCulate:X:UNIT:TIME S SYM
TRIGGER	see sub menu SETTINGS
EDIT	--
PHASE PEAK	CONFigure[:BTS]:LIMit:PPEak <num_value>
PHASE RMS	CONFigure[:BTS]:LIMit:PRMS <num_value>
FREQUENCY	CONFigure[:BTS]:LIMit:FREQuency <num_value>
USER LIMIT ON OFF	CONFigure[:BTS]:LIMit:STANdard ON   OFF
CARRIER POWER	CONFigure:BURSt:POWer[:IMMediate] CALCulate:LIMit:BURSt:POWer?
MEAS MAX OUTPUT PWR	READ:BURSt:POWer?
INC STATIC PWR CTRL	READ:BURSt:POWer:STATic?
INC DYNAM PWR CTRL	READ:BURSt:POWer:DYNamic?
NO. OF BURSTS	--
SET MANUAL	CONFigure:BURSt:POWer:COUNT <num_value>

SET TO STANDARD	--
SGL MEAS ON OFF	CONFigure[:BTS]:POWer:SINGLE[:STATe] ON   OFF
MEAS SGL PWR LEVEL	READ:BURSt:POWer?
STATIC PWR CTRL LEVEL	CONFigure[:BTS]:POWer:STATic <num_value>
DYNAM PWR CTRL LEVEL	CONFigure[:BTS]:POWer:DYNamic <num_value>
CLEAR SGL RESULT TAB	CONFigure[:BTS]:POWer:SINGLE:CLEar
SIGNAL POWER	CONFigure[:BTS]:POWer:EXPEcted <num_value>
ARFCN / FREQUENCY	see sub menu SETTINGS
POWER SETTINGS	see sub menu SETTINGS
CONDITIONS NORM EXTR	CONFigure:BURSt:POWer:CONDition NORMal   EXTReMe
MEAS BANDWIDTH	[SENSe<1 2>:]BANDwidth BWIDth[:RESolution] DEF   300 kHz   1 MHz
SYNC TO MIDAMBLE	TRIGger<1 2>[:SEquence]:SYNChronize:SOURce FRAME   TSC
TRIGGER	see sub menu SETTINGS
POWER VS TIME	CONFigure:BURSt:PTEmplate[:IMMediate] CALCulate:LIMit:BURSt:PTEmplate?
SINGLE	INITiate<1 2>:CONTinuous OFF; INITiate[:IMMediate]
CONTINUOUS	INITiate<1 2>:CONTinuous ON; INITiate[:IMMediate]
BURST HIGH RESOLUTION	CONFigure:BURSt:PTEmplate:SElect TOP
NO. OF BURSTS	--
SET MANUAL	CONFigure:BURSt:PTEmplate:COUNt <num_value>
SET TO STANDARD	--
FULL BURST	CONFigure:BURSt:PTEmplate:SElect FULL
RISING EDGE	CONFigure:BURSt:PTEmplate:SElect RISing
FALLING EDGE	CONFigure:BURSt:PTEmplate:SElect FALLing
START REF MEAS	READ:BURSt:REFerence[:IMMediate]?



REF MEAS AUTO USER	CONFigure:BURSt:REFeRence:AUTO ON   OFF
ARFCN / FREQUENCY	see sub menu SETTINGS
POWER SETTINGS	see sub menu SETTINGS
X UNIT SYMB TIME	CALCulate:X:UNIT:TIME S SYM
MEAS BANDWIDTH	[SENSe<1 2>:]BANDwidth BWiDth[:RESolution] DEF   300 kHz   1 MHz
SYNC TO MIDAMBLE	TRIGger<1 2>[:SEquence]:SYNChronize:SOURce FRAMe   TSC
TRIGGER	see sub menu SETTINGS
EDIT	--
LIMIT LINE FILTER	--
NEW LIMIT LINE	see Basic Instrument - Signal Analysis
EDIT LIMIT LINE	see Basic Instrument - Signal Analysis
COPY LIMIT LINE	see Basic Instrument - Signal Analysis
DELETE LIMIT LINE	see Basic Instrument - Signal Analysis
USER LIMIT ON OFF	CONFigure[:BTS]:LIMit:STANdard ON   OFF
PAGE UP	--
PAGE DOWN	--
MODULATION SPECTRUM	CONFigure:SPECTrum:MODulation[:IMMediate] CALCulate:LIMit:SPECTrum:MODulation? ARFCn TXBand RXBand COMBined CALCulate:LIMit:SPECTrum:MODulation:FAILs? ARFCn TXBand RXBand COMBined CALCulate:LIMit:SPECTrum:MODulation:EXceptions? ARFCn TXBand RXBand  COMBined
SINGLE FREQ SWEEP	INITiate<1 2>:CONTinuous OFF; INITiate[:IMMediate]
CONTINUOUS FREQ SWEEP	INITiate<1 2>:CONTinuous ON; INITiate[:IMMediate]
START LIST	READ:SPECTrum:MODulation[:ALL]?
NO. OF BURSTS	--
SET MANUAL	CONFigure:SPECTrum:MODulation:COUNT <num_value>
SET TO STANDARD	--

ARFCN ±1.8 MHz	CONFigure:SPECTrum:MODulation:RANGE ARFCn
TX BAND	CONFigure:SPECTrum:MODulation:RANGE TXBand
±1.8 MHz / TX BAND	CONFigure:SPECTrum:MODulation:RANGE COMBined
RX BAND	CONFigure:SPECTrum:MODulation:RANGE RXBand
ARFCN / FREQUENCY	see sub menu SETTINGS
POWER SETTINGS	see sub menu SETTINGS
RX BAND GAIN	[SENSe<1 2>:]CORRection:RXGain:INPut[:MAGNitude] <num_value>
TX GATE ON OFF	CONFigure:SPECTrum:MODulation:TGATe ON   OFF
TRIGGER	see sub menu SETTINGS
EDIT	--
LIMIT LINE FILTER	--
NEW LIMIT LINE	see Basic Instrument - Signal Analysis
EDIT LIMIT LINE	see Basic Instrument - Signal Analysis
COPY LIMIT LINE	see Basic Instrument - Signal Analysis
DELETE LIMIT LINE	see Basic Instrument - Signal Analysis
USER LIMIT ON OFF	CONFigure[:BTS]:LIMit:STANdard ON   OFF
PAGE UP	--
PAGE DOWN	--
TRANSIENT SPECTRUM	CONFigure:SPECTrum:SWITChing[:IMMediate] CALCulate:LIMit:SPECTrum:SWITChing? CALCulate:LIMit:SPECTrum:SWITChing:FAILs?
SINGLE FREQ SWEEP	INITiate<1 2>:CONTInuous OFF; INITiate[:IMMediate]
CONTINUOUS FREQ SWEEP	INITiate<1 2>:CONTInuous ON; INITiate[:IMMediate]
START LIST	READ:SPECTrum:SWITChing[:ALL]?
NO. OF BURSTS	--

SET MANUAL	CONFigure:SPECTrum:SWITChing:COUNT <num_value>	
SET TO STANDARD	--	
ARFCN / FREQUENCY	see sub menu SETTINGS	
POWER SETTINGS	see sub menu SETTINGS	
BTS SFH ON OFF	CONFigure[:BTS]:CHANnel:SFH ON   OFF	
MEAS BANDWIDTH	[SENSe<1 2>:]BANDwidth BWIDth[:RESolution] DEF   300 kHz   1 MHz	
TRIGGER	see sub menu SETTINGS	
EDIT	--	
LIMIT LINE FILTER	--	
NEW LIMIT LINE	see Basic Instrument - Signal Analysis	
EDIT LIMIT LINE	see Basic Instrument - Signal Analysis	
COPY LIMIT LINE	see Basic Instrument - Signal Analysis	
DELETE LIMIT LINE	see Basic Instrument - Signal Analysis	
USER LIMIT ON OFF	CONFigure[:BTS]:LIMit:STANdard ON   OFF	
PAGE UP	--	
PAGE DOWN	--	
SPURIOUS	CONFigure:SPURious[:IMMediate] CALCulate:LIMit:SPURious? CALCulate:LIMit:SPURious:FAILs?	TXBand   OTXBand   RXBand TXBand   OTXBand   RXBand
START LIST SGL STEP	ABORT;READ:SPURious:STEP?	
CONT LIST SGL STEP	READ:SPURious:STEP?	
START LIST	READ:SPURious [:ALL]?	
SWEEP COUNT	--	
SWP COUNT TX / <> TX	CONFigure:SPURious:COUNT <num_value>	
SWP COUNT RX BAND	CONFigure:SPURious:COUNT:RXBand <num_value>	
SET TO STANDARD	--	

TX BAND	CONFigure:SPURious:RANGe	TXBand
<> TX BAND	CONFigure:SPURious:RANGe	OTXBand
RX BAND	CONFigure:SPURious:RANGe	RXBand
TX BAND ±2.MHZ	CONFigure:SPURious:RANGe	COMBined
SELECT STEP	CONFigure:SPURious:STEP:COUNT? CONFigure:SPURious:STEP<1..26>	ON   OFF
ARFCN / FREQUENCY	see sub menu SETTINGS	
POWER SETTINGS	see sub menu SETTINGS	
BTS SFH ON OFF	CONFigure[:BTS]:CHANnel:SFH	ON   OFF
TX SUPPR ON OFF	CONFigure[:BTS]:TXSupp	ON   OFF
RX BAND GAIN	[SENSe<1 2>:]CORREction:RXGain:INPut[:MAGNitude]	<num_value>
COSITING	CONFigure[:BTS]:COSiting	ON   OFF
SWEEPTIME STD AUTO	CONFigure[:BTS]:SWEeptime	STANDARD AUTO
TRIGGER	see sub menu SETTINGS	
EDIT	--	
LIMIT LINE FILTER	--	
NEW LIMIT LINE	see Basic Instrument - Signal Analysis	
EDIT LIMIT LINE	see Basic Instrument - Signal Analysis	
COPY LIMIT LINE	see Basic Instrument - Signal Analysis	
DELETE LIMIT LINE	see Basic Instrument - Signal Analysis	
USER LIMIT ON OFF	CONFigure[:BTS]:LIMit:STANDard	ON   OFF
PAGE UP	--	
PAGE DOWN	--	

## GSM MS Analysis (Option FSE-K10)

### CONFIGURATION Key Group

<b>MODE</b>	
GSM MS ANALYZER	INSTRument<1 2>[:SElect] MGSM
SETTINGS	--
EXTERNAL ATTEN	[SENSe<1 2>:]CORRection:LOSS:INPut[:MAGNitude] <num_value>
ARFCN / FREQUENCY	--
ARFCN	CONFigure[:MS]:ARFCn <num_value>
ARFCN AUTOSELECT	CONFigure[:MS]:ARFCn:AUTO ONCE
FREQUENCY	[SENSe<1 2>:]FREQUency:CENTer <num_value>
POWER SETTINGS	--
EXTERNAL ATTEN	[SENSe<1 2>:]CORRection:LOSS:INPut[:MAGNitude] <num_value>
OUTPUT MS POWER	CONFigure[:MS]:POWer:EXPEcted <num_value>
POWER CLASS	CONFigure[:MS]:POWer:CLASs <num_value>
POWER CTRL LEVEL	CONFigure[:MS]:POWer:LEVel <num_value>
SMALL MS ON OFF	CONFigure[:MS]:POWer:SMAlL ON   OFF
SMALL MS ON OFF	CONFigure[:MS]:POWer:SMAlL ON   OFF
LIMIT/PWR COUPLED	CONFigure[:MS]:POWer:COUPled ON   OFF
SIGNAL POWER	CONFigure[:MS]:POWer:EXPEcted <num_value>
LIMIT LINE REF POWER	CONFigure[:MS]:POWer:LIMit <num_value>
LIMIT MARGIN	CALCulate:LIMit:MARGin <num_value>
MIDAMBLE	CONFigure[:MS]:CHANnel:TSC 0...7

TRIGGER	--
FREE RUN	TRIGger<1 2>[:SEquence]:SOURce IMMEDIATE
VIDEO	TRIGger<1 2>[:SEquence]:SOURce VIDEO
EXTERN	TRIGger<1 2>[:SEquence]:SOURce EXTERNAL TRIGger<1 2>[:SEquence]:LEVel[:EXTernal] -5.0...+5.0V
RF POWER	TRIGger<1 2>[:SEquence]:SOURce RFPower
SLOPE POS NEG	TRIGger<1 2>[:SEquence]:SLOPe POSitive NEGative
TRIGGER ADJUST	--
COARSE ADJUST	TRIGger<1 2>[:SEquence]:SYNChronize:ADJust:SLOT <num_value>
FINE ADJUST	TRIGger<1 2>[:SEquence]:SYNChronize:ADJust:SLOT <num_value>
AUTO ADJUST	TRIGger<1 2>[:SEquence]:SYNChronize:ADJust:SLOT:AUTO ONCE
TRIGGER LEVEL	TRIGger<1 2>[:SEquence]:LEVel[:EXTernal] <num_value>
SLOPE POS NEG	TRIGger<1 2>[:SEquence]:SLOPe POSitive NEGative
DEFAULT SETTINGS	CONFigure[:MS]:PRESet
P-GSM 900	CONFigure[:MS]:NETWork[:TYPE] PGSM   PGSM900
E-GSM 900	CONFigure[:MS]:NETWork[:TYPE] EGSM   EGSM900
GSM 1800 (DCS 1800)	CONFigure[:MS]:NETWork[:TYPE] DCS   GSM1800
GSM 1900 (PCS 1900)	CONFigure[:MS]:NETWork[:TYPE] PCS   GSM1900
R-GSM 900	CONFigure[:MS]:NETWork[:TYPE] RGSM   RGSM900
PHASE I	CONFigure[:MS]:NETWork:PHASe 1
PHASE II	CONFigure[:MS]:NETWork:PHASe 2
PHASE II+	CONFigure[:MS]:NETWork:PHASe 2,PLUS

PHASE/FREQ ERROR	CONFigure:BURSt:PFERror[:IMMediate]
SINGLE	INITiate<1 2>:CONTInuous OFF; INITiate[:IMMediate]
CONTINUOUS	INITiate<1 2>:CONTInuous ON; INITiate[:IMMediate]
NO. OF BURSTS	
SET MANUAL	CONFigure:BURSt:PFERror:COUNT <num_value>
SET TO STANDARD	--
ARFCN / FREQUENCY	see sub menu SETTINGS
POWER SETTINGS	see sub menu SETTINGS
X UNIT SYMB TIME	CALCulate<1 2>::X:UNIT:TIME S SYM
TRIGGER	see sub menu SETTINGS
EDIT	--
PHASE PEAK	CONFigure[:MS]:LIMit:PPEak <num_value>
PHASE RMS	CONFigure[:MS]:LIMit:PRMS <num_value>
FREQUENCY	CONFigure[:MS]:LIMit:FREQuency <num_value>
USER LIMIT ON OFF	CONFigure[:MS]:LIMit:STANdard ON   OFF
CARRIER POWER	CONFigure:BURSt:POWer[:IMMediate] CALCulate:LIMit:BURSt:POWer?
MEAS MAX OUTPUT PWR	READ:BURSt:POWer?
INC PWR CTRL LEVEL	READ:BURSt:POWer:LEVel?
NO. OF BURSTS	--
SET MANUAL	CONFigure:BURSt:POWer:COUNT <num_value>
SET TO STANDARD	--
SGL MEAS ON OFF	CONFigure[:MS]:POWer:SINGle[:STATe] ON   OFF

MEAS SGL PWR LEVEL	READ: BURSt: PWEr?
POWER CTRL LEVEL	CONFigure[:MS]: PWEr: LEVel <num_value>
CLEAR SGL RESULT TAB	CONFigure[:MS]: PWEr: SINGle: CLEar
SIGNAL POWER	CONFigure[:MS]: PWEr: EXPEcted <num_value>
ARFCN / FREQUENCY	see sub menu SETTINGS
POWER SETTINGS	see sub menu SETTINGS
CONDITIONS NORM EXTR	CONFigure: BURSt: PWEr: CONDition NORMal   EXTREme
MEAS BANDWIDTH	[SENSe<1 2>:] BAndwidth  BwidTh[: RESolution] DEF   300 kHz   1 MHz
SYNC TO MIDAMBLE	TRIGger<1 2>[: SEquence]: SYNChronize: SOURce FRAMe   TSC
TRIGGER	see sub menu SETTINGS
POWER VS TIME	CONFigure: BURSt: PTEMplate[: IMMEDIATE] CALCulate: LIMit: BURSt: PTEMplate?
SINGLE	INITiate<1 2>: CONTinuous OFF; INITiate[: IMMEDIATE]
CONTINUOUS	INITiate<1 2>: CONTinuous ON; INITiate[: IMMEDIATE]
BURST HIGH RESOLUTION	CONFigure: BURSt: PTEMplate: SElect TOP
NO. OF BURSTS	--
SET MANUAL	CONFigure: BURSt: PTEMplate: COUNT <num_value>
SET TO STANDARD	--
FULL BURST	CONFigure: BURSt: PTEMplate: SElect FULL
RISING EDGE	CONFigure: BURSt: PTEMplate: SElect RISing
FALLING EDGE	CONFigure: BURSt: PTEMplate: SElect FALLing
START REF MEAS	READ: BURSt: REFerence[: IMMEDIATE]?
REF MEAS AUTO USER	CONFigure: BURSt: REFerence: AUTO ON   OFF



ARFCN / FREQUENCY	see sub menu SETTINGS
POWER SETTINGS	see sub menu SETTINGS
X UNIT SYMB TIME	CALCulate<1 2>:X:UNIT:TIME S SYM
MEAS BANDWIDTH	[SENSe<1 2>:]BANDwidth BWIDth[:RESolution] DEF   300 kHz   1 MHz
SYNC TO MIDAMBLE	TRIGger<1 2>[:SEquence]:SYNChronize:SOURce FRAME   TSC
TRIGGER	see sub menu SETTINGS
EDIT	--
LIMIT LINE FILTER	--
EDIT LIMIT LINE	see Basic Instrument - Signal Analysis
USER LIMIT ON OFF	CONFigure[:MS]:LIMit:STANdard ON   OFF
PAGE UP	--
PAGE DOWN	--
MODULATION SPECTRUM	CONFigure:SPECTrum:MODulation[:IMMediate] CALCulate:LIMit:SPECTrum:MODulation? ARFCn TXBand RXBand COMBined DCSRx1800 CALCulate:LIMit:SPECTrum:MODulation:FAILs? ARFCn TXBand RXBand COMBined DCSRx1800 CALCulate:LIMit:SPECTrum:MODulation:EXCEptions? ARFCn TXBand RXBand COMBined DCSRx1800
SINGLE FREQ SWEEP	INITiate<1 2>:CONTInuous OFF; INITiate[:IMMediate]
CONTINUOUS FREQ SWEEP	INITiate<1 2>:CONTInuous ON; INITiate[:IMMediate]
START LIST	READ:SPECTrum:MODulation[:ALL]?
NO. OF BURSTS	--
SET MANUAL	CONFigure:SPECTrum:MODulation:COUNT <num_value>
SET TO STANDARD	--
ARFCN ± 1.8 MHz	CONFigure:SPECTrum:MODulation:RANGE ARFCn
TX BAND	CONFigure:SPECTrum:MODulation:RANGE TXBand

±1.8 MHZ TX BAND	CONFigure:SPECTrum:MODulation:RANGE COMBined
RX BAND GSM 900	CONFigure:SPECTrum:MODulation:RANGE RXBand
RX BAND DCS 1800	CONFigure:SPECTrum:MODulation:RANGE DCSRx1800
RX BAND	CONFigure:SPECTrum:MODulation:RANGE RXBand
ARFCN / FREQUENCY	see sub menu SETTINGS
POWER SETTINGS	see sub menu SETTINGS
RX BAND GAIN	[SENSe<1 2>:]CORRection:RXGain:INPut[:MAGNitude] <num_value>
TRIGGER	see sub menu SETTINGS
EDIT	--
LIMIT LINE FILTER	--
EDIT LIMIT LINE	see Basic Instrument - Signal Analysis
USER LIMIT ON OFF	CONFigure[:MS]:LIMit:STANdard ON   OFF
PAGE UP	--
PAGE DOWN	--
TRANSIENT SPECTRUM	CONFigure:SPECTrum:SWITChing[:IMMediate] CALCulate:LIMit:SPECTrum:SWITChing? ARFCn TXBand RXBand COMBined CALCulate:LIMit:SPECTrum:SWITChing:FAILs? ARFCn TXBand RXBand COMBined
SINGLE FREQ SWEEP	INITiate<1 2>:CONTinuous OFF; INITiate[:IMMediate]
CONTINUOUS FREQ SWEEP	INITiate<1 2>:CONTinuous ON; INITiate[:IMMediate]
START LIST	READ:SPECTrum:SWITChing[:ALL]?
NO. OF BURSTS	--
SET MANUAL	CONFigure:SPECTrum:SWITChing:COUNT <num_value>
SET TO STANDARD	--
ARFCN / FREQUENCY	see sub menu SETTINGS

POWER SETTINGS	see sub menu SETTINGS
MS SFH ON OFF	CONFigure[:MS]:CHANnel:SFH ON   OFF
MEAS BANDWIDTH	[SENSe<1 2>:]BANDwidth BWIDth[:RESolution] DEF   300 kHz   1 MHz
TRIGGER	see sub menu SETTINGS
EDIT	--
LIMIT LINE FILTER	--
EDIT LIMIT LINE	see Basic Instrument - Signal Analysis
USER LIMIT ON OFF	CONFigure[:MS]:LIMit:STANdard ON   OFF
PAGE UP	--
PAGE DOWN	--
SPURIOUS	CONFigure:SPURious[:IMMediate] CALCulate:LIMit:SPURious? TXBand   OTXBand   IDLeband CALCulate:LIMit:SPURious:FAILs? TXBand   OTXBand   IDLeband
START LIST SGL STEP	ABORT;READ:SPURious:STEP?
CONT LIST SGL STEP	READ:SPURious:STEP?
START LIST	READ:SPURious [:ALL]?
SWEEP COUNT	--
SWP COUNT TX / <>TX	CONFigure:SPURious:COUNT <num_value>
TX BAND	CONFigure:SPURious:RANGe TXBand
<> TX BAND	CONFigure:SPURious:RANGe OTXBand
IDLE MODE	CONFigure:SPURious:RANGe IDLeband
TX BAND ±2.0 MHZ	CONFigure:SPURious:RANGe COMBined
SELECT STEP	CONFigure:SPURious:STEP:COUNT? CONFigure:SPURious:STEP<1..26> ON   OFF
ARFCN / FREQUENCY	see sub menu SETTINGS

POWER SETTINGS	see sub menu SETTINGS
MS SFH ON OFF	CONFigure[:MS]:CHANnel:SFH ON   OFF
TX SUPPR ON OFF	CONFigure[:MS]:TXSupp ON   OFF
ANTENNA COND RAD	CONFigure:SPURious:ANTenna CONDUCTed RADIated
SWEEPTIME STD AUTO	CONFigure[:MS]:SWEeptime STANdard AUTO
TRIGGER	see sub menu SETTINGS
EDIT	--
LIMIT LINE FILTER	--
EDIT LIMIT LINE	see Basic Instrument - Signal Analysis
USER LIMIT ON OFF	CONFigure[:MS]:LIMIt:STANdard ON   OFF
PAGE UP	--
PAGE DOWN	--

## External Mixer (Option FSE-B21)

### INPUT Key Group

<b>INPUT</b>	
MIXER INTERNAL	[SENSe<1 2>:]MIXer[:STATE] OFF
MIXER EXTERNAL	[SENSe<1 2>:]MIXer[:STATE] ON
BAND LOCK ON OFF	[SENSe<1 2>:]MIXer:BLOCK ON   OFF
SELECT BAND	--
BAND	[SENSe<1 2>:]MIXer:HARMonic:BAND A Q U V E W F D G Y J
EVEN HARMONICS	[SENSe<1 2>:]MIXer:HARMonic:TYPE ODD EVEN EODD
ODD HARMONICS	[SENSe<1 2>:]MIXer:HARMonic:TYPE ODD EVEN EODD
PORTS 2 3	[SENSe<1 2>:]MIXer:PORT 2 3
BIAS	[SENSe<1 2>:]MIXer:BIAS <value>
ACCEPT BIAS	--
AVG CONV LOSS LOW	[SENSe<1 2>:]MIXer:LOSS[:LOW] <value>
AVG CONV LOSS HIGH	[SENSe<1 2>:]MIXer:LOSS:HIGH <value>
CONV LOSS TABLE	--
EDIT TABLE	--
TABLE NAME	[SENSe<1 2>:]CORRection:CVL:SElect <name>
VALUES	[SENSe<1 2>:]CORRection:CVL:DATA <x1-val>,<y1-val>,<x2-val>,... input of the following values in CVL table: [SENSe<1 2>:]CORRection:CVL:MIXer <string> [SENSe<1 2>:]CORRection:CVL:SNUMber <string> [SENSe<1 2>:]CORRection:CVL:BAND A Q U V E W F D G Y J [SENSe<1 2>:]CORRection:CVL:TYPE ODD EVEN EODD [SENSe<1 2>:]CORRection:CVL:PORTs 2 3 [SENSe<1 2>:]CORRection:CVL:BIAS <value> [SENSe<1 2>:]CORRection:CVL:COMMeNt <string>
INSERT LINE	--

DELETE LINE	--
COPY TABLE	--
SAVE TABLE	table is saved with every change of values.
PAGE UP	--
PAGE DOWN	--
NEW TABLE	see softkey EDIT TABLE
LOAD TABLE	--
DELETE TABLE	[SENSe<1 2>:]CORRection:CVL:CLear
PAGE UP	--
PAGE DOWN	--
DEFAULT SETTINGS	--
HARMONIC#	[SENSe<1 2>:]MIXer:HARMonic <value>
PORTS 2      3	[SENSe<1 2>:]MIXer:PORT 2 3
AVG CONV LOSS	[SENSe<1 2>:]MIXer:LOSS[:LOW] <num_value>
BIAS	--
BIAS	[SENSe<1 2>:]MIXer:BIAS <num_value>
BIAS OFF	--
SIGNAL ID	--
SIGNAL ID	[SENSe<1 2>:]MIXer:SIGNAL OFF   ON
AUTO ID	[SENSe<1 2>:]MIXer:SIGNAL OFF   AUTO
AUTO ID THRESHOLD	[SENSe<1 2>:]MIXer:THReshold <value>



# Contents - Chapter 7 "Remote Control - Programming Examples"

## 7 Programming Examples

<b>Programming via IEC/IEEE Bus.....</b>	<b>7.1</b>
Including IEC-Bus Library for QuickBasic.....	7.1
Initialization and Default Status .....	7.1
Initiate Controller .....	7.1
Initiate Instrument.....	7.1
Transmission of Instrument Setting Commands .....	7.2
Switchover to Manual Control.....	7.2
Reading out Instrument Settings .....	7.2
Positioning a Marker and Displaying Values .....	7.2
Command synchronization .....	7.3
Service Request .....	7.4
<b>Programming via the RSIB Interface .....</b>	<b>7.6</b>
Visual Basic .....	7.6
C / C++ .....	7.8
WinWord (Word Basic) .....	7.10
Excel .....	7.12





## 7 Programming Examples

The examples explain the programming of the instrument and can serve as a basis to solve more complex programming tasks.

QuickBASIC has been used as programming language. However, the programs can be translated into other languages.

### Programming via IEC/IEEE Bus

#### Including IEC-Bus Library for QuickBasic

```
REM ----- Include IEC-bus library for quickbasic -----
'$INCLUDE: 'c:\qbasic\qbdecl4.bas'
```

#### Initialization and Default Status

The IEC bus as well as the settings of the instrument are brought into a defined default status at the beginning of every program. Subroutines "InitController" and "InitDevice" are used to this effect.

##### Initiate Controller

```
REM ----- Initiate controller -----
REM InitController
iecaddress% = 20                                'IEC-bus address of the
                                                'instrument
CALL IBFIND("DEV1", analyzer%)                 'Open port to the instrument
CALL IBPAD(analyzer%, iecaddress%)             'Inform controller on instrument
                                                'address
CALL IBTMO(analyzer%, 11)                      'Response time to 1 sec
REM *****
```

##### Initiate Instrument

The IEC-bus status registers and instrument settings of the instrument are brought into the default status.

```
REM ----- Initiate instrument -----
REM InitDevice
CALL IBWRT(analyzer%, "*CLS")                  'Reset status register
CALL IBWRT(analyzer%, "*RST")                 'Reset instrument
REM*****
```

## Transmission of Instrument Setting Commands

Center frequency, span, and reference level of the instrument are set in this example.

```
REM ----- Instrument setting commands -----
CALL IBWRT(analyzer%, "FREQUENCY:CENTER 120MHz") 'Center frequency 120 MHz
CALL IBWRT(analyzer%, "FREQUENCY:SPAN 10MHZ")    'Span 10 MHz
CALL IBWRT(analyzer%, "DISPLAY:TRACE:Y:RLEVEL -10dBm")
                                                    'Reference level -10dBm
REM *****
```

## Switchover to Manual Control

```
REM ----- Switch instrument over to manual control -----
CALL IBLOC(analyzer%) 'Set instrument to Local state
REM *****
```

## Reading out Instrument Settings

The settings made in example 3 are read out here. The abbreviated commands are used.

```
REM ----- Reading out instrument settings -----
CFfrequency$ = SPACE$(20) 'Provide text variables (20 characters)
CALL IBWRT(analyzer%, "FREQ:CENT?") 'Request center frequency
CALL IBRD(analyzer%, CFfrequency$) 'Read value

CFspan$ = SPACE$(20) 'Provide text variables (20 characters)
CALL IBWRT(analyzer%, "FREQ:SPAN?") 'Request span
CALL IBRD(analyzer%, CFspan$) 'Read value

RLevel$ = SPACE$(20) 'Provide text variables (20 characters)
CALL IBWRT(analyzer%, "DISP:TRAC:Y:RLEV?")
                                                    'Request reference level
CALL IBRD(analyzer%, RLevel$) 'Read value

REM ----- Display values on the screen -----
PRINT "Center frequency: "; CFfrequency$,
PRINT "Span: "; CFspan$,
PRINT "Reference level: "; RLevel$,
REM *****
```

## Positioning a Marker and Displaying Values

```
REM ----- Examples of marker functions -----
CALL IBWRT(analyzer%, "CALC:MARKER ON;MARKER:MAX")
                                                    'Activate marker1 and start peak search
MKmark$ = SPACE$(30) 'Provide text variables (30 characters)
CALL IBWRT(analyzer%, "CALC:MARK:X?;Y?") 'Request frequency and level
CALL IBRD(analyzer%, MKmark$) 'Read value

REM ----- Display values on the screen -----
PRINT "Center frequency / level "; MKmark$,
REM *****
```

## Command synchronization

The possibilities for synchronization implemented in the following example are described in Chapter 5, Section "Command Order and Command Synchronization".

```

REM ----- Examples of command synchronization -----
REM The command INITiate[:IMMEDIATE] starts a single sweep if the command
REM INIT:CONT OFF was previously sent. It should be ensured that the next
REM command is only then executed when the entire sweep is complete.

CALL IBWRT(analyzer%, "INIT:CONT OFF")

REM ----- First possibility: Use of *WAI -----
CALL IBWRT(analyzer%, "ABOR;INIT:IMM; *WAI")

REM ----- Second possibility: Use of *OPC? -----
OpcOk$ = SPACE$(2)           'Space for *OPC? - Provide response
CALL IBWRT(analyzer%, "ABOR;INIT:IMM; *OPC?")
REM ----- here the controller can service other instruments -----
CALL IBRD(analyzer%, OpcOk$) 'Wait for "1" from *OPC?

REM ----- Third possibility: Use of *OPC -----
REM In order to be able touse the service request function in conjugation
REM with a National Instruments GPIB driver, the setting "Disable
REM Auto Serial Poll" must be changed to "yes" by means of IBCONF!

CALL IBWRT(analyzer%, "*SRE 32") 'Permit service request for ESR
CALL IBWRT(analyzer%, "*ESE 1")  'Set event-enable bit for
                                'operation-complete bit
ON PEN GOSUB OpcReady           'Initialization of the
                                'service request routine

PEN ON
CALL IBWRT(analyzer%, "ABOR;INIT:IMM; *OPC")

REM Continue main program here
STOP                            'End of program

OpcReady:
REM As soon as the sweep has ended, this subroutine is activated
REM Program suitable reaction to the OPC service request.
ON PEN GOSUB OpcReady           'Enable service request routine again
RETURN
REM *****

```

## Service Request

The service request routine requires an extended initialization of the instrument in which the respective bits of the transition and enable registers are set.

In order to use the service request function in conjugation with National Instruments GPIB driver, the setting "Disable Auto Serial Poll" must be changed to "yes" by means of IBCONF!

```

REM ---- Example of initialization of the SRQ in the case of errors -----
CALL IBWRT(analyzer%, "*CLS")           'Reset Status Reporting System
CALL IBWRT(analyzer%, "*SRE 168")      'Permit service request for
                                        'STAT:OPER, STAT:QUES and ESR
                                        'register
CALL IBWRT(analyzer%, "*ESE 60")      'Set event-enable bit for
                                        'command, execution, device-
                                        'dependent and query error
CALL IBWRT(analyzer%, "STAT:OPER:ENAB 32767") 'Set OPERation enable bit for
                                        'all events
CALL IBWRT(analyzer%, "STAT:OPER:PTR 32767") 'Set appropriate OPERation
                                        'Ptransition bits
CALL IBWRT(analyzer%, "STAT:QUES:ENAB 32767") 'Set questionable enable bits
                                        'for all events
CALL IBWRT(analyzer%, "STAT:QUES:PTR 32767") 'Set appropriate questionable
                                        'Ptransition bits
ON PEN GOSUB Srq                       'Initialization of the service
                                        'request routine

PEN ON
REM Continue main program here
STOP

```

A service request is then processed in the service request routine.

Note: the variables userN% and userM% must be pre-assigned usefully!

```

Srq:
REM ----- Service request routine -----
DO
  SRQFOUND% = 0
  FOR I% = userN% TO userM%           'Poll all bus users
    ON ERROR GOTO nouser              'No user existing
    CALL IBRSP(I%, STB%)             'Serial poll, read status byte
    IF STB% > 0 THEN                  'This instrument has bits set
                                        'in the STB
      SRQFOUND% = 1
      IF (STB% AND 16) > 0 THEN GOSUB Outputqueue
      IF (STB% AND 4) > 0 THEN GOSUB Failure
      IF (STB% AND 8) > 0 THEN GOSUB Questionablestatus
      IF (STB% AND 128) > 0 THEN GOSUB Operationstatus
      IF (STB% AND 32) > 0 THEN GOSUB Esrread
    END IF
  NEXT I%
nouser:
  LOOP UNTIL SRQFOUND% = 0
  ON ERROR GOTO error handling
  ON PEN GOSUB Srq: RETURN           'Enable SRQ routine again
                                        'End of SRQ routine

```

Reading out the status event registers, the output buffer and the error/event queue is effected in subroutines.

```

REM ----- Subroutines for the individual STB bits -----
Outputqueue:                                'Reading the output buffer
Message$ = SPACE$(100)                       'Make space for response
CALL IBRD(analyzer%, Message$)
PRINT "Message in output buffer :"; Message$
RETURN

Failure:                                    'Read error queue
ERROR$ = SPACE$(100)                          'Make space for error variable
CALL IBWRT(analyzer%, "SYSTEM:ERROR?")
CALL IBRD(analyzer%, ERROR$)
PRINT " Error text :"; ERROR$
RETURN

Questionablestatus:                          'Read questionable status register
Ques$ = SPACE$(20)                            'Preallocate blanks to text variable
CALL IBWRT(analyzer%, "STaTus:QUEStionable:EvEnt?")
CALL IBRD(analyzer%, Ques$)
PRINT "Questionable Status: "; Ques$
RETURN

Operationstatus:                             'Read operation status register
Oper$ = SPACE$(20)                            'Preallocate blanks to text variable
CALL IBWRT(analyzer%, "STaTus:OPERation:EvEnt?")
CALL IBRD(analyzer%, Oper$)
PRINT "Operation Status: "; Oper$
RETURN

Esrread:                                     'Read event status register
Esr$ = SPACE$(20)                             'Preallocate blanks to text variable
CALL IBWRT(analyzer%, "*ESR?")                'Read ESR
CALL IBRD(analyzer%, Esr$)
IF (VAL(Esr$) AND 1) > 0 THEN PRINT "Operation complete"
IF (VAL(Esr$) AND 4) > 0 THEN GOTO Failure
IF (VAL(Esr$) AND 8) > 0 THEN PRINT "Device dependent error"
IF (VAL(Esr$) AND 16) > 0 THEN GOTO Failure
IF (VAL(Esr$) AND 32) > 0 THEN GOTO Failure
IF (VAL(Esr$) AND 64) > 0 THEN PRINT "User request"
IF (VAL(Esr$) AND 128) > 0 THEN PRINT "Power on"
RETURN
REM *****

REM ----- Error routine -----
Error handling:
PRINT "ERROR"                                'Output error message
STOP                                          'Stop software

```

## Programming via the RSIB Interface

The following hints apply to both the 16-bit and the 32-bit DLL versions (RSIB.DLL and RSIB32.DLL) unless an explicit distinction is made.

The RSIB interface supports links to max. 16 measuring instruments at the same time.

### Visual Basic

#### Programming Hints:

- Access to RSIB.DLL functions

To generate Visual Basic control applications, the file RSIB.BAS for 16 bit basic programs or RSIB32.BAS for 32 bit basic programs (C:/R\_S/INSTR/RSIB) is added to a project to enable call-up of the RSIB.DLL or RSIB32.DLL functions.

- Declaration of DLL functions as procedures

All DLL functions return an integer value. All functions in the file RSIB.BAS are therefore declared as follows:

```
Declare Function RSDLLxxx Lib "rsib.dll" ( ... ) As Integer
```

The function value with the status variable `ibsta` must be assigned a variable for every call. Since this value is also returned via a reference parameter of the functions, it is possible to declare the functions as procedures in the following way:

```
Declare Sub RSDLLxxx Lib "rsib.dll" ( ... )
```

- Generation of reply buffer

Since the DLL returns zero-terminated strings as replies, a string of sufficient length must be generated before functions `RSDLLibrd()` and `RSDLLilrd()` are called because Visual Basic assigns the strings a length value which is not updated by the DLL. The string length data can be generated with one of the following:

```
-Dim Rd as String * 100  
-Dim Rd as String  
  Rd = Space$(100)
```

- Reading trace data in real format

When the function declarations of the file RSIB.BAS are used, replies from the instrument can be assigned to only one string. Trace data can be read faster and processing is simpler, however, if data are read in real format into float arrays. Data can be assigned to an array with float values as follows:

Function declaration of RSDLLibrd() in RSIB.BAS:

```
Declare Function RSDLLibrd Lib "rsib.dll" (ByVal ud%, ByVal Rd$,
    ibsta%, iberr%, ibcntl%) As Integer
```

To read data directly into an array with real numbers, the string variable must be replaced by a suitable structure which can be defined as follows:

```
Type TRACEREAL
    len As String * 6          ' Header of real data "#42000"
    Points(500) As Single     ' Float-Array
End Type
```

**Note:** the structure must be defined in a code module.

To be able to transfer the structure as a reference parameter to the DLL, a special function declaration must be created.

```
eg Declare Function RSDLLibrdTraceReal Lib "rsib.dll" Alias "RSDLLibrd"
    (ByVal ud%, rd as Any, ibsta%, iberr%, ibcntl%) As Integer
```

Using this function, trace data can be read into a reply buffer of the type TRACEREAL. This mechanism is operational only for 16-bit Basic versions. With 32-bit Basic programs the header and useful data must be read by means of two separate function calls.

### Programming examples:

- In the following example, the start frequency of the local instrument is queried.

```
Dim ibsta As Integer ' Status variable
Dim iberr As Integer ' Error variable
Dim ibcntl As Long ' Count variable
Dim ud As Integer ' Handle for measuring instrument
Dim Cmd As String ' Command string

' Setting up link to measuring instrument
ud = RSDLLibfind("@local", ibsta, iberr, ibcntl)
If (ud < 0) Then
    ' error handling
End If

' Sending query command to instrument
Cmd = "SENS:FREQ:STAR?"
If (RSDLLibwrt(ud, Cmd, ibsta, iberr, ibcntl) And IBSTA_ERR) Then
    ' error handling
End If

' Making space for response
Response = Space$(100)

' Querying response of instrument
If (RSDLLibrd(ud, Response, ibsta, iberr, ibcntl) And IBSTA_ERR) Then
    ' error handling
End If
```



- In the following example, save and recall of the instrument settings is made.

```

Dim ibsta As Integer      ' Status variable
Dim iberr As Integer     ' Error variable
Dim ibcntl As Long       ' Count variable
Dim ud As Integer        ' Handle for measuring instrument
Dim Cmd As String        ' Command string

' Setting up link to measuring instrument
  ud = RSDLLibfind("@local", ibsta, iberr, ibcntl)
  If (ud < 0) Then
    ' error handling
  End If

' Querying instrument settings
  Cmd = "SYST:SET?"
  RSDLLibwrt(ud, Cmd, ibsta, iberr, ibcntl) And IBSTA_ERR
' Saving response of instrument in file
  RSDLLibrdf(ud, "C:\db.sav", ibsta, iberr, ibcntl)

' Resetting the instrument
  RSDLLibwrt(ud, "*RST", ibsta, iberr, ibcntl)

' and recalling the previous settings
' Disabling END message for this purpose
  RSDLLibeot(ud, 0, ibsta, iberr, ibcntl) And IBSTA_ERR
' Sending command first
  RSDLLibwrt(ud, "SYST:SET ", ibsta, iberr, ibcntl) And IBSTA_ERR
' Enabling the END message
  RSDLLibeot(ud, 1, ibsta, iberr, ibcntl) And IBSTA_ERR
' and sending the data
  RSDLLibrwtf(ud, "C:\db.sav", ibsta, iberr, ibcntl)

```

## C / C++

### Programming Hint:

#### Access to RSIB.DLL functions

The functions of RSIB.DLL are declared in the header file RSIBC.H. The DLL functions can be incorporated in a C/C++ program in three different ways:

1. By generating the import library RSIB.LIB by means of IMPLIB.EXE from RSIB.DLL and adding the library to the project.
2. By specifying the functions of RSIB.DLL in the module definition file (\*.def) under IMPORTS.
3. By loading the library with the LoadLibrary() function while the program is running and determining the pointers of the DLL functions with GetProcAddress(). Prior to program end, RSIB.DLL must be freed with function FreeLibrary().

For the first two ways of incorporating a DLL, the latter will be automatically loaded immediately before the start of the application. At the end of the program, the DLL will be freed provided it is not used by other applications.

**Programming example:**

In the following C program, a single sweep is started on the instrument with the IP address 89.1.1.200 and a marker is set to the maximum level. Before the maximum level can be determined, the sweep must be terminated. Synchronization to the end of the sweep is made by triggering a service request at the end of the sweep with command "\*OPC" (operation complete). The control program waits for the SRQ with the function RSDLLWaitSrqr(). Then the maximum level is determined ("CALC:MARK:MAX") and the level is read out ("Y?"). Prior to readout a check is made with serial poll whether data are available (MAV bit set in status register

```
#define MAX_RESP_LEN 100

short          ibsta, iberr;
unsigned long  ibcntl;
short         ud;
short         srq;
char          Maxlevel[MAX_RESP_LEN];
char          spr;
// Determining the handle for the instrument
ud = RSDLLibfind( "89.1.1.200", &ibsta, &iberr, &ibcntl );

// If instrument exists
if ( ud >= 0 ) {

    // Setting timeout for RSDLLWaitSrqr() to 10 seconds
    RSDLLibtmo( ud, 10, &ibsta, &iberr, &ibcntl );

    // Activate SRQ generation through event status register (ESR)
    // and enable ESB bit of SRE register
    RSDLLibwrt( ud, "*ESE 1;*SRE 32", &ibsta, &iberr, &ibcntl );

    // Set single sweep, trigger sweep
    // and generate SRQ at the end of the sweep with "*OPC"
    RSDLLibwrt( ud, "INIT:CONT off;INIT;*OPC", &ibsta, &iberr, &ibcntl );

    // Wait for SRQ (end of sweep)
    RSDLLWaitSrqr( ud, &srq, &ibsta, &iberr, &ibcntl );

    // If sweep is terminated
    if (srq) {

        // Set marker to first maximum and query level
        RSDLLibwrt( ud, "CALC:MARK:MAX;Y?", &ibsta, &iberr, &ibcntl );
        // Check if data are available (MAV bit in status register set)
        RSDLLibrsp( ud, &spr, &ibsta, &iberr, &ibcntl );
        if (spr & 0x10) {
            // then read out data
            RSDLLilrd( ud, MaxPegel, MAX_RESP_LEN, &ibsta, &iberr, &ibcntl );
        }
    }
    // end connection to instrument
    RSDLLibonl( ud, 0, &ibsta, &iberr, &ibcntl );
}

else {
    ; // Error - instrument not found
}
}
```

## WinWord (Word Basic)

### Programming Hints:

- Access to RSIB.DLL functions

The functions of DLL `RSIB.DLL` can be utilized from a WinWord macro (WinWord 2.0/6.0) with certain restrictions. The function declarations for WinWord are defined in the module `rsibwb.bas` and must be copied into the macro when a WinWord macro is created.

- Examples of macros in the file RSIB.DOT

The following programming examples show examples of the macros `SetStartFreq` and `GetStartFreq`, by which setting commands are sent to the instrument or instrument settings can be queried. The two macros are contained in the document pattern `rsib.dot`.

- Restrictions for WinWord macros

Parameters of the integer type can be defined only as value parameters in the declaration of the DLL functions with the statement `Declare`. However, the functions of DLL `RSIB.DLL` expect, for the variables `ibsta`, `iberr` and `ibcntl`, references via which the DLL can return values to the caller. To be able to specify variable references for these parameters, the functions are to be declared with the string parameter type.

By declaring the variables `ibsta`, `iberr` and `ibcntl` as strings, attempts to access undefined memory ranges are avoided. This method, however, makes the querying of parameters more difficult. For example, the error code is returned in the event of an error in the variable `iberr`. In this process, the two bytes of the integer value are copied into the string. WinWord however does not use the length information to handle strings but expects a zero at the end of the string. Therefore, for an integer value whose low-byte is equal to zero, the high-byte will not be queried since the low-byte with the zero is regarded as the end of the string.

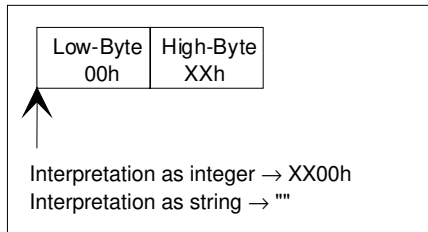

Problem of variable declaration in WinWord

Querying error variables with values other than zero is nevertheless possible since error codes with the first character being less than 100h can be queried (`iberr=ASC(iberr$)`).

Querying the status variable, on the other hand, is not possible in the manner described since the low-byte of the status variable is always zero. The status byte is however returned also by the DLL function value so that an error check can be made.

For the use of the DLL `RSIB.DLL` from WinWord, it would be expedient to generate a DLL whose interface functions are adapted to the capabilities of WinWord.

**Programming examples:**

- Sending a setting command

The macro `SetStartFreq` is used as an example for setting the start frequency of an instrument with the IP address 89.1.1.200. The macro first reads the desired value from an input box. The value is then set with the DLL function `RSDLLibwrt()` via an SCPI command.

```
' Declaration from file "rsibwb.bas":
  Declare Function RSDLLibfind Lib "rsib.dll" (udName$, ibsta$, iberr$,
  ibcntl$) As Integer
  Declare Function RSDLLibwrt Lib "rsib.dll" (ud As Integer, Wrt$, ibsta$,
  iberr$, ibcntl$) As Integer

Sub MAIN

  Dim ud, status
  Dim cmd$, value$
  Dim ibsta$, iberr$, ibcntl$

  ' Query the frequency to be set:
  value$ = InputBox$("Enter the start frequency:", "R&S-IECBUS-
  Interface")

  ' Generate SCPI command
  cmd$ = "SENS:FREQ:STAR" + value$

  // Determine the handle for the instrument
  ud = RSDLLibfind("89.1.1.200", ibsta$, iberr$, ibcntl$)
  If (ud < 0) Then
    MsgBox "Error in function RSDLLibfind" + Chr$(10) + "Errorcode:
    " + Str$(Asc(iberr$)), 'error', 48
    Goto End
  End If

  ' Send command to instrument parser
  status = RSDLLibwrt(ud, cmd$, ibsta$, iberr$, ibcntl$)
  If (status <> 0) Then
    MsgBox "Error in function RSDLLibwrt" + Chr$(10) + "Errorcode:
    " + Str$(Asc(iberr$)), 'error', 48
    Goto End
  End If

End:

End Sub
```

- Querying instrument setups

The macro `GetStartFreq` is used as an example for querying the start frequency of the local instrument and reading it into the current document. First, the SCPI query command is sent to the instrument with the function `RSDLLibwrt()`, then the value is fetched with the function `RSDLLibrd()`. A string of sufficient length is not required for reading the output buffer since WinWord, like language C, processes the string length by using the terminating zero rather than a prefixed length information as in Visual Basic.

```

' Declaration from file "rsibwb.bas"
Declare Function RSDLLibfind Lib "rsib.dll"(udName$, ibsta$, iberr$,
ibcntl$) As Integer
Declare Function RSDLLibwrt Lib "rsib.dll"(ud As Integer, Wrt$, ibsta$,
iberr$, ibcntl$) As Integer
Declare Function RSDLLilrd Lib "rsib.dll"(ud As Integer, Rd$, cnt As
Long, ibsta$, iberr$, ibcntl$) As Integer

Sub MAIN

    Dim ud, status
    Dim buffer$, cmd$
    Dim ibsta$, iberr$, ibcntl$

// Determine the handle for the instrument
    ud = RSDLLibfind("@local", ibsta$, iberr$, ibcntl$)
    If(ud < 0) Then
        MsgBox "Error in function ibfind" + Chr$(10) + "Errorcode: " +
Str$(Asc(iberr$)), 'error', 48
        Goto End
    End If

' Generate SCPI command for querying the start frequency
    cmd$ = "SENS:FREQ:STAR?"

' Send command to instrument parser
    status = RSDLLibwrt(ud, cmd$, ibsta$, iberr$, ibcntl$)
    If(status <> 0) Then
        MsgBox "Error in function ibwrt" + Chr$(10) + "Errorcode: " +
Str$(Asc(iberr$)), 'error', 48
        Goto End
    End If

' Read reply from parser
    status = RSDLLilrd(ud, buffer$, 10, ibsta$, iberr$, ibcntl$)
    If(status <> 0) Then
        MsgBox "Error in function ibrd" + Chr$(10) + "Errorcode: " +
Str$(Asc(iberr$)), 'error', 48
        Goto End
    End If

' Insert reply into document
    Insert buffer$ + "Hz"

End:
End Sub

```

## Excel

The use of DLL functions in the macro language of Excel 4.0 has not been examined. Excel 5.0 uses VBA (Visual Basic for Applications) as macro language, which can create Excel macros same as Visual Basic programs.

# Contents - Chapter 8 "Maintenance and Instrument Interfaces"

## 8 Maintenance and Instrument Interfaces

<b>Maintenance .....</b>	<b>8.1</b>
Mechanical Maintenance .....	8.1
Electrical Maintenance.....	8.1
Testing the Level Measuring Accuracy .....	8.1
Testing the Frequency Accuracy .....	8.1
<b>Instrument Interfaces .....</b>	<b>8.2</b>
IEC Bus Interface .....	8.2
Interface Characteristics.....	8.2
Bus Lines.....	8.3
Interface Functions.....	8.4
IEC Bus Messages.....	8.4
Interface Messages .....	8.4
Instrument Messages.....	8.5
RS-232-C Interface.....	8.6
Interface Characteristics.....	8.6
Signal Lines .....	8.6
Transmission Parameters .....	8.7
Handshake .....	8.8
RSIB Interface Functions.....	8.10
Variables ibsta, iberr, ibcntl .....	8.11
List of Interface Functions .....	8.12
Description of Interface Functions.....	8.13
User Interface (USER).....	8.19
Printer Interface (LPT) .....	8.20
Measurement Converters (PROBE CODE).....	8.21
Probe Connector (PROBE POWER).....	8.21
AF-Output (AF OUTPUT) .....	8.22
IF Output 21.4 MHz (21.4 MHz OUT) .....	8.22
Video Output (VIDEO OUT) .....	8.22
Reference Output/Input (EXT REF IN/OUT) .....	8.22
Sweep Output (SWEEP) .....	8.22
External Trigger Input (EXT TRIGGER/GATE) .....	8.22
Noise Source Control (NOISE SOURCE) .....	8.22
External Keyboard (KEYBOARD) .....	8.23
Mouse Connector (MOUSE).....	8.23
Monitor Connector (MONITOR).....	8.23



## 8 Maintenance and Instrument Interfaces

The following chapter contains information on the maintenance of the FSIQ and on the instrument interfaces.

The address of our support center and a list of all Rohde & Schwarz service centers can be found at the beginning of this manual.

### Maintenance

#### Mechanical Maintenance

The FSIQ does not require any mechanical maintenance. The front panel can be cleaned from time to time using a damp, soft cloth.

#### Electrical Maintenance

##### Testing the Level Measuring Accuracy

Due to the total calibration facility by means of the built-in calibration generator, high long-term stability of the level measuring characteristics is guaranteed. It is recommended to check the measuring accuracy every two years according to the performance test. Reprogramming of the correction data by a R&S servicing shop is necessary, if tolerances are exceeded.

##### Testing the Frequency Accuracy

The frequency accuracy of the reference oscillator is to be checked once a year according to section 5. It is not necessary to perform this test if the instrument is operated using an external reference.

Test utility: Frequency counter of signal generator

Test setup: Measurement with frequency counter  
Connect frequency counter to the REF OUT/IN socket at the rear of the instrument.

Measurement with signal generator  
Apply signal with 1GHz, -10dBm to RFin.

Measurement: Settings on FSIQ:

```
[CENTER      1000 MHz]
[SPAN        0 MHz]
[REF REF LEVEL -10 dBm]
[MARKER COUNT ON]
COUNTER RESOL 0.1 Hz]
```

Activate internal frequency counter (marker function)



## Instrument Interfaces

### IEC Bus Interface

The standard instrument is equipped with an IEC/IEEE Bus connector. An IEEE 488 interface connector is located on the rear panel of the FSIQ. An external controller for remote control of the instrument can be connected via the IEEE 488 interface connector using a shielded cable.

A further optional IEC/IEEE-bus interface can be installed in the FSIQ and is assigned to the computer. This interface can be controlled by standard software (R&S-Basic, QUICK-Basic, etc.). It enables the remote control of the instrument via an external link to the two IEC/IEEE-bus interfaces and in addition the control of other equipment via the IEC/IEEE-bus connector at the rear of the unit (eg control of a complete test setup).

The following section describes the first IEC Bus interface over which the instrument can be remotely controlled. The characteristics of the PC2A/PC-AT controller interface depend upon the user-installed software running on the processor and is, therefore, not described here.

### Interface Characteristics

- 8-bit parallel data transfer
- bidirectional data transfer
- three-line handshake
- high data transfer rate of max. 350 kbyte/s
- up to 15 instruments can be connected
- maximal length of the interconnecting cables 15 m (single connection, 2m)
- wired-OR connection if several instruments are connected in parallel.

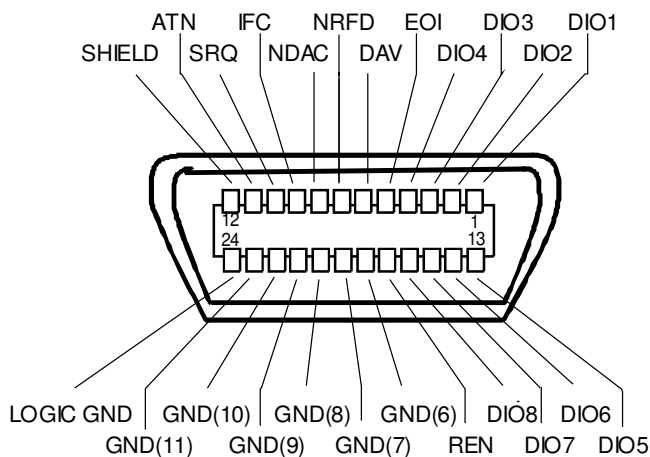

Fig. 8-1 Pin assignment of IEC-Bus interface

## Bus Lines

### 1. Data bus with 8 lines DIO 1 to DIO 8.

The transmission is bit-parallel and byte-serial in the ASCII/ISO code. DIO1 is the least significant, DIO8 the most significant bit.

### 2. Control bus with 5 lines.

**IFC** (Interface Clear),

active low resets the interfaces of the devices connected to the default setting.

**ATN** (Attention),

active low signals the transmission of interface messages

inactive high signals the transmission of device messages.

**SRQ (Service Request)**,

active low enables a device connected to send a service request to the controller.

**REN (Remote Enable)**,

active low permits the switch over to remote control.

**EOI (End or Identify)**,

has two functions in connection with ATN:

active low marks the end of data transmission when ATN=high

active low triggers a parallel poll when ATN=low.

### 3. Handshake bus with three lines.

**DAV** (Data Valid),

active low signals a valid data byte on the data bus.

**NRFD (Not Ready For Data)**,

active low signals that one of the devices connected is not ready for data transfer .

**NDAC (Not Data Accepted)**,

active low as long as the device connected is accepting the data present on the data bus.

## Interface Functions

Instruments which can be remote controlled via the IEC bus can be equipped with different interface functions. Table 8-1 lists the interface functions appropriate for the instrument.

Table 8-1 Interface functions

Control character	Interface function
SH1	Handshake source function (source handshake), full capability
AH1	Handshake sink function (acceptor handshake), full capability
L4	Listener function, full capability, deaddressed by MTA.
T6	Talker function, full capability, ability to respond to serial poll, deaddressed by MLA
SR1	Service request function (Service Request), full capability
PP1	Parallel poll function, full capability
RL1	Remote/Local switch over function, full capability
DC1	Reset function (Device Clear), full capability
DT1	Trigger function (Device Trigger), full capability
C12	Controller function, capability to send interface messages, to accept or relinquish the controller function

## IEC Bus Messages

The messages transferred via the data lines of the IEC bus can be divided into two groups:

- **interface messages**
- and
- **instrument messages.**

## Interface Messages

Interface messages are transferred on the data lines of the IEC Bus when the "ATN" control line is active (LOW). They are used for communication between controller and instruments and can only be sent by the controller which currently has control of the IEC Bus.

### Universal Commands

The universal commands are encoded 10 - 1F hex. They affect all instruments connected to the bus without addressing.

Table 8-2 Universal Commands

Command	QuickBASIC command	Effect on the instrument
DCL (Device Clear)	IBCMD (controller%, CHR\$(20))	Aborts the processing of the commands just received and sets the command processing software to a defined initial state. Does not change the instrument settings.
IFC (Interface Clear)	IBSIC (controller%)	Resets the interfaces to the default setting.
LLO (Local Lockout)	IBCMD (controller%, CHR\$(17))	The LOC/IEC ADDR key is disabled.
SPE (Serial Poll Enable)	IBCMD (controller%, CHR\$(24))	Ready for serial poll.
SPD (Serial Poll Disable)	IBCMD (controller%, CHR\$(25))	End of serial poll.
PPU (Parallel Poll Unconfigure)	IBCMD (controller%, CHR\$(21))	End of the parallel-poll state.

### Addressed Commands

The addressed commands are encoded 00 - 0F hex. They are only effective for instruments addressed as listeners.

Table 8-3 Addressed Commands

Command	QuickBASIC command	Effect on the instrument
SDC (Selected Device Clear)	IBCLR (device%)	Aborts the processing of the commands just received and sets the command processing software to a defined initial state. Does not change the instrument setting.
GTL (Go to Local)	IBLOC (device%)	Transition to the "Local" state (manual control).
PPC (Parallel Poll Configure)	IBPPC (device%, data%)	Configure instrument for parallel poll. Additionally, the QuickBASIC command executes PPE/PPD.

### Instrument Messages

Instrument messages are transferred on the data lines of the IEC bus when the "ATN" control line is not active. ASCII code is used.

Structure and syntax of the instrument messages are described in Chapter 5. The commands are listed and explained in detail in Chapter 6.

## RS-232-C Interface

The standard FSIQ is equipped with two serial interfaces (RS-232-C). The interfaces can be set up manually in the *SETUP-GENERAL SETUP* menu in the *COM PORT1/2* table.

Each of the active RS-232-C interfaces is assigned to one of the 9-pin connectors located on the rear panel. Interface 1 is assigned to the connector COM1 and Interface 2 is assigned to the connector COM2.

### Interface Characteristics

- Serial data transmission in asynchronous mode
- Bidirectional data transfer via two separate lines
- Transmission rate selectable from 110 to 19200 baud
- Logic '0' signal from +3 V to +15 V
- Logic '1' signal from -15 V to -3 V
- An external instrument (controller) can be connected.
- Software handshake (XON, XOFF)
- Hardware handshake

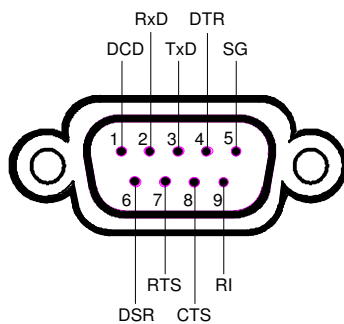

Fig. 8-2 Pin assignment of the RS-232-C interface

### Signal Lines

#### 1. Data lines

The data transmission is bit-serial in ASCII code starting with the LSB. Two lines, **RxD** and **TxD** are necessary as the minimum requirement for transmission; however, no hardware handshake is possible. For handshaking, only the XON/XOFF software handshake protocol can be used .

##### **RxD** (Receive Data)

Input, LOW = logic '1', HIGH = logic '0'.

Data line, local terminal receives data from remote station.

##### **TxD** (Transmit Data)

Output, LOW = logic '1', HIGH = logic '0'.

Data line, local terminal transmits data to remote station.

## 2. Control lines

**DCD** (Data Carrier Detect),  
Not used in FSIQ.

Input; active LOW.

Using this signal, the local terminal recognises that the modem of the remote station receives valid signals with sufficient level. DCD is used to disable the receiver in the local terminal and prevent reading of false data if the modem cannot interpret the signals of the remote station.

**DTR** (Data Terminal Ready),  
Output, active LOW,

Indicates that the local terminal is ready to receive data.

**DSR** (Data Set Ready),  
Input, active LOW,

Indicates that the remote station is ready to receive data.

**RTS** (Request To Send),  
Output, active LOW.

Indicates that the local terminal wants to transmit data.

**CTS** (Clear To Send),  
Input, active LOW.

Used to tell the local terminal that the remote station is ready to receive data.

**RI** (Ring Indicator),  
Not used in FSIQ.

Input, active LOW.

Used by a modem to indicate that a remote station wants to establish a connection.

## Transmission Parameters

To ensure error-free data transmission, the parameters of the instrument and the controller must have the same settings. The parameters are defined in the *SETUP-GENERAL SETUP* menu.

<b>Transmission rate (baud rate)</b>	the following transmission rates can be set in the analyzer: 110, 300, 600, 1200, 2400, 4800, 9600, 19200.
<b>Data bits</b>	Data transmission is in 7- or 8-bit ASCII code. The first bit transmitted is the LSB (least significant bit).
<b>Start bit</b>	Each data byte starts with a start bit. The falling edge of the start bit indicates the beginning of the data byte.
<b>Parity bit</b>	In order to detect errors, a parity bit may be transmitted. No parity, even parity or odd parity may be selected. In addition, the parity bit can be set to logic '0' or to logic '1'.
<b>Stop bits</b>	The transmission of a data byte is terminated by 1, 1,5 or 2 stop bits.

### Example:

Transmission of character 'A' (41 hex) in 7-bit ASCII code,  
with even parity and 2 stop bits:

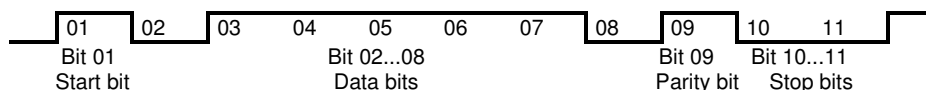

## Handshake

### Software handshake

In the software handshake mode of operation, the data transfer is controlled using the two control characters XON / XOFF.

The instrument uses the control character XON to indicate that it is ready to receive data. If the receive buffer is full, it sends the XOFF character via the interface to the controller. The controller then interrupts the data output until it receives another XON from the instrument. The controller indicates to the instrument that it is ready to receive data in the same way.

### Cable required for software handshake

The connection of the instrument with a controller for software handshake is made by crossing the data lines. The following wiring diagram applies to a controller with a 9-pin or 25-pin configuration.

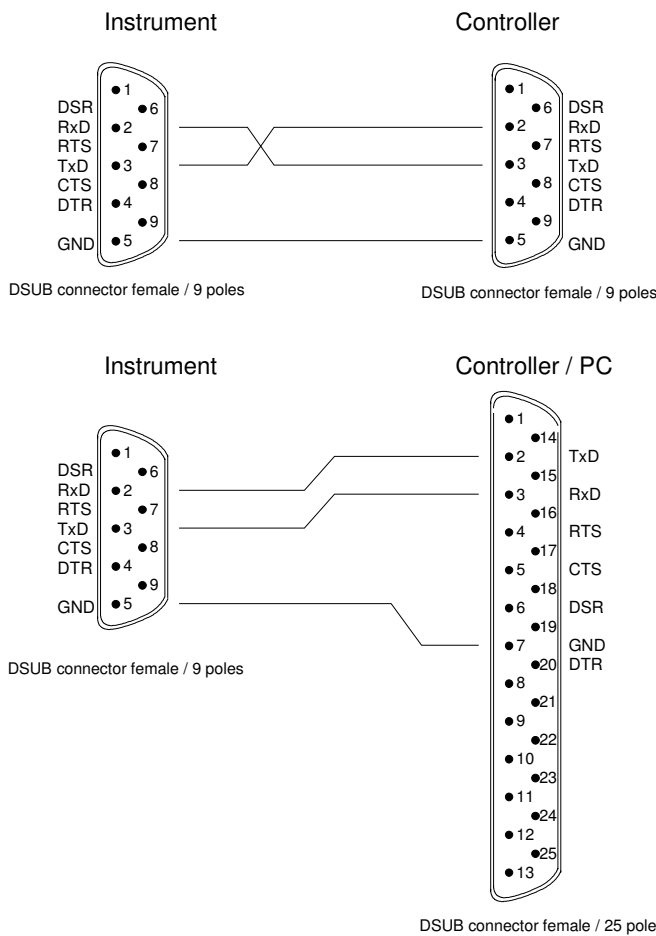

Fig. 8-3 Wiring of the data lines for software handshake

**Hardware handshake**

For hardware handshake, the instrument indicates that it is ready to receive data via the lines DTR and RTS. A logic '0' on both lines means 'ready' and a logic '1' means 'not ready'. The RTS line is always active (logic '0') as long as the serial interface is switched on. The DTR line thus controls the readiness of the instrument to receive data.

The readiness of the remote station to receive data is reported to the instrument via the CTS and DSR line. A logic '0' on both lines activates the data output and a logic '1' on both lines stops the data output of the instrument. The data output takes place via the TxD line.

**Cable for hardware handshake**

The connection of the instrument to a controller is made with a so-called zero modem cable. Here, the data, control and acknowledge lines must be crossed. The following wiring diagram applies to a controller with a 9-pin or 25-pin configuration.

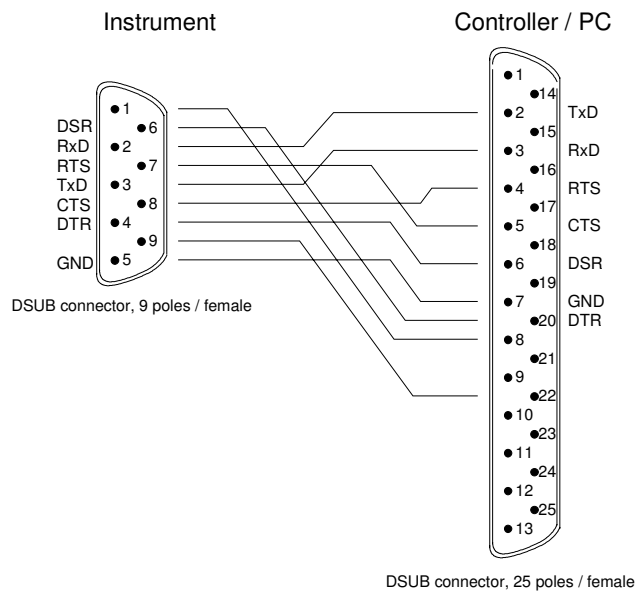
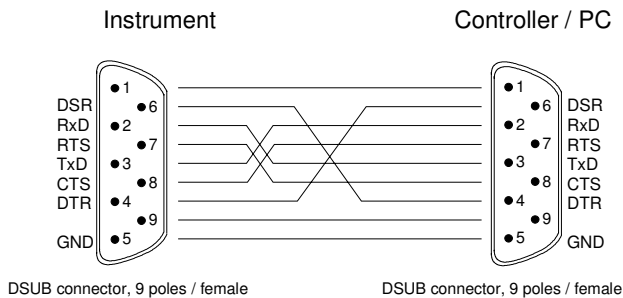

Fig. 8-4 Wiring of the data, control and acknowledge lines for hardware handshake



## RSIB Interface Functions

The RSIB interface allows the control of FSIQ by Windows applications WinWord and Excel or by Visual C++ and VisualBasic programs. The functions for the programming of control applications are provided by DLLs `RSIB32.DLL` (for 32-bit applications) and `RSIB.DLL` (for 16-bit applications).

Control applications may run locally on the measuring instrument as well as on a remote controller in a network. With local control, the name '@local' is specified for link setup by means of function `RSDLLibfind()`. If '@local' is not specified, the `RSIB.DLL` interprets the name as an IP address and attempts to set up a link to the device via the Winsock interface.

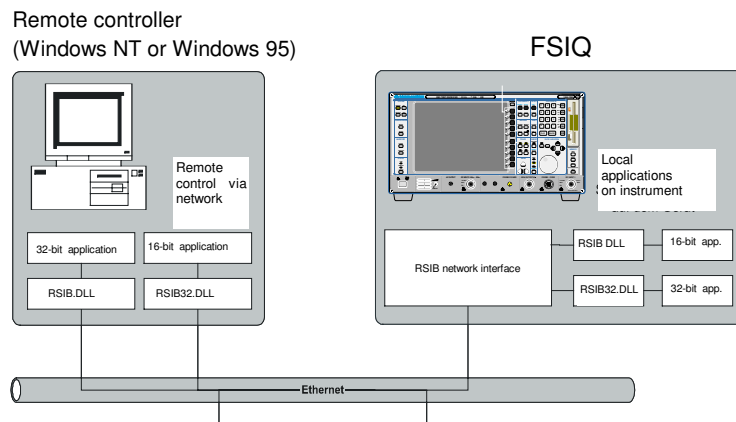

To access the measuring instruments via the RSIB interface the DLLs should be installed in the corresponding directories:

- `RSIB.DLL` in Windows NT `system` directory or control application directory.
- `RSIB32.DLL` in Windows NT `system32` directory or control application directory.

The DLLs are already installed in the corresponding directories on the measuring instruments.

For the different programming languages, files exist containing the declarations for the DLL functions and the error code definitions.

Visual Basic (16 bit):	'RSIB.BAS'	(C:/R_S/Instr/RSIB)
Visual Basic (32 bit):	'RSIB32.BAS'	(C:/R_S/Instr/RSIB)
C:	'RSIBC.H'	(C:/R_S/Instr/RSIB)
Winword:	'RSIBWB.BAS'	(C:/R_S/Instr/RSIB)

Thus, the RSIB directory features a program 'RSIBCNTN.EXE' with SCPI commands which can be sent to the instrument by the RSIB interface. This program can be used as a test for the function of the interface. Transit-time module `VBRUN3200.DLL` in the path or the Windows directory are required.

This following sections describe all functions of DLL 'RSIB.DLL' or by means of which control applications can be written.

## Variables `ibsta`, `iberr`, `ibcntl`

Same as with the National Instrument interface, successful execution of a command can be checked by means of the variables `ibsta`, `iberr` and `ibcntl`. To this end, references to the three variables are transferred to all RSIB functions. In addition, the status word `ibsta` is returned as a function value by all functions.

### Status word `ibsta`

All functions send back a status word that provides information on the status of the RSIB interface. The following bits are defined:

Bit name	Bit	Hex code	Description
ERR	15	8000	This bit is set if an error occurs during a function call. If this bit is set, <code>iberr</code> contains an error code which specifies the error.
TIMO	14	4000	This bit is set if a timeout occurs during a function call. A timeout may occur in the following situations: <ul style="list-style-type: none"> <li>while waiting for an SRQ with the function <code>RSDLLWaitSrq()</code>.</li> <li>if no acknowledgment is received for data sent to an instrument with <code>RSDLLibwrt()</code> or <code>RSDLLilwrt()</code>.</li> <li>if no response from server to a data request with function <code>RSDLLibrd()</code> or <code>RSDLLilrd()</code>.</li> </ul>
CMPL	8	0100	This bit is set if the reply of the IEC/IEEE-bus parser is completely read. If a reply of the parser is read with the function <code>RSDLLilrd()</code> and the buffer length is not sufficient, the bit is cleared.

### Error variable `iberr`

If the ERR bit (8000h) is set in the status word, `iberr` contains an error code that specifies the error. The RSIB has error codes of its own independent of the National Instrument interface.

Error	Error code	Description
IBERR_DEVICE_REGISTER	1	RSIB.DLL cannot register any new device.
IBERR_CONNECT	2	Link to the device has failed.
IBERR_NO_DEVICE	3	An interface function was called with an invalid device handle.
IBERR_MEM	4	No free memory available.
IBERR_TIMEOUT	5	Timeout has occurred.
IBERR_BUSY	6	The RSIB interface is blocked by a function not yet completed. Windows is not blocked, for example, by function <code>RSDLLibrd()</code> if data are still to be transmitted in response to this function. In this case a new call is possible. Further calls are however rejected by RSIB.DLL with error code <code>IBERR_BUSY</code> .
IBERR_FILE	7	Error in reading from or writing to a file.

### Count variable - `ibcntl`

The variable `ibcntl` is updated with the number of bytes transmitted on every read and write function call.

## List of Interface Functions

The DLL functions are matched to the interface functions for IEC/IEEE-bus programming from National Instruments. Functions supported by the DLLs are listed in the following table.

Function	Description
RSDLLibfind()	Provides a handle for accessing a device.
RSDLLibwrt()	Sends a string terminated with a null to a device.
RSDLLilwrt()	Sends a specific number of bytes to a device.
RSDLLibwrtf()	Sends the contents of a file to a device.
RSDLLibrd()	Reads data from a device into a string.
RSDLLilrd()	Reads a specific number of bytes from a device.
RSDLLibrdf()	Reads data from a device into a file.
RSDLLibtmo()	Sets timeout period for RSIB functions.
RSDLLibsre()	Switches a device to local or remote.
RSDLLibloc()	Switches a device temporarily to local.
RSDLLibeot()	Enables/disables END message in write operations.
RSDLLibrsp()	Starts a serial poll and reads the status byte
RSDLLibonl()	Switches the instrument online/offline
RSDLLTestSrqr()	Checks if a device has generated an SRQ.
RSDLLWaitSrqr()	Waits until a device generates an SRQ.

## Description of Interface Functions

### RSDLLibfind()

The function provides a handle for accessing the instrument with the name `udName`.

**VB format:**       Function RSDLLibfind (ByVal udName\$, ibsta%, iberr%, ibcntl&)  
                  As Integer

**C format:**       short FAR PASCAL RSDLLibfind( char far \*udName, short far  
                  \*ibsta, short far \*iberr, unsigned long far \*ibcntl)

**Parameter:**     udName               Instrument name

**Example:**       ud = RSDLLibfind ("@local", ibsta, iberr, ibcntl)

The function must be called before all other interface functions.

The function supplies a handle as a return value. The handle must be specified in all functions for accessing the instrument. If no instrument with the name `udName` is found, the handle will take on a negative value.

The local link on the instrument is established with the name '@local'. For setting up a link via a network, on the other hand, the IP address of the instrument must be given (eg '89.1.1.200')

### RSDLLibwrt

The function sends data to the instrument with the handle `ud`.

**VB format:**       Function RSDLLibwrt (ByVal ud%, ByVal Wrt\$, ibsta%, iberr%,  
                  ibcntl&) As Integer

**C format:**       short FAR PASCAL RSDLLibwrt( short ud, char far \*Wrt, short  
                  far \*ibsta, short far \*iberr, unsigned long far \*ibcntl )

**Parameter:**     ud                   Device handle  
                  Wrt                 String sent to the instrument.

**Example:**       RSDLLibwrt(ud, "SENS:FREQ:STAR?", ibsta, iberr, ibcntl)

The function allows setting and query commands to be sent to the measuring instruments. The function `RSDLLibeot()` is used for defining whether the data are interpreted as a complete command.

### RSDLLilwrt

The function sends `Cnt` bytes to the instrument with the handle `ud`.

**VB format:**       Function RSDLLilwrt (ByVal ud%, ByVal Wrt\$, ByVal Cnt&,  
                  ibsta%, iberr%, ibcntl&) As Integer

**C format:**       short FAR PASCAL RSDLLilwrt( short ud, char far \*Wrt,  
                  unsigned long Cnt, short far \*ibsta, short far \*iberr,  
                  unsigned long far \*ibcntl)

**Parameter:**     ud                   Device handle  
                  Wrt                 String sent to the IEC/IEEE-bus parser.  
                  Cnt                 Number of bytes sent to the instrument.

**Example:**       RSDLLilwrt (ud, '.....', 100, ibsta, iberr, ibcntl)

This function sends data to an instrument same as function `RSDLLibwrt()` but with the difference that binary data, too, can be sent. The length of the data is determined not by a zero-terminated string but by the definition of `Cnt` bytes. If the data are to be terminated with EOS (0Ah), the EOS byte must be appended to the string.

## RSDLLibwrtf

The function sends the contents of a file to the instrument with the handle `ud`.

**VB format:** Function RSDLLibwrtf (ByVal ud%, ByVal file\$, ibsta%, iberr%, ibcntl&) As Integer

**C format:** short FAR PASCAL RSDLLibwrtf( short ud, char far \*Wrt, short far \*ibsta, short far \*iberr, unsigned long far \*ibcntl )

**Parameter:** ud Device handle  
file File whose contents are sent to the instrument.

**Example:** RSDLLibrdf(ud, "C:\db.sav", ibsta, iberr, ibcntl)

The function allows setting and query commands to be sent to the measuring instruments. The function RSDLLibeot () is used for defining whether the data are interpreted as a complete command.

## RSDLLibrd()

The function reads data from the instrument into the string `Rd` with the handle `ud`.

**VB format:** Function RSDLLibrd (ByVal ud%, ByVal Rd\$, ibsta%, iberr%, ibcntl&) As Integer

**C format:** short FAR PASCAL RSDLLibrd( short ud, char far \*Rd, short far \*ibsta, short far \*iberr, unsigned long far \*ibcntl )

**Parameter:** ud Device handle  
Rd String into which the read data are copied.

**Example:** RSDLLibrd (ud, Rd, ibsta, iberr, ibcntl)

This function fetches replies of the IEC/IEEE-bus parser in response to a query command.

For this, a string of sufficient length must be generated when programming in Visual Basic. This can be accomplished in the definition of the string or with the command `Space$()`.

Generation of a string of the length 100:     - Dim Rd as String \* 100  
  - Dim Rd as String  
  Rd = Space\$(100)

## RSDLLilrd

The function reads `Cnt` bytes from the instrument with the handle `ud`.

**VB format:** Function RSDLLilrd (ByVal ud%, ByVal Rd\$, ByVal Cnt&, ibsta%, iberr%, ibcntl&) As Integer

**C format:** short FAR PASCAL RSDLLilrd( short ud, char far \*Rd, unsigned long Cnt, short far \*ibsta, short far \*iberr, unsigned long far \*ibcntl )

**Parameter:** ud Device handle  
cnt Maximum number of bytes copied to target string `Rd` by the DLL.

**Example:** RSDLLilrd (ud, RD, 100, ibsta, iberr, ibcntl)

The function reads data from an instrument same as function RSDLLibrd() but with the difference that here the maximum number of bytes is allowed to be copied to target string `Rd` to be defined with `Cnt`.

Writing beyond a string can thus be prevented with this function. The number of bytes cut off is lost.

## RSDLLibrdf()

Reads data from the instrument into the file `file` with the handle `ud`.

**VB format:** Function RSDLLibrdf (ByVal ud%, ByVal file\$, ibsta%, iberr%, ibcntl&) As Integer

**C format:** short FAR PASCAL RSDLLibrdf( short ud, char far \*file, short far \*ibsta, short far \*iberr, unsigned long far \*ibcntl )

**Parameter:** ud Device handle  
file File into which the read data are written.

**Example:** RSDLLibrdf (ud, c:\db.sav, ibsta, iberr, ibcntl)

This function serves to read replies of the IEC/IEEE-bus parser that are larger than 64 KB. The file name may include the drive and path.

## RSDLLibtmo

The function defines the timeout for an instrument. The default value for the timeout is 5 seconds.

**VB format:** Function RSDLLibtmo (ByVal ud%, ByVal tmo%, ibsta%, iberr%, ibcntl&) As Integer

**C format:** void FAR PASCAL RSDLLibtmo( short ud, short tmo, short far \*ibsta, short far \*iberr, unsigned long far \*ibcntl )

**Parameter:** ud Device handle  
tmo Time in seconds

**Example:** RSDLLibtmo (ud, 10, ibsta, iberr, ibcntl)

Timeout can occur in the following cases:

- Waiting for an SRQ with the function RSDLLWaitSrq().
- Waiting for an acknowledgment for data sent to an instrument with RSDLLibwrt() or RSDLLilwrt().
- Waiting for a reply to a data request made with function RSDLLibrd() or RSDLLilrd().

## RSDLLibsre

The function switches the instrument to LOCAL or REMOTE mode.

**VB format:** Function RSDLLibsre (ByVal ud%, ByVal v%, ibsta%, iberr%, ibcntl&) As Integer

**C format:** void FAR PASCAL RSDLLibsre( short ud, short v, short far \*ibsta, short far \*iberr, unsigned long far \*ibcntl)

**Parameter:** ud Device handle  
v Instrument status  
0 - local  
1 - remote

**Example:** RSDLLibsre (ud, 0, ibsta, iberr, ibcntl)

## RSDLLibloc

The function switches the instrument temporarily to LOCAL mode.

**VB format:** Function RSDLLibloc (ByVal ud%, ibsta%, iberr%, ibcntl%) As Integer

**C format:** void FAR PASCAL RSDLLibloc( short ud, short far \*ibsta, short far \*iberr, unsigned long far \*ibcntl)

**Parameter:** ud Device handle

**Example:** RSDLLibloc (ud, ibsta, iberr, ibcntl)

After switchover the instrument can be manually operated from the front panel. On the next access to the instrument by means of one of the functions of the RSIB.DLL, the instrument is switched again to the REMOTE state.

## RSDLLibeot

The function enables the END message after write operations or disables it.

**VB format:** Function RSDLLibeot (ByVal ud%, ByVal v%, ibsta%, iberr%, ibcntl%) As Integer

**C format:** void FAR PASCAL RSDLLibeot( short ud, short v, short far \*ibsta, short far \*iberr, unsigned long far \*ibcntl)

**Parameter:** ud Device handle.  
v 0 - no END message  
1 - send END message

**Example:** RSDLLibeot (ud, 1, ibsta, iberr, ibcntl)

If the END message is disabled, the data of a command can be sent by means of several successive write function calls. The END message must be enabled prior to the last data block.

## RSDLLibrsp

The function carries out a Serial Poll and outputs the instrument status.

**VB format:** Function RSDLLibrsp(ByVal ud%, spr%, ibsta%, iberr%, ibcntl%) As Integer

**C format:** void FAR PASCAL RSDLLibrsp( short ud, char far\* spr, short far \*ibsta, short far \*iberr, unsigned long far \*ibcntl)

**Parameter:** ud Device handle.  
spr Reference to status byte

**Example:** RSDLLibrsp(ud, spr, ibsta, iberr, ibcntl)

## RSDLLibonl

The function switches the instrument to the 'online' or 'offline' state. When switching to 'offline' the interface is enabled and the device handle made invalid. The next call of RSDLLibfind sets up the communication again.

**VB format:** Function RSDLLibonl (ByVal ud%, ByVal v%, ibsta%, iberr%, ibcntl&) As Integer

**C format:** void FAR PASCAL RSDLLibonl( short ud, short v, short far \*ibsta, short far \*iberr, unsigned long far \*ibcntl)

**Parameter:**

ud	Device handle.
v	Status of instrument
	0 - local
	1 - remote

**Example:** RSDLLibonl(ud, 0, ibsta, iberr, ibcntl)

## RSDLLTestSRQ

The function checks the status of the SRQ bit.

**VB format:** Function RSDLLTestSrq (ByVal ud%, Result%, ibsta%, iberr%, ibcntl&) As Integer

**C format:** void FAR PASCAL RSDLLTestSrq( short ud, short far \*result, short far \*ibsta, short far \*iberr, unsigned long far \*ibcntl)

**Parameter:**

ud	Device handle
result returns	Reference to an integer value in which the library the status of the SRQ bit.
	0 - no SRQ
	1 - SRQ active, instrument has output a service request

**Example:** RSDLLTestSrq (ud, result%, ibsta, iberr, ibcntl)

The function corresponds to the function RSDLLWaitSrq but with the difference that RSDLLTestSRQ returns immediately the current status of the SRQ bit whereas RSDLLWaitSrq waits for an SRQ to occur.





## User Interface (USER)

The user interface, located on the rear panel of the FSIQ, is a 25 pin Cannon connector which provides access to the two user ports (Port A and Port B). Each port is 8 bits wide (A0 - A7 and B0 -B7) and can be configured either as output or as input. The voltage levels are TTL levels (Low < 0,4 V, High > 2 V).

In addition, an internal +5 V power supply voltage is provided. The maximum load current is 100 mA.

The pin assignments for the USER connector can be seen in the following diagram:

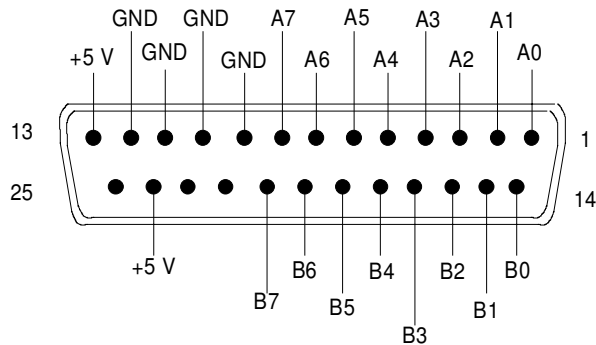
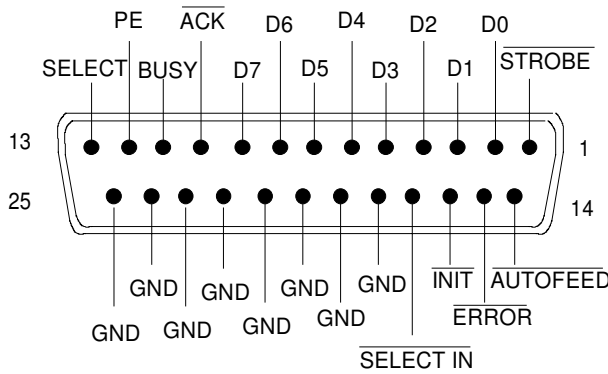

Fig. 8-5 Pin assignments for the USER connector.

The configuration of the user ports takes place in the *SETUP* menu (SETUP key) in the *GENERAL SETUP* sub-menu.

## Printer Interface (LPT)

The 25-pin LPT connector on the rear panel of the FSIQ is provided for the connection of a printer.. The LPT interface is compatible with the CENTRONICS printer interface.



Pin	Signal	Input (I) Output (O)	Description
1	STROBE	O	Pulse for transmitting a data byte, min. 1µs pulse width (active LOW)
2	D0	O	Data Line 0
3	D1	O	Data Line 1
4	D2	O	Data Line 2
5	D3	O	Data Line 3
6	D4	O	Data Line 4
7	D5	O	Data Line 5
8	D6	O	Data Line 6
9	D7	O	Data Line 7
10	ACK	I	Indicates that the printer is ready to receive the next byte. (active LOW)
11	BUSY	I	Signal is active when the printer cannot accept data. (active HIGH)
12	PE	I	Signal is active when the paper tray is empty. (active HIGH)
13	SELECT	I	Signal is active when the printer is selected. (active HIGH)
14	AUTOFEED	O	When signal is active, the printer automatically performs a linefeed after each line. (active LOW)
15	ERROR	I	This signal is high when the printer has no paper, is not selected or has an error status. (active LOW)
16	INIT	O	Initialise the printer. (active LOW)
17	SELECT IN	O	If signal is active, the codes DC1/DC3 are ignored by the printer. (active LOW).
18 - 25	GND		Ground connection.

Fig. 8-6 Pin assignments for the LPT connector.

## Measurement Converters (PROBE CODE)

The PROBE CODE connector is used for supplying power to measurement converters and the providing the correct conversion factor coding to the FSIQ. Using it, the conversion factors for high-impedance probes, current converters and antennas can be encoded in 10dB steps. In addition, the quantity to be measured (field strength, current and voltage) is also passed to the FSIQ. Active converters can be supplied with  $\pm 10$  V via the PROBE CODE connector. The following R&S accessories are deliverable with the applicable coding:

- Wide band dipole 20...80 MHz HUF-Z2
- HF current converter 100 kHz..30 MHz ESH2-Z1
- VHF current converter 20...300 MHz ESV-Z1
- Current converter 20 Hz...100 MHz EZ-17
- Preamplifier 20...1000 MHz ESV-Z2.

The pins of the PROBE CODE connector are assigned as follows:

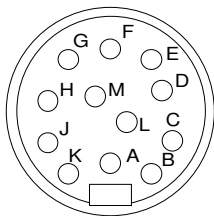

Pin	Signal
A	ground
B	+10 V, max. 50 mA
C	$\mu\text{V}/\text{m}$ (elec. field strength)
D	$\mu\text{A}$
E	10 dB
F	20 dB
G	40 dB
H	80 dB
K	- 10 V, max. 50 mA
M	factor sign inversion

Fig 8-7 Pin assignment for the 12-pin Tuchel connector.

A 12-pin connector is used for coding (manufacturer: Tuchel, R&S part number 0018.5362.00, Tuchel type number: T3635/2). The input pins for implementing the code are connected to ground.

**Example:** An antenna for measurement of the electromagnetic field strength has an antenna factor of 10 dB, i.e., a field strength of 10 dB $\mu\text{V}/\text{m}$  produces a voltage at the RF input of 0 dB $\mu\text{V}$ .  
-> Pins C and E are connected to ground.

## Probe Connector (PROBE POWER)

To allow the connection of probes, the FSIQ provides the PROBE POWER power connector. It delivers the power supply voltages +15 V and -12,6 V and ground.

The connector is also suited for powering the high-impedance probes from Hewlett Packard.

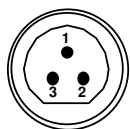

Pin	Signal
1	GND
2	-12,6 V; max 150 mA
3	+15 V; max 150 mA

## AF-Output (AF OUTPUT)

A miniature telephone jack can be used at the AF OUTPUT connector to connect an external loudspeaker, a headphone set or, e.g., a LF voltmeter. The internal resistance is 10 ohms and the output voltage can be controlled in the *MARKER DEMOD* menu. When a jack is plugged in, the internal loudspeaker is automatically turned off.

## IF Output 21.4 MHz (21.4 MHz OUT)

The 21,4 MHz IF signal of the FSIQ is available at the IF 21.4 MHz OUT BNC connector. The bandwidth corresponds to the selected bandwidth for a resolution bandwidth between 2 kHz and 10 MHz. For a resolution bandwidth below 2 kHz, the bandwidth of the output is 5 kHz.

The signal level at the IF output is 0 dBm for signals which correspond to the selected reference level.

## Video Output (VIDEO OUT)

The video output delivers the logarithmic envelope curve of the IF signal independent of the level scaling on the display screen (linear or logarithmic). The bandwidth of the video signal always corresponds to one-half of the IF bandwidth and is not limited by the video filter in the measurement path.

## Reference Output/Input (EXT REF IN/OUT)

When the FSIQ is operated with the internal reference, the internal 10 MHz reference signal is also available at the REF IN/OUT connector and thus provides the capability of, e.g., synchronisation of external instruments to the FSIQ. The level is 1 V RMS at 50 ohms source impedance.

For operation with an external reference, this connector becomes an input connector. The internal reference oscillator is then synchronised to the reference applied to the connector. The reference frequency can be between 1 and 16 MHz in 1 MHz steps. The necessary level is > 0 dBm.

The selection of internal or external references takes place in the *SETUP* menu.

## Sweep Output (SWEEP)

The SWEEP BNC connector delivers a saw-tooth voltage between - 5V and + 5 V which, for the frequency spectrum display, is proportional to the instantaneous frequency. The selected start frequency corresponds to a voltage of -5 V and the stop frequency corresponds to a voltage of +5 V.

## External Trigger Input (EXT TRIGGER/GATE)

The EXT TRIG/GATE connector is used for controlling the measurement via an external signal.

Trigger voltage range: -5 V ... +5 V

## Noise Source Control (NOISE SOURCE)

Using the NOISE SOURCE connector, an external noise source can be switched on/off, in order, e.g., to measure the noise figure of Units Under Test (UUTs). Usual noise sources require a +28 V signal to be turned on. At 0 V, they are turned off. These switching voltages are delivered by the connector.

### External Keyboard (KEYBOARD)

A 5-pin DIN connector is provided to allow connecting an external keyboard. Because of its low interference radiation, the PSA-Z1 keyboard is recommended (Order No. 1009.5001.31). However, any other multi-function keyboard may also be used.

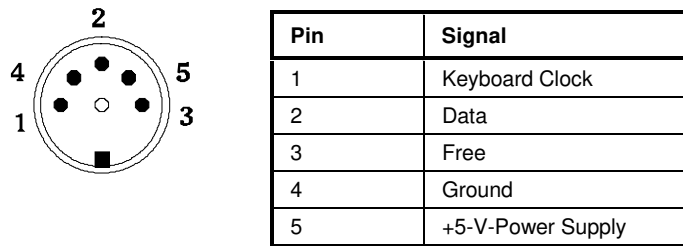

Fig. 8-8 Pin assignments of the KEYBOARD connector.

### Mouse Connector (MOUSE)

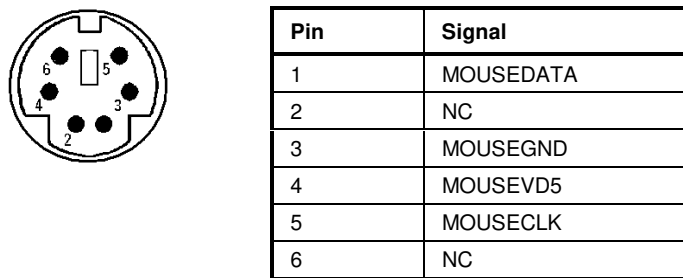

Fig 8-9 Pin assignments for the MOUSE connector.

### Monitor Connector (MONITOR)

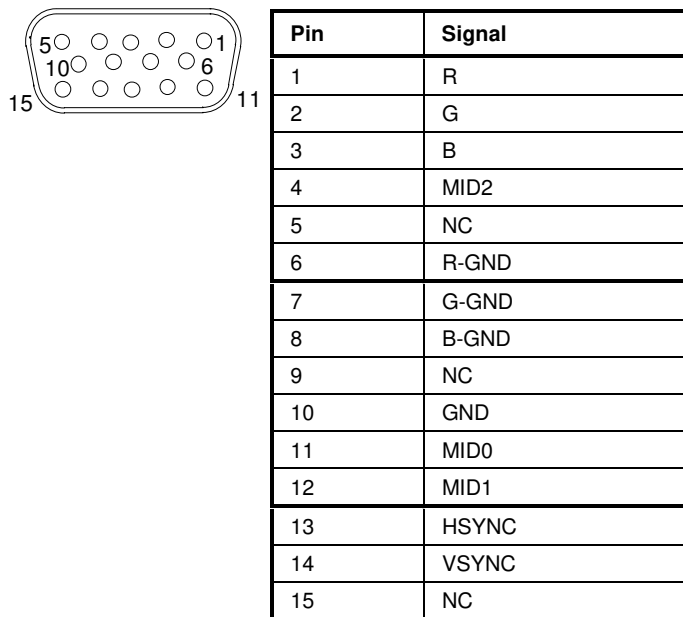

Fig. 8-10 Pin assignments of the MONITOR connector.



# Contents - Chapter 9 "Error Messages"

## 9 List of Error Messages

<b>SCPI-Specific Error Messages.....</b>	<b>9.1</b>
Command Error - Faulty command; sets bit 5 in the ESR register. ....	9.1
Execution Error - Error on execution of a command; sets bit 4 in the ESR register.....	9.4
Device Specific Error; sets bit 3 in the ESR register .....	9.7
Query Error - Error in data request; sets bit 2 in the ESR register .....	9.7





## 9 List of Error Messages

The following list contains the error messages for errors occurring in the instrument. The meaning of negative error codes is defined in SCPI, positive error codes mark errors specific of the instrument.

Error messages are entered in the error/event queue of the status reporting system in the remote control mode and can be queried with the command `SYSTem:ERRor?`. The answer format of FSIQ to the command is as follows:

`<error code>, "<error text with queue query>; <remote control command concerned>"`

The indication of the remote control command with prefixed semicolon is optional.

Example:

The command `"TEST:COMMAND"` generates the following answer to the query `SYSTem:ERRor?` :

`-113,"Undefined header;TEST:COMMAND"`

The table contains the error code in the left-hand column. In the right-hand column the error text being entered into the error/event queue or being displayed is printed in bold face. Below the error text, there is an explanation as to the respective error.

### SCPI-Specific Error Messages

No Error

Error code	Error text in the case of queue poll Error explanation
0	<b>No error</b> This message is output if the error queue does not contain any entries.

### Command Error - Faulty command; sets bit 5 in the ESR register.

Error code	Error text in the case of queue poll Error explanation
-100	<b>Command Error</b> The command is faulty or invalid.
-101	<b>Invalid Character</b> The command contains an invalid sign. Example: A header contains an ampersand, " <code>SENSe&amp;</code> ".
-102	<b>Syntax error</b> The command is invalid. Example: The command contains block data the instrument does not accept.
-103	<b>Invalid separator</b> The command contains an impermissible sign instead of a separator. Example: A semicolon is missing after the command.

Continuation: Command Error

Error code	Error text in the case of queue poll Error explanation
-104	<b>Data type error</b> The command contains an invalid value indication. Example: ON is indicated instead of a numeric value for frequency setting.
-105	<b>GET not allowed</b> A Group Execute Trigger (GET) is within a command line.
-108	<b>Parameter not allowed</b> The command contains too many parameters. Example: Command <b>SENSe:FREQuency:CENTer</b> permits only one frequency indication.
-109	<b>Missing parameter</b> The command contains too few parameters. Example: The command <b>SENSe:FREQuency:CENTer</b> requires a frequency indication.
-110	<b>Command header error</b> The header of the command is faulty.
-111	<b>Header separator error</b> The header contains an impermissible separator. Example: the header is not followed by a "White Space", " <b>*ESE255</b> "
-112	<b>Program mnemonic too long</b> The header contains more than 12 characters.
-113	<b>Undefined header</b> The header is not defined for the instrument. Example: <b>*XYZ</b> is undefined for every instrument.
-114	<b>Header suffix out of range</b> The header contains an impermissible numeric suffix. Example: <b>SENSe3</b> does not exist in the instrument.
-120	<b>Numeric data error</b> The command contains a faulty numeric parameter.
-121	<b>Invalid character in number</b> A number contains an invalid character. Example: An "A" in a decimal number or a "9" in an octal number.
-123	<b>Exponent too large</b> The absolute value of the exponent is greater than 32000.
-124	<b>Too many digits</b> The number includes too many digits.
-128	<b>Numeric data not allowed</b> The command includes a number which is not allowed at this position. Example: The command <b>INPut:COUPLing</b> requires indication of a text parameter.
-130	<b>Suffix error</b> The command contains a faulty suffix.
-131	<b>Invalid suffix</b> The suffix is invalid for this instrument. Example: nHz is not defined.
-134	<b>Suffix too long</b> The suffix contains more than 12 characters.

## Continuation: Command Error

Error code	Error text in the case of queue poll Error explanation
-138	<b>Suffix not allowed</b> A suffix is not allowed for this command or at this position of the command. Example: The command *RCL does not permit a suffix to be indicated.
-140	<b>Character data error</b> The command contains a faulty text parameter
-141	<b>Invalid character data</b> The text parameter either contains an invalid character or it is invalid for this command. Example: Write error with parameter indication;INPut:COUPling XC.
-144	<b>Character data too long</b> The text parameter contains more than 12 characters.
-148	<b>Character data not allowed</b> The text parameter is not allowed for this command or at this position of the command. Example: The command *RCL requires a number to be indicated.
-150	<b>String data error</b> The command contains a faulty string.
-151	<b>Invalid string data</b> The command contains a faulty string. Example: An END message has been received prior to the terminating apostrophe.
-158	<b>String data not allowed</b> The command contains a valid string at a position which is not allowed. Example: A text parameter is set in quotation marks, INPut:COUPling "DC"
-160	<b>Block data error</b> The command contains faulty block data.
-161	<b>Invalid block data</b> The command contains faulty block data. Example: An END message was received prior to reception of the expected number of data.
-168	<b>Block data not allowed</b> The command contains valid block data at an impermissible position. Example: The command *RCL requires a number to be indicated.
-170	<b>Expression error</b> The command contains an invalid mathematical expression.
-171	<b>Invalid expression</b> The command contains an invalid mathematical expression. Example: The expression contains mismatching parentheses.
-178	<b>Expression data not allowed</b> The command contains a mathematical expression at an impermissible position.
-180	<b>Macro error</b> A faulty macro has been defined, or an error has occurred during execution of a macro.
-181	<b>Invalid outside macro definition</b> A macro parameter placeholder was encountered outside of a macro definition.
-183	<b>Invalid inside macro definition</b> A macro definition is syntactically wrong.
-184	<b>Macro parameter error</b> A command inside the macro definition has the wrong number or type of parameters.

## Execution Error - Error on execution of a command; sets bit 4 in the ESR register

Error code	Error text in the case of queue poll Error explanation
-200	<b>Execution error</b> Error on execution of the command.
-201	<b>Invalid while in local</b> The command is not executable while the device is in local due to a hard local control. Example: The device receives a command which would change the rotary knob state, but the device is in local so the command can not be executed.
-202	<b>Settings lost due to rtl</b> A setting associated with hard local control was lost when the device changed to LOCS from REMS or to LWLS from RWLS.
-210	<b>Trigger error</b> Error on triggering the device.
-211	<b>Trigger ignored</b> The trigger (GET, *TRG or trigger signal) was ignored because of device timing considerations. Example: The device was not ready to respond.
-212	<b>Arm ignored</b> An arming signal was ignored by the device.
-213	<b>Init ignored</b> Measurement initialisation was ignored as another measurement was already in progress.
-214	<b>Trigger deadlock</b> The trigger source for the initiation of measurement is set to GET and subsequent measurement is received. The measurement cannot be started until a GET is received, but the GET would cause an interrupted-error)
-215	<b>Arm deadlock</b> The trigger source for the initiation of measurement is set to GET and subsequent measurement is received. The measurement cannot be started until a GET is received, but the GET would cause an interrupted-error.
-220	<b>Parameter error</b> The command contains a faulty or invalid parameter.
-221	<b>Settings conflict</b> There is a conflict between setting of parameter value and instrument state.
-222	<b>Data out of range</b> The parameter value lies out of the permissible range of the instrument.
-223	<b>Too much data</b> The command contains too many data. Example: The instrument does not have sufficient storage space.
-224	<b>Illegal parameter value</b> The parameter value is invalid. Example: The text parameter is invalid , <b>TRIGger : SWEEp : SOURce TASTe</b>

Continuation: Execution Error

Error code	Error text in the case of queue poll Error explanation
-230	<b>Data corrupt or stale</b> The data are incomplete or invalid. Example: The instrument has aborted a measurement.
-231	<b>Data questionable</b> The measurement accuracy is suspect.
-240	<b>Hardware error</b> The command cannot be executed due to problems with the instrument hardware.
-241	<b>Hardware missing</b> Hardware is missing. Example: An option is not fitted.
-250	<b>Mass storage error</b> A mass storage error occurred.
-251	<b>Missing mass storage</b> The mass storage is missing. Example: An option is not installed.
-252	<b>Missing media</b> The media is missing. Example: There is no floppy in the floppy disk drive.
-253	<b>Corrupt media</b> The media is corrupt. Example: The floppy is bad or has the wrong format.
-254	<b>Media full</b> The media is full. Example: There is no room on the floppy.
-255	<b>Directory full</b> The media directory is full.
-256	<b>File name not found</b> The file name cannot be found on the media.
-257	<b>File name error</b> The file name is wrong. Example: An attempt is made to copy to a duplicate file name.
-258	<b>Media protected</b> The media is protected. Example: The write-protect tab on the floppy is present.
-260	<b>Expression error</b> The expression contains an error.
-261	<b>Math error in expression</b> The expression contains a math error. Example: Divide-by-zero.

Continuation: Execution Error

Error code	Error text in the case of queue poll Error explanation
-270	<b>Macro error</b> Error on the execution of a macro.
-271	<b>Macro syntax error</b> The macro definition contains a syntax error.
-272	<b>Macro execution error</b> The macro definition contains an error.
-273	<b>illegal macro label</b> An illegal macro label is defined in the *DMC command. Example: The label is too long. The label is identical with the common command header or contains an invalid header syntax.
-274	<b>Macro parameter error</b> The macro definition improperly uses a macro parameter placeholder.
-275	<b>Macro definition too long</b> The macro definition is too long.
-276	<b>Macro recursion error</b> The command sequence defined by the macro is trapped in a program loop. Example: The event that would allow the loop to be exited does not occur.
-277	<b>Macro redefinition not allowed</b> The macro label defined in the *DMC command is already defined elsewhere.
-278	<b>Macro header not found</b> The macro label in the *GMC? query is not yet defined.
-280	<b>Program error</b> Error on the execution of a down-loaded program.
-281	<b>Cannot create program</b> The program cannot be created.
-282	<b>illegal program name</b> The name of the program is illegal. Example: The name relates to a non-existing program.
-283	<b>illegal variable name</b> The inputted variable does not exist in the program.
-284	<b>Program currently running</b> The desired operation is not possible while the program is running. Example: A running program cannot be deleted.
-285	<b>Program syntax error</b> The down-loaded program contains a syntax error.
-286	<b>Program runtime error</b>

**Device Specific Error; sets bit 3 in the ESR register**

<b>Error code</b>	<b>Error test in the case of queue poll</b> Error explanation
-300	<b>Device-specific error</b> FSIQ-specific error not defined in greater detail.
-310	<b>System error</b> This error message suggests an error within the instrument. Please inform the R&S Service.
-311	<b>Memory error</b> Error in the instrument memory.
-312	<b>PUD memory lost</b> Loss of the protected user data stored using the *PUD command.
-313	<b>Calibration memory lost</b> Loss of the non-volatile calibration data stored using the *CAL? command.
-314	<b>Save/recall memory lost</b> Loss of the non-volatile data stored using the *SAV command.
-315	<b>Configuration memory lost</b> Loss of the non-volatile configuration data stored by the instrument.
-330	<b>Self-test failed</b> The selftest could not be executed.
-350	<b>Queue overflow</b> This error code is entered in the queue instead of the actual error code if the queue is full. It indicates that an error has occurred but not been accepted. The queue can accept 5 entries.

**Query Error - Error in data request; sets bit 2 in the ESR register**

<b>Error code</b>	<b>Error text in the case of queue poll</b> Error explanation
-400	<b>Query error</b> General error occurring when data are requested by a query.
-410	<b>Query INTERRUPTED</b> The query has been interrupted. Example: After a query, the instrument receives new data before the response has been sent completely.
-420	<b>Query UNTERMINATED</b> The query is incomplete. Example: The instrument is addressed as a talker and receives incomplete data.
-430	<b>Query DEADLOCKED</b> The query cannot be processed. Example: The input and output buffers are full, the instrument cannot continue operation.
-440	<b>Query UNTERMINATED after indefinite response</b> A query is in the same command line after a query which requests an indefinite response.





## 10 Index

### Note:

- The softkeys are listed alphabetically under the keyword "Softkey".
- For each softkey, the page in chapter 6 containing the description of the corresponding remote command is quoted in addition.
- The assignment between IEEE-bus commands and softkeys is described in Chapter 6, Section "Table of Softkeys with IEC/IEEE-Bus Command Assignment".
- Chapter 6 contains an alphabetical list of all IEEE-bus commands

### A

Abort	
hardcopy .....	4.42
macro .....	4.41
ACP, absolut/relativ .....	4.102
Addressed command .....	8.5
Administrator identification .....	1.23
Adjacent channel power measurement .....	4.97
AF demodulation .....	4.18, 4.19
Alpha (roll-off factor) .....	4.214
Alphanumeric parameter, editing .....	3.17
AM signal .....	4.186
AM-demodulated time signal .....	4.186
Amplitude droop (sum error) .....	4.228
Amplitude modulation .....	4.201
Analog demodulation .....	4.179
Analysis bandwidth .....	4.234
Ascii # .....	5.14
Attenuator (tracking generator) .....	4.278
Audio signal .....	4.186
AUI connector .....	1.43
Average .....	4.140, 4.190
carrier power .....	4.249
single sweep .....	4.141
sweep count .....	4.140
value, display .....	4.121
Averaging .....	4.200, 4.262
continuous sweep .....	4.140
summary markers .....	4.249

### B

Bandwidth	
analog .....	4.264
analog demodulation .....	4.179
analog IF filters .....	4.180
channel .....	4.99
IF .....	4.264
occupied .....	4.106
resolution .....	4.153
video .....	4.154
Bandwidth/symbol period product .....	4.214
Beeper .....	4.39
Block data .....	5.14
BNC connector .....	1.42
Boolean parameter .....	5.13
BPSK .....	4.208
BT .....	4.214
Burst search .....	4.268

### C

Calibrate .....	4.9
Capture buffer .....	4.216, 4.231
CCITT filter .....	4.182
CD-ROM installation .....	1.34
CDPD .....	4.207, 4.209
Center frequency .....	4.70, 4.234
Channel	
bandwidth .....	4.99
power measurement .....	4.101
spacing .....	4.99
Characters, special .....	6.2
Clear/Write .....	4.139
Colon .....	5.14
COM1/2 interface .....	4.36
Comma .....	5.14
Command	
# .....	5.14
addressed .....	8.5
alphabetical list .....	6.217
assignment .....	6.233
colon .....	5.14
comma .....	5.14
header .....	5.10
line .....	5.12
list .....	6.217
long form .....	5.11
overlapping execution .....	5.17
query .....	5.12
question mark .....	5.12, 5.14
quotation mark .....	5.14
recognition .....	5.16
sequence .....	5.17
short form .....	5.11
structure .....	5.9
suffix .....	5.11
synchronization .....	5.17
syntax elements .....	5.14
universal .....	8.5
white space .....	5.14
Common commands .....	6.4
CONDition register part .....	5.19
Configuration .....	4.20
save .....	4.50
Constellation diagram .....	4.221
Controller function .....	1.23
Copy file .....	4.53
Coupling .....	4.152
DC or AC .....	4.183
default settings .....	4.155
define .....	4.158
CT2 .....	4.209
Cursor keys .....	3.14

**D**

D Lines	4.126, 4.252
D8PSK	4.208
DQPSK	4.208
Data set	
creation	4.58
partial	4.57
recall	4.58
save	4.54
Date	4.38
dB*/MHz	4.80
dB $\mu$ A/MHz	4.80
dB $\mu$ A/mMHz	4.80
dB $\mu$ V/MHz	4.80
dB $\mu$ V/mMHz	4.80
dBmV/MHz	4.80
DC coupling	4.183
DCL	5.16
DCS1800	4.209
Decision point	4.223
DECT standard	4.208
Deemphasis	4.185
Delete file	4.53
Delta marker	4.110, 4.244
step size	4.114
Demodulation	4.92
analog	4.179
bandwidth	4.179
digital	4.208
Detector	
autopeak	4.145
average	4.146
max peak	4.145
min peak	4.145
RMS	4.146
sample	4.146
Device reset (overall)	4.2
Differential PSK	4.205
Digital demodulator	4.208
Digital modulation methods	4.202
Digital standard	4.209
Directory	
create	4.53
rename	4.53
Disable	
front panel	3.19
keyboard	3.19
Diskette, format	4.53
Display	
configuration	4.3
mean value	4.121
range	4.237
rms value	4.121
Display mode	4.3
full screen	3.9
split Screen	3.8
Display width (eye diagram)	4.220, 4.223
DMSK	4.208
Driver software	1.37
ethernet adapter	1.43
firmware	1.36
printer	1.28
second IEC/IEEE-bus interface	1.38
service pack	1.37
Double dagger	5.14
DQPSK	4.208
Dynamic range	4.236

**E**

EDGE	4.204
Electrostatic discharge	1.20
ENABLE register part	5.19
Enhancement labels	3.6
Entry	
abortion	3.16
alphanumeric parameters	3.17
numeric parameter	3.16
table	3.18
termination	3.16
Entry window	3.15
mouse control	3.22
ERMES standard	4.209
Error	
constellation diagram	4.226
frequency	4.225
frequency (FSK)	4.226
magnitude	4.225
magnitude (FSK)	4.226
magnitude of error vector	4.226
phase	4.225
real and imaginary part	4.225
vector diagram	4.226
Error messages	9.1
Error signal	4.225
Error-queue query	5.33
ESE (event status enable register)	5.22
ESR (event status register)	5.22
Ethernet Adapter	1.42
EVENT register part	5.19
Event status enable register (ESE)	5.22
Event status register (ESR)	5.22
Ext Trig/Gate, input	8.22
External triggering	4.267
Eye diagram	4.219, 4.223
Eye length	4.220

**F**

FFT-Filter	4.156
File	
copy	4.53
delete	4.53
rename	4.53
sort	4.53
Filter	
input	4.212
reference	4.212
Find burst	4.268
Find sync	4.269
Firmware	
update	1.36, 4.40
version	4.13
FLEX	4.209
Floating averaging	4.200
FM signal	4.187
FM-demodulated time signal	4.187
Frame length	4.232
Free-running trigger	4.266
Frequency	
axis labelling	3.8
carrier	4.234
counter	4.94
demodulated signal	4.218, 4.223
error	4.225
error (FSK)	4.226, 4.230
error (sum error)	4.228
line	4.125

measurement window	4.67
offset	4.71, 4.234
setting	4.234
setting accuracy	4.234
shift keying	4.206
zoom	4.76
Front panel	
disable	3.19
keyboard emulation	3.21, 3.23
FSK	4.206, 4.209
deviation	4.214, 4.230
deviation error	4.230
FTP operation	1.53
Full screen	3.9
Fuse	1.21

**G**

GET (Group Execute Trigger)	5.16
Group mid-points	4.215
GSM	4.209

**H**

Handshake	8.8
Hardcopy	
abort	4.42
comments	4.47
format	4.49
output device	4.48
position	4.46
settings	4.44
start	4.42
Hardware options, installed	4.13
Hardware settings, indication	3.5
Header	5.10
Help line editor	3.17
High pass AF filter	4.182

**I**

I/Q diagram	4.221
I/Q imbalance (sum error)	4.229
I/Q modulation	4.290
I/Q offset (sum error)	4.229
IEC bus	
address	4.34
interface	8.2
interface functions	8.4
IF bandwidth	4.264
IF filter	4.180
Indication	
hardware settings	3.5
instrument settings	3.6
marker information	3.5
Inphase component	4.221
Input	
buffer	5.15
Ext Trig/Gate	8.22
external reference	8.22
filter	4.212
Instrument functions	4.1
Instrument settings, indication	3.6
Interfaces	8.2
functions	
IEC-bus	8.4
RSIB	8.10
Interrupt	5.32
IST flag	5.22

**K**

## Key

CAL	4.9
CENTER	4.70, 4.234
CONFIG	4.52
COUPLING	4.152, 4.264
cursor	3.14
D LINES	4.125, 4.251
DELTA	4.110, 4.244
DISPLAY	4.3
HOLD	3.19
INFO	4.13
INPUT	4.83
LIMITS	4.129, 4.254
LOCAL	4.41
MENU	3.12
MKR	4.123, 4.250
MODE	4.18, 4.175
NORMAL	4.88, 4.241
numeric keypad	3.13
PRESET	4.2, 6.209
RANGE	4.82, 4.196
RECALL	4.58
REF	4.77, 4.236
roll-key	3.14
SAVE	4.54
SEARCH	4.115
SETTINGS	4.44
SETUP	4.20
SPAN	4.74
START (frequency)	4.67
START (hardcopy)	4.42, 6.111
STEP	3.20
STOP	4.69
SWEEP	4.162, 4.265
TRACE	4.138, 4.261
TRIGGER	4.160, 4.266
USER	4.62

## Keyboard

connection	1.25
connector	8.23
disable	3.19
external	3.21

**L**

## Level

control, external	4.289
line	4.127, 4.252
maximum	4.78
mixer	4.84
offset (tracking generator)	4.278
range	4.82
reference	4.77
unit	4.79
LF demodulation	4.92

## Limit line

copy	4.132, 4.256
delete	4.132, 4.256
edit	4.133
save	4.137, 4.260
select	4.130, 4.254
shift	4.137
value	4.136, 4.260

## Line

display 1,2	4.127, 4.252
frequency 1, 2	4.127
limit	4.130, 4.253
reference	4.127, 4.252
threshold	4.127, 4.252
time 1, 2	4.127, 4.252

Login (NT controller).....	1.23
Logout (NT controller).....	1.23
Low pass AF filter.....	4.182
Lower case.....	6.2
LPT interface.....	8.20
<b>M</b>	
Macro	
abort.....	4.41
definition.....	4.64
start.....	4.62
Magnitude	
capture buffer.....	4.217
error.....	4.225, 4.226
error (FSK).....	4.230
error (sum error).....	4.228
measurement signal.....	4.218
peak.....	4.248
reference signal.....	4.218
Maintenance.....	8.1
Manual control	
switch to.....	4.41
return to.....	5.4
Marker.....	4.241
center.....	4.123
coupled.....	4.242
delta.....	4.110, 4.244
demodulation.....	4.93
indication.....	3.5
info.....	4.92
Marker ->.....	4.250
n-dB-down.....	4.119
normal.....	4.88
peak.....	4.116, 4.123
phase indication.....	4.242
polar diagram.....	4.242
search.....	4.115, 4.245
search limit.....	4.119, 4.246
signal track.....	4.91
step size.....	4.109
zoom.....	4.92
Max hold.....	4.141, 4.263
Mean.....	4.249
Mean power (GSM burst).....	4.121
Measurement	
converters, connector.....	8.21
curve	
minimum-value averaging.....	4.263
peak-value averaging.....	4.263
digital demodulation.....	4.216
filter.....	4.212
frequency-converting.....	4.287
save.....	4.50
signal, phase.....	4.218
transmission.....	4.279
window.....	4.3
Measuring time.....	4.192
Memory	
battery-powered.....	1.22
configuration.....	4.52
size.....	4.231
Menu switching.....	3.11
MICROSOFT NET.....	1.47
Min hold.....	4.141, 4.263
Minimum	
search.....	4.116
shift keying.....	4.207
value averaging.....	4.263
Mixer level.....	4.84
MODACOM.....	4.209
Mode.....	4.18
signal analysis.....	4.66
tracking generator.....	4.277
vector signal analysis.....	4.174
Modification level of modules.....	4.13
Modulation	
error.....	4.224
filter.....	4.99
I/Q.....	4.290
parameters.....	4.181, 4.211
summary.....	4.188
Monitor	
connecting.....	4.39
connection.....	1.26
connector.....	8.23
Mouse	
connection.....	1.24
connector.....	8.23
control.....	3.22
display elements.....	3.23
MSK.....	4.207, 4.208
<b>N</b>	
NADC (IS54).....	4.209
Network operating system	
FTP.....	1.53
MICROSOFT NET.....	1.47
NOVELL NETWARE.....	1.47
TCP/IP.....	1.52
Noise power density measurement.....	4.95
Normalization.....	4.215
NT controller.....	1.23
NTRansion register part.....	5.19
Number of sweeps.....	4.249
Numeric keypad.....	3.13
Numeric parameter, editing.....	3.16
Numerical values (command).....	5.13
Nyquist filter.....	4.214
<b>O</b>	
Offset frequency.....	4.71
Option	
FSE-B5 - FFT Filter.....	1.41
FSE-B8/9/10/11/12 - Tracking Generator.....	4.277
FSE-B13 - 1 dB Attenuator.....	2.86
FSE-B16 - Ethernet Adapter.....	1.42
FSE-B17 - Second IEC/IEEE-bus interface.....	1.38
FSE-B70 - DSP and IQ Memory Extension.....	1.54
OQPSK.....	4.208
Output	
AF.....	8.22
buffer.....	5.17
formats (digital demodulation).....	4.217
IF.....	8.22
level control.....	4.278
noise source control.....	8.22
reference.....	8.22
sweep.....	8.22
video out.....	8.22
<b>P</b>	
Parallel poll.....	5.32
Parallel poll enable register (PPE).....	5.22
Parameter	
block data.....	5.14
boolean.....	5.13
numerical values.....	5.13

- string ..... 5.14
  - text ..... 5.14
  - Password
    - Service ..... 4.33
    - Windows NT ..... 1.23
  - Path ..... 4.52
  - Pattern ..... 4.274
    - name ..... 4.275
    - selection ..... 4.274
  - PCS1900 ..... 4.209
  - PDC ..... 4.209
  - Peak ..... 4.248
    - excursion ..... 4.117
    - hold ..... 4.249
    - search ..... 4.116
  - Peak-value averaging ..... 4.263
  - Phase
    - error ..... 4.225
    - error (sum error) ..... 4.228
    - measurement ..... 4.218
    - shift ..... 4.218
    - shift keying ..... 4.203
    - wrap ..... 4.218
  - PHS ..... 4.209
  - PM signal ..... 4.187
  - Point of decision ..... 4.233
    - highlighting ..... 4.222
  - Points per symbol ..... 4.233
  - Polar diagram ..... 4.221
    - marker ..... 4.242
  - Power mean ..... 4.121
  - Power measurement
    - adjacent channel ..... 4.105
    - automatic optimisation of settings ..... 4.107
    - bandwidth, occupied ..... 4.106
    - channel ..... 4.101
    - channel configuration ..... 4.96
    - signal/noise ..... 4.103
  - PPE (parallel poll enable register) ..... 5.22
  - Preset ..... 4.2
  - Pre-trigger ..... 4.172
  - Print abort ..... 4.42
  - Printer connection ..... 1.28, 8.20
  - Probe Code connector ..... 8.21
  - Probe Power connector ..... 8.21
  - PSK ..... 4.203, 4.208
    - differential ..... 4.205
  - Ptransition register part ..... 5.19
- Q**
- QAM ..... 4.207
  - QPSK ..... 4.208
  - Quadrature amplitude modulation ..... 4.207
  - Quadrature component ..... 4.221
  - Quasi analog display ..... 4.146
  - Query ..... 5.12, 5.33
  - Question mark ..... 5.12, 5.14
  - Quotation mark ..... 5.14
- R**
- Rack installation ..... 1.21
  - Range ..... 4.196, 4.237
  - Real-time demodulation ..... 4.177, 4.192
  - Recall data set ..... 4.58
  - Reference
    - deviation ..... 4.214, 4.227
    - external ..... 4.31
    - filter ..... 4.212
    - level ..... 4.77, 4.235
  - level offset ..... 4.78, 4.237
  - line ..... 4.127, 4.252
  - modulation ..... 4.191
  - position ..... 4.239
  - signal (digital demodulation) ..... 4.213, 4.217
  - value ..... 4.191, 4.235
  - value position ..... 4.196, 4.239
  - value X/Y axis ..... 4.196, 4.237
  - Remote control
    - basics ..... 5.1
    - IEC-bus ..... 5.4
    - indication ..... 4.41, 5.3
    - RS-232-C ..... 5.5
    - RSIB ..... 5.6, 8.10
    - switch over ..... 5.3
  - Rename
    - directory ..... 4.53
    - file ..... 4.53
  - Reset device ..... 4.2
  - Resolution bandwidth ..... 4.153, 4.264
  - Result length ..... 4.200, 4.233, 4.265
  - RF attenuation
    - auto ..... 4.84
    - auto low distortion ..... 4.84
    - auto low noise ..... 4.84
  - RF input ..... 4.83
    - configuration ..... 4.240
  - Rho factor (sum error) ..... 4.230
  - RJ45 (star topology) ..... 1.43
  - Rms value ..... 4.248
    - display ..... 4.121
  - Roll-key ..... 3.14
  - Roll-off factor ..... 4.214
  - RS-232-C
    - interface ..... 8.6
    - transmission parameters ..... 8.7
- S**
- Save
    - configuration ..... 4.50
    - data set ..... 4.54
    - limit line ..... 4.137, 4.260
    - measurement ..... 4.50
  - Scaling
    - AF output ..... 4.193
    - unit ..... 4.239
    - vertical ..... 4.196, 4.237
  - SCPI introduction ..... 5.9
  - Screen ..... 3.2
    - split screen ..... 3.9
    - subdivision ..... 3.3
  - Search
    - limit ..... 4.119
    - minimum ..... 4.116
    - peak ..... 4.116
  - Self test ..... 4.15
  - Sensitivity AF output ..... 4.193
  - Serial poll ..... 5.32
  - Service functions ..... 4.32
  - Service request (SRQ) ..... 5.21, 5.32
    - indication ..... 4.41
  - Service request enable register (SRE) ..... 5.21
  - Setup ..... 4.20
    - general ..... 4.34
  - Side band ..... 4.184
  - SINAD measurement ..... 4.191
  - Slope ..... 4.195
  - Softkey
    - 50us ..... 4.185
    - 750us ..... 4.185

75us	4.185	COPY	4.53, 6.122
ACP STANDARD	4.98, 6.51	COPY (TRACE)	4.142; 6.212
ACTIVE MKR / DELTA	4.116, 4.246, 4.250	COPY LIMIT LINE	4.132, 4.256, 6.27
ACTIVE SCREEN A/B	4.4	COPY SCREEN	4.45, 6.111
ADJACENT CHAN POWER	4.105, 6.49, 6.50	COPY TABLE	4.45, 6.112
ADJUST CP SETTING	4.107, 6.186	COPY TRACE	4.45, 6.112
ADJUST TO TRACE	4.148	COUNTER RESOL	4.95, 6.39
AF COUPL'G AC/DC	4.183, 6.145	COUPLED MARKER	4.242, 6.39
AF SIGNAL	4.195, 6.213	COUPLING CONTROL	4.5, 6.119
ALL DELTA OFF	4.111, 4.244, 6.9	COUPLING DEFAULT	4.155, 6.150, 6.188
ALL MARKER OFF	4.91, 4.243, 6.38	COUPLING RATIO	4.158
ALL SUM MKR OFF	4.122, 4.249, 6.58	CP/ACP ABS/REL	4.102, 6.186
ALPHA/BT	4.214, 6.166	DATA ENTRY FIELD	4.8
AM	4.93, 6.44	DATA SET CLEAR	4.56, 6.126
AM SIGNAL	4.186, 6.18	DATA SET CLEAR ALL	4.56, 6.126
AM/FM DEEMPH	4.185, 6.173	DATA SET LIST	4.55
AMPERE	4.81, 6.61	DATAENTRY OPAQUE	4.8
ANALOG DEMOD	4.179, 6.118	DATAENTRY X	4.8
ANALOG TR ON/OFF	4.146, 6.94	DATAENTRY Y	4.8
ANALYZER	4.18, 4.66, 6.118	DATE	4.38, 6.208
APPEND NEW	4.149, 6.108	dB*/MHz	4.80, 6.61
area	3.10	dBm	4.80, 6.61
ASCII CONFIG	4.148, 6.107	dBmV	4.80, 6.61
ASCII EXPORT	4.148, 6.126	dBµA	4.80, 6.61
ATT SWITCHES	4.17, 6.84	dBµV	4.80, 6.61
ATTEN AUTO LOW DIST	4.84, 6.115	DECIM SEP	4.149, 6.107
ATTEN AUTO LOW NOISE	4.84, 6.115	DEEMPHASIS ON/OFF	4.185, 6.173
ATTEN AUTO NORMAL	4.84, 6.115	DEFAULT COLORS	4.7, 6.88
ATTEN STEP 1dB/10dB	4.85, 4.87, 6.116	DEFAULT CONFIG	4.57, 6.130
AUTO 0.1 * RBW	4.72, 6.175	DEFAULT POSITION	4.8
AUTO 0.1 * SPAN	4.72, 6.175	DEFINE MACRO	4.64
AUTO 0.5 * RBW	4.73, 6.175	DEFINE PAUSE	4.64
AUTO 0.5 * SPAN	4.73, 6.175	DELETE	4.53, 6.122, 6.125
AUTO X * RBW	4.73, 6.175	DELETE FACTOR/SET	4.23, 6.156, 6.158
AUTO X * SPAN	4.73, 6.175	DELETE LIMIT LINE	4.132, 4.256, 6.28
AUTO RECALL	4.59, 6.123	DELETE MACRO	4.65
AUTO SELECT	4.145, 6.162	DELETE PATTERN	4.274
AVERAGE	4.140, 4.262, 6.93, 6.148	DELETE VALUE (limit line)	4.136, 4.260
AVERAGE ON/OFF	4.122, 6.58	DELTA 1 to 4	4.110, 6.8, 6.9, 6.10
AVERAGE/HOLD ON	4.190, 4.249, 6.182	DELTA 1/2	4.244
BASELINE CLIPPING	4.128, 6.15	DELTA ABS REL	4.111, 4.244, 6.9
BLANK	4.139, 4.261, 6.94	DELTA TO STEPSIZE	4.109
BRIGHTNESS	4.6, 6.88	DEMOD BANDWIDTH	4.179, 4.180; 6.151
C/N	4.103, 6.49, 6.50	DETECTOR	4.145
C/No	4.103, 6.49, 6.50	DETECTOR AUTOPEAK	4.145, 6.162
CAL CORR ON/OFF	4.11, 6.63	DETECTOR AVERAGE	4.146, 6.162
CAL I/Q	4.10, 6.62	DETECTOR MAX PEAK	4.145, 6.162
CAL LO SUPP	4.10, 6.63	DETECTOR MIN PEAK	4.145, 6.162
CAL LOG	4.10, 6.63	DETECTOR RMS	4.146, 6.162
CAL REFL OPEN	4.285, 6.153	DETECTOR SAMPLE	4.146, 6.162
CAL REFL SHORT	4.285, 6.153	DIGITAL DEMOD	4.208, 6.118, 6.164, 6.165, 6.170
CAL RES BW	4.10, 6.62	DIGITAL STANDARD	4.209, 6.170
CAL RESULTS	4.12	DISABLE ALL ITEMS	4.57, 4.61, 6.130
CAL SHORT	4.10, 6.63	DISPLAY COMMENT	4.7, 6.89
CAL TOTAL	4.10, 6.62	DISPLAY LINE 1/2	4.127, 4.252, 6.14
CENTER FIXED	4.68, 4.69, 4.75, 6.176, 6.177	D-LINES	4.252
CENTER MANUAL	4.70, 6.174	EDIT ACP LIMITS	4.100, 6.33, 6.34
CH FILTER ON/OFF	4.99, 6.51	EDIT COMMENT	4.55, 6.130
CHANNEL BANDWIDTH	4.99, 6.185	EDIT LIMIT LINE	4.134, 4.258, 6.22, 6.23, 6.24, 6.25, 6.26, 6.27
CHANNEL POWER	4.101, 6.49, 6.50	EDIT NAME	4.55, 4.59, 6.123, 6.125
CHANNEL SPACING	4.99, 6.184, 6.185	EDIT PATH	4.52, 4.55, 4.59, 4.149, 6.121, 6.124
CLEAR ALL MESSAGES	4.16	EDIT SYNC PATTERN	4.275, 6.168
CLEAR MESSAGE	4.16, 6.209	EDIT TRD FACTOR	4.24, 6.155
CLEAR/WRITE	4.139, 4.261, 6.93	EDIT TRD SET	4.27, 6.157
COLOR ON/ OFF	4.45, 6.110	ENABLE ALL ITEMS	4.57, 4.61, 6.130
COM PORT 1/2	4.36, 6.206, 6.207	ENABLE DEV1 / DEV2	4.49
COMMENT (SYNC PATTERN)	4.275, 6.168	ENABLE OPTION	4.31
COMMENT SCREEN A/B	4.47, 6.112	ENTER PASSWORD	4.33, 6.209
CONFIG	4.148	ENTER TEXT	4.47
CONFIG DISPLAY	4.6	ERROR SIGNAL	4.225, 6.18
CONTINUOUS SWEEP	4.162, 4.199, 4.265, 6.114		
CONTINUOUS WRITE	4.262, 6.93		

ERROR VECT MAGNITUDE.....	4.226, 6.18	LOCK DATA .....	3.19
EXCLUDE LO ON/OFF .....	4.117, 6.39	LOG MANUAL .....	4.82, 6.91, 6.93
EXECUTE TESTS.....	4.15, 6.6	LOG 10dB/20dB/50dB/100dB/120dB .....	4.82
EXT ALC .....	4.289, 6.193	LOGO ON/OFF .....	4.7, 6.87
EXT AM .....	4.289, 6.193	LOW PASS AF FILTER .....	4.182, 6.172
EXT FM .....	4.289, 6.193	LOWER LEFT .....	4.46, 6.113
EXT I/Q .....	4.290, 6.193	LOWER RIGHT.....	4.46, 6.113
EXT REF FREQUENCY.....	4.31, 6.187	MACRO 1 to 7.....	4.63
EXTERN .....	4.161, 4.194, 4.267 6.213	MACRO TITLE.....	4.65
EYE DIAG [FREQ] .....	4.223, 6.19	MAGNITUDE .....	4.218, 4.222,4.225, 6.19
EYE DIAG [I] .....	4.219, 6.19	MAGNITUDE CAP BUFFER.....	4.21, 76.18
EYE DIAG [Q] .....	4.219, 6.19	MAIN PLL BANDWIDTH.....	4.157, 6.151
EYE DIAG TRELLIS.....	4.219, 6.19	MAKE DIRECTORY.....	4.53, 6.124
EYE LENGTH.....	4.220, 4.223, 6.95	MARKER 1 to 4.....	4.89, 4.241, 6.37, 6.38, 6.39
FIND BURST ON/OFF .....	4.268, 6.167	MARKER DEMOD .....	4.93
FIND SYNC ON/OFF.....	4.269, 6.168	MARKER INFO.....	4.92, 4.243, 6.13, 6.43, 6.44, 6.46, 6.49, 6.50, 6.52, 6.53, 6.54, 6.55, 6.56, 6.57, 6.89
FIRMWARE UPDATE .....	4.40	MARKER ZOOM.....	4.92, 6.44
FIRMWARE VERSION.....	4.13, 6.5	MAX  PEAK .....	4.246, 4.248, 6.10, 6.40, 6.52
FM .....	4.93, 6.44	MAX HOLD.....	4.141, 4.263, 6.93, 6.148
FM SIGNAL.....	4.187, 6.18	MAX LEVEL AUTO.....	4.78, 6.92
FORMAT DISK .....	4.53, 6.123	MAX LEVEL MANUAL .....	4.78, 6.92
FRAME LENGTH .....	4.232, 6.169	MEAN.....	4.121, 4.249, 6.57
FREE RUN.....	4.160, 4.194, 4.266, 6.213	MEAS FILTER .....	4.212, 6.166
FREQ AXIS LIN/LOG .....	4.68, 6.91	MEAS ONLY IF SYNC'D.....	4.267, 6.169
FREQUENCY .....	4.225, 6.19	MEAS RESULT.....	4.186, 4.216
FREQUENCY (FSK demodulation).....	4.223, 6.19	MEAS SIGNAL .....	4.217, 6.18
FREQUENCY (MSK demodulation).....	4.218, 6.19	MEAS→REF.....	4.191, 6.183
FREQUENCY LINE 1/2.....	4.127, 6.16	MEMORY SIZE.....	4.231, 6.170
FREQUENCY OFFSET.....	4.71, 4.234, 4.287, 6.177	MIN.....	4.116, 4.246, 6.11, 6.41
FREQUENCY ON/OFF .....	4.7, 6.87	MIN HOLD .....	4.141, 4.263, 6.93, 6.148
FSE MODE ON/OFF .....	4.40, 6.209	MIXER LEVEL .....	4.84, 6.117
FSK REF DEVIATION.....	4.214, 6.19	MKR -> CENTER.....	4.123, 6.58
FULL PAGE .....	4.46, 6.113	MKR -> CF STEPSIZE.....	4.124, 6.58
FULL SCREEN.....	4.4, 6.87	MKR -> REF LEVEL .....	4.124, 6.59
FULL SPAN.....	4.74, 6.176	MKR -> START.....	4.124, 6.59
GAP LENGTH.....	4.173, 6.191	MKR -> STOP.....	4.124, 6.59
GAP SWEEP ON/OFF .....	4.171, 6.190	MKR ->TRACE .....	4.124, 4.250, 6.9, 6.38
GAP SWEEP SETTINGS.....	4.172	MKR DEMOD ON/OFF .....	4.93, 6.45
GATE ADJUST.....	4.168	MKR STOP TIME.....	4.93, 6.45
GATE DELAY.....	4.167, 6.190	MKR TO STEPSIZE.....	4.109, 6.59
GATE EXTERN.....	4.167, 6.190	MODE COUPLED.....	4.5, 6.119
GATE LENGTH.....	4.167, 6.190	MODULATION.....	4.288
GATE LEVEL .....	4.166, 6.189	MODULATION PARAMETERS.....	4.181, 4.211
GATE MODE LEVEL/EDGE.....	4.166, 6.189	MODULATION SUMMARY.....	4.188, 6.18, 6.46, 6.47, 6.48
GATE ON / OFF .....	4.165, 6.189	MONITOR CONNECTED.....	4.39
GATE POL .....	4.166, 6.190	MOVE ZOOM START.....	4.76, 6.90
GATE RF POWER .....	4.167, 6.190	MOVE ZOOM STOP.....	4.76, 6.90
GATE SETTINGS.....	4.166	MOVE ZOOM WINDOW.....	4.76, 6.90
GENERAL SETUP .....	4.34	N dB DOWN .....	4.119, 6.43
GPIB ADDRESS .....	4.34, 6.205	NAME (limit line) .....	4.135, 4.259, 6.28
GRID ABS/REL .....	4.78, 4.82, 6.91	NAME (SYNC PATTERN).....	4.275; 6.168
HARDCOPY DEVICE.....	4.48, 6.110	NEW FACT/SET.....	4.24, 4.27, 6.154, 6.156
HARDWARE+OPTIONS .....	4.14, 6.5	NEW LIMIT LINE .....	4.134, 4.258
HEADER ON/OFF.....	4.149, 6.108	NEW SYNC PATTERN.....	4.275, 6.168
HIGHPASS AF FILTER.....	4.182, 6.171	NEXT MIN.....	4.117, 6.11, 6.41
HOLD CONT ON/OFF.....	4.142, 6.94	NEXT MIN LEFT.....	4.117, 6.11, 6.41
HORIZONTAL SCALING.....	4.5, 6.119	NEXT MIN RIGHT.....	4.117, 6.11, 6.41
IF BANDWIDTH .....	4.180	NEXT PEAK.....	4.116, 6.10, 6.40
IF BW AUTO .....	4.180, 4.264, 6.150	NEXT PEAK LEFT.....	4.116, 6.11, 6.40
IF BW MANUAL .....	4.180, 4.264, 6.149	NEXT PEAK RIGHT.....	4.116, 6.10, 6.40
INDICATION ABS REL.....	4.191, 6.182	NOISE .....	4.95, 6.44
INPUT CAL .....	4.32, 6.84	NOISE SOURCE .....	4.32, 6.84
INPUT RF.....	4.32, 6.84	NORMALIZE.....	4.215, 4.281, 6.167
INSERT VALUE (limit line) .....	4.136, 4.260	OCCUPIED PWR BANDW .....	4.106, 6.49, 6.50
KEY CLICK ON/OFF.....	4.39	OPTIONS.....	4.14, 4.31, 6.5
LAST SPAN .....	4.75	PEAK.....	4.116, 4.246, 6.10, 6.40
LIMIT CHECK.....	4.100, 6.32, 6.33, 6.34	+PEAK .....	4.248, 6.53
LINE (trigger).....	4.160, 6.213	±PEAK .....	4.248, 6.55
LINEAR/%.....	4.82, 6.93	-PEAK.....	4.248, 6.54
LINEAR/dB.....	4.82, 6.93		
LOCK ALL.....	3.19		



PEAK EXCURSION .....	4.117, 6.42	SELECT OBJECT .....	4.6
PEAK HOLD ON/OFF .....	4.122, 4.249, 6.58	SELECT PATTERN .....	4.274
PHASE .....	4.218, 4.225, 6.19	SELECT QUADRANT .....	4.46
PHASE NOISE .....	4.113, 6.12	SELFTTEST .....	4.15, 6.6
PHASE WRAP ON/OFF .....	4.218, 6.19	SENSITIV AF OUTPUT .....	4.193, 4.197, 6.132
PM SIGNAL .....	4.187, 6.18	SERVICE .....	4.32, 6.84
POINTS PER SYMBOL .....	4.233, 6.166	SET CP REFERENCE .....	4.102, 6.186
POLAR [IQ] CONSTELL .....	4.221, 4.226, 6.19	SET NO. OF ADJ CHAN'S .....	4.97, 6.185
POLAR [IQ] VECTOR .....	4.221, 4.226, 6.19	SET REFERENCE .....	4.191, 6.182
POLAR MARKER DEG/ RAD .....	4.242, 6.61	SETTINGS DEVICE 1/2 .....	4.48, 6.110
POLAR MARKER R/I / MA/PH .....	4.242, 6.42	SGL SWEEP DISP OFF .....	4.163, 6.114
% POWER BANDWIDTH .....	4.100, 6.186	SHAPE FACT 60/3dB .....	4.120, 6.45
POWER MEAS SETTINGS .....	4.97	SHAPE FACT 60/6dB .....	4.120, 6.45
POWER OFFSET .....	4.278	SHIFT X LIMIT LINE .....	4.137, 4.260, 6.23
PRE DISPL ON/OFF .....	4.185, 6.173	SHIFT Y LIMIT LINE .....	4.137, 4.260, 6.25, 6.26
PRE TRIGGER (gap sweep) .....	4.172, 6.191	SIDE BAND NORM / INV .....	4.184, 4.212, 6.146, 6.164
PREDEFINED COLORS .....	4.7, 6.88	SIGNAL COUNT .....	4.94, 6.38, 6.39
PRESEL PEAK .....	4.11, 6.63	SIGNAL TRACK .....	4.91, 6.46
PROBE CODE ON/OFF .....	4.81, 6.216	SINAD 1 kHz ON .....	4.191, 6.48
RANGE .....	4.196, 4.237	SINGLE SWEEP .....	4.162, 4.199, 4.265, 6.114
RBW / VBW MANUAL .....	4.159, 6.151	SLOPE POS/NEG .....	4.161, 4.195, 4.267, 6.214
RBW / VBW NOISE .....	4.159, 6.151	SORT MODE .....	4.53
RBW / VBW PULSE .....	4.159, 6.151	SOURCE CAL .....	4.279
RBW / VBW SINE [1] .....	4.158, 6.151	SOURCE ON/OFF .....	4.278, 6.131
RBW <= NORM/FFT .....	4.156, 6.150	SOURCE POWER .....	4.278, 6.193
RBW 1kHz ANA/DIG .....	4.155, 6.150	SPAN / RBW AUTO [50] .....	4.159, 6.150
REAL TIME ON/OFF .....	4.192, 6.146	SPAN / RBW MANUAL .....	4.159, 6.150
REAL/IMAG PART .....	4.218, 4.225, 6.19	SPAN FIXED .....	4.67, 4.69, 4.71, 6.174, 6.176, 6.177
RECORD ON/OFF .....	4.64	SPAN MANUAL .....	4.74, 6.175
REF LEVEL .....	4.78, 4.236, 6.91	SPLIT SCREEN .....	4.4, 6.87
REF LEVEL OFFSET .....	4.78, 4.237, 6.92	SQUELCH LEVEL .....	4.184, 6.146
REF POINT FREQUENCY .....	4.112, 6.12	SQUELCH ON .....	4.184, 6.145
REF POINT LEVEL .....	4.112, 6.12	START FIXED .....	4.69, 4.71, 4.75, 6.174, 6.176, 6.177
REF POINT LVL OFFSET .....	4.112, 6.12	START MANUAL .....	4.67, 6.176
REF POINT TIME .....	4.112, 6.12	STATISTICS .....	4.17, 6.85
REF VALUE .....	4.283	STEP SIZE = CENTER .....	4.73
REF VALUE POSITION .....	4.196, 4.239, 4.282, 6.93	STEP SIZE AUTO .....	3.20, 6.13, 6.42
REF VALUE X AXIS .....	4.237, 6.89	STEP SIZE MANUAL .....	4.73, 6.13, 6.42, 6.175
REF VALUE Y AXIS .....	4.196, 4.237, 6.92	STOP FIXED .....	4.67, 4.71, 4.75, 6.174, 6.176, 6.177
REFERENCE .....	4.33, 6.187	STOP MANUAL .....	4.69, 6.176
REFERENCE FILTER .....	4.212, 6.166	SUM MKR .....	4.120, 4.247, 6.51
REFERENCE FIXED .....	4.111, 6.12	SUMMARY MARKER .....	4.121, 4.247
REFERENCE INT/EXT .....	4.31, 6.187	SUMMARY MEAS TIME .....	4.192, 6.183
REFERENCE LINE .....	4.127, 4.252, 6.16	SUMMARY SETTINGS .....	4.190
REFERENCE POINT .....	4.112, 6.12	SWEEP .....	4.199
REFERENCE PROG .....	4.33, 6.187	SWEEP COUNT .....	4.122, 4.141, 4.163, 4.190, 4.200, 4.249, 4.262, 4.265, 6.188
REFERENCE SIGNAL .....	4.217, 6.18	SWEEP TIME .....	4.200, 6.189
REL UNIT .....	4.190, 6.61, 6.182	SWEEP TIME AUTO .....	4.154, 6.188
RENAME .....	4.53, 6.124	SWEEP TIME MANUAL .....	4.155, 6.188
RES BW AUTO .....	4.153, 6.150	SYMB TABLE / ERRORS .....	4.227, 6.18
RES BW MANUAL .....	4.153, 6.149	SYMBOL DISPLAY .....	4.222, 6.94
RESTORE .....	4.40	SYMBOL RATE .....	4.211, 6.165
RESULT LENGTH .....	4.200, 4.233, 4.265, 6.165	SYNC OFFSET .....	4.270, 6.167
RF ATTEN MANUAL .....	4.83, 6.115	SYNC PATTERN .....	4.274
RF INPUT 50 OHM .....	4.85, 6.116	SYSTEM MESSAGES .....	4.16, 6.209
RF INPUT 75 OHM/RAM .....	4.85, 6.117	T1-REF .....	4.147, 6.60
RF INPUT 75 OHM/RAZ .....	4.85, 6.117	T1-T2+REF .....	4.147, 6.60
RF POWER (trigger) .....	4.161, 6.213	T1-T3+REF .....	4.147, 6.60
RMS .....	4.121, 4.248, 6.56	THRESHOLD LINE .....	4.127, 4.252, 6.15, 6.16
SATURATION .....	4.7, 6.88	TIME .....	4.7, 6.89
SAVE LIMIT LINE .....	4.137, 4.260	TIME LINE 1/2 .....	4.7, 4.127, 4.252, 6.17
SAVE PATTERN .....	4.276	TIME ON/OFF .....	4.38, 6.210
SCALE UNIT .....	4.198, 4.239	TINT .....	4.7, 6.88
SCR. SAVER .....	4.7, 6.95	TITLE .....	4.47, 6.111
SCR. SAVER TIME .....	4.7, 6.95	TRACE MATH .....	4.147
SCREEN COUPLING .....	4.5	TRACE MATH OFF .....	4.148, 6.60
SCREENS UNCOUPLED .....	4.5, 6.119	TRACKING GENERATOR .....	4.18, 4.278, 6.118, 6.131
SEARCH LIMIT ON/OFF .....	4.119, 4.246, 6.38	TRANSD SET NAME .....	4.28, 6.156
SELECT ITEMS .....	4.57, 4.61, 6.127, 6.128, 6.129	TRANSD SET RANGES .....	4.29, 6.157
SELECT LIMIT LINE .....	4.130, 4.254, 6.21, 6.28	TRANSD SET UNIT .....	4.28, 6.157
SELECT MACRO .....	4.65	TRANSDUCER FACTOR .....	4.22, 6.155
SELECT MARKER .....	4.116, 4.246		

TRANSDUCER SET..... 4.22, 6.156, 6.158  
 TRC COLOR AUTO INC ..... 4.45, 6.113  
 TRD FACTOR NAME ..... 4.25, 6.155  
 TRD FACTOR UNIT ..... 4.25, 6.154  
 TRD FACTOR VALUES ..... 4.26, 6.155  
 TRG TO GAP TIME..... 4.173, 6.191  
 TRIGGER..... 4.194  
 TRIGGER DELAY ..... 4.161, 6.214  
 TRIGGER LEVEL (gap sweep) ..... 4.172, 6.213  
 TRIGGER OFFSET..... 4.195, 4.267  
 UNIT..... 4.79, 6.216  
 UNLOCK ..... 3.19  
 UPDATE..... 4.40  
 UPDATE MESSAGES..... 4.16  
 UPPER LEFT ..... 4.46, 6.113  
 UPPER RIGHT..... 4.46, 6.113  
 USER PORT A/B..... 4.35, 6.116, 6.131  
 VALUE (SYNC PATTERN)..... 4.276, 6.168  
 VALUES (limit line)..... 4.136, 4.260, 6.25  
 VECTOR ANALYZER..... 4.19, 4.175, 6.118  
 VERTICAL SCALING ..... 4.5, 6.119  
 VIDEO..... 4.160, 4.194, 4.266, 6.214  
 VIDEO BW AUTO ..... 4.154, 6.151  
 VIDEO BW MANUAL ..... 4.154, 6.151  
 VIEW..... 4.139, 4.261, 6.93  
 VOLT..... 4.81, 6.61  
 VOLUME ..... 4.93, 4.193, 4.197, 6.210  
 WATT..... 4.81, 6.61  
 WEIGHTING AF FILTER..... 4.182, 6.172  
 X OFFSET..... 4.132, 4.256, 6.23  
 X UNIT SYMBOL..... 6.61  
 Y OFFSET..... 4.132, 4.256, 6.24, 6.26  
 Y PER DIV ..... 4.196, 4.237, 6.93  
 Y UNIT DBM ..... 4.239, 6.61  
 Y UNIT DEG..... 4.239, 6.61  
 Y UNIT LINEAR..... 4.239, 6.61  
 Y UNIT LOG(dB)..... 4.239, 6.61  
 Y UNIT VOLT ..... 4.239, 6.61  
 Y UNIT WATT ..... 4.239, 6.61  
 ZERO SPAN ..... 4.74, 6.175  
 ZOOM ..... 4.76, 6.90  
 ZOOM OFF ..... 4.76, 6.90  
 Span..... 4.74  
     measurement window..... 4.67  
 Special characters ..... 6.2  
 Split Screen ..... 3.9, 4.4  
 Squelch ..... 4.184  
 SRE (service request enable register) ..... 5.21  
 SRQ (service request) ..... 5.21, 5.32  
 Start frequency ..... 4.67  
 Start-Up..... 1.20  
 Status byte (STB) ..... 5.21  
 Status information..... 3.4  
 Status register  
     CONDition part..... 5.19  
     ENABle part ..... 5.19  
     ESE..... 5.22  
     ESR..... 5.22  
     EVENT part ..... 5.19  
     NTRAnsition part ..... 5.19  
     overview ..... 5.20  
     PPE ..... 5.22  
     PTRAnsition part..... 5.19  
     SRE..... 5.21  
     STATus:OPERation ..... 5.23  
     STATus:QUESTionable..... 5.24  
         FREQuency ..... 5.26  
         LIMit ..... 5.27  
         LMARgin ..... 5.28  
         POWer ..... 5.29  
         SYNC ..... 5.30  
         TRANsducer..... 5.31

STB..... 5.21  
     structure..... 5.18  
     sum bit ..... 5.19  
 Status reporting system..... 5.18  
     resetting values..... 5.34  
 Status information  
     DIFOVL ..... 3.4  
     ExtRef..... 3.4  
     IFOVL..... 3.4  
     LO Lvd..... 3.4  
     LO Lvl ..... 3.4  
     LO unl ..... 3.4  
     OCXO ..... 3.4  
     OVL..... 3.4  
     UNCAL..... 3.4  
 STB (status byte) ..... 5.21  
 Step size  
     center frequency ..... 4.72  
     delta marker..... 4.114  
     marker ..... 4.109  
     setting ..... 3.20  
 Stop frequency..... 4.69  
 String ..... 5.14  
 Suffix ..... 5.11  
 Sum bit ..... 5.19  
 Sum level..... 4.235  
 Summary, numeric measured values ..... 4.190  
 Summary Marker..... 4.247  
 Sweep  
     continuous ..... 4.199, 4.265  
     count..... 4.141, 4.163, 4.249, 4.262  
     coupling ..... 4.152  
     gap..... 4.170  
     gap length ..... 4.173  
     gated..... 4.164  
     mode..... 4.162  
     number..... 4.190, 4.200  
     single ..... 4.162, 4.199, 4.265  
     time..... 4.154, 4.200  
 Switching operations ..... 4.17  
 Symbol  
     decision points ..... 4.222  
     mapping ..... 4.203  
     rate ..... 4.211  
     table..... 4.227  
 Sync  
     offset..... 4.270  
     pattern..... 4.274  
     search..... 4.269  
 Synchronization sequence ..... 4.269  
 Syntax elements, command ..... 5.14  
 System messages..... 4.16

**T**

Table entry ..... 3.18  
 TCP/IP operation..... 1.52  
 Test, functional..... 1.22  
 TETRA ..... 4.209  
 Text parameter..... 5.14  
 TFTS ..... 4.209  
 Thick Ethernet ..... 1.43  
 Thin Ethernet..... 1.42  
 Threshold line..... 4.252  
 Time, input ..... 4.38  
 Time lines..... 4.252  
 Time signal  
     AM-demodulated..... 4.186  
     FM-demodulated ..... 4.187  
     PM-demodulated..... 4.187  
 Trace..... 4.138

copy .....	4.142
detector .....	4.143
export .....	4.148
mathematics .....	4.147
Transducer .....	4.20
entry .....	4.23
set .....	4.27
switch on .....	4.21
Transmission measurement .....	4.279
Transmission parameters, RS-232-C .....	8.7
Trellis diagram .....	4.219
Trigger .....	4.266
AF signal .....	4.195
delay .....	4.161, 4.267
edge, pos./neg .....	4.195, 4.267
external .....	4.194, 4.267
free running .....	4.160, 4.194, 4.266
gap sweep .....	4.172
line .....	4.160
offset .....	4.195, 4.267
pre-trigger .....	4.172
RF power .....	4.161
slope .....	4.161, 4.195
threshold .....	4.266
video .....	4.160, 4.266
video voltage .....	4.194

**U**

Unit .....	4.79, 4.239
circle .....	4.215
relative display .....	4.190
Y-axis .....	4.198
Universal command .....	8.5
Upper case .....	6.2
User interface .....	8.19
User port configuration .....	4.35

**V**

Vector analyzer mode .....	4.19, 4.174
Vector diagram .....	4.221
Vector error (sum error) .....	4.228
Video bandwidth .....	4.154
Video trigger .....	4.266
View .....	4.139
Volume .....	4.93, 4.193

**W**

WCPE .....	4.209
Weighting filter .....	4.182
White space .....	5.14
Windows NT .....	1.23
administrator .....	1.23
login .....	1.23
password .....	1.23

**Z**

Zero span .....	4.74
Zoom .....	4.76, 4.139
amplitude .....	4.139