

# Operating Manual



## EMI Test Receiver

**R&S<sup>®</sup> ESL3    R&S<sup>®</sup> ESL6**

**1300.5001K03**

**1300.5001K06**

**1300.5001K13**

**1300.5001K16**



1300.5053.62-03

[www.valuetronics.com](http://www.valuetronics.com)

**Dear Customer,**

Throughout this manual, the EMI Test Receiver R&S<sup>®</sup> ESL is abbreviated as R&S ESL.

R&S<sup>®</sup> is a registered trademark of Rohde & Schwarz GmbH & Co. KG  
Trade names are trademarks of the owners



**ROHDE & SCHWARZ**

## **Kundeninformation zur Batterieverordnung (BattV)**

Dieses Gerät enthält eine schadstoffhaltige Batterie.  
Diese darf nicht mit dem Hausmüll entsorgt werden.  
Nach Ende der Lebensdauer darf die Entsorgung nur  
über eine Rohde&Schwarz-Kundendienststelle oder eine  
geeignete Sammelstelle erfolgen.

## **Safety Regulations for Batteries (according to BattV)**

This equipment houses a battery containing harmful  
substances that must not be disposed of as normal  
household waste.  
After its useful life, the battery may only be disposed of  
at a Rohde & Schwarz service center or at a suitable  
depot.

## **Normas de Seguridad para Baterías (Según BattV)**

Este equipo lleva una batería que contiene sustancias  
perjudiciales, que no se debe desechar en los  
contenedores de basura domésticos.  
Después de la vida útil, la batería sólo se podrá eliminar  
en un centro de servicio de Rohde & Schwarz o en un  
depósito apropiado.

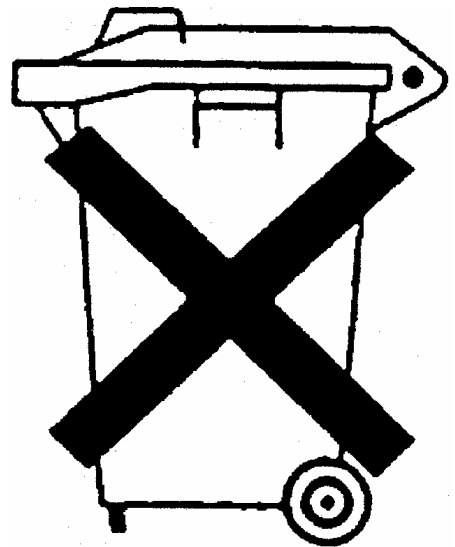

## **Consignes de sécurité pour batteries (selon BattV)**

Cet appareil est équipé d'une pile comprenant des  
substances nocives. Ne jamais la jeter dans une  
poubelle pour ordures ménagères.  
Une pile usagée doit uniquement être éliminée par un  
centre de service client de Rohde & Schwarz ou peut  
être collectée pour être traitée spécialement comme  
déchets dangereux.

# Customer Information Regarding Product Disposal

The German Electrical and Electronic Equipment (ElektroG) Act is an implementation of the following EC directives:

- 2002/96/EC on waste electrical and electronic equipment (WEEE) and
- 2002/95/EC on the restriction of the use of certain hazardous substances in electrical and electronic equipment (RoHS).

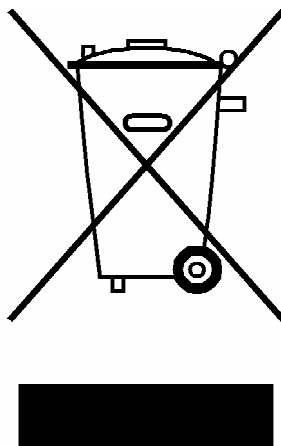

Product labeling in accordance with EN 50419

Once the lifetime of a product has ended, this product must not be disposed of in the standard domestic refuse. Even disposal via the municipal collection points for waste electrical and electronic equipment is not permitted.

Rohde & Schwarz GmbH & Co. KG has developed a disposal concept for the environmental-friendly disposal or recycling of waste material and fully assumes its obligation as a producer to take back and dispose of electrical and electronic waste in accordance with the ElektroG Act.

Please contact your local service representative to dispose of the product.





**ROHDE & SCHWARZ**  
EC Certificate of Conformity



Certificate No.: 2008-43

This is to certify that:

Equipment type	Stock No.	Designation
ESL3	1300.5001.03/.13	EMI Test Receiver
ESL6	1300.5001.06/.16	
FSL-B4	1300.6008.02	OCXO Reference Frequency
FSL-B5	1300.6108.02	Additional Interfaces
FSL-B8	1300.5701.02	Gated Sweep Function
FSL-B10	1300.6208.02	GPIB Interface
FSL-B22	1300.5953.02	RF Amplifier
FSL-B30	1300.6308.02	DC Power Supply
FSL-B31	1300.6408.02	NIMH Battery Pack
FSL-Z4	1300.5430.02	Additional Charger Unit

complies with the provisions of the Directive of the Council of the European Union on the approximation of the laws of the Member States

- relating to electrical equipment for use within defined voltage limits (2006/95/EC)
- relating to electromagnetic compatibility (2004/108/EC)

Conformity is proven by compliance with the following standards:

EN 61010-1 : 2001  
EN 61326 : 1997 + A1 : 1998 + A2 : 2001 + A3 : 2003  
EN 55011 : 1998 + A1 : 1999 + A2 : 2002, Klasse B  
EN 61000-3-2 : 2000 + A2 : 2005  
EN 61000-3-3 : 1995 + A1 : 2001

For the assessment of electromagnetic compatibility, the limits of radio interference for Class B equipment as well as the immunity to interference for operation in industry have been used as a basis.

Affixing the EC conformity mark as from 2008

**ROHDE & SCHWARZ GmbH & Co. KG**  
**Mühldorfstr. 15, D-81671 München**

Munich, 2008-06-18

Central Quality Management MF-QZ / Radde

## Documentation Overview

The user documentation for the R&S ESL is divided as follows:

- Quick Start Guide
- Online Help
- Operating Manual
- Internet Site
- Service Manual
- Release Notes

## Quick Start Guide

This manual is delivered with the instrument in printed form and in PDF format on the CD. It provides the information needed to set up and start working with the instrument. Basic operations and basic measurements are described. Also a brief introduction to remote control is given. The manual includes general information (e.g. Safety Instructions) and the following chapters:

Chapter 1	Front and Rear Panel
Chapter 2	Putting into Operation
Chapter 3	Firmware Update and Installation of Firmware Options
Chapter 4	Basic Operations
Chapter 5	Basic Measurement Examples
Chapter 6	Brief Introduction to Remote Control
Appendix A	Printer Interface
Appendix B	LAN Interface

## Online Help

The Online Help is part of the firmware. It provides a quick access to the description of the instrument functions and the remote control commands. For information on other topics refer to the Quick Start Guide, Operating Manual and Service Manual provided in PDF format on CD or in the Internet. For detailed information on how to use the Online Help, refer to the chapter "Basic Operations" in the Quick Start Guide.

## Operating Manual

This manual is a supplement to the Quick Start Guide and is available in PDF format on the CD delivered with the instrument. To retain the familiar structure that applies to all operating manuals of Rohde&Schwarz Test & Measurement instruments, the chapters 1 and 3 exist, but only in form of references to the corresponding Quick Start Guide chapters.

In this manual, all instrument functions are described in detail. For additional information on default settings and parameters, refer to the data sheets. The set of measurement examples in the Quick Start Guide is expanded by more advanced measurement examples. In addition to the brief introduction to remote control in the Quick Start Guide, a description of the commands and programming examples is given. Information on maintenance, instrument interfaces and error messages is also provided.

The manual includes the following chapters:

Chapter 1	Putting into Operation, see Quick Start Guide chapters 1 and 2
Chapter 2	Advanced Measurement Examples

Chapter 3	Manual Operation, see Quick Start Guide chapter 4
Chapter 4	Instrument Functions
Chapter 5	Remote Control - Basics
Chapter 6	Remote Control - Commands
Chapter 7	Remote Control - Programming Examples
Chapter 8	Maintenance
Chapter 9	Error Messages

This manual is delivered with the instrument on CD only. The printed manual can be ordered from Rohde & Schwarz GmbH & Co. KG.

## Internet Site

The Internet site at: [R&S ESL EMI Test Receiver](#) provides the most up to date information on the R&S ESL. The current operating manual at a time is available as printable PDF file in the download area. Also provided for download are firmware updates including the associated release notes, instrument drivers, current data sheets and application notes.

## Service Manual

This manual is available in PDF format on the CD delivered with the instrument. It informs on how to check compliance with rated specifications, on instrument function, repair, troubleshooting and fault elimination. It contains all information required for repairing the R&S ESL by the replacement of modules. The manual includes the following chapters:

Chapter 1	Performance Test
Chapter 2	Adjustment
Chapter 3	Repair
Chapter 4	Software Update / Installing Options
Chapter 5	Documents

## Release Notes

The release notes describe the installation of the firmware, new and modified functions, eliminated problems, and last minute changes to the documentation. The corresponding firmware version is indicated on the title page of the release notes. The current release notes are provided in the Internet.

## Conventions Used in the Documentation

To visualize important information quickly and to recognize information types faster, a few conventions has been introduced. The following character formats are used to emphasize words:

Bold	All names of graphical user interface elements as dialog boxes, softkeys, lists, options, buttons etc.
	All names of user interface elements on the front and rear panel as keys, connectors etc.
Courier	All remote commands (apart from headings, see below)
Capital letters	All key names (front panel or keyboard)

The description of a softkey (Operating Manual and Online Help) always starts with the softkey name, and is followed by explaining text and one or more remote control commands framed by two lines. Each remote command is placed in a single line.

The description of remote control commands (Operating Manual and Online Help) always starts with the command itself, and is followed by explaining text including an example, the characteristics and the mode (standard or only with certain options) framed by two grey lines. The remote commands consist of abbreviations to accelerate the procedure. All parts of the command that have to be entered are in capital letters, the rest is added in small letters to complete the words and transport their meaning.



# 1 Putting into Operation

For details refer to the Quick Start Guide chapters 1, "Front and Rear Panel", and 2, "Preparing for Use".

## Contents of Chapter 2

<b>2</b>	<b>Advanced Measurement Examples .....</b>	<b>2.1</b>
	<b>Test Setup .....</b>	<b>2.2</b>
	<b>Measurement of Harmonics .....</b>	<b>2.2</b>
	High–Sensitivity Harmonics Measurements .....	2.4
	<b>Measuring the Spectra of Complex Signals .....</b>	<b>2.6</b>
	Separating Signals by Selecting an Appropriate Resolution Bandwidth .....	2.6
	Intermodulation Measurements .....	2.7
	Measurement example – Measuring the R&S ESL's intrinsic intermodulation .....	2.9
	<b>Measuring Signals in the Vicinity of Noise .....</b>	<b>2.13</b>
	Measurement example – Measuring level at low S/N ratios .....	2.14
	<b>Noise Measurements .....</b>	<b>2.17</b>
	Measuring Noise Power Density .....	2.17
	Measurement example – Measuring the intrinsic noise power density of the R&S ESL at 1 GHz and calculating the R&S ESL's noise figure .....	2.17
	Measurement of Noise Power within a Transmission Channel .....	2.19
	Measurement example – Measuring the intrinsic noise of the R&S ESL at 1 GHz in a 1.23 MHz channel bandwidth with the channel power function .....	2.20
	Measuring Phase Noise .....	2.24
	Measurement example – Measuring the phase noise of a signal generator at a carrier offset of 10 kHz .....	2.24
	<b>Measurements on Modulated Signals .....</b>	<b>2.25</b>
	Measuring Channel Power and Adjacent Channel Power .....	2.25
	Measurement example 1 – ACPR measurement on an CDMA 2000 signal .....	2.26
	Measurement example 2 – Measuring adjacent channel power of a W–CDMA uplink signal .....	2.32
	Amplitude Distribution Measurements .....	2.36
	Measurement example – Measuring the APD and CCDF of white noise generated by the R&S ESL .....	2.36
	<b>Noise Figure Measurements Option (K30) .....</b>	<b>2.39</b>
	Direct Measurements .....	2.39
	Basic Measurement Example .....	2.39
	DUTs with very Large Gain .....	2.41
	Frequency–Converting Measurements .....	2.42
	Fixed LO Measurements .....	2.42
	Image–Frequency Rejection (SSB, DSB) .....	2.42

## 2 Advanced Measurement Examples

This chapter explains how to operate the R&S ESL using typical measurements as examples. Additional background information on the settings is given. Examples of more basic character are provided in the Quick Start Guide, chapter 5, as an introduction. The following topics are included in the Quick Start Guide:

- Performing a Level and Frequency Measurement
- Measuring a Sinusoidal Signal
  - Measuring the Level and Frequency Using Markers
  - Measuring the Signal Frequency Using the Frequency Counter
- Measuring Harmonics of Sinusoidal Signals
  - Measuring the Suppression of the First and Second Harmonic of an Input Signal
- Measuring Signal Spectra with Multiple Signals
  - Separating Signals by Selecting the Resolution Bandwidth
  - Measuring the Modulation Depth of an AM-Modulated Carrier (Span > 0)
  - Measuring of AM-Modulated Signals
- Measurements with Zero Span
  - Measuring the Power Characteristic of Burst Signals
  - Measuring the Signal-to-Noise Ratio of Burst Signals
  - Measurement of FM-Modulated Signals
- Storing and Loading Instrument Settings
  - Storing an Instrument Configuration (without Traces)
  - Storing Traces
  - Loading an Instrument Configuration (with Traces)
  - Configuring Automatic Loading

## Test Setup

All of the following examples are based on the standard settings of the R&S ESL. These are set with the **PRESET** key. A complete listing of the standard settings can be found in chapter "Instrument Functions", section "Initializing the Configuration – PRESET Key".

In the following examples, a signal generator is used as a signal source. The RF output of the signal generator is connected to the RF input of R&S ESL.

If a 65 MHz signal is required for the test setup, as an alternative to the signal generator, the internal 65 MHz reference generator can be used:

1. Switch on the internal reference generator.
  - Press the **SETUP** key.
  - Press the **Service** softkey.
  - Press the **Input RF/Cal/TG** softkey, until **Cal** is highlighted.

The internal 65 MHz reference generator is now on. The R&S ESL's RF input is switched off.
2. Switch on the RF input again for normal operation of the R&S ESL. Two ways are possible:
  - Press the **PRESET** key
  - Press the **SETUP** key.
  - Press the **Service** softkey.
  - Press the **Input RF/Cal/TG** softkey, until **RF** is highlighted.

The internal signal path of the R&S ESL is switched back to the RF input in order to resume normal operation.

## Measurement of Harmonics

Measuring the harmonics of a signal is a frequent problem which can be solved best by means of a spectrum analyzer. In general, every signal contains harmonics which are larger than others. Harmonics are particularly critical regarding high-power transmitters such as transceivers because large harmonics can interfere with other radio services.

Harmonics are generated by nonlinear characteristics. They can often be reduced by lowpass filters. Since the spectrum analyzer has a nonlinear characteristic, e.g. in its first mixer, measures must be taken to ensure that harmonics produced in the spectrum analyzer do not cause spurious results. If necessary, the fundamental wave must be selectively attenuated with respect to the other harmonics with a highpass filter.

When harmonics are being measured, the obtainable dynamic range depends on the second harmonic intercept of the spectrum analyzer. The second harmonic intercept is the virtual input level at the RF input mixer at which the level of the 2nd harmonic becomes equal to the level of the fundamental wave. In practice, however, applying a level of this magnitude would damage the mixer. Nevertheless the available dynamic range for measuring the harmonic distance of a DUT can be calculated relatively easily using the second harmonic intercept.

As shown in [Fig. 2-1](#), the level of the 2<sup>nd</sup> harmonic drops by 20 dB if the level of the fundamental wave is reduced by 10 dB.

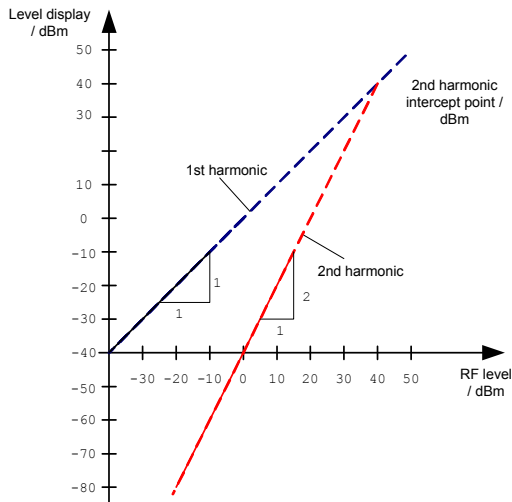

Fig. 2-1 Extrapolation of the 1st and 2nd harmonics to the 2nd harmonic intercept at 40 dBm

The following formula for the obtainable harmonic distortion  $d_2$  in dB is derived from the straight-line equations and the given intercept point:

$$d_2 = S.H.I - P_1 \quad (1)$$

$d_2$  = harmonic distortion

$P_1$  = mixer level/dBm

S.H.I. = second harmonic intercept

**Note:** The mixer level is the RF level applied to the RF input minus the set RF attenuation.

The formula for the internally generated level  $P_1$  at the 2<sup>nd</sup> harmonic in dBm is:

$$P_1 = 2 \cdot P_I - S.H.I. \quad (2)$$

The lower measurement limit for the harmonic is the noise floor of the spectrum analyzer. The harmonic of the measured DUT should – if sufficiently averaged by means of a video filter – be at least 4 dB above the noise floor so that the measurement error due to the input noise is less than 1 dB.

The following rules for measuring high harmonic ratios can be derived:

- Select the smallest possible IF bandwidth for a minimal noise floor.
- Select an RF attenuation which is high enough to just measure the harmonic ratio.

The maximum harmonic distortion is obtained if the level of the harmonic equals the intrinsic noise level of the receiver. The level applied to the mixer, according to (2), is:

$$P_1 = \frac{P_{noise} / dBm + IP2}{2} \quad (3)$$

At a resolution bandwidth of 10 Hz (noise level –143 dBm, S.H.I. = 40 dBm), the optimum mixer level is – 51.5 dBm. According to (1) a maximum measurable harmonic distortion of 91.5 dB minus a minimum S/N ratio of 4 dB is obtained.

---

**Note:** *If the harmonic emerges from noise sufficiently (approx. >15 dB), it is easy to check (by changing the RF attenuation) whether the harmonics originate from the DUT or are generated internally by the spectrum analyzer. If a harmonic originates from the DUT, its level remains constant if the RF attenuation is increased by 10 dB. Only the displayed noise is increased by 10 dB due to the additional attenuation. If the harmonic is exclusively generated by the spectrum analyzer, the level of the harmonic is reduced by 20 dB or is lost in noise. If both – the DUT and the spectrum analyzer – contribute to the harmonic, the reduction in the harmonic level is correspondingly smaller.*

---

## High–Sensitivity Harmonics Measurements

If harmonics have very small levels, the resolution bandwidth required to measure them must be reduced considerably. The sweep time is, therefore, also increased considerably. In this case, the measurement of individual harmonics is carried out with the R&S ESL set to a small span. Only the frequency range around the harmonics will then be measured with a small resolution bandwidth.

### Signal generator settings (e.g. R&S SMU):

Frequency: 128 MHz

Level: – 25 dBm

### Procedure:

1. Set the R&S ESL to its default state.
  - Press the **PRESET** key.  
The R&S ESL is set to its default state.
2. Set the center frequency to 128 MHz and the span to 100 kHz.
  - Press the **FREQ** key.  
The frequency menu is displayed.
  - In the dialog box, enter *128* using the numeric keypad and confirm with the **MHz** key.
  - Press the **SPAN** key.
  - In the dialog box, enter *100* using the numeric keypad and confirm with the **kHz** key.  
The R&S ESL displays the reference signal with a span of 100 kHz and resolution bandwidth of 3 kHz.
3. Switching on the marker.
  - Press the **MKR** key.  
The marker is positioned on the trace maximum.
4. Set the measured signal frequency and the measured level as reference values
  - Press the Phase Noise/Ref Fixed softkey.  
The position of the marker becomes the reference point. The reference point level is indicated by a horizontal line, the reference point frequency with a vertical line. At the same time, the delta marker 2 is switched on.
  - Press the **Ref Fixed** softkey.

The mode changes from phase noise measurement to reference fixed, the marker readout changes from dB/Hz to dB.

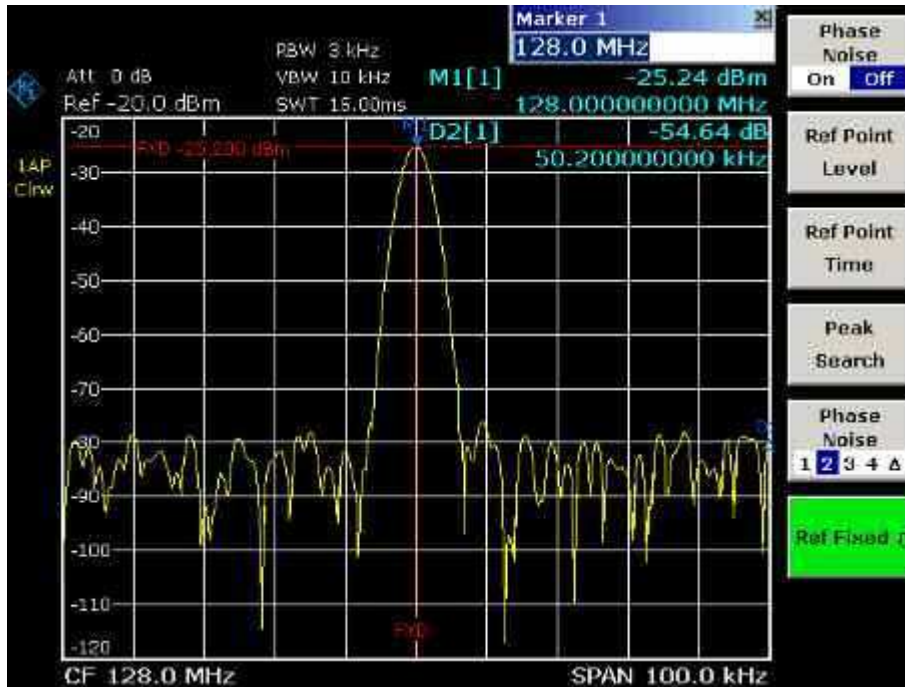

Fig. 2-2 Fundamental wave and the frequency and level reference point

5. Make the step size for the center frequency equal to the signal frequency
  - Press the **FREQ** key.  
The frequency menu is displayed.
  - Press the **CF–Stepsize** softkey and press the = **Marker** softkey in the submenu.  
The step size for the center frequency is now equal to the marker frequency.
6. Set the center frequency to the 2<sup>nd</sup> harmonic of the signal
  - Press the **FREQ** key.  
The frequency menu is displayed.
  - Press the **UPARROW** key once.  
The center frequency is set to the 2<sup>nd</sup> harmonic.
7. Place the delta marker on the 2<sup>nd</sup> harmonic.
  - Press the **MKR→** key.
  - Press the **Peak** softkey.  
The delta marker moves to the maximum of the 2<sup>nd</sup> harmonic. The displayed level result is relative to the reference point level (= fundamental wave level).

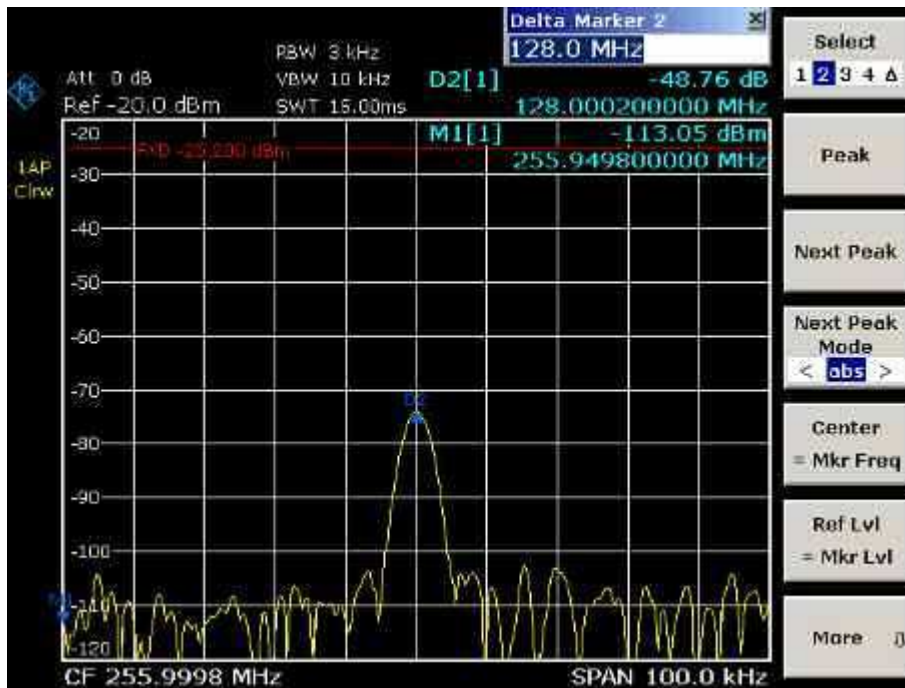

Fig. 2-3 Measuring the level difference between the fundamental wave (= reference point level) and the 2<sup>nd</sup> harmonic

The other harmonics are measured with steps 5 and 6, the center frequency being incremented or decremented in steps of 128 MHz using the **UPARROW** or **DNARROW** key.

## Measuring the Spectra of Complex Signals

### Separating Signals by Selecting an Appropriate Resolution Bandwidth

A basic feature of a spectrum analyzer is being able to separate the spectral components of a mixture of signals. The resolution at which the individual components can be separated is determined by the resolution bandwidth. Selecting a resolution bandwidth that is too large may make it impossible to distinguish between spectral components, i.e. they are displayed as a single component.

An RF sinusoidal signal is displayed by means of the passband characteristic of the resolution filter (RBW) that has been set. Its specified bandwidth is the 3 dB bandwidth of the filter.

Two signals with the same amplitude can be resolved if the resolution bandwidth is smaller than or equal to the frequency spacing of the signal. If the resolution bandwidth is equal to the frequency spacing, the spectrum display screen shows a level drop of 3 dB precisely in the center of the two signals. Decreasing the resolution bandwidth makes the level drop larger, which thus makes the individual signals clearer.

If there are large level differences between signals, the resolution is determined by selectivity as well as by the resolution bandwidth that has been selected. The measure of selectivity used for spectrum analyzers is the ratio of the 60 dB bandwidth to the 3 dB bandwidth (= shape factor).

For the R&S ESL, the shape factor for bandwidths is < 5, i.e. the 60 dB bandwidth of the 30 kHz filter is < 150 kHz.



The higher spectral resolution with smaller bandwidths is won by longer sweep times for the same span. The sweep time has to allow the resolution filters to settle during a sweep at all signal levels and frequencies to be displayed. It is given by the following formula.

$$SWT = k \cdot \text{Span}/RBW^2 \quad (4)$$

- SWT = max. sweep time for correct measurement
- k = factor depending on type of resolution filter  
= 1 for digital IF filters
- Span = frequency display range
- RBW = resolution bandwidth

If the resolution bandwidth is reduced by a factor of 3, the sweep time is increased by a factor of 9.

---

**Note:** The impact of the video bandwidth on the sweep time is not taken into account in (4). For the formula to be applied, the video bandwidth must be  $\geq 3 \times$  the resolution bandwidth.

---

FFT filters can be used for resolution bandwidths up to 30 kHz. Like digital filters, they have a shape factor of less than 5 up to 30 kHz. For FFT filters, however, the sweep time is given by the following formula:

$$SWT = k \cdot \text{span}/RBW \quad (5)$$

If the resolution bandwidth is reduced by a factor of 3, the sweep time is increased by a factor of 3 only.

## Intermodulation Measurements

If several signals are applied to a transmission two-port device with nonlinear characteristic, intermodulation products appear at its output by the sums and differences of the signals. The nonlinear characteristic produces harmonics of the useful signals which intermodulate at the characteristic. The intermodulation products of lower order have a special effect since their level is largest and they are near the useful signals. The intermodulation product of third order causes the highest interference. It is the intermodulation product generated from one of the useful signals and the 2nd harmonic of the second useful signal in case of two-tone modulation.

The frequencies of the intermodulation products are above and below the useful signals. Fig. 2-4 shows intermodulation products  $P_{I1}$  and  $P_{I2}$  generated by the two useful signals  $P_{U1}$  and  $P_{U2}$ .

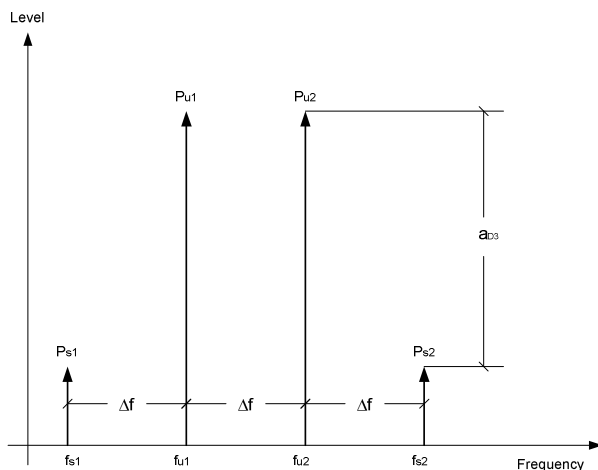

Fig. 2-4 Intermodulation products  $P_{U1}$  and  $P_{U2}$

The intermodulation product at  $f_{i2}$  is generated by mixing the 2nd harmonic of useful signal  $P_{U2}$  and signal  $P_{U1}$ , the intermodulation product at  $f_{i1}$  by mixing the 2nd harmonic of useful signal  $P_{U1}$  and signal  $P_{U2}$ .

$$f_{i1} = 2 \times f_{u1} - f_{u2} \quad (6)$$

$$f_{i2} = 2 \times f_{u2} - f_{u1} \quad (7)$$

The level of the intermodulation products depends on the level of the useful signals. If the two useful signals are increased by 1 dB, the level of the intermodulation products increases by 3 dB, which means that spacing  $a_{D3}$  between intermodulation signals and useful signals are reduced by 2 dB. This is illustrated in Fig. 2-5.

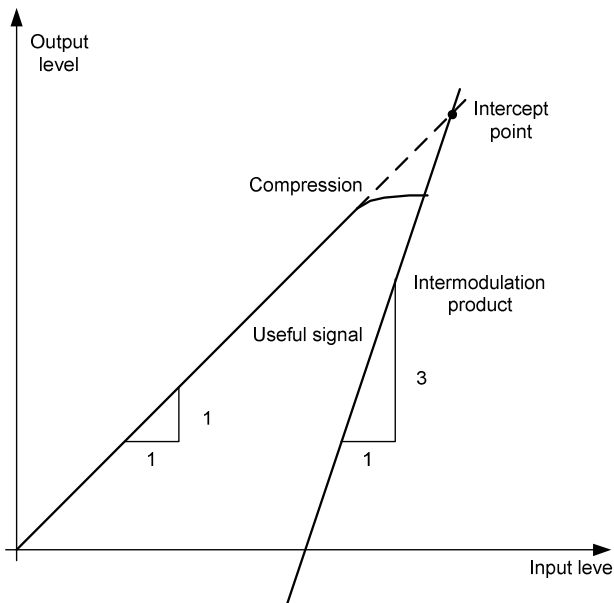

Fig. 2-5 Dependence of intermodulation level on useful signal level

The useful signals at the two-port output increase proportionally with the input level as long as the two-port is in the linear range. A level change of 1 dB at the input causes a level change of 1 dB at the output. Beyond a certain input level, the two-port goes into compression and the output level stops increasing. The intermodulation products of the third order increase three times as much as the useful signals. The intercept point is the fictitious level where the two lines intersect. It cannot be measured directly since the useful level is previously limited by the maximum two-port output power.

It can be calculated from the known line slopes and the measured spacing  $a_{D3}$  at a given level according to the following formula.

$$IP3 = \frac{a_{D3}}{2} + P_N \quad (8)$$

The 3<sup>rd</sup> order intercept point (TOI), for example, is calculated for an intermodulation of 60 dB and an input level  $P_U$  of -20 dBm according to the following formula:

$$IP3 = \frac{60}{2} + (-20dBm) = 10dBm \quad (9)$$

## Measurement example – Measuring the R&S ESL's intrinsic intermodulation

### Test setup:

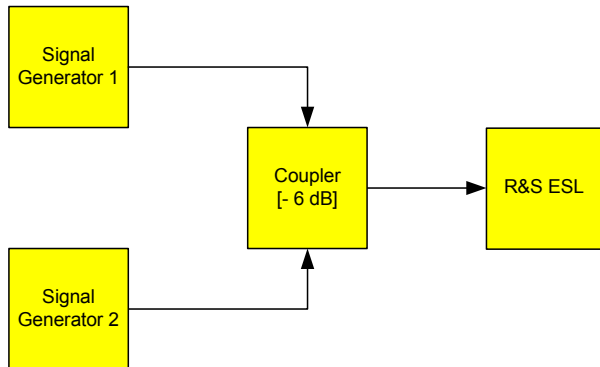

### Signal generator settings (e.g. R&S SMU):

	Level	Frequency
Signal generator 1	−4 dBm	999.7 MHz
Signal generator 2	−4 dBm	1000.3 MHz

### Procedure:

1. Set the R&S ESL to its default settings.
  - Press the **PRESET** key.
  - The R&S ESL is in its default state.
2. Set center frequency to 1 GHz and the frequency span to 3 MHz.
  - Press the **FREQ** key and enter *1 GHz*.
  - Press the **SPAN** key and enter *3 MHz*.
3. Set the reference level to −10 dBm and RF attenuation to 0 dB.
  - Press the **AMPT** key and enter *−10 dBm*.
  - Press the **RF Atten Manual** softkey and enter *0 dB*.
4. Set the resolution bandwidth to 10 kHz.
  - Press the **BW** key.
  - Press the **Res BW Manual** softkey and enter *10 kHz*.
  - The noise is reduced, the trace is smoothed further and the intermodulation products can be clearly seen.
  - Press the **Video BW Manual** softkey and enter *1 kHz*.
5. Measuring intermodulation by means of the 3<sup>rd</sup> order intercept measurement function
  - Press the **MEAS** key.
  - Press the **TOI** softkey.

The R&S ESL activates four markers for measuring the intermodulation distance. Two markers are positioned on the useful signals and two on the intermodulation products. The 3<sup>rd</sup> order intercept is calculated from the level difference between the useful signals and the intermodulation products. It is then displayed on the screen:

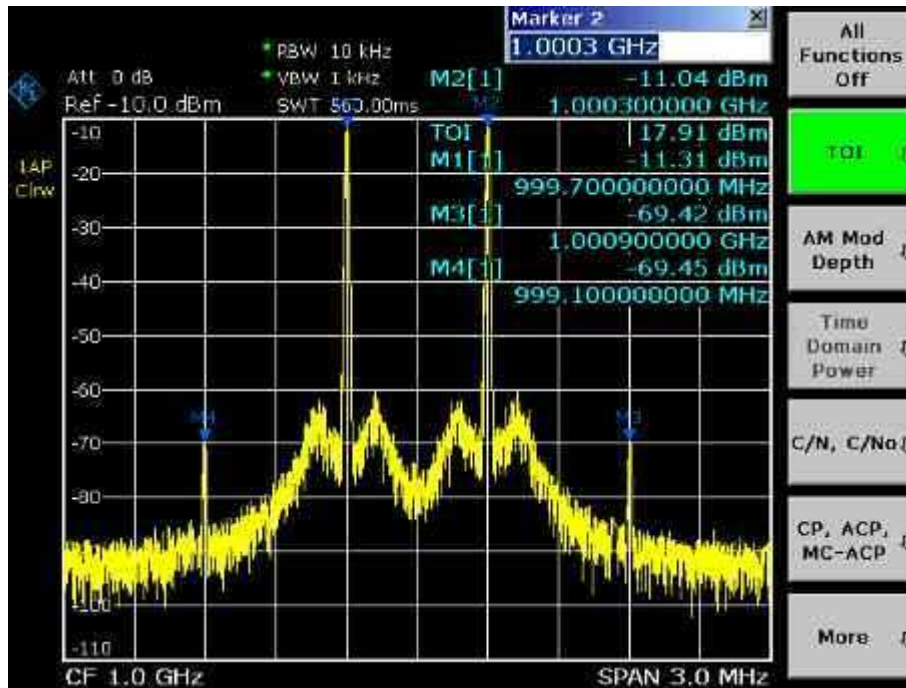

Fig. 2-6 Result of intrinsic intermodulation measurement on the R&S ESL. The 3<sup>rd</sup> order intercept (TOI) is displayed at the top right corner of the grid.

The level of a spectrum analyzer's intrinsic intermodulation products depends on the RF level of the useful signals at the input mixer. When the RF attenuation is added, the mixer level is reduced and the intermodulation distance is increased. With an additional RF attenuation of 10 dB, the levels of the intermodulation products are reduced by 20 dB. The noise level is, however, increased by 10 dB.

6. Increasing RF attenuation to 10 dB to reduce intermodulation products.

- Press the **AMPT** key.
- Press the **RF Atten Manual** softkey and enter *10 dB*.

The R&S ESL's intrinsic intermodulation products disappear below the noise floor.

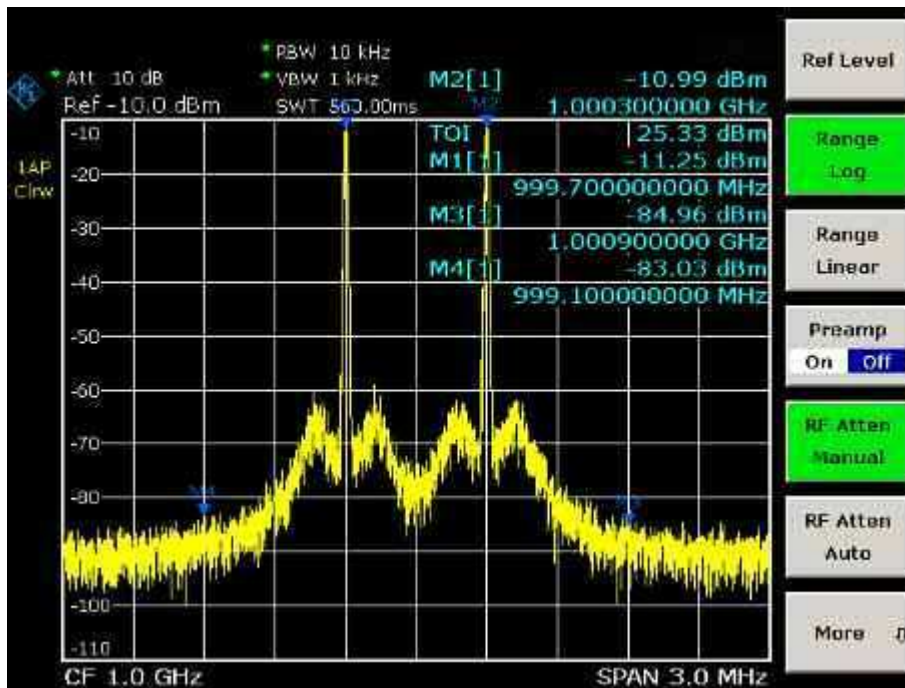

Fig. 2-7 If the RF attenuation is increased, the R&S ESL's intrinsic intermodulation products disappear below the noise floor.

#### Calculation method:

The method used by the R&S ESL to calculate the intercept point takes the average useful signal level  $P_u$  in dBm and calculates the intermodulation  $d_3$  in dB as a function of the average value of the levels of the two intermodulation products. The third order intercept (TOI) is then calculated as follows:

$$TOI/dBm = \frac{1}{2} d_3 + P_u$$

#### Intermodulation– free dynamic range

The **Intermodulation – free dynamic range**, i.e. the level range in which no internal intermodulation products are generated if two–tone signals are measured, is determined by the 3<sup>rd</sup> order intercept point, the phase noise and the thermal noise of the spectrum analyzer. At high signal levels, the range is determined by intermodulation products. At low signal levels, intermodulation products disappear below the noise floor, i.e. the noise floor and the phase noise of the spectrum analyzer determine the range. The noise floor and the phase noise depend on the resolution bandwidth that has been selected. At the smallest resolution bandwidth, the noise floor and phase noise are at a minimum and so the maximum range is obtained. However, a large increase in sweep time is required for small resolution bandwidths. It is, therefore, best to select the largest resolution bandwidth possible to obtain the range that is required. Since phase noise decreases as the carrier–offset increases, its influence decreases with increasing frequency offset from the useful signals.

The following diagrams illustrate the intermodulation–free dynamic range as a function of the selected bandwidth and of the level at the input mixer (= signal level – set RF attenuation) at different useful signal offsets.

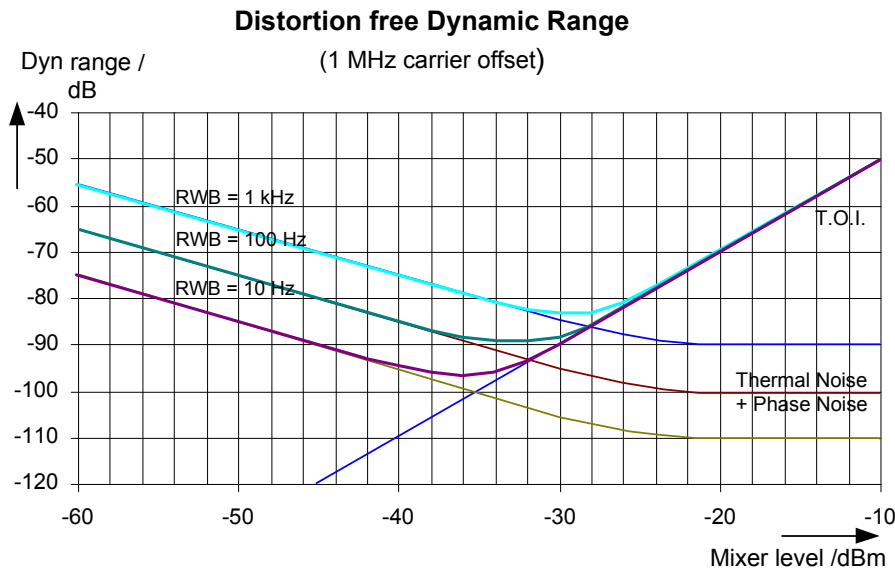

Fig. 2-8 Intermodulation-free range of the R&S ESL as a function of level at the input mixer and the set resolution bandwidth (useful signal offset = 1 MHz, DANL = -145 dBm /Hz, TOI = 15 dBm; typical values at 2 GHz)

The optimum mixer level, i.e. the level at which the intermodulation distance is at its maximum, depends on the bandwidth. At a resolution bandwidth of 10 Hz, it is approx. -35 dBm and at 1 kHz increases to approx. -30 dBm.

Phase noise has a considerable influence on the intermodulation-free range at carrier offsets between 10 and 100 kHz (Fig. 2-9). At greater bandwidths, the influence of the phase noise is greater than it would be with small bandwidths. The optimum mixer level at the bandwidths under consideration becomes almost independent of bandwidth and is approx. -40 dBm.

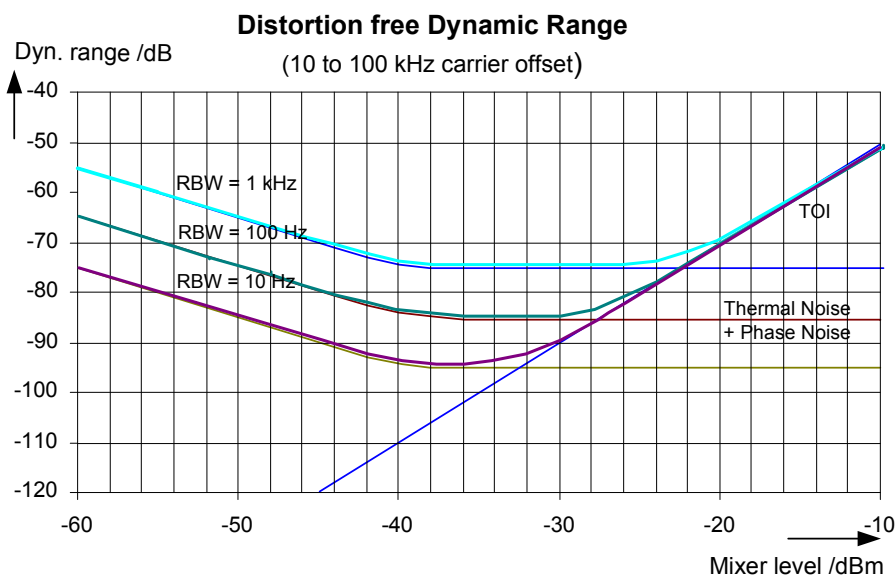

Fig. 2-9 Intermodulation-free dynamic range of the R&S ESL as a function of level at the input mixer and of the selected resolution bandwidth (useful signal offset = 10 to 100 kHz, DANL = -145 dBm /Hz, TOI = 15 dBm; typical values at 2 GHz).

---

**Note:** *If the intermodulation products of a DUT with a very high dynamic range are to be measured and the resolution bandwidth to be used is therefore very small, it is best to measure the levels of the useful signals and those of the intermodulation products separately using a small span. The measurement time will be reduced— in particular if the offset of the useful signals is large. To find signals reliably when frequency span is small, it is best to synchronize the signal sources and the R&S ESL.*

---

## Measuring Signals in the Vicinity of Noise

The minimum signal level a spectrum analyzer can measure is limited by its intrinsic noise. Small signals can be swamped by noise and therefore cannot be measured. For signals that are just above the intrinsic noise, the accuracy of the level measurement is influenced by the intrinsic noise of the spectrum analyzer.

The displayed noise level of a spectrum analyzer depends on its noise figure, the selected RF attenuation, the selected reference level, the selected resolution and video bandwidth and the detector. The effect of the different parameters is explained in the following.

### Impact of the RF attenuation setting

The sensitivity of a spectrum analyzer is directly influenced by the selected RF attenuation. The highest sensitivity is obtained at a RF attenuation of 0 dB. The attenuation can be set in 10 dB steps up to 70 dB. Each additional 10 dB step reduces the sensitivity by 10 dB, i.e. the displayed noise is increased by 10 dB.

### Impact of the resolution bandwidth

The sensitivity of a spectrum analyzer also directly depends on the selected bandwidth. The highest sensitivity is obtained at the smallest bandwidth (for the R&S ESL: 10 Hz, for FFT filtering: 1 Hz). If the bandwidth is increased, the reduction in sensitivity is proportional to the change in bandwidth. The R&S ESL has bandwidth settings in 1, 3, 10 sequence. Increasing the bandwidth by a factor of 3 increases the displayed noise by approx. 5 dB (4.77 dB precisely). If the bandwidth is increased by a factor of 10, the displayed noise increases by a factor of 10, i.e. 10 dB.

### Impact of the video bandwidth

The displayed noise of a spectrum analyzer is also influenced by the selected video bandwidth. If the video bandwidth is considerably smaller than the resolution bandwidth, noise spikes are suppressed, i.e. the trace becomes much smoother. The level of a sinewave signal is not influenced by the video bandwidth. A sinewave signal can therefore be freed from noise by using a video bandwidth that is small compared with the resolution bandwidth, and thus be measured more accurately.

### Impact of the detector

Noise is evaluated differently by the different detectors. The noise display is therefore influenced by the choice of detector. Sinewave signals are weighted in the same way by all detectors, i.e. the level display for a sinewave RF signal does not depend on the selected detector, provided that the signal-to-noise ratio is high enough. The measurement accuracy for signals in the vicinity of intrinsic spectrum analyzer noise is also influenced by the detector which has been selected. For details on the detectors of the R&S ESL refer to chapter "Instrument Functions", section "Detector overview" or the Online Help.

**Measurement example – Measuring level at low S/N ratios**

The example shows the different factors influencing the S/N ratio.

**Signal generator settings (e.g. R&S SMU):**

Frequency: 128 MHz  
 Level: -80 dBm

**Procedure:**

1. Set the R&S ESL to its default state.
  - Press the **PRESET** key.  
 The R&S ESL is in its default state.
2. Set the center frequency to 128 MHz and the frequency span to 100 MHz.
  - Press the **FREQ** key and enter 128 MHz.
  - Press the **SPAN** key and enter 100 MHz.
3. Set the RF attenuation to 60 dB to attenuate the input signal or to increase the intrinsic noise.
  - Press the **AMPT** key.
  - Press the **RF Atten Manual** softkey and enter 60 dB.

The RF attenuation indicator is marked with an asterisk (\*Att 60 dB) to show that it is no longer coupled to the reference level. The high input attenuation reduces the reference signal which can no longer be detected in noise.

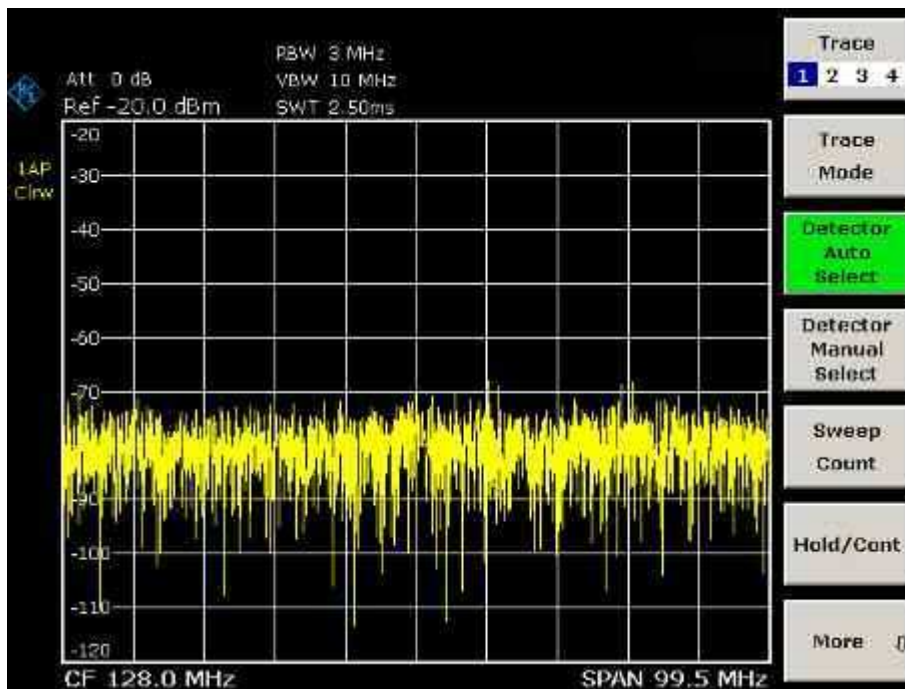

Fig. 2-10 Sinewave signal with low S/N ratio. The signal is measured with the auto peak detector and is completely hidden in the intrinsic noise of the R&S ESL.



4. To suppress noise spikes the trace can be averaged.

- Press the **TRACE** key.
- Press the **Trace Mode** key.
- Press the **Average** softkey.

The traces of consecutive sweeps are averaged. To perform averaging, the R&S ESL automatically switches on the sample detector. The RF signal, therefore, can be more clearly distinguished from noise.

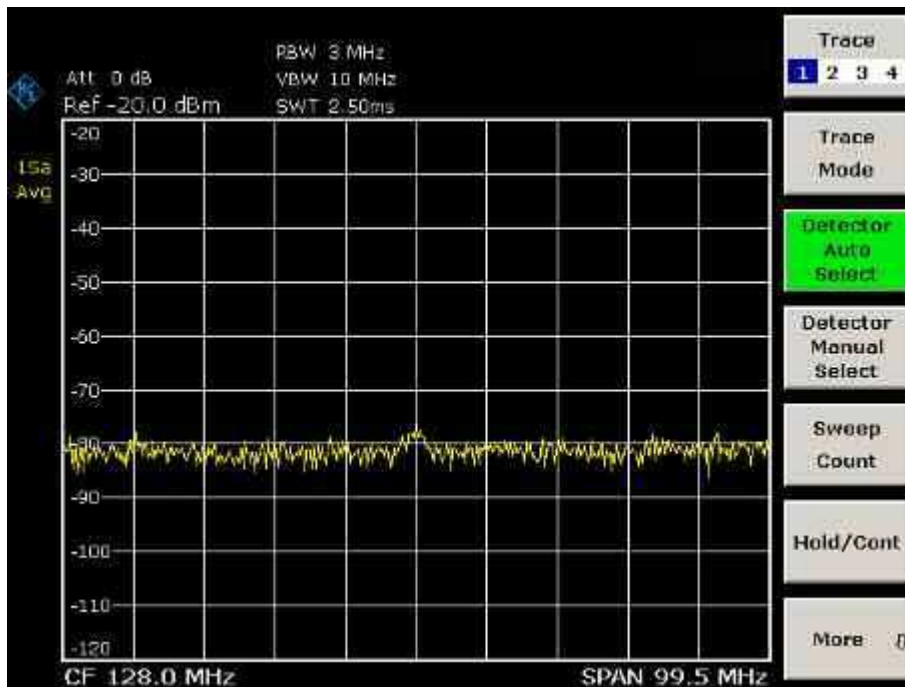

Fig. 2-11 RF sinewave signal with low S/N ratio if the trace is averaged.

5. Instead of trace averaging, a video filter that is narrower than the resolution bandwidth can be selected.

- Press the **Trace Mode** key.
- Press the **Clear Write** softkey.
- Press the **BW** key.
- Press the **Video BW Manual** softkey and enter *10 kHz*.

The RF signal can be more clearly distinguished from noise.

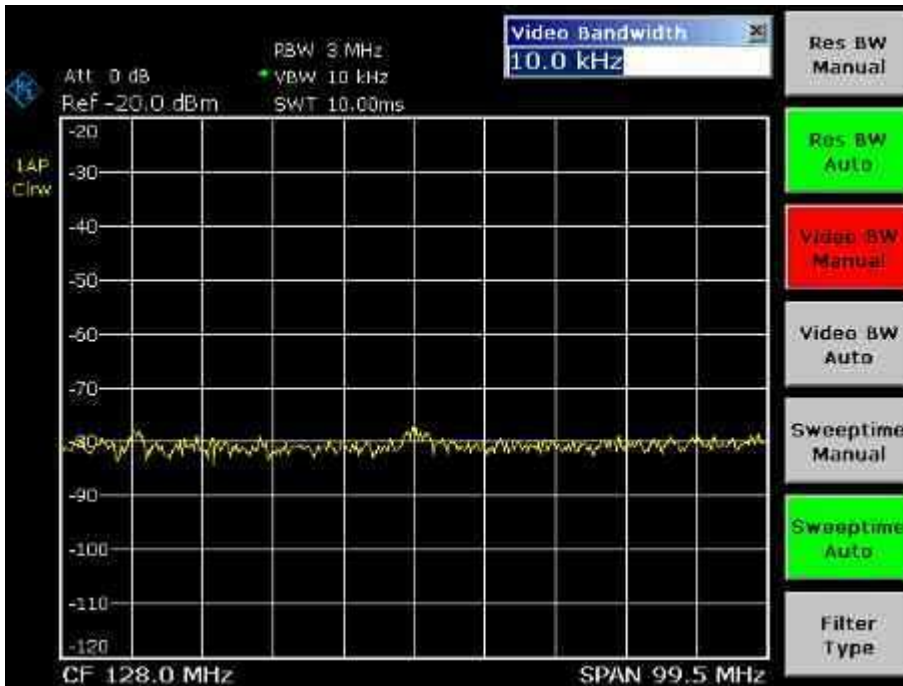

Fig. 2-12 RF sinewave signal with low S/N ratio if a smaller video bandwidth is selected.

6. By reducing the resolution bandwidth by a factor of 10, the noise is reduced by 10 dB.
  - Press the **Res BW Manual** softkey and enter *300 kHz*.

The displayed noise is reduced by approx. 10 dB. The signal, therefore, emerges from noise by about 10 dB. Compared to the previous setting, the video bandwidth has remained the same, i.e. it has increased relative to the smaller resolution bandwidth. The averaging effect of the video bandwidth is therefore reduced. The trace will be noisier.

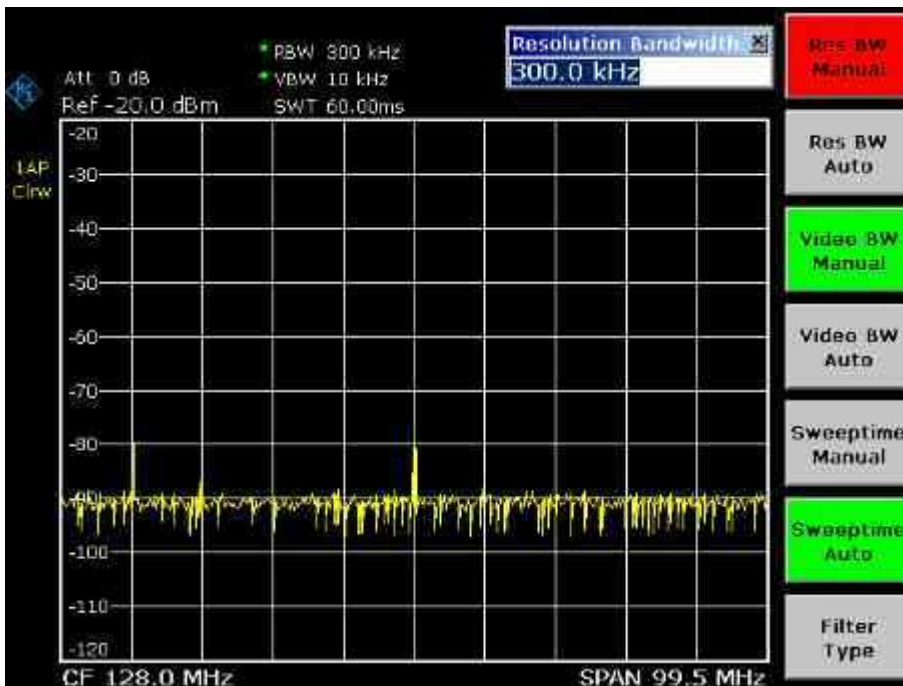

Fig. 2-13 Reference signal at a smaller resolution bandwidth

## Noise Measurements

Noise measurements play an important role in spectrum analysis. Noise e.g. affects the sensitivity of radio communication systems and their components.

Noise power is specified either as the total power in the transmission channel or as the power referred to a bandwidth of 1 Hz. The sources of noise are, for example, amplifier noise or noise generated by oscillators used for the frequency conversion of useful signals in receivers or transmitters. The noise at the output of an amplifier is determined by its noise figure and gain.

The noise of an oscillator is determined by phase noise near the oscillator frequency and by thermal noise of the active elements far from the oscillator frequency. Phase noise can mask weak signals near the oscillator frequency and make them impossible to detect.

## Measuring Noise Power Density

To measure noise power referred to a bandwidth of 1 Hz at a certain frequency, the R&S ESL provides marker function. This marker function calculates the noise power density from the measured marker level.

### Measurement example – Measuring the intrinsic noise power density of the R&S ESL at 1 GHz and calculating the R&S ESL's noise figure

#### Test setup:

- Connect no signal to the RF input; terminate RF input with 50 Ω.

#### Procedure:

1. Set the R&S ESL to its default state.
  - Press the **PRESET** key.  
The R&S ESL is in its default state.
2. Set the center frequency to 1.234 GHz and the span to 1 MHz.
  - Press the **FREQ** key and enter *1.234 GHz*.
  - Press the **SPAN** key and enter *1 MHz*.
3. Switch on the marker and set the marker frequency to 1.234 GHz.
  - Press the **MKR** key and enter *1.234 GHz*.
4. Switch on the noise marker function.
  - Switch on the **Noise Meas** softkey.  
The R&S ESL displays the noise power at 1 GHz in dBm (1 Hz).

---

**Note:** *Since noise is random, a sufficiently long measurement time has to be selected to obtain stable measurement results. This can be achieved by averaging the trace or by selecting a very small video bandwidth relative to the resolution bandwidth.*

---

5. The measurement result is stabilized by averaging the trace.

- Press the **TRACE** key.
- Press the **Trace Mode** key.
- Press the **Average** softkey.

The R&S ESL performs sliding averaging over 10 traces from consecutive sweeps. The measurement result becomes more stable.

### Conversion to other reference bandwidths

The result of the noise measurement can be referred to other bandwidths by simple conversion. This is done by adding  $10 \cdot \log(\text{BW})$  to the measurement result, BW being the new reference bandwidth.

#### Example

A noise power of  $-150$  dBm (1 Hz) is to be referred to a bandwidth of 1 kHz.

$$P_{[1\text{kHz}]} = -150 + 10 \cdot \log(1000) = -150 + 30 = -120 \text{ dBm (1 kHz)}$$

### Calculation method for noise power

If the noise marker is switched on, the R&S ESL automatically activates the sample detector. The video bandwidth is set to 1/10 of the selected resolution bandwidth (RBW).

To calculate the noise, the R&S ESL takes an average over 17 adjacent pixels (the pixel on which the marker is positioned and 8 pixels to the left, 8 pixels to the right of the marker). The measurement result is stabilized by video filtering and averaging over 17 pixels.

Since both video filtering and averaging over 17 trace points is performed in the log display mode, the result would be 2.51 dB too low (difference between logarithmic noise average and noise power). The R&S ESL, therefore, corrects the noise figure by 2.51 dB.

To standardize the measurement result to a bandwidth of 1 Hz, the result is also corrected by  $-10 \cdot \log(\text{RBW}_{\text{noise}})$ , with  $\text{RBW}_{\text{noise}}$  being the power bandwidth of the selected resolution filter (RBW).

### Detector selection

The noise power density is measured in the default setting with the sample detector and using averaging. Other detectors that can be used to perform a measurement giving true results are the average detector or the RMS detector. If the average detector is used, the linear video voltage is averaged and displayed as a pixel. If the RMS detector is used, the squared video voltage is averaged and displayed as a pixel. The averaging time depends on the selected sweep time ( $=\text{SWT}/501$ ). An increase in the sweep time gives a longer averaging time per pixel and thus stabilizes the measurement result. The R&S ESL automatically corrects the measurement result of the noise marker display depending on the selected detector (+1.05 dB for the average detector, 0 dB for the RMS detector). It is assumed that the video bandwidth is set to at least three times the resolution bandwidth. While the average or RMS detector is being switched on, the R&S ESL sets the video bandwidth to a suitable value.

The Pos Peak, Neg Peak, Auto Peak and Quasi Peak detectors are not suitable for measuring noise power density.

### Determining the noise figure

The noise figure of amplifiers or of the R&S ESL alone can be obtained from the noise power display. Based on the known thermal noise power of a  $50 \Omega$  resistor at room temperature ( $-174$  dBm (1Hz)) and the measured noise power  $P_{\text{noise}}$  the noise figure (NF) is obtained as follows:

$$NF = P_{\text{noise}} + 174 - g,$$

where  $g$  = gain of DUT in dB

**Example**

The measured internal noise power of the R&S ESL at an attenuation of 0 dB is found to be  $-143$  dBm/1 Hz. The noise figure of the R&S ESL is obtained as follows

$$NF = -143 + 174 = 31 \text{ dB}$$

**Note:** If noise power is measured at the output of an amplifier, for example, the sum of the internal noise power and the noise power at the output of the DUT is measured. The noise power of the DUT can be obtained by subtracting the internal noise power from the total power (subtraction of linear noise powers). By means of the following diagram, the noise level of the DUT can be estimated from the level difference between the total and the internal noise level.

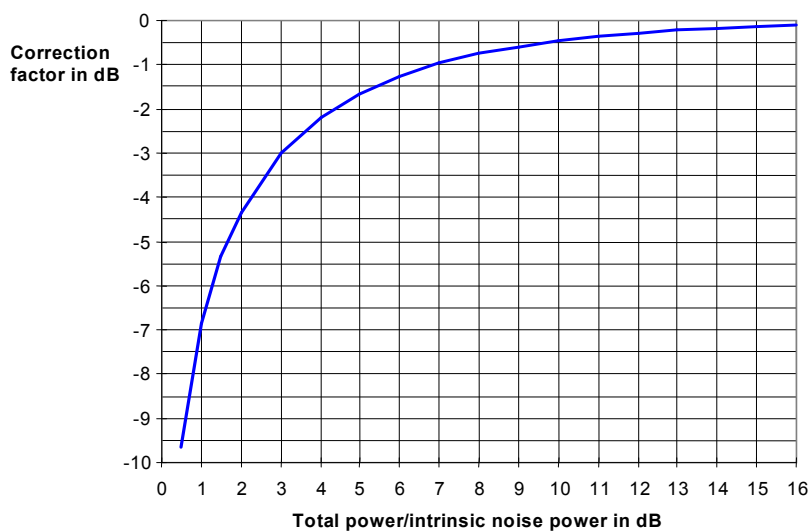

Fig. 2-14 Correction factor for measured noise power as a function of the ratio of total power to the intrinsic noise power of the spectrum analyzer

## Measurement of Noise Power within a Transmission Channel

Noise in any bandwidth can be measured with the channel power measurement functions. Thus the noise power in a communication channel can be determined, for example. If the noise spectrum within the channel bandwidth is flat, the noise marker from the previous example can be used to determine the noise power in the channel by considering the channel bandwidth. If, however, phase noise and noise that normally increases towards the carrier is dominant in the channel to be measured, or if there are discrete spurious signals in the channel, the channel power measurement method must be used to obtain correct measurement results.

**Measurement example – Measuring the intrinsic noise of the R&S ESL at 1 GHz in a 1.23 MHz channel bandwidth with the channel power function****Test setup:**

- Leave the RF input of the R&S ESL open-circuited or terminate it with 50 Ω.

**Procedure:**

1. Set the R&S ESL to its default state.
  - Press the **PRESET** key.  
The R&S ESL is in its default state.
2. Set the center frequency to 1 GHz and the span to 1 MHz.
  - Press the **FREQ** key and enter *1 GHz*.
  - Press the **SPAN** key and enter *2 MHz*.
3. To obtain maximum sensitivity, set RF attenuation on the R&S ESL to 0 dB.
  - Press the **AMPT** key.
  - Press the **RF Atten Manual** softkey and enter *0 dB*.
4. Switch on and configure the channel power measurement.
  - Press the **MEAS** key.
  - Press the **CP, ACP, MC-ACP** softkey.  
The R&S ESL activates the channel or adjacent channel power measurement according to the currently set configuration.
  - Press the **CP/ACP Config** softkey.  
The submenu for configuring the channel is displayed.
  - Press the **Channel Settings** softkey.  
The submenu for channel settings is displayed.
  - Press the **Channel Bandwidth** softkey and enter *1.23 MHz*.  
The R&S ESL displays the 1.23 MHz channel as two vertical lines which are symmetrical to the center frequency.
  - Press the **Adjust Settings** softkey.  
The settings for the frequency span, the bandwidth (RBW and VBW) and the detector are automatically set to the optimum values required for the measurement.

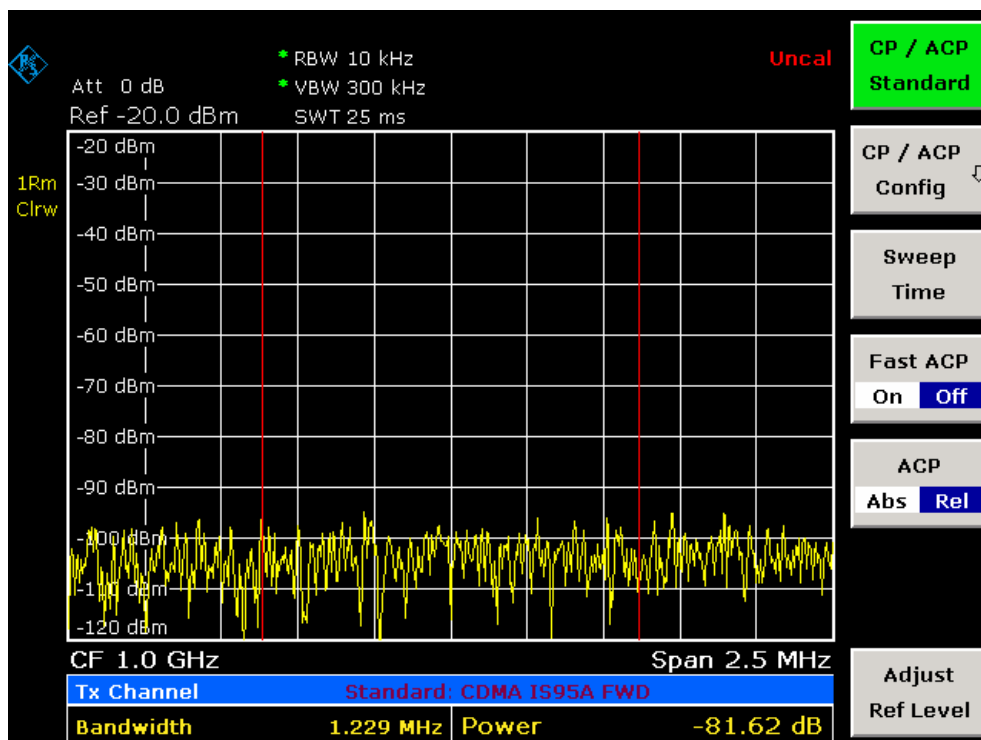

Fig. 2-15 Measurement of the R&S ESL's intrinsic noise power in a 1.23 MHz channel bandwidth.

#### 5. Stabilizing the measurement result by increasing the sweep time

- Press the ▲ key twice.

The main menu for channel and adjacent channel power measurement is displayed.

- Press the **Sweep Time** softkey and enter 1 s.

The trace becomes much smoother because of the RMS detector and the channel power measurement display is much more stable.

#### Method of calculating the channel power

When measuring the channel power, the R&S ESL integrates the linear power which corresponds to the levels of the pixels within the selected channel. The spectrum analyzer uses a resolution bandwidth which is far smaller than the channel bandwidth. When sweeping over the channel, the channel filter is formed by the passband characteristics of the resolution bandwidth (see Fig. 2-16).

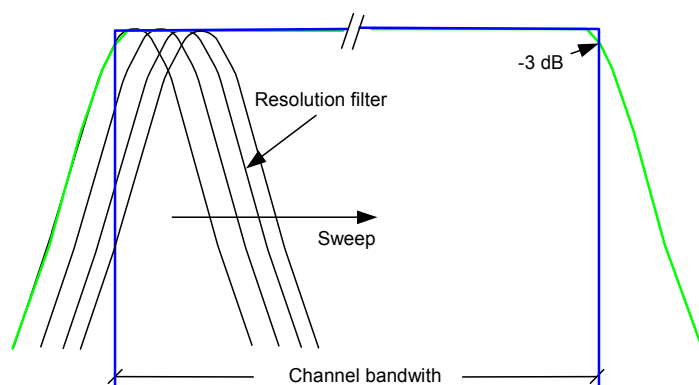

Fig. 2-16 Approximating the channel filter by sweeping with a small resolution bandwidth

The following steps are performed:

- The linear power of all the trace pixels within the channel is calculated.

$$P_i = 10^{(L_i/10)}$$

where  $P_i$  = power of the trace pixel  $i$

$L_i$  = displayed level of trace point  $i$

- The powers of all trace pixels within the channel are summed up and the sum is divided by the number of trace pixels in the channel.
- The result is multiplied by the quotient of the selected channel bandwidth and the noise bandwidth of the resolution filter (RBW).

Since the power calculation is performed by integrating the trace within the channel bandwidth, this method is also called the IBW method (Integration Bandwidth method).

### Parameter settings

For selection of the sweep time, see next section. For details on the parameter settings refer to chapter "Instrument Functions", section "Settings of the CP / ACP test parameters" or the Online Help.

### Sweep time selection

The number of A/D converter values,  $N$ , used to calculate the power, is defined by the sweep time. The time per trace pixel for power measurements is directly proportional to the selected sweep time.

If the sample detector is used, it is best to select the smallest sweep time possible for a given span and resolution bandwidth. The minimum time is obtained if the setting is coupled. This means that the time per measurement is minimal. Extending the measurement time does not have any advantages as the number of samples for calculating the power is defined by the number of trace pixels in the channel.

If the RMS detector is used, the repeatability of the measurement results can be influenced by the selection of sweep times. Repeatability is increased at longer sweep times.

Repeatability can be estimated from the following diagram:



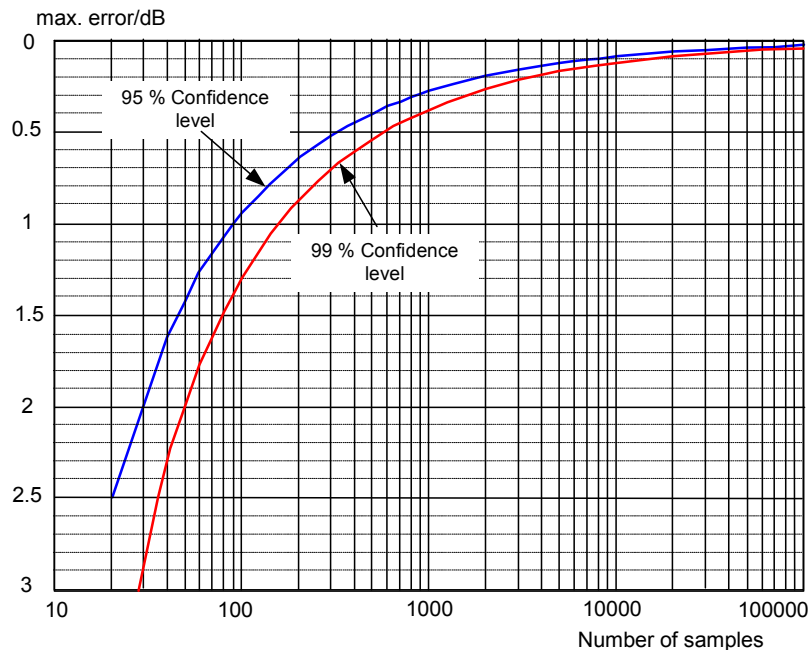

Fig. 2-17 Repeatability of channel power measurements as a function of the number of samples used for power calculation

The curves in Fig. 2-17 indicate the repeatability obtained with a probability of 95% and 99% depending on the number of samples used.

The repeatability with 600 samples is  $\pm 0.5$  dB. This means that – if the sample detector and a channel bandwidth over the whole diagram (channel bandwidth = span) is used – the measured value lies within  $\pm 0.5$  dB of the true value with a confidence level of 99%.

If the RMS detector is used, the number of samples can be estimated as follows:

Since only uncorrelated samples contribute to the RMS value, the number of samples can be calculated from the sweep time and the resolution bandwidth.

Samples can be assumed to be uncorrelated if sampling is performed at intervals of  $1/\text{RBW}$ . The number of uncorrelated samples is calculated as follows:

$$N_{\text{decorr}} = \text{SWT} \cdot \text{RBW} \quad (N_{\text{decorr}} \text{ means uncorrelated samples})$$

The number of uncorrelated samples per trace pixel is obtained by dividing  $N_{\text{decorr}}$  by 501 (= pixels per trace).

### Example

At a resolution bandwidth of 30 kHz and a sweep time of 100 ms, 3000 uncorrelated samples are obtained. If the channel bandwidth is equal to the frequency display range, i.e. all trace pixels are used for the channel power measurement, a repeatability of 0.2 dB with a probability of 99% is the estimate that can be derived from Fig. 2-17.

## Measuring Phase Noise

The R&S ESL has an easy-to-use marker function for phase noise measurements. This marker function indicates the phase noise of an RF oscillator at any carrier in dBc in a bandwidth of 1 Hz.

### Measurement example – Measuring the phase noise of a signal generator at a carrier offset of 10 kHz

#### Test setup:

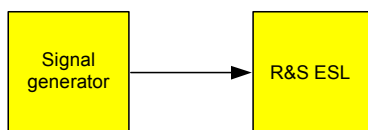

#### Signal generator settings (e.g. R&S SMU):

Frequency: 100 MHz

Level: 0 dBm

#### Procedure:

1. Set the R&S ESL to its default state.
  - Press the **PRESET** key.  
R&S ESL is in its default state.
2. Set the center frequency to 100 MHz and the span to 50 kHz.
  - Press the **FREQ** key and enter *100 MHz*.
  - Press the **SPAN** key and enter *50 kHz*.
3. Set the R&S ESL's reference level to 0 dBm (=signal generator level).
  - Press the **AMPT** key and enter *0 dBm*.
4. Enable phase noise measurement.
  - Press the **MKR** key.
  - Press the Phase Noise/Ref Fixed softkey.  
The R&S ESL activates phase noise measurement. Marker 1 (=main marker) and marker 2 (=delta marker) are positioned on the signal maximum. The position of the marker is the reference (level and frequency) for the phase noise measurement. A horizontal line represents the level of the reference point and a vertical line the frequency of the reference point. The dialog box for the delta marker is displayed so that the frequency offset at which the phase noise is to be measured can be entered directly.
5. Set the frequency offset to 10 kHz for determining phase noise.
  - Enter *10 kHz*.

The R&S ESL displays the phase noise at a frequency offset of 10 kHz. The magnitude of the phase noise in dBc/Hz is displayed in the delta marker output field at the top right of the screen (Phn2).

6. Stabilize the measurement result by activating trace averaging.
  - Press the **TRACE** key.
  - Press the **Trace Mode** key.
  - Press the **Average** softkey.

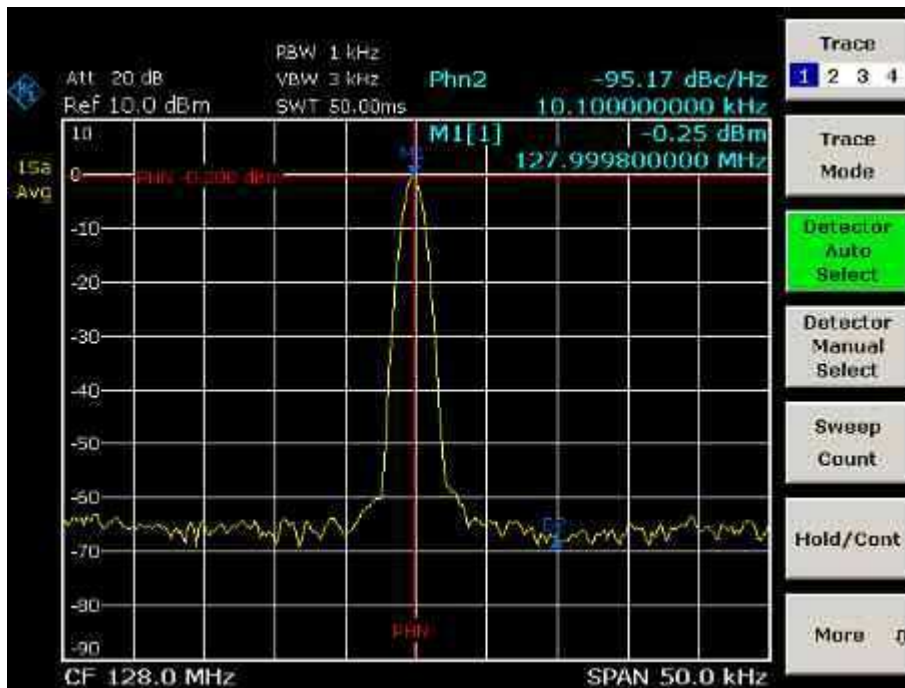

Fig. 2-18 Measuring phase noise with the phase-noise marker function

The frequency offset can be varied by moving the marker with the rotary knob or by entering a new frequency offset as a number.

## Measurements on Modulated Signals

For measurements on AM and FM signals refer to the Quick Start Guide, chapter 5, "Basic Measurements Examples".

### Measuring Channel Power and Adjacent Channel Power

Measuring channel power and adjacent channel power is one of the most important tasks in the field of digital transmission for a spectrum analyzer with the necessary test routines. While, theoretically, channel power could be measured at highest accuracy with a power meter, its low selectivity means that it is not suitable for measuring adjacent channel power as an absolute value or relative to the transmit channel power. The power in the adjacent channels can only be measured with a selective power meter.

A spectrum analyzer cannot be classified as a true power meter, because it displays the IF envelope voltage. However, it is calibrated such as to correctly display the power of a pure sinewave signal irrespective of the selected detector. This calibration cannot be applied for non-sinusoidal signals. Assuming that the digitally modulated signal has a Gaussian amplitude distribution, the signal power within the selected resolution bandwidth can be obtained using correction factors. These correction factors are normally used by the spectrum analyzer's internal power measurement routines in order to determine the signal power from IF envelope measurements. These factors apply if and only if the assumption of a Gaussian amplitude distribution is correct.

Apart from this common method, the R&S ESL also has a true power detector, i.e. an RMS detector. It correctly displays the power of the test signal within the selected resolution bandwidth irrespective of the amplitude distribution, without additional correction factors being required. The absolute measurement uncertainty of the R&S ESL is < 1.5 dB and a relative measurement uncertainty of < 0.5 dB (each with a confidence level of 95%).

There are two possible methods for measuring channel and adjacent channel power with a spectrum analyzer:

- **IBW method (Integration Bandwidth Method)**  
The spectrum analyzer measures with a resolution bandwidth that is less than the channel bandwidth and integrates the level values of the trace versus the channel bandwidth. This method is described in section "[Method of calculating the channel power](#)".
- **Using a channel filter**  
For a detailed description, refer to the following section.

### Measurement using a channel filter

In this case, the spectrum analyzer makes zero span measurements using an IF filter that corresponds to the channel bandwidth. The power is measured at the output of the IF filter. Until now, this method has not been used for spectrum analyzers, because channel filters were not available and the resolution bandwidths, optimized for the sweep, did not have a sufficient selectivity. The method was reserved for special receivers optimized for a particular transmission method. It is available in R&S FSQ, FSU, FSP, FSL and ESL series.

The R&S ESL has test routines for simple channel and adjacent channel power measurements. These routines give quick results without any complex or tedious setting procedures.

### Measurement example 1 – ACPR measurement on an CDMA 2000 signal

#### Test setup:

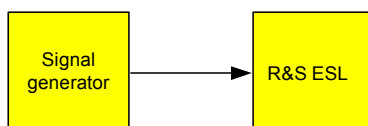

#### Signal generator settings (e.g. R&S SMU):

Frequency: 850 MHz  
Level: 0 dBm  
Modulation: CDMA 2000

#### Procedure:

1. Set the R&S ESL to its default state.

- Press the **PRESET** key.  
The R&S ESL is in its default state.
- 2. Set the center frequency to 850 MHz and span to 4 MHz.
  - Press the **FREQ** key and enter *850 MHz*.
  - Press the **SPAN** key and enter *4 MHz*.
- 3. Set the reference level to +10 dBm.
  - Press the **AMPT** key and enter *10 dBm*.
- 4. Configuring the adjacent channel power for the CDMA 2000 MC1.
  - Press the **MEAS** key.
  - Press the **CP, ACP, MC-ACP** softkey.
  - Press the **CP / ACP Standard** softkey.
  - In the standards list, mark **CDMA 2000 MC1** using the rotary knob or the arrow keys and confirm pressing the rotary knob or the **ENTER** key.

The R&S ESL sets the channel configuration according to the 2000 MC1 standard for mobile stations with 2 adjacent channels above and below the transmit channel. The spectrum is displayed in the upper part of the screen, the numeric values of the results and the channel configuration in the lower part of the screen. The various channels are represented by vertical lines on the graph.

The frequency span, resolution bandwidth, video bandwidth and detector are selected automatically to give correct results. To obtain stable results – especially in the adjacent channels (30 kHz bandwidth) which are narrow in comparison with the transmission channel bandwidth (1.23 MHz) – the RMS detector is used.

- 5. Set the optimal reference level and RF attenuation for the applied signal level.
  - Press the **Adjust Ref Level** softkey.  
The R&S ESL sets the optimal RF attenuation and the reference level based on the transmission channel power to obtain the maximum dynamic range. [Fig. 2-19](#) shows the result of the measurement.

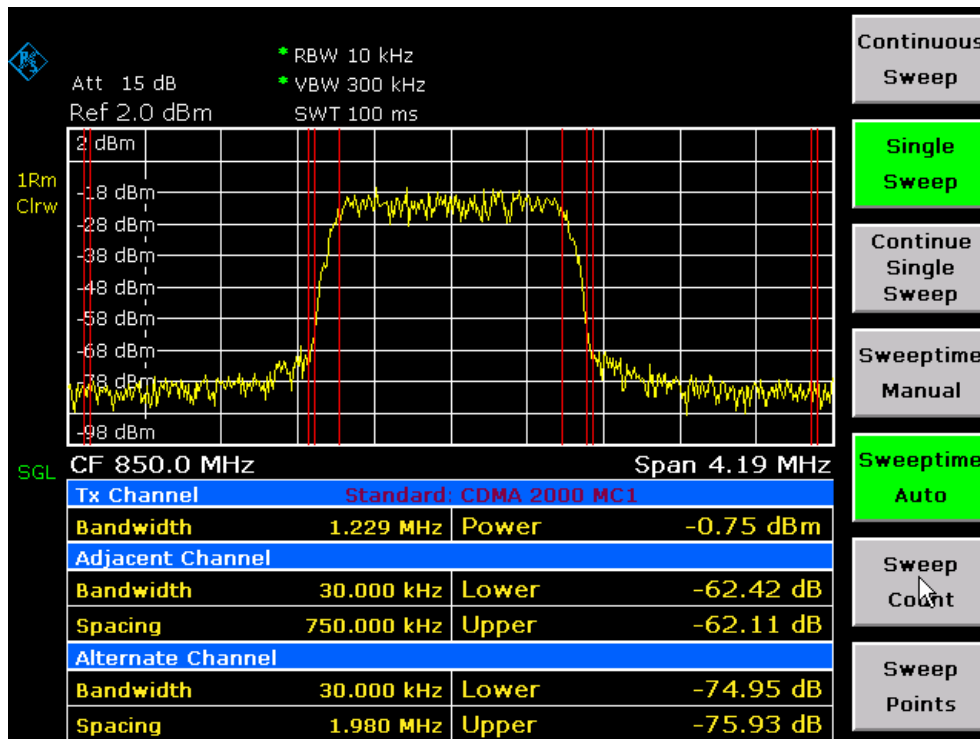

Fig. 2-19 Adjacent channel power measurement on a CDMA 2000 MC1 signal

The repeatability of the results, especially in the narrow adjacent channels, strongly depends on the measurement time since the dwell time within the 30 kHz channels is only a fraction of the complete sweep time. A longer sweep time may increase the probability that the measured value converges to the true value of the adjacent channel power, but this increases measurement time.

To avoid long measurement times, the R&S ESL measures the adjacent channel power with zero span (fast ACP mode). In the fast ACP mode, the R&S ESL measures the power of each channel at the defined channel bandwidth, while being tuned to the center frequency of the channel in question. The digital implementation of the resolution bandwidths makes it possible to select filter characteristics that is precisely tailored to the signal. In case of CDMA 2000 MC1, the power in the useful channel is measured with a bandwidth of 1.23 MHz and that of the adjacent channels with a bandwidth of 30 kHz. Therefore the R&S ESL changes from one channel to the other and measures the power at a bandwidth of 1.23 MHz or 30 kHz using the RMS detector. The measurement time per channel is set with the sweep time. It is equal to the selected measurement time divided by the selected number of channels. The five channels from the above example and the sweep time of 100 ms give a measurement time per channel of 20 ms.

Compared to the measurement time per channel given by the span (= 5 MHz) and sweep time (= 100 ms, equal to 0.600 ms per 30 kHz channel) used in the example, this is a far longer dwell time on the adjacent channels (factor of 12). In terms of the number of uncorrelated samples this means  $20000/33 \mu s = 606$  samples per channel measurement compared to  $600/33 \mu s = 12.5$  samples per channel measurement.

Repeatability with a confidence level of 95% is increased from  $\pm 1.4$  dB to  $\pm 0.38$  dB as shown in Fig. 2-17. For the same repeatability, the sweep time would have to be set to 1.2 s with the integration method. Fig. 2-20 shows the standard deviation of the results as a function of the sweep time.

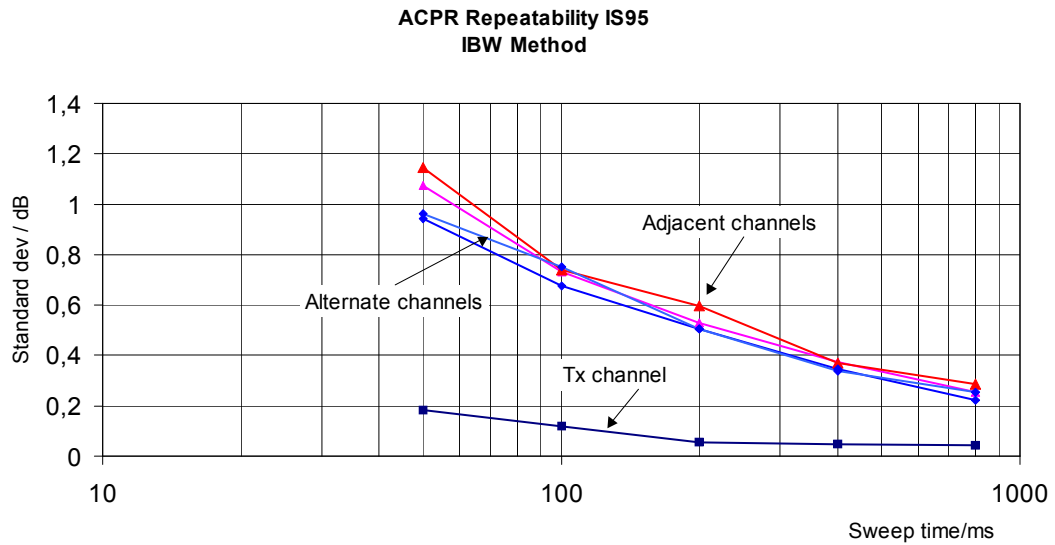

Fig. 2-20 Repeatability of adjacent channel power measurement on CDMA 2000 standard signals if the integration bandwidth method is used

6. Switch to fast ACP mode to increase the repeatability of results.

- Switch the **Fast ACP** softkey to **On**.

The R&S ESL measures the power of each channel with zero span. The trace represents power as a function of time for each channel (see Fig. 2-23). The numerical results over consecutive measurements become much more stable.

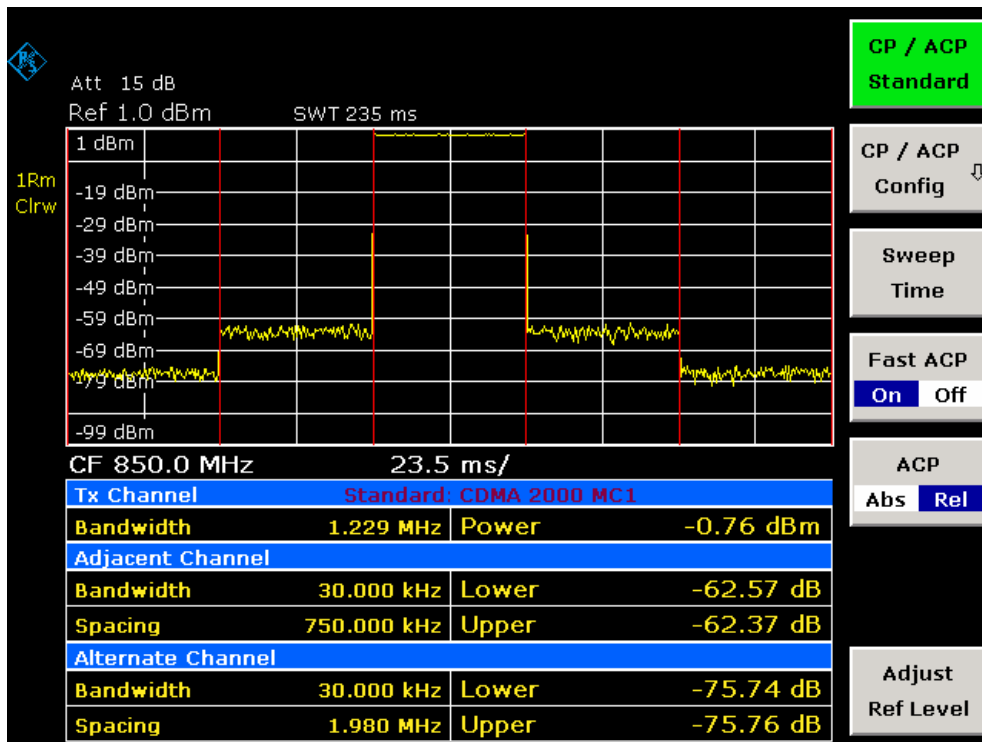

Fig. 2-21 Measuring the channel power and adjacent channel power ratio for 2000 MC1 signals with zero span (Fast ACP)

Fig. 2-22 shows the repeatability of power measurements in the transmit channel and of relative power measurements in the adjacent channels as a function of sweep time. The standard deviation of measurement results is calculated from 100 consecutive measurements as shown in Fig. 2-22. Take scaling into account if comparing power values.

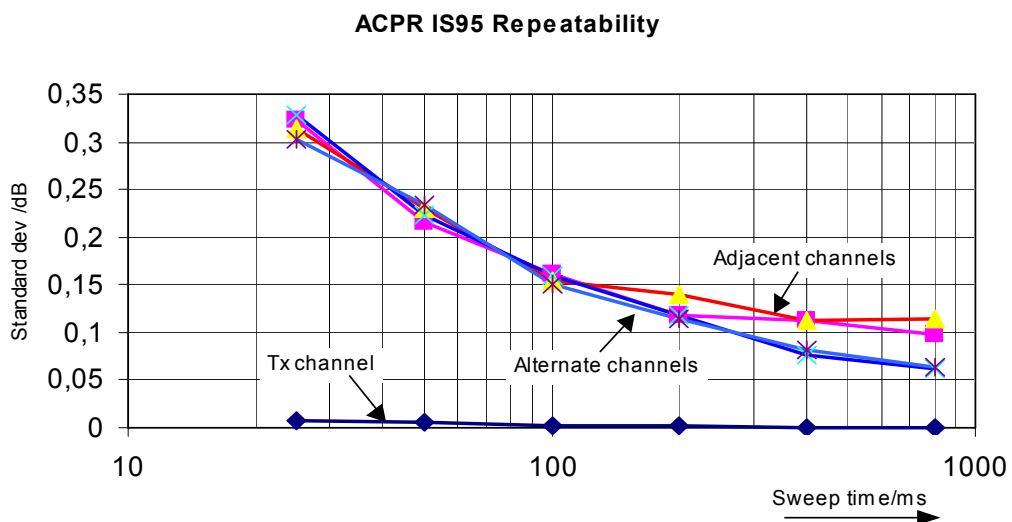

Fig. 2-22 Repeatability of adjacent channel power measurements on CDMA 2000 signals in the fast ACP mode



**Note on adjacent channel power measurements on 2000 MC1 base-station signals:**

When measuring the adjacent channel power of 2000 MC1 base-station signals, the frequency spacing of the adjacent channel to the nominal transmit channel is specified as  $\pm 750$  kHz. The adjacent channels are, therefore, so close to the transmit channel that the power of the transmit signal leaks across and is also measured in the adjacent channel if the usual method using the 30 kHz resolution bandwidth is applied. The reason is the low selectivity of the 30 kHz resolution filter. The resolution bandwidth, therefore, must be reduced considerably, e.g. to 3 kHz to avoid this. This causes very long measurement times (factor of 100 between a 30 kHz and 3 kHz resolution bandwidth).

This effect is avoided with the zero span method which uses steep IF filters. The 30 kHz channel filter implemented in the R&S ESL has a very high selectivity so that even with a  $\pm 750$  kHz spacing to the transmit channel the power of the useful modulation spectrum is not measured.

The following figure shows the passband characteristics of the 30 kHz channel filter in the R&S ESL.

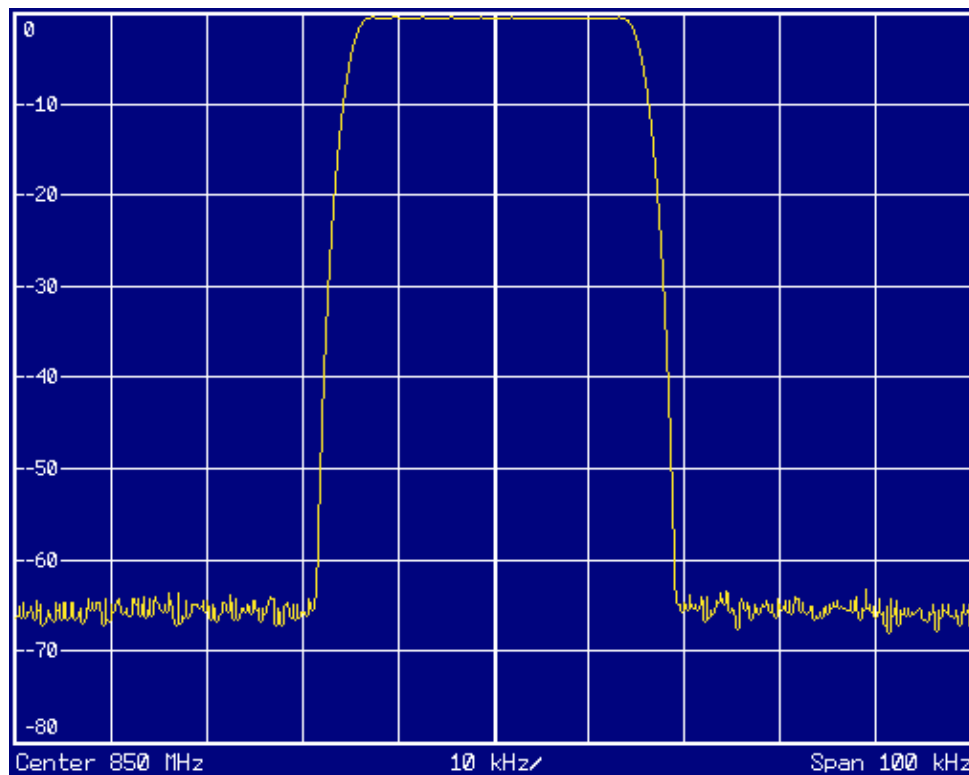
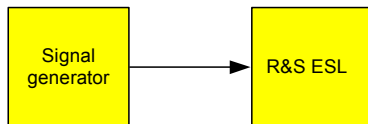

Fig. 2-23 Frequency response of the 30 kHz channel filter for measuring the power in the 2000 MC1 adjacent channel

## Measurement example 2 – Measuring adjacent channel power of a W-CDMA uplink signal

### Test setup:



### Signal generator settings (e.g. R&S SMU):

Frequency: 1950 MHz  
Level: 4 dBm  
Modulation: 3 GPP W-CDMA Reverse Link

### Procedure:

1. Set the R&S ESL to its default state.
  - Press the **PRESET** key.  
The R&S ESL is in its default state.
2. Set the center frequency to 1950 MHz.
  - Press the **FREQ** key and enter *1950 MHz*.
3. Switch on the ACP measurement for W-CDMA.
  - Press the **MEAS** key.
  - Press the **CP, ACP, MC-ACP** softkey.
  - Press the **CP / ACP Standard** softkey.
  - In the standards list, mark **W-CDMA 3GPP REV** using the rotary knob or the arrow keys and confirm pressing the rotary knob or the **ENTER** key.

The R&S ESL sets the channel configuration to the 3GPP W-CDMA standard for mobiles with two adjacent channels above and below the transmit channel. The frequency span, the resolution and video bandwidth and the detector are automatically set to the correct values. The spectrum is displayed in the upper part of the screen and the channel power, the level ratios of the adjacent channel powers and the channel configuration in the lower part of the screen. The individual channels are displayed as vertical lines on the graph.

4. Set the optimum reference level and the RF attenuation for the applied signal level.
  - Press the **Adjust Ref Level** softkey.

The R&S ESL sets the optimum RF attenuation and the reference level for the power in the transmission channel to obtain the maximum dynamic range. The following figure shows the result of the measurement.

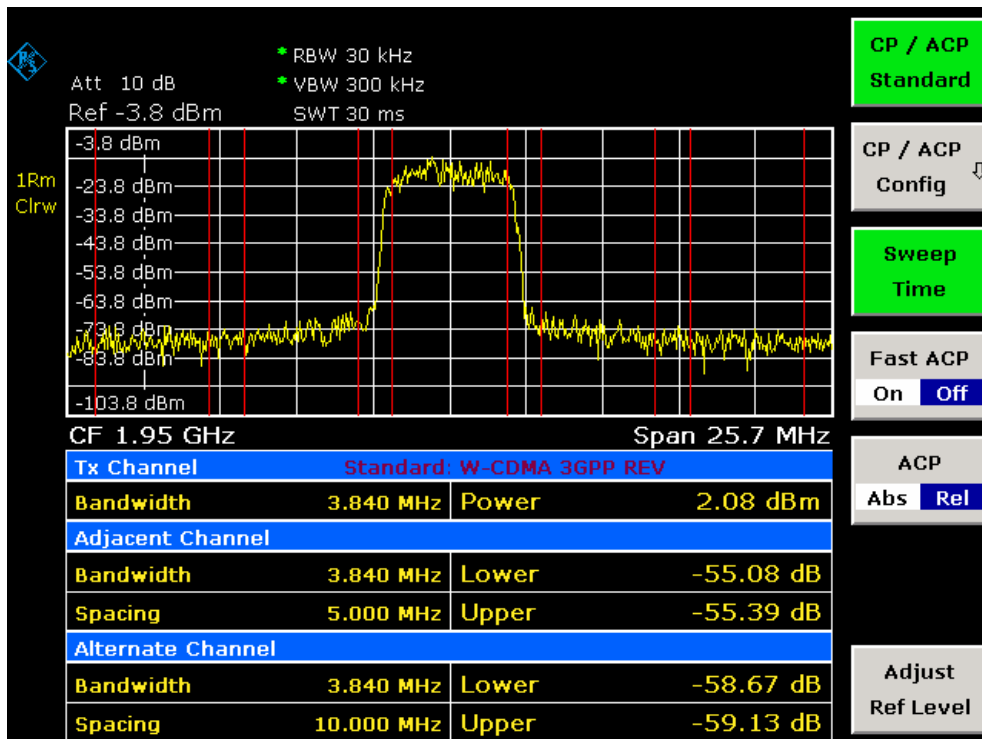

Fig. 2-24 Measuring the relative adjacent channel power on a W-CDMA uplink signal

- Measuring adjacent channel power with the fast ACP mode.
  - Set **Fast ACP** softkey to **On**.
  - Press the **Adjust Ref Level** softkey.

The R&S ESL measures the power of the individual channels with zero span. A root raised cosine filter with the parameters  $\alpha = 0.22$  and chip rate 3.84 Mcps (= receive filter for 3GPP W-CDMA) is used as channel filter.

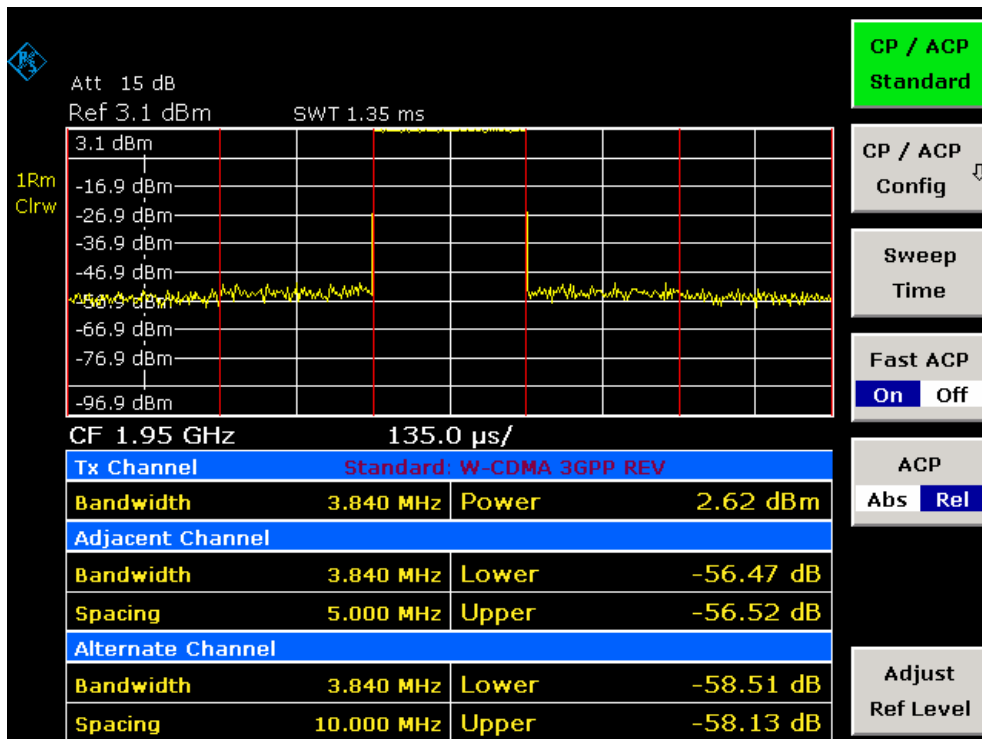

Fig. 2-25 Measuring the adjacent channel power of a W-CDMA signal with the fast ACP mode

**Note:** With W-CDMA, the R&S ESL's dynamic range for adjacent channel measurements is limited by the 12-bit A/D converter. The greatest dynamic range is, therefore, obtained with the IBW method.

**Optimum Level Setting for ACP Measurements on W-CDMA Signals**

The dynamic range for ACPR measurements is limited by the thermal noise floor, the phase noise and the intermodulation (spectral regrowth) of the spectrum analyzer. The power values produced by the R&S ESL due to these factors accumulate linearly. They depend on the applied level at the input mixer. The three factors are shown in the figure below for the adjacent channel (5 MHz carrier offset).

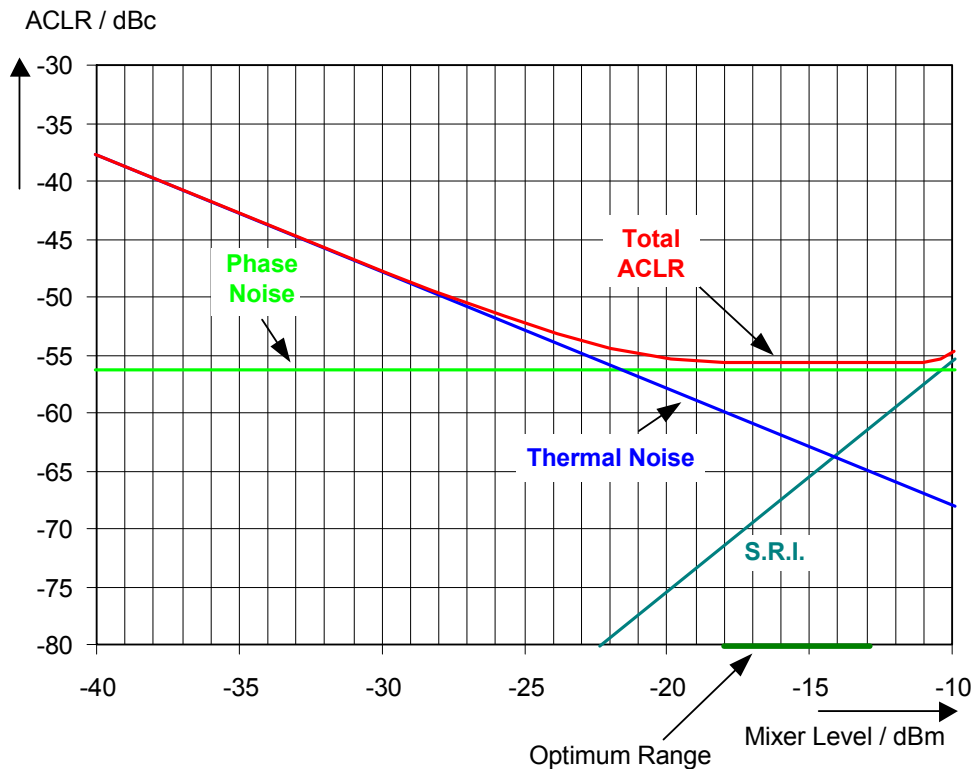

Fig. 2-26 The R&S ESL's dynamic range for adjacent channel power measurements on W-CDMA uplink signals is a function of the mixer level.

The level of the W-CDMA signal at the input mixer is shown on the horizontal axis, i.e. the measured signal level minus the selected RF attenuation. The individual components which contribute to the power in the adjacent channel and the resulting relative level (total ACPR) in the adjacent channel are displayed on the vertical axis. The optimum mixer level is  $-21$  dBm. The relative adjacent channel power (ACPR) at an optimum mixer level is  $-65$  dBc. Since, at a given signal level, the mixer level is set in 10 dB steps with the 10 dB RF attenuator, the optimum 10 dB range is shown in the figure: it spreads from  $-16$  dBm to  $-26$  dBm. In this range, the obtainable dynamic range is 62 dB.

To set the attenuation parameter manually, the following method is recommended:

- Set the RF attenuation so that the mixer level (= measured channel power – RF attenuation) is between  $-11$  dBm and  $-21$  dBm.
- Set the reference level to the largest possible value where no overload (IFOVL) is indicated.

This method is automated with the **Adjust Ref Level** function. Especially in remote control mode, e.g. in production environments, it is best to correctly set the attenuation parameters prior to the measurement, as the time required for automatic setting can be saved.

---

**Note:** To measure the R&S ESL's intrinsic dynamic range for W-CDMA adjacent channel power measurements, a filter which suppresses the adjacent channel power is required at the output of the transmitter. A SAW filter with a bandwidth of 4 MHz, for example, can be used.

---

## Amplitude Distribution Measurements

If modulation types are used that do not have a constant zero span envelope, the transmitter has to handle peak amplitudes that are greater than the average power. This includes all modulation types that involve amplitude modulation –QPSK for example. CDMA transmission modes in particular may have power peaks that are large compared to the average power.

For signals of this kind, the transmitter must provide large reserves for the peak power to prevent signal compression and thus an increase of the bit error rate at the receiver.

The peak power or the crest factor of a signal is therefore an important transmitter design criterion. The crest factor is defined as the peak power / mean power ratio or, logarithmically, as the peak level minus the average level of the signal.

To reduce power consumption and cut costs, transmitters are not designed for the largest power that could ever occur, but for a power that has a specified probability of being exceeded (e.g. 0.01%).

To measure the amplitude distribution, the R&S ESL has simple measurement functions to determine both the APD = Amplitude Probability Distribution and CCDF = Complementary Cumulative Distribution Function.

In the APD display mode, the probability of occurrence of a certain level is plotted against the level.

In the CCDF display mode, the probability that the mean signal power will be exceeded is shown in percent.

### Measurement example – Measuring the APD and CCDF of white noise generated by the R&S ESL

1. Set the R&S ESL to its default state.

- Press the **PRESET** key.

The R&S ESL is in its default state.

2. Configure the R&S ESL for APD measurement

- Press the **AMPT** key and enter  $-60$  dBm.

The R&S ESL's intrinsic noise is displayed at the top of the screen.

- Press the **MEAS** key.
- Press the **More** softkey.
- Press the **APD** softkey.

The R&S ESL sets the frequency span to 0 Hz and measures the amplitude probability distribution (APD). The number of uncorrelated level measurements used for the measurement is 100000. The mean power and the peak power are displayed in dBm. The crest factor (peak power – mean power) is output as well.

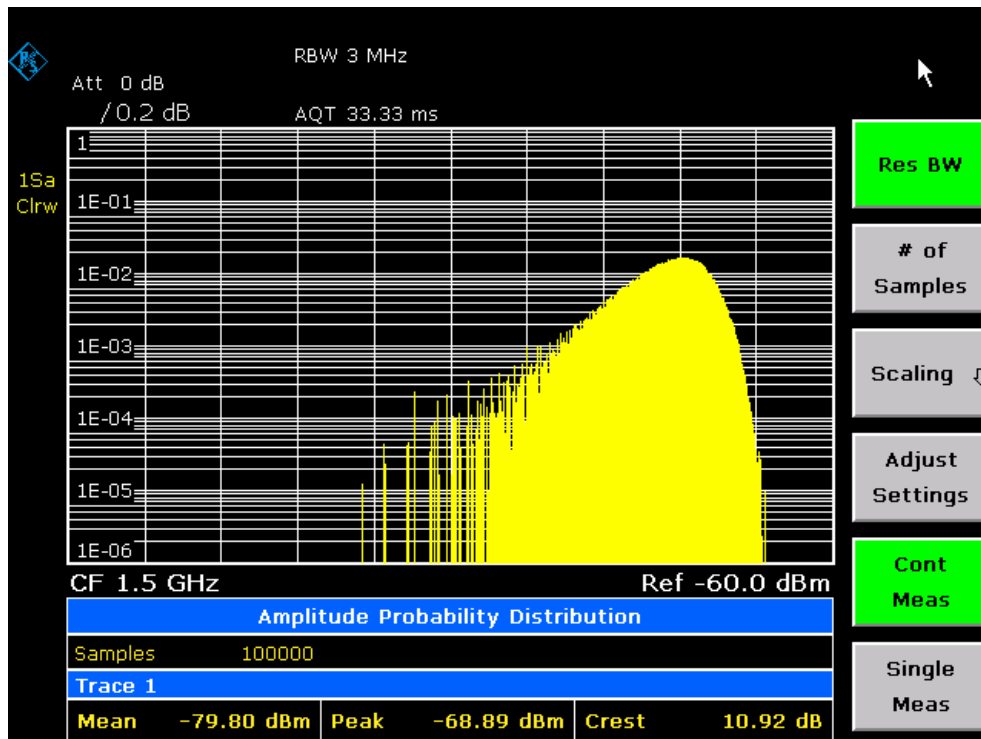

Fig. 2-27 Amplitude probability distribution of white noise

3. Switch to the CCDF display mode.

- Press the ▲ key.
- Press the **CCDF** softkey.

The CCDF display mode is switched on.

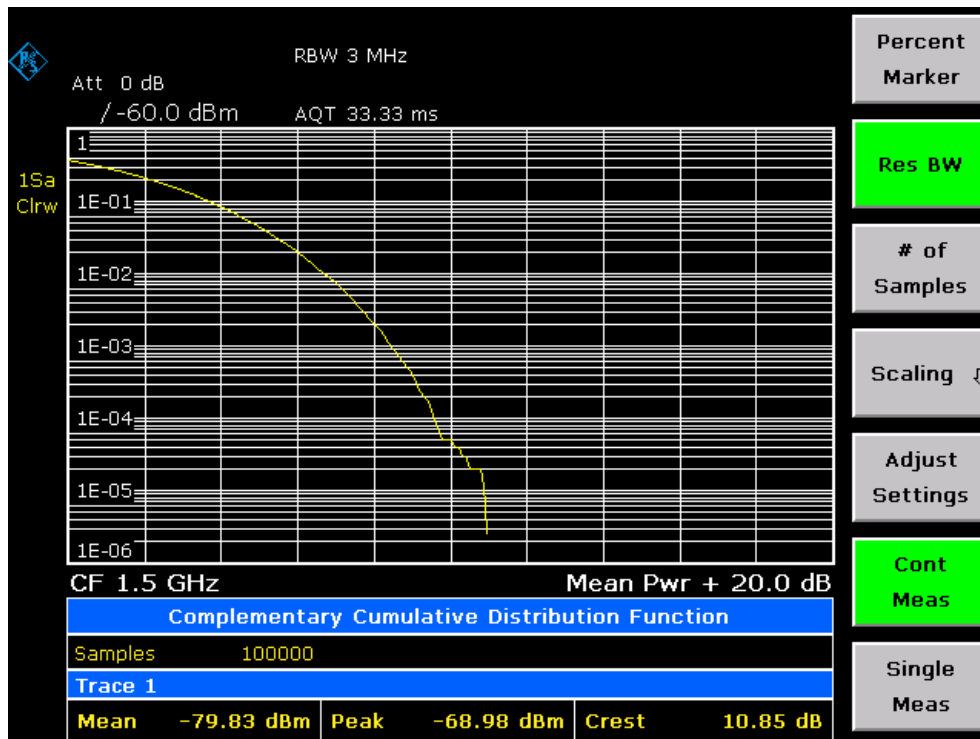

Fig. 2-28 CCDF of white noise

The CCDF trace indicates the probability that a level will exceed the mean power. The level above the mean power is plotted along the x-axis of the graph. The origin of the axis corresponds to the mean power level. The probability that a level will be exceeded is plotted along the y-axis.

4. Bandwidth selection

When the amplitude distribution is measured, the resolution bandwidth must be set so that the complete spectrum of the signal to be measured falls within the bandwidth. This is the only way of ensuring that all the amplitudes will pass through the IF filter without being distorted. If the resolution bandwidth which is selected is too small for a digitally modulated signal, the amplitude distribution at the output of the IF filter becomes a Gaussian distribution according to the central limit theorem and so corresponds to a white noise signal. The true amplitude distribution of the signal therefore cannot be determined.

5. Selecting the number of samples

For statistics measurements with the R&S ESL, the number of samples  $N_{\text{Samples}}$  is entered for statistical evaluation instead of the sweep time. Since only statistically independent samples contribute to statistics, the measurement or sweep time is calculated automatically and displayed. The samples are statistically independent if the time difference is at least  $1/\text{RBW}$ . The sweep time  $\text{SWT}$  is, therefore, expressed as follows:

$$\text{SWT} = N_{\text{Samples}} / \text{RBW}$$



## Noise Figure Measurements Option (K30)

This section describes measurement examples for the Noise Figure Measurements option (K30). For further information on measurement examples refer to the Quick Start Guide, chapter 5 "Basic Measurement Examples", or the Operating Manual on CD, chapter "Advanced Measurement Examples".

### Direct Measurements

Direct measurements are designed for DUTs without frequency–conversion, e.g. amplifiers. For details refer also to the Operating Manual on CD, chapter "Instrument Functions", section "Noise Figure Measurements Option (K30)".

#### Basic Measurement Example

This section provides step–by–step instructions for working through an ordinary noise figure measurement. The following steps are described:

1. Setting up the measurement
2. Performing the calibration
3. Performing the main measurement

The gain and noise figure of an amplifier are to be determined in the range from 220 MHz to 320 MHz.

#### Setting up the measurement

1. Activate the **Noise** mode (for details refer to chapter "Instrument Functions", section "Measurement Mode Selection – MODE Key").
2. Press the **Freq Settings** softkey to open the **Frequency Settings** dialog box.

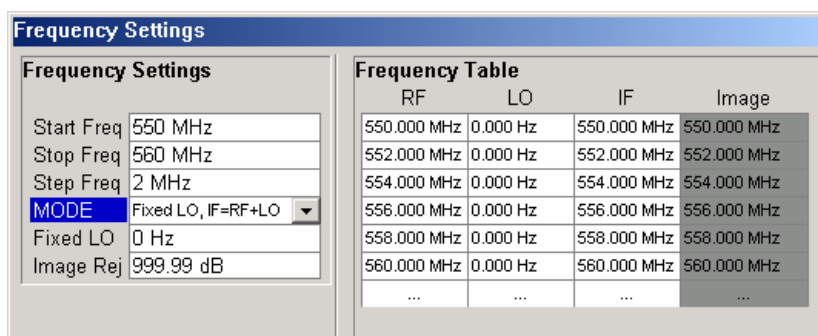

- In the **Start Freq** field, enter *550 MHz*.
- In the **Stop Freq** field, enter *560 MHz*.
- In the **Step Freq** field, enter *2 MHz*.

A measurement at 6 frequency points is performed: 550 MHz, 552 MHz, 554 MHz, ..., 560 MHz.

3. Press the **ENR Settings** softkey to open the **ENR** dialog box.

ENR Settings		ENR Table	
		RF	ENR
Selection	Constant	550 MHz	5 dB
ENR Constant	15 dB	560 MHz	10 dB
Room Temperature	293 K	570 MHz	20 dB
		...	...

- In the **ENR Constant** field, enter the average ENR value of the used noise source for the frequency range of interest, for example *15 dB*.
4. Press the **Meas Settings** softkey to open the **Measurement Settings** dialog box.

Measurement Settings	
<b>Calibration</b>	
2nd Stage Correction	<input type="checkbox"/>
<b>Analyzer Settings</b>	
RBW	1 MHz
Sweep Time	100 ms
Settling Time	50 ms
Average	1
RF Attenuation	0 dB
Automatic Ref Level	<input checked="" type="checkbox"/>
Ref Level	-61 dBm
Range	30 dB
Preamplifier	<input type="checkbox"/>

- Activate the **2nd Stage Correction** option to perform the measurement as accurately as possible.

### Performing the calibration

1. Connect the noise source to the RF input of the R&S ESL (see Fig. 2-29).
2. If you perform the measurement in an environment with radiated emissions, you may consider to connect a lowpass filter to the voltage supply input of the noise source.
3. Provide the voltage supply for the noise source by connecting it to the +28 V connector of the R&S ESL (labeled NOISE SOURCE CONTROL on the rear panel of the instrument) via a coax cable and the lowpass filter. Connect the lowpass filter between the noise source itself and the NOISE SOURCE CONTROL connector of the R&S ESL as shown in Fig. 2-29.

The purpose of the lowpass filter is to suppress any interference (e.g. due to RF interference), including interference from the supply line. This makes it possible to perform very precise measurements.

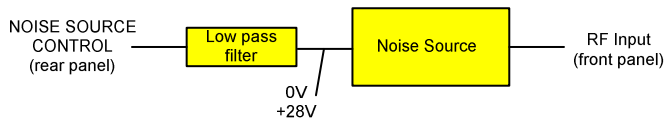

Fig. 2-29: Preparation for calibration

4. Start the calibration for the Noise Figure Measurements option.

- Press the **SWEEP** key.
- Press the **Cal** softkey.

The progress bar indicates the progress of the calibration measurement. After successful calibration, in the status bar, a corresponding message is displayed and the title bar at the top of the screen shows the status on the right-hand-side.

### Performing the main measurement

1. Insert the DUT (in this example, the amplifier) into the test setup between the noise source and RF input of the R&S ESL (see Fig. 2-30).

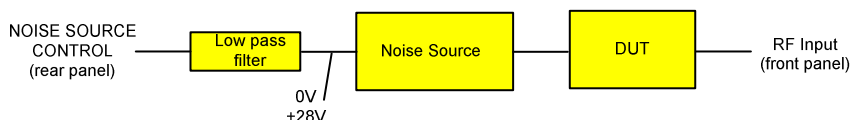

Fig. 2-30: Test setup for the main measurement

2. To select the sweep mode, press the **SWEEP** key.
3. Press the **RUN** key to start the measurement.

Measurement results are updated as the measurement is in progress. The results are displayed in graphical form. There are two traces, one for noise figure/temperature and one for the gain of the DUT.

4. To change the display from the graphical form to a tabular list of measurement points, press the **Display List/Graph** softkey.

---

**Note:** If a measurement is started while another measurement is still in progress, the first measurement is aborted and the new measurement started immediately.

---

### DUTs with very Large Gain

If the gain of the DUT exceeds 60 dB, the total gain must be reduced by an external attenuator. The total gain of the DUT together with the external attenuator should lie within the range from 10 dB to 60 dB. A total gain of 20 dB to 30 dB is recommended. For a DUT with a gain of e.g. 64 dB, it is recommended to use an external 40 dB-attenuator.

If an external attenuator is used, in the **Measurement Settings** dialog box, the entry in the **Range** field should be modified according to the total gain ( $= G_{\text{DUT}} - \text{external attenuator}$ ).

The attenuation values of the external attenuator are entered in the **Loss Settings** dialog box under **Loss Output Settings**.

Inaccuracies when entering this attenuation mainly influence the measured gain. The noise figure remains to a large extent unaffected.

**Calibration****Measurement**

Fig. 2-31: Calibration and measurement on DUTs with a high gain

## Frequency–Converting Measurements

The frequency–converting measurement is used for DUTs with an output frequency that differs from the input frequency, e.g. mixers and frequency converters. The frequency–converting measurement allows many variations, which differ from each other in two criteria:

- Fixed LO Measurements
- Image–Frequency Rejection (SSB, DSB)

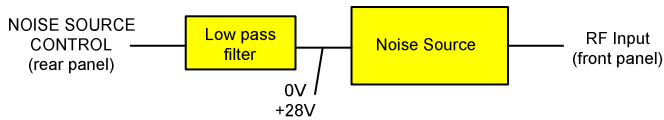
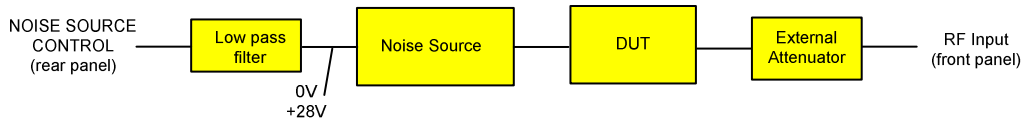
### Fixed LO Measurements

In the **Frequency Settings** dialog box, select one of the following settings for the **Mode** parameter:

- fixed LO,  $IF=RF+LO$ , for up–converting devices
- fixed LO,  $IF=abs(RF-LO)$ , for down converters or image measurements

### Image–Frequency Rejection (SSB, DSB)

Frequency–converting DUTs often do not only convert the desired input frequency but also the image frequency. A broadband noise source offers noise to the DUT not only at the input frequency but also at the image frequency. If the noise power at the IF gate is measured, the origin of the noise can no longer be determined. It may have been converted both from the input and from the image frequency range.

### Test setup

- Set the following parameters:
  - IF (intermediate frequency): 100 MHz
  - RF (input frequency): 400 MHz
  - LO (local oscillator frequency): 500 MHz
  - image (image frequency): 600 MHz

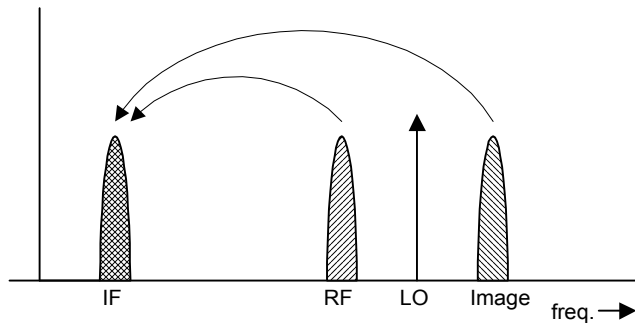

If a DUT, which equally converts the useful signal and the image to the IF frequency, is measured using the conventional y factor method or with the 2nd stage correction switched on, a measuring error of 3 dB is produced. The noise figure is displayed 3 dB lower and the gain 3 dB higher. The following examples help to configure the test setup in order to measure the actual values.

#### Measurement on a single-sideband mixer

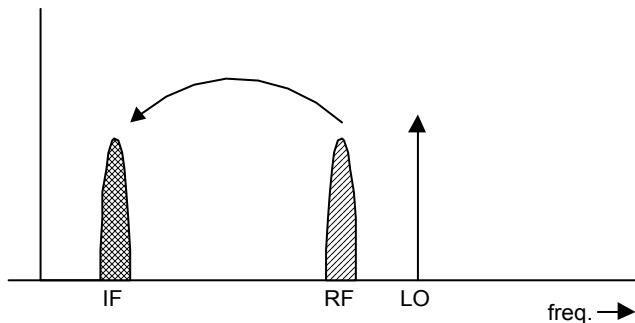

In general, a single-sideband mixer with a very high image rejection causes very few problems. The measurement is analogous to an amplifier. In this case, set the image rejection in the **Frequency Settings** dialog box to a large value (e.g. 999.99 dB).

#### Measurement on a mixer without sideband suppression

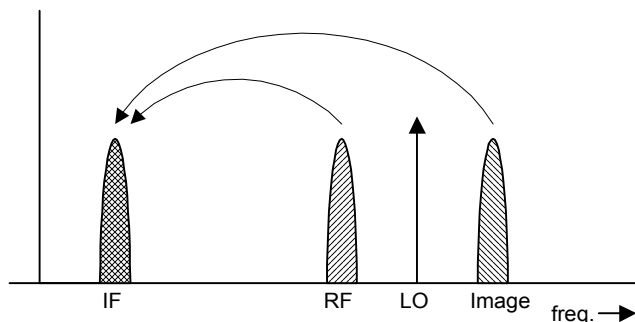

If the input and image frequencies are converted with the same application, an error of 3 dB occurs in the measurement results if the image rejection is not taken into account. In this case, set the image rejection in the **Frequency Settings** dialog box to a small value (e.g. 0.0 dB).

#### Measurement on a mixer with an average sideband suppression

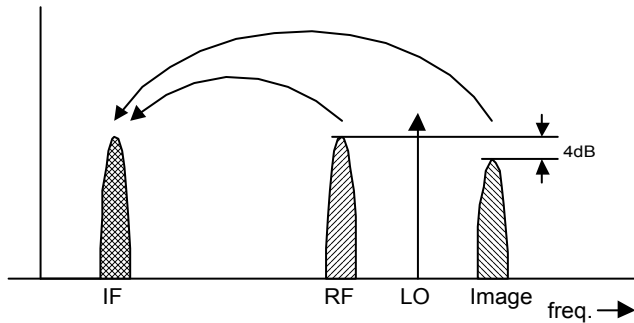

For measurements on a mixer with a low image–frequency rejection, a measuring error of 0 to 3 dB is obtained if the image–frequency rejection is not taken into account. In this case, set the image rejection in the **Frequency Settings** dialog box to 4 dB to produce the correct results.

**Measurement on a mixer with unknown sideband suppression**

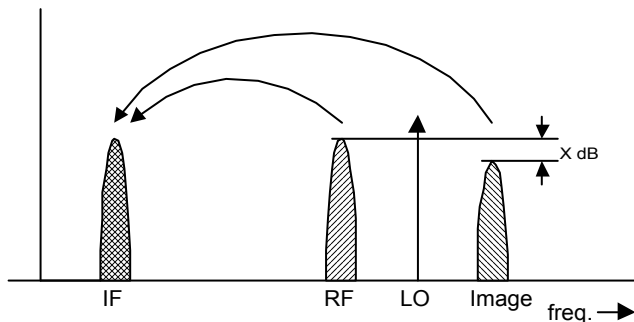

If the image rejection is not known, accurate noise results can still be produced. However, the gain of the DUT must be known and an additional filter is required.

**Test setup**

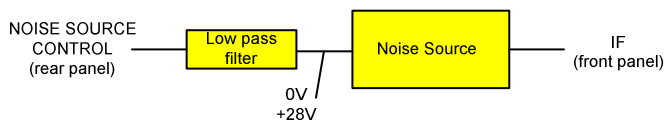

Fig. 2-32: Preparation for calibration

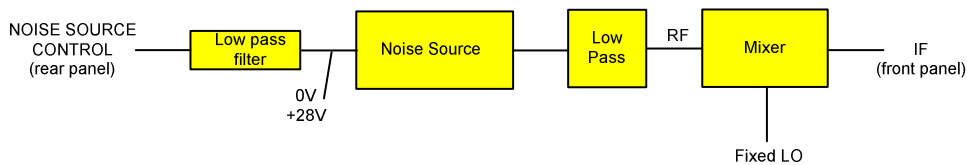

Fig. 2-33: Test setup for the main measurement

In this test setup, a low pass filter prevents noise from the noise source from being fed in at the image frequency. Depending on the position of the frequency bands, a highpass or bandpass filter may also be necessary for the RF frequency instead of the lowpass filter. The important point is that noise from the noise source is not converted by a further receive path of the mixer. The noise of the noise source at the receive frequency must not be reduced. The insertion loss must be considered, if applicable.

With this test setup, the measurement on a mixer without sideband suppression corresponds to the measurement on a single-sideband mixer. As in that case, set the image rejection in the **Frequency Settings** dialog box to a large value (e.g. 999.99 dB) to produce accurate results.

To take the characteristics of the filter into account, in the **Loss Settings** dialog box, enter the insertion loss of the filter at the RF frequency. To consider the actual filter suppression at the image frequency, do not enter 999 dB but the actual attenuation for the image rejection.

#### **Measurement on a harmonics mixer**

For a harmonics mixer, the input signals are not only converted to the IF by the wanted harmonic, but also by the harmonic of the LO signal produced in the mixer. In many cases, the mixer even features a lower conversion loss in the case of unwanted harmonics. For measurements on this type of mixer, a bandpass filter must be used to make sure that there is only noise at the desired input frequency at the input of the DUT. This measurement is similar to measurements on a mixer with an average sideband suppression.

## **3 Manual Operation**

For details refer to the Quick Start Guide chapter 4, "Basic Operations".



## Contents of Chapter 4

<b>4</b>	<b>Instrument Functions .....</b>	<b>4.1</b>
	<b>Instrument Functions – Receiver.....</b>	<b>4.2</b>
	Measurement Parameters .....	4.3
	Initializing the Configuration – PRESET key .....	4.4
	Operation on a Discrete Frequency – FREQ Key .....	4.6
	Level Display and RF Input Configuration – AMPT Key.....	4.9
	Setting the IF Bandwidth – BW Key .....	4.13
	Frequency Scan – SWEEP Key .....	4.18
	Triggering the Scan – TRIG Key .....	4.26
	Selection and Setting of Traces – TRACE Key .....	4.28
	Measurement Functions .....	4.39
	Marker Functions – MKR Key.....	4.40
	Change of Settings via Markers – MKR-> Key.....	4.44
	Selection of the Measurement Function – MEAS Key .....	4.48
	Running a Scan – RUN key.....	4.66
	Using Limit Lines and Display Lines – LINES Key.....	4.68
	Measurement Modes .....	4.77
	Measurement Mode Selection – MODE Key.....	4.78
	<b>Instrument Functions – Analyzer.....</b>	<b>4.79</b>
	<b>Measurement Parameters.....</b>	<b>4.80</b>
	Initializing the Configuration – PRESET Key.....	4.81
	Selecting the Frequency and Span – FREQ Key .....	4.83
	Setting the Frequency Span – SPAN Key.....	4.89
	Setting the Level Display and Configuring the RF Input – AMPT Key .....	4.91
	Setting the Bandwidths and Sweep Time – BW Key.....	4.95
	Configuring the Sweep Mode – SWEEP Key .....	4.102
	Triggering the Sweep – TRIG Key.....	4.105
	Setting Traces – TRACE Key .....	4.113
	<b>Measurement Functions .....</b>	<b>4.123</b>
	Using Markers and Delta Markers – MKR Key.....	4.124
	Changing Settings via Markers – MKR-> Key .....	4.136
	Power Measurements – MEAS Key .....	4.144
	Using Limit Lines and Display Lines – LINES Key .....	4.183
	<b>Measurement Modes.....</b>	<b>4.193</b>
	Measurement Mode Selection – MODE Key.....	4.194
	Measurement Mode Menus – MENU Key .....	4.195
	<b>Models and Options .....</b>	<b>4.196</b>
	Tracking Generator (Models 13, 16).....	4.197
	Analog Demodulation (Option K7).....	4.203

Power Meter (Option K9).....4.222  
Noise Figure Measurements Option (K30).....4.226  
**Instrument Functions - Basic Settings.....4.260**  
**General Settings, Printout and Instrument Settings.....4.261**  
Instrument Setup and Interface Configuration - SETUP Key .....4.262  
Saving and Recalling Settings Files - FILE Key .....4.279  
Manual Operation - Local Menu .....4.287  
Measurement Documentation - PRINT Key .....4.288

## 4 Instrument Functions

This chapter describes the analyzer and receiver functions and all basic settings functions of the R&S ESL in detail.

- ["Instrument Functions – Receiver"](#) on page 4.2  
This section describes measurement functions and measurement parameter for the R&S ESL in receiver mode.
- ["Instrument Functions – Analyzer"](#) on page 4.79  
This section describes measurement functions and measurement parameter for the R&S ESL in spectrum analyzer mode.
- ["Measurement Modes"](#) on page 4.194  
This section describes the provided measurement modes, the change of measurement modes and the access to the menus of all active measurement modes.
- ["Models and Options"](#) on page 4.197  
This section informs about optional functions and their application that are included in the basic unit configuration.

## Instrument Functions – Receiver

### How to open the Receiver mode

The receiver mode is selected using the **MODE** key ("Measurement Mode Selection – MODE Key" on page 4.78).

→ Remote: `INST REC`

In the receiver mode the R&S ESL measures the level of a signal at the set frequency with a selected bandwidth and measurement time (see also **Res BW Manual** and **Meas Time**). Signal weighting is done by means of detectors (see also **Scan Detector**, **Final Meas Detector** and "[Selecting the Detector](#)").

The functions for data reduction and the control of line impedance simulating network are available in the **Final Meas** submenus.

A frequency scan can be performed after setting the start and stop frequency and the step width. The scan subranges can be defined in a table (**Edit Scan Table** softkey).

The scan is started with the **RUN** key.

The **MENU** key opens the root menu of the receiver. The root menu contains the essential measurement functions. The contents are the same as in the measurement menu (**MEAS** key).

- "[Measurement Parameters](#)" on page 4.3

This section describes how to reset the instrument, to set up specific measurements and to set the measurement parameters. Examples of basic operations are provided in the Quick Start Guide, chapter 5 "Basic Measurement Examples".

- "[Measurement Functions](#)" on page 4.39

This section informs about how to select and configure the measurement functions. Examples of basic operations are provided in the Quick Start Guide, chapter 5 "Basic Measurement Examples".

- "[Measurement Modes](#)" on page 4.194

This section describes the provided measurement modes, the change of measurement modes and the access to the menus of all active measurement modes.

- "[Models and Options](#)" on page 4.197

This section informs about optional functions and their application that are included in the basic unit configuration.

More basic information on operation is given in the Quick Start Guide. The front and the rear view of the instrument together with a table of all available keys and a short description are provided in chapter "Front and Rear Panel". Chapter "Preparing for Use" informs how to start working with the instrument for the first time. A brief introduction on handling the instrument is given in chapter "Basic Operations". This includes also the description of the keys for basic operations like switching the instrument on and off or starting a measurement.

## Measurement Parameters

In this section all menus necessary for setting measurement parameters are described. This includes the following topics and keys. For details on changing the mode refer to "[Measurement Modes](#)"

- "[Initializing the Configuration – PRESET key](#)" on page 4.4
- "[Operation on a Discrete Frequency – FREQ Key](#)" on page 4.6
- "[Level Display and RF Input Configuration – AMPT Key](#)" on page 4.9
- "[Setting the IF Bandwidth – BW Key](#)" on page 4.13
- "[Frequency Scan – SWEEP Key](#)" on page 4.18
- "[Triggering the Scan – TRIG Key](#)" on page 4.26
- "[Selection and Setting of Traces – TRACE Key](#)" on page 4.28

## Initializing the Configuration – PRESET key

The **PRESET** key resets the instrument to the default settings. Therefore it provides a defined initial state as a known starting point for measurements.

---

**Note:** If the **LOCAL LOCKOUT** function is active in the remote control mode, the **PRESET** key is disabled.

---

### Further information

- ["Initial configuration"](#) on page 4.82

### Task

- [To preset the instrument](#)

### To preset the instrument

1. Define the data set for the preset:
  - To retrieve the originally provided settings file (see [Initial configuration](#)), in the file menu, deactivate the **Startup Recall** softkey and, in the setup menu, activate the **Preset Receiver** softkey.
  - For compatibility to the R&S FSL spectrum analyzers the preset state can be set to the R&S FSL settings by activating the **Preset Spectrum** softkey in the setup menu.
  - To retrieve a customized settings file, in the file menu, activate the **Startup Recall** softkey, press the **Startup Recall Setup** softkey, and select the corresponding file.  
For details refer to section "Saving and Recalling Settings Files – FILE Key".
2. Press the **PRESET** key to trigger a preset.
  - Remote: \*RST or SYSTem:PRESet (for details refer to chapter "Remote Control – Commands", section "Common Commands" or section "SYSTem Subsystem").

---

**Note:** In order to save the current settings after reboot of the instrument, create a shutdown file by switching the analyzer in the standby mode (press the On/Off key on the FRONT panel and wait until the yellow LED is ON). With the battery pack option, use a USB keyboard and terminate the analyzer firmware with ALT+F4 to create the shutdown file.

---

## Initial configuration

The initial configuration is selected in a way that the RF input is always protected against overload, provided that the applied signal levels are in the allowed range for the instrument.

The parameter set of the initial configuration can be customized by using the **Startup Recall** softkey in the file menu. For further information refer to section "Instrument Functions – Basic Settings", "Saving and Recalling Settings Files – FILE Key".

Table 4-1: Initial configuration of the receiver

Parameter	Setting
mode	Receiver
receiver frequency	100 MHz
scan step size	auto coarse
scan start frequency	150 kHz
stop frequency	1 GHz
step mode	Auto
RF attenuation	Auto 10 dB
preamplifier	off
level range	100 dB log
level unit	dB $\mu$ V
measurement time	100 ms
resolution bandwidth (RBW)	120 kHz
filter type	EMI (6 dB)
scan	continuous
bargraph	continuous
trigger	free run
trace 1	Clear Write
trace 2-6	blank
scan detector	peak
scan count	1
peak search	peaks
No of peaks	25
final measurement time	1 s
LISN settings	off

## Operation on a Discrete Frequency – FREQ Key

The **FREQ** key opens the frequency menu for setting the receiver frequency in manual operation and the frequency axis for scan display.

### To open the frequency menu

- Press the **FREQ** key.

The frequency menu is displayed and the receiver frequency field activated.

### Menu and softkey description

- ["Softkeys of the frequency menu"](#) on page 4.6

To display help to a softkey, press the **HELP** key and then the softkey for which you want to display help. To close the help window, press the **ESC** key. For further information refer to section "How to use the Help System".

### Softkeys of the frequency menu

The following table shows all softkeys available in the frequency menu. It is possible that your instrument configuration does not provide all softkeys. If a softkey is only available with a special option, model or (measurement) mode, this information is delivered in the corresponding softkey description.

Menu / Command	Command
Frequency	
Stepsize ↓	Auto Coarse
	Auto Fine
	Manual
	Stepsize = Freq
Start Frequency	
Stop Frequency	

### Frequency

The **Frequency** softkey activates the entry field of the receiver frequency in the bargraph diagram.

The tuning frequency has to be set to at least twice the IF bandwidth.

When the tuning frequency is lower than twice the IF bandwidth, the IF bandwidth is automatically reduced so that this condition is met again.

If the frequency is increased again, the original IF bandwidth is restored (memory function). The memory is cleared when the IF bandwidth is manually changed.

The resolution of the receiver frequency is always 0.1 Hz.

Range:  $9 \text{ kHz} \leq f_{\text{rec}} \leq f_{\text{max}}$

➔ Remote: FREQ:CENT 300 MHz



---

## Stepsize

---

The **Stepsize** softkey opens a submenu for setting the step size of the receiver frequency. The step size can be coupled to the set frequency or be manually set to a fixed value. The softkeys of the submenu are mutually exclusive selection switches. Only one switch can be activated at a time.

The following softkeys are available:

Auto Coarse
Auto Fine
Manual
Stepsize = Freq

---

## Auto Coarse

---

If the **Auto Coarse** softkey is activated, the receiver frequency is set in coarse steps. The 4th digit of the selected frequency is varied.

---

## Auto Fine

---

If the **Auto Fine** softkey is activated, the receiver frequency is set in fine steps. The 7th digit of the selected frequency is varied.

---

## Manual

---

The **Manual** softkey opens the dialog box for the input of a fixed step size

→ Remote: `FREQ:CENT:STEP 50 kHz`

---

## Stepsize = Freq

---

The **Stepsize = FREQ** softkey sets the step size to a value equal to the receiver frequency.

This function is especially useful during measurements of the signal harmonic content, because, when entering the receiver frequency, the receiver frequency of another harmonic is selected with each stroke of the **Stepsize** softkey.

---

## Start Frequency

---

The **Start Frequency** softkey opens a dialog box to enter the start frequency of the scan diagram.

The permissible value range for the start frequency is:

$$f_{min} \leq f_{start} \leq f_{max} - 10 \text{ Hz}$$

$f_{start}$ : start frequency

$f_{max}$ : maximum frequency

$f_{min}$ : 9 kHz

→ Remote: `FREQ:STAR 20 MHz`

**Stop Frequency**

---

The **Stop Frequency** softkey opens a dialog box to enter the stop frequency of the scan diagram.

The permissible value range for the stop frequency is:

$$f_{min} + 10 \text{ Hz} \leq f_{stop} \leq f_{max}$$

$f_{stop}$ : stop frequency

$f_{max}$ : maximum frequency

→ Remote: `FREQ:STOP 2000 MHz`

---

## Level Display and RF Input Configuration – AMPT Key

The **AMPT** key is used to set the input attenuation, the Preamplifier (option RF Preamplifier, B22), the auto range function and the Display Unit.

In addition, the level display range for the scan can be set.

### To open the amplitude menu

- Press the **AMPT** key.

The amplitude menu is displayed.

### Menu and softkey description

#### – Softkeys of the amplitude menu

To display help to a softkey, press the **HELP** key and then the softkey for which you want to display help. To close the help window, press the **ESC** key. For further information refer to section "How to use the Help System".

#### Softkeys of the amplitude menu

Menu / Command	Command
RF Atten Manual	
Preamp On Off	
10 dB Min On Off	
Auto Range On Off	
Autopreamp On Off	
Unit	
Grid Level	Grid Range Log 100 dB
	Grid Range Log Manual
	Grid Min Level

#### RF Atten Manual

The **RF Atten Manual** softkey activates the attenuation entry field.

The attenuation can be set between 0 and 50 dB in 5 dB steps. Other entries are rounded up to the nearest valid integer.

**Note:** To protect the input mixer against inadvertent overload, 0 dB can only be switched on when the 10 dB Min softkey is switched off.

→ Remote: INP:ATT 20 dB

---

**Preamp On Off (option RF Preamplifier, B22)**

---

The **Preamp On/Off** softkey switches the preamplifier (9 kHz to 6 GHz) on and off.

Switching on the preamplifier reduces the total mark figure of the R&S ESL and thus improves the sensitivity.

The signal level of the subsequent mixer is 20 dB higher so that the maximum input level is reduced by the gain of the preamplifier.

The use of the preamplifier is recommended when measurements with a maximum sensitivity are to be performed. On the other hand, if the measurement should be performed at maximum dynamic range, the preamplifier should be switched off.

The gain of the preamplifier is automatically considered in the level display.

Default value is OFF.

→ Remote: INP:GAIN:STAT ON

---

---

**10 dB Min On Off**

---

The **10 dB Min** softkey determines whether the 10 dB setting of the attenuator may be used in the manual or automatic setting of the attenuator.

10 dB Min ON is the default value, i.e. an RF attenuation of at least 10 dB is always set on the R&S ESL to protect the input mixer.

An attenuation of 0 dB cannot be set manually either. This avoids 0 dB being switched on inadvertently, particularly when DUTs with high RFI voltage are measured.

→ Remote: INP:ATT:PROT ON

---

---

**Auto Range On Off**

---

The **Auto Range On/Off** softkey switches the autorange function on and off.

ON The attenuation is automatically set so that a good S/N ratio is obtained without the receiver stages being overdriven.

OFF The attenuation is set manually.

→ Remote: INP:ATT:AUTO ON

---

---

**Autopreamp On Off (option RF Preamplifier, B22)**

---

The **Autopreamp On/Off** softkey switches the auto preamp function and or off.

ON The preamplifier is considered in the autorange procedure. The preamplifier is cut in when the RF attenuation is reduced to the minimum settable value.

OFF The preamplifier is not considered in the autorange procedure.

→ Remote: INP:GAIN:AUTO ON

---

---

**Unit**

---

The **Unit** softkey opens a list in which the desired units for the level axis can be selected: dBm, dBpW, dBmV, dB $\mu$ V, dB $\mu$ A or dBpT. Default setting is dB $\mu$ V.

dBm
dBpW
dBmV
dB $\mu$ V
dB $\mu$ A
dBpT

In general, a receiver measures the signal voltage at the RF input. The level display is calibrated in RMS values of an unmodulated sinewave signal.

Via the known input resistance of 50  $\Omega$  a conversion can be made to other units. The units dBm, dBpW, dBmV, dB $\mu$ V, dB $\mu$ A and dBpT are directly convertible.

→ Remote: CALC:UNIT:POW DBM

---

**Grid Level**

---

The Grid Level softkey opens a submenu to adjust the range of the y-axis. The submenu contains the following softkeys:

Grid Range Log 100 dB
Grid Range Log Manual
Grid Min Level

---

**Grid Range Log 100 dB**

---

The **Grid Range Log 100 dB** softkey sets the level display range for the scan diagram to 100 dB (= default setting).

→ Remote: DISP:WIND:TRAC:Y:SPAC LOG

→ Remote: DISP:WIND:TRAC:Y 100DB

---

**Grid Range Log Manual**

---

The **Grid Range Log Manual** softkey activates the entry of the level display range for the scan diagram.

The display ranges go from 10 to 200 dB in 10-dB steps. Invalid entries are rounded off to the nearest valid value.

→ Remote: DISP:WIND:TRAC:Y:SPAC LOG

→ Remote: DISP:WIND:TRAC:Y 120DB

---

**Grid Min Level**

---

The **Grid Min Level** softkey activates the entry of the minimum level of the display range.  
Allowed values are:

- 200 ≤ *Grid Min Level* ≤ + 200 dB - *Grid Range*

- Remote: DISP:WIND:TRAC:Y:SPAC LOG
  - Remote: DISP:WIND:TRAC:Y:BOTT 0 DBM
-

## Setting the IF Bandwidth – BW Key

The R&S ESL offers the IF bandwidths (3 dB bandwidths) from 10 Hz to 10 MHz. The IF bandwidths are available in steps of 1/3/10. Also available are the IF bandwidths (6 dB bandwidths) 200 Hz, 1 kHz, 9 kHz, 120 kHz and 1 MHz.

### To open the bandwidth menu

- Press the **BW** key.

The bandwidth menu is displayed.

### Menu and softkey description

- [Softkeys of the bandwidth menu](#)

To display help to a softkey, press the **HELP** key and then the softkey for which you want to display help. To close the help window, press the **ESC** key. For further information refer to section "How to use the Help System".

### Further Information

- [List of available channel filters](#)

### List of available channel filters

The channel filters listed in the following table are available as resolution filters (softkey **Res BW Manual**) after activation with the softkey **Filter Type**.

**Note:** For filter type RRC (Root Raised Cosine) the indicated filter bandwidth describes the sampling rate of the filter. For all other filters (CFILter) the filter bandwidth is the 3dB bandwidth.

Table 4-1: List of available channel filters

Filter Bandwidth		Filter Type	Application
100	Hz	CFILter	A0
200	Hz	CFILter	
300	Hz	CFILter	
500	Hz	CFILter	
1	kHz	CFILter	SSB
1.5	kHz	CFILter	
2	kHz	CFILter	
2.4	kHz	CFILter	
2.7	kHz	CFILter	
3	kHz	CFILter	
3.4	kHz	CFILter	
4	kHz	CFILter	DAB, Satellite
4.5	kHz	CFILter	
5	kHz	CFILter	
6	kHz	CFILter	

Filter Bandwidth		Filter Type	Application
8.5	kHz	CFILter	ETS300 113 (12.5 kHz channels)
9	kHz	CFILter	AM radio
10	kHz	CFILter	CDMAone ETS300 113 (20 kHz channels) ETS300 113 (25 kHz channels) TETRA PDC IS 136 (NADC) CDPD, CDMAone
12.5	kHz	CFILter	
14	kHz	CFILter	
15	kHz	CFILter	
16	kHz	CFILter	
18	kHz, $\alpha = 0.35$	RRC	
20	kHz	CFILter	
21	kHz	CFILter	
24.3	kHz, $\alpha = 0.35$	RRC	
25	kHz	CFILter	
30	kHz	CFILter	
50	kHz	CFILter	
100	kHz	CFILter	
150	kHz	CFILter	
192	kHz	CFILter	
200	kHz	CFILter	
300	kHz	CFILter	
500	kHz	CFILter	
1.0	MHz	CFILter	CDMAone CDMAone DAB W-CDMA 3GPP W-CDMA NTT DOCOMO
1.2288	MHz	CFILter	
1.5	MHz	CFILter	
2.0	MHz	CFILter	
3.0	MHz	CFILter	
3.75	MHz	CFILter	
3.84	MHz, $\alpha = 0.22^*$	RRC	
4.096	MHz, $\alpha = 0.22^*$	RRC	
5.0	MHz	CFILter	
20 MHz	MHz	CFILter	

---

**Note:** The 20 MHz channel filter is unavailable in sweep mode.

---



## Softkeys of the bandwidth menu

The **BW** key calls a menu for setting the resolution bandwidth (RES BW) for the receiver.

Menu / Command	Command
Res BW Manual	
Res BW 200 Hz	
Res BW 9 kHz	
Res BW 120 kHz	
Res BW 1 MHz	
CISPR RBW Uncoupled	
Filter Type	Gaussian
	EMI (6dB)
	Channel
	RRC

### Res BW Manual

The **Res BW** softkey activates the manual entry mode for the resolution bandwidth.

For filter type **Normal** (3 dB), the bandwidth can be set from 10 Hz to 20 MHz in steps of 1/3/10 (e.g. 10 Hz, 30 Hz, 100 Hz, 300 Hz, 1000 Hz/ 1 kHz, 3 kHz, 10 kHz etc.). For filter type **Normal** (6 dB), the 6-dB bandwidth 200 Hz, 9 kHz, 120 kHz and 1 MHz can be set.

For numerical inputs, the values are always rounded to the nearest valid bandwidth. For rotary knob or the **Up/Down** key entries, the bandwidth is adjusted in the steps mentioned above either upwards or downwards.

For the **Channel** and **RRC** filter types, the bandwidth is selected from a list of available channel filters, which is included above. Only the filters on the list can be selected (see [List of available channel filters](#)).

When the quasipeak detector is switched on, a fixed bandwidth is preset depending on the frequency. The coupling of the IF bandwidth to the frequency range with activated quasipeak detector can be cancelled using the **CISPR RBW Uncoupled** softkey (see below).

The bandwidth is limited by the set receiver frequency:

$$Res\ BW \leq f_{in} / 2$$

→ Remote: BAND 1 MHz

### Res BW 200 Hz

The **200 Hz** softkey sets the CISPR bandwidth 200 Hz.

→ Remote: BAND 200 Hz

### Res BW 9 kHz

The **9 kHz** softkey sets the CISPR bandwidth 9 kHz.

→ Remote: BAND 9 kHz

**Res BW 120 kHz**

The **120 kHz** softkey sets the CISPR bandwidth 120 kHz.

→ Remote: BAND 120 kHz

**Res BW 1 MHz**

The **1 MHz** softkey sets the 6-dB bandwidth 1 MHz.

→ Remote: BAND 1 MHz

**CISPR RBW Uncoupled**

The **CISPR RBW Uncoupled** softkey cancels the coupling of the IF bandwidth to the frequency range with the activated detector.

If the coupling is cancelled, any of the three CISPR bandwidths 200 Hz, 9 kHz, 120 kHz can be selected for a given frequency range.

→ Remote: BAND:AUTO ON

**Filter Type**

The **Filter Type** softkey opens a list of available filter types. Gaussian bandpass filters of 3 dB and 6 dB bandwidth are available as well as particularly steep-edged channel filters for power measurements.

Gaussian
EMI (6dB)
Channel
RRC

**Gaussian**

The resolution bandwidths are implemented by Gaussian filters with a set 3 dB bandwidth. These bandwidths correspond to the noise bandwidth approximately.

→ Remote: BAND:TYPE NOIS

→ Remote: BAND:TYPE NORM

**EMI (6dB)**

The resolution bandwidths are implemented by Gaussian filters with the set 6 dB bandwidth and correspond approximately to the pulse bandwidth.

→ Remote: BAND:TYPE PULS

**Channel**

Steep-edged channel filters (for available filter types refer to [List of available channel filters](#)).

→ Remote: BAND:TYPE CFIL

**RRC**

---

Root Raised Cosine filters (for available filter types refer to [List of available channel filters](#)).

→ Remote: BAND:TYPE RRC

---

## Frequency Scan – SWEEP Key

The **SWEEP** key is used to configure the sweep mode. Continuous sweep or single sweep are possible. The sweep time and the number of measured values are set.

### To open the sweep menu

- Press the **SWEEP** key.  
The sweep menu is displayed.

### Menu and softkey description

- [Softkeys of the sweep menu](#)

To display help to a softkey, press the **HELP** key and then the softkey for which you want to display help. To close the help window, press the **ESC** key. For further information refer to section "How to use the Help System".

### Further information

- [Stepped scan in the frequency domain](#)
- [Display of Measurement Results](#)

### Stepped scan in the frequency domain

In the scan mode, the R&S ESL measures in a predefined frequency range with selectable step width and measurement time for each frequency.

Either the current receiver settings or the settings defined in the Scan table are used. Up to 10 subranges which need not to be next to each other can be defined within one scan. The subranges are then scanned by R&S ESL one after the other. Measurement ranges must not overlap. The parameters to be measured in each subrange can be selected independently (sweep menu, scan table table).

Transducer factors and limit lines can be defined and displayed separately and are not part of the scan data record.

The scanned frequency range is defined by the start and stop frequency set independently of the scan table (scan table or frequency menu). A scan table can thus be defined for each measurement task, which can be stored and reloaded. The required frequency range can be defined by means of two parameters which can be set via keys so that no elaborate editing has to be done in the scan table.

Scanning is started with the **RUN** key. The scan can be performed as a single scan or continuously (set via the **Scan Control** dialog box). In the case of single scan it is stopped when the stop frequency is reached. The continuous scan can be interrupted with the **Hold Scan** softkey or terminated with the **Stop Scan** softkey.

The maximal number of measured frequencies is limited to 1.000.000. A maximum of 6 x 1.000.000 values (1.000.000 per detector) can be stored for postprocessing. If the scan subranges are defined so that more than the possible values would be measured, a respective message is output upon the scan start. Afterwards the scan is performed up to the maximum value.

At least one scan is defined in the list. Two subranges are defined in the default setup. All other parameters are shown in the following table:

Table 4-2: Default setup of scan table

	Range 1	Range 2
Start frequency	150 kHz	30 MHz
Stop frequency	30 MHz	1 GHz
Step Size	Auto	Auto
RES BW	9 kHz	120 kHz
Meas Time	1 ms	100 $\mu$ s
Auto ranging	OFF	OFF
RF Attne	10 dB	10 dB
Preamp	OFF	OFF
Auto Preamp	OFF	OFF

The diagram parameters to be defined are: start frequency 150 kHz, stop frequency 1 GHz, min. level 0 dB $\mu$ V, grid range log 100 dB, log. frequency axis and continuous scan.

The measurement parameters correspond to the settings recommended for overview measurements to CISPR 16.

### Display of Measurement Results

To display measurement results, the screen of the R&S ESL in receiver mode is split into two areas.

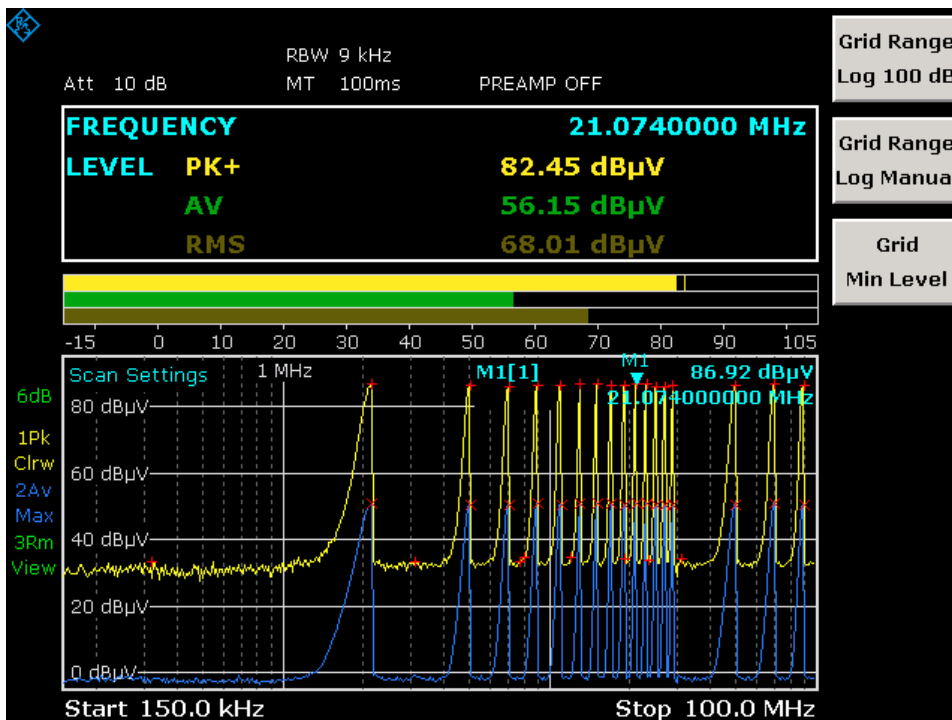

In the upper area the frequency and level readout, i.e. a bargraph, is displayed. Each bargraph is shown in a different color. In the table just above the bargraph, the following information is displayed:

Parameter	Description
Frequency	Displays the receiver frequency (for details refer to the <b>Frequency</b> softkey)
Level	Shows the current power level for the selected detectors (for details see <a href="#">Selecting the Detector</a> ).

The R&S ESL expands the table after the selection of the Bargraph Maxhold. In this case, the R&S ESL additionally displays the value for the maximum power level and the corresponding frequency.

<b>FREQUENCY</b>	<b>100.000000 MHz</b>
<b>PK+     -23.44 dBm ( -23.2</b>	<b>100.000000 MHz )</b>
<b>PK-     -136.90 dBm ( -136.6</b>	<b>100.000000 MHz )</b>
<b>AV       -50.60 dBm ( -50.4</b>	<b>100.000000 MHz )</b>

In the lower area, the results of the scan measurement (preliminary or final) are shown. The R&S ESL can measure up to 6 detectors simultaneously. They are assigned to traces 1 to 6. Since the detectors are set only once, it is not possible to measure with different detectors in different subranges.

**Softkeys of the sweep menu**

Pressing the **SWEEP** key opens the menu to configure and start the scan.

Command
<a href="#">Scan Control</a>
<a href="#">Edit Scan Table</a>
<a href="#">Adjust Axis</a>
<a href="#">Insert Range</a>
<a href="#">Delete Range</a>
<a href="#">10dB Min On/Off</a>
<a href="#">Freq Axis Lin/Log</a>

A scan is defined in the form of tables or it is performed using the current setting.

In the Scan table, the scan subranges are defined. Each scan range is specified by start frequency, stop frequency, step width and the measurement parameters that are valid for this range.

The scan can be performed as a single scan or continuously (softkeys **Single Scan** and **Continuous Scan**).

Scanning is started with the **RUN** key.

**Scan Control**

Opens the **Scan Control** dialog box. In the dialog box select if the R&S ESL should run a single or a continuous scan. In case of a single scan the R&S ESL stops the measurement after exactly one scan of the frequency range. Select also if the R&S ESL should use the current receiver settings or if the settings of the scan table are to be used for the scan.

The default settings are Continuous Scan and Use Scan table.

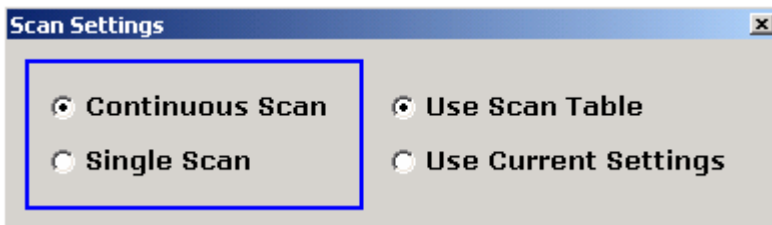

- Remote: INIT2:CONT ON | OFF
- Remote: SCAN:RANG 1...10
- Remote: SCAN:RANG 0 (use current settings)

**Edit Scan Table**

Opens the **Edit Scan Table** dialog box. Set the parameters for each subrange to be scanned. By default, two ranges are defined.

STEPPED SCAN TABLE				
Scan Start	25.0000 MHz			
Scan Stop	99.0000 MHz			
Step Mode	AUTO			
	RANGE 1	RANGE 2	RANGE 3	RANGE 4
Start	150.0000 kHz	30.0000 MHz		
Stop	30.0000 MHz	1.0000 GHz		
Step Size	6.000 kHz	6.000 kHz		
Res BW	18 kHz	18 kHz		
Meas Time	1.00 ms	100 µs		
Auto Ranging	OFF	OFF		
RF Attn	10 dB	10 dB		
Preamp	OFF	OFF		
Auto Preamp	OFF	OFF		

The following parameters can be set:

Scan Start
Scan Stop
Step Mode
Start
Stop

Step Size
Res BW
Meas Time
Auto Ranging
Auto Ranging
RF Attn
Preamp
Auto Preamp

**Scan Start**

Enter the start frequency of the scan in this field (refer also to the **Start Frequency** softkey of the frequency menu.

Range is  $f_{min}$  to  $f_{max} - 10$  Hz

→ Remote: `FREQ:STAR <value>`

**Scan Stop**

Enter the stop frequency of the scan in this field (refer also to the **Stop Frequency** softkey of the frequency menu.

Range is  $f_{min}$  to  $f_{max}$ .

→ Remote: `FREQ:STOP <value>`

**Step Mode**

Selects the frequency switching mode. Linear or logarithmic frequency switching can be selected. The selected setting is valid for all scan ranges.

Lin	Linear frequency switching
Auto	Linear frequency switching. The step width is selected automatically depending on the set resolution bandwidth so that all signals occurring in the scan range are reliably detected without any significant measurement error (about one third of resolution bandwidth)
Log	Logarithmic frequency switching. The frequency is incremented in % of the current frequency.

→ Remote: `SWE:SPAC LIN`



---

**Start**

---

Sets the start frequency of the subrange in focus. The start frequency of a subrange must be equal to or greater than the stop frequency of the previous subrange.

On entering the start frequency, the preceding scan range is – if necessary – adapted automatically to avoid overlapping of scan ranges.

→ Remote: `SCAN1:STAR <value>`

---

**Stop**

---

Sets the stop frequency of the subrange in focus. The stop frequency of a subrange must be equal to or greater than the start frequency of the subrange.

On entering the stop frequency, the preceding scan range is – if necessary – adapted automatically to avoid overlapping of scan ranges.

→ Remote: `SCAN1:STOP <value>`

---

**Step Size**

---

Sets the step size of the subrange in focus. In the case of linear frequency increments, step widths between 1 Hz and the maximum frequency can be set. When a step size greater than the scan range is entered (from start to stop), the R&S ESL performs a measurement each at the start and stop frequency.

With logarithmic frequency increments, values between 0.1% and 100% can be set in steps of 0.1%.

With Step Auto selected, the step size cannot be changed because it is automatically set with respect to the IF bandwidth.

→ Remote: `SCAN1:STEP <value>`

---

**Res BW**

---

Sets the bandwidth resolution of the subrange in focus. In the case of quasipeak weighting, usually a fixed bandwidth is set which cannot be changed (CISPR).

However, the coupling of the IF bandwidth to the frequency range can be cancelled using softkey CISPR RBW Uncoupled in the bandwidth menu.

→ Remote: `SCAN1:BAND:RES <num_value>`

---

**Meas Time**

---

Sets the measurement time of the subrange in focus. The measurement time can be set between 50  $\mu$ s and 100 s separately for each subrange. In the case of quasipeak weighting, the minimum is 10 ms. For the CISPR AV and CISPR RMS detectors the minimum measurement time is 100 ms. The measurement time can be set independently for each scan range.

→ Remote: `SCAN1:TIME <value>`

---

**Auto Ranging**

**NOTICE**

**Risk of damage to the input mixer**

If 0 dB RF attenuation is used with autoranging, care must be taken that the permissible signal level at the RF input is not exceeded.

Exceeding this level would causes damage to the input mixer

The 0 dB attenuation should under no circumstances be used when RFI voltage measurements are performed with the aid of artificial networks since very high pulses occur during phase switching.

Define whether or not the R&S ESL should automatically set the range..

ON	The R&S ESL automatically sets the input attenuation as a function of the signal level.
OFF	The input attenuation setting of the scan table is used.

→ Remote: SCAN1:INP:ATT:AUTO ON

**RF Attn**

Sets the RF attenuation for each subrange.

→ Remote: SCAN1:INP:ATT <value>

**Preamp (option RF Preamp, B22)**

Activates or deactivates the preamplifier. The preamplifier can be switched on/off separately for each subrange.

→ Remote: SCAN1:INP:GAIN ON

**Auto Preamp (option RF Preamp, B22)**

ON	The preamplifier is considered in autoranging. It is only cut in after the attenuation has been reduced to the minimum settable value.
OFF	Auto ranging without preamplification.

→ Remote: SCAN1:INP:GAIN:AUTO ON

**Adjust Axis**

The **Adjust Axis** softkey automatically sets the limits of the diagram so that the lower limit frequency corresponds to the start frequency of range 1 and the upper limit frequency to the stop frequency of the last range.

**Insert Range**

---

The **Insert Range** softkey inserts an additional range that can be defined as described under the **Edit Scan Table** softkey. A maximum number of 10 ranges can be inserted (Range 1 – 10). The softkey is only available if the cursor is on a field inside the table.

---

**Delete Range**

---

The **Delete Range** softkey clears the activated scan range. All other ranges are shifted to the left by one column. The softkey is only available if the cursor is on a field inside the table.

---

**10dB Min On/Off**

---

For details refer to the **10 dB Min On Off** softkey in the amplitude menu.

---

**Freq Axis Lin/Log**

---

The **Freq Axis Lin/Log** switches between linear and logarithmic display of the frequency axis.  
Default is Log.

→ Remote: `DISP:TRAC:X:SPAC LOG`

---

## Triggering the Scan – TRIG Key

The **TRIG** key opens a menu for selection of the trigger sources and the trigger polarity. The active trigger mode is indicated by highlighting the corresponding softkey.

To indicate that a trigger mode other than Free Run has been set, the enhancement label **TRG** is displayed on the screen. If two windows are displayed, **TRG** appears next to the appropriate window.

### To open the trigger menu

- Press the **TRIG** key.  
The trigger menu is displayed.

### Menu and softkey description

- [Softkeys of the trigger menu](#)

#### Softkeys of the trigger menu

Command
Trg / Gate Source
Trg / Gate Level
Trg / Gate Polarity Pos Neg

#### Trg / Gate Source

The Trg / Gate softkey opens a list, in which the trigger source can be selected. The following trigger sources are available.

Free Run
External
Video

#### Free Run

The **Free Run** radio button activates the free-run sweep mode, i.e. start of a scan is not triggered. Once a measurement is completed, another is started immediately.

Free Run is the default setting of the R&S ESL.

- ➔ Remote: TRIG:SOUR IMM

#### External

The **Extern** radio button activates triggering via a TTL signal at the input connector **Ext Trigger / Gate** on the rear panel.

- ➔ Remote: TRIG:SOUR EXT

**Video**

---

The **Video** radio button activates triggering via the displayed voltage.

For the video triggering mode, a level line showing the trigger threshold is displayed. Using the level line, the threshold can be adjusted between 0% and 100% of the diagram height.

- Remote: TRIG:SOUR VID
  - Remote: TRIG:LEV:VID 50 PCT
- 

**Trg / Gate Level**

---

Opens an edit dialog box to enter the trigger / gate level.

- Remote: TRIG:LEV:EXT
  - Remote: TRIG:LEV:VID 50 PCT
- 

**Trg / Gate Polarity Pos Neg**

---

The **Polarity Pos / Neg** softkey selects the polarity of the trigger source.

The scan starts after a positive or negative edge of the trigger signal. The selected setting is highlighted.

The selection is valid for all trigger modes with the exception of Free Run.

The default setting is Polarity Pos.

- Remote: TRIG:SLOP POS
-

## Selection and Setting of Traces – TRACE Key

The R&S ESL is capable of displaying up to six different traces at a time in a diagram. A trace consists of a maximum of 501 pixels on the horizontal axis. If more measured values than pixels are available, several measured values are combined in one pixel.

The traces are selected using the **Select Trace** softkey in the menu of the **TRACE** key.

The traces can individually be activated for a measurement or frozen after completion of a measurement. Traces that are not activated are blanked.

The display mode can be selected for each trace. Traces can be overwritten in each measurement (Clear/Write mode), or a maximum or minimum value can be determined from several measurements and displayed (Max Hold or Min Hold).

Individual detectors can be selected for the various traces. For example, the max peak detector and min peak detector display the maximum and minimum value of the level within a pixel. The RMS detector displays the power (RMS value) of the measured values within a pixel, the average detector the average value. Further details on available detectors are discussed below.

### To open the trace menu

- Press the **TRACE** key

The trace menu is displayed. The **Trace Configuration** dialog box is displayed.

### Menu and softkey description

- [Softkeys of the trace menu](#)

### Further information

- [Selection of Trace Function](#)
- [Selecting the Detector](#)
- [Selection of Detectors for Final Measurement](#)
- [ASCII File Export – file header example](#)

### Selection of Trace Function

The trace functions are subdivided as follows:

- Display mode of trace (**Clear Write**, **View** and **Blank**)
- Evaluation of the trace as a whole (**Max Hold** and **Min Hold**)
- Evaluation of individual pixels of a trace (**Peak**, **Min Peak**, **Average**, **RMS**, **Quasipeak**, **CISPR AV** and **CISPR RMS**).

## Selecting the Detector

The following detectors are available:

- The peak detector displays the highest sample values of the measured levels during the set measurement time.
- The min peak detector displays the lowest sample values of the levels measured during the set measurement time.
- The average detector displays the average level of the samples measured during the set measurement time.
- The CISPR average detector supplies a weighted average. When measuring the average according to CISPR 16-1-1, the maximum value of the linear average during the measurement time is displayed. The detector is used, for example, to measure pulsed sinusoidal signals with a low pulse frequency. It is calibrated with the RMS value of an unmodulated sinusoidal signal. Averaging is done with lowpass filters of the 2nd order (simulation of a mechanical instrument). The lowpass time constants and the IF bandwidths are fixed depending on the frequency. The main parameters are listed in the following table:

	Band A	Band B	Band C / D	Band E
Frequency range	<150 kHz	150 kHz to 30 MHz	30 MHz to 1 GHz	>1 GHz
IF bandwidth	200 Hz	9 kHz	120 kHz	1 MHz
Time constant of instrument	160 ms	160 ms	100 ms	100 ms
				1 kHz

Coupling of the IF bandwidth to the frequency range with the CISPR average detector activated can be switched off by the **QP RBW Uncoupled** softkey.

- The RMS detector displays the root mean square (RMS) level of the samples measured. The integration time corresponds to the set measurement time.
- The CISPR RMS detector supplies a weighted average. When measuring the average according to CISPR 16-1-1, the maximum value of the linear average during the measurement time is displayed. The detector is used, for example, to measure pulsed sinusoidal signals with a low pulse frequency. It is calibrated with the RMS value of an unmodulated sinusoidal signal. Averaging is done with lowpass filters of the 2nd order (simulation of a mechanical instrument). The lowpass time constants and the IF bandwidths are fixed depending on the frequency. The main parameters are listed in the following table:

	Band A	Band B	Band C / D	Band E
Frequency range	<150 kHz	150 kHz to 30 MHz	30 MHz to 1 GHz	>1 GHz
IF bandwidth	200 Hz	9 kHz	120 kHz	1 MHz
Time constant of instrument	160 ms	160 ms	100 ms	100 ms
Corner frequency	10 Hz	100 Hz	100 Hz	1 kHz

- The quasipeak detector displays the maximum detected value weighted to CISPR 16. Depending on the set frequency, the R&S ESL automatically selects the detectors and IF bandwidths defined for bands A, B and C/D listed in the following table:

	Band A	Band B	Band C / D
Frequency range	<150 kHz	150 kHz to 30 MHz	>30 MHz
IF bandwidth	200 Hz	9 kHz	120 kHz
Charge time constant	45 ms	1 ms	1 ms
Discharge time constant	150 ms	500 ms	550 ms
Time constant of instrument	160 ms	160 ms	100 ms

For frequencies above 1 GHz, the R&S ESL uses the 120 kHz bandwidth of band C/D.

The coupling of the IF bandwidth to the frequency range with activated quasipeak detector can be cancelled using the **QP RBW Uncoupled** softkey.

- The input signal of R&S ESL can be displayed weighted by four detectors simultaneously.

Multiple detection is important in EMI measurements since, for example, commercial standards specify limits for both the quasipeak and the average value. Thanks to the multiple use of detectors, only one test run is needed. The peak detector can be combined with any other detector since it is the fastest detector and therefore ideal for overview measurements.

### Selection of Detectors for Final Measurement

To define the detectors used in the final measurement, press the Final Meas Detector softkey in the trace menu and select one of the available detectors.

The detectors to be used for the final measurement can be set here for each trace, i.e. any combination of scan and final measurement is possible. The required flexibility is thus obtained for the diverse test specifications which are covered by means of the R&S ESL.



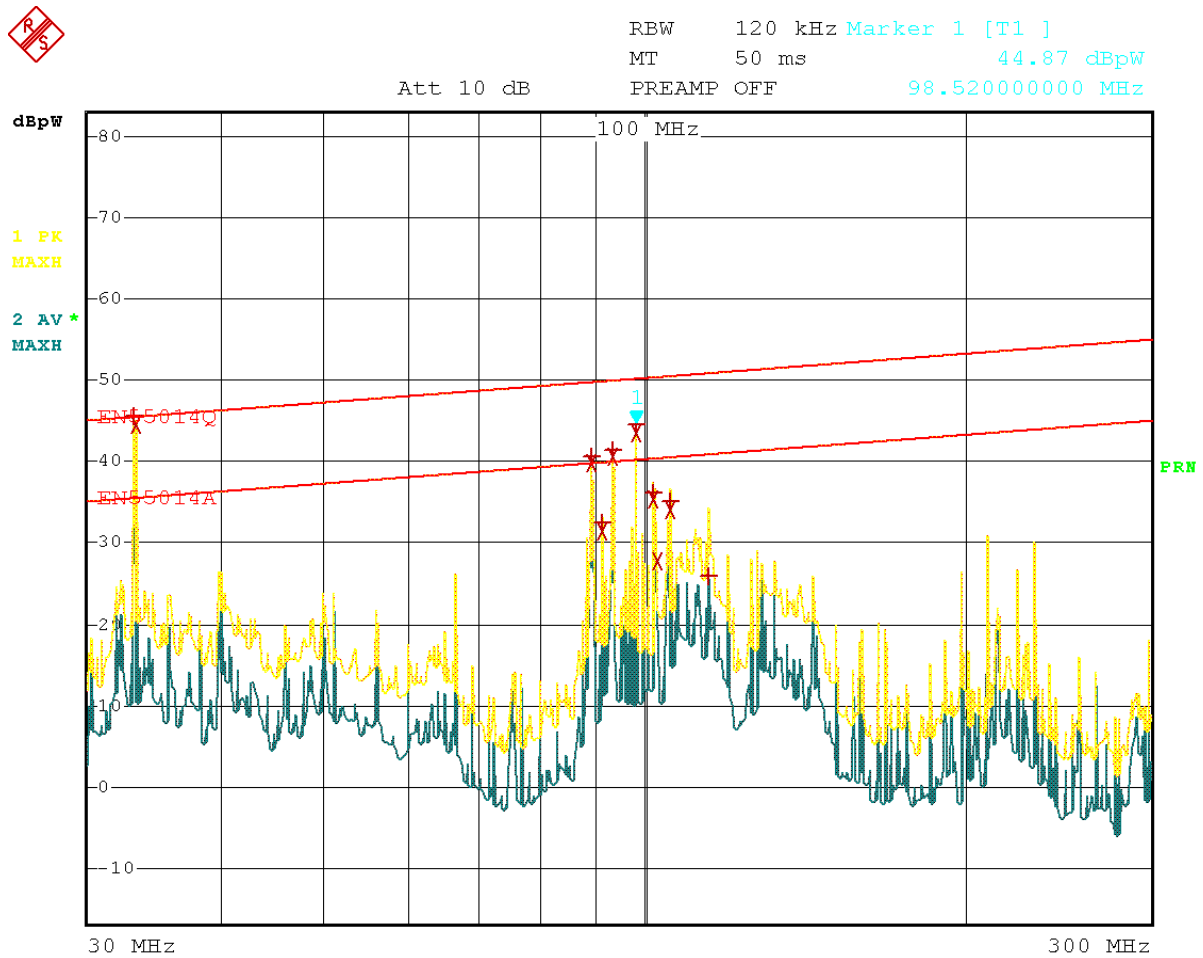

Date: 8.AUG.2001 16:41:37

Figure 4-1: Results of scan and final measurements

### ASCII File Export – file header example

Table 4-3: Example: File header

File contents	Description
Type; R&S ESL	Instrument model
Version;1.00;	Firmware version
Date;10. Nov 03	Date of data set storage
Mode;Receiver	Instrument mode
Start;150000.000000;Hz Stop;1000000000.000000;Hz	Start / stop of the display range Unit: Hz
x-axis;LOG;	Scaling of x-axis:linear (LIN) or logarithmic (LOG)
Detector;Average;	Selected detector: Maxpeak, Minpeak, Average, RMS, Quasipeak
Scan Count;1;	Scan Count

Transducer;;	Transducer name (if switched on)
--------------	----------------------------------

Table 4-4: Example: Data section of the file, scan ranges

File contents	Description
Scan 1;	Settings for scan range 1
Start;150000.000000;Hz	Range 1 – start frequency in Hz
Stop;30000000.000000;Hz	Range 1 – stop frequency in Hz
Step;4000.000000;Hz	Range 1 – step size
RBW;9000.000000;Hz	Range 1 – resolution bandwidth
Meas Time;0.001000;s	Range 1 – measurement time
Auto Ranging;OFF;	Range 1 – auto ranging on or off
RF Att;10.000000;dB	Range 1 – input attenuation
Auto Preamp;OFF;	Range 1 – auto preamp on or off
Preamp;0.000000;dB	Range 1 – preamplifier on (20dB) or off (0dB)
Scan 2:	Settings for scan range 2
Start;30000000.000000;Hz	Range 2 – start frequency in Hz
Stop;1000000000.000000;Hz	Range 2 – stop frequency in Hz
Step; 50000.000000;Hz	Range 2 – step size
RBW;120000.000000;Hz	Range 2 – resolution bandwidth
Meas Time;0.000100;s	Range 2 – measurement time
Auto Ranging;OFF;	Range 2 – auto ranging on or off
RF Att;10.000000;dB	Range 2 – input attenuation
Auto Preamp;OFF;	Range 2 – Auto Preamp on or off
Preamp;0.000000;dB	Range 2 – preamplifier on (20dB) or off (0dB)

Table 4-5: Example: Data section of the file, trace

File contents	Description
Trace 1:	Selected trace
Trace Mode;CLR/WRITE	Trace mode: Clear Write, Maxhold
x-Unit;Hz;	Unit of x values: Hz for span > 0
y-Unit;dBµV	Unit of y values: dB*V/A/W depending on the selected unit
Values;26863;	Number of tested points
150000.000000;15.604355; 154000.000000;13.236252; 158000.000000;11.907021; ...;...	Measured values: <x-value>;<y-value>

### Softkeys of the trace menu

The **TRACE** key opens a menu offering the setting options for the selected trace.

In this menu, the mode of representing the measured data in the frequency or time domain in the 625 pixels of the display is determined. Upon start of the measurement, each trace can be displayed either completely new or based on the previous results.

Traces can be displayed, blanked and copied.

The measurement detector for the individual display modes can be selected directly by the user.

The default setting is trace 1 in the overwrite mode (**Clear Write**) and detector **Max Peak** is selected. The other traces are in **Blank** mode..

The **Clear Write**, **Max Hold**, **Min Hold**, **View** and **Blank** softkeys are mutually exclusive selection keys.

Menu / Command	Command
Trace 1 2 3 4 5 6	
Trace Mode↓	Clear Write
	Max Hold
	Min Hold
	View
	Blank
Scan Detector↓	Peak
	Min Peak
	Average
	RMS
	Quasipeak
	CISPR AV
	CISPR RMS
Final Meas Detector↓	Final Peak
	Final Min Peak
	Final Average
	Final RMS
	Final Quasipeak
	More↓
	Final CISPR AV
	Final CISPR RMS
Scan Count	
Peak List On Off	
More↓	
Copy Trace	
ASCII File Export	
Decim Sep	

---

**Trace 1 2 3 4 5 6**

---

Select a specific trace with the **Trace 1 2 3 4 5 6** softkey.

→ Remote: --- (selected via numeric suffix of :TRACe)

---

**Trace Mode**

---

Opens a submenu from which the trace mode can be selected. For details see "[Trace mode overview](#)" on page 4.114..

The following trace modes are available:

Clear Write
Max Hold
Min Hold
View
Blank

---

**Clear Write**

---

Selects the **Clear Write** mode. For details see "[Trace mode overview](#)" on page 4.114.

→ Remote: DISP:TRAC:MODE WRIT

---

**Max Hold**

---

Selects the **Max Hold** mode. For details see "[Trace mode overview](#)" on page 4.114.

→ Remote: DISP:TRAC:MODE MAXH

---

**Min Hold**

---

Selects the **Min Hold** mode. For details see "[Trace mode overview](#)" on page 4.114.

→ Remote: DISP:TRAC:MODE MINH

---

**View**

---

Selects the **View** mode. For details see "[Trace mode overview](#)" on page 4.114.

→ Remote: DISP:TRAC:MODE VIEW

---

**Blank**

---

Selects the **Blank** mode. For details see "[Trace mode overview](#)" on page 4.114.

→ Remote: DISP:TRAC OFF

---

---

### Scan Detector

---

Selects the detector to be used for a scan measurement. The detector can be set independently for each trace.

The following detector types are available for scan measurements:

Peak
Min Peak
Average
RMS
Quasipeak
CISPR AV
CISPR RMS

For details on the detector types refer to [Selecting the Detector](#) on page 4.29

→ Remote: DET POS

---

### Peak

---

The **Peak** softkey selects the peak detector.

→ Remote: DET POS

---

### Min Peak

---

The **Min Peak** softkey selects the min peak detector.

→ Remote: DET NEG

---

### Average

---

The **Average** softkey selects the average detector.

→ Remote: DET AVER

---

### RMS

---

The **RMS** softkey selects the quasipeak detector.

→ Remote: DET RMS

---

### Quasipeak

---

The **Quasipeak** softkey selects the quasipeak detector.

The IF bandwidth is adapted as a function of the frequency range. The coupling of the IF bandwidth to the frequency range can be cancelled using the softkey **QP RBW Uncoupled**.

→ Remote: DET :QPE

---

**CISPR AV**

The CISPR AV softkey selects the weighting average detector according to CISPR 16-1 for the final measurement.

→ Remote: DET : CAV

**CISPR RMS**

The CISPR RMS softkey selects the weighting RMS detector according to CISPR 16-1-1 for the final measurement.

→ Remote: DET : CRMS

**Final Meas Detector**

Selects the detector to be used in the final measurement. The detector can be selected independently for each trace.

The following detector types are available for preliminary measurements:

Final Peak
Final Min Peak
Final Average
Final RMS
Final Quasipeak
Final CISPR AV
Final CISPR RMS

For details on the detector types refer to [Selecting the Detector](#) on page 4.29

→ Remote: DET : FME POS

**Final Peak**

The **Final Peak** selects the peak detector for the final measurement.

→ Remote: DET : FME POS

**Final Min Peak**

The **Final Min Peak** selects the min peak detector for the final measurement.

→ Remote: DET : FME NEG

**Final Average**

The **Final Average** selects the average detector for the final measurement.

→ Remote: DET : FME AVER

---

**Final RMS**

---

The **Final RMS** selects the RMS detector for the final measurement.

→ Remote: DET:FME RMS

---

---

**Final Quasipeak**

---

The **Final Quasipeak** selects the quasipeak detector for the final measurement.

→ Remote: DET:FME QPE

---

---

**Final CISPR AV**

---

The **Final CISPR AV** selects the weighting average detector according to CISPR 16-1 for the final measurement.

→ Remote: DET:FME CAV

---

---

**Final CISPR RMS**

---

The **Final CISPR RMS** softkey selects the weighting RMS detector according to CISPR 16-1-1 for the final measurement.

→ Remote: DET:FME CRMS

---

---

**Scan Count**

---

The **Scan Count** softkey opens an edit dialog box to enter the number of scans used in Single Scan mode.

The allowed range of values is 0 to 30000. The default setting is 1.

→ Remote: SWE:COUN 10

---

---

**Peak List On Off**

---

The **Peak List On Off** softkey switches on and off the indication of the peak list or of the final measurement results in the diagram. Each peak value is indicated as a symbol (e.g. an x or a +). The symbol in use varies from one trace to another to better distinguish the traces from one another. The assignment of symbol to trace is fixed.

Run Scan automatically switches Peak List to OFF in order to prevent the indication of preceding final measurement results. Peak Search automatically sets Peak List to ON (see [Data Reduction and Peak List](#) on page 4.50).

→ Remote: DISP:TRAC:SYMB CROS

---

---

**Copy Trace**

---

The **Copy Trace** softkey copies the screen contents of the current trace into another trace memory. The desired memory is selected by entering the number 1, 2 or 3.

Upon copying, the contents of the selected memory are overwritten and the new contents displayed in view mode.

→ Remote: TRAC:COPY TRACE1,TRACE2

---

---

**ASCII File Export**

---

The **ASCII FILE Export** softkey stores the active trace in ASCII format on a memory stick.

The file consists of the header containing important scaling parameters, several data sections containing the scan settings and a data section containing the trace data.

The data of the file header consist of three columns, each separated by a semicolon:

parameter name; numeric value; base unit

The data section for the scan ranges starts with the keyword "Scan <n>:", (<n> = number of scan range), followed by the scan data in one or several columns which are also separated by a semicolon.

The data section for the trace data starts with the keyword " Trace <n> " (<n> = number of stored trace), followed by the measured data in one or several columns which are also separated by a semicolon.

This format can be read in from spreadsheet calculation programs, e.g. MS Excel. It is necessary to define ';' as a separator.

---

*Note: Different language versions of evaluation programs may require a different handling of the decimal point. It is therefore possible to select between separators '.' (decimal point) and ',' (comma) using softkey **Decim Sep**.*

---

- Remote: FORM ASC;
  - Remote: MMEM:STOR:TRAC 1, 'TRACE.DAT'
- 

**Decim Sep**

---

The **Decim Sep** softkey selects the decimal separator between '.' (decimal point) and ',' (comma) with floating-point numerals for the function ASCII File Export.

With the selection of the decimal separator different language versions of evaluation programs (e.g. MS Excel) can be supported.

- Remote: FORM:DEXP:DSEP POIN
-



## Measurement Functions

In this section all menus necessary for setting measurement functions are described. This includes the following topics and keys:

- [“Marker Functions – MKR Key”](#) on page 4.40
- [“Change of Settings via Markers – MKR-> Key”](#) on page 4.44
- [“Selection of the Measurement Function – MEAS Key”](#) on page 4.48
- [“Running a Scan – RUN key”](#) on page 4.66
- [“Using Limit Lines and Display Lines – LINES Key”](#) on page 4.184

## Marker Functions – MKR Key

The markers are used for marking points on traces, reading out measurement results and for quickly selecting a display section. The R&S ESL provides four markers per trace.

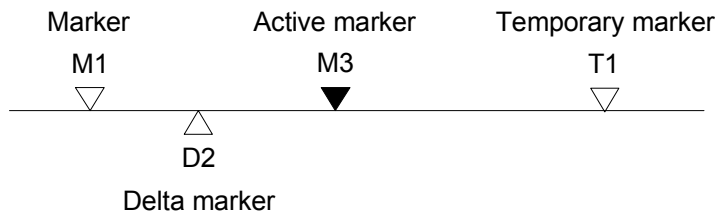

Fig. 4-1: Marker types

All markers can be used either as markers or delta markers. The marker that can be moved by the user is defined in the following as the active marker. Temporary markers are used in addition to the markers and delta markers to evaluate the measurement results. They disappear when the associated function is deactivated..

The measurement results of the active marker (also called marker values) are displayed in the marker field. The marker field is located at the upper right corner of the display and shows the following:

- marker type (M1 in the example)
- trace in square brackets ([1] in the example)
- level (-33.09 dBm in the example)
- marker location (3 GHz in the example)

```
M1[1]           -33.09 dBm
                3.000000000 GHz
```

Fig. 4-2: Marker values

The **MKR** key is used to select and position the absolute and relative measurement markers (markers and delta markers). In addition, the functions for frequency counter, fixed reference point for relative measurement markers and enlargement of the measurement area are assigned to this key.

### To open the marker menu

- Press the **MKR** key

The marker menu is displayed. If no marker is active, marker 1 is activated and a peak search on the trace is carried out. Otherwise, the edit dialog box for the last activated marker is opened and the current frequency / time value is displayed.

### Menu and softkey description

- [Softkeys of the marker menu](#)

### Softkeys of the marker menu

Command
Marker 1
Marker 2
Marker Norm Delta
More↓
Marker 3
Marker 4
Marker to Trace
All Marker Off
Marker Zoom
Previous Zoom Range
Marker Zoom Off

### Marker 1 Marker 2 Marker 3 Marker 4 Marker Norm Delta

The **Marker <no>** softkey selects the corresponding marker and activates it.

Marker 1 is always the reference marker for relative measurements. After they have been switched on, Markers 2 to 4 are delta markers that refer to Marker 1. These markers can be converted into markers with absolute value display by means of the **Marker Norm Delta** softkey. If Marker 1 is the active marker, pressing the **Marker Norm Delta** softkey switches on an additional delta marker.

Pressing the **Marker <no>** softkey again switches off the selected marker.

#### Example:

Press the **MKR** key.

On calling the menu, Marker 1 is switched on (softkey **Marker 1** is highlighted) and positioned on the maximum value of the trace. It is a normal marker and the Marker Normal softkey is highlighted.

Press the **Marker 2** softkey.

Marker 2 is switched on (softkey **Marker 2** is highlighted). It is automatically defined as a delta marker on switching on so the Delta is highlighted on softkey Marker Norm Delta. The frequency and level of Marker 2 with reference to Marker 1 are output in the marker info field.

Press the **Marker Norm Delta** softkey.

The Marker Norm Delta softkey is highlighted. Marker 2 becomes a normal marker. The frequency and level of Marker 2 are output as absolute values in the marker info field.

Press the **Marker 2** softkey.

Marker 2 is switched off. Marker 1 is the active marker for entry. The frequency and level of Marker 1 are output in the marker info field.

If several traces are being displayed, the marker is set to the maximum value (peak) of the active trace which has the lowest number (1 to 6). In case a marker is already located there, it will be set to the frequency of the next lowest level (next peak).

A marker can only be enabled when at least one trace in the corresponding window is visible.

If a trace is turned off, the corresponding markers and marker functions are also deactivated. If the trace is switched on again (View, Clr/Write,..), the markers along with coupled functions will be restored to their original positions provided the markers have not been used on another trace.

- Remote: CALC:MARK ON;
- Remote: CALC:MARK:X <value>;
- Remote: CALC:MARK:Y?
- Remote: CALC:DELT ON;
- Remote: CALC:DELT:MODE ABS
- Remote: CALC:DELT:X <value>;
- Remote: CALC:DELT:X:REL?
- Remote: CALC:DELT:Y?

### Marker to Trace

The **MKR->Trace** softkey places the marker on a new trace. The trace is selected via a data entry field. Only those traces can be selected which are visible on the screen in the same window.

#### *Example:*

Three traces are presented on the screen. The marker is always on Trace 1 on switching on.

Press the **MKR->Trace** softkey and enter the number '2'.

The marker jumps to Trace 2 but remains on the previous frequency or time.

Press the **MKR->Trace** softkey and enter the number '3'.

The marker jumps to Trace 3.

- Remote: CALC:MARK1:TRAC 1
- Remote: CALC:DELT:TRAC 1

### All Marker Off

Pressing the **All Marker Off** softkey switches off all marker.

- Remote: CALC:MARK:AOFF

### Marker Zoom

The **Marker Zoom** softkey zooms 10% of the diagram around the current marker. It opens at the same time a data entry field which allows to enter any frequency range which is then displayed.

Pressing the softkey again expands the diagram such that only 3 measured values are represented.

- Remote: CALC:MARK:FUNC:ZOOM <num\_value>

**Previous Zoom Range**

---

The **Previous Zoom Range** softkey zooms to the previous frequency range.

---

**Marker Zoom Off**

---

The **Marker Zoom Off** softkey deactivates the zoom.

→ Remote: `DISP:TRAC:X:ZOOM OFF`

---

## Change of Settings via Markers – MKR-> Key

The MKR-> menu offers functions through which instrument parameters can be changed with the aid of the currently active marker. The functions can be used on markers and delta markers.

On opening the menu, the entry for the last active marker is activated; if no marker was enabled, Marker 1 is activated and a peak search is performed.

### To open the marker-> menu

- Press the **MKR->** key.

The marker-> menu is displayed. If no marker is active, marker 1 will be activated and a peak search on the trace carried out. Otherwise, the edit dialog box for the last activated marker is opened and the current frequency / time value is displayed.

### Menu and softkey description

- [Softkeys of the marker to menu](#)

#### Softkeys of the marker to menu

Menu / Command	Command
Select 1 2 3 4	
Peak	
Next Peak	
Next Peak Mode <abs>	
Add To Peak List	
Tune to Marker	
More↓	
Select 1 2 3 4	
Min	
Next Min	
Next Min Mode <abs>	
Search Limits↓	Left Limit
	Right Limit
	Threshold
	Search Limit Off
Marker Track On Off	
Peak Excursion	
Marker to Stepsize	
Settings Coupled	

**Select 1 2 3 4**

---

Select one of the active markers with the Select Marker softkey. An edit dialog box that shows the position of the active marker opens. To change the position of the marker, enter another frequency in the edit dialog box.

On entering the MKR-> menu, marker 1 is automatically switched on.

- Remote: CALC:MARK1 ON
  - Remote: CALC:MARK1:X <value>
  - Remote: CALC:MARK1:Y?
- 

**Peak**

---

The **Peak** softkey sets the active marker or delta marker to the peak of the trace.

If no marker is active when MKR-> menu is called, Marker 1 is automatically switched on and the peak search is performed.

- Remote: CALC:MARK:MAX
  - Remote: CALC:DELT:MAX
- 

**Next Peak**

---

The **Next Peak** softkey sets the active marker/delta marker to the next lower peak value on the trace. The search direction is defined in the Next Mode submenu (see **Next Peak Mode <abs>** softkey).

- Remote: CALC:MARK:MAX:NEXT
  - Remote: CALC:DELT:MAX:NEXT
- 

**Next Peak Mode <abs>**

---

The **Next Peak Mode** softkey sets the active marker/delta marker to the next lower peak value to the right or left side of the current marker position on the selected trace.

- Remote: CALC:MARK:MAX:RIGH
  - Remote: CALC:DELT:MAX:RIGH
- 

**Add To Peak List**

---

The **Add To Peak List** softkey adds the receiver frequency of the currently active marker to the peak list (see also section [Data Reduction and Peak List](#)).

- Remote: CALC:PEAK:ADD 23.512 MHz
- 

**Tune to Marker**

---

The **Tune To Marker** softkey sets the receiver frequency to the marker frequency.

- Remote: CALC:MARK:FUNC:CENT
-

---

**Min**

---

The **Min** softkey sets the active marker to the minimum value on the corresponding trace.

- Remote: CALC:MARK:MIN
  - Remote: CALC:DELT:MIN
- 

**Next Min**

---

The **Next Min** softkey sets the active marker/delta marker to the next higher minimum of the selected trace. The search direction is defined in the Next Mode submenu (see below).

- Remote: CALC:MARK:MIN:NEXT
  - Remote: CALC:DELT:MIN:NEXT
- 

**Next Min Mode <abs>**

---

The **Next Min Mode** softkey sets the active marker/delta marker to the next higher minimum value to the right or left of the current marker position on the corresponding trace.

- Remote: CALC:MARK:MIN:LEFT
  - Remote: CALC:DELT:MIN:LEFT
  - Remote: CALC:MARK:MIN:RIGH
  - Remote: CALC:DELT:MIN:RIGH
- 

**Search Limits**

---

The **Search Limits** softkey limits the search range for maximum or minimum search. The softkey switches to a submenu in which the search range limits can be set in the x and y direction.

Left Limit
Right Limit
Threshold
Search Limit Off

**Left Limit Right Limit**

---

The **Left Limit** and **Right Limit** softkeys define the two vertical lines S1 and S2 in the frequency domain (span > 0). The search is performed between these lines in the frequency domain.

If only Left Limit is enabled, line S1 is the lower limit and the upper limit corresponds to the stop frequency. If Right Limit is also enabled, it determines the upper limit.

- Remote: CALC:MARK:X:SLIM:LEFT 1MHz
  - Remote: CALC:MARK:X:SLIM:RIGH 10MHz
  - Remote: CALC:MARK:X:SLIM ON
-



**Threshold**

---

The **Threshold** softkey defines the threshold line.

The threshold line represents a limit for the level range of the max. search at the lower end and that of the min. search at the upper end.

- Remote: CALC:THR -20dBm
  - Remote: CALC:THR ON
- 

**Search Limit Off**

---

The **Search Limit Off** softkey disables all limits of the search range.

- Remote: CALC:MARK:X:SLIM OFF
  - Remote: CALC:THR OFF
- 

**Marker Track On Off**

---

This softkey automatically sets the receiver frequency to the frequency of the active marker. The receiver frequency is updated with every change of the marker position.

- Remote: CALC:MARK1:COUP ON
- 

**Peak Excursion**

---

The Peak Excursion softkey sets the minimum amount by which a signal level must decrease / increase before it is recognized by the Next Peak and Next Min search functions as maximum or minimum.

- Remote: CALC:MARK:PEXC 10 dB
- 

**Marker to Stepsize**

---

Sets the stepsize of the marker (see **Next Peak** and **Next Min** softkeys) to the stepsize of the receiver frequency (see **Stepsize** softkey).

- Remote: CALC:MARK:FUNC:CST
- 

**Settings Coupled**

---

The **Settings Coupled** softkey couples the receiver frequency settings from the corresponding subs cans to the marker frequency for functions Tune To Marker and Marker Track.

- Remote: CALC:MARK:SCO ON
-

## Selection of the Measurement Function – MEAS Key

The MEAS key opens the menu to select basic instrument parameters like receiver frequency, detector, measurement time and the audio demodulator.

The final measurement softkey gives access to receiver settings for test automation and to the peak list. The test automation includes an automatic sequence of scan, data reduction and final measurements. It also enables remote control of line impedance stabilization networks (LISN).

### To open the measurement menu

- Press the **MEAS** key.  
The measurement menu is displayed.

### Menu and softkey description

#### – [Softkeys of the measurement menu](#)

To display help to a softkey, press the **HELP** key and then the softkey for which you want to display help. To close the help window, press the **ESC** key. For further information refer to section "How to use the Help System".

### Further information

- [Setting the measurement time and weighting modes](#)
- [Data Reduction and Peak List](#)
- [Data Reduction using the Subrange Maximum](#)
- [Automatic Control of Line Impedance Stabilization Networks](#)
- [ASCII file export format](#)

### Setting the measurement time and weighting modes

The measurement time can be set in the range from 50  $\mu$ s to 100 s with a two-digit resolution.

The measurement time is the time during which R&S ESL measures the input signal and forms a measurement result weighted by the selected detector. The measurement time does not include settling times of the synthesizer and the IF filter.

When the quasipeak detector is used, the minimum measurement time is 500  $\mu$ s. When the CISPR average detector is used, the useful minimum measurement time is 20 ms. With the average, RMS, AC video, or min/max peak detector, the smallest settable measurement time depends on the bandwidth.

Bandwidth	Shortest measurement time AV, RMS	Shortest measurement time PK+, PK-
200 Hz	50 ms	1 ms
1 kHz	10 ms	0.1 ms
9 kHz	1 ms	0.1 ms
100 kHz	0.1 ms	0.05 ms

Effect of measurement time with different weighting modes:

- Min/Max Peak measurement:

With peak weighting selected, the maximum or minimum level during the selected measurement time is displayed. The peak detector is reset at the beginning of each measurement. At the end of the measurement time the maximum or minimum level occurred during the measurement time is displayed. Since the peak detector of R&S ESL is a digital detector, discharging is irrelevant even with long measurement times.

Unmodulated signals can be measured with the shortest possible measurement time. When pulses are measured, the selected measurement time must be long enough for at least one pulse to occur during the measurement time.

- RMS measurement

With RMS weighting the same applies to the measurement time as with the average measurement.

- Average measurement:

With average detection selected, the video voltage (envelope of IF signal) is averaged during the measurement time. Averaging is digital, i.e. the digitized values of the video voltage are summed up and divided by the number of samples at the end of the measurement time. This corresponds to a filtering with a rectangular window in the time domain and a filtering with  $\sin x/x$  characteristic in the frequency domain. With unmodulated signals the shortest possible measurement time can be selected. With modulated signals the measurement time is determined by the lowest modulation frequency to be averaged. With pulse signals, the selected measurement time should be long enough for sufficient number of pulses ( $>10$ ) to occur in the measurement window for averaging.

- CISPR average and CISPR RMS measurement:

With a CISPR average or a CISPR RMS measurement, the maximum value of the weighted signal during the measurement time is displayed. The relatively long time constants used with CISPR average and CISPR RMS detectors result in long measurement times in order to obtain a correct measurement result. If unknown signals are measured, the measurement time should be at least one second so that pulses down to a frequency of 5 Hz are correctly weighted.

After a frequency change or a modification of the attenuation, the R&S ESL waits until the lowpass has settled before the measurement time starts. The measurement time is selected depending on the IF bandwidth and the characteristics of the signal to be measured. Unmodulated sinusoidal signals as well as signals with high modulation frequency can be measured within a short time. Slowly fluctuating signals or pulse signals require longer measurement times.

- Quasipeak measurement:

With quasipeak measurements, the maximum value of the weighted signal during the measurement time is displayed. The relatively long time constants used with quasipeak detectors entail long measurement times to obtain correct results. With unknown signals the measurement time should be at least 1 s. This ensures correct weighting of pulses down to a pulse frequency of 5 Hz.

After internal switching, R&S ESL waits until the measurement result has stabilized before it starts the actual measurement. Since the level does not change during a frequency scan, known signals (e.g. broadband RFI) can be correctly measured with a much shorter measurement time.

- Measurement with several detectors:

If several detectors are used simultaneously, a measurement time suiting the slowest detector should be selected to obtain correct results for all detectors. It is therefore recommended to set a measurement time that matches the average detector when the peak and average detectors are used.

## Data Reduction and Peak List

EMI measurements may involve much time because the time constants prescribed by the standard for the detector weighting require long measurement times for each value. In addition, the standards stipulate procedures for finding local EMI maxima such as shifting the absorbing clamp, variation of the test antenna height and rotating the DUT. Measuring with quasipeak weighting at each frequency and for each setting of the test configuration would lead to unacceptably long measurement times. For this reason, R&S has developed a method which reduces the time-consuming measurements with the standard detectors like quasipeak, CISPR avergae and CISPR RMS to a minimum with an optimum reliability of detection.

## Data Reduction using the Subrange Maximum

The interference spectrum is first pre-analyzed in a fast scan to optimize the duration of the measurement. Data reduction follows so that the time-consuming final measurement is performed at only some important frequencies:

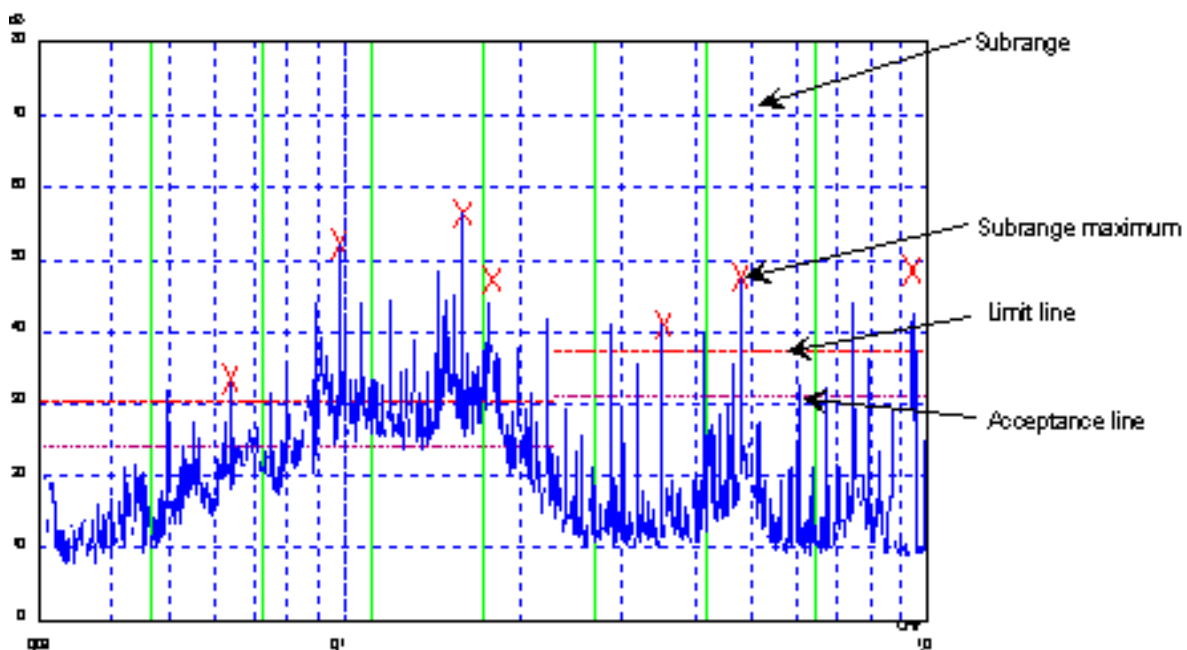

Figure 4-2: Dividing the spectrum into eight subranges

Data reduction is of crucial importance. It is automatically initiated by pressing a key after the scan. Data reduction is used to select frequencies with a very high interference level. Several data reduction methods are used:

- Acceptance analysis, i.e. the interference spectrum is further analyzed at frequencies with levels above a line parallel to a limit line.
- Generating subrange maxima, i.e. the interference spectrum is further analyzed at frequencies with the highest interference level of a frequency subrange (search method Subranges).
- Determination of a specific number of peak values relative to the limit lines with the level values being independent of their frequency spectral distribution (search method Peaks).

For generation of subrange maxima, the whole frequency range is divided into equidistant subranges. A subrange maximum is determined for each subrange (search method Subranges).

Determining the level maxima irrespective of their distribution in the frequency spectrum (search mode Peaks) is suitable for measurement regulations that demand determination of the relatively highest level irrespective of the distribution in the measured frequency range, e.g. FCC.

If the scan is performed in parallel with several detectors, typically with peak value and average value, the maxima are determined separately for the two detectors so that the distribution of narrowband and wideband sources of interference can be taken into account. For example, the frequency of the maximum determined with the average detector can be used for the final measurement performed with this detector and the frequency found in the scan carried out with the peak detector is taken for the final measurement using the quasipeak detector.

Consideration of the limit lines ensures that the final measurement is not performed at frequencies at which the inference level is far below the limit value. The margin between the acceptance line and the limit line can be selected by the user in dB as the Margin. Each limit line is allocated to a trace, i.e. different limit lines are taken for the different detectors.

Two values should therefore be defined for this purpose:

- the number of subranges or highest level values (No Of Peaks in the range from 1 to 500; default value: 25)
- the acceptance margin (Margin; default value: 6 dB). It is valid for all limit lines.

As an alternative method, it is possible to preset a list of frequencies at which the final measurements are performed. A typical application is, for example, the statistical analysis of several units.

The peak list can be either edited manually or can be filled with desired values by adopting the marker values.

If no limit lines are activated, the measurement procedure is as if all measured values would exceed the limit line.

### Automatic Control of Line Impedance Stabilization Networks

The selected phases are controlled during the scan and the final measurement via the Userport with the LISN switched on.

Only one phase (1 out of n) can be selected for the scan. Any number of settings can be selected for the final measurement (m out of n).

All selected phase combinations are measured during the final measurement and the maximum value is determined.

The selection of the V-Networks to be used in the Scan Phases and the Final Phases is done via the **Test Automation** dialog box.

Settings made in the Prescan Phases menu are immediately output at the user port. This way, the menu can be used to remote control the LISN during manual measurements.

For automatic phase selection with the LISN, the R&S ESL user interface and the LISN have to be connected via a control line.

ASCII file export format

Table 4-6: Receiver mode, final measurement data – file header

Content of file	Description
Type;R&S ESL;	Instrument model
Version;1.82;	Firmware version
Date;03.Mar 2008	Date record storage date
Mode;Receiver	Instrument operating mode
Start;10000;Hz Stop;100000;Hz	Start/stop of the display range Unit: Hz
x-axis;LIN;	Scaling of x-axis linear (LIN) or logarithmic (LOG)
Scan Count;1;	Number of scans set
Transducer;TRD1;	Transducer name (if switched on)
Scan 1	Loop over all defined scan ranges (1-10)
Start;150000;Hz	Range – start frequency in Hz
Stop;1000000;Hz	Range – stop frequency in Hz
Step;4000;Hz	Range – step size in Hz for linear step size or in % (1-100) for logarithmic step size
RBW;100000;Hz	Range – resolution bandwidth
Meas Time;0.01;s	Range – measurement time
Auto Ranging;ON;	Auto ranging on or off for current range
RF Att;20;dB	Range – input attenuation
Auto Preamp;OFF;	Auto preamp on or off for current range
Preamp;0;dB	Range – preamplifier on (20dB) or off (0dB)

Table 4-7: Receiver mode, final measurement data – data section of the file

Content of file	Description
Trace 1 Final:	Selected Trace
Trace Mode;Clr/Write	Trace mode: Clr/Write, Average, Max Hold, Min Hold, View, Blank
Final Detector;Quasipeak	Final detector: Max Peak, Min Peak, RMS, Average, Quasipeak, AC Video
x-unit;Hz;	
y-unit;dBuV;	
Final Meas Time;1.000000;s	
Margin;6.000000;s	
Values;8;	
2;154000.000000;81.638535;15.638535;N;GND 1;158000.000000;86.563789;7.563789;N;GND 2;1018000.000000;58.689873;-1.310127;GND	Measured values: <trace>;<x-value>;<y-value>;<phase>;<ground> Phase and protective grounding are output only if a line impedance stabilization has been active. They specify the setting at which the maximum RFI level at the associated frequency was found.

*Example for exported final measurement data*

```

Type; R&S ESL;
Version;1.82;
Date;03.Mar 08;
Mode;Receiver;
Start;150000.000000;Hz
Stop;30000000.000000;Hz
x-Axis;LOG;
Scan Count;1;
Transducer;;
Scan 1:
Start;150000.000000;Hz
Stop;30000000.000000;Hz
Step;4000.000000;Hz
RBW;9000.000000;Hz
Meas Time;0.001000;s
Auto Ranging;OFF;
RF Att;10.000000;dB
Auto Preamp;OFF;
Preamp;0.000000;dB
TRACE 1 FINAL:
Trace Mode;CLR/WRITE;
Final Detector;MAX PEAK;
TRACE 2 FINAL:
Trace Mode;CLR/WRITE;
Final Detector;AVERAGE;
x-Unit;Hz;
y-Unit;dBuV;
Final Meas Time;1.000000;s
Margin;6.000000;dB
Values;11;
2;154000.000000;81.638535;15.638535;N;GND
1;158000.000000;86.563789;7.563789;N;GND
2;1018000.000000;58.689873;-1.310127;N;GND
2;302000.000000;63.177345;-2.822655;L1;GND
2;3294000.000000;56.523022;-3.476978;N;GND
2;1122000.000000;53.849747;-6.150253;N;GND
2;10002000.000000;47.551216;-12.448784;N;GND
1;3390000.000000;59.762917;-13.237083;N;GND
1;9998000.000000;58.309189;-14.690811;L1;GND
2;20002000.000000;45.142456;-14.857544;L1;GND
2;7502000.000000;36.406967;-23.593033;L1;GND

```

**Softkeys of the measurement menu**

Softkeys in the measurement menu:

Menu / Command	Menu / Command	Menu / Command	Command
Receiver Frequency			
Add to Peak List			
Bargraph Detector	Max Peak		
	Min Peak		
	Average		
	RMS		
	Quasipeak		
	CISPR Average		
	CISPR RMS		
Meas Time			
Demod ↓	Demod On Off		
	AM FM		
	Squelch		
	Volume		
Final Meas Settings ↓	Test Automation		
	Peak Search		
	Edit Peak List		
	Run Final Meas	Hold Final Meas ↓	Automatic Final
			Interactive Final
			Skip Frequency
			Get Maxhold
			Measure
			Stop Final Meas
		Stop Final Meas	
	Peak List Export		
	Decim Sep		
Continous Bargraph			
Single Bargraph			
Bargraph Maxhold			
Bargraph Reset			



### Receiver Frequency

---

For details refer to the **Receiver Frequency** softkey in the frequency menu.

---

### Add to Peak List

---

The **Add To Peak List** softkey adds the current receiver frequency to the peak list (see also section [Data Reduction and Peak List](#)).

→ Remote: CALC:PEAK:ADD 23.512 MHz

---

### Bargraph Detector

---

Opens the detector submenu to select the detector for the bargraph. The menu contains the following softkeys:.

Peak
Min Peak
Average
RMS
Quasipeak
CISPR Average
CISPR RMS

For further details on detectors refer to [Selecting the Detector](#).

---

### Max Peak

---

The **Peak** softkey selects the peak detector for the bargraph measurement. For details on the peak detector refer to [Selecting the Detector](#).

→ Remote: DET:REC POS

---

### Min Peak

---

The **Min Peak** softkey selects the peak detector for the bargraph measurement. For details on the min peak detector refer to [Selecting the Detector](#).

→ Remote: DET:REC NEG

---

### Average

---

The **Peak** softkey selects the peak detector for the bargraph measurement. For details on the average detector refer to [Selecting the Detector](#).

→ Remote: DET:REC AVER

---

**RMS**

The **RMS** softkey selects the peak detector for the bargraph measurement. For details on the RMS detector refer to [Selecting the Detector](#).

→ Remote: DET:REC RMS

**Quasipeak**

The **Quasipeak** softkey selects the peak detector for the bargraph measurement. For details on the quasipeak detector refer to [Selecting the Detector](#).

→ Remote: DET:REC QPE

**CISPR Average**

The **CISPR Average** softkey activates the weighting average detector according to CISPR 16-1. The IF bandwidth is automatically set to the required value according to the receiving frequency. This coupling can be cancelled by the softkey **QP RBW Uncoupled**.

→ Remote: DET:REC CAV

**CISPR RMS**

The **CISPR RMS** softkey activates the weighting RMS detector according to CISPR 16-1. The IF bandwidth is automatically set to the required value according to the receiving frequency. This coupling can be cancelled by the **QP RBW Uncoupled** softkey.

→ Remote: DET:REC CRMS

**Meas Time**

For details refer to the **Meas Time** softkey of the sweep menu.

**Demod**

The R&S ESL provides demodulators for AM and FM signals. With these demodulators selected, a displayed signal can be monitored using headphones.

The **Demod** softkey calls a submenu in which the desired type of demodulation can be switched on.

Command
<a href="#">Demod On Off</a>
<a href="#">AM FM</a>
<a href="#">Squelch</a>
<a href="#">Volume</a>

A squelch function enables the input of a level threshold below which the audible AF is cut off.

---

**Demod On Off**

---

The **Demod On/Off** softkey switches demodulation on/off.

→ Remote: DEM OFF (DEModulation ON automatically switched on with DEM AM | FM)

---

**AM FM**

---

The **AM** and **FM** softkeys can be activated one at a time. They are used to set the desired demodulation type, FM or AM.

→ Remote: DEM AM | FM

---

**Squelch**

---

The **Squelch** softkey enables the input of a level threshold below which the audible AF is cut off. The squelch function is associated with the internal trigger function (trigger menu), which will be switched on automatically with the squelch. Squelch level and trigger level do have the same value.

The softkey can take on three states:

- Gray     The squelch function is deactivated.
- Green    The squelch function is activated.
- Red      An edit dialog box to enter the level threshold opens

The default setting for the squelch is off.

→ Remote: SENS:DEM:SQU ON | OFF  
→ Remote: SENS:DEM:SQU:LEV 80 PCT

---

**Volume**

---

The Volume softkey sets the volume for headphones. The volume can be set between 1 and 100. 1 is the lowest volume and 100 the loudest.

Default value is 1.

→ Remote: SYST:SPE:VOL 0.7

---

**Final Meas Settings**

Opens a submenu to modify settings concerning the final measurement. The following softkeys are available:

Test Automation		
Peak Search		
Edit Peak List		
Run Final Meas ↓	Hold Final Meas ↓	Automatic Final
		Interactive Final
		Skip Frequency
		Get Maxhold
		Measure
		Stop Final Meas
	Stop Final Meas	
Peak List Export		
Decim Sep		

**Test Automation**

The **Test Automation** softkey opens the Test Automation dialog box. The dialog box contains two tabs, one to modify the [Final Meas Settings](#) and one to set the [LISN Settings](#) (line impedance stabilization networks).

## Final Meas Settings

In the **Final Measurement Settings** tab, parameters regarding the peak search can be modified as well as [Final Test Settings](#):

The R&S ESL offers two methods to determine peak values of a scan.

The Peaks search determines a specific number of peak values relative to the limit lines. Set the number of peaks to be determined in the **Peaks** field.

The Subranges search analyzes the peaks of each subrange. Instead of the **No of Peaks** field, two new fields are shown in the dialog box. The number of subranges to be analyzed can be set in the **No of Subranges** field. The **Peaks / Subrange** field determines the number of peaks for each subrange.

Specify the acceptance threshold for the generation of the peak list in the **Margin** field. The R&S ESL shifts the currently used limit line by this amount.

The value range is -200 dB to 200 dB.

For details on the **Peak Excursion** field refer to the **Peak Excursion** softkey of the marker to menu.

For further information on the peak search refer to [Data Reduction using the Subrange Maximum](#).

- Remote: CALC:PEAK:SUBR 5
- Remote: CALC:PEAK:SUBR:PCO 5

---

**Final Test Settings**

---

The final test settings control the actions of the R&S ESL regarding the final measurement.

Set the dwell time of the final measurement in the Final Meas Time field. The value range is from 50  $\mu$ s to 100 s.

The **Peak Search after Prescan** check box initiates a peak search after the scan.

The **Run Final Test after Prescan** check box initiates a final measurement after the scan. This includes a peak search.

Select whether the final measurement runs automatically or in interactive mode.

Select the **Automatic** radio button to select the automatic routine of the final measurement. The R&S ESL automatically runs the final measurement according to the preliminary peak list. No user interaction is possible.

To adjust settings during the final measurement, activate the **Interactive** radio button. The following measurement sequence is now available:

- The R&S ESL adjusts to the first frequency in the peak list. The receiver settings are the same as in the preliminary scan.
- The R&S ESL sets the marker on the frequency in the scan diagram.
- The R&S ESL interrupts the final measurement.
- To analyze the signal in detail, modify the receiver settings as desired.
- After continuing the final measurement, the current frequency replaces the preliminary one in the peak list (drifting interference sources).
- The R&S ESL proceeds with the next frequency in the list.

---

**Note:** *A switch to the automatic final measurement is always possible while in Interactive mode. The R&S ESL then continues the final measurement according to the routine of the automatic measurement.*

---

The Peak Search can be started with the **Peak Search** button, the final measurement is started with the **Run Final Meas** button.

→ Remote: FME:AUTO ON | OFF

→ Remote: FME:TIME 100 us

---

**LISN Settings**

Activate or deactivate the usage of a V-network in the measurement. Also, set the parameters of the network in this tab. For details on the networks refer to [Automatic Control of Line Impedance Stabilization Networks](#)

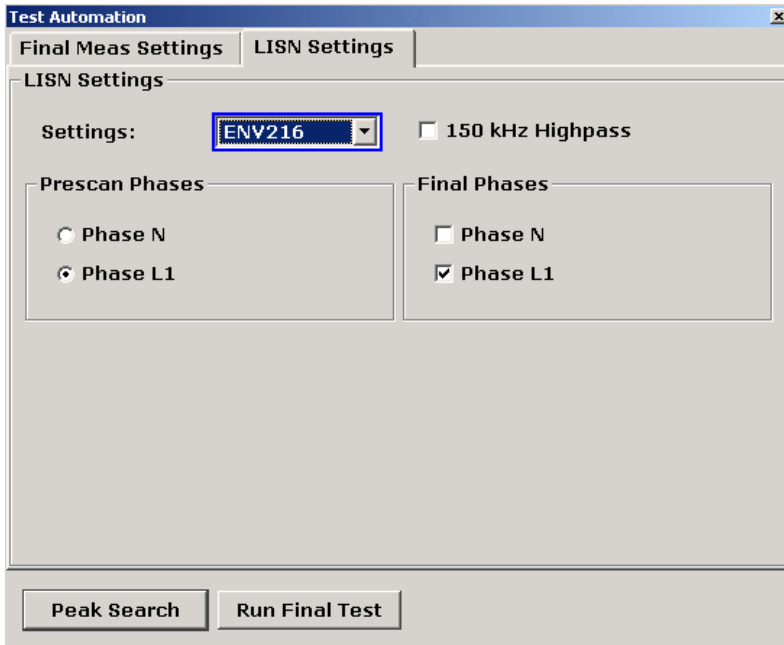

From the dropdown menu, select one of the following networks:

ESH2-Z5	Four-line V-network is controlled
ESH3-Z5	Two-line V-network is controlled
ENV 4200	Four-line V-network is controlled
ENV 216	Two-line V-network is controlled

→ Remote: INP:LISN ESH3Z5 | ESH2Z5 | ENV4200 | ENV216 | OFF

Additionally, select the Prescan Phases and Final Phases for the selection of phase and protective earth settings. The availability of the phases depend on the selected network.

Prescan Phases	Softkeys ESH2-Z5, ESH3-Z5, ENV 4200, ENV 216 and OFF or Phase N, Phase L1, Phase L2 and Phase L3 as well as PE Grounded and PE Floating are toggle keys. Only one of them can be activated at a time.
Final Phases	All combinations of phases and PE settings are possible.

Phase N	RFI on phase N is measured
Phase L1	RFI on phase L1 is measured
Phase L2	RFI on phase L2 is measured (only for ESH2-Z5/ENV 4200)
Phase L3	RFI on phase L3 is measured (only for ESH2-Z5/ENV 4200)

→ Remote: INP:LISN:PHAS L1 | L2 | L3 | N

For the ENV216 network a 150 kHz highpass filter is available. Activate the filter by activating the corresponding check box.

→ Remote: INP:LISN:FILT:HPAS ON

**Peak Search**

The Peak Search softkey starts a peak search of the scan. Additionally the R&S ESL generates a peak list of the current scan. Repeat the procedure to try out different settings of margin and number of subranges.

For details on the peak list, refer to [Edit Peak List](#).

→ Remote: CALC : PEAK

**Edit Peak List**

The Edit Peak List softkey opens the Edit Peak List dialog box.

Trace/Detector	Frequency $\Delta$	Level dB $\mu$ V	DeltaLimit
1 Pos. Peak	170.1200 MHz	86.69	-1.30 dB
1 Pos. Peak	190.1600 MHz	86.79	-1.32 dB
1 Pos. Peak	210.2400 MHz	86.75	-1.48 dB
1 Pos. Peak	250.3200 MHz	86.80	-1.63 dB
1 Pos. Peak	350.5600 MHz	86.76	-2.05 dB
1 Pos. Peak	370.6000 MHz	86.65	-2.22 dB
1 Pos. Peak	470.7600 MHz	86.76	-2.38 dB
1 Pos. Peak	490.7200 MHz	86.68	-2.51 dB
1 Pos. Peak	530.7600 MHz	86.71	-2.57 dB
1 Pos. Peak	570.9600 MHz	86.82	-2.54 dB
1 Pos. Peak	651.0400 MHz	86.67	-2.84 dB
1 Pos. Peak	691.0800 MHz	86.67	-2.91 dB
1 Pos. Peak	791.4400 MHz	86.76	-2.97 dB
1 Pos. Peak	811.4000 MHz	86.79	-2.97 dB
1 Pos. Peak	891.5600 MHz	86.73	-3.14 dB

The dialog box contains the following items:

– **Status Line**

The status line displays the name of the assigned limit lines. A limit line can be assigned to each trace. If more than two traces are in use, the field size is adjusted accordingly. If no limit line is assigned to a trace, the text 'LimitLine not assigned' is displayed next to the trace number.

– **Trace / Detector**

Displays the trace number and the corresponding detector.

– **Frequency**

Shows the frequency of the measured peaks. To add a new frequency to the peak list, use the **Insert Frequency** button. To remove a frequency from the list, use the **Delete Frequency** button. The frequencies are displayed in ascending order.

– **Level**

Shows the power levels of the measured peaks. The unit depends on the current settings (see **Unit** softkey)



---

– **DeltaLimit**

Shows the difference of the measured value and the value of the limit line. Values which passed the test have a negative sign. Values which did not pass the test have a positive sign.

The R&S ESL considers margins in this calculation (see **Margin** field in the **Test Automation** dialog box). To sort the list by DeltaLimit instead of frequency, use the **Sort by Delta Limit** button.

---

### Run Final Meas

---

The Run Final Meas softkey starts the final measurement sequence. Refer to [Data Reduction and Peak List](#) for details on the final measurement sequence.

→ Remote: INIT:FME

Additionally, the final measurement submenu opens. It contains the following softkeys:

Hold Final Meas
Stop Final Meas

In Interactive mode the R&S ESL directly opens the [Hold Final Meas](#) submenu, containing the following softkeys.

Automatic Final
Interactive Final
Skip Frequency
Get Maxhold
Measure
Stop Final Meas

---

### Hold Final Meas

---

To modify the receiver settings during the final measurement, use the Hold Final Meas softkey. The measurement is interrupted for now, and the settings can be adjusted.

To resume the final measurement, use the [Measure](#) softkey.

→ Remote: HOLD

The Hold Final Meas submenu contains the following softkeys:

Automatic Final
Interactive Final
Skip Frequency
Get Maxhold
Measure
Stop Final Meas

---

---

**Automatic Final**

---

Select **Automatic Final** to select the automatic routine of the final measurement. The R&S ESL automatically runs the final measurement according to the preliminary peak list. No user interaction is possible.

→ Remote: FME:AUTO ON

---

**Interactive Final**

---

To adjust settings during the final measurement, activate the **Interactive** radio button. The following measurement sequence is now available:

- The R&S ESL adjusts to the first frequency in the peak list. The receiver settings are the same as in the preliminary scan.
  - The R&S ESL sets the marker on the frequency in the scan diagram.
  - The R&S ESL interrupts the final measurement.
  - To analyze the signal in detail, modify the receiver settings as desired.
  - After continuing the final measurement, the current frequency replaces the preliminary one in the peak list (drifting interference sources).
  - The R&S ESL proceeds with the next frequency in the list.
- 

**Note:** A switch to the automatic final measurement is always possible while in Interactive mode. The R&S ESL then continues the final measurement according to the routine of the automatic measurement.

---

→ Remote: FME:AUTO OFF

---

**Skip Frequency**

---

Skip a frequency of the peak list during final measurement with the **Skip Frequency** softkey. The softkey is only available in interactive measurement mode.

→ Remote: -

---

**Get Maxhold**

---

Accepts the highest level measured during the Hold Scan state as the result of the final measurement and continues the scan (the level value in question is displayed as a small bar in the bargraph).

The softkey is only available in interactive measurement mode.

→ Remote: -

---

**Measure**

---

To resume the final measurement in interactive mode, press the Measure softkey (see **Test Automation** dialog box). The R&S ESL resumes the measurement with the next frequency of the peak list.

→ Remote: INIT:FME

---

---

**Stop Final Meas**

---

The Stop Final Meas softkey stops the final measurement. All data of the previous measurement is lost. Upon restart, the final measurement again starts at the first frequency of the peak list.

The R&S ESL automatically displays the peak list after the abortion of the measurement. See **Edit Peak List** on how to edit the peak list.

→ Remote: ABOR

---

**Peak List Export**

---

The Peak List Export softkey exports the peak list in the ASCII format. For details on the file export refer to ASCII file export format.

→ Remote: FORM ASC;

→ Remote: MMEM:STOR:FIN 1, 'FINAL.DAT'

---

**Decim Sep**

---

For details refer to the **Decim Sep** softkey in the trace menu.

---

**Continous Bargraph**

---

The **Continuous Bargraph** softkey activates the continuous measurement of the power level of the specified receiver frequency.

→ Remote: INIT:CONT ON

---

**Single Bargraph**

---

The Single Bargraph softkey activates a single measurement of the power level of the specified receiver frequency.

→ Remote: INIT:CONT OFF

---

**Bargraph Maxhold**

---

The Bargraph Maxhold softkey activates the maxhold function. A marker in the bargraph display (shown as a small bar) indicates the maximum power level of the measurement.

The bargraph table is expanded accordingly (see [Display of Measurement Results](#))

→ Remote: DISP:BARG:PHOL ON

---

**Bargraph Reset**

---

The Bargraph Reset softkey resets the bargraph maxhold marker and results. The softkey is only available if Bargraph Maxhold is activated.

→ Remote: DISP:BARG:PHOL:RES

---

## Running a Scan – RUN key

The **RUN** key is used to start a scan.

At the beginning of the scan, the R&S ESL sets up the diagram as specified in the scan table and starts the scan in the selected mode (Single or Continuous). With Single selected, the R&S ESL performs a single scan and stops at the end frequency. With Continuous selected, the scan is performed continuously until it is deliberately stopped.

The measurement can be interrupted with **Hold Scan** or stopped with **Stop Scan**. The two softkeys are displayed instead of the menu shown before the scan is started.

Remote: :INIT2

### To start the Scan

- Press the RUN key

The Scan starts automatically.

## Menu and softkey description

### – Softkeys of the run menu

To display help to a softkey, press the **HELP** key and then the softkey for which you want to display help. To close the help window, press the **ESC** key. For further information refer to section "How to use the Help System".

### Softkeys of the run menu

The following table shows all softkeys available in the run menu. It is possible that your instrument configuration does not provide all softkeys. If a softkey is only available with a special option, model or (measurement) mode, this information is delivered in the corresponding softkey description.

Menu / Command	Command
Hold Scan↓	Continue at Rec Frequency
	Continue at Hold
	Stop Scan
Stop Scan↓	Back to the menu menu

### Hold Scan

The **Hold Scan** softkey interrupts the automatic run of the preliminary measurement.

The scan stops at the frequency at which it was interrupted until it is continued with the **Continue at Rec Frequency** or **Continue at Hold** softkeys.

With the scan interrupted, all receiver settings can be modified, e.g. to analyse the recorded trace.

Continue at Rec Frequency
Continue at Hold

➔ Remote: HOLD

**Continue at Rec Frequency**

---

With the **Cont At Rec Freq** softkey the scan is continued at the current receiver frequency when the receiver frequency is lower than the frequency at which the scan was interrupted. Otherwise the scan continues at the frequency at which it was interrupted.

The scan is always continued with the settings in the scan table.

→ Remote: `INIT2`

---

**Continue at Hold**

---

With the **Cont At Hold** softkey the scan is continued where it was interrupted. The scan is always continued with the settings in the scan table.

→ Remote: `INIT2`

---

**Stop Scan**

---

The **Stop Scan** softkey stops the scan. Upon restart, scanning starts at the beginning. The results of the performed measurements are lost.

→ Remote: `ABOR`

---

## Using Limit Lines and Display Lines – LINES Key

The **LINES** key is used to configure limit and display lines.

### To open the lines menu

- Press the **LINES** key.

The lines menu and the **Select Limit Line** dialog box are displayed. For details on the **Select Limit Line** dialog box refer to "[To select a limit line](#)" on page 4.185.

### Menu and softkey description

- "[Softkeys of the lines menu](#)" on page 4.190

To display help to a softkey, press the **HELP** key and then the softkey for which you want to display help. To close the help window, press the **ESC** key. For further information refer to section "How to use the Help System".

### Further information

- "[Display Lines](#)" on page 4.188
- "[Limit Lines](#)" on page 4.189

### Task

- [To work with display lines](#)
- [To select a limit line](#)
- [To create a new limit line](#)
- [To edit an existing limit line](#)
- [To create a new limit line based upon an existing limit line](#)
- [To activate/deactivate a limit line](#)

### To work with display lines

Initial situation: The line is switched on (softkey with highlighted background) or off (softkey without highlighted background), for example the Display Line 1.

1. Press the **Display Lines** softkey.
2. Press the **Display Line 1** softkey for the first time.  
An edit dialog box is opened to enter the position of the display line (by rotary knob, step keys or numerical entry). If the line was switched off, it is switched on. If it was switched on, it remains switched on.
3. If another softkey is pressed, the edit dialog box for the **Display Line 1** softkey is closed, but the line remains switched on (softkey with highlighted background).
4. Press the **Display Line 1** softkey for the second time.  
The edit dialog box for the display line will be opened again.
5. Press the **Display Line 1** softkey again.  
The line is switched off (softkey without highlighted background).

### To select a limit line

1. To display the **Select Limit Line** dialog box, press the **LINES** key or go to the main limit line menu.

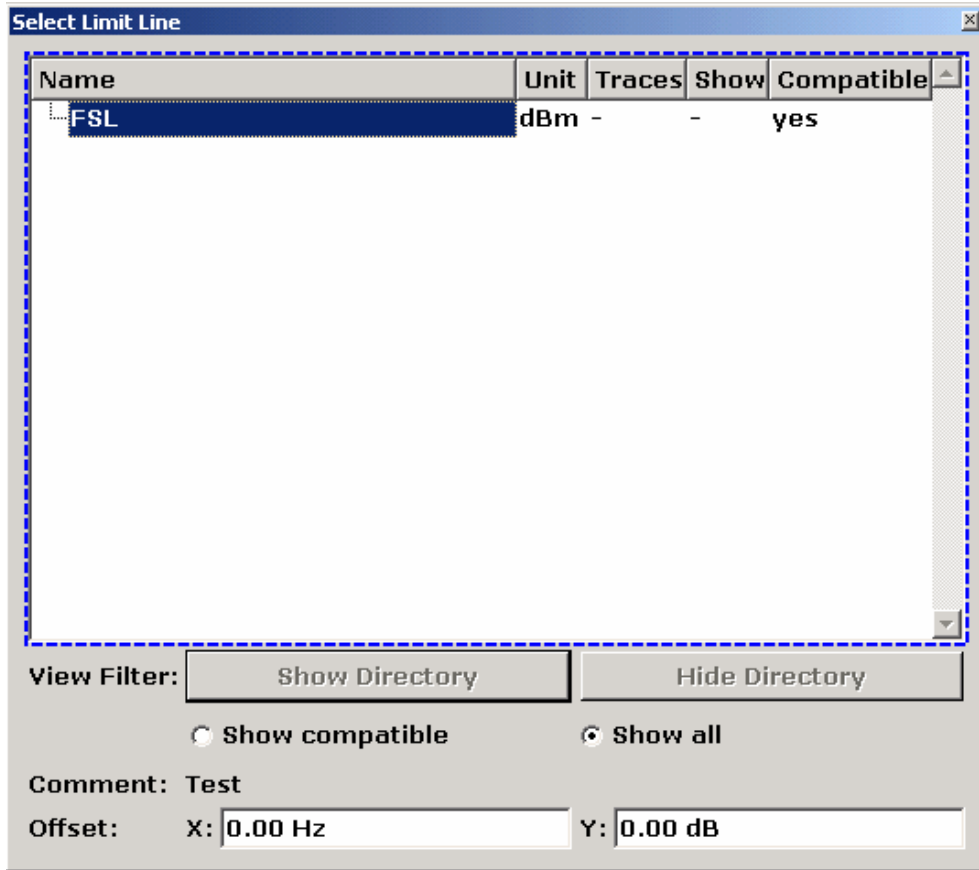

All limit lines, saved in the default directory, and all subdirectories are displayed. For each limit line, the following information is given:

<b>Unit</b>	unit of the y-axis
<b>Traces</b>	selected traces to check
<b>Show</b>	limit line displayed in the measurement diagram or hidden
<b>Compatible</b>	compatibility of the limit line to the current measurement settings

2. To display only the limit lines that are compatible, activate the **Show compatible** option. For details on compatibility refer to "[Limit Lines](#)" on page 4.189.
3. To navigate into a subdirectory, use the **Show Directory** and **Hide Directory** buttons.

### To create a new limit line

1. Press the **New** softkey to define a new limit line.

The **Edit Limit Line** dialog box is displayed. For more details on limit lines refer also to "[Limit Lines](#)" on page 4.189.

2. Press the **Edit Name** softkey and enter a name, if you want to save the limit line in the main directory. To save the limit line in an existing subdirectory, enter the relative path. A new subdirectory can only be created using the **FILE** key (for details refer to section "Instrument Functions – Basic Settings", "Saving and Recalling Settings Files – FILE Key").
3. To change the span setting, set the focus in the **X–Axis** field and change the unit via the rotary knob: **Hz** for span > 0 Hz or **s** for zero span.
4. To change between absolute and relative scale mode for the x–axis, set the focus on the **abs** or **rel** option next to the **X–Axis** field and press the **CHECKMARK** key. Relative scaling is always suitable, if masks for bursts are to be defined in zero span, or if masks for modulated signals are required for span > 0 Hz.

absolute: The frequencies are interpreted as absolute physical units.

relative: In the data point table, the frequencies are referred to the currently set center frequency.

5. To change the scaling of the y–axis, set the focus in the **Y–Axis** field and change the unit using the rotary knob.
6. To change between absolute and relative units for the y–axis, set the focus on the **abs** or **rel** option next to the **Y–Axis** field and press the **CHECKMARK** key.

absolute: The limit values refer to absolute levels or voltages.

relative: The limit values refer to the reference level (Ref Level). Limit values with the unit dB are always relative values.

7. To define the limit line as upper or lower limit line, set the focus on the **Upper** or **Lower** option and press the **CHECKMARK** key.
8. To change between linear or logarithmic scale of the x–axis, set the focus on the **lin** or **log** option and press the **CHECKMARK** key.
9. If the scaling of the y–axis is relative, you can define an absolute threshold value that works as a lower limit for the relative limit values (see figure below). Set the focus in the **Threshold** field and enter a value.

The function is especially useful for mobile radio applications provided the limit values are defined in relation to the carrier power as long as they are above an absolute limit value.

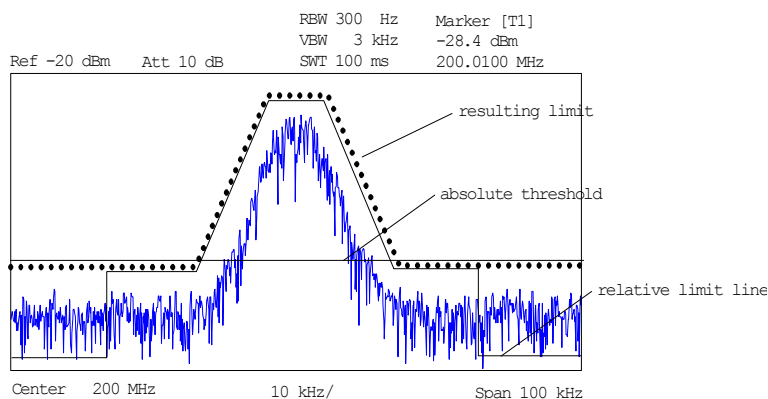



10. To define a signal–level distance to the limit line, press the **Edit Margin** softkey and enter a value.  
If the limit line is defined as an upper limit, the margin means that the level is below the limit line. If the limit line is defined as a lower limit, the margin means that the level is above the limit line.
11. To enter a comment, press the **Edit Comment** and enter a comment, e.g. a description of the application.
12. To enter a new data point:
  - Press the **Insert Value Above** softkey.
  - Enter the new x and y value in the successive displayed edit dialog boxes.
13. To change a data point:
  - Set the focus on the x and y value to be changed and press the **Value** softkey.
  - Enter the new x or y value in the displayed edit dialog box.
14. To delete a data point, select the corresponding entry and press the **Delete Value** softkey.
15. To shift the complete limit line parallel in the horizontal direction, select the **Shift x** button and enter a x shift value.
16. To shift the complete limit line parallel in the vertical direction, select the **Shift y** button and enter an y shift value.
17. Press the **Save Limit Line** softkey.  
If an existing name is used, a message box is displayed. You have to confirm before the limit line is overwritten.

### To edit an existing limit line

1. In the **Select Limit Line** dialog box, select the limit line you want to alter. For details see also "[To select a limit line](#)" on page 4.185.
2. Press the **Edit** softkey.
3. Edit the data as described in "[To select a limit line](#)" on page 4.185.
4. Save the limit line (**Save Limit Line** softkey).

### To create a new limit line based upon an existing limit line

1. In the **Select Limit Line** dialog box, select the limit line you want to use as a basis for a new limit line. For details see also "[To select a limit line](#)" on page 4.185.
2. Press the **Copy to** softkey to transfer the data of the limit line into the **Edit Limit Line** dialog box.
3. Press the **Edit Name** softkey and enter a new name.
4. To shift the complete limit line parallel in the horizontal direction, select the **Shift x** button and enter an x shift value. In this manner, a new limit line can be easily generated based upon an existing limit line which has been shifted horizontally.
5. To shift the complete limit line parallel in the vertical direction, select the **Shift y** button and enter a y shift value. In this manner, a new limit line can be easily generated based upon an existing limit line which has been shifted in Y direction
6. If required, edit the data as described in "[To select a limit line](#)" on page 4.185.
7. Save the limit line (**Save Limit Line** softkey).

### To activate/deactivate a limit line

Prerequisites:

- The x- and y-units of limit line and current measurement setting have to be compatible. For details refer to "[Limit Lines](#)" on page 4.189.
  - The limit line has to consist of 2 or more data points.
1. In the **Select Limit Line** dialog box, select the limit line you want to activate/deactivate. For details see also "[To select a limit line](#)" on page 4.185.
  2. To activate or deactivate a limit line for a trace, press the **Select Traces to check** softkey and select or deselect the trace(s) to which this limit line applies.
  3. To deactivate the limit line for all traces, press the **Deselect All** softkey.

### Display Lines

Display lines help to evaluate a trace – as do markers. The function of a display line is comparable to that of a ruler that can be shifted on the trace in order to mark absolute values. They are exclusively used to optically mark relevant frequencies or points in time (span = 0) as well as constant level values. It is not possible to check automatically whether the points are below or above the marked level values.

The softkeys for setting and switching the display lines on/off work like triple switches. For details see "[To work with display lines](#)" on page 4.184.

Two different types of display lines are provided:

- Two horizontal level lines for marking levels – Display Line 1 and 2  
The level lines are continuous horizontal lines across the entire width of a diagram and can be shifted in y direction.
- Two vertical frequency lines for marking frequencies – Frequency Line 1 and 2  
The frequency or time lines are continuous vertical lines across the entire height of the diagram and can be shifted in x direction.

Each line is identified by one of the following abbreviations:

- D1: Display Line 1
- D2: Display Line 2
- F1: Frequency Line 1
- F2: Frequency Line 2

### Limit Lines

Limit lines are used to define amplitude curves or spectral distribution boundaries on the display screen which are not to be exceeded. They indicate, for example, the upper limits for interference radiation or spurious waves which are allowed from a device under test (DUT). For transmission of information in TDMA systems (e.g. GSM), the amplitude of the bursts in a timeslot must adhere to a curve that falls within a specified tolerance band. The lower and upper limits may each be specified by a limit line. Then, the amplitude curve can be controlled either visually or automatically for any violations of the upper or lower limits (GO/NOGO test).

The instrument supports limit lines with a maximum of 50 data points. 8 of the limit lines stored in the instrument can be activated simultaneously. The number of limit lines stored in the instrument is only limited by the capacity of the flash disk used. For details see also "[To select a limit line](#)" on page 4.185.

Limit lines are compatible with the current measurement settings, if the following applies:

- The x unit of the limit line has to be identical to the current setting.
- The y unit of the limit line has to be identical to the current setting with the exception of dB based units; all dB based units are compatible with each other.

At the time of entry, the R&S ESL immediately checks that all limit lines are in accordance with the following guidelines:

- The frequencies/times for each data point must be entered in ascending order, however, for any single frequency/time, two data points may be entered (vertical segment of a limit line).
- The data points are allocated in order of ascending frequency/time. Gaps are not allowed. If gaps are desired, two separate limit lines must be defined and then both enabled.
- The entered frequencies/times need not necessarily be selectable in R&S ESL. A limit line may also exceed the specified frequency or time range. The minimum frequency for a data point is –200 GHz, the maximum frequency is 200 GHz. For the time range representation, negative times may also be entered. The allowed range is –1000 s to +1000 s.

### Softkeys of the lines menu

The following table shows all softkeys available in the lines menu. It is possible that your instrument configuration does not provide all softkeys. If a softkey is only available with a special option, model or (measurement) mode, this information is delivered in the corresponding softkey description.

Menu / Command	Command
Select Traces to check	
Deselect All	
New ↓	Edit Name
	Edit Comment
	Edit Margin
	Value
	Insert Value Above
	Delete Value
	Save Limit Line
Edit ↓	same contents as New Limit Line menu
Copy to ↓	same contents as New Limit Line menu
Delete	
Display Lines ↓	Display Line 1
	Display Line 2
	Frequency Line 1
	Frequency Line 2

---

**Select Traces to check**

---

Opens the **Select Traces to Check** dialog box to activate the selected limit line for a trace. One limit line can be activated for several traces simultaneously. For details see also "[To activate/deactivate a limit line](#)" on page 4.188 .

→ Remote: CALC:LIM2:TRAC 3

→ Remote: CALC:LIM:STAT ON

---

**Deselect All**

---

Deactivates the selected limit line for all assigned traces. For details see also "[To activate/deactivate a limit line](#)" on page 4.188 .

→ Remote: CALC:LIM:STAT OFF

---

**New**

---

Opens the **Edit Limit Line** dialog box and a submenu to define a new limit line. For details see also "[Limit Lines](#)" on page 4.189 and "[To select a limit line](#)" on page 4.185.

---

**Edit Name**

---

Sets the focus on the **Name** field to enter or change the limit line name. A maximum of 8 characters is permitted for each name. All names must be compatible with the Windows XP conventions for file names. The limit line data are stored under this name. The instrument stores all limit lines with LIM as extension.

→ Remote: CALC:LIM3:NAME "GSM1"

---

**Edit Comment**

---

Sets the focus on the **Comment** field to enter or change a comment for the limit line. The text must not exceed 40 characters.

→ Remote: CALC:LIM5:COMM 'Upper limit for spectrum'

---

**Edit Margin**

---

Sets the focus on the **Margin** field to enter or change a margin for the limit line. The default setting is 0 dB (i.e. no margin).

---

---

**Value**

---

Opens an edit dialog box to change an existing x or y value, depending on the selected column. The softkey is only available if an existing value is selected.

The desired data points are entered in ascending order (two repeated frequencies/time values are permitted).

- Remote: CALC:LIM3:CONT:DATA 1MHz, 3MHz, 30MHz
  - Remote: CALC:LIM3:UPP:DATA -10, 0, 0
  - Remote: CALC:LIM3:LOW:DATA -30, -40, -40
- 

---

**Insert Value Above**

---

Creates an empty line above the selected data point to enter a new data point. This softkey corresponds to the **Insert** button in the dialog box.

It is also possible to add a data point at the end of the list, if the focus is set below the last entry line of the list.

The data points are entered in ascending order (two repeated frequencies/time values are permitted). If the entered values are not in accordance with the ascending order rule, an error message is displayed and the values are discarded.

---



---

**Delete Value**

---

Deletes the selected data point (x and y value). All succeeding data points are shifted up accordingly. This softkey corresponds to the **Delete** button in the dialog box.

The softkey is only available if an existing value is selected.

---



---

**Save Limit Line**

---

Saves the currently edited limit line under the name defined in the **Name** field.

---



---

**Edit**

---

Opens a submenu to edit limit lines. For details see also "[Limit Lines](#)" on page 4.189 and "[To edit an existing limit line](#)" on page 4.187.

- Remote: For details refer to chapter "Remote Control – Commands", section "Definition of the limit line".
- 

---

**Copy to**

---

Copies the data of the selected limit line and displays it in the **Edit Limit Line** dialog box. If the limit line is edited and saved under a new name, a new limit line can be easily generated by parallel translation or editing of an existing limit line.

For details see also "[Limit Lines](#)" on page 4.189 and "[To create a new limit line based upon an existing limit line](#)" on page 4.187.

- Remote: CALC:LIM3:COPY 2
-

**Delete**

---

Deletes the selected limit line.

→ Remote: CALC:LIM3:DEL

---

**Display Lines**

---

Opens a submenu to enable, disable and set display lines. Which softkeys are available depends on the display mode (frequency or time range). For details see also "[Display Lines](#)" on page 4.188 and "[To work with display lines](#)" on page 4.184.

---

**Display Line 1 and Display Line 2**

---

Enable or disable the level lines 1/2 and open an edit dialog box to enter the position of the lines. For details see also "[Display Lines](#)" on page 4.188 and "[To work with display lines](#)" on page 4.184.

→ Remote: CALC:DLIN:STAT ON

→ Remote: CALC:DLIN -20dBm

---

**Frequency Line 1 and Frequency Line 2 (span > 0)**

---

Enable or disable the frequency lines 1/2 and open an edit dialog box to enter the position of the lines. For details see also "[Display Lines](#)" on page 4.188 and "[To work with display lines](#)" on page 4.184.

→ Remote: CALC:FLIN:STAT ON

→ Remote: CALC:FLIN 120MHz

---

## Measurement Modes

This section describes the provided measurement modes, the change of measurement modes and the access to the menus of all active measurement modes. For details refer to the following sections:

- ["Measurement Mode Selection – MODE Key"](#)

## Measurement Mode Selection – MODE Key

The **MODE** key provides a quick access to the menu of the current measurement mode and a fast change of the measurement mode. You can choose from the following measurement modes:

- [Instrument Functions – Receiver](#) on page 4.2
- [Instrument Functions – Analyzer](#) on page 4.79
- [Analog Demodulation mode \(Analog Demodulation option, K7\)](#) on page 4.195
- [Noise mode \(Noise Figure Measurements option, K30\)](#) on page 4.195

### To change the measurement mode

1. Press the **MODE** key.  
The menu of the current measurement mode is displayed and the **Measurement Modes** dialog box is opened.
2. To activate another mode, select the corresponding option and press the **CHECKMARK** key. More than one measurement mode can be activated simultaneously.
3. To deactivate an activated mode, select the corresponding option and press the **CHECKMARK** key.

### Receiver mode

In the Receiver mode the functions provided correspond to those of a conventional receiver. The receiver measures the power level of a signal at the set frequency with a selected bandwidth and measurement time. This mode is set in the initial configuration.

### Spectrum Analyzer mode

In the **Spectrum Analyzer** mode the functions provided correspond to those of a conventional spectrum analyzer. The analyzer measures the frequency spectrum of the test signal over the selected frequency range with the selected resolution and sweep time, or, for a fixed frequency, displays the waveform of the video signal.

### Analog Demodulation mode (Analog Demodulation option, K7)

The **Analog Demodulation** mode requires an instrument equipped with the corresponding optional software. This mode provides measurement functions for demodulating AM, FM, or PM signals. For details refer to "[Analog Demodulation \(Option K7\)](#)" on page 4.204.

### Noise mode (Noise Figure Measurements option, K30)

The **Noise** mode requires an instrument equipped with the corresponding optional software. This mode provides accurate and flexible noise measurement functions. For details refer to "[Noise Figure Measurements Option \(K30\)](#)" on page 4.227.



## Instrument Functions – Analyzer

In this section, all analyzer functions of the R&S ESL and their application are explained in detail. The basic settings functions are described in section "Instrument Functions – Basic Settings".

For every key a table is provided in which all submenus and corresponding commands are listed. The description of the submenus and commands follows the order of the table. The commands for the optional remote control (if any) are indicated for each softkey. The description is divided into the following topics:

- ["Measurement Parameters"](#) on page 4.80

This section describes how to reset the instrument, to set up specific measurements and to set the measurement parameters. Examples of basic operations are provided in the Quick Start Guide, chapter 5 "Basic Measurement Examples". Advanced examples are described in chapter "Advanced Measurement Examples".

- ["Measurement Functions"](#) on page 4.123

This section informs about how to select and configure the measurement functions. Examples of basic operations are provided in the Quick Start Guide, chapter 5 "Basic Measurement Examples". Advanced examples are described in chapter "Advanced Measurement Examples".

- ["Measurement Modes"](#) on page 4.194

This section describes the provided measurement modes, the change of measurement modes and the access to the menus of all active measurement modes.

- ["Models and Options"](#) on page 4.197

This section informs about optional functions and their application that are included in the basic unit configuration.

More basic information on operation is given in the Quick Start Guide. The front and the rear view of the instrument together with a table of all available keys and a short description are provided in chapter "Front and Rear Panel". Chapter "Preparing for Use" informs how to start working with the instrument for the first time. A brief introduction on handling the instrument is given in chapter "Basic Operations". This includes also the description of the keys for basic operations like switching the instrument on and off or starting a measurement.

## Measurement Parameters

In this section all menus necessary for setting measurement parameters are described. This includes the following topics and keys. For details on changing the mode refer to "[Measurement Mode Selection – MODE Key](#)" on page 4.195.

- "[Initializing the Configuration – PRESET Key](#)" on page 4.81
- "[Selecting the Frequency and Span – FREQ Key](#)" on page 4.83
- "[Setting the Frequency Span – SPAN Key](#)" on page 4.89
- "[Setting the Level Display and Configuring the RF Input – AMPT Key](#)" on page 4.91
- "[Setting the Bandwidths and Sweep Time – BW Key](#)" on page 4.95
- "[Configuring the Sweep Mode – SWEEP Key](#)" on page 4.102
- "[Triggering the Sweep – TRIG Key](#)" on page 4.105
- "[Setting Traces – TRACE Key](#)" on page 4.113

Table 4-2: Sweep range variables

Abbreviation	Definition	R&S ESL 3 value	R&S ESL 6 value
$f_{\max}$	max. frequency	3 GHz	6 GHz
$f_{\min}$	min. frequency available	0 Hz	0 Hz
$\text{span}_{\min}$	Smallest selectable span > 0 Hz	10 Hz	10 Hz

## Initializing the Configuration – PRESET Key

The **PRESET** key resets the instrument to the default settings. Therefore it provides a defined initial state as a known starting point for measurements

---

**Note:** If the **LOCAL LOCKOUT** function is active in the remote control mode, the **PRESET** key is disabled.

---

### Further information

- ["Initial configuration"](#) on page 4.82

### Task

- [To preset the instrument](#)

### To preset the instrument

1. Define the data set for the preset:
  - To retrieve the originally provided settings file (see [Initial configuration](#)), in the file menu, deactivate the **Startup Recall** softkey and, in the setup menu, activate the Preset Spectrum softkey.
  - To retrieve a customized settings file, in the file menu, activate the **Startup Recall** softkey, press the **Startup Recall Setup** softkey, and select the corresponding file.  
For details refer to section "Saving and Recalling Settings Files – FILE Key".
2. Press the **PRESET** key to trigger a preset.
  - Remote: \*RST or SYSTem:PRESet (for details refer to chapter "Remote Control – Commands", section "Common Commands" or section "SYSTem Subsystem").

---

**Note:** In order to save the current settings after reboot of the instrument, create a shutdown file by switching the analyzer in the standby mode (press the On/Off key on the FRONT panel and wait until the yellow LED is ON). With the battery pack option, use a USB keyboard and terminate the analyzer firmware with ALT+F4 to create the shutdown file.

---

**Initial configuration**

The initial configuration is selected in a way that the RF input is always protected against overload, provided that the applied signal levels are in the allowed range for the instrument.

The parameter set of the initial configuration can be customized by using the **Startup Recall** softkey in the file menu. For further information refer to section "Instrument Functions – Basic Settings", "Saving and Recalling Settings Files – FILE Key".

Table 4-3: Initial configuration of the analyzer

Parameter	Setting
mode	Spectrum Analyzer
center frequency	$f_{max} / 2$
center frequency step size	0.1 * center frequency
span	R&S ESL3: 3 GHz R&S ESL6: 6 GHz
RF attenuation	auto (R&S ESL3/6: 0 dB;)
reference level	R&S ESL3/6: -20 dBm;
level range	100 dB log
level unit	dBm
sweep time	auto
resolution bandwidth	auto (3 MHz)
video bandwidth	auto (10 MHz)
FFT filters	off
span / RBW	50
RBW / VBW	0.33
sweep	cont
trigger	free run
trace 1	clr write
trace 2/3/4/5/6	blank
detector	auto peak
frequency offset	0 Hz
reference level offset	0 dB
reference level position	100 %
grid	abs
cal correction	on
noise source	off
input	RF
tracking generator (models 13, 16,)	off

## Selecting the Frequency and Span – **FREQ** Key

The **FREQ** key is used to specify the frequency axis, and to set the frequency offset and the signal track function. The frequency axis can be specified either by the start and stop frequency or by the center frequency and the span.

### To open the frequency menu

- Press the **FREQ** key.

The frequency menu is displayed. The **Frequency Center** edit dialog box is displayed.

### Menu and softkey description

- ["Softkeys of the frequency menu"](#) on page 4.85

To display help to a softkey, press the **HELP** key and then the softkey for which you want to display help. To close the help window, press the **ESC** key. For further information refer to section "How to use the Help System".

### Tasks

- [To specify the frequency axis by the start and stop frequency](#)
- [To specify the frequency axis by the center frequency and the span](#)
- [To specify the step size for the arrow keys and the rotary knob](#)
- [To modify the frequency axis by an offset](#)
- [To track signals \(only possible if span >0\)](#)

### To specify the frequency axis by the start and stop frequency

1. Press the **Start** softkey and enter a start frequency.
2. Press the **Stop** softkey and enter a stop frequency.

### To specify the frequency axis by the center frequency and the span

3. Press the **FREQ** key and enter a center frequency in the **Frequency Center** edit dialog box.
4. Press the **SPAN** key and enter the bandwidth you want to analyze.

---

**Note:** Entering a value of 0 Hz will cause a change to the zero span analysis mode.

---

### To specify the step size for the arrow keys and the rotary knob

1. Press the **CF Stepsize** softkey.

The softkeys are displayed according to the selected frequency span (zero span or span > 0).

2. To define the step size of the center frequency:
  - Only if span > 0: Press **0.1\*Span**, **0.5\*Span** or **x\*Span** to define the step size for the center frequency as percentage of the span.
  - Only if span = 0: Press **0.1\*RBW**, **0.5\*RBW** or **x\*RBW** to define the step size for the center frequency as percentage of the resolution bandwidth.
  - Press the **=Center** softkey to set the step size to the value of the center frequency and to remove the dependency of the step size to span or resolution bandwidth.
  - Press the **=Marker** softkey to set the step size to the value of the marker and to remove the dependency of the step size to span or resolution bandwidth.
  - Press the **Manual** softkey and enter a fixed step size for the center frequency.

---

**Note:** *The step size assigned to arrow keys corresponds to the selected value; the step size of the rotary knob is  $\frac{1}{10}$  of it.*

---

### To modify the frequency axis by an offset

- Press the **Frequency Offset** softkey and enter the offset to shift the displayed frequency span.

### To track signals (only possible if span >0)

1. Press the **Signal Track** softkey.

The softkeys of this submenu are displayed to start and stop signal tracking with specified parameters.

2. Press the **Track On/Off** softkey to switch signal tracking on or off.
3. Press the **Track BW** softkey and enter a bandwidth for signal tracking.
4. Press the **Track Threshold** softkey and enter the threshold for signal tracking.
5. Press the **Select Trace** softkey and select the trace for signal tracking.

### Softkeys of the frequency menu

The following table shows all softkeys available in the frequency menu. It is possible that your instrument configuration does not provide all softkeys. If a softkey is only available with a special option, model or (measurement) mode, this information is delivered in the corresponding softkey description.

Menu / Command	Command
Center	
Start	
Stop	
CF Stepsize ↓	0.1*Span/0.1*RBW
	0.5*Span/0.5*RBW
	x*Span/x*RBW
	=Center
	=Marker
	Manual
Frequency Offset	
Signal Track ↓	Track On/Off
	Track BW
	Track Threshold
	Select Trace

### Center

Opens an edit dialog box to enter the center frequency. The allowed range of values for the center frequency depends on the frequency span.

$$\text{span} > 0: \text{span}_{\min} / 2 \leq f_{\text{center}} \leq f_{\text{max}} - \text{span}_{\min} / 2$$

$$\text{span} = 0: 0 \text{ Hz} \leq f_{\text{center}} \leq f_{\text{max}}$$

$f_{\text{max}}$  and  $\text{span}_{\min}$  are specified in the data sheet. To help analyze signals located at the end of the frequency range the  $f_{\text{max}}$  value is extended by 0.05 GHz for direct entry via the key pad. The preset and full span values remain unchanged.

→ Remote: FREQ:CENT 100MHz

### Start

Opens an edit dialog box to define the start frequency. The following range of values is allowed:

$$f_{\min} \leq f_{\text{start}} \leq f_{\text{max}} - \text{span}_{\min}$$

$f_{\min}$ ,  $f_{\text{max}}$  and  $\text{span}_{\min}$  are specified in the data sheet. To help analyze signals located at the end of the frequency range the  $f_{\text{max}}$  value is extended by 0.05 GHz for direct entry via the key pad. The preset and full span values remain unchanged.

→ Remote: FREQ:STAR 20MHz

**Stop**

Opens an edit dialog box to define the stop frequency. The following range of values for the stop frequency is allowed:

$$f_{min} + span_{min} \leq f_{stop} \leq f_{max}$$

$f_{min}$ ,  $f_{max}$  and  $span_{min}$  are specified in the data sheet. To help analyze signals located at the end of the frequency range the  $f_{max}$  value is extended by 0.05 GHz for direct entry via the key pad. The preset and full span values remain unchanged.

Remote: FREQ:STOP 2000MHz

**CF Stepsize**

Opens a submenu to set the step size of the center frequency. In addition to the =Center, =Marker and Manual softkeys, the other softkeys are displayed depending on the selected frequency span.

The step size can be coupled to the span (span > 0) or the resolution bandwidth (span = 0) or it can be manually set to a fixed value.

**0.1\*Span (span > 0)**

Sets the step size for the center frequency to 10% of the span.

- Remote: FREQ:CENT:STEP:LINK SPAN
- Remote: FREQ:CENT:STEP:LINK:FACT 10PCT

**0.1\*RBW (zero span)**

Sets the step size for the center frequency to 10% of the resolution bandwidth. This is the default setting.

- Remote: FREQ:CENT:STEP:LINK RBW
- Remote: FREQ:CENT:STEP:LINK:FACT 10PCT

**0.5\*Span (span > 0)**

Sets the step size for the center frequency to 50% of the span.

- Remote: FREQ:CENT:STEP:LINK SPAN
- Remote: FREQ:CENT:STEP:LINK:FACT 50PCT

**0.5\*RBW (zero span)**

Sets the step size for the center frequency to 50% of the resolution bandwidth.

- Remote: FREQ:CENT:STEP:LINK RBW
- Remote: FREQ:CENT:STEP:LINK:FACT 50PCT



**x\*Span (span > 0)**

Opens an edit dialog box to set the step size for the center frequency as % of the span.

- Remote: FREQ:CENT:STEP:LINK SPAN
- Remote: FREQ:CENT:STEP:LINK:FACT 20PCT

**x\*RBW (zero span)**

Opens an edit dialog box to set the step size for the center frequency as % of the resolution bandwidth. Values between 1 and 100% in steps of 1% are allowed. The default setting is 10%.

- Remote: FREQ:CENT:STEP:LINK RBW
- Remote: FREQ:CENT:STEP:LINK:FACT 20PCT

**=Center**

Sets the step size to the value of the center frequency and removes the coupling of the step size to span or resolution bandwidth. This function is especially useful during measurements of the signal harmonic content because by entering the center frequency each stroke of the arrow key selects the center frequency of another harmonic.

**=Marker**

Sets the step size to the value of the current marker and removes the coupling of the step size to span or resolution bandwidth. This function is especially useful during measurements of the signal harmonic content at the marker position because by entering the center frequency each stroke of the arrow key selects the center frequency of another harmonic.

**Manual**

Opens an edit dialog box to enter a fixed step size for the center frequency.

- Remote: FREQ:CENT:STEP 120MHz

**Frequency Offset**

Opens an edit dialog box to enter a frequency offset that shifts the displayed frequency range by the specified offset. The allowed values range from –100 GHz to 100 GHz. The default setting is 0 Hz.

- Remote: FREQ:OFFS 10 MHz

**Signal Track (span > 0)**

Opens a submenu to modify the parameters for signal tracking: search bandwidth, threshold value and trace.

The search bandwidth and the threshold value are shown in the diagram by two vertical lines and one horizontal line, which are labeled as **TRK**. After each sweep the center frequency is set to the maximum signal found within the searched bandwidth. If no maximum signal above the set threshold value is found in the searched bandwidth, the track mechanism stops.

- Remote: CALC:MARK:FUNC:STR OFF

---

**Track On/Off (span > 0)**

---

Switches the signal tracking on or off.

→ Remote: CALC:MARK:FUNC:STR OFF

---

**Track BW (span > 0)**

---

Opens an edit dialog box to set the search bandwidth for signal tracking. The frequency range is calculated as a function of the center frequency.

→ Remote: CALC:MARK:FUNC:STR:BAND 1MHZ

---

**Track Threshold (span > 0)**

---

Opens an edit dialog box to set the threshold value for signal tracking.

→ Remote: CALC:MARK:FUNC:STR:THR -70DBM

---

**Select Trace (span > 0)**

---

Opens an edit dialog box to select the trace on which the signal is tracked.

→ Remote: CALC:MARK:FUNC:STR:TRAC 1

---

## Setting the Frequency Span – SPAN Key

The **SPAN** key is used to set the frequency span to be analyzed.

### To open the span menu

- Press the **SPAN** key.

The span menu is displayed. For span > 0 an edit dialog box to enter the frequency is displayed. For zero span, an edit dialog box to enter the sweep time is displayed.

### Menu and softkey description

- ["Softkeys of the span menu"](#) on page 4.89

To display help to a softkey, press the **HELP** key and then the softkey for which you want to display help. To close the help window, press the **ESC** key. For further information refer to section "How to use the Help System".

### Task

- [To specify the span \(alternatives\)](#)

### To specify the span (alternatives)

1. To set the span, use the **Span Manual**, **Full Span**, **Zero Span** and **Last Span** softkeys.
2. To define a frequency range, use the **Start** and **Stop** softkeys.
3. For zero span, press the **Sweeptime Manual** softkey and enter a sweep time.

### Softkeys of the span menu

The following table shows all softkeys available in the span menu. It is possible that your instrument configuration does not provide all softkeys. If a softkey is only available with a special option, model or (measurement) mode, this information is delivered in the corresponding softkey description.

Command
<a href="#">Span Manual</a>
<a href="#">Sweeptime Manual</a>
<a href="#">Start</a>
<a href="#">Stop</a>
<a href="#">Full Span</a>
<a href="#">Zero Span</a>
<a href="#">Last Span</a>
<a href="#">Freq Axis Lin / Log</a>

---

**Span Manual**

---

Opens an edit dialog box to enter the frequency span. The center frequency is kept constant. The following range is allowed:

$span = 0$ : 0 Hz

$span > 0$ :  $span_{min} \leq f_{span} \leq f_{max}$

$f_{max}$  and  $span_{min}$  are specified in the data sheet. To help analyze signals located at the end of the frequency range the  $f_{max}$  value is extended by 0.05 GHz for direct entry via the key pad. The preset and full span values remain unchanged.

→ Remote: `FREQ:SPAN 2GHz`

---

**Start**

---

Opens an edit dialog box to enter the start frequency. For details see **Start** softkey in the frequency menu.

→ Remote: `FREQ:STAR 20MHz`

---

**Stop**

---

Opens an edit dialog box to enter the stop frequency. For details see **Stop** softkey in the frequency menu.

→ Remote: `FREQ:STOP 2000MHz`

---

**Full Span**

---

Sets the span to the full frequency range of the R&S ESL specified in the data sheet. This setting is useful for overview measurements.

→ Remote: `FREQ:SPAN:FULL`

---

**Zero Span**

---

Sets the span to 0 Hz (zero span). The x-axis becomes the time axis with the grid lines corresponding to 1/10 of the current sweep time (**SWT**).

→ Remote: `FREQ:SPAN 0Hz`

---

**Last Span**

---

Sets the span to the previous value. With this function e.g. a fast change between overview measurement and detailed measurement is possible.

---

**Freq Axis Lin / Log**

---

The **Freq Axis Lin/Log** switches between linear and logarithmic frequency axis.

→ Remote: `DISP:TRAC:X:SPAC LOG`

---

## **Setting the Level Display and Configuring the RF Input – AMPT Key**

The **AMPT** key is used to set the reference level, the level range and unit, the scaling and the RF attenuation.

### **To open the amplitude menu**

- Press the **AMPT** key.

The amplitude menu is displayed. The **Reference Level** dialog box is displayed.

### **Menu and softkey description**

- ["Softkeys of the amplitude menu"](#) on page 4.92

To display help to a softkey, press the **HELP** key and then the softkey for which you want to display help. To close the help window, press the **ESC** key. For further information refer to section "How to use the Help System".

### **Task**

- [To specify the amplitude](#)

### **To specify the amplitude**

1. Set the reference level, offset and position, using the **Ref Level**, **Ref Level Offset** and **Ref Level Position** softkeys.
2. Select the level range and the unit for the level axis, using the **Range Log** and **Unit** softkeys.
3. Set the scaling, using the **Range Linear** and/or **Grid Abs / Rel** softkeys.
4. Set the attenuation, using the **RF Atten Manual** or **RF Atten Auto** softkeys.

**Softkeys of the amplitude menu**

The following table shows all softkeys available in the amplitude menu. It is possible that your instrument configuration does not provide all softkeys. If a softkey is only available with a special option, model or (measurement) mode, this information is delivered in the corresponding softkey description.

Menu / Command	Command
Ref Level	
Range Log	
Range Linear ↓	Range Linear %
	Range Lin. Unit
Preamp On/Off	
RF Atten Manual	
RF Atten Auto	
More ↓	
Ref Level Offset	
Ref Level Position	
Grid Abs / Rel	
Unit	
Input 50 Ω / 75 Ω	

**Ref Level**

---

Opens an edit dialog box to enter the reference level in the currently active unit (dBm, dBμV, etc).

The reference level value is the maximum value the AD converter can handle without distortion of the measured value. Signal levels above this value will not be measured correctly, which is indicated by the **IFOVL** status display.

→ Remote: `DISP:TRAC:Y:RLEV -60dBm`

---

**Range Log**

---

Selects logarithmic scaling for the level display range and opens the **Range Log** dialog box to select a value for the level range.

→ Remote: `DISP:TRAC:Y:SPAC LOG`

→ Remote: `DISP:TRAC:Y 120DB`

---

**Range Linear**

---

Selects linear scaling for the level display range and opens a submenu to select the type of linear scaling.

---

## R&S ESL *Setting the Level Display and Configuring the RF Input – AMPT Key*

---

### Range Linear %

---

Selects linear scaling in % for the level display range, i.e. the horizontal grid lines are labelled in %. The grid is divided in decadic steps.

Markers are displayed in the selected unit (**Unit** softkey). Delta markers are displayed in % referenced to the voltage value at the position of marker 1. This is the default setting for linear scaling.

→ Remote: `DISP:TRAC:Y:SPAC LIN`

---

### Range Lin. Unit

---

Selects linear scaling in dB for the level display range, i.e. the horizontal lines are labelled in dB.

Markers are displayed in the selected unit (**Unit** softkey). Delta markers are displayed in dB referenced to the power value at the position of marker 1.

→ Remote: `DISP:TRAC:Y:SPAC LDB`

---

### Preamp On/Off (option RF Preamplifier, B22)

---

Switches the preamplifier on or off.

→ Remote: `INP:GAIN:STAT ON`

---

### RF Atten Manual

---

Opens an edit dialog box to enter the attenuation, irrespective of the reference level.

The attenuation can be set in 5 dB steps. The range is specified in the data sheet. If the defined reference level cannot be set for the set RF attenuation, the reference level will be adjusted accordingly.

The RF attenuation defines the level at the input mixer according to the formula:

$$level_{mixer} = level_{input} - RF \text{ attenuation}$$

The maximum mixer level allowed is –10 dBm. Mixer levels above this value may lead to incorrect measurement results, which are indicated by the **OVL**D status display.

→ Remote: `INP:ATT 30 DB`

---

### RF Atten Auto

---

Sets the RF attenuation automatically as a function of the selected reference level. This ensures that the optimum RF attenuation is always used. It is the default setting.

→ Remote: `INP:ATT:AUTO ON`

---

### Ref Level Offset

---

Opens an edit dialog box to enter the arithmetic level offset. This offset is added to the measured level irrespective of the selected unit. The scaling of the y-axis is changed accordingly. The setting range is ±200 dB in 0.1 dB steps.

→ Remote: `DISP:WIND:TRAC:Y:RLEV:OFFS -10dB`

---

**Ref Level Position**

---

Opens an edit dialog box to enter the reference level position, i.e. the position of the maximum AD converter value on the level axis. The setting range is from –200 to +200%, 0% corresponding to the lower and 100% to the upper limit of the diagram.

→ Remote: `DISP:WIND:TRAC:Y:RPOS 100PCT`

---

**Grid Abs / Rel (not available with Range Linear)**

---

Switches between absolute and relative scaling of the level axis.

Absolute scaling	The labeling of the level lines refers to the absolute value of the reference level. Absolute scaling is the default setting.
Relative scaling	The upper line of the grid is always at 0 dB. The scaling is in dB whereas the reference level is always in the set unit (for details on unit settings see <b>Unit</b> softkey).

→ Remote: `DISP:WIND:TRAC:Y:MODE ABS`

---

**Unit**

---

Opens the **Unit** dialog box to select the unit for the level axis. The default setting is dBm. If a transducer is switched on, the softkey is not available.

In general, the spectrum analyzer measures the signal voltage at the RF input. The level display is calibrated in RMS values of an unmodulated sinewave signal. In the default state, the level is displayed at a power of 1 mW (= dBm). Via the known input impedance (50 Ω or 75 Ω), conversion to other units is possible. The units dBm, dBmV, dBμV, V and W are directly convertible.

→ Remote: `CALC:UNIT:POW DBM`

---

**Input 50 Ω / 75 Ω**

---

Uses 50 Ω or 75 Ω as reference impedance for the measured levels. Default setting is 50 Ω .

Changes the reference impedance for the measured levels

The setting 75 Ω should be selected, if the 50 Ω input impedance is transformed to a higher impedance using a 75 Ω adapter of the RAZ type (= 25 Ω in series to the input impedance of the instrument). The correction value in this case is 1.76 dB = 10 log ( 75 Ω / 50 Ω).

All levels specified in this Operating Manual refer to the default setting of the instrument (50 Ω).

→ Remote: `INP:IMP 50OHM`

---



## Setting the Bandwidths and Sweep Time – BW Key

The **BW** key is used to set the resolution bandwidth, video bandwidth (VBW) and sweep time (SWT). The values available for resolution bandwidth and video bandwidth depend on the selected filter type. For details on channel filters see also "[List of available RRC and channel filters](#)" on page 4.97.

### To open the bandwidth menu

- Press the **BW** key.

The bandwidth menu is displayed.

### Menu and softkey description

- "[Softkeys of the bandwidth menu](#)" on page 4.99

To display help to a softkey, press the **HELP** key and then the softkey for which you want to display help. To close the help window, press the **ESC** key. For further information refer to section "How to use the Help System".

### Further information

- "[List of available RRC and channel filters](#)" on page 4.97

### Tasks

- [To specify the bandwidth](#)
- [To choose the appropriate filter type](#)

### To specify the bandwidth

1. Set the resolution bandwidth using the **Res BW Manual** or **Res BW Auto** softkey.
2. Set the video bandwidth using the **Video BW Manual** or **Video BW Auto** softkey.
3. Set the sweep time using the **Sweeptime Manual** or **Sweeptime Auto** softkey.
4. Press the **Filter Type** softkey and select the appropriate filters.

### To choose the appropriate filter type

All resolution bandwidths are realized with digital filters.

The video filters serve for smoothing the displayed trace. Using video bandwidths that are small compared to the resolution bandwidth, only the signal average is displayed and noise peaks and pulsed signals are repressed. If pulsed signals are to be measured, it is recommended to use a video bandwidth that is large compared to the resolution bandwidth ( $VBW * 10 \times RBW$ ) for the amplitudes of pulses to be measured correctly.

The following filter types are available:

- Gaussian filters

The Gaussian filters are set by default. The available bandwidths are specified in the data sheet.

- EMI (6dB) filters

The available bandwidths are specified in the data sheet.

- FFT filters

The available bandwidths are specified in the data sheet.

The FFT algorithm offers considerably higher measurement speeds with all the other settings remaining the same. The reason is that for analog filters the sweep time required for a particular span is proportional to  $(\text{span}/RBW^2)$ . When using the FFT algorithm, however, the sweep time is proportional to  $(\text{span}/RBW)$ .

FFT filters are particularly suitable for stationary signals (sinusoidal signals or signals that are continuously modulated in time). For burst signals (TDMA) or pulsed signals, normal filters are preferable. When the tracking generator is used as signal source for the DUT, filtering with the FFT algorithm is not useful. The **FFT** option is thus not available if the tracking generator is switched on.

If the FFT filters are activated, the sweep time display (**SWT**) is replaced by the acquisition time (**AQT**) display. The sweep time is defined by the selected bandwidth and span, and cannot be changed. The video bandwidth is not defined and therefore cannot be set.

The sample detector and the peak detector are available. If the **Detector Auto Select** softkey in the trace menu is activated, the peak detector is selected.

- channel filters

details see "[List of available RRC and channel filters](#)"

- RRC filters

details see "[List of available RRC and channel filters](#)"

### List of available RRC and channel filters

For power measurement a number of especially steep-edged channel filters are available (see the following table).

For filters of type RRC (Root Raised Cosine), the filter bandwidth indicated describes the sampling rate of the filter. For all other filters (CFILter) the filter bandwidth is the 3 dB bandwidth.

Table 4-4: Filter types

Filter Bandwidth		Filter Type	Application	
100	Hz	CFILter	A0	
200	Hz	CFILter		
300	Hz	CFILter		
500	Hz	CFILter		
1	kHz	CFILter	SSB	
1.5	kHz	CFILter		
2	kHz	CFILter		
2.4	kHz	CFILter		
2.7	kHz	CFILter		
3	kHz	CFILter		
3.4	kHz	CFILter		
4	kHz	CFILter		DAB, Satellite
4.5	kHz	CFILter		
5	kHz	CFILter		
6	kHz	CFILter		
8.5	kHz	CFILter	ETS300 113 (12.5 kHz channels)	
9	kHz	CFILter	AM radio	
10	kHz	CFILter	CDMAone ETS300 113 (20 kHz channels) ETS300 113 (25 kHz channels) TETRA PDC IS 136 (NADC) CDPD, CDMAone	
12.5	kHz	CFILter		
14	kHz	CFILter		
15	kHz	CFILter		
16	kHz	CFILter		
18	kHz, $\alpha = 0.35$	RRC		
20	kHz	CFILter		
21	kHz	CFILter		
24.3	kHz, $\alpha = 0.35$	RRC		
25	kHz	CFILter		
30	kHz	CFILter		
50	kHz	CFILter		
100	kHz	CFILter		FM radio PHS J.83 (8-VSB DVB, USA)
150	kHz	CFILter		
192	kHz	CFILter		
200	kHz	CFILter		
300	kHz	CFILter		
500	kHz	CFILter		

Filter Bandwidth		Filter Type	Application
1.0	MHz	CFILter	CDMAone
1.2288	MHz	CFILter	CDMAone
1,28	MHz	RRC	
1.5	MHz	CFILter	DAB
2.0	MHz	CFILter	
3.0	MHz	CFILter	
3.75	MHz	CFILter	
3.84	MHz, $\alpha = 0.22^*$	RRC	W-CDMA 3GPP
4.096	MHz, $\alpha = 0.22^*$	RRC	W-CDMA NTT DOCoMo
5.0	MHz	CFILter	
20 MHz	MHz	CFILter	

**Note:** The 20 MHz channel filter is unavailable in sweep mode.

The 3.84 and 4.096 MHz filters (marked with an asterisk in the table) require an IF filter model index  $\geq 3$ .

### Softkeys of the bandwidth menu

The following table shows all softkeys available in the bandwidth menu. It is possible that your instrument configuration does not provide all softkeys. If a softkey is only available with a special option, model or (measurement) mode, this information is delivered in the corresponding softkey description.

Command
Res BW Manual
Res BW Auto
Video BW Manual
Video BW Auto
Sweptime Manual
Sweptime Auto
Filter Type

#### Res BW Manual

---

Opens an edit dialog box to enter a value for the resolution bandwidth. The available resolution bandwidths are specified in the data sheet. For details on the correlation between resolution bandwidth and filter type refer to "[To choose the appropriate filter type](#)" on page 4.96.

Numeric input is always rounded to the nearest possible bandwidth. For rotary knob or **UP/DNARROW** key inputs, the bandwidth is adjusted in steps either upwards or downwards.

The manual input mode of the resolution bandwidth is indicated by a green asterisk (\*) at the **RBW** display.

- Remote: BAND:AUTO OFF
  - Remote: BAND 1MHz
- 

#### Res BW Auto (span > 0)

---

Couples the resolution bandwidth to the selected span. If the span is changed, the resolution bandwidth is automatically adjusted.

This setting is recommended, if a favorable setting of the resolution bandwidth in relation to the selected span is desired.

- Remote: BAND:AUTO ON
- 

#### Video BW Manual (not available for FFT filter)

---

Opens an edit dialog box to enter the video bandwidth. The available video bandwidths are specified in the data sheet.

Numeric input is always rounded to the nearest possible bandwidth. For rotary knob or **UP/DNARROW** key inputs, the bandwidth is adjusted in steps either upwards or downwards.

The manual input mode of the video bandwidth is indicated by a green asterisk (\*) at the **VBW** display.

- Remote: BAND:VID:AUTO OFF
  - Remote: BAND:VID 10 kHz
-

---

**Video BW Auto (not available for FFT filter)**

---

Couples the video bandwidth to the resolution bandwidth. If the resolution bandwidth is changed, the video bandwidth is automatically adjusted.

This setting is recommended, if a minimum sweep time is required for a selected resolution bandwidth. Narrow video bandwidths require longer sweep times due to the longer settling time. Wide bandwidths reduce the signal/noise ratio.

→ Remote: BAND:VID:AUTO ON

---

**Sweptime Manual (not available for FFT filter)**

---

Opens an edit dialog box to enter the sweep time.

**Sweep time**

Absolute max. sweep time value	16000 s
Absolute min. sweep time value	1 $\mu$ s (zero span)
	2.5 ms (span > 0)

Allowed values depend on the ratio of span to RBW and RBW to VBW. For details refer to the data sheet.

Numeric input is always rounded to the nearest possible sweep time. For rotary knob or **UPARROW/DNARROW** key inputs, the sweep time is adjusted in steps either downwards or upwards.

The manual input mode of the sweep time is indicated by a green asterisk (\*) at the **SWT** display. If the selected sweep time is too short for the selected bandwidth and span, level measurement errors will occur due to a too short settling time for the resolution or video filters. In this case, the R&S ESL displays the error message **UNCAL** and marks the indicated sweep time with a red asterisk (\*).

→ Remote: SWE:TIME:AUTO OFF

→ Remote: SWE:TIME 10s

---

**Sweptime Auto (not available for FFT filter and zero span)**

---

Couples the sweep time to the span, video bandwidth (VBW) and resolution bandwidth (RBW). If the span, resolution bandwidth or video bandwidth are changed, the sweep time is automatically adjusted.

The R&S ESL always selects the shortest sweep time that is possible without falsifying the signal. The maximum level error is < 0.1 dB, compared to using a longer sweep time.

→ Remote: SWE:TIME:AUTO ON

---

**Filter Type**

---

Opens the **Filter Type** dialog box to select the filter type.

For detailed information on filters see "To choose the appropriate filter type" on page 4.96 and "[List of available RRC and channel filters](#)" on page 4.97.

→ Remote: BAND:TYPE NORM

---

## Configuring the Sweep Mode – SWEEP Key

The **SWEEP** key is used to configure the sweep mode. Continuous sweep or single sweep are possible. The sweep time and the number of measured values are set.

### To open the sweep menu

- Press the **SWEEP** key.  
The sweep menu is displayed.

### Menu and softkey description

- ["Softkeys of the sweep menu"](#) on page 4.102

To display help to a softkey, press the **HELP** key and then the softkey for which you want to display help. To close the help window, press the **ESC** key. For further information refer to section "How to use the Help System".

### Task

- [To specify the sweep settings](#)

### To specify the sweep settings

1. Press the **Sweep Count** softkey and enter the sweep count.
2. Set the sweep time by using the **Sweeptime Manual** or **Sweeptime Auto** softkey.
3. Press the **Sweep Points** softkey and enter the number of sweep points.
4. Select the sweep mode using the **Continuous Sweep** or **Single Sweep** softkey.
5. To repeat the single sweep, press the **Continue Single Sweep** softkey.

### Softkeys of the sweep menu

The following table shows all softkeys available in the sweep menu. It is possible that your instrument configuration does not provide all softkeys. If a softkey is only available with a special option, model or (measurement) mode, this information is delivered in the corresponding softkey description.

Command
<a href="#">Continuous Sweep</a>
<a href="#">Single Sweep</a>
<a href="#">Continue Single Sweep</a>
<a href="#">Sweeptime Manual</a>
<a href="#">Sweeptime Auto</a>
<a href="#">Sweep Count</a>
<a href="#">Sweep Points</a>



**Continuous Sweep**

---

Sets the continuous sweep mode: the sweep takes place continuously according to the trigger settings. This is the default setting. The trace averaging is determined by the sweep count value (see **Sweep Count** softkey).

→ Remote: INIT:CONT ON

---

**Single Sweep**

---

Sets the single sweep mode: after triggering, starts the number of sweeps that are defined by using the **Sweep Count** softkey. The measurement stops after the defined number of sweeps has been performed.

→ Remote: INIT:CONT OFF

---

**Continue Single Sweep**

---

Repeats the number of sweeps set by using the **Sweep Count** softkey, without deleting the trace of the last measurement.

This is particularly of interest when using the trace configurations **Average** or **Max Hold** to take previously recorded measurements into account for averaging / maximum search. For details on trace configuration refer to "[Setting Traces – TRACE Key](#)" on page 4.113.

→ Remote: INIT:CONM

---

**Sweeptime Manual**

---

Opens an edit dialog box to enter the sweep time. For details see **Sweeptime Manual** softkey in the bandwidth menu.

→ Remote: SWE:TIME 10s

---

**Sweeptime Auto**

---

Sets the automatic sweep time mode. For details see **Sweeptime Auto** softkey in the bandwidth menu.

→ Remote: SWE:TIME:AUTO ON

---

**Sweep Count**

---

Opens an edit dialog box to enter the number of sweeps to be performed in the single sweep mode. Values from 0 to 32767 are allowed. If the values 0 or 1 are set, one sweep is performed. The sweep count is applied to all the traces in a diagram.

The sweep count set in the sweep menu is the same as that in the trace menu (for further details see **Sweep Count** softkey). If the trace configurations **Average**, **Max Hold** or **Min Hold** are set, the sweep count value also determines the number of averaging or maximum search procedures (for details on trace configuration see "[Setting Traces – TRACE Key](#)" on page 4.113).

*Example:*

**TRACE** key – **Trace Mode** softkey – **Mode Max Hold** softkey

**SWEEP** key – **Sweep Count** softkey – **Average Sweep Count** dialog box: enter 10

**Single Sweep** softkey: R&S ESL performs the **Max Hold** function over 10 sweeps.

→ Remote: `SWE:COUN 64`

---

### Sweep Points

---

Opens an edit dialog box to enter the number of measured values to be collected during one sweep.

– Entry via rotary knob:

In the range from 101 to 1001, the sweep points are increased or decreased in steps of 100 points.

In the range from 1001 to 32001, the sweep points are increased or decreased in steps of 1000 points.

– Entry via keypad:

All values in the defined range can be set.

The default value is 501 sweep points. If a value  $\neq$  501 is set, the auto peak detector is turned off automatically.

→ Remote: `SWE:POIN 501`

---

## Triggering the Sweep – TRIG Key

The **TRIG** key is used to set trigger mode, trigger threshold, trigger delay, trigger polarity and for gated sweep the gate configuration.

### To open the trigger menu

- Press the **TRIG** key.  
The trigger menu is displayed.

### Menu and softkey description

- ["Softkeys of the trigger menu"](#) on page 4.109

To display help to a softkey, press the **HELP** key and then the softkey for which you want to display help. To close the help window, press the **ESC** key. For further information refer to section "How to use the Help System".

### Further information

- ["Trigger mode overview"](#) on page 4.108

### Tasks

- [To specify the trigger settings](#)
- [To use gated sweep operation \(option Gated Sweep, B8\)](#)

### To specify the trigger settings

1. Press the **Trg / Gate Source** softkey to select the trigger mode (for details see ["Trigger mode overview"](#) on page 4.108).
2. Press the **Trg / Gate Level** softkey to set the trigger level.
3. Press the **Trigger Offset** softkey to set the trigger offset.
4. For details on gated sweep operation, see ["To use gated sweep operation \(option Gated Sweep, B8\)"](#) on page 4.105.

### To use gated sweep operation (option Gated Sweep, B8)

By using a gate in sweep mode and stopping the measurement while the gate signal is inactive, the spectrum for pulsed RF carriers can be displayed without the superposition of frequency components generated during switching. Similarly, the spectrum can also be examined for an inactive carrier. The sweep can be controlled by an external gate or by the internal power trigger.

Gated sweep operation is also possible for span = 0. This enables – e.g. in burst signals – level variations of individual slots to be displayed versus time.

1. Press the **Gate Settings** submenu softkey to define the settings of the gate mode.  
At the center frequency a transition to zero span is made and the time parameters gate delay and gate length are displayed as vertical lines to adjust them easily.  
When quitting the **Gate Settings** submenu, the original span is retrieved so the desired measurement can be performed with the accurately set gate.
2. To set the parameters gate delay and gate length highly accurate, press the **Sweep Time** softkey to alter the x-axis in a way that the signal range concerned (e.g. one full burst) is displayed.

3. Press the **Gate Delay** softkey to set the sampling time in a way that the desired portion of the signal is shown.
4. Press the **Gate Mode Lvl/Edge** softkey to set the gate mode.
5. If the **Edge** gate mode has been selected, press the **Gate Length** softkey to set the sampling duration in a way that the desired portion of the signal is shown.
6. Press the **Trg / Gate Polarity Pos/Neg** softkey to set the polarity of the trigger source.
7. Press the **Gated Trigger** softkey to activate the gated sweep mode.

To indicate that a gate is used for the sweep, the enhancement label **GAT** is displayed on the screen. This label appears to the right of the window for which the gate is configured.

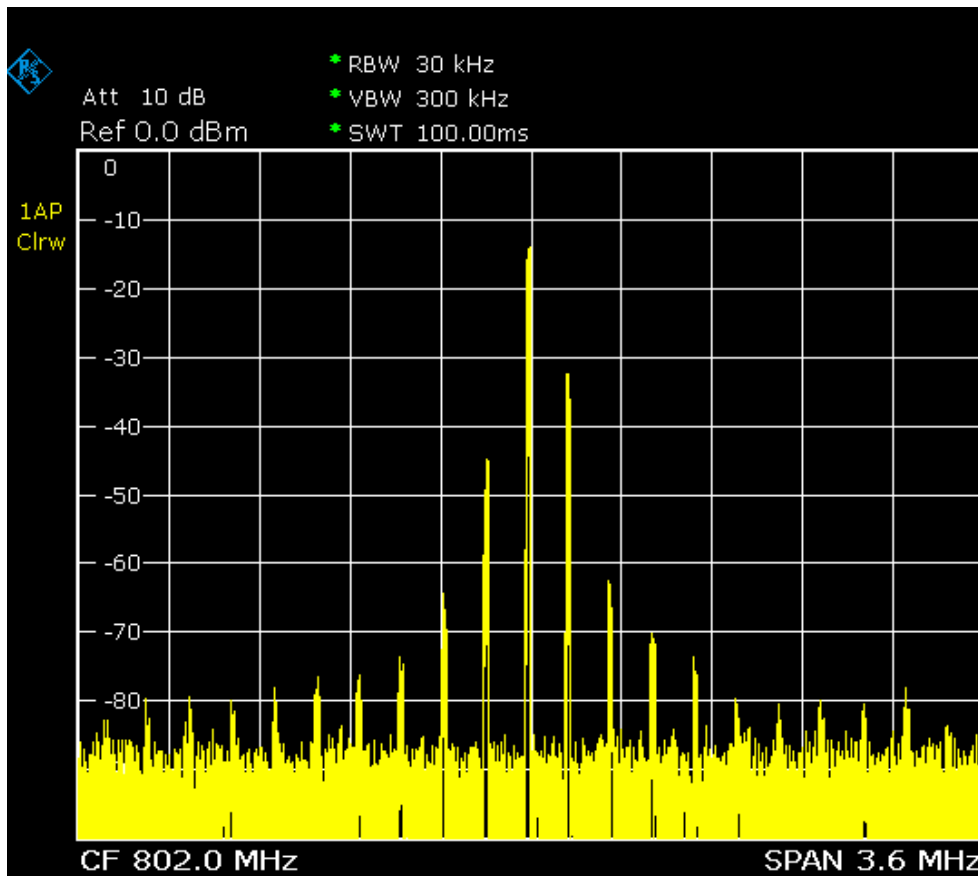

Fig. 4-3: TDMA signal with GATE OFF

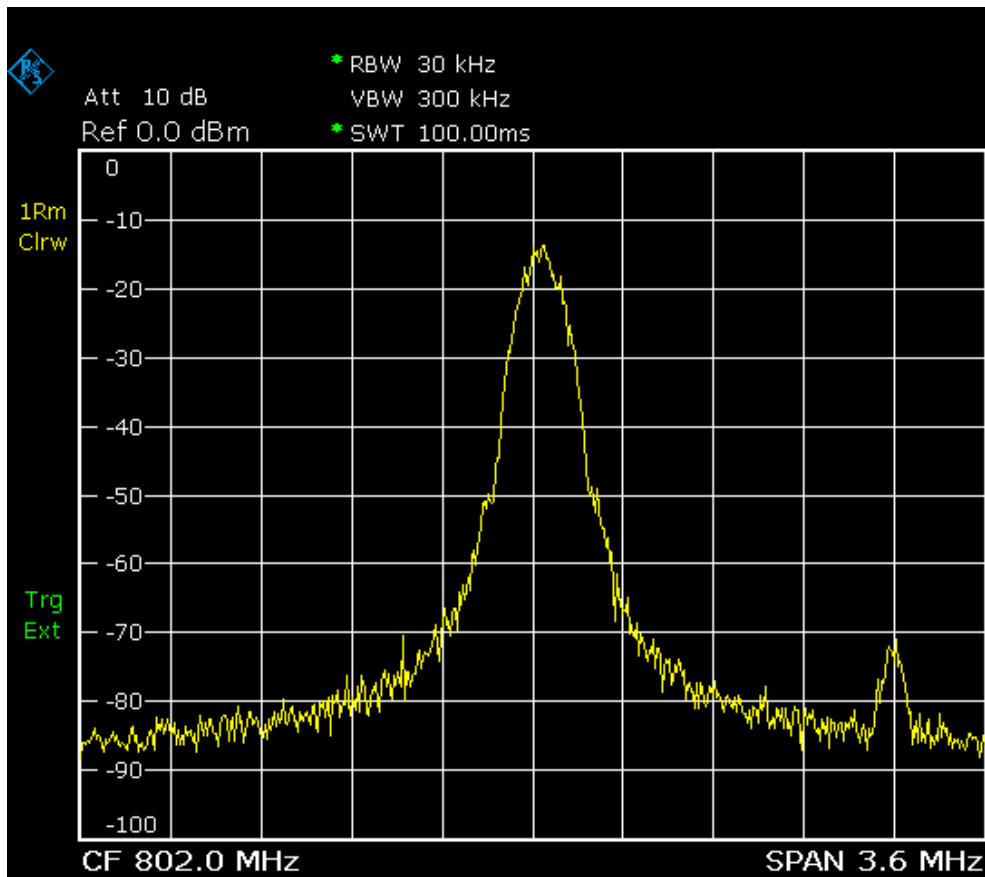

Fig. 4-4: Pulsed signal with GATE ON

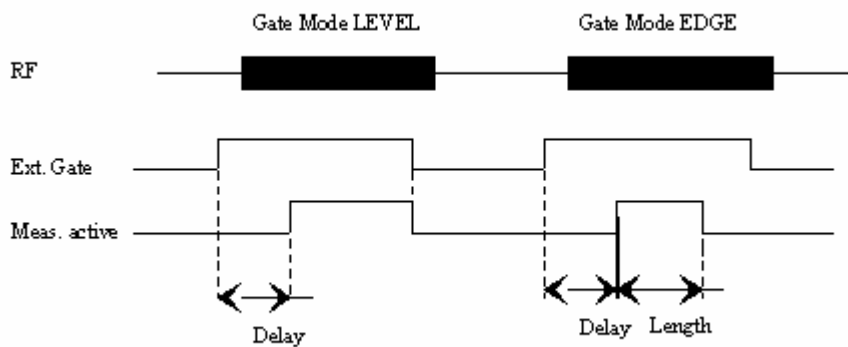

Fig. 4-5: Timing diagram for GATE, GATE DELAY and GATE LENGTH

## Trigger mode overview

The R&S ESL offers the following trigger modes:

- **Free Run**

The start of a sweep is not triggered. Once a measurement is completed, another is started immediately.

- **External**

Triggering via a TTL signal at the input connector **EXT TRIG / GATE IN** on the rear panel.

- **Video**

Triggering by the displayed voltage.

A horizontal trigger line is shown in the diagram. It is used to set the trigger threshold from 0% to 100% of the diagram height.

- **IF Power**

Triggering of the measurement via signals which are outside the measurement channel.

For this purpose, the R&S ESL uses a level detector at the second intermediate frequency. Its threshold can be set in a range between –50 dBm and –10 dBm at the input mixer. The resulting trigger level at the RF input is calculated via the following formula:

$$\text{Mixerlevel}_{min} + \text{RFAtt} - \text{PreampGain} \leq \text{Input Signal} \leq \text{Mixerlevel}_{max} + \text{RFAtt} - \text{PreampGain}$$

The bandwidth at the intermediate frequency is 20 MHz. The R&S ESL is triggered as soon as the trigger threshold is exceeded within a 10 MHz range around the selected frequency (= start frequency in the frequency sweep).

Thus, the measurement of spurious emissions, e.g. for pulsed carriers, is possible even if the carrier lies outside the selected frequency span.

- **Time Trigger**

Triggering of the measurement by a time interval, set via the **Repetition Intervall** softkey.

## Softkeys of the trigger menu

The following table shows all softkeys available in the trigger menu. It is possible that your instrument configuration does not provide all softkeys. If a softkey is only available with a special option, model or (measurement) mode, this information is delivered in the corresponding softkey description.

Menu / Command	Command
Trg / Gate Source	
Trg / Gate Level	
Trg / Gate Polarity Pos/Neg	
Trigger Offset / Repetition Intvall	
Gated Trigger	
Gate Settings ↓	Gate Mode Lvl/Edge
	Gate Delay
	Gate Length
	Trg / Gate Source
	Trg / Gate Level
	Trg / Gate Polarity Pos/Neg
	Sweep Time
More ↓	
IF Power Retrigger Holdoff	
IF Power Retrigger Hysteresis	

### Trg / Gate Source

Opens the **Trigger / Gate Source** dialog box to select the trigger / gate mode. For detailed information on trigger modes see "[Trigger mode overview](#)" on page 4.108.

The gate-related settings are only available with option Gated Sweep, R&S FSL-B8. For details see also "[To use gated sweep operation \(option Gated Sweep, B8\)](#)" on page 4.105.

The default setting is **Free Run**. If a trigger mode other than **Free Run** has been set, the enhancement label **TRG** is displayed.

- Remote: TRIG:SOUR IMM | VID | IFP | EXT | TIME (Free Run, Video, IF Power, Extern, Time Trigger)
- Remote: SWE:EGAT:SOUR EXT (Extern)

### Trg / Gate Level

Opens an edit dialog box to enter the trigger / gate level. The gate-related settings are only available with option Gated Sweep, R&S FSL-B8. For details see also "[Trigger mode overview](#)" on page 4.108 and "[To use gated sweep operation \(option Gated Sweep, B8\)](#)" on page 4.105.

In the **Time Trigger** mode, this softkey is not available.

- Remote: TRIG:LEV:VID 50PCT
- Remote: TRIG:LEV:IFP -30DBM

**Trg / Gate Polarity Pos/Neg**

Sets the polarity of the trigger / gate source. The gate-related settings are only available with option Gated Sweep, R&S FSL-B8.

The sweep starts after a positive or negative edge of the trigger signal. The default setting is **Pos**. The setting applies to all modes with the exception of the **Free Run** mode.

- level triggering     In the setting **Pos** the sweep is stopped by the logic '0' signal and restarted by the logical '1' signal after the gate delay time has elapsed.
- edge triggering     The sweep is continued on a '0' to '1' transition for the gate length duration after the gate delay time has elapsed.

In the **Time Trigger** mode, this softkey is not available.

For details also see "[To use gated sweep operation \(option Gated Sweep, B8\)](#)" on page 4.105.

- Remote: TRIG:SLOP POS
- Remote: SWE:EGAT:POL POS

**Trigger Offset**

Opens an edit dialog box to enter the time offset between the trigger signal and the start of the sweep. The time may be entered in multiples of 125 ns in the range -100 s to 100 s (default 0 s).

- offset > 0:     start of the sweep is delayed
- offset < 0:     sweep starts earlier (pre-trigger)
  - only possible for span = 0 and gated trigger switched off
  - not possible if RMS or average detector activated
  - maximum allowed range and the maximum resolution limited by the sweep time:
 
$$range_{max} = - 499/500 \times sweep\ time$$

$$resolution_{max} = sweep\ time/500$$

In the **External** or **IF Power** trigger mode, a common input signal is used for both trigger and gate. Therefore changes to the gate delay will affect the trigger delay (trigger offset) as well.

In the **Time Trigger** mode, this softkey is not available.

- Remote: TRIG:HOLD 10US

**Repetition Intervall (Time Trigger mode)**

Opens an edit dialog box to enter the time intervall after which the sweep is started. The possible values range from 100 ms to 5000 s.

- Remote: TRIG:TIME:RINT 50



---

### Gated Trigger (option Gated Sweep, B8)

---

Switches the sweep mode with gate on or off .

This softkey requires the following trigger mode:

span > 0    **External** or **IF Power**

span = 0    **External** or **IF Power** or **Video**

If a different mode is active, the **IF Power** trigger mode is automatically selected.

If the gate is switched on, a gate signal applied to the rear panel connector EXT TRIGGER/GATE or the internal IF power detector controls the sweep of the analyzer.

In the **Time Trigger** mode, this softkey is not available.

For details also see "[To use gated sweep operation \(option Gated Sweep, B8\)](#)" on page 4.105.

→ Remote: SWE:EGAT ON

→ Remote: SWE:EGAT:SOUR IFP | EXT

---

### Gate Settings (option Gated Sweep, B8)

---

Opens a submenu to make all the settings required for gated sweep operation.

In the **Time Trigger** mode, this softkey is not available.

For details also see "[To use gated sweep operation \(option Gated Sweep, B8\)](#)" on page 4.105.

---

### Gate Mode Lvl/Edge (option Gated Sweep, B8)

---

Sets the gate mode. As settings level-triggered or edge-triggered gate mode can be selected.

For details also see "[To use gated sweep operation \(option Gated Sweep, B8\)](#)" on page 4.105.

→ Remote: SWE:EGAT:TYPE EDGE

---

### Gate Delay (option Gated Sweep, B8)

---

Opens an edit dialog box to enter the gate delay time between the gate signal and the continuation of the sweep. Values between 125 ns and 100 s are allowed. The delay position on the time axis in relation to the sweep is indicated by a line labeled **GD**.

This is useful for e.g. taking into account a delay between the gate signal and the stabilization of an RF carrier.

As a common input signal is used for both trigger and gate when selecting the **External** or **IF Power** trigger mode, changes to the gate delay will affect the trigger delay (trigger offset) as well.

For details also see "[To use gated sweep operation \(option Gated Sweep, B8\)](#)" on page 4.105.

→ Remote: SWE:EGAT:HOLD 1US

---

---

### Gate Length (Gate Mode Edge)

---

Opens an edit dialog box to enter the gate length. Values between 125 ns and 100 s are allowed. The gate length in relation to the sweep is indicated by a line labeled **GL**.

The length of the gate signal defines if the sweep is to be interrupted. Only in the edge-triggered mode the gate length can be set, while in the level-triggered the gate length depends on the length of the gate signal.

For details also see "[To use gated sweep operation \(option Gated Sweep, B8\)](#)" on page 4.105.

→ Remote: `SWE:EGAT:LENG 100US`

---

### Sweep Time (option Gated Sweep, B8)

---

Opens an edit dialog box to change the sweep time in order to obtain a higher resolution for positioning gate delay and gate length. When quitting the **Gate Settings** submenu, the original sweep time is retrieved.

For details also see "[To use gated sweep operation \(option Gated Sweep, B8\)](#)" on page 4.105.

---

### IF Power Retrigger Holdoff (

---

Opens an edit dialog box to define the value for the IF power trigger holdoff. This softkey is only available if the IF power trigger is selected as the trigger source. The holdoff value in s is the time which must pass since another IF power trigger event may happen. The range of the value is between 150 ns and 10 s in the step width of 10 ns.

→ Remote: `TRIG:IFP:HOLD 200 ns`

---

### IF Power Retrigger Hysteresis

---

Opens an edit dialog box to define the value for the IF power trigger hysteresis. This softkey is only available if the IF power trigger is selected as the trigger source. The hysteresis in dB is the value the input signal must decay below the IF power trigger level in order to allow an IF power trigger starting the measurement. The range of the value is between 3 dB and 50 dB in the step width of 1 dB.

→ Remote: `TRIG:IFP:HYST 10DB`

---

## Setting Traces – TRACE Key

The **TRACE** key is used to configure the data acquisition for measurement and the analysis of the measurement data.

The R&S ESL is capable of displaying up to six different traces at a time in a diagram. A trace consists of a maximum of 501 measurement points on the horizontal axis (frequency or time). If more measured values than measurement points are available, several measured values are combined in one measurement point.

The trace functions are subdivided as follows:

- Display mode of trace (**Clear Write**, **View** and **Blank**). For details on trace modes see "[Trace mode overview](#)" on page 4.114.
- Evaluation of the trace as a whole (**Average**, **Max Hold** and **Min Hold**). For details on trace modes see "[Trace mode overview](#)" on page 4.114. For details on averaging see "[Description of the averaging method](#)" on page 4.115.
- Evaluation of individual measurement points of a trace. For details on detectors see "[Detector overview](#)" on page 4.116.

### To open the trace menu

- Press the **TRACE** key.

The trace menu is displayed. The **Trace Configuration** dialog box is displayed.

### Menu and softkey description

- "[Softkeys of the trace menu](#)" on page 4.117

To display help to a softkey, press the **HELP** key and then the softkey for which you want to display help. To close the help window, press the **ESC** key. For further information refer to section "How to use the Help System".

### Further information

- "[Trace mode overview](#)" on page 4.114
- "[Detector overview](#)" on page 4.116
- "[Description of the averaging method](#)" on page 4.115
- "[ASCII file export format](#)" on page 4.122

### Task

- [To specify the trace settings](#)

### To specify the trace settings

1. Press the **Trace 1 2 3 4 5 6** softkey to select the trace.
2. Press the **Trace Mode** softkey to select the trace mode for the selected trace (for details see "[Trace mode overview](#)" on page 4.114).
3. Press the **Detector Auto Select** softkey for automatic detector selection or press the **Detector Manual Select** softkey to select a detector (for details see "[Detector overview](#)" on page 4.116).
4. To change the sweep count setting, which also determines trace averaging, press the **Sweep Count** softkey.

5. To deactivate the reset of the traces in **Min Hold** and **Max Hold** mode after some specific parameter changes, press the **Hold/Cont** softkey.
6. To copy a trace into another trace memory, press the **Copy Trace** softkey.  
Upon copying, the contents of the selected memory are overwritten and the new contents are displayed in the **View** mode.
7. To export the active trace in ASCII format:
  - Press the **More** softkey.
  - If necessary, press the **Decim Sep** softkey to change the decimal separator with floating–point numerals.
  - Press the **ASCII File Export** softkey to enter the ASCII file export name.The active trace is saved in ASCII format on the flash disk or a USB device.

### Trace mode overview

The traces can individually be activated for a measurement or frozen after completion of a measurement. Traces that are not activated are hidden. Each time the trace mode is changed, the selected trace memory is cleared.

The R&S ESL offers 6 different trace modes:

- **Clear Write**

Overwrite mode: the trace is overwritten by each sweep. All available detectors can be selected. This is the default setting.

- **Max Hold**

The maximum value is determined over several sweeps and displayed. The R&S ESL saves the sweep result in the trace memory only if the new value is greater than the previous one. The detector is automatically set to **Positive Peak**.

This mode is especially useful with modulated or pulsed signals. The signal spectrum is filled up upon each sweep until all signal components are detected in a kind of envelope.

- **Min Hold**

The minimum value is determined from several measurements and displayed. The R&S ESL saves for each sweep the smallest of the previously stored/currently measured values in the trace memory. The detector is automatically set to **Negative Peak**.

This mode is useful e.g. for making an unmodulated carrier in a composite signal visible. Noise, interference signals or modulated signals are suppressed whereas a CW signal is recognized by its constant level.

- **Average**

The average is formed over several sweeps. All available detectors can be selected. If the detector is automatically selected, the sample detector is used. For details see also "[Description of the averaging method](#)" on page 4.115.

- **View**

The current contents of the trace memory is frozen and displayed.

If a trace is frozen, the instrument settings, apart from level range and reference level (see below), can be changed without impact on the displayed trace. The fact that the trace and the current instrument setting do not correspond any more is indicated by the enhancement label "\*" at the left edge of the grid.

If level range or reference level are changed, the R&S ESL automatically adapts the measured data to the changed display range. This allows an amplitude zoom to be made after the measurement in order to show details of the trace.

- **Blank**

Hides the selected trace.

## Description of the averaging method

Averaging is carried out over the measurement points derived from the measurement samples. Several measured values may be combined in a measurement point. This means that with linear level display the average is formed over linear amplitude values. The sweep mode (continuous or single sweep, for details see "[Configuring the Sweep Mode – SWEEP Key](#)" on page 4.102) and running averaging apply to the average display analogously. In principle, two methods for calculating the average are used: continuous averaging and averaging over the selected number of sweeps.

- sweep count > 1

Depending on the relation of the following two parameters, two different situations exist:

$n$  = number of sweeps performed since measurement start

$c$  = sweep count (number of sweeps forming one statistics cycle)

- $n \leq c$

In single sweep or continuous sweep mode during the first statistics cycle, averaging over the selected number of sweeps is performed. The average trace  $n$  is calculated at each measurement point according to:

$$Avg(n) = \frac{n-1}{n} Avg(n-1) + \frac{1}{n} Curr(n) \quad \text{Equ. 4-1}$$

with  $Avg$  = average trace;  $Curr$  = current trace

Until the first statistics cycle is completed ( $n < c$ ), a preliminary average is displayed which represents the arithmetic mean value over all measured sweeps. With  $n$  increasing, the displayed trace is increasingly smoothed since there are more single sweeps for averaging.

When the first statistics cycle is completed ( $n = c$ ), the average trace is saved in the trace memory.

- $n > c$

In continuous sweep mode after the first statistics cycle, continuous averaging is performed. The average trace  $n$  is calculated at each measurement point according to:

$$Avg(n) = \frac{c-1}{c} Avg(n-1) + \frac{1}{c} Curr(n) \quad \text{Equ. 4-2}$$

with  $Avg$  = average trace;  $Curr$  = current trace

In single sweep mode, the same formula holds true if the **Continue Single Sweep** softkey is pressed.

- sweep count = 0

In continuous sweep mode, a continuous average is calculated according to Equ. 4–3.

with  $c = 10$ :

$$Avg(n) = \frac{9}{10} Avg(n-1) + \frac{1}{10} Curr(n) \quad \text{Equ. 4-3}$$

with  $Avg = \text{average trace}$ ;  $Curr = \text{current trace}$

Due to the weighting between the current trace and the average trace, past values have practically no influence on the displayed trace after about ten sweeps. With this setting, signal noise is effectively reduced without need for restarting the averaging process after a change of the signal.

- sweep count = 1

The current trace is displayed. No averaging is performed. This is a special case of Equ. 4–1 with  $n = 0$ .

### Detector overview

The measurement detector for the individual display modes can be selected directly by you or set automatically by R&S ESL. The detector activated for the specific trace is identified in the respective trace display field in form of an abbreviation (for details see detector list).

The detectors of the R&S ESL are implemented as pure digital devices. They collect signal power data within each measured point during a sweep. The default number of sweep points is 501. The following detectors are available:

Detector	Indicator	Function
auto peak detector <b>(Auto Peak)</b>	Ap	determines the maximum and the minimum value within a measurement point
peak detector <b>(Positive Peak)</b>	Pk	determines the maximum value within a measurement point
min peak detector <b>(Negative Peak)</b>	Mi	determines the minimum value within a measurement point
sample detector <b>(Sample)</b>	Sa	selects a random value within a measurement point
RMS detector <b>(RMS)</b>	Rm	determines the root mean square power within a measurement point
average detector <b>(Average)</b>	Av	determines the linear average power within a measurement point
quasi peak detector <b>(Quasi Peak)</b>	QP	determines the quasipeak power within a measurement point for EMI measurements
CISPR RMS detector <b>(CISPR RMS)</b>	CR	continuously determines RMS values in combination with a linear average detector that includes an instrument time constant.
CISPR AV detector <b>(CISPR AV)</b>	CA	determines linear average power by assigning an instrument time constant.

The result obtained from the selected detector within a measurement point is displayed as the power value at this measurement point.

All detectors work in parallel in the background, which means that the measurement speed is independent of the detector combination used for different traces.

**Note:** During a frequency sweep, R&S ESL increments the 1st local oscillator in steps that are smaller than approximately 1/10 of the bandwidth. This makes sure that the oscillator step speed is conforming to the hardware settling times and does not affect the precision of the measured power.

The number of measured values taken during a sweep is independent of the number of oscillator steps. It is always selected as a multiple or a fraction of 501 (= default number of trace points displayed on the screen). Choosing less than 501 measured values (e.g. 125 or 251) will lead to an interpolated measurement curve, choosing more than 501 points (e.g. 1001, 2001 ...) will result in several measured values being overlaid at the same frequency position.

### Softkeys of the trace menu

The following table shows all softkeys available in the trace menu. It is possible that your instrument configuration does not provide all softkeys. If a softkey is only available with a special option, model or (measurement) mode, this information is delivered in the corresponding softkey description.

Menu / Command	Command
Trace 1 2 3 4 5 6	
Trace Mode ↓	Clear Write
	Max Hold
	Min Hold
	Average
	View
	Blank
Detector Auto Select	
Detector Manual Select ↓	Detector Auto Peak
	Detector Positive Peak
	Detector Negative Peak
	Detector Sample
	Detector RMS
	More ↓
	Detector Average
	Detector Quasi Peak
	Detector CISPR RMS
	Detector CISPR AV
Sweep Count	
Hold/Cont	
More ↓	
Trace 1 2 3 4 5 6	
Copy Trace	
ASCII File Export	
Decim Sep	
Trace Math	
Trace Math Position	

---

**Trace 1 2 3 4 5 6**

---

Selects the active trace (1, 2, 3, 4, 5, 6). The default setting is trace 1 in the overwrite mode (see **Clear Write** mode), the other traces are switched off (see **Blank** mode).

→ Remote: (selected via numeric suffix of :TRACe<1 . . . 6>)

---

**Trace Mode**

---

Opens a submenu to select the trace mode. For details see "[Trace mode overview](#)" on page 4.114.

---

**Clear Write**

---

Selects the **Clear Write** mode. For details see "[Trace mode overview](#)" on page 4.114.

→ Remote: DISP:TRAC:MODE WRIT

---

**Max Hold**

---

Selects the **Max Hold** mode. For details see "[Trace mode overview](#)" on page 4.114.

→ Remote: DISP:TRAC:MODE MAXH

---

**Min Hold**

---

Selects the **Min Hold** mode. For details see "[Trace mode overview](#)" on page 4.114.

→ Remote: DISP:TRAC:MODE MINH

---

**Average**

---

Selects the **Average** mode. For details see "[Trace mode overview](#)" on page 4.114.

→ Remote: DISP:TRAC:MODE AVER

---

**View**

---

Selects the **View** mode. For details see "[Trace mode overview](#)" on page 4.114.

→ Remote: DISP:TRAC:MODE VIEW

---

**Blank**

---

Selects the **Blank** mode. For details see "[Trace mode overview](#)" on page 4.114.

→ Remote: DISP:TRAC OFF

---



---

**Detector Auto Select**

---

Selects the optimum detector for the selected trace and filter mode. This is the default setting. For details see also "[Detector overview](#)" on page 4.116.

Trace mode	Detector (band-pass filter)	Detector (FFT filter)
Clear/Write	Auto Peak	Max Peak
Average	Sample	Sample
Max Hold	Max Peak	Max Peak
Min Hold	Min Peak	Max Peak

→ Remote: DET:AUTO ON

---



---

**Detector Manual Select**

---

Opens a submenu to select the detector. For details see "[Detector overview](#)" on page 4.116.

---



---

**Detector Auto Peak**

---

Selects the **Auto Peak** detector. For details see "[Detector overview](#)" on page 4.116.

---



---

**Detector Positive Peak**

---

Selects the **Positive Peak** detector. For details see "[Detector overview](#)" on page 4.116.

→ Remote: DET POS

---



---

**Detector Negative Peak**

---

Selects the **Negative Peak** detector. For details see "[Detector overview](#)" on page 4.116.

→ Remote: DET NEG

---



---

**Detector Sample**

---

Selects the **Sample** detector. For details see "[Detector overview](#)" on page 4.116.

→ Remote: DET SAMP

---



---

**Detector RMS**

---

Selects the **RMS** detector. For details see "[Detector overview](#)" on page 4.116.

→ Remote: DET RMS

---



---

**Detector Average**

---

Selects the **Average** detector. For details see "[Detector overview](#)" on page 4.116.

→ Remote: DET AVER

---

---

**Detector Quasi Peak**

---

Selects the **Quasi Peak** detector. For details see "[Detector overview](#)" on page 4.116.

→ Remote: DET QPE

---

---

**Detector CISPR RMS**

---

Selects the **CISPR RMS** detector. For details see "[Detector overview](#)" on page 4.116.

→ Remote: DET CRMS

---

---

**Detector CISPR AV**

---

Selects the **CISPR AV** detector. For details see "[Detector overview](#)" on page 4.116.

→ Remote: DET CAV

---

---

**Sweep Count**

---

Opens an edit dialog box to enter the number of sweeps used for averaging. Values from 0 to 32767 are allowed. The default setting is 0. The sweep count is applied to all the traces in a diagram. The sweep count set in the trace menu is the same as that in the sweep menu (for further details see **Sweep Count** softkey).

In the continuous sweep mode, the sweep count value determines the trace averaging:

- sweep count = 0: continuous averaging
- sweep count = 1: no averaging
- sweep count > 1: averaging over the selected number of sweeps; in the continuous sweep mode averaging is performed until the set number of sweeps is attained and is then continued as continuous averaging (see also "[Description of the averaging method](#)" on page 4.115).

→ Remote: SWE:COUN 64

---

---

**Hold/Cont**

---

Switches on or off the reset of the traces in Min Hold, Max Hold and Average mode after some specific parameter changes have been made. The default setting is off.

Normally, the measurement is started anew after parameter changes, before the measurement results are evaluated (e.g. using a marker). In all cases that require a new measurement after parameter changes, the trace is reset automatically to avoid false results (e.g. with span changes). For applications that require no reset after parameter changes, the automatic reset can be switched off.

→ Remote: DISP:TRAC:MODE:HCON ON

---

---

**Copy Trace**

---

Opens an edit dialog box to enter the number of the trace memory, in which the currently selected trace shall be copied.

→ Remote: TRAC:COPY TRACE1,TRACE2

---

---

**ASCII File Export**

---

Opens the **ASCII File Export Name** dialog box and saves the active trace in ASCII format to the specified file and directory.

The file consists of the header containing important scaling parameters and a data section containing the trace data. For details on an ASCII file see "[ASCII file export format](#)" on page 4.122.

This format can be processed by spreadsheet calculation programs, e.g. MS Excel. It is necessary to define ';' as a separator for the data import. Different language versions of evaluation programs may require a different handling of the decimal point. It is therefore possible to select between separators '.' (decimal point) and ',' (comma) using the **Decim Sep** softkey.

- Remote: FORM ASC
  - Remote: MMEM:STOR:TRAC 1, 'TRACE.DAT'
- 

**Decim Sep**

---

Selects the decimal separator with floating–point numerals for the ASCII file export to support evaluation programs (e.g. MS Excel) in different languages. The values '.' (decimal point) and ',' (comma) can be set. For details see also **ASCII File Export** softkey.

- Remote: FORM:DEXP:DSEP POIN
- 

**Trace Math**

---

Opens the **Trace Mathematics** dialog box to define which trace is subtracted from trace 1. The result is displayed in trace 1 and refers to the zero point defined with the **Trace Math Position** softkey. The following subtractions can be performed:

- T1→T1–T2**     Subtracts trace 2 from trace 1.
- T1→T1–T3**     Subtracts trace 3 from trace 1
- T1→T1–T4**     Subtracts trace 4 from trace 1
- T1→T1–T5**     Subtracts trace 5 from trace 1
- T1→T1–T6**     Subtracts trace 6 from trace 1

If the **Trace Math Off** option is activated, the function is switched off (default setting).

- Remote: CALC1:MATH (TRACE1 – TRACE2)
  - Remote: CALC:MATH:STAT ON
- 

**Trace Math Position**

---

Opens an edit dialog box to define the zero point in % of the diagram height. The range of values extends from –100% to +200%.

- Remote: CALC:MATH:POS 50PCT
-

**ASCII file export format**

The data of the file header consist of three columns, each separated by a semicolon: parameter name; numeric value; basic unit. The data section starts with the keyword "Trace <n>" (<n> = number of stored trace), followed by the measured data in one or several columns (depending on measurement) which are also separated by a semicolon.

<b>File contents: header</b>	<b>Description</b>
Type;ESL;	Instrument model
Version;5.00;	Firmware version
Date;01.Oct 2006;	Date of data set storage
Mode;RECEIVER;	Instrument mode
Center Freq;55000;Hz	Center frequency
Freq Offset;0;Hz	Frequency offset
Span;90000;Hz	Frequency range (0 Hz in zero span and statistics measurements)
x-Axis;LIN;	Scaling of x-axis linear (LIN) or logarithmic (LOG)
Start;10000;Hz Stop;100000;Hz	Start/stop of the display range. Unit: Hz for span > 0, s for span = 0, dBm/dB for statistics measurements
Ref Level;-30;dBm	Reference level
Level Offset;0;dB	Level offset
Ref Position;75;%	Position of reference level referred to diagram limits (0% = lower edge)
y-Axis;LOG;	Scaling of y-axis linear (LIN) or logarithmic (LOG)
Level Range;100;dB	Display range in y direction. Unit: dB with x-axis LOG, % with x-axis LIN
Rf Att;20;dB	Input attenuation
RBW;100000;Hz	Resolution bandwidth
VBW;30000;Hz	Video bandwidth
SWT;0.005;s	Sweep time
Trace Mode;AVERAGE;	Display mode of trace: CLR/WRITE,AVERAGE,MAXHOLD,MINHOLD
Detector;AUTOPEAK;	Detector set: AUTOPEAK,MAXPEAK,MINPEAK,AVERAGE,RMS,SAMPLE,QUASPEAK
Sweep Count;20;	Number of sweeps set
<b>File contents: data section of the file</b>	<b>Description</b>
Trace 1;;	Selected trace
x-Unit;Hz;	Unit of x values: Hz with span > 0; s with span = 0; dBm/dB with statistics measurements
y-Unit;dBm;	Unit of y values: dB*V/A/W depending on the selected unit with y-axis LOG or % with y-axis LIN
Values; 501;	Number of measurement points
10000;-10.3;-15.7 10180;-11.5;-16.9 10360;-12.0;-17.4 ...;...	Measured values: <x value>, <y1>, <y2>; <y2> being available only with detector AUTOPEAK and containing in this case the smallest of the two measured values for a measurement point.

## Measurement Functions

In this section all menus necessary for setting measurement functions are described. This includes the following topics and keys:

- ["Using Markers and Delta Markers – MKR Key"](#) on page 4.124
- ["Changing Settings via Markers – MKR-> Key"](#) on page 4.136
- ["Power Measurements – MEAS Key"](#) on page 4.144
- ["Using Limit Lines and Display Lines – LINES Key"](#) on page 4.184

## Using Markers and Delta Markers – MKR Key

The markers are used for marking points on traces, reading out measurement results and for quickly selecting a display section. The R&S ESL provides four markers per trace.

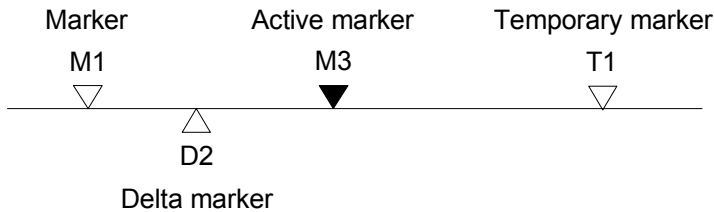

Fig. 4-6: Marker types

All markers can be used either as markers or delta markers. The marker that can be moved by the user is defined in the following as the active marker. Temporary markers are used in addition to the markers and delta markers to evaluate the measurement results. They disappear when the associated function is deactivated.

The measurement results of the active marker (also called marker values) are displayed in the marker field. The marker field is located at the upper right corner of the display and shows the following:

- marker type (M1 in the example)
- trace in square brackets ([1] in the example)
- level (-33.09 dBm in the example)
- marker location (3 GHz in the example)

```
M1[1]          -33.09 dBm
                3.000000000 GHz
```

Fig. 4-7: Marker values

The **MKR** key is used to select and position the absolute and relative measurement markers (markers and delta markers). In addition, the functions for frequency counter, fixed reference point for relative measurement markers and enlargement of the measurement area are assigned to this key.

Also the following measurements can be carried out:

- Noise density (**Noise Meas On/Off** softkey; see also "[Measurement of noise density](#)" on page 4.127)
- Frequency measurement (**Sig Count On/Off** softkey; see also "[Frequency measurement with the frequency counter](#)" on page 4.126)
- Filter or signal bandwidth (**n dB down** softkey)
- AF demodulation (**Marker Demod** softkey; see also "[AF demodulation](#)" on page 4.126)

For further information on markers see also "[Changing Settings via Markers – MKR-> Key](#)" on page 4.136.

### To open the marker menu

- Press the **MKR** key.

The marker menu is displayed. If no marker is active, marker 1 is activated and a peak search on the trace is carried out. Otherwise, the edit dialog box for the last activated marker is opened and the current frequency / time value is displayed.

### Menu and softkey description

- ["Softkeys of the marker menu"](#) on page 4.128

To display help to a softkey, press the **HELP** key and then the softkey for which you want to display help. To close the help window, press the **ESC** key. For further information refer to section "How to use the Help System".

### Further information

- ["AF demodulation"](#) on page 4.126
- ["Frequency measurement with the frequency counter"](#) on page 4.126
- ["Measurement of noise density"](#) on page 4.127

### Tasks

- [To define the basic marker settings](#)
- [To set a fixed reference point \(phase noise measurement\)](#)
- [To set the demodulation mode and duration](#)

### To define the basic marker settings

1. Press the **MKR** key to open the marker menu.

Marker 1 is activated and positioned on the maximum value of the trace as normal marker. If several traces are being displayed, the marker is set to the maximum value (peak) of the trace which has the lowest number (1 to 3) and is not frozen (View mode). In case a marker is already located there, it will be set to the frequency of the next lowest level (next peak).

2. To change to another trace, press the **Marker to Trace** softkey and enter the number of the trace on which the marker is to be placed.

The marker changes to selected trace, but remains on the previous frequency or time. If a trace is turned off, the corresponding markers and marker functions are also deactivated.

3. To switch on a delta marker, press the **Marker 2** softkey.

Marker 2 is switched on as a delta marker. The frequency and level of marker 2 are displayed in relation to marker 1 in the marker field.

4. To change the marker type of marker 2, press the **/Marker Norm/Delta** softkey.

Marker 2 becomes a normal marker. The frequency and level of marker 2 are displayed as absolute values in the marker field.

5. To switch off marker 2, press the **Marker 2** softkey again.

Marker 2 is deactivated. Marker 1 becomes the active marker for entry. The frequency and level of marker 1 are displayed in the marker field.

### To set a fixed reference point (phase noise measurement)

1. Press the **Phase Noise/Ref Fixed** softkey.  
The submenu with the **Phase Noise On/Off** softkey switched on is displayed. The level and frequency or time values of marker 1 immediately become the reference point.
2. To set the maximum of the selected trace as reference point, press the **Peak Search** softkey.
3. To define the values for the reference point, proceed as follows:
  - Press the **Ref Point Level** softkey and enter a reference level value.
  - If span > 0, press the **Ref Point Frequency** softkey and enter a frequency reference value.
  - If span = 0, press the **Ref Point Time** softkey and enter a reference time value.

### To set the demodulation mode and duration

1. Press the **Marker Demod** softkey.  
The submenu with the **Mkr Demod On/Off** softkey switched on is displayed.
2. To change the demodulation mode, press the **AM** or **FM** softkey.  
For details see "[AF demodulation](#)" on page 4.126.
3. To modify the demodulation time for span > 0, press the **Mkr Stop Time** softkey.
4. To change to continuous demodulation for span > 0, press the **Cont Demod** softkey.
5. To tune the volume for acoustic monitoring, press the **Volume** softkey.

### AF demodulation

The R&S ESL provides demodulators for AM and FM signals. With these demodulators, a displayed signal can be identified acoustically by using headphones.

#### CAUTION



#### Risk of hearing damage

Check the volume setting carefully before putting on the headphones in order to protect your hearing.

For span > 0, the demodulation is not continuous. The frequency at which the demodulation takes place is set by the active marker. If the level of the selected frequency is above the threshold line, the sweep stops for the selected time (stop time) and the RF signal is demodulated. For span = 0, the demodulation is continuously active irrespective of the stop time set.

### Frequency measurement with the frequency counter

In order to accurately determine the frequency of a signal, the R&S ESL is equipped with a frequency counter which measures the frequency of the RF signal at the intermediate frequency. Using the measured IF, the R&S ESL calculates the frequency of the RF input signal by applying the known frequency conversion factors.

The frequency measurement uncertainty depends only upon the accuracy of the frequency reference used (external or internal reference). Although the R&S ESL always operates synchronously irrespective of the set span, the frequency counter delivers a more exact result than a measurement performed with a marker. This is due to the following:



- The marker measures only the position of the point on the trace and infers from this value the signal frequency. The trace, however, contains only a limited number of points. Depending upon the selected span, each point may contain many measurement values, which therefore limits the frequency resolution.
- The resolution, with which the frequency can be measured with a marker, is dependant on the selected resolution bandwidth which in return affects the necessary measurement time. For this reason, the bandwidth is normally made as wide as possible and the sweep time as short as possible. This results in a loss of frequency resolution. For the measurement with the frequency counter, the sweep is stopped at the reference marker, the frequency is counted with the desired resolution and then the sweep is allowed to continue.

### Measurement of noise density

During noise measurement, the noise power density is measured at the position of the marker. For span = 0, all points of the trace are used to determine the noise power density. For span > 0, two points to the right and left of the marker are used for the measurement to obtain a stable result.

The noise power density is indicated in the marker field. With logarithmic amplitude units (dBm, dBmV, dBm $\mu$ V, dB $\mu$ A), the noise power density is output in dBm/Hz, i.e. as level in 1 Hz bandwidth with reference to 1 mW. With linear amplitude units (V, A, W), the noise voltage density is evaluated in  $\mu$ V/Hz, the noise current density in  $\mu$ A/Hz or the noise power density in  $\mu$ W/Hz.

In the default setting, the R&S ESL uses the sample detector for the noise function.

With the sample detector, the trace can additionally be set to Average to stabilize the measured values. With RMS detector used, trace averaging must not be used since in this case it produces too low noise levels which cannot be corrected. Instead, the sweep time can be increased to obtain stable measurement results.

The following settings have to be made to ensure that the power density measurement yields correct values:

- Detector: Sample or RMS
- Video bandwidth:
  - $\leq 0.1$  resolution bandwidth with sample detector
  - $\geq 3 \times$  resolution bandwidth with RMS detector
- Trace averaging:

With the sample detector, the trace can additionally be set to average to stabilize the measured values. With RMS detector used, trace averaging must not be used since in this case it produces too low noise levels which cannot be corrected. Instead, the sweep time can be increased to obtain stable measurement results.

The R&S ESL uses the following correction factors to evaluate the noise density from the marker level:

- Since the noise power is indicated with reference to 1 Hz bandwidth, the bandwidth correction value is deducted from the marker level. It is  $10 \times \lg(1 \text{ Hz}/\text{BW}_{\text{Noise}})$ , where  $\text{BW}_{\text{Noise}}$  is the noise or power bandwidth of the set resolution filter (RBW).
- RMS detector: With the exception of bandwidth correction, no further corrections are required since this detector already indicates the power with every point of the trace.
- Sample detector: As a result of video filter averaging and trace averaging, 1.05 dB is added to the marker level. This is the difference between the average value and the RMS value of white noise. With a logarithmic level axis, 1.45 dB is added additionally. Logarithmic averaging is thus fully taken into account which yields a value that is 1.45 dB lower than that of linear averaging.

- To allow a more stable noise display the adjacent (symmetric to the measurement frequency) points of the trace are averaged.
- For span > 0, the measured values are averaged versus time (after a sweep).

---

**Note:** *The R&S ESL noise figure can be calculated from the measured power density level. It is calculated by deducting the set RF attenuation (RF Att) from the displayed noise level and adding 174 to the result.*

---

**Softkeys of the marker menu**

The following table shows all softkeys available in the marker menu. It is possible that your instrument configuration does not provide all softkeys. If a softkey is only available with a special option, model or (measurement) mode, this information is delivered in the corresponding softkey description.

Menu / Command	Submenu / Command	Command
Marker 1		
Marker 2		
Marker Norm/Delta		
Noise Meas On/Off		
Phase Noise/Ref Fixed ↓	Phase Noise On/Off	
	Ref Point Level	
	Ref Point Frequency/ Ref Point Time	
	Peak Search	
	Phase Noise 1 2 3 4 Δ	
	Reference Fixed ↓	Reference Fixed On/Off
		Ref Point Level
		Ref Point Frequency/ Ref Point Time
		Peak Search
Sig Count On/Off		
More ↓		
Marker 3		
Marker 4		
Marker to Trace		
Marker Demod ↓	Mkr Demod On/Off	
	AM	
	FM	
	Mkr Stop Time	
	Cont Demod	
	Volume	
n dB down		
All Marker Off		

Menu / Command	Submenu / Command	Command
More ↓		
Marker Zoom		
Marker Peak List ↓	New Search	
	Sort Mode Freq/Lvl	
	Peak Excursion	
	Left Limit	
	Right Limit	
	Threshold	
	More ↓	
	Peak List Off	
	Threshold	
	ASCII File Export	
	Decim Sep	
Marker Stepsize ↓	Stepsize Standard	
	Stepsize Sweep Points	

### Marker 1/Marker 2/Marker 3/Marker 4/Marker Norm/Delta

The **Marker <no>** softkey activates the corresponding marker and opens an edit dialog box to enter a value for the marker to be set to. Pressing the softkey again deactivates the selected marker.

If a marker value is changed using the rotary knob, the step size is defined via the **Stepsize Standard** or **Stepsize Sweep Points** softkeys.

Marker 1 is always the reference marker for relative measurements. If activated, markers 2 to 4 are delta markers that refer to marker 1. These markers can be converted into markers with absolute value display by means of the **Marker Norm/Delta** softkey. If marker 1 is the active marker, pressing the **Marker Norm/Delta** softkey switches on an additional delta marker.

- Remote: CALC:MARK ON
- Remote: CALC:MARK:X <value>
- Remote: CALC:MARK:Y?
- Remote: CALC:DELT ON
- Remote: CALC:DELT:X <value>
- Remote: CALC:DELT:X:REL?
- Remote: CALC:DELT:Y?

---

**Noise Meas On/Off**

---

Switches the noise measurement for the active marker on or off. The corresponding marker becomes the normal marker. For more details on noise measurement see "[Measurement of noise density](#)" on page 4.127.

- Remote: CALC:MARK:FUNC:NOIS ON
  - Remote: CALC:MARK:FUNC:NOIS:RES?
- 

---

**Phase Noise/Ref Fixed**

---

The function of this softkey depends on the setting of the **Noise Meas** softkey:

- **Noise Meas On:** activates phase noise measurements.
  - **Noise Meas Off:** freezes the current position of marker 1 as a reference for relative measurements. Additionally it opens a submenu to set all values of a reference point. Instead of using the current values of the reference marker (marker 1) as reference point for the delta markers, level and frequency or time are set to fixed values and used as reference point.
- 

---

**Phase Noise On/Off**

---

Switches the relative measurement to a fixed reference value on or off. The level and frequency or time values of marker 1 immediately become the reference point, but can be altered using the corresponding softkeys (**Ref Point Level**, **Ref Point Frequency**, **Ref Point Time** and **Peak Search**).

- Remote: CALC:DELT2:FUNC:FIX ON
- 

---

**Ref Point Level**

---

Opens an edit dialog box to enter a reference level value. All relative level values of the delta markers refer to this reference level.

- Remote: CALC:DELT2:FUNC:FIX:RPO:Y -10dBm
- 

---

**Ref Point Frequency (span > 0) / Ref Point Time (zero span)**

---

Opens an edit dialog box to enter a frequency reference or time value. All relative frequency or time values of the delta markers refer to this frequency reference. For phase noise measurement, input of reference time is not possible..

- Remote: CALC:DELT2:FUNC:FIX:RPO:X 10.7MHz
  - Remote: CALC:DELT2:FUNC:FIX:RPO:X 5MS
- 

---

**Peak Search**

---

Sets the maximum value of the selected trace as the reference point.

- Remote: CALC:DELT:FUNC:FIX:RPO:MAX
-

**Phase Noise 1 2 3 4 Δ**

Selects the normal marker or the delta markers, activates the marker and opens an edit dialog box to enter a value for the marker to be set to. Δ stands for delta marker 1.

**Reference Fixed**

Opens a submenu for relative measurement to a fixed reference value.

**Reference Fixed On/Off**

Switches the relative measurement to a fixed reference value on or off. The level and frequency or time values of marker 1 immediately become the reference point, but can be altered using the corresponding softkeys (**Ref Point Level**, **Ref Point Frequency**, **Ref Point Time** and **Peak Search**).

→ Remote: CALC:DELT2:FUNC:FIX ON

**Sig Count On/Off**

Switches the frequency counter on/off. The frequency is counted at the position of the reference marker (marker 1). If no marker is activated, marker 1 is switched on and set at the largest signal.

The sweep stops at the reference marker until the frequency counter has delivered a result. The result is displayed in the marker field (see "[Fig. 4-7: Marker values](#)" on page 4.124), labeled with [Tx CNT]. For more details see "[Frequency measurement with the frequency counter](#)" on page 4.126.

→ Remote: CALC:MARK1:COUN ON

→ Remote: CALC:MARK:COUN:FREQ?

**Marker to Trace**

Opens an edit dialog box to enter the number of the trace, on which the marker is to be placed.

→ Remote: CALC:MARK1:TRAC 1

→ Remote: CALC:DELT:TRAC 1

**Marker Demod**

Opens a submenu to set the demodulation mode and duration. For more details see also "[AF demodulation](#)" on page 4.126.

**Mkr Demod On/Off**

Switches the demodulation on/off. For more details see also "[AF demodulation](#)" on page 4.126.

→ Remote: CALC:MARK1:FUNC:DEM ON

**AM**

Sets AM as demodulation mode. This is the default setting. For more details see also "[AF demodulation](#)" on page 4.126.

→ Remote: CALC:MARK1:FUNC:DEM:SEL AM

**FM**

Sets FM as demodulation mode. Default setting is AM. For more details see also "[AF demodulation](#)" on page 4.126.

→ Remote: CALC:MARK1:FUNC:DEM:SEL FM

**Mkr Stop Time**

Opens an edit dialog box to enter the demodulation stop time for span > 0. For more details see also "[AF demodulation](#)" on page 4.126.

→ Remote: CALC:MARK1:FUNC:DEM:HOLD 3s

**Cont Demod (span > 0)**

Switches the continuous demodulation on or off. If the sweep time is long enough, the set frequency range can be monitored acoustically. For more details see also "[AF demodulation](#)" on page 4.126.

→ Remote: CALC:MARK1:FUNC:DEM:CONT ON

**Volume**

Opens an edit dialog box to regulate the volume for acoustic monitoring. For more details see also "[AF demodulation](#)" on page 4.126.

→ Remote: SYST:SPE:VOL 0.5

**n dB down**

Opens an edit dialog box to enter a value to define the level spacing of the two temporary markers to the right and left of marker 1 (default setting: 3 dB). Activates the temporary markers T1 and T2. The values of the temporary markers (T1, T2) and the entered value (ndB) are displayed in the marker field.

If a positive value is entered, the markers T1 and T2 are placed below the active reference marker. If a negative value (e.g. for notch filter measurements) is entered, the markers T1 and T2 are placed above the active reference marker. Marker T1 is placed to the left and marker T2 to the right of the reference marker.

In the marker field, the following results are displayed:

Span setting	Parameter name	Description
span > 0	Bw	frequency spacing of the two temporary markers
	Q factor	quality of the displayed bandwidth value (Bw)
span = 0	PWid	pulse width between the two temporary markers

If it is not possible to form the frequency spacing for the n dB value (e.g. because of noise display), dashes instead of a measured value are displayed.

- Remote: CALC:MARK1:FUNC:NDBD:STAT ON
- Remote: CALC:MARK1:FUNC:NDBD 3dB
- Remote: CALC:MARK1:FUNC:NDBD:RES?
- Remote: CALC:MARK:FUNC:NDBD:QFAC?
- Remote: CALC:MARK1:FUNC:NDBD:FREQ? (span > 0)
- Remote: CALC:MARK1:FUNC:NDBD:TIME? (span = 0)

---

### All Marker Off

Switches all markers off.

- Remote: CALC:MARK:AOFF

---

### Marker Zoom (span > 0)

Opens an edit dialog box to enter a display range for the zoom. The area around marker 1 is expanded accordingly and more details of the spectrum can be seen. If no marker is activated, marker 1 is switched on and set on the largest signal..

The following sweep is stopped at the position of the reference marker. The frequency of the signal is counted and the measured frequency becomes the new center frequency. The zoomed display range is then configured and the new settings are used by the R&S ESL for further measurements.

As long as switching to the new frequency display range has not yet taken place, pressing the softkey will abort the procedure. If an instrument setting is changed while using this function, the procedure is aborted.

- Remote: CALC:MARK1:FUNC:ZOOM 1kHz

---

### Marker Peak List

Opens the **Peak List** dialog box and a submenu to define criterias for the sort order and the contents of the peak list. The number of listed peaks is indicated in the title bar. For all listed peaks the frequency and level values are given. Maximal 50 entries are listed.

- Remote: CALC:MARK:FUNC:FPE:COUN?
- Remote: CALC:MARK:FUNC:FPE:X?
- Remote: CALC:MARK:FUNC:FPE:Y?

---

### New Search

Starts a new peak search and enters the results in the peak list.

- Remote: CALC:MARK:FUNC:FPE 3

---

**Sort Mode Freq/Lvl**

---

Defines the criteria for sorting:

**Freq**      sorting in ascending order of frequency values (span > 0) or time values (span = 0)  
**Lvl**        sorting in ascending order of the level

→ Remote: CALC:MARK:FUNC:FPE:SORT Y

---

**Peak List Off**

---

Switches the peak list function off.

---

**ASCII File Export**

---

Opens the **ASCII File Export Name** dialog box and saves the content of the marker peak list in ASCII format to the specified file and directory. The file consists of a data section containing the peak list.

*Example:*

Peak;1  
1089743590;Hz  
-105.24;dBm  
...

This format can be processed by spreadsheet calculation programs, e.g. MS Excel. It is necessary to define ';' as a separator for the data import. Different language versions of evaluation programs may require a different handling of the decimal point. It is therefore possible to select between separators '.' (decimal point) and ',' (comma) using the **Decim Sep** softkey.

→ Remote: FORM ASC

→ Remote: MMEM:STOR:PEAK 'test'

---

**Decim Sep**

---

For details refer to the **Decim Sep** softkey in the trace menu of the base unit.

---

**Marker Stepsize**

---

Opens a submenu to set the step size of all markers and delta markers.

---

**Stepsize Standard**

---

Moves the marker or delta marker from one measurement point to the next, if the marker or delta marker value is changed via the rotary knob (**Marker 1/Marker 2/Marker 3/Marker 4** softkeys). If more measured values than measurement points exist, it is not possible to read out all measured values. In this case, use the **Stepsize Sweep Points** softkey.

→ Remote: CALC:MARK:X:SSIZ STAN

---



**Stepsize Sweep Points**

---

Moves the marker or delta marker from one measured value to the next, if the marker or delta marker value is changed via the rotary knob (**Marker 1/Marker 2/Marker 3/Marker 4** softkeys). If more measured values than measurement points exist, every single measured value is accessible and its value is displayed in the marker field.

The number of measured values is defined in the sweep menu via the **Sweep Points** softkey.

This functionality is available for all base unit measurements with the exception of statistics (**APD** and **CCDF** softkeys in the measurement menu).

→ Remote: `CALC:MARK:X:SSIZ POIN`

---

## Changing Settings via Markers – MKR→ Key

The **MKR→** key is used for search functions of measurement markers, assignment of the marker frequency as center frequency, restriction of the search area and characterization of maxima and minima. For details on markers in general, see "[Using Markers and Delta Markers – MKR Key](#)" on page 4.124.

### To open the marker→ menu

- Press the **MKR→** key.

The marker→ menu is displayed. If no marker is active, marker 1 will be activated and a peak search on the trace carried out. Otherwise, the edit dialog box for the last activated marker is opened and the current frequency / time value is displayed.

### Menu and softkey description

- "[Softkeys of the marker→ menu](#)" on page 4.140

To display help to a softkey, press the **HELP** key and then the softkey for which you want to display help. To close the help window, press the **ESC** key. For further information refer to section "How to use the Help System".

### Further information

- "[Effect of different peak excursion settings \(example\)](#)" on page 4.138

### Tasks

- [To search for a maximum](#)
- [To search for a minimum](#)
- [To specify the search limits](#)
- [To specify the search range](#)
- [To examine a signal at the center in detail](#)
- [To specify the suitable peak excursion](#)

### To search for a maximum

1. To search the highest maximum, press the **Peak** softkey.
2. To define the search mode for the next maximum, use the **Next Peak Mode < abs >** softkey.
3. To start the search, press **Next Peak** the softkey.

### To search for a minimum

1. To search the minimum, press the **Min** softkey.
2. To define the search mode for the next maximum, use the **Next Min Mode < abs >** softkey.
3. To start the search, press the **Next Min** softkey.

**To specify the search limits**

1. To define the lower limit, press the **Left Limit** softkey.
2. To define the upper limit, press the **Right Limit** softkey.
3. To define the threshold, press the **Threshold** softkey.
4. To switch the search limits off, press the **Search Lim Off** softkey.

**To specify the search range**

- Press the **Exclude LO** softkey to include the frequency 0 Hz in the marker search functions.

**To examine a signal at the center in detail**

1. Press the **PRESET** key to set the R&S ESL to the default setting.
2. Press the **MKR→** key to open the marker→ menu.
3. Marker 1 is activated and set to the largest signal of the trace.
4. Press the **Center =Mkr Freq** softkey to set to the marker frequency.
5. The span is adapted in such a way that the minimum frequency (= 0 Hz) or the maximum frequency is not exceeded.
6. Press the **Ref Lvl =Mkr Lvl** softkey to set the reference level to the measured marker level.
7. Press the **SPAN** key.
8. The edit dialog box to enter a frequency span is displayed.
9. Reduce the span, e.g. using the rotary knob.

**To specify the suitable peak excursion**

1. If the next peak mode **abs** of softkey **Next Peak Mode < abs > / Next Min Mode < abs >** is used, the default value is sufficient, since, in this mode, the next lower maximum or next higher minimum will always be detected.
2. If the next peak mode **< or >** of softkey **Next Peak Mode < abs > / Next Min Mode < abs >** is used, the 6 dB level change set as a default value may be attained already by the inherent noise of the instrument. To avoid identifying noise peaks as maxima or minima, enter a peak excursion value that is higher than the difference between the highest and the lowest value measured for the displayed inherent noise.

**Effect of different peak excursion settings (example)**

The following figure shows a trace to be examined.

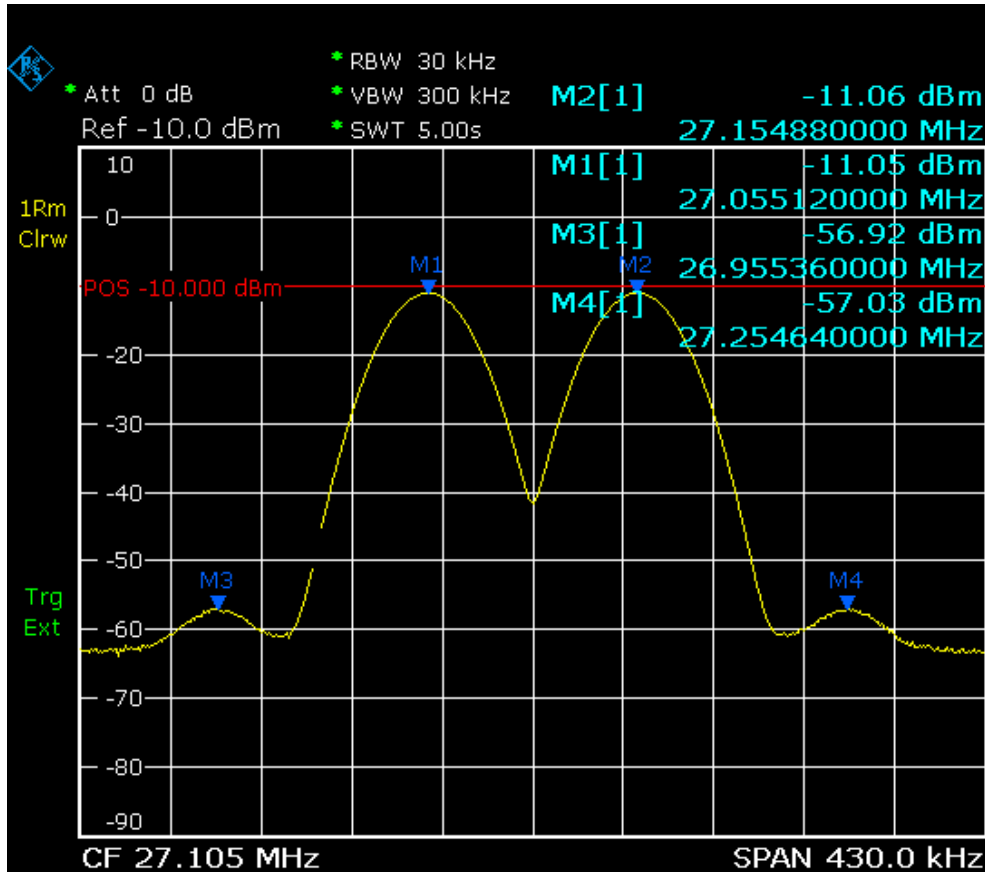

Fig. 4-8: Trace example

The following table lists the signals as indicated by the marker numbers in the diagram above, as well as the minimum of the amplitude decrease to both sides of the signal:

signal #	min. amplitude decrease to both sides of the signal
1	30 dB
2	29.85 dB
3	7 dB
4	7 dB

The detected signals and their order are different depending on the peak excursion setting and the peak search method (whether the next lower maximum or the next relative maximum are searched). The following results are obtained. All tests start with the marker set to signal 1 by pressing the softkey **Peak**.

- 40 dB peak excursion

Result: With both methods apart from signal 1 no signal is detected, as the signal level does not decrease by more than 30 dB to either side of any signal.

next lower maximum	next relative maximum
next peak mode <b>abs</b> : signal 1 (no further signal detected)	next peak mode <: signal 1 (no further signal detected)
	next peak mode >: signal 1 (no further signal detected)

- 20 dB peak excursion

Result: With both methods apart from signal 1 signal 2 is detected, as the signal level decreases at least by 29.85 dB to either side of this signal, which is now greater than the peak excursion.

next lower maximum	next relative maximum
next peak mode <b>abs</b> : signal 2	next peak mode <: signal 1 (no further signal detected)
next peak mode <b>abs</b> : signal 2 (no further signal detected)	next peak mode >: signal 2
	next peak mode >: signal 2 (no further signal detected)

- 6 dB peak excursion

Result: With both methods all signals are detected.

next lower maximum	next relative maximum
next peak mode <b>abs</b> : signal 2	next peak mode <: signal 3
next peak mode <b>abs</b> : signal 3	next peak mode >: signal 1
next peak mode <b>abs</b> : signal 4	next peak mode >: signal 2
	next peak mode >: signal 4

**Softkeys of the marker→ menu**

The following table shows all softkeys available in the marker→ menu. It is possible that your instrument configuration does not provide all softkeys. If a softkey is only available with a special option, model or (measurement) mode, this information is delivered in the corresponding softkey description.

Menu / Command	Command
Select 1 2 3 4 Δ	
Peak	
Next Peak	
Next Peak Mode < abs >	
Center =Mkr Freq	
Ref Lvl =Mkr Lvl	
More ↓	
Select 1 2 3 4 Δ	
Min	
Next Min	
Next Min Mode < abs >	
Search Limits ↓	Left Limit
	Right Limit
	Threshold
	Search Lim Off
Peak Excursion	
More ↓	
Exclude LO	
Auto Max Peak/Auto Min Peak	

**Select 1 2 3 4 Δ**

Selects the normal marker or the delta markers, activates the marker and opens an edit dialog box to enter a value for the marker to be set to. Δ stands for delta marker 1.

- Remote: CALC:MARK1 ON
- Remote: CALC:MARK1:X <value>
- Remote: CALC:MARK1:Y?

**Peak**

Sets the active marker/delta marker to the highest maximum of the trace.

- Remote: CALC:MARK:MAX
- Remote: CALC:DELT:MAX

---

**Next Peak**

---

Sets the active marker/delta marker to the next maximum of the selected trace according to the mode selected using the **Next Peak Mode < abs >** softkey.

---



---

**Next Peak Mode < abs >**

---

Selects the mode of the **Next Peak** softkey. Three settings are available:

- < Sets the active marker/delta marker to the next maximum left to the marker of the selected trace.
- abs Sets the active marker/delta marker to the next lower maximum of the selected trace.
- > Sets the active marker/delta marker to the next maximum right to the marker of the selected trace.

- Remote: CALC:MARK:MAX:LEFT (>)
  - Remote: CALC:DELT:MAX:LEFT (<)
  - Remote: CALC:MARK:MAX:RIGH (>)
  - Remote: CALC:DELT:MAX:RIGH (>)
  - Remote: CALC:MARK:MAX:NEXT (abs)
  - Remote: CALC:DELT:MAX:NEXT (abs)
- 

---

**Center =Mkr Freq (span > 0)**

---

Sets the center frequency to the current marker or delta marker frequency. A signal can thus be set to as center frequency, for example to examine it in detail with a smaller span.

Remote: CALC:MARK:FUNC:CENT

---



---

**Ref Lvl =Mkr Lvl**

---

Sets the reference level to the current marker level.

- Remote: CALC:MARK:FUNC:REF
- 

---

**Min**

---

Sets the active marker/delta marker to the minimum of the selected trace.

- Remote: CALC:MARK:MIN
  - Remote: CALC:DELT:MIN
- 

---

**Next Min**

---

Sets the active marker/delta marker to the next minimum of the selected trace according to the mode selected using the **Next Min Mode < abs >** softkey.

- Remote: CALC:MARK:MIN:NEXT
  - Remote: CALC:DELT:MIN:NEXT
-

**Next Min Mode < abs >**

---

Selects the mode of the **Next Min** softkey. Three settings are available:

- < Sets the active marker/delta marker to the next minimum left to the marker of the selected trace.
- abs Sets the active marker/delta marker to the next higher minimum of the selected trace.
- > Sets the active marker/delta marker to the next minimum right to the marker of the selected trace.

→ Remote: CALC:MARK:MAX:LEFT

→ Remote: CALC:DELT:MAX:LEFT

---

**Search Limits**

---

Opens a submenu to set the limits for maximum or minimum search in the x and y direction.

→ Remote: CALC:MARK:X:SLIM ON

---

**Left Limit**

---

Opens an edit dialog box to enter a value for the lower limit (left vertical line: S1 for span > 0; T1 for zero span). The search is performed between the lines of the left and right limit (see also **Right Limit** softkey).

→ Remote: CALC:MARK:X:SLIM:LEFT 1MHZ

---

**Right Limit**

---

Opens an edit dialog box to enter a value for the upper limit (left vertical line: S2 for span > 0; T2 for zero span). The search is performed between the lines of the left and right limit (see also **Left Limit** softkey). If no value is set, the upper limit corresponds to the stop frequency.

→ Remote: CALC:MARK:X:SLIM:RIGH 10MHZ

---

**Threshold**

---

Opens an edit dialog box to define the threshold line. The threshold line represents the lower level limit for a **Peak** search and the upper level limit for a **Min** search.

Opens an edit dialog box to define the threshold line. The threshold line represents the lower limit of the peak search level range.

→ Remote: CALC:THR -20dBm

→ Remote: CALC:THR ON

---

**Search Lim Off**

---

Deactivates all limits of the search range.

→ Remote: CALC:MARK:X:SLIM OFF

→ Remote: CALC:THR:STAT OFF

---



**Peak Excursion**

---

Opens – for level measurements – an edit dialog box to enter the minimum level value by which a signal must rise or fall so that it will be identified as a maximum or a minimum by the search functions. Entries from 0 dB to 80 dB are allowed; the resolution is 0.1 dB. The default setting for the peak excursion is 6 dB.

For details see also "[To specify the suitable peak excursion](#)" on page 4.137 and "[Effect of different peak excursion settings \(example\)](#)" on page 4.138.

→ Remote: `CALC:MARK:PEXC 10dB`

---

**Exclude LO**

---

Switches the frequency range limit for the marker search functions on or off.

activated      minimum frequency  $\geq 6 \times$  resolution bandwidth (RBW)

Because of the interference by the first local oscillator to the first intermediate frequency at the input mixer, the LO is represented as a signal at 0 Hz. To avoid the marker jumping to the LO at 0 Hz with the peak function when setting the display range, this frequency is excluded.

deactivated    no restriction to the search range. The frequency 0 Hz is included in the marker search functions.

→ Remote: `CALC:MARK:LOEX ON`

---

**Auto Max Peak / Auto Min Peak**

---

Adds an automatic peak search action for marker 1 at the end of each particular sweep. This function may be used during adjustments of a device under test to keep track of the actual peak marker position and level.

The actual marker search limit settings (**Left Limit**, **Right Limit**, **Threshold**, **Exclude LO** softkeys) are taken into account.

→ Remote: `CALC:MARK:MIN:AUTO ON`

→ Remote: `CALC:MARK:MAX:AUTO ON`

---

## Power Measurements – MEAS Key

With its power measurement functions, the R&S ESL is able to measure all the necessary parameters with high accuracy in a wide dynamic range.

A modulated carrier is almost always used (except e.g. SSB-AM) for high-frequency transmission of information. Due to the information modulated upon the carrier, the latter covers a spectrum which is defined by the modulation, the transmission data rate and the signal filtering. Within a transmission band each carrier is assigned a channel taking into account these parameters. In order to ensure error-free transmission, each transmitter must be conforming to the specified parameters. These include among others:

- the output power
- the occupied bandwidth, i.e. the bandwidth which must contain a defined percentage of the power
- the power dissipation allowed in the adjacent channels

The **MEAS** key is used for complex measurement functions as power measurements, occupied bandwidth, signal statistic, carrier to noise spacing, AM modulation depth, third-order intercept point, harmonics and spurious emissions. For measurement examples refer to chapter "Advanced Measurement Examples" and to the Quick Start Guide, chapter 5, "Basic Measurement Examples".

The following measurements can be performed:

- Power in zero span (**Time Domain Power** softkey; for details see "[Power measurement in zero span](#)" on page 4.146)
- Channel power and adjacent-channel power with span > 0 and with a single or several carriers (**CP, ACP, MC-ACP** softkey)
- Occupied bandwidth (**OBW** softkey, for details see "[Measurement of occupied bandwidth](#)" on page 4.147)
- Carrier-to-noise ratio (**C/N, C/No** softkey)
- Amplitude probability distribution (**APD** and **CCDF** softkeys, for details refer to chapter "Advanced Measurement Examples", "Amplitude Distribution Measurement")
- Modulation depth (**AM Mod Depth** softkey)
- 3rd order intercept (**TOI** softkey, for details refer to chapter "Advanced Measurement Examples", "Intermodulation Measurements")

### To open the power measurement menu

- Press the **MEAS** key.

The power measurement menu is displayed.

### Menu and softkey description

- "[Softkeys of the power measurement menu](#)" on page 4.155

To display help to a softkey, press the **HELP** key and then the softkey for which you want to display help. To close the help window, press the **ESC** key. For further information refer to section "How to use the Help System".

## Further information

- ["Power measurement in zero span"](#) on page 4.146
- ["Measurement of occupied bandwidth"](#) on page 4.147
- ["Predefined CP / ACP standards"](#) on page 4.148
- ["Settings of CP / ACP test parameters"](#) on page 4.149
- ["Ranges and range settings"](#) on page 4.150
- ["Provided XML files for the Spectrum Emission Mask measurement"](#) on page 4.151
- ["Format description of Spectrum Emission Mask XML files"](#) on page 4.152
- ["ASCII file export format \(Spectrum Emission Mask\)"](#) on page 4.154

## Tasks

- [To measure the power in zero span](#)
- [To set the channel configuration](#)
- [To measure the occupied bandwidth](#)
- [To measure signal statistics](#)
- [To measure the carrier-to-noise ratio](#)

### To measure the power in zero span

1. Press the **Time Domain Power** softkey to activate the power measurement.  
The corresponding submenu is displayed.
2. To limit the power evaluation range, switch on the limits (**Limits On/Off** softkey) and enter the limits by using the **Left Limit** and **Right Limit** softkeys.
3. Select the type of power measurement by using the **Mean** or **RMS** softkey. (RMS or mean power), the settings for max hold and averaging as well as the definition of limits.
4. To calculate and display the peak value, press the **Peak** softkey.
5. To calculate and display the standard deviation from the mean value, press the **Std Dev** softkey.

### To set the channel configuration

1. Press the **CP, ACP, MC-ACP** softkey to active channel or adjacent-channel power measurement.  
The corresponding submenu is displayed.
2. To use a predefined standard for measurement, press the **CP / ACP Standard** softkey (for details on available standards see ["Predefined CP / ACP standards"](#) on page 4.148).
3. To configure the parameters independently of the predefined standards, press the **CP / ACP Config** softkey (for details see ["Settings of CP / ACP test parameters"](#) on page 4.149).
4. To enter the sweep time, press the **Sweep Time** softkey.
5. To display the whole diagram, press the **Full Size Diagram** softkey.
6. To adjust the reference level to the measured channel power, press the **Adjust Ref Level** softkey.

### To measure the occupied bandwidth

1. Press the **OBW** softkey to activate the measurement of the occupied bandwidth (for details see also "[Measurement of occupied bandwidth](#)" on page 4.147).

The corresponding submenu is displayed.

2. Press the **% Power Bandwidth** softkey to enter the percentage of power.
3. To change the channel bandwidth for the transmission channel, press the **Channel Bandwidth** softkey.
4. To optimize the settings for the selected channel configuration, press the **Adjust Settings** softkey (for details see also "[Settings of CP / ACP test parameters](#)" on page 4.149).
5. To adjust the reference level to the measured total power after the first sweep, press the **Adjust Ref Level** softkey.

### To measure signal statistics

- To activate and configure the measurement of the amplitude probability distribution (APD), press the **APD** softkey (for details refer to chapter "Advanced Measurement Examples", "Amplitude Distribution Measurement").

The corresponding submenu is displayed.

- To activate and configure the measurement of the complementary cumulative distribution (CCDF), press the **CCDF** softkey (for details refer to chapter "Advanced Measurement Examples", "Amplitude Distribution Measurement").

The corresponding submenu is displayed.

### To measure the carrier-to-noise ratio

1. Press the **C/N, C/No** softkey to configure the carrier-to-noise ratio measurement.  
The corresponding submenu is displayed.
2. To activate the measurements without reference to the bandwidth, press the **C/N** softkey.
3. To activate the measurements with reference to the bandwidth, press the **C/No** softkey.
4. To change the channel bandwidth for the transmission channel, press the **Channel Bandwidth** softkey.
5. To optimize the settings for the selected channel configuration, press the **Adjust Settings** softkey (for details see also "[Settings of CP / ACP test parameters](#)" on page 4.149).

### Power measurement in zero span

With the aid of the power measurement function, the R&S ESL determines the power of the signal in zero span by summing up the power at the individual measurement points and dividing the result by the number of measurement points. In this way it is possible to measure for example the power of TDMA signals during transmission or during the muting phase. Both the mean power and the RMS power can be measured by means of the individual power values.

The result is displayed in the marker field. The measured values are updated after each sweep or averaged over a user-defined number of sweeps in order to determine e.g. the mean power over several bursts. For determination of the peak value the maximum value from several sweeps is displayed.

If both the on and off phase of a burst signal are displayed, the measurement range can be limited to the transmission or to the muting phase with the aid of vertical lines. The ratio between signal and noise power of a TDMA signal for instance can be measured by using a measurement as a reference value and after that varying the measurement range.

Upon switching on power measurement the sample detector is activated.

### Measurement of occupied bandwidth

An important characteristic of a modulated signal is its occupied bandwidth. In a radio communications system for instance the occupied bandwidth must be limited to enable distortion-free transmission in adjacent channels. The occupied bandwidth is defined as the bandwidth containing a defined percentage of the total transmitted power. A percentage between 10% and 99.9% can be set.

The measurement principle is the following: The bandwidth containing 99% of the signal power is to be determined, for example. The routine first calculates the total power of all displayed points of the trace. In the next step, the points from the right edge of the trace are summed up until 0.5% of the total power is reached. Auxiliary marker 1 is positioned at the corresponding frequency. Then the points from the left edge of the trace are summed up until 0.5% of the power is reached. Auxiliary marker 2 is positioned at this point. 99% of the power is now between the two markers. The distance between the two frequency markers is the occupied bandwidth which is displayed in the marker field.

To ensure correct power measurement, especially for noise signals, and to obtain the correct occupied bandwidth, the following prerequisites and settings are necessary:

- Only the signal to be measured is displayed on the screen. An additional signal would falsify the measurement.
- $RBW \ll \text{occupied bandwidth}$   
(approx. 1/20 of occupied bandwidth, for voice communication type 300 Hz or 1 kHz)
- $VBW \geq 3 \times RBW$
- RMS detector
- $\text{Span} \geq 2 \text{ to } 3 \times \text{occupied bandwidth}$

Some of the measurement specifications (e.g. PDC, RCR STD-27B) require measurement of the occupied bandwidth using a peak detector. The detector setting of the R&S ESL has to be changed accordingly then.

### Predefined CP / ACP standards

The test parameters for the channel and adjacent-channel measurements are set according to the mobile radio standard. The available standards are listed below.

Parameter	Standard
CDMA2000	CDMA 2000
CDMA IS95A FWD	CDMA IS95A forward
CDMA IS95A REV	CDMA IS95A reverse
CDMA IS95C Class 0 FWD	CDMA IS95C Class 0 forward
CDMA IS95C Class 0 REV	CDMA IS95C Class 0 reverse
CDMA IS95C Class 1 FWD	CDMA IS95C Class 1 forward
CDMA IS95C Class 1 REV	CDMA IS95C Class 1 reverse
CDMA J-STD008 FWD	CDMA J-STD008 forward
CDMA J-STD008 REV	CDMA J-STD008 reverse
CDPD	CDPD
NADC IS136	NADC IS136
PDC	PDC
PHS	PHS
RFID 14443	RFID 14443
TD-SCDMA FWD	TD-SCDMA forward
TD-SCDMA REV	TD-SCDMA reverse
TETRA	TETRA
W-CDMA 3GPP FWD	W-CDMA 3.84 MHz forward
W-CDMA 3GPP REV	W-CDMA 3.84 MHz reverse
WIBRO	WIBRO
WiMAX	WiMAX
WLAN 802.11A	WLAN 802.11A
WLAN 802.11B	WLAN 802.11B

**Note:** For the R&S ESL, the channel spacing is defined as the distance between the center frequency of the adjacent channel and the center frequency of the transmission channel. The definition of the adjacent-channel spacing in standards IS95 B / C, IS97 B / C, IS98 B / C and CDMA2000 DS / MC1 / MC3 is different. These standards define the adjacent-channel spacing from the center of the transmission channel to the closest border of the adjacent channel. This definition is also used for the R&S ESL if the standard settings marked with a dagger are selected.

## Settings of CP / ACP test parameters

- **Frequency span**

The frequency span must at least cover the channels to be measured plus a measurement margin of approx. 10%.

---

**Note:** *If the frequency span is large in comparison to the channel bandwidth (or the adjacent-channel bandwidths) being examined, only a few points on the trace are available per channel. This reduces the accuracy of the waveform calculation for the channel filter used, which has a negative effect on the measurement accuracy. It is therefore strongly recommended that the formulas mentioned be taken into consideration when selecting the frequency span.*

---

For channel power measurements the **Adjust Settings** softkey sets the frequency span as follows:

*(No. of transmission channels – 1) x transmission channel spacing + 2 x transmission channel bandwidth + measurement margin*

For adjacent-channel power measurements, the **Adjust Settings** softkey sets the frequency span as a function of the number of transmission channels, the transmission channel spacing, the adjacent-channel spacing, and the bandwidth of one of adjacent-channels ADJ, ALT1 or ALT2, whichever is furthest away from the transmission channels:

*(No. of transmission channels – 1) x transmission channel spacing + 2 x (adjacent-channel spacing + adjacent-channel bandwidth) + measurement margin*

The measurement margin is approx. 10% of the value obtained by adding the channel spacing and the channel bandwidth.

- **Resolution bandwidth (RBW)**

To ensure both, acceptable measurement speed and required selection (to suppress spectral components outside the channel to be measured, especially of the adjacent channels), the resolution bandwidth must not be selected too small or too large. As a general approach, the resolution bandwidth is to be set to values between 1% and 4% of the channel bandwidth.

A larger resolution bandwidth can be selected if the spectrum within the channel to be measured and around it has a flat characteristic. In the standard setting, e.g. for standard IS95A REV at an adjacent channel bandwidth of 30 kHz, a resolution bandwidth of 30 kHz is used. This yields correct results since the spectrum in the neighborhood of the adjacent channels normally has a constant level. For standard NADC/IS136 this is not possible for example, since the spectrum of the transmit signal penetrates into the adjacent channels and a too large resolution bandwidth causes a too low selection of the channel filter. The adjacent-channel power would thus be measured too high.

With the exception of the IS95 CDMA standards, the **Adjust Settings** softkey sets the resolution bandwidth (RBW) as a function of the channel bandwidth:

*RBW ≤ 1/40 of channel bandwidth*

The maximum possible resolution bandwidth (with respect to the requirement  $RBW \leq 1/40$ ) resulting from the available RBW steps (1, 3) is selected.

- **Video bandwidth (VBW)**

For a correct power measurement, the video signal must not be limited in bandwidth. A restricted bandwidth of the logarithmic video signal would cause signal averaging and thus result in a too low indication of the power (–2.51 dB at very low video bandwidths). The video bandwidth should therefore be selected at least three times the resolution bandwidth:

*VBW ≥ 3 x RBW*

The **Adjust Settings** softkey sets the video bandwidth (VBW) as a function of the channel bandwidth (see formula above) and the smallest possible VBW with regard to the available step size will be selected.

- **Detector**

The **Adjust Settings** softkey selects the RMS detector. This detector is selected since it correctly indicates the power irrespective of the characteristics of the signal to be measured. The whole IF envelope is used to calculate the power for each measurement point. The IF envelope is digitized using a sampling frequency which is at least five times the resolution bandwidth which has been selected. Based on the sample values, the power is calculated for each measurement point using the following formula:

$$P_{RMS} = \sqrt{\frac{1}{N} \cdot \sum_{i=1}^N s_i^2}$$

$s_i$  = linear digitized video voltage at the output of the A/D converter

$N$  = number of A/D converter values per measurement point

$P_{RMS}$  = power represented by a measurement point

When the power has been calculated, the power units are converted into decibels and the value is displayed as a measurement point.

In principle, the sample detector would be possible as well. Due to the limited number of measurement points used to calculate the power in the channel, the sample detector would yield less stable results.

- **Trace averaging**

The **Adjust Settings** softkey switches off this function. Averaging, which is often performed to stabilize the measurement results, leads to a too low level indication and should therefore be avoided. The reduction in the displayed power depends on the number of averages and the signal characteristics in the channel to be measured.

- **Reference level**

The **Adjust Settings** softkey does not influence the reference level. It can be separately adjusted using the **Adjust Settings** softkey.

## Ranges and range settings

In the Spectrum Emission Mask and Spurious Emissions measurements, a range defines a segment, for which you can define the following parameters separately: start and stop frequency, RBW, VBW, sweep time, sweep points, reference level, attenuator settings, and limit values. Via the sweep list, you define the ranges and their settings (for details on settings refer to the **Sweep List** softkey).

The following rules apply to ranges:

- The minimum span of a range is 20 Hz.
- The individual ranges must not overlap (but need not directly follow one another).
- The maximum number of ranges is 20.
- Spectrum Emission Mask measurement only: A minimum of three ranges is mandatory.
- Spectrum Emission Mask measurement only: The reference range cannot be deleted (it is marked in blue color).



### Provided XML files for the Spectrum Emission Mask measurement

You can change the settings manually or via XML files. The XML files offer a quick way to change the configuration. A set of XML files for different standards is already provided. For details see Table 4-5: Provided XML files. You can also create and use your own XML files (for details see "[Format description of Spectrum Emission Mask XML files](#)" on page 4.152). All XML files are stored under `C:\r_sl\instr\sem_std`. Use the [Load Standard](#) softkey for quick access to the available XML files.

Table 4-5: Provided XML files

Path	XML file name	Displayed standard characteristics*
C:\r_sl\instr\sem_std\cdma2000\DL	default0.xml	cdma2000 BTS BC0 default
	default1.xml	cdma2000 BTS BC1 default
C:\r_sl\instr\sem_std\cdma2000\UL	default0.xml	cdma2000 MS BC0 default
	default1.xml	cdma2000 MS BC1 default
C:\r_sl\instr\sem_std\WCDMA\3GPP\DL	PowerClass_31_39.xml	W-CDMA 3GPP DL (31,39)dBm
	PowerClass_39_43.xml	W-CDMA 3GPP DL (39,43)dBm
	PowerClass_43_INF.xml	W-CDMA 3GPP DL (43,INF)dBm
	PowerClass_negINF_31.xml	W-CDMA 3GPP DL (-INF,31)dBm
C:\r_sl\instr\sem_std\WIBRO\DL	PowerClass_29_40.xml	WiBro TTA DL (29,40)dBm
	PowerClass_40_INF.xml	WiBro TTA DL (40,INF)dBm
	PowerClass_negINF_29.xml	WiBro TTA DL (-INF,29)dBm
C:\r_sl\instr\sem_std\WIBRO\UL	PowerClass_23_INF.xml	WiBro TTA UL (23,INF)dBm
	PowerClass_negINF_23.xml	WiBro TTA UL (23,INF)dBm
C:\R_S\instr\sem_std\WIMAX\DL\ETSI\...MHz (1.75 MHz, 2.00 MHz, 3.5 MHz, 7.00 MHz, 14.00 MHz, 28 MHz)	System_Type_E.xml	WIMAX DL ETSI-System Type E
	System_Type_F.xml	WIMAX DL ETSI-System Type F
	System_Type_G.xml	WIMAX DL ETSI-System Type G
C:\R_S\instr\sem_std\WIMAX\DL\IEEE	10MHz.xml	WIMAX DL 10MHz
	20MHz.xml	WIMAX DL 20MHz
C:\R_S\instr\sem_std\WIMAX\UL\ETSI\...MHz (1.75 MHz, 2.00 MHz, 3.5 MHz, 7.00 MHz, 14.00 MHz, 28 MHz)	System_Type_E.xml	WIMAX UL ETSI-System Type E
	System_Type_F.xml	WIMAX UL ETSI-System Type F
	System_Type_G.xml	WIMAX UL ETSI-System Type G
C:\R_S\instr\sem_std\WIMAX\UL\IEEE	10MHz.xml	WIMAX UL 10MHz
	20MHz.xml	WIMAX UL 20MHz
C:\R_S\instr\sem_std\WLAN\802_11_TURBO	ETSI.xml	IEEE 802.11 TURBO (ETSI)
	IEEE.xml	IEEE 802.11 TURBO (IEEE)
C:\R_S\instr\sem_std\WLAN\802_11a	ETSI.xml	IEEE 802.11a (ETSI)
	IEEE.xml	IEEE 802.11a
C:\R_S\instr\sem_std\WLAN\802_11b	IEEE.xml	IEEE 802.11b

Path	XML file name	Displayed standard characteristics*
C:\R_S\instr\sem_std\WLAN\802_11j_10MHz	ETSI.xml	IEEE.11j 10MHz (ETSI)
	IEEE.xml	IEEE.11j 10MHz
C:\R_S\instr\sem_std\WLAN\802_11j_20MHz	ETSI.xml	IEEE 802.11j 20MHz (ETSI)
	IEEE.xml	IEEE 802.11j 20MHz

\*Used abbreviations:

- BTS: base station (uplink)
- BC: band class
- MS: mobile station (downlink)
- UL: uplink
- DL: downlink
- TTA: Telecommunications Technology Association

Note: For the WIBRO standards, the 1 MHz channel filter is used for every occurrence of a 1 MHz filter.

### Format description of Spectrum Emission Mask XML files

The files for importing range settings are in XML format and therefore obey the rules of the XML standard. In the following, the elements, attributes, and structure defined for the range data import are described. Build your own XML files according to these conventions because the R&S ESL can only interpret XML files of a known structure. For example files look in the C:\r\_s\instr\sem\_std directory.

The base format consists of the following XML structure:

```

<Root_Element>
  <SEMConfig ... >
    <Ranges>
      <Range ... />
      ...
    </Ranges>
  </SEMConfig>
</Root_Element>
    
```

In Table 4-6 the possible attributes of the SEMConfig element are listed. These attributes define global settings for all ranges. The Standard, LinkDirection, PowerClass, BandClass and Comment attributes do not affect the measurement. They are used to display the Spectrum Emission Mask Standard information on the measurement screen.

Spectrum Emission Mask Standard: W-CDMA 3GPP DL (39,43)dBm							
Tx Power		-70.75 dBm	Tx Bandwidth		3.840 MHz	RBW	1 MHz
Range [Hz]	RBW [Hz]	Frequency [Hz]	PwrAbs [dBm]	PwrRel [dBc]	ΔLimit [dB]		
-12.750 M	-8.000 M	1 M	2.991974 G	-77.89	-7.14	47.36	*
-8.000 M	-4.000 M	1 M	2.995923 G	-93.74	-22.99	-82.24	
-4.000 M	-3.515 M	30 k	2.996404 G	-100.18	-29.43	-75.68	
-3.515 M	-2.715 M	30 k	2.996512 G	-105.54	-34.78	-81.04	
-2.715 M	-2.515 M	30 k	2.997318 G	-105.54	-34.78	-93.04	
2.515 M	2.715 M	30 k	3.002548 G	-105.54	-34.78	-93.04	
2.715 M	3.515 M	30 k	3.003382 G	-102.45	-31.70	-79.95	
3.515 M	4.000 M	30 k	3.003919 G	-100.18	-29.43	-75.68	
4.000 M	8.000 M	1 M	3.004026 G	-105.54	-34.78	-81.04	
8.000 M	12.750 M	1 M	3.012724 G	-77.89	-7.14	47.36	*

In the example above (*DLPowerClass\_39\_43.xml* under *C:\r\_s\instr\sem\_std\WCDMA\3GPP*), these attributes are defined as follows:

- Standard="W-CDMA 3GPP"
- LinkDirection="DL"
- PowerClass="(39,43)dBm"

Table 4-6: Attributes of the *SEMConfig* element

Attribute name	Attribute value	Parameter description	Mandatory?
Standard	<string>	–	no
ReferencePower	TX Channel Peak Power   TX Channel Power	Edit Reference Range	no
Limit_Check_Mode	Absolute   Relative   Abs and Rel   Abs or Rel	Limit Check	no
LinkDirection	DL   UL	–	no
BandClass	<string>	–	no
Comment	<string>	–	no
PowerClass	(<minPower>,<maxPower>)dBm	–	no
Detector	RMS   NEGative   POSitive   SAMPlE   AVERAge	Detector Manual Select (TRACE key)	no

The attributes of the *Range* element carry the settings information of the range. Accordingly, the same rules apply as characterized for the settings parameter. For details refer to the **Sweep List** softkey und the corresponding parameter descriptions.

Sort the ranges according to their frequency values in increasing order. Define one reference range. The reference range carries special attributes listed in Table 4-8.

Table 4-7: Attributes of the *Range* element (normal ranges)

Attribute name	Attribute value	Parameter description	Mandatory?
StartF	<frequency value in Hz>	Range Start	yes
StopF	<frequency value in Hz>	Range Stop	yes
FilterType	NORMal   CFILTer   RRC   PULSe	Filter Type	no
RBW	<RBW value in Hz>	RBW	no
VBW	<VBW value in Hz>	VBW	no
SWT_Mode	Auto   Manual	Sweep Time Mode	no
SWT_Value	<sweep time in s>	Sweep Time	no
REF_Level	<reference level in dBm>	Ref. Level	no
RF_ATT_Mode	Auto   Manual	RF Att. Mode	no
RF_ATT_Value	On   Off	RF Attenuator	no
Preamp	1   0	Preamp	no
Limit_Abs_Start	<limit value in dBm>	Abs Limit Start	no
Limit_Abs_Stop	<limit value in dBm>	Abs Limit Stop	no
Limit_Rel_Start	<limit value in dBc>	Rel Limit Start	no
Limit_Rel_Stop	<limit value in dBc>	Rel Limit Stop	no

The reference range is defined by the *TX* attribute. Only if the channel power reference type is selected (*ReferencePower="TX Channel Power"*, see Table 4-6 Attributes of the *SEMConfig* element), further attributes are available to characterize the reference range. These attributes correspond to the setting parameters provided via the **Edit Reference Range** softkey.

Table 4-8: Special attributes of the *Range* element (reference range)

Attribute name	Attribute value	Mandatory?
TX	1	yes
FilterState	On   Off	no
Alpha	0 ... 1	yes if FilterState="On"
TxBandwidth	<value in Hz>	yes if FilterState="On"

**ASCII file export format (Spectrum Emission Mask)**

The first part of the file lists information about the spectrum analyzer and the general setup. For a detailed description refer to "[ASCII file export format](#)" on page 4.122.

File contents	Description
RefType; CPOWER; TxBandwidth;9540000;Hz Filter State; ON; Alpha;0.22;	reference range setup, for details see <b>Edit Reference Range</b> softkey
PeaksPerRange;1; Values;4;	evaluation list information
0;-22500000;-9270000;1000000;2986455000;-74.762840270996094; -10.576210021972656;-45.762840270996094;PASS; 1;-9270000;-4770000;100000;2991405000;-100.17695617675781; -35.990325927734375;-1.490325927734375;PASS 3;4770000;9270000;100000;3005445000;-100.17695617675781; -35.990325927734375;-1.490325927734375;PASS; 4;9270000;22500000;1000000;3018225000;-74.762840270996094; -10.576210021972656;-45.762840270996094;PASS;	information about each peak:  <range number>; <start frequency>; <stop frequency>; <resolution bandwidth of range>; <frequency of peak>; <absolute power in dBm of peak>; <relative power in dBc of peak (related to the channel power)>; <distance to the limit line in dB (positive value means above the limit)>; <limit fail (pass = 0, fail =1)>;

### Softkeys of the power measurement menu

The following table shows all softkeys available in the power measurement menu. It is possible that your instrument configuration does not provide all softkeys. If a softkey is only available with a special option, model or (measurement) mode, this information is delivered in the corresponding softkey description.

Menu / Command	Submenu / Command	Submenu / Command	Command
All Functions Off			
TOI ↓	Marker 1		
	Marker 2		
	Marker 3		
	Marker 4		
	Search Signals		
AM Mod Depth ↓	same contents as TOI menu		
Time Domain Power ↓	Peak		
	RMS		
	Mean		
	Std Dev		
	Limits On/Off		
	Left Limit		
	Right Limit		
C/N, C/No ↓	C/N		
	C/No		
	Channel Bandwidth		
	Adjust Settings		
CP, ACP, MC-ACP ↓	CP / ACP Standard		
	CP / ACP Config ↓	# of TX Chan	
		# of Adj Chan	
		Channel Settings ↓	Channel Bandwidth
			Channel Spacing
			Chan Pwr/Hz
			ACP Ref Settings
			Adjust Ref Level
			Adjust Settings
		Limit Checking ↓	Limit Chk On/Off
			Edit ACP Limit
		Power Mode ↓	Clear/Write
			Max Hold
		Select Trace	

Menu / Command	Submenu / Command	Submenu / Command	Command
		Adjust Settings	
	Sweep Time		
	Fast ACP On/Off		
	ACP Abs/Rel		
	Adjust Ref Level		
More ↓			
All Functions Off			
OBW ↓	% Power Bandwidth		
	Channel Bandwidth		
	Adjust Ref Level		
	Adjust Settings		
APD ↓	Percent Marker		
	Res BW		
	# of Samples		
	Scaling ↓	x–Axis Ref Level	
		x–Axis Range	
		y–Axis Max Value	
		y–Axis Min Value	
		y–Unit %/Abs	
		Default Settings	
		Adjust Settings	
	Adjust Settings		
CCDF ↓	same contents as APD menu		
Spectrum Emission Mask ↓	Sweep List ↓	Edit Sweep List/Close Sweep List	
		Insert before Range	
		Insert after Range	
		Delete Range	
		Edit Reference Range	
	List Evaluation ↓	List Evaluation On/Off	
		List Full Screen	
		Margin	
		Show Peaks	
		List Up	
		List Down	
		Save Evaluation List ↓	ASCII File Export
			Decim Sep
	Edit Reference Range		

Menu / Command	Submenu / Command	Submenu / Command	Command
	Load Standard		
	Restore Standard Files		
	Meas Start/Stop		
Spurious Emissions ↓	Sweep List ↓	Edit Sweep List/Close Sweep List	
		Insert before Range	
		Insert after Range	
		Delete Range	
		Adjust X-Axis	
	List Evaluation ↓	List Evaluation On/Off	
		List Full Screen	
		Details On/Off	
		Peaks per Range	
		Margin	
		Show Peaks	
		More ↓	
		List Up	
		List Down	
		Save Evaluation List ↓	ASCII File Export
			Decim Sep
	Meas Start/Stop		
More ↓			
All Functions Off			
Harmonic Distortion ↓	Harmonic On/Off		
	No. of Harmonics		
	Harmonic Sweep Time		
	Harmonic RBW Auto		
	Adjust Settings		
Full Size Diagram			

### All Functions Off

Switches off all power measurement functions.

→ Remote: CALC:MARK:FUNC:<function> OFF

---

**TOI**

---

Opens a submenu and activates the measurement of the 3rd order intercept point.

A two-tone signal with equal carrier levels is expected at the R&S ESL input. Marker 1 and marker 2 (both normal markers) are set to the maximum of the two signals. Marker 3 and marker 4 (also both normal markers) are placed on the intermodulation products. When the function is enabled, the frequency entry is activated for the delta markers. They can be set manually.

The R&S ESL calculates the third order intercept point from the level spacing between normal markers and delta markers and displays it in the marker field.

- Remote: CALC:MARK:FUNC:TOI ON
  - Remote: CALC:MARK:FUNC:TOI:RES?
- 

---

**Search Signals**

---

Activates all markers.

- Remote: CALC:MARK:FUNC:TOI:RES?
- 

---

**AM Mod Depth**

---

Opens a submenu and activates the measurement of the AM modulation depth. An AM-modulated carrier is required on the screen for ensuring correct operation.

The level value of marker 1 is taken as the carrier level. When this function is activated, marker 2 and marker 3 are automatically set symmetrically to the carrier on the adjacent peak values of the trace as delta markers and marker 2 is activated for the entry.

When the position of marker 2 (delta) is changed, marker 3 (delta) is moved symmetrically with respect to the reference marker (marker 1).

If the edit dialog box is opened for marker 3, the latter can be moved for fine adjustment irrespective of marker 2.

The R&S ESL calculates the power at the marker positions from the measured levels. The AM modulation depth is calculated from the ratio between the power values at the reference marker and at the delta markers. If the powers of the two AM side bands are unequal, the mean value of the two power values is used for AM modulation depth calculation.

- Remote: CALC:MARK:FUNC:MDEP ON
  - Remote: CALC:MARK:FUNC:MDEP:RES?
- 

---

**Time Domain Power (zero span)**

---

Activates the power measurement in zero span and opens a submenu to configure the power measurement. For more details see also "[Power measurement in zero span](#)" on page 4.146.

- Remote: CALC:MARK:FUNC:SUMM:STAT ON
-



**Peak (zero span)**

Activates the calculation of the peak value from the points of the displayed trace or a segment thereof. For more details see also "[Power measurement in zero span](#)" on page 4.146.

- Remote: CALC:MARK:FUNC:SUMM:PPE ON
- Remote: CALC:MARK:FUNC:SUMM:PPE:RES?

**RMS (zero span)**

Activates the calculation of the RMS value from the points of the displayed trace or a segment thereof. For more details see also "[Power measurement in zero span](#)" on page 4.146.

- Remote: CALC:MARK:FUNC:SUMM:RMS ON
- Remote: CALC:MARK:FUNC:SUMM:RMS:RES?

**Mean (zero span)**

Activates the calculation of the mean value from the points of the displayed trace or a segment thereof. The linear mean value of the equivalent voltages is calculated.

This can be used for instance to measure the mean power during a GSM burst.

For more details see also "[Power measurement in zero span](#)" on page 4.146.

- Remote: CALC:MARK:FUNC:SUMM:MEAN ON
- Remote: CALC:MARK:FUNC:SUMM:MEAN:RES?

**Std Dev (zero span)**

Activates the calculation of the standard deviation of measurement points from the mean value and displays them as measured value. The measurement of the mean power is automatically switched on at the same time. For more details see also "[Power measurement in zero span](#)" on page 4.146.

- Remote: CALC:MARK:FUNC:SUMM:SDEV ON
- Remote: CALC:MARK:FUNC:SUMM:SDEV:RES?

**Limits On/Off (zero span)**

Switches the limitation of the evaluation range on or off. Default setting is off.

If switched off, the evaluation range is not limited. If switched on, the evaluation range is defined by the left and right limit. If only one limit is set, it corresponds to the left limit and the right limit is defined by the stop frequency. If the second limit is also set, it defines the right limit.

For more details see also "[Power measurement in zero span](#)" on page 4.146.

- Remote: CALC:MARK:X:SLIM OFF

**Left Limit (zero span)**

Opens an edit dialog box to enter a value for line 1. For more details see also "[Power measurement in zero span](#)" on page 4.146.

- Remote: CALC:MARK:X:SLIM:LEFT <value>

**Right Limit (zero span)**

Opens an edit dialog box to enter a value for line 2. For more details see also "[Power measurement in zero span](#)" on page 4.146.

→ Remote: CALC:MARK:X:SLIM:RIGH <value>

**C/N, C/No (span > 0)**

Opens a submenu to configure the carrier/noise ratio measurement. Measurements without (C/N) and measurements with reference to the bandwidth (C/No) are possible.

**C/N (span > 0)**

Switches the measurement of the carrier/noise ratio on or off. If no marker is active, marker 1 is activated.

The measurement is performed on the trace where marker 1 is located. To shift marker 1 and measure another trace, use the **Marker to Trace** softkey in the marker menu. To determine the maximum value of the current trace, use the **Phase Noise/Ref Fixed** softkey in the marker menu.

→ Remote: CALC:MARK:FUNC:POW:SEL CN  
 → Remote: CALC:MARK:FUNC:POW:RES? CN  
 → Remote: CALC:MARK:FUNC:POW OFF

**C/No (span > 0)**

Switches the measurement of the carrier/noise ratio with reference to a 1 Hz bandwidth on or off. If no marker is active, marker 1 is activated.

The measurement is performed on the trace where marker 1 is located. To shift marker 1 and measure another trace, use the **Marker to Trace** softkey in the marker menu. To determine the maximum value of the current trace, use the **Phase Noise/Ref Fixed** softkey in the marker menu.

→ Remote: CALC:MARK:FUNC:POW:SEL CN0  
 → Remote: CALC:MARK:FUNC:POW:RES? CN0  
 → Remote: CALC:MARK:FUNC:POW OFF

**Channel Bandwidth (span > 0)**

Opens an edit dialog box to enter the measurement channel bandwidth. The default setting is 14 kHz.

→ Remote: POW:ACH:BWID 30kHz

**Adjust Settings (span > 0)**

Enables the RMS detector (see also "[Detector overview](#)" on page 4.116) and adjusts the span to the selected channel bandwidth according to:

*4 x channel bandwidth + measurement margin*

The adjustment is performed once; if necessary, the setting can be changed later on.

→ Remote: POW:ACH:PRES CN | CN0

---

---

**CP, ACP, MC-ACP**

---

Activates the active channel or adjacent-channel power measurement either for a single carrier signal or for several carrier signals, depending on the current measurement configuration, and opens a submenu to configure the channel power measurement. With default settings the measurement is performed by integrating the powers at the display points within the specified channels (IBW method).

If multi-carrier ACP measurement is activated, the number of measured values is increased to ensure that adjacent-channel powers are measured with adequate accuracy.

- Remote: CALC:MARK:FUNC:POW:SEL CPOW|ACP|MCAC
  - Remote: CALC:MARK:FUNC:POW:RES? CPOW|ACP|MCAC
  - Remote: CALC:MARK:FUNC:POW OFF
- 

---

**CP / ACP Standard**

---

Opens an edit dialog box to select the settings according to predefined standards. For details on the available standards see "[Predefined CP / ACP standards](#)" on page 4.148. By default no standard is set.

The selection of the standard influences the following parameters:

- channel spacing and adjacent-channel spacing
- channel bandwidth, adjacent-channel bandwidth, and type of filtering
- resolution bandwidth
- video bandwidth
- detector
- # of adjacent channels
- trace averaging (switched off)

- Remote: CALC:MARK:FUNC:POW:PRES <standard>
- 

---

**CP / ACP Config**

---

Opens a submenu to configure the channel power and adjacent channel power measurement independently of the predefined standards (for details see also "[To set the channel configuration](#)" on page 4.145 and "[Settings of CP / ACP test parameters](#)" on page 4.149).

---



---

**# of TX Chan (MC-ACP)**

---

Opens an edit dialog box to enter the number of carrier signals to be taken into account in channel and adjacent-channel power measurements. Values from 1 to 12 are allowed.

- Remote: POW:ACH:TXCH:COUN 4
-

---

**# of Adj Chan**

---

Opens an edit dialog box to enter the number of adjacent channels to be considered in the adjacent-channel power measurement. Values from 0 to 12 are allowed.

The following measurements are performed depending on the number of the channels:

- 0 Only the channel powers are measured.
- 1 The channel powers and the power of the upper and lower adjacent channel are measured.
- 2 The channel powers, the power of the upper and lower adjacent channel, and of the next higher and lower channel (alternate channel 1) are measured.
- 3 The channel power, the power of the upper and lower adjacent channel, the power of the next higher and lower channel (alternate channel 1), and of the next but one higher and lower adjacent channel (alternate channel 2) are measured.
- ...
- 12 The channel power, the power of the upper and lower adjacent channel, and the power of the all higher and lower channels (alternate channel 1 to 11) are measured.

→ Remote: POW:ACH:ACP 1

---

**Channel Settings**

---

Opens a submenu to define the channel settings.

---

**Channel Bandwidth**

---

Opens the **TX/ACP Channel Bandwidth** dialog box to enter the channel bandwidths for the transmission channels and the adjacent channels. The entry **TX** is only available for the multi-carrier ACP measurement.

The transmission-channel bandwidth is normally defined by the transmission standard. The correct bandwidth is set automatically for the selected standard (see **CP / ACP Standard** softkey).

Measurements in zero span (see **Fast ACP On/Off** softkey) are performed in the zero span mode. The channel limits are indicated by vertical lines. For measurements requiring channel bandwidths deviating from those defined in the selected standard the IBW method is to be used.

With the IBW method (see **Fast ACP On/Off** softkey), the channel bandwidth limits are marked by two vertical lines right and left of the channel center frequency. It can in this way be visually checked whether the entire power of the signal under test is within the selected channel bandwidth.

If measuring according to the IBW method (**Fast ACP Off**), the bandwidths of the different adjacent channels are to be entered numerically. Since all adjacent channels often have the same bandwidth, the other channels Alt1 and Alt2 are set to the bandwidth of the adjacent channel on entering the adjacent-channel bandwidth (ADJ). Thus only one value needs to be entered in case of equal adjacent channel bandwidths. The same holds true for the Alt2 channels (alternate channels 2) if the bandwidth of the Alt1 channel (alternate channel 1) is entered.

For details on available channel filters see "[List of available RRC and channel filters](#)" on page 4.97.

- Remote: POW:ACH:BWID 30kHz
- Remote: POW:ACH:BWID:ACH 30kHz
- Remote: POW:ACH:BWID:ALT2 30kHz

---

## Channel Spacing

---

Opens the **TX/ACP Channel Spacing** dialog box to enter the channel spacings for the TX channels and for the adjacent channels.

The entry **TX** is only available for the multi-carrier ACP measurement.

- TX channels (left column)

TX1– spacing between the first and the second carrier  
2

TX2– spacing between the second and the third carrier  
3

... ..

The spacings between all adjacent TX channels can be defined separately. In order to allow a convenient setup for the system with equal TX channel spacing, the value of TX spacing 1–2 is copied in all the spacing below after entry, the TX spacing 2–3 is copied in all the spacing below after entry and so forth. For different spacings, a setup from top to bottom is necessary.

If the spacings are not equal, the channel distribution according to the center frequency is as follows:

- |                            |  |
|----------------------------|--|
| Odd number of TX channels  | The middle TX channel is centered to center frequency.   |
| Even number of TX channels | The two TX channels in the middle are used to calculate the frequency between those two channels. This frequency is aligned to the center frequency. |

- Adjacent channels (right column)

Since all the adjacent channels often have the same distance to each other, the modification of the adjacent-channel spacing (ADJ) causes a change in all higher adjacent-channel spacings (Alt1, Alt2, ...): they are all multiplied by the same factor (new spacing value / old spacing value). Thus only one value needs to be entered in case of equal channel spacing. A modification of a higher adjacent-channel spacing (Alt1, Alt2, ...) causes a change by the same factor in all higher adjacent-channel spacings, while the lower adjacent-channel spacings remain unchanged.

**Example:**

In the default setting, the adjacent channels have the following spacing: 20 kHz (**ADJ**), 40 kHz (**Alt1**), 60 kHz (**Alt2**), 80 kHz (**Alt3**), 100 kHz (**Alt4**), ...

If the spacing of the first adjacent channel (**ADJ**) is set to 40 kHz, the spacing of all other adjacent channels is multiplied by factor 2 to result in 80 kHz (**Alt1**), 120 kHz (**Alt2**), 160 kHz (**Alt3**), ...

If, starting from the default setting, the spacing of the 5th adjacent channel (**Alt4**) is set to 150 kHz, the spacing of all higher adjacent channels is multiplied by factor 1.5 to result in 180 kHz (**Alt5**), 210 kHz (**Alt6**), 240 kHz (**Alt7**), ...

If a ACP or MC-ACP measurement is started, all settings according to the standard including the channel bandwidths and channel spacings are set and can be adjusted afterwards.

- Remote: POW:ACH:SPAC:CHAN 25kHz
- Remote: POW:ACH:SPAC 33kHz
- Remote: POW:ACH:SPAC:ALT1 100kHz

**Chan Pwr/Hz**

If deactivated, the channel power is displayed in dBm. If activated, the channel power density is displayed instead. Thus, the absolute unit of the channel power is switched from dBm to dBm/Hz. The channel power density in dBm/Hz corresponds to the power inside a bandwidth of 1 Hz and is calculated as follows:

$$\text{channel power density} = \text{channel power} - \log_{10}(\text{channel bandwidth})$$

By means of this function it is possible e.g. to measure the signal/noise power density or use the additional functions **ACP Abs/Rel** and **ACP Ref Settings** to obtain the signal to noise ratio.

- Remote: CALC:MARK:FUNC:POW:RES:PHZ ON

**ACP Ref Settings (MC-ACP)**

Opens an edit dialog box to select the transmission channel to which the adjacent-channel relative power values should be referenced.

TX Channel 1 – 12	Selection of one of channels 1 to 12.
Min Power TX Channel	The transmission channel with the lowest power is used as a reference channel.
Max Power TX Channel	The transmission channel with the highest power is used as a reference channel.
Lowest & Highest Channel	The outer left-hand transmission channel is the reference channel for the lower adjacent channels, the outer right-hand transmission channel that for the upper adjacent channels.

- Remote: POW:ACH:REF:TXCH:MAN 3
- Remote: POW:ACH:REF:TXCH:AUTO MAX

**Limit Checking**

Opens a submenu to activate and define the limits for the ACP measurement.

---

**Limit Chk On/Off**

---

Activates or deactivates the limit check for the ACP measurement.

- Remote: CALC:LIM:ACP ON
  - Remote: CALC:LIM:ACP:ACH:RES?
  - Remote: CALC:LIM:ACP:ALT:RES?
- 

---

**Edit ACP Limit**

---

Opens the **ACP Limits** dialog box to define the limits for the ACP measurement.

The following rules apply for the limits:

- A separate limit can be defined for each adjacent channel. The limit applies to both the upper and the lower adjacent channel.
  - A relative and/or absolute limit can be defined. The check of both limit values can be activated independently.
  - The R&S ESL checks adherence to the limits irrespective of whether the limits are absolute or relative or whether the measurement is carried out with absolute or relative levels. If both limits are active and if the higher of both limit values is exceeded, the measured value is marked by a preceding asterisk.
- Remote: CALC:LIM:ACP ON
  - Remote: CALC:LIM:ACP:<adjacent-channel> 0dB,0dB
  - Remote: CALC:LIM:ACP:<adjacent-channel>:STAT ON
  - Remote: CALC:LIM:ACP:<adjacent-channel>:ABS -10dBm,-10dBm
  - Remote: CALC:LIM:ACP:<adjacent-channel>:ABS:STAT ON
- For details refer to chapter "Remote Control – Commands", section "CALCulate:LIMit:ACPower Subsystem".
- 

---

**Power Mode**

---

Opens a submenu to select the power mode.

---

---

**Clear/Write**

---

If this mode is activated, the channel power and the adjacent channel powers are calculated directly from the current trace (default mode).

- Remote: CALC:MARK:FUNC:POW:MODE WRIT
- 

---

**Max Hold**

---

If this mode is activated, the power values are calculated from the current trace and compared with the previous power value using a maximum algorithm. The higher value is retained. If activated, the enhancement label **Pwr Max** is displayed.

- Remote: CALC:MARK:FUNC:POW:MODE MAXH
-



---

### Select Trace

---

Opens an edit dialog box to enter the trace number on which the CP/ACP measurement is to be performed. Only activated traces can be selected (for details on trace modes see "[Trace mode overview](#)" on page 4.114).

→ Remote: POW:TRAC 2

---

### Adjust Settings

---

Automatically optimizes all instrument settings for the selected channel configuration (channel bandwidth, channel spacing) within a specific frequency range (channel bandwidth). The adjustment is carried out only once. If necessary, the instrument settings can be changed later.

For details on the settings of span, resolution bandwidth, video bandwidth, detector and trace averaging see "[Settings of CP / ACP test parameters](#)" on page 4.149.

→ Remote: POW:ACH:PRES ACP

---

### Sweep Time

---

Opens an edit dialog box to enter the sweep time. With the RMS detector, a longer sweep time increases the stability of the measurement results.

The function of this softkey is identical to the **SweepTime Manual** softkey in the bandwidth menu.

→ Remote: SWE:TIM <value>

---

### Fast ACP On/Off

---

Switches between the IBW method (**Fast ACP Off**) and the zero span method (**Fast ACP On**).

When switched on, the R&S ESL sets the center frequency consecutively to the different channel center frequencies and measures the power with the selected measurement time (= sweep time/number of channels). The RBW filters suitable for the selected standard and frequency offset are automatically used (e.g. root raised cos with IS 136). For details on available channel filters see "[List of available RRC and channel filters](#)" on page 4.97.

The RMS detector is used for obtaining correct power measurement results. Therefore this requires no software correction factors.

Measured values are output as a list. The powers of the transmission channels are output in dBm, the powers of the adjacent channels in dBm.

The sweep time is selected depending on the desired reproducibility of results. Reproducibility increases with sweep time since power measurement is then performed over a longer time period. As a general approach, it can be assumed that approx. 500 non-correlated measured values are required for a reproducibility of 0.5 dB (99% of the measurements are within 0.5 dB of the true measured value). This holds true for white noise. The measured values are considered as non-correlated if their time interval corresponds to the reciprocal of the measured bandwidth.

With IS 136 the measurement bandwidth is approx. 25 kHz, i.e. measured values at an interval of 40  $\mu$ s are considered as non-correlated. A measurement time of 40 ms is thus required per channel for 1000 measured values. This is the default sweep time which the R&S ESL sets in coupled mode. Approx. 5000 measured values are required for a reproducibility of 0.1 dB (99%), i.e. the measurement time is to be increased to 200 ms.

→ Remote: POW:HSP ON

---

---

**ACP Abs/Rel**

---

Switches between absolute and relative power measurement in the adjacent channels.

- Abs     The absolute power in the adjacent channels is displayed in the unit of the y-axis, e.g. in dBm, dB $\mu$ V.
- Rel     The level of the adjacent channels is displayed relative to the level of the transmission channel in dBc.

→ Remote: POW:ACH:MODE REL

---

**Adjust Ref Level**

---

Adjusts the reference level to the measured channel power. This ensures that the settings of the RF attenuation and the reference level are optimally adjusted to the signal level without overloading the R&S ESL or limiting the dynamic range by a too small S/N ratio. For details on manual settings see "[Settings of CP / ACP test parameters](#)" on page 4.149.

The reference level is not influenced by the selection of a standard. To achieve an optimum dynamic range, the reference level has to be set in a way that places the signal maximum close to the reference level without forcing an overload message. Since the measurement bandwidth for channel power measurements is significantly lower than the signal bandwidth, the signal path may be overloaded although the trace is still significantly below the reference level.

→ Remote: POW:ACH:PRES:RLEV

---

**OBW (span > 0)**

---

Activates measurement of the occupied bandwidth according to the current configuration and opens a submenu to configure the measurement. The occupied bandwidth is displayed in the marker display field and marked on the trace by temporary markers. For details see also "[Measurement of occupied bandwidth](#)" on page 4.147.

The measurement is performed on the trace with marker 1. In order to evaluate another trace, marker 1 must be placed on another trace (see **Marker to Trace** softkey in the marker menu).

- Remote: CALC:MARK:FUNC:POW:SEL OBW
- Remote: CALC:MARK:FUNC:POW:RES? OBW
- Remote: CALC:MARK:FUNC:POW OFF
- 

**% Power Bandwidth (span > 0)**

---

Opens an edit dialog box to enter the percentage of total power in the displayed frequency range which defines the occupied bandwidth. Values from 10% to 99.9% are allowed.

→ Remote: POW:BWID 95PCT

---

---

**Channel Bandwidth (span > 0)**

---

Opens an edit dialog box to enter the channel bandwidth for the transmission channel. The specified channel bandwidth is used for optimization of the test parameters (for details see "[Settings of CP / ACP test parameters](#)" on page 4.149). The default setting is 14 kHz.

For measurements in line with a specific transmission standard, the bandwidth specified by the standard for the transmission channel must be entered.

→ Remote: POW:ACH:BWID 30kHz

---

---

**Adjust Ref Level (span > 0)**

---

Adjusts the reference level to the measured total power of the signal. The softkey is activated after the first sweep with active measurement of the occupied bandwidth has been completed and the total power of the signal is thus known.

Adjusting the reference level ensures that the signal path will not be overloaded and the dynamic range not limited by too low a reference level. Since the measurement bandwidth for channel power measurements is significantly lower than the signal bandwidth, the signal path may be overloaded although the trace is distinctly below the reference level. If the measured channel power is equal to the reference level, the signal path cannot be overloaded.

→ Remote: POW:ACH:PRES:RLEV

---

---

**APD**

---

Activates the function to measure the amplitude probability density (APD) and opens a submenu.

→ Remote: CALC:STAT:APD ON

---

---

**Percent Marker**

---

Opens an edit dialog box to enter a probability value and to position marker 1. Thus, the power which is exceeded with a given probability can be determined very easily. If marker 1 is deactivated, it will be switched on automatically.

→ Remote: CALC:MARK:Y:PERC 0...100%

---

---

**Res BW**

---

Opens an edit dialog box to set the resolution bandwidth directly. The function of this softkey is identical to the **Res BW Manual** softkey in the bandwidth menu.

For correct measurement of the signal statistics the resolution bandwidth has to be wider than the signal bandwidth in order to measure the actual peaks of the signal amplitude correctly. In order not to influence the peak amplitudes the video bandwidth is automatically set to 10 MHz. The sample detector is used for detecting the video voltage.

→ Remote: BAND 3 MHz

---

---

**# of Samples**

---

Opens an edit dialog box to set the number of power measurements that are taken into account for the statistics.

Apart from the number of measurements the overall measurement time depends also on the set resolution bandwidth as the resolution bandwidth directly influences the sampling rate.

→ Remote: `CALC:STAT:NSAM <value>`

---

---

**Scaling**

---

Opens a submenu to change the scaling parameters of x- and y-axis.

---

---

**x-Axis Ref Level**

---

Opens an edit dialog box to enter the reference level in the currently active unit (dBm, dBμV, etc). The function of this softkey is identical to the **Ref Level** softkey in the amplitude menu.

For the APD function this value is mapped to the right diagram border. For the CCDF function there is no direct representation of this value on the diagram as the x-axis is scaled relatively to the measured mean power.

→ Remote: `CALC:STAT:SCAL:X:RLEV <value>`

---

---

**x-Axis Range**

---

Opens the **Range Log** dialog box to select a value for the level range to be covered by the statistics measurement selected. The function is identical to the **Range Log** softkey in amplitude menu.

→ Remote: `CALC:STAT:SCAL:X:RANG <value>`

---

---

**y-Axis Max Value**

---

Opens an edit dialog box to define the upper limit of the displayed probability range. Values on the y-axis are normalized which means that the maximum value is 1.0. The y-axis scaling is defined via the **y-Unit %/Abs** softkey. If the y-axis has logarithmic scale, the distance between max and min value must be at least one decade.

→ Remote: `CALC:STAT:SCAL:Y:UPP <value>`

---

---

**y-Axis Min Value**

---

Opens an edit dialog box to define the lower limit of the displayed probability range. Values in the range  $0 < \text{value} < 1$  are allowed. The y-axis scaling is defined via the **y-Unit %/Abs** softkey. If the y-axis has logarithmic scale, the distance between max and min value must be at least one decade.

→ Remote: `CALC:STAT:SCAL:Y:LOW <value>`

---

---

**y-Unit %/Abs**

---

Defines the scaling type of the y-axis. The default value is absolute scaling.

→ Remote: `CALC:STAT:SCAL:Y:UNIT PCT`

---

**Default Settings**

---

Resets the x- and y-axis scalings to their preset values.

x-axis ref level:        –20 dBm  
x-axis range APD:       100 dB  
x-axis range CCDF:     20 dB  
y-axis upper limit:     1.0  
y-axis lower limit:     1E–6

→ Remote: CALC:STAT:PRES

---

**Adjust Settings**

---

Adjusts the level settings according to the measured difference between peak and minimum power for APD measurement or peak and mean power for CCDF measurement in order to obtain maximum power resolution. Adapts the probability scale to the selected number of samples. Adjusts the reference level to the current input signal. For details see also **Adjust Ref Level** softkey.

→ Remote: CALC:STAT:SCAL:AUTO ONCE

---

**CCDF**

---

Activates the function to measure the complementary cumulative distribution function (CCDF) and opens a submenu.

→ Remote: CALC:STAT:CCDF ON

---

**Spectrum Emission Mask**

Opens a submenu to configure the Spectrum Emission Mask measurement.

The Spectrum Emission Mask (SEM) measurement defines a measurement that monitors compliance with a spectral mask. The SEM measurement of the base unit allows a flexible definition of all parameters in the SEM measurement.

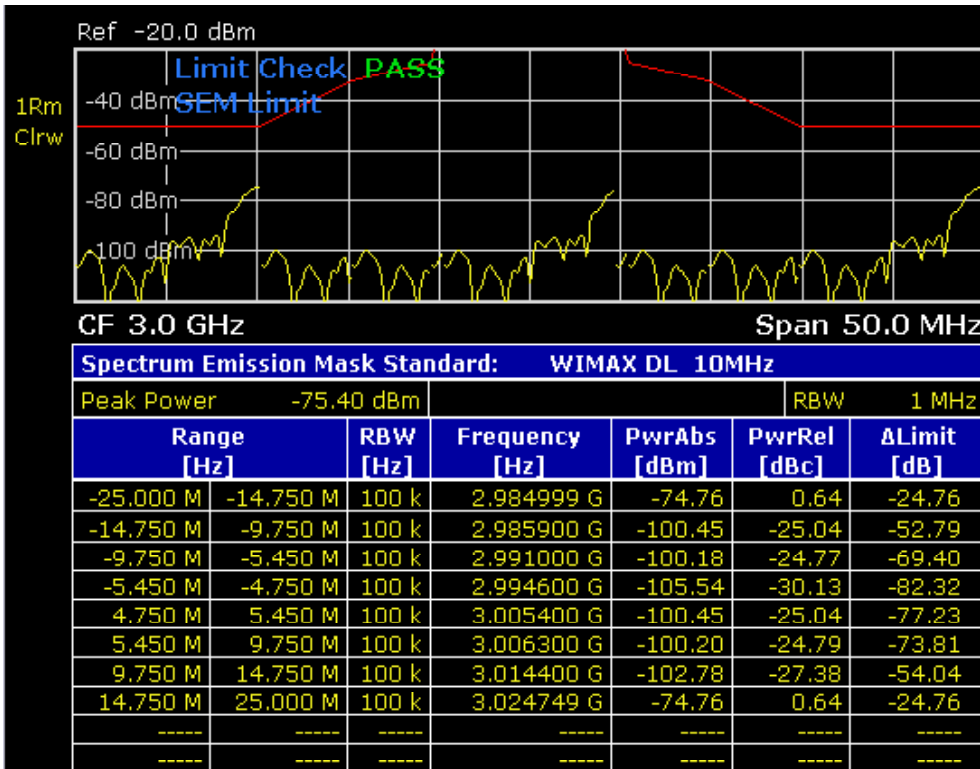

→ Remote: SWE:MODE ESP

**Sweep List**

Opens a submenu to edit the sweep list and displays the **Sweep List** dialog box. After a preset, the sweep list contains a set of default ranges and parameters. For each range, you can change the parameters listed below. To insert or delete ranges, use the **Insert before Range**, **Insert after Range**, **Delete Range** softkeys. The measurement results are not updated during editing but on closing the dialog box (**Close Sweep List** softkey).

**Note:** If you edit the sweep list, always follow the rules described in "Ranges and range settings" on page 4.150.

Parameter	Restriction
Range Start	
Range Stop	
Filter Type	
RBW	
VBW	
Sweep Time Mode	
Sweep Time	

Parameter	Restriction
Detector	Spurious Emissions measurement only
Ref. Level	
RF Att. Mode	
RF Attenuator	
Preamp	
Sweep Points	Spurious Emissions measurement only
Stop after Sweep	Spurious Emissions measurement only
Transd. Factor	
Limit Check	
Abs Limit Start	
Abs Limit Stop	
Rel Limit Start	Spectrum Emission Mask measurement only
Rel Limit Stop	Spectrum Emission Mask measurement only

- Spectrum Emission Mask measurement:

The changes of the sweep list are only kept until you load another parameter set (via a preset or by loading an XML file). If you want to have a parameter set permanently available, create an XML file for this configuration.

If you load one of the provided XML files (**Load Standard** softkey), the sweep list contains ranges and parameters according to the selected standard.

---

### Range Start/Range Stop (Sweep List dialog box)

---

Sets the start frequency/stop frequency of the selected range. Follow the rules described in "[Ranges and range settings](#)" on page 4.150.

In order to change the start/stop frequency of the first/last range, select the appropriate span with the **SPAN** key. If you set a span that is smaller than the overall span of the ranges, the measurement includes only the ranges that lie within the defined span and have a minimum span of 20 Hz. The first and last range are adapted to the given span as long as the minimum span of 20 Hz is not violated.

- Spectrum Emission Mask measurement:

Frequency values for each range have to be defined relative to the center frequency. The reference range has to be centered on the center frequency. The minimum span of the reference range is given by the current TX Bandwidth. For details refer to the **Edit Reference Range** softkey description.

- Remote: ESP:RANG1:STAR 100000000 (Spectrum Emission Mask)
  - Remote: ESP:RANG3:STOP 10000000 (Spectrum Emission Mask)
  - Remote: LIST:RANG1:STAR 100000000 (Spurious Emissions)
  - Remote: LIST:RANG3:STOP 10000000 (Spurious Emissions)
-

---

**Filter Type (Sweep List dialog box)**

---

Sets the filter type for this range. For details on filters see also "[To choose the appropriate filter type](#)" on page 4.96.

- Remote: `ESP:RANG1:FILT:TYPE RRC` (Spectrum Emission Mask)
  - Remote: `LIST:RANG1:FILT:TYPE RRC` (Spurious Emissions)
- 

---

**RBW (Sweep List dialog box)**

---

Sets the RBW value for this range.

- Remote: `ESP:RANG2:BAND:RES 5000` (Spectrum Emission Mask)
  - Remote: `LIST:RANG2:BAND:RES 5000` (Spurious Emissions)
- 

---

**VBW (Sweep List dialog box)**

---

Sets the VBW value for this range.

- Remote: `ESP:RANG1:BAND:VID 5000000` (Spectrum Emission Mask)
  - Remote: `LIST:RANG1:BAND:VID 5000000` (Spurious Emissions)
- 

---

**Sweep Time Mode (Sweep List dialog box)**

---

Activates or deactivates the auto mode for the sweep time.

- Remote: `ESP:RANG3:SWE:TIME:AUTO OFF` (Spectrum Emission Mask)
  - Remote: `LIST:RANG3:SWE:TIME:AUTO OFF` (Spurious Emissions)
- 

---

**Sweep Time (Sweep List dialog box)**

---

Sets the sweep time value for the range.

- Remote: `ESP:RANG1:SWE:TIME 1` (Spectrum Emission Mask)
  - Remote: `LIST:RANG1:SWE:TIME 1` (Spurious Emissions)
- 

---

**Detector (Sweep List dialog box, Spurious Emissions)**

---

Sets the detector for the range. For details refer to "[Detector overview](#)" on page 4.116.

- Remote: `LIST:RANGe3:DET SAMP`
- 

---

**Ref. Level (Sweep List dialog box)**

---

Sets the reference level for the range.

- Remote: `ESP:RANG2:RLEV 0` (Spectrum Emission Mask)
  - Remote: `LIST:RANG2:RLEV 0` (Spurious Emissions)
-



**RF Att. Mode (Sweep List dialog box)**

Activates or deactivates the auto mode for RF attenuation.

- Remote: `ESP:RANG2:INP:ATT:AUTO OFF` (Spectrum Emission Mask)
- Remote: `LIST:RANG2:INP:ATT:AUTO OFF` (Spurious Emissions)

**RF Attenuator (Sweep List dialog box)**

Sets the attenuation value for that range.

- Remote: `ESP:RANG3:INP:ATT 10` (Spectrum Emission Mask)
- Remote: `LIST:RANG3:INP:ATT 10` (Spurious Emissions)

**Preamp (Sweep List dialog box)**

Switches the preamplifier on or off.

- Remote: `ESP:RANG3:INP:GAIN:STATE ON` (Spectrum Emission Mask)
- Remote: `LIST:RANG3:INP:GAIN:STATE ON` (Spurious Emissions)

**Sweep Points (Sweep List dialog box, Spurious Emissions)**

Sets the number of sweep points per range. For details on possible values refer to the **Sweep Points** softkey of the sweep menu.

- Remote: `LIST:RANG3:POIN 601`

**Stop after Sweep (Sweep List dialog box, Spurious Emissions)**

Configures the sweep behavior.

**On** The R&S ESL stops after one range is swept and continues only if you confirm (a message box is displayed).

**Off** The R&S ESL sweeps all ranges in one go.

- Remote: `LIST:RANG1:BRE ON`

**Transd. Factor (Sweep List dialog box)**

Sets a transducer for the specified range. You can only choose a transducer that fulfills the following conditions:

- The transducer overlaps or equals the span of the range.
- The x-axis is linear.
- The unit is dB.

- Remote: `ESP:RANG1:TRAN 'test'` (Spectrum Emission Mask)
- Remote: `LIST:RANG1:TRAN 'test'` (Spurious Emissions)

**Limit Check (Sweep List dialog box)**

Sets the type of limit check for all ranges. Possible states are:

<b>Absolute</b>	Checks only the absolute limits defined.
<b>Relative</b>	Checks only the relative limits. Relative limits are defined as relative to the measured power in the reference range.
<b>Abs and Rel</b>	Combines the absolute and relative limit. The limit check fails when both limits are violated.
<b>Abs or Rel</b>	Combines the absolute and relative limit. The limit check fails when one of the limits is violated.

The limit state affects the availability of all limit settings (**Abs Limit Start, Abs Limit Stop, Rel Limit Start, Rel Limit Stop**).

- Remote: `ESP:RANG3:LIM:STAT AND` (Spectrum Emission Mask)
- Remote: `LIST:RANG3:LIM:STAT ON` (Spurious Emissions)
- Remote: `CALC:LIM3:FAIL?`

**Abs Limit Start (Sweep List dialog box)**

Sets an absolute limit value at the start frequency of the range [dBm].

This parameter is only available if the limit check is set accordingly (see **Limit Check** parameter).

- Remote: `ESP:RANG1:LIM:ABS:STAR 10` (Spectrum Emission Mask)
- Remote: `LIST:RANG1:LIM:STAR 10` (Spurious Emissions)

**Abs Limit Stop (Sweep List dialog box)**

Sets an absolute limit value at the stop frequency of the range [dBm].

This parameter is only available if the limit check is set accordingly (see **Limit Check** parameter).

- Remote: `ESP:RANG1:LIM:ABS:STOP 20` (Spectrum Emission Mask)
- Remote: `LIST:RANG1:LIM:STOP 20` (Spurious Emissions)

**Rel Limit Start (Sweep List dialog box, Spectrum Emission Mask)**

Sets a relative limit value at the start frequency of the range [dBc].

This parameter is only available if the limit check is set accordingly (see **Limit Check** parameter).

- Remote: `ESP:RANG3:LIM:REL:STAR -20`

**Rel Limit Stop (Sweep List dialog box, Spectrum Emission Mask)**

Sets a relative limit value at the stop frequency of the range [dBc].

This parameter is only available if the limit check is set accordingly (see **Limit Check** parameter).

- Remote: `ESP:RANG3:LIM:REL:STOP 20`

**Edit Sweep List/Close Sweep List**

---

Opens/ closes the **Sweep List** dialog box. Closing the dialog box updates the measurement results.

For further details refer to "[Ranges and range settings](#)" on page 4.150.

---

**Insert before Range**

---

Inserts a new range to the left of the currently focussed range. The range numbers of the currently focused range and all higher ranges are increased accordingly. The maximum number of ranges is 20.

For further details refer to "[Ranges and range settings](#)" on page 4.150.

→ Remote: `ESP:RANG3:INS BEF` (Spectrum Emission Mask)

---

**Insert after Range**

---

Inserts a new range to the right of the currently focused range. The range numbers of all higher ranges are increased accordingly. The maximum number of ranges is 20.

For further details refer to "[Ranges and range settings](#)" on page 4.150.

→ Remote: `ESP:RANG1:INS AFT` (Spectrum Emission Mask)

---

**Delete Range**

---

Deletes the currently focused range, if possible. The range numbers are updated accordingly. For further details refer to "[Ranges and range settings](#)" on page 4.150.

→ Remote: `ESP:RANG4:DEL` (Spectrum Emission Mask)

→ Remote: `LIST:RANG4:DEL` (Spurious Emissions)

---

**Edit Reference Range**

Opens the **Reference Range** dialog box to edit the additional settings used for SEM measurements.

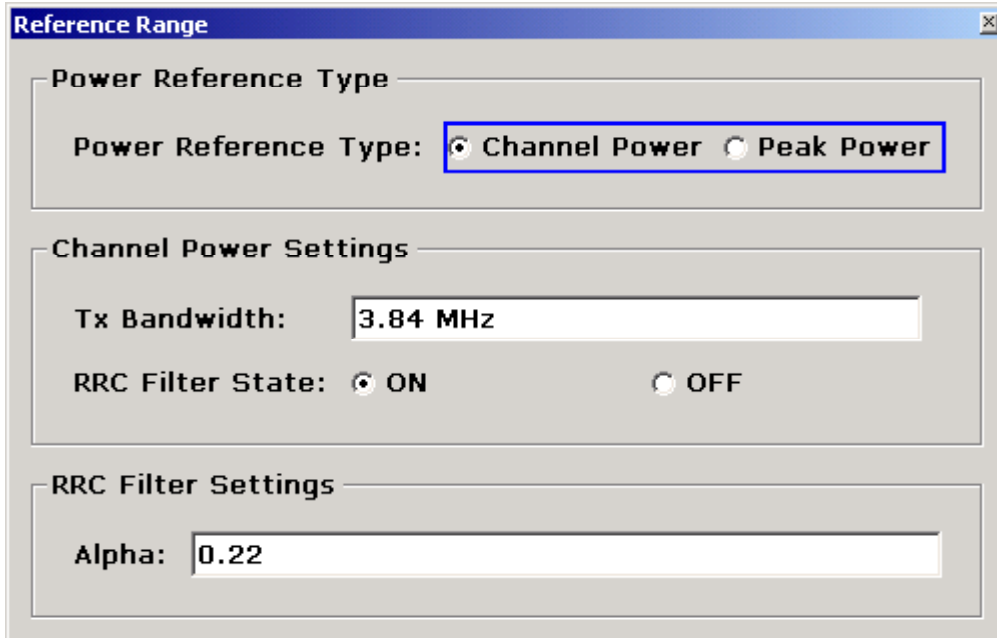

- **Peak Power**

Measures the highest peak within the reference range.

- **Channel Power**

Measures the channel power within the reference range (integral bandwidth method).

If the **Channel Power** reference power type is activated, the dialog box is extended to define additional settings:

- **Tx Bandwidth**

Defines the bandwidth used for measuring the channel power:  
 $\text{minimum span} \leq \text{value} \leq \text{span of reference range}$

- **RRC Filter State**

Activates or deactivates the use of an RRC filter.

- **RRC Filter Settings**

Sets the alpha value of the RRC filter. This pane is only available if the RRC filter is activated.

For further details refer to "[Ranges and range settings](#)" on page 4.150.

- Remote: ESP:RTYP PEAK
- Remote: ESP:BWID 1MHZ
- Remote: ESP:FILT OFF
- Remote: ESP:FILT:ALPH 0.5

**List Evaluation**

Opens a submenu to edit the list evaluation settings.

---

**List Evaluation On/Off**

---

Activates or deactivates the list evaluation.

- Remote: CALC:ESP:PSE:AUTO OFF (Spectrum Emission Mask)
  - Remote: CALC:PSE:AUTO OFF (Spurious Emissions)
  - Remote: TRAC? LIST
- 

**List Full Screen**

---

Switches between split screen and full screen.

deactivated      split screen (diagram and list)  
activated        list in full screen

- Remote: DISP:WIND2:SIZE LARG
- 

**Margin**

---

Opens an edit dialog box to enter the margin used for the limit check/peak search.

- Remote: CALC:ESP:PSE:MARG 100 (Spectrum Emission Mask)
  - Remote: CALC:PEAK:MARG 100 (Spurious Emissions)
- 

**Show Peaks**

---

In the diagram, marks all peaks with blue squares that have been listed during an active list evaluation.

- Remote: CALC:ESP:PSE:PSH ON (Spectrum Emission Mask)
  - Remote: CALC:PSE:PSH ON (Spurious Emissions)
- 

**List Up/List Down**

---

Scrolls through the evaluation list if the number of found peaks exceeds the number of rows shown in the evaluation list table.

---

**Save Evaluation List**

---

Opens the **ASCII File Export Name** dialog box to save the result in ASCII format to a specified file and directory. For further details refer also to the **ASCII File Export** softkey.

- Remote: MMEM:STOR:LIST 'test'
- 

**ASCII File Export**

---

An example of an output file is given in "[ASCII file export format \(Spectrum Emission Mask\)](#)" on page 4.154. For further details refer also to the **ASCII File Export** softkey in the trace menu of the base unit.

- Remote: MMEM:STOR:LIST 'test'
-

---

**Decim Sep**

---

For details refer to the **Decim Sep** softkey in the trace menu of the base unit.

---

**Load Standard**

---

Opens a dialog box to select an XML file which includes the desired standard specification. For details on the provided XML files refer to "[Provided XML files for the Spectrum Emission Mask measurement](#)" on page 4.151.

→ Remote: ESP: PRES 'WCDMA\3GPP\DL\PowerClass\_31\_39.xml'

---

**Restore Standard Files**

---

Copies the XML files from the C:\R\_S\instr\sem\_backup folder to the C:\R\_S\instr\sem\_std folder. Files of the same name are overwritten.

→ Remote: ESP: PRES: REST

---

**Meas Start/Stop**

---

Aborts/restarts the current measurement and displays the status:

**Start** The measurement is currently running.

**Stop** The measurement has been stopped, or, in single sweep mode, the end of the sweep has been reached.

→ Remote: ABOR

→ Remote: INIT: ESP (Spectrum Emission Mask)

→ Remote: INIT: SPUR (Spurious Emissions)

→ Remote: INIT: CONM (Spurious Emissions)

---

**Spurious Emissions**

Opens a submenu to configure the Spurious Emissions measurement.

The Spurious Emissions measurement defines a measurement that monitors unwanted RF products outside the assigned frequency band generated by an amplifier. The spurious emissions are usually measured across a wide frequency range. The Spurious Emissions measurement allows a flexible definition of all parameters.

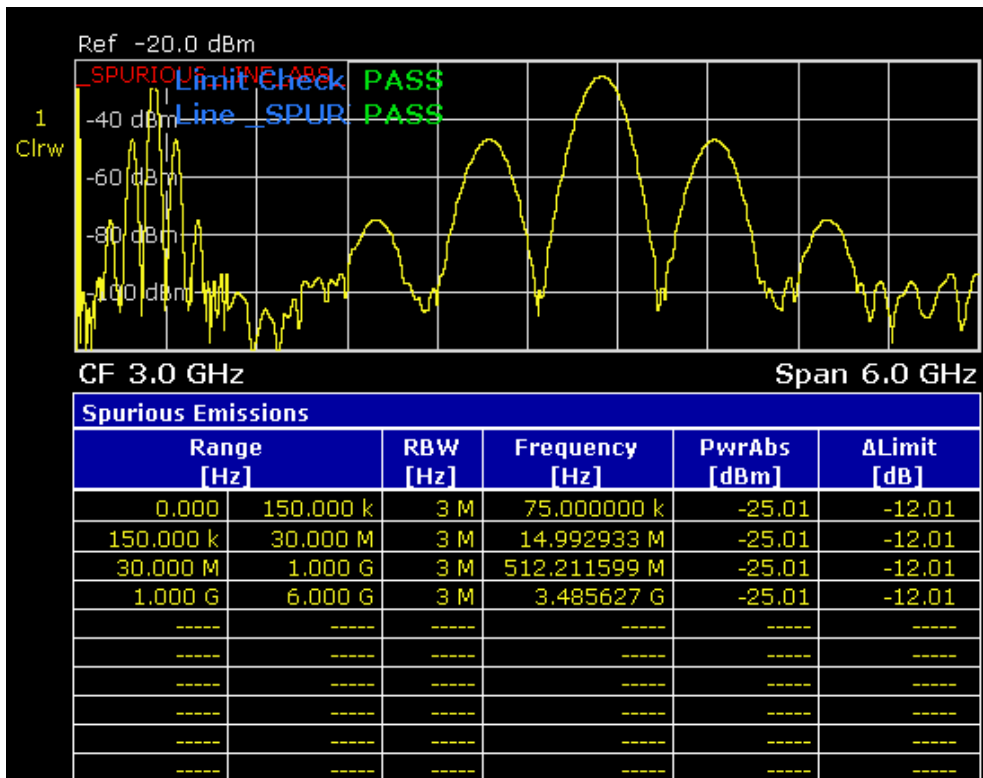

→ Remote: SWE:MODE LIST

**Adjust X-Axis**

Adjusts the frequency axis of measurement diagram automatically so that the start frequency matches the start frequency of the first sweep range, and the stop frequency of the last sweep range.

**Details On/Off**

Configures the list contents.

On Displays the whole list contents.

Off Displays only the highest peaks (one peak per range).

---

**Peaks per Range**

---

Opens an edit dialog box to enter the number of peaks per range that are stored in the list. Once the selected number of peaks has been reached, the peak search is stopped in the current range and continued in the next range. The maximum value is 50.

→ Remote: CALC:PSE:SUBR 10

---



---

**Harmonic Distortion**

---

Opens a submenu to determine the settings for harmonics measurement and activates the harmonic distortion measurement. With this measurement it is possible to measure easily the harmonics e.g. from a VCO. In addition the THD (total harmonic distortion) is calculated in % and dB.

With span > 0 Hz, an automatic search for the first harmonic is carried out within the set frequency range. Also the level is adjusted. In zero span, the center frequency is unchanged.

In the upper pane, the zero span sweeps on all harmonics are shown, separated by display lines. This provides a very good overview about the measurement. In the lower pane, the mean RMS results are displayed in numerical values. The THD values are displayed in the marker field.

- Remote: CALC:MARK:FUNC:HARM:STAT ON
  - Remote: CALC:MARK:FUNC:HARM:DIST? TOT
  - Remote: CALC:MARK:FUNC:HARM:LIST?
- 

---

**Harmonic On/Off**

---

Activates/deactivates the harmonic distortion measurement.

→ Remote: CALC:MARK:FUNC:HARM:STAT ON

---



---

**No. of Harmonics**

---

Sets the number of harmonics that shall be measured. The range is from 1 to 26.

→ Remote: CALC:MARK:FUNC:HARM:NHAR 2

---



---

**Harmonic Sweep Time**

---

For details refer to the **Sweeptime Manual** softkey in the bandwidth menu.

---



---

**Harmonic RBW Auto**

---

Enables/disables the automatic adjustment of the resolution bandwidth. The automatic adjustment is carried out according to:

$$RBW_n = RBW_1 * n$$

If  $RBW_n$  is not available, the next higher value is used.

→ Remote: CALC:MARK:FUNC:HARM:BAND:AUTO OFF

---



**Adjust Settings**

---

Activates the frequency search in the frequency range that was set before starting the harmonic measurement (if harmonic measurement was with span > 0) and adjusts the level.

→ Remote: CALC:MARK:FUNC:HARM:PRES

---

**Full Size Diagram (span > 0)**

---

Displays the diagram in full screen size.

→ Remote: DISP:SIZE LARG|SMAL

---

## Using Limit Lines and Display Lines – LINES Key

The **LINES** key is used to configure limit and display lines.

### To open the lines menu

- Press the **LINES** key.

The lines menu and the **Select Limit Line** dialog box are displayed. For details on the **Select Limit Line** dialog box refer to "[To select a limit line](#)" on page 4.185.

### Menu and softkey description

- "[Softkeys of the lines menu](#)" on page 4.190

To display help to a softkey, press the **HELP** key and then the softkey for which you want to display help. To close the help window, press the **ESC** key. For further information refer to section "How to use the Help System".

### Further information

- "[Display Lines](#)" on page 4.188
- "[Limit Lines](#)" on page 4.189

### Task

- [To work with display lines](#)
- [To select a limit line](#)
- [To create a new limit line](#)
- [To edit an existing limit line](#)
- [To create a new limit line based upon an existing limit line](#)
- [To activate/deactivate a limit line](#)

### To work with display lines

Initial situation: The line is switched on (softkey with highlighted background) or off (softkey without highlighted background), for example the Display Line 1.

1. Press the **Display Lines** softkey.
2. Press the **Display Line 1** softkey for the first time.  
An edit dialog box is opened to enter the position of the display line (by rotary knob, step keys or numerical entry). If the line was switched off, it is switched on. If it was switched on, it remains switched on.
3. If another softkey is pressed, the edit dialog box for the **Display Line 1** softkey is closed, but the line remains switched on (softkey with highlighted background).
4. Press the **Display Line 1** softkey for the second time.  
The edit dialog box for the display line will be opened again.
5. Press the **Display Line 1** softkey again.  
The line is switched off (softkey without highlighted background).

### To select a limit line

1. To display the **Select Limit Line** dialog box, press the **LINES** key or go to the main limit line menu.

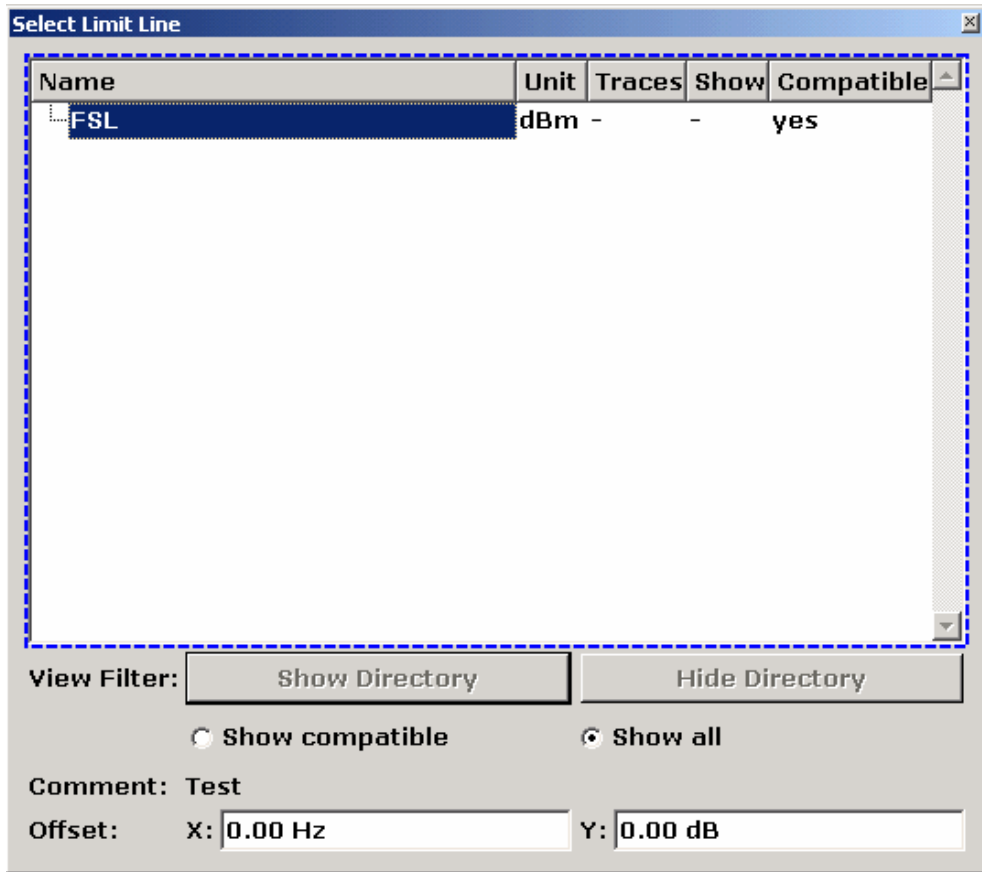

All limit lines, saved in the default directory, and all subdirectories are displayed. For each limit line, the following information is given:

<b>Unit</b>	unit of the y-axis
<b>Traces</b>	selected traces to check
<b>Show</b>	limit line displayed in the measurement diagram or hidden
<b>Compatible</b>	compatibility of the limit line to the current measurement settings

2. To display only the limit lines that are compatible, activate the **Show compatible** option. For details on compatibility refer to "[Limit Lines](#)" on page 4.189.
3. To navigate into a subdirectory, use the **Show Directory** and **Hide Directory** buttons.

### To create a new limit line

1. Press the **New** softkey to define a new limit line.

The **Edit Limit Line** dialog box is displayed. For more details on limit lines refer also to "[Limit Lines](#)" on page 4.189.

2. Press the **Edit Name** softkey and enter a name, if you want to save the limit line in the main directory. To save the limit line in an existing subdirectory, enter the relative path. A new subdirectory can only be created using the **FILE** key (for details refer to section "Instrument Functions – Basic Settings", "Saving and Recalling Settings Files – FILE Key").
3. To change the span setting, set the focus in the **X–Axis** field and change the unit via the rotary knob: **Hz** for span > 0 Hz or **s** for zero span.
4. To change between absolute and relative scale mode for the x–axis, set the focus on the **abs** or **rel** option next to the **X–Axis** field and press the **CHECKMARK** key. Relative scaling is always suitable, if masks for bursts are to be defined in zero span, or if masks for modulated signals are required for span > 0 Hz.

absolute: The frequencies or times are interpreted as absolute physical units.

relative: In the data point table, the frequencies are referred to the currently set center frequency. In the zero span mode, the left boundary of the diagram constitutes the reference.

5. To change the scaling of the y–axis, set the focus in the **Y–Axis** field and change the unit using the rotary knob.
6. To change between absolute and relative units for the y–axis, set the focus on the **abs** or **rel** option next to the **Y–Axis** field and press the **CHECKMARK** key.

absolute: The limit values refer to absolute levels or voltages.

relative: The limit values refer to the reference level (Ref Level). Limit values with the unit dB are always relative values.

7. To define the limit line as upper or lower limit line, set the focus on the **Upper** or **Lower** option and press the **CHECKMARK** key.
8. To change between linear or logarithmic scale of the x–axis, set the focus on the **lin** or **log** option and press the **CHECKMARK** key.
9. If the scaling of the y–axis is relative, you can define an absolute threshold value that works as a lower limit for the relative limit values (see figure below). Set the focus in the **Threshold** field and enter a value.

The function is especially useful for mobile radio applications provided the limit values are defined in relation to the carrier power as long as they are above an absolute limit value.

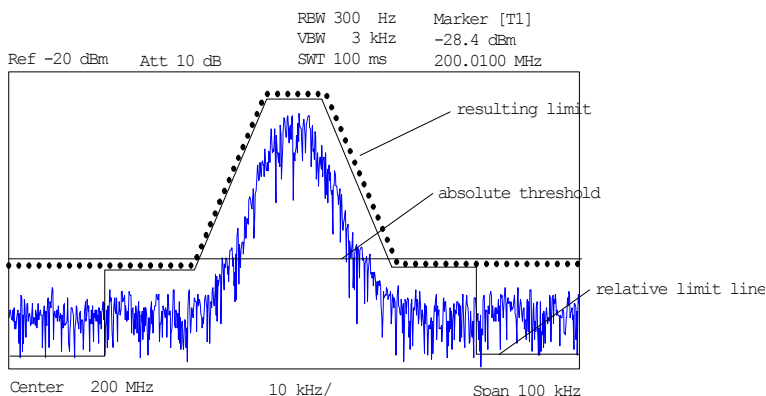

10. To define a signal–level distance to the limit line, press the **Edit Margin** softkey and enter a value.  
If the limit line is defined as an upper limit, the margin means that the level is below the limit line. If the limit line is defined as a lower limit, the margin means that the level is above the limit line.
11. To enter a comment, press the **Edit Comment** and enter a comment, e.g. a description of the application.
12. To enter a new data point:
  - Press the **Insert Value Above** softkey.
  - Enter the new x and y value in the successive displayed edit dialog boxes.
13. To change a data point:
  - Set the focus on the x and y value to be changed and press the **Value** softkey.
  - Enter the new x or y value in the displayed edit dialog box.
14. To delete a data point, select the corresponding entry and press the **Delete Value** softkey.
15. To shift the complete limit line parallel in the horizontal direction, select the **Shift x** button and enter a x shift value.
16. To shift the complete limit line parallel in the vertical direction, select the **Shift y** button and enter an y shift value.
17. Press the **Save Limit Line** softkey.  
If an existing name is used, a message box is displayed. You have to confirm before the limit line is overwritten.

### To edit an existing limit line

1. In the **Select Limit Line** dialog box, select the limit line you want to alter. For details see also "[To select a limit line](#)" on page 4.185.
2. Press the **Edit** softkey.
3. Edit the data as described in "[To select a limit line](#)" on page 4.185.
4. Save the limit line (**Save Limit Line** softkey).

### To create a new limit line based upon an existing limit line

1. In the **Select Limit Line** dialog box, select the limit line you want to use as a basis for a new limit line. For details see also "[To select a limit line](#)" on page 4.185.
2. Press the **Copy to** softkey to transfer the data of the limit line into the **Edit Limit Line** dialog box.
3. Press the **Edit Name** softkey and enter a new name.
4. To shift the complete limit line parallel in the horizontal direction, select the **Shift x** button and enter an x shift value. In this manner, a new limit line can be easily generated based upon an existing limit line which has been shifted horizontally.
5. To shift the complete limit line parallel in the vertical direction, select the **Shift y** button and enter a y shift value. In this manner, a new limit line can be easily generated based upon an existing limit line which has been shifted in Y direction
6. If required, edit the data as described in "[To select a limit line](#)" on page 4.185.
7. Save the limit line (**Save Limit Line** softkey).

### To activate/deactivate a limit line

Prerequisites:

- The x– and y–units of limit line and current measurement setting have to be compatible. For details refer to "[Limit Lines](#)" on page 4.189.
  - The limit line has to consist of 2 or more data points.
1. In the **Select Limit Line** dialog box, select the limit line you want to activate/deactivate. For details see also "[To select a limit line](#)" on page 4.185.
  2. To activate or deactivate a limit line for a trace, press the **Select Traces to check** softkey and select or deselect the trace(s) to which this limit line applies.
  3. To deactivate the limit line for all traces, press the **Deselect All** softkey.

### Display Lines

Display lines help to evaluate a trace – as do markers. The function of a display line is comparable to that of a ruler that can be shifted on the trace in order to mark absolute values. They are exclusively used to optically mark relevant frequencies or points in time (span = 0) as well as constant level values. It is not possible to check automatically whether the points are below or above the marked level values.

The softkeys for setting and switching the display lines on/off work like triple switches. For details see "[To work with display lines](#)" on page 4.184.

Two different types of display lines are provided:

- Two horizontal level lines for marking levels – Display Line 1 and 2  
The level lines are continuous horizontal lines across the entire width of a diagram and can be shifted in y direction.
- Two vertical frequency or time lines for marking frequencies or points in time – Frequency/Time Line 1 and 2  
The frequency or time lines are continuous vertical lines across the entire height of the diagram and can be shifted in x direction.

Each line is identified by one of the following abbreviations:

- D1: Display Line 1
- D2: Display Line 2
- F1: Frequency Line 1
- F2: Frequency Line 2
- T1: Time Line 1
- T2: Time Line 2

## Limit Lines

Limit lines are used to define amplitude curves or spectral distribution boundaries on the display screen which are not to be exceeded. They indicate, for example, the upper limits for interference radiation or spurious waves which are allowed from a device under test (DUT). For transmission of information in TDMA systems (e.g. GSM), the amplitude of the bursts in a timeslot must adhere to a curve that falls within a specified tolerance band. The lower and upper limits may each be specified by a limit line. Then, the amplitude curve can be controlled either visually or automatically for any violations of the upper or lower limits (GO/NOGO test).

The instrument supports limit lines with a maximum of 50 data points. 8 of the limit lines stored in the instrument can be activated simultaneously. The number of limit lines stored in the instrument is only limited by the capacity of the flash disk used. For details see also "[To select a limit line](#)" on page 4.185.

Limit lines are compatible with the current measurement settings, if the following applies:

- The x unit of the limit line has to be identical to the current setting.
- The y unit of the limit line has to be identical to the current setting with the exception of dB based units; all dB based units are compatible with each other.

At the time of entry, the R&S ESL immediately checks that all limit lines are in accordance with the following guidelines:

- The frequencies/times for each data point must be entered in ascending order, however, for any single frequency/time, two data points may be entered (vertical segment of a limit line).
- The data points are allocated in order of ascending frequency/time. Gaps are not allowed. If gaps are desired, two separate limit lines must be defined and then both enabled.
- The entered frequencies/times need not necessarily be selectable in R&S ESL. A limit line may also exceed the specified frequency or time range. The minimum frequency for a data point is –200 GHz, the maximum frequency is 200 GHz. For the time range representation, negative times may also be entered. The allowed range is –1000 s to +1000 s.

### Softkeys of the lines menu

The following table shows all softkeys available in the lines menu. It is possible that your instrument configuration does not provide all softkeys. If a softkey is only available with a special option, model or (measurement) mode, this information is delivered in the corresponding softkey description.

Menu / Command	Command
Select Traces to check	
Deselect All	
New ↓	Edit Name
	Edit Comment
	Edit Margin
	Value
	Insert Value Above
	Delete Value
	Save Limit Line
Edit ↓	same contents as New Limit Line menu
Copy to ↓	same contents as New Limit Line menu
Delete	
Display Lines ↓	Display Line 1
	Display Line 2
	Frequency Line 1
	Frequency Line 2
	Time Line 1
	Time Line 2

### Select Traces to check

Opens the **Select Traces to Check** dialog box to activate the selected limit line for a trace. One limit line can be activated for several traces simultaneously. For details see also "[To activate/deactivate a limit line](#)" on page 4.188 .

- Remote: CALC:LIM2:TRAC 3
- Remote: CALC:LIM:STAT ON

### Deselect All

Deactivates the selected limit line for all assigned traces. For details see also "[To activate/deactivate a limit line](#)" on page 4.188 .

- Remote: CALC:LIM:STAT OFF



**New**

---

Opens the **Edit Limit Line** dialog box and a submenu to define a new limit line. For details see also "[Limit Lines](#)" on page 4.189 and "[To select a limit line](#)" on page 4.185.

---

**Edit Name**

---

Sets the focus on the **Name** field to enter or change the limit line name. A maximum of 8 characters is permitted for each name. All names must be compatible with the Windows XP conventions for file names. The limit line data are stored under this name. The instrument stores all limit lines with LIM as extension.

→ Remote: `CALC:LIM3:NAME "GSM1"`

---

**Edit Comment**

---

Sets the focus on the **Comment** field to enter or change a comment for the limit line. The text must not exceed 40 characters.

→ Remote: `CALC:LIM5:COMM 'Upper limit for spectrum'`

---

**Edit Margin**

---

Sets the focus on the **Margin** field to enter or change a margin for the limit line. The default setting is 0 dB (i.e. no margin).

---

**Value**

---

Opens an edit dialog box to change an existing x or y value, depending on the selected column. The softkey is only available if an existing value is selected.

The desired data points are entered in ascending order (two repeated frequencies/time values are permitted).

→ Remote: `CALC:LIM3:CONT:DATA 1MHz,3MHz,30MHz`

→ Remote: `CALC:LIM3:UPP:DATA -10,0,0`

→ Remote: `CALC:LIM3:LOW:DATA -30,-40,-40`

---

**Insert Value Above**

---

Creates an empty line above the selected data point to enter a new data point. This softkey corresponds to the **Insert** button in the dialog box.

It is also possible to add a data point at the end of the list, if the focus is set below the last entry line of the list.

The data points are entered in ascending order (two repeated frequencies/time values are permitted). If the entered values are not in accordance with the ascending order rule, an error message is displayed and the values are discarded.

---

**Delete Value**

---

Deletes the selected data point (x and y value). All succeeding data points are shifted up accordingly. This softkey corresponds to the **Delete** button in the dialog box.

The softkey is only available if an existing value is selected.

---

**Save Limit Line**

---

Saves the currently edited limit line under the name defined in the **Name** field.

---

**Edit**

---

Opens a submenu to edit limit lines. For details see also "[Limit Lines](#)" on page 4.189 and "[To edit an existing limit line](#)" on page 4.187.

- Remote: For details refer to chapter "Remote Control – Commands", section "Definition of the limit line".
- 

**Copy to**

---

Copies the data of the selected limit line and displays it in the **Edit Limit Line** dialog box. If the limit line is edited and saved under a new name, a new limit line can be easily generated by parallel translation or editing of an existing limit line.

For details see also "[Limit Lines](#)" on page 4.189 and "[To create a new limit line based upon an existing limit line](#)" on page 4.187.

- Remote: `CALC:LIM3:COPY 2`
- 

**Delete**

---

Deletes the selected limit line.

- Remote: `CALC:LIM3:DEL`
- 

**Display Lines**

---

Opens a submenu to enable, disable and set display lines. Which softkeys are available depends on the display mode (frequency or time range). For details see also "[Display Lines](#)" on page 4.188 and "[To work with display lines](#)" on page 4.184.

---

**Display Line 1 and Display Line 2**

---

Enable or disable the level lines 1/2 and open an edit dialog box to enter the position of the lines. For details see also "[Display Lines](#)" on page 4.188 and "[To work with display lines](#)" on page 4.184.

- Remote: `CALC:DLIN:STAT ON`
  - Remote: `CALC:DLIN -20dBm`
-

**Frequency Line 1 and Frequency Line 2 (span > 0)**

---

Enable or disable the frequency lines 1/2 and open an edit dialog box to enter the position of the lines. For details see also "[Display Lines](#)" on page 4.188 and "[To work with display lines](#)" on page 4.184.

- Remote: CALC:FLIN:STAT ON
  - Remote: CALC:FLIN 120MHz
- 

**Time Line 1 and Time Line 2 (zero span)**

---

Enable or disable the time lines 1/2 and open an edit dialog box to enter the position of the lines. For details see also "[Display Lines](#)" on page 4.188 and "[To work with display lines](#)" on page 4.184.

- Remote: CALC:TLIN:STAT ON
  - Remote: CALC:TLIN 10ms
-

## **Measurement Modes**

This section describes the provided measurement modes, the change of measurement modes and the access to the menus of all active measurement modes. For details refer to the following sections:

- ["Measurement Mode Selection – MODE Key"](#) on page 4.195
- ["Measurement Mode Menus – MENU Key"](#) on page 4.196

## Measurement Mode Selection – MODE Key

The **MODE** key provides a quick access to the menu of the current measurement mode and a fast change of the measurement mode. You can choose from the following measurement modes:

- [Spectrum Analyzer mode](#)
- [Analog Demodulation mode \(Analog Demodulation option, K7\)](#)
- [Noise mode \(Noise Figure Measurements option, K30\)](#)

### To change the measurement mode

1. Press the **MODE** key.

The menu of the current measurement mode is displayed and the **Measurement Modes** dialog box is opened.

2. To activate another mode, select the corresponding option and press the **CHECKMARK** key. More than one measurement mode can be activated simultaneously.
3. To deactivate an activated mode, select the corresponding option and press the **CHECKMARK** key.

### Spectrum Analyzer mode

In the **Spectrum Analyzer** mode the functions provided correspond to those of a conventional spectrum analyzer. The analyzer measures the frequency spectrum of the test signal over the selected frequency range with the selected resolution and sweep time, or, for a fixed frequency, displays the waveform of the video signal. This mode is set in the initial configuration.

### Analog Demodulation mode (Analog Demodulation option, K7)

The **Analog Demodulation** mode requires an instrument equipped with the corresponding optional software. This mode provides measurement functions for demodulating AM, FM, or PM signals. For details refer to "[Analog Demodulation \(Option K7\)](#)" on page 4.204.

### Noise mode (Noise Figure Measurements option, K30)

The **Noise** mode requires an instrument equipped with the corresponding optional software. This mode provides accurate and flexible noise measurement functions. For details refer to "[Noise Figure Measurements Option \(K30\)](#)" on page 4.227.

## Measurement Mode Menus – MENU Key

The **MENU** key provides a quick access to the menu of the current measurement mode. For details on measurement modes refer to "[Measurement Mode Selection – MODE Key](#)" on page 4.195.

### To access the main menu of an active measurement mode

- Press the **MENU** key.

The menu of the current measurement mode is displayed.

If the tracking generator, the power meter, and the spectrogram are available in the current measurement mode, softkeys for these functions are also provided. In the **Spectrum Analyzer** mode with active acoustic monitoring, the softkey **Marker Demod Volume** to control the volume control for acoustic monitoring is displayed.

### Menu and softkey description

- "[Optional softkeys of the menu menu](#)" on page 4.196

To display help to a softkey, press the **HELP** key and then the softkey for which you want to display help. To close the help window, press the **ESC** key. For further information refer to section "How to use the Help System".

### Optional softkeys of the menu menu

Apart from the softkeys of the current measurement mode, the following optional softkeys are available in the menu menu. It is possible that the basic unit does not provide all these softkeys. If a softkey is only available with a special option, model or (measurement) mode, this information is delivered in the corresponding softkey description.

Menu / Command
<a href="#">Tracking Generator</a>
<a href="#">Power Meter</a>
<a href="#">Marker Demod Volume</a>

#### Tracking Generator (models 13, 16)

---

Displays the menu of the **Tracking Generator** measurement mode. For details refer to "[Tracking Generator \(Models 13 and 16\)](#)" on page 4.198.

---

#### Power Meter (Power Sensor Support option, K9)

---

Displays the menu of the **Power Meter** measurement mode. For details refer to "[Power Meter \(Option K9\)](#)" on page 4.223.

---

#### Marker Demod Volume (Spectrum Analyzer mode)

---

Opens a dialog box to regulate the volume for acoustic monitoring.

---

## Models and Options

This section describes models and firmware options that are not included in the basic unit configuration. If hardware options are controlled via the firmware, the provided softkeys are described in the corresponding menu section. The information, with which special option or model these softkeys are supplied, is delivered in the corresponding softkey description.

A list of all available hardware and firmware options is provided on CD-ROM. To check the options your instrument provides, refer to the Quick Start Guide, chapter 2 "Preparing for Use". For details on models and firmware options refer to the following sections:

- ["Tracking Generator \(Models 13 and 16\)"](#) on page 4.198
- ["Analog Demodulation \(Option K7\)"](#) on page 4.204
- ["Power Meter \(Option K9\)"](#) on page 4.223
- ["Noise Figure Measurements Option \(K30\)"](#) on page 4.227

## Tracking Generator (Models 13 and 16)

During operation the tracking generator emits a signal exactly at the input frequency of the R&S ESL.

The tracking generator can be used in all measurement modes. Acquisition of test setup calibration values (see **Source Cal** softkey) and normalization using these correction values (see **Normalize** softkey) is only possible in the tracking generator measurement mode. For details on measurement modes refer to "[Measurement Mode Selection – MODE Key](#)" on page 4.195.

FFT filters (for details see "[To choose the appropriate filter type](#)" on page 4.96) are not available if the tracking generator is active.

For measurements with running tracking generator it is recommended to set the start frequency to 3 x resolution bandwidth in order to meet the data sheet accuracy.

---

**Note:** *The RF characteristics of some DUTs are especially sensitive concerning the input VSWR. In such cases insertion of 10–20 dB attenuation between the DUT and the tracking generator output is recommended.*

---

### To open the tracking generator menu

1. Press the **MENU** key.
2. Press the **Tracking Generator** softkey.  
The tracking generator menu is displayed.

### Menu and softkey description

- "[Softkeys of the tracking generator menu](#)" on page 4.201

To display help to a softkey, press the **HELP** key and then the softkey for which you want to display help. To close the help window, press the **ESC** key. For further information refer to section "How to use the Help System".

### Further information

- "[Transmission measurement](#)" on page 4.199
- "[Reflection measurement](#)" on page 4.199
- "[Calibration mechanism](#)" on page 4.199

### Tasks

- [To calibrate for transmission and reflection measurement](#)

### To calibrate for transmission and reflection measurement

Prerequisite: The instrument is in tracking generator measurement mode (for details refer to "[Measurement Mode Selection – MODE Key](#)" on page 4.195).

1. Press the **Source Power** softkey to enter the generator output level.  
If the tracking generator is off, it is switched on.
2. To enter a constant level offset for the tracking generator, press the **Power Offset** softkey.
3. Press the **Source Cal** softkey to open the submenu for calibration.



4. To record a reference trace for transmission measurement, press the **Cal Trans** softkey.  
The recording of the reference trace and the completion of the calibration sweep are indicated by message boxes.
5. To record a reference trace for reflection measurement, press the **Cal Refl Short** or **Cal Refl Open** softkey.  
The recording of the reference trace and the completion of the calibration sweep are indicated by message boxes.
6. Press the **Normalize** softkey to switch on the normalization.
7. Press the **Ref Value Position** softkey to display the reference line.
8. Press the **Ref Value** softkey to enter a value to shift the reference line.
9. Press the **Recall** softkey to restore the settings used for source calibration.

### Transmission measurement

This measurement will yield the transmission characteristics of a two-port network. The built-in tracking generator serves as a signal source. It is connected to the input connector of the DUT. The input of the R&S ESL is fed from the output of the DUT. A calibration can be carried out to compensate for the effects of the test setup (e.g. frequency response of connecting cables).



Fig. 4-9: Test setup for transmission measurement

### Reflection measurement

Scalar reflection measurements can be carried out by means of a reflection-coefficient measurement bridge.

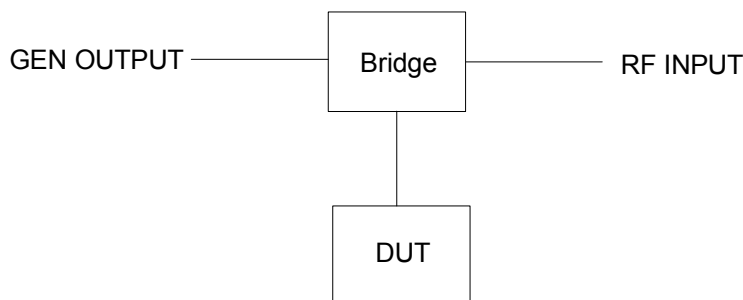

Fig. 4-10: Test setup for reflection measurement

### Calibration mechanism

Calibration means a calculation of the difference between the currently measured power and a reference curve, independent of the selected type of measurement (transmission/reflection). The hardware settings used for measuring the reference curve are included in the reference dataset.

Even with normalization switched on, the device settings can be changed in a wide area without stopping the normalization. This reduces the necessity to carry out a new normalization to a minimum.

For this purpose the reference dataset (trace with 501 measured values) is stored internally as a table of 501 points (frequency/level).

Differences in level settings between the reference curve and the current device settings are taken into account automatically. If the span is reduced, a linear interpolation of the intermediate values is applied. If the span increases, the values at the left or right border of the reference dataset are extrapolated to the current start or stop frequency, i.e. the reference dataset is extended by constant values.

An enhancement label is used to mark the different levels of measurement accuracy. This enhancement label is displayed at the right diagram border if normalization is switched on and a deviation from the reference setting occurs. Three accuracy levels are defined:

Table 4-9: Measurement accuracy levels

Accuracy	Enhancement label	Reason/Limitation
high	NOR	no difference between reference setting and measurement
medium	APX (approximation)	change of the following settings: coupling (RBW, VBW, SWT) reference level, RF attenuation start or stop frequency output level of tracking generator detector (max. peak, min. peak, sample, etc.) change of frequency: max. 501 points within the set sweep limits (corresponds to a doubling of the span)
–	Aborted normalization	more than 500 extrapolated points within the current sweep limits (in case of span doubling)

**Note:** At a reference level of  $-10$  dBm and at a tracking generator output level of the same value the R&S ESL operates without overrange reserve, i.e. the R&S ESL is in danger of being overloaded if a signal is applied whose amplitude is higher than the reference line. In this case, either the message **OVL** for overload or **IFOVL** for exceeded display range (clipping of the trace at the upper diagram border = overrange) is displayed in the status line.

Overloading can be avoided as follows:

- Reducing the output level of the tracking generator (**Source Power** softkey in the tracking generator menu)
- Increasing the reference level (**Ref Level** softkey in the amplitude menu)

### Softkeys of the tracking generator menu

The following table shows all softkeys available in the tracking generator menu. It is possible that your instrument configuration does not provide all softkeys. If a softkey is only available with a special option, model or (measurement) mode, this information is delivered in the corresponding softkey description.

For the description of the other main softkeys refer to "[Optional softkeys of the menu menu](#)" on page 4.196.

Menu / Command	Command
Source On/Off	
Source Power	
Power Offset	
Source Cal ↓	Cal Trans
	Cal Refl Short
	Cal Refl Open
	Normalize
	Ref Value Position
	Ref Value
	Recall

#### Source On/Off

Switches the tracking generator on or off. Default setting is off.

If the tracking generator is switched off, the corresponding hardware settings and the normalization are discarded. To switch off the tracking generator but keep the hardware settings and the normalization, enter  $-400$  dBm into the edit dialog box displayed by pressing the **Source Power** softkey.

→ Remote: `OUTP:STAT ON`

#### Source Power

Opens an edit dialog box to enter a tracking generator output power. The default output power is  $-20$  dBm. The range is specified in the data sheet. Additionally, the value  $-400$  dBm is available to switch off the tracking generator but keep the hardware settings.

If the tracking generator is off, it is automatically switched on if an output power value is entered. For details on switching on or off refer to the **Source On/Off** softkey.

→ Remote: `SOUR:POW -20dBm`

**Power Offset**

---

Opens an edit dialog box to enter a constant level offset for the tracking generator. Values from –200 dB to +200 dB in 1 dB steps are allowed. The default setting is 0 dB. Offsets are indicated by the enhancement label **LVL**.

With this offset for example attenuators or amplifiers at the output connector of the tracking generator can be taken into account for the displayed output power values on screen or during data entry. Positive offsets apply to an amplifier and negative offsets to an attenuator subsequent to the tracking generator.

→ Remote: SOUR:POW:OFFS -10dB

---

**Source Cal**

---

Opens a submenu to configure calibration for transmission and reflection measurement. For details on the test setups see "[Transmission measurement](#)" on page 4.199 and "[Reflection measurement](#)" on page 4.199.

---

**Cal Trans**

---

Starts a sweep that records a reference trace. This trace is used to calculate the difference for the normalized values.

→ Remote: CORR:METH TRAN

---

**Cal Refl Short**

---

Starts a sweep as reference trace for short–circuit calibration.

If both calibrations (open circuit, short circuit) are carried out, the calibration curve is calculated by averaging the two measurements and stored in the memory. The order of the two calibration measurements is free.

→ Remote: CORR:METH REFL

---

**Cal Refl Open**

---

Starts a sweep as reference trace the open–circuit calibration.

If both calibrations (open circuit, short circuit) are carried out, the calibration curve is calculated by averaging the two measurements and stored in the memory. The order of the two calibration measurements is free.

→ Remote: CORR:COLL OPEN

---

**Normalize**

---

Switches the normalization on or off. The softkey is only available if the memory contains a reference trace. For details on normalization see "[Calibration mechanism](#)" on page 4.199.

→ Remote: CORR ON

---

**Ref Value Position**

---

Switches the reference line on or off. The reference line marks the reference position at which the normalization result (calculated difference with a reference trace) is displayed. For details on the reference line see "[Calibration mechanism](#)" on page 4.199.

→ Remote: `DISP:WIND:TRAC:Y:RPOS 10PCT`

---

**Ref Value**

---

Opens an edit dialog box to enter a position value that shifts the reference line vertically. By default the reference line corresponds to a difference of 0 dB between the currently measured trace and the reference trace.

If, e.g. after a source calibration, a 10 dB attenuation is inserted into the signal path between DUT and R&S ESL input, the measurement trace will be moved by 10 dB down. Entering a reference value of -10 dB will shift the reference line also by 10 dB down and place the measurement trace on the reference line. The deviation from the nominal power level can be displayed with higher resolution (e.g. 1 dB/div). The power is still displayed in absolute values.

→ Remote: `DISP:WIND:TRAC:Y:RVAL -10dB`

---

**Recall**

---

Restores the settings that were used during source calibration. This can be useful if device settings were changed after calibration (e.g. center frequency, frequency deviation, reference level, etc).

→ Remote: `CORR:REC`

---

## Analog Demodulation (Option K7)

The digital signal processing in the R&S ESL, used in the analyzer mode for digital IF filters, is also ideally suited for demodulating AM, FM, or PM signals. The firmware option R&S FSL–K7 provides the necessary measurement functions.

The R&S ESL is equipped with a demodulator that is capable of performing AM, FM, and PM demodulation at a time. Additionally maximum, minimum and average or current values can be obtained parallelly over a selected number of measurements.

By sampling (digitization) already at the IF and digital down–conversion to the baseband (I/Q), the demodulator achieves maximum accuracy and temperature stability. There is no evidence of typical errors of an analog down–conversion and demodulation like AM to FM conversion and vice versa, deviation error, frequency response or frequency drift at DC coupling.

### To open the analog demodulation menu

- If the **Analog Demodulation** mode is not the active measurement mode, press the **MODE** key and activate the **Analog Demodulation** option.
- If the **Analog Demodulation** mode is already active, press the **MENU** key.

The analog demodulation menu is displayed. If the tracking generator (models 13, 16) or the power meter (option Power Sensor Support, K9) is available, softkeys for these functions are also provided.

### Menu and softkey description

- ["Softkeys of the analog demodulation menu"](#) on page 4.208
- ["Softkeys of the frequency menu \(Analog Demodulation mode\)"](#) on page 4.215
- ["Softkeys of the span menu \(Analog Demodulation mode\)"](#) on page 4.217
- ["Softkeys of the amplitude menu \(Analog Demodulation mode\)"](#) on page 4.218
- ["Softkeys of the bandwidth menu \(Analog Demodulation mode\)"](#) on page 4.220
- ["Softkeys of the sweep menu \(Analog Demodulation mode\)"](#) on page 4.220
- ["Softkeys of the trigger menu \(Analog Demodulation mode\)"](#) on page 4.221

Apart from the power measurement menu that is not available in the **Analog Demodulation** mode, all other menus are provided as described for the base unit. For details refer to the corresponding menu descriptions.

To display help to a softkey, press the **HELP** key and then the softkey for which you want to display help. To close the help window, press the **ESC** key. For further information refer to section "How to use the Help System".

### Further information

- ["Circuit description – block diagrams"](#) on page 4.205
- ["Demodulation bandwidth"](#) on page 4.206
- ["AF trigger"](#) on page 4.206
- ["Stability of measurement results"](#) on page 4.206
- ["Sample rate, measurement time and trigger offset"](#) on page 4.207

**Circuit description – block diagrams**

The software demodulator runs on the main processor of the analyzer. The demodulation process is shown in Fig. 4-11: Block diagram of software demodulator. All calculations are performed simultaneously with the same I/Q data set. Magnitude (= amplitude) and phase of the complex I/Q pairs are determined. The frequency result is obtained from the differential phase.

For details on the analyzer signal processing refer to chapter "Remote Control – Commands", section "TRACe:IQ Subsystem".

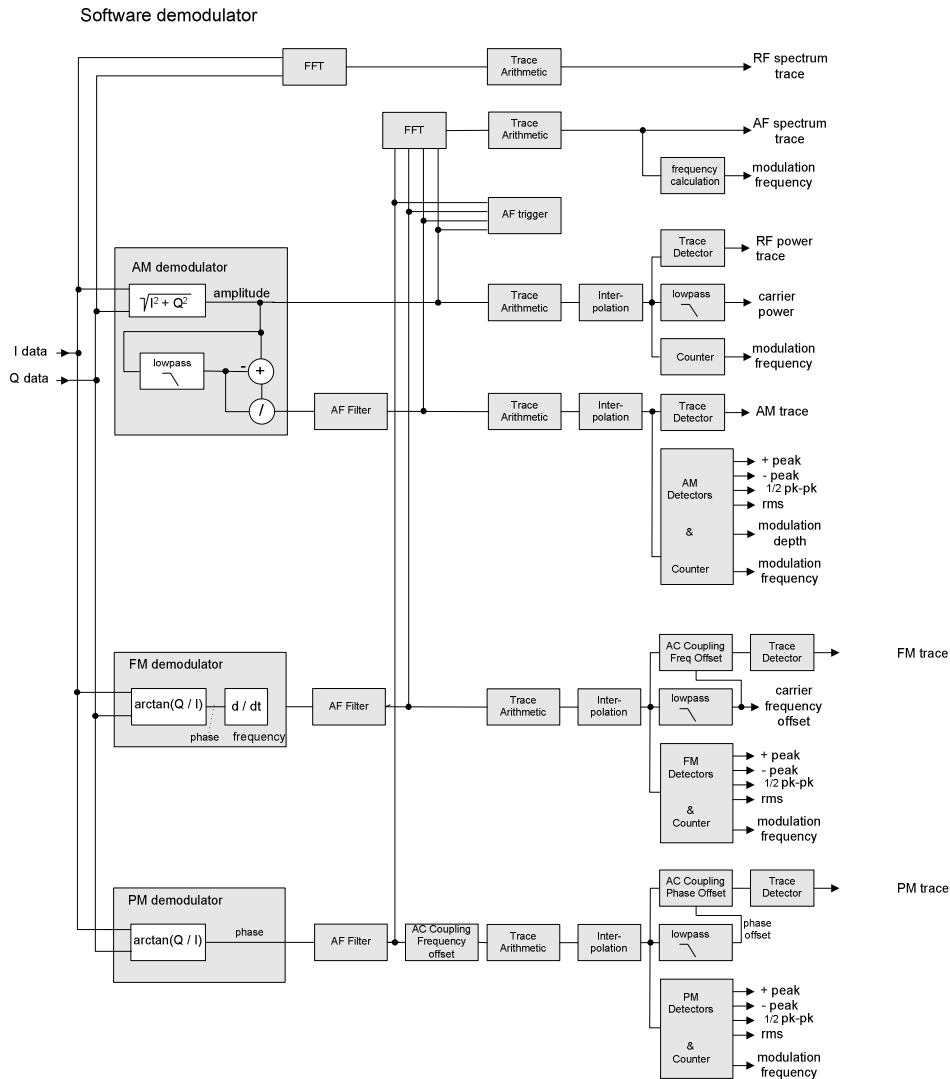

Fig. 4-11: Block diagram of software demodulator

The AM DC, FM DC and PM DC raw data of the demodulators is fed into the *Trace Arithmetic* block that combines consecutive data sets. Possible trace modes are: Clear Write, Max Hold, Min Hold and Average (for details refer to section "[Trace mode overview](#)" on page 4.114). The output data of the *Trace Arithmetic* block can be read via remote control.

The collected measured values are evaluated by the selected detector (for details refer to chapter "Instrument Functions", section "Detector overview". The result is displayed on the screen and can be read out via remote control.

In addition, important parameters are calculated:

- A counter determines the modulation frequency for AM, FM, and PM.
- average power = carrier power (RF power)
- average frequency = carrier frequency offset (FM)
- The modulation depth or the frequency or phase deviation is displayed.
- AC coupling is possible with FM and PM display. The deviations are determined from the trace data. +Peak, –Peak, ½ Peak–Peak and RMS are displayed.

### **Demodulation bandwidth**

The demodulation bandwidth is not the 3 dB bandwidth but the useful bandwidth which is distortion-free with regard to phase and amplitude.

Therefore the following formulas apply:

- AM: demodulation bandwidth  $\geq 2 \times$  modulation frequency
- FM: demodulation bandwidth  $\geq 2 \times$  (frequency deviation + modulation frequency)
- PM: demodulation bandwidth  $\geq 2 \times$  modulation frequency  $\times (1 +$  phase deviation)

---

**Note:** *If the center frequency of the analyzer is not set exactly to the signal frequency, the demodulation bandwidth must be selected larger by the carrier offset, in addition to the requirement described above. This also applies if FM or PM AC coupling has been selected.*

---

In general, the demodulation bandwidth should be as narrow as possible to improve the S/N ratio. The residual FM caused by noise floor and phase noise increases dramatically with the bandwidth, especially with FM.

### **AF trigger**

The analog demodulation option allows triggering to the demodulated signal. The display is stable if a minimum of five modulation periods are within the recording time.

Triggering is always DC-coupled. Therefore triggering is possible directly to the point where a specific carrier level, phase or frequency is exceeded or not attained.

### **Stability of measurement results**

Despite amplitude and frequency modulation, the display of carrier power and carrier frequency offset is stable.

This is achieved by a digital filter which sufficiently suppresses the modulation, provided, however, that the measurement time is  $\geq 3 \times 1 /$  modulation frequency, i.e. that at least three periods of the AF signal are recorded.

The mean carrier power for calculating the AM is also calculated with a digital filter that returns stable results after a measurement time of  $\geq 3 \times 1 /$  modulation frequency, i.e. at least three cycles of the AF signal must be recorded before a stable AM can be shown.



### Sample rate, measurement time and trigger offset

Depending on the sample rate, the maximum demodulation bandwidths listed in the table can be obtained during the measurement. The permissible value range of the measurement time and trigger offset depends on the selected demodulation bandwidth. If the AF filter or the AF trigger are not active, the measurement time enlarges by 20%.

Demod. bandwidth	Sample rate	Measurement time			Trigger offset	
		Min.	Max. with AF filter or AF trigger active	Max. with AF filter and AF trigger deactive	Min.	Max.
18 MHz	32 MHz	31.25 ns	12.5 ms	15 ms	-12.5 ms	507.9 ms
10 MHz	32 MHz	31.25 ns	12.5 ms	15 ms	-12.5 ms	507.9 ms
8 MHz	16 MHz	62.5 ns	25 ms	30 ms	-25 ms	1.015 s
5 MHz	8 MHz	125 ns	50 ms	60 ms	-50 ms	2.031 s
3 MHz	4 MHz	250 ns	100 ms	120 ms	-100 ms	4.063 s
1.6 MHz	2 MHz	500 ns	200 ms	240 ms	-200 ms	8.126 s
800 kHz	1 MHz	1 µs	400 ms	480 ms	-400 ms	16.25 s
400 kHz	500 kHz	2 µs	800 ms	960 ms	-800 ms	32.50 s
200 kHz	250 kHz	4 µs	1.6 s	1.92 s	-1.6 s	65.00 s
100 kHz	125 kHz	8 µs	3.2 s	3.84 s	-3.2 s	130.0 s
50 kHz	62.5 kHz	16 µs	6.4 s	7.68 s	-6.4 s	260.0 s
25 kHz	31.25 kHz	32 µs	12.8 s	15.36 s	-12.8 s	520.0 s
12.5 kHz	15.625 kHz	64 µs	25.6 s	30.72 s	-25.6 s	1040 s
6.4 kHz	7,8125 kHz	128 µs	51.2 s	61.44 s	-51.2 s	2080 s
3.2 kHz	3,90625 kHz	256 µs	102.4 s	122.88 s	-102.4 s	4160 s
1.6 kHz	1,953125 kHz	512 µs	204.8 s	245.76 s	-204.8 s	8321 s
800 Hz	976,5625 Hz	1.024 ms	409.6 s	491.52 s	-409.6 s	16643 s
400 Hz	488,28125 Hz	2.048 ms	819.2 s	983.04 s	-819.2 s	33287 s
200 Hz	244,140625 Hz	4.096 ms	1638.4 s	1966.08 s	-1638.4 s	66574 s
100 Hz	122,0703125 Hz	8.192 ms	3276.8 s	3932.16 s	-3276.8 s	133148 s

**Softkeys of the analog demodulation menu**

The following table shows all softkeys available in the analog demodulation menu. It is possible that your instrument configuration does not provide all softkeys. If a softkey is only available with a special option, model or (measurement) mode, this information is delivered in the corresponding softkey description.

Menu / Command	Submenu / Command	Command
Modulation AM/FM/PM		
Result Display	AF Time Domain	
	AF Spectrum	
	RF Time Domain	
	RF Spectrum	
	Select Trace	
	Diagram Full Size	
Demod BW		
Meas Time		
AF Range ↓	Dev per Division/dB per Division	
	Reference Position	
	Reference Value	
	Deviation Lin/Log	
Demod Settings ↓	AF Coupling AC/DC	
	AF Filter ↓	Low Pass AF Filter
		High Pass AF Filter
		Deemphasis
	Zero Phase Reference Point	
	Phase Wrap On/Off	
	Phase Unit Rad/Deg	
More ↓		
Zoom		

**Modulation AM/FM/PM**

Selects the display of demodulated AM, FM, or PM signal. In single sweep mode, the data is determined from the current I/Q data set, i.e. a change to AM/FM/PM does not trigger a new measurement.

If FM is selected, the average value of the demodulated signal is mapped depending on the **AF Coupling AC/DC** softkey setting.

→ Remote: CALC:FEED 'XTIM:FM'

---

**Result Display**

---

Opens a submenu to select the measurement result to be displayed. The RF or AF signal in the zero span or the RF or AF frequency spectrum determined via FFT can be selected for display.

In order to display the measurement results, the screen is divided in two halves. In the upper half, the measurement results are displayed as a trace. In the lower half the results of additional evaluation functions are shown.

All displays are determined from the I/Q data set recorded for the measurement. In single sweep mode, the single data set recorded can be evaluated in all displays simply by switching the result display.

---

**AF Time Domain**

---

Selects the AF display in zero span, calculated from the AM, FM, or PM signal.

→ Remote: `CALC:FEED 'XTIM:FM'`

---

**AF Spectrum**

---

Selects the display of the AF spectrum. The AF spectrum can be calculated from the AM, FM, or PM signal in zero span.

→ Remote: `CALC:FEED 'XTIM:FM:AFSP'`

---

**RF Time Domain**

---

Selects the display of the RF signal in zero span. In contrast to normal analyzer operation, the level values are determined from the recorded I/Q data set as root-mean-square values.

The softkey is not available if the RF spectrum display is selected.

→ Remote: `CALC:FEED 'XTIM:RFP'`

---

**RF Spectrum**

---

Selects the display of the RF signal in span > 0. In contrast to normal spectrum analyzer operation, the measured values are determined using FFT from the recorded I/Q data set.

→ Remote: `CALC:FEED 'XTIM:SPECTRUM'`

---

**Select Trace**

---

Opens an edit dialog box to enter the number of the trace for which the data is to be displayed in the lower half of the screen. Only activated traces can be selected.

---

**Diagram Full Size**

---

Switches the diagram to full screen size.

→ Remote: `DISP:SIZE LARG`

---

---

**Demod BW**

---

Opens an edit dialog box to enter the demodulation bandwidth of the analog demodulation. The demodulation bandwidth determines the sampling rate for recording the signal to be analyzed. For details on the relation between demodulation bandwidth and sampling rate refer to "[Sample rate, measurement time and trigger offset](#)" on page 4.207.

→ Remote: BAND:DEM 1MHz

---

---

**Meas Time**

---

Opens an editor for entering the measurement time of the analog demodulation. For details on the measurement time values refer to "[Sample rate, measurement time and trigger offset](#)" on page 4.207.

→ Remote: ADEM:MTIM 62.5US

→ Remote: SWE:TIME 10s

---

---

**AF Range**

---

Opens a submenu for determining the diagram scaling for AF displays.

The range for RF displays is set via the amplitude menu. For details refer to "[Setting the Level Display and Configuring the RF Input – AMPT Key](#)" on page 4.91.

---

---

**Dev per Division**

---

Opens an edit dialog box to set the modulation depth or the phase or frequency deviation per division:

AM display: 0.0001% to 1000%

FM display: 1 Hz/div to 1 MHz/div

PM display: 0.0001 rad/div to 1000 rad/div

The softkey is not available if logarithmic display is set (**Deviation Lin/Log** softkey).

→ Remote: DISP:WIND:TRAC:Y:PDIV 50kHz

---

---

**dB per Division**

---

Opens an edit dialog box to set the modulation depth or the FM or PM deviation to be displayed in the range 0.1 dB/div to 20 dB/div.

The softkey is not available if linear display is set (**Deviation Lin/Log** softkey).

→ Remote: DISP:TRAC:Y:PDIV 5DB

---

---

**Reference Position**

---

Determines the position of the reference line for the modulation depth or the phase or frequency deviation on the y-axis of the diagram. By default, this line is set to 0.

The position is entered as a percentage of the diagram height with 100 % corresponding to the upper diagram border. The default setting is 50 % (diagram center) for the display of the AM, FM, or PM signal, and 100% (upper diagram border) for the AF spectrum display of the AM, FM, or PM signal.

→ Remote: `DISP:TRAC:Y:RPOS 50PCT`

---



---

**Reference Value**

---

Determines the modulation depth or the frequency or phase deviation at the reference line of the y-axis. The reference value is set separately for each display of the AM, FM, and PM signal and the AF spectrum of the AM, FM, and PM signal.

- AM/FM/PM signal display

The trace display takes individual frequency/phase offsets into account (in contrast, the **AF Coupling AC/DC** softkey permits automatic correction by the average frequency/phase offset of the signal, and can therefore not be activated simultaneously).

Possible values: 0 and  $\pm 10000\%$  (AM), 0 and  $\pm 10$  MHz (FM), 0 and  $\pm 10000$  rad (PM).

- AF spectrum display of the AM/FM/PM signal

In the default setting, the reference value defines the modulation depth or the FM/PM deviation at the upper diagram border.

Possible values: 0 and 10000% (AM), 0 and 10 MHz (FM), 0 and 10000 rad (PM).

→ Remote: `DISP:TRAC:Y:RVAL 0HZ`

---



---

**Deviation Lin/Log**

---

Switches between logarithmic and linear display of the modulation depth or the frequency or phase deviation.

→ Remote: `DISP:TRAC:Y:SPAC LOG`

---



---

**Demod Settings**

---

Opens a submenu for the demodulation settings.

---



---

**AF Coupling AC/DC**

---

Controls the automatic correction of the frequency offset and phase offset of the input signal:

- FM signal display

If DC is selected, the absolute frequency is displayed, i.e. an input signal with an offset relative to the center frequency is not displayed symmetrically with respect to the zero line.

If AC is selected, the frequency offset is automatically corrected, i.e. the trace is always symmetric with respect to the zero line.

- PM signal display

If DC is selected, the phase runs according to the existing frequency offset. In addition, the DC signal contains a phase offset of  $\pm\pi$ .

If AC is selected, the frequency offset and phase offset are automatically corrected, i.e. the trace is always symmetric with respect to the zero line.

The softkey is not available with the AF spectrum display of the FM or PM signal.

→ Remote: ADEM:AF:COUP DC

---

## AF Filter

Opens a submenu to select the appropriate filters. The bandwidth of the demodulated signal can be reduced by high pass or low pass filters and also a de-emphasis can be switched on. The selected filters are used for AM, FM and PM demodulation in common. Individual settings are not possible.

---

### Low Pass AF Filter

Opens the **Low Pass AF Filter** dialog box to select the filter type. Relative and absolute low pass filter are available.

- Relative low pass filters:

The filters (3 dB) can be selected in % of the demodulation bandwidth. The filters are designed as 5th-order Butterworth filter (30 dB/octave) and active for all demodulation bandwidths.

- Absolute low pass filters:

The filter are indicated by the 3 dB cutoff frequency. The 3 kHz and 15 kHz filters are designed as 5th-order Butterworth filter (30 dB/octave). The 150 kHz filter is designed as 8th-order Butterworth filter (48 dB/octave).

The absolute low pass filters are active in the following demodulation bandwidth range:

3 kHz:	$6.4 \text{ kHz} \leq \text{demodulation bandwidth} \leq 4 \text{ MHz}$
15 kHz:	$50 \text{ kHz} \leq \text{demodulation bandwidth} \leq 16 \text{ MHz}$
150 kHz:	$400 \text{ kHz} \leq \text{demodulation bandwidth} \leq 16 \text{ MHz}$

→ Remote: FILT:LPAS ON

→ Remote: FILT:LPAS:FREQ 150kHz

→ Remote: FILT:LPAS:FREQ 25PCT

---

---

### High Pass AF Filter

---

Opens the **High Pass AF Filter** dialog box to switch on a high pass filter with the given limit to separate the DC component. The filters are indicated by the 3 dB cutoff frequency. The filters are designed as 2nd-order Butterworth filter (12 dB/octave).

The high pass filters are active in the following demodulation bandwidth range:

50 Hz:  $200 \text{ Hz} \leq \text{demodulation bandwidth} \leq 4 \text{ MHz}$

300 Hz:  $800 \text{ Hz} \leq \text{demodulation bandwidth} \leq 16 \text{ MHz}$

- Remote: `FILT:HPAS ON`
  - Remote: `FILT:HPAS:FREQ 300Hz`
- 

### Deemphasis

---

Opens the **Deemphasis** dialog box to switch on a deemphasis with the given time constant.

The deemphasis is active in the following demodulation bandwidth range:

25  $\mu\text{s}$ :  $25 \text{ kHz} \leq \text{demodulation bandwidth} \leq 18 \text{ MHz}$

50  $\mu\text{s}$ :  $6.4 \text{ kHz} \leq \text{demodulation bandwidth} \leq 18 \text{ MHz}$

75  $\mu\text{s}$ :  $6.4 \text{ kHz} \leq \text{demodulation bandwidth} \leq 18 \text{ MHz}$

750  $\mu\text{s}$ :  $800 \text{ Hz} \leq \text{demodulation bandwidth} \leq 4 \text{ MHz}$

The following table shows the required demodulation bandwidth for an error less than 0.5 dB up to a maximum AF frequency.

deemphasis	25 $\mu\text{s}$	50 $\mu\text{s}$	75 $\mu\text{s}$	750 $\mu\text{s}$
max. AF frequency	25 kHz	12 kHz	8 kHz	800 Hz
required demodulation bandwidth	$\geq 200 \text{ kHz}$	$\geq 100 \text{ kHz}$	$\geq 50 \text{ kHz}$	$\geq 6.4 \text{ kHz}$

For higher AF frequencies the demodulation bandwidth must be increased.

- Remote: `FILT:DEMP ON`
  - Remote: `FILT:DEMP:TCON 750us`
- 

### Zero Phase Reference Point

---

Defines the position at which the phase of the PM-demodulated signal is set to 0 rad. The entry is made with respect to time. In the default setting, the first measured value is set to 0 rad.

This softkey is only available in the PM display with DC coupling.

- Remote: `ADEM:PM:RPO 500us`
-

---

**Phase Wrap On/Off**

---

Activates/deactivates the phase wrap.

**On** The phase will be displayed in the range  $\pm 180^\circ$  ( $\pm \Pi$ ). For example, if the phase exceeds  $+180^\circ$ ,  $360^\circ$  is subtracted from the phase value, with the display thus showing  $>-180^\circ$ .

**Off** The phase will not be wrapped.

This softkey is available in the PM signal displays.

→ Remote: CALC:FORM PHAS

---

**Phase Unit Rad/Deg**

---

Sets the phase unit to rad or deg for displaying PM signals.

→ Remote: UNIT:ANGL RAD

---

**Zoom**

---

Activates or deactivates the zoom function. The zoom function is not available if the number of measurement points falls below 501.

**activated:** A 1-to-1 allocation is selected, i.e. each measurement point corresponds to a measured value. The start of the zoom window can be determined in the associated field by entering the time.

**deactivated:** If more measured values than measurement points are available, several measured values are combined in one measurement point according to the method of the selected trace detector. For details on detectors refer to "[Detector overview](#)" on page 4.116.

→ Remote: ADEM:ZOOM ON

→ Remote: ADEM:ZOOM:START 30US

---



### Softkeys of the frequency menu (Analog Demodulation mode)

The following table shows all softkeys available in the frequency menu in **Analog Demodulation** mode (**FREQ** key). It is possible that your instrument configuration does not provide all softkeys. If a softkey is only available with a special option, model or (measurement) mode, this information is delivered in the corresponding softkey description.

Menu / Command	Command
Center	
CF Stepsize ↓	0.1*Span/0.1*Demod BW
	0.5*Span/0.5*Demod BW
	x*Span/x*Demod BW
	=Center
	Manual
AF Center	
AF Start	
AF Stop	

#### Center

For details refer to the **Center** softkey in the frequency menu of the base unit.

#### CF Stepsize

For details refer to the **CF Stepsize** softkey in the frequency menu of the base unit.

#### 0.1\*Span (RF Spectrum)

For details refer to the **0.1\*Span** softkey in the frequency menu of the base unit.

#### 0.1\*Demod BW (AF/RF Time Domain, AF Spectrum)

For details see **0.1\*RBW** softkey in the frequency menu of the base unit.

#### 0.5\*Span (RF Spectrum)

For details refer to the **0.5\*Span** softkey in the frequency menu of the base unit.

#### 0.5\*Demod BW (AF/RF Time Domain, AF Spectrum)

For details see **0.5\*RBW** softkey in the frequency menu of the base unit.

#### x\*Span (RF Spectrum)

For details refer to the **x\*Span** softkey in the frequency menu of the base unit.

---

**x\*Demod BW (AF/RF Time Domain, AF Spectrum)**

---

For details see **x\*RBW** softkey in the frequency menu of the base unit.

---

**=Center**

---

For details refer to the **=Center** softkey in the frequency menu of the base unit.

---

**Manual**

---

For details refer to the **Manual** softkey in the frequency menu of the base unit.

---

**AF Center (AF Spectrum)**

---

Opens an edit box to enter the center frequency within the AF spectrum.

→ Remote: ADEM:AF:CENT 1MHZ

---

**AF Start**

---

Opens an edit box to define the start frequency within the AF spectrum.

→ Remote: ADEM:AF:STAR 0HZ

---

**AF Stop**

---

Opens an edit box to define the stop frequency within the AF spectrum.

The maximum AF stop frequency corresponds to half the demodulation bandwidth.

→ Remote: ADEM:AF:STOP 2MHZ

---

### Softkeys of the span menu (Analog Demodulation mode)

The following table shows all softkeys available in the span menu in **Analog Demodulation** mode (**SPAN** key). It is possible that your instrument configuration does not provide all softkeys. If a softkey is only available with a special option, model or (measurement) mode, this information is delivered in the corresponding softkey description.

Command
Span Manual/AF Span Manual
Demod Bandwidth
Full Span/AF Full Span

#### Span Manual (RF Spectrum)

If the RF spectrum display is active, values between the sampling rate/200 and the demodulation bandwidth/2 are allowed.

For further details refer to the **Span Manual** softkey in the span menu of the base unit.

→ Remote: ADEM:SPEC:SPAN:ZOOM 5 MHz

#### AF Span Manual (AF Spectrum)

Opens an edit dialog box to enter the frequency range for the AF spectrum display. Values between the sampling rate/1000 and the demodulation bandwidth/2 are allowed.

→ Remote: ADEM:AF:SPAN 2.5 MHz

#### Demod Bandwidth

For details see **Demod BW** softkey in the analog demodulation menu.

#### Full Span (RF Spectrum)

If the RF spectrum display is active, the full frequency range corresponds to the demodulation bandwidth.

For further details refer to the **Full Span** softkey in the span menu of the base unit.

→ Remote: ADEM:SPEC:SPAN:ZOOM MAX

#### AF Full Span (AF Spectrum)

Sets the span to the maximum frequency range for the AF spectrum display. The maximum frequency range corresponds to the demodulation bandwidth.

→ Remote: ADEM:AF:SPAN:FULL

**Softkeys of the amplitude menu (Analog Demodulation mode)**

The following table shows all softkeys available in the amplitude menu in **Analog Demodulation** mode (**AMPT** key). It is possible that your instrument configuration does not provide all softkeys. If a softkey is only available with a special option, model or (measurement) mode, this information is delivered in the corresponding softkey description.

Menu / Command	Command
Ref Level	
Range Log/Range Linear	
AF Range ↓	Dev per Division/dB per Division
	Reference Position
	Reference Value
	Deviation Lin/Log
Preamp On/Off	
RF Atten Manual	
RF Atten Auto	
More ↓	
Ref Level Offset	
Ref Level Position	
Grid Abs / Rel	
Unit	
Input 50 Ω / 75 Ω	

**Ref Level**

For details refer to the **Ref Level** softkey in the amplitude menu of the base unit.

**Range Log (RF result display)**

This softkey is only available for the RF result display. For the RF result display, the **AF Range** softkey is used.

For details refer to the **Range Log** softkey in the amplitude menu of the base unit.

**Range Linear (RF result display)**

This softkey is only available for the RF result display. For the RF result display, the **AF Range** softkey is used.

For details refer to the **Range Linear** softkey in the amplitude menu of the base unit.

**AF Range (AF result display)**

For details refer to the **AF Range** softkey in the analog demodulation menu.

**Dev per Division**

---

For details refer to the **Dev per Division** softkey in the analog demodulation menu.

---

**dB per Division**

---

For details refer to the **dB per Division** softkey in the analog demodulation menu.

---

**Reference Position**

---

For details refer to the **Reference Position** softkey in the analog demodulation menu.

---

**Reference Value**

---

For details refer to the **Reference Value** softkey in the analog demodulation menu.

---

**Deviation Lin/Log**

---

For details refer to the **Deviation Lin/Log** softkey in the analog demodulation menu.

---

**Preamp On/Off (option RF Preamplifier, B22)**

---

For details refer to the **Preamp On/Off** softkey in the amplitude menu of the base unit.

---

**RF Atten Manual**

---

For details refer to the **RF Atten Manual** softkey in the amplitude menu of the base unit.

---

**RF Atten Auto**

---

For details refer to the **RF Atten Auto** softkey in the amplitude menu of the base unit.

---

**Ref Level Offset**

---

For details refer to the **Ref Level Offset** softkey in the amplitude menu of the base unit.

---

**Ref Level Position**

---

For details refer to the **Ref Level Position** softkey in the amplitude menu of the base unit.

---

**Grid Abs / Rel (not available with Range Linear)**

---

For details refer to the **Grid Abs / Rel** softkey in the amplitude menu of the base unit.

---

**Unit (PM AF result display)**

For details refer to the **Unit** softkey in the amplitude menu of the base unit.

**Input 50 Ω / 75 Ω**

For details refer to the **Input 50 Ω / 75 Ω** softkey in the amplitude menu of the base unit.

**Softkeys of the bandwidth menu (Analog Demodulation mode)**

The following table shows all softkeys available in the bandwidth menu in **Analog Demodulation** mode (**BW** key). It is possible that your instrument configuration does not provide all softkeys. If a softkey is only available with a special option, model or (measurement) mode, this information is delivered in the corresponding softkey description.

Command
Res BW
Demod BW
Meas Time

**Res BW (span > 0)**

Opens an edit dialog box to enter a value for the resolution bandwidth. The range is specified in the data sheet.

→ Remote: ADEM:SPEC:BAND 10 kHz

**Demod BW**

For details refer to the **Demod BW** softkey in the in the analog demodulation menu.

**Meas Time**

For details refer to the **Meas Time** softkey in the in the analog demodulation menu.

**Softkeys of the sweep menu (Analog Demodulation mode)**

The following table shows all softkeys available in the sweep menu in **Analog Demodulation** mode (**SWEEP** key). It is possible that your instrument configuration does not provide all softkeys. If a softkey is only available with a special option, model or (measurement) mode, this information is delivered in the corresponding softkey description.

Command
Continuous Sweep
Single Sweep
Continue Sgl Sweep
Meas Time
Sweep Count

**Continuous Sweep**

For details refer to the **Continuous Sweep** softkey in the in the sweep menu of the base unit.

**Single Sweep**

For details refer to the **Single Sweep** softkey in the in the sweep menu of the base unit.

**Continue Sgl Sweep**

For details refer to the **Continue Single Sweep** softkey in the in the sweep menu of the base unit.

**Meas Time**

For details refer to the **Meas Time** softkey in the in the analog demodulation menu.

**Sweep Count**

For details refer to the **Sweep Count** softkey in the in the sweep menu of the base unit.

**Softkeys of the trigger menu (Analog Demodulation mode)**

The following table shows all softkeys available in the trigger menu in **Analog Demodulation** mode (**TRIG** key). It is possible that your instrument configuration does not provide all softkeys. If a softkey is only available with a special option, model or (measurement) mode, this information is delivered in the corresponding softkey description.

<b>Command</b>
Trigger Source
Trigger Level
Trigger Polarity Pos/Neg
Trigger Offset

**Trigger Source**

Opens the **Trigger** dialog box to select the trigger mode. Additional to the trigger modes described in section "[Trigger mode overview](#)" on page 4.108, the following trigger modes are available:

Selected option	Specified threshold
<b>AM (Offline)</b>	modulation depth of the AM signal
<b>FM (Offline)</b>	frequency of the FM signal
<b>PM (Offline)</b>	phase of the PM signal
<b>RF (Offline)</b>	level of the RF signal

In **Analog Demodulation** mode, the next measurement is triggered if the selected input signal exceeds the threshold specified using the **Trg / Gate Level** softkey. A periodic signal modulated onto the carrier frequency can be displayed in this way. It is recommended that the measurement time covers at least five periods of the audio signal.

For further details refer to the **Trg / Gate Source** softkey in the trigger menu.

- Remote: TRIG:SOUR IMM | IFP | EXT | FM | PM | AM | RF (Free Run, IF Power, Extern, FM (Offline), PM (Offline), AM (Offline), RF (Offline))
- 

### **Trigger Level**

---

For details refer to the **Trg / Gate Level** softkey in the in the trigger menu of the base unit.

---

### **Trigger Polarity Pos/Neg**

---

For details refer to the **Trg / Gate Polarity Pos/Neg** softkey in the in the trigger menu of the base unit.

---

### **Trigger Offset**

---

For details on the relation between demodulation bandwidth (option Analog Demodulation, R&S FSL–K7) and trigger offset refer to "[Sample rate, measurement time and trigger offset](#)" on page 4.207.

For details refer to the **Trigger Offset** softkey in the in the trigger menu of the base unit.

---



## Power Meter (Option K9)

For precise power measurement a power sensor is connected to the instrument via the front panel (USB connector) or the rear panel (power sensor, option R&S FSL–B5). The Power Sensor Support firmware option provides the power measurement functions for this test setup (see Fig. 4-12: Power sensor support – standard test setup). Both manual operation and remote control are supported. The functions of this firmware option are described in this section. For details on the connectors and compatible power sensors refer to the Quick Start Guide, chapter 1, "Front and Rear Panel".

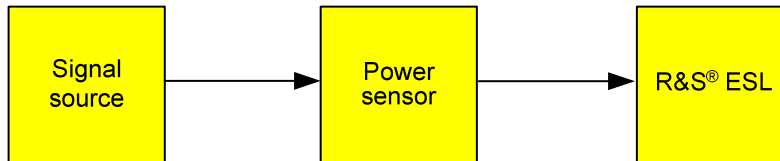

Fig. 4-12: Power sensor support – standard test setup

### To open the power meter menu

1. Press the **MENU** key.
2. Press the **Power Meter** softkey.  
The power meter menu is displayed.

### Menu and softkey description

- ["Softkeys of the power meter menu"](#) on page 4.224

To display help to a softkey, press the **HELP** key and then the softkey for which you want to display help. To close the help window, press the **ESC** key. For further information refer to section "How to use the Help System".

### Tasks

- [To zero the power meter](#)
- [To use the power meter](#)

### To zero the power meter

1. Press the **Zero** softkey.  
A dialog box is displayed that prompts you to disconnect all signals from the input of the power sensor.
2. Disconnect all signals from the input of the power sensor and press **ENTER** to continue.
3. Wait until zeroing is complete.  
A corresponding message is displayed.

### To use the power meter

1. Press the **Frequency Coupling** softkey to select the coupling option.
2. If you have selected the **Manual** coupling option, press the **Frequency Manual** softkey to enter the frequency of the signal which power you want to measure.
3. Press the **Unit/Scale** softkey to set the unit for the power result display.
4. If you have selected dB or % as units (relative display), define a reference value:
  - To set the currently measured power as a reference value, press the **Meas→Ref** softkey.
  - To enter a reference value, press the **Reference Value** softkey.
5. Press the **Meas Time/Average** softkey to select the measurement time. For recommendations refer to the **Meas Time/Average** softkey description.

### Softkeys of the power meter menu

The following table shows all softkeys available in the power meter menu. It is possible that your instrument configuration does not provide all softkeys. If a softkey is only available with a special option, model or (measurement) mode, this information is delivered in the corresponding softkey description.

For the description of the other main softkeys refer to "[Optional softkeys of the menu menu](#)" on page 4.196.

Command
<a href="#">Power Meter On/Off</a>
<a href="#">Frequency Manual</a>
<a href="#">Frequency Coupling</a>
<a href="#">Unit/Scale</a>
<a href="#">Zero</a>
<a href="#">Meas Time/Average</a>
More ↓
<a href="#">Meas→Ref</a>
<a href="#">Reference Value</a>
<a href="#">Use Ref Lev Offset</a>
<a href="#">Number of Readings</a>

#### Power Meter On/Off

---

Switches the power measurement on or off.

→ Remote: PMET ON

---

#### Frequency Manual

---

Opens an edit dialog box to enter the frequency of the signal to be measured. The power sensor has a memory with frequency-dependent correction factors. This allows extreme accuracy for signals of a known frequency.

→ Remote: PMET:FREQ 1GHZ

---

---

**Frequency Coupling**

---

Opens the **Frequency Coupling** dialog box to select the coupling option. The frequency can be coupled automatically to the center frequency of the instrument or to the frequency of marker 1, or manually to a set frequency (see **Frequency Manual** softkey).

→ Remote: PMET:FREQ:LINK CENT

---

**Unit/Scale**

---

Opens the **Unit/Scale** dialog box to select the unit with which the measured power is to be displayed.

If dB or % is selected, the display is relative to a reference value that is defined with either the Meas→Ref softkey or the **Reference Value** softkey.

→ Remote: UNIT:PMET:POW DBM

→ Remote: UNIT:PMET:POW:RAT DB

---

**Zero**

---

Starts zeroing of the power sensor. For details on the zeroing process refer to "[To zero the power meter](#)" on page 4.223.

→ Remote: CAL:PMET:ZERO:AUTO ONCE;\*WAI

---

**Meas Time/Average**

---

Opens the **Meas Time** dialog box to select the measurement time or to switch to manual averaging mode. In general, results are more precise with longer measurement times. The following settings are recommended for different signal types to obtain stable and precise results:

<b>Short</b>	Stationary signals with high power (> -40dBm), because they require only a short measurement time and short measurement time provides the highest repetition rates.
<b>Normal</b>	Signals with lower power or of modulated signals
<b>Long</b>	Signals at the lower end of the measurement range (<-50 dBm) or signals with lower power to minimize the influence of noise.
<b>Manual</b>	Switches to manual averaging mode. The average count is set with the <b>Number of Readings</b> softkey.

→ Remote: PMET:MTIM SHOR

→ Remote: PMET:MTIM:AVER ON

---

**Meas→Ref**

---

Sets the currently measured power as a reference value for the relative display. The reference value can also be set manually via the **Reference Value** softkey.

→ Remote: CALC:PMET:REL:AUTO ONCE

---

**Reference Value**

---

Opens an edit dialog box to enter a reference value for relative measurements in the unit dBm.

→ Remote: CALC:PMET:REL -30DBM

---

**Use Ref Lev Offset**

---

If activated, takes the reference level offset set for the analyzer (**Ref Level Offset** softkey) into account for the measured power. If deactivated, takes no offset into account.

→ Remote: PMET:ROFF OFF

---

**Number of Readings**

---

Opens an edit dialog box to enter the number of readings (averagings) to be performed after a single sweep has been started. This softkey is only available if manual averaging is selected (**Meas Time/Average** softkey).

The values for the average count range from 0 to 256 in binary steps (1, 2, 4, 8,...). For average count = 0 or 1, one reading is performed. The averaging and sweep count of the trace menu are independent from this setting.

Results become more stable with extended average, particularly if signals with low power are measured. This setting can be used to minimize the influence of noise in the power meter measurement.

→ Remote: PMET:MTIM:AVER:COUN 8

---

## Noise Figure Measurements Option (K30)

The Noise Figure Measurements option provides noise figure measurements. Using this option, the noise figure of a Device Under Test, e.g. low-noise FET amplifier circuits, with noise figures of less than 1 dB can be measured.

### To open the noise figure measurements menu

- If the **Noise** mode is not the active measurement mode, press the **MODE** key and activate the **Noise** option.
- If the **Noise** mode is already active, press the **MENU** key or the **MEAS** key.  
The noise figure measurements menu is displayed. .

### Menu and softkey description

- ["Softkeys of the noise figure measurements menu \(Noise mode\)"](#) on page 4.232
- ["Softkeys of the sweep menu \(Noise mode\)"](#) on page 4.245
- ["Softkeys of the trace menu \(Noise mode\)"](#) on page 4.246
- ["Softkeys of the marker menu \(Noise mode\)"](#) on page 4.247
- ["Softkeys of the marker→ menu \(Noise mode\)"](#) on page 4.248
- ["Softkeys of the lines menu \(Noise mode\)"](#) on page 4.249

The span and trigger menus are not available in the **Noise** mode. All other menus are provided as described for the base unit. For details refer to the corresponding menu descriptions.

To display help to a softkey, press the **HELP** key and then the softkey for which you want to display help. To close the help window, press the **ESC** key. For further information refer to section "How to use the Help System".

### Further information

- ["Measurement modes of the noise figure measurement"](#) on page 4.228
- ["Calibration"](#) on page 4.229
- ["Measurement forms"](#) on page 4.229
- ["Measurement settings"](#) on page 4.229
- ["Result displays"](#) on page 4.230
- ["Status bar information"](#) on page 4.232

### Tasks

- [To edit tables](#)
- [To work with limit lines](#)

### To edit tables

1. Select the table header using the rotary knob or arrow keys and press rotary knob or the **ENTER** key to enter into the edit mode.
2. Focus the field you want to edit using the arrow keys or the rotary knob.
3. Enter the values (for details refer to the Quick Start Guide, chapter 4, "Basic Operations").
4. To insert a new row above the currently selected row, press the **Insert** softkey.
5. To delete the currently selected row, press the **Delete** softkey.
6. Only available for the **Frequency Table**:  
To update the table according to the **Frequency Settings**, press the **Build Tbl** softkey.
7. Press the **Exit** softkey to leave the edit mode.

### To work with limit lines

1. Press the **LINES** key.  
The **Limit Lines** dialog box is displayed. It contains information on name, limit, status, and a comment.
2. To activate limit lines, select the limit line you want to activate and press the **Enable/Disable** softkey.
3. To define a new limit line, press the **New** softkey and enter the limit line characteristics.
4. To modify a limit line, select the limit line you want to edit and press the **Edit** softkey.
5. To save a limit line, press the **Exit** softkey.  
If data are missing or if some data are invalid, an error message is displayed.
6. To delete a limit line, select the limit line you want to edit and press the **Delete** softkey.

### Further information

This section provides background information on measurements and displayed information.

### Measurement modes of the noise figure measurement

Noise measurements are performed on many different types of device under test (DUT). The type of DUT to be measured determines the test setup and also how the frequency list is to be generated. To support these different types of DUT, two different noise figure measurement types are available:

- [Direct measurement](#)
- [Frequency-converting measurement](#)
  - Fixed LO,  $IF = RF + LO$
  - Fixed LO,  $IF = \text{abs}(RF - LO)$

The setup for the different measurement types is described with the **Schematic** softkey. The measurement mode is set in the **Frequency Settings** dialog box, **Mode** field.

## Calibration

The calibration measures the noise introduced to a signal by the spectrum analyzer itself to compensate it in measurements on a device under test. This compensation is called 2nd stage correction, because the spectrum analyzer is the second stage of the test setup, the DUT being the first stage.

If the second stage correction is activated (**Measurement Settings** dialog box, **2nd Stage Correction** option), a separate calibration measurement is performed before the main measurement (for details on the measurement setup refer to chapter "Advanced Measurement Examples"). The data measured in the calibration measurement are used for compensation in the main measurement.

It is strongly recommended to perform calibration before running measurements (**Cal** softkey). It is possible to run measurements in an uncalibrated status, but the measurement results will not be corrected for any noise introduced by the spectrum analyzer itself.

If the list of receive frequencies (RF) is changed, at which the measurements are performed, calibration is necessary again to ensure that calibration data are available for every measurement step. For details on frequency settings refer to the **Freq Settings** softkey.

## Measurement forms

Two forms of measurements are possible:

- frequency list measurement

A measurement is performed at each of the frequencies listed in the frequency list (**Freq Settings** softkey). The noise figure of the DUT across a user-specified range of frequencies is measured. In single sweep mode, each frequency point is measured once and complete. In continuous sweep mode, one frequency point after the other is measured in turn until the measurement is aborted.

- fixed frequency measurement

A continuous measurement is performed at the single frequency currently selected in the **Frequency List Results**. This individual frequency from the frequency list measurement is investigated in more detail, for example to see the effect of dynamic changes to the noise figure of the DUT at a particular frequency (see also **Fix Freq** softkey).

## Measurement settings

The overall measurement settings used to obtain the current measurement results are displayed below the title bar (see Fig. 4-13). The following settings are listed:

Setting	Defined in
RBW	<b>Measurement Settings</b> dialog box, <b>RBW</b> field
Average	<b>Measurement Settings</b> dialog box, <b>Average</b> field
RF Attenuation	<b>Measurement Settings</b> dialog box, <b>RF Attenuation</b> field
Auto Ref Level	<b>Measurement Settings</b> dialog box, <b>Automatic Ref Level</b> field
2nd Stage Corr	<b>Measurement Settings</b> dialog box, <b>2nd Stage Correction</b> field
Image Rej	<b>Frequency Settings</b> dialog box, <b>Image Rej</b> field

R&S FSL-K30 Noise & Gain			
RBW:	1 MHz	RF Attenuation:	0 dB
Average:	1	Auto Ref Level:	On
		2nd Stage Corr:	On
		Image Rej:	999.99 dB

Fig. 4-13 Measurement settings for the noise figure measurement (example)

**Result displays**

The result displays consist of two panes:

- **Current Value** pane

In the title bar of this pane, the current measurement mode of the noise figure measurement (on the left) and the calibration status of the noise figure measurement (on the right, if the second stage correction is switched on) are displayed.

Below, the settings and measurement results for the currently selected measurement point in the frequency list are displayed:

Parameter	Description
RF	Receive frequency at the DUT at which the current values were measured (Hz).
LO	Local oscillator frequency (Hz), only displayed for frequency-converting measurements
IF	Intermediate frequency (Hz), only displayed for frequency-converting measurements
ENR	ENR value (dB), refers to the receive frequency (RF)
Loss In	Loss at the input of the DUT (dB), refers to the receive frequency (RF)
Loss Out	Loss at the output of the DUT (dB) frequency-converting measurements: refers to the intermediate frequency (IF) direct measurements: refers to the receive frequency (RF)
NF	Noise figure measured (dB)
Noise Temp	Noise temperature (K), derived from measured noise figure
Gain	Gain measured (dB)

Fixed LO,IF=RF+LO		Current Value		CALIBRATED	
RF:	554 MHz	ENR:	15 dB	NF:	17.13 dB
LO:	0 Hz	Loss In:	0 dB	Noise Temp:	14674.41 K
IF:	554 MHz	Loss Out:	0 dB	Gain:	0.35 dB

Fig. 4-14 Current Value pane (example)

- **Frequency List Result** or graph (frequency list results only)

The measurement results are represented according to the measurement form (see "[Measurement forms](#)").

- frequency list results

The measurement results for all frequencies defined in the **Frequency Table** are displayed in form of a graph (see Fig. Graphical result display (example)) or a table (**Frequency List Results**, see Fig. Tabular result display (example)), depending on the currently selected result display (see **Display List/Graph** softkey). The measurement results are updated as the measurement is in progress. Under **Current Value**, the details of the currently selected frequency in the **Frequency List Results** are displayed.



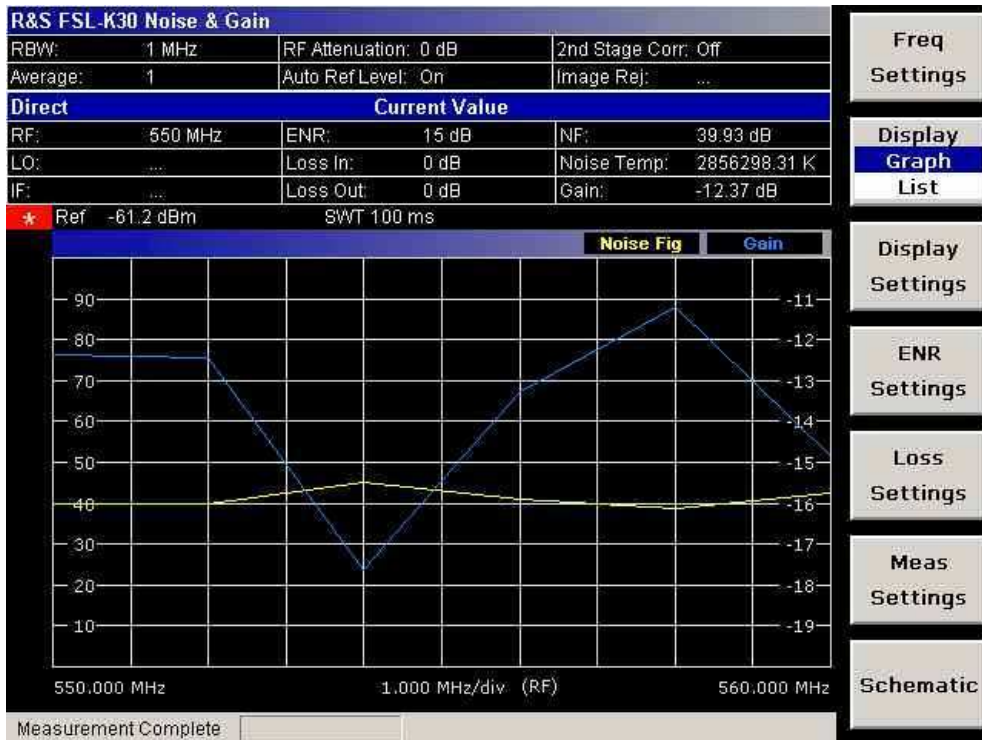

Fig. 4-15 Graphical result display (example)



Fig. 4-16 Tabular result display (example)

- fixed frequency results

Under **Current Value**, the measurement results for the fixed frequency are displayed and continuously updated. The **Frequency List Results** do not change – these are the results of the last frequency list measurement.

**Status bar information**

The status bar displays the following information:

- parameter values

If a parameter in a settings dialog box is selected, the minimum and maximum values for the selected parameter are displayed.

If a Boolean or an enumerated parameter in a dialog box is selected, the minimum and maximum values are displayed as N/A for not applicable.

- measurement status

During the measurement, the current measurement status along with detailed information about the progress is displayed.

- error messages (with red background)
- warning messages (with yellow background)

**Softkeys of the noise figure measurements menu (Noise mode)**

The following table shows all softkeys available in the noise figure measurements menu. It is possible that your instrument configuration does not provide all softkeys. If a softkey is only available with a special option, model or (measurement) mode, this information is delivered in the corresponding softkey description.

<b>Command</b>
Freq Settings
Display List/Graph
Display Settings
ENR Settings
Loss Settings
Meas Settings
Schematic
Table edit mode
Build Tbl
Exit
Insert
Delete

**Freq Settings**

Opens the **Frequency Settings** dialog box. Alternatively, this dialog box is opened by pressing the **FREQ** key (with focus on the **Start Freq** field).

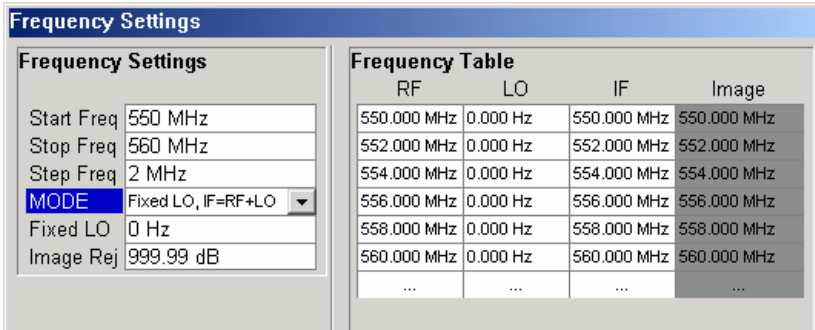

The **Frequency Settings** dialog box contains the following elements:

Frequency Settings	Start Freq
	Stop Freq
	Step Freq
	Mode
	Fixed LO
	Image Rej
Frequency Table	

Under **Frequency Settings**, the frequency settings and the measurement mode are set.

Under **Frequency Table**, the individual measurement steps are listed that will be performed exactly in the order of the table. They are generated from the start frequency, the stop frequency, and the step size on basis of the selected mode. If the start frequency is smaller than the stop frequency, the RF values are generated into a list of ascending frequencies. If the start frequency is larger, the list is descending. Not more than 100 measurement steps are possible. If the gap between start and stop frequency is too large, increase the step frequency.

Depending on the measurement type, the **Frequency Table** contains the following columns:

Measurement type	Column	Description
Direct measurement Frequency-converting measurement	RF	receive frequency, generated from the <b>Start Freq</b> , the <b>Stop Freq</b> , and the <b>Step Freq</b> field entries
Frequency-converting measurement	LO	constant LO frequency, defined via the <b>Fixed LO</b> field
	IF	IF frequency, calculated according to the <b>Mode</b> field
	Image	image frequency, shows whether image frequency filters are required and for which frequency range the image rejection of the DUT is needed ( <b>Image Rej</b> field)

It is possible to customize the **Frequency Table** by editing, deleting, and inserting measurement steps. This might be useful in order to insert extra measurement steps near to a specific frequency of interest in order to get more detailed results. If the start, stop, or step frequency is changed, the **Frequency Table** is generated afresh and all manual modifications are overwritten. To customize this table, proceed according to "[To edit tables](#)" on page 4.228.

→ Remote: FREQ:LIST:DATA 550MHz,300MHz,900MHz (Frequency Table)

---

**Start Freq**

---

Specifies the start frequency. This is the first receive frequency (RF) entry in the **Frequency Table** and the **Frequency List Results** (result display).

If the start frequency is changed, the **Frequency Table** is updated accordingly.

→ Remote: `FREQ:STAR 500MHZ`

---

**Stop Freq**

---

Specifies the stop frequency. This is the last receive frequency (RF) entry in the **Frequency Table** and the **Frequency List Results** (result display).

If the stop frequency is changed, the **Frequency Table** is updated accordingly.

→ Remote: `FREQ:STOP 700MHZ`

---

**Step Freq**

---

Specifies the step size between the single measurement steps. If the step frequency is larger than the difference between the start frequency and the stop frequency, the **Frequency Table** and the **Frequency List Results** (result display) just contain the start and stop frequency.

If the step frequency is changed, the **Frequency Table** is updated accordingly.

→ Remote: `FREQ:STEP 10MHZ`

---

**Mode**

---

Specifies the measurement mode. For details on modes refer to "[Measurement modes of the noise figure measurement](#)" on page 4.228.

If the mode is changed, the **Frequency Table** is updated accordingly.

→ Remote: `SENS:CONF:MODE:DUT DOWN`

---

**Fixed LO**

---

Specifies the fixed local oscillator frequency. This field is only available if a frequency-converting measurement mode is selected (**Mode** field). For details on modes refer to [Measurement modes of the noise figure measurement](#).

If the fixed LO is changed, the **Frequency Table** is updated accordingly.

→ Remote: `SENS:CONF:MODE:SYST:LOSC:FREQ 1MHZ`

---

**Image Rej**

Specifies the suppression applied to the second sideband. This field is only available if a frequency-converting measurement mode is selected. For details on modes refer to "[Measurement modes of the noise figure measurement](#)" on page 4.228.

The value entered is applied across the complete frequency range. A value of 999.99 dB corresponds to the generally used single-sideband measurement (SSB), where the second sideband does not noticeably affect the measurement result. This is the default value. A value of 0 dB corresponds to the double-sideband measurement (DSB), where both sidebands are converted to the same extent.

→ Remote: CORR:IREJ 100

**Display List/Graph**

Configures the result display. The measurement results are displayed either in form of a list of measurement points or as a graphical trace. For further details refer to "[Result displays](#)" on page 4.230.

→ Remote: DISP:TABL ON

**Display Settings**

Opens the **Graphic** dialog box to modify the graphical results display.

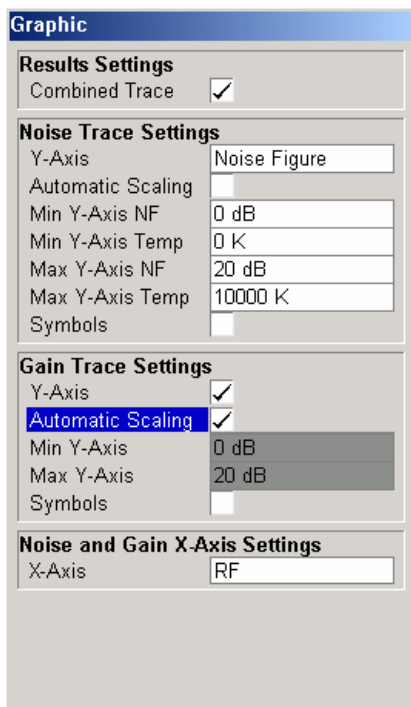

Under **Results Settings**, the settings that affect the overall results display are defined. Under **Noise Trace Settings**, the settings related to the graphical display of noise results are defined. Under **Gain Trace Settings**, the settings related to the graphical display of gain results are defined.

The **Graphic** dialog box contains the following elements:

Results Settings	<a href="#">Combined Trace Display</a>
Noise Trace Settings	<a href="#">Y-Axis</a>

	Automatic Scaling
	Min Y–Axis NF
	Min Y–Axis Temp
	Max Y–Axis NF
	Max Y–Axis Temp
	Symbols
Gain Trace Settings	Y–Axis
	Automatic Scaling
	Min Y–Axis
	Max Y–Axis
	Symbols
Noise and Gain X–Axis Settings	X–Axis

**Combined Trace Display**

Activates or deactivates the combined trace display of noise and gain results.

- On The noise and gain traces are displayed in the same trace display in different colors.
- Off The noise and gain traces are displayed in different trace displays.

→ Remote: DISP:FORM SING

**Y–Axis**

Specifies the type of noise result that is to be displayed graphically:

- **Noise Figure**
- **Noise Temperature**
- **Off** (no noise results are displayed graphically)

→ Remote: DISP:DATA:TRAC1 NFIG|TEFF

→ Remote: DISP:TRAC OFF

**Automatic Scaling**

Activates or deactivates the automatic scaling of the Y–axis.

- On The y–axis is scaled automatically. The automatic scaling algorithm provides the optimal display of the complete range of results.
- Off The automatic scaling of the y–axis is switched off, and the scale has to be specified manually:  
 for noise results via the **Min Y–Axis NF/Min Y–Axis Temp/Max Y–Axis NF/Max Y–Axis Temp** fields,  
 for gain results via the **Min Y–Axis/Max Y–Axis** fields.

→ Remote: DISP:TRAC:Y:AUTO ON

---

**Min Y–Axis NF/Max Y–Axis NF**

---

Specifies the minimum/maximum noise figure result that can be displayed graphically. It is only possible to enter a value, if the automatic scaling is deactivated (see **Automatic Scaling** option), and the y–axis is set to **Noise Figure** (see **Y–Axis** field).

- Remote: `DISP:TRAC:Y:BOTT -30`
  - Remote: `DISP:TRAC:Y:TOP 30`
- 

---

**Min Y–Axis Temp/Max Y–Axis Temp**

---

Specifies the minimum/maximum noise temperature result that can be displayed graphically. It is only possible to enter a value, if the automatic scaling is deactivated (see **Automatic Scaling** option), and the y–axis is set to **Noise Figure** (see **Y–Axis** field).

- Remote: `DISP:TRAC:Y:BOTT -30`
  - Remote: `DISP:TRAC:Y:TOP 30`
- 

---

**Symbols**

---

Activates or deactivates the symbol representation. If activated, each measured value is marked by a symbol. This helps to distinguish result types in a monochrome printout.

- Remote: `DISP:TRAC:SYMB ON`
- 

---

**Y–Axis**

---

Activates or deactivates the graphical display of gain results.

- Remote: `DISP:TRAC2 OFF`
- 

---

**Min Y–Axis/Max Y–Axis**

---

Specifies the minimum/maximum gain result that can be displayed graphically. It is only possible to enter a value, if the automatic scaling is deactivated (see **Automatic Scaling** option), and the y–axis is activated (see **Y–Axis** field).

- Remote: `DISP:TRAC2:Y:BOTT 1`
  - Remote: `DISP:TRAC2:Y:TOP 10`
- 

---

**X–Axis**

---

Specifies the scaling of the x–axis. This parameter is only editable in a frequency–converting measurement mode.

- Remote: `DISP:TRAC:X IF`
-

**ENR Settings**

Opens the **ENR** dialog box.

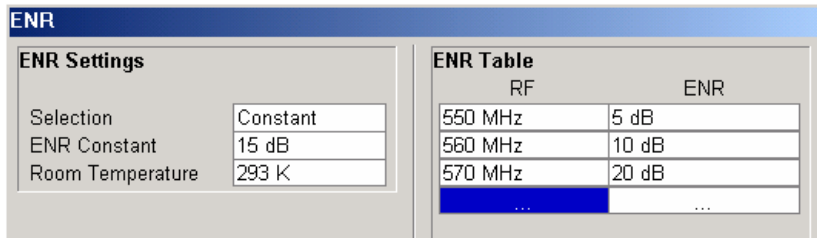

The abbreviation ENR stands for excess noise ratio. Correct ENR values for the noise source are essential to perform accurate measurements. They are used to calculate the effective noise temperature of the noise source that in turn is used for calculation of measurement results.

Under **ENR Settings**, the default ENR value is 15 dB as a constant value that is valid for all frequencies.

Under **ENR Table**, the frequency–dependent ENR values are listed. The list can contain up to 100 RF/ENR pairs. The order of the RF values in the list is not important. To modify this table, proceed as described in "To edit tables" on page 4.228. ENR tables can be saved and recalled at any time via the **FILE** key (for details refer to the section "Saving and Recalling Settings Files – FILE Key"). Additionally to the data saved by the basic unit, all data entered in the **ENR Settings** dialog box are saved.

The **ENR Settings** dialog box contains the following elements:

ENR Settings	Selection
	ENR Constant
	Room Temperature
ENR Table	

→ Remote: CORR:ENR:MEAS:TABL:DATA 1MHZ,10,2MHZ,12 (ENR Table)

**Selection**

Defines the used ENR values.

**Constant** The value specified in the **ENR Constant** field is used for all frequencies. The entries of the **ENR Table** are ignored.

**Table** The entries of the **ENR Table** provide the basis for the ENR values. Between these values the R&S ESL uses interpolated values.

→ Remote: CORR:ENR:MODE SPOT

**ENR Constant**

Specifies the constant ENR value of the noise source that is used throughout the entire frequency range. This parameter is only editable if, in the **Selection** list, **Constant** is selected.

→ Remote: CORR:ENR:SPOT 30



**Room Temperature**

Specifies the current room temperature as an absolute value in Kelvin. This value is used in the calculation of the noise results.

→ Remote: CORR:TEMP 291.50

**Loss Settings**

Opens the **LOSS** dialog box to take additional losses due to cables or attenuators into account that are not considered in the calibration.

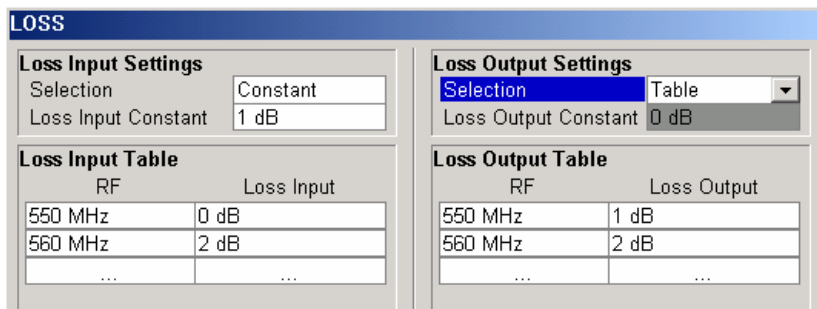

Under **Loss Input Settings**, the additional loss between the noise source and the DUT is defined. Under **Loss Output Settings**, the additional loss between the DUT and the analyzer is defined.

Under **Loss Input Table** or **Loss Output Table**, the list can contain up to 100 RF/ENR pairs. The order of the RF values in the list is not important. To modify this table, proceed as described in "To edit tables" on page 4.228. Loss tables can be saved and recalled at any time via the **FILE** key (for details refer to the section "Saving and Recalling Settings Files – FILE Key"). Additionally to the data saved by the basic unit, all loss input & output data entered in the **Loss Settings** dialog box are saved.

The **Loss Settings** dialog box contains the following elements:

Loss Input Settings	Selection
	Loss Input Constant
Loss Input Table	
Loss Output Settings	Selection
	Loss Output Constant
Loss Output Table	

- Remote: CORR:LOSS:INP:TABL 1MHz, 10, 2MHz, 12 (Loss Input Table)
- Remote: CORR:LOSS:OUTP:TABL 1MHz, 10, 2MHz, 12 (Loss Output Table)

**Selection**

Defines the used Loss values.

**Constant** The values specified in the **Loss Input Constant/Loss Output Constant** fields are used for all frequencies. The entries of the **Loss Input/Output Table** are ignored.

**Table** The entries of the **Loss Input/Output Table** provide the basis for the Loss values. Between these values the R&S ESL uses interpolated values.

- Remote: CORR:LOSS:INP:MODE SPOT
- Remote: CORR:LOSS:OUTP:MODE SPOT

**Loss Input Constant/Loss Output Constant**

Specifies the constant loss value that is used across the entire frequency range. This parameter is only editable if, in the **Selection** list, **Constant** is selected.

- Remote: CORR:LOSS:INP:SPOT 10
- Remote: CORR:LOSS:OUTP:SPOT 10

**Meas Settings**

Opens the **Measurement Settings** dialog box to modify all settings related to the overall measurement.

Alternatively, the **Measurement Settings** dialog box is opened as follows:

- **AMPT** key, with focus on the **RF Attenuation** field
- **BW** key, with focus on the **RBW** field

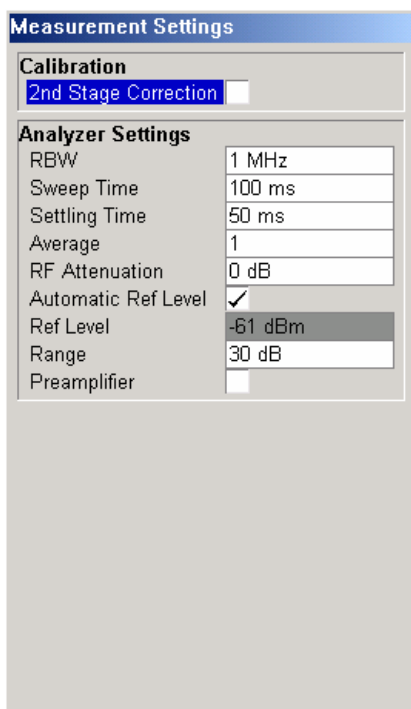

Under **Calibration**, the second stage correction can be activated or deactivated. For details refer also to "[Calibration](#)" on page 4.229.

Under **Analyzer Settings**, the general settings for the spectrum analyzer concerning the level, attenuation and bandwidth of the signal to be measured are defined.

The **Measurement Settings** dialog box contains the following elements:

Calibration	<a href="#">2nd Stage Correction</a>
Analyzer Settings	<a href="#">RBW</a>
	<a href="#">Sweep Time</a>
	<a href="#">Settling Time</a>
	<a href="#">Average</a>
	<a href="#">RF Attenuation</a>
	<a href="#">Automatic Ref Level</a>
	<a href="#">Ref Level</a>
	<a href="#">Range</a>
	<a href="#">Preamplifier</a>

---

## 2nd Stage Correction

---

Activates or deactivates the second stage correction.

- On The calibration data recorded via the **Cal** softkey are used to correct the measurement results. The calibration data are stored independent of the state of the option.
- Off No correction is applied to the measurement results.

For details refer also to "[Calibration](#)" on page 4.229.

→ Remote: CORR ON

---

## RBW

---

Specifies the resolution bandwidth for the measurement.

A large value improves the averaging of the display considerably, reduces the influence of external sources of interference, and permits the fastest measurement time possible.

A low value should only be used across a very small frequency range. For measurements at low frequencies, the RBW must be reduced to prevent the LO frequency of the analyzer from invalidating the measurement. At receive frequencies of 100 kHz, the RBW must not exceed 10 kHz.

→ Remote: BAND 1MHz

---

## Sweep Time

---

Specifies the time one complete measurement sweep takes. Two sweeps are performed for each measurement step (once with noise source on, once with noise source off).

For narrow bandwidths, the sweep time should be increased in order to give accurate measurement results.

→ Remote: SWE:TIME 10s

---

---

**Settling Time**

---

Specifies the time the DUT takes to settle after a noise source has been turned on or off.

Most noise sources generate an interfering DC component in addition to the noise spectrum. If the noise source is switched on or off, low-frequency DUTs may require this settling time for coupling capacitors to be charged or discharged.

→ Remote: `SYST:CONF:DUT:STIM 1000MS`

---

**Average**

---

Specifies the number of measurement sweeps over which the average is taken to produce the displayed measurement results.

The higher the number of sweeps, the more accurate the measurement results, but the measurement time is significantly longer.

An average value of 1 means that each displayed result is produced from one measurement sweep. This is sufficient for most cases.

→ Remote: `SWE:COUN 10`

---

**RF Attenuation**

---

Specifies the attenuation that is applied to the received RF signal.

To obtain a low noise figure for the analyzer and hence more accurate noise measurements, 0 dB should be set. For high DUT power levels or critical matching, a higher setting is also possible. A setting of 10 dB will give a much better VSWR (voltage standing wave ratio) of the analyzer, but will result in a worse noise figure of the analyzer.

→ Remote: `INP:ATT 30 DB`

---

**Automatic Ref Level**

---

Activates or deactivates the automatic reference level setting.

Off Specify a reference level manually (see **Ref Level** softkey).

On The reference level is measured automatically. The total measurement time increases.

The automatic reference level measurement is performed as follows:

– 2nd stage correction activated:

At the beginning of the calibration measurement, several measurements are performed at the first frequency test point and the reference level is calculated from these results taking into account the maximum gain of the DUT (see **Range** softkey).

– 2nd stage correction deactivated:

At the beginning of the main measurement, several measurements are performed at the first frequency test point and the reference level is calculated from these results. The range setting is not significant.

→ Remote: `DISP:TRAC:Y:RLEV:AUTO ON`

---

---

**Ref Level**

---

Specifies the reference level. It is only possible to enter a reference level manually, if the automatic reference level is deactivated (see **Automatic Ref Level** softkey).

The reference level should be about 5 to 15 dB above the noise display that occurs with the DUT connected and the noise source activated.

Even for DUTs with a high-ripple frequency response it can be useful to enter the reference level manually, because an automatic reference level setting may not always result in optimal settings.

→ Remote: `DISP:TRAC:Y:RLEV 0`

---

**Range**

---

Specifies the maximum gain expected from the DUT.

If the **2nd Stage Correction** is activated, this value is used to calculate the automatic reference level to ensure that the expected power of the measured signal will be within the optimum operating range of the spectrum analyzer (see **Automatic Ref Level** softkey).

To ensure accurate measurement results, the range should not exceed the actual gain of the DUT by more than a margin of 10 dB.

→ Remote: `SYST:CONF:DUT:GAIN 10`

---

**Preamplifier**

---

Activates or deactivates the preamplifier of the R&S ESL.

→ Remote: `INP:GAIN:STAT ON`

---

**Schematic**

---

Displays the schematic diagram of the test setup for the selected measurement type and the specified frequency ranges. If the frequency ranges are changed, the schematic diagram is updated accordingly.

– Direct measurement

The direct measurement mode is designed for DUTs without frequency-conversion, e.g. amplifiers.

The schematic display for the direct measurement mode is shown in Fig. 4-17. The upper part of the figure shows the setup for calibration. The lower part of the figure shows the test setup for the measurement.

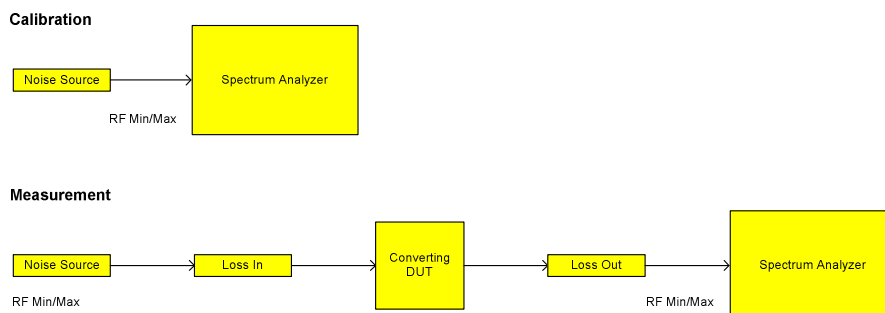

Fig. 4-17 Schematic diagram for direct measurements

- Frequency-converting measurement

The frequency-converting measurement mode is designed for frequency-converting DUTs that have a fixed Local Oscillator (LO) frequency, for example, satellite converters with a fixed LO frequency. .

The schematic display for the frequency-converting measurement mode is shown in Fig. 4-18. The upper part of the figure shows the setup for calibration. The lower part of the figure shows the test setup for the measurement.

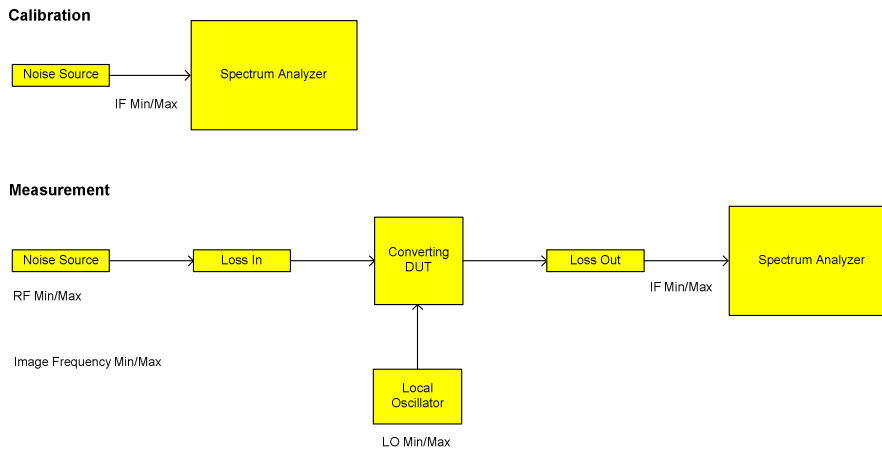

Fig. 4-18 Schematic diagram for frequency converting measurements

---

**Build Tbl**

Updates the table according to the **Frequency Settings (Freq Settings** softkey).

---

**Exit**

Exits the edit mode of a table.

---

**Insert**

Inserts a row above the currently selected row and sets the focus on the first field of the new row.

This softkey is only available if the **Frequency Table** contains less than 100 measurement steps.

---

**Delete**

Deletes the currently selected row. This action requires no confirmation.

---

### Softkeys of the sweep menu (Noise mode)

The following table shows all softkeys available in the sweep menu in **Noise** mode (**SWEEP** key). It is possible that your instrument configuration does not provide all softkeys. If a softkey is only available with a special option, model or (measurement) mode, this information is delivered in the corresponding softkey description.

Command
Sweep Single/Cont
Cal
Fix Freq

#### Sweep Single/Cont

Selects the sweep mode.

- Single**    single sweep mode  
**Cont**      continuous sweep mode

If a measurement is started while another measurement is in progress, the first measurement will be aborted and the new measurement started immediately.

For further details refer to "[Measurement forms](#)" on page 4.229.

- Remote: CONF:LIST:CONT
- Remote: CONF:LIST:SING

#### Cal

Performs a calibration. The calibration status of the noise figure measurement is displayed in the title bar. For further details refer to "[Calibration](#)" on page 4.229.

This softkey is only available, if the **2nd Stage Correction** option in the Measurement Settings dialog box is activated.

- Remote: CONF:CORR

#### Fix Freq

Starts a fixed frequency measurement for the frequency that is currently selected in the **Frequency List Results**. For further details refer to "[Measurement forms](#)" on page 4.229 and "[Result displays](#)" on page 4.230.

This softkey is only available after a frequency list measurement has been completed and the measurement results are displayed in list form (**Display List/Graph** softkey).

- Remote: CONF:SING
- Remote: FREQ 10MHz

**Softkeys of the trace menu (Noise mode)**

Using the trace memory facility, you can save graphical display results (max. 3 trace sets) for comparison with subsequent measurements. This facility is recommended in order to compare and to document the effects of small changes on the DUT.

The following table shows all softkeys available in the trace menu in **Noise** mode (**TRACE** key). It is possible that your instrument configuration does not provide all softkeys. If a softkey is only available with a special option, model or (measurement) mode, this information is delivered in the corresponding softkey description.

<b>Command</b>
Display Graph/List
ASCII File Export
Decim Sep
More ↓
Data → Mem1
Data → Mem2
Data → Mem3
Data On/Off
Mem1 On/Off
Mem2 On/Off
Mem3 On/Off

**Display Graph/List**

For details refer to the **Display List/Graph** softkey in the noise figure measurements menu.

**ASCII File Export**

For details refer to the **ASCII File Export** softkey in the trace menu of the base unit.

**Decim Sep**

For details refer to the **Decim Sep** softkey in the trace menu of the base unit.



**Data → Mem1/Data → Mem2/Data → Mem3**

Saves the current trace results to trace memory <n>. If a trace memory <n> contains data, the corresponding softkey has a green background. The content of the trace memory <n> is displayed via the **Mem1 On/Off/Mem2 On/Off/Mem3 On/Off** softkeys.

If data is transferred to a trace memory that already contains trace data, the new trace data overwrite the current trace data in the memory.

- Remote: CONF:ARR:MEM2 ONCE
- Remote: FETC:ARR:MEM2:NOIS:FIG?
- Remote: FETC:ARR:MEM2:NOIS:GAIN?
- Remote: FETC:ARR:MEM2:NOIS:TEMP?

**Data On/Off**

Switches the display of the current measurement results on or off. The display of trace memory results is not affected if this softkey is pressed. If a new frequency list measurement is started, the display of the current result trace is switched on automatically.

- Remote: DISP:CURR:DATA OFF

**Mem1 On/Off / Mem2 On/Off / Mem3 On/Off**

Switches the display of trace memory <n> on or off. This softkey is not available if no data is held in the selected trace memory.

- Remote: DISP:ARR:MEM2 ON

**Softkeys of the marker menu (Noise mode)**

The following table shows all softkeys available in the marker menu in **Noise** mode (**MKR** key). It is possible that your instrument configuration does not provide all softkeys. If a softkey is only available with a special option, model or (measurement) mode, this information is delivered in the corresponding softkey description.

Command
Marker 1
Marker to Trace
All Marker Off

**Marker 1**

Activates marker 1 and opens an edit dialog box to enter a value for marker 1 to be set to. Pressing the softkey again deactivates the marker 1. This softkey is only available if measurement results are displayed.

- Remote: CALC:MARK ON
- Remote: CALC:MARK:X 550 MHZ
- Remote: CALC:MARK:Y?

**Marker to Trace**

Opens a dialog box to select the trace (noise figure or gain), on which the marker is to be placed. This softkey is only available if measurement results are displayed.

→ Remote: CALC:MARK:TRAC GAIN

**All Marker Off**

Switches off the active marker. This softkey is only available if measurement results are displayed.

→ Remote: CALC:MARK:AOFF

**Softkeys of the marker→ menu (Noise mode)**

The following table shows all softkeys available in the marker→ menu in **Noise** mode (**MKR→** key). It is possible that your instrument configuration does not provide all softkeys. If a softkey is only available with a special option, model or (measurement) mode, this information is delivered in the corresponding softkey description.

Command
Peak
Min

**Peak**

Activates marker 1 and sets it to the highest maximum of the trace.

→ Remote: CALC:MARK:MAX

**Min**

Activates marker 1 and sets it to the minimum of the selected trace.

→ Remote: CALC:MARK:MIN

### Softkeys of the lines menu (Noise mode)

The following table shows all softkeys available in the lines menu in **Noise** mode (**LINES** key). It is possible that your instrument configuration does not provide all softkeys. If a softkey is only available with a special option, model or (measurement) mode, this information is delivered in the corresponding softkey description.

Menu / Command	Command
New ↓	Exit
	Insert
	Delete
Edit ↓	same contents as New menu
Enable/Disable	
Delete	

### New

Displays the **Limit Line** dialog box in edit mode with all fields necessary to define a new limit line. For further details see "[To work with limit lines](#)" on page 4.228.

In the edit mode, the **Limit Line** dialog box contains the following elements:

Name
Limit
Comment
Frequency
Limit

### Name

Specifies the name of the limit line to uniquely identify every limit line. Any combination of alphanumeric characters is allowed. If the entered name already exists, an error message is displayed with the request to alter the name.

→ Remote: `CALC:LIM1:NAME FM1`

### Limit

Specifies the result type (noise or gain) and the limit type (upper or lower) for the limit line.

→ Remote: `CALC:LIM2:TRAC NFIG`

### Comment

Specifies a description for the limit line. Any combination of alphanumeric characters is allowed.

→ Remote: `CALC:LIM5:COMM 'Upper limit for spectrum'`

---

**Frequency**

---

Specifies the receive frequencies.

→ Remote: `CALC:LIM2:CONT 1MHz,30MHz,100MHz,300MHz,1GHz`

---

**Limit**

---

Specifies the limits for the receive frequencies.

→ Remote: `CALC:LIM2:LOW -30,-40,-10,-40,-30` (lower limit line)

→ Remote: `CALC:LIM2:UPP -10,0,0,-10,-5` (upper limit line)

---

**Exit**

---

Exits the edit mode of a table.

---

**Insert**

---

Inserts a row above the currently selected row and sets the focus on the first field of the new row.

---

**Delete**

---

Deletes the currently selected row. This action requires no confirmation.

---

**Edit**

---

Displays the **Limit Line** dialog box in edit mode with all data of the selected limit line. For further details refer to the **New** softkey.

---

**Enable/Disable**

---

Enables or disables the selected limit line. Limit checking is only performed for activated limit lines. Only one limit line of each type can be active at a given time.

→ Remote: `CALC:LIM:STAT ON`

→ Remote: `CALC:LIM4:LOW:STAT ON`

→ Remote: `CALC:LIM4:UPP:STAT ON`

---

**Delete**

---

Deletes the selected limit line.

→ Remote: `CALC:LIM1:DEL`

---

## **Instrument Functions - Basic Settings**

In this section, all basic settings functions of the R&S ESL and their application are explained in detail. The analyzer functions are described in section "Instrument Functions - Analyzer".

For every key a table is provided in which all submenus and corresponding commands are listed. The description of the submenus and commands follows the order of the table. The commands for the optional remote control (if any) are indicated for each softkey. The description includes the following:

- ["General Settings, Printout and Instrument Settings"](#) on page 4.261

This section provides information on how to prepare measurements and process their results: setting the instrument, managing and retrieving data, returning to manual operation, and printout.

More basic information on operation is given in the Quick Start Guide. The front and the rear view of the instrument together with a table of all available keys and a short description are provided in chapter "Front and Rear Panel". Chapter "Preparing for Use" informs how to start working with the instrument for the first time. A brief introduction on handling the instrument is given in chapter "Basic Operations". This includes also the description of the keys for basic operations like switching the instrument on and off or starting a measurement.

## General Settings, Printout and Instrument Settings

After putting the instrument into operation and becoming familiar with the handling of the instrument (for details see Quick Start Guide), the preparations for measurements can start. In this section the general settings of the instrument, the data management and the processing of measurement results are described. This includes the following topics and keys:

- ["Instrument Setup and Interface Configuration - SETUP Key"](#) on page 4.262
- ["Saving and Recalling Settings Files - FILE Key"](#) on page 4.279
- ["Manual Operation - Local Menu"](#) on page 4.287
- ["Measurement Documentation - PRINT Key"](#) on page 4.288

## Instrument Setup and Interface Configuration - SETUP Key

The **SETUP** key is used to set or display the default settings of the instrument: reference frequency, noise source, level correction values, date, time, LAN interface, firmware update and enabling of options, information about instrument configuration and service support functions. For further details refer also to the Quick Start Guide, chapter 2 "Preparing for Use".

### To open the setup menu

- Press the **SETUP** key.  
The setup menu is displayed.

### Menu and softkey description

- ["Softkeys of the setup menu"](#) on page 4.262

To display help to a softkey, press the **HELP** key and then softkey for which you want to display help. To close the help window, press the **ESC** key. For further information refer to section "How to use the Help System".

### Softkeys of the setup menu

The following table shows all softkeys available in the setup menu. It is possible that your instrument configuration does not provide all softkeys. If a softkey is only available with a special option, model or (measurement) mode, this information is delivered in the corresponding softkey description.

Menu Command	Submenu / Command	Submenu / Command	Command
Reference Int/Ext			
Transducer ↓	Active On/Off		
	Edit ↓	Insert Line	
		Delete Line	
		Edit Name	
		Edit Unit	
		Edit Value	
		Interpolation Lin/Log	
		Save Factor	
	New ↓	same contents as Edit menu	
	Copy to ↓	same contents as Edit menu	
	Delete		
	Ref Level Adjust Man/Auto		
	Show Directory		
IF Output			
Noise Src On/Off			
Alignment ↓	Self Align		
	Show Align Results		
	Corr Data On/Off		
General Setup ↓	Configure Network		

Menu Command	Submenu / Command	Submenu / Command	Command
	Network Address ↓	Computer Name	
		IP Address	
		Subnet Mask	
		DHCP On/Off	
	GPIB ↓	GPIB Address	
		ID String Factory	
		ID String User	
		GPIB Language	
		Display Update On/Off	
		More ↓	
		GPIB Terminator LFEOI/EOI	
		*IDN Format Leg./New	
		I/O Logging On/Off	
	Time+Date		
	Meas Display ↓	Screen Title	
		Time+Date On/Off	
		Logo On/Off	
		Annotation On/Off	
		Screen Colors ↓	Select Screen Color Set
			Color On/Off
			Select Object
			Predefined Colors
			User Defined Colors
			Set to Default
		Print Colors ↓	Select Print Color Set
			Color On/Off
			Select Object
			Predefined Colors
			User Defined Colors
			Set to Default
		Display Pwr Save On/Off	
	Monitor Int/Ext		



Menu Command	Submenu / Command	Submenu / Command	Command
	Soft Frontpanel		
More ↓			
Firmware Update ↓	Firmware Update		
Option Licenses ↓	Install Option		
Shutdown Off/Standby			
Preset Receiver			
Preset Spectrum			
System Info ↓	Hardware Info		
	Versions+Options		
	System Messages		
	Clear All Messages		
Service ↓	Input RF/Cal/TG		
	Comb Frequency		
	Reset Password		
	Selftest		
	Selftest Results		
	Password		
	Service Function		

**Reference Int/Ext**

Switches between the internal and external reference signal source. The default setting is internal reference. It is important, that the external reference signal is deactivated when switching from external to internal reference to avoid interactions.

If the reference signal is missing when switching to external reference, the message **EXREF** is displayed to indicate that no synchronization is performed.

The R&S ESL can use the internal reference source or an external reference source as frequency standard from which all internal oscillators are derived. A 10 MHz crystal oscillator is used as internal reference source. In the external reference setting, all internal oscillators of the R&S ESL are synchronized to the external reference frequency (also 10 MHz). For details on connectors refer to the Quick Start Guide, chapter 1 "Front and Rear Panel".

→ Remote: ROSC : SOUR INT

**Transducer**

---

Opens the **Select Transducer** dialog box and a submenu to activate or deactivate defined transducer factors, to generate new transducer factors or to edit existing ones.

In the **Select Transducer** dialog box, a transducer factor can be edited, deleted or copied, if selected, using the corresponding softkeys. The default directory, in which the transducer factors are saved, is displayed (C:\R\_S\INSTR\TRD; the extension of transducer factor files is \*.TDF). Subdirectories can be added or deleted via the file manager. They are displayed or hidden using the arrow keys or the **Show Directory** softkey / **Hide Directory** button.

Two different directory views are possible: If the **Show all** option is activated, all transducer factors in the directory are displayed. If the **Show compatible** option is activated, only the compatible transducer factors in the directory are displayed.

For details on transducer factors refer to the Operating Manual on CD-ROM, chapter "Advanced Measurement Examples".

→ Remote: CORR:TRAN:SEL FACTOR1

---

**Active On/Off**

---

Activates or deactivates the selected transducer factor. A maximum of 10 transducer factors can be activated at the same time. If an additional transducer factor is activated, its unit compatibility is checked. If one factor has a different unit than dB, all the other activated factors must have the unit dB.

→ Remote: CORR:TRAN:SEL <name>

→ Remote: CORR:TRAN ON

---

**Edit**

---

Opens the **Edit Transducer** dialog box with the data of the selected factor. During editing, a transducer factor remains stored in the background until the factor is saved using the **Save Factor** softkey.

→ Remote: Comment: CORR:TRAN:COMM <string>

---

**Insert Line**

---

Inserts an empty line above the selected reference value to enter a new reference value. When entering a new reference value in the line, the ascending order of frequencies must be taken into consideration, however.

---

**Delete Line**

---

Deletes the selected reference value (complete line). The reference values that follow move one line up.

---

---

**Edit Name**

---

Sets the focus on the **Name** field to enter a file name. The extension is added automatically.

→ Remote: CORR:TRAN:SEL <name>

---

---

**Edit Unit**

---

Sets the focus on the **Unit** field to select the unit.

→ Remote: CORR:TRAN:UNIT <string>

---

---

**Edit Value**

---

Sets the focus to enter positions and values as frequency/level pairs. The entered data are also displayed graphically. Using the **Shift x** or **Shift y** button, all entered values can be shifted in x or y direction.

→ Remote: CORR:TRAN:DATA <freq>,<level>

---

---

**Interpolation Lin/Log**

---

Sets the scaling of the x-axis to linear or logarithmic.

→ Remote: CORR:TRAN:SCAL LIN|LOG

---

---

**Save Factor**

---

Saves the changed factor to a file on the internal flash disk. If a transducer factor with the same name already exists, a confirmation query is displayed. If the new factor is active, the new values are immediately applied.

→ Remote: In remote control, the save operation is performed automatically after the definition of the reference values.

---

---

**New**

---

Opens the **Edit Transducer** dialog box to enter data for a new factor.

---

---

**Copy to**

---

Opens the **Edit Transducer** dialog box to copy the selected factor.

---

---

**Delete**

---

Deletes the selected factor after confirmation.

→ Remote: CORR:TRAN DEL

---

**Ref Level Adjust Man/Auto**

---

Activates or deactivates the automatic adjustment of the reference level to the selected transducer factor.

**Auto** Activates the automatic adjustment.

**Man** Deactivates the automatic adjustment. Adjust the reference level via the amplitude menu.

If a transducer factor is used (active), the trace is moved by a calculated shift. However, an upward shift reduces the dynamic range for the displayed values. With this softkey set to **Auto**, the original dynamic range is restored by also shifting the reference level by the maximum value of the transducer factor.

→ Remote: CORR:TRAN:ADJ:RLEV ON

---

**Show Directory**

---

Displays the subdirectory of the selected directory.

---

**LISN**

---

Selects and configures the V-network to be controlled via the user port.

The contents of the LISN menu is equivalent to the contents of the LISN tab of the **Test Automation** dialog box.

---

**IF Output (option Additional Interfaces, B5 only)**

---

Opens the **IF Output Source** dialog box to select the output of the IF/VIDEO OUT connector: **IF**, **Video 200 mV**, or **Video 1 V**.

**Note:** *The AF output available at the frontpanel can only be used if the IF output source is set to video.*

---

For further details refer to the Quick Start Guide, chapter 1 "Front and Rear Panel".

→ Remote: OUTP IF VID

---

**Noise Src On/Off (option Additional Interfaces, B5 only)**

---

Switches the supply voltage for an external noise source on or off. For details on connectors refer to the Quick Start Guide, chapter 1 "Front and Rear Panel" .

→ Remote: DIAG:SERV:NSO ON

---

**Alignment**

---

Opens a submenu with the available functions for recording, displaying and activating the data for self alignment.

The correction data and characteristics required for the alignment are determined by comparison of the results at different settings with the known characteristics of the high-precision calibration

signal source at 65.83 MHz. The correction data are stored as a file on flash disk and can be displayed using the **Show Align Results** softkey.

---

### **Self Align**

---

Starts the recording of correction data of the instrument. If the correction data acquisition has failed or if the correction values are deactivated, a corresponding message is displayed in the status field.

As long as the self alignment data is collected the procedure can be cancelled using the **Abort** button.

→ Remote: \*CAL?

---

### **Show Align Results**

---

Opens a dialog box that displays the correction data of the alignment:

- date and time of last correction data record
- overall results of correction data record
- list of found correction values according to function/module

The results are classified as follows:

<b>PASSED</b>	calibration successful without any restrictions
<b>CHECK</b>	deviation of correction value larger than expected, correction could however be performed
<b>FAILED</b>	deviations of correction value too large, no correction was possible. The found correction data are not applicable.

As long as the self alignment data is collected the procedure can be cancelled using the **Abort** button.

→ Remote: CAL:RES?

→ Remote: CAL:ABOR

---

### **Corr Data On/Off**

---

Activates and deactivates the alignment data, e.g. for service purposes the correction data can be deactivated.

→ Remote: CAL:STAT ON

---

### **General Setup**

---

Opens a submenu for all general settings such as IP address and LAN settings, date and time, remote control (optional) and MEAS display.

---

### **Configure Network**

---

Opens the **Network Connections** dialog box to change the LAN settings. For details refer to the Quick Start Guide, chapter 2 "Preparing for Use" and appendix B "LAN Interface".

**Network Address**

---

Opens a submenu to configure the internet protocol properties and the computer name.

---

**Computer Name**

---

Opens an edit dialog box to enter the computer name via the keypad. The naming conventions of Windows apply. If too many characters and/or numbers are entered, in the status line, an according message is displayed. For step-by-step instructions refer to the Quick Start Guide, appendix B "LAN Interface".

---

**IP Address**

---

Opens an edit dialog box to enter the IP address via the keypad. The TCP/IP protocol is preinstalled with the IP address 10.0.0.10. If the DHCP server is available (**DHCP On**), the dialog box entry is read-only.

The IP address consists of four number blocks separated by dots. Each block contains 3 numbers in maximum (e.g. 100.100.100.100), but also one or two numbers are allowed in a block (as an example see the preinstalled address). For step-by-step instructions refer to the Quick Start Guide, chapter 2 "Preparing for Use".

---

**Subnet Mask**

---

Opens an edit dialog box to enter the subnet mask via the keypad. The TCP/IP protocol is preinstalled with the subnet mask 255.255.255.0. If the DHCP server is available (**DHCP On**), the dialog box entry is read-only.

The subnet mask consists of four number blocks separated by dots. Each block contains 3 numbers in maximum (e.g. 100.100.100.100), but also one or two numbers are allowed in a block (as an example see the preinstalled address). For step-by-step instructions refer to the Quick Start Guide, chapter 2 "Preparing for Use".

---

**DHCP On/Off**

---

Switches between DHCP server available (On) or not available (Off). If a DHCP server is available in the network, the IP address and subnet mask of the instrument are obtained automatically from the DHCP server. For further details refer to the Quick Start Guide, chapter 2 "Preparing for Use".

---

**GPIB (option GPIB Interface, B10 only)**

---

Opens a submenu to set the parameters of the remote control interface.

---

---

**GPIB Address (option GPIB Interface, B10 only)**

---

Opens an edit dialog box to enter the GPIB address. Values from 0 to 30 are allowed. The default address is 20.

If, e.g. after a firmware update, the R&S ESL does not maintain the GPIB address after reboot, the shutdown file needs to be recreated. Perform the following steps:

- Set the GPIB address.
- Create a shutdown file by switching the R&S ESL in the standby mode: Press the ON/STANDBY key on the front panel and wait until the yellow LED is on. With the battery pack option, use a USB keyboard and terminate the R&S ESL firmware with ALT+F4 to create the shutdown file.

If the shutdown file was created once, the R&S ESL boots with exactly those settings after a reboot with the main switch on the rear panel. During a firmware update or cold boot for service reasons the shutdown file is deleted, and the setup is necessary once again.

→ Remote: `SYST:COMM:GPIB:ADDR 20`

---

**ID String Factory (option GPIB Interface, B10 only)**

---

Selects the default response to the \*IDN? query.

---

**ID String User (option GPIB Interface, B10 only)**

---

Opens an edit dialog box to enter a user-defined response to the \*IDN? query. Max. 36 characters are allowed.

---

**GPIB Language (option GPIB Interface, B10 only)**

---

Only the remote control language SCPI is available for the R&S ESL and is set by default.

→ Remote: `SYST:LANG 'SCPI'`

---

**Display Update On/Off**

---

Defines whether the instrument display is switched off when changing from manual operation to remote control. In remote control mode, this softkey is displayed in the local menu (for details refer to section "[Manual Operation - Local Menu](#)" on page 4.287).

→ Remote: `SYST:DISP:UPD ON`

---

**GPIB Terminator LFEI/EOI (option GPIB Interface, B10 only)**

---

Changes the GPIB receive terminator.

According to the standard the terminator in ASCII is <LF> and/or <EOI>. For binary data transfers (e.g. trace data) from the control computer to the instrument, the binary code used for <LF> might be included in the binary data block, and therefore should not be interpreted as a terminator in this particular case. This can be avoided by changing the receive terminator to EOI.

→ Remote: `SYST:COMM:GPIB:RTER EOI`

---

**\*IDN Format Leg./New**

---

Defines the response format to the \*IDN? remote command. This function is intended for re-use of existing control programs together with the R&S ESL.

**Leg.** Legacy format, compatible to the R&S FSP/FSU/FSQ family  
**New** R&S ESL format

→ Remote: SYST:FORM:IDEN LEG

---

**I/O Logging On/Off (option GPIB Interface, B10 only)**

---

Activates or deactivates the SCPI error log function. All remote control commands received by the R&S ESL are recorded in the following log file:

*C:\R\_S\Instr\ScpiLogging\ScpiLog.txt*

Logging the commands may be extremely useful for debug purposes, e.g. in order to find misspelled keywords in control programs.

---

**Time+Date**

---

Opens an edit dialog box to enter time and date for the internal real time clock. For details refer to the Quick Start Guide, chapter 2 "Preparing for Use".

→ Remote: SYST:TIME 12,30

→ Remote: SYST:DATE 2004,10,01

---

**Meas Display**

---

Opens a submenu to configure the display and the print colors.

---

**Screen Title**

---

Activates/deactivates the display of a diagram title (if available) and opens an edit dialog box to enter a new title for the active diagram. Max. 20 characters are allowed.

→ Remote: DISP:TEXT 'Noise Meas'

→ Remote: DISP:TEXT:STATE ON

---

**Time+Date On/Off**

---

Activates/deactivates the display of date and time above the diagram.

→ Remote: DISP:TIME OFF

---

**Logo On/Off**

---

Activates/deactivates the display of the Rohde & Schwarz company logo in the upper left corner.

→ Remote: DISP:LOGO ON

---



---

**Annotation On/Off**

---

Activates/deactivates the display of the frequency information. For example to protect confidential data it can be useful to hide the frequency information.

→ Remote: DISP:ANN:FREQ ON

---

**Screen Colors**

---

Opens a submenu to configure the screen colors. For details on screen colors refer to the Quick Start Guide, chapter 2 "Preparing for Use".

→ Remote: DISP:CMAP2:HSL 0.3,0.8,1.0

---

**Select Screen Color Set**

---

Opens the **Select Screen Color Set** dialog box to select default or user defined color settings.

If one of the default settings is selected (**Default Colors 1/2**), the default settings for brightness, color tint and color saturation for all display screen elements are restored. The default color schemes provide optimum visibility of all picture elements at an angle of vision from above or below. Default setting is **Default Colors 1**.

If **User Defined Colors** is selected, a user-defined color set can be defined. For step-by-step instruction refer to the Quick Start Guide, chapter 2 "Preparing for Use".

→ Remote: DISP:CMAP:DEF2

---

**Color On/Off**

---

Switches from color display to black-and-white display and back. The default setting is color display.

---

**Select Object**

---

Opens the **Color Setup** dialog box to select the color settings for a selected object.

The **Selected Object** list is displayed to select the object. For setting the color the predefined colors are displayed.

→ Remote: DISP:CMAP2:HSL 0.3,0.8,1.0 (screen colors)

→ Remote: HCOP:CMAP2:HSL 0.3,0.8,1.0 (print colors)

---

**Predefined Colors**

---

In the **Color Setup** dialog box, displays the **Predefined Colors** (alternative to the **Predefined Colors** button). This softkey is only available if, in the **Select Color Set** dialog box, the **User Defined Colors** option is selected or the **Color Setup** dialog box is displayed. For further details refer to the Quick Start Guide, chapter 2 "Preparing for Use".

→ Remote: DISP:CMAP2:PDEF GRE (screen colors)

→ Remote: HCOP:CMAP2:PDEF GRE (print colors)

---

---

**User Defined Colors**

---

In the **Color Setup** dialog box, displays the **User Defined Colors** (alternative to the **User Defined Colors** button). This softkey is only available if, in the **Select Color Set** dialog box, the **User Defined Colors** option is selected or the **Color Setup** dialog box is displayed. For further details refer to the Quick Start Guide, chapter 2 "Preparing for Use".

- Remote: DISP:CMAP2:HSL 0.3,0.8,1.0 (screen colors)
  - Remote: HCOP:CMAP2:HSL 0.3,0.8,1.0 (print colors)
- 

**Set to Default**

---

Opens the **Set to Default** dialog box to select one of the factory default color settings.

- Remote: DISP:CMAP:DEF2 (screen colors)
  - Remote: HCOP:CMAP:DEF2 (print colors)
- 

**Print Colors**

---

Opens a submenu to select the colors for the printout. To facilitate color selection, the selected color combination is displayed when the menu is entered. The previous colors are restored when the menu is exited.

---

**Select Print Color Set**

---

Opens the **Select Print Color Set** dialog box to select the color settings for printout.

<b>Screen Colors (Print)</b>	Selects the current screen colors for the printout. The background is always printed in white and the grid in black.
<b>Screen Colors (Hardcopy)</b>	Selects the current screen colors without any changes for a hardcopy. The output format is set via the <b>Device Setup</b> softkey in the print menu.
<b>Optimized Colors</b>	Selects an optimized color setting for the printout to improve the visibility of the colors (default setting). Trace 1 is blue, trace 2 black, trace 3 green, and the markers are turquoise. The background is always printed in white and the grid in black.
<b>User Defined Colors</b>	Enables the softkeys to define colors for the printout.

- Remote: HCOP:CMAP:DEF1
- 

**Color On/Off**

---

Switches from color printout to black-and-white printout and back. All colored areas are printed in white and all colored lines in black. This improves the contrast. The default setting is color printout, provided that the selected printer can produce color printouts.

- Remote: HCOP:DEV:COL ON
-

---

**Display Pwr Save On/Off**

---

Switches the power-save mode for the display on/off and opens an edit dialog box to enter the time for the power-save function to respond. After the elapse of this time the display is completely switched off, i.e. including backlighting. This mode is recommended when the instrument is exclusively operated in remote control.

For details on the power-save mode for the display refer to the Quick Start Guide, chapter 2 "Preparing for Use".

- Remote: `DISP:PSAV ON`
  - Remote: `DISP:PSAV:HOLD 15`
- 

---

**Monitor Int/Ext**

---

Switches from the internal instrument monitor to an external monitor and vice versa. The softkey is only effective, if an external monitor is connected. For further details refer to the Quick Start Guide, chapter 2 "Preparing for Use".

---

---

**Soft Frontpanel**

---

Activates or deactivates the display of the instrument emulation.

- |             |   |
|-------------|---|
| deactivated | Only the measurement screen is displayed. This is the setting for working at the R&S ESL.   |
| activated   | Additionally to the measurement screen, the whole front panel is displayed. This is the setting for working at a computer with XP Remote Desktop or at an external monitor. |

Alternatively to this softkey, you can use the F6 key.

- Remote: `SYST:DISP:FPAN ON`
- 

---

**Firmware Update**

---

Opens a submenu to install firmware versions. The installation of a new firmware version can be performed via USB or LAN interface. For details on installation refer to the Quick Start Guide, chapter 3 "Firmware Update and Installation of Firmware Options".

---

---

**Firmware Update**

---

Opens the **Firmware Update** dialog box. The update path is changed by entering the new path or via the **Browse** button. The installation is started via the **Execute** button. For details on installation refer to the Quick Start Guide, chapter 3 "Firmware Update and Installation of Firmware Options".

- Remote: `SYST:FIRM:UPD 'D:\FW_UPDATE'`
- 

---

**Option Licenses**

---

Opens a submenu to install options. For details on options refer to the Quick Start Guide, chapter 3 "Firmware Update and Installation of Firmware Options".

---

**Install Option**

---

Opens an edit dialog box to enter the license key for the option that you want to install.

A message box open if an option is about to expire or has already expired (in which case all functions (including remote control) are unavailable until the R&S ESL is rebooted). For more information about the option in question refer to the **System Info** softkey in the setup menu.

---

**Shutdown Off/Standby**

---

Configures the shutdown behavior of the R&S ESL when switched off via the ON/STANDBY key on the front panel.

- Off** If activated, the R&S ESL is shutdown completely when switched off via the ON/STANDBY key on the front panel. When switched on the next time, the R&S ESL will completely reboot.  
To prevent the instrument from overheating, the fan remains active.
- Standby** If activated, the R&S ESL goes into the standby mode when switched off via the ON/STANDBY key on the front panel. When switched on the next time, the boot time is shorter. This is the default setting.
- 

**Preset Receiver**

---

If the **Preset Receiver** softkey is activated, pressing the **PRESET** key resets the instrument to the default settings of the receiver. For a list of the default settings of the receiver refer to Initializing the Configuration - PRESET Key.

→ Remote: SYST: PRES: COMP REC

---

**Preset Spectrum**

---

If the **Preset Spectrum** softkey is activated, pressing the **PRESET** key resets the instrument to the default settings of the spectrum analyzer. For a list of the default settings of the spectrum analyzer refer to Initializing the Configuration - PRESET Key:

→ Remote: SYST: PRES: COMP SAN

---

**System Info**

---

Opens a submenu to display detailed information on module data, device statistics and system messages.

---

**Hardware Info**

---

Opens a dialog box that displays hardware information, e.g. on the frontend and motherboard. Every listed component is described by its serial number, order number, model information, hardware code, and hardware revision.

→ Remote: DIAG: SERV: HWIN?

---

**Versions+Options**

Opens a dialog box that displays a list of hardware and firmware information, e.g. the firmware version, the image version, BIOS version, data sheet version of the basic device, installed options (hardware and firmware options).

For details on options refer to the Quick Start Guide, chapter 2 "Checking the Furnished Items".

- Remote: \*IDN?
- Remote: \*OPT?

**System Messages**

Opens the **System Messages** dialog box that displays the generated system messages in the order of their occurrence. The most recent messages are placed at the top of the list. Messages that have occurred since the last display of system messages menu are marked with an asterisk "\*". The following information is available:

<b>No</b>	device-specific error code
<b>Message</b>	brief description of the message
<b>Component</b>	hardware messages: name of the affected module software messages: name of the affected software
<b>Date/Time</b>	date and time of the occurrence of the message

If the number of error messages exceeds the capacity of the error buffer, **Message buffer overflow** is displayed. To delete messages see **Clear All Messages** softkey.

- Remote: SYST:ERR:LIST?

**Clear All Messages**

Deletes all system messages. The softkey is only available if the **System Messages** dialog box is displayed.

- Remote: SYST:ERR:CLE:ALL?

**Service**

Opens a submenu that contains additional functions for maintenance and/or trouble shooting.

**NOTICE Risk of incorrect operation**

The service functions are not necessary for normal measurement operation. However, incorrect use can affect correct operation and / or data integrity of the R&S ESL. Therefore, many of the functions can only be used after entering a password. They are described in the instrument service manual.

---

**Input RF/Cal/TG**

---

Selects the input for measurement.

- |     |  |
|-----|--|
| RF  | Switches the input of the R&S ESL to the input connector (normal position). This is the default setting.   |
| Cal | Switches the RF input of the R&S ESL to the internal calibration source (65.83 MHz) and activates the data entry of the output level of the calibration source. Possible values are 0 dB and -30 dB. |
| TG  | Switches the RF input of the R&S ESL to the tracking generator output. Only the models 13 and 16 offer this setting.   |

→ Remote: `DIAG:SERV:INP RF|CAL|TG`

---

**Comb Frequency**

---

Opens a dialog box to set the comb generator frequency for the internal calibration:

- |                |                  |
|----------------|------------------|
| <b>Comb/1</b>  | 65.8333 MHz / 1  |
| <b>Comb/64</b> | 65.8333 MHz / 64 |
| <b>Comb/65</b> | 65.8333 MHz / 65 |

- Remote: Sine: `DIAG:SERV:INP:PULS OFF`  
 → Remote: Comb: `DIAG:SERV:INP:PULS ON`  
 → Remote: Comb: `DIAG:SERV:INP:PRAT COMB64`
- 

**Reset Password**

---

Deactivates all set passwords.

→ Remote: `SYST:PASS:RES`

---

**Selftest**

---

Initiates the self test of the instrument modules to identify a defective module in case of failure . All modules are checked consecutively and the test result is displayed.

→ Remote: `*TST?`

---

**Selftest Results**

---

Opens the **Selftest Result** dialog box that contains the test results. In case of failure a short description of the failed test, the defective module, the associated value range and the corresponding test results are indicated.

→ Remote: `DIAG:SERV:STE:RES?`

---

**Password**

---

Opens an edit dialog box to enter the password. This ensures that the service functions are only used by authorized personnel.

→ Remote: SYST:PASS "Password"

---

**Service Function**

---

Opens the **Service Function** dialog box to start special service functions. For further information refer to the service manual.

→ Remote: DIAG:SERV:SFUNC <value>,<value>...

---

## Saving and Recalling Settings Files - FILE Key

The **FILE** key is used to store and load instrument settings and to manage stored files.

The file menu includes functions for storing (**Save** softkey) instrument settings such as instrument configurations (measurement/display settings, etc) and measurement results on permanent storage media, or to load (**Recall** softkey) stored data back onto the instrument.

Functions for management of storage media (**File Manager** softkey) include among others functions for listing, copying, and deleting/renaming files.

The R&S E SL is capable of internally storing complete instrument settings with instrument configurations and measurement data in the form of settings files. The respective data are stored on the internal flash disk or, if selected, on a memory stick or network drive. The mass media are assigned to the volume names as follows:

Drive	Designation	Comment
C	operating system, firmware and stored instrument settings	for customer data
A	USB floppy drive	if connected
D	USB memory stick or USB CD-ROM	if connected
E ...Z	additional USB mass storage devices or mounted LAN volumes	if connected

### To open the file menu

- Press the **FILE** key.

The file menu is displayed.

### Menu and softkey description

- ["Softkeys of the file menu"](#) on page 4.280

To display help to a softkey, press the **HELP** key and then softkey for which you want to display help. To close the help window, press the **ESC** key. For further information refer to section "How to use the Help System".

### Further information

- ["Navigation in the dialog boxes for saving and loading settings files"](#) on page 4.279
- ["Navigation in the file manager"](#) on page 4.280

### Navigation in the dialog boxes for saving and loading settings files

The **Save** and **Recall** dialog boxes are used to save and recall settings files. For both dialog boxes, the same navigation principle applies. Press the **Save** or **Recall** softkey to open the corresponding dialog box.

- **Path** field

To change the directory, press the **Select Path** softkey.

To select a folder, use the rotary knob or the **UPARROW** and **DNARROW** keys. To open a subfolder, press the **RIGHTARROW** key. To close subfolders, press the **LEFTARROW** key. To confirm the selection, press the rotary knob or the **ENTER** key.



- **Files list**

If the **Recall** or **Startup Recall** dialog box is opened, the focus is on the **Files** list. To set the focus on the **Files** list, press the **Select File** softkey.

To select a folder, use the rotary knob or the **UPARROW** and **DNARROW** keys. To open a subfolder, press the **ENTER** key. To select a file, use the rotary knob or the **UPARROW** and **DNARROW** keys. To load the selected file, press the rotary knob or the **ENTER** key. To delete the selected file, press the softkey.

- **File Name field**

If the **Save** dialog box is opened, the focus is on the **File Name** field. To set the focus on **File Name** field, press the **Edit File Name** softkey. Enter the name in the **File Name** field. The extension of the data name is ignored (for details on entering the name, see Quick Start Guide, chapter 4 "Basic Operations").

- **Comment field**

To enter a comment, press the **Edit Comment** softkey (for details on entering the name, see Quick Start Guide, chapter 4 "Basic Operations").

- Items saved in the settings file

- To select a special item, set the focus on the entry using the arrow keys or the rotary knob. To confirm the selection, press the **CHECKMARK** key. To deselect the item, press the **CHECKMARK** key again.

**Navigation in the file manager**

- To change from one subfolder to another, use the **ENTER** key.
- To change to the next higher directory, select the dots "..".
- To change into a subfolder, use the **RIGHTARROW** and **LEFTARROW** keys.
- To select a file or a folder, use the **UPARROW** and **DNARROW** keys.
- To confirm the selection of a file or folder, press the **ENTER** key.

**Softkeys of the file menu**

The following table shows all softkeys available in the file menu. It is possible that your instrument configuration does not provide all softkeys. If a softkey is only available with a special option, model or (measurement) mode, this information is delivered in the corresponding softkey description.

Menu / Command	Submenu / Command	Command
Save ↓	Save File	
	Select Path	
	Select File	
	Edit File Name	
	Edit Comment	
	Select Items ↓	Select Items
		Enable all Items
		Disable all Items
	Delete File	
Recall ↓	Recall File	
	Select Path	

Menu / Command	Submenu / Command	Command
	Select File	
	Edit File Name	
	Select Items ↓	Select Items
		Enable all Items
		Disable all Items
	Delete File	
Startup Recall		
Startup Recall Setup		
File Manager ↓	Edit Path	
	New Folder	
	Copy	
	Rename	
	Cut	
	Paste	
	More ↓	
	Delete	
	Sort Mode ↓	Name
		Date
		Extension
		Size
	File Lists 1/2	
	Current File List 1/2	
	Network Drive	Map Network Drive
		Disconnect Network Drive
Export		
Import		
Hardcopy		

**Save**

Opens the **Save** dialog box to define and store the settings file. To navigate in the dialog box and define/enter data, use the corresponding softkeys. For details see also "[Navigation in the dialog boxes for saving and loading settings files](#)" on page 4.279.

- Path                      Directory in which the settings file is stored. The default path for user settings files is C:\r\_s\instr\user
- Files                      List of settings files already stored
- File Name                Name of settings file
- Comment                Comment regarding the settings file
- [Items]                   Selection of items to be saved in the settings file

**Save File / Recall File**

---

Saves the settings file with the defined file name (**Save** dialog box), or recalls the selected settings file (**Recall** dialog box). If the file name already exists, upon saving, a message is displayed. Selecting **Yes** overwrites the existing file, selecting **No** aborts the saving process.

For details on the file name conventions refer to the **Edit File Name** softkey description.

- Remote: MMEM:STOR:STAT 1, 'Save'
  - Remote: MMEM:STOR:STAT:NEXT
  - Remote: MMEM:LOAD:STAT 1, 'C:\R\_S\Instr\user\TEST01'
- 

**Select Path**

---

Opens the directory list to select the drive and folder for the settings file to be stored or loaded. The default path is C:\r\_s\instr\user. For details see also ["Navigation in the dialog boxes for saving and loading settings files"](#) on page 4.279.

---

**Select File**

---

Sets the focus on the **Files** list. For details see also ["Navigation in the dialog boxes for saving and loading settings files"](#) on page 4.279.

- Remote: MMEM:CAT? 'C:\R\_S\Instr\user\\*.DFL'
- 

**Edit File Name**

---

Sets the focus on the **File Name** field.

In the **Save** dialog box, the field already contains a suggestion for a new name: the file name used in the last saving process is counted up to the next unused name. For example, if the name last used was "test\_004", the new name "test\_005" is suggested, but only if this name is not in use. If the name "test\_005" is already in use, the next free name is suggested, e.g. "test\_006". You can change the suggested name to any name conform to the following naming conventions.

The name of a settings file consists of a base name followed by an underscore and three numbers, e.g. limit\_lines\_005. In the example, the base name is "limit\_lines". The base name can contain characters, numbers and underscores. The file extension is added automatically.

---

**Edit Comment**

---

Sets the focus on the **Comment** field to enter a comment for the settings file. Max. 60 characters are allowed. For details see also ["Navigation in the dialog boxes for saving and loading settings files"](#) on page 4.279.

---

**Select Items**

---

Displays the softkey submenu for selecting the items to be stored or loaded.

---

---

**Select Items**

---

Sets the focus on the items list. For details see also ["Navigation in the dialog boxes for saving and loading settings files"](#) on page 4.279.

In the **Save** dialog box, all items that can be saved are displayed. The number of displayed items depends on the installed options, as for some options additional items can be stored.

In the **Recall** dialog box, the items saved in the selected file are displayed.

- Remote: MMEM:SEL:HWS ON
  - Remote: MMEM:SEL:LIN:ALL ON
  - Remote: MMEM:SEL:TRAC ON
  - Remote: MMEM:SEL:TRAN:ALL ON
- 

---

**Enable all Items**

---

Selects all items for saving or loading.

- Remote: MMEM:SEL:ALL
- 

---

**Disable all Items**

---

Selects none of the items for saving or loading.

- Remote: MMEM:SEL:NONE
- 

---

**Delete File**

---

Deletes the selected settings file.

- Remote: MMEM:CLE:STAT 1, 'TEST'
- 

---

**Recall**

---

Opens the **Recall** dialog box to load a settings file. To navigate in the dialog box, use the corresponding softkeys. For details see also ["Navigation in the dialog boxes for saving and loading settings files"](#) on page 4.279.

Path	Directory from which the settings file is loaded. The default path for user settings files is C:\r_s\instr\user
Files	List of stored settings files
File Name	Name of settings file
Comment	Comment of the settings file
[Items]	Items saved in the settings file

---



---

**Startup Recall**

---

Activates or deactivates the startup recall function. If activated, the settings stored in the file selected via the **Startup Recall Setup** softkey are loaded when booting or for preset. If deactivated, the default settings are loaded.

- Remote: MMEM:LOAD:AUTO 1, 'C:\R\_S\Instr\user\TEST'
-

---

**Startup Recall Setup**

---

Opens the **Startup Recall** dialog box to select the settings file for the startup recall function (see also **Startup Recall** softkey).

→ Remote: MMEM:LOAD:AUTO 1, 'C:\R\_S\Instr\user\TEST'

---

**File Manager**

---

Opens the **File Manager** dialog box and a submenu to manage mass storage media and files. In the upper left corner, the current drive is displayed. Below the folders and subfolders of the current directory are displayed. For details on navigation see also "[Navigation in the file manager](#)" on page 4.280.

The following tasks can be performed:

- to copy files from flash disk to other media
  - to copy files into another directory
  - to rename and delete files
- 

**Edit Path**

---

For details see **Select Path** softkey.

→ Remote: MMEM:MSIS "D:"

→ Remote: MMEM:CDIR "C:\R\_S\Instr\user"

---

**New Folder**

---

Creates a new folder and opens an edit dialog box to enter name and path (absolute or relative to the current directory) of the new folder.

→ Remote: MMEM:MDIR "C:\R\_S\Instr\user\TEST"

---

**Copy**

---

Copies the selected item to the clipboard. The item can be copied later using the **Paste** softkey. For details on navigation see also "[Navigation in the file manager](#)" on page 4.280.

→ Remote: MMEM:COPY "C:\R\_S\Instr\user\set.cfg", "E:"

---

**Rename**

---

Opens an edit dialog box to enter a new file or folder name. For details on navigation see also "[Navigation in the file manager](#)" on page 4.280.

→ Remote: MMEM:MOVE "test02.cfg", "set2.cfg"

---

**Cut**

---

Copies the selected file to the clipboard. If the file is later copied to a different directory using the **Paste** softkey, it is deleted in the current directory. For details on navigation see also "[Navigation in the file manager](#)" on page 4.280.

---

**Paste**

---

Copies a file from the clipboard to the currently selected directory. For details on navigation see also "[Navigation in the file manager](#)" on page 4.280.

---

**Delete**

---

Deletes the selected item after confirmation. For details on navigation see also "[Navigation in the file manager](#)" on page 4.280.

- Remote: MMEM:DEL "test01.hcp"
  - Remote: MMEM:RDIR "C:\R\_S\Instr\user\TEST"
- 

**Sort Mode**

---

Opens a submenu to select the sorting mode for the displayed files. The entry for the next higher directory level ("..") and the folders are always located at the top of the list.

---

**Name**

---

Sorts the displayed files in alphabetical order of the file names.

---

**Date**

---

Sorts the displayed files in respect to the date.

---

**Extension**

---

Sorts the displayed files in respect to the extension.

---

**Size**

---

Sorts the displayed files in respect to the size.

---

**File Lists 1/2**

---

Splits the screen to copy files from one directory to the other. The focus between the two panes is switched using the **FIELD RIGHT** and **FIELD LEFT** keys.

---

**Current File List 1/2**

---

Changes the focus to the selected file list.

---

**Network Drive**

---

Opens the **Map Network Drive** dialog box. For further information refer to the Quick Start Guide.

---

---

**Map Network Drive**

---

Sets the focus on the **Drive** list. For further information refer to the Quick Start Guide.

- Remote: MMEM:NETW:MAP 'T:', '\\server\folder'
  - Remote: MMEM:NETW:USED ON
  - Remote: MMEM:NETW:UNUS?
- 

**Disconnect Network Drive**

---

Opens the **Disconnect Network Drive** dialog box. In the **Drive** list, select the drive you want to disconnect and confirm with **OK**.

- Remote: MMEM:NETW:DISC 'T: '
- 

**Export**

---

Opens a submenu to configure exports of trace data. For details see **ASCII File Export** softkey in the trace menu.

ASCII File Export
Decim Sep

---

**Import**

---

This function is currently not available in spectrum analyzer mode.

---

**Hardcopy**

---

Opens the print menu. For details on submenus and softkeys refer to Measurement Documentation - PRINT Key.

---

## Manual Operation - Local Menu

When switched on, the instrument is always in the manual measurement mode and can be operated via the front panel. As soon as the instrument receives a remote command, it is switched to the remote control mode.

In remote control mode, all keys of the instrument except the **PRESET** key are disabled. The **LOCAL** softkey and the **Display Update On/Off** softkey are displayed. Depending on the setting of the **Display Update On/Off** softkey, the diagrams, traces and display fields are displayed or hidden. For further details on the **Display Update On/Off** softkey refer to section "Instrument Setup and Interface Configuration - SETUP Key".

For details on remote control refer to chapter 5 "Remote Control - Basics".

### The change to manual operation consists of:

- Enabling the Front Panel Keys

Returning to manual mode enables all inactive keys. The main softkey menu of the current mode is displayed.

- Displaying the measurement diagrams again.

The diagrams, traces and display fields are displayed again.

- Generating the **OPERATION COMPLETE** message

If, at the time of pressing the **LOCAL** softkey, the synchronization mechanism via \*OPC, \*OPC? or \*WAI is active, the currently running measurement procedure is aborted and synchronization is achieved by setting the corresponding bits in the registers of the status reporting system.

- Setting Bit 6 (User Request) of the Event Status Register

With a corresponding configuration of the status reporting system, this bit immediately causes the generation of a service request (SRQ) to inform the control software that the user wishes to return to front panel control. For example this can be used to interrupt the control program and to correct instrument settings manually. This bit is set each time the **LOCAL** softkey is pressed.

### To return to manual operation

- Press the **LOCAL** softkey.

The instrument switches from remote to manual operation, but only if the local lockout function has not been activated in the remote control mode.



## Measurement Documentation - PRINT Key

The **PRINT** key is used to select and configure the printer and to customize the screen printout. For detailed information on printer selection and installation refer to the Quick Start Guide.

### To open the print menu

- Press the **PRINT** key.  
The print menu is displayed.

### Menu and softkey description

- ["Softkeys of the print menu"](#) on page 4.288

To display help to a softkey, press the **HELP** key and then softkey for which you want to display help. To close the help window, press the **ESC** key. For further information refer to section "How to use the Help System".

### Softkeys of the print menu

The following table shows all softkeys available in the print menu. It is possible that your instrument configuration does not provide all softkeys. If a softkey is only available with a special option, model or (measurement) mode, this information is delivered in the corresponding softkey description.

Menu / Command	Submenu / Command
Print Screen	
Device Setup	
Device 1/2	
Colors	Select Print Color Set
	Color On/Off
	Select Object
	Predefined Colors
	User Defined Colors
	Set to Default
Comment	
Install Printer	

---

## Print Screen

Starts to printout all test results displayed on the screen: diagrams, traces, markers, marker lists, limit lines etc. Comments, title, date, and time are included at the bottom margin of the printout. All displayed items belonging to the instrument software (softkeys, tables, dialog boxes) are not printed out. The date and time can be excluded from the printout via the **Device Setup** softkey.

The output is defined via the **Device Setup** softkey. If the output is saved in a file, the file name used in the last saving process is counted up to the next unused name. If you use a file name that already exists, upon saving, a message is displayed. Selecting **Yes** overwrites the existing file, selecting **No** aborts the saving process. For further details on the file name and an example, refer to the file menu, **Edit File Name** softkey.

Path	Directory in which the file is stored. The default path is C:\r_slinstr\user
Files	List of the existing files in the same format
File Name	Name of the file

- Remote: HCOP:ITEM:ALL
  - Remote: HCOP
  - Remote: HCOP:NEXT
- 

## Device Setup

Opens the **Hardcopy Setup** dialog box to define the output: image file, clipboard, or the printer. The dialog box consists of two tabs which are selected via the **Device 1/2** softkey. For further information refer to the Quick Start Guide.

- Remote: HCOP:DEV:LANG GDI
  - Remote: SYST:COMM:PRIN:ENUM:FIRS?
  - Remote: SYST:COMM:PRIN:ENUM:NEXT?
  - Remote: SYST:COMM:PRIN:SEL <Printer>
  - Remote: HCOP:PAGE:ORI PORT
  - Remote: HCOP:DEST "SYST:COMM:PRIN"
  - Remote: HCOP:TDST:STAT?
  - Remote: HCOP:TDST:STAT OFF
- 

## Device 1/2

Selects the tab of the device in the **Device Setup** dialog box. The analyzer is able to manage two print settings independently of each other. For each device the print setting is displayed on the corresponding tab of the **Device Setup** dialog box (**Device Setup** softkey). For further information refer to the Quick Start Guide.

---

## Colors

For details see **Print Colors** softkey of the setup menu.

---

---

**Select Print Color Set**

For details see **Select Print Color Set** softkey of the setup menu.

---

---

**Color On/Off**

For details see **Color On/Off** softkey of the setup menu.

---

---

**Select Object**

For details see **Select Object** softkey of the setup menu.

---

---

**Predefined Colors**

For details see **Predefined Colors** softkey of the setup menu.

---

---

**User Defined Colors**

For details see **User Defined Colors** softkey of the setup menu.

---

---

**Set to Default**

For details see **Set to Default** softkey of the setup menu.

---

---

**Comment**

Opens dialog box to enter a comment. Max. 120 characters are allowed. 60 characters fit in one line. In the first line, at any point a manual line-feed can be forced by entering "@".

Date and time are inserted automatically. The comment is printed below the diagram area, but not displayed on the screen. If a comment should not be printed, it must be deleted.

For details on the alphanumeric entries refer to the Quick Start Guide, chapter 4 "Basic Operations".

---

**Install Printer**

Opens the **Printers and Faxes** window to install a new printer. All printers that are already installed are displayed. For details refer to the Quick Start Guide, appendix A, "Printer Interface".

---

## Contents of Chapter 5

<b>5 Remote Control – Basics</b> .....	<b>5.3</b>
Introduction.....	5.3
Getting Started.....	5.5
Setting the Remote Control (IP/GPIB) Address .....	5.5
Starting Remote Control .....	5.6
Returning to Manual Operation.....	5.6
<b>SCPI Command Structure and Syntax</b> .....	<b>5.7</b>
Structure of a Command.....	5.7
Structure of a Command Line .....	5.9
Responses to Queries.....	5.10
Parameters.....	5.10
Overview of Syntax Elements .....	5.12
<b>Instrument Model and Command Processing</b> .....	<b>5.12</b>
Command Sequence and Command Synchronization .....	5.14
<b>Status Reporting System</b> .....	<b>5.15</b>
Structure of an SCPI Status Register.....	5.16
Overview of the Status Registers.....	5.17
Status Byte (STB) and Service Request Enable Register (SRE).....	5.18
IST Flag and Parallel Poll Enable Register (PPE).....	5.20
Event Status Register (ESR) and Event Status Enable Register (ESE) .....	5.20
STATUS:OPERation Register.....	5.21
STATUS:QUESTionable Register .....	5.21
STATUS:QUESTionable:ACPLimit Register.....	5.22
STATUS:QUESTionable:FREQuency Register .....	5.23
STATUS:QUESTionable:LIMit Register .....	5.24
STATUS:QUESTionable:LMARgin Register .....	5.24
STATUS:QUESTionable:POWEr Register.....	5.25
STATUS:QUESTionable:SYNC Register.....	5.26
Application of the Status Reporting Systems .....	5.26
Service Request.....	5.26
Serial Poll .....	5.27
Parallel Poll .....	5.27
Query by Means of Commands .....	5.27
Error Queue Query.....	5.28
Reset Values of the Status Reporting System .....	5.28
<b>Interfaces and Protocols</b> .....	<b>5.29</b>
LAN Interface .....	5.29
VXI Basics.....	5.29
VXI-11 Interface Messages.....	5.31
RSIB Protocol Basics.....	5.31
RSIB Interface Functions .....	5.32
GPIB Interface (Option R&S FSL-B10) .....	5.34
GPIB Basics.....	5.34
GPIB Interface Functions.....	5.35
GPIB Interface Messages .....	5.35
Instrument Messages.....	5.36

**Noise Figure Measurements (K30) – Status Reporting System.....5.37**  
    STATus:OPERation Register .....5.38  
    STATus:QUEStionable Register .....5.38  
    STATus:QUEStionable:CORRection Register .....5.38  
    Error Reporting .....5.39

## 5 Remote Control – Basics

This chapter assumes basic knowledge of programming and operation of the controller. It provides the following:

- Instructions on how to put the R&S ESL into operation via remote control.
- A general introduction to remote control of programmable instruments. This includes the description of the command structure and syntax according to the SCPI standard, the description of command execution and of the status registers.
- Diagrams and tables describing the status registers used in the R&S ESL.
- A description of the interfaces and protocols used for remote control.

In chapter "Instrument Functions" of this manual and in the Online Help, the remote control commands available for an instrument function are listed after each function description. In the Online Help, these remote control commands are linked to their description, provided in the manual in chapter "Remote Control – Commands". Program examples for the R&S ESL are given in chapter 7 "Remote Control – Programming Examples".

### Introduction

The instrument is equipped with the following interfaces for remote control:

- LAN interface: The protocol is based on TCP/IP and supports the VXI-11 standard.
  - Option GPIB Interface, R&S FSL-B10: GPIB interface according to standard IEC 625/IEEE 488
- The connectors are located at the rear of the instrument and permit a connection to a controller for remote control via a local area network (LAN) or directly (option GPIB Interface, R&S FSL-B10).

SCPI (**S**tandard **C**ommands for **P**rogrammable **I**nstruments) commands – messages – are used for remote control. Commands that are not taken from the SCPI standard follow the SCPI syntax rules. The instrument supports the SCPI version 1999. The SCPI standard is based on standard IEEE 488.2 and aims at the standardization of device-specific commands, error handling and the status registers. The tutorial "Automatic Measurement Control – A tutorial on SCPI and IEEE 488.2" from John M. Pieper (R&S order number 0002.3536.00) offers detailed information on concepts and definitions of SCPI.

The requirements that the SCPI standard places on command syntax, error handling and configuration of the status registers are explained in detail in the following sections. Tables provide a fast overview of the bit assignment in the status registers. The tables are supplemented by a comprehensive description of the status registers.

VISA is a standardized software interface library providing input and output functions to communicate with instruments. The I/O channel (LAN, GPIB...) is selected at initialization time by means of a channel-specific resource string. For more information about VISA refer to its user documentation.

The programming examples for remote control are all written in Microsoft® VISUAL BASIC®. Access to the VISA functions require the declaration of the functions and constants prior to their use in the project. This can be accomplished either by adding the modules VISA32.BAS and VPPTYPE.BAS or a reference to the VISA32.DLL to the project.

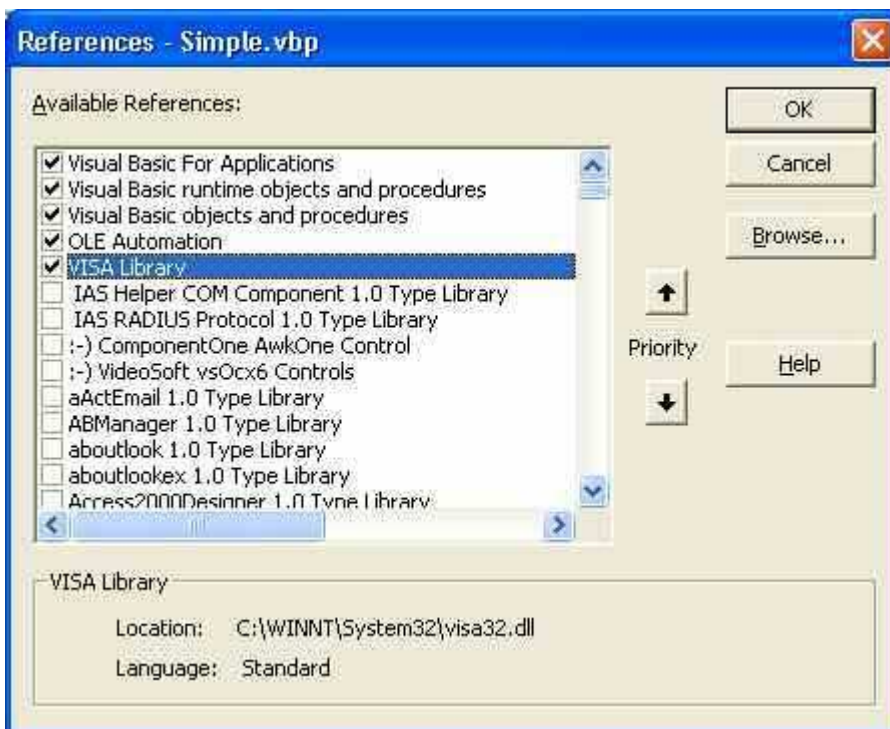

The modules visa32.bas and vpptype.bas can be found in the <VXIlnpPath>\WinNT\include (typically C:\VXIlnp\WinNT\include).

**Note:** Manual operation is designed for maximum possible operating convenience. In contrast, the priority of remote control is the "predictability" of the device status. Therefore, control programs should always define an initial device status (e.g. with the command \*RST) and then implement the required settings.

To make remote control operation more comfortable and faster, you can use IVI drivers. They bundle remote control commands, reduce the I/O to the instrument by status caching, check status and parameters and offer simulation modes.

## Getting Started

The short and simple operating sequence below shows how to put the instrument into operation and quickly set its basic functions. The remote control address, which is factory-set to 10.0.0.10, subnet mask 255.255.255.0 for LAN operation and 20 for operation via GPIB, is used. If you want to change the IP address, see "[Setting the Remote Control \(IP/GPIB\) Address](#)".

### To prepare for remote control

1. Connect the instrument to the LAN or directly to the GPIB controller (option GPIB Interface, R&S FSL-B10).

For details refer to the Quick Start Guide, appendix B.

2. Switch on the instruments.

3. Write and start the following program on the controller:

```

status = viOpenDefaultRM(defaultRM)           ' Open default resource manager
Cmd = "*RST;*CLS"                             ' Reset instrument and clear status
status = viWrite(vi, Cmd, Len(Cmd),          registers
retCount)

Cmd = "FREQ:CENT 100MHz"                       ' Set center frequency to 100 MHz
status = viWrite(vi, Cmd, Len(Cmd),
retCount)
Cmd = "FREQ:SPAN 10MHz"                       ' Set span to 10 MHz
status = viWrite(vi, Cmd, Len(Cmd),
retCount)
Cmd = "DISP:TRAC:Y:RLEV -10dBm"              ' Set reference level to -10 dBm
status = viWrite(vi, Cmd, Len(Cmd),
retCount)

```

The instrument now performs a sweep in the frequency range of 95 MHz to 105 MHz.

## Setting the Remote Control (IP/GPIB) Address

In order to operate the instrument via remote control, it must be addressed using the set IP or GPIB address. The remote control address is factory-set (for details refer to "[Getting Started](#)"), but it can be changed, if it does not fit in the network environment.

### To change the GPIB address via R&S ESL

For details see Quick Start Guide, chapter 2 "Preparing for Use".

### To change the GPIB address via GPIB

```

status = viOpenDefaultRM(defaultRM)           ' Open default resource manager
status = viOpen(defaultRM, "GPIB:20::INSTR", 0, ' Open connection to instrument
5000, vi)                                     with old address
Cmd = "SYST:COMM:GPIB:ADDR 18"               ' Set instrument to new address
status = viWrite(vi, Cmd, Len(Cmd), retCount)
status = viClose(vi)                         ' Close old connection and reopen
status = viOpen(defaultRM, "GPIB:18::INSTR", 0, with new address
5000, vi)

```

### To change the IP address via R&S ESL

For details see Quick Start Guide, chapter 2 "Preparing for Use".



## Starting Remote Control

On power-on, the instrument is always in the manual operating state ("local" state) and can be operated via the front panel.

### To start remote control

- Send an addressed command from a controller to the instrument.

The instrument is switched to remote control ("remote" state). Operation via the front panel is disabled. Only the **Local** softkey is displayed to return to manual operation. The instrument remains in the remote state until it is reset to the manual state via the instrument or via remote control interfaces. Switching from manual operation to remote control and vice versa does not affect the other instrument settings.

- During program execution, send the `SYSTem:DISPlay:UPDate ON` command to activate the display of results.

The changes in the device settings and the recorded measurement curves are displayed on the instrument screen.

- To obtain optimum performance during remote control, send the `SYSTem:DISPlay:UPDate OFF` command to hide the display of results and diagrams again (default setting in remote control).

- To prevent unintentional return to manual operation, disable the keys of the R&S ESL by the universal command LLO.

Then the transition to manual mode is only possible via remote control.

This function is only available for the GPIB interface.

- To enable the keys of the R&S ESL again, switch the instrument to local mode, i.e. deactivate the REN line of the remote control interface.

---

**Note:** *If the instrument is exclusively operated in remote control, it is recommended to switch on the power-save mode for the display. For more details on this mode refer to the Quick Start Guide.*

---

## Returning to Manual Operation

Before the transition, command processing must be completed. If command processing is not completed, it is not possible to return to manual operation and the instrument will switch back to remote control immediately.

### To return to manual operation via R&S ESL

- Press the **Local** softkey or the **Preset** key.

### To return to manual operation via GPIB

```
...
status = viGpibControlREN(vi,                               ' Set instrument to manual
VI_GPIB_REN_ADDRESS_GTL)                                  operation
...

```

## SCPI Command Structure and Syntax

SCPI (Standard Commands for Programmable Instruments) describes a standard command set for programming instruments, irrespective of the type of instrument or manufacturer. The goal of the SCPI consortium is to standardize the device-specific commands to a large extent. For this purpose, a model was developed which defines the same functions inside a device or for different devices. Command systems were generated which are assigned to these functions. Thus it is possible to address the same functions with identical commands. The command systems are of a hierarchical structure.

SCPI is based on standard IEEE 488.2, i.e. it uses the same syntactic basic elements as well as the common commands defined in this standard. Part of the syntax of the device responses is defined with greater restrictions than in standard IEEE 488.2 (see section "Responses to Queries").

### Structure of a Command

The commands consist of a so-called header and, in most cases, one or more parameters. Header and parameter are separated by a "white space" (ASCII code 0 to 9, 11 to 32 decimal, e.g. blank). The headers may consist of several key words. Queries are formed by directly appending a question mark to the header.

---

**Note:** *Not all commands used in the following examples are implemented in the instrument.*

---

#### Common commands

Common commands consist of a header preceded by an asterisk "\*" and one or several parameters, if any.

Examples:	*RST	RESET, resets the device
	*ESE 253	EVENT STATUS ENABLE, sets the bits of the event status enable register
	*ESR?	EVENT STATUS QUERY, queries the contents of the event status register.

#### Device-specific commands

- Hierarchy

Device-specific commands are of hierarchical structure (see [Fig. 5-1](#)). The different levels are represented by combined headers. Headers of the highest level (root level) have only one key word. This key word denotes a complete command system.

*Example:* SENSE

This key word denotes the SENSE command system.

For commands of lower levels, the complete path has to be specified, starting on the left with the highest level, the individual key words being separated by a colon ":".

*Example:* SENSE:FREQUENCY:SPAN 10MHZ

This command lies in the third level of the SENSE system. It sets the frequency span.

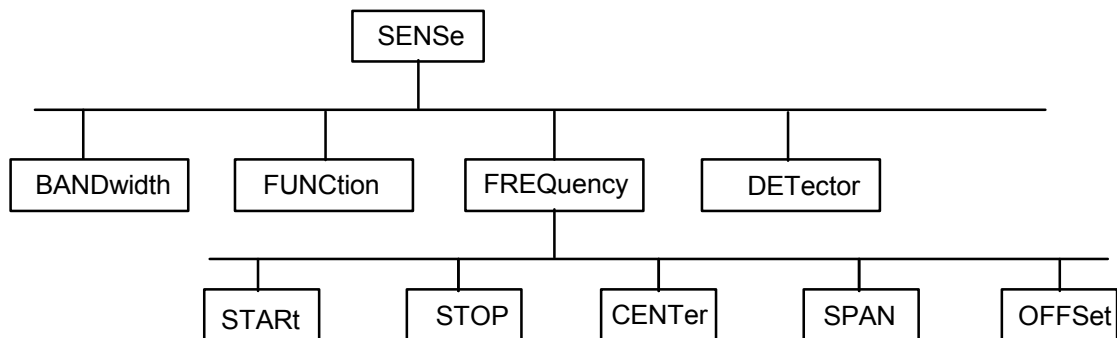

Fig. 5-1 Tree structure the SCPI command systems using the SENSE system as example

- Multiple key words

Some key words occur in several levels within one command system. Their effect depends on the structure of the command, i.e. at which position in the header of a command they are inserted.

*Example:* `SOURce:FM:POLarity NORMal`

This command contains key word POLarity in the third command level. It defines the polarity between modulator and modulation signal.

*Example:* `SOURce:FM:EXTernal:POLarity NORMal`

This command contains key word POLarity in the fourth command level. It defines the polarity between modulation voltage and the resulting direction of the modulation only for the external signal source indicated.

- Optional key words

Some command systems permit certain key words to be inserted into the header or omitted. These key words are marked by square brackets in the description. The full command length must be recognized by the instrument for reasons of compatibility with the SCPI standard. Some commands are considerably shortened by these optional key words.

*Example:* `[SENSe]:BANDwidth[:RESolution]:AUTO`

This command couples the resolution bandwidth of the instrument to other parameters. The following command has the same effect: `BANDwidth:AUTO`

---

**Note:** An optional key word must not be omitted if its effect is specified in detail by a numeric suffix.

---

- Long and short form

The key words feature a long form and a short form. Either the short form or the long form can be entered, other abbreviations are not permitted.

*Example:* `STATus:QUESTionable:ENABle 1= STAT:QUES:ENAB 1`

---

**Note:** Upper-case and lower-case notation only serves to distinguish the two forms in the manual, the instrument itself does not distinguish upper-case and lower-case letters.

---

- Parameter

The parameter must be separated from the header by a "white space". If several parameters are specified in a command, they are separated by a comma ",". A few queries permit the parameters MINimum, MAXimum and DEFault to be entered. For a description of the types of parameter, refer to section "[Parameters](#)".

*Example:* SENSE:FREQUENCY:STOP? MAXimum, Response: 3.5E9

This query requests the maximal value for the stop frequency.

- Numeric suffix

If a device features several functions or features of the same kind, e.g. inputs, the desired function can be selected by a suffix added to the command. Entries without suffix are interpreted like entries with the suffix 1. Optional keywords must be specified if they select a function with the suffix.

*Example:* SYSTEM:COMMUNICATE:SERIAL2:BAUD 9600

This command sets the baud rate of a second serial interface.

---

**Note:** In case of remote control, suffix counting may differ from the numbers of the corresponding selection used in manual operation. SCPI prescribes that suffix counting starts with 1. Suffix 1 is the default state and used when no specific suffix is specified.

*Some standards define a fixed numbering, starting with 0. With GSM, for instance, slots are counted from 0 to 7. In the case of remote control, the slots are selected with the suffixes 1 to 8. If the numbering differs in manual operation and remote control, it is indicated with the respective command.*

---

## Structure of a Command Line

A command line may consist of one or several commands. It is terminated by an EOI signal together with the last data byte.

Several commands in a command line must be separated by a semicolon ";". If the next command belongs to a different command system, the semicolon is followed by a colon. A colon ":" at the beginning of a command marks the root node of the command tree.

*Example:*

```
CALL InstrWrite(analyzer, "SENSe:FREQuency:CENTer 100MHz;:INPut:ATTenuation 10")
```

This command line contains two commands. The first one is part of the SENSE command system and is used to determine the center frequency of the instrument. The second one is part of the INPut command system and sets the input signal attenuation.

If the successive commands belong to the same system, having one or several levels in common, the command line can be abbreviated. For that purpose, the second command after the semicolon starts with the level that lies below the common levels (see also [Fig. 5-1](#)). The colon following the semicolon must be omitted in this case.

*Example:*

```
CALL InstrWrite(analyzer, "SENSe:FREQuency:START 1E6;:SENSe:FREQuency:STOP 1E9")
```

This command line is represented in its full length and contains two commands separated from each other by the semicolon. Both commands are part of the SENSE command system, subsystem FREQUENCY, i.e. they have two common levels.

When abbreviating the command line, the second command begins with the level below `SENSe:FREQuency`. The colon after the semicolon is omitted. The abbreviated form of the command line reads as follows:

```
CALL InstrWrite(analyzer, "SENSe:FREQuency:START 1E6;STOP 1E9")
```

However, a new command line always begins with the complete path.

*Example:*

```
CALL InstrWrite(analyzer, "SENSe:FREQuency:START 1E6")
CALL InstrWrite(analyzer, "SENSe:FREQuency:STOP 1E9")
```

## Responses to Queries

A query is defined for each setting command unless explicitly specified otherwise. It is formed by adding a question mark to the associated setting command. According to SCPI, the responses to queries are partly subject to stricter rules than in standard IEEE 488.2.

- The requested parameter is transmitted without header.  
*Example:* `INPut:COUPling?`, Response: DC
- Maximum values, minimum values and all further quantities, which are requested via a special text parameter are returned as numerical values.  
*Example:* `SENSe:FREQuency:STOP? MAX`, Response: 3.5E9
- Numerical values are output without a unit. Physical quantities are referred to the basic units or to the units set using the Unit command.  
*Example:* `SENSe:FREQuency:CENTer?`, Response: 1E6 (for 1 MHz)
- Truth values <Boolean values> are returned as 0 (for OFF) and 1 (for ON).  
*Example:* `SENSe:BANDwidth:AUTO?`, Response: 1 (for ON)
- Text (character data) is returned in a short form.  
*Example:* `SYSTem:COMMunicate:SERial:CONTRol:RTS?`, Response STAN (for standard)

## Parameters

Most commands require a parameter to be specified. The parameters must be separated from the header by a "white space". Permissible parameters are numerical values, Boolean parameters, text, character strings and block data. The type of parameter required for the respective command and the permissible range of values are specified in the command description.

### Numerical values

Numerical values can be entered in any form, i.e. with sign, decimal point and exponent. Values exceeding the resolution of the instrument are rounded up or down. The mantissa may comprise up to 255 characters, the exponent must lie inside the value range  $-32000$  to  $32000$ . The exponent is introduced by an "E" or "e". Entry of the exponent alone is not permissible. In the case of physical quantities, the unit can be entered. Permissible unit prefixes are G (giga), MA (mega), MOHM and MHZ (are also permissible), K (kilo), M (milli), U (micro) and N (nano). If the unit is missing, the basic unit is used.

*Example:* `SENSe:FREQuency:STOP 1.5GHz = SENSe:FREQuency:STOP 1.5E9`

### Special numerical

The texts MINimum, MAXimum, DEFault, UP and DOWN are interpreted as values special numerical values. In the case of a query, the numerical value is provided.

*Example:*

Setting command: `SENSe:FREQuency:STOP MAXimum`

Query: `SENSe:FREQuency:STOP?`, Response: `3.5E9`

- `MIN/MAX`  
MINimum and MAXimum denote the minimum and maximum value.
- `DEF`  
DEFault denotes a preset value which has been stored in the EPROM. This value conforms to the default setting, as it is called by the \*RST command
- `UP/DOWN`  
UP, DOWN increases or reduces the numerical value by one step. The step width can be specified via an allocated step command (see annex C, List of Commands) for each parameter which can be set via UP, DOWN.
- `INF/NINF`  
INFINITY, Negative INFINITY (NINF) Negative INFINITY (NINF) represent the numerical values  $-9.9E37$  or  $9.9E37$ , respectively. INF and NINF are only sent as device responses.
- `NAN`  
Not A Number (NAN) represents the value  $9.91E37$ . NAN is only sent as device response. This value is not defined. Possible causes are the division of zero by zero, the subtraction of infinite from infinite and the representation of missing values.

### Boolean parameters

Boolean parameters represent two states. The ON state (logically true) is represented by ON or a numerical value unequal to 0. The OFF state (logically untrue) is represented by OFF or the numerical value 0. The numerical values are provided as response for query.

*Example:*

Setting command: `DISPlay:WINDow:STATe ON`

Query: `DISPlay:WINDow:STATe?`, Response: `1`

### Text

Text parameters observe the syntactic rules for key words, i.e. they can be entered using a short or long form. Like any parameter, they have to be separated from the header by a white space. In the case of a query, the short form of the text is provided.

*Example:*

Setting command: `INPut:COUPling GROund`

Query: `INPut:COUPling?`, Response: `GRO`

### Strings

Strings must always be entered in quotation marks (' or ").

*Example:*

`SYSTem:LANGUage "SCPI"` or `SYSTem:LANGUage 'SCPI'`

### Block data

Block data are a transmission format which is suitable for the transmission of large amounts of data. A command using a block data parameter has the following structure:

*Example:*

`HEADer:HEADer #45168xxxxxxxx`

ASCII character # introduces the data block. The next number indicates how many of the following digits describe the length of the data block. In the example the 4 following digits indicate the length to be 5168 bytes. The data bytes follow. During the transmission of these data bytes all end or other control signs are ignored until all bytes are transmitted.

## Overview of Syntax Elements

The following survey offers an overview of the syntax elements.

- : The colon separates the key words of a command. In a command line the separating semicolon marks the uppermost command level.
  - ; The semicolon separates two commands of a command line. It does not alter the path.
  - , The comma separates several parameters of a command.
  - ? The question mark forms a query.
  - \* The asterisk marks a common command.
  - " Quotation marks introduce a string and terminate it.
  - # The hash symbol # introduces binary, octal, hexadecimal and block data.
    - Binary: #B10110
    - Octal: #O7612
    - Hexa: #HF3A7
    - Block: #21312
- A "white space" (ASCII-Code 0 to 9, 11 to 32 decimal, e.g. blank) separates header and parameter.

## Instrument Model and Command Processing

The block diagram in [Fig. 5-2](#) shows how SCPI commands are serviced in the instrument. The individual components work independently and simultaneously. They communicate with each other by means of so-called "messages".

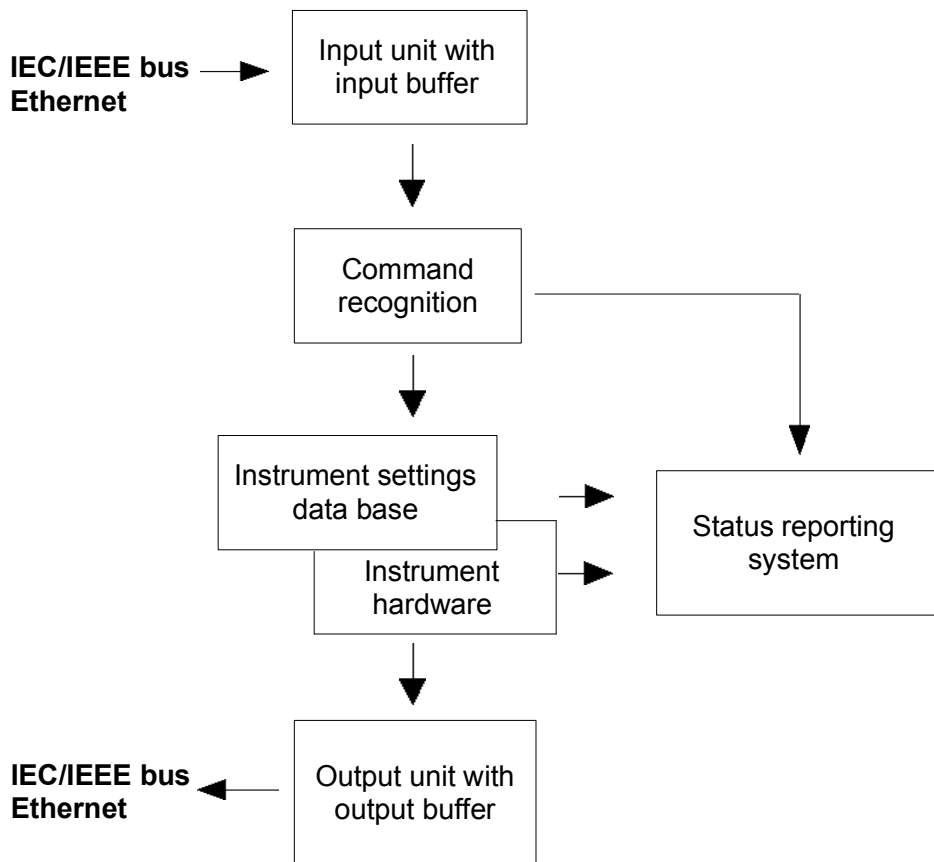

Fig. 5–2 Instrument model in the case of remote control

### Input unit

The input unit receives commands character by character from the controller and collects them in the input buffer. The input unit sends a message to the command recognition as soon as the input buffer is full or as soon as it receives a delimiter, <PROGRAM MESSAGE TERMINATOR>, as defined in IEEE 488.2, or the interface message *DCL*.

If the input buffer is full, the traffic is stopped and the data received up to then are processed. Subsequently the traffic is continued. If, however, the buffer is not yet full when receiving the delimiter, the input unit can already receive the next command during command recognition and execution. The receipt of *DCL* clears the input buffer and immediately resets the command recognition.

### Command recognition

The command recognition analyses the data received from the input unit. It proceeds in the order in which it receives the data. Only *DCL* is serviced with priority, for example *GET* (Group Execute Trigger) is only executed after the commands received before. Each recognized command is immediately transferred to the internal instrument settings data base but not executed immediately.

The command recognition detects syntax errors in the commands and transfers them to the status reporting system. The rest of a command line after a syntax error is analyzed further if possible and serviced. After the syntax test, the value range of the parameter is checked, if required.

If the command recognition detects a delimiter, it passes the command to an execution unit that performs the instrument settings. In the meantime, the command recognition is ready to process new commands (overlapping execution). A *DCL* command is processed in the same way.



**Data base and instrument hardware**

Here the expression "instrument hardware" denotes the part of the instrument fulfilling the actual instrument function – signal generation, measurement etc. The controller is not included. The term "data base" denotes a database that manages all the parameters and associated settings required for setting the instrument hardware.

Setting commands lead to an alteration in the data set. The data set management enters the new values (e.g. frequency) into the data set, however, only passes them on to the hardware when requested by the command recognition. This only takes place at the end of a command line.

The data are checked for compatibility with the current instrument settings before they are transmitted to the instrument hardware. If the execution is not possible, an "execution error" is signaled to the status reporting system. The corresponding settings are discarded.

Before passing on the data to the hardware, the settling bit in the STATus:OPERation register is set (refer to section "[STATus:OPERation Register](#)"). The hardware executes the settings and resets the bit again as soon as the new state has settled. This fact can be used to synchronize command servicing.

Queries induce the data set management to send the desired data to the output unit.

**Status reporting system**

For detailed information refer to section "[Status Reporting System](#)".

**Output unit**

The output unit collects the information requested by the controller, which it receives from the data base management. It processes it according to the SCPI rules and makes it available in the output buffer.

If the instrument is addressed as a talker without the output buffer containing data or awaiting data from the data base management, the output unit sends error message "Query UNTERMINATED" to the status reporting system. No data are sent on the GPIB or via the Ethernet, the controller waits until it has reached its time limit. This behavior is specified by SCPI.

**Command Sequence and Command Synchronization**

What has been said above makes clear that all commands can potentially be carried out overlapping. In order to prevent an overlapping execution of commands, one of the commands \*OPC, \*OPC? or \*WAI must be used. All three commands cause a certain action only to be carried out after the hardware has been set. By suitable programming, the controller can be forced to wait for the respective action to occur (refer to [Table 5–1](#)).

Table 5–1 Synchronization using \*OPC, \*OPC? and \*WAI

Command	Action	Programming the controller
*OPC	Sets the Operation Complete bit in the ESR after all previous commands have been executed.	<ul style="list-style-type: none"> <li>– Setting bit 0 in the ESE</li> <li>– Setting bit 5 in the SRE</li> <li>– Waiting for service request (SRQ)</li> </ul>

Command	Action	Programming the controller
*OPC?	Stops command processing until 1 is returned. This is only the case after the Operation Complete bit has been set in the ESR. This bit indicates that the previous setting has been completed.	Sending *OPC? directly after the command whose processing should be terminated before other commands can be executed.
*WAI	Stops further command processing until all commands sent before *WAI have been executed.	Sending *WAI directly after the command whose processing should be terminated before other commands are executed.

An example for command synchronization can be found in chapter 7 "Remote Control – Programming Examples".

For a couple of commands the synchronization to the end of command execution is mandatory in order to obtain the desired result. The affected commands require either more than one measurement in order to accomplish the desired instrument setting (e.g. auto range functions), or they require a longer period of time for execution. If a new command is received during execution of the corresponding function this may either lead to either to an aborted measurement or to incorrect measurement data.

The following list includes the commands, for which a synchronization via \*OPC, \*OPC? or \*WAI is mandatory:

Table 5–2 Commands with mandatory synchronization (overlapping commands)

Command	Purpose
INIT	start measurement
INIT:CONM	continue measurement
CALC:MARK:FUNC:ZOOM	zoom frequency range around marker 1
CALC:STAT:SCAL:AUTO ONCE	optimize level settings for signal statistic measurement functions
[SENS:]POW:ACH:PRES:RLEV	optimize level settings for adjacent channel power measurements

## Status Reporting System

The status reporting system (refer to [Fig. 5–4](#)) stores all information on the present operating state of the instrument, and on errors which have occurred. This information is stored in the status registers and in the error queue. The status registers and the error queue can be queried via GPIB or via the Ethernet.

The information is of a hierarchical structure. The register status byte (STB) defined in IEEE 488.2 and its associated mask register service request enable (SRE) form the uppermost level. The STB receives its information from the standard event status register (ESR) which is also defined in IEEE 488.2 with the associated mask register standard event status enable (ESE) and registers STATus:OPERation and STATus:QUESTionable which are defined by SCPI and contain detailed information on the instrument.

The IST flag ("Individual STatus") and the parallel poll enable register (PPE) allocated to it are also part of the status reporting system. The IST flag, like the SRQ, combines the entire instrument status in a single bit. The PPE fulfills the same function for the IST flag as the SRE for the service request.

The output buffer contains the messages the instrument returns to the controller. It is not part of the status reporting system but determines the value of the MAV bit in the STB.

## Structure of an SCPI Status Register

Each standard SCPI register consists of 5 parts which each have a width of 16 bits and have different functions (refer to Fig. 5–3). The individual bits are independent of each other, i.e. each hardware status is assigned a bit number that applies to all five parts. For example, bit 3 of the STATUS:OPERation register is assigned to the hardware status "wait for trigger" in all five parts. Bit 15 (the most significant bit) is set to zero for all parts. Thus the contents of the register parts can be processed by the controller as positive integer.

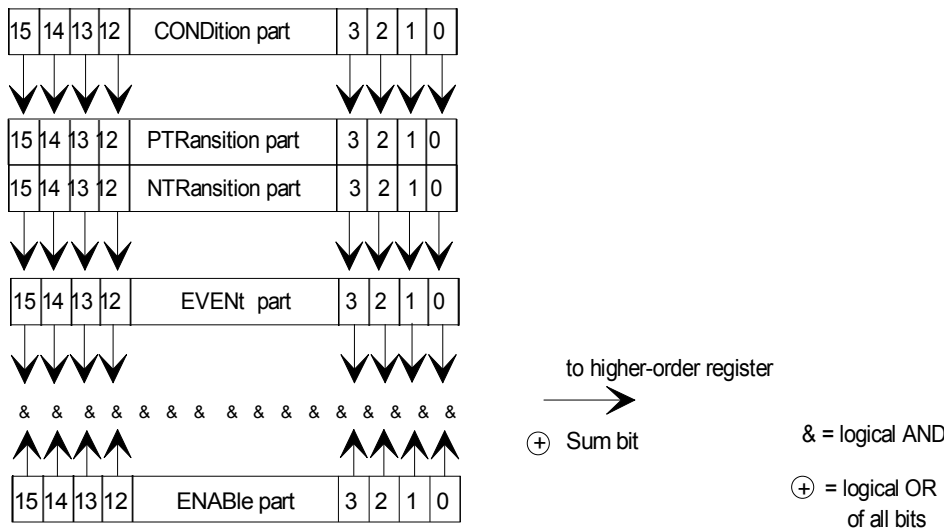

Fig. 5–3 The status–register model

### CONDition part

The CONDition part is directly written into by the hardware or the sum bit of the next lower register. Its contents reflects the current instrument status. This register part can only be read, but not written into or cleared. Its contents is not affected by reading.

### PTRansition part

The Positive–TRansition part acts as an edge detector. When a bit of the CONDition part is changed from 0 to 1, the associated PTR bit decides whether the EVENT bit is set to 1.

PTR bit =1: the EVENT bit is set.

PTR bit =0: the EVENT bit is not set.

This part can be written into and read at will. Its contents is not affected by reading.

### NTRansition part

The Negative–TRansition part also acts as an edge detector. When a bit of the CONDition part is changed from 1 to 0, the associated NTR bit decides whether the EVENT bit is set to 1.

NTR–Bit = 1: the EVENT bit is set.

NTR–Bit = 0: the EVENT bit is not set.

This part can be written into and read at will. Its contents is not affected by reading.

With these two edge register parts the user can define which state transition of the condition part (none, 0 to 1, 1 to 0 or both) is stored in the EVENT part.

#### **EVENT part**

The EVENT part indicates whether an event has occurred since the last reading, it is the "memory" of the condition part. It only indicates events passed on by the edge filters. It is permanently updated by the instrument. This part can only be read by the user. Reading the register clears it. This part is often equated with the entire register.

#### **ENABLE part**

The ENABLE part determines whether the associated EVENT bit contributes to the sum bit (see below). Each bit of the EVENT part is ANDed with the associated ENABLE bit (symbol '&'). The results of all logical operations of this part are passed on to the sum bit via an OR function (symbol '+').

ENABLE–Bit = 0: the associated EVENT bit does not contribute to the sum bit

ENABLE–Bit = 1: if the associated EVENT bit is "1", the sum bit is set to "1" as well.

This part can be written into and read by the user at will. Its contents is not affected by reading.

#### **Sum bit**

As indicated above, the sum bit is obtained from the EVENT and ENABLE part for each register. The result is then entered into a bit of the CONDition part of the higher–order register.

The instrument automatically generates the sum bit for each register. Thus an event, e.g. a PLL that has not locked, can lead to a service request throughout all levels of the hierarchy.

---

**Note:** *The service request enable register SRE defined in IEEE 488.2 can be taken as ENABLE part of the STB if the STB is structured according to SCPI. By analogy, the ESE can be taken as the ENABLE part of the ESR.*

---

## **Overview of the Status Registers**

The following figure shows the status registers used by the R&S ESL base unit. The status registers used by the R&S ESL options are described in separate sections at the end of this chapter.

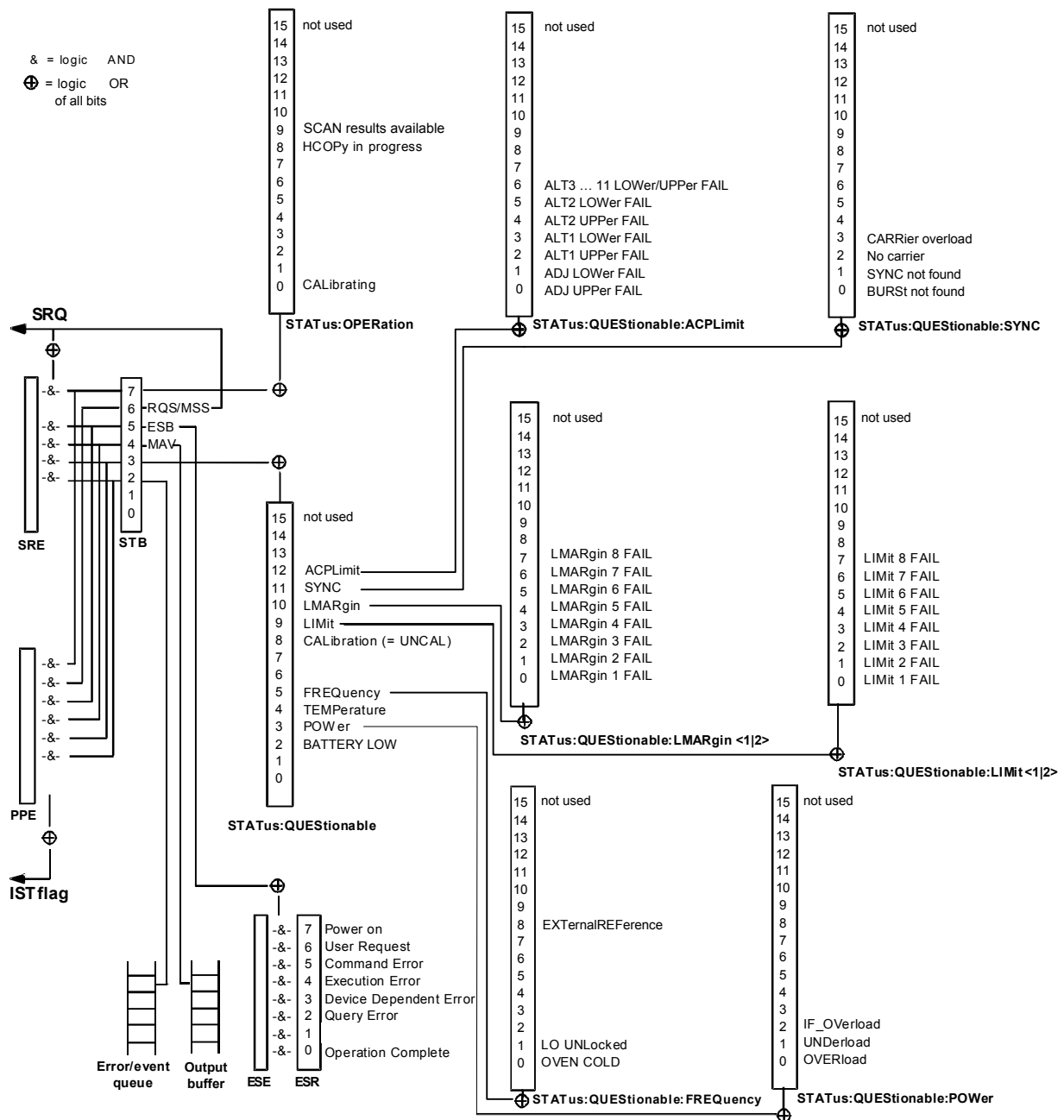

Fig. 5-4 Overview of the status registers (base unit)

## Status Byte (STB) and Service Request Enable Register (SRE)

The STB is already defined in IEEE 488.2. It provides a rough overview of the instrument status by collecting the pieces of information of the lower registers. It can thus be compared with the CONDition part of an SCPI register and assumes the highest level within the SCPI hierarchy. A special feature is that bit 6 acts as the sum bit of the remaining bits of the status byte.

The STATUS BYTE is read using the command `"*STB?"` or a serial poll.

The STB is linked to the SRE. The latter corresponds to the ENABLE part of the SCPI registers in its function. Each bit of the STB is assigned a bit in the SRE. Bit 6 of the SRE is ignored. If a bit is set in the SRE and the associated bit in the STB changes from 0 to 1, a service request (SRQ) is generated on the GPIB or via the Ethernet, which triggers an interrupt in the controller if this is appropriately configured and can be further processed there.

The SRE can be set using the command "**\*SRE**" and read using the command "**\*SRE?**"

Table 5–3 Meaning of the bits used in the status byte

Bit No.	Meaning
0...1	Not used
2	<p><b>Error Queue not empty</b></p> <p>The bit is set when an entry is made in the error queue. If this bit is enabled by the SRE, each entry of the error queue generates a service request. Thus an error can be recognized and specified in greater detail by polling the error queue. The poll provides an informative error message. This procedure is to be recommended since it considerably reduces the problems involved with remote control.</p>
3	<p><b>QUESTIONable status sum bit</b></p> <p>The bit is set if an EVENT bit is set in the QUESTIONable: status register and the associated ENABLE bit is set to 1. A set bit indicates a questionable instrument status, which can be specified in greater detail by polling the QUESTIONable status register.</p>
4	<p><b>MAV bit</b> (message available)</p> <p>The bit is set if a message is available in the output buffer which can be read. This bit can be used to enable data to be automatically read from the instrument to the controller.</p>
5	<p><b>ESB bit</b></p> <p>Sum bit of the event status register. It is set if one of the bits in the event status register is set and enabled in the event status enable register. Setting of this bit indicates a serious error which can be specified in greater detail by polling the event status register.</p>
6	<p><b>MSS bit</b> (master status summary bit)</p> <p>The bit is set if the instrument triggers a service request. This is the case if one of the other bits of this registers is set together with its mask bit in the service request enable register SRE.</p>
7	<p><b>OPERation status register sum bit</b></p> <p>The bit is set if an EVENT bit is set in the OPERation status register and the associated ENABLE bit is set to 1. A set bit indicates that the instrument is just performing an action. The type of action can be determined by polling the OPERation status register.</p>

## IST Flag and Parallel Poll Enable Register (PPE)

By analogy with the SRQ, the IST flag combines the entire status information in a single bit. It can be read by means of a parallel poll (refer to section "Parallel Poll") or using the command \*IST?.

The parallel poll enable register (PPE) determines which bits of the STB contribute to the IST flag. The bits of the STB are ANDed with the corresponding bits of the PPE, with bit 6 being used as well in contrast to the SRE. The IST flag results from the ORing of all results. The PPE can be set using commands \*PRE and read using command \*PRE?.

## Event Status Register (ESR) and Event Status Enable Register (ESE)

The ESR is defined in IEEE 488.2. It can be compared with the EVENT part of a SCPI register. The event status register can be read out using command \*ESR?.

The ESE is the associated ENABLE part. It can be set using the command \*ESE and read using the command \*ESE?.

Table 5–4 Meaning of the bits in the event status register

Bit No.	Meaning
0	<b>Operation Complete</b> This bit is set on receipt of the command *OPC exactly when all previous commands have been executed.
1	Not used
2	<b>Query Error</b> This bit is set if either the controller wants to read data from the instrument without having sent a query, or if it does not fetch requested data and sends new instructions to the instrument instead. The cause is often a query which is faulty and hence cannot be executed.
3	<b>Device-dependent Error</b> This bit is set if a device-dependent error occurs. An error message with a number between –300 and –399 or a positive error number, which denotes the error in greater detail, is entered into the error queue.
4	<b>Execution Error</b> This bit is set if a received command is syntactically correct but cannot be performed for other reasons. An error message with a number between –200 and –300, which denotes the error in greater detail, is entered into the error queue.
5	<b>Command Error</b> This bit is set if a command is received, which is undefined or syntactically incorrect. An error message with a number between –100 and –200, which denotes the error in greater detail, is entered into the error queue.
6	<b>User Request</b> This bit is set on pressing the <b>Local</b> softkey.

Bit No.	Meaning
7	<b>Power On</b> (supply voltage on) This bit is set on switching on the instrument.

### STATus:OPERation Register

In the CONDition part, this register contains information on which actions the instrument is being executing or, in the EVENt part, information on which actions the instrument has executed since the last reading. It can be read using the commands `STATus:OPERation:CONDition?` or `STATus:OPERation[:EVENt]?`.

Table 5-5 Meaning of the bits in the STATus:OPERation register

Bit No.	Meaning
0	<b>CALibrating</b> This bit is set as long as the instrument is performing a calibration.
1 to 7	Not used
8	<b>HardCOPy in progress</b> This bit is set while the instrument is printing a hardcopy.
9 to 14	Not used
15	This bit is always 0

### STATus:QUEStionable Register

This register contains information about indefinite states which may occur if the unit is operated without meeting the specifications. It can be read using the commands `STATus:QUEStionable:CONDition?` and `STATus:QUEStionable[:EVENt]?`.

Table 5-6 Meaning of bits in STATus:QUEStionable register

Bit No.	Meaning
0 to 1	These bits are not used
2	<b>BATTERY LOW</b> If the instrument is running without any external power supply and the charging level of the internal battery is approximately lower than 5% this bit is set to indicate that the system will be shut down automatically in approx. 5 minutes.
3	<b>POWer</b> This bit is set if a questionable power occurs (refer also to section " <a href="#">STATus:QUEStionable:POWer Register</a> ")
4	<b>TEMPerature</b> This bit is set if a questionable temperature occurs.



Bit No.	Meaning
5	<b>FREQUENCY</b> The bit is set if a frequency is questionable (refer to section " <a href="#">STATus:QUESTIONable:FREQUENCY Register</a> ")
6 to 7	Not used
8	<b>CALibration</b> The bit is set if a measurement is performed unaligned (label <b>UNCAL</b> )
9	<b>LIMit</b> (device-specific) This bit is set if a limit value is violated (see also section " <a href="#">STATus:QUESTIONable:LIMit Register</a> ")
10	<b>LMARgin</b> (device-specific) This bit is set if a margin is violated (see also section " <a href="#">STATus:QUESTIONable:LMARgin Register</a> ")
11	<b>SYNC</b> (device-dependent) This bit is set if, in measurements or pre-measurements, synchronization to midamble fails or no burst is found. This bit is also set if, in pre-measurements mode, the result differs too strongly from the expected value (see also " <a href="#">STATus:QUESTIONable:SYNC Register</a> ").
12	<b>ACPLimit</b> (device-specific) This bit is set if a limit for the adjacent channel power measurement is violated (see also section " <a href="#">STATus:QUESTIONable:ACPLimit Register</a> ")
13 to 14	Not used
15	This bit is always 0.

### STATus:QUESTIONable:ACPLimit Register

This register contains information about the observance of limits during adjacent power measurements. It can be read using the commands 'STATus:QUESTIONable:ACPLimit :CONDition?' and 'STATus:QUESTIONable:ACPLimit[:EVENT]?'

Table 5-7 Meaning of bits in STATus:QUESTIONable:ACPLimit register

Bit No.	Meaning
0	<b>ADJ UPPER FAIL</b> This bit is set if the limit is exceeded in the upper adjacent channel
1	<b>ADJ LOWER FAIL</b> This bit is set if the limit is exceeded in the lower adjacent channel.
2	<b>ALT1 UPPER FAIL</b> This bit is set if the limit is exceeded in the upper 1st alternate channel.

Bit No.	Meaning
3	<b>ALT1 LOWER FAIL</b> This bit is set if the limit is exceeded in the lower 1st alternate channel.
4	<b>ALT2 UPPER FAIL</b> This bit is set if the limit is exceeded in the upper 2nd alternate channel.
5	<b>ALT2 LOWER FAIL</b> This bit is set if the limit is exceeded in the lower 2nd alternate channel.
6	<b>ALT3 ... 11 LOWER/UPPER FAIL</b> This bit is set if the limit is exceeded in one off the lower or upper alternate channels 3 ... 11
7 to 14	Not used
15	This bit is always set to 0.

### STATUS:QUESTIONABLE:FREQUENCY Register

This register contains information about the reference and local oscillator.

It can be read using the commands `STATUS:QUESTIONABLE:FREQUENCY:CONDITION?` and `STATUS :QUESTIONABLE:FREQUENCY[:EVENT]?`.

Table 5–8 Meaning of bits in STATUS:QUESTIONABLE:FREQUENCY register

Bit No.	Meaning
0	<b>OVEN COLD</b> This bit is set if the reference oscillator has not yet attained its operating temperature. <b>OCXO</b> is displayed.
1	<b>LO UNLOCKED</b> This bit is set if the local oscillator no longer locks. <b>LOUNL</b> is displayed.
2 to 7	Not used
8	<b>EXTERNALREFERENCE</b> Bit 8 indicates that the external reference oscillator is selected and no useable external reference source is connected to the instrument. Therefore the synthesizer can not lock and the frequency accuracy is not guaranteed.
9 to 14	Not used
15	This bit is always 0.

**STATUS:QUESTIONABLE:LIMIT Register**

This register contains information about the observance of limit lines. It can be read using the commands `STATUS:QUESTIONABLE:LIMIT:CONDITION?` and `STATUS:QUESTIONABLE:LIMIT[:EVENT]?`.

Table 5–9 Meaning of bits in STATUS:QUESTIONABLE:LIMIT register

Bit No.	Meaning
0	<b>LIMIT 1 FAIL</b> This bit is set if limit line 1 is violated.
1	<b>LIMIT 2 FAIL</b> This bit is set if limit line 2 is violated.
2	<b>LIMIT 3 FAIL</b> This bit is set if limit line 3 is violated.
3	<b>LIMIT 4 FAIL</b> This bit is set if limit line 4 is violated.
4	<b>LIMIT 5 FAIL</b> This bit is set if limit line 5 is violated.
5	<b>LIMIT 6 FAIL</b> This bit is set if limit line 6 is violated.
6	<b>LIMIT 7 FAIL</b> This bit is set if limit line 7 is violated.
7	<b>LIMIT 8 FAIL</b> This bit is set if limit line 8 is violated.
8 to 14	Not used
15	This bit is always 0.

**STATUS:QUESTIONABLE:LMARGIN Register**

This register contains information about the observance of limit margins. It can be read using the commands `STATUS:QUESTIONABLE:LMARGIN:CONDITION?` and `STATUS:QUESTIONABLE:LMARGIN[:EVENT]?`.

Table 5–10 Meaning of bits in STATUS:QUESTIONABLE:LMARGIN register

Bit No.	Meaning
0	<b>LMARGIN 1 FAIL</b> This bit is set if limit margin 1 is violated.
1	<b>LMARGIN 2 FAIL</b> This bit is set if limit margin 2 is violated.

Bit No.	Meaning
2	<b>LMARgin 3 FAIL</b> This bit is set if limit margin 3 is violated.
3	<b>LMARgin 4 FAIL</b> This bit is set if limit margin 4 is violated.
4	<b>LMARgin 5 FAIL</b> This bit is set if limit margin 5 is violated.
5	<b>LMARgin 6 FAIL</b> This bit is set if limit margin 1 is violated.
6	<b>LMARgin 7 FAIL</b> This bit is set if limit margin 7 is violated.
7	<b>LMARgin 8 FAIL</b> This bit is set if limit margin 8 is violated.
8 to 14	Not used
15	This bit is always 0.

### STATus:QUEStionable:POWer Register

This register contains all information about possible overloads of the unit.

It can be read using the commands `STATus:QUEStionable:POWer:CONDition?` and `STATus:QUEStionable:POWer[:EVENT]?`.

Table 5–11 Meaning of bits in STATus:QUEStionable:POWer register

Bit No.	Meaning
0	<b>OVERload</b> This bit is set if the RF input is overloaded. <b>OVLD</b> is displayed.
1	<b>UNDerload</b> This bit is set if the RF input is underloaded. <b>UNLD</b> is displayed.
2	<b>IF_Overload</b> This bit is set if the IF path is overloaded. <b>IFOVL</b> is displayed.
3 to 14	Not used
15	This bit is always 0.

**STATus:QUEStionable:SYNC Register**

This register contains information about sync and bursts not found, and about pre-measurement results exceeding or falling short of expected values (for details on GSM power measurements refer to chapter "Advanced Measurement Examples", and the Quick Start Guide, chapter 5, "Basic Measurement Examples").

It can be read using the commands `STATus:QUEStionable:SYNC:CONDition?` and `STATus:QUEStionable:SYNC[:EVENT]?`.

Table 5-12 Meaning of bits in STATus:QUEStionable:SYNC register

Bit No.	Meaning
0	<b>BURSt not found</b> This bit is set if no burst is found in the measurements/pre-measurements for phase/frequency error (PFE) or carrier power versus time (PVT). If a burst is found in these measurements/pre-measurements, the bit is reset.
1	<b>SYNC not found</b> This bit is set if the synchronization sequence (training sequence) of the midamble is not found in the measurements/pre-measurements for phase/frequency error (PFE) or carrier power versus time (PVT). If the synchronization sequence (training sequence) of the midamble is found in these measurements/pre-measurements, the bit is reset. With option TV Trigger (B6), this bis is set in the free run trigger mode if the trigger does not return data.
2	<b>No carrier</b> This bit is set if the level value determined in the pre-measurements for carrier power versus time (PVT) and spectrum due to modulation is too low. The bit is reset at the beginning of the pre-measurement.
3	<b>Carrier overload</b> This bit is set if the level value determined in the pre-measurements for carrier versus time (PVT) and spectrum due to modulation is too high. The bit is reset at the beginning of the pre-measurement.
4-14	Not used.
15	This bit is always 0.

**Application of the Status Reporting Systems**

In order to be able to effectively use the status reporting system, the information contained there must be transmitted to the controller and further processed there. There are several methods which are represented in the following. For detailed program examples refer to chapter 7 "Remote Control – Programming Examples".

**Service Request**

Under certain circumstances, the instrument can send a service request (SRQ) to the controller. Usually this service request initiates an interrupt at the controller, to which the control program can react appropriately. As evident from Fig. 5-4, an SRQ is always initiated if one or several of bits 2, 3, 4, 5 or 7 of the status byte are set and enabled in the SRE. Each of these bits combines the information of a

further register, the error queue or the output buffer. The ENABLE parts of the status registers can be set so that arbitrary bits in an arbitrary status register initiate an SRQ. In order to make use of the possibilities of the service request effectively, all bits should be set to "1" in enable registers SRE and ESE.

*Example:* Use of the command \*OPC to generate an SRQ at the end of a sweep

1. CALL InstrWrite(analyzer, "\*ESE 1") 'Set bit 0 in the ESE (Operation Complete)
2. CALL InstrWrite(analyzer, "\*SRE 32") 'Set bit 5 in the SRE (ESB)?

After its settings have been completed, the instrument generates an SRQ.

The SRQ is the only possibility for the instrument to become active on its own. Each controller program should set the instrument in a way that a service request is initiated in the case of malfunction. The program should react appropriately to the service request. A detailed example for a service request routine is to be found in chapter 7 "Remote Control – Programming Examples".

## Serial Poll

In a serial poll, just as with command \*STB, the status byte of an instrument is queried. However, the query is realized via interface messages and is thus clearly faster. The serial-poll method has already been defined in IEEE 488.1 and used to be the only standard possibility for different instruments to poll the status byte. The method also works with instruments which do not adhere to SCPI or IEEE 488.2.

The VISUAL BASIC command for executing a serial poll is `IBRSP()`. Serial poll is mainly used to obtain a fast overview of the state of several instruments connected to the controller.

## Parallel Poll

In a parallel poll, the controller uses a single command to request up to eight instruments to transmit one bit of information each on the data lines, i.e., to set the data line allocated to each instrument to a logical "0" or "1". In addition to the SRE register, which determines the conditions under which an SRQ is generated, there is a parallel poll enable register (PPE). This register is ANDed with the STB bit by bit, considering bit 6 as well. The results are ORed, the result is possibly inverted and then sent as a response to the parallel poll of the controller. The result can also be queried without parallel poll by means of the command \*IST?.

The instrument first has to be set for the parallel poll using the VISUAL BASIC command `IBPPC()`. This command allocates a data line to the instrument and determines whether the response is to be inverted. The parallel poll itself is executed using `IBRPP()`.

The parallel poll method is mainly used to find out quickly which one of the instruments connected to the controller has sent a service request. To this effect, SRE and PPE must be set to the same value.

## Query by Means of Commands

Each part of any status register can be read by means of queries. The individual commands are listed in the description of the STATus Subsystem. The returned value is always a number that represents the bit pattern of the queried register. This number is evaluated by the controller program.

Queries are usually used after an SRQ in order to obtain more detailed information on the cause of the SRQ.

### Error Queue Query

Each error state in the instrument leads to an entry in the error queue. The entries of the error queue are detailed plain-text error messages that can be displayed via manual operation using the setup menu or queried via remote control using the command `SYSTem:ERRor?`. Each call of `SYSTem:ERRor?` provides one entry from the error queue. If no error messages are stored there any more, the instrument responds with 0, "No error".

The error queue should be queried after every SRQ in the controller program as the entries describe the cause of an error more precisely than the status registers. Especially in the test phase of a controller program the error queue should be queried regularly since faulty commands from the controller to the instrument are recorded there as well.

### Reset Values of the Status Reporting System

Table 5–13 contains the different commands and events causing the status reporting system to be reset. None of the commands, except `*RST` and `SYSTem:PRESet`, influences the functional instrument settings. In particular, `DCL` does not change the instrument settings.

Table 5–13 Resetting the status reporting system

Event	Switching on supply voltage		DCL,SDC (Device Clear, Selected Device Clear)	*RST or SYSTem:PRE Set	STATus:PRE Set	*CLS
	Power-On-Status-Clear					
Effect	0	1				
Clear STB,ESR	—	yes	—	—	—	yes
Clear SRE,ESE	—	yes	—	—	—	—
Clear PPE	—	yes	—	—	—	—
Clear EVENT parts of the registers	—	yes	—	—	—	yes
Clear ENABLE parts of all OPERATION and QUESTIONABLE registers; Fill ENABLE parts of all other registers with "1".	—	yes	—	—	yes	—
Fill PTRansition parts with "1"; Clear NTRansition parts	—	yes	—	—	yes	—
Clear error queue	yes	yes	—	—	—	yes
Clear output buffer	yes	yes	yes	1)	1)	1)

Event	Switching on supply voltage		DCL,SDC (Device Clear, Selected Device Clear)	*RST or SYSTem:PRE Set	STATus:PRE Set	*CLS
	Power-On-Status-Clear					
Effect	0	1				
Clear command processing and input buffer	yes	yes	yes	—	—	—

1) Every command being the first in a command line, i.e., immediately following a <PROGRAM MESSAGE TERMINATOR> clears the output buffer.

## Interfaces and Protocols

The standard instrument is accessed via LAN in order to perform for remote control. Optional a GPIB interface can be used for remote control, provided by option GPIB Interface, R&S ESL-B10.

### LAN Interface

To be integrated in a LAN, the instrument is equipped with a LAN interface, consisting of a connector, a network interface card and protocols (VXI-11 and RSIB). For details on the connector and its use refer to the Quick Start Guide, chapter 1 "Front and Rear Panel".

Instrument access via VXI11 or RSIB is usually achieved from high level programming platforms by using VISA as an intermediate abstraction layer. VISA encapsulates the low level VXI, RSIB or even GPIB function calls and thus makes the transport interface transparent for the user. The necessary VISA library is available as a separate product. For details contact your local R&S sales representative.

### VXI Basics

The VXI-11 standard is based on the RPC protocol which in turn relies on TCP/IP as the network/transport layer. The TCP/IP network protocol and the associated network services are preconfigured. TCP/IP ensures connection-oriented communication, where the order of the exchanged messages is adhered to and interrupted links are identified. With this protocol, messages cannot be lost.

Remote control of an instrument via a network is based on standardized protocols which follow the OSI reference model (see Fig. below).



Application	SCPI
Presentation	XDR (VXI-11)
Session	ONC-RPC
Transport	TCP / UDP
Network	IP
Data Link	Ethernet/802.3
Physical	802.3/10BASE-T

Fig. 5-5 Example for LAN remote control based on the OSI reference model

Based on TCP/UDP, messages between the controller and the instrument are exchanged via open network computing (ONC) – remote procedure calls (RPC). With XDR (VXI-11), legal RPC messages are known as VXI-11 standard. Based on this standard, messages are exchanged between the controller and the instrument. The messages are identical with SCPI commands. They can be organized in four groups:

- program messages (control command to the instrument)
- response messages (values returned by the instrument)
- service request (spontaneous queries of the instrument)
- low-level control messages (interface messages).

A VXI-11 link between a controller and an instrument uses three channels: core, abort and interrupt channel. Instrument control is mainly performed on the core channel (program, response and low-level control messages). The abort channel is used for immediate abort of the core channel; the interrupt channel transmits spontaneous service requests of the instrument. Link setup itself is very complex. For more details refer to the VXI-11 specification.

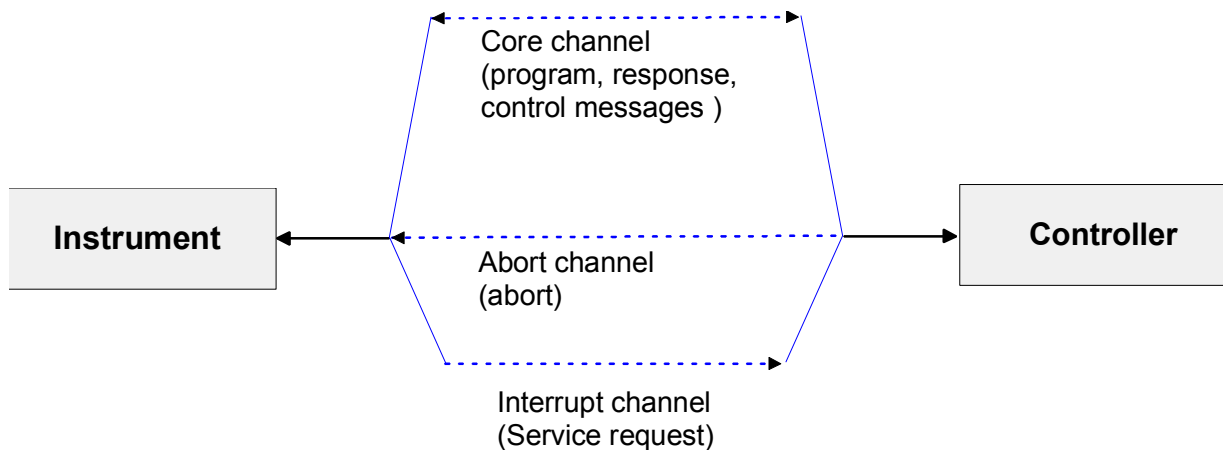

Fig. 5-6 VXI-11 channels between instrument and controller

The number of controllers that can address an instrument is practically unlimited in the network. In the instrument, the individual controllers are clearly distinguished. This distinction continues up to the application level in the controller, i.e. two applications on a computer are identified by the instrument as two different controllers.

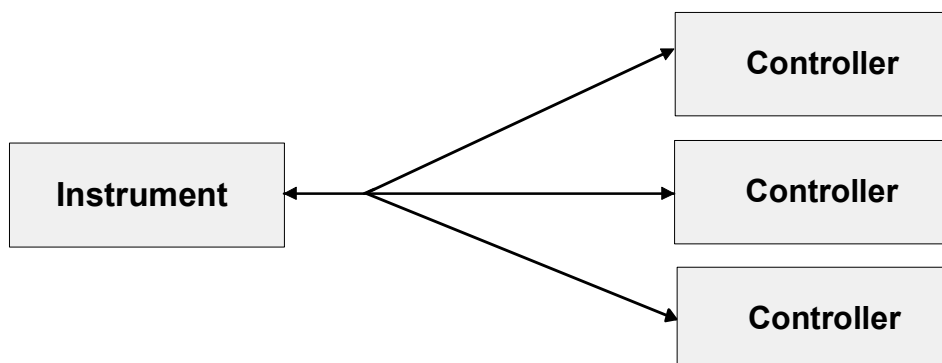

Fig. 5–7 Remote control via LAN from several controllers

The controllers can lock and unlock the instrument for exclusive access. This regulates access to the instrument of several controllers.

### VXI–11 Interface Messages

On the Ethernet link, the interface messages are called low–level control messages. These messages can be used to emulate interface messages of the GPIB.

Table 5–14 VXI–11 Interface Messages

Command	Effect on the instrument
&ABO (Abort)	Aborts the processing of the commands just received.
&DCL (Device Clear)	Aborts the processing of the commands just received and sets the command processing software to a defined initial state. Does not change the instrument setting.
&GTL (Go to Local)	Transition to the "Local" state (manual operation)
&GTR (Go to Remote)	Transition to the "Remote" state (remote control)
&GET (Group Execute Trigger)	Triggers a previously active device function (e.g. a sweep). The effect of the command is the same as with that of a pulse at the external trigger signal input.
&LLO (Local Lockout)	Disables switchover from remote control to manual operation by means of the front panel keys
&POL (Serial Poll)	Starts a serial poll
&NREN (Not Remote Enable)	Enables switchover from remote control to manual operation by means of the front panel keys

### RSIB Protocol Basics

The R&S defined RSIB protocol uses the TCP/IP protocol for communication with the instrument. Remote control over RSIB is done on a message level basis using the SCPI command set of the instrument. The RSIB protocol allows you to control the instrument not only via Visual C++– and Visual Basic programs but also via the two Windows applications WinWord and Excel as well as via National Instruments LabView, LabWindows/CVI and Agilent VEE. The control applications run on an external computer in the network.

A UNIX operating system can be installed on an external computer in addition to a Windows operating system. In this case, the control applications are created either in C or C++. The supported UNIX operating systems include:

- Sun Solaris 2.6 Sparc Station
- Sun Solaris 2.6 Intel Platform
- Red Hat Linux 6.2 x86 Processors

**RSIB Interface Functions**

The library functions are adapted to the interface functions of National Instruments for GPIB programming. The functions supported by the libraries are listed in the following table.

<b>Function</b>	<b>Description</b>
RSDLLibfind()	Provides a handle for access to a device.
RSDLLibwrt()	Sends a zero-terminated string to a device.
RSDLLilwrt()	Sends a certain number of bytes to a device.
RSDLLibwrtf()	Sends the contents of a file to a device.
RSDLLibrd()	Reads data from a device into a string.
RSDLLilrd()	Reads a certain number of bytes from a device.
RSDLLibrdf()	Reads data from a device into a file.
RSDLLibtmo()	Sets timeout for RSIB functions.
RSDLLibsre()	Switches a device to the local or remote state.
RSDLLibloc()	Temporarily switches a device to the local state.
RSDLLibeot()	Enables/disables the END message for write operations.
RSDLLibrsp()	Performs a serial poll and provides the status byte.
RSDLLibonl()	Sets the device online/offline.
RSDLLTestSrq()	Checks whether a device has generated an SRQ.
RSDLLWaitSrq()	Waits until a device generates an SRQ.
RSDLLSwapBytes	Swaps the byte sequence for binary numeric display (only required for non-Intel platforms).

As with the National Instrument interface, the successful execution of a command can be checked by means of the variables *ibsta*, *iberr* and *ibcntl*. For this purpose, all RSIB functions are assigned references to these three variables.

**Status word – `ibsta`**

The status word `ibsta` provides information on the status of the RSIB interface. The following bits are defined:

Bit designation	Bit	Hex code	Description
ERR	15	8000	Is set when an error has occurred on calling a function. If this bit is set, <code>iberr</code> contains an error code that specifies the error in greater detail.
TIMO	14	4000	Is set when a timeout has occurred on calling a function.
CMPL	8	0100	Is set if the response of the GPIB parser has been read out completely. If a parser response is read out with the function <code>RSDLl1rd()</code> and the length of the buffer is insufficient for the answer, the bit will be cleared.

**Error variable – `iberr`**

If the ERR bit (8000h) is set in the status word, `iberr` contains an error code which allows the error to be specified in greater detail. Extra error codes are defined for the RSIB protocol, independent of the National Instruments interface.

Error	Error code	Description
IBERR_CONNECT	2	Setup of the connection to the measuring instrument has failed.
IBERR_NO_DEVICE	3	A function of the interface has been called with an illegal device handle.
IBERR_MEM	4	No empty memory available.
IBERR_TIMEOUT	5	Timeout has occurred.
IBERR_BUSY	6	The RSIB protocol is blocked by a function that is still running.
IBERR_FILE	7	Error when reading or writing to a file.
IBERR_SEMA	8	Error upon creating or assigning a semaphore (only under UNIX).

**Count variable – `ibcntl`**

The variable `ibcntl` is updated with the number of transferred bytes each time a read or write function is called.

## GPIB Interface (Option R&S FSL–B10)

The standard instrument is not equipped with an GPIB connector, but can be accessed via the LAN interface for remote control. The option R&S FSL–B10 provides a GPIB interface. For details on the connector and its use refer to the Quick Start Guide, chapter 1 "Front and Rear Panel".

### GPIB Basics

The GPIB interface is described by the following characteristics:

- 8-bit parallel data transfer
- bi-directional data transfer
- three-line handshake
- high data transfer rate of max. 700 kbyte/s
- up to 15 instruments can be connected
- maximal length of the interconnecting cables 15 m (single connection, 2m)
- wired-OR connection if several instruments are connected in parallel.

Depending on the bus type the following bus lines are used:

- Data bus with 8 lines D0 to D7.  
The transmission is bit-parallel and byte-serial in the ASCII/ISO code. D0 is the least significant bit, D7 the most significant bit.
- Control bus with 5 lines
 

IFC (Interface Clear)	active LOW resets the interfaces of the instruments connected to the default setting.
ATN (Attention)	active LOW signals the transmission of interface messages. inactive HIGH signals the transmission of device messages.
SRQ (Service Request)	active LOW enables the connected device to send a service request to the controller.
REN (Remote Enable)	active LOW permits switchover to remote control.
EOI (End or Identify)	has two functions in connection with ATN: ATN = HIGH active LOW marks the end of data transmission. ATN = LOW active LOW triggers a parallel poll.
- Handshake bus with three lines
 

DAV (Data Valid)	active LOW signals a valid data byte on the data bus.
NRFD (Not Ready For Data)	active LOW signals that one of the connected devices is not ready for data transfer.
NDAC (Not Data Accepted)	active LOW signals that the instrument connected is accepting the data on the data bus.

## GPIB Interface Functions

Instruments which can be remote controlled via the GPIB can be equipped with different interface functions. Table 5–1 lists the interface functions appropriate for the instrument.

Table 5–1 Interface functions

Control character	Interface function
SH1	Handshake source function (source handshake), full capability
AH1	Handshake sink function (acceptor handshake), full capability
L4	Listener function, full capability, unaddress if MTA.
T6	Talker function, full capability, ability to respond to serial poll, unaddress if MLA
SR1	Service request function (Service Request), full capability
PP1	Parallel poll function, full capability
RL1	Remote/Local switch over function, full capability
DC1	Reset function (Device Clear), full capability
DT1	Trigger function (Device Trigger), full capability
C0	No controller function

## GPIB Interface Messages

The messages transferred via the data lines of the GPIB can be divided into two groups: interface messages and device messages

Interface messages are transferred on the data lines of the GPIB if the "ATN" control line is active (LOW). They are used for communication between controller and instruments and can only be sent by the controller which currently has control of the GPIB.

### Universal Commands

The universal commands are encoded 10 – 1F hex. They affect all instruments connected to the bus without addressing.

Table 5–2 Universal Commands

Command	QuickBASIC command	Effect on the instrument
DCL (Device Clear)	IBCMD (controller%, CHR\$(20))	Aborts the processing of the commands just received and sets the command processing software to a defined initial state. Does not change the instrument settings.
IFC (Interface Clear)	IBSIC (controller%)	Resets the interfaces to the default setting.

Command	QuickBASIC command	Effect on the instrument
LLO (Local Lockout)	IBCMD (controller%, CHR\$(17))	The LOC/IEC ADDR key is disabled.
SPE (Serial Poll Enable)	IBCMD (controller%, CHR\$(24))	Ready for serial poll.
SPD (Serial Poll Disable)	IBCMD (controller%, CHR\$(25))	End of serial poll.
PPU (Parallel Poll Unconfigure)	IBCMD (controller%, CHR\$(21))	End of the parallel-poll state.

**Addressed Commands**

The addressed commands are encoded 00 – 0F hex. They are only effective for instruments addressed as listeners.

Table 5–3Addressed Commands

Command	QuickBASIC command	Effect on the instrument
SDC(Selected Device Clear)	IBCLR (device%)	Aborts the processing of the commands just received and sets the command processing software to a defined initial state. Does not change the instrument setting.
GET(Group Execute Trigger)	IBTRG (device%)	Triggers a previously active device function (e.g. a sweep). The effect of the command is the same as with that of a pulse at the external trigger signal input.
GTL (Go to Local)	IBLOC (device%)	Transition to the "Local" state (manual operation).
PPC (Parallel Poll Configure)	IBPPC (device%, data%)	Configure instrument for parallel poll. Additionally, the QuickBASIC command executes PPE/PPD.

**Instrument Messages**

For different interfaces, device messages are more or less alike. They are divided into two groups, depending on the direction they are sent: commands and device responses.

**Commands**

Commands (program messages)are messages the controller sends to the instrument. They operate the device functions and request information. The commands are subdivided according to two criteria:

- According to the effect they have on the instrument:
  - *Setting commands* cause instrument settings such as a reset of the instrument or setting the frequency.

- *Queries* cause data to be provided for remote control, e.g. for identification of the device or polling a parameter value. Queries are formed by directly appending a question mark to the header.
- According to their definition in standard:
  - *Common commands* are exactly defined as to their function and notation in standard IEEE 488.2. They refer to functions such as management of the standardized status registers, reset and self test.
  - *Device-specific commands* refer to functions depending on the features of the instrument such as frequency setting. A majority of these commands has also been standardized by the SCPI committee. Device-specific extensions following the SCPI rules are permitted by the standard.

### Device responses

Device responses (response messages and service request) are messages the instrument sends to the controller after a query. They can contain measurement results, instrument settings and information on the instrument status (refer to section "Responses to Queries").

## Noise Figure Measurements (K30) – Status Reporting System

Additionally to the registers provided by the base system, the following registers are used or modified in the Noise Figure Measurements option (K30):

- [STATus:OPERation Register](#)  
Although this register is provided by the base system, the Noise Figure Measurements option makes use of bits not used within the base system.
- [STATus:QUESTionable Register](#)  
Although this register is provided by the base system, the Noise Figure Measurements option uses different bits and definitions.
- [STATus:QUESTionable:CORRection Register](#)  
This register is provided by the R&S FS–K30 option.

The following registers are provided by the base system and are not available from the Noise Figure Measurements option (K30) command tree:

- [STATus:QUESTionable:ACPLimit Register](#)
- [STATus:QUESTionable:LIMit Register](#)
- [STATus:QUESTionable:LMARgin Register](#)
- [STATus:QUESTionable:POWer Register](#)

Detailed information on the status registers of the base system is given in section [Status Reporting System](#). In this section, only the new and altered status registers / bits for the Noise Figure Measurements option (K30) are described.



## STATus:OPERation Register

Additionally to the bits assigned by the base system (for details refer to [STATus:OPERation Register](#)), the bits no. 4 and 7 are defined:

Bit No	Meaning
4	<b>MEASuring</b> A '1' in this bit position indicates that a measurement is in progress.
7	<b>CORRection</b> Indicates that a user calibration is in progress.

## STATus:QUEStionable Register

Additionally to the bits assigned by the base system (for details refer to [STATus:QUEStionable Register](#)), the bit no. 11 is defined differently:

Bit No	Meaning
11	<b>CORRection</b> This bit is set if a questionable correction data occurs (see also section <a href="#">STATus:QUEStionable:CORRection Register</a> ).

## STATus:QUEStionable:CORRection Register

This register comprises information about the correction state of noise measurements. It can be queried by `STATus:QUEStionable:CONDition?` and `STATus:QUEStionable[:EVENT]? commands`.

Bit No	Meaning
0	<b>NO CORRection</b> User calibration is required (i.e. not done, or setup changed). Will remain 1 until a user calibration is done. Set to 1 at the start of a user calibration. It will go to 0 at the end of a user calibration only if at least all points on one range have been calibrated. Initial value is 1.
1	These bits are not used
2	<b>UNCorrected measurement</b> Uncorrected measurement data (one or more points could not be corrected using existing user calibration). Set to 0 at the start of each sweep/redisplay of result. Will remain 0 until an attempt is made to correct a point and the calibration data does not exist (the required range has not been calibrated). If no calibration data exist, this bit will not be set when an attempt is made to make a corrected measurement.
3 to 14	These bits are not used
15	This bit is always 0

## **Error Reporting**

Error reporting for the Noise Figure Measurements option is carried out using the Service Request (SRQ) interrupt in the GPIB interface. When an error occurs a Service Request interrupt will be generated. The master can then query the slave instrument for the error that triggered the interrupt. Errors are queried through the "SYSTem:ERRor" command.

## Contents of Chapter 6

<b>6</b>	<b>Remote Control – Commands.....</b>	<b>6.1</b>
	<b>Notation.....</b>	<b>6.2</b>
	<b>Remote Commands of the Base Unit.....</b>	<b>6.5</b>
	ABORt Subsystem.....	6.6
	CALCulate Subsystem.....	6.7
	DISPlay Subsystem.....	6.114
	FORMat Subsystem.....	6.123
	INITiate Subsystem.....	6.124
	INPut Subsystem.....	6.128
	OUTPut Subsystem.....	6.133
	SENSe Subsystem.....	6.135
	SOURce Subsystem (Models 13 and 16).....	6.201
	STATus Subsystem.....	6.203
	SYSTem Subsystem.....	6.214
	TRACe Subsystem.....	6.215
	TRIGger Subsystem.....	6.230
	UNIT Subsystem.....	6.234
	<b>Remote Commands of the Analog Demodulation Option (K7).....</b>	<b>6.235</b>
	CALCulate Subsystem (Analog Demodulation, K7).....	6.236
	DISPlay Subsystem (Analog Demodulation, K7).....	6.246
	INSTrument Subsystem (Analog Demodulation, K7).....	6.248
	SENSe Subsystem (Analog Demodulation, K7).....	6.249
	TRACe Subsystem (Analog Demodulation, K7).....	6.277
	TRIGger Subsystem (Analog Demodulation, K7).....	6.278
	UNIT Subsystem (Analog Demodulation, K7).....	6.280
	<b>Remote Commands of the Power Meter Option (K9).....</b>	<b>6.281</b>
	CALCulate Subsystem (Power Meter, K9).....	6.282
	CALibration Subsystem (Power Meter, K9).....	6.284
	FETCh Subsystem (Power Meter, K9).....	6.285
	READ Subsystem (Power Meter, K9).....	6.286
	SENSe Subsystem (Power Meter, K9).....	6.287
	UNIT Subsystem (Power Meter, K9).....	6.292
	<b>Remote Commands of the Noise Figure Measurements Option (K30).....</b>	<b>6.293</b>
	ABORt Subsystem (Noise Figure, K30).....	6.294
	CALCulate Subsystem (Noise Figure, K30).....	6.295
	CONFigure Subsystem (Noise Figure, K30).....	6.304
	DISPlay Subsystem (Noise Figure, K30).....	6.306
	FETCh Subsystem (Noise Figure, K30).....	6.313
	INITiate Subsystem (Noise Figure, K30).....	6.317
	INPut Subsystem (Noise Figure, K30).....	6.318

---

INSTrument Subsystem (Noise Figure, K30) .....	6.319
SENSE Subsystem (Noise Figure, K30).....	6.320
STATus Subsystem (Noise Figure, K30).....	6.330
SYSTem Subsystem (Noise Figure, K30) .....	6.335
<b>Remote Control - Description of Basic Settings Commands .....</b>	<b>6.336</b>
Common Commands .....	6.337
CALibration Subsystem .....	6.341
DIAGnostic Subsystem .....	6.343
DISPlay Subsystem .....	6.347
FORMat Subsystem .....	6.354
HCOPY Subsystem .....	6.355
INSTrument Subsystem.....	6.362
MMEMory Subsystem.....	6.363
OUTPut Subsystem (Option Additional Interfaces, B5).....	6.380
SENSE Subsystem .....	6.381
SOURce Subsystem .....	6.386
STATus Subsystem .....	6.387
SYSTem Subsystem.....	6.392

## 6 Remote Control – Commands

This chapter describes all remote control commands for the analyzer functions, firmware options (see list below) and the basic settings functions of the R&S ESL in detail. Commands that are used both for analyzer functions and firmware options are described in the analyzer commands section. The mode information is provided for each command.

A few commands are implemented for reasons of compatibility with the R&S FSP family only. These commands are not described in the R&S ESL documentation, because they have no effect.

Each subsystem starts with a list of commands, which provides quick access to all commands of the subsystem. Be aware, that for one subsystem more than one SCPI command lists can exist, depending on the functionality (analyzer and basic settings, options). For details on the notation refer to "[Notation](#)".

### Remote commands of firmware and firmware options

- ["Remote Commands of the Base Unit"](#) on page 6.5
- ["Remote Commands of the Analog Demodulation Option \(K7\)"](#) on page 6.235
- ["Remote Commands of the Power Meter Option \(K9\)"](#) on page 6.281
- ["Remote Commands of the Noise Figure Measurements Option \(K30\)"](#) on page 6.293
- ["Remote Control – Description of Basic Settings Commands"](#) on page 6.336

## Notation

In the following sections, all commands implemented in the instrument are first listed and then described in detail, arranged according to the command subsystems. The notation is adapted to the SCPI standard. The SCPI conformity information is included in the individual description of the commands.

- [Individual Description](#)
- [Upper/Lower Case Notation](#)
- [Special Characters](#)
- [Description of Parameters](#)

### Individual Description

The individual description contains the complete notation of the command. An example for each command, the \*RST value and the SCPI information are included as well.

The options and operating modes for which a command can be used are indicated by the following abbreviations:

Abbreviation	Description
A	spectrum analysis
A-F	spectrum analysis – span > 0 only (frequency mode)
A-T	spectrum analysis – zero span only (time mode)
ADEMOD	analog demodulation (option R&S FSL-K7)
NF	noise figure measurements (option R&S FSL-K30)
PSM	power sensor measurements (option R&S FSL-K9)
R	receiver

---

**Note:** *The spectrum analysis (analyzer) mode and the receiver mode are implemented in the base unit. For the other modes the corresponding options are required.*

---

### Upper/Lower Case Notation

Upper/lower case letters are used to mark the long or short form of the key words of a command in the description (see chapter 5 "Remote Control – Basics"). The instrument itself does not distinguish between upper and lower case letters.

## Special Characters

- | A selection of key words with an identical effect exists for several commands. These keywords are indicated in the same line; they are separated by a vertical stroke. Only one of these keywords needs to be included in the header of the command. The effect of the command is independent of which of the keywords is used.

*Example:*

```
SENSe:FREQuency:CW|:FIXed
```

The two following commands with identical meaning can be created. They set the frequency of the fixed frequency signal to 1 kHz:

```
SENSe:FREQuency:CW 1E3
```

```
SENSe:FREQuency:FIXed 1E3
```

A vertical stroke in parameter indications marks alternative possibilities in the sense of "or". The effect of the command is different, depending on which parameter is used.

*Example: Selection of the parameters for the command*

```
[SENSe<1|2>:]AVERage:TYPE VIDEo | LINear
```

If parameter `SINGLE` is selected, full screen is displayed, in the case of `SPLIT`, split screen is displayed.

- [] Key words in square brackets can be omitted when composing the header. The full command length must be accepted by the instrument for reasons of compatibility with the SCPI standards.

Parameters in square brackets can be incorporated optionally in the command or omitted as well.

- { } Parameters in braces can be incorporated optionally in the command, either not at all, once or several times.

## Description of Parameters

Due to the standardization, the parameter section of SCPI commands consists always of the same syntactical elements. SCPI has therefore specified a series of definitions, which are used in the tables of commands. In the tables, these established definitions are indicated in angled brackets (<...>) and will be briefly explained in the following (see also chapter 5 "Remote Control – Basics", section "Parameters").

<Boolean>

This keyword refers to parameters which can adopt two states, "on" and "off". The "off" state may either be indicated by the keyword OFF or by the numeric value 0, the "on" state is indicated by ON or any numeric value other than zero. Parameter queries are always returned the numeric value 0 or 1.

<numeric\_value> <num>

These keywords mark parameters which may be entered as numeric values or be set using specific keywords (character data). The following keywords given below are permitted:

MAXimum: This keyword sets the parameter to the largest possible value.

MINimum: This keyword sets the parameter to the smallest possible value.

DEFault: This keyword is used to reset the parameter to its default value.

UP: This keyword increments the parameter value.

DOWN: This keyword decrements the parameter value.

The numeric values associated to MAXimum/MINimum/DEFault can be queried by adding the corresponding keywords to the command. They must be entered following the quotation mark.

**Example:**

```
SENSe:FREQuency:CENTer? MAXimum
```

Returns the maximum possible numeric value of the center frequency as result.

<arbitrary block program data>

This keyword is provided for commands the parameters of which consist of a binary data block.



## Remote Commands of the Base Unit

In this section all remote control commands for base unit functions are described in detail. For details on basic settings commands refer to section "Remote Control – Description of Basic Settings Commands".

### Subsystems of the analyzer

- ["ABORt Subsystem"](#) on page 6.6
- ["CALCulate Subsystem"](#) on page 6.7
- ["DISPlay Subsystem"](#) on page 6.114
- ["FORMat Subsystem"](#) on page 6.123
- ["INITiate Subsystem"](#) on page 6.124
- ["INPut Subsystem"](#) on page 6.128
- ["OUTPut Subsystem"](#) on page 6.133
- ["SENSe Subsystem"](#) on page 6.135
- ["SOURce Subsystem \(Models 13 and 16\)"](#) on page 6.201
- ["STATus Subsystem"](#) on page 6.203
- ["SYSTem Subsystem"](#) on page 6.214
- ["TRACe Subsystem"](#) on page 6.215
- ["TRIGger Subsystem"](#) on page 6.230
- ["UNIT Subsystem"](#) on page 6.234

## ABORt Subsystem

The ABORt subsystem contains the commands for aborting triggered actions. An action can be triggered again immediately after being aborted. All commands trigger events, and therefore they have no \*RST value.

### Commands of the ABORt Subsystem

- [ABORt](#)
- [HOLD](#)

---

#### ABORt

This command aborts a current measurement and resets the trigger system.

**Example**

```
ABOR; INIT: IMM
```

**Characteristics**

RST value: –

SCPI: conform

**Mode**

all

---

#### HOLD

This command interrupts a current scan measurement. The scan is resumed by [INITiate<1|2>\[:IMMEDIATE\]](#).

**Example**

```
HOLD
```

Interrupts the current measurement.

**Characteristics**

\*RST value: -

SCPI: conform

**Mode**

R

---

## CALCulate Subsystem

The CALCulate subsystem contains commands for converting instrument data, transforming and carrying out corrections. These functions are carried out subsequent to data acquisition, i.e. following the SENSE subsystem.

The following subsystems are included:

- "CALCulate:DELTamarker Subsystem" on page 6.7
- "CALCulate:DLINe Subsystem" on page 6.18
- "CALCulate:ESPEctrum Subsystem" on page 6.19
- "CALCulate:FLINe Subsystem" on page 6.21
- "CALCulate:LIMit Subsystem" on page 6.22
- "CALCulate:MARKer Subsystem" on page 6.47
- "CALCulate:MATH Subsystem" on page 6.100
- "CALCulate:PSEarch|PEAKsearch Subsystem" on page 6.102
- "CALCulate:STATistics Subsystem" on page 6.106
- "CALCulate:THReshold Subsystem" on page 6.111
- "CALCulate:TLINE Subsystem" on page 6.112
- "CALCulate:UNIT Subsystem" on page 6.113

### CALCulate:DELTamarker Subsystem

The CALCulate:DELTamarker subsystem controls the delta marker functions of the instrument.

#### Commands of the CALCulate:DELTamarker Subsystem

- CALCulate<1|2>:DELTamarker<1...4>[:STATe]
- CALCulate<1|2>:DELTamarker<1...4>:AOFF
- CALCulate<1|2>:DELTamarker<1...4>:FUNCTion:FIXed[:STATe]
- CALCulate<1|2>:DELTamarker<1...4>:FUNCTion:FIXed:RPOint:MAXimum[:PEAK]
- CALCulate<1|2>:DELTamarker<1...4>:FUNCTion:FIXed:RPOint:X
- CALCulate<1|2>:DELTamarker<1...4>:FUNCTion:FIXed:RPOint:Y
- CALCulate<1|2>:DELTamarker<1...4>:FUNCTion:FIXed:RPOint:Y:OFFSet
- CALCulate<1|2>:DELTamarker<1...4>:FUNCTion:PNOise[:STATe]
- CALCulate<1|2>:DELTamarker<1...4>:FUNCTion:PNOise:RESult?
- CALCulate<1|2>:DELTamarker<1...4>:MAXimum[:PEAK]
- CALCulate<1|2>:DELTamarker<1...4>:MAXimum:LEFT
- CALCulate<1|2>:DELTamarker<1...4>:MAXimum:NEXT
- CALCulate<1|2>:DELTamarker<1...4>:MAXimum:RIGHT
- CALCulate<1|2>:DELTamarker<1...4>:MINimum[:PEAK]
- CALCulate<1|2>:DELTamarker<1...4>:MINimum:LEFT
- CALCulate<1|2>:DELTamarker<1...4>:MINimum:NEXT

- CALCulate<1|2>:DELTamarker<1...4>:MINimum:RIGHT
- CALCulate<1|2>:DELTamarker<1...4>:MODE
- CALCulate<1|2>:DELTamarker<1...4>:TRACe
- CALCulate<1|2>:DELTamarker<1...4>:X
- CALCulate<1|2>:DELTamarker<1...4>:X:RELative?
- CALCulate<1|2>:DELTamarker<1...4>:Y?

---

**CALCulate<1|2>:DELTamarker<1...4>[:STATE]**

---

This command switches on and off the delta marker when delta marker 1 is selected. The corresponding marker becomes the delta marker when delta marker 2 to 4 is selected. If the corresponding marker is not activated, it will be activated and positioned on the maximum of the measurement curve.

If no numeric suffix with DELTmarker is indicated, delta marker 1 is selected automatically. The numeric suffixes <1|2> are irrelevant for this command.

**Parameter**

ON | OFF

**Example**

```
CALC:DELT3 ON
```

Switches marker 3 to delta marker mode.

**Characteristics**

RST value: OFF

SCPI: device-specific

**Mode**

all

---

---

**CALCulate<1|2>:DELTamarker<1...4>:AOFF**

---

This command switches off all active delta markers.

The numeric suffixes <1|2> are irrelevant for this command.

**Example**

```
CALC:DELT:AOFF
```

Switches off all delta markers.

**Characteristics**

RST value: –

SCPI: device-specific

**Mode**

R, A, ADEMOD

---

**CALCulate<1|2>:DELTaMarker<1...4>:FUNCTION:FIXed[:STATe]**

This command switches the relative measurement to a fixed reference value on or off. Marker 1 will be activated previously and a peak search will be performed, if necessary. If marker 1 is activated, its position becomes the reference point for the measurement. The reference point can then be modified with the `CALCulate<1|2>:DELTaMarker<1...4>:FUNCTION:FIXed:RPOint:X` commands and `CALCulate<1|2>:DELTaMarker<1...4>:FUNCTION:FIXed:RPOint:Y` independently of the position of marker 1 and of a trace. It applies to all delta markers as long as the function is active.

The numeric suffixes <1|2> are irrelevant for this command.

**Parameter**

ON | OFF

**Example**

```
CALC:DELT:FUNC:FIX ON
```

Switches on the measurement with fixed reference value for all delta markers.

```
CALC:DELT:FUNC:FIX:RPO:X 128 MHZ
```

Sets the frequency reference to 128 MHz.

```
CALC:DELT:FUNC:FIX:RPO:Y 30 DBM
```

Sets the reference level to +30 dBm.

**Characteristics**

RST value: OFF

SCPI: device-specific

**Mode**

A

**CALCulate<1|2>:DELTaMarker<1...4>:FUNCTION:FIXed:RPOint:MAXimum[:PEAK]**

This command sets the reference point level for all delta markers for a measurement with fixed reference point (`CALCulate<1|2>:DELTaMarker<1...4>:FUNCTION:FIXed[:STATe]`) to the peak of the selected trace.

For phase-noise measurements

(`CALCulate<1|2>:DELTaMarker<1...4>:FUNCTION:PNOise[:STATe]`), the command defines a new reference point level for delta marker 2.

The numeric suffixes <1|2> are irrelevant for this command.

This command is an event and therefore has no \*RST value and no query.

**Parameter**

<numeric\_value>

**Example**

```
CALC:DELT:FUNC:FIX:RPO:MAX
```

Sets the reference point level for delta markers to the peak of the selected trace.

**Characteristics**

RST value: –

SCPI: device-specific

**Mode**

A

---

**CALCulate<1|2>:DELTamarker<1...4>:FUNction:FIXed:RPOint:X**

---

This command defines a new frequency reference (span > 0) or time (span = 0) for all delta markers for a measurement with fixed reference value

(CALCulate<1|2>:DELTamarker<1...4>:FUNction:FIXed[:STATe]).

For phase-noise measurements

(CALCulate<1|2>:DELTamarker<1...4>:FUNction:PNOise[:STATe]), the command defines a new frequency reference or time for delta marker 2.

The numeric suffixes <1|2> are irrelevant for this command.

**Parameter**

<numeric\_value>

**Example**

```
CALC:DELT:FUNC:FIX:RPO:X 128MHz
```

Sets the frequency reference to 128 MHz.

**Characteristics**

RST value: – (CALCulate<1|2>:DELTamarker<1...4>:FUNction:FIXed[:STATe] is set to OFF)

SCPI: device-specific

**Mode**

A

---

**CALCulate<1|2>:DELTamarker<1...4>:FUNction:FIXed:RPOint:Y**

---

This command defines a new reference point level for all delta markers for a measurement with fixed reference point

(CALCulate<1|2>:DELTamarker<1...4>:FUNction:FIXed[:STATe]).

For phase-noise measurements

(CALCulate<1|2>:DELTamarker<1...4>:FUNction:PNOise[:STATe]), the command defines a new reference point level for delta marker 2.

The numeric suffixes <1|2> are irrelevant for this command.

**Parameter**

<numeric\_value>

**Example**

```
CALC:DELT:FUNC:FIX:RPO:Y -10dBm
```

Sets the reference point level for delta markers to –10 dBm.

**Characteristics**

RST value: – (CALCulate<1|2>:DELTamarker<1...4>:FUNction:FIXed[:STATe] is set to OFF)

SCPI: device-specific

**Mode**

A

---

**CALCulate<1|2>:DELTaMarker<1...4>:FUNCTION:FIXed:RPOint:Y:OFFSet**

This command defines an additional level offset for the measurement with fixed reference value (CALCulate:DELTaMarker:FUNCTION:FIXed:STATe ON). For this measurement, the offset is included in the display of all delta markers.

For phase-noise measurements

(CALCulate<1|2>:DELTaMarker<1...4>:FUNCTION:PNOise[:STATe]), the command defines an additional level offset which is included in the display of delta marker 2.

The numeric suffixes <1|2> are irrelevant for this command.

**Parameter**

<numeric\_value>

**Example**

```
CALC:DELT:FUNC:FIX:RPO:Y:OFFS 10dB
```

Sets the level offset for the measurement with fixed reference value or the phase-noise measurement to 10 dB.

**Characteristics**

RST value: 0 dB

SCPI: device-specific

**Mode**

A

**CALCulate<1|2>:DELTaMarker<1...4>:FUNCTION:PNOise[:STATe]**

This command switches on or off the phase-noise measurement with all active delta markers. The correction values for the bandwidth and the log amplifier are taken into account in the measurement.

Marker 1 will be activated, if necessary, and a peak search will be performed. If marker 1 is activated, its position becomes the reference point for the measurement.

The reference point can then be modified with the

CALCulate<1|2>:DELTaMarker<1...4>:FUNCTION:FIXed:RPOint:X and  
CALCulate<1|2>:DELTaMarker<1...4>:FUNCTION:FIXed:RPOint:Y commands independently of the position of marker 1 and of a trace (the same commands used for the measurement with fixed reference point).

The numeric suffixes <1|2> and <1...4> are irrelevant for this command.

**Parameter**

ON | OFF

**Example**

```
CALC:DELT:FUNC:PNO ON
```

Switches on the phase-noise measurement with all delta markers.

```
CALC:DELT:FUNC:FIX:RPO:X 128 MHZ
```

Sets the frequency reference to 128 MHz.

```
CALC:DELT:FUNC:FIX:RPO:Y 30 DBM
```

Sets the reference level to +30 dBm

**Characteristics**

RST value: OFF

SCPI: device-specific

**Mode**

A

---

**CALCulate<1|2>:DELTamarker<1...4>:FUNCtion:PNOise:RESult?**

---

This command queries the result of the phase-noise measurement. The measurement will be switched on, if necessary.

The numeric suffixes <1|2> are irrelevant for this command.

This command is only a query and therefore has no \*RST value.

**Example**

```
CALC:DELT:FUNC:PNO:RES?
```

Outputs the result of phase-noise measurement of the selected delta marker.

**Characteristics**

RST value: –

SCPI: device-specific

**Mode**

A

---

**CALCulate<1|2>:DELTamarker<1...4>:MAXimum[:PEAK]**

---

This command positions the delta marker to the current maximum value on the measured curve. If necessary, the corresponding delta marker will be activated first.

The numeric suffixes <1|2> are irrelevant for this command.

This command is an event and therefore has no \*RST value and no query.

**Example**

```
CALC:DELT3:MAX
```

Sets delta marker 3 to the maximum value of the associated trace.

**Characteristics**

RST value: –

SCPI: device-specific

**Mode**

R, A, ADEMOD



**CALCulate<1|2>:DELTamarker<1...4>:MAXimum:LEFT**

---

This command positions the delta marker to the next smaller maximum value to the left of the current value (i.e. descending X values). The corresponding delta marker will be activated first, if necessary.

The numeric suffixes <1|2> are irrelevant for this command.

This command is an event and therefore has no \*RST value and no query.

**Example**

```
CALC:DELT:MAX:LEFT
```

Sets delta marker 1 to the next smaller maximum value to the left of the current value.

**Characteristics**

RST value: –

SCPI: device-specific

**Mode**

R, A, ADEMOD

---

**CALCulate<1|2>:DELTamarker<1...4>:MAXimum:NEXT**

---

This command positions the delta marker to the next smaller maximum value on the measured curve. The corresponding delta marker will be activated first, if necessary.

The numeric suffixes <1|2> are irrelevant for this command.

This command is an event and therefore has no \*RST value and no query.

**Example**

```
CALC:DELT2:MAX:NEXT
```

Sets delta marker 2 to the next smaller maximum value.

**Characteristics**

RST value: –

SCPI: device-specific

**Mode**

R, A, ADEMOD

---

**CALCulate<1|2>:DELTamarker<1...4>:MAXimum:RIGHT**

---

This command positions the delta marker to the next smaller maximum value to the right of the current value (i.e. ascending X values). The corresponding delta marker is activated first, if necessary.

The numeric suffixes <1|2> are irrelevant for this command.

This command is an event and therefore has no \*RST value and no query.

**Example**

```
CALC:DELT:MAX:RIGH
```

Sets delta marker 1 to the next smaller maximum value to the right of the current value.

**Characteristics**

RST value: –

SCPI: device-specific

**Mode**

R, A, ADEMOD

---

**CALCulate<1|2>:DELTamarker<1...4>:MINimum[:PEAK]**

---

This command positions the delta marker to the current minimum value on the measured curve. The corresponding delta marker will be activated first, if necessary.

The numeric suffixes <1|2> are irrelevant for this command.

This command is an event and therefore has no \*RST value and no query.

**Example**

```
CALC : DELT3 : MIN
```

Sets delta marker 3 to the minimum value of the associated trace.

**Characteristics**

RST value: –

SCPI: device-specific

**Mode**

R, A, ADEMOD

---

---

**CALCulate<1|2>:DELTamarker<1...4>:MINimum:LEFT**

---

This command positions the delta marker to the next higher minimum value to the left of the current value (i.e. descending X values). The corresponding delta marker will be activated first, if necessary.

The numeric suffixes <1|2> are irrelevant for this command.

This command is an event and therefore has no \*RST value and no query.

**Example**

```
CALC : DELT : MIN : LEFT
```

Sets delta marker 1 to the next higher minimum to the left of the current value.

**Characteristics**

RST value: –

SCPI: device-specific

**Mode**

R, A, ADEMOD

---

---

**CALCulate<1|2>:DELTamarker<1...4>:MINimum:NEXT**

---

This command positions the delta marker to the next higher minimum value of the measured curve. The corresponding delta marker will be activated first, if necessary.

The numeric suffixes <1|2> are irrelevant for this command.

This command is an event and therefore has no \*RST value and no query.

**Example**

```
CALC : DELT2 : MIN : NEXT
```

Sets delta marker 2 to the next higher minimum value.

**Characteristics**

RST value: –

SCPI: device-specific

**Mode**

R, A, ADEMOD

---

**CALCulate<1|2>:DELTamarker<1...4>:MINimum:RIGHT**

---

This command positions the delta marker to the next higher minimum value to the right of the current value (i.e. ascending X values). The corresponding delta marker will be activated first, if necessary.

The numeric suffixes <1|2> are irrelevant for this command.

This command is an event and therefore has no \*RST value and no query.

**Example**

```
CALC:DELT:MIN:RIGH
```

Sets delta marker 1 to the next higher minimum value to the right of the current value.

**Characteristics**

RST value: –

SCPI: device-specific

**Mode**

R, A, ADEMOD

---

**CALCulate<1|2>:DELTamarker<1...4>:MODE**

---

This command switches between relative and absolute frequency input of the delta marker (or time with span = 0).

The numeric suffixes <1|2> are irrelevant for this command.

**Parameter**

ABSolute | RELative

**Example**

```
CALC:DELT:MODE ABS
```

Switches the frequency/time indication for all delta markers to absolute values.

```
CALC:DELT:MODE REL
```

Switches the frequency/time indication for all delta markers to relative to marker 1.

**Characteristics**

RST value: REL

SCPI: device-specific

**Mode**

all

---

**CALCulate<1|2>:DELTamarker<1...4>:TRACe**

---

This command assigns the selected delta marker to the indicated trace. The selected trace must be active, i.e. its state must be different from "BLANK".

The numeric suffixes <1|2> are irrelevant for this command.

**Parameter**

1 to 6

**Example**

```
CALC:DELT3:TRAC 2
```

Assigns delta marker 3 to trace 2.

**Characteristics**

RST value: –

SCPI: device-specific

**Mode**

R, A, ADEMOD

**CALCulate<1|2>:DELTamarker<1...4>:X**

This command positions the selected delta marker to the indicated frequency (span > 0), time (span = 0) or level (APD measurement = ON or CCDF measurement = ON). The input is in absolute values or relative to marker 1 depending on the command

`CALCulate<1|2>:DELTamarker<1...4>:MODE`. If reference fixed measurement (`CALCulate<1|2>:DELTamarker<1...4>:FUNCTION:FIXed[:STATe]` is ON) is active, relative values refer to the reference position are entered. The query always returns absolute values.

The numeric suffixes <1|2> are irrelevant for this command.

**Parameter**

0 to MAX (frequency | sweep time)

**Example**

```
CALC:DELT:MOD REL
```

Switches the input for all delta markers to relative to marker 1.

```
CALC:DELT2:X 10.7MHz
```

Positions delta marker 2 10.7 MHz to the right of marker 1.

```
CALC:DELT:X?
```

Outputs the absolute frequency/time of delta marker 1.

```
CALC:DELT:X:REL?
```

Outputs the relative frequency/time/level of delta marker 1.

**Characteristics**

RST value: –

SCPI: device-specific

**Mode**

R, A, ADEMOD

**CALCulate<1|2>:DELTamarker<1...4>:X:RELative?**

This command queries the frequency (span > 0) or time (span = 0) of the selected delta marker relative to marker 1 or to the reference position ( for

`CALCulate<1|2>:DELTamarker<1...4>:FUNCTION:FIXed[:STATe]` is ON). The command activates the corresponding delta marker, if necessary.

The numeric suffixes <1|2> are irrelevant for this command.

**Example**

```
CALC:DELT3:X:REL?
```

Outputs the frequency of delta marker 3 relative to marker 1 or relative to the reference position.

**Characteristics**

RST value: –

SCPI: device-specific

**Mode**

R, A, ADEMOD

**CALCulate<1|2>:DELTamarker<1...4>:Y?**

This command queries the measured value of the selected delta marker. The corresponding delta marker will be activated, if necessary. The output is always a relative value referred to marker 1 or to the reference position (reference fixed active).

To obtain a correct query result, a complete sweep with synchronization to the sweep end must be performed between the activation of the delta marker and the query of the y value. This is only possible in single sweep mode.

In receiver mode, the markers can only be activated after a scan was carried out.

Depending on the unit defined with `CALCulate<1|2>:UNIT:POWer` or on the activated measuring functions, the query result is output in the units below:

Parameter or measuring functions	Output unit
DBM   DBPW   DBUV   DBMV   DBUA	dB (lin/log)
WATT   VOLT   AMPere	dB (lin), % (log)
statistics function (APD or CCDF) on	dimensionless output

The numeric suffixes <1|2> are irrelevant for this command.

**Example**

```
INIT:CONT OFF
```

Switches to single sweep mode.

```
CALC:DELT2 ON
```

Switches on delta marker 2.

```
INIT;*WAI
```

Starts a sweep and waits for its end.

```
CALC:DELT2:Y?
```

Outputs measurement value of delta marker 2.

**Characteristics**

RST value: –

SCPI: device-specific

**Mode**

R, A, ADEMOD

**CALCulate:DLINe Subsystem**

The CALCulate:DLINe subsystem defines the position of the display lines.

**Commands of the CALCulate:DLINe Subsystem**

- CALCulate<1|2>:DLINe<1|2>
- CALCulate<1|2>:DLINe<1|2>:STATe

**CALCulate<1|2>:DLINe<1|2>**

---

This command defines the position of display line 1 or 2. These lines enable the user to mark any levels in the diagram. The unit depends on the setting made with [CALCulate<1|2>:UNIT:POWer](#).

The numeric suffixes <1|2> at CALCulate are irrelevant for this command.

**Parameter**

MINimum to MAXimum (depending on current unit)

**Example**

```
CALC:DLIN -20dBm
```

**Characteristics**

\*RST value: – (STATe to OFF)

SCPI: device-specific

**Mode**

R, A

---

**CALCulate<1|2>:DLINe<1|2>:STATe**

---

This command switches display line 1 or 2 (level lines) on or off.

The numeric suffixes <1|2> are irrelevant for this command.

**Parameter**

ON | OFF

**Example**

```
CALC:DLIN2:STAT OFF
```

**Characteristics**

\*RST value: OFF

SCPI: device-specific

**Mode**

R, A

---

**CALCulate:ESpectrum Subsystem**

The CALCulate:ESpectrum subsystem contains the remote commands for Spectrum Emission Mask (SEM) measurements. Both groups of commands (PSEarch and PEAKsearch) perform the same functions.

**Commands of the CALCulate:ESpectrum Subsystem**

- [CALCulate<1|2>:ESpectrum:PSEarch|PEAKsearch:AUTO](#)
- [CALCulate<1|2>:ESpectrum:PSEarch|PEAKsearch:MARGIN](#)
- [CALCulate<1|2>:ESpectrum:PSEarch|PEAKsearch:PSHOW](#)

**CALCulate<1|2>:ESpectrum:PSEarch|PEAKsearch:AUTO**

---

This command activates or deactivates the list evaluation.  
The numeric suffixes <1|2> are not relevant.

**Parameter**

ON | OFF

**Example**

```
CALC:ESP:PSE:AUTO OFF
```

Deactivates the list evaluation.

**Characteristics**

RST value: ON

SCPI: device-specific

**Mode**

A

---

**CALCulate<1|2>:ESpectrum:PSEarch|PEAKsearch:MARGIN**

---

This command sets the margin used for the limit check/peak search.  
The numeric suffixes <1|2> are not relevant.

**Parameter**

–200 to 200 dB

**Example**

```
CALC:ESP:PSE:MARG 100
```

Sets the margin to 100 dB.

**Characteristics**

RST value: 200 dB

SCPI: device-specific

**Mode**

A

---

**CALCulate<1|2>:ESPectrum:PSEarch|:PEAKsearch:PSHow**

---

This command marks all peaks with blue squares in the diagram.  
The numeric suffixes <1|2> are not relevant.

**Parameter**

ON | OFF

**Example**

```
CALC:ESP:PSE:PSH ON
```

Marks all peaks with blue squares.

**Characteristics**

RST value: OFF

SCPI: device-specific

**Mode**

A

---



**CALCulate:FLINe Subsystem**

The CALCulate:FLINe subsystem defines the position of the frequency lines.

**Commands of the CALCulate:FLINe Subsystem**

- CALCulate<1|2>:FLINe<1|2>
- CALCulate<1|2>:FLINe<1|2>:STATe

**CALCulate<1|2>:FLINe<1|2>**

---

This command defines the position of the frequency lines that mark the frequencies.  
The numeric suffixes <1|2> are irrelevant for this command.

**Parameter**

0 to  $f_{\max}$

**Example**

```
CALC:FLIN2 120MHz
```

**Characteristics**

\*RST value: – (STATe to OFF)

SCPI: device-specific

**Mode**

R, A-F

---

**CALCulate<1|2>:FLINe<1|2>:STATe**

---

This command switches the frequency line on or off.  
The numeric suffixes <1|2> are irrelevant for this command.

**Parameter**

ON | OFF

**Example**

```
CALC:FLIN2:STAT ON
```

**Characteristics**

\*RST value: OFF

SCPI: device-specific

**Mode**

R, A-F

---

## CALCulate:LIMit Subsystem

The CALCulate:LIMit subsystem contains commands for the limit lines and the corresponding limit checks. Limit lines can be defined as upper or lower limit lines. The individual Y values of the limit lines correspond to the values of the x-axis (CONTRol). The number of X and Y values must be identical. For details on limit lines refer to chapter "Instrument Functions", section "Using Limit Lines and Display Lines – LINES Key".

The following subsystems are included:

- "CALCulate:LIMit:ACPower Subsystem" on page 6.28
- "CALCulate:LIMit:CONTRol Subsystem" on page 6.36
- "CALCulate:LIMit:LOWer Subsystem" on page 6.39
- "CALCulate:LIMit:UPPer Subsystem" on page 6.43

### Commands of the CALCulate:LIMit Subsystem

- CALCulate<1|2>:LIMit<1...8>:ACTive?
- CALCulate<1|2>:LIMit<1...8>:CLEar[:IMMEDIATE]
- CALCulate<1|2>:LIMit<1...8>:COMMeNT
- CALCulate<1|2>:LIMit<1...8>:COpy
- CALCulate<1|2>:LIMit<1...8>:DELeTE
- CALCulate<1|2>:LIMit<1...8>:FAIL?
- CALCulate<1|2>:LIMit<1...8>:NAME
- CALCulate<1|2>:LIMit<1...8>:STATe
- CALCulate<1|2>:LIMit<1...8>:TRACe
- CALCulate<1|2>:LIMit<1...8>:UNIT

### Further information

- Example (analyzer mode)
- Definition of the limit line
- Switching on and evaluating the line

### Example (analyzer mode)

Definition and use of a new limit line 5 for trace 2 with the following features:

- upper limit line
- absolute x-axis with span > 0.
- 5 ref. values: 126 MHz/–40 dB, 127 MHz/–40 dB, 128 MHz/–20 dB, 129 MHz/–40 dB, 130 MHz/–40 dB
- relative y-axis with unit dB
- absolute threshold value at –35 dBm
- no safety margin

**Definition of the limit line**

1. Defining the name:

```
CALC:LIM5:NAME 'TEST1'
```

2. Entering the comment:

```
CALC:LIM5:COMM 'Upper limit line'
```

3. Associated trace:

```
CALC:LIM5:TRAC 2
```

4. Defining the x-axis range:

```
CALC:LIM5:CONT:DOM FREQ
```

5. Defining the x-axis scaling:

```
CALC:LIM5:CONT:MODE ABS
```

6. Defining the y-axis unit:

```
CALC:LIM5:UNIT DB
```

7. Defining the y-axis scaling:

```
CALC:LIM5:UPP:MODE REL
```

8. Defining the x-axis values:

```
CALC:LIM5:CONT 126MHZ, 127MHZ, 128MHZ, 129 MHZ, 130MHZ
```

9. Defining the y values:

```
CALC:LIM5:UPP -40, -40, -30, -40, -40
```

10. Defining the y threshold value:

```
CALC:LIM5:UPP:THR -35DBM
```

The definition of the safety margin and shifting in X and/or Y direction can take place as from here (see commands below).

**Switching on and evaluating the line**

1. Switching on the line:

```
CALC:LIM5:UPP:STAT ON
```

2. Switching on the limit check:

```
CALC:LIM5:STAT ON
```

3. Starting a new measurement with synchronization:

```
INIT;*WAI
```

4. Querying the limit check result:

```
CALC:LIM5:FAIL?
```

---

**CALCulate<1|2>:LIMit<1...8>:ACTive?**

---

This command queries the names of all active limit lines.

The numeric suffixes <1|2> and <1...8> are irrelevant for this command.

This command is only a query and therefore has no \*RST value.

**Example**

```
CALC:LIM:ACT?
```

Queries the names of all active limit lines.

**Return values**

```
'3GBAA,3GBBA,3GBCR'
```

Returns the names of the active limit lines in alphabetical order, separated by commas.

**Characteristics**

RST value: –

SCPI: device-specific

**Mode**

R, A

---

---

**CALCulate<1|2>:LIMit<1...8>:CLEar[:IMMediate]**

---

This command deletes the result of the current limit check for all limit lines.

The numeric suffixes <1|2> and <1...8> are irrelevant for this command.

This command is an event and therefore has no \*RST value.

**Example**

```
CALC:LIM:CLE
```

Deletes the result of the limit check.

**Characteristics**

\*RST value: –

SCPI: conform

**Mode**

A, ADEMOD, NF

---

---

**CALCulate<1|2>:LIMit<1...8>:COMMent**

---

This command defines a comment for the limit line selected (max. 40 characters).

The numeric suffixes <1|2> are irrelevant for this command.

**Parameter**

<string>, max. 40 alphanumeric characters

**Example**

```
CALC:LIM5:COMM 'Upper limit for spectrum'
```

Defines the comment for limit line 5.

**Characteristics**

\*RST value: blank comment

SCPI: device-specific

**Mode**

R, A, ADEMOD, NF

---

**CALCulate<1|2>:LIMit<1...8>:COPY**

---

This command copies one limit line onto another one  
The numeric suffixes <1|2> are irrelevant for this command.  
This command is an event and therefore has no \*RST value and no query.

**Parameter**

1 to 8        number of the new limit line  
<name>      name of the new limit line given as a string

**Example**

```
CALC:LIM1:COPY 2  
Copies limit line 1 to line 2.  
CALC:LIM1:COPY 'FM2'  
Copies limit line 1 to a new line named FM2.
```

**Characteristics**

\*RST value: –  
SCPI: device-specific

**Mode**

R, A, ADEMOD, NF

---

**CALCulate<1|2>:LIMit<1...8>:DELeTe**

---

This command deletes the selected limit line.  
The numeric suffixes <1|2> are irrelevant for this command.  
This command is an event and therefore has no \*RST value and no query.

**Example**

```
CALC:LIM1:DEL  
Deletes limit line 1.
```

**Characteristics**

\*RST value: –  
SCPI: device-specific

**Mode**

R, A, ADEMOD, NF

---

**CALCulate<1|2>:LIMit<1...8>:FAIL?**

---

This command queries the result of the limit check of the indicated limit line. It should be noted that a complete sweep must have been performed to obtain a correct result. A synchronization with \*OPC, \*OPC? or \*WAI should therefore be provided. The result of the limit check is given with 0 for PASS, 1 for FAIL, and 2 for MARGIN.

The numeric suffixes <1|2> are irrelevant for this command.

**Return values**

0 for pass, 1 for fail

**Example**

```
INIT; *WAI
```

Starts a new sweep and waits for its end.

```
CALC:LIM3:FAIL?
```

Queries the result of the check for limit line 3.

**Characteristics**

\*RST value: –

SCPI: conform

**Mode**

R, A, ADEMOD, NF

---

**CALCulate<1|2>:LIMit<1...8>:NAME**

This command assigns a name to a limit line numbered 1 to 8. If it does not exist already, a limit line with this name is created.

The numeric suffixes <1|2> are irrelevant for this command.

**Parameter**

<name of limit line>

**Example**

```
CALC:LIM1:NAME 'FM1'
```

Assigns the name FM1 to limit line 1.

**Characteristics**

\*RST value: REM1 to REM8 for lines 1 to 8

SCPI: device-specific

**Mode**

R, A, ADEMOD

---

**CALCulate<1|2>:LIMit<1...8>:STATe**

This command switches on or off the limit check for the selected limit line.

The result of the limit check can be queried with [CALCulate<1|2>:LIMit<1...8>:FAIL?](#).

The numeric suffixes <1|2> are irrelevant for this command.

**Parameter**

ON | OFF

**Example**

```
CALC:LIM:STAT ON
```

Switches on the limit check for limit line 1.

**Characteristics**

\*RST value: OFF

SCPI: conform

**Mode**

R, A, ADEMOD, NF

---

---

**CALCulate<1|2>:LIMit<1...8>:TRACe**

---

This command assigns a limit line to a trace.  
The numeric suffixes <1|2> are irrelevant for this command.

**Parameter**

1 to 6

**Example**

```
CALC:LIM2:TRAC 3
```

Assigns limit line 2 to trace 3.

**Characteristics**

\*RST value: 1

SCPI: device-specific

**Mode**

R, A, ADEMOD

---

**CALCulate<1|2>:LIMit<1...8>:UNIT**

---

This command defines the unit of the selected limit line.  
Upon selection of the unit DB the limit line is automatically switched to the relative mode. For units different from DB the limit line is automatically switched to absolute mode.  
The units DEG, RAD, S, HZ, PCT are not available in spectrum analyzer mode.  
The numeric suffixes <1|2> are irrelevant for this command.

**Parameter**

DBM | DB | DBPW | W | DBMV | DBMV\_MHZ | DBUV | DBUV\_MHZ | DBMV\_M | DBMV\_MMHZ  
| V | DBUA | DBUA\_MHZ | DBUA\_M | DBUA\_MMHZ | AMPere | PCT | HZ | DEG | RAD | dBpT

**Example**

```
CALC:LIM4:UNIT DBUV
```

Sets the unit of limit line 4 to dB $\mu$ V.

**Characteristics**

\*RST value: DBM

SCPI: device-specific

**Mode**

R, A, ADEMOD

---

**CALCulate:LIMit:ACPower Subsystem**

The CALCulate:LIMit:ACPower subsystem defines the limit check for adjacent channel power measurement.

**Commands of the CALCulate:LIMit:ACPower Subsystem**

- CALCulate<1|2>:LIMit<1...8>:ACPower[:STATe]
- CALCulate<1|2>:LIMit<1...8>:ACPower:ACHannel[:RELative]
- CALCulate<1|2>:LIMit<1...8>:ACPower:ACHannel[:RELative]:STATe
- CALCulate<1|2>:LIMit<1...8>:ACPower:ACHannel:ABSolute
- CALCulate<1|2>:LIMit<1...8>:ACPower:ACHannel:ABSolute:STATe
- CALCulate<1|2>:LIMit<1...8>:ACPower:ACHannel:RESult?
- CALCulate<1|2>:LIMit<1...8>:ACPower:ALternate<1...11>[:RELative]
- CALCulate<1|2>:LIMit<1...8>:ACPower:ALternate<1...11>[:RELative]:STATe
- CALCulate<1|2>:LIMit<1...8>:ACPower:ALternate<1...11>:ABSolute
- CALCulate<1|2>:LIMit<1...8>:ACPower:ALternate<1...11>:ABSolute:STATe
- CALCulate<1|2>:LIMit<1...8>:ACPower:ALternate<1...11>:RESult?

**CALCulate<1|2>:LIMit<1...8>:ACPower[:STATe]**

This command switches on and off the limit check for adjacent-channel power measurements. The `CALCulate<1|2>:LIMit<1...8>:ACPower:ACHannel[:RELative]:STATe` or `CALCulate<1|2>:LIMit<1...8>:ACPower:ALternate<1...11>[:RELative]:STATe` commands must be used in addition to specify whether the limit check is to be performed for the upper/lower adjacent channel or for the alternate adjacent channels. The numeric suffixes <1|2> and <1...8> are irrelevant for this command.

**Parameter**

ON | OFF

**Example**

```
CALC:LIM:ACP ON
Switches on the ACP limit check.
```

**Characteristics**

\*RST value: OFF  
SCPI: device-specific

**Mode**

A



**CALCulate<1|2>:LIMit<1...8>:ACPowEr:ACHannel[:RELative]**

This command defines the relative limit of the upper/lower adjacent channel for adjacent-channel power measurements. The reference value for the relative limit value is the measured channel power.

It should be noted that the relative limit value has no effect on the limit check as soon as it is below the absolute limit value defined with the `CALCulate<1|2>:LIMit<1...8>:ACPowEr:ACHannel:ABSolute` command. This mechanism allows automatic checking of the absolute basic values of adjacent-channel power as defined in mobile radio standards.

The numeric suffixes <1|2> and <1...8> are irrelevant for this command.

**Parameter**

first value: 0 to 100dB; limit for the upper (lower) adjacent channel

second value: 0 to 100dB; is ignored but must be indicated for reasons of compatibility with the FSP family

**Example**

```
CALC:LIM:ACP:ACH 30DB, 30DB
```

Sets the relative limit value for the power in the lower and upper adjacent channel to 30 dB below the channel power.

**Characteristics**

\*RST value: 0 dB

SCPI: device-specific

**Mode**

A

**CALCulate<1|2>:LIMit<1...8>:ACPowEr:ACHannel[:RELative]:STATe**

This command activates the limit check for the relative limit value of the adjacent channel when adjacent-channel power measurement is performed. Before the command, the limit check must be activated using `CALCulate<1|2>:LIMit<1...8>:ACPowEr[:STATe]`.

The result can be queried with

`CALCulate<1|2>:LIMit<1...8>:ACPowEr:ACHannel:RESult?`. It should be noted that a complete measurement must be performed between switching on the limit check and the result query, since otherwise no correct results are available.

The numeric suffixes <1|2> and <1...8> are irrelevant for this command.

**Parameter**

ON | OFF

**Example**

```
CALC:LIM:ACP:ACH 30DB, 30DB
```

Sets the relative limit value for the power in the lower and upper adjacent channel to 30 dB below the channel power.

```
CALC:LIM:ACP:ACH:ABS -35DBM, -35DBM
```

Sets the absolute limit value for the power in the lower and upper adjacent channel to -35 dBm.

```
CALC:LIM:ACP ON
```

Switches on globally the limit check for the channel/adjacent channel measurement.

```
CALC:LIM:ACP:ACH:STAT ON
```

Switches on the check of the relative limit values for adjacent channels.

```
CALC:LIM:ACP:ACH:ABS:STAT ON
```

Switches on the check of absolute limit values for the adjacent channels.

INIT; \*WAI

Starts a new measurement and waits for the sweep end.

CALC:LIM:ACP:ACH:RES?

Queries the limit check result in the adjacent channels.

#### Characteristics

\*RST value: OFF

SCPI: device-specific

#### Mode

A

### CALCulate<1|2>:LIMit<1...8>:ACPpower:ACHannel:ABSolute

This command defines the absolute limit value for the lower/upper adjacent channel during adjacent-channel power measurement (Adjacent Channel Power).

It should be noted that the absolute limit value has no effect on the limit check as soon as it is below the relative limit value defined with

`CALCulate<1|2>:LIMit<1...8>:ACPpower:ACHannel[:RELative]`. This mechanism allows automatic checking of the absolute basic values of adjacent-channel power as defined in mobile radio standards.

The numeric suffixes <1|2> and <1...8> are irrelevant for this command.

#### Parameter

first value: –200DBM to 200DBM; limit for the lower and the upper adjacent channel

second value: –200 to 200DBM; is ignored but must be indicated for reasons of compatibility with the FSP family

#### Example

CALC:LIM:ACP:ACH:ABS -35DBM, -35DBM

Sets the absolute limit value for the power in the lower and upper adjacent channel to –35 dBm.

#### Characteristics

\*RST value: –200DBM

SCPI: device-specific

#### Mode

A

### CALCulate<1|2>:LIMit<1...8>:ACPpower:ACHannel:ABSolute:STATe

This command activates the limit check for the adjacent channel when adjacent-channel power measurement (Adjacent Channel Power) is performed. Before the command, the limit check for the channel/adjacent-channel measurement must be globally switched on using

`CALCulate<1|2>:LIMit<1...8>:ACPpower[:STATe]`.

The result can be queried with

`CALCulate<1|2>:LIMit<1...8>:ACPpower:ACHannel:RESult?`. It should be noted that a complete measurement must be performed between switching on the limit check and the result query, since otherwise no correct results are available.

The numeric suffixes <1|2> and <1...8> are irrelevant for this command.

#### Parameter

ON | OFF

**Example**

```
CALC:LIM:ACP:ACH 30DB, 30DB
```

Sets the relative limit value for the power in the lower and upper adjacent channel to 30 dB below the channel power.

```
CALC:LIM:ACP:ACH:ABS -35DBM, -35DBM
```

Sets the absolute limit value for the power in the lower and upper adjacent channel to –35 dBm.

```
CALC:LIM:ACP ON
```

Switches on globally the limit check for the channel/adjacent–channel measurement.

```
CALC:LIM:ACP:ACH:REL:STAT ON
```

Switches on the check of the relative limit values for adjacent channels.

```
CALC:LIM:ACP:ACH:ABS:STAT ON
```

Switches on the check of absolute limit values for the adjacent channels.

```
INIT;*WAI
```

Starts a new measurement and waits for the sweep end.

```
CALC:LIM:ACP:ACH:RES?
```

Queries the limit check result in the adjacent channels.

**Characteristics**

\*RST value: OFF

SCPI: device–specific

**Mode**

A

**CALCulate<1|2>:LIMit<1...8>:ACPpower:ACHannel:RESult?**

This command queries the result of the limit check for the upper/lower adjacent channel when adjacent channel power measurement is performed.

If the power measurement of the adjacent channel is switched off, the command produces a query error.

The numeric suffixes <1|2> and <1...8> are irrelevant for this command.

This command is a query and therefore has no \*RST value.

**Parameter**

The result is returned in the form <result>, <result> where <result> = PASSED | FAILED, and where the first returned value denotes the lower, the second denotes the upper adjacent channel.

**Example**

```
CALC:LIM:ACP:ACH 30DB, 30DB
```

Sets the relative limit value for the power in the lower and upper adjacent channel to 30 dB below the channel power.

```
CALC:LIM:ACP:ACH:ABS -35DBM, -35DBM
```

Sets the absolute limit value for the power in the lower and upper adjacent channel to –35 dB.

```
CALC:LIM:ACP ON
```

Switches on globally the limit check for the channel/adjacent channel measurement.

```
CALC:LIM:ACP:ACH:STAT ON
```

Switches on the limit check for the adjacent channels.

```
INIT;*WAI
```

Starts a new measurement and waits for the sweep end.

```
CALC:LIM:ACP:ACH:RES?
```

Queries the limit check result in the adjacent channels.

**Characteristics**

\*RST value: –

SCPI: device-specific

**Mode**

A

**CALCulate<1|2>:LIMit<1...8>:ACPpower:ALTernate<1...11>[:RELative]**

This command defines the limit for the alternate adjacent channels for adjacent channel power measurements. The reference value for the relative limit value is the measured channel power.

The numeric suffix after `ALTernate` denotes the alternate channel. The numeric suffixes `<1|2>` with `CALCulate` and `<1...8>` with `LIMit` are irrelevant for this command.

It should be noted that the relative limit value has no effect on the limit check as soon as it is below the absolute limit defined with

`CALCulate<1|2>:LIMit<1...8>:ACPpower:ALTernate<1...11>:ABSolute`. This mechanism allows automatic checking of the absolute basic values of adjacent-channel power as defined in mobile radio standards.

**Parameter**

first value: 0 to 100dB; limit for the lower and the upper alternate adjacent channel

second value: 0 to 100dB; is ignored but must be indicated for reasons of compatibility with the FSP family

**Example**

```
CALC:LIM:ACP:ALT2 30DB, 30DB
```

Sets the relative limit value for the power in the lower and upper second alternate adjacent channel to 30 dB below the channel power.

**Characteristics**

\*RST value: 0 DB

SCPI: device-specific

**Mode**

A

**CALCulate<1|2>:LIMit<1...8>:ACPpower:ALTernate<1...11>[:RELative]:STATe**

This command activates the limit check for the alternate adjacent channels for adjacent channel power measurements. Before the command, the limit check must be activated using

`CALCulate<1|2>:LIMit<1...8>:ACPpower[:STATe]`.

The numeric suffix after `ALTernate` denotes the alternate channel. The numeric suffixes `<1|2>` with `CALCulate` and `<1...8>` with `LIMit` are irrelevant for this command.

The result can be queried with

`CALCulate<1|2>:LIMit<1...8>:ACPpower:ALTernate<1...11>:RESult?`. It should be noted that a complete measurement must be performed between switching on the limit check and the result query, since otherwise no correct results are obtained.

**Parameter**

ON | OFF

**Example**

```
CALC:LIM:ACP:ALT2 30DB, 30DB
```

Sets the relative limit value for the power in the lower and upper second alternate adjacent channel to 30 dB below the channel power.

```
CALC:LIM:ACP:ALT2:ABS -35DBM, -35DBM
```

Sets the absolute limit value for the power in the lower and upper second alternate adjacent channel to -35 dBm.

```
CALC:LIM:ACP ON
```

Switches on globally the limit check for the channel/adjacent channel measurement.

```
CALC:LIM:ACP:ALT2:STAT ON
```

Switches on the check of the relative limit values for the lower and upper second alternate adjacent channel.

```
CALC:LIM:ACP:ALT2:ABS:STAT ON
```

Switches on the check of absolute limit values for the lower and upper second alternate adjacent channel.

```
INIT;*WAI
```

Starts a new measurement and waits for the sweep end.

```
CALC:LIM:ACP:ALT2:RES?
```

Queries the limit check result in the second alternate adjacent channels.

### Characteristics

\*RST value: OFF

SCPI: device-specific

### Mode

A

## CALCulate<1|2>:LIMit<1...8>:ACPpower:ALTernate<1...11>:ABSolute

This command defines the absolute limit value for the lower/upper alternate adjacent-channel power measurement (Adjacent Channel Power).

The numeric suffix after `ALTernate` denotes the alternate channel. The numeric suffixes `<1|2>` with `CALCulate` and `<1...8>` with `LIMit` are irrelevant for this command.

It should be noted that the absolute limit value for the limit check has no effect as soon as it is below the relative limit value defined with

`CALCulate<1|2>:LIMit<1...8>:ACPpower:ALTernate<1...11>[:RELative]`. This mechanism allows automatic checking of the absolute basic values defined in mobile radio standards for the power in adjacent channels.

### Parameter

first value: -200DBM to 200DBM; limit for the lower and the upper alternate adjacent channel

second value: -200DBM to 200DBM; is ignored but must be indicated for reasons of compatibility with the FSP family

### Example

```
CALC:LIM:ACP:ALT2:ABS -35DBM, -35DBM
```

Sets the absolute limit value for the power in the lower and upper second alternate adjacent channel to -35 dBm.

### Characteristics

\*RST value: -200DBM

SCPI: device-specific

### Mode

A

**CALCulate<1|2>:LIMit<1..8>:ACPoweR:ALTErnate<1..11>:ABSolute:STATe**

This command activates the limit check for the alternate adjacent channels for adjacent-channel power measurement (Adjacent Channel Power).

Before the command, the limit check must be globally switched on for the channel/adjacent-channel power with the `CALCulate<1|2>:LIMit<1..8>:ACPoweR[:STATe]` command.

The numeric suffix after `ALTErnate` denotes the alternate channel. The numeric suffixes `<1|2>` with `CALCulate` and `<1..8>` with `LIMit` are irrelevant for this command.

The result can be queried with

`CALCulate<1|2>:LIMit<1..8>:ACPoweR:ALTErnate<1..11>:RESult?`. It should be noted that a complete measurement must be performed between switching on the limit check and the result query, since otherwise no correct results are available.

**Parameter**

ON | OFF

**Example**

```
CALC:LIM:ACP:ALT2 30DB, 30DB
```

Sets the relative limit value for the power in the lower and upper second alternate adjacent channel to 30 dB below the channel power.

```
CALC:LIM:ACP:ALT2:ABS -35DBM, -35DBM
```

Sets the absolute limit value for the power in the lower and upper second alternate adjacent channel to -35 dBm.

```
CALC:LIM:ACP ON
```

Switches on globally the limit check for the channel/adjacent channel measurement.

```
CALC:LIM:ACP:ALT2:STAT ON
```

Switches on the check of the relative limit values for the lower and upper second alternative adjacent channels.

```
CALC:LIM:ACP:ALT2:ABS:STAT ON
```

Switches on the check of absolute limit values for the lower and upper second alternative adjacent channels.

```
INIT;*WAI
```

Starts a new measurement and waits for the sweep end.

```
CALC:LIM:ACP:ALT2:RES?
```

Queries the limit check result in the second alternate adjacent channels.

**Characteristics**

\*RST value: OFF

SCPI: device-specific

**Mode**

A

**CALCulate<1|2>:LIMit<1...8>:ACPpower:ALTernate<1...11>:RESult?**

---

This command queries the result of the limit check for the alternate adjacent channels for adjacent channel power measurements.

The numeric suffix after *ALTernate* denotes the alternate channel. The numeric suffixes <1|2> with *CALCulate* and <1...8> with *LIMit* are irrelevant for this command.

If the power measurement of the adjacent channel is switched off, the command produces a query error.

This command is a query and therefore has no \*RST value.

**Parameter**

The result is returned in the form <result>, <result> where <result> = PASSED | FAILED and where the first (second) returned value denotes the lower (upper) alternate adjacent channel.

**Example**

```
CALC:LIM:ACP:ALT2 30DB, 30DB
```

Sets the relative limit value for the power in the lower and upper second alternate adjacent channel to 30 dB below the channel power.

```
CALC:LIM:ACP:ALT2:ABS -35DBM, -35DBM
```

Sets the absolute limit value for the power in the lower and upper second alternate adjacent channel to -35 dBm.

```
CALC:LIM:ACP ON
```

Switches on globally the limit check for the channel/adjacent channel measurement.

```
CALC:LIM:ACP:ALT2:STAT ON
```

Switches on the limit check for the lower and upper second adjacent channel.

```
INIT;*WAI
```

Starts a new measurement and waits for the sweep end.

```
CALC:LIM:ACP:ALT2:RES?
```

Queries the limit check result in the second alternate adjacent channels.

**Characteristics**

\*RST value: –

SCPI: device-specific

**Mode**

A

---

**CALCulate:LIMit:CONTrol Subsystem**

The CALCulate:LIMit:CONTrol subsystem defines the x-axis (CONTrol axis).

**Commands of the CALCulate:LIMit:CONTrol Subsystem**

- CALCulate<1|2>:LIMit<1...8>:CONTrol[:DATA]
- CALCulate<1|2>:LIMit<1...8>:CONTrol:DOMain
- CALCulate<1|2>:LIMit<1...8>:CONTrol:MODE
- CALCulate<1|2>:LIMit<1...8>:CONTrol:OFFSet
- CALCulate<1|2>:LIMit<1...8>:CONTrol:SHIFt
- CALCulate<1|2>:LIMit<1...8>:CONTrol:SPACing

**CALCulate<1|2>:LIMit<1...8>:CONTrol[:DATA]**

This command defines the x-axis values (frequencies or times) of the upper or lower limit lines. The number of values for the CONTrol axis and for the corresponding UPPer and/or LOWEr limit lines has to be identical. Otherwise default values are entered for missing values or not required values are deleted.

In analyzer mode, the unit of values depends on the span setting of the x-axis. For details refer to [CALCulate<1|2>:LIMit<1...8>:CONTrol:DOMain](#).

The numeric suffixes <1|2> are irrelevant for this command.

**Parameter**

<numeric\_value>,<numeric\_value>

**Example**

```
CALC:LIM2:CONT 1MHz,30MHz,100MHz,300MHz,1GHz
```

Defines 5 reference values for the x-axis of limit line 2.

```
CALC:LIM2:CONT?
```

Outputs the reference values for the x-axis of limit line 2 separated by a comma.

**Characteristics**

\*RST value: – ([CALCulate<1|2>:LIMit<1...8>:STATe](#) is set to OFF)

SCPI: conform

**Mode**

R, A, ADEMOD, NF

**CALCulate<1|2>:LIMit<1...8>:CONTrol:DOMain**

This command defines the span setting for the x-axis values.

The numeric suffixes <1|2> are irrelevant for this command.

**Parameter**

FREQuency | TIME

**Example**

```
CALC:LIM2:CONT:DOM TIME
```

Defines zero span for the x-axis of limit line 2.



**Characteristics**

\*RST value: FREQuency  
SCPI: device-specific

**Mode**

R, A, ADEMOD

---

**CALCulate<1|2>:LIMit<1...8>:CONTrol:MODE**

---

This command selects the relative or absolute scaling for the x-axis of the selected limit line. The numeric suffixes <1|2> are irrelevant for this command.

**Parameter**

RELative | ABSolute

**Example**

```
CALC:LIM2:CONT:MODE REL
```

Defines the x-axis of limit line 2 as relatively scaled.

**Characteristics**

\*RST value: ABSolute  
SCPI: device-specific

**Mode**

R, A, ADEMOD

---

**CALCulate<1|2>:LIMit<1...8>:CONTrol:OFFSet**

---

This command defines an offset for the x-axis value of the selected relative limit line for span > 0 or zero span.

In analyzer mode, the unit of values depends on the span setting of the x-axis. For details refer to [CALCulate<1|2>:LIMit<1...8>:CONTrol:DOMain](#).

The numeric suffixes <1|2> are irrelevant for this command.

**Parameter**

<numeric\_value>

**Example**

```
CALC:LIM2:CONT:OFFS 100us
```

Sets the X offset for limit line 2 (defined in zero span) to 100µs.

**Characteristics**

\*RST value: 0  
SCPI: device-specific

**Mode**

R, A, ADEMOD

---

---

**CALCulate<1|2>:LIMit<1...8>:CONTRol:SHIFt**

---

This command moves a limit line by the indicated value in x direction. In contrast to `CALCulate<1|2>:LIMit<1...8>:CONTRol:OFFSet`, the line is shifted by modifying the individual x values and not by means of an additive offset.

In analyzer mode, the unit of values depends on the span setting of the x-axis. For details refer to `CALCulate<1|2>:LIMit<1...8>:CONTRol:DOMain`.

The numeric suffixes <1|2> are irrelevant for this command.

This command is an event and therefore has no \*RST value and no query.

**Parameter**

<numeric\_value>

**Example**

```
CALC:LIM2:CONT:SHIF 50KHZ
```

Shifts all reference values of limit line 2 by 50 kHz.

**Characteristics**

\*RST value: –

SCPI: device-specific

**Mode**

R, A, ADEMOD, NF

---

**CALCulate<1|2>:LIMit<1...8>:CONTRol:SPACing**

---

This command selects linear or logarithmic interpolation for the calculation of limit lines from frequency points.

The numeric suffixes <1|2> are irrelevant for this command.

**Parameter**

LINear | LOGarithmic

**Example**

```
CALC:LIM:CONT:SPAC LIN
```

**Characteristics**

\*RST value: LIN

SCPI: device-specific

**Mode**

R, A

---

**CALCulate:LIMit:LOWer Subsystem**

The CALCulate:LIMit:LOWer subsystem defines the lower limit line.

**Commands of the CALCulate:LIMit:LOWer Subsystem**

- CALCulate<1|2>:LIMit<1...8>:LOWer[:DATA]
- CALCulate<1|2>:LIMit<1...8>:LOWer:STATe
- CALCulate<1|2>:LIMit<1...8>:LOWer:OFFSet
- CALCulate<1|2>:LIMit<1...8>:LOWer:MARGIn
- CALCulate<1|2>:LIMit<1...8>:LOWer:MODE
- CALCulate<1|2>:LIMit<1...8>:LOWer:SHIFt
- CALCulate<1|2>:LIMit<1...8>:LOWer:SPACIng
- CALCulate<1|2>:LIMit<1...8>:LOWer:THReshold

**CALCulate<1|2>:LIMit<1...8>:LOWer[:DATA]**

This command defines the values for the selected lower limit line.

The number of values for the CONTrol axis and for the corresponding LOWer limit line has to be identical. Otherwise default values are entered for missing values or not necessary values are deleted.

The unit must be identical with the unit selected by CALCulate<1|2>:LIMit<1...8>:UNIT. If no unit is indicated, the unit defined with CALCulate<1|2>:LIMit<1...8>:UNIT is automatically used.

If the measured values are smaller than the LOWer limit line, the limit check signals errors.

The units DEG, RAD, S, HZ, PCT are not available in the spectrum analyzer mode.

The numeric suffixes <1|2> are irrelevant for this command.

**Parameter**

<numeric\_value>,<numeric\_value>

**Example**

```
CALC:LIM2:LOW -30,-40,-10,-40,-30
```

Defines 5 lower limit values for limit line 2 in the preset unit.

```
CALC:LIM2:LOW?
```

Outputs the lower limit values of limit line 2 separated by a comma.

**Characteristics**

\*RST value: – (LIMit:STATe is set to OFF)

SCPI: conform

**Mode**

R, A, ADEMOD, NF

---

**CALCulate<1|2>:LIMit<1...8>:LOWer:STATe**

---

This command switches on or off the indicated limit line. The limit check is activated separately with `CALCulate<1|2>:LIMit<1...8>:STATe`.

In spectrum analyzer mode, the result of the limit check can be queried with `CALCulate<1|2>:LIMit<1...8>:FAIL?`.

The numeric suffixes <1|2> are irrelevant for this command.

**Parameter**

ON | OFF

**Example**

```
CALC:LIM4:LOW:STAT ON
Switches on limit line 4 (lower limit).
```

**Characteristics**

\*RST value: OFF

SCPI: conform

**Mode**

R, A, ADEMOD, NF

---

---

**CALCulate<1|2>:LIMit<1...8>:LOWer:OFFSet**

---

This command defines an offset for the y-axis of the selected relative lower limit line. In contrast to `CALCulate<1|2>:LIMit<1...8>:LOWer:SHIFt`, the line is not shifted by modifying the individual Y values but by means of an additive offset.

The numeric suffixes <1|2> are irrelevant for this command.

**Parameter**

<numeric\_value>

**Example**

```
CALC:LIM2:LOW:OFFS 3dB
Shifts limit line 2 by 3 dB upwards.
```

**Characteristics**

\*RST value: 0

SCPI: device-specific

**Mode**

R, A, ADEMOD

---

---

**CALCulate<1|2>:LIMit<1...8>:LOWer:MARGin**

---

This command defines a margin to a lower limit line, at which out-of-limit values are signaled (if the limit check is active), but not handled as a violation of the limit value.

Only the unit dB is available in spectrum analyzer mode.

The numeric suffixes <1|2> are irrelevant for this command.

**Parameter**

<numeric\_value>

**Example**

```
CALC:LIM:LOW:MARG 10dB
```

**Characteristics**

\*RST value: 0

SCPI: device-specific

**Mode**

R, A, ADEMOD

---

**CALCulate<1|2>:LIMit<1...8>:LOWer:MODE**

---

This command selects the relative or absolute scaling for the y-axis of the selected lower limit line.

Selecting RELative causes the unit to be switched to DB.

The numeric suffixes <1|2> are irrelevant for this command.

**Parameter**

RELative | ABSolute

**Example**

```
CALC:LIM:LOW:MODE REL
```

Defines the y-axis of limit line 2 as relative scaled.

**Characteristics**

\*RST value: ABSolute

SCPI: device-specific

**Mode**

R, A, ADEMOD

---

**CALCulate<1|2>:LIMit<1...8>:LOWer:SHIFt**

---

This command shifts a limit line by the indicated value in Y direction. In contrast to [CALCulate<1|2>:LIMit<1...8>:LOWer:OFFSet](#), the line is shifted by modifying the individual Y values but not by means of an additive offset.

The numeric suffixes <1|2> are irrelevant for this command.

This command is an event and therefore has no \*RST value and no query.

**Parameter**

<numeric\_value>

**Example**

```
CALC:LIM3:LOW:SHIF 20DB
```

Shifts all Y values of limit line 3 by 20 dB.

**Characteristics**

\*RST value: –

SCPI: device-specific

**Mode**

R, A, ADEMOD, NF

---

---

**CALCulate<1|2>:LIMit<1...8>:LOWer:SPACing**

---

This command selects linear or logarithmic interpolation for the lower limit line.  
The numeric suffixes <1|2> are irrelevant for this command.

**Parameter**

LINear | LOGarithmic

**Example**

```
CALC:LIM:LOW:SPAC LIN
```

**Characteristics**

\*RST value: LIN

SCPI: device-specific

**Mode**

R, A

---

**CALCulate<1|2>:LIMit<1...8>:LOWer:THReshold**

---

This command defines an absolute threshold value for limit lines with relative y-axis scaling.  
The absolute threshold value is used in the limit check as soon as it exceeds the relative limit value.

The unit must correspond to the unit selected with [CALCulate<1|2>:LIMit<1...8>:UNIT](#) (except dB which is not allowed). If no unit is indicated, the unit defined with [CALCulate<1|2>:LIMit<1...8>:UNIT](#) is automatically used (exception: dBm instead of dB).

The units DEG, RAD, S, HZ, PCT are not available in the spectrum analyzer mode.

The numeric suffixes <1|2> are irrelevant for this command.

**Parameter**

<numeric\_value>

**Example**

```
CALC:LIM2:LOW:THR -35DBM
```

Defines an absolute threshold value for limit line 2.

**Characteristics**

\*RST value: -200 dBm

SCPI: device-specific

**Mode**

R, A, ADEMOD

---

**CALCulate:LIMit:UPPer Subsystem**

The CALCulate:LIMit:UPPer subsystem defines the upper limit line.

**Commands of the CALCulate:LIMit:UPPer Subsystem**

- CALCulate<1|2>:LIMit<1...8>:UPPer[:DATA]
- CALCulate<1|2>:LIMit<1...8>:UPPer:MARGin
- CALCulate<1|2>:LIMit<1...8>:UPPer:MODE
- CALCulate<1|2>:LIMit<1...8>:UPPer:OFFSet
- CALCulate<1|2>:LIMit<1...8>:UPPer:SHIFt
- CALCulate<1|2>:LIMit<1...8>:UPPer:SPACing
- CALCulate<1|2>:LIMit<1...8>:UPPer:STATe
- CALCulate<1|2>:LIMit<1...8>:UPPer:THReshold

**CALCulate<1|2>:LIMit<1...8>:UPPer[:DATA]**

This command defines the values for the upper limit lines

The number of values for the CONTROL axis and for the corresponding UPPER and/or LOWER limit line has to be identical. Otherwise default values are entered for missing values or not necessary values are deleted.

The unit must be identical with the unit selected by CALCulate<1|2>:LIMit<1...8>:UNIT. If no unit is indicated, the unit defined with CALCulate<1|2>:LIMit<1...8>:UNIT is automatically used.

In spectrum analyzer mode, the limit check indicates errors if the measured values exceed the UPPER limit line. The units DEG, RAD, S, HZ, PCT are not available in spectrum analyzer mode.

The numeric suffixes <1|2> are irrelevant for this command.

**Parameter**

<numeric\_value>,<numeric\_value>

**Example**

```
CALC:LIM2:UPP -10,0,0,-10,-5
```

Defines 5 upper limit values for limit line 2 in the preset unit.

```
CALC:LIM2:UPP?
```

Outputs the upper limit values for limit line 2 separated by a comma.

**Characteristics**

\*RST value: – (CALCulate<1|2>:LIMit<1...8>:STATe is set to OFF)

SCPI: conform

**Mode**

R, A, ADEMOD, NF

---

**CALCulate<1|2>:LIMit<1...8>:UPPer:MARGin**

---

This command defines a margin to an upper limit line, at which out-of-limit values are signaled (if the limit check is active), but not handled as a violation of the limit value.

Only the unit dB is available in spectrum analyzer mode.

The numeric suffixes <1|2> are irrelevant for this command.

**Parameter**

<numeric\_value>

**Example**

```
CALC:LIM2:UPP:MARG 10dB
```

Defines the margin of limit line 2 to 10 dB below the limit value.

**Characteristics**

\*RST value: 0

SCPI: device-specific

**Mode**

R, A, ADEMOD

---

---

**CALCulate<1|2>:LIMit<1...8>:UPPer:MODE**

---

This command selects the relative or absolute scaling for the y-axis of the selected upper limit line.

Selecting RELative causes the unit to be switched to DB.

The numeric suffixes <1|2> are irrelevant for this command.

**Parameter**

RELative | ABSolute

**Example**

```
CALC:LIM2:UPP:MODE REL
```

Defines the y-axis of limit line 2 as relative scaled.

**Characteristics**

\*RST value: ABSolute

SCPI: device-specific

**Mode**

R, A, ADEMOD

---

---

**CALCulate<1|2>:LIMit<1...8>:UPPer:OFFSet**

---

This command defines an offset for the y-axis of the selected relative upper limit line. In contrast to [CALCulate<1|2>:LIMit<1...8>:UPPer:SHIFt](#), the line is not shifted by modifying the individual Y values but by means of an additive offset.

Only the unit dB is available in the spectrum analyzer mode.

The numeric suffixes <1|2> are irrelevant for this command.

**Parameter**

<numeric\_value>



**Example**

```
CALC:LIM2:UPP:OFFS 3dB
```

Shifts limit line 2 by 3 dB upwards.

**Characteristics**

\*RST value: 0

SCPI: device-specific

**Mode**

R, A, ADEMOD

---

**CALCulate<1|2>:LIMit<1...8>:UPPer:SHIFt**

This command moves a limit line by the indicated value in Y direction. In contrast to [CALCulate<1|2>:LIMit<1...8>:UPPer:OFFSet](#), the line is shifted by modifying the individual Y values and not by means of an additive offset.

The numeric suffixes <1|2> are irrelevant for this command.

This command is an event and therefore has no \*RST value and no query.

**Parameter**

<numeric\_value>

**Example**

```
CALC:LIM3:UPP:SHIF 20
```

Shifts all Y values of limit line 3 by 20 limit line units, e.g. dB.

**Characteristics**

\*RST value: –

SCPI: device-specific

**Mode**

R, A, ADEMOD, NF

---

**CALCulate<1|2>:LIMit<1...8>:UPPer:SPACing**

This command selects linear or logarithmic interpolation for the upper limit line.

The numeric suffixes <1|2> are irrelevant for this command.

**Parameter**

LINear | LOGarithmic

**Example**

```
CALC:LIM:UPP:SPAC LIN
```

**Characteristics**

\*RST value: LIN

SCPI: device-specific

**Mode**

R, A

---

---

**CALCulate<1|2>:LIMit<1...8>:UPPer:STATe**

---

This command switches on or off the indicated limit line. The limit check is activated separately with `CALCulate<1|2>:LIMit<1...8>:STATe`.

In spectrum analyzer mode, the result of the limit check can be queried with `CALCulate<1|2>:LIMit<1...8>:FAIL?`.

The numeric suffixes <1|2> are irrelevant for this command.

**Parameter**

ON | OFF

**Example**

```
CALC:LIM4:UPP:STAT ON
Switches on limit line 4 (upper limit).
```

**Characteristics**

\*RST value: OFF

SCPI: conform

**Mode**

R, A, ADEMOD, NF

---

**CALCulate<1|2>:LIMit<1...8>:UPPer:THReshold**

---

This command defines an absolute threshold value for limit lines with relative y-axis scaling. The absolute threshold value is used in the limit check as soon as it exceeds the relative limit value.

The unit must correspond to the unit selected with `CALCulate<1|2>:LIMit<1...8>:UNIT` (except dB which is not possible). If no unit is indicated, the unit defined with `CALCulate<1|2>:LIMit<1...8>:UNIT` is automatically used (exception: dBm instead of dB).

The units DEG, RAD, S, HZ, PCT are not available in the spectrum analyzer mode.

The numeric suffixes <1|2> are irrelevant for this command.

**Parameter**

<numeric\_value>

**Example**

```
CALC:LIM2:UPP:THR -35DBM
Defines an absolute threshold value for limit line 2.
```

**Characteristics**

\*RST value: -200 dBm

SCPI: device-specific

**Mode**

R, A, ADEMOD

---

**CALCulate:MARKer Subsystem**

The CALCulate:MARKer subsystem checks the marker functions of the instrument.

The following subsystem is included:

- ["CALCulate:MARKer:FUNCTION Subsystem"](#) on page 6.60

**Commands of the CALCulate:MARKer Subsystem**

- CALCulate<1|2>:MARKer<1...4>[:STATe]
- CALCulate<1|2>:MARKer<1...4>:AOFF
- CALCulate<1|2>:MARKer<1...4>:COUNT
- CALCulate<1|2>:MARKer<1...4>:COUNT:FREQuency?
- CALCulate<1|2>:MARKer<1...4>:COUNT:RESolution
- CALCulate<1|2>:MARKer<1...4>:COUPled[:STATe]
- CALCulate<1|2>:MARKer<1...4>:LOEXclude
- CALCulate<1|2>:MARKer<1...4>:MAXimum[:PEAK]
- CALCulate<1|2>:MARKer<1...4>:MAXimum:AUTO
- CALCulate<1|2>:MARKer<1...4>:MAXimum:LEFT
- CALCulate<1|2>:MARKer<1...4>:MAXimum:NEXT
- CALCulate<1|2>:MARKer<1...4>:MAXimum:RIGHT
- CALCulate<1|2>:MARKer<1...4>:MINimum[:PEAK]
- CALCulate<1|2>:MARKer<1...4>:MINimum:AUTO
- CALCulate<1|2>:MARKer<1...4>:MINimum:LEFT
- CALCulate<1|2>:MARKer<1...4>:MINimum:NEXT
- CALCulate<1|2>:MARKer<1...4>:MINimum:RIGHT
- CALCulate<1|2>:MARKer<1...4>:PEXCursion
- CALCulate<1|2>:MARKer<1...4>:SCOupled[:STATe]
- CALCulate<1|2>:MARKer<1...4>:TRACe
- CALCulate<1|2>:MARKer<1...4>:X
- CALCulate<1|2>:MARKer<1...4>:X:SLIMits[:STATe]
- CALCulate<1|2>:MARKer<1...4>:X:SLIMits:LEFT
- CALCulate<1|2>:MARKer<1...4>:X:SLIMits:RIGHT
- CALCulate<1|2>:MARKer<1...4>:X:SSIZE
- CALCulate<1|2>:MARKer<1...4>:Y?
- CALCulate<1|2>:MARKer<1...4>:Y:PERCent

---

**CALCulate<1|2>:MARKer<1...4>[:STATe]**

---

This command switches on or off the currently selected marker. If no indication is made, marker 1 is selected automatically. If marker 2, 3 or 4 is selected and used as a delta marker, it is switched to marker mode.

The numeric suffixes <1|2> are irrelevant for this command.

**Parameter**

ON | OFF

**Example**

```
CALC:MARK3 ON
```

Switches on marker 3 or switches to marker mode.

**Characteristics**

\*RST value: OFF

SCPI: device-specific

**Mode**

R, A, ADEMOD

---

---

**CALCulate<1|2>:MARKer<1...4>:AOFF**

---

This command switches off all active markers and all delta markers and active marker/delta marker measurement functions.

The numeric suffixes <1|2> are irrelevant for this command.

This command is an event and therefore has no \*RST value and no query.

**Example**

```
CALC:MARK:AOFF
```

Switches off all markers.

**Characteristics**

\*RST value: –

SCPI: device-specific

**Mode**

R, A, ADEMOD

---

---

**CALCulate<1|2>:MARKer<1...4>:COUNT**

---

This command switches on or off the frequency counter at the marker position.

The count result is queried with [CALCulate<1|2>:MARKer<1...4>:COUNT:FREQuency?](#).

Frequency counting is possible only for one marker at a time. If it is activated for another marker, it is automatically deactivated for the previous marker.

It should be noted that a complete sweep must be performed after switching on the frequency counter to ensure that the frequency to be measured is actually reached. The synchronization to the sweep end required for this is only possible in single sweep mode.

The numeric suffixes <1|2> are irrelevant for this command.

**Parameter**

ON | OFF

**Example**

```
INIT:CONT OFF
Switches to single sweep mode.
CALC:MARK ON
Switches on marker 1.
CALC:MARK:COUN ON
Switches on the frequency counter for marker 1.
INIT;*WAI
Starts a sweep and waits for the end.
CALC:MARK:COUN:FREQ?
Outputs the measured value.
```

**Characteristics**

\*RST value: OFF  
SCPI: device-specific

**Mode**

A

---

**CALCulate<1|2>:MARKer<1...4>:COUNT:FREQUency?**

---

This command queries the result of the frequency counter for the indicated marker. Before the command, the frequency counter should be switched on and a complete measurement performed to obtain a correct count result. Therefore, a single sweep with synchronization must be performed between switching on the frequency counter and querying the count result.

The numeric suffixes <1|2> are irrelevant for this command.

This command is only a query and therefore has no \*RST value.

**Example**

```
INIT:CONT OFF
Switches to single sweep mode.
CALC:MARK2 ON
Switches on marker 2.
CALC:MARK2:COUN ON
Switches the frequency counter for marker 2.
INIT;*WAI
Starts a sweep and waits for the end.
CALC:MARK2:COUN:FREQ?
Outputs the measured value of marker 2.
```

**Characteristics**

\*RST value: –  
SCPI: device-specific

**Mode**

A

---

---

**CALCulate<1|2>:MARKer<1...4>:COUNT:RESolution**

---

This command specifies the resolution of the frequency counter.  
The numeric suffixes <1|2> and <1...4> are irrelevant for this command.

**Parameter**

0.1 | 1 | 10 | 100 | 1000 | 10000 Hz

**Example**

```
CALC:MARK:COUN:RES 1kHz
```

Sets the resolution of the frequency counter to 1 kHz.

**Characteristics**

\*RST value: 1kHz

SCPI: device-specific

**Mode**

A

---

---

**CALCulate<1|2>:MARKer<1...4>:COUPled[:STATe]**

---

This command couples the receiver frequency to the marker. With every update of the marker position, the receiver frequency is adjusted to the position of the marker. If deactivated, an update of the marker position has no effect on the receiver frequency.

**Parameter**

ON | OFF

**Example**

```
CALC:MARK:COUP ON
```

Activates marker coupling

**Characteristics**

\*RST value: OFF

SCPI: device-specific

**Mode**

R

---

---

**CALCulate<1|2>:MARKer<1...4>:LOEXclude**

---

This command switches the local oscillator suppression for peak search on or off. This setting applies to all markers and delta markers.

The numeric suffixes <1|2> and <1...4> are irrelevant.

**Parameter**

ON | OFF

**Example**

```
CALC:MARK:LOEX ON
```

**Characteristics**

\*RST value: ON

SCPI: device-specific

**Mode**

A-F, ADEM0D

---

**CALCulate<1|2>:MARKer<1...4>:MAXimum[:PEAK]**

---

This command positions the marker to the current maximum value of the corresponding trace. The corresponding marker is activated first or switched to the marker mode.

The numeric suffixes <1|2> are irrelevant for this command.

This command is an event and therefore has no \*RST value and no query.

**Note:** *If no maximum value is found on the trace (level spacing to adjacent values < peak excursion), an execution error (error code: -200) is produced.*

**Example**

```
CALC:MARK2:MAX
```

Positions marker 2 to the maximum value of the trace.

**Characteristics**

\*RST value: –

SCPI: device-specific

**Mode**

R, A, ADEMOD

---

**CALCulate<1|2>:MARKer<1...4>:MAXimum:AUTO**

---

Activates the automatic peak search function for marker 1 at the end of each particular sweep. This function may be used during adjustments of a device under test to keep track of the actual peak marker position and level.

The numeric suffixes <1|2> are irrelevant for this command.

**Note:** *If no maximum value is found on the trace (level spacing to adjacent values < peak excursion), an execution error (error code: -200) is produced.*

**Parameter**

ON | OFF

**Example**

```
CALC:MARK:MAX:AUTO ON
```

Activates the automatic peak search function for marker 1 at the end of each particular sweep.

**Characteristics**

\*RST value: OFF

SCPI: device-specific

**Mode**

A

---

**CALCulate<1|2>:MARKer<1...4>:MAXimum:LEFT**

---

This command positions the marker to the next smaller maximum value to the left of the current value (i.e. in descending X values) on the trace.

The numeric suffixes <1|2> are irrelevant for this command.

This command is an event and therefore has no \*RST value and no query.

**Note:** *If no next smaller maximum value is found on the trace (level spacing to adjacent values < peak excursion), an execution error (error code: -200) is produced.*

**Example**

```
CALC:MARK2:MAX:LEFT
```

Positions marker 2 to the next lower maximum value to the left of the current value.

**Characteristics**

\*RST value: –

SCPI: device-specific

**Mode**

R, A, ADEMOD

---

**CALCulate<1|2>:MARKer<1...4>:MAXimum:NEXT**

This command positions the marker to the next smaller maximum value of the corresponding trace.

The numeric suffixes <1|2> are irrelevant for this command.

This command is an event and therefore has no \*RST value and no query.

**Note:** *If no next smaller maximum value is found on the trace (level spacing to adjacent values < peak excursion), an execution error (error code: –200) is produced.*

**Example**

```
CALC:MARK2:MAX:NEXT
```

Positions marker 2 to the next lower maximum value.

**Characteristics**

\*RST value: –

SCPI: device-specific

**Mode**

R, A, ADEMOD

---

**CALCulate<1|2>:MARKer<1...4>:MAXimum:RIGHT**

This command positions the marker to the next smaller maximum value to the right of the current value (i.e. in ascending X values) on the corresponding trace.

The numeric suffixes <1|2> are irrelevant for this command.

This command is an event and therefore has no \*RST value and no query.

**Note:** *If no next smaller maximum value is found on the trace (level spacing to adjacent values < peak excursion), an execution error (error code: –200) is produced.*

**Example**

```
CALC:MARK2:MAX:RIGHT
```

Positions marker 2 to the next lower maximum value to the right of the current value.

**Characteristics**

\*RST value: –

SCPI: device-specific

**Mode**

R, A, ADEMOD

---



**CALCulate<1|2>:MARKer<1...4>:MINimum[:PEAK]**

This command positions the marker to the current minimum value of the corresponding trace. The corresponding marker is activated first or switched to marker mode, if necessary.

The numeric suffixes <1|2> are irrelevant for this command.

This command is an event and therefore has no \*RST value and no query.

**Note:** *If no minimum value is found on the trace (level spacing to adjacent values < peak excursion), an execution error (error code: -200) is produced.*

**Example**

```
CALC:MARK2:MIN
```

Positions marker 2 to the minimum value of the trace.

**Characteristics**

\*RST value: –

SCPI: device-specific

**Mode**

R, A, ADEMOD

**CALCulate<1|2>:MARKer<1...4>:MINimum:AUTO**

Activates the automatic minimum value search function for marker 1 at the end of each particular sweep. This function may be used during adjustments of a device under test to keep track of the actual peak marker position and level.

The numeric suffixes <1|2> are irrelevant for this command.

**Note:** *If no minimum value is found on the trace (level spacing to adjacent values < peak excursion), an execution error (error code: -200) is produced.*

**Parameter**

ON | OFF

**Example**

```
CALC:MARK:MIN:AUTO ON
```

Activates the automatic minimum value search function for marker 1 at the end of each particular sweep.

**Characteristics**

\*RST value: OFF

SCPI: device-specific

**Mode**

A

**CALCulate<1|2>:MARKer<1...4>:MINimum:LEFT**

This command positions the marker to the next higher minimum value to the left of the current value (i.e. in descending X direction) on the corresponding trace.

The numeric suffixes <1|2> are irrelevant for this command.

This command is an event and therefore has no \*RST value and no query.

**Note:** *If no next higher minimum value is found on the trace (level spacing to adjacent values < peak excursion), an execution error (error code: -200) is produced.*

**Example**

```
CALC:MARK2:MIN
```

Positions marker 2 to the minimum value of the trace.

```
CALC:MARK2:MIN:LEFT
```

Positions marker 2 to the next higher minimum value to the left of the current value.

**Characteristics**

\*RST value: –

SCPI: device-specific

**Mode**

R, A, ADEMOD

---

**CALCulate<1|2>:MARKer<1...4>:MINimum:NEXT**

This command positions the marker to the next higher minimum value of the corresponding trace.

The numeric suffixes <1|2> are irrelevant for this command.

This command is an event and therefore has no \*RST value and no query.

**Note:** *If no next higher minimum value is found on the trace (level spacing to adjacent values < peak excursion), an execution error (error code: –200) is produced.*

**Example**

```
CALC:MARK2:MIN
```

Positions marker 2 to the minimum value of the trace.

```
CALC:MARK2:MIN:NEXT
```

Positions marker 2 to the next higher maximum value.

**Characteristics**

\*RST value: –

SCPI: device-specific

**Mode**

R, A, ADEMOD

---

**CALCulate<1|2>:MARKer<1...4>:MINimum:RIGHT**

This command positions the marker to the next higher minimum value to the right of the current value (i.e. in ascending X direction) on the corresponding trace.

The numeric suffixes <1|2> are irrelevant for this command.

This command is an event and therefore has no \*RST value and no query.

**Note:** *If no next higher minimum value is found on the trace (level spacing to adjacent values < peak excursion), an execution error (error code: –200) is produced.*

**Example**

```
CALC:MARK2:MIN
```

Positions marker 2 to the minimum value of the trace.

```
CALC:MARK2:MIN:RIGH
```

Positions marker 2 to the next higher minimum value to the right of the current value.

**Characteristics**

\*RST value: –

SCPI: device-specific

**Mode**

R, A, ADEMOD

---

**CALCulate<1|2>:MARKer<1...4>:PEXCursion**

---

This command defines the peak excursion, i.e. the spacing below a trace maximum which must be attained before a new maximum is recognized, or the spacing above a trace minimum which must be attained before a new minimum is recognized. The set value applies to all markers and delta markers. The unit depends on the selected operating mode.

The numeric suffixes <1|2> and <1...4> are irrelevant.

**Parameter**

<numeric\_value>

**Example**

```
CALC:MARK:PEXC 10dB
```

Defines peak excursion 10 dB in spectrum **Spectrum Analyzer** mode.

**Characteristics**

\*RST value: 6dB in **Spectrum Analyzer** mode

SCPI: device-specific

**Mode**

R, A, ADEMOD

---

**CALCulate<1|2>:MARKer<1...4>:SCOupled[:STATe]**

---

This command couples the receiver frequency settings of the corresponding subscans to the marker. With every update of the marker position, the receiver frequency is adjusted to the position of the marker. If deactivated, an update of the marker position has no effect on the receiver frequency.

**Parameter**

ON | OFF

**Example**

```
CALC:MARK:SCO ON
```

Activates marker coupling of subscans

**Characteristics**

\*RST value: ON

SCPI: device-specific

**Mode**

R

---

---

**CALCulate<1|2>:MARKer<1...4>:TRACe**

---

This command assigns the selected marker (1 to 4) to the indicated measurement curve. The corresponding trace must be active, i.e. its status must be different from "BLANK".

If necessary the corresponding marker is switched on prior to the assignment.

The numeric suffixes <1|2> are irrelevant for this command.

**Parameter**

1 to 6

**Example**

```
CALC:MARK3:TRAC 2
```

Assigns marker 3 to trace 2.

**Characteristics**

\*RST value: –

SCPI: device-specific

**Mode**

R, A, ADEMOD

---

---

**CALCulate<1|2>:MARKer<1...4>:X**

---

This command positions the selected marker to the indicated frequency (span > 0), time (span = 0) or level (APD measurement or CCDF measurement ON).

If marker 2, 3 or 4 is selected and used as delta marker, it is switched to marker mode.

The numeric suffixes <1|2> are irrelevant for this command.

**Parameter**

0 to MAX (frequency | sweep time)

**Example**

```
CALC:MARK2:X 10.7MHz
```

Positions marker 2 to frequency 10.7 MHz.

**Characteristics**

\*RST value: –

SCPI: device-specific

**Mode**

R, A, ADEMOD

---

---

**CALCulate<1|2>:MARKer<1...4>:X:SLIMits[:STATe]**

---

This command switches between a limited (ON) and unlimited (OFF) search range.

If the power measurement in zero span is active, this command limits the evaluation range on the trace.

The numeric suffixes <1|2> and <1...4> are irrelevant for this command.

**Parameter**

ON | OFF

**Example**

```
CALC:MARK:X:SLIM ON
```

Switches on search limitation.

**Characteristics**

\*RST value: OFF

SCPI: device-specific

**Mode**

R, A, ADEMOD

**CALCulate<1|2>:MARKer<1...4>:X:SLIMits:LEFT**

This command sets the left limit of the search range for markers and delta markers. Depending on the span setting of the x-axis the indicated value defines a frequency (span > 0) or time (span = 0).

The numeric suffixes <1|2> and <1...4> are irrelevant for this command.

If the power measurement in zero span is active, this command limits the evaluation range to the trace.

**Note:** The function is only available if the search limit for marker and delta marker is switched on (CALCulate<1|2>:MARKer<1...4>:X:SLIMits[:STATe]).

**Parameter**

0 to MAX (frequency | sweep time)

**Example**

```
CALC:MARK:X:SLIM ON
```

Switches the search limit function on.

```
CALC:MARK:X:SLIM:LEFT 10MHz
```

Sets the left limit of the search range to 10 MHz.

**Characteristics**

\*RST value: – (is set to the left diagram border when switching on search limits)

SCPI: device-specific

**Mode**

R, A, ADEMOD

**CALCulate<1|2>:MARKer<1...4>:X:SLIMits:RIGHT**

This command sets the right limit of the search range for markers and delta markers. Depending on the span setting of the x-axis the indicated value defines a frequency (span > 0) or time (span = 0).

The numeric suffixes <1|2> and <1...4> are irrelevant for this command.

If the power measurement in zero span is active, this command limits the evaluation range to the trace.

**Note:** The function is only available if the search limit for marker and delta marker is switched on (CALCulate<1|2>:MARKer<1...4>:X:SLIMits[:STATe]).

**Parameter**

0 to MAX (frequency | sweep time)

**Example**

```
CALC:MARK:X:SLIM ON
```

Switches the search limit function on.

```
CALC:MARK:X:SLIM:RIGH 20MHz
```

Sets the right limit of the search range to 20 MHz.

**Characteristics**

\*RST value: – (is set to the right diagram border when switching on search limits)

SCPI: device-specific

**Mode**

R, A, ADEMODO

**CALCulate<1|2>:MARKer<1...4>:X:SSIZE**

This command defines the step size of the rotary knob for marker or delta marker value changes. It takes only effect in manual operation. It is available for all base unit measurements with the exception of statistics.

The numeric suffixes <1|2> and <1...4> are irrelevant for this command.

**Parameter**

STANdard measurement point step size

POINts measured value step size (number of measured values is defined via the [SENSe<1|2>:]SWEep:POINts command)

**Example**

```
CALC:MARK:X:SSIZ POIN
```

Sets the measured value step size.

**Characteristics**

RST value: STANdard

SCPI: device-specific

**Mode**

A

**CALCulate<1|2>:MARKer<1...4>:Y?**

This command queries the measured value of the selected marker. The corresponding marker is activated before or switched to marker mode, if necessary.

To obtain a correct query result, a complete sweep with synchronization to the sweep end must be performed between the activation of the marker and the query of the Y value. This is only possible in single sweep mode.

The query result is output in the unit determined with CALCulate<1|2>:UNIT:POWer.

In the default setting, the output is made depending on the unit determined with CALCulate<1|2>:UNIT:POWer; only with linear level scaling is the output in %.

The numeric suffixes <1|2> are irrelevant for this command.

**Example**

```
INIT:CONT OFF
```

Switches to single sweep mode.

```
CALC:MARK2 ON
```

Switches marker 2.

```
INIT;*WAI
```

Starts a sweep and waits for the end.

```
CALC:MARK2:Y?
```

Outputs the measured value of marker 2.

**Characteristics**

\*RST value: –

SCPI: device-specific

**Mode**

R, A, ADEMODO

---

**CALCulate<1|2>:MARKer<1...4>:Y:PERCent**

---

This command positions the selected marker to the given probability. If marker 2, 3 or 4 is selected and used as a delta marker, it is switched to marker mode.

The numeric suffixes <1|2> are irrelevant for this command.

**Note:** *The command is only available with the CCDF measurement switched on. The associated level value can be determined with the [CALCulate<1|2>:MARKer<1...4>:X](#) command.*

**Parameter**

0 to 100%

**Example**

```
CALC1:MARK:Y:PERC 95PCT
```

Positions marker 1 to a probability of 95%.

**Characteristics**

\*RST value: –

SCPI: device-specific

**Mode**

A

---

**CALCulate:MARKer:FUNCTion Subsystem**

The CALCulate:MARKer:FUNCTion subsystem checks the marker functions in the instrument.

The following subsystems are included:

- "CALCulate:MARKer:FUNCTion:HARMonics Subsystem" on page 6.74
- "CALCulate:MARKer:FUNCTion:POWer Subsystem" on page 6.78
- "CALCulate:MARKer:FUNCTion:STRack Subsystem" on page 6.85
- "CALCulate:MARKer:FUNCTion:SUMMary Subsystem" on page 6.87

**Commands of the CALCulate:MARKer:FUNCTion Subsystem**

- CALCulate<1|2>:MARKer<1...4>:FUNCTion:DEModulation[:STATe]
- CALCulate<1|2>:MARKer<1...4>:FUNCTion:DEModulation:CONTInuous
- CALCulate<1|2>:MARKer<1...4>:FUNCTion:DEModulation:HOLDoff
- CALCulate<1|2>:MARKer<1...4>:FUNCTion:DEModulation:SElect
- CALCulate<1|2>:MARKer<1...4>:FUNCTion:CENTer
- CALCulate<1|2>:MARKer<1...4>:FUNCTion:CSTep
- CALCulate<1|2>:MARKer<1...4>:FUNCTion:FPEaks[:IMMediate]
- CALCulate<1|2>:MARKer<1...4>:FUNCTion:FPEaks:COUNt?
- CALCulate<1|2>:MARKer<1...4>:FUNCTion:FPEaks:SORT
- CALCulate<1|2>:MARKer<1...4>:FUNCTion:FPEaks:X?
- CALCulate<1|2>:MARKer<1...4>:FUNCTion:FPEaks:Y?
- CALCulate<1|2>:MARKer<1...4>:FUNCTion:MDEPth[:STATe]
- CALCulate<1|2>:MARKer<1...4>:FUNCTion:MDEPth:RESult?
- CALCulate<1|2>:MARKer<1...4>:FUNCTion:MDEPth:SEARChsignal
- CALCulate<1|2>:MARKer<1...4>:FUNCTion:NDBDown
- CALCulate<1|2>:MARKer<1...4>:FUNCTion:NDBDown:FREQUency?
- CALCulate<1|2>:MARKer<1...4>:FUNCTion:NDBDown:QFACTOR?
- CALCulate<1|2>:MARKer<1...4>:FUNCTion:NDBDown:RESult?
- CALCulate<1|2>:MARKer<1...4>:FUNCTion:NDBDown:STATe
- CALCulate<1|2>:MARKer<1...4>:FUNCTion:NDBDown:TIME?
- CALCulate<1|2>:MARKer<1...4>:FUNCTion:NOISE[:STATe]
- CALCulate<1|2>:MARKer<1...4>:FUNCTion:NOISE:RESult?
- CALCulate<1|2>:MARKer<1...4>:FUNCTion:REFerence
- CALCulate<1|2>:MARKer<1...4>:FUNCTion:TOI[:STATe]
- CALCulate<1|2>:MARKer<1...4>:FUNCTion:TOI:RESult?
- CALCulate<1|2>:MARKer<1...4>:FUNCTion:TOI:SEARChsignal
- CALCulate<1|2>:MARKer<1...4>:FUNCTion:ZOOM



**CALCulate<1|2>:MARKer<1...4>:FUNCtion:DEModulation[:STATe]**

This command switches on or off the audio demodulator when the indicated marker is reached. With span > 0 the hold time can be defined at the corresponding marker position with `CALCulate<1|2>:MARKer<1...4>:FUNCtion:DEModulation:HOLDoff`. In zero span the demodulation is permanently active.

The numeric suffixes <1|2> are irrelevant for this command.

**Parameter**

ON | OFF

**Example**

```
CALC:MARK3:FUNC:DEM ON
```

Switches on the demodulation for marker 3.

**Characteristics**

\*RST value: OFF

SCPI: device-specific

**Mode**

A

**CALCulate<1|2>:MARKer<1...4>:FUNCtion:DEModulation:CONTinuous**

This command switches on or off the continuous demodulation for span >0. Thus acoustic monitoring of the signals can be performed.

The numeric suffixes <1|2> and <1...4> are irrelevant for this command.

**Parameter**

ON | OFF

**Example**

```
CALC2:MARK3:FUNC:DEM:CONT ON
```

Switches on the continuous ' demodulation.

**Characteristics**

RST value: OFF

SCPI: device-specific

**Mode**

A

**CALCulate<1|2>:MARKer<1...4>:FUNCtion:DEModulation:HOLDoff**

This command defines the hold time at the marker position for the demodulation with span > 0. The setting is independent of the selected marker, the suffixes <1|2> and <1...4> are irrelevant. The numeric suffixes <1|2> are irrelevant for this command.

**Parameter**

10ms to 1000s

**Example:**

```
CALC:MARK:FUNC:DEM:HOLD 3s
```

**Characteristics:**

\*RST value: – (DEModulation is set to OFF)

SCPI: device-specific

**Mode:**

A

---

**CALCulate<1|2>:MARKer<1...4>:FUNCtion:DEModulation:SElect**

---

This command selects the demodulation type for the audio demodulator. The command is independent of the selected marker, the suffixes 1|2 and 1 to 4 are irrelevant.

The numeric suffixes <1|2> are irrelevant for this command.

**Parameter**

AM | FM

**Example**

```
CALC:MARK:FUNC:DEM:SEL FM
```

**Characteristics**

\*RST value: AM

SCPI: device-specific

**Mode**

A

---

**CALCulate<1|2>:MARKer<1...4>:FUNCtion:CENter**

---

This command sets the center frequency equal to the frequency of the indicated marker.

In receiver mode, the receiver frequency is set to the frequency of the indicated marker.

If marker 2, 3 or 4 is selected and used as delta marker, the marker is switched to the marker mode.

The numeric suffix <1|2> are irrelevant for this command.

This command is an "event" and therefore has no \*RST value and no query.

**Example**

```
CALC:MARK2:FUNC:CENT
```

Sets the center frequency to the frequency of marker 2.

**Characteristics**

\*RST value: –

SCPI: device-specific

**Mode**

R, A-F

---

**CALCulate<1|2>:MARKer<1...4>:FUNCtion:CSTep**

---

This command sets the step size of the center frequency to the X value of the current marker.

In receiver mode, the command sets the receiver frequency to the X value of the indicated marker.

If marker 2, 3 or 4 is selected and used as delta marker, it is switched to the marker mode.

The numeric suffix <1|2> are irrelevant for this command.

This command is an event and therefore has no \*RST value and no query.

### Example

```
CALC:MARK3:FUNC:CST
```

Sets the center frequency to the same value as the frequency of marker 3.

### Characteristics

\*RST value: –

SCPI: device-specific

### Mode

R, A–F

## CALCulate<1|2>:MARKer<1...4>:FUNCTION:FPEaks[:IMMediate]

This command searches the selected trace for the indicated number of maxima. The results are entered in a list and can be queried with the

`CALCulate<1|2>:MARKer<1...4>:FUNCTION:FPEaks:X?` and

`CALCulate<1|2>:MARKer<1...4>:FUNCTION:FPEaks:Y?` commands. The number of maxima found can be queried with

`CALCulate<1|2>:MARKer<1...4>:FUNCTION:FPEaks:COUNT?`. The trace to be examined is selected with `CALCulate<1|2>:MARKer<1...4>:TRACe`. The order of the results in the list can be defined with `CALCulate<1|2>:MARKer<1...4>:FUNCTION:FPEaks:SORT`.

The numeric suffixes <1|2> are irrelevant for this command.

**Note:** *The number of maxima found depends on the waveform and value set for the Peak Excursion parameter (`CALCulate<1|2>:MARKer<1...4>:PEXCursion`), however, a maximum number of 200 maxima are determined. Only the signals which exceed their surrounding values at least by the value indicated by the peak excursion parameter will be recognized as maxima. Therefore, the number of maxima found is not automatically the same as the number of maxima desired.*

### Parameter

1 to 200

### Example

```
INIT:CONT OFF
```

Switches to single sweep mode

```
INIT;*WAI
```

Starts measurement and synchronizes to end

```
CALC:MARK:TRAC 1
```

Sets marker 1 to trace 1

```
CALC:MARK:FUNC:FPE:SORT X
```

Sets the sort mode to increasing X values

```
CALC:MARK:FUNC:FPE 3
```

Searches the 3 highest maxima for trace 1

```
CALC:MARK:FUNC:COUN?
```

Queries the number of maxima found

```
CALC:MARK:FUNC:Y?
```

Queries the level of maxima found

```
CALC:MARK:FUNC:X?
```

Queries the frequencies (span <> 0) or time (span = 0) of maxima found.

**Characteristics**

\*RST value: –

SCPI: device-specific

**Mode**

A

---

**CALCulate<1|2>:MARKer<1...4>:FUNCtion:FPEaks:COUNT?**

---

This query reads out the number of maxima found during the search. If no search for maxima has been performed, 0 is returned.

The numeric suffixes <1|2> are irrelevant for this command.

**Example**

```
CALC:MARK:FUNC:FPE 3
```

Searches the 3 highest maxima for trace 1

```
CALC:MARK:FUNC:FPE:COUNT?
```

Queries the number of maxima found

**Characteristics**

\*RST value: –

SCPI: device-specific

**Mode**

A

---

**CALCulate<1|2>:MARKer<1...4>:FUNCtion:FPEaks:SORT**

---

This command sets the sort mode for the search for maxima:

X: the maxima are sorted in the list of responses according to increasing X values

Y: the maxima are sorted in the list of responses according to decreasing Y values

The numeric suffixes <1|2> are irrelevant for this command.

**Parameter**

X | Y

**Example**

```
CALC:MARK:FUNC:FPE:SORT Y
```

Sets the sort mode to decreasing y values

**Characteristics**

\*RST value: –

SCPI: device-specific

**Mode**

A

---

**CALCulate<1|2>:MARKer<1...4>:FUNCtion:FPEaks:X?**

This query reads out the list of X values of the maxima found. The number of available values can be queried with `CALCulate<1|2>:MARKer<1...4>:FUNCtion:FPEaks:COUNT?`.

With sort mode X, the X values are in increasing order; with sort mode Y the order corresponds to the decreasing order of the Y values.

The numeric suffixes <1|2> are irrelevant for this command.

**Example**

```
CALC:MARK:FUNC:FPE:SORT Y
```

Sets the sort mode to decreasing y values

```
CALC:MARK:FUNC:FPE 3
```

Searches the 3 highest maxima for trace 1

```
CALC:MARK:FUNC:FPE:COUN?
```

Queries the number of maxima found

```
CALC:MARK:FPE:FUNC:X?
```

Queries the frequencies (span <> 0) or. time (span = 0) of the maxima found

**Return values**

```
107.5E6,153.8E6,187.9E6
```

frequencies in increasing order

```
2.05E-3,2.37E-3, 3.71e-3
```

times in increasing order

**Characteristics**

\*RST value: –

SCPI: device-specific

**Mode**

A

**CALCulate<1|2>:MARKer<1...4>:FUNCtion:FPEaks:Y?**

This query reads out the list of X values of the maxima found. The number of available values can be queried with `CALCulate<1|2>:MARKer<1...4>:FUNCtion:FPEaks:COUNT?`.

With sort mode X, the X values are in increasing order; with sort mode Y the order corresponds to the decreasing order of the Y values.

The numeric suffixes <1|2> are irrelevant for this command.

**Example**

```
CALC:MARK:FUNC:FPE:SORT Y
```

Sets the sort mode to decreasing y values

```
CALC:MARK:FUNC:FPE 3
```

Searches the 3 highest maxima for trace 1

```
CALC:MARK:FUNC:FPE:COUN?
```

Queries the number of maxima found

```
CALC:MARK:FUNC:FPE:Y?
```

Queries the levels of the maxima found

**Return values**

```
-37.5,-58.3,-59.6
```

level in decreasing order

**Characteristics**

\*RST value: –

SCPI: device-specific

**Mode**

A

**CALCulate<1|2>:MARKer<1...4>:FUNCtion:MDEPth[:STATe]**

This command switches on the measurement of the AM modulation depth. An AM-modulated carrier is required on the screen for correct operation. If necessary, marker 1 is previously activated and set to the largest signal available.

The level value of marker 1 is regarded as the carrier level. On activating the function, marker 2 and marker 3 are automatically set as delta markers symmetrically to the carrier to the adjacent maxima of the trace.

If the position of delta marker 2 is changed, delta marker 3 is moved symmetrically with respect to the reference marker (marker 1). If the position of delta marker 3 is changed, fine adjustment can be performed independently of delta marker 2.

The power at the marker positions is calculated from the measured levels.

The AM modulation depth is calculated from the ratio of power values at the reference marker and the delta markers. If the two AM sidebands differ in power, the average value of the two power values is used for calculating the AM modulation depth.

The numeric suffix <1|2> and <1...4> are irrelevant for this command.

**Example**

```
CALC:MARK:X 10MHZ
```

Sets the reference marker (marker 1) to the carrier signal at 10 MHz.

```
CALC:MARK:FUNC:MDEP ON
```

Switches on the modulation depth measurement.

```
CALC:DELT2:X 10KHZ
```

Sets delta markers 2 and 3 to the signals at 10 kHz from the carrier signal.

```
CALC:DELT3:X 9.999KHZ
```

Corrects the position of delta marker 3 relative to delta marker 2.

**Characteristics**

\*RST value: OFF

SCPI: device-specific

**Mode**

A

**CALCulate<1|2>:MARKer<1...4>:FUNCtion:MDEPth:RESult?**

This command queries the AM modulation depth.

A complete sweep with synchronization to sweep end must be performed between switching on the function and querying the measured value to obtain a correct query result. This is only possible in single sweep mode.

The numeric suffix <1|2> and <1...4> are irrelevant for this command.

This command is only a query and therefore has no \*RST value.

**Example**

```
INIT:CONT OFF
```

Switches to single sweep mode.

```
CALC:MARK:X 10MHZ
```

Sets the reference marker (marker 1) to the carrier signal at 10 MHz.

```
CALC:MARK:FUNC:MDEP ON
```

Switches on the modulation depth measurement.

```
INIT;*WAI
```

Starts a sweep and waits for the end.

```
CALC:MARK:FUNC:MDEP:RES?
```

Outputs the measured value.

**Characteristics**

\*RST value: –

SCPI: device-specific

**Mode**

A

**CALCulate<1|2>:MARKer<1...4>:FUNCTion:MDEPth:SEARChsignal**

This command starts the search of the signals required for the modulation depth measurement.

The numeric suffix <1|2> are irrelevant for this command.

**Note:** *No new measurement is done. Only the currently available trace selected for the modulation depth measurement is used*

**Parameter**

ONCE

**Example**

```
CALC:MARK:FUNC:MDEP:SEAR ONCE
```

Executes the search of an AM modulated signal at the currently available trace.

**Characteristics**

\*RST value: –

SCPI: conform

**Mode**

A

**CALCulate<1|2>:MARKer<1...4>:FUNCTion:NDBDown**

This command defines the level spacing of the two temporary markers to the right and left of marker 1.

The temporary markers T1 and T2 are positioned by n dB below the active reference marker.

The value measured by these markers can be queried with

```
CALCulate<1|2>:MARKer<1...4>:FUNCTion:NDBDown:RESult??.
```

The numeric suffixes <1|2> and <1...4> are irrelevant for this command.

**Parameter**

<numeric\_value>

**Example**

CALC:MARK:FUNC:NDBD 3dB  
Sets the level spacing to 3 dB.

**Characteristics**

\*RST value: 6dB  
SCPI: device-specific

**Mode**

A

**CALCulate<1|2>:MARKer<1...4>:FUNCtion:NDBDown:FREQuency?**

This command queries the values of the two temporary markers for span>0. The frequency values are separated by comma and output in ascending order.

A complete sweep with synchronization to sweep end must be performed between switching on the function and querying the measured value to obtain a correct query result. This is only possible in single sweep mode.

The numeric suffixes <1|2> and <1...4> are irrelevant for this command.

This command is only a query and therefore has no \*RST value.

**Example**

INIT:CONT OFF  
Switches to single sweep mode.  
CALC:MARK:FUNC:NDBD ON  
Switches on the n dB down function.  
INIT;\*WAI  
Starts a sweep and waits for the end.  
CALC:MARK:FUNC:NDBD:FREQ?  
Outputs the frequencies of the temporary markers.

**Characteristics**

\*RST value: –  
SCPI: device-specific

**Mode**

A

**CALCulate<1|2>:MARKer<1...4>:FUNCtion:NDBDown:QFACtor?**

This command queries the Q factor (quality) of the measured bandwidth for span>0.

This command is only a query and therefore has no \*RST value.

**Example**

INIT:CONT OFF  
Switches to single sweep mode.  
CALC:MARK:FUNC:NDBD ON  
Switches on the n dB down function.  
INIT;\*WAI  
Starts a sweep and waits for the end.  
CALC:MARK:FUNC:NDBD:QFAC?  
Queries the Q factor of the measured bandwidth.



**Characteristics**

RST value: –

SCPI: device-specific

**Mode**

A

**CALCulate<1|2>:MARKer<1...4>:FUNCTION:NDBDown:RESult?**

This command queries the measured value. The value depends on the span setting:

- span > 0: frequency spacing of the two temporary markers (in Hz)
- span = 0: pulse width between the two temporary markers (in s)

A complete sweep with synchronization to sweep end must be performed between switching on the function and querying the measured value in order to obtain a correct query result. This is only possible in single sweep mode.

The numeric suffixes <1|2> and <1...4> are irrelevant for this command.

This command is only a query and therefore has no \*RST value.

**Example**

```
INIT:CONT OFF
```

Switches to single sweep mode.

```
CALC:MARK:FUNC:NDBD ON
```

Switches on the n dB down function.

```
INIT;*WAI
```

Starts a sweep and waits for the end.

```
CALC:MARK:FUNC:NDBD:RES?
```

Outputs the measured value.

**Characteristics**

\*RST value: –

SCPI: device-specific

**Mode**

A

**CALCulate<1|2>:MARKer<1...4>:FUNCTION:NDBDown:STATe**

This command switches the "N dB Down" function on or off. Marker 1 is activated first, if necessary.

The numeric suffixes <1|2> and <1...4> are irrelevant for this command.

**Parameter**

ON | OFF

**Example**

```
CALC:MARK:FUNC:NDBD:STAT ON
```

Switches on the "N dB Down" function.

**Characteristics**

\*RST value: OFF

SCPI: device-specific

**Mode**

A

**CALCulate<1|2>:MARKer<1...4>:FUNCtion:NDBDown:TIME?**

This command queries the values of the two temporary markers in zero span. The time values are separated by comma and output in ascending order.

A complete sweep with synchronization to sweep end must be performed between switching on the function and querying the measured value to obtain a correct query result. This is only possible in single sweep mode.

The numeric suffixes <1|2> and <1...4> are irrelevant for this command.

This command is only a query and therefore has no \*RST value.

**Example**

```
INIT:CONT OFF
```

Switches to single sweep mode

```
CALC:MARK:FUNC:NDBD ON
```

Switches on the n dB down function.

```
INIT;*WAI
```

Starts a sweep and waits for the end.

```
CALC:MARK:FUNC:NDBD:TIME?
```

Outputs the time values of the temporary markers.

**Characteristics**

\*RST value: –

SCPI: device-specific

**Mode**

A–T

**CALCulate<1|2>:MARKer<1...4>:FUNCtion:NOISe[:STATe]**

This command switches the noise measurement on or off for all markers. The noise power density is measured at the position of the markers. The result can be queried with [CALCulate<1|2>:MARKer<1...4>:FUNCtion:NOISe:RESult?](#).

The numeric suffixes <1|2> are irrelevant for this command.

**Parameter**

ON | OFF

**Example**

```
CALC:MARK:FUNC:NOIS ON
```

Switches on the noise measurement.

**Characteristics**

\*RST value: OFF

SCPI: device-specific

**Mode**

A

**CALCulate<1|2>:MARKer<1...4>:FUNCtion:NOISe:RESult?**

---

This command queries the result of the noise measurement.

A complete sweep with synchronization to the sweep end must be performed between switching on the function and querying the measured value in order to obtain a correct query result. This is only possible in single sweep mode.

The numeric suffixes <1|2> are irrelevant for this command.

This command is an event and therefore has no \*RST value and no query.

**Example**

```
INIT:CONT OFF
```

Switches to single sweep mode.

```
CALC:MARK2 ON
```

Switches on marker 2.

```
CALC:MARK2:FUNC:NOIS ON
```

Switches on noise measurement for marker 2.

```
INIT;*WAI
```

Starts a sweep and waits for the end.

```
CALC:MARK2:NOIS:RES?
```

Outputs the noise result of marker 2.

**Characteristics**

\*RST value: –

SCPI: device-specific

**Mode**

A

---

**CALCulate<1|2>:MARKer<1...4>:FUNCtion:REFerence**

---

This command sets the reference level to the power measured by the indicated marker. If marker 2, 3 or 4 is selected and used as delta marker, it is switched to marker mode.

The numeric suffix <1|2> are irrelevant for this command.

This command is an event and therefore has no \*RST value and no query.

**Example**

```
CALC:MARK2:FUNC:REF
```

Sets the reference level to the level of marker 2.

**Characteristics**

\*RST value: –

SCPI: device-specific

**Mode**

A

---

---

**CALCulate<1|2>:MARKer<1...4>:FUNCtion:TOI[:STATe]**

---

This command initiates the measurement of the third-order intercept point.

A two-tone signal with equal carrier levels is expected at the RF input of the instrument. Marker 1 and marker 2 (both normal markers) are set to the maximum of the two signals. Delta marker 3 and delta marker 4 are positioned to the intermodulation products. The delta markers can be modified separately afterwards with the `CALCulate<1|2>:DELTaMarker<1...4>:X` command.

The third-order intercept is calculated from the level spacing between the normal markers and the delta markers.

The numeric suffix <1|2> and <1...4> are irrelevant for this command.

**Parameter**

ON | OFF

**Example**

```
CALC:MARK:FUNC:TOI ON
```

Switches on the measurement of the third-order intercept.

**Characteristics**

\*RST value: OFF

SCPI: device-specific

**Mode**

A

---

---

**CALCulate<1|2>:MARKer<1...4>:FUNCtion:TOI:RESult?**

---

This command queries the third-order intercept point measurement.

A complete sweep with synchronization to sweep end must be performed between switching on the function and querying the measured value to obtain a correct query result. This is only possible in single sweep mode.

The numeric suffix <1|2> and <1...4> are irrelevant for this command.

This command is only a query and therefore has no \*RST value.

**Example**

```
INIT:CONT OFF
```

Switches to single sweep mode.

```
CALC:MARK:FUNC:TOI ON
```

Switches the intercept measurement.

```
INIT;*WAI
```

Starts a sweep and waits for the end.

```
CALC:MARK:FUNC:TOI:RES?
```

Outputs the measured value.

**Characteristics**

\*RST value: –

SCPI: device-specific

**Mode**

A

---

**CALCulate<1|2>:MARKer<1...4>:FUNCtion:TOI:SEARChsignal**

This command starts the search of the signals required for the third order intercept measurement.

The numeric suffix <1|2> are irrelevant for this command.

**Note:** *No new measurement is done. Only the currently available trace selected for the TOI measurement is used*

**Parameter**

ONCE

**Example**

```
CALC:MARK:FUNC:TOI:SEAR ONCE
```

Executes the search for 2 signals and their intermodulation product at the currently available trace.

**Characteristics**

\*RST value: –

SCPI: conform

**Mode**

A

**CALCulate<1|2>:MARKer<1...4>:FUNCtion:ZOOM**

This command defines the range to be zoomed around marker 1. Marker 1 is activated first, if necessary.

The subsequent frequency sweep is stopped at the marker position and the frequency of the signal is counted. This frequency becomes the new center frequency, and the zoomed span is set. In order to recognize the end of the operation the synchronization to the sweep end should be activated. This is only possible in single sweep mode.

The numeric suffixes <1|2> are irrelevant for this command.

This command is an event and therefore has no \*RST value and no query.

**Parameter**

<numeric\_value>

**Example**

```
INIT:CONT OFF
```

Switches to single sweep mode

```
CALC:MARK:FUNC:ZOOM 1kHz;*WAI
```

Activates zooming and waits for its end.

```
CALC:MARK1:FUNC:ZOOM 10
```

Zooms in around marker 1 by a factor of 10.

**Characteristics**

\*RST value: –

SCPI: device-specific

**Mode**

R, A–F

**CALCulate:MARKer:FUNCtion:HARMonics Subsystem**

The CALCulate:MARKer:FUNCtion:POWER subsystem contains the commands to define the settings for harmonics measurement.

**Commands of the CALCulate:MARKer:FUNCtion:HARMonics Subsystem**

- CALCulate<1|2>:MARKer<1...4>:FUNCtion:HARMonics[:STATe]
- CALCulate<1|2>:MARKer<1...4>:FUNCtion:HARMonics:BANDwidth:AUTO
- CALCulate<1|2>:MARKer<1...4>:FUNCtion:HARMonics:DISToRtion?
- CALCulate<1|2>:MARKer<1...4>:FUNCtion:HARMonics:LIST?
- CALCulate<1|2>:MARKer<1...4>:FUNCtion:HARMonics:NHARmonics
- CALCulate<1|2>:MARKer<1...4>:FUNCtion:HARMonics:PRESet

**CALCulate<1|2>:MARKer<1...4>:FUNCtion:HARMonics[:STATe]**

This command activates/deactivates the harmonic distortion measurement.

If the measurement is started in span > 0, the last span defines the search range for the first harmonic. The level is determined for the first harmonic.

If the measurement is started in zero span, center frequency and level are used unchanged.

The numeric suffix <1|2> and <1...4> are irrelevant for this command.

**Parameter**

ON | OFF

**Example**

```
CALC:MARK:FUNC:HARM ON
```

Activates the harmonic distortion measurement.

**Characteristics**

RST value: OFF

SCPI: device-specific

**Mode**

A-F, A-T

**CALCulate<1|2>:MARKer<1...4>:FUNCtion:HARMonics:BANDwidth:AUTO**

This command defines the resolution bandwidth of the harmonic in respect to the bandwidth of the first harmonic. For details refer to chapter "Instrument Functions", section "Harmonic RBW Auto".

The numeric suffix <1|2> are irrelevant for this command.

**Parameter**

OFF identical

ON a multiple

**Example**

```
CALC:MARK:FUNC:HARM:BAND:AUTO OFF
```

Deactivates the automatic bandwidth enlargement.

**Characteristics**

RST value: ON

SCPI: device-specific

**Mode**A-F, A-T

---

**CALCulate<1|2>:MARKer<1...4>:FUNCtion:HARMonics:DISToRTion?**

---

This command queries the distortion results (THD: total harmonic distortion). Two values separated by a comma are returned: <THD in %>, <THD in dB>.

To obtain a correct result, a complete sweep with synchronization to the end of the sweep must be performed before a query is output. Synchronization is possible only in the single sweep mode.

The numeric suffix <1|2> and <1...4> are irrelevant for this command.

**Parameter**

TOTal

**Example**

INIT:CONT OFF

Switches to single sweep mode.

CALC:MARK:FUNC:HARM:NHARM 3

Sets the number of harmonics to be measured to 3.

CALC:MARK:FUNC:HARM ON

Activates the harmonic distortion measurement.

INIT;\*WAI

Starts a sweep and waits for the end of the sweep.

CALC:MARK:FUNC:HARM:DIS? TOT

Returns the total distortion in % and dB.

**Characteristics**

RST value: –

SCPI: device-specific

**Mode**A-F, A-T

---

**CALCulate<1|2>:MARKer<1...4>:FUNCtion:HARMonics:LIST?**

This command reads out the list of the harmonics. The first value is the absolute power of the first harmonic (the unit is set via the CALCulate<1|2>:UNIT:POWER command). The following values are relative to the carrier signal and have the unit dB. They are separated by commas and correspond to the harmonics to be measured (set via the CALCulate<1|2>:MARKer<1...4>:FUNCtion:HARMonics:NHARmonics command).

To obtain a correct result, a complete sweep with synchronization to the end of the sweep must be performed before a query is output. Synchronization is possible only in the single sweep mode.

The numeric suffixes <1|2> are not relevant.

**Example**

```
INIT:CONT OFF
```

Switches to single sweep mode.

```
CALC:MARK:FUNC:HARM:NHARM 3
```

Sets the number of harmonics to be measured to 3.

```
CALC:MARK:FUNC:HARM ON
```

Activates the harmonic distortion measurement.

```
INIT;*WAI
```

Starts a sweep and waits for the end of the sweep.

```
CALC:MARK:FUNC:HARM:LIST?
```

Returns the values for the 3 measured harmonics.

**Characteristics**

RST value: –

SCPI: device-specific

**Mode**

A-F, A-T

**CALCulate<1|2>:MARKer<1...4>:FUNCtion:HARMonics:NHARmonics**

This command sets the number of harmonics to be measured.

The numeric suffix <1|2> and <1...4> are irrelevant for this command.

**Parameter**

1...26

**Example**

```
CALC:MARK:FUNC:HARM:NHARM 3
```

Sets the number of harmonics to be measured to 3.

**Characteristics**

RST value: 10

SCPI: device-specific

**Mode**

A-F, A-T



**CALCulate<1|2>:MARKer<1...4>:FUNCtion:HARMonics:PRESet**

---

This command optimizes the device settings depending on the span setting:

- |           |   |
|-----------|---|
| span > 0  | Frequency and level of the first harmonic are determined and used for the measurement list. |
| zero span | The level of the first harmonic is determined. The frequency remains unchanged.             |

The numeric suffixes <1/2> and <1...4> are irrelevant.

This command is an event and therefore has no \*RST value.

**Example**

```
CALC:MARK:FUNC:HARM:PRES
```

Optimizes the device settings for the harmonic measurement.

**Characteristics**

RST value: –

SCPI: device-specific

**Mode**

A-F, A-T

---

**CALCulate:MARKer:FUNCTION:POWER Subsystem**

The CALCulate:MARKer:FUNCTION:POWER subsystem contains the commands for control of power measurement.

**Commands of the CALCulate:MARKer:FUNCTION:POWER Subsystem**

- CALCulate<1|2>:MARKer:FUNCTION:POWer[:STATe]
- CALCulate<1|2>:MARKer:FUNCTION:POWer:MODE
- CALCulate<1|2>:MARKer:FUNCTION:POWer:PRESet
- CALCulate<1|2>:MARKer:FUNCTION:POWer:RESult?
- CALCulate<1|2>:MARKer:FUNCTION:POWer:RESult:PHZ
- CALCulate<1|2>:MARKer:FUNCTION:POWer:SElect

**Further information**

- "Predefined CP / ACP standards" on page 6.78

**Predefined CP / ACP standards**

Parameter	Standard
AWLan	WLAN 802.11A
BWLan	WLAN 802.11B
CDPD	CDPD
D2CDma	CDMA 2000 direct sequence
FIS95A, F8CDma	CDMA IS95A forward
FIS95C0	CDMA IS95C Class 0 forward
FIS95C1	CDMA IS95C Class 1 forward
FJ008, F19CDma	CDMA J–STD008 forward
FTCDMa / TCDMa	TD–SCDMA forward
FW3Gppcdma	W–CDMA 3.84 MHz forward
M2CDma	CDMA 2000 MC3 multi carrier with 3 carriers
NADC	NADC IS136
PDC	PDC
PHS	PHS
RFID14443	RFID 14443
RIS95A, R8CDma	CDMA IS95A reverse
RIS95C0	CDMA IS95C Class 0 reverse
RIS95C1	CDMA IS95C Class 1 reverse
RJ008, R19CDma	CDMA J–STD008 reverse
RTCDMA	TD–SCDMA reverse
RW3Gppcdma	W–CDMA 3.84 MHz reverse
S2CDma	CDMA 2000 MC1 multi carrier with 1 carrier
TETRA	TETRA
WIBRo	WIBRO
WIMax	WIMAX

**CALCulate<1|2>:MARKer:FUNCtion:POWER[:STATe]**

---

This command switches off the power measurement.  
 The numeric suffixes <1|2> are not relevant.  
 This command is an event and therefore has no \*RST value.

**Parameter**

OFF

**Example**

```
CALC:MARK:FUNC:POW OFF
```

Switches off the power measurement.

**Characteristics**

\*RST value: –  
 SCPI: device-specific

**Mode**A–F

---

**CALCulate<1|2>:MARKer:FUNCtion:POWER:MODE**

---

This commands defines the method by which the channel power values are calculated from the current trace.  
 The numeric suffixes <1|2> are not relevant.

**Parameter**

WRITE	The channel power and the adjacent channel powers are calculated directly from the current trace
MAXHold	The power values are calculated from the current trace and compared with the previous power value using a maximum algorithm.

**Example**

```
CALC:MARK:FUNC:POW:MODE MAXH
```

Sets the Maxhold channel power mode.

**Characteristics**

\*RST value: –  
 SCPI: device-specific

**Mode**A–F

---

**CALCulate<1|2>:MARKer:FUNCtion:POWER:PRESet**

This command selects the power measurement setting for a standard and previously switches on the corresponding measurement, if required.

The configuration for a standard comprises of the parameters weighting filter, channel bandwidth and spacing, resolution and video bandwidth, as well as detector and sweep time.

The numeric suffixes <1|2> are not relevant.

**Note:** *The settings for standards IS95A and C differ as far as the calculation method of channel spacings is concerned. For IS95A and J-STD008 the spacing is calculated from the center of the main channel to the center of the corresponding adjacent channel, for IS95C from the center of the main channel to the nearest border of the adjacent channel.*

**Parameter**

NADC | TETRA | PDC | PHS | CDPD | FWCDma | RWCDma | F8CDma | R8CDma | F19Cdma | R19Cdma | FW3Gppcdma | RW3Gppcdma | S2CDma | FIS95A | RIS95A | FIS95C0 | RIS95C0 | FIS95C1 | RIS95C1 | FJ008 | RJ008 | TCDMa | FTCDMa | RTCDMa | AWLan | BWLan | WIMax | WIBRo | RFID14443 | NONE

For further details refer to "[Predefined CP / ACP standards](#)" on page 6.78.

**Example**

```
CALC:MARK:FUNC:POW:PRES NADC
Selects the standard setting for NADC
```

**Characteristics**

\*RST value: –

SCPI: device-specific

**Mode**

A–F

**CALCulate<1|2>:MARKer:FUNCtion:POWER:RESult?**

This command queries the result of the performed power measurement. If necessary, the measurement is switched on prior to the query.

The channel spacings and channel bandwidths are configured in the "[SENSe:POWER Subsystem](#)" on page 6.183.

To obtain a correct result, a complete sweep with synchronization to the end of the sweep must be performed before a query is output. Synchronization is possible only in the single sweep mode.

The numeric suffixes <1|2> are not relevant.

This command is a query and therefore has no \*RST value.

**Parameter**

ACPower            Adjacent-channel power measurement

Results are output in the following sequence, separated by commas:

Power of transmission channel  
 Power of lower adjacent channel  
 Power of upper adjacent channel  
 Power of lower alternate channel 1  
 Power of upper alternate channel 1  
 Power of lower alternate channel 2  
 Power of upper alternate channel 2

	<p>The number of measured values returned depends on the number of adjacent/alternate channels selected with  <code>[SENSe&lt;1 2&gt;:]POWer:ACHannel:ACPairs</code>.</p> <p>With logarithmic scaling (RANGE LOG), the power is output in the currently selected level unit; with linear scaling (RANGE LIN dB or LIN %), the power is output in W. If <code>[SENSe&lt;1 2&gt;:]POWer:ACHannel:MODE</code> is set to REL, the adjacent/alternate-channel power is output in dB.</p>
CN	<p>Measurement of carrier-to-noise ratio</p> <p>The carrier-to-noise ratio in dB is returned.</p>
CN0	<p>Measurement of carrier-to-noise ratio referenced to 1 Hz bandwidth.</p> <p>The carrier-to-noise ratio in dB/Hz is returned.</p>
CPOWer	<p>Channel power measurement</p> <p>In a Spectrum Emission Mask measurement, the query returns the power result for the reference range, if this power reference type is selected.</p> <p>With logarithmic scaling (RANGE LOG), the channel power is output in the currently selected level unit; with linear scaling (RANGE LIN dB or LIN %), the channel power is output in W.</p>
MCACpower	<p>Channel/adjacent-channel power measurement with several carrier signals</p> <p>Results are output in the following sequence, separated by commas:</p> <ul style="list-style-type: none"> <li>Power of carrier signal 1 to 12 in ascending order</li> <li>Total power of all carrier signals</li> <li>Power of lower adjacent channel</li> <li>Power of upper adjacent channel</li> <li>Power of lower alternate channel 1</li> <li>Power of upper alternate channel 1</li> <li>Power of lower alternate channel 2</li> <li>Power of upper alternate channel 2</li> </ul> <p>The number of measured values returned depends on the number of carrier signals and adjacent/alternate channels selected with  <code>[SENSe&lt;1 2&gt;:]POWer:ACHannel:TXChannel:COUNT</code> and  <code>[SENSe&lt;1 2&gt;:]POWer:ACHannel:ACPairs</code>.</p> <p>If only one carrier signal is measured, the total value of all carrier signals will not be output.</p> <p>With logarithmic scaling (RANGE LOG), the power is output in dBm; with linear scaling (RANGE LIN dB or LIN %), the power is output in W. If <code>[SENSe&lt;1 2&gt;:]POWer:ACHannel:MODE</code> is set to REL, the adjacent/alternate-channel power is output in dB.</p>
OBANdwidth   OBWidth	<p>Measurement of occupied bandwidth</p> <p>The occupied bandwidth in Hz is returned.</p>
PPOWer	<p>Power of the highest peak</p> <p>In a Spectrum Emission Mask measurement, the query returns the power result for the reference range, if this power reference type is selected.</p>

#### Example of channel/adjacent-channel power measurement

`POW:ACH:ACP 3`

Sets the number of adjacent/alternate channels to 3.

`POW:ACH:BAND 30KHZ`

Sets the bandwidth of the transmission channel to 30 kHz.

POW:ACH:BAND:ACH 40KHZ

Sets the bandwidth of each adjacent channel to 40 kHz.

POW:ACH:BAND:ALT1 50KHZ

Sets the bandwidth of each alternate channel to 50 kHz.

POW:ACH:BAND:ALT2 60KHZ

Sets the bandwidth of alternate channel 2 to 60 kHz.

POW:ACH:SPAC 30KHZ

Sets the spacing between the transmission channel and the adjacent channel to 30 kHz, the spacing between the transmission channel and alternate channel 1 to 60 kHz, and the spacing between the transmission channel and alternate channel 2 to 90 kHz.

POW:ACH:SPAC:ALT1 100KHZ

Sets the spacing between the alternate adjacent channels and the TX channel. For details refer to the `[SENSe<1|2>:]POWer:ACHannel:SPACing:ALternate<1...11>` command.

POW:ACH:SPAC:ALT2 140KHZ

Sets the spacing between the transmission channel and alternate channel 2 to 140 kHz.

POW:ACH:MODE ABS

Switches on absolute power measurement.

CALC:MARK:FUNC:POW:SEL ACP

Switches on the adjacent-channel power measurement.

INIT:CONT OFF

Switches over to single sweep mode.

INIT;\*WAI

Starts a sweep and waits for the end of the sweep.

CALC:MARK:FUNC:POW:RES? ACP

Queries the result of adjacent-channel power measurement.

POW:ACH:REF:AUTO ONCE

Defines the measured channel power as the reference value for relative power measurements.

**Note:** *If the channel power only is to be measured, all commands relating to adjacent/alternate channel bandwidth and channel spacings are omitted. The number of adjacent/alternate channels is set to 0 with `[SENSe<1|2>:]POWer:ACHannel:ACPairs`.*

### Example of occupied bandwidth measurement

POW:BAND 90PCT

Defines 90% as the percentage of the power to be contained in the bandwidth range to be measured.

INIT:CONT OFF

Switches over to single sweep mode.

INIT;\*WAI

Starts a sweep and waits for the end of the sweep.

CALC:MARK:FUNC:POW:RES? OBW

Queries the occupied bandwidth measured.

### Characteristics

\*RST value: –

SCPI: device-specific

### Mode

A–F

**CALCulate<1|2>:MARKer:FUNCtion:POWer:RESult:PHZ**

This command switches the query response of the power measurement results between output of absolute values and output referred to the measurement bandwidth.

The measurement results are output with the

`CALCulate<1|2>:MARKer:FUNCtion:POWer:RESult?` command.

The numeric suffixes <1|2> are not relevant.

**Parameter**

ON	Results output: channel power density in dBm/Hz
OFF	Results output: channel power is displayed in dBm

**Example**

```
CALC:MARK:FUNC:POW:RES:PHZ ON
```

Output of results referred to the channel bandwidth.

For details on a complete measurement example refer to [Example of channel/adjacent-channel power measurement](#).

**Characteristics**

\*RST value: OFF

SCPI: device-specific

**Mode**

A-F

**CALCulate<1|2>:MARKer:FUNCtion:POWer:SElect**

This command selects – and switches on – specified power measurement type.

The channel spacings and channel bandwidths are configured in the "[SENSe:POWer Subsystem](#)" on page 6.183.

The numeric suffixes <1|2> are not relevant.

**Note:** *If CPOwer is selected, the number of adjacent channels ([SENSe<1|2>:]POWer:ACHannel:ACPairs) is set to 0. If ACPower is selected, the number of adjacent channels is set to 1, unless adjacent-channel power measurement is switched on already.*

*The channel/adjacent-channel power measurement is performed for the trace selected with [SENSe<1|2>:]POWer:TRACe.*

The occupied bandwidth measurement is performed for the trace on which marker 1 is positioned. To select another trace for the measurement, marker 1 is to be positioned on the desired trace by means of `CALCulate<1|2>:MARKer<1..4>:TRACe`.

**Parameter**

ACPower	Adjacent-channel power measurement with a single carrier signal
CPOwer	Channel power measurement with a single carrier signal (equivalent to adjacent-channel power measurement with <i>NO. OF ADJ CHAN = 0</i> )
MCACpower	Channel/adjacent-channel power measurement with several carrier signals
OBANdwidth   OBWidth	Measurement of occupied bandwidth
CN	Measurement of carrier-to-noise ratio
CN0	Measurement of carrier-to-noise ratio referenced to 1 Hz bandwidth

**Example**

CALC:MARK:FUNC:POW:SEL ACP

Switches on adjacent-channel power measurement.

**Characteristics**

\*RST value: –

SCPI: device-specific

**Mode**

A–F

---



**CALCulate:MARKer:FUNCtion:STRack Subsystem**

The CALCulate:MARKer:FUNCtion:STRack subsystem defines the settings of the signal track.

**Commands of the CALCulate:MARKer:FUNCtion:STRack Subsystem**

- CALCulate<1|2>:MARKer:FUNCtion:STRack[:STATe]
- CALCulate<1|2>:MARKer:FUNCtion:STRack:BANDwidth|BWIDth
- CALCulate<1|2>:MARKer:FUNCtion:STRack:THReshold
- CALCulate<1|2>:MARKer:FUNCtion:STRack:TRACe

**CALCulate<1|2>:MARKer:FUNCtion:STRack[:STATe]**

This command switches the signal-track function on or off.

With signal track activated, the maximum signal is determined after each frequency sweep and the center frequency is set to the frequency of this signal. Thus with drifting signals the center frequency follows the signal.

The numeric suffixes <1|2> are not relevant.

**Parameter**

ON | OFF

**Example**

```
CALC:MARK:FUNC:STR ON
```

Switches on the signal track function.

**Characteristics**

\*RST value: OFF

SCPI: device-specific

**Mode**

A-F

**CALCulate<1|2>:MARKer:FUNCtion:STRack:BANDwidth|BWIDth**

These commands have the same function. They define the bandwidth around the center frequency within which the largest signal is searched.

The numeric suffixes <1|2> are not relevant.

**Note:** *The entry of the search bandwidth is only possible if the Signal Track function is switched on (CALCulate<1|2>:MARKer:FUNCtion:STRack[:STATe]).*

**Parameter**

10Hz to MAX (span)

**Example**

```
CALC:MARK:FUNC:STR:BAND 1MHZ
```

Sets the search bandwidth to 1 MHz.

```
CALC:MARK:FUNC:STR:BWID 1MHZ
```

Alternative command for the same function.

**Characteristics**

\*RST value: – (= span/10 on activating the function)

SCPI: device-specific

**Mode**

A–F

---

**CALCulate<1|2>:MARKer:FUNCtion:STRack:THReshold**

---

This command defines the threshold above which the largest signal is searched for.

The response unit depends on the settings defined with `CALCulate<1|2>:UNIT:POWER`.

The numeric suffixes <1|2> are not relevant.

**Note:** *The entry of the search bandwidth is only possible if the Signal Track function is switched on (`CALCulate<1|2>:MARKer:FUNCtion:STRack[:STATE]`).*

**Parameter**

–330dBm to +30dBm

**Example**

```
CALC:MARK:FUNC:STR:THR -50DBM
```

Sets the threshold for signal tracking to –50 dBm.

**Characteristics**

\*RST value: –120 dBm

SCPI: device-specific

**Mode**

A–F

---

**CALCulate<1|2>:MARKer:FUNCtion:STRack:TRACe**

---

This command defines the trace on which the largest signal is searched for.

The numeric suffixes <1|2> are not relevant.

**Parameter**

1 to 6

**Example**

```
CALC:MARK:FUNC:STR:TRAC 3
```

Defines trace 3 as the trace for signal tracking.

**Characteristics**

\*RST value: 1

SCPI: device-specific

**Mode**

A–F

---

**CALCulate:MARKer:FUNCTion:SUMMary Subsystem**

This subsystem contains the commands for controlling the power functions in zero span.

**Commands of the CALCulate:MARKer:FUNCTion:SUMMary Subsystem**

- CALCulate<1|2>:MARKer:FUNCTion:MSUMmary?
- CALCulate<1|2>:MARKer:FUNCTion:SUMMary[:STATe]
- CALCulate<1|2>:MARKer:FUNCTion:SUMMary:AOFF
- CALCulate<1|2>:MARKer:FUNCTion:SUMMary:AVERage
- CALCulate<1|2>:MARKer:FUNCTion:SUMMary:MEAN[:STATe]
- CALCulate<1|2>:MARKer:FUNCTion:SUMMary:MEAN:AVERage:RESult?
- CALCulate<1|2>:MARKer:FUNCTion:SUMMary:MEAN:PHOLd:RESult?
- CALCulate<1|2>:MARKer:FUNCTion:SUMMary:MEAN:RESult?
- CALCulate<1|2>:MARKer:FUNCTion:SUMMary:MODE
- CALCulate<1|2>:MARKer:FUNCTion:SUMMary:PHOLd
- CALCulate<1|2>:MARKer:FUNCTion:SUMMary:PPEak[:STATe]
- CALCulate<1|2>:MARKer:FUNCTion:SUMMary:PPEak:AVERage:RESult?
- CALCulate<1|2>:MARKer:FUNCTion:SUMMary:PPEak:PHOLd:RESult?
- CALCulate<1|2>:MARKer:FUNCTion:SUMMary:PPEak:RESult?
- CALCulate<1|2>:MARKer:FUNCTion:SUMMary:REFerence:AUTO
- CALCulate<1|2>:MARKer:FUNCTion:SUMMary:RMS[:STATe]
- CALCulate<1|2>:MARKer:FUNCTion:SUMMary:RMS:AVERage:RESult?
- CALCulate<1|2>:MARKer:FUNCTion:SUMMary:RMS:PHOLd:RESult?
- CALCulate<1|2>:MARKer:FUNCTion:SUMMary:RMS:RESult?
- CALCulate<1|2>:MARKer:FUNCTion:SUMMary:SDEViation[:STATe]
- CALCulate<1|2>:MARKer:FUNCTion:SUMMary:SDEViation:AVERage:RESult?
- CALCulate<1|2>:MARKer:FUNCTion:SUMMary:SDEViation:PHOLd:RESult?
- CALCulate<1|2>:MARKer:FUNCTion:SUMMary:SDEViation:RESult?

---

**CALCulate<1|2>:MARKer:FUNCTION:MSUMmary?**



---

The commands of this subsystem are used to determine the power of a sequence of signal pulses having the same interval, as are typical for the slots of a GSM signal, for example. The number of pulses to be measured as well as the measurement time and the period can be set. To define the position of the first pulse in the trace, a suitable offset can be entered.

The evaluation is performed on the measurement data of a previously recorded trace. The data recorded during the set measurement time is combined to a measured value for each pulse according to the detector specified and the indicated number of results is output as a list.

Trace 1 is always used by the function.

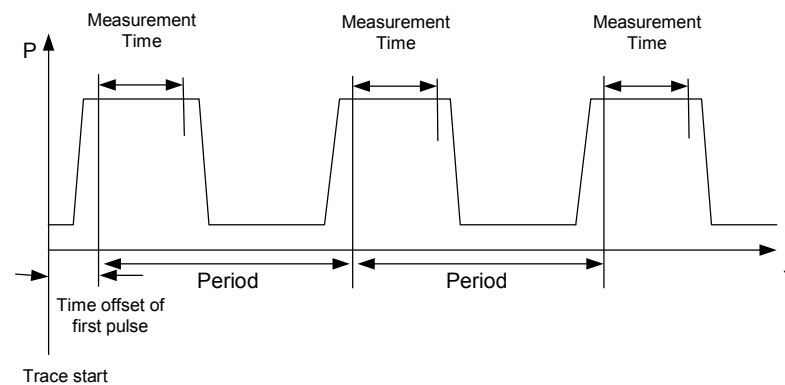
The numeric suffixes <1|2> are not relevant.



### Parameter

<time offset of first pulse>, <measurement time>, <period>, < # of pulses to measure>

### Example

```
DISP:WIND:TRAC:Y:RLEV -10dBm
```

Sets the reference level to 10 dB

```
INP:ATT 30 dB
```

Sets the input attenuation to 30 dB

```
FREQ:CENT 935.2MHz;SPAN 0Hz
```

Sets the receive frequency to 935.2 MHz and the span to 0 Hz

```
BAND:RES 1MHz;VID 3MHz
```

Sets the resolution bandwidth to 1 MHz and the video bandwidth to 3 MHz

```
DET RMS
```

Sets the RMS detector

```
TRIG:SOUR VID;LEV:VID 50 PCT
```

Selects the trigger source VIDEo and sets the level of the video trigger source to 50 PCT

```
SWE:TIME 50ms
```

Sets the sweep time to 50 ms

```
INIT;*WAI
```

Starts the measurement with synchronization

```
CALC:MARK:FUNC:MSUM? 50US,450US,576.9US,8
```

Queries 8 bursts with an offset of 50  $\mu$ s, a test time of 450  $\mu$ s and a period of 576.9  $\mu$ s

### Characteristics

\*RST value: –

SCPI: device-specific

### Mode

A–T

---

**CALCulate<1|2>:MARKer:FUNCtion:SUMMary[:STATe]**

---

This command switches on or off the previously selected power measurements in zero span. Thus one or several measurements can be first selected and then switched on and off together with [CALCulate<1|2>:MARKer:FUNCtion:SUMMary\[:STATe\]](#).

The numeric suffixes <1|2> are not relevant.

**Parameter**

ON | OFF

**Example**

```
CALC:MARK:FUNC:SUMM:STAT ON
```

**Characteristics**

\*RST value: OFF

SCPI: device-specific

**Mode**

A-T

---

---

**CALCulate<1|2>:MARKer:FUNCtion:SUMMary:AOFF**

---

This command switches off all measurements in zero span.

The numeric suffixes <1|2> are not relevant.

This command is an event and therefore has no \*RST value and no query.

**Example**

```
CALC:MARK:FUNC:SUMM:AOFF
```

Switches off the functions for power measurement in zero span.

**Characteristics**

\*RST value: –

SCPI: device-specific

**Mode**

A-T

---

---

**CALCulate<1|2>:MARKer:FUNCtion:SUMMary:AVERage**

---

This command switches on or off averaging for the active power measurement in zero span.

Averaging is reset by switching it off and on again.

The number of results required for the calculation of average is defined with [\[SENSe<1|2>:\]AVERage:COUNT](#).

Synchronization to the end of averaging is only possible in single sweep mode.

The numeric suffixes <1|2> are not relevant.

**Parameter**

ON | OFF

**Example**

```
INIT:CONT OFF
```

Switches to single sweep mode.

```
CALC:MARK:FUNC:SUMM:AVER ON
```

Switches on the calculation of average.

```
AVER:COUN 200
```

Sets the measurement counter to 200.

```
INIT;*WAI
```

Starts a sweep and waits for the end.

**Characteristics**

\*RST value: OFF

SCPI: device-specific

**Mode**

A-T

**CALCulate<1|2>:MARKer:FUNCtion:SUMMery:MEAN[:STATe]**

This command switches on or off the measurement of the mean value.

The numeric suffixes <1|2> are not relevant.

**Note:** *The measurement is performed on the trace on which marker 1 is positioned. In order to evaluate another trace, marker 1 must be positioned on another trace with*

[CALCulate<1|2>:MARKer<1...4>:TRACe](#).

**Parameter**

ON | OFF

**Example**

```
CALC:MARK:FUNC:SUMM:MEAN ON
```

Switches on the function.

**Characteristics**

\*RST value: OFF

SCPI: device-specific

**Mode**

A-T

**CALCulate<1|2>:MARKer:FUNCtion:SUMMery:MEAN:AVERAge:RESult?**

This command queries the result of the measurement of the averaged mean value. The query is only possible if averaging has been activated previously using

[CALCulate<1|2>:MARKer:FUNCtion:SUMMery:AVERAge](#).

A complete sweep with synchronization to sweep end must be performed between switching on the function and querying the measured value to obtain a correct query result. This is only possible in single sweep mode.

The numeric suffixes <1|2> are not relevant.

This command is only a query and therefore has no \*RST value.

**Example**

```
INIT:CONT OFF
```

Switches to single sweep mode.

```
CALC:MARK:FUNC:SUMM:MEAN ON
```

Switches on the function.

```
CALC:MARK:FUNC:SUMM:AVER ON
```

Switches on the average value calculation.

```
INIT;*WAI
```

Starts a sweep and waits for the end.

```
CALC:MARK:FUNC:SUMM:MEAN:AVER:RES?
```

Outputs the result.

**Characteristics**

\*RST value: –

SCPI: device-specific

**Mode**

A–T

**CALCulate<1|2>:MARKer:FUNCtion:SUMMary:MEAN:PHOLd:RESult?**

This command queries the result of the measurement of the mean value with active peak hold.

The query is only possible if the peak hold function has been switched on previously using

[CALCulate<1|2>:MARKer:FUNCtion:SUMMary:PHOLd](#).

The query is possible only if the peak hold function is active.

A complete sweep with synchronization to sweep end must be performed between switching on the function and querying the measured value to obtain a correct query result. This is only possible in single sweep mode.

The numeric suffixes <1|2> are not relevant.

This command is only a query and therefore has no \*RST value.

**Example**

```
INIT:CONT OFF
```

Switches to single sweep mode.

```
CALC:MARK:FUNC:SUMM:MEAN ON
```

Switches on the function.

```
CALC:MARK:FUNC:SUMM:PHOL ON
```

Switches on the peak value measurement.

```
INIT;*WAI
```

Starts a sweep and waits for the end.

```
CALC:MARK:FUNC:SUMM:MEAN:PHOL:RES?
```

Outputs the result.

**Characteristics**

\*RST value: –

SCPI: device-specific

**Mode**

A–T

---

**CALCulate<1|2>:MARKer:FUNCtion:SUMMary:MEAN:RESult?**

---

This command queries the result of the measurement of the mean value.

A complete sweep with synchronization to sweep end must be performed between switching on the function and querying the measured value to obtain a correct query result. This is only possible in single sweep mode.

The numeric suffixes <1|2> are not relevant.

This command is only a query and therefore has no \*RST value.

**Example**

```
INIT:CONT OFF
```

Switches to single sweep mode.

```
CALC:MARK:FUNC:SUMM:MEAN ON
```

Switches on the function.

```
INIT;*WAI
```

Starts a sweep and waits for the end.

```
CALC:MARK:FUNC:SUMM:MEAN:RES?
```

Outputs the result.

**Characteristics**

\*RST value: –

SCPI: device-specific

**Mode**

A–T

---

---

**CALCulate<1|2>:MARKer:FUNCtion:SUMMary:MODE**

---

This command selects absolute or relative power measurement in zero span.

The reference power for relative measurement is defined with

[CALCulate<1|2>:MARKer:FUNCtion:SUMMary:REference:AUTO](#). If the reference power is not defined, the value 0 dBm is used.

The numeric suffixes <1|2> and <1...4> are irrelevant for this command.

**Parameter**

ABSolute | RELative

**Example**

```
CALC:MARK:FUNC:SUMM:MODE REL
```

Switches the power measurement in zero span to relative.

**Characteristics**

RST value: ABSolute

SCPI: device-specific

**Mode**

A–T

---



**CALCulate<1|2>:MARKer:FUNCtion:SUMMary:PHOLd**

---

This command switches on or off the peak–hold function for the active power measurement in zero span.

The peak–hold function is reset by switching it off and on again.

The numeric suffixes <1|2> are not relevant.

**Parameter**

ON | OFF

**Example**

CALC:MARK:FUNC:SUMM:PHOL ON  
Switches on the function.

**Characteristics**

\*RST value: OFF

SCPI: device–specific

**Mode**

A–T

---

**CALCulate<1|2>:MARKer:FUNCtion:SUMMary:PPEak[:STATe]**

---

This command switches on or off the measurement of the positive peak value.

The numeric suffixes <1|2> are not relevant.

**Parameter**

ON | OFF

**Example**

CALC:MARK:FUNC:SUMM:PPE ON  
Switches on the function.

**Characteristics**

\*RST value: OFF

SCPI: device–specific

**Mode**

A–T

---

**CALCulate<1|2>:MARKer:FUNCtion:SUMMary:PPEak:AVERage:RESult?**

---

This command is used to query the result of the measurement of the averaged positive peak value. The query is only possible if averaging has been activated previously using

[CALCulate<1|2>:MARKer:FUNCtion:SUMMary:AVERage](#).

A complete sweep with synchronization to sweep end must be performed between switching on the function and querying the measured value to obtain a correct query result. This is only possible in single sweep mode.

The numeric suffixes <1|2> are not relevant.

This command is only a query and therefore has no \*RST value.

**Example**

```
INIT:CONT OFF
```

Switches to single sweep mode.

```
CALC:MARK:FUNC:SUMM:PPE ON
```

Switches on the function.

```
CALC:MARK:FUNC:SUMM:AVER ON
```

Switches on the calculation of average.

```
INIT;*WAI
```

Starts a sweep and waits for the end.

```
CALC:MARK:FUNC:SUMM:PPE:AVER:RES?
```

Outputs the result.

**Characteristics**

\*RST value: –

SCPI: device-specific

**Mode**

A–T

**CALCulate<1|2>:MARKer:FUNCTION:SUMMary:PPEak:PHOLd:RESult?**

This command is used to query the result of the measurement of the positive peak value with active peak hold function. The query is only possible if the peak hold function has been activated previously using `CALCulate<1|2>:MARKer:FUNCTION:SUMMary:PHOLd`.

A complete sweep with synchronization to sweep end must be performed between switching on the function and querying the measured value to obtain a correct query result. This is only possible in single sweep mode.

The numeric suffixes <1|2> are not relevant.

This command is only a query and therefore has no \*RST value.

**Example**

```
INIT:CONT OFF
```

Switches to single sweep mode.

```
CALC:MARK:FUNC:SUMM:PPE ON
```

Switches on the function.

```
CALC:MARK:FUNC:SUMM:PHOL ON
```

Switches on the measurement of the peak value.

```
INIT;*WAI
```

Starts a sweep and waits for the end.

```
CALC:MARK:FUNC:SUMM:PPE:PHOL:RES?
```

Outputs the result.

**Characteristics**

\*RST value: –

SCPI: device-specific

**Mode**

A–T

**CALCulate<1|2>:MARKer:FUNCTION:SUMMary:PPEak:RESult?**

This command is used to query the result of the measurement of the positive peak value. The measurement may have to be switched on previously.

A complete sweep with synchronization to sweep end must be performed between switching on the function and querying the measured value to obtain a correct query result. This is only possible in single sweep mode.

The numeric suffixes <1|2> are not relevant.

This command is only a query and therefore has no \*RST value.

**Example**

```
INIT:CONT OFF
```

Switches to single sweep mode.

```
CALC:MARK:FUNC:SUMM:PPE ON
```

Switches on the function.

```
INIT;*WAI
```

Starts a sweep and waits for the end.

```
CALC:MARK:FUNC:SUMM:PPE:RES?
```

Outputs the result.

**Characteristics**

\*RST value: –

SCPI: device-specific

**Mode**

A–T

**CALCulate<1|2>:MARKer:FUNCTION:SUMMary:REFerence:AUTO**

This command sets the currently measured average value (`CALCulate<1|2>:MARKer:FUNCTION:SUMMary:MEAN[:STATe]`) and RMS value (`CALCulate<1|2>:MARKer:FUNCTION:SUMMary:RMS[:STATe]`) as reference values for relative measurements in zero span.

If the measurement of RMS value and average is not activated, the reference value 0 dBm is used.

If the function `CALCulate<1|2>:MARKer:FUNCTION:SUMMary:AVERage` or `CALCulate<1|2>:MARKer:FUNCTION:SUMMary:PHOLd` is switched on, the current value is the accumulated measurement value at the time considered.

The numeric suffixes <1|2> and <1...4> are irrelevant for this command.

This command is an event and therefore has no \*RST value and no query.

**Parameter**

ONCE

**Example**

```
CALC:MARK:FUNC:SUMM:REF:AUTO ONCE
```

Takes the currently measured power as reference value for the relative power measurement in zero span.

**Characteristics**

RST value: –

SCPI: device-specific

**Mode**

A–T

**CALCulate<1|2>:MARKer:FUNCtion:SUMMary:RMS[:STATe]**

This command switches on or off the measurement of the effective (RMS) power. If necessary the function is switched on previously.

The numeric suffixes <1|2> are not relevant.

**Parameter**

ON | OFF

**Example**

CALC:MARK:FUNC:SUM:RMS ON  
Switches on the function.

**Characteristics**

\*RST value: OFF

SCPI: device-specific

**Mode**

A-T

**CALCulate<1|2>:MARKer:FUNCtion:SUMMary:RMS:AVERage:RESult?**

This command queries the result of the measurement of the averaged RMS value. The query is only possible if averaging has been activated previously using [CALCulate<1|2>:MARKer:FUNCtion:SUMMary:AVERage](#).

A complete sweep with synchronization to sweep end must be performed between switching on the function and querying the measured value to obtain a correct query result. This is only possible in single sweep mode.

The numeric suffixes <1|2> are not relevant.

This command is only a query and therefore has no \*RST value.

**Example**

INIT:CONT OFF  
Switches to single sweep mode.  
CALC:MARK:FUNC:SUMM:RMS ON  
Switches on the function.  
CALC:MARK:FUNC:SUMM:AVER ON  
Switches on the average value calculation.  
INIT;\*WAI  
Starts a sweep and waits for the end.  
CALC:MARK:FUNC:SUMM:RMS:AVER:RES?  
Outputs the result.

**Characteristics**

\*RST- value: -

SCPI: device-specific

**Mode**

A-T

**CALCulate<1|2>:MARKer:FUNCtion:SUMMary:RMS:PHOLd:RESult?**

---

This command queries the result of the measurement of the RMS value with active peak hold. The query is only possible only if the peak hold function has been activated previously using [CALCulate<1|2>:MARKer:FUNCtion:SUMMary:PHOLd](#).

A complete sweep with synchronization to sweep end must be performed between switching on the function and querying the measured value to obtain a correct query result. This is only possible in single sweep mode.

The numeric suffixes <1|2> are not relevant.

This command is only a query and therefore has no \*RST value.

**Example**

```
INIT:CONT OFF
```

Switches to single sweep mode.

```
CALC:MARK:FUNC:SUMM:RMS ON
```

Switches on the function.

```
CALC:MARK:FUNC:SUMM:PHOL ON
```

Switches on the peak value measurement.

```
INIT;*WAI
```

Starts a sweep and waits for the end.

```
CALC:MARK:FUNC:SUMM:RMS:PHOL:RES?
```

Outputs the result.

**Characteristics**

\*RST– value: –

SCPI: device–specific

**Mode**

A–T

---

**CALCulate<1|2>:MARKer:FUNCtion:SUMMary:RMS:RESult?**

---

This command queries the result of the measurement of the RMS power value.

A complete sweep with synchronization to sweep end must be performed between switching on the function and querying the measured value to obtain a correct query result. This is only possible in single sweep mode.

The numeric suffixes <1|2> are not relevant.

This command is only a query and therefore has no \*RST value.

**Example**

```
INIT:CONT OFF
```

Switches to single sweep mode.

```
CALC:MARK:FUNC:SUMM:RMS ON
```

Switches on the function.

```
INIT;*WAI
```

Starts a sweep and waits for the end.

```
CALC:MARK:FUNC:SUMM:RMS:RES?
```

Outputs the result.

**Characteristics**

\*RST value: –

SCPI: device–specific

**Mode**

A–T

**CALCulate<1|2>:MARKer:FUNCtion:SUMMary:SDEViation[:STATe]**

This command switches on or off the measurement of the standard deviation.  
On switching on the measurement, the mean power measurement is switched on as well.  
The numeric suffixes <1|2> are not relevant.

**Parameter**

ON | OFF

**Example**

```
CALC:MARK:FUNC:SUMM:SDEV ON
```

Switches on the measurement of the standard deviation.

**Characteristics**

\*RST value: OFF

SCPI: device-specific

**Mode**

A

**CALCulate<1|2>:MARKer:FUNCtion:SUMMary:SDEViation:AVERage:RESult?**

This command queries the result of the averaged standard deviation determined in several sweeps. The query is possible only if averaging is active.

A complete sweep with synchronization to sweep end must be performed between switching on the function and querying the measured value to obtain a correct query result. This is only possible in single sweep mode.

The numeric suffixes <1|2> are not relevant.

This command is only a query and therefore has no \*RST value.

**Example**

```
INIT:CONT OFF
```

Switches to single sweep mode.

```
CALC:MARK:FUNC:SUMM:SDEV ON
```

Switches on the function.

```
CALC:MARK:FUNC:SUMM:AVER ON
```

Switches on the calculation of average.

```
INIT;*WAI
```

Starts a sweep and waits for the end.

```
CALC:MARK:FUNC:SUMM:MEAN:SDEV:RES?
```

Outputs the result.

**Characteristics**

\*RST value: –

SCPI: device-specific

**Mode**

A–T

**CALCulate<1|2>:MARKer:FUNCtion:SUMMary:SDEViation:PHOLd:RESult?**

This command queries the maximum standard deviation value determined in several sweeps. The query is possible only if the peak hold function is active.

A complete sweep with synchronization to sweep end must be performed between switching on the function and querying the measured value to obtain a correct query result. This is only possible in single sweep mode.

The numeric suffixes <1|2> are not relevant.

This command is only a query and therefore has no \*RST value.

**Example**

```
INIT:CONT OFF
```

Switches to single sweep mode.

```
CALC:MARK:FUNC:SUMM:SDEV ON
```

Switches on the function.

```
CALC:MARK:FUNC:SUMM:PHOL ON
```

Switches on the peak value measurement.

```
INIT;*WAI
```

Starts a sweep and waits for the end.

```
CALC:MARK:FUNC:SUMM:SDEV:PHOL:RES?
```

Outputs the result.

**Characteristics**

\*RST value: –

SCPI: device-specific

**Mode**

A–T

**CALCulate<1|2>:MARKer:FUNCtion:SUMMary:SDEViation:RESult?**

This command queries the results of the standard deviation measurement.

A complete sweep with synchronization to sweep end must be performed between switching on the function and querying the measured value to obtain a correct query result. This is only possible in single sweep mode.

The numeric suffixes <1|2> are not relevant.

This command is only a query and therefore has no \*RST value.

**Example**

```
INIT:CONT OFF
```

Switches to single sweep mode.

```
CALC:MARK:FUNC:SUMM:SDEV ON
```

Switches on the function.

```
INIT;*WAI
```

Starts a sweep and waits for the end.

```
CALC:MARK:FUNC:SUMM:SDEV:RES?
```

Outputs the result.

**Characteristics**

\*RST value: –

SCPI: device-specific

**Mode**

A–T

**CALCulate:MATH Subsystem**

The CALCulate:MATH subsystem allows to process data from the SENSE-subsystem in numeric expressions.

**Commands of the CALCulate:MATH Subsystem**

- CALCulate<1|2>:MATH[:EXpression][:DEFine]
- CALCulate<1|2>:MATH:MODE
- CALCulate<1|2>:MATH:POSition
- CALCulate<1|2>:MATH:STATe

**CALCulate<1|2>:MATH[:EXpression][:DEFine]**

---

This command defines the mathematical expression for relating traces to trace1.

**Parameter**

- (TRACE1–TRACE2) Subtracts trace 2 from trace 1.
- (TRACE1–TRACE3) Subtracts trace 3 from trace 1.
- (TRACE1–TRACE4) Subtracts trace 4 from trace 1.
- (TRACE1–TRACE5) Subtracts trace 5 from trace 1.
- (TRACE1–TRACE6) Subtracts trace 6 from trace 1.

**Example**

```
CALC1:MATH (TRACE1 - TRACE2)
```

Selects the subtraction of trace 2 from trace 1.

**Characteristics**

\*RST value: –  
SCPI: conform

**Mode**

A

---

**CALCulate<1|2>:MATH:MODE**

---

This command selects the averaging method for the average trace mode.

The numeric suffixes <1|2> are irrelevant.

**Parameter**

LIN | LOG | POWer

**Example**

```
CALC:MATH:MODE LIN
```

Selects linear averaging for average trace mode.

**Characteristics**

\*RST value: LOG  
SCPI: device-specific

**Mode**

A

---



**CALCulate<1|2>:MATH:POSition**

---

This command defines the position of the result of the trace mathematics. The indication is in % of the screen height, with 100% corresponding to the upper diagram border.

**Parameter**

–100PCT to 200PCT

**Example**

```
CALC:MATH:POS 50PCT
```

Sets the position to the horizontal diagram center.

**Characteristics**

\*RST value: 50PCT

SCPI: device-specific

**Mode**

A

---

**CALCulate<1|2>:MATH:STATe**

---

This command switches the mathematical relation of traces on or off.

**Parameter**

ON | OFF

**Example**

```
CALC:MATH:STAT ON
```

Switches on the trace mathematics.

**Characteristics**

\*RST value: OFF

SCPI: conform

**Mode**

A

---

**CALCulate:PSEarch|PEAKsearch Subsystem**

The CALCulate:PSEarch|PEAKsearch subsystem contains the remote commands for Spurious Emissions measurements. Both groups of commands (PSEarch and PEAKsearch) perform the same functions.

**Commands of the CALCulate:PSEarch|PEAKsearch Subsystem**

- CALCulate<1|2>:PSEarch|PEAKsearch[:IMMEDIATE]
- CALCulate<1|2>:PSEarch|PEAKsearch:ADD
- CALCulate<1|2>:PSEarch|PEAKsearch:AUTO
- CALCulate<1|2>:PSEarch|PEAKsearch:MARGIN
- CALCulate<1|2>:PSEarch|PEAKsearch:METHOD
- CALCulate<1|2>:PSEarch|PEAKsearch:PSHOW
- CALCulate<1|2>:PSEarch|PEAKsearch:SUBRANGES
- CALCulate<1|2>:PSEarch|PEAKsearch:SUBRANGES:PCOUNT

**CALCulate<1|2>:PSEarch|PEAKsearch[:IMMEDIATE]**

---

In receiver mode, this command activates the generation of a peak list.

In analyzer mode, this command determines the list of the subrange maximums from the existing sweep results.

The numeric suffixes <1|2> are not relevant.

This command is an event and therefore has no \*RST value and no query.

**Example**

CALC:PSE

Starts to generate the list.

**Characteristics**

RST value: –

SCPI: device-specific

**Mode**

R, A

---

**CALCulate<1|2>:PSEarch|PEAKsearch:ADD**

---

This command adds a receiver frequency to the peak list. Only frequencies in the currently displayed frequency range of the scan are allowed.

The numeric suffixes <1|2> are not relevant.

**Parameter**

<numeric value>

**Example:**

CALC:PEAK:ADD 93 MHz

The frequency 93 MHz is added to the peak list

**Characteristics**

\*RST value: -

SCPI: device-specific

**Mode**

R

---

**CALCulate<1|2>:PSEarch|PEAKsearch:AUTO**

---

In receiver mode, this command performs an automatic peak search after the prescan. For each range, exactly one peak value is calculated.

In analyzer mode, the command has the same effect as "[CALCulate<1|2>:ESpectrum:PSEarch|PEAKsearch:AUTO](#)" on page 6.19.

The numeric suffixes <1|2> are not relevant.

**Example**

```
CALC:PEAK:AUTO ON
```

Performs a peak search after the prescan

**Characteristics**

\*RST value: -

SCPI: device-specific

**Mode**

R, A

---

**CALCulate<1|2>:PSEarch|PEAKsearch:MARGin**

---

In receiver mode, this command defines the margin for the peak search.

In analyzer mode, the command has the same effect as "[CALCulate<1|2>:ESpectrum:PSEarch|PEAKsearch:MARGin](#)" on page 6.20.

The numeric suffixes <1|2> are not relevant

**Parameter**

MIN | MAX | <numeric\_value>

**Example**

```
CALC:PEAK:MARG 5 dB
```

Sets the threshold of the peaks to be considered to 5 dB.

**Characteristics**

\*RST value: 6 dB

SCPI: device-specific

**Mode**

R, A

---

**CALCulate<1|2>:PSEarch|PEAKsearch:METHOD**

This command defines the method used to determine the peak levels of the scan. Two methods are available:

PEAK	Determines a specific number of peaks relative to the limit line
SUBRanges	Executes a peak search in the subranges

The numeric suffixes <1|2> are not relevant

**Parameter**

SUBRange | PEAK

**Example**

CALC:PEAK:METH SUBR

Sets the peak search method to Subranges

**Characteristics**

\*RST value: PEAK

SCPI: device-specific

**Mode**

R

**CALCulate<1|2>:PSEarch|PEAKsearch:PSHow**

For details refer to "[CALCulate<1|2>:ESPectrum:PSEarch|PEAKsearch:PSHow](#)" on page 6.19.

**CALCulate<1|2>:PSEarch|PEAKsearch:SUBRanges**

In receiver mode, this command changes two settings, depending on which method to determine the peak levels is activated:

Peaks	The command sets the number of peaks to be determined
Subranges	The command sets the number of subranges to be analyzed

In analyzer mode, the command sets the number of peaks per range that are stored in the list. Once the selected number of peaks has been reached, the peak search is stopped in the current range and continued in the next range.

The numeric suffixes <1|2> are not relevant.

**Parameter**

Analyzer mode: 1 to 50

Receiver mode: 1 to 500

**Example**

CALC:PSE:SUBR 10

Sets 10 peaks per range to be stored in the list.

**Characteristics**

RST value: 25

SCPI: device-specific

**Mode**

R, A

**CALCulate<1|2>:PSEarch|PEAKsearch:SUBRanges:PCOunt**

---

This command sets the number of peaks to be found in each subrange. It is used if the peak search method is set to Subranges.

**Parameter**

1 to 10

**Example**

CALC:PSE:SUBR:PCO 5

Sets 5 peaks to be determined in the subrange

**Characteristics**

RST value: 1

SCPI: device-specific

**Mode**

R

---

**CALCulate:STATistics Subsystem**

The CALCulate:STATistics subsystem controls the statistical measurement functions in the instrument.

**Commands of the CALCulate:STATistics Subsystem**

- CALCulate:STATistics:APD[:STATe]
- CALCulate:STATistics:CCDF[:STATe]
- CALCulate:STATistics:NSAMples
- CALCulate:STATistics:PRESet
- CALCulate:STATistics:RESult<1...4>?
- CALCulate:STATistics:SCALE:AUTO
- CALCulate:STATistics:SCALE:X:RANGe
- CALCulate:STATistics:SCALE:X:RLEVel
- CALCulate:STATistics:SCALE:Y:LOWer
- CALCulate:STATistics:SCALE:Y:UNIT
- CALCulate:STATistics:SCALE:Y:UPPer

**CALCulate:STATistics:APD[:STATe]**

---

This command switches on or off the measurement of amplitude distribution (APD). On activating this function, the CCDF measurement is switched off.

**Parameter**

ON | OFF

**Example**

```
CALC:STAT:APD ON  
Switches on the APD measurement.
```

**Characteristics**

\*RST value: OFF  
SCPI: device-specific

**Mode**

A

---

**CALCulate:STATistics:CCDF[:STATe]**

---

This command switches on or off the measurement of the complementary cumulative distribution function (CCDF). On activating this function, the APD measurement is switched off.

**Parameter**

ON | OFF

**Example**

```
CALC:STAT:CCDF ON  
Switches on the CCDF measurement.
```

**Characteristics**

\*RST value: OFF

SCPI: device-specific

**Mode**

A

---

**CALCulate:STATistics:NSAMples**

---

This command sets the number of measurement points to be acquired for the statistical measurement functions.

**Parameter**

100 to 1E9

**Example**

```
CALC:STAT:NSAM 500
```

Sets the number of measurement points to be acquired to 500.

**Characteristics**

\*RST value: 100000

SCPI: device-specific

**Mode**

A

---

**CALCulate:STATistics:PRESet**

---

This command resets the scaling of the X and Y axes in a statistical measurement. The following values are set:

x-axis ref level:        -20 dBm

x-axis range APD:       100 dB

x-axis range CCDF:     20 dB

y-axis upper limit:     1.0

y-axis lower limit:    1E-6

This command is an event and therefore has no \*RST value and no query.

**Example**

```
CALC:STAT:PRESet
```

Resets the scaling for statistical functions

**Characteristics**

\*RST value: -

SCPI: device-specific

**Mode**

A

---

---

**CALCulate:STATistics:RESult<1...4>?**

---

This command reads out the results of statistical measurements of a recorded trace. The trace is selected with the numeric suffix <1...4> attached to RESult.

**Parameter**

The required result is selected via the following parameters:

MEAN	Average (=RMS) power in dBm measured during the measurement time.
PEAK	Peak power in dBm measured during the measurement time.
CFACtor	Determined CREST factor (= ratio of peak power to average power) in dB.
ALL	Results of all three measurements mentioned before, separated by commas: <mean power>,<peak power>,<crest factor>

**Example**

```
CALC:STAT:RES2? ALL
```

Reads out the three measurement results of trace 2. Example of answer string:

5.56,19.25,13.69 i.e. mean power: 5.56 dBm, peak power 19.25 dBm, CREST factor 13.69 dB

**Characteristics**

\*RST value: –

SCPI: device-specific

**Mode**

A

---

**CALCulate:STATistics:SCALE:AUTO**

---

This command optimizes the level setting of the instrument depending on the measured peak power, in order to obtain maximum instrument sensitivity.

To obtain maximum resolution, the level range is set as a function of the measured spacing between peak power and the minimum power for the APD measurement and of the spacing between peak power and mean power for the CCDF measurement. In addition, the probability scale for the number of test points is adapted.

This command is an event and therefore has no \*RST value and no query.

**Note:** *Subsequent commands have to be synchronized with \*WAI, \*OPC or \*OPC? to the end of the auto range process which would otherwise be aborted.*

**Parameter**

ONCE

**Example**

```
CALC:STAT:SCAL:AUTO ONCE;*WAI
```

Adapts the level setting for statistical measurements.

**Characteristics**

\*RST value: –

SCPI: device-specific

**Mode**

A

---



---

**CALCulate:STATistics:SCALe:X:RANGe**

---

This command defines the level range for the x-axis of the measurement diagram. The setting is identical to the level range setting defined with the [DISPlay\[:WINDow<1|2>\]:TRACe<1...6>:Y\[:SCALe\]](#) command.

**Parameter**

10dB to 200dB

**Example**

```
CALC:STAT:SCAL:X:RANG 20dB
```

**Characteristics**

\*RST value: 100dB

SCPI: device-specific

**Mode**

A

---

**CALCulate:STATistics:SCALe:X:RLEVel**

---

This command defines the reference level for the x-axis of the measurement diagram. The setting is identical to the reference level setting using the [DISPlay\[:WINDow<1|2>\]:TRACe<1...6>:Y\[:SCALe\]:RLEVel](#) command.

With the reference level offset <> 0 the indicated value range of the reference level is modified by the offset.

The unit depends on the setting performed with [CALCulate<1|2>:UNIT:POWer](#).

**Parameter**

-120dBm to 20dBm

**Example**

```
CALC:STAT:SCAL:X:RLEV -60dBm
```

**Characteristics**

\*RST value: -20dBm

SCPI: device-specific

**Mode**

A

---

**CALCulate:STATistics:SCALe:Y:LOWer**

---

This command defines the lower limit for the y-axis of the diagram in statistical measurements. Since probabilities are specified on the y-axis, the entered numeric values are dimensionless.

**Parameter**

1E-9 to 0.1

**Example**

```
CALC:STAT:SCAL:Y:LOW 0.001
```

**Characteristics**

\*RST value: 1E-6

SCPI: device-specific

**Mode**

A

**CALCulate:STATistics:SCALe:Y:UNIT**

---

This command defines the scaling type of the y-axis.

**Parameter**

PCT | ABS

**Example**

CALC:STAT:SCAL:Y:UNIT PCT  
Sets the percentage scale.

**Characteristics**

RST value: ABS

SCPI: device-specific

**Mode**

A

---

**CALCulate:STATistics:SCALe:Y:UPPer**

---

This command defines the upper limit for the y-axis of the diagram in statistical measurements. Since probabilities are specified on the y-axis, the entered numeric values are dimensionless.

**Parameter**

1E-8 to 1.0

**Example**

CALC:STAT:Y:UPP 0.01

**Characteristics**

\*RST value: 1.0

SCPI: device-specific

**Mode**

A

---

**CALCulate:THReshold Subsystem**

The CALCulate:THReshold subsystem controls the threshold value for the maximum/minimum search of markers.

**Commands of the CALCulate:THReshold Subsystem**

- CALCulate<1|2>:THReshold
- CALCulate<1|2>:THReshold:STATe

**CALCulate<1|2>:THReshold**

---

This command defines the threshold value for the maximum/minimum search of markers with marker search functions. The associated display line is automatically switched on.

The numeric suffixes <1|2> are not relevant.

**Parameter**

MINimum to MAXimum (depending on current unit)

**Example**

```
CALC:THR -82DBM
```

Sets the threshold value to –82 dBm.

**Characteristics**

\*RST value: – (STATe to OFF)

SCPI: device-specific

**Mode**

R, A, ADEMOD

---

**CALCulate<1|2>:THReshold:STATe**

---

This command switches on or off the threshold line. The unit depends on the setting performed with CALCulate<1|2>:UNIT:POWer.

The numeric suffixes <1|2> are not relevant.

**Parameter**

ON | OFF

**Example**

```
CALC:THR:STAT ON
```

Switches on the threshold line.

**Characteristics**

\*RST value: OFF

SCPI: device-specific

**Mode**

R, A, ADEMOD

---

**CALCulate:TLINe Subsystem**

The CALCulate:TLINe subsystem defines the position of the time lines.

**Commands of the CALCulate:TLINe Subsystem**

- CALCulate<1|2>:TLINe<1|2>
- CALCulate<1|2>:TLINe<1|2>:STATe

**CALCulate<1|2>:TLINe<1|2>**

---

This command defines the position of the time lines that mark the times.  
The numeric suffixes <1|2> are not relevant.

**Parameter**

0 to 1000s

**Example**

```
CALC:TLIN 10ms
```

**Characteristics**

\*RST value: – (STATe to OFF)

SCPI: device-specific

**Mode**

A–T

---

**CALCulate<1|2>:TLINe<1|2>:STATe**

---

This command switches the time line on or off.  
The numeric suffixes <1|2> are not relevant.

**Parameter**

ON | OFF

**Example**

```
CALC:TLIN2:STAT ON
```

**Characteristics**

\*RST value: OFF

SCPI: device-specific

**Mode**

A–T

---

**CALCulate:UNIT Subsystem**

The CALCulate:UNIT subsystem defines the units for the parameters that can be set and the measurement results.

**Commands of the CALCulate:UNIT Subsystem**

– [CALCulate<1|2>:UNIT:POWer](#)

**CALCulate<1|2>:UNIT:POWer**

---

This command selects the unit for power.  
The numeric suffixes <1|2> are not relevant.

**Parameter**

DBM | V | A | W | DB | PCT | UNITLESS | DBPW | WATT | DBUV | DBMV | VOLT | DBUA |  
AMPere | DBPT | DBUV\_MHZ | DBMV\_MHZ | DBUA\_MHZ | DBUV\_M | DBUA\_M |  
DBUV\_MMHZ | DBUA\_MMHZ

**Example**

```
CALC:UNIT:POW DBM
```

Sets the power unit to dBm.

**Characteristics**

\*RST value: dBm  
SCPI: device-specific

**Mode**

R, A

---

## DISPlay Subsystem

The DISPlay subsystem controls the selection and presentation of textual and graphic information as well as of measurement data on the display.

### Commands of the DISPlay Subsystem

- DISPlay[:WINDow<1|2>]:SIZE
- DISPlay[:WINDow<1|2>]:TRACe<1...6>[:STATe]
- DISPlay[:WINDow<1|2>]:TRACe<1...6>:MODE
- DISPlay[:WINDow<1|2>]:TRACe<1...6>:MODE:HCONtinuous
- DISPlay[:WINDow<1|2>]:TRACe<1...6>:SYMBol
- DISPlay[:WINDow<1|2>]:TRACe<1...6>:X[:SCALe]:ZOOM
- DISPlay[:WINDow<1|2>]:TRACe<1...6>:X:SPACing
- DISPlay[:WINDow<1|2>]:TRACe<1...6>:Y[:SCALe]:BOTTOm
- DISPlay[:WINDow<1|2>]:TRACe<1...6>:Y[:SCALe]:TOP
- DISPlay[:WINDow<1|2>]:TRACe<1...6>:Y:SPACing
- DISPlay[:WINDow<1|2>]:TRACe<1...6>:Y[:SCALe]
- DISPlay[:WINDow<1|2>]:TRACe<1...6>:Y[:SCALe]:MODE
- DISPlay[:WINDow<1|2>]:TRACe<1...6>:Y[:SCALe]:RLEVel
- DISPlay[:WINDow<1|2>]:TRACe<1...6>:Y[:SCALe]:RLEVel:OFFSet
- DISPlay[:WINDow<1|2>]:TRACe<1...6>:Y[:SCALe]:RPOSition (models 13, 16)
- DISPlay[:WINDow<1|2>]:TRACe<1...6>:Y[:SCALe]:RVALue (models 13, 16)
- DISPlay[:WINDow<1|2>]:TRACe<1...6>:Y[:SCALe]:RVALue:AUTO
- DISPlay:BARGraph:LEVel:LOWer?
- DISPlay:BARGraph:LEVel:UPPer?
- DISPlay:BARGraph:PHOLd
- DISPlay:BARGraph:PHOLd:RESet

**DISPlay[:WINDow<1|2>]:SIZE**

This command configures the measurement display.

Channel and adjacent-channel power measurements: Only "1" is allowed as a numeric suffix.

Spectrum Emission Mask and Spurious Emissions measurements: The numeric suffix <1|2> selects the item that is displayed in full size; 1 for measurement diagram, 2 for list

**Parameter**

**LARGE** Channel and adjacent-channel power measurements: diagram in full screen.  
Spectrum Emission Mask and Spurious Emissions measurements: diagram or list in full screen, depending on the value of the numeric suffix.

**SMALI** split screen (diagram and list)

**Example**

```
DISP:SIZE LARG
```

Displays the measurement diagram in full screen size.

```
DISP:WIND2:SIZE LARG
```

Displays the list in full screen size.

**Characteristics**

\*RST value: SMALI

SCPI: device-specific

**Mode**

A, ADEMOD

**DISPlay[:WINDow<1|2>]:TRACe<1...6>[:STATe]**

This command switches on or off the display of the corresponding trace.

The numeric suffixes <1|2> are irrelevant.

**Parameter**

ON | OFF

**Example**

```
DISP:TRAC3 ON
```

**Characteristics**

\*RST value: ON for TRACe1, OFF for TRACe2 to 6

SCPI: conform

**Mode**

all

**DISPlay[:WINDow<1|2>]:TRACe<1...6>:MODE**

This command defines the type of display and the evaluation of the traces. WRITE corresponds to the Clr/Write mode of manual operation. The trace is switched off (= BLANK in manual operation) with `DISPlay[:WINDow<1|2>]:TRACe<1...6>[:STATe]`.

The number of measurements for AVERage, MAXHold and MINHold is defined with the `[SENSe<1|2>:]AVERage:COUNT` or `[SENSe<1|2>:]SWEep:COUNT` commands. It should be noted that synchronization to the end of the indicated number of measurements is only possible in single sweep mode.

If calculation of average values is active, selection between logarithmic and linear averaging is possible. For more detail see [SENSe<1|2>:]AVERAge:TYPE command.

The numeric suffixes <1|2> are irrelevant.

#### Parameter

WRITE | VIEW | AVERAge | MAXHold | MINHold |RMS

For details on trace modes refer to chapter "Instrument Functions", section "Trace mode overview".

#### Example

```
SWE:CONT OFF
```

Switching to single sweep mode.

```
SWE:COUN 16
```

Sets the number of measurements to 16.

```
DISP:TRAC3:MODE MAXH
```

Switches on the calculation of the for trace 3.

```
INIT;*WAI
```

Starts the measurement and waits for the end of the 16 sweeps.

#### Characteristics

\*RST value: WRITE for TRACe1, STATe OFF for TRACe2/3/4/5/6

SCPI: device-specific

#### Mode

all

### DISPlay[:WINDow<1|2>]:TRACe<1...6>:MODE:HCONtinuous

This command defines, whether traces in Min Hold, Max Hold and Average mode are reset after parameter change or not.

Normally, the measurement is started anew after parameter changes, before the measurement results are evaluated (e.g. using a marker). In all cases that require a new measurement after parameter changes, the trace is reset automatically to avoid false results (e.g. with span changes). For applications that require no reset after parameter changes, the automatic reset can be switched off.

The numeric suffixes <1|2> are irrelevant.

#### Parameter

OFF After certain parameter changes the traces are reset.

ON The automatic reset is switched off.

#### Example

```
DISP:WIND:TRAC3:MODE:HCON ON
```

Switches off the reset function.

#### Characteristics

\*RST value: OFF

SCPI: device-specific

#### Mode

A



**DISPlay[:WINDow<1|2>]:TRACe<1...6>:SYMBol**

This command assigns a symbol to the peak values of a trace. For each trace another symbol is used (e.g. an x or a +).

The numeric suffixes <1|2> are irrelevant.

**Parameter**

CROsS	Assigns a symbol to the peaks
OFF	Deactivates the symbols

**Example**

```
DISP:TRAC:SYMB CROS
```

Displays an x on the frequencies of the peak list.

**Characteristics**

\*RST value: ON

SCPI: device-specific

**Mode**

R

**DISPlay[:WINDow<1|2>]:TRACe<1...6>:X[:SCALe]:ZOOM**

This command activates or deactivates the zoom. The display is centered on the marker. The zoom factor is set with CALCulate<1|2>:MARKer<1...4>:FUNCTion:ZOOM on page 6.73.

**Parameter**

ON | OFF

**Example**

```
DISP:TRAC:X:ZOOM
```

**Characteristics**

\*RST value: OFF

SCPI: conform

**Mode**

R

**DISPlay[:WINDow<1|2>]:TRACe<1...6>:X:SPACing**

This command toggles between linear and logarithmic scaling of the x-axis.

**Parameter**

LINear | LOGarithmic

**Example**

```
DISP:TRAC:X:SPAC LOG
```

Sets the x-axis to a logarithmic scale

**Characteristics**

\*RST value: LOG

SCPI: conform

**Mode**

R, A-F

---

**DISPlay[:WINDow<1|2>]:TRACe<1...6>:Y[:SCALe]:BOTTom**

---

This command sets the minimum level of the grid in the current unit of the scan display.

The numeric suffix <1...6> is irrelevant.

**Parameter**

<numeric\_value>

**Example**

```
DISP:TRAC:Y:BOTT -10
```

Sets the minimum value of the y-axis to -10 of the selected unit.

**Characteristics**

\*RST value: 0

SCPI: conform

**Mode**

R

---

---

**DISPlay[:WINDow<1|2>]:TRACe<1...6>:Y[:SCALe]:TOP**

---

This command sets the maximum level of the grid in the current unit of the scan display.

The numeric suffix <1...6> is irrelevant.

**Parameter**

<numeric\_value>

**Example**

```
DISP:TRAC:Y:TOP 10
```

Sets the upper value of the y-axis to 10 of the selected unit.

**Characteristics**

\*RST value: 0

SCPI: conform

**Mode**

R

---

---

**DISPlay[:WINDow<1|2>]:TRACe<1...6>:Y:SPACing**

---

This command selects the scaling for the level display range.

The numeric suffixes <1|2> and <1...6> are irrelevant.

**Parameter**

LOGarithmic    Selects logarithmic scaling.

LINear         Selects linear scaling in %.

LDB            Selects linear scaling in dB.

**Example**

```
DISP:TRAC:Y:SPAC LIN
```

**Characteristics**

\*RST value: LOGarithmic

SCPI: conform

**Mode**

A, ADEMODO

**DISPlay[:WINDow<1|2>]:TRACe<1...6>:Y[:SCALe]**

This command defines the display range of the y-axis (level axis) with logarithmic scaling (`DISPlay[:WINDow<1|2>]:TRACe<1...6>:Y:SPACing`).

For linear scaling, the display range is fixed and cannot be modified.

The numeric suffixes <1|2> and <1...6> are irrelevant.

**Parameter**

10 dB to 200 dB or value in Hz

**Example**

```
DISP:TRAC:Y 110dB
```

**Characteristics**

\*RST value: 100dB

SCPI: device-specific

**Mode**

all

**DISPlay[:WINDow<1|2>]:TRACe<1...6>:Y[:SCALe]:MODE**

This command defines the scale type of the y-axis (absolute or relative).

When `SYSTEM:DISPlay:UPDate` is set to OFF, this command has no immediate effect on the screen. The numeric suffixes <1|2> and <1...6> are irrelevant.

**Parameter**

ABSolute | RELative

**Example**

```
DISP:TRAC:Y:MODE REL
```

**Characteristics**

\*RST value: ABS

SCPI: device-specific

**Mode**

all, except receiver

**DISPlay[:WINDow<1|2>]:TRACe<1...6>:Y[:SCALe]:RLEVel**

This command defines the reference level.

With the reference level offset <> 0, the indicated value range of the reference level is modified by the offset.

The unit depends on the setting defined with `CALCulate<1|2>:UNIT:POWer`.

The numeric suffixes <1|2> and <1...6> are irrelevant.

**Parameter**

<numeric\_value> in dBm, range specified in data sheet

**Example**

```
DISP:TRAC:Y:RLEV -60dBm
```

**Characteristics**

\*RST value: -20dBm

SCPI: conform

**Mode**

A

---

**DISPlay[:WINDow<1|2>]:TRACe<1...6>:Y[:SCALe]:RLEVel:OFFSet**

This command defines the offset of the reference level.

The numeric suffixes <1|2> and <1...6> are irrelevant.

**Parameter**

-200dB to 200dB

**Example**

```
DISP:TRAC:Y:RLEV:OFFS -10dB
```

**Characteristics**

\*RST value: 0dB

SCPI: conform

**Mode**

A

---

**DISPlay[:WINDow<1|2>]:TRACe<1...6>:Y[:SCALe]:RPOSition (models 13, 16)**

This command requires a tracking generator and active normalization in the **Tracking Generator** mode. It defines the position of the reference value.

The numeric suffixes <1|2> and <1...6> are irrelevant.

**Parameter**

0 to 100PCT

**Example**

```
DISP:TRAC:Y:RPOS 50PCT
```

**Characteristics**

\*RST value:

100 PCT     Spectrum Analyzer mode

50 PCT     Tracking Generator mode

SCPI: conform

**Mode**

A, ADEM0D

---

**DISPlay[:WINDow<1|2>]:TRACe<1...6>:Y[:SCALe]:RVALue (models 13, 16)**

This command requires a tracking generator and active normalization in the **Tracking Generator** mode. The command defines the power value assigned to the reference position. The numeric suffixes <1|2> and <1...6> are irrelevant.

**Parameter**

<numeric\_value>

**Example**

```
DISP:TRAC:Y:RVAL -20dBm
```

(Analyzer)

```
DISP:TRAC:Y:RVAL 0
```

Sets the power value assigned to the reference position to 0 dB (tracking generator)

**Characteristics**

\*RST value: 0 dB, coupled to reference level

SCPI: device-specific

**Mode**

A, ADEMOD

**DISPlay[:WINDow<1|2>]:TRACe<1...6>:Y[:SCALe]:RVALue:AUTO**

This command defines whether the reference value for the y-axis is coupled to the reference level (default) or not.

The numeric suffixes <1|2> and <1...6> are irrelevant.

**Parameter**

ON | OFF

**Example**

```
DISP:TRAC:Y:RVAL:AUTO ON
```

**Characteristics**

\*RST value: ON

SCPI: device-specific

**Mode**

A

**DISPlay:BARGraph:LEVel:LOWer?**

This command queries the minimum level of the bargraph.

**Example**

```
DISP:BARG:LEV:LOW?
```

**Characteristics**

\*RST value: -

SCPI: device-specific

**Mode**

R

**DISPlay:BARGraph:LEVel:UPPer?**

---

This command queries the upper level of the bargraph.

**Example**

```
DISP: BARG: LEV: UPP?
```

**Characteristics**

\*RST value: -

SCPI: device-specific

**Mode**

R

---

**DISPlay:BARGraph:PHOLd**

---

This command activates or deactivates the bargraph maxhold. The bargraph maxhold indicates the maximum measured value of the signal..

**Parameter**

ON | OFF

**Example**

```
DISP: BARG: PHOL ON  
Activates the bargraph maxhold
```

**Characteristics**

\*RST value: OFF

SCPI: device-specific

**Mode**

R

---

**DISPlay:BARGraph:PHOLd:RESet**

---

This command resets the bargraph maxhold value.

**Example**

```
DISP: BARG: PHOL: RES
```

**Characteristics**

\*RST value: -

SCPI: device-specific

**Mode**

R

---

## FORMat Subsystem

The FORMat subsystem specifies the data format of the data transmitted from and to the instrument.

### Commands of the FORMat Subsystem

- [FORMat:DEXPort:DSEPARATOR](#)

#### FORMat:DEXPort:DSEPARATOR

---

This command defines which decimal separator (decimal point or comma) is to be used for outputting measurement data to the file in ASCII format. Different languages of evaluation programs (e.g. MS Excel) can thus be supported.

**Parameter**

POINT | COMMA

**Example**

```
FORM:DEXP:DSEP POIN
```

Sets the decimal point as separator.

**Characteristics**

\*RST value: – (factory setting is POINT; \*RST does not affect setting)

SCPI: device-specific

**Mode**

all

---

## INITiate Subsystem

The INITiate subsystem is used to control the init–measurement function.

### Commands of the INITiate Subsystem

- INITiate<1|2>[:IMMediate]
- INITiate<1|2>:CONMeas
- INITiate<1|2>:CONTInuous
- INITiate<1|2>:DISPlay
- INITiate<1|2>:EMIttest
- INITiate<1|2>:FMeasurement
- INITiate<1|2>:ESPectrum
- INITiate<1|2>:SPURious

### INITiate<1|2>[:IMMediate]

---

The command initiates a new measurement sequence.

With sweep count > 0 or average count > 0, this means a restart of the indicated number of measurements. With trace functions MAXHold, MINHold and AVERage, the previous results are reset on restarting the measurement.

In receiver mode, the R&S ESL performs a single scan and stops at the end frequency. A continuous scan that can only be stopped deliberately is possible when Continuous Scan is selected.

In single sweep mode, synchronization to the end of the indicated number of measurements can be achieved with the command \*OPC, \*OPC? or \*WAI. In continuous–sweep mode, synchronization to the sweep end is not possible since the overall measurement never ends.

The numeric suffixes <1|2> are irrelevant for this command.

This command is an event and therefore has no \*RST value and no query.

#### Example

```
INIT:CONT OFF
```

Switches to single sweep mode.

```
DISP:WIND:TRAC:MODE AVER
```

Activates trace averaging.

```
SWE:COUN 20
```

Setting the sweep counter to 20 sweeps.

```
INIT;*WAI
```

Starts the measurement and waits for the end of the 20 sweeps.

#### Characteristics

\*RST value: –

SCPI: conform

#### Mode

all

---



**INITiate<1|2>:CONMeas**

This command continues a stopped measurement at the current position in single sweep mode. The function is useful especially for trace functions MAXHold, MINHold and AVERage, if the previous results are not to be cleared with sweep count > 0 or average count > 0 on restarting the measurement (INIT:IMMediate resets the previous results on restarting the measurement).

The single sweep mode is automatically switched on. Synchronization to the end of the indicated number of measurements can then be performed with the commands \*OPC, \*OPC? or \*WAI. In the continuous sweep mode, synchronization to the sweep end is not possible since the overall measurement "never" ends.

The numeric suffixes <1|2> are irrelevant for this command.

This command is an event and therefore has no \*RST value and no query.

**Example**

```
INIT:CONT OFF
```

Switches to single sweep mode.

```
DISP:WIND:TRAC:MODE AVER
```

Switches on trace averaging.

```
SWE:COUN 20
```

Setting the sweep counter to 20 sweeps.

```
INIT;*WAI
```

Starts the measurement and waits for the end of the 20 sweeps.

```
INIT:CONM;*WAI
```

Continues the measurement (next 20 sequences) and waits for the end.

**Characteristics**

\*RST value: –

SCPI: device-specific

**Mode**

A

**INITiate<1|2>:CONTInuous**

This command determines whether the trigger system is continuously initiated (continuous) or performs single measurements (single).

This setting refers to the sweep sequence (switching between continuous/single sweep).

The numeric suffixes <1|2> are irrelevant for this command.

**Parameter**

ON | OFF

**Example**

```
INIT:CONT OFF
```

Switches the sequence single sweep.

```
INIT:CONT ON
```

Switches the sequence to continuous sweep.

**Characteristics**

\*RST value: ON

SCPI: conform

**Mode**

all

---

**INITiate<1|2>:DISPlay**

---

This command switches the display during a single sweep measurement on (ON) or off (OFF).  
The numeric suffixes <1|2> are irrelevant for this command.

**Parameter**

ON | OFF

**Example**

```
INIT:CONT OFF
```

Switches to single sweep mode

```
INIT:DISP OFF
```

Sets the display behavior to OFF

```
INIT;*WAI
```

Starts the measurement with display switched off.

**Characteristics**

\*RST value: ON

SCPI: device-specific

**Mode**

A

---

**INITiate<1|2>:EMItest**

---

This command starts an automatic sequence consisting of the scan, determination of the peak list and subsequent final measurement.

This command is an event and therefore has no \*RST value and no query.

**Example**

```
INIT:EMI
```

Starts the sequence: scan, peak search and final measurement

**Characteristics**

\*RST value: -

SCPI: device-specific

**Mode**

R

---

**INITiate<1|2>:FMeasurement**

---

This command starts the final measurement based on the peak list.

This command is an event and therefore has no \*RST value and no query.

**Example**

```
INIT:FME
```

Starts the final measurement

**Characteristics**

\*RST value: -

SCPI: device-specific

**Mode**

R

---

**INITiate<1|2>:ESpectrum**

---

This command starts a Spectrum Emission Mask measurement.  
The numeric suffixes <1|2> are not relevant.  
This command is an event and therefore has no \*RST value and no query.

**Example**

```
INIT:ESP
```

Starts a Spectrum Emission Mask measurement.

**Characteristics**

RST value: –

SCPI: device-specific

**Mode**

A

---

**INITiate<1|2>:SPURious**

---

This command starts a Spurious Emissions measurement.  
The numeric suffixes <1|2> are not relevant.  
This command is an event and therefore has no \*RST value and no query.

**Example**

```
INIT:SPUR
```

Starts a Spurious Emissions measurement.

**Characteristics**

RST value: –

SCPI: device-specific

**Mode**

A

---

## INPut Subsystem

The INPut subsystem controls the input characteristics of the RF inputs of the instrument.

### Commands of the INPut Subsystem

- INPut<1|2>:ATTenuation
- INPut<1|2>:ATTenuation:AUTO
- INPut<1|2>:ATTenuation:PROTection[:STATe]
- INPut<1|2>:GAIN:AUTO
- INPut<1|2>:GAIN:STATe
- INPut<1|2>:IMPedance
- INPut<1|2>:LISN[:TYPE]
- INPut<1|2>:LISN:FILTer:HPAS[:STATe]
- INPut<1|2>:LISN:PHASe
- INPut<1|2>:UPORt[:VALue]?
- INPut<1|2>:UPORt:STATe

### INPut<1|2>:ATTenuation

---

This command programs the input attenuator. To protect the input mixer against damage from overloads, the setting 0 dB can be obtained by entering numerals, not by using the command DECrease.

The step width is 5 dB.

In receiver mode, if the attenuation is programmed directly, the auto range function is deactivated if necessary. Activate the protection function (INPut<1|2>:ATTenuation:PROTection[:STATe]) to prevent a level of 0 dB.

#### Parameter

0 to 75 dB

#### Example

```
INP:ATT 40 dB
```

Sets the attenuation on the attenuator to 40 dB and switches off the coupling of the reference level.

#### Characteristics

\*RST value: 10 dB (AUTO is set to ON)

SCPI: conform

#### Mode

all

---

**INPut<1|2>:ATTenuation:AUTO**

---

This command automatically couples the input attenuation to the reference level (state ON) or switches the input attenuation to manual entry (state OFF).

In receiver mode, this command automatically sets the attenuation so that a good S/N ratio is obtained without the receiver stages being overdriven (state ON).

**Parameter**

ON | OFF

**Example**

```
INP:ATT:AUTO ON
```

Couples the attenuation set on the attenuator to the reference level.

**Characteristics**

\*RST value: ON

SCPI: conform

**Mode**

all

---

**INPut<1|2>:ATTenuation:PROTection[:STATe]**

---

This command defines whether the 0 dB position of the attenuator is to be used in manual or automatic adjustment.

**Parameter**

ON | OFF

**Example**

```
INP:ATT:PROT ON
```

**Characteristics**

\*RST value: -

SCPI: device-specific

**Mode**

R

---

**INPut<1|2>:GAIN:AUTO**

---

This command includes the preamplifier into the autoranging function of the receiver.

**Parameter**

ON | OFF

**Example**

```
INP:GAIN:AUTO ON
```

Activates the preamplifier

**Characteristics**

\*RST value: OFF

SCPI: conform

**Mode**

R

---

**INPut<1|2>:GAIN:STATe**

---

This command switches the preamplifier of the instrument on or off. The switchable gain is fixed to 20 dB.

The command is only available in conjunction with option RF Preamplifier, B22.

**Parameter**

ON | OFF

**Example**

```
INP:GAIN:STAT ON
Activates the preamplifier
```

**Characteristics**

\*RST value: OFF

SCPI: conform

**Mode**

R, A

---

**INPut<1|2>:IMPedance**

---

This command sets the nominal input impedance of the instrument. The set impedance is taken into account in all level indications of results.

The setting 75  $\Omega$  should be selected, if the 50  $\Omega$  input impedance is transformed to a higher impedance using a 75  $\Omega$  adapter of the RAZ type (= 25  $\Omega$  in series to the input impedance of the instrument). The correction value in this case is 1.76 dB = 10 log ( 75 $\Omega$  / 50 $\Omega$ ).

**Parameter**

50 | 75

**Example**

```
INP:IMP 75
```

**Characteristics**

\*RST value: 50  $\Omega$

SCPI: conform

**Mode**

All, except receiver

---

**INPut<1|2>:LISN[:TYPE]**

This command selects the V-network that is controlled via the USER port. This setting is used in the receiver mode also for the preliminary measurement.

**Parameter**

TWOPhase & ESH3Z5	R&S ESH3-Z5 (two phases and protective earth are controllable)
FOURPhase & ESH2Z5	R&S ESH2-Z5 (four phases and protective earth are controllable)
ENV4200	R&S ENV 4200 (four phases are controllable)
ENV216	R&S ENV 216 (two phases and highpass are controllable)
OFF	No network is selected

**Example:**

```
INP:LISN:TWOP
Selects the R&S ESH3-Z5 network
```

**Characteristics**

\*RST value: OFF  
SCPI: device-specific

**Mode**

R, A

**INPut<1|2>:LISN:FILT:HPAS[:STATe]**

This command activates or deactivates the highpass filter of the V-network that is controlled via the user port. In receiver mode, this command is also used for the preliminary measurement.

This command is available only for the R&S ENV 216 V-network (INPut:LISN ENV216).

**Parameter**

ON | OFF

**Example**

```
INP:LISN:FILT:HPAS ON
Activates the highpass filter of the V-network.
```

**Characteristics**

\*RST value: OFF  
SCPI: device-specific

**Mode**

R

---

**INPut<1|2>:LISN:PHASe**

---

This command selects the phase of the V-network that is used and which is controlled via the user port. This setting is used in the receiver mode also for the preliminary measurement. The permissible selection depends on the selected V-network..

**Parameter**

L1 | L2 | L3 | N

**Example**

```
INP:LISN:PHAS L1
```

Activates phase L1 to be used in the network

**Characteristics**

\*RST value: L1

SCPI: device-specific

**Mode**

R

---

---

**INPut<1|2>:UPORt[:VALue]?**

---

This command queries the control lines of the user ports.

This command is a query and therefore has no \*RST value.

**Example**

```
INP:UPOR?
```

**Characteristics**

RST value: –

SCPI: device-specific

**Mode**

all, except receiver

---

---

**INPut<1|2>:UPORt:STATe**

---

This command toggles the control lines of the user ports between INPut and OUTPut. With ON, the user port is switched to INPut, with OFF to OUTPut.

**Parameter**

ON | OFF

**Example**

```
INP:UPOR:STAT ON
```

**Characteristics**

RST value: ON

SCPI: device-specific

**Mode**

all, except receiver

---



## OUTPut Subsystem

The OUTPut subsystem controls the output features of the instrument.

### Commands of the OUTPut Subsystem

- `OUTPut<1|2>[:STATe]` (models 13 and 16)
- `OUTPut:UPORt[:VALue]`
- `OUTPut:UPORt:STATe`

### OUTPut<1|2>[:STATe] (models 13 and 16)

This command switches the tracking generator on or off.

**Note:** *With the tracking generator switched on, the maximum stop frequency is limited to 3 GHz. This upper limit is automatically modified by the set frequency offset of the generator.*

*If measurements in compliance with specs are to be performed with the tracking generator, the start frequency has to be  $\geq 3$  x resolution bandwidth.*

*If a sweep time shorter than recommended in the data sheet is selected, the sweep time indicator SWT on the screen is marked with a red asterisk and the message UNCAL is also displayed.*

*With the tracking generator switched on, the FFT filters*

*(`[SENSe<1|2>:]BANDwidth|BWIDth[:RESolution]:TYPE`) are not available.*

*To switch off the tracking generator without losing the the corresponding hardware settings and the normalization see the*

*`SOURce<1|2>:POWer[:LEVel][:IMMediate][:AMPLitude]` command.*

#### Parameter

ON | OFF

#### Example

OUTP ON

Switches on the tracking generator.

#### Characteristics

\*RST value: –

SCPI: conform

#### Mode

A

**OUTPut:UPORt[:VALue]**

---

This command sets the control lines of the user ports.

The user port is written to with the given binary pattern. If the user port is programmed to INPut instead of OUTPut, the output value is temporarily stored.

**Parameter**

#B00000000 to #B11111111

**Example**

```
OUTP:UPOR #B10100101
```

**Characteristics**

\*RST value: –

SCPI: device-specific

**Mode**

all

---

**OUTPut:UPORt:STATe**

---

This command switches the control line of the user ports between INPut and OUTPut. The user port is switched to OUTPut with parameter ON, to INPut with OFF.

**Parameter**

ON | OFF

**Example**

```
OUTP:UPOR:STAT ON
```

**Characteristics**

\*RST value: OFF

SCPI: device-specific

**Mode**

all, except receiver

---

## SENSe Subsystem

The SENSe subsystem is organized in several subsystems. The commands of these subsystems directly control device-specific settings, they do not refer to the signal characteristics of the measurement signal.

The SENSe subsystem controls the essential parameters of the analyzer. In accordance with the SCPI standard, the keyword "SENSe" is optional for this reason, which means that it is not necessary to include the SENSe node in command sequences.

The following subsystems are included:

- ["SENSe:AVERage Subsystem"](#) on page 6.136
- ["SENSe:BANDwidth Subsystem"](#) on page 6.138
- ["SENSe:CORREction Subsystem \(Models 13 and 16\)"](#) on page 6.143
- ["SENSe:DETEctor Subsystem"](#) on page 6.147
- ["SENSe:ESPectrum Subsystem"](#) on page 6.149
- ["SENSe:FREQuency Subsystem"](#) on page 6.163
- ["SENSe:LIST Subsystem"](#) on page 6.168
- ["SENSe:MPOWer Subsystem"](#) on page 6.178
- ["SENSe:POWer Subsystem"](#) on page 6.183
- ["SENSe:SCAN Subsystem"](#) on page 6.191
- ["SENSe:SWEep Subsystem"](#) on page 6.195

**SENSe:AVERage Subsystem**

The SENSe:AVERage subsystem calculates the average of the acquired data. A new test result is obtained from several successive measurements.

There are two types of average calculation: logarithmic and linear. In case of logarithmic average calculation (denoted with VIDEo), the average value of the measured logarithmic power is calculated and in case of linear average calculation, the linear power is averaged before the logarithm is applied.

**Commands of the SENSe:AVERage Subsystem**

- [SENSe<1|2>:]AVERage[:STATe<1...4>]
- [SENSe<1|2>:]AVERage:COUNt
- [SENSe<1|2>:]AVERage:COUNt:AUTO
- [SENSe<1|2>:]AVERage:TYPE

**[SENSe<1|2>:]AVERage[:STATe<1...4>]**

This command switches on or off the average calculation for the selected trace (STATe<1...4>). The numeric suffixes <1|2> are not relevant.

**Parameter**

ON | OFF

**Example**

AVER OFF

Switches off the average calculation for trace 1.

AVER:STAT3 ON

Switches on the average calculation for trace 3.

**Characteristics**

\*RST value: OFF

SCPI: conform

**Mode**

all, except receiver

**[SENSe<1|2>:]AVERage:COUNt**

This command defines the number of measurements which contribute to the average value.

It should be noted that continuous averaging will be performed after the indicated number has been reached in continuous sweep mode.

In single sweep mode, the sweep is stopped as soon as the indicated number of measurements (sweeps) is reached. Synchronization to the end of the indicated number of measurements is only possible in single sweep mode.

The [SENSe<1|2>:]AVERage:COUNt command effects the same as the [SENSe<1|2>:]SWEep:COUNt command. In both cases, the number of measurements is defined whether the average calculation is active or not.

The number of measurements applies to all traces.

The numeric suffixes <1|2> are not relevant.

**Parameter**

0 to 32767

**Example**

```
SWE:CONT OFF
```

Switching to single sweep mode.

```
AVER:COUN 16
```

Sets the number of measurements to 16.

```
AVER:STAT ON
```

Switches on the calculation of average.

```
INIT;*WAI
```

Starts the measurement and waits for the end of the 16 sweeps.

**Characteristics**

\*RST value: 0

SCPI: conform

**Mode**

all, except receiver

**[SENSe<1|2>:]AVERAge:COUNT:AUTO**

This command is implemented only for reasons of compatibility with the FSP family. It selects a suitable number of counts for the selected measurement type.

The numeric suffixes <1|2> are not relevant.

**Parameter**

ON | OFF

**Example**

```
AVER:COUN:AUTO ON
```

**Characteristics**

RST value: OFF

SCPI: conform

**Mode**

all, except receiver

**[SENSe<1|2>:]AVERAge:TYPE**

This command selects the type of average function.

**Parameter**

VIDeo The logarithmic power values are averaged.

LINear The power values are averaged before they are converted to logarithmic values.

**Example**

```
AVER:TYPE LIN
```

Switches to linear average calculation.

**Characteristics**

RST value: VIDeo

SCPI: device-specific

**Mode**

A

**SENSe:BANDwidth Subsystem**

This subsystem controls the setting of the instruments filter bandwidths. Both groups of commands (BANDwidth and BWIDth) perform the same functions.

**Commands of the SENSe:BANDwidth Subsystem**

- [SENSe<1|2>:]BANDwidth|BWIDth[:RESolution]
- [SENSe<1|2>:]BANDwidth|BWIDth[:RESolution]:AUTO
- [SENSe<1|2>:]BANDwidth|BWIDth[:RESolution]:RATio
- [SENSe<1|2>:]BANDwidth|BWIDth[:RESolution]:TYPE
- [SENSe<1|2>:]BANDwidth|BWIDth:VIDeo
- [SENSe<1|2>:]BANDwidth|BWIDth:VIDeo:AUTO
- [SENSe<1|2>:]BANDwidth|BWIDth:VIDeo:RATio
- [SENSe<1|2>:]BANDwidth|BWIDth:VIDeo:TYPE

**[SENSe<1|2>:]BANDwidth|BWIDth[:RESolution]**

This command defines the IF bandwidth.

Analog resolution filters of 10 Hz to 20 MHz in 1, 2, 3, 5, 10 steps are available. These filters are implemented as 5-circuit LC filters in the range from 300 kHz to 10 MHz and as digital filters with analog characteristics in the range from 10 Hz to 100 kHz.

In addition, the EMI bandwidths 200 Hz, 9kHz and 120 kHz are available (6 dB bandwidths each). These bandwidths can only be obtained by entering numeric values and not with the commands INCRement and DECrement.

The EMI bandwidths are only available when parameter PULSe is selected by command BAND:TYPE. FFT filters from 1 Hz to 30 kHz (3dB bandwidth each) are also available in the frequency domain (span>0) for fast measurements on periodic signals. The instrument automatically switches to analog filters above 30 kHz.

The FFT bandwidths are not available if the preselector is switched on.

CFILter or RRC are selected using the BAND:TYPE command. The possible combinations of filter type and filter bandwidths are listed in the table "List of available channel filters".

**Parameter**

10 Hz to 10 MHz

**Example**

BAND 120 kHz

Sets the IF bandwidth to 120 kHz

**Characteristics**

\*RST value: – (AUTO is set to ON)

SCPI: conform

**Mode**

all, except ADEMOD

**[SENSe<1|2>:]BANDwidth|BWIDth[:RESolution]:AUTO**

In receiver mode, this command either automatically couples the IF bandwidth of the R&S ESL to the frequency range or cancels the coupling. Note that this command is only effective in conjunction with the quasipeak, the CISPR average or CISPR RMS detector.

In analyzer mode, the command couples the resolution bandwidth to the span or cancels it.

The automatic coupling adapts the resolution bandwidth to the current frequency span according to the relationship between frequency span and resolution bandwidth. The numeric suffixes <1|2> are not relevant. The ratio resolution bandwidth/span can be modified with the `[SENSe<1|2>:]BANDwidth|BWIDth[:RESolution]:RATio` command.

The 6 dB bandwidths 200 Hz, 9 kHz and 120 kHz and the channel filters are not set by the automatic coupling.

The numeric suffixes <1|2> are not relevant.

**Parameter**

ON | OFF

**Example**

```
BAND:AUTO OFF
```

Switches off the coupling of the resolution bandwidth to the span.

**Characteristics**

\*RST value: ON

SCPI: conform

**Mode**

R, A–F

**[SENSe<1|2>:]BANDwidth|BWIDth[:RESolution]:RATio**

This command defines the ratio resolution bandwidth (Hz) / span (Hz). The ratio to be entered is reciprocal to the ratio span/RBW used in manual operation.

The numeric suffixes <1|2> are not relevant.

**Parameter**

0.0001 to 1

**Example**

```
BAND:RAT 0.1
```

**Characteristics**

\*RST value: 0.02 with BAND:TYPE NORMal or RBW > 30 kHz; 0.01 with BAND:TYPE FFT for RBW ≤ 30 kHz

SCPI: conform

**Mode**

A

**[SENSe<1|2>:]BANDwidth|BWIDth[:RESolution]:TYPE**

This command switches the filter type for the resolution bandwidth between "normal" analog or FIR filters in 1, 3, 10 steps and the FFT filtering for bandwidths <100 kHz.

For detailed information on filters see chapter "Instrument Functions", section "To choose the appropriate filter" and "List of available RRC and channel filters".

The numeric suffixes <1|2> are not relevant.

**Note:** *When changing the filter type, the next larger filter bandwidth is selected if the same filter bandwidth is not available for the new filter type.*

**Parameter**

NORMal	Gaussian filters
FFT	FFT filters (analyzer only)
CFILter	channel filters
NOISe	Gaussian filters (receiver only)
RRC	RRC filters
PULSe	EMI (6dB) filters

**Example**

BAND:TYPE NORM

**Characteristics**

\*RST value: NORMal

SCPI: device-specific

**Mode**

all, except ADEMOD

**[SENSe<1|2>:]BANDwidth|BWIDth:VIDeo**

This command defines the instruments video bandwidth. The available video bandwidths are specified in the data sheet. The command is not available if FFT filtering is switched on and the set bandwidth is  $\leq 30$  kHz or if the quasi-peak detector is switched on.

The numeric suffixes <1|2> are not relevant.

**Parameter**

refer to data sheet

**Example**

BAND:VID 10kHz

**Characteristics**

\*RST value: – (AUTO is set to ON)

SCPI: conform

**Mode**

A



---

**[SENSe<1|2>:]BANDwidth|BWIDth:VIDeo:AUTO**

---

This command either automatically couples the instruments video bandwidth to the resolution bandwidth or cancels the coupling.

The ratio video bandwidth/resolution bandwidth can be modified with the `[SENSe<1|2>:]BANDwidth|BWIDth[:RESolution]:RATio` command.

The numeric suffixes <1|2> are not relevant.

**Parameter**

ON | OFF

**Example**

```
BAND:VID:AUTO OFF
```

**Characteristics**

\*RST value: ON

SCPI: conform

**Mode**

A

---

**[SENSe<1|2>:]BANDwidth|BWIDth:VIDeo:RATio**

---

This command defines the ratio video bandwidth (Hz) / resolution bandwidth (Hz). The ratio to be entered is reciprocal to the ratio RBW/VBW used in manual operation.

The numeric suffixes <1|2> are not relevant.

**Parameter**

0.01 to 1000

**Example**

```
BAND:VID:RAT 3
```

Sets the coupling of video bandwidth to video bandwidth = 3\*resolution bandwidth

**Characteristics**

\*RST value: 3

SCPI: conform

**Mode**

A

---

---

**[SENSe<1|2>:]BANDwidth|BWIDth:VIDeo:TYPE**

---

This command selects the position of the video filter in the signal path, provided that the resolution bandwidth is  $\leq 100$  kHz.

The essential difference between the two modes is the transient response at falling signal edges: If LINear is selected, the measurement with logarithmic level scaling yields a much "flatter" falling edge than LOGarithmic. This behavior is due to the conversion of linear power into logarithmic level. If the linear power is halved, the level decreases by only 3 dB.

The numeric suffixes <1|2> are not relevant.

**Parameter**

LINear                The video filter is connected ahead of the logarithmic amplifier (default).  
LOGarithmic        The video filter follows the logarithmic amplifier

**Example**

```
BAND:VID:TYPE LIN
```

Video filter ahead of the logarithmic amplifier

**Characteristics**

RST value: LIN

SCPI: device-specific

**Mode**

A

---

## SENSe:CORRection Subsystem (Models 13 and 16)

This subsystem controls calibration and normalization during operation with the tracking generator.

### Commands of the SENSe:CORRection Subsystem

- [SENSe<1|2>:]CORRection[:STATe]
- [SENSe<1|2>:]CORRection:COLLect[:ACQuire]
- [SENSe<1|2>:]CORRection:EGAI:n:INPut[:MAGNIitude]
- [SENSe<1|2>:]CORRection:METhod
- [SENSe<1|2>:]CORRection:RECall

#### [SENSe<1|2>:]CORRection[:STATe]

This command activates/deactivates the normalization of the measurement results provided that the tracking generator is active. The command is available only after acquisition of a reference trace for the selected type of measurement (transmission/reflection, see [SENSe<1|2>:]CORRection:COLLect[:ACQuire] command).

The numeric suffixes <1|2> are not relevant.

#### Parameter

ON | OFF

#### Example

CORR ON  
Activates normalization.

#### Characteristics

\*RST value: OFF

SCPI: conform

#### Mode

A

#### [SENSe<1|2>:]CORRection:COLLect[:ACQuire]

When the tracking generator is active, this command determines the type of result acquisition for the normalization reference measurement and starts the measurement selected:

To obtain a correct reference measurement, a complete sweep with synchronization to the end of the sweep must have been carried out. This is only possible in the single sweep mode.

The numeric suffixes <1|2> are not relevant.

This command is an "event" and therefore has no \*RST value and no query.

#### Parameter

THRough	"TRANsmission" mode	calibration with direct connection between tracking generator and device input
	"REFLection" mode	calibration with short circuit at the input
OPEN	only allowed in "REFLection" mode	calibration with open input

**Example**

```
INIT:CONT OFF
```

Selects single sweep operation

```
CORR:COLL THR;*WAI
```

Starts the measurement of reference data using direct connection between generator and device input and waits for the sweep end.

**Characteristics**

\*RST value: –

SCPI: conform

**Mode**

A

---

**[SENSe<1|2>:]CORRection:EGAI:n:INPut[:MAGNItude]**

This command makes an external gain known to the analyzer, which will take it into account during the display of measurement results. With this function the gain of an antenna or of an external preamplifier can be taken into account for the measurement values.

The numeric suffixes <1|2> are not relevant.

**Parameter**

–200...200dB

**Example**

```
CORR:EGA:INP 10DB
```

Takes 10 dB external gain into account.

**Characteristics**

\*RST value: 0 dB

SCPI: device-specific

**Mode**

A

---

**[SENSe<1|2>:]CORRection:METHod**

This command selects the type of measurement with active tracking generator (transmission/reflection).

The numeric suffixes <1|2> are not relevant.

**Parameter**

TRANsmission | REFLection

**Example**

```
CORR:METH TRAN
```

Sets the type of measurement to "transmission".

**Characteristics**

\*RST value: TRANsmission

SCPI: device-specific

**Mode**

A

---

**[SENSe<1|2>:]CORRection:RECall**

---

This command restores the instrument setting that was applied to the measurement of the reference data, provided that the tracking generator is active.

The numeric suffixes <1|2> are not relevant.

This command is an event and therefore has no \*RST value and no query.

**Example**

CORR:REC

**Characteristics**

\*RST value: –

SCPI: conform

**Mode**

A

---

**SENSe:DEMod Subsystem**

The SENSe:DEMod subsystem controls the analog demodulation of the video signal.

**Commands of the SENSe:DEMod Subsystem**

- [SENSe<1|2>:]DEMod
- [SENSe<1|2>:]DEMod:SQUelch[:STATe]

**[SENSe<1|2>:]DEMod**

---

This command selects the type of analog demodulation..

**Parameter**

OFF | AM | FM

**Example:**

```
DEM FM
```

Selects FM demodulation

**Characteristics**

\*RST value: OFF

SCPI: device-specific

**Mode**

R

---

**[SENSe<1|2>:]DEMod:SQUelch[:STATe]**

---

This command enables the input of a level threshold below which the audible AF is cut off..

**Parameter**

<numeric\_value> | MIN | MAX | DEF

**Example**

```
DEM:SQU:LEV 80
```

Sets the squelch level to 80

**Characteristics**

\*RST value: 60

SCPI: device-specific

**Mode**

R

---

## SENSe:DETECTOR Subsystem

The SENSe:DETECTOR subsystem controls the acquisition of measurement data via the selection of the detector for the corresponding trace.

### Commands of the SENSe:DETECTOR Subsystem

- [SENSe<1|2>:]DETECTOR<1...6>[:FUNCTION]
- [SENSe<1|2>:]DETECTOR<1...6>[:FUNCTION]:AUTO
- [SENSe<1|2>:]DETECTOR<1...6>:FMEASUREMENT
- [SENSe<1|2>:]DETECTOR<1...6>:RECEIVER[:FUNCTION]

#### [SENSe<1|2>:]DETECTOR<1...6>[:FUNCTION]

---

This command selects the detector for recording measured values of the selected trace.

For more information on available detectors refer to "Selecting the detector".

If QPEAK is selected, the video filter is automatically switched off. In addition, the couplings between the span and RBW as well as between RBW and the sweep time are switched off. They are not restored until another detector is selected. Accordingly, the sweep time should be set to a value that is large enough so that the quasipeak detector can settle in completely at each measurement point.

The trace is indicated as a numerical suffix for DETECTOR.

The numeric suffixes <1|2> are not relevant.

#### Parameter

APEAK | NEGATIVE | POSITIVE | SAMPLE | RMS | AVERAGE | QPEAK | CRMS | CAVERAGE

For details on detectors refer to chapter "Instrument Functions", section "Detector overview".

#### Example

```
DET POS
```

Sets the prescan detector to "positive peak".

#### Characteristics

\*RST value: POS

SCPI: conform

#### Mode

R, A

#### [SENSe<1|2>:]DETECTOR<1...6>[:FUNCTION]:AUTO

---

This command either couples the detector to the current trace setting or turns coupling off. The trace is selected by the numeric suffix at DETECTOR.

The numeric suffixes <1|2> are not relevant.

#### Parameter

ON | OFF

#### Example

```
DET:AUTO OFF
```

#### Characteristics

\*RST value: ON

SCPI: conform

**Mode**

A

**[SENSe<1|2>:]DETECTOR<1...6>:FMEASUREMENT**

This command sets the detector used to record measured values for a specific trace in the final measurement.

- The POSitive or NEGative detector only displays the positive or the negative peak value.
- The AVERage detector displays the power average value at each measurement point.
- The detectors QPEak for quasipeak, CAVERage for CISPR average and CRMS for CISPR-RMS perform standard-compliant signal evaluations for the EMC test equipment.

For further details on available detectors refer to Selecting the detector.

If QPEak is selected, the video filter is automatically switched off. In addition, the couplings between the span and RBW as well as between RBW and the sweep time are switched off. They are not restored until another detector is selected. Accordingly, the sweep time should be set to a value that is large enough so that the quasipeak detector can settle in completely at each measurement point.

The trace is indicated as a numerical suffix for DETECTOR.

**Parameter**

NEGative | POSitive | RMS | AVERage | QPEak | CAVERage | CRMS

**Example**

```
DET POS
```

Sets the detector to positive peak

**Characteristics**

\*RST value: QPEak

SCPI: device-specific

**Mode**

R

**[SENSe<1|2>:]DETECTOR<1...6>:RECEIVER[:FUNCTION]**

This command selects the detector used in the bargraph measurement.

**Parameter**

NEGative | POSitive | RMS | AVERage | QPEak | CAVERage | CRMS

**Example**

```
DET:REC POS, AVER, QPE
```

Activates the peak, average and quasipeak detectors

**Characteristics**

\*RST value: AVERage

SCPI: device-specific

**Mode**

R



**SENSe:ESpectrum Subsystem**

The SENSe:ESpectrum subsystem contains the remote commands to configure Spectrum Emission Mask (SEM) measurements.

**Commands of the SENSe:ESpectrum Subsystem**

- [SENSe<1|2>:]ESpectrum:BWID
- [SENSe<1|2>:]ESpectrum:FILTER[:RRC][:STATe]
- [SENSe<1|2>:]ESpectrum:FILTER[:RRC]:ALPHa
- [SENSe<1|2>:]ESpectrum:PRESet[:STANdard]
- [SENSe<1|2>:]ESpectrum:PRESet:RESTore
- [SENSe<1|2>:]ESpectrum:RANGe<1...20>:BANDwidth
- [SENSe<1|2>:]ESpectrum:RANGe<1...20>:BANDwidth:RESolution
- [SENSe<1|2>:]ESpectrum:RANGe<1...20>:BANDwidth:VIDeo
- [SENSe<1|2>:]ESpectrum:RANGe<1...20>:COUNT?
- [SENSe<1|2>:]ESpectrum:RANGe<1...20>:DELete
- [SENSe<1|2>:]ESpectrum:RANGe<1...20>[:FREQuency]:START
- [SENSe<1|2>:]ESpectrum:RANGe<1...20>[:FREQuency]:STOP
- [SENSe<1|2>:]ESpectrum:RANGe<1...20>:FILTer:TYPE
- [SENSe<1|2>:]ESpectrum:RANGe<1...20>:INPut:ATTenuation
- [SENSe<1|2>:]ESpectrum:RANGe<1...20>:INPut:ATTenuation:AUTO
- [SENSe<1|2>:]ESpectrum:RANGe<1...20>:INPut:GAIN:STATe
- [SENSe<1|2>:]ESpectrum:RANGe<1...20>:INSert
- [SENSe<1|2>:]ESpectrum:RANGe<1...20>:LIMit:ABSolute:START
- [SENSe<1|2>:]ESpectrum:RANGe<1...20>:LIMit:ABSolute:STOP
- [SENSe<1|2>:]ESpectrum:RANGe<1...20>:LIMit:RELative:START
- [SENSe<1|2>:]ESpectrum:RANGe<1...20>:LIMit:RELative:STOP
- [SENSe<1|2>:]ESpectrum:RANGe<1...20>:LIMit:STATe
- [SENSe<1|2>:]ESpectrum:RANGe<1...20>:RLEVel
- [SENSe<1|2>:]ESpectrum:RANGe<1...20>:SWEep:TIME
- [SENSe<1|2>:]ESpectrum:RANGe<1...20>:SWEep:TIME:AUTO
- [SENSe<1|2>:]ESpectrum:RANGe<1...20>:TRANsducer
- [SENSe<1|2>:]ESpectrum:RRANGe?
- [SENSe<1|2>:]ESpectrum:RTYPE

---

**[SENSe<1|2>:]ESpectrum:BWID**

---

This command defines the bandwidth used for measuring the channel power (reference range). This setting takes only effect if channel power is selected as power reference type (`[SENSe<1|2>:]ESpectrum:RTYPE` command).

The numeric suffixes <1|2> are not relevant.

**Parameter**

minimum span ≤ value ≤ span of reference range

**Example**

```
ESP:RTYP CPOW
```

Sets the power reference type to channel power.

```
ESP:BWID 1MHZ
```

Sets the Tx bandwidth to 1 MHz.

**Characteristics**

RST value: 3.84 MHz

SCPI: device-specific

**Mode**

A

---

**[SENSe<1|2>:]ESpectrum:FILTer[:RRC][:STATe]**

---

This command activates or deactivates the use of an RRC filter. This setting takes only effect if channel power is selected as power reference type (`[SENSe<1|2>:]ESpectrum:RTYPE` command).

The numeric suffixes <1|2> are not relevant.

**Parameter**

ON | OFF

**Example**

```
ESP:RTYP CPOW
```

Sets the power reference type to channel power.

```
ESP:FILT OFF
```

Deactivates the use of an RRC filter.

**Characteristics**

RST value: ON

SCPI: device-specific

**Mode**

A

---

**[SENSe<1|2>:]ESpectrum:FILTer[:RRC]:ALPHa**

This command sets the alpha value of the RRC filter. This setting takes only effect if channel power is selected as power reference type ([SENSe<1|2>:]ESpectrum:RTYPe command) and if the RRC filter is activated ([SENSe<1|2>:]ESpectrum:FILTer[:RRC][:STATe] command).

The numeric suffixes <1|2> are not relevant.

**Parameter**

0 to 1

**Example**

```
ESP:RTYP CPOW
```

Sets the power reference type to channel power.

```
ESP:FILT ON
```

Activates the use of an RRC filter.

```
ESP:FILT:ALPH 0.5
```

Sets the alpha value of the RRC filter to 0.5.

**Characteristics**

RST value: 0.22

SCPI: device-specific

**Mode**

A

**[SENSe<1|2>:]ESpectrum:PRESet[:STANdard]**

This command selects the specified XML file under *C:\r\_s\instr\sem\_std*. If the file is stored in a subdirectory, include the relative path.

The numeric suffixes <1|2> are not relevant.

This command is an event and therefore has no \*RST value and no query.

**Example**

```
ESP:PRES 'WCDMA\3GPP\DL\PowerClass_31_39.xml'
```

Selects the *PowerClass\_31\_39.xml* XML file in the *C:\R\_S\instr\sem\_std\WCDMA\3GPP\DL* directory.

```
ESP:PRES?
```

```
W-CDMA 3GPP DL (31,39)dBm
```

The query returns information about the selected standard, the link direction and the power class. If no standard has been selected, the query returns *None*.

**Characteristics**

RST value: –

SCPI: device-specific

**Mode**

A

**[SENSe<1|2>:]ESpectrum:PRESet:RESTore**

This command copies the XML files from the *C:\R\_S\instr\sem\_backup* folder to the *C:\R\_S\instr\sem\_std* folder. Files of the same name are overwritten.

The numeric suffixes <1|2> are not relevant.

This command is an event and therefore has no \*RST value and no query.

**Example**

```
ESP:PRESet:REST
```

Restores the originally provided XML files.

**Characteristics**

RST value: –

SCPI: device-specific

**Mode**

A

**[SENSe<1|2>:]ESpectrum:RANGe<1...20>:BANDwidth /  
[SENSe<1|2>:]ESpectrum:RANGe<1...20>:BANDwidth:RESolution**

This command sets the RBW value for the specified range.

The numeric suffixes <1...20> specify the range. The numeric suffixes <1|2> are not relevant.

**Parameter**

Refer to the data sheet.

**Example**

```
ESP:RANG2:BAND:RES 5000
```

Sets the RBW for range 2 to 5 kHz.

**Characteristics**

RST value: 30.0 kHz

SCPI: device-specific

**Mode**

A

**[SENSe<1|2>:]ESpectrum:RANGe<1...20>:BANDwidth:VIDeo**

This command sets the VBW value for the specified range.

The numeric suffixes <1...20> specify the range. The numeric suffixes <1|2> are not relevant.

**Parameter**

Refer to the data sheet.

**Example**

```
ESP:RANG1:BAND:VID 5000000
```

Sets the VBW for range 1 to 5 MHz.

**Characteristics**

RST value: 10.0 MHz

SCPI: device-specific

**Mode**

A

---

**[SENSe<1|2>:]ESpectrum:RANGe<1...20>:COUNT?**

---

This command returns the number of defined ranges.  
The numeric suffixes are not relevant.  
This command is only a query and therefore has no \*RST value.

**Example**

```
ESP:RANG:COUNT?
```

Returns the number of defined ranges.

**Characteristics**

RST value: –  
SCPI: device-specific

**Mode**

A

---

---

**[SENSe<1|2>:]ESpectrum:RANGe<1...20>:DELeTe**

---

This command deletes the specified range. The range numbers are updated accordingly. The reference range cannot be deleted. A minimum of three ranges is mandatory.  
The numeric suffixes <1...20> specify the range. The numeric suffixes <1|2> are not relevant.  
This command is an event and therefore has no \*RST value and no query.

**Example**

```
ESP:RANG4:DEL
```

Deletes range 4.

**Characteristics**

RST value: –  
SCPI: device-specific

**Mode**

A

---

---

**[SENSe<1|2>:]ESpectrum:RANGe<1...20>[:FREQuency]:STARt**

---

This command sets the start frequency for the specified range.  
In order to change the start/stop frequency of the first/last range, select the appropriate span. If you set a span that is smaller than the overall span of the ranges, the measurement includes only the ranges that lie within the defined span and have a minimum span of 20 Hz. The first and last range are adapted to the given span as long as the minimum span of 20 Hz is not violated.  
The numeric suffixes <1...20> specify the range. The numeric suffixes <1|2> are not relevant.

**Parameter**

see rules in chapter 4, "Ranges and settings"

**Example**

```
ESP:RANG1:STAR 100000000
```

Sets the start frequency for range 1 to 100 MHz.

**Characteristics**

RST value: -250.0 MHz (range 1), -2.52 MHz (range 2), 2.52 MHz (range 3)

SCPI: device-specific

**Mode**

A

---

**[SENSe<1|2>:]ESpectrum:RANGe<1...20>[:FREQUENCY]:STOP**

This command sets the stop frequency for the specified range. For further details refer to the [\[SENSe<1|2>:\]ESpectrum:RANGe<1...20>\[:FREQUENCY\]:START](#) command.

The numeric suffixes <1...20> specify the range. The numeric suffixes <1|2> are not relevant.

**Parameter**

see rules in chapter 4, "Ranges and settings"

**Example**

```
ESP:RANG3:STOP 10000000
```

Sets the stop frequency for range 2 to 10 MHz.

**Characteristics**

RST value: -2.52 MHz (range 1), 2.52 MHz (range 2), 250.0 MHz (range 3)

SCPI: device-specific

**Mode**

A

---

**[SENSe<1|2>:]ESpectrum:RANGe<1...20>:FILTer:TYPE**

This command sets the filter type for the specified range.

The numeric suffixes <1...20> specify the range. The numeric suffixes <1|2> are not relevant.

**Parameter**

NORMal    Gaussian filters

CFILter    channel filters

RRC        RRC filters

PULSe     EMI (6dB) filters

The available bandwidths of the filters are specified in the data sheet.

**Example**

```
ESP:RANG1:FILT:TYPE RRC
```

Sets the RRC filter type for range 1.

**Characteristics**

RST value: NORM

SCPI: device-specific

**Mode**

A

---

---

**[SENSe<1|2>:]ESpectrum:RANGe<1...20>:INPut:ATTenuation**

---

This command sets the attenuation for the specified range.

The numeric suffixes <1...20> specify the range. The numeric suffixes <1|2> are not relevant.

**Parameter**

Refer to the data sheet.

**Example**

```
ESP:RANG3:INP:ATT 10
```

Sets the attenuation of range 3 to 10 dB.

**Characteristics**

RST value: 0 dB

SCPI: device-specific

**Mode**

A

---

---

**[SENSe<1|2>:]ESpectrum:RANGe<1...20>:INPut:ATTenuation:AUTO**

---

This command activates or deactivates the automatic RF attenuation setting for the specified range.

The numeric suffixes <1...20> specify the range. The numeric suffixes <1|2> are not relevant.

**Parameter**

ON | OFF

**Example**

```
ESP:RANG2:INP:ATT:AUTO OFF
```

Deactivates the RF attenuation auto mode for range 2.

**Characteristics**

RST value: ON

SCPI: device-specific

**Mode**

A

---

---

**[SENSe<1|2>:]ESpectrum:RANGe<1...20>:INPut:GAIN:STATe**

---

This command switches the preamplifier on or off for the specified range.

The numeric suffixes <1...20> specify the range. The numeric suffixes <1|2> are not relevant.

**Parameter**

ON | OFF

**Example**

```
ESP:RANG3:INP:GAIN:STATe ON
```

Switches the preamplifier for range 3 on or off.

**Characteristics**

RST value: OFF

SCPI: device-specific

**Mode**

A

---

---

**[SENSe<1|2>:]ESpectrum:RANGe<1...20>:INSert**

---

This command inserts a new range before or after the specified range. The range numbers are updated accordingly.

The numeric suffixes <1...20> specify the range. The numeric suffixes <1|2> are not relevant.

**Parameter**

AFTer | BEFore

**Example**

```
ESP:RANG3:INS BEF
```

Inserts a new range before range 3.

```
ESP:RANG1:INS AFT
```

Inserts a new range after range 1.

**Characteristics**

RST value:

SCPI: device-specific

**Mode**

A

---

---

**[SENSe<1|2>:]ESpectrum:RANGe<1...20>:LIMit:ABSolute:STARt**

---

This command sets an absolute limit value at the start frequency of the specified range.

Different from manual operation, this setting is independently of the defined limit check type.

The numeric suffixes <1...20> specify the range. The numeric suffixes <1|2> are not relevant.

**Parameter**

–400 to in 400 dBm

**Example**

```
ESP:RANG1:LIM:ABS:STAR 10
```

Sets an absolute limit of 10 dBm at the start frequency of the range.

**Characteristics**

RST value: –13 dBm

SCPI: device-specific

**Mode**

A

---

---

**[SENSe<1|2>:]ESpectrum:RANGe<1...20>:LIMit:ABSolute:STOP**

---

This command sets an absolute limit value at the stop frequency of the specified range.

Different from manual operation, this setting is independently of the defined limit check type.

The numeric suffixes <1...20> specify the range. The numeric suffixes <1|2> are not relevant.

**Parameter**

–400 to in 400 dBm

**Example**

```
ESP:RANG1:LIM:ABS:STOP 20
```

Sets an absolute limit of 20 dBm at the stop frequency of the range.



**Characteristics**

RST value: -13 dBm

SCPI: device-specific

**Mode**A

---

**[SENSe<1|2>:]ESpectrum:RANGe<1...20>:LIMit:RELative:START**

---

This command sets a relative limit value at the start frequency of the specified range. Different from manual operation, this setting is independently of the defined limit check type.

The numeric suffixes <1...20> specify the range. The numeric suffixes <1|2> are not relevant.

**Parameter**

-400 to in 400 dBc

**Example**

```
ESP:RANG3:LIM:REL:STAR -20
```

Sets a relative limit of -20 dBc at the start frequency of the range.

**Characteristics**

RST value: -50 dBc

SCPI: device-specific

**Mode**A

---

**[SENSe<1|2>:]ESpectrum:RANGe<1...20>:LIMit:RELative:STOP**

---

This command sets a relative limit value at the stop frequency of the specified range. Different from manual operation, this setting is independently of the defined limit check type.

The numeric suffixes <1...20> specify the range. The numeric suffixes <1|2> are not relevant.

**Parameter**

-400 to in 400 dBc

**Example**

```
ESP:RANG3:LIM:REL:STOP 20
```

Sets a relative limit of 20 dBc at the stop frequency of the range.

**Characteristics**

RST value: -50 dBc

SCPI: device-specific

**Mode**A

---

---

**[SENSe<1|2>:]ESpectrum:RANGe<1...20>:LIMit:STATe**

---

This command sets the type of limit check for all ranges.  
The numeric suffixes are not relevant.

**Parameter**

ABSolute	Checks only the absolute limits defined.
RELative	Checks only the relative limits. Relative limits are defined as relative to the measured power in the reference range.
AND	Combines the absolute and relative limit. The limit check fails when both limits are violated.
OR	Combines the absolute and relative limit. The limit check fails when one of the limits is violated.

**Example**

```
ESP:RANG3:LIM:STAT AND
```

Sets for all ranges the combined absolute/relative limit check.

**Characteristics**

RST value: REL

SCPI: device-specific

**Mode**

A

---

**[SENSe<1|2>:]ESpectrum:RANGe<1...20>:RLEVel**

---

This command sets the reference level for the specified range.  
The numeric suffixes <1...20> specify the range. The numeric suffixes <1|2> are not relevant.

**Parameter**

Refer to the data sheet.

**Example**

```
ESP:RANG2:RLEV 0
```

Sets the reference level of range 2 to 0 dBm.

**Characteristics**

RST value: -20 dBm

SCPI: device-specific

**Mode**

A

---

**[SENSe<1|2>:]ESpectrum:RANGe<1...20>:SWEep:TIME**

This command sets the sweep time for the specified range.

The numeric suffixes <1...20> specify the range. The numeric suffixes <1|2> are not relevant.

**Parameter**

Allowed values depend on the ratio of span to RBW and RBW to VBW. For details refer to the data sheet.

**Example**

```
ESP:RANG1:SWE:TIME 1
```

Sets the sweep time for range 1 to 1 s.

**Characteristics**

RST value: 0.27 s

SCPI: device-specific

**Mode**

A

**[SENSe<1|2>:]ESpectrum:RANGe<1...20>:SWEep:TIME:AUTO**

This command activates or deactivates the automatic sweep time setting for the specified range.

The numeric suffixes <1...20> specify the range. The numeric suffixes <1|2> are not relevant.

**Parameter**

ON | OFF

**Example**

```
ESP:RANG3:SWE:TIME:AUTO OFF
```

Deactivates the sweep time auto mode for range 3.

**Characteristics**

RST value: ON

SCPI: device-specific

**Mode**

A

**[SENSe<1|2>:]ESpectrum:RANGe<1...20>:TRANsducer**

This command sets a transducer for the specified range. You can only choose a transducer that fulfills the following conditions:

- The transducer overlaps or equals the span of the range.
- The x-axis is linear.
- The unit is dB.

The numeric suffixes <1...20> specify the range. The numeric suffixes <1|2> are not relevant.

**Parameter**

'string' = name of the transducer

**Example**

```
ESP:RANG1:TRAN 'test'
```

Sets the transducer called test for range 1.

**Characteristics**

RST value: –

SCPI: device-specific

**Mode**

A

---

**[SENSe<1|2>:]ESpectrum:RRANge?**

---

This command returns the current position (number) of the reference range.

The numeric suffixes <1|2> are not relevant.

This command is only a query and therefore has no \*RST value.

**Example**

```
ESP:RRAN?
```

Returns the current position (number) of the reference range.

**Characteristics**

RST value: –

SCPI: device-specific

**Mode**

A

---

**[SENSe<1|2>:]ESpectrum:RTYPE**

---

This command sets the power reference type.

The numeric suffixes <1|2> are not relevant.

**Parameter**

PEAK Measures the highest peak within the reference range.

CPOWer Measures the channel power within the reference range (integral bandwidth method).

**Example**

```
ESP:RTYP PEAK
```

Sets the peak power reference type.

**Characteristics**

RST value: CPOWer

SCPI: device-specific

**Mode**

A

---

**SENSe:FMEasurement Subsystem**

This subsystem controls the final measurement of the receiver.

**Commands of the SENSe:FMEasurement Subsystem**

- [SENSe<1|2>:]FMEasurement:AUTO
- [SENSe<1|2>:]FMEasurement:LISN[:TYPE]
- [SENSe<1|2>:]FMEasurement:LISN:FILTer:HPAS[:STATe]
- [SENSe<1|2>:]FMEasurement:LISN:PHASe
- [SENSe<1|2>:]FMEasurement:TIME

**[SENSe<1|2>:]FMEasurement:AUTO**

This command activates automatic or interactive final measurement.

**Parameter**

ON | OFF

**Example**

```
FME:AUTO ON
```

Activates automatic final measurement

**Characteristics**

\*RST value: ON

SCPI: device-specific

**Mode**

R

**[SENSe<1|2>:]FMEasurement:LISN[:TYPE]**

This command selects whether a V-network is accessed automatically via the user port in the final measurement. The command also selects which network is accessed.

**Parameter**

TWOPhase   ESH3Z5	R&S ESH3-Z5: two phases and protective earth are controllable
FOURPhase   ESH2Z5	R&S ESH2-Z5: four phases and protective earth are controllable
ENV4200	R&S ENV4200: four phases are controllable
ENV216	R&S ENV216: two phases and highpass are controllable
OFF	No network is selected

**Example**

```
FME:LISN:FILT FOURP
```

Selects the ESH ESH2-Z5 network

**Characteristics**

\*RST value: OFF

SCPI: device-specific

**Mode**

R

**[SENSe<1|2>:]FMEasurement:LISN:FILTer:HPAS[:STATe]**

This command selects the setting for the high pass filter on the V-network with which the level measurement is performed in the final measurement. This command is available only for the R&S ENV 216 Vnetwork (FMEasurement:LISN ENV216).

**Parameter**

ON | OFF

**Example**

```
FME:LISN:FILT:HPAS ON
Activates the high pass filter
```

**Characteristics**

\*RST value: ON

SCPI: device-specific

**Mode**

R

**[SENSe<1|2>:]FMEasurement:LISN:PHASe**

This command selects the phases of the V-network on which level measurements are consecutively performed in the final measurement. L2 and L3 are only available with four-line V-networks (FMEasurement:LISN FOURphase | ENV4200).

**Parameter**

L1 | L2 | L3 | N[,L1 | L2 | L3 | N],...

**Example**

```
FME:LISN:PHAS L1, N
```

**Characteristics**

\*RST value: 1N

SCPI: device-specific

**Mode**

R

**[SENSe<1|2>:]FMEasurement:TIME**

This command defines the measurement time in which the values indicated in the peak list (final measurement values) are re-checked.

**Parameter**

<numeric\_value>

**Example**

```
FME:TIME 0.01
```

**Characteristics**

\*RST value: 1 s

SCPI: device-specific

**Mode**

R

## SENSe:FREQUENCY Subsystem

The SENSe:FREQUENCY subsystem defines the frequency axis of the active display. The frequency axis can either be defined via the start/stop frequency or via the center frequency and span.

### Commands of the SENSe:FREQUENCY Subsystem

- [SENSe<1|2>:]FREQUENCY:CENTer
- [SENSe<1|2>:]FREQUENCY:CENTer:STEP
- [SENSe<1|2>:]FREQUENCY:CENTer:STEP:AUTO
- [SENSe<1|2>:]FREQUENCY:CENTer:STEP:LINK
- [SENSe<1|2>:]FREQUENCY:CENTer:STEP:LINK:FACTor
- [SENSe<1|2>:]FREQUENCY:CW
- [SENSe<1|2>:]FREQUENCY:CW:STEP
- [SENSe<1|2>:]FREQUENCY:FIXed
- [SENSe<1|2>:]FREQUENCY:FIXed:STEP
- [SENSe<1|2>:]FREQUENCY:MODE
- [SENSe<1|2>:]FREQUENCY:OFFSet
- [SENSe<1|2>:]FREQUENCY:SPAN
- [SENSe<1|2>:]FREQUENCY:SPAN:FULL
- [SENSe<1|2>:]FREQUENCY:START
- [SENSe<1|2>:]FREQUENCY:STOP

### [SENSe<1|2>:]FREQUENCY:CENTer

---

This command defines the center frequency of the analyzer or the measuring frequency for span = 0.

In receiver mode, the command defines the receiver frequency.

The numeric suffixes <1|2> are not relevant.

#### Parameter

0 to  $f_{max}$

$f_{max}$  is specified in the data sheet. To help analyze signals located at the end of the frequency range, for R&S ESL models with an upper frequency limit of 6 GHz or less, the  $f_{max}$  value is extended by 0.05 GHz for direct entry. The preset and maximum values remain unchanged.

#### Example

```
FREQ:CENT 100MHz
```

#### Characteristics

\*RST value:  $f_{max} / 2$  with  $f_{max}$  = maximum frequency

SCPI: conform

#### Mode

all

---

### [SENSe<1|2>:]FREQUENCY:CENTer:STEP

---

This command defines the step size of the center frequency.

The numeric suffixes <1|2> are not relevant.

**Parameter**0 to  $f_{\max}$ **Example**

FREQ:CENT:STEP 120MHz

**Characteristics**

\*RST value: – (AUTO 0.1 × SPAN is switched on)

SCPI: conform

**Mode**

all

**[SENSe<1|2>]:FREQUENCY:CENTer:STEP:AUTO**

This command couples the step size of the center frequency to the span (ON) or sets the value of the center frequency entered via [SENSe<1|2>]:FREQUENCY:CENTer:STEP (OFF).

The numeric suffixes <1|2> are not relevant.

**Parameter**

ON | OFF

**Example**

FREQ:CENT:STEP:AUTO ON

Activates the coupling of the step size to the span.

**Characteristics**

\*RST value: ON

SCPI: device-specific

**Mode**

all, except receiver

**[SENSe<1|2>]:FREQUENCY:CENTer:STEP:LINK**

This command couples the step size of the center frequency to span (span >0) or to the resolution bandwidth (span = 0) or cancels the couplings.

The numeric suffixes <1|2> are not relevant.

**Parameter**

SPAN coupling to frequency display range (for span &gt; 0)

RBW coupling to resolution bandwidth (for span = 0)

OFF manual input, no coupling

**Example**

FREQ:CENT:STEP:LINK SPAN

**Characteristics**

\*RST value: SPAN

SCPI: device-specific

**Mode**

A, ADEMOD



**[SENSe<1|2>:]FREQuency:CENTer:STEP:LINK:FACTor**

This command couples the step size of the center frequency with a factor to the span (span >0) or to the resolution bandwidth (span = 0).

The numeric suffixes <1|2> are not relevant.

**Parameter**

1 to 100 PCT

**Example**

```
FREQ:CENT:STEP:LINK:FACT 20PCT
```

**Characteristics**

\*RST value: – (AUTO 0.1 × SPAN is switched on)

SCPI: device-specific

**Mode**

A

**[SENSe<1|2>:]FREQuency:CW**

This command is the same as [\[SENSe<1|2>:\]FREQuency:CENTer](#).

**[SENSe<1|2>:]FREQuency:CW:STEP**

This command is the same as [\[SENSe<1|2>:\]FREQuency:CENTer:STEP](#).

**[SENSe<1|2>:]FREQuency:FIXed**

This command is the same as [\[SENSe<1|2>:\]FREQuency:CENTer](#).

**[SENSe<1|2>:]FREQuency:FIXed:STEP**

This command is the same as [\[SENSe<1|2>:\]FREQuency:CENTer:STEP](#).

**[SENSe<1|2>:]FREQuency:MODE**

This command switches between span > 0 (SWEep) and zero span (CW | FIXed) in the **Spectrum Analyzer** mode.

For CW and FIXed, the frequency setting is via the [\[SENSe<1|2>:\]FREQuency:CENTer](#) command. In the sweep mode, the setting is via the [\[SENSe<1|2>:\]FREQuency:START](#), [\[SENSe<1|2>:\]FREQuency:STOP](#), [\[SENSe<1|2>:\]FREQuency:CENTer](#), and [\[SENSe<1|2>:\]FREQuency:SPAN](#) commands.

The numeric suffixes <1|2> are not relevant.

**Parameter**

CW | FIXed | SWEep | SCAN

**Example**

```
FREQ:MODE SWE
```

**Characteristics**

\*RST value: SWEep

SCPI: conform

**Mode**

R, A

---

**[SENSe<1|2>:]FREQUENCY:OFFSet**

---

This command defines the frequency offset of the instrument.  
The numeric suffixes <1|2> are not relevant.

**Parameter**

–100 GHz to 100 GHz

**Example**

```
FREQ:OFFS 1GHZ
```

**Characteristics**

\*RST value: 0 Hz

SCPI: conform

**Mode**

A, ADEM0D

---

**[SENSe<1|2>:]FREQUENCY:SPAN**

---

This command defines the frequency span in the **Spectrum Analyzer** mode.  
The numeric suffixes <1|2> are not relevant.

**Parameter**

0 to  $f_{max}$

$f_{max}$  is specified in the data sheet. To help analyze signals located at the end of the frequency range, for R&S ESL models with an upper frequency limit of 6 GHz or less, the  $f_{max}$  value is extended by 0.05 GHz for direct entry. The preset and maximum values remain unchanged.

**Example**

```
FREQ:SPAN 10MHz
```

**Characteristics**

\*RST value:  $f_{max}$  with  $f_{max}$  = maximum frequency

SCPI: conform

**Mode**

A

---

**[SENSe<1|2>:]FREQUENCY:SPAN:FULL**

---

This command sets the frequency span to its maximum.  
The numeric suffixes <1|2> are not relevant.

**Parameter**

$f_{max}$ , specified in the data sheet.

**Example**

```
FREQ:SPAN:FULL
```

**Characteristics**

\*RST value: –  
 SCPI: conform

**Mode**

A

---

**[SENSe<1|2>:]FREQuency:STARt**

This command defines the start frequency of the analyzer. This command is only available with span > 0.

In receiver mode this command defines the start frequency of the scan range.

The numeric suffixes <1|2> are not relevant.

**Parameter**

0 to  $f_{max}$

$f_{max}$  is specified in the data sheet. To help analyze signals located at the end of the frequency range, for R&S ESL models with an upper frequency limit of 6 GHz or less, the  $f_{max}$  value is extended by 0.05 GHz for direct entry. The preset and maximum values remain unchanged.

**Example**

FREQ:STAR 20MHz

**Characteristics**

\*RST value: 0  
 SCPI: conform

**Mode**

R, A–F

---

**[SENSe<1|2>:]FREQuency:STOP**

This command defines the stop frequency of the analyzer. This command is only available with span > 0.

In receiver mode this command defines the stop frequency of the scan range.

The numeric suffixes <1|2> are not relevant.

**Parameter**

0 to  $f_{max}$

$f_{max}$  is specified in the data sheet. To help analyze signals located at the end of the frequency range, for R&S ESL models with an upper frequency limit of 6 GHz or less, the  $f_{max}$  value is extended by 0.05 GHz for direct entry. Example

FREQ:STOP 2000MHz

**Characteristics**

\*RST value:  $f_{max}$   
 SCPI: conform

**Mode**

R, A–F

---

### SENSe:LIST Subsystem

The commands of this subsystem are used for measuring the power at a list of frequency points with different device settings. The measurement is always performed in zero span. A new trigger event is required for each test point (exception: trigger FREE RUN).

The results are output as a list in the order of the entered frequency points. The number of results per test point depends on the number of concurrently active measurements (peak/RMS/average). The number of frequencies is limited to 100 entries.

Selection of concurrently active measurements and setting of parameters that are constant for the whole measurement is performed via a configuration command (`[SENSe<1|2>:]LIST:POWer:SET`). This also includes the setting for trigger and gate parameters.

---

**Note:** *Settings that are not directly included in commands of this subsystem can be configured by sending the corresponding commands prior to the [SENSe:LIST Subsystem](#) commands. Please note that changes to the trigger level have to be executed in zero span in order to take effect for the [SENSe:LIST Subsystem](#) commands.*

---

The following subsystem is included:

- "[SENSe:LIST:RANGe Subsystem](#)" on page 6.174

### Commands of the SENSe:LIST Subsystem

- `[SENSe<1|2>:]LIST:POWer[:SEQuence]`
- `[SENSe<1|2>:]LIST:POWer:RESult?`
- `[SENSe<1|2>:]LIST:POWer:SET`
- `[SENSe<1|2>:]LIST:POWer:STATe`

### Further information

- [More details on the SENSe:LIST Subsystem](#)

**More details on the SENSe:LIST Subsystem**

The following setting parameters can be selected independently for each frequency point:

- analyzer frequency
- reference level
- resolution filter
- resolution bandwidth
- video bandwidth
- measurement time
- detector

The commands of this subsystem can be used in two different ways:

- Instrument setup, measurement and querying of the results in a single command line. With this method, there is the least delay between the measurement and the result output. However, it requires the control computer to wait for the response from the instrument.
- Instrument setup and querying of the result list at the end of the measurement: With this method, the control computer may be used for other activities while the measurement is being performed. However, more time is needed for synchronization via service request.

**[SENSe<1|2>:]LIST:POWer[:SEQuence]**

This command configures the list of settings (max. 200 entries) for the multiple power measurement and starts a measurement sequence. When synchronizing the command with \*OPC, a service request is generated as soon as all frequency points are processed and the defined number of individual measurements is reached.

To reduce the setting time, all indicated parameters are set up simultaneously at each test point.

The query form of the command processes the list and immediately returns the list of results.

The number of results per test point depends on the setting of the

[\[SENSe<1|2>:\]LIST:POWer:SET](#) command.

The numeric suffixes <1|2> are not relevant.

**Parameter**

The following parameters are the settings for an individual frequency point. They are repeated for every other frequency point.

<analyzer freq>	Receive frequency for the signal to be measured (= center frequency in manual operation)  Range of values: 0 Hz to max. frequency, depending on the instrument model.
<ref level>	Reference level  Range of values: +20 dBm to –130 dBm in 0.1 dB steps
<rf att>	RF input attenuation  Range of values: 0 dB to 30 dB in 5 dB steps
<rf att 2>	Only listed due to reasons of compatibility with the FSP family. Takes no effect.
<filter type>	For details refer to " <a href="#">[SENSe&lt;1 2&gt;:]BANDwidth[BWIDth[:RESolution]:TYPE</a> " on page 6.140
<rbw>	Resolution bandwidth  For the range of values refer to chapter "Instrument Functions", section "Res BW Manual".  Refer to chapter "Instrument Functions", section "To choose the appropriate filter type", for possible combinations of filter type and filter bandwidth for the <filter type> = CFILter and <filter type> = RRC.
<vbw>	Video bandwidth  Range of values: 1 Hz to 10 MHz in 1, 3, 10 steps. The value is ignored for <filter type> = CFILter or RRC
<meas time>	Measurement time  Range of values: 1us to 16000s  For details refer to chapter "Instrument Functions", section "Sweeptime Manual"
<trigger level>	Reserved. Must be set to 0.

**Return values**

The query command returns a list of comma-separated values (CSV) which contains the power measurement results in floating-point format. The unit depends on the setting with `CALCulate<1|2>:UNIT:POWer`

**The command**

```
SENSe:LIST:POWer?
935.2MHz,0dBm,10dB,OFF,NORM,1MHz,3MHz,440us,0,
935.4MHz,0dBm,10dB,10dB,NORM,30kHz,100kHz,440us,0,
935.6MHz,0dBm,10dB,20dB,NORM,30kHz,100kHz,440us,0
```

thus returns the following list, for example:

```
-28.3,-30.6,-38.1
```

If the command sequence is extended to

```
SENSe:LIST:POWer:SET ON,ON,ON,IMM,POS,0,0
SENSe:LIST:POWer?
935.2MHz,0dBm,10dB,OFF,NORM,1MHz,3MHz,440us,0,
935.4MHz,0dBm,10dB,10dB,NORM,30kHz,100kHz,440us,0,
935.6MHz,0dBm,10dB,20dB,NORM,30kHz,100kHz,440us,0
```

the result list is extended to 3 results per frequency point (peak, RMS and average):

```
-28.3,-29.6,1.5,-30.6,-31.9,0.9,-38.1,-40.0,2.3
```

**Example**

```
SENSe:LIST:POWer
935.2MHz,0dBm,10dB,OFF,NORM,1MHz,3MHz,440us,0,
935.4MHz,0dBm,10dB,10dB,CFIL,30kHz,100kHz,440us,0,
935.6MHz,0dBm,10dB,20dB,CFIL,30kHz,100kHz,440us,0
```

Performs a measurement sequence with the following settings:

Step	Freq. [MHz]	Ref Level [dBm]	RF Att [dB]	el Att [dB]	Filter type	RBW	VBW	Meas Time [us]	TRG Level (reserved)
1	935.2	0	10	OFF	Normal	1 MHz	3 MHz	440	0
2	935.4	0	10	10	Channel	30 kHz	100 kHz	440	0
3	935.6	0	10	20	Channel	30 kHz	100 kHz	440	0

```
SENSe:LIST:POWer?
935.2MHz,0dBm,10dB,OFF,NORM,1MHz,3MHz,440us,0,
935.4MHz,0dBm,10dB,10dB,CFIL,30kHz,100kHz,440us,0,
935.6MHz,0dBm,10dB,20dB,CFIL,30kHz,100kHz,440us,0
```

Performs the same measurement and returns the result list immediately after the last frequency point.

**Note:** The measurement is performed in zero span and therefore the span is set to 0 Hz. If the span > 0 is set, the function is automatically switched off.

The measurement is not compatible with other measurements, especially as far as marker, adjacent channel power measurement or statistics are concerned. The corresponding commands thus automatically deactivate the function.

The function is only available in REMOTE operation. It is deactivated when switching the instrument back to LOCAL.

**Characteristics**

\*RST value: –

SCPI: device-specific

**Mode**

A-F, A-T

**[SENSe<1|2>:]LIST:POWer:RESult?**

This command queries the result of a previous list measurement as configured and initiated with `[SENSe<1|2>:]LIST:POWer[:SEQuence]`. The measured results are output in a list of floating point values separated by commas. The unit of the results depends on the setting made with the `CALCulate<1|2>:UNIT:POWer` command.

This command may be used to obtain measurement results in an asynchronous way, using the service request mechanism for synchronization with the end of the measurement.

If no measurement results are available, the command will return a query error.

The numeric suffixes <1|2> are not relevant.

**Example**

```
*ESE 1
*SRE 32
```

Configuration of the status reporting system for the generation of an SRQ on operation complete

```
SENSe:LIST:POWer
935.2MHz,-20dBm,10dB,OFF,NORM,1MHz,3MHz,434us,0,
935.4MHz,-20dBm,10dB,10dB,NORM,30kHz,100kHz,434us,0,
935.6MHz,-20dBm,10dB,20dB,NORM,30kHz,100kHz,434us,0;
*OPC
```

Configuring and starting the measurement

...

Further actions of the control computer during measurement

On SRQ:

```
SENSe:LIST:POWer:RESult?
```

Response to service request

**Characteristics**

\*RST value: –

SCPI: device-specific

**Mode**

A–F, A–T

**[SENSe<1|2>:]LIST:POWer:SET**

This command defines the constant settings for the list during multiple power measurement.

Parameters <PEAK meas>, <RMS meas> and <AVG meas> define, which measurements are to be performed at the same time at the frequency point. Correspondingly, one, two or three results per frequency point are returned for the `[SENSe<1|2>:]LIST:POWer[:SEQuence]` command. If all three parameters are set to OFF, the command generates an execution error.

The numeric suffixes <1|2> are not relevant.

**Parameter**

<PEAK meas>	ON: activates the measurement of the peak power (peak detector) OFF: deactivates the measurement of the peak power
<RMS meas>	ON: activates the measurement of the RMS power (RMS detector) OFF: deactivates the measurement of the RMS power
<AVG meas>	ON: activates the measurement of the average power (average detector) OFF: deactivates the measurement of the average power



<trigger mode>	Selection of the trigger source used for the list measurement Possible values: IMMEDIATE   EXTERNAL   VIDEO   IFFPOWER
<trigger slope>	Used trigger slope Possible values: POSITIVE   NEGATIVE
<trigger offset>	Offset between the detection of the trigger signal and the start of the measurement at the next frequency point. Range of values: 0 s, 125 ns to 100s
<gate length>	Gate length with gated sweep Range of values: 0 s, 125 ns to 100s The value 0 s deactivates the use of gated trigger; other values activate the gated trigger function. Values <> 0 s are only possible if <trigger mode> is different from IMMEDIATE. Otherwise, an execution error is triggered.

**Return values**

The query command returns a list of comma-separated values (CSV) of the settings, i.e.

```
ON, ON, ON, IMM, POS, 0, 0
```

if the configuration has been set with the command

```
SENSe:LIST:POWer:SET ON, ON, ON, IMM, POS, 0, 0
```

**Example**

```
SENSe:LIST:POWer:SET ON, OFF, OFF, EXT, POS, 10US, 434US
```

**Characteristics**

\*RST value: ON, OFF, OFF, IMM, POS, 0S, 0S

SCPI: device-specific

**Mode**

A-F, A-T

**[SENSe<1|2>:]LIST:POWer:STATe**

This command deactivates the list measurement.

The numeric suffixes <1|2> are not relevant.

**Parameter**

OFF

**Example**

```
SENSe:LIST:POWer:STATe OFF
```

**Characteristics**

\*RST value: –

SCPI: device-specific

**Mode**

A-F, A-T

**SENSe:LIST:RANGe Subsystem**

The SENSe:LIST:RANGe Subsystem contains the remote commands to configure Spurious Emissions measurements.

**Commands of the SENSe:LIST:RANGe Subsystem**

- [SENSe<1|2>:]LIST:RANGe<1...20>:BANDwidth
- [SENSe<1|2>:]LIST:RANGe<1...20>:BANDwidth:RESolution
- [SENSe<1|2>:]LIST:RANGe<1...20>:BANDwidth:VIDeo
- [SENSe<1|2>:]LIST:RANGe<1...20>:BREak
- [SENSe<1|2>:]LIST:RANGe<1...20>:DELeTe
- [SENSe<1|2>:]LIST:RANGe<1...20>:COUnT?
- [SENSe<1|2>:]LIST:RANGe<1...20>:DETEctor
- [SENSe<1|2>:]LIST:RANGe<1...20>[:FREQuency]:STARt
- [SENSe<1|2>:]LIST:RANGe<1...20>[:FREQuency]:STOP
- [SENSe<1|2>:]LIST:RANGe<1...20>:FILTer:TYPE
- [SENSe<1|2>:]LIST:RANGe<1...20>:INPut:ATTenuation
- [SENSe<1|2>:]LIST:RANGe<1...20>:INPut:ATTenuation:AUTO
- [SENSe<1|2>:]LIST:RANGe<1...20>:INPut:GAIN:STATe
- [SENSe<1|2>:]LIST:RANGe<1...20>:POINts
- [SENSe<1|2>:]LIST:RANGe<1...20>:RLEVel
- [SENSe<1|2>:]LIST:RANGe<1...20>:SWEep:TIME
- [SENSe<1|2>:]LIST:RANGe<1...20>:SWEep:TIME:AUTO
- [SENSe<1|2>:]LIST:RANGe<1...20>:LIMit:STARt
- [SENSe<1|2>:]LIST:RANGe<1...20>:LIMit:STOP
- [SENSe<1|2>:]LIST:RANGe<1...20>:LIMit:STATe
- [SENSe<1|2>:]LIST:RANGe<1...20>:TRANsducer

**[SENSe<1|2>:]LIST:RANGe<1...20>:BANDwidth**

For details refer to "[SENSe<1|2>:]ESpectrum:RANGe<1...20>:BANDwidth" on page 6.152.

**[SENSe<1|2>:]LIST:RANGe<1...20>:BANDwidth:RESolution**

For details refer to "[SENSe<1|2>:]ESpectrum:RANGe<1...20>:BANDwidth:RESolution" on page 6.152.

**[SENSe<1|2>:]LIST:RANGe<1...20>:BANDwidth:VIDeo**

For details refer to "[SENSe<1|2>:]ESpectrum:RANGe<1...20>:BANDwidth:VIDeo" on page 6.152.

**[SENSe<1|2>:]LIST:RANGe<1...20>:BREak**

This command configures the sweep behavior.  
The numeric suffixes are not relevant.

**Parameter**

- ON The R&S ESL stops after one range is swept and continues only if you confirm (a message box is displayed).  
OFF The R&S ESL sweeps all ranges in one go.

**Example**

```
LIST:RANG:BRE ON
```

Configures a stop after each range.

**Characteristics**

RST value: OFF  
SCPI: device-specific

**Mode**

A

**[SENSe<1|2>:]LIST:RANGe<1...20>:DELeTe**

For details refer to "[SENSe<1|2>:]ESpectrum:RANGe<1...20>:DELeTe" on page 6.153.

**[SENSe<1|2>:]LIST:RANGe<1...20>:COUNt?**

For details refer to "[SENSe<1|2>:]ESpectrum:RANGe<1...20>:COUNt?" on page 6.153.

**[SENSe<1|2>:]LIST:RANGe<1...20>:DETector**

This command sets the detector for the specified range. For details refer to chapter 4, "Detector overview".

The numeric suffixes <1...20> specify the range. The numeric suffixes <1|2> are not relevant.

**Parameter**

- APEak auto peak detector  
NEGative minimum peak detector  
POSitive peak detector  
SAMPle sample detector  
RMS RMS detector  
AVERage average detector

**Example**

```
LIST:RANGe3:DET SAMP
```

Sets the sample detector for range 3.

**Characteristics**

RST value: RMS  
SCPI: device-specific

**Mode**

A

**[SENSe<1|2>:]LIST:RANGe<1...20>[:FREQuency]:START**

For details refer to "[SENSe<1|2>:]ESpectrum:RANGe<1...20>[:FREQuency]:START" on page 6.153.

**[SENSe<1|2>:]LIST:RANGe<1...20>[:FREQuency]:STOP**

For details refer to "[SENSe<1|2>:]ESpectrum:RANGe<1...20>[:FREQuency]:STOP" on page 6.154.

**[SENSe<1|2>:]LIST:RANGe<1...20>:FILTer:TYPE**

For details refer to "[SENSe<1|2>:]ESpectrum:RANGe<1...20>:FILTer:TYPE" on page 6.154.

**[SENSe<1|2>:]LIST:RANGe<1...20>:INPut:ATTenuation**

For details refer to "[SENSe<1|2>:]ESpectrum:RANGe<1...20>:INPut:ATTenuation" on page 6.155.

**[SENSe<1|2>:]LIST:RANGe<1...20>:INPut:ATTenuation:AUTO**

For details refer to "[SENSe<1|2>:]ESpectrum:RANGe<1...20>:INPut:ATTenuation:AUTO" on page 6.155.

**[SENSe<1|2>:]LIST:RANGe<1...20>:INPut:GAIN:STATe**

For details refer to "[SENSe<1|2>:]ESpectrum:RANGe<1...20>:INPut:GAIN:STATe" on page 6.155.

**[SENSe<1|2>:]LIST:RANGe<1...20>:POINts**

This command sets the number of sweep points for the specified range.  
The numeric suffixes <1...20> specify the range. The numeric suffixes <1|2> are not relevant.

**Parameter**

For details on possible values refer to chapter 4, **Sweep Points** softkey of the sweep menu.

**Example**

```
LIST:RANG3:POIN 601
Sets 601 sweep points for range 3.
```

**Characteristics**

RST value: 501  
SCPI: device-specific

**Mode**

A

---

**[SENSe<1|2>:]LIST:RANGe<1...20>:RLEVel**

---

For details refer to "[SENSe<1|2>:]ESPectrum:RANGe<1...20>:RLEVel" on page 6.158.

---

---

**[SENSe<1|2>:]LIST:RANGe<1...20>:SWEep:TIME**

---

For details refer to "[SENSe<1|2>:]ESPectrum:RANGe<1...20>:SWEep:TIME" on page 6.159.

---

---

**[SENSe<1|2>:]LIST:RANGe<1...20>:SWEep:TIME:AUTO**

---

For details refer to "[SENSe<1|2>:]ESPectrum:RANGe<1...20>:SWEep:TIME:AUTO" on page 6.159.

---

---

**[SENSe<1|2>:]LIST:RANGe<1...20>:LIMit:START**

---

For details refer to "[SENSe<1|2>:]ESPectrum:RANGe<1...20>:LIMit:ABSolute:START" on page 6.156.

---

---

**[SENSe<1|2>:]LIST:RANGe<1...20>:LIMit:STOP**

---

For details refer to "[SENSe<1|2>:]ESPectrum:RANGe<1...20>:LIMit:ABSolute:STOP" on page 6.156.

---

---

**[SENSe<1|2>:]LIST:RANGe<1...20>:LIMit:STATe**

---

For details refer to "[SENSe<1|2>:]ESPectrum:RANGe<1...20>:LIMit:STATe" on page 6.158.

---

---

**[SENSe<1|2>:]LIST:RANGe<1...20>:TRANsducer**

---

For details refer to "[SENSe<1|2>:]ESPectrum:RANGe<1...20>:TRANsducer" on page 6.159.

---

### SENSe:MPOWER Subsystem

The commands of this subsystem are used to determine the mean burst power or peak burst power for a given number of signal bursts, and for outputting the results in a list. Since all the settings required for a measurement are combined in a single command, the measurement speed is considerably higher than when using individual commands.

For measuring the signal bursts, the gated sweep function is used in zero span. The gate is controlled either by an external trigger signal or by the video signal. An individual trigger event is required for each burst to be measured. If an external trigger signal is used, the threshold is fixed to TTL level, while with a video signal the threshold can be set as desired.

#### Commands of the SENSe:MPOWER Subsystem

- [SENSe<1|2>:]MPOWER[:SEQuence]
- [SENSe<1|2>:]MPOWER:FTYPE
- [SENSe<1|2>:]MPOWER:RESult[:LIST]?
- [SENSe<1|2>:]MPOWER:RESult:MIN?

#### Further information

- [More details on the SENSe:MPOWER Subsystem](#)

#### More details on the SENSe:MPOWER Subsystem

The following graphics shows the relation between trigger time, trigger offset (for delayed gate opening) and measurement time.

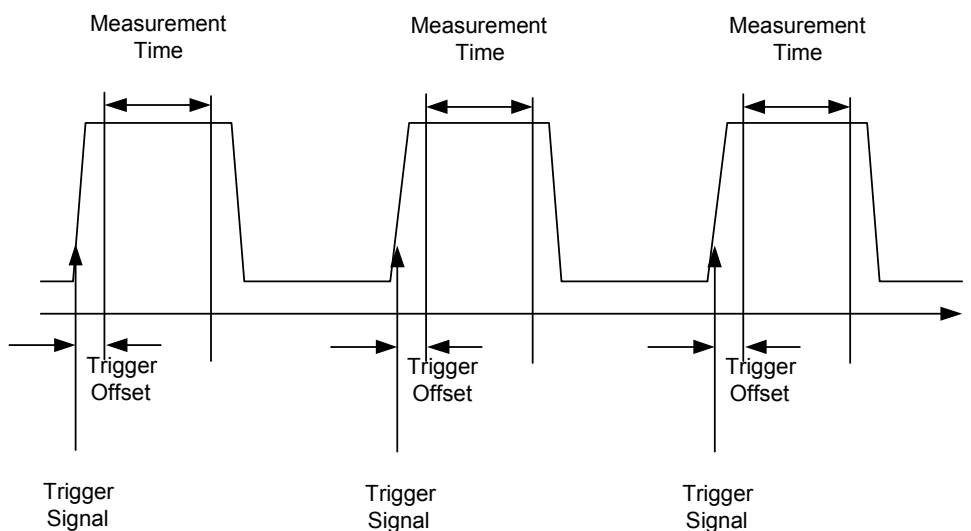

Depending on the settings made, the measurements are performed with the RMS detector for RMS power or the PEAK detector for peak power. For all these measurements, trace 1 of the selected system is used.

The setting parameters for this measurement are:

- analyzer frequency
- resolution bandwidth
- measurement time used for a single burst

- trigger source
- trigger level
- trigger offset
- type of power measurement (PEAK, MEAN)
- number of bursts to be measured

The commands of this subsystem can be used in two different ways:

- Setting up the instrument and at the same time querying the result list: This method ensures the smallest delay between measurement and the output of the measured values, but requires the control computer to wait actively for the response of the instrument.
- Setting up the instrument and querying the result list after synchronization to the end of measurement: With this method the control computer can be used for other activities while the instrument is performing the measurement at the cost of additional time needed for synchronization via service request.

### **[SENSe<1|2>:]MPOWER[:SEquence]**

This command configures the instrument setup for multiple burst power measurement and starts a measurement sequence. When synchronizing the command with \*OPC, a service request is generated as soon as the defined number of individual measurements (# of meas) is reached. To reduce the setting time, the setup is performed simultaneously for all selected parameters. The command in the form of a query makes the instrument settings, performs the defined number of measurements and outputs the measurement results list. The numeric suffixes <1|2> are not relevant.

#### **Parameter**

<analyzer freq>	Receive frequency for the burst signals to be measured (= center frequency in manual operation) Range: 0 Hz to max. frequency, depending on instrument model
<rbw>	resolution bandwidth for the measurement Range: 10 Hz to 10 MHz in steps of 1, 3, 10
<meas time>	Time span during which measurement samples are sampled for RMS / peak measurement. The type of measurement is selected by <type of meas>. Range: 1us to 30s
<trigger source>	trigger signal source. Possible settings: EXTernal: The trigger signal is fed from the "Ext. Trigger/Gate" input on the rear of the unit. VIDeo: The internal video signal is used as trigger signal.
<trigger level>	Signal level at which the trigger becomes active. For <trigger source> = VIDeo this is the level of the video signal as a percentage of the diagram height. If <trigger source> = EXTernal is selected, the value entered here is ignored, as in this case the trigger input uses TTL levels. Range: 0 – 100PCT(<trigger source> = VIDeo)
<trigger offset>	Offset between the detection of the trigger signal and the start of the measurement. Range: 125 ns to 100s

- <type of meas> Determines whether mean power (RMS) or peak power (PEAK) is to be measured. The detector is selected accordingly.  
Possible values: MEAN, PEAK
- <# of meas> Number of individual bursts to be measured.  
Range: 1 to 32001

**Return values**

The query command returns a list separated by commas (comma separated values = CSV), which contains the power measurement results in floating–point format. The unit used for the return values is always dBm.

The command `SENSe:MPOWer? 935.2MHz,1MHz,434us,VIDEO,50PCT,5us,MEAN,20`

may, for instance, cause the following list to be returned:

18.3,18.6,18.1,18.0,17.9,18.3,18.6,18.1,18.0,17.9,18.3,18.6,18.1,18.0,17.9,18.3,18.6,18.1,18.0,17.9

**Example**

`SENSe:MPOWer 935.2MHz,1MHz,434us,VIDEO,50PCT,5us,MEAN,20`

Performs a measurement sequence with the following settings:

Frequency = 935.2 MHz,

Resolution bandwidth = 1 MHz

Measurement time = 434  $\mu$ s

Trigger source = VIDEO

Trigger threshold = 50%

Trigger offset = 5  $\mu$ s

Type of measurement = MEAN power

No. of measurements = 20

`SENSe:MPOWer? 935.2MHz,1MHz,434us,VIDEO,50PCT,5us,MEAN,20`

Performs the same measurement and in addition returns the results list immediately after completion of the last measurement.

**Note:** *The measurement function always uses trace 1.*

*Repeated use of the command without changes to its parameters (i.e. using the same settings again) will speed up the measurement since the previous hardware settings will be cached and therefore additional hardware settling times will be avoided. This also holds true if only part of the parameters (e.g. only the trigger delay) are changed, as in this case the rest of the parameters will be cached.*

*This measurement is not compatible with other measurements, especially as far as marker functions, adjacent–channel measurement or statistics are concerned. The corresponding functions are therefore automatically switched off. In return incompatible commands will automatically deactivate the multi burst power function.*

*The function is only available in the REMOTE operation. It is deactivated on switching back to LOCAL.*

**Characteristics**

\*RST value: –

SCPI: device–specific

**Mode**

A



**[SENSe<1|2>:]MPOWer:FTYPE**

This command defines the filter type for the measurement.  
The numeric suffixes <1|2> are not relevant.

**Parameter**

NORMal | CFILter | RRC

**Example**

```
SENSe:MPOWer:FTYPE CFILter
```

**Characteristics**

\*RST value: –

SCPI: device-specific

**Mode**

A

**[SENSe<1|2>:]MPOWer:RESult[:LIST]?**

This command queries the results of a multiple burst power measurement as configured and initiated with `[SENSe<1|2>:]MPOWer[:SEQuence]`. The results are output in a comma-separated list of floating point values. The unit used for the return values is always dBm.

This command may be used to obtain measurement results in an asynchronous way using the service request mechanism for synchronization with the end of the measurement.

The numeric suffixes <1|2> are not relevant.

If no measurement results are available, the command will return a query error.

**Example**

```
*ESE 1
```

```
*SRE 32
```

Configuration of status reporting systems for the generation of an SRQ on operation complete

```
SENSe:MPOWer 935.2MHz,1MHz,434us,VIDEO,50PCT,5us,MEAN,20;*OPC
```

Configuring and starting the measurement

...

Further actions of the control computer during measurement

On SRQ:

Response to service request

```
SENSe:MPOWer:RESult?
```

**Characteristics**

\*RST value: –

SCPI: device-specific

**Mode**

A

---

**[SENSe<1|2>:]MPOWer:RESult:MIN?**

---

This command queries the minimum power value in a multiple burst power measurement as configured and initiated with [SENSe<1|2>:]MPOWer [:SEQuence]. The unit used for the return values is always dBm.

The numeric suffixes <1|2> are not relevant.

If no measurement result is available, the command will return a query error.

**Example**

```
*ESE 1
*SRE 32
```

Configuration of status reporting systems for the generation of an SRQ on operation complete

```
SENSe:MPOWer 935.2MHz,1MHz,434us,VIDEO,50PCT,5us,MEAN,20;*OPC
```

Configuring and starting the measurement

...

Further actions of the control computer during measurement

On SRQ:

Response to service request

```
SENSe:MPOWer:RESult:MIN?
```

**Characteristics**

\*RST value: –

SCPI: device-specific

**Mode**

A

---

## SENSe:POWer Subsystem

This subsystem controls the setting of the instruments channel and adjacent channel power measurements.

### Commands of the SENSe:POWer Subsystem

- [SENSe<1|2>:]POWer:ACHannel:ACPairs
- [SENSe<1|2>:]POWer:ACHannel:BANDwidth|BWIDth[:CHANnel]
- [SENSe<1|2>:]POWer:ACHannel:BANDwidth|BWIDth:ACHannel
- [SENSe<1|2>:]POWer:ACHannel:BANDwidth|BWIDth:ALTErnate<1...11>
- [SENSe<1|2>:]POWer:ACHannel:MODE
- [SENSe<1|2>:]POWer:ACHannel:PRESet
- [SENSe<1|2>:]POWer:ACHannel:PRESet:RLEVel
- [SENSe<1|2>:]POWer:ACHannel:REFerence:AUTO
- [SENSe<1|2>:]POWer:ACHannel:REFerence:TXCHannel:AUTO
- [SENSe<1|2>:]POWer:ACHannel:REFerence:TXCHannel:MANual
- [SENSe<1|2>:]POWer:ACHannel:SPACing[:ACHannel]
- [SENSe<1|2>:]POWer:ACHannel:SPACing:ALTErnate<1...11>
- [SENSe<1|2>:]POWer:ACHannel:SPACing:CHANnel
- [SENSe<1|2>:]POWer:ACHannel:TXCHannel:COUNT
- [SENSe<1|2>:]POWer:BANDwidth|BWIDth
- [SENSe<1|2>:]POWer:HSPeed
- [SENSe<1|2>:]POWer:TRACe

### [SENSe<1|2>:]POWer:ACHannel:ACPairs

This command sets the number of adjacent channels (upper and lower channel in pairs). The figure 0 stands for pure channel power measurement.

The numeric suffixes <1|2> are not relevant.

#### Parameter

1 to 12

#### Example

```
POW:ACH:ACP 3
```

Sets the number of adjacent channels to 3, i.e. the adjacent channel and alternate adjacent channels 1 and 2 are switched on.

#### Characteristics

\*RST value: 1

SCPI: device-specific

#### Mode

A-F

**[SENSe<1|2>:]POWer:ACHannel:BANDwidth|BWIDth[:CHANnel]**

This command sets the channel bandwidth of the radio communication system. The bandwidths of adjacent channels are not influenced by this modification.

With [SENSe<1|2>:]POWer:HSPEED set to ON, steep-edged channel filters are available. For further information on filters refer to chapter "Instrument Functions", section "List of available RRC and channel filters".

The numeric suffixes <1|2> are not relevant.

**Parameter**

100 Hz to 1000 MHz

**Example**

```
POW:ACH:BWID 30kHz
```

Sets the bandwidth of the TX channel to 30 kHz.

**Characteristics**

\*RST value: 14 kHz

SCPI: device-specific

**Mode**

A-F

**[SENSe<1|2>:]POWer:ACHannel:BANDwidth|BWIDth:ACHannel**

This command defines the channel bandwidth of the adjacent channel of the radio transmission system. If the bandwidth of the adjacent channel is changed, the bandwidths of all alternate adjacent channels are automatically set to the same value.

With [SENSe<1|2>:]POWer:HSPEED set to ON, steep-edged channel filters are available. For further information on filters refer to chapter "Instrument Functions", section "List of available RRC and channel filters".

The numeric suffixes <1|2> are not relevant.

**Parameter**

100 Hz to 1000 MHz

**Example**

```
POW:ACH:BWID:ACH 30kHz
```

Sets the bandwidth of all adjacent channels to 30 kHz.

**Characteristics**

\*RST value: 14 kHz

SCPI: device-specific

**Mode**

A-F

**[SENSe<1|2>:]POWer:ACHannel:BANDwidth|BWIDth:ALternate<1...11>**

This command defines the channel bandwidth of the alternate adjacent channels of the radio transmission system. If the channel bandwidth of alternate adjacent channel 1 is changed, the bandwidth of alternate adjacent channels 2 to 11 is automatically set to the same value.

With [SENSe<1|2>:]POWer:HSPEED set to ON, steep-edged channel filters are available. For further information on filters refer to chapter "Instrument Functions", section "List of available RRC and channel filters".

**Parameter**

100 Hz to 1000 MHz

**Example**

POW:ACH:BWID:ALT2 30kHz

**Characteristics**

\*RST value: 14 kHz

SCPI: device-specific

**Mode**

A-F

**[SENSe<1|2>:]POWer:ACHannel:MODE**

This command switches between absolute and relative adjacent channel measurement. The command is only available with span > 0 and if the number of adjacent channel is greater than 0.

The numeric suffixes <1|2> are not relevant.

**Parameter**

ABSolute | RELative

**Example**

POW:ACH:MODE REL

Sets the adjacent channel measurement mode to relative.

**Characteristics**

RST value: RELative

SCPI: device-specific

**Mode**

A-F

**[SENSe<1|2>:]POWer:ACHannel:PRESet**

This command adjusts the frequency span, the measurement bandwidths and the detector as required for the number of channels, the channel bandwidths and the channel spacings selected in the active power measurement. If necessary, adjacent-channel power measurement is switched on prior to the adjustment.

To obtain correct results, a complete sweep with synchronization to the end of the sweep must be performed after the adjustment. Synchronization is possible only in the single sweep mode.

The result is queried with the `CALCulate<1|2>:MARKer:FUNction:POWer:RESult?` command.

The numeric suffixes <1|2> are not relevant.

**Parameter**

ACPower | CPOWer | MCACpower | OBANdwidth | OBWidth | CN | CN0

**Example**

POW:ACH:PRES ACP

Sets the frequency span, the measurement bandwidths and the detector as required for the ACP measurement.

INIT:CONT OFF

Switches over to single sweep mode.

INIT;\*WAI

Starts a sweep and waits for the end of the sweep.

CALC:MARK:FUNC:POW:RES? ACP

Queries the result of the adjacent-channel power measurement.

#### Characteristics

\*RST value: –

SCPI: device-specific

#### Mode

A–F

### [SENSe<1|2>:]POWer:ACHannel:PRESet:RLEVel

This command adapts the reference level to the measured channel power and – if required – switches on previously the adjacent channel power measurement. This ensures that the signal path of the instrument is not overloaded. Since the measurement bandwidth is significantly smaller than the signal bandwidth in channel power measurements, the signal path can be overloaded although the trace is still significantly below the reference level. If the measured channel power equals the reference level, the signal path is not overloaded.

The numeric suffixes <1|2> are not relevant.

This command is an event and therefore has no \*RST value and no query.

**Note:** *Subsequent commands have to be synchronized with \*WAI, \*OPC or \*OPC? to the end of the auto range process which would otherwise be aborted.*

#### Example

POW:ACH:PRESet:RLEV; \*WAI

Adapts the reference level to the measured channel power.

#### Characteristics

\*RST value: –

SCPI: device-specific

#### Mode

A–F

### [SENSe<1|2>:]POWer:ACHannel:REFerence:AUTO

This command sets the reference value to the currently measured channel power for the relative measurement.

The numeric suffixes <1|2> are not relevant.

This command is an event and therefore has no \*RST value and no query.

#### Parameter

ONCE

#### Example

POW:ACH:REF:AUTO ONCE

#### Characteristics

RST value: –

SCPI: device-specific

#### Mode

A–F

**[SENSe<1|2>:]POWer:ACHannel:REFerence:TXCHannel:AUTO**

This command activates the automatic selection of a transmission channel to be used as a reference channel in relative adjacent-channel power measurements.

The transmission channel with the highest power, the transmission channel with the lowest power, or the transmission channel nearest to the adjacent channels can be defined as a reference channel.

The command is available only for multicarrier channel and adjacent-channel power measurements with span > 0 (`CALCulate<1|2>:MARKer:FUNction:POWer:SElect`).

The numeric suffixes <1|2> are not relevant.

**Parameter**

MINimum	Transmission channel with the lowest power
MAXimum	Transmission channel with the highest power
LHIGhest	Lowermost transmission channel for the lower adjacent channels, uppermost transmission channel for the upper adjacent channels

**Example**

```
POW:ACH:REF:TXCH:AUTO MAX
```

The transmission channel with the highest power is used as a reference channel.

**Characteristics**

\*RST value: –

SCPI: device-specific

**Mode**

A–F

**[SENSe<1|2>:]POWer:ACHannel:REFerence:TXCHannel:MANual**

This command selects a transmission channel to be used as a reference channel in relative adjacent-channel power measurements.

The command is available only for multicarrier channel and adjacent-channel power measurements with span > 0 (`CALCulate<1|2>:MARKer:FUNction:POWer:SElect`).

The numeric suffixes <1|2> are not relevant.

**Parameter**

1 to 12

**Example**

```
POW:ACH:REF:TXCH:MAN 3
```

Transmission channel 3 is used as a reference channel.

**Characteristics**

\*RST value: 1

SCPI: device-specific

**Mode**

A–F

---

**[SENSe<1|2>:]POWer:ACHannel:SPACing[:ACHannel]**

---

This command defines the spacing between the carrier signal and the adjacent channel (ADJ). The modification of the adjacent–channel spacing (ADJ) causes a change in all higher adjacent–channel spacings (ALT1, ALT2, ...): they are all multiplied by the same factor (new spacing value / old spacing value).

The numeric suffixes <1|2> are not relevant.

**Parameter**

100 Hz to 2000 MHz

**Example**

```
POW:ACH:SPAC 33kHz
```

Sets the spacing between the carrier signal and the adjacent channel to 33 kHz, the alternate adjacent channel 1 to 66 kHz, the alternate adjacent channel 2 to 99 kHz, and so on.

**Characteristics**

\*RST value: 14 kHz

SCPI: device–specific

**Mode**

A–F

---

**[SENSe<1|2>:]POWer:ACHannel:SPACing:ALTernate<1...11>**

---

This command defines the spacing between the alternate adjacent channels and the TX channel (ALT1, ALT2, ...). A modification of a higher adjacent–channel spacing causes a change by the same factor (new spacing value / old spacing value) in all higher adjacent–channel spacings, while the lower adjacent–channel spacings remain unchanged.

The numeric suffixes <1...11> defines the alternate adjacent channel. The numeric suffixes <1|2> are not relevant.

**Parameter**

100 Hz to 2000 MHz

**Example**

```
POW:ACH:SPAC:ALT1 100kHz
```

Sets the spacing between TX channel and alternate adjacent channel 1 (ALT1) from 40 kHz to 100 kHz. In consequence, the spacing between the TX channel and all higher alternate adjacent channels is increased by the factor  $100/40 = 2.5$ : ALT2 = 150 kHz, ALT3 = 200 kHz, ALT4 = 250 kHz.

**Characteristics**

\*RST value: 40 kHz (ALT1), 60 kHz (ALT2), 80 kHz (ALT3), ...

SCPI: device–specific

**Mode**

A–F

---



---

**[SENSe<1|2>:]POWer:ACHannel:SPACing:CHANnel<1...11>**

---

This command defines the channel spacing for the carrier signals.

The numeric suffixes <1...11> defines the TX channel. The numeric suffixes <1|2> are not relevant.

**Parameter**

14 kHz to 2000 MHz

**Example**

```
POW:ACH:SPAC:CHAN 25kHz
```

**Characteristics**

\*RST value: 20 kHz

SCPI: device-specific

**Mode**

A-F

---

---

**[SENSe<1|2>:]POWer:ACHannel:TXChannel:COUNT**

---

This command selects the number of carrier signals.

The command is available only for multicarrier channel and adjacent-channel power measurements with span > 0 ([CALCulate<1|2>:MARKer:FUNCTION:POWer:SElect](#)).

The numeric suffixes <1|2> are not relevant.

**Parameter**

1 to 12

**Example**

```
POW:ACH:TXCH:COUN 3
```

**Characteristics**

\*RST value: 1

SCPI: device-specific

**Mode**

A

---

---

**[SENSe<1|2>:]POWer:BANDwidth|BWIDth**

---

This command defines the percentage of the power with respect to the total power. This value is the basis for the occupied bandwidth measurement

([\[SENSe<1|2>:\]POWer:ACHannel:PRESet](#)).

The numeric suffixes <1|2> are not relevant.

**Parameter**

10 to 99.9PCT

**Example**

```
POW:BWID 95PCT
```

**Characteristics**

\*RST value: 99PCT

SCPI: device-specific

**Mode**

A-F

**[SENSe<1|2>:]POWer:HSPeed**

This command switches on or off the high-speed channel/adjacent channel power measurement. The measurement itself is performed in zero span on the center frequencies of the individual channels. The command automatically switches to zero span and back.

Depending on the selected mobile radio standard, weighting filters with  $\sqrt{\cos}$  characteristic or very steep-sided channel filters are used for band limitation.

The numeric suffixes <1|2> are not relevant.

**Parameter**

ON | OFF

**Example**

POW:HSP ON

**Characteristics**

\*RST value: OFF

SCPI: device-specific

**Mode**

A-F

**[SENSe<1|2>:]POWer:TRACe**

This command assigns the channel/adjacent channel power measurement to the indicated trace. The corresponding trace must be active, i.e. its state must be different from blank.

The numeric suffixes <1|2> are not relevant.

**Note:** *The measurement of the occupied bandwidth (OBW) is performed on the trace on which marker 1 is positioned. To evaluate another trace, marker 1 must be positioned to another trace with `CALCulate<1|2>:MARKer<1...4>:TRACe`.*

**Parameter**

1 to 6

**Example**

POW:TRAC 2

Assigns the measurement to trace 2.

**Characteristics**

\*RST value: –

SCPI: device-specific

**Mode**

A

**SENSe:SCAN Subsystem**

This subsystem controls the parameters for the receiver scan data. The numeric suffix in [SENSe<1|2>] is not significant.

**Commands of the SENSe:SCAN Subsystem**

- [SENSe<1|2>:]SCAN<1...10>:BANDwidth:RESolution
- [SENSe<1|2>:]SCAN<1...10>:INPut:ATTenuation
- [SENSe<1|2>:]SCAN<1...10>:INPut:ATTenuation:AUTO
- [SENSe<1|2>:]SCAN<1...10>:INPut:GAIN[:STATe]
- [SENSe<1|2>:]SCAN<1...10>:INPut:GAIN:AUTO
- [SENSe<1|2>:]SCAN<1...10>:RANGes:COUNT
- [SENSe<1|2>:]SCAN<1...10>:STARt
- [SENSe<1|2>:]SCAN<1...10>:STOP
- [SENSe<1|2>:]SCAN<1...10>:STEP
- [SENSe<1|2>:]SCAN<1...10>:TIME

**[SENSe<1|2>:]SCAN<1...10>:BANDwidth:RESolution**

This command sets the bandwidth for the selected receiver scan range.

**Parameter**

10 Hz to 10 MHz

**Example**

```
SCAN1:BAND:RES 1 MHz
```

Sets the resolution bandwidth of the first scan range to 1 MHz

**Characteristics**

\*RST value: 9 kHz (range 1)

\*RST value: 120 kHz (range 2)

SCPI: device-specific

**Mode**

R

**[SENSe<1|2>:]SCAN<1...10>:INPut:ATTenuation**

This command sets the RF attenuation for the selected receiver scan range.

**Parameter**

dB<sub>min</sub> to dB<sub>max</sub>

**Example**

```
SCAN1:INP:ATT 30 dB
```

Sets the RF attenuation of the first scan range to 30 dB

**Characteristics**

\*RST value: 10 dB

SCPI: device-specific

**Mode**

R

---

**[SENSe<1|2>:]SCAN<1...10>:INPut:ATTenuation:AUTO**

---

This command activates or deactivates the autoranging function in the selected receiver scan range.

**Parameter**

ON | OFF

**Example**

```
SCAN1:INP:ATT:AUTO ON
```

Activates auto ranging for the first scan range

**Characteristics**

\*RST value: OFF

SCPI: device-specific

**Mode**

R

---

**[SENSe<1|2>:]SCAN<1...10>:INPut:GAIN[:STATe]**

---

This command activates or deactivates the preamplifier in the selected scan range.

**Parameter**

ON | OFF

**Example**

```
SCAN1:INP:GAIN ON
```

Activates the preamplifier in the first scan range

**Characteristics**

\*RST value: OFF

SCPI: device-specific

**Mode**

R

---

**[SENSe<1|2>:]SCAN<1...10>:INPut:GAIN:AUTO**

---

This command includes the preamplifier in the autoranging function of the selected receiver scan range.

**Parameter**

ON | OFF

**Example**

```
SCAN1:INP:GAIN:AUTO ON
```

Activates the preamplifier inclusion in the autoranging function for the first scan range

**Characteristics**

\*RST value: OFF

SCPI: device-specific

**Mode**

R

---

---

**[SENSe<1|2>:]SCAN<1...10>:RANGes:COUNT**

---

This command determines the number of ranges. With setting 0, the scan is performed using the current receiver settings and not the settings defined with commands `SENSe:SCAN:...`

**Parameter**

1 to 10

**Example**

```
SCAN:RANG:COUN 3
```

Sets the number of ranges to 3

**Characteristics**

\*RST value: 0

SCPI: device-specific

**Mode**

R

---

---

**[SENSe<1|2>:]SCAN<1...10>:START**

---

This command defines the start frequency of the selected receiver scan range.

**Parameter**

$f_{\min}$  to  $f_{\max}$

**Example**

```
SCAN:STAR 50 kHz
```

Sets the start frequency of the first scan range to 50 kHz

**Characteristics**

\*RST value: 150 kHz (range 1)

\*RST value: 30 MHz (range 2)

SCPI: device-specific

**Mode**

R

---

---

**[SENSe<1|2>:]SCAN<1...10>:STOP**

---

This command defines the stop frequency of the selected receiver scan range.

**Parameter**

$f_{\min}$  to  $f_{\max}$

**Example**

```
SCAN:STAR 200 kHz
```

Sets the stop frequency of the first scan range to 200 kHz

**Characteristics**

\*RST value: 30 MHz (range 1)

\*RST value: 1 GHz (range 2)

SCPI: device-specific

**Mode**

R

---

---

**[SENSe<1|2>:]SCAN<1...10>:STEP**

---

This command defines the step size of the receiver frequency of the selected receiver scan range.

**Parameter**

$f_{\min}$  to  $f_{\max}$

**Example**

```
SCAN:STEP 100 Hz
```

Sets the step size of the receiver frequency of the first scan range to 100 Hz

**Characteristics**

\*RST value: 4 kHz (range 1)

\*RST value: 40 kHz (range 2)

SCPI: device-specific

**Mode**

R

---

**[SENSe<1|2>:]SCAN<1...10>:TIME**

---

This command sets the measurement time of the selected receiver scan range.

**Parameter**

50  $\mu$ s to 100 s

**Example**

```
SCAN:TIME 1 ms
```

Sets the measurement time of the first scan range to 1 ms

**Characteristics**

\*RST value: 1 ms (range 1)

\*RST value: 100  $\mu$ s (range 2)

SCPI: device-specific

**Mode**

R

---

## SENSe:SWEEp Subsystem

The SENSe:SWEEp subsystem controls the sweep parameters.

### Commands of the SENSe:SWEEp Subsystem

- [SENSe<1|2>:]SWEEp:COUNT
- [SENSe<1|2>:]SWEEp:COUNT:CURRent?
- [SENSe<1|2>:]SWEEp:EGATe
- [SENSe<1|2>:]SWEEp:EGATe:HOLDoff
- [SENSe<1|2>:]SWEEp:EGATe:LENGth
- [SENSe<1|2>:]SWEEp:EGATe:POLarity
- [SENSe<1|2>:]SWEEp:EGATe:SOURce
- [SENSe<1|2>:]SWEEp:EGATe:TYPE
- [SENSe<1|2>:]SWEEp:MODE
- [SENSe<1|2>:]SWEEp:POINts
- [SENSe<1|2>:]SWEEp:SPACing
- [SENSe<1|2>:]SWEEp:TIME
- [SENSe<1|2>:]SWEEp:TIME:AUTO

### [SENSe<1|2>:]SWEEp:COUNT

---

In receiver mode, this command defines the number of scans started with single scan.

In analyzer mode, the command defines the number of sweeps started with single sweep, which are used for calculating the average or maximum value. If the values 0 or 1 are set, one sweep is performed.

The numeric suffixes <1|2> are not relevant.

#### Parameter

0 to 32767

#### Example

```
SWE:COUNT 64
```

Sets the number of sweeps to 64.

```
INIT:CONT OFF
```

Switches to single sweep mode.

```
INIT;*WAI
```

Starts a sweep and waits for its end.

#### Characteristics

\*RST value: 0 (analyzer)

\*RST value: 1 (receiver)

SCPI: conform

#### Mode

R, A, ADEMOD

---

**[SENSe<1|2>:]SWEep:COUNT:CURRent?**

This query command returns the current number of started sweeps. A sweep count value should be set and the device should be in single sweep mode.

The numeric suffixes <1|2> are not relevant.

**Example**

```
SWE:COUNT 64
Sets sweep count to 64
INIT:CONT OFF
Switches to single sweep mode
INIT
Starts a sweep (without waiting for the sweep end!)
SWE:COUN:CURR?
Queries the number of started sweeps
```

**Characteristics**

\*RST value: 0

SCPI: conform

**Mode**

A, ADEMODO

**[SENSe<1|2>:]SWEep:EGATe**

This command switches on/off the sweep control by an external gate signal. If the external gate is selected the trigger source is automatically switched to EXTERNAL as well.

In case of measurement with external gate, the measured values are recorded as long as the gate is opened. During a sweep the gate can be opened and closed several times. The synchronization mechanisms with \*OPC, \*OPC? and \*WAI remain completely unaffected.

The sweep end is detected when the required number of measurement points (501 in **Spectrum Analyzer** mode) has been recorded.

The numeric suffixes <1|2> are not relevant.

**Parameter**

ON | OFF

**Example**

```
SWE:EGAT ON
Switches on the external gate mode.
SWE:EGAT:TYPE EDGE
Switches on the edge-triggered mode.
SWE:EGAT:HOLD 100US
Sets the gate delay to 100 µs.
SWE:EGAT:LEN 500US
Sets the gate opening time to 500 µs.
INIT;*WAI
Starts a sweep and waits for its end.
```

**Characteristics**

\*RST value: OFF

SCPI: device-specific

**Mode**

A



---

**[SENSe<1|2>:]SWEep:EGATe:HOLDoff**

---

This command defines the delay time between the external gate signal and the continuation of the sweep.

The numeric suffixes <1|2> are not relevant.

**Parameter**

125  $\mu$ s to 100 s

**Example**

```
SWE:EGAT:HOLD 100us
```

**Characteristics**

\*RST value: 0s

SCPI: device-specific

**Mode**

A

---

---

**[SENSe<1|2>:]SWEep:EGATe:LENGth**

---

In case of edge triggering, this command determines the time interval during which the instrument sweeps.

The numeric suffixes <1|2> are not relevant.

**Parameter**

0 to 100 s

**Example**

```
SWE:EGAT:LENG 10ms
```

**Characteristics**

\*RST value: 0s

SCPI: device-specific

**Mode**

A

---

---

**[SENSe<1|2>:]SWEep:EGATe:POLarity**

---

This command determines the polarity of the external gate signal. The setting applies both to the edge of an edge-triggered signal and the level of a level-triggered signal.

The numeric suffixes <1|2> are not relevant.

**Parameter**

POSitive | NEGative

**Example**

```
SWE:EGAT:POL POS
```

**Characteristics**

\*RST value: POSitive

SCPI: device-specific

**Mode**

A

---

---

**[SENSe<1|2>:]SWEep:EGATe:SOURce**

---

This command toggles between external gate signal and IF power signal as a signal source for the gate mode. If an IF power signal is used, the gate is opened as soon as a signal at > -20 dBm is detected within the IF path bandwidth (10 MHz).

The numeric suffixes <1|2> are not relevant.

**Parameter**

EXTernal | IFPower | VIDEo

**Example**

```
SWE:EGAT:SOUR IFP
```

Switches the gate source to IF power.

**Characteristics**

\*RST value: IFPower

SCPI: device-specific

**Mode**

A

---

**[SENSe<1|2>:]SWEep:EGATe:TYPE**

---

This command sets the type of triggering (level or edge) by the external gate signal.

The gate is edge-triggered (`[SENSe<1|2>:]SWEep:EGATe:TYPE`):

After detection of the set gate signal edge, the gate remains open until the gate delay (`[SENSe<1|2>:]SWEep:EGATe:HOLDoff`) has expired.

The gate is level-triggered (`[SENSe<1|2>:]SWEep:EGATe:TYPE`):

After detection of the gate signal, the gate remains open until the gate signal disappears. The gate opening time cannot be defined with the parameter

`[SENSe<1|2>:]SWEep:EGATe:LENGTH`.

A delay between applying the gate signal and the start of recording measured values can be defined with `[SENSe<1|2>:]SWEep:EGATe:HOLDoff`.

The numeric suffixes <1|2> are not relevant.

**Parameter**

LEVel | EDGE

**Example**

```
SWE:EGAT:TYPE EDGE
```

**Characteristics**

\*RST value: EDGE

SCPI: device-specific

**Mode**

A

---

**[SENSe<1|2>:]SWEep:MODE**

This command changes from Spectrum Analyzer to Spectrum Emission Mask or Spurious Emissions measurement mode and back.

The numeric suffixes <1|2> are not relevant.

**Parameter**

AUTO	Switches to Spectrum Analyzer measurement mode or stays in the current mode if it is not ESP / LIST
ESpectrum	Spectrum Emission Mask measurement mode
LIST	Spurious Emissions measurement mode

**Example**

```
SWE:MODE ESP
```

Sets the Spectrum Emission Mask measurement mode.

**Characteristics**

RST value: AUTO

SCPI: device-specific

**Mode**

A

**[SENSe<1|2>:]SWEep:POINTs**

This command defines the number of measurement points to be collected during one sweep.

The numeric suffixes <1|2> are not relevant.

**Parameter**

101 to 32001

**Example**

```
SWE:POIN 251
```

**Characteristics**

\*RST value: 501

SCPI: conform

**Mode**

A

**[SENSe<1|2>:]SWEep:SPACing**

This command toggles between linear and logarithmic step modes of the receiver.

**Parameter**

LINear | LOGarithmic | AUTO

**Example**

```
SWE:SPAC LOG
```

Sets the step mode to a logarithmic scale

**Characteristics:**

\*RST value: AUTO

SCPI: conform

**Mode**

R

---

**[SENSe<1|2>:]SWEep:TIME**

In receiver mode, this command defines the measurement time for the bargraph. The available time range is 30  $\mu$ s to 100 s with a two-digit resolution.

In analyzer mode, this command defines the sweep time. The available time values vary depending on the span setting.

If [SENSe<1|2>:]SWEep:TIME is directly programmed, automatic coupling to resolution bandwidth and video bandwidth is switched off.

The numeric suffixes <1|2> are not relevant.

**Parameter**

Receiver: 50 $\mu$ s to 100 s

Analyzer: refer to data sheet

**Example**

```
SWE:TIME 10s
```

Sets the measurement time to 10 s

**Characteristics**

\*RST value: – (AUTO is set to ON)

SCPI: conform

**Mode**

R, A, ADEMOD, NF

---

**[SENSe<1|2>:]SWEep:TIME:AUTO**

This command controls the automatic coupling of the sweep time to the frequency span and bandwidth settings.

If [SENSe<1|2>:]SWEep:TIME is directly programmed, automatic coupling is switched off.

The numeric suffixes <1|2> are not relevant.

**Parameter**

ON | OFF

**Example**

```
SWE:TIME:AUTO ON
```

Switches on the coupling to frequency span and bandwidths.

**Characteristics**

\*RST value: ON

SCPI: conform

**Mode**

A

---

## SOURce Subsystem (Models 13 and 16)

The SOURce subsystem controls the output signals of the instrument for the models with tracking generator, 13 and 16.

The following subsystem is included:

- "SOURce:POWER Subsystem" on page 6.201

### SOURce:POWER Subsystem

The SOURce:POWER subsystem controls the power of the tracking generator signal.

#### Commands of the SOURce:POWER Subsystem

- SOURce<1|2>:POWER[:LEVel][:IMMediate][:AMPLitude]
- SOURce<1|2>:POWER[:LEVel][:IMMediate]:OFFSet

#### SOURce<1|2>:POWER[:LEVel][:IMMediate][:AMPLitude]

---

This command defines the output level of the tracking generator.

##### Parameter

<numeric\_value> in dBm, range specified in data sheet;

–400 dBm: switches off the tracking generator and keeps the corresponding hardware settings and the normalization

##### Example

```
SOUR:POW -20dBm
```

Sets the tracking generator level to –20 dBm.

##### Characteristics

\*RST value: –20 dBm

SCPI: conform

##### Mode

all, except receiver

---

#### SOURce<1|2>:POWER[:LEVel][:IMMediate]:OFFSet

---

This command defines a level offset for the tracking generator level. Thus, for example, attenuators or amplifiers at the output of the tracking generator can be taken into account for the setting.

##### Parameter

–200 dB to +200 dB

##### Example

```
SOUR:POW:OFFS -10dB
```

Sets the level offset of the tracking generator to – 20 dBm.

**Characteristics**

\*RST value: 0dB

SCPI: conform

**Mode**

all, except receiver

---

## STATus Subsystem

The STATus subsystem contains the commands for the status reporting system (for details refer to the Operating Manual on the CD-ROM, chapter 5 "Remote Control – Basics", section "Status Reporting System"). \*RST does not influence the status registers.

The following subsystem is included:

- ["STATus:QUEStionable Subsystem"](#) on page 6.203

### STATus:QUEStionable Subsystem

The STATus:QUEStionable subsystem contains information about the observance of limits during adjacent power measurements, the reference and local oscillator, the observance of limit lines and limit margins and possible overloads of the unit.

#### Commands of the STATus:QUEStionable Subsystem

- STATus:QUEStionable:ACPLimit[:EVENT]?
- STATus:QUEStionable:ACPLimit:CONDition?
- STATus:QUEStionable:ACPLimit:ENABLE
- STATus:QUEStionable:ACPLimit:NTRansition
- STATus:QUEStionable:ACPLimit:PTRansition
- STATus:QUEStionable:FREQuency[:EVENT]?
- STATus:QUEStionable:FREQuency:CONDition?
- STATus:QUEStionable:FREQuency:ENABLE
- STATus:QUEStionable:FREQuency:NTRansition
- STATus:QUEStionable:FREQuency:PTRansition
- STATus:QUEStionable:LIMit<1|2> [:EVENT]?
- STATus:QUEStionable:LIMit<1|2>:CONDition?
- STATus:QUEStionable:LIMit<1|2>:ENABLE
- STATus:QUEStionable:LIMit<1|2>:NTRansition
- STATus:QUEStionable:LIMit<1|2>:PTRansition
- STATus:QUEStionable:LMARgin<1|2>[:EVENT]?
- STATus:QUEStionable:LMARgin<1|2>:CONDition?
- STATus:QUEStionable:LMARgin<1|2>:ENABLE
- STATus:QUEStionable:LMARgin<1|2>:NTRansition
- STATus:QUEStionable:LMARgin<1|2>:PTRansition
- STATus:QUEStionable:POWer[:EVENT]?
- STATus:QUEStionable:POWer:CONDition?
- STATus:QUEStionable:POWer:ENABLE
- STATus:QUEStionable:POWer:NTRansition
- STATus:QUEStionable:POWer:PTRansition
- STATus:QUEStionable:SYNC[:EVENT]?

- STATus:QUEStionable:SYNC:CONDition?
- STATus:QUEStionable:SYNC:ENABle
- STATus:QUEStionable:SYNC:NTRansition
- STATus:QUEStionable:SYNC:PTRansition

---

**STATus:QUEStionable:ACPLimit[:EVENT]?**

---

This command queries the contents of the EVENT section of the STATus:QUEStionable:ACPLimit register. Readout deletes the contents of the EVENT section.

**Example**

```
STAT:QUES:ACPL?
```

**Characteristics**

\*RST value: –

SCPI: device-specific

**Mode**

all, except receiver

---

---

**STATus:QUEStionable:ACPLimit:CONDition?**

---

This command queries the contents of the CONDition section of the STATus:QUEStionable:ACPLimit register. Readout does not delete the contents of the CONDition section.

**Example**

```
STAT:QUES:ACPL:COND?
```

**Characteristics**

\*RST value: –

SCPI: device-specific

**Mode**

all, except receiver

---

---

**STATus:QUEStionable:ACPLimit:ENABle**

---

This command sets the bits of the ENABle section of the STATus:QUEStionable:ACPLimit register. The ENABle register selectively enables the individual events of the associated EVENT section for the summary bit.

**Parameter**

0 to 65535

**Example**

```
STAT:QUES:ACPL:ENAB 65535
```

**Characteristics**

\*RST value: –

SCPI: device-specific

**Mode**

all, except receiver

---



**STATus:QUEStionable:ACPLimit:NTRansition**

---

This command sets the edge detectors of all bits of the STATus:QUEStionable: ACPLimit register from 1 to 0 for the transitions of the CONDition bit.

**Parameter**

0 to 65535

**Example**

```
STAT:QUES:ACPL:NTR 65535
```

**Characteristics**

\*RST value: –

SCPI: device-specific

**Mode**

all, except receiver

---

**STATus:QUEStionable:ACPLimit:PTRansition**

---

This command sets the edge detectors of all bits of the STATus:QUEStionable: ACPLimit register from 0 to 1 for the transitions of the CONDition bit.

**Parameter**

0 to 65535

**Example**

```
STAT:QUES:ACPL:PTR 65535
```

**Characteristics**

\*RST value: –

SCPI: device-specific

**Mode**

all, except receiver

---

**STATus:QUEStionable:FREQuency[:EVENT]?**

---

This command queries the contents of the EVENT section of the STATus:QUEStionable: FREQuency register.

Readout deletes the contents of the EVENT section.

**Example**

```
STAT:QUES:FREQ?
```

**Characteristics**

\*RST value: –

SCPI: device-specific

**Mode**

all

---

**STATus:QUESTionable:FREQuency:CONDition?**

This command queries the contents of the CONDition section of the STATus:QUESTionable:FREQuency register. Readout does not delete the contents of the CONDition section.

**Example**

STAT:QUES:FREQ:COND?

**Characteristics**

\*RST value: –

SCPI: device-specific

**Mode**

all

**STATus:QUESTionable:FREQuency:ENABLE**

This command sets the bits of the ENABLE section of the STATus:QUESTionable:FREQuency register. The ENABLE register selectively enables the individual events of the associated EVENT section for the summary bit.

**Parameter**

0 to 65535

**Example**

STAT:QUES:FREQ:ENAB 65535

**Characteristics**

\*RST value: –

SCPI: device-specific

**Mode**

all

**STATus:QUESTionable:FREQuency:NTRansition**

This command sets the edge detectors of all bits of the STATus:QUESTionable:FREQuency register from 1 to 0 for the transitions of the CONDition bit.

**Parameter**

0 to 65535

**Example**

STAT:QUES:FREQ:NTR 65535

**Characteristics**

\*RST value: –

SCPI: device-specific

**Mode**

all, except NF

**STATus:QUEStionable:FREQuency:PTRansition**

---

This command sets the edge detectors of all bits of the STATus:QUEStionable:FREQuency register from 0 to 1 for the transitions of the CONDition bit.

**Parameter**

0 to 65535

**Example**

```
STAT:QUES:FREQ:PTR 65535
```

**Characteristics**

\*RST value: –

SCPI: device-specific

**Mode**

all, except NF

---

**STATus:QUEStionable:LIMit<1|2> [:EVENT]?**

---

This command queries the contents of the EVENT section of the STATus:QUEStionable:LIMit register. Readout deletes the contents of the EVENT section.

**Example**

```
STAT:QUES:LIM?
```

**Characteristics**

\*RST value: –

SCPI: device-specific

**Mode**

all

---

**STATus:QUEStionable:LIMit<1|2>:CONDition?**

---

This command queries the contents of the CONDition section of the STATus:QUEStionable:LIMit register.

Readout does not delete the contents of the CONDition section.

**Example**

```
STAT:QUES:LIM:COND?
```

**Characteristics**

\*RST value: –

SCPI: device-specific

**Mode**

all

---

---

**STATus:QUEStionable:LIMit<1|2>:ENABle**

---

This command sets the bits of the ENABle section of the STATus:QUEStionable register. The ENABle register selectively enables the individual events of the associated EVENT section for the summary bit.

**Parameter**

0 to 65535

**Example**

```
STAT:QUES:LIM:ENAB 65535
```

**Characteristics**

\*RST value: –

SCPI: device-specific

**Mode**

all

---

**STATus:QUEStionable:LIMit<1|2>:NTRansition**

---

This command sets the edge detectors of all bits of the STATus:QUEStionable:LIMit register from 1 to 0 for the transitions of the CONDition bit.

**Parameter**

0 to 65535

**Example**

```
STAT:QUES:LIM:NTR 65535
```

**Characteristics**

\*RST value: –

SCPI: device-specific

**Mode**

all, except NF

---

**STATus:QUEStionable:LIMit<1|2>:PTRansition**

---

This command sets the edge detectors of all bits of the STATus:QUEStionable:LIMit register from 0 to 1 for the transitions of the CONDition bit.

**Parameter**

0 to 65535

**Example**

```
STAT:QUES:LIM:PTR 65535
```

**Characteristics**

\*RST value: –

SCPI: device-specific

**Mode**

all, except NF

---

**STATus:QUESTionable:LMARgin<1|2>[:EVENT]?**

---

This command queries the contents of the EVENT section of the STATus:QUESTionable:LMARgin register. Readout deletes the contents of the EVENT section.

**Example**

```
STAT:QUES:LMAR?
```

**Characteristics**

\*RST value: –

SCPI: device-specific

**Mode**

all

---

**STATus:QUESTionable:LMARgin<1|2>:CONDition?**

---

This command queries the contents of the CONDition section of the STATus:QUESTionable:LMARgin register. Readout does not delete the contents of the CONDition section.

**Example**

```
STAT:QUES:LMAR:COND?
```

**Characteristics**

\*RST value: –

SCPI: device-specific

**Mode**

all

---

**STATus:QUESTionable:LMARgin<1|2>:ENABLE**

---

This command sets the bits of the ENABLE section of the STATus:QUESTionable:LMARgin register. The ENABLE register selectively enables the individual events of the associated EVENT section for the summary bit.

**Parameter**

0 to 65535

**Example**

```
STAT:QUES:LMAR:ENAB 65535
```

**Characteristics**

\*RST value: –

SCPI: device-specific

**Mode**

all

---

**STATus:QUEStionable:LMARgin<1|2>:NTRansition**

This command sets the edge detectors of all bits of the STATus:QUEStionable:LMARgin register from 1 to 0 for the transitions of the CONDition bit.

**Parameter**

0 to 65535

**Example**

STAT:QUES:LMAR:NTR 65535

**Characteristics**

\*RST value: –

SCPI: device-specific

**Mode**

all

**STATus:QUEStionable:LMARgin<1|2>:PTRansition**

This command sets the edge detectors of all bits of the STATus:QUEStionable:LMARgin register from 0 to 1 for the transitions of the CONDition bit.

**Parameter**

0 to 65535

**Example**

STAT:QUES:LMAR:PTR 65535

**Characteristics**

\*RST value: –

SCPI: device-specific

**Mode**

all

**STATus:QUEStionable:POWER[:EVENT]?**

This command queries the contents of the EVENT section of the STATus:QUEStionable:POWER register. Readout deletes the contents of the EVENT section.

**Example**

STAT:QUES:POW?

**Characteristics**

\*RST value: –

SCPI: conform

**Mode**

all

**STATus:QUEStionable:POWer:CONDition?**

---

This command queries the contents of the CONDition section of the STATus:QUEStionable:POWer register. Readout does not delete the contents of the CONDition section.

**Example**

```
STAT:QUES:POW:COND?
```

**Characteristics**

\*RST value: –

SCPI: conform

**Mode**

all

---

**STATus:QUEStionable:POWer:ENABle**

---

This command sets the bits of the ENABle section of the STATus:QUEStionable:POWer register. The ENABle register selectively enables the individual events of the associated EVENT section for the summary bit.

**Parameter**

0 to 65535

**Example**

```
STAT:QUES:POW:ENAB 65535
```

**Characteristics**

\*RST value: –

SCPI: conform

**Mode**

all

---

**STATus:QUEStionable:POWer:NTRansition**

---

This command sets the edge detectors of all bits of the STATus:QUEStionable:POWer register from 1 to 0 for the transitions of the CONDition bit.

**Parameter**

0 to 65535

**Example**

```
STAT:QUE:POWS:NTR 65535
```

**Characteristics**

\*RST value: –

SCPI: conform

**Mode**

all

---

**STATus:QUEStionable:POWer:PTRansition**

---

This command sets the edge detectors of all bits of the STATus:QUEStionable:POWer register from 0 to 1 for the transitions of the CONDition bit.

**Parameter**

0 to 65535

**Example**

STAT:QUES:POW:PTR 65535

**Characteristics**

\*RST value: –

SCPI: conform

**Mode**

all

**STATus:QUEStionable:SYNC[:EVENT]?**

This command queries the contents of the EVENT section of the STATus:QUEStionable:SYNC register.

Readout deletes the contents of the EVENT section.

**Example**

STAT:QUES:SYNC?

**Characteristics**

\*RST value: –

SCPI: device-specific

**Mode**

all, except receiver

**STATus:QUEStionable:SYNC:CONDition?**

This command queries the contents of the CONDition section of the STATus:QUEStionable:SYNC register. Readout does not delete the contents of the CONDition section.

**Example**

STAT:QUES:SYNC:COND?

**Characteristics**

\*RST value: –

SCPI: device-specific

**Mode**

all, except receiver



**STATus:QUEStionable:SYNC:ENABLE**

---

This command sets the bits of the ENABLE section of the STATus:QUEStionable:SYNC register. The ENABLE register selectively enables the individual events of the associated EVENT section for the summary bit.

**Parameter**

0 to 65535

**Example**

```
STAT:QUES:SYNC:ENAB 65535
```

**Characteristics**

\*RST value: –

SCPI: device-specific

**Mode**

all, except receiver

---

**STATus:QUEStionable:SYNC:NTRansition**

---

This command sets the edge detectors of all bits of the STATus:QUEStionable:SYNC register from 1 to 0 for the transitions of the CONDition bit.

**Parameter**

0 to 65535

**Example**

```
STAT:QUES:SYNC:NTR 65535
```

**Characteristics**

\*RST value: –

SCPI: device-specific

**Mode**

all, except receiver

---

**STATus:QUEStionable:SYNC:PTRansition**

---

This command sets the edge detectors of all bits of the STATus:QUEStionable:SYNC register from 0 to 1 for the transitions of the CONDition bit.

**Parameter**

0 to 65535

**Example**

```
STAT:QUES:SYNC:PTR 65535
```

**Characteristics**

\*RST value: –

SCPI: device-specific

**Mode**

all, except receiver

---

## **SYSTEM Subsystem**

This subsystem contains a series of commands for general functions.

The following subsystem is included:

- ["SYSTEM:SPEaker Subsystem"](#) on page 6.214

### **SYSTEM:SPEaker Subsystem**

This subsystem controls the headset functions.

#### **Commands of the SYSTEM:SPEaker Subsystem**

- [SYSTEM:SPEaker:VOLume](#)

#### **SYSTEM:SPEaker:VOLume**

---

This command sets the volume of the headset for demodulated signals.

**Parameter**

0 to 1; value 0 is the lowest volume, value 1 the highest volume.

**Example**

```
SYST:SPE:VOL 0.5
```

**Characteristics**

\*RST value: 0

SCPI: device-specific

**Mode**

all

---

## TRACe Subsystem

The TRACe subsystem controls access to the instruments internal trace memory.

### Commands of the TRACe Subsystem

- TRACe<1|2>[:DATA]
- TRACe:COPY
- TRACe<1|2>:FEED:CONTRol
- TRACe<1|2>:POINTs

### TRACe<1|2>[:DATA]

This command transfers trace data from the control computer to the instrument, the query reads trace data out of the instrument. The transfer of trace data from the control computer to the instrument takes place by indicating the trace name and then the data to be transferred.

For details on saving and recalling data refer to chapter 5 "Remote Control - Basics", section "MMEMory Subsystem".

#### Parameter

TRACE1 | TRACE2 | TRACE3 | TRACE4 | TRACE5 | TRACE6 | LIST | SPURious, <block> | <numeric\_value>

TRACE1 | TRACE2 | TRACE3 | TRACE4 | TRACE5 | TRACE6 | SINGLE | FINAL1 | FINAL2 | FINAL3 | FINAL4 | FINAL5 | FINAL6 | LIST | SPURious | PHOLd | SINGLE | SCAN | STATus, <block> | <numeric\_value>

TRACE1, ... , TRACE6            trace memory to be read out

<block> or <numeric\_value>    data to be transferred

query only (analyzer mode):

LIST            lists all results of the Spectrum Emission Mask and Spurious Emissions measurement

SPURious      lists all peaks of the Spurious Emissions measurement

query only (receiver mode)

FINAL1,...,    Final measurement values  
FINAL6

FINAL           Lists the whole content of the peak list. Each peak element consists of the following values:

- 4 bytes: Frequency
- 4 bytes: Absolute level
- 4 bytes: Delta between absolute level and limit line value at given frequency. If no limit line is active, the delta value is set to 0.0.

PHOLd           Lists the maximum peak obtained from measurements at successive sweeps. This query is only available for bargraph measurements

SINGLE           Lists the values of all activated detectors. The results are transferred separated by commas in the following order: POS, NEG, QPE, AVER, RMS. For inactive detectors, the value and the comma are omitted at the position(s) in question. This query is only available for bargraph measurements.

SCAN            The number of transmitted measurement results depend on the scan settings. This query is only available for scan measurements.

## Structure of transmitted data:

4 bytes: Trace status information: Bit 0 to 9 define the actual range number (bit coded) /  
 Bit 11: last block if last subscan / Bit 12: last of all blocks (for multiple scans after last scan; only in single scan mode)  
 4 bytes: Number n of the transmitted measurement results of a trace  
 4 bytes: Bit 0 indicates trace 1 is active; bit 8 indicates trace 5 is active  
 4 bytes: Bit 0 indicates trace 2 is active; bit 8 indicates trace 6 is active  
 4 bytes: Bit 0 indicates trace 3 is active  
 4 bytes: Bit 0 indicates trace 4 is active  
 n\*4 bytes measurement results of trace 1 if trace 1 is active  
 n\*4 bytes measurement results of trace 2 if trace 2 is active  
 n\*4 bytes measurement results of trace 3 if trace 3 is active  
 n\*4 bytes measurement results of trace 4 if trace 4 is active  
 n\*4 bytes measurement results of trace 5 if trace 5 is active  
 n\*4 bytes measurement results of trace 6 if trace 6 is active  
 n\*1 byte status information per measurement result: bit2 is set if an overrange occurred

STATus 1 byte status information per measurement result is transmitted:

Bit 2: overrange trace 1 to trace 6.

**Return values for trace data**

The number of returned results depends on the sweep points that have been set. By default 501 results are returned. The returned values are scaled in the current level unit.

FORMat REAL, 32 is used as format for binary transmission, and FORMat ASCII for ASCII transmission. For details on formats refer to "[Formats for returned values: ASCII format and binary format](#)" on page 6.254.

**Note:** With the auto peak detector, only positive peak values can be read out.

**Return values for Spectrum Emission Mask/Spurious Emissions measurement results**

Returns the list evaluation results.

<no>, <start>, <stop>, <rbw>, <freq>, <power abs>, <power rel>, <delta>, <limit check>, <unused1>, <unused2>

Value	Description
<no>	range number
<start>	start frequency
<stop>	stop frequency
<rbw>	resolution bandwidth of range
<freq>	frequency of peak
<power abs>	absolut power in dBm of peak
<power rel>	relative power in dBc (related to the channel power) of peak
<delta>	distance to the limit line in dB (positive indicates value above the limit, fail)
<limit check>	limit fail (pass = 0, fail =1)
<unused1>	reserved (0.0)
<unused2>	reserved (0.0)

**Example**

```
TRAC TRACE1
TRAC? TRACE1
```

**Characteristics**

\*RST value: -  
 SCPI: conform

**Mode**

all

**TRACe:COPY**

---

This command copies data from one trace to another.

This command is an event and therefore has no query and no \*RST value.

**Parameter**

TRACE1 | TRACE2 | TRACE3 | TRACE4 | TRACE5 | TRACE6,TRACE1 | TRACE2 | TRACE3 | TRACE4 | TRACE5 | TRACE6

The first operand the destination of the data to be copied, the second operand describes the source.

**Example**

TRAC:COPY TRACE1,TRACE2

**Characteristics**

\*RST value: -

SCPI: conform

**Mode**

R, A, CATV

**TRACe<1|2>:FEED:CONTRol**

---

This command switches block data transmission during a scan on and off. The availability of data is reported in the STATus:OPERation-Register.

The block size depends on scan time and the upper limit defined by TRACe:POINTs:LIMit.

**Parameter**

ALWays | NEVer

**Example**

TRAC:FEED:CONT ALW

Activates single sweep mode

**Characteristics**

\*RST value: NEVer

SCPI: device-specific

**Mode**

R

**TRACe<1|2>:POINTs**

---

This command defines the maximum number of measurement points which are transferred in one block after the query command TRACE? SCAN. The total amount of bytes which is transferred depends on the number of active traces.

**Parameter**

LIMit, 1 to 10000

**Example**

TRAC:POIN LIM, 8000

A maximum of 8000 measurement values per trace will be transferred with a single query

**Characteristics**

\*RST value: 1000

SCPI: device-specific

**Mode**

R

### TRACe:IQ Subsystem

The commands of this subsystem are used for collection and output of measured IQ data. A special memory is therefore available in the instrument for about 512k complex samples (pairs of I and Q data). The measurement is always performed in zero span at the selected center frequency. The number of complex samples to be collected and the sample rate can be set (for details refer to "Sample rate and maximum usable bandwidth" on page 6.220). Prior to being stored in memory or output via GPIB, the measurement data are corrected in terms of frequency response.

The block diagrams below show the analyzer hardware from the IF section to the processor. The block diagrams differ between the instrument models because two different motherboards are fitted. The main difference is the position of the fractional resampling and the analog IF bandwidth. For details on the distinction refer to "Sample rate and maximum usable bandwidth" on page 6.220.

The A/D converter samples the IF signal (47.9 MHz) at a rate of  $65.8\bar{3}$  MHz. The digital signal is down-converted to the complex baseband, lowpass-filtered, and the sampling rate is reduced. The continuously adjustable sampling rates are realized using an optimal decimation filter and subsequent resampling on the set sampling rate.

The I/Q data are written to separate memories of 512 k words each. The memories are hardware-triggered. 512 samples are designated as buffer for triggering, which leads to a max. recording length of 523776 (=512k – 512) complex samples.

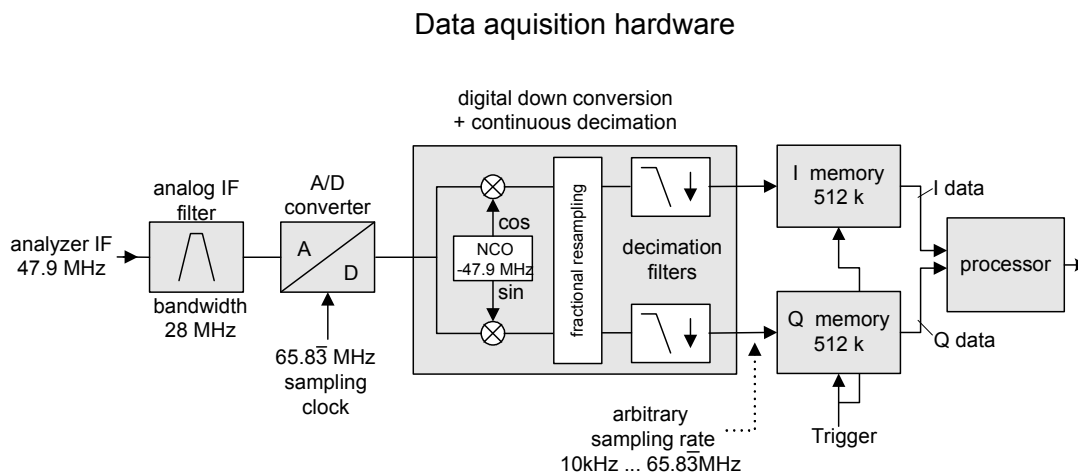

Fig. 6–1 Signal processing in models with UDC motherboards

## Data acquisition hardware

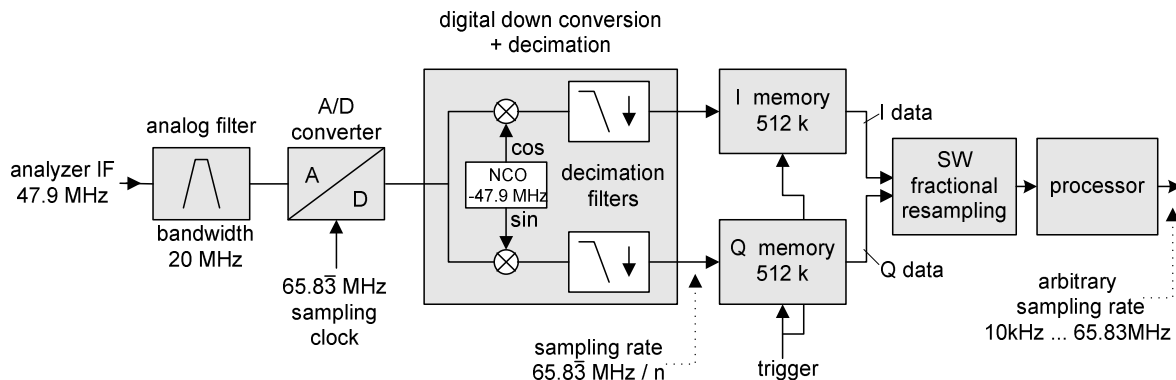

Fig. 6–2 Signal processing in models with WDDC motherboards

The trigger sources EXT (external trigger) and IFP (IF Power Trigger) can be used for triggering, additionally IMM (Free Run). The number of complex sample to be recorded prior to the trigger event can be selected (`TRACe<1|2>:IQ:SET` command) for all available trigger sources, except for FREE RUN.

The measurement results are output in the form of a list, with the Q values following immediately after the list of I values in the output buffer. The `FORMAT` command can be used to select between binary output (32 bit IEEE 754 floating–point values) and output in ASCII format.

For details on formats refer to "[Formats for returned values: ASCII format and binary format](#)" on page 6.251.

The commands of this subsystem can be used in two ways:

- Measurement and result query with one command:  
This method causes the least delay between measurement and output of the result data, but it requires the control computer to wait actively for the response data.
- Setting up the instrument, start of the measurement via `INIT` and query of the result list at the end of the measurement:  
With this method the control computer can be used for other activities during the measurement. In this case the additional time needed for synchronization via service request must be taken into account.

### Commands of the TRACe:IQ Subsystem

- TRACe<1|2>:IQ[:STATe]
- TRACe<1|2>:IQ:AVERAge[:STATe]
- TRACe<1|2>:IQ:AVERAge:COUNT
- TRACe<1|2>:IQ:DATA?
- TRACe<1|2>:IQ:DATA:MEMory?
- TRACe<1|2>:IQ:SET
- TRACe<1|2>:IQ:SRATe

### Further information

- [Sample rate and maximum usable bandwidth](#)

### Sample rate and maximum usable bandwidth

Within the usable bandwidth range, the analog IF filter of the R&S ESL is equalized in regard to amplitude characteristic and group delay (provided that the R&S ESL is aligned; for details see chapter 4, section "Instrument Setup and Interface Configuration – SETUP Key", "Alignment"). In consequence, signals within this bandwidth range are hardly distorted at all (provided the R&S ESL is not overloaded).

For the I/Q data acquisition, digital decimation filters are used internally. The passband of these digital filters corresponds to the maximum usable bandwidth. In consequence, signals within the usable bandwidth (passband) remain unchanged, while signals outside the usable bandwidth (passband) are suppressed. Usually, the suppressed signals are noise, artifacts, and the second IF side band. If frequencies of interest to you are also suppressed, you should try to increase the output sample rate, since this increases the maximum usable IQ bandwidth.

As a rule, the usable bandwidth is proportional to the output sample rate (see section [Instrument models with UDC motherboard](#) or [Instrument models with WDDC motherboard](#)). Yet, when the I/Q bandwidth reaches the bandwidth of the analog IF filter (at very high output sample rates), the curve breaks. For the base unit, the sample rate ranges from 10 kHz to 65.83 MHz .

The maximum usable bandwidth is listed in the data sheet. The value differs between the instrument models due to different motherboards:

- UDC motherboard (order # 2112.1800)
- WDDC motherboard (order # 1300.3080)

If you are not sure which motherboard your model has, check the **Hardware Information** list (**SETUP** key – More – **System Info** – **Hardware Info**; for details see chapter 4).

### Instrument models with UDC motherboard

The following diagram shows the maximum usable IQ bandwidths depending on the output sample rates. The values are rounded off to two decimal places.



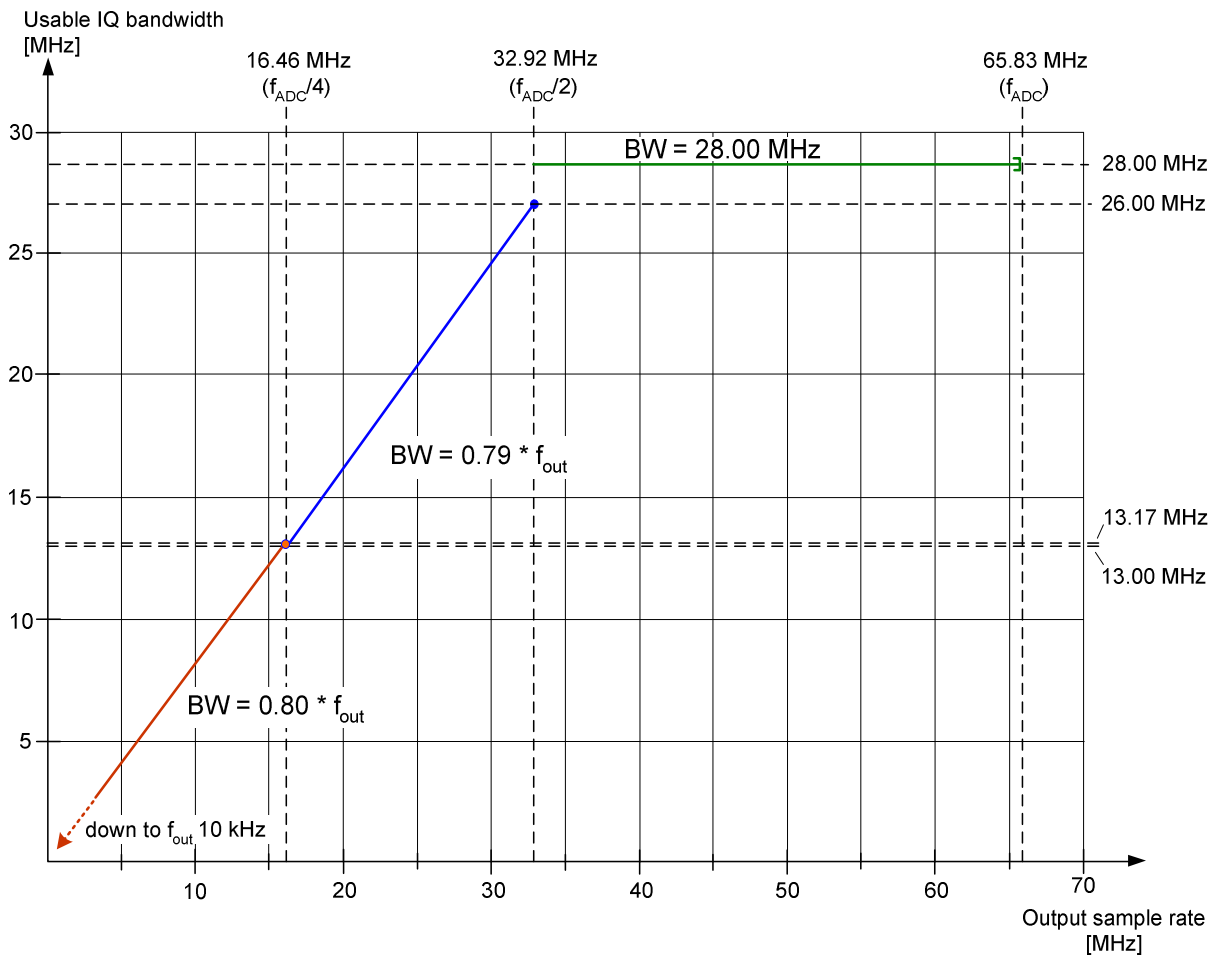

Fig. 6-3 Relation between maximum usable bandwidth and output sample rate

*Note: Do not use an output sample rate in the range from 65.833333.0 MHz to  $65.8\bar{3}$  MHz for measurements. This range is for test purposes only.*

*At this sample rate, the whole bandwidth of the IF filter is equalized, but the digital filters are switched to bypass. In consequence, not only the effective signal but all signals pass, including noise and image-spectra.*

### Instrument models with WDDC motherboard

The following tables list the maximum bandwidths depending on the output sample rates.

- 65,833,333.333 MHz to 65,833,333.000 MHz
- 65,833,332.999 MHz to 10.7 MHz
- 10.7 MHz to 3.2 MHz
- 3.2 MHz to 1 MHz
- 1 MHz to 105 kHz
- 105 kHz to 10 kHz

**65,833,333.333 MHz to 65,833,333.000 MHz**

This small range of the sample rate is for test purposes only and is not recommended for normal measurements!

Sample rate from [Hz]	Sample rate to [Hz]	Max bandwidth [Hz]
65 833 333.333	65 833 333.000	20 000 000.000 Beware: decimation filters are bypassed!

**65,833,332.999 MHz to 10.7 MHz**

Sample rate from [Hz]	Sample rate to [Hz]	Max bandwidth [Hz]
65 833 332.999	32 916 666.670	20 000 000.000
22 500 000.000	20 248 687.500	17 998 833.330
20 248 687.500	16 401 436.880	14 579 055.000
16 401 436.880	14 812 500.000	13 166 666.670
14 812 500.000	13 331 250.000	11 850 000.000
13 331 250.000	11 998 125.000	10 665 000.000
11 998 125.000	10 798 312.500	9 598 500.000

**10.7 MHz to 3.2 MHz**

Sample rate from [Hz]	Sample rate to [Hz]	Max bandwidth [Hz]
10 798 312.500	9 875 000.000	8 777 777.778
9 875 000.000	8 887 500.000	7 900 000.000
8 887 500.000	7 998 750.000	7 110 000.000
7 998 750.000	7 406 250.000	6 583 333.333
7 406 250.000	6 665 625.000	5 925 000.000
6 665 625.000	6 583 333.333	5 851 851.852
6 583 333.333	5 925 000.000	5 266 666.667
5 925 000.000	5 332 500.000	4 740 000.000
5 332 500.000	4 937 500.000	4 388 888.889
4 937 500.000	4 443 750.000	3 950 000.000
4 443 750.000	4 232 142.857	3 761 904.762
4 232 142.857	3 950 000.000	3 511 111.111
3 950 000.000	3 703 125.000	3 291 666.667
3 703 125.000	3 332 812.500	2 962 500.000
3 332 812.500	3 291 666.667	2 925 925.926

**3.2 MHz to 1 MHz**

Sample rate from [Hz]	Sample rate to [Hz]	Max bandwidth [Hz]
3 291 666.667	2 962 500.000	2 633 333.333
2 962 500.000	2 821 428.571	2 507 936.508
2 821 428.571	2 539 285.714	2 257 142.857
2 539 285.714	2 468 750.000	2 194 444.444
2 468 750.000	2 370 000.000	2 106 666.667
2 370 000.000	2 194 444.444	1 950 617.284
2 194 444.444	2 116 071.429	1 880 952.381
2 116 071.429	1 975 000.000	1 755 555.556
1 975 000.000	1 851 562.500	1 645 833.333
1 851 562.500	1 795 454.545	1 595 959.596
1 795 454.545	1 645 833.333	1 462 962.963
1 645 833.333	1 481 250.000	1 316 666.667
1 481 250.000	1 346 590.909	1 196 969.697
1 346 590.909	1 234 375.000	1 097 222.222
1 234 375.000	1 139 423.077	1 012 820.513
1 139 423.077	1 039 473.684	923 976.608

**1 MHz to 105 kHz**

Sample rate from [Hz]	Sample rate to [Hz]	Max bandwidth [Hz]
1 039 473.684	940 476.191	835 978.836
940 476.191	846 428.571	752 380.952
846 428.571	779 605.263	692 982.456
779 605.263	705 357.143	626 984.127
705 357.143	637 096.774	566 308.244
637 096.774	580 882.353	516 339.869
580 882.353	529 017.857	470 238.095
529 017.857	477 822.581	424 731.183
477 822.581	435 661.765	387 254.902
435 661.765	395 000.000	351 111.111
395 000.000	359 090.909	319 191.919
359 090.909	323 770.492	287 795.993
323 770.492	294 776.119	262 023.217
294 776.119	266 891.892	237 237.237
266 891.892	240 853.659	214 092.141
240 853.659	217 032.967	192 918.193
217 032.967	195 544.555	173 817.382
195 544.555	176 339.286	156 746.032
176 339.286	159 274.194	141 577.061
159 274.194	143 810.680	127 831.715

Sample rate from [Hz]	Sample rate to [Hz]	Max bandwidth [Hz]
143 810.680	129 934.211	115 497.076
129 934.211	117 559.524	104 497.355
117 559.524	105 803.571	94 047.619

**105 kHz to 10 kHz**

Sample rate from [Hz]	Sample rate to [Hz]	Max bandwidth [Hz]
105 803.571	95 410.628	84 809.447
95 410.628	85 869.565	76 328.502
85 869.565	77 450.980	68 845.316
77 450.980	69 787.986	62 033.765
69 787.986	62 898.089	55 909.413
62 898.089	56 752.874	50 446.999
56 752.874	51 077.586	45 402.299
51 077.586	46 001.553	40 890.269
46 001.553	41 404.612	36 804.100
41 404.612	37 264.151	33 123.690
37 264.151	33 588.435	29 856.387
33 588.435	30 229.592	26 870.748
30 229.592	27 228.860	24 203.431
27 228.860	24 524.007	21 799.117
24 524.007	22 075.261	19 622.454
22 075.261	19 869.215	17 661.525
19 869.215	17 889.493	15 901.771
17 889.493	16 100.543	14 311.594
16 100.543	14 493.640	12 883.235
14 493.640	13 044.914	11 595.479
13 044.914	11 741.974	10 437.310
11 741.974	10 572.805	9 398.049
10 572.805	10 000.000	8 460.509

---

**TRACe<1|2>:IQ[:STATe]**

---

This command switches the I/Q data acquisition on or off.

**Note:** *The I/Q data acquisition is not compatible with other measurement functions. Therefore all other measurement functions will be switched off as soon as the I/Q measurement function is switched on. Additionally a trace display is not possible in this operating mode. Therefore all traces are set to "BLANK".*

**Parameter**

ON | OFF

**Example**

```
TRAC:IQ ON
```

Switches on I/Q data acquisition

**Characteristics**

\*RST value: OFF

SCPI: device-specific

**Mode**

A-T

---

---

**TRACe<1|2>:IQ:AVERAge[:STATe]**

---

The command enables averaging of the recorded I/Q data provided that I/Q data acquisition was previously enabled with [TRACe<1|2>:IQ\[:STATe\]](#).

**Parameter**

ON | OFF

**Example**

```
TRAC:IQ ON
```

Switches on acquisition of I/Q data.

```
TRAC:IQ:AVER ON
```

Enables averaging of the I/Q measurement data.

```
TRAC:IQ:AVER:COUN 10
```

Selects averaging over 10 data sets.

```
TRAC:IQ:DATA?
```

Starts the measurement and reads out the averaged data.

**Characteristics**

\*RST value: OFF

SCPI: device-specific

**Mode**

A-T

---

**TRACe<1|2>:IQ:AVERage:COUNT**

This command defines the number of I/Q data sets that are to serve as a basis for averaging.

**Parameter**

0 to 32767

**Example**

TRAC:IQ ON

Switches on acquisition of I/Q data.

TRAC:IQ:AVER ON

Enables averaging of the I/Q measurement data

TRAC:IQ:AVER:COUNT 10

Selects averaging over 10 data sets

TRAC:IQ:DATA?

Starts the measurement and reads out the averaged data.

**Characteristics**

\*RST value: 0

SCPI: conform

**Mode**

A-T

**TRACe<1|2>:IQ:DATA?**

This command starts a measurement with the settings defined via [TRACe<1|2>:IQ:SET](#) and returns the list of measurement results immediately after they are corrected in terms of frequency response. The number of measurement results depends on the settings defined with [TRACe<1|2>:IQ:SET](#), the output format depends on the settings of the FORMat subsystem.

**Note:** *The command requires that all response data are read out completely before the instrument accepts further commands.*

**Return values**

The result values are scaled linear in unit *Volt* and correspond to the voltage at the RF input of the instrument. In ASCII format, the number of the returned values is 2 \* the number of samples. The first set contains the I–data, the second the Q–data.

**Note:** *If the sampling rate exceeds 512k (= 524288), the data are output in 512k blocks.*

In binary format, the number of I– and Q–data can be calculated as follows:

$$\# \text{ of I-Data} = \# \text{ of Q-Data} = \frac{\# \text{ of DataBytes}}{8}$$

The offset of Q–data in the output buffer can be calculated as follows:

$$Q\text{-Data-Offset} = \frac{(\# \text{ of DataBytes})}{2} + \text{LengthIndicatorDigits}$$

with LengthIndicatorDigits being the number of digits of the length indicator including the #. In the example above (#41024...) this results in a value of 6 for LengthIndicatorDigits and the offset for the Q–data will result in 512 + 6 = 518.

For further details on formats refer to "[Formats for returned values: ASCII format and binary format](#)" on page 6.251.

**Example**

```
TRAC:IQ:STAT ON
Enables acquisition of I/Q data
TRAC:IQ:SET NORM,10MHz,32MHz,EXT,POS,0,4096
Measurement configuration:
Sample Rate: 32 MHz
Trigger Source: External
Trigger Slope: Positive
Pretrigger Samples: 0
# of Samples: 4096
FORMat REAL,32
Selects format of response data
TRAC:IQ:DATA?
Starts measurement and reads results
```

**Characteristics**

\*RST value: –

**Note:** Using the command with the \*RST values for the TRACe<1|2>:IQ:SET command, the following minimum buffer sizes for the response data are recommended: ASCII format 10 kBytes, binary format: 2 kBytes

SCPI: device-specific

**Mode**

A–T

**TRACe<1|2>:IQ:DATA:MEMory?**

This command permits the readout of previously acquired (and frequency response corrected) I/Q data from the memory, with indication of the offset related to the start of measurement and with indication of the number of measurement values. Therefore a previously acquired data set can be read out in smaller portions. The maximum amount of available data depends on the settings of the TRACe<1|2>:IQ:SET command, the output format on the settings in the FORMat subsystem.

**Note:** The command requires that all response data are read out completely before the instrument accepts further commands.  
If there are not I/Q data available in memory because the corresponding measurement had not been started, the command will cause a query error.

**Parameter**

<offset samples> Offset of the values to be read related to the start of the acquired data.  
Value range: 0 to <# of samples> – 1, with <# of samples> being the value indicated with the TRACe<1|2>:IQ:SET command.

<# of samples> Number of measurement values to be read.  
Value range: 1 to <# of samples> – <offset samples> with <# of samples> being the value indicated with the TRACe<1|2>:IQ:SET command.

**Return values**

The returned values are scaled linear in unit Volt and correspond to the voltage at the RF input of the instrument.

The format of the output buffer corresponds to the TRACe<1|2>:IQ:DATA? command.

**Example**

```
TRAC:IQ:STAT ON
```

Enables acquisition of I/Q data

```
TRAC:IQ:SET NORM,10MHz,32MHz,EXT,POS,100,4096
```

To configure the measurement:

Sample Rate: 32 MHz

Trigger Source: External

Slope: Positive

Pretrigger Samples: 100

# of Samples: 4096

```
INIT;*WAI
```

Starts measurement and wait for sync

```
FORMat REAL,32
```

Determines output format

To read the results:

```
TRAC:IQ:DATA:MEM? 0,2048
```

Reads 2048 I/Q data starting at the beginning of data acquisition

```
TRAC:IQ:DATA:MEM? 2048,1024
```

Reads 1024 I/Q data from half of the recorded data

```
TRAC:IQ:DATA:MEM? 100,512
```

Reads 512 I/Q data starting at the trigger point (<Pretrigger Samples> was 100)

**Characteristics**

\*RST value: –

SCPI: device-specific

**Mode**

A–T, WLAN, OFDM, OFDMA/WiBro

**TRACe<1|2>:IQ:SET**

This command defines the settings of the analyzer hardware for the measurement of I/Q data. This allows setting the bandwidth of the analog filters in front of the A/D converter as well as setting the sample rate, trigger conditions and the record length.

**Note:** If this command is omitted, the current analyzer settings will be used for the corresponding parameters.

This command switches to IQ mode automatically (see also

[TRACe<1|2>:IQ\[:STATe\]](#)).

The parameter <filter\_type> has no effect but is indicated for reasons of compatibility with the FSP family.

The trigger level can be set using the [TRIGger<1|2>\[:SEquence\]:LEVel:IFPower](#) command.

**Parameter**

<filter type>	can be omitted
<rbw>	can be omitted
<sample rate>	Sampling rate for the data acquisition. Value range: 10 kHz to 65.8 $\bar{3}$ MHz, continuously adjustable
<trigger mode>	Selection of the trigger source used for the measurement. Values: IMMEDIATE   EXTERNAL   IFPower



<trigger slope>	Used trigger slope. Values: POSitive
<pretrigger samples>	Number of measurement values to be recorded before the trigger point.  Range: $-16253439 (= -(2^{24}-1-512k-512)) \dots 523775 (= 512*1024 - 512 - 1)$ . Negative values correspond to a trigger delay.
<# of samples>	Number of measurement values to record. Value range: $1 \dots 523776 (= 512*1024 - 512)$

**Example**

TRAC:IQ:SET NORM,10MHz,32MHz,EXT,POS,0,2048

Reads 2048 I/Q-values starting at the trigger point.

sample rate: 32 MHz

trigger: External

slope: Positive

TRAC:IQ:SET NORM,10MHz,4MHz,EXT,POS,1024,512

Reads 512 I/Q-values from 1024 measurement points before the trigger point.

filter type: NORMAL

RBW: 10 MHz

sample rate: 4 MHz

trigger: External

slope: Positive

**Characteristics**

\*RST values:  $-, -, 32\text{MHz}, \text{IMM}, \text{POS}, 0, 128$

**Note:** For using these default settings with the TRACe<1|2>:IQ:DATA? command the following minimum buffer sizes for the response data are recommended: ASCII format 10 kBytes, Binary format 2 kBytes.

SCPI: device-specific

**Mode**

A-T

**TRACe<1|2>:IQ:SRATe**

This command sets the sampling rate for the I/Q data acquisition. Thus the sample rate can be modified without affecting the other settings.

**Parameter**

10 kHz to  $65.8\bar{3}$  MHz , continuously adjustable

**Example**

TRAC:IQ:SRAT 4MHZ

**Characteristics**

\*RST value: 32 MHz

SCPI: device-specific

**Mode**

A-T

## TRIGger Subsystem

The TRIGger subsystem is used to synchronize instrument actions with events. It is thus possible to control and synchronize the start of a sweep.

### Commands of the TRIGger Subsystem

- TRIGger<1|2>[:SEQuence]:HOLDoff[:TIME]
- TRIGger<1|2>[:SEQuence]:IFPower:HOLDoff
- TRIGger<1|2>[:SEQuence]:IFPower:HYSTeresis
- TRIGger<1|2>[:SEQuence]:LEVel:IFPower
- TRIGger<1|2>[:SEQuence]:LEVel:VIDeo
- TRIGger<1|2>[:SEQuence]:SLOPe
- TRIGger<1|2>[:SEQuence]:SOURce
- TRIGger<1|2>[:SEQuence]:TIME:RINTerval

#### TRIGger<1|2>[:SEQuence]:HOLDoff[:TIME]

---

This command defines the length of the trigger delay.  
A negative delay time (pretrigger) can be set in zero span only.

##### Parameter

–100 s to +100 s

##### Example

```
TRIG:HOLD 500us
```

##### Characteristics

\*RST value: 0 s

SCPI: conform

##### Mode

all, except receiver

---

#### TRIGger<1|2>[:SEQuence]:IFPower:HOLDoff

---

ffThis command sets the holding time before the next IF power trigger event.

##### Parameter

<numeric\_value> in s: 150 ns to 1000 s

##### Example

```
TRIG:SOUR IFP
```

Sets the IF power trigger source.

```
TRIG:IFP:HOLD 200 ns
```

Sets the holding time to 200 ns.

##### Characteristics

\*RST value: 150 ns

SCPI: device-specific

##### Mode

A–F

---

**TRIGger<1|2>[:SEQuence]:IFPower:HYSTerisis**

---

sThis command sets the limit that the hysteresis value has to fall below in order to trigger the next measurement.

**Parameter**

<numeric\_value> in dB: 3 dB to 50 dB

**Example**

```
TRIG:SOUR IFP
```

Sets the IF power trigger source.

```
TRIG:IFP:HYST 10DB
```

Sets the hysteresis limit value.

**Characteristics**

\*RST value: 3 dB

SCPI: device-specific

**Mode**

A-F

---

---

**TRIGger<1|2>[:SEQuence]:LEVel:IFPower**

---

This command sets the level of the IF power trigger source.

**Parameter**

-50 to -10 DBM

**Example**

```
TRIG:LEV:IFP -30DBM
```

**Characteristics**

\*RST value: -20 DBM

SCPI: device-specific

**Mode**

all, except receiver

---

---

**TRIGger<1|2>[:SEQuence]:LEVel:VIDeo**

---

This command sets the level of the video trigger source.

**Parameter**

0 to 100 PCT

**Example**

```
TRIG:LEV:VID 50PCT
```

**Characteristics**

\*RST value: 50 PCT

SCPI: device-specific

**Mode**

all, except ADEMODO

---

**TRIGger<1|2>[:SEQuence]:SLOPe**

---

This command selects the slope of the trigger signal. The selected trigger slope applies to all trigger signal sources.

**Parameter**

POSitive | NEGative

**Example**

```
TRIG:SLOP NEG
```

**Characteristics**

\*RST value: POSitive

SCPI: conform

**Mode**

all

---

**TRIGger<1|2>[:SEQuence]:SOURce**

---

This command selects the trigger source for the start of a sweep.

**Parameter**

IMMEDIATE (Free Run) | EXTern | IFPower | VIDEo | TIME

For details on trigger modes refer to chapter "Instrument Functions", section "Trigger mode overview".

**Example**

```
TRIG:SOUR EXT
```

Selects the external trigger input as source of the trigger signal

**Characteristics**

\*RST value: IMMEDIATE

SCPI: conform

**Mode**

R, A, ADEMOD

---

**TRIGger<1|2>[:SEQUence]:TIME:RINTerval**

---

This command sets the time interval for the time trigger source.  
The numeric suffixes <1|2> are irrelevant for this command.

**Parameter**

0.1 to 5000 s

**Example**

```
TRIG:SOUR TIME
```

Selects the time trigger input for triggering.

```
TRIG:TIME:RINT 50
```

The sweep starts after 50 s.

**Characteristics**

RST value: 1.0

SCPI: device-specific

**Mode**

A

---

## UNIT Subsystem

The UNIT subsystem sets the basic unit of the setting parameters.

### Commands of the UNIT Subsystem

– UNIT<1|2>:POWer

#### UNIT<1|2>:POWer

---

This command selects the default unit.

##### Parameter

DBM | V | A | W | DB | PCT | UNITLESS | DBPW | WATT | DBUV | DBMV | VOLT | DBUA |  
AMPere | DBPT | DBUV\_MHZ | DBMV\_MHZ | DBUA\_MHZ | DBUV\_M | DBUA\_M |  
DBUV\_MMHZ | DBUA\_MMHZ

##### Example

```
UNIT:POW DBUV
```

Sets the power unit to dBm.

##### Characteristics

\*RST value: DBM

SCPI: conform

##### Mode

R, A

---

## Remote Commands of the Analog Demodulation Option (K7)

In this section all remote control commands for Analog Demodulation option are described in detail. The abbreviation ADEMODO stands for the Analog Demodulation operating mode. For details on conventions used in this chapter refer to section "Notation" on page 6.2 at the beginning of this chapter.

For further information on analyzer or basic settings commands, refer to the corresponding subsystem in "Remote Commands of the Base Unit" on page 6.5 or section "Remote Control – Description of Basic Settings Commands".

### Subsystems of the Analog Demodulation option (K7)

- "CALCulate Subsystem (Analog Demodulation, K7)" on page 6.236
- "DISPlay Subsystem (Analog Demodulation, K7)" on page 6.246
- "INSTrument Subsystem (Analog Demodulation, K7)" on page 6.248
- "SENSe Subsystem (Analog Demodulation, K7)" on page 6.249
- "TRACe Subsystem (Analog Demodulation, K7)" on page 6.277
- "TRIGger Subsystem (Analog Demodulation, K7)" on page 6.278
- "UNIT Subsystem (Analog Demodulation, K7)" on page 6.280

## CALCulate Subsystem (Analog Demodulation, K7)

The CALCulate subsystem contains commands for converting instrument data, transforming and carrying out corrections. These functions are carried out subsequent to data acquisition, i.e. following the SENSE subsystem.

The following subsystems are included:

- "CALCulate:DELTamarker Subsystem" on page 6.236
- "CALCulate:FEED Subsystem" on page 6.237
- "CALCulate:FORMat Subsystem (Analog Demodulation, K7)" on page 6.238
- "CALCulate:MARKer Subsystem" on page 6.239
- "CALCulate:UNIT Subsystem" on page 6.245

### CALCulate:DELTamarker Subsystem (Analog Demodulation, K7)

The CALCulate:DELTamarker subsystem controls the delta marker functions of the instrument.

#### Commands of the CALCulate:DELTamarker Subsystem

– [CALCulate<1|2>:DELTamarker<1...4>:Y?](#)

#### CALCulate<1|2>:DELTamarker<1...4>:Y?

Depending on the unit defined with [CALCulate<1|2>:UNIT:POWer](#) or on the activated measuring functions, the query result is output in the units below:

Result display	Output unit
AM result display (R&S FSL-K7)	% (lin) dB (log)
FM result display (R&S FSL-K7)	Hz (lin) dB (log)
PM result display (R&S FSL-K7)	rad   deg (lin) dB (log)
RF result display (R&S FSL-K7)	output unit defined with <a href="#">CALCulate&lt;1 2&gt;:UNIT:POWer</a>

For further details refer to "[CALCulate<1|2>:DELTamarker<1...4>:Y?](#)" on page 6.17.



**CALCulate:FEED Subsystem (Analog Demodulation, K7)**

The CALCulate:FEED subsystem selects the evaluation method of the measured data. This corresponds to the selection of the result display in manual mode.

**Commands of the CALCulate:FEED Subsystem**

– [CALCulate<1|2>:FEED](#)

**CALCulate<1|2>:FEED**

This command selects the measured data that are to be displayed.  
The numeric suffixes <1|2> are irrelevant.

**Parameter**

XTIM:AM:RELative[:TDOMain]	Demodulated AM signal in standardized display
XTIM:AM:RELative:AFSPectrum<1...6>	AF spectrum of the demodulated AM signal in standardized display, results referenced to traces 1 to 4
XTIM:AM[:ABSolute][:TDOMain]	Demodulated AM signal in level display Same as 'XTIM:RFPower'
XTIM:RFPower[:TDOMain]	RF power of the signal
XTIM:FM[:TDOMain]	Demodulated FM signal
XTIM:FM:AFSPectrum<1...6>	AF spectrum of the demodulated FM signal, results referenced to traces 1 to 4
XTIM:PM[:TDOMain]	Demodulated PM signal
XTIM:PM:AFSPectrum<1...6>	AF spectrum of the demodulated PM signal, results referenced to traces 1 to 4
XTIM:AMSummary<1...6>[:ABSolute]	AM results in level display, referenced to traces 1 to 4
XTIM:AMSummary<1...6>:RELative	AM results in standardized display, referenced to traces 1 to 4
XTIM:FMSummary<1...6>	FM results, referenced to traces 1 to 4
XTIM:PMSummary<1...6>	PM results, referenced to traces 1 to 4
XTIM:SPECTrum	RF spectrum of the signal determined from the measured data via FFT

**Example**

```
INST:SEL ADEM
Activates analog demodulator.
CALC:FEED 'XTIM:FM'
Selects the display of the FM signal.
```

**Characteristics**

RST value: –  
SCPI: conform

**Mode**

ADEM0D

**CALCulate:FORMat Subsystem (Analog Demodulation, K7)**

The CALCulate:FORMat subsystem defines the conversion of measured data.

**Commands of the CALCulate:FORMat Subsystem**

- [CALCulate<1|2>:FORMat](#)

**CALCulate<1|2>:FORMat**

---

This command activates the limitation to  $\pm 180^\circ$ .

The numeric suffixes <1|2> are irrelevant.

**Parameter**

PHASe      Limitation to  $\pm 180^\circ$

UPHase     Unwrapped

**Example**

```
CALC:FORM PHAS
```

Activates the limitation to  $\pm 180^\circ$ .

**Characteristics**

RST value: UPHase

SCPI: conform

**Mode**

ADEMOD

---

**CALCulate:MARKer Subsystem (Analog Demodulation, K7)**

The CALCulate:MARKer subsystem checks the marker functions of the instrument.

The following subsystem is included:

- ["CALCulate:MARKer:FUNCTION:ADEMod Subsystem \(Analog Demodulation, K7\)"](#) on page 6.240

**Commands of the CALCulate:MARKer Subsystem**

- [CALCulate<1|2>:MARKer<1...4>:PEXCursion](#)
- [CALCulate<1|2>:MARKer<1...4>:Y?](#)

**CALCulate<1|2>:MARKer<1...4>:PEXCursion**

The unit depends on the active display.

**Example**

```
CALC:MARK:PEXC 100 HZ
Defines peak excursion 100 Hz
```

**Characteristics**

\*RST value:

6dB	RF displays
5 PCT	AM displays
50 kHz	FM displays
0.5 RAD	PM displays

For further details refer to ["CALCulate<1|2>:MARKer<1...4>:PEXCursion"](#) on page 6.55.

**CALCulate<1|2>:MARKer<1...4>:Y?**

If the analog demodulator (option Analog Demodulation, R&S FSL–K7) is activated, the query result is output in the following units:

Result display	Output unit
AM	%
FM	Hz
PM	rad/deg (defined with <a href="#">CALCulate&lt;1 2&gt;:UNIT:ANGLE</a> )
RF	output unit defined with <a href="#">CALCulate&lt;1 2&gt;:UNIT:POWer</a>

For further details refer to ["CALCulate<1|2>:MARKer<1...4>:Y?"](#) on page 6.58.

**CALCulate:MARKer:FUNCTION:ADEMod Subsystem (Analog Demodulation, K7)**

The CALCulate:MARKer:FUNCTION:ADEMod subsystem contains the marker functions for the option Analog Demodulation, R&S FSL–K7.

**Commands of the CALCulate:MARKer:FUNCTION:ADEMod Subsystem**

- CALCulate<1|2>:MARKer:FUNCTION:ADEMod:AFRequency[:RESult<1...6>?]
- CALCulate<1|2>:MARKer:FUNCTION:ADEMod:AM[:RESult<1...6>?]
- CALCulate<1|2>:MARKer:FUNCTION:ADEMod:CARRier[:RESult<1...6>?]
- CALCulate<1|2>:MARKer:FUNCTION:ADEMod:FERRor[:RESult<1...6>?]
- CALCulate<1|2>:MARKer:FUNCTION:ADEMod:FM[:RESult<1...6>?]
- CALCulate<1|2>:MARKer:FUNCTION:ADEMod:PM[:RESult<1...6>?]
- CALCulate<1|2>:MARKer:FUNCTION:ADEMod:SINad:RESult<1...6>?
- CALCulate<1|2>:MARKer:FUNCTION:ADEMod:THD:RESult<1...6>?

**CALCulate<1|2>:MARKer:FUNCTION:ADEMod:AFRequency[:RESult<1...6>?]**

This command queries the audio frequency with analog demodulation. The numeric suffix (:RESult<1...6>) indicates whether trace 1, 2, 3, 4, 5 or 6 is selected. The numeric suffixes <1|2> are irrelevant.

**Note:** If several demodulation modes are activated simultaneously (e.g. with the [SENSe:]ADEMod:FM[:TDOMain] [:TYPE] command, the audio frequency of the display mode selected with CALCulate<1|2>:FEED is returned.

**Example**

```
ADEM ON
Switches on analog demodulator
CALC:FEED 'XTIM:AM:TDOM'
Switches on AM result display.
or
CALC:FEED 'XTIM:FM:TDOM'
Switches on FM result display.
or
CALC:FEED 'XTIM:FM:AFSP'
DISP:TRAC ON
Switches on AF spectrum result display of FM and trace.
CALC:MARK:FUNC:ADEM:AFR?
Queries the audio frequency.
```

**Characteristics**

\*RST value: –  
SCPI: device-specific

**Mode**

ADEMOD

**CALCulate<1|2>:MARKer:FUNCtion:ADEMod:AM[:RESult<1...6>?]**

This command queries the results of the AM modulation measurement. The numeric suffix (:RESult<1...6>) indicates whether trace 1, 2, 3, 4, 5 or 6 is selected. The numeric suffixes <1|2> are irrelevant.

**Parameter**

PPEak	Result of measurement with detector +PK
MPEak	Result of measurement with detector –PK
MIDDLE	Result of averaging $\pm$ PK/2
RMS	Result of rms measurement

**Example**

```
ADEM ON
Switches on the analog demodulator.
CALC:FEED 'XTIM:AM:REL:TDOM'
Switches on the AM result display.
DISP:TRAC ON
Switches on the trace.
CALC:MARK:FUNC:ADEM:AM? PPE
Queries the peak value.
```

**Characteristics**

RST value: –  
 SCPI: device-specific

**Mode**

ADEMOD

**CALCulate<1|2>:MARKer:FUNCtion:ADEMod:CARRier[:RESult<1...6>?]**

This command queries the carrier power. The numeric suffix (:RESult<1...6>) indicates whether trace 1, 2, 3, 4, 5 or 6 is selected. The numeric suffixes <1|2> are irrelevant.

With RF Power result display, the carrier power is determined from trace 1 to 6 indicated in the numeric suffix. With all other result displays, the carrier power is determined from the current trace data (CLR/WRITE trace).

This command is only a query and therefore has no \*RST value.

**Example**

```
ADEM ON
Switches on analog demodulator
CALC:FEED 'XTIM:RFP'
Switches on RF power result display
CALC:MARK:FUNC:ADEM:CARR?
Queries the carrier power
```

**Characteristics**

\*RST value: –

SCPI: device-specific

**Mode**

ADEMOD

**CALCulate<1|2>:MARKer:FUNCtion:ADEMod:FERRor[:RESult<1...6>?]**

This command queries the frequency error with FM and PM demodulation. With FM demodulation, trace 1 to 6 is selected with the numeric suffix (:RESult<1...6>). With PM demodulation, the frequency error is determined from the current measurement data (CLR/WRITE trace). The numeric suffixes <1|2> are irrelevant.

The offset thus determined differs from that calculated in the [\[SENSe:\]ADEMod:FM:OFFSet?](#) command since, for determination of the frequency deviation, the modulation is removed by means of lowpass filtering, producing results that are different from those obtained by averaging with the [SENSe](#) command.

This command is only available for traces in the FM and PM result display. If another result display is selected, the command is disabled.

**Example**

ADEM ON

Switches on analog demodulator

CALC:FEED 'XTIM:FM:TDOM'

Switches on FM result display

CALC:MARK:FUNC:ADEM:FERR?

Queries the frequency error of trace 1

**Characteristics**

\*RST value: –

SCPI: device-specific

**Mode**

ADEMOD

**CALCulate<1|2>:MARKer:FUNCtion:ADEMod:FM[:RESult<1...6>?]**

This command queries the results of FM modulation measurement. The numeric suffix (:RESult<1...6>) indicates whether trace 1, 2, 3, 4, 5 or 6 is selected. The numeric suffixes <1|2> are irrelevant.

**Parameter**

PPEak	Result of measurement with detector +PK
MPEak	Result of measurement with detector –PK
MIDDLE	Result of averaging $\pm$ PK/2
RMS	Result of rms measurement

**Example**

ADEM ON  
Switches on the analog demodulator.  
CALC:FEED 'XTIM:FM:TDOM'  
Switches on the FM result display.  
CALC:MARK:FUNC:ADEM:FM? PPE  
Queries the peak value.

**Characteristics**

\*RST value: –  
SCPI: device-specific

**Mode**

ADEMOD

**CALCulate<1|2>:MARKer:FUNCTION:ADEMod:PM[:RESult<1..6>?]**

This command queries the results of PM modulation measurement of analog demodulation. The numeric suffix (:RESult<1..6>) indicates whether trace 1, 2, 3, 4, 5 or 6 is selected. The numeric suffixes <1|2> are irrelevant.

**Parameter**

PPEak	Result of measurement with detector +PK
MPEak	Result of measurement with detector –PK
MIDDLE	Result of averaging $\pm$ PK/2
RMS	Result of rms measurement

**Example**

ADEM ON  
Switches on the analog demodulator.  
CALC:FEED 'XTIM:PM:TDOM'  
Switches on the FM result display.  
CALC:MARK:FUNC:ADEM:PM? PPE  
Queries the peak value.

**Characteristics**

\*RST value: –  
SCPI: device-specific

**Mode**

ADEMOD

---

**CALCulate<1|2>:MARKer:FUNCtion:ADEMod:SINad:RESult<1...6>?**

---

This command queries the result of the SINAD measurement. The numeric suffix (:RESult<1...6>) indicates whether trace 1, 2, 3, 4, 5 or 6 is selected. The numeric suffixes <1|2> are irrelevant.

This command is a query only and thus has no \*RST value.

**Example**

```
ADEM ON
Switches on analog demodulator
CALC:FEED 'XTIM:FM:AFSP'
DISP:TRAC ON
Switches on AF spectrum of FM and trace
CALC:MARK:FUNC:ADEM:SIN:RES?
Queries SINAD value
```

**Characteristics**

\*RST value: –  
SCPI: device-specific

**Mode**

ADEMOD

---

**CALCulate<1|2>:MARKer:FUNCtion:ADEMod:THD:RESult<1...6>?**

---

This command queries the result of the THD measurement. The numeric suffix (:RESult<1...6>) indicates whether trace 1, 2, 3, 4, 5 or 6 is selected. The numeric suffixes <1|2> are irrelevant.

This command is a query only and thus has no \*RST value.

**Example**

```
ADEM ON
Switches on analog demodulator
CALC:FEED 'XTIM:FM:AFSP'
Switches on AF spectrum of FM and trace
DISP:TRAC ON
Switches on the trace
CALC:MARK:FUNC:ADEM:THD:RES?
Queries THD result
```

**Characteristics**

\*RST value: –  
SCPI: device-specific

**Mode**

ADEMOD

---



**CALCulate:UNIT Subsystem (Analog Demodulation, K7)**

The CALCulate:Unit subsystem defines the units for the parameters that can be set and the measurement results.

**Commands of the CALCulate:UNIT Subsystem**

- [CALCulate<1|2>: UNIT:ANGLE](#)

**CALCulate<1|2>: UNIT:ANGLE**

---

This command selects the unit for angles.

**Parameter**

DEG | RAD

**Example:**

CALC:UNIT:ANGL DEG

**Characteristics:**

\*RST value: RAD

SCPI: device-specific

**Mode**

ADEMODO

---

## DISPlay Subsystem (Analog Demodulation, K7)

The DISPlay subsystem controls the selection and presentation of textual and graphic information as well as of measurement data on the display.

### Commands of the DISPlay Subsystem

- [DISPlay\[:WINDow<1|2>\]:SIZE](#)
- [DISPlay\[:WINDow<1|2>\]:TRACe<1...6>:Y\[:SCALe\]:PDIVision](#)
- [DISPlay\[:WINDow<1|2>\]:TRACe<1...6>:Y\[:SCALe\]:RPOSition](#)
- [DISPlay\[:WINDow<1|2>\]:TRACe<1...6>:Y\[:SCALe\]:RVALue](#)
- [DISPlay\[:WINDow<1|2>\]:TRACe<1...6>:Y:SPACing](#)

---

### DISPlay[:WINDow<1|2>]:SIZE

This command switches the measurement window for active analog demodulation to full screen or half screen.

For further details refer to "[DISPlay\[:WINDow<1|2>\]:SIZE](#)" on page 6.115.

---



---

### DISPlay[:WINDow<1|2>]:TRACe<1...6>:Y[:SCALe]:PDIVision

This command defines the scaling of the y-axis in the current unit. The numeric suffix in TRACe<1...6> is irrelevant. The numeric suffixes <1|2> are irrelevant.

#### Parameter

<numeric\_value>

#### Example

```
DISP:TRAC:Y:PDIV +10kHz
```

Sets the Y scale to 10 kHz/div.

#### Characteristics

\*RST value:

20 PCT	linear AM display
50 kHz	linear FM display
2 rad	linear PM display
10 dB	logarithmic AF spectrum display

SCPI: conform

#### Mode

ADEMODO

---

**DISPlay[:WINDow<1|2>]:TRACe<1...6>:Y[:SCALe]:RPOSition**

---

**Characteristics**

\*RST value:

100 PCT AF spectrum display of AM, FM, or PM

50 PCT AM, FM, or PM display

For further details refer to "[DISPlay\[:WINDow<1|2>\]:TRACe<1...6>:Y\[:SCALe\]:RPOSition \(models 13, 16\)](#)" on page 6.120.

---

**DISPlay[:WINDow<1|2>]:TRACe<1...6>:Y[:SCALe]:RVALue**

---

This command defines the reference value assigned to the reference position. Separate reference values are maintained for the various displays.

**Example**

DISP:TRAC:Y:RVAL 0

Sets the value assigned to the reference position to 0 Hz (analog demodulation)

**Characteristics**

\*RST value:

0 PCT AM display

0 Hz FM display

0 rad PM display

100 PCT AF spectrum display of AM signal

250 kHz AF spectrum display of FM signal

10 rad AF spectrum display of PM signal

For further details refer to "[DISPlay\[:WINDow<1|2>\]:TRACe<1...6>:Y\[:SCALe\]:RPOSition \(models 13, 16\)](#)" on page 6.120.

---

**DISPlay[:WINDow<1|2>]:TRACe<1...6>:Y:SPACing**

---

When the AF spectrum result display is selected, only the parameters LINear and LOGarithmic are allowed.

For further details refer to "[DISPlay\[:WINDow<1|2>\]:TRACe<1...6>:Y:SPACing](#)" on page 6.118.

---

## **INSTRument Subsystem (Analog Demodulation, K7)**

The INSTRument subsystem selects the operating mode of the unit either via text parameters or fixed numbers.

### **Commands of the INSTRument Subsystem**

- [INSTRument\[:SElect\]](#)
- [INSTRument:NSElect](#)

#### **INSTRument[:SElect]**

---

##### **Parameter**

ADEMod (Analog Demodulation option, R&S FSL-K7)

For further details refer to section "Remote Control – Description of Basic Settings Commands", INSTRument subsystem.

---

#### **INSTRument:NSElect**

---

##### **Parameter**

3 (Analog Demodulation option, R&S FSL-K7)

For further details refer to section "Remote Control – Description of Basic Settings Commands", INSTRument subsystem.

---

## SENSe Subsystem (Analog Demodulation, K7)

The SENSe subsystem is organized in several subsystems. The commands of these subsystems directly control device-specific settings, they do not refer to the signal characteristics of the measurement signal.

The SENSe subsystem controls the essential parameters of the analyzer. In accordance with the SCPI standard, the keyword "SENSe" is optional for this reason, which means that it is not necessary to include the SENSe node in command sequences.

The following subsystems are included:

- "SENSe:ADEMod Subsystem" on page 6.249
- "SENSe:BANDwidth Subsystem" on page 6.272
- "SENSe:FILTer Subsystem" on page 6.273
- "SENSe:FREQuency Subsystem" on page 6.276
- "SENSe:SWEEp Subsystem" on page 6.276

### SENSe:ADEMod Subsystem (Analog Demodulation, K7)

The SENSe:ADEMod Subsystem contains commands to set up the instrument for the measurement of analog demodulated signals and query the result at the end of the measurement.

#### Commands of the SENSe:ADEMod Subsystem

- [SENSe:]ADEMod[:STATe]
- [SENSe:]ADEMod:AF:CENTer
- [SENSe:]ADEMod:AF:COUPLing
- [SENSe:]ADEMod:AF:SPAN
- [SENSe:]ADEMod:AF:SPAN:FULL
- [SENSe:]ADEMod:AF:STARt
- [SENSe:]ADEMod:AF:STOP
- [SENSe:]ADEMod:AM[:ABSolute][:TDOMain][:TYPE]
- [SENSe:]ADEMod:AM[:ABSolute][:TDOMain]:RESult?
- [SENSe:]ADEMod:AM:RELative[:TDOMain][:TYPE]
- [SENSe:]ADEMod:AM:RELative[:TDOMain]:RESult?
- [SENSe:]ADEMod:AM:RELative:AFSPectrum[:TYPE]
- [SENSe:]ADEMod:AM:RELative:AFSPectrum:RESult?
- [SENSe:]ADEMod:BANDwidth|BWIDth:DEModulation
- [SENSe:]ADEMod:FM[:TDOMain][:TYPE]
- [SENSe:]ADEMod:FM[:TDOMain]:RESult?
- [SENSe:]ADEMod:FM:AFSPectrum[:TYPE]
- [SENSe:]ADEMod:FM:AFSPectrum:RESult?
- [SENSe:]ADEMod:FM:OFFSet?
- [SENSe:]ADEMod:MTIME

- [SENSe:]ADEMod:PM[:TDOMain][:TYPE]
- [SENSe:]ADEMod:PM[:TDOMain]:RESult?
- [SENSe:]ADEMod:PM:AFSPectrum[:TYPE]
- [SENSe:]ADEMod:PM:AFSPectrum:RESult?
- [SENSe:]ADEMod:PM:RPOint[:X]
- [SENSe:]ADEMod:RLENgth?
- [SENSe:]ADEMod:SET
- [SENSe:]ADEMod:SPECTrum[:TYPE]
- [SENSe:]ADEMod:SPECTrum:BANDwidth|BWIDth[:RESolution]
- [SENSe:]ADEMod:SPECTrum:RESult?
- [SENSe:]ADEMod:SPECTrum:SPAN[:MAXimum]
- [SENSe:]ADEMod:SPECTrum:SPAN:ZOOM
- [SENSe:]ADEMod:SRATe?
- [SENSe:]ADEMod:ZOOM[:STATe]
- [SENSe:]ADEMod:ZOOM:STARt

### Further information

- Trace mode result types
- Formats for returned values: ASCII format and binary format

### Trace mode result types

The following result types can be set:

WRITE	The current trace results will be obtained
AVERAge	The trace results will be averaged over the given # of measurements
MAXHold	The maximum trace result values will be obtained over the given # of measurements
MINHold	The minimum trace result values will be obtained over the given # of measurements
VIEW	The trace results are frozen and displayed, i.e. they are not calculated for subsequent measurements. Traces in this mode cannot be queried.
OFF	The result type will not be used.

**Note:** *It is not possible to query trace data when result type VIEW is selected.  
Each value besides OFF can only be assigned to one result type at a time.  
If all result types are set to OFF, the AM, FM, or PM demodulator will be deactivated.*

**Formats for returned values: ASCII format and binary format**

- ASCII Format (FORMat ASCII):

The command reads out a list of comma separated values (CSV) of the measured values in floating point format.

- Binary Format (FORMat REAL,32):

The command reads out binary data (Definite Length Block Data according to IEEE 488.2), each measurement value being formatted in 32 Bit IEEE 754 Floating-Point-Format. The schematics of the result string will be as follows:

#41024<value1><value2>...<value n> with

#4            number of digits (= 4 in the example) of the following number of data bytes

1024        number of following data bytes (= 1024 in the example)

<value>    4-byte floating point value

**[SENSe:]ADEMod[:STATe]**

This command activates the analog demodulator of the instrument. The instrument will be set to zero span at the current center frequency.

**Parameter**

ON | OFF

**Example**

ADEM ON

Switches the analog demodulator on.

**Characteristics**

\*RST value: OFF

SCPI: device-specific

**Mode**

ADEMOD

**[SENSe:]ADEMod:AF:CENTer**

This command sets the center frequency for AF spectrum result display.

**Parameter**

<numeric\_value>

**Example**

ADEM ON

Switches on the analog demodulator

CALC:FEED 'XTIM:FM:AFSP'

Switches on AF spectrum result display of FM

ADEM:BAND 5 MHz

Sets the measurement bandwidth to 5 MHz

ADEM:AF:CENT 500kHz

Sets the AF center frequency to 500 kHz

ADEM:AF:SPAN 200kHz

Sets the AF span to 200 kHz

**Characteristics**

\*RST value: 1.25 MHz

SCPI: device-specific

**Mode**

ADEMOD

---

**[SENSe:]ADEMod:AF:COUPling**

---

This command selects the coupling of the AF path of the analyzer.

**Parameter**

AC | DC

**Example**

```
ADEM:AF:COUP DC
```

Switches on DC coupling.

**Characteristics**

\*RST value: AC (PM); DC (FM)

SCPI: device-specific

**Mode**

ADEMOD

---

**[SENSe:]ADEMod:AF:SPAN**

---

This command sets the span for AF spectrum result display.

The span is limited to half the measurement bandwidth of analog demodulation

([\[SENSe:\]ADEMod:BANDwidth|BWIDth:DEModulation](#)).

**Parameter**

<numeric\_value>

**Example**

```
ADEM ON
```

Switches on the analog demodulator

```
CALC:FEED 'XTIM:FM:AFSP'
```

Switches on AF spectrum result display of FM

```
ADEM:BAND 5 MHz
```

Sets the measurement bandwidth to 5 MHz

```
ADEM:AF:CENT 500kHz
```

Sets the AF center frequency to 500 kHz

```
ADEM:AF:SPAN 200kHz
```

Sets the AF span to 200 kHz

**Characteristics**

\*RST value: 2.5 MHz

SCPI: device-specific

**Mode**

ADEMOD

---



---

**[SENSe:]ADEMod:AF:SPAN:FULL**

---

This command sets the maximum span for AF spectrum result display.  
The maximum span corresponds to half the measurement bandwidth of analog demodulation (`[SENSe:]ADEMod:BANDwidth|BWIDth:DEModulation`).

**Example**

```
ADEM ON  
Switches on the analog demodulator  
CALC:FEED 'XTIM:FM:AFSP'  
Switches on AF spectrum result display of FM  
ADEM:BAND 5 MHz  
Sets the measurement bandwidth to 5 MHz  
ADEM:AF:SPAN:FULL  
Sets the AF span to 2.5 MHz
```

**Characteristics**

\*RST value: –  
SCPI: device-specific

**Mode**

ADEMOD

---

**[SENSe:]ADEMod:AF:STARt**

---

This command sets the start frequency for AF spectrum result display.

**Parameter**

<numeric\_value>

**Example**

```
ADEM ON  
Switches on analog demodulator  
CALC:FEED 'XTIM:FM:AFSP'  
Switches on AF spectrum result display of FM  
ADEM:BAND 5 MHz  
Sets the measurement bandwidth to 5 MHz  
ADEM:AF:STAR 0kHz  
Sets the AF start frequency to 0 kHz  
ADEM:AF:STOP 500kHz  
Sets the AF stop frequency to 500 kHz
```

**Characteristics**

\*RST value: 0 MHz  
SCPI: device-specific

**Mode**

ADEMOD

---

**[SENSe:]ADEMod:AF:STOP**

This command sets the stop frequency for AF spectrum result display.  
The stop frequency is limited to half the measurement bandwidth of analog demodulation ([\[SENSe:\]ADEMod:BANDwidth|BWIDth:DEModulation](#)).

**Parameter**

<numeric\_value>

**Example**

ADEM ON

Switches on the analog demodulator

CALC:FEED 'XTIM:FM:AFSP'

Switches on AF spectrum result display of FM

ADEM:BAND 5 MHz

Sets the measurement bandwidth to 5 MHz

ADEM:AF:STAR 0kHz

Sets the AF start frequency to 0 kHz

ADEM:AF:STOP 500kHz

Sets the AF stop frequency to 500 kHz

**Characteristics**

\*RST value: 2.5 MHz

SCPI: device-specific

**Mode**

ADEMOD

**[SENSe:]ADEMod:AM[:ABSolute][:TDOMain][:TYPE]**

This command selects the result types of the RF signal to be measured simultaneously in zero span.

**Parameter**

<result type 1|2|3|4|5|6>: WRITe, AVERage, MAXHold, MINHold, VIEW, OFF; for details see "[Trace mode result types](#)" on page 6.250.

**Example**

ADEM:AM AVER,MAXH,MINH

Determines average, max hold and min hold values at a time.

ADEM:AM WRIT,OFF,OFF

Determines only the current measurement values.

ADEM:AM OFF,OFF,OFF

Switches AM demodulation off.

**Characteristics**

\*RST value: WRITe,OFF,OFF

SCPI: device-specific

**Mode**

ADEMOD

**[SENSe:]ADEMod:AM[:ABSolute][:TDOMain]:RESult?**

This command reads the result data of the RF signal in zero span for the specified result type. The data format of the output data block is defined by the `FORMat` command.

**Parameter**

<result type>: WRITe, AVERage, MAXHold, MINHold; for details see "[Trace mode result types](#)" on page 6.250.

**Note:** *The result type indicated must be one of those configured by [SENSe:]ADEMod:AM[:ABSolute][:TDOMain][:TYPE]. Otherwise a query error will be generated.*

**Return values**

ASCII Format (FORMat ASCII) or Binary Format (FORMat REAL,32); for details see "[Formats for returned values: ASCII format and binary format](#)" on page 6.251. The output units are described in "[CALCulate<1|2>:MARKer<1...4>:PEXCursion](#)" on page 6.55.

**Example**

```
ADEM:SET 8MHz,32000,EXT,POS,-500,30
```

Sets up demodulator parameters

```
ADEM:AM AVER,MAXH,MINH
```

Sets up AM results to be measured

```
ADEM ON
```

Switches on demodulator

```
INIT;*WAI
```

Starts measurement and waits for sync

```
FORM ASC
```

Selects output format

```
ADEM:AM:RES? AVER
```

Reads AM average results

```
ADEM:AM:RES? MAXH
```

Reads AM max hold results

```
ADEM:AM:RES? MINH
```

Reads AM min hold results

**Characteristics**

\*RST value: –

SCPI: device-specific

**Mode**

ADEMOD

**[SENSe:]ADEMod:AM:RELative[:TDOMain][:TYPE]**

This command selects the result types to be measured simultaneously by AM demodulation.

**Parameter**

<result type 1|2|3|4|5|6>: WRITe, AVERage, MAXHold, MINHold, VIEW, OFF; for details see "[Trace mode result types](#)" on page 6.250.

**Example**

```
ADEM:AM:REL AVER,MAXH,MINH
```

Determines average, max hold and min hold values simultaneously.

```
ADEM:AM:REL WRIT,OFF,OFF
```

Determines only the current measurement values.

ADEM:AM:REL OFF,OFF,OFF  
Switches AM demodulation off.

### Characteristics

\*RST value: OFF,OFF,OFF  
SCPI: device-specific

### Mode

ADEM0D

## [SENSe:]ADEMod:AM:RELative[:TDOMain]:RESult?

This command reads the result data obtained by AM demodulation for the specified result type. The data format of the output data block is defined by the FORMat command.

### Parameter

<result type>: WRITe, AVERage, MAXHold, MINHold; for details see "[Trace mode result types](#)" on page 6.250.

**Note:** The result type indicated must be one of those configured by [SENSe:]ADEMod:AM:RELative[:TDOMain][:TYPE]. Otherwise a query error will be generated.

### Return values

ASCII Format (FORMat ASCII) or Binary Format (FORMat REAL,32); for details see "[Formats for returned values: ASCII format and binary format](#)" on page 6.251. The output units are described in "[CALCulate<1|2>:MARKer<1...4>:PEXCursion](#)" on page 6.55.

### Example

ADEM:SET 8MHz,32000,EXT,POS,-500,30

Sets up demodulator parameters

ADEM:FM AVER,MAXH,MINH

Selects FM results to be measured

ADEM:AM:REL WRIT,OFF,OFF

Selects AM results to be measured

ADEM ON

Switches on demodulator

INIT;\*WAI

Starts measurement and waits for sync

FORM ASC

Selects output format

ADEM:FM:RES? AVER

Reads FM average results

ADEM:FM:RES? MAXH

Reads FM max hold results

ADEM:FM:RES? MINH

Reads FM min hold results

ADEM:AM:REL:RES? WRIT

Reads current AM result data

### Characteristics

\*RST value: –  
SCPI: device-specific

### Mode

ADEM0D

**[SENSe:]ADEMod:AM:RELative:AFSPectrum[:TYPE]**

This command selects the AF spectrum result types of the AM–demodulated signal to be measured simultaneously.

**Parameter**

<result type 1|2|3|4|5|6>: WRITe, AVERage, MAXHold, MINHold, VIEW, OFF; for details see "[Trace mode result types](#)" on page 6.250.

**Note:** *The result type "AF spectrum of AM–demodulated signal" cannot be activated at the same time as "AF spectrum of FM or PM demodulated signal".*

**Example**

```
ADEM:AM:REL:AFSP AVER,MAXH,MINH
```

Determines average, maximum and minimum value simultaneously

```
ADEM:AM:REL:AFSP WRIT,OFF,OFF
```

Determines only current measurement results

```
ADEM:AM:REL:AFSP OFF,OFF,OFF
```

Switches off calculation of the AF spectrum

**Characteristics**

\*RST value: OFF,OFF,OFF

SCPI: device–specific

**Mode**

ADEMOD

**[SENSe:]ADEMod:AM:RELative:AFSPectrum:RESult?**

This command reads out the AF spectrum result data of the AM–demodulated signal for the specified result type. The data format of the output data is determined with the FORMat command.

**Parameter**

<result type>: WRITe, AVERage, MAXHold, MINHold; for details see "[Trace mode result types](#)" on page 6.250.

**Note:** *The specified result type must be one of those configured with the [SENSe:]ADEMod:AM:RELative:AFSPectrum[:TYPE] command. Otherwise a query error will be generated.*

**Return values**

ASCII Format (FORMat ASCII) or Binary Format (FORMat REAL,32); for details see "[Formats for returned values: ASCII format and binary format](#)" on page 6.251. The output units are described in section "[CALCulate<1|2>:MARKer<1...4>:PEXCursion](#)" on page 6.55.

**Example**

```
ADEM:SET 8MHz,32000,EXT,POS,-500,30
```

Sets the demodulator

```
ADEM:FM AVER,MAXH,MINH
```

Selects the FM results to be measured

```
ADEM:AM:REL WRIT,OFF,OFF
```

Selects the AM results to be measured

```
ADEM:AM:REL:AFSP WRIT,OFF,OFF
```

Selects the AF spectrum results of the demodulated AM signal to be measured

```
ADEM ON
```

Switches on the demodulator

INIT; \*WAI

Starts the measurement and waits for the termination

FORM ASC

Selects the output format

ADEM:FM:RES? AVER

Reads the FM average result data

ADEM:FM:RES? MAXH

Reads the FM Maxhold result data

ADEM:FM:RES? MINH

Reads the FM Minhold result data

ADEM:AM:REL:RES? WRIT

Reads the current AM result data

ADEM:AM:REL:AFSP:RES? WRIT

Reads the current AF spectrum result data of the demodulated AM signal

### Characteristics

\*RST value: –

SCPI: device-specific

### Mode

ADEMOD

---

## **[SENSe:]ADEMod:BAWidth|BWIDth:DEModulation**

---

This command defines the demodulation bandwidth used for analog demodulation. The required sampling rate is automatically set depending on the selected demodulation bandwidth. The available demodulation bandwidths are determined by the existing sampling rates (see table below).

### Parameter

<numeric\_value>

For details on the correlation of bandwidth and sample rate refer to chapter "Instrument Functions", section "Analog Demodulation (Option K7)" – "Sample rate, measurement time and trigger offset".

### Example

ADEM:BAW:DEM 1MHz

Sets the demodulation bandwidth to 1 MHz.

### Characteristics

\*RST value: 5 MHz

SCPI: device-specific

### Mode

ADEMOD

---

**[SENSe:]ADEMod:FM[:TDOMain][:TYPE]**

This command selects the result types to be measured simultaneously by FM demodulation.

**Parameter**

<result type 1|2|3|4>: WRITe, AVERage, MAXHold, MINHold, VIEW, OFF; for details see "[Trace mode result types](#)" on page 6.250.

**Example**

```
ADEM: FM AVER, MAXH, MINH
```

"Creates average, max hold and min hold values simultaneously

```
DEM: FM WRIT, OFF, OFF
```

Only creates the current measurement values

```
ADEM: FM OFF, OFF, OFF
```

Switches analog demodulator off

**Characteristics**

\*RST value: WRITe, OFF, OFF

SCPI: device-specific

**Mode**

ADEMODO

**[SENSe:]ADEMod:FM[:TDOMain]:RESult?**

This command reads the result data obtained by analog demodulation for the specified result type. The data format of the output data block is defined by the FORMat command.

**Parameter**

<result type>: WRITe, AVERage, MAXHold, MINHold; for details see "[Trace mode result types](#)" on page 6.250.

**Note:** *The result type indicated must be one of those configured by [SENSe:]ADEMod:FM[:TDOMain][:TYPE]. Otherwise a query error will be generated.*

**Return values**

ASCII Format (FORMat ASCII) or Binary Format (FORMat REAL,32); for details see "[Formats for returned values: ASCII format and binary format](#)" on page 6.251. The output units are described in "[CALCulate<1|2>:MARKer<1...4>:PEXCursion](#)" on page 6.55.

**Example**

```
ADEM: SET 8MHz, 32000, EXT, POS, -500, 30
```

Sets up demodulator parameters

```
ADEM: FM AVER, MAXH, MINH
```

Selects FM results to be measured

```
ADEM: AM WRIT, OFF, OFF
```

Selects AM results to be measured

```
ADEM ON
```

Switches on demodulator

```
INIT; *WAI
```

Starts measurement and waits for sync

```
FORM ASC
```

Selects output format

```
ADEM: FM: RES? AVER
```

Reads FM average results

ADEM:FM:RES? MAXH  
Reads FM max hold results

ADEM:FM:RES? MINH  
Reads FM min hold results

ADEM:AM:RES? WRIT  
Reads current AM results

**Characteristics**

\*RST value: –  
SCPI: device-specific

**Mode**

ADEMOD

**[SENSe:]ADEMod:FM:AFSPectrum[:TYPE]**

This command selects the AF spectrum result types of the FM demodulated signal to be measured simultaneously.

**Parameter**

<result type 1|2|3|4|5|6>: WRITe, AVERAge, MAXHold, MINHold, VIEW, OFF; for details see "[Trace mode result types](#)" on page 6.250.

**Note:** *The result type "AF spectrum of the FM demodulated signal" cannot be activated at the same time as "AF spectrum of AM or PM demodulated signal".*

**Example**

ADEM:FM:AFSP AVER,MAXH,MINH  
Determines average, maximum and minimum value simultaneously

ADEM:FM:AFSP WRIT,OFF,OFF  
Determines only current measurement results

ADEM:FM:AFSP OFF,OFF,OFF  
Switches calculation of AF spectrum off

**Characteristics**

\*RST value: OFF,OFF,OFF  
SCPI: device-specific

**Mode**

A

**[SENSe:]ADEMod:FM:AFSPectrum:RESult?**

This command reads out the AF spectrum result data of the FM demodulated signal for the specified result type. The data format of the output data is determined with the FORMat command.

**Parameter**

<result type>: WRITe, AVERAge, MAXHold, MINHold; for details see "[Trace mode result types](#)" on page 6.250.

**Note:** *The specified result type must be one of those configured with the [SENSe:]ADEMod:FM:AFSPectrum[:TYPE] command. Otherwise a query error will be generated.*



**Return values**

ASCII Format (FORMat ASCII) or Binary Format (FORMat REAL,32); for details see "[Formats for returned values: ASCII format and binary format](#)" on page 6.251. The output units are described in "[CALCulate<1|2>:MARKer<1...4>:PEXCursion](#)" on page 6.55.

**Example**

```
ADEM:SET 8MHz,32000,EXT,POS,-500,30
Sets demodulator

ADEM:FM AVER,MAXH,MINH
Selects the FM results to be measured

ADEM:AM:REL WRIT,OFF,OFF
Selects the AM results to be measured

ADEM:FM:AFSP WRIT,OFF,OFF
Selects the AF spectrum results of the demodulated FM signal to be measured

ADEM ON
Switches the demodulator on

INIT;*WAI
Starts the measurement and waits for termination

FORM ASC
Selects output format

ADEM:FM:RES? AVER
Reads FM average result data

ADEM:FM:RES? MAXH
Reads FM maxhold result data

ADEM:FM:RES? MINH
Reads FM minhold result data

ADEM:AM:RES? WRIT
Reads current AM result data

ADEM:FM:AFSP:RES? WRIT
Reads current AF spectrum result data of demodulated FM signal
```

**Characteristics**

\*RST value: –  
SCPI: device-specific

**Mode**

ADEMOD

**[SENSe:]ADEMod:FM:OFFSet?**

This command calculates the FM offset of the currently available measurement data set.

If averaging has been activated before acquiring the data set (using [\[SENSe:\]ADEMod:FM\[:TDOMain\] \[:TYPE\]](#)), the averaged FM offset over several measurements can also be obtained by setting <result type> = AVERAge.

The offset thus determined differs from the one calculated by the [CALCulate<1|2>:MARKer:FUNction:ADEMod:FERRor\[:RESult<1...6>?\]](#) command since, for determination of the frequency deviation, the modulation is removed by means of lowpass filtering, producing results that are different from those obtained by averaging.

**Parameter**

<result type>

IMMediate The current measurement results will be used for calculating the FM offset

**AVERage** The measurement results that were averaged over the given # of measurements will be used for calculating the FM offset

**Note:** *If no average measurement was active during the last measurement sequence only the [SENSe:]ADEMod:FM:OFFSet? IMMEDIATE command will return a correct result (data to calculate the offset are taken from the last measured data set). [SENSe:]ADEMod:FM:OFFSet? AVERage will cause a query error in this case.*

### Example

```
ADEM:SET 8MHz,32000,EXT,POS,-500,30
Sets up demodulator parameters to execute 30 measurements
ADEM:FM AVER,OFF,OFF
Selects FM results to perform averaging
ADEM:AM OFF,OFF,OFF
Switches off AM demodulation
ADEM ON
Switches on analog demodulator
INIT;*WAI
Starts measurement and waits for sync
ADEM:FM:OFFS? IMM
Reads FM offset of last measurement of the sequence of 30
ADEM:FM:OFFS? AVER
Reads FM offset averaged over 30 measurements
```

### Characteristics

\*RST values: –  
SCPI: device-specific

### Mode

ADEMOD

## [SENSe:]ADEMod:MTIME

This command defines the measurement time for analog demodulation.

### Parameter

<numeric\_value>

### Example

```
ADEM:MTIM 62.5us
Sets the measurement time to 62.5 μs.
```

### Characteristics

\*RST value: 62.5us  
SCPI: device-specific

### Mode

ADEMOD

**[SENSe:]ADEMod:PM[:TDOMain][:TYPE]**

This command selects the result types of the PM–demodulated signal to be created simultaneously.

**Parameter**

<result type 1|2|3|4|5|6>: WRITe, AVERage, MAXHold, MINHold, VIEW; for details see "[Trace mode result types](#)" on page 6.250.

**Example**

```
ADEM:PM AVER,MAXH,MINH
```

Determines average, maximum and minimum value simultaneously

```
ADEM:PM WRIT,OFF,OFF
```

Determines only current measurement results

```
ADEM:PM OFF,OFF,OFF
```

Switches the PM demodulator off.

**Characteristics**

RST value: OFF,OFF,OFF

SCPI: device–specific

**Mode**

ADEM0D

**[SENSe:]ADEMod:PM[:TDOMain]:RESult?**

This command reads the result data of the PM demodulation for the specified result type. The data format of the output data is determined with the FORMat command.

**Parameter**

<result type>: WRITe, AVERage, MAXHold, MINHold; for details see "[Trace mode result types](#)" on page 6.250.

**Note:** *The specified result type must be one of those configured with the [SENSe:]ADEMod:PM[:TDOMain][:TYPE] command. Otherwise a query error will be generated.*

**Return values**

ASCII Format (FORMat ASCII) or Binary Format (FORMat REAL,32); for details see "[Formats for returned values: ASCII format and binary format](#)" on page 6.251. The output units are described in "[CALCulate<1|2>:MARKer<1...4>:PEXCursion](#)" on page 6.55.

**Example**

```
ADEM:SET 8MHz,32000,EXT,POS,-500,30
```

Sets the demodulator parameters.

```
ADEM:PM AVER,MAXH,MINH
```

Selects the PM results to be measured.

```
ADEM:AM WRIT,OFF,OFF
```

Selects the AM results to be measured.

```
ADEM ON
```

Switches on the demodulator.

```
INIT;*WAI
```

Starts the measurement and waits for termination.

```
FORM ASC
```

Selects the output format.

ADEM:PM:RES? AVER  
 Reads the PM average result data.

ADEM:PM:RES? MAXH  
 Reads the PM maxhold result data.

ADEM:PM:RES? MINH  
 Reads the PM minhold result data.

ADEM:AM:RES? WRIT  
 Reads the current AM result data.

**Characteristics**

RST value: –  
 SCPI: device-specific

**Mode**

ADEMOD

**[SENSe:]ADEMod:PM:AFSPectrum[:TYPE]**

This command selects the AF spectrum result types of the PM-demodulated signal to be measured simultaneously.

**Parameter**

<result type 1|2|3|4|5|6>: WRITe, AVERage, MAXHold, MINHold, VIEW; for details see "[Trace mode result types](#)" on page 6.250.

**Note:** *The result type "AF spectrum of the PM demodulated signal" cannot be activated at the same time as "AF spectrum of AM or FM demodulated signal".*

**Example**

ADEM:PM:AFSP AVER,MAXH,MINH  
 Determines average, maximum and minimum value simultaneously

ADEM:PM:AFSP WRIT,OFF,OFF  
 Determines only current measurement results

ADEM:PM:AFSP OFF,OFF,OFF  
 Switches calculation of AF spectrum off

**Characteristics**

RST value: OFF,OFF,OFF  
 SCPI: device-specific

**Mode**

ADEMOD

**[SENSe:]ADEMod:PM:AFSPectrum:RESult?**

This command reads out the AF spectrum result data of the PM-demodulated signal for the specified result type. The data format of the output data is determined with the FORMat command.

**Parameter**

<result type>: WRITe, AVERage, MAXHold, MINHold; for details see "[Trace mode result types](#)" on page 6.250.

**Note:** *The specified result type must be one of those configured with the [SENSe:]ADEMod:PM:AFSPectrum[:TYPE] command. Otherwise a query error will be generated.*

**Return values**

ASCII Format (FORMat ASCII) or Binary Format (FORMat REAL,32); for details see "[Formats for returned values: ASCII format and binary format](#)" on page 6.251. The output units are described in section "[CALCulate<1|2>:MARKer<1...4>:PEXCursion](#)" on page 6.55.

**Example**

```
ADEM:SET 8MHz,32000,EXT,POS,-500,30
Sets demodulator
ADEM:PM AVER,MAXH,MINH
Selects the PM results to be measured
ADEM:AM:REL WRIT,OFF,OFF
Selects the AM results to be measured
ADEM:PM:AFSP WRIT,OFF,OFF
Selects the AF spectrum results of the demodulated PM signal to be measured
ADEM ON
Switches the demodulator on
INIT;*WAI
Starts the measurement and waits for termination
FORM ASC
Selects output format
ADEM:PM:RES? AVER
Reads PM average result data
ADEM:PM:RES? MAXH
Reads PM maxhold result data
ADEM:PM:RES? MINH
Reads PM minhold result data
ADEM:AM:RES? WRIT
Reads current AM result data
ADEM:PM:AFSP:RES? WRIT
Reads current AF spectrum result data of demodulated PM signal
```

**Characteristics**

RST value: –  
SCPI: device-specific

**Mode**

ADEMOD

**[SENSe:]ADEMod:PM:RPOint[:X]**

This command determines the position where the phase of the PM-demodulated signal is set to 0 rad. The maximum possible value depends on the measurement time selected in the instrument; this value is output in response to the query `ADEM:PM:RPO:X? MAX`.

**Parameter**

0 s to measurement time

**Example**

```
ADEM:PM:RPO 500us
Sets the position where the phase to 0 rad setting to 500 μs.
```

**Characteristics**

RST value: 0 s  
SCPI: conform

**Mode**

ADEMOD

**[SENSe:]ADEMod:RLENgth?**

This command returns the record length set up for the current analog demodulation measurement.

**Example**

ADEM:RLEN?

Returns the current record length.

**Characteristics**

\*RST value: –

SCPI: device-specific

**Mode**

ADEMOD

**[SENSe:]ADEMod:SET**

This command configures the analog demodulator of the instrument.

**Parameter**

<sample rate>	The frequency at which measurement values are taken from the A/D-converter and stored in I/Q memory. Allowed range: refer to chapter "Instrument Functions", section "Analog Demodulation (Option K7)" – "Sample rate, measurement time and trigger offset".
<record length>	Number of samples to be stored in I/Q memory. Allowed range: 1 to 400001 with AF filter or AF trigger active 1 to 480001 with both AF filter and AF trigger deactive
<trigger source>	Selection of the trigger source to use for the demodulator. Allowed values: IMMEDIATE   EXTERNAL   IFPOWER   RFPower   AF   AM   AMRelative   FM   PM (see note below)
<trigger slope>	Used slope of the trigger signal. Allowed values: POSITIVE   NEGATIVE The value indicated here will be ignored for <trigger source> = IMMEDIATE.
<offset samples>	Number of samples to be used as an offset to the trigger signal. Allowed range: –65024 to 130559 (= –64 * 1024 + 512 to 128 * 1024 – 513) The value indicated here will be ignored for <trigger source> = IMMEDIATE.
<# of meas>	Number of repetitions of the measurement to be executed. The value indicated here is especially necessary for the average/maxhold/minhold function. Allowed range: 0 to 32767

**Note:** After selecting *IFPower*, the trigger threshold can be set with the `TRIGger<1|2>[:SEquence]:LEVel:IFPower` command.

### Example

```
ADEM:SET 8MHz,32000,EXT,POS,-500,30
```

Performs a measurement at:

sample rate	8 MHz
record length	32000
trigger source	EXTernal
trigger slope	POSitive
offset samples	-500 (500 samples before trigger occurred)
# of meas	30

### Characteristics

\*RST value:

sample rate	8 MHz
record length	501
trigger source	IMMediate
trigger slope	POSitive
offset samples	0
# of meas	0

SCPI: device-specific

### Mode

ADEMOD

## [SENSe:]ADEMod:SPECTrum[:TYPE]

This command selects the result types to be created in parallel by the RF spectrum measurement with active analog demodulation.

### Parameter

<result type 1|2|3|4>: WRITe, AVERage, MAXHold, MINHold, VIEW, OFF; for details see "[Trace mode result types](#)" on page 6.250.

### Example

```
ADEM:SPEC AVER,MAXH,MINH
```

Creates average, max hold and min hold values at a time

```
ADEM:SPEC WRIT,OFF,OFF
```

Only creates the current measurement values

```
ADEM:SPEC OFF,OFF,OFF
```

Switches analog demodulator off

### Characteristics

\*RST value: OFF,OFF,OFF

SCPI: device-specific

### Mode

ADEMOD

**[SENSe:]ADEMod:SPECTrum:BANDwidth|BWIDth[:RESolution]**

This command sets the resolution bandwidth for spectrum representation that was determined from the analog demodulation data.

The recording time required is calculated from the sampling rate indirectly set via `[SENSe:]ADEMod:SPECTrum:SPAN[:MAXimum]` or `[SENSe:]ADEMod:BANDwidth|BWIDth:DEModulation`. If the available recording time is not sufficient for the given bandwidth, the recording time is set to its maximum and the resolution bandwidth is enlarged to the resulting bandwidth.

**Parameter**

refer to data sheet

**Example**

```
ADEM ON
```

Switches on the analog demodulator

```
CALC:FEED 'XTIM:SPEC'
```

Switches on the RF spectrum result display

or

```
CALC:FEED 'XTIM:FM:AFSP'
```

Switches on the AF spectrum result display of FM signal

```
ADEM:SPEC:BAND 61.2kHz
```

Sets the resolution bandwidth to 61.2 kHz.

**Characteristics**

\*RST value: 61.2 kHz

SCPI: device-specific

**Mode**

ADEMOD

**[SENSe:]ADEMod:SPECTrum:RESult?**

This command reads out the RF spectrum result data for the specified result type. The data format of the output data block is defined by the `FORMat` command.

**Parameter**

<result type>: `WRITe`, `AVERage`, `MAXHold`, `MINHold`; for details see "[Trace mode result types](#)" on page 6.250.

**Note:** *The result type indicated must be one of those configured by `[SENSe:]ADEMod:SPECTrum[:TYPE]`. Otherwise a query error will be generated.*

**Return values**

ASCII Format (`FORMat ASCII`) or Binary Format (`FORMat REAL,32`); for details see "[Formats for returned values: ASCII format and binary format](#)" on page 6.251. The output units are described in "[CALCulate<1|2>:MARKer<1...4>:PEXCursion](#)" on page 6.55.

**Example**

```
ADEM:SET 8MHz,32000,EXT,POS,-500,30
```

Sets up demodulator parameters

```
ADEM:SPEC AVER,MAXH,MINH
```

Selects RF spectrum results to be measured

```
ADEM:SPEC WRIT,OFF,OFF
```

Selects AM results to be measured

```
ADEM ON
```

Switches on demodulator



```

INIT; *WAI
Starts measurement and waits for sync
FORM ASC
Selects output format
ADEM:SPEC:RES? AVER
Reads RF spectrum average results
ADEM:SPEC:RES? MAXH
Reads RF spectrum max hold results
ADEM:SPEC:RES? MINH
Reads RF spectrum min hold results
ADEM:SPEC:RES? WRIT
Reads spectrum current results

```

**Characteristics**

\*RST value: –  
 SCPI: device-specific

**Mode**

ADEMOD

---

**[SENSe:]ADEMod:SPECTrum:SPAN[:MAXimum]**

This command sets the maximum frequency range for displaying the RF spectrum that was determined from the analog demodulation data. The maximum span corresponds to the measurement bandwidth of analog demodulation (for details refer to [\[SENSe:\]ADEMod:BANDwidth|BWIDth:DEModulation](#)). For details refer on the relation of bandwidth and sample rate refer to chapter "Instrument Functions", section "Analog Demodulation (Option K7)" – "Sample rate, measurement time and trigger offset".

**Parameter**

<numeric\_value>

**Example**

```

ADEM ON
Switches on the analog demodulator
CALC:FEED 'XTIM:SPEC'
Switches on RF spectrum result display.
ADEM:SPEC:SPAN:MAX 5 MHz
Sets the max. span to 5 MHz
ADEM:SPEC:SPAN:ZOOM 1 MHz
Sets the displayed span to 1 MHz

```

**Characteristics**

\*RST value: 5 MHz  
 SCPI: device-specific

**Mode**

ADEMOD

---

**[SENSe:]ADEMod:SPECTrum:SPAN:ZOOM**

---

This command sets the frequency range for the RF spectrum result display determined from analog demodulation data. The frequency range for result display is limited to the maximum span ( [SENSe:]ADEMod:SPECTrum:SPAN[:MAXimum] ) or to the measurement bandwidth of analog demodulation ( [SENSe:]ADEMod:BANDwidth|BWIDth:DEModulation).

**Parameter**

<numeric\_value>

**Example**

ADEM ON

Switches on the analog demodulator

CALC:FEED 'XTIM:SPEC'

Switches on RF spectrum result display"

ADEM:SPEC:SPAN:MAX 5 MHz

Sets the maximum span to 5 MHz

ADEM:SPEC:SPAN:ZOOM 1 MHz

Sets displayed span to 1 MHz

**Characteristics**

\*RST value: 5 MHz

SCPI: device-specific

**Mode**

ADEMOD

---

**[SENSe:]ADEMod:SRATe?**

---

This command returns the sample rate set up for the current analog demodulation measurement.

**Example**

ADEM:SRAT?

Returns the current sample rate.

**Characteristics**

\*RST value: –

SCPI: device-specific

**Mode**

ADEMOD

---

**[SENSe:]ADEMod:ZOOM[:STATe]**

---

The command enables or disables the zoom function for the analog-demodulated measurement data. Depending on the selected measurement time and the demodulation bandwidth, the number of recorded test points may be greater than that shown on the display.

If the zoom function is enabled, 501 test points of the result memory are displayed from the specified start time with [SENSe:]ADEMod:ZOOM:START.

If the zoom function is disabled, data reduction is used to adapt the test points to the number of points available on the display.

**Parameter**

ON | OFF

**Example**

```
ADEM:ZOOM ON
```

Switches on the zoom function

**Characteristics**

\*RST value: OFF

SCPI: device-specific

**Mode**

ADEMOD

---

**[SENSe:]ADEMod:ZOOM:STARt**

---

The command selects the start time for the display of individual measured values of the analog demodulation. The maximum possible value depends on the measurement time, which is set in the instrument and can be queried with the `[SENSe:]ADEMod:MTIME` command.

If the zoom function is enabled, 501 test points of the result memory are displayed from the specified start time with `[SENSe:]ADEMod:ZOOM:STARt`.

**Parameter**

0 s to measurement time – (500 \* 1/sample rate)

**Example**

```
ADEM:ZOOM ON
```

Switches on the zoom function

```
ADEM:ZOOM:STAR 500us
```

Sets the starting point of the display to 500 µs.

**Characteristics**

\*RST value: 0 s

SCPI: device-specific

**Mode**

ADEMOD

---

**SENSe:BANDwidth Subsystem (Analog Demodulation, K7)**

This subsystem controls the setting of the instruments filter bandwidths. Both groups of commands (BANDwidth and BWIDth) perform the same functions.

**Commands of the SENSe:BANDwidth Subsystem**

– [SENSe<1|2>:]BANDwidth|BWIDth:DEMod

**[SENSe<1|2>:]BANDwidth|BWIDth:DEMod**

---

This command sets the bandwidth for analog demodulation. Depending on the selected demodulation bandwidth, the instrument selects the required sampling rate.

The available values of the demodulation bandwidths are determined by the sampling rates. For details on the correlation between demodulation bandwidth and sampling rate refer to chapter "Instrument Functions", sections "Analog Demodulation (Option K7)" – "Sample rate, measurement time and trigger offset".

**Parameter**

<numeric\_value>

**Example:**

```
BAND:DEM 1MHz
```

Sets test bandwidth to 1 MHz

**Characteristics:**

\*RST value: 5 MHz

SCPI: device-specific

**Mode**

A–F, ADEMOM

---

**SENSe:FILTer Subsystem (Analog Demodulation, K7)**

The SENSe:FILTer subsystem selects the filters to reduce the bandwidth of the demodulated signal. The selected filters are used for AM, FM and PM demodulation in common.

**Commands of the SENSe:FILTer subsystem**

- [SENSe<1|2>:]FILTer:DEMPHasis[:STATe]
- [SENSe<1|2>:]FILTer:DEMPHasis:TCONstant
- [SENSe<1|2>:]FILTer:HPASs[:STATe]
- [SENSe<1|2>:]FILTer:HPASs:FREQuency
- [SENSe<1|2>:]FILTer:LPASs[:STATe]
- [SENSe<1|2>:]FILTer:LPASs:FREQuency[:ABSolute]
- [SENSe<1|2>:]FILTer:LPASs:FREQuency:RELative

**[SENSe<1|2>:]FILTer:DEMPHasis[:STATe]**

This command activates/deactivates the selected deemphasis.  
The numeric suffixes <1|2> are irrelevant.

**Parameter**

ON | OFF

**Example**

```
FILT:DEMP ON
```

Activates the selected deemphasis.

**Characteristics**

RST value: OFF

SCPI: device-specific

**Mode**

ADEMODO

**[SENSe<1|2>:]FILTer:DEMPHasis:TCONstant**

This command selects the deemphasis. For details on deemphasis refer to chapter "Instrument Functions", section "Analog Demodulation (Option K7)", **Deemphasis** softkey.

The numeric suffixes <1|2> are irrelevant.

**Parameter**

25 us | 50 us | 75 us | 750 us

**Example**

```
FILT:DEMP:TCON 750us
```

Selects the deemphasis for the demodulation bandwidth range from 800 Hz to 4 MHz with a time constant of 750 μs.

**Characteristics**

RST value: 50 us

SCPI: device-specific

**Mode**

ADEMODO

---

**[SENSe<1|2>:]FILTer:HPASs[:STATE]**

---

This command activates/deactivates the selected high pass filter.  
The numeric suffixes <1|2> are irrelevant.

**Parameter**

ON | OFF

**Example**

```
FILT:HPAS ON
```

Activates the selected high pass filter.

**Characteristics**

RST value: OFF

SCPI: device-specific

**Mode**ADEMOD

---

**[SENSe<1|2>:]FILTer:HPASs:FREQuency**

---

This command selects the high pass filter type. For details on filters refer to chapter "Instrument Functions", section "Analog Demodulation (Option K7)", **High Pass AF Filter** softkey.

The numeric suffixes <1|2> are irrelevant.

**Parameter**

50Hz | 300Hz

**Example**

```
FILT:HPAS:FREQ 300Hz
```

Selects the high pass filter for the demodulation bandwidth range from 800 Hz to 16 MHz.

**Characteristics**

RST value: 300Hz

SCPI: device-specific

**Mode**ADEMOD

---

**[SENSe<1|2>:]FILTer:LPASs[:STATE]**

---

This command activates/deactivates the selected low pass filter.  
The numeric suffixes <1|2> are irrelevant.

**Parameter**

ON | OFF

**Example**

```
FILT:LPAS ON
```

Activates the selected low pass filter.

**Characteristics**

RST value: OFF

SCPI: device-specific

**Mode**

ADEMOD

**[SENSe<1|2>:FILTer:LPASs:FREQuency[:ABSolute]**

---

This command selects the absolute low pass filter type. For details on filters refer to chapter "Instrument Functions", section "Analog Demodulation (Option K7)", **Low Pass AF Filter** softkey.

The numeric suffixes <1|2> are irrelevant.

**Parameter**

3kHz | 15kHz | 150kHz

**Example**

```
FILT:LPAS:FREQ 150kHz
```

Selects the low pass filter for the demodulation bandwidth range from 400 kHz to 16 MHz.

**Characteristics**

RST value: 15kHz

SCPI: device-specific

**Mode**

ADEMODO

---

**[SENSe<1|2>:FILTer:LPASs:FREQuency:RELAtive]**

---

This command selects the relative low pass filter type. For details on filters refer to chapter "Instrument Functions", section "Analog Demodulation (Option K7)", **Low Pass AF Filter** softkey.

The numeric suffixes <1|2> are irrelevant.

**Parameter**

5PCT | 10PCT | 25PCT

**Example**

```
FILT:LPAS:FREQ 25PCT
```

Selects the low pass filter as 25% of the demodulation bandwidth.

**Characteristics**

RST value: 25PCT

SCPI: device-specific

**Mode**

ADEMODO

---

**SENSe:FREQUENCY Subsystem (Analog Demodulation, K7)**

The SENSe:FREQUENCY subsystem defines the frequency axis of the active display. The frequency axis can either be defined via the start/stop frequency or via the center frequency and span.

**Commands of the SENSe:FREQUENCY Subsystem**

- [\[SENSe<1|2>:\]FREQUENCY:CENTer:STEP:LINK](#)

**[SENSe<1|2>:]FREQUENCY:CENTer:STEP:LINK**

---

**Parameter**

SPAN	coupling to frequency display range (for RF spectrum result display)
RBW	coupling to demodulation bandwidth (for all result displays except RF spectrum)
OFF	manual input, no coupling

For further details refer to "[\[SENSe<1|2>:\]FREQUENCY:CENTer:STEP:LINK](#)" on page 6.164.

---

**SENSe:SWEep Subsystem (Analog Demodulation, K7)**

The SENSe:SWEep subsystem controls the sweep parameters.

**Commands of the SENSe:SWEep Subsystem**

- [\[SENSe<1|2>:\]SWEep:TIME](#)

**[SENSe<1|2>:]SWEep:TIME**

---

**Parameter**

Refer to chapter "Instrument Functions", section "Analog Demodulation (Option K7)" – "Sample rate, measurement time and trigger offset".

For further details refer to "[\[SENSe<1|2>:\]SWEep:TIME](#)" on page 6.200.

---



## TRACe Subsystem (Analog Demodulation, K7)

The TRACe subsystem controls access to the instruments internal trace memory.

### Commands of the TRACe Subsystem

– [TRACe<1|2>\[:DATA\]](#)

#### **TRACe<1|2>[:DATA]**

---

If the analog demodulator (option Analog Demodulation, R&S FSL–K7) is active, only the displayed trace data is read out and recalled. A portion of the measurement data that can be called by means of a marker, however, is calculated from the raw measurement data. These results are no longer available after recalling a trace; the associated queries generate a query error.

For further information refer to "[TRACe<1|2>\[:DATA\]](#)" on page 6.215.

---

## TRIGger Subsystem (Analog Demodulation, K7)

The TRIGger subsystem is used to synchronize instrument actions with events. It is thus possible to control and synchronize the start of a sweep.

### Commands of the TRIGger Subsystem

- TRIGger<1|2>[:SEQuence]:LEVel:AM[:ABSolute]
- TRIGger<1|2>[:SEQuence]:LEVel:AM:RELative
- TRIGger<1|2>[:SEQuence]:LEVel:FM
- TRIGger<1|2>[:SEQuence]:LEVel:PM
- TRIGger<1|2>[:SEQuence]:SOURce

#### TRIGger<1|2>[:SEQuence]:LEVel:AM[:ABSolute]

---

The command sets the level when RF power signals are used as trigger source.

**Note:** For triggering with AF, AM, AMRelative, FM, and PM trigger sources to be successful, the measurement time must cover at least 5 periods of the audio signal.

##### Parameter

–100 to +30 dBm

##### Example

```
TRIG:LEV:AM -30 dBm
```

Sets the RF power signal trigger threshold to –30 dBm

##### Characteristics

\*RST value: –20 dBm

SCPI: device-specific

##### Mode

ADEMOD

---

#### TRIGger<1|2>[:SEQuence]:LEVel:AM:RELative

---

The command sets the level when AM-modulated signals are used as trigger source.

**Note:** For triggering with AF, AM, AMRelative, FM, and PM trigger sources to be successful, the measurement time must cover at least 5 periods of the audio signal.

##### Parameter

–100 to +100 %

##### Example

```
TRIG:LEV:AM:REL -20 %
```

Sets the AM trigger threshold to –20 %

##### Characteristics

\*RST value: 0 %

SCPI: device-specific

##### Mode

ADEMOD

---

---

**TRIGger<1|2>[:SEQuence]:LEVel:FM**

---

The command sets the level when FM–modulated signals are used as trigger source.

**Note:** For triggering with AF, AM, AMRelative, FM, and PM trigger sources to be successful, the measurement time must cover at least 5 periods of the audio signal.

**Parameter**

–10 to +10 MHz

**Example**

```
TRIG:LEV:FM 10 kHz
```

Sets the FM trigger threshold to 10 kHz

**Characteristics**

\*RST value: 0 Hz

SCPI: device–specific

**Mode**

ADEMOD

---



---

**TRIGger<1|2>[:SEQuence]:LEVel:PM**

---

The command sets the level when PM–modulated signals are used as trigger source.

**Note:** For triggering with AF, AM, AMRelative, FM, and PM trigger sources to be successful, the measurement time must cover at least 5 periods of the audio signal.

**Parameter**

–1000 to +1000 RAD | DEG

**Example**

```
TRIG:LEV:PM 1.2 RAD
```

Sets the PM trigger threshold to 1.2 rad

**Characteristics**

\*RST value: 0 RAD

SCPI: device–specific

**Mode**

ADEMOD

---



---

**TRIGger<1|2>[:SEQuence]:SOURce**

---

**Parameter**

IMMediate (Free Run) | EXTern | IFPower | AF | FM | AM | AMRelative | PM

The parameter AM corresponds to the RF power signal, the parameter AMRelative corresponds to the AM signal.

For details on trigger modes refer to chapter "Instrument Functions", section "Analog Demodulation (Option K7)".

**Note:** For triggering with AF, AM, AMRelative, FM, and PM trigger sources to be successful, the measurement time must cover at least 5 periods of the audio signal.

For further details refer to "[TRIGger<1|2>\[:SEQuence\]:SOURce](#)" on page 6.232.

---

## **UNIT Subsystem (Analog Demodulation, K7)**

The UNIT subsystem sets the basic unit of the setting parameters.

### **Commands of the UNIT Subsystem**

- [UNIT:ANGLE](#)

#### **UNIT:ANGLE**

---

This command selects the unit for angles.

**Parameter**

DEG | RAD

**Example**

UNIT:ANGL DEG

**Characteristics**

RST value: RAD

SCPI: conform

**Mode**

ADEMOD

---

## Remote Commands of the Power Meter Option (K9)

In this section all remote control commands for Power Meter option are described in detail. The abbreviation For details on conventions used in this chapter refer to section "[Notation](#)" on page 6.2 at the beginning of this chapter.

For further information on analyzer or basic settings commands, refer to the corresponding subsystem in "[Remote Commands of the Base Unit](#)" on page 6.5 or section "Remote Control – Description of Basic Settings Commands".

### Subsystems of the Power Meter option (K9)

- "[CALCulate Subsystem \(Power Meter, K9\)](#)" on page 6.282
- "[CALibration Subsystem \(Power Meter, K9\)](#)" on page 6.284
- "[FETCh Subsystem \(Power Meter, K9\)](#)" on page 6.285
- "[READ Subsystem \(Power Meter, K9\)](#)" on page 6.286
- "[SENSe Subsystem \(Power Meter, K9\)](#)" on page 6.287
- "[UNIT Subsystem \(Power Meter, K9\)](#)" on page 6.292

## CALCulate Subsystem (Power Meter, K9)

The CALCulate subsystem contains commands for converting instrument data, transforming and carrying out corrections. These functions are carried out subsequent to data acquisition, i.e. following the SENSE subsystem.

The following subsystems are included:

- "CALCulate:PMETer Subsystem" on page 6.282

### CALCulate:PMETer Subsystem (Power Meter, K9)

This subsystem controls the instrument settings for power sensor measurements.

#### Commands of the CALCulate:PMETer Subsystem

- CALCulate<1|2>:PMETer:RELative[:MAGNitude]
- CALCulate<1|2>:PMETer:RELative[:MAGNitude]:AUTO
- CALCulate<1|2>:PMETer:RELative:STATe

---

#### CALCulate<1|2>:PMETer:RELative[:MAGNitude]

---

This command sets the reference value for relative measurements.  
The numeric suffixes <1|2> are irrelevant.

**Parameter**

–200 to 200

**Example**

```
CALC:PMET:REL -30
```

Sets the reference value for relative measurements to –30 dBm.

**Characteristics**

\*RST value: 0

SCPI: device-specific

**Mode**

PSM

---

---

#### CALCulate<1|2>:PMETer:RELative[:MAGNitude]:AUTO

---

This command takes the current measurement value as reference value for relative measurements.

The numeric suffixes <1|2> are irrelevant.

**Parameter**

ONCE

**Example**

```
CALC:PMET:REL:AUTO ONCE
```

Takes the current measurement value as reference value for relative measurements.

**Characteristics**

\*RST value: –

SCPI: device-specific

**Mode**

PSM

---

**CALCulate<1|2>:PMETer:RELative:STATe**

---

This command switches between relative and absolute display of the measured power.

The numeric suffixes <1|2> are irrelevant.

**Parameter**

ON | OFF

**Example**

```
CALC:PMET:REL:STAT ON
```

Activates the relative display of the measured value.

**Characteristics**

\*RST value: OFF

SCPI: device-specific

**Mode**

PSM

---

## **CALibration Subsystem (Power Meter, K9)**

The CALibration subsystem determines the data for system error correction in the instrument.

The following subsystem is included:

- ["CALibration:PMETer Subsystem \(Power Meter, K9\)"](#) on page 6.284

### **CALibration:PMETer Subsystem (Power Meter, K9)**

The CALibration:PMETer Subsystem determines the error correction data for measurements in the power meter mode.

#### **Commands of the CALibration:PMETer Subsystem**

- [CALibration:PMETer:ZERO:AUTO](#)

#### **CALibration:PMETer:ZERO:AUTO**

---

This command starts zeroing of the power sensor.

**Parameter**

ONCE

**Example**

```
:CAL:PMET:ZERO:AUTO ONCE;*WAI
```

Starts zeroing and delays the execution of further commands until zeroing is concluded.

**Characteristics**

\*RST value: –

SCPI: device-specific

**Mode**

PSM

---



## FETCh Subsystem (Power Meter, K9)

The FETCh subsystem contains commands for reading out results of complex measurement tasks.

The following subsystem is included:

- ["FETCh:PMETer Subsystem"](#) on page 6.285

### FETCh:PMETer Subsystem (Power Meter, K9)

The FETCh:PMETer subsystem contains commands to read measurement results of power sensor measurements without starting the measurement itself.

#### Commands of the FETCh:PMETer Subsystem

- [FETCh<1|2>:PMETer?](#)

#### **FETCh<1|2>:PMETer?**

---

This command reads the result of the power sensor measurement.

If no measurement has been performed, this command will lead to a query error. This command is a query and therefore has no \*RST value.

#### **Example**

```
FETCh:PMETer?
```

Reads the result of the power sensor measurement.

#### **Characteristics**

\*RST value: –

SCPI: device-specific

#### **Mode**

PSM

---

## READ Subsystem (Power Meter, K9)

The READ subsystem contains commands for starting complex measurement tasks, and for querying the results subsequently.

The following subsystem is included:

- "READ:PMETer Subsystem" on page 6.286

### READ:PMETer Subsystem

This subsystem contains commands to start power sensor measurements and to read the results after the measurement is concluded.

#### Commands of the READ:PMETer Subsystem

- [READ<1|2>:PMETer?](#)

#### READ<1|2>:PMETer?

---

This command starts a power sensor measurement and reads the result after the measurement is concluded.

This command is a query and therefore has no \*RST value.

##### Example

```
READ:PMET?
```

Starts a measurement and read the result.

##### Characteristics

\*RST value: –

SCPI: device-specific

##### Mode

PSM

---

## SENSe Subsystem (Power Meter, K9)

The SENSe subsystem is organized in several subsystems. The commands of these subsystems directly control device-specific settings, they do not refer to the signal characteristics of the measurement signal.

The SENSe subsystem controls the essential parameters of the analyzer. In accordance with the SCPI standard, the keyword "SENSe" is optional for this reason, which means that it is not necessary to include the SENSe node in command sequences.

The following subsystems are included:

- "[SENSe:PMETer Subsystem](#)" on page 6.287

### SENSe:PMETer Subsystem (Power Meter, K9)

This subsystem controls the device settings for power sensor measurements.

#### Commands of the SENSe:PMETer Subsystem

- [\[SENSe<1|2>:\]PMETer\[:STATe\]](#)
- [\[SENSe<1|2>:\]PMETer:FREQuency](#)
- [\[SENSe<1|2>:\]PMETer:FREQuency:LINK](#)
- [\[SENSe<1|2>:\]PMETer:MTIME](#)
- [\[SENSe<1|2>:\]PMETer:MTIME:AVERAge\[:STATe\]](#)
- [\[SENSe<1|2>:\]PMETer:MTIME:AVERAge:COUNT](#)
- [\[SENSe<1|2>:\]PMETer:ROFFset\[:STATe\]](#)
- [\[SENSe<1|2>:\]PMETer:TRIGger\[:STATe\]](#)
- [\[SENSe<1|2>:\]PMETer:TRIGger:LEVel](#)

#### [\[SENSe<1|2>:\]PMETer\[:STATe\]](#)

---

This command switches the power sensor measurements on or off.

The numeric suffixes <1|2> are irrelevant.

##### Parameter

ON | OFF

##### Example

```
PMET ON
```

Switches the power sensor measurements on.

##### Characteristics

\*RST value: OFF

SCPI: device-specific

##### Mode

PSM

---

**[SENSe<1|2>:]PMETer:FREQuency**

---

This command sets the frequency of the power sensor. The limits  $f_{\min}$  and  $f_{\max}$  are defined by the power sensor.

The numeric suffixes <1|2> are irrelevant.

**Parameter**

$f_{\min}$  ...  $f_{\max}$

**Example**

```
PMET:FREQ 1GHZ
```

Sets the frequency of the power sensor to 1 GHz.

**Characteristics**

\*RST value: 50 MHz

SCPI: device-specific

**Mode**

PSM

---

**[SENSe<1|2>:]PMETer:FREQuency:LINK**

---

This command sets the frequency coupling of the power sensor.

The numeric suffixes <1|2> are irrelevant.

**Parameter**

CENTER couples the frequency to the center frequency of the analyzer

MARKer1 couples the frequency to the position of marker 1

OFF switches the frequency coupling off

**Example**

```
PMET:FREQ:LINK CENT
```

Couples the frequency to the center frequency of the analyzer

**Characteristics**

\*RST value: CENT

SCPI: device-specific

**Mode**

PSM

---

**[SENSe<1|2>:]PMETer:MTIME**

---

This command sets the measurement duration of the power sensor.

The numeric suffixes <1|2> are irrelevant.

**Parameter**

SHORT | NORMal | LONG

**Example**

```
PMET:MTIM SHOR
```

Sets a short measurement duration for measurements of stationary high power signals.

**Characteristics**

\*RST value: NORM

SCPI: device-specific

**Mode**

PSM

**[SENSe<1|2>:]PMETer:MTIMe:AVERAge[:STATe]**

This command activates or deactivates manual averaging. The average count is set with the `[SENSe<1|2>:]PMETer:MTIMe:AVERAge:COUNT` command.

**Parameter**

ON | OFF

**Example**`PMET:MTIM:AVER ON`

Activates manual averaging.

**Characteristics**

RST value: OFF

SCPI: device-specific

**Mode**

PSM

**[SENSe<1|2>:]PMETer:MTIMe:AVERAge:COUNT**

This command defines the number of readings (averagings) to be performed after a single sweep has been started. This command is only available if the `[SENSe<1|2>:]PMETer:MTIMe:AVERAge[:STATe]` command is set to ON.

Results become more stable with extended average, particularly if signals with low power are measured. This setting can be used to minimize the influence of noise in the power meter measurement.

**Parameter**

0 to 256 in binary steps (1, 2, 4, 8,...)

For average count = 0 or 1, one reading is performed.

**Example**`PMET:MTIM:AVER ON`

Activates manual averaging.

`PMET:MTIM:AVER:COUNT 8`

Sets the number of readings to 8.

**Characteristics**

RST value:

SCPI: device-specific

**Mode**

PSM

**[SENSe<1|2>:]PMETer:ROFFset[:STATe]**

---

This command defines whether the reference level offset set for the analyzer is taken into account for the measured power or not.

The numeric suffixes <1|2> are irrelevant.

**Parameter**

- ON        Adds the offset defined by the  
          `DISPlay[:WINDow<1|2>]:TRACe<1...6>:Y[:SCALE]:RLEVEL:OFFSet`  
          command to the measured level.
- OFF       Takes no offset into account.

**Example**

```
PMET:ROFF OFF
```

Takes no offset into account for the measured power.

**Characteristics**

\*RST value: ON

SCPI: device-specific

**Mode**

PSM

---

**[SENSe<1|2>:]PMETer:TRIGger[:STATe]**

---

This command switches the external power trigger on or off.

The numeric suffixes <1|2> are irrelevant.

This command is only available in conjunction with a NRP-Z81 power sensor.

**Parameter**

ON | OFF

**Example**

```
PMET:TRIG ON
```

Switches the external power trigger on.

**Characteristics**

\*RST value: OFF

SCPI: device-specific

**Mode**

PSM

---

**[SENSe<1|2>:]PMETer:TRIGger:LEVel**

---

This command sets the power level of the external power trigger.

The numeric suffixes <1|2> are irrelevant.

This command is only available in conjunction with a NRP-Z81 power sensor.

**Parameter**

-20 bis + 20 dBm

**Example**

```
PMET:TRIG:LEV -10 dBm
```

Sets the level of the trigger.

**Characteristics**

\*RST value: -20dBm

SCPI: device-specific

**Mode**

PSM

---

## UNIT Subsystem (Power Meter, K9)

The UNIT subsystem sets the basic unit of the setting parameters.

The following subsystems are included:

- ["UNIT:PMETer Subsystem \(Power Meter, K9\)"](#) on page 6.292

### UNIT:PMETer Subsystem (Power Meter, K9)

The UNIT:PMETer subsystem sets the basic unit for power sensor measurement.

#### Commands of the UNIT:PMETer Subsystem

- [UNIT<1|2>:PMETer:POWer](#)
- [UNIT<1|2>:PMETer:POWer:RATio](#)

#### UNIT<1|2>:PMETer:POWer

---

This command selects the unit for absolute power sensor measurement.

**Parameter**

DBM | WATT | W

**Example**

```
UNIT:PMET:POW DBM
```

**Characteristics**

\*RST value: DBM

SCPI: conform

**Mode**

PSM

---

#### UNIT<1|2>:PMETer:POWer:RATio

---

This command selects the unit for relative power sensor measurement.

**Parameter**

DB | PCT

**Example**

```
UNIT:PMET:POW DB
```

**Characteristics**

\*RST value: DB

SCPI: conform

**Mode**

PSM

---



## Remote Commands of the Noise Figure Measurements Option (K30)

This section describes the remote commands for the Noise Figure Measurements option (K30). The abbreviation NF stands for the operating mode of noise figure measurements. For details on conventions used in this chapter refer to section "Notation" on page 6.2 at the beginning of this chapter.

For further information on analyzer or basic settings commands, refer to the corresponding subsystem in section "Remote Commands of the Base Unit" on page 6.5 or section "Remote Control – Description of Basic Settings Commands".

### Subsystems of the Noise Figure Measurements option (K30)

- "ABORt Subsystem (Noise Figure, K30)" on page 6.294
- "CALCulate Subsystem (Noise Figure, K30)" on page 6.295
- "CONFigure Subsystem (Noise Figure, K30)" on page 6.304
- "DISPlay Subsystem (Noise Figure, K30)" on page 6.306
- "FETCh Subsystem (Noise Figure, K30)" on page 6.313
- "INITiate Subsystem (Noise Figure, K30)" on page 6.317
- "INPut Subsystem (Noise Figure, K30)" on page 6.318
- "INSTrument Subsystem (Noise Figure, K30)" on page 6.319
- "SENSe Subsystem (Noise Figure, K30)" on page 6.320
- "STATus Subsystem (Noise Figure, K30)" on page 6.330
- "SYSTem Subsystem (Noise Figure, K30)" on page 6.335

## **ABORt Subsystem (Noise Figure, K30)**

The ABORt subsystem contains the commands for aborting triggered actions.

### **Commands of the ABORt Subsystem**

- [ABORt](#)

#### **ABORt**

---

For details refer to "[ABORt](#)" on page 6.6.

---

## CALCulate Subsystem (Noise Figure, K30)

The CALCulate subsystem checks the marker functions and contains commands for limit lines and their limit checks.

The following subsystems are included:

- "CALCulate:LIMit Subsystem (Noise Figure, K30)" on page 6.295
- "CALCulate:MARKer Subsystem (Noise Figure, K30)" on page 6.301

### CALCulate:LIMit Subsystem (Noise Figure, K30)

The CALCulate:LIMit subsystem contains commands for the limit lines and the corresponding limit checks. Limit lines can be defined as upper or lower limit lines. The individual y values of the limit lines correspond to the values of the x-axis (CONTRol). The number of x and y values must be identical. For details on limit lines refer to chapter "Instrument Functions", section "Using Limit Lines and Display Lines – LINES Key".

Different to the basic unit, only 6 limit lines can be active at the same time (indicated by LIMIT1 to LIMIT6).

The following subsystems are included:

- "CALCulate:LIMit:CONTRol Subsystem" on page 6.298
- "CALCulate:LIMit:LOWer Subsystem" on page 6.299
- "CALCulate:LIMit:UPPer Subsystem" on page 6.300

### Commands of the CALCulate:LIMit Subsystem

- CALCulate<1|2>:LIMit<1...6>:CLEar[:IMMediate]
- CALCulate<1|2>:LIMit<1...6>:COMMeNt
- CALCulate<1|2>:LIMit<1...6>:COpy
- CALCulate<1|2>:LIMit<1...6>:DELeTe
- CALCulate<1|2>:LIMit<1...6>:FAIL?
- CALCulate<1|2>:LIMit<1...6>:NAME
- CALCulate<1|2>:LIMit<1...6>:STATe
- CALCulate<1|2>:LIMit<1...6>:TRACe

#### CALCulate<1|2>:LIMit<1...6>:CLEar[:IMMediate]

---

Different to the basic unit, only 6 limit lines can be active at the same time (indicated by LIMIT1 to LIMIT6).

For further details refer to "CALCulate<1|2>:LIMit<1...8>:CLEar[:IMMediate]" on page 6.24.

---

#### CALCulate<1|2>:LIMit<1...6>:COMMeNt

---

Different to the basic unit, only 6 limit lines can be active at the same time (indicated by LIMIT1 to LIMIT6).

For further details refer to "CALCulate<1|2>:LIMit<1...8>:COMMeNt" on page 6.24.

---

**CALCulate<1|2>:LIMit<1...6>:COPY**

---

**Parameter**

- 1 to 6      number of the new limit line  
 <name>     name of the new limit line given as a string (max. 8 alphanumeric characters)

For further details refer to "[CALCulate<1|2>:LIMit<1...8>:COPY](#)" on page 6.25.

---

**CALCulate<1|2>:LIMit<1...6>:DELEte**

---

Different to the basic unit, only 6 limit lines can be active at the same time (indicated by LIMIT1 to LIMIT6).

For further details refer to "[CALCulate<1|2>:LIMit<1...8>:DELEte](#)" on page 6.25.

---

**CALCulate<1|2>:LIMit<1...6>:FAIL?**

---

Different to the basic unit, only 6 limit lines can be active at the same time (indicated by LIMIT1 to LIMIT6).

For further details refer to "[CALCulate<1|2>:LIMit<1...8>:FAIL?](#)" on page 6.25.

---

**CALCulate<1|2>:LIMit<1...6>:NAME**

---

This command assigns a name to a limit line. If it does not exist already, a limit line with this name is created.

The numeric suffixes <1...6> indicate the limit line.

**Parameter**

<name of limit line>, max. 8 alphanumeric characters

**Example**

```
CALC:LIM1:NAME FM1
```

Assigns the name FM1 to limit line 1.

**Characteristics**

\*RST value: REM1 to REM6 for lines 1 to 6

SCPI: device-specific

**Mode**

NF

---

**CALCulate<1|2>:LIMit<1...6>:STATe**

---

Different to the basic unit, only 6 limit lines can be active at the same time (indicated by LIMIT1 to LIMIT6).

For further details refer to "[CALCulate<1|2>:LIMit<1...8>:STATe](#)" on page 6.26.

---

**CALCulate<1|2>:LIMit<1...6>:TRACe**

---

This command assigns a limit line to a particular measurement type.  
The numeric suffixes <1...6> indicate the limit line.

**Parameter**

NFIGure	noise figure
TEFFective	noise temperature
GAIN	gain

**Example**

```
CALC:LIM2:TRAC NFIG
```

Assigns limit line 2 to the noise figure measurement.

```
CALC:LIM3:TRAC GAIN
```

Assigns limit line 3 to the gain measurement.

**Characteristics**

\*RST value: –

SCPI: device-specific

**Mode**

NF

---

**CALCulate:LIMit:CONTRol Subsystem (Noise Figure, K30)**

The CALCulate:LIMit:CONTRol subsystem defines the x-axis (CONTRol axis).

**Commands of the CALCulate:LIMit:CONTRol Subsystem**

- [CALCulate<1|2>:LIMit<1...6>:CONTRol\[:DATA\]](#)
- [CALCulate<1|2>:LIMit<1...6>:CONTRol:SHIFt](#)

**CALCulate<1|2>:LIMit<1...6>:CONTRol[:DATA]**

---

Different to the basic unit, only 6 limit lines can be active at the same time (indicated by LIMIT1 to LIMIT6).

For further details refer to "[CALCulate<1|2>:LIMit<1...8>:CONTRol\[:DATA\]](#)" on page 6.36.

---

**CALCulate<1|2>:LIMit<1...6>:CONTRol:SHIFt**

---

Different to the basic unit, only 6 limit lines can be active at the same time (indicated by LIMIT1 to LIMIT6).

For further details refer to "[CALCulate<1|2>:LIMit<1...8>:CONTRol:SHIFt](#)" on page 6.38.

---

**CALCulate:LIMit:LOWer Subsystem (Noise Figure, K30)**

The CALCulate:LIMit:LOWer subsystem defines the lower limit line. If a set command is issued in this subsystem the limit line effected is automatically converted to a lower limit line.

**Commands of the CALCulate:LIMit:LOWer Subsystem**

- CALCulate<1|2>:LIMit<1...6>:LOWer[:DATA]
- CALCulate<1|2>:LIMit<1...6>:LOWer:SHIFt
- CALCulate<1|2>:LIMit<1...6>:LOWer:STATe

**CALCulate<1|2>:LIMit<1...6>:LOWer[:DATA]**

---

Different to the basic unit, only 6 limit lines can be active at the same time (indicated by LIMIT1 to LIMIT6).

For further details refer to "[CALCulate<1|2>:LIMit<1...8>:LOWer\[:DATA\]](#)" on page 6.39.

---

**CALCulate<1|2>:LIMit<1...6>:LOWer:SHIFt**

---

Different to the basic unit, only 6 limit lines can be active at the same time (indicated by LIMIT1 to LIMIT6).

For further details refer to "[CALCulate<1|2>:LIMit<1...8>:LOWer:SHIFt](#)" on page 6.41.

---

**CALCulate<1|2>:LIMit<1...6>:LOWer:STATe**

---

Different to the basic unit, only 6 limit lines can be active at the same time (indicated by LIMIT1 to LIMIT6).

For further details refer to "[CALCulate<1|2>:LIMit<1...8>:LOWer:STATe](#)" on page 6.40.

---

**CALCulate:LIMit:UPPer Subsystem (Noise Figure, K30)**

The CALCulate:LIMit:UPPer subsystem defines the upper limit line. If a set command is issued in this subsystem the limit line effected is automatically converted to an upper limit line.

**Commands of the CALCulate:LIMit:UPPer Subsystem**

- [CALCulate<1|2>:LIMit<1...6>:UPPer\[:DATA\]](#)
- [CALCulate<1|2>:LIMit<1...6>:UPPer:SHIFt](#)
- [CALCulate<1|2>:LIMit<1...6>:UPPer:STATe](#)

**[CALCulate<1|2>:LIMit<1...6>:UPPer\[:DATA\]](#)**

---

Different to the basic unit, only 6 limit lines can be active at the same time (indicated by LIMIT1 to LIMIT6).

For further details refer to "[CALCulate<1|2>:LIMit<1...8>:UPPer\[:DATA\]](#)" on page 6.43.

---

**[CALCulate<1|2>:LIMit<1...6>:UPPer:SHIFt](#)**

---

Different to the basic unit, only 6 limit lines can be active at the same time (indicated by LIMIT1 to LIMIT6).

For further details refer to "[CALCulate<1|2>:LIMit<1...8>:UPPer:SHIFt](#)" on page 6.45.

---

**[CALCulate<1|2>:LIMit<1...6>:UPPer:STATe](#)**

---

Different to the basic unit, only 6 limit lines can be active at the same time (indicated by LIMIT1 to LIMIT6).

For further details refer to "[CALCulate<1|2>:LIMit<1...8>:UPPer:STATe](#)" on page 6.46.

---



**CALCulate:MARKer Subsystem (Noise Figure, K30)**

The CALCulate:MARKer subsystem checks the marker functions of the instrument.

**Commands of the CALCulate:MARKer Subsystem**

- CALCulate:MARKer[:STATE]
- CALCulate:MARKer:AOFF
- CALCulate:MARKer:TRACe
- CALCulate:MARKer:X
- CALCulate:MARKer:Y?
- CALCulate:MARKer:MAXimum[:PEAK]
- CALCulate:MARKer:MiNimum[:PEAK]

**CALCulate:MARKer[:STATE]**

This command switches on or off the marker 1 for the selected trace. It is only available if measurement results are displayed.

If the selected trace is switched off (`DISPlay[:WINDow<1>]:TRACe<1|2>[:STATE]`), the marker is also switched off. If the marker is switched on again, the marker is set to the active trace. If both noise and gain traces are switched off, the marker can not be switched on again.

**Parameter**

ON | OFF

**Example**

`CALC:MARK ON`  
Marker 1 is switched on.

**Characteristics**

RST value: OFF  
SCPI: device-specific

**Mode**

NF

**CALCulate:MARKer:AOFF**

This command switches off the marker 1.

This command is an event and therefore has no \*RST value and no query.

**Example**

`CALC:MARK:AOFF`  
Marker 1 is switched off.

**Characteristics**

RST value: –  
SCPI: device-specific

**Mode**

NF

---

**CALCulate:MARKer:TRACe**

---

This command assigns the marker1 to the indicated trace.

**Parameter**

NOISe | GAIN

**Example**

```
CALC:MARK:TRAC GAIN
```

Assigns marker 1 to the gain trace.

**Characteristics**

RST value: NOIS

SCPI: device-specific

**Mode**

NF

---

**CALCulate:MARKer:X**

---

This command positions the marker1 to the indicated frequency measurement point. If the marker is off, it is switched on first.

**Parameter**

0 to MAX (frequency | sweep time)

**Example**

```
CALC:MARK:X 550 MHZ
```

Positions marker 1 to frequency 550 MHz.

**Characteristics**

RST value: –

SCPI: device-specific

**Mode**

NF

---

**CALCulate:MARKer:Y?**

---

This command queries the measured value of the marker 1. If the marker is off, it is switched on first. To obtain a valid query result, a complete sweep with synchronization to the sweep end must be performed before the query of the y value. The query result is output in the unit determined with the selected trace (see also [DISPlay:DATA:TRACe<1>](#) command).

This command is only a query and therefore has no \*RST value.

**Example**

```
CALC:MARK:Y?
```

Outputs the measured value of marker 1.

**Characteristics**

RST value: –

SCPI: device-specific

**Mode**

NF

---

**CALCulate:MARKer:MAXimum[:PEAK]**

---

This command positions the marker to the current maximum value of the selected trace (CALCulate:MARKer:TRACe command). If the marker is off, it is switched on first.

This command is an event and therefore has no \*RST value and no query.

**Example**

```
CALC:MARK:MAX
```

Positions marker 1 to the maximum of the selected trace.

**Characteristics**

RST value: –

SCPI: device-specific

**Mode**

NF

---

**CALCulate:MARKer:MiNimum[:PEAK]**

---

This command positions the marker to the current minimum value of the selected trace (CALCulate:MARKer:TRACe command). If the marker is off, it is switched on first.

This command is an event and therefore has no \*RST value and no query.

**Example**

```
CALC:MARK:MIN
```

Positions marker 1 to the minimum of the selected trace.

**Characteristics**

RST value: –

SCPI: device-specific

**Mode**

NF

---

## CONFigure Subsystem (Noise Figure, K30)

The CONFigure subsystem contains commands for configuring complex measurement tasks.

### Commands of the CONFigure Subsystem

- CONFigure:ARRay:MEMory<1...3>
- CONFigure:CORRection
- CONFigure:LIST:CONTInuous
- CONFigure:LIST:SINGle
- CONFigure:SINGle

#### CONFigure:ARRay:MEMory<1...3>

---

This command saves the current trace results (noise figure, noise temperature and noise gain traces) to trace memory <n>.

This command is an event and therefore has no \*RST value and no query.

##### Parameter

ONCE

##### Example

INIT

Starts a new measurement, if no measurement sequence is already in progress.

CONF:ARR:MEM2 ONCE

Copies the last recorded measurement result into the memory 2.

##### Characteristics

RST value: –

SCPI: device-specific

##### Mode

NF

---

#### CONFigure:CORRection

---

This command configures for a second stage correction measurement.

This command is an event and therefore has no \*RST value and no query.

##### Example

CONF:CORR

Configures to run second stage correction measure measurements.

INIT

Starts a new measurement, if no measurement sequence is already in progress.

##### Characteristics

\*RST value: –

SCPI: device-specific

##### Mode

NF

---

**CONFigure:LIST:CONTInuous**

---

This command configures for a frequency list measurement in continuous sweep mode.  
This command is an event and therefore has no \*RST value and no query.

**Example**

```
CONF:LIST:CONT
```

Configures to run a frequency list measurement in continuous sweep mode.

```
INIT
```

Starts a new measurement, if no measurement sequence is already in progress.

**Characteristics**

\*RST value: –

SCPI: device-specific

**Mode**

NF

---

**CONFigure:LIST:SINGle**

---

This command configures for a frequency list measurement in single sweep mode.  
This command is an event and therefore has no \*RST value and no query.

**Example**

```
CONF:LIST:SING
```

Configures to run frequency list measurement in single sweep modes.

```
INIT
```

Starts a new measurement, if no measurement sequence is already in progress.

**Characteristics**

\*RST value: –

SCPI: device-specific

**Mode**

NF

---

**CONFigure:SINGle**

---

This command configures for a fixed frequency measurement.  
This command is an event and therefore has no \*RST value and no query.

**Example**

```
CONF:SING
```

Configures to run fixed frequency measurements.

```
INIT
```

Starts a new measurement, if no measurement sequence is already in progress.

**Characteristics**

\*RST value: –

SCPI: device-specific

**Mode**

NF

---

## DISPlay Subsystem (Noise Figure, K30)

The DISPlay subsystem controls the selection and presentation of textual and graphic information as well as of measurement data on the display.

### Commands of the DISPlay Subsystem

- DISPlay:ARRay:MEMory<1...3>[:STATe]
- DISPlay:CURRent:DATA[:STATe]
- DISPlay:DATA:TRACe<1>
- DISPlay:FORMat
- DISPlay[:WINDow<1>]:TABLe
- DISPlay[:WINDow<1>]:TRACe<1|2>[:STATe]
- DISPlay[:WINDow<1>]:TRACe<1|2>:SYMBols
- DISPlay[:WINDow<1>]:TRACe<1|2>:X[:SCALe]
- DISPlay[:WINDow<1>]:TRACe<1|2>:Y[:SCALe]:AUTO
- DISPlay[:WINDow<1>]:TRACe<1|2>:Y[:SCALe]:BOTTOm
- DISPlay[:WINDow<1>]:TRACe<1|2>:Y[:SCALe]:RLEVel
- DISPlay[:WINDow<1>]:TRACe<1|2>:Y[:SCALe]:RLEVel:AUTO
- DISPlay[:WINDow<1>]:TRACe<1|2>:Y[:SCALe]:TOP

### DISPlay:ARRay:MEMory<1...3>[:STATe]

---

This command switches the display of trace memory <n> on or off.

**Parameter**

ON | OFF

**Example**

```
DISP:ARR:MEM2 ON
```

Switches on the display of memory 2.

**Characteristics**

RST value: OFF

SCPI: device-specific

**Mode**

NF

---

**DISPlay:CURRent:DATA[:STATe]**

---

This command switches the display of the current measurement results on or off.

**Parameter**

ON | OFF

**Example**

```
DISP:CURR:DATA OFF
```

Removes the current result traces from display.

**Characteristics**

RST value: ON

SCPI: device-specific

**Mode**

NF

---

**DISPlay:DATA:TRACe<1>**

---

This command specifies the type of noise results to be displayed in trace 1.

Only the numeric suffix <1> for noise results is valid.

**Parameter**

NFIGure        noise figure results in dB

TEFFective    noise temperature in K

**Example**

```
DISP:DATA:TRAC1 NFIG
```

Displays the noise figure results in trace 1.

**Characteristics**

\*RST value: NFIGure

SCPI: device-specific

**Mode**

NF

---

**DISPlay:FORMat**

---

This command activates or deactivates the combined trace display of noise and gain results.

**Parameter**

SPLit | SINGle

**Example**

```
DISP:FORM SPL
```

Displays noise and gain results in separate graphs.

**Characteristics**

\*RST value: SING

SCPI: device-specific

**Mode**

NF

---

**DISPlay[:WINDow<1>]:TABLe**

This command activates or deactivates the tabular result display.

**Parameter**

ON | OFF

**Example**

```
DISP:TABL ON
```

Displays the table of results.

**Characteristics**

\*RST value: OFF

SCPI: device-specific

**Mode**

NF

**DISPlay[:WINDow<1>]:TRACe<1|2>[:STATe]**

This command activates or deactivates the display of the corresponding trace and related information.

The numeric suffixes <1|2> indicate the measurement results: Trace 1 is always used for noise results, and trace 2 is always used for gain results.

**Parameter**

ON | OFF

**Example**

```
DISP:TRAC OFF
```

Switches off the display of trace 1 (noise results).

```
DISP:TRAC2 OFF
```

Switches off the display of trace 2 (gain results).

**Characteristics**

\*RST value: ON for both traces

SCPI: conform

**Mode**

NF

**DISPlay[:WINDow<1>]:TRACe<1|2>:SYMBols**

This command activates or deactivates the display of the symbols to mark the measurement points for the specified trace.

The numeric suffixes <1|2> indicate the measurement results: Trace 1 is always used for noise results, and trace 2 is always used for gain results.

**Parameter**

ON | OFF

**Example**

```
DISP:TRAC ON
```

Switches on the display of trace 1 (noise results).

```
DISP:TRAC:SYMB ON
```

Switches on the display of symbols for trace 1 (noise results)



**Characteristics**

\*RST value: OFF for both traces

SCPI: device-specific

**Mode**

NF

---

**DISPlay[:WINDow<1>]:TRACe<1|2>:X[:SCALe]**

---

This command selects the frequency to be displayed on the x-axis if the DUT is not an amplifier, i.e. in a frequency-converting measurement mode.

The numeric suffixes <1|2> indicate the measurement results: Trace 1 is always used for noise results, and trace 2 is always used for gain results.

**Parameter**

IF | RF

**Example**

```
CONF:MODE:DUT DOWN
```

The DUT converts the input frequency to a lower output frequency.

```
DISP:TRAC:X IF
```

The IF frequency is displayed on x-axis.

**Characteristics**

\*RST value: RF

SCPI: device-specific

**Mode**

NF

---

**DISPlay[:WINDow<1>]:TRACe<1|2>:Y[:SCALe]:AUTO**

---

This command activates or deactivates the automatic scaling of the Y-axis for the specified trace display. Automatic scaling provides best fit of the Y-axis to the measurement results.

The numeric suffixes <1|2> indicate the measurement results: Trace 1 is always used for noise results, and trace 2 is always used for gain results.

**Parameter**

ON | OFF

**Example**

```
DISP:TRAC2 ON
```

Switches on the display of trace 2 (gain results).

```
DISP:TRAC2:Y:AUTO ON
```

Switches on automatic scaling of the Y-axis for trace 2.

**Characteristics**

\*RST value: ON for both traces

SCPI: conform

**Mode**

NF

---

---

**DISPlay[:WINDow<1>]:TRACe<1|2>:Y[:SCALe]:BOTTom**

---

This command sets the minimum (bottom) Y-axis display value for the specified trace display. It has no affect if automatic scaling of the Y-axis is enabled

(DISPlay[:WINDow<1>]:TRACe<1|2>:Y[:SCALe]:AUTO command).

The numeric suffixes <1|2> indicate the measurement results: Trace 1 is always used for noise results, and trace 2 is always used for gain results.

**Parameter**

noise figure:            -75 dB to 75 dB  
noise temperature:      -999990000 K to 999990000 K  
gain:                    -75 dB to 75 dB

**Example 1**

```
DISP:DATA:TRAC1 NFIG
```

Sets the noise figure to trace1.

```
DISP:TRAC ON
```

Switches on the display of trace 1 (noise results).

```
DISP:TRAC:Y:BOTT -30
```

Sets the minimum Y-axis display to -30 dB for trace 1.

**Example 2**

```
DISP:DATA:TRAC1 TEFF
```

Sets the noise temperature to trace1.

```
DISP:TRAC ON
```

Switches on the display of trace 1 (noise results).

```
DISP:TRAC:Y:BOTT 100
```

Sets the minimum Y-axis display to 100 K for trace 1.

**Example 3**

```
DISP:TRAC2 ON
```

Switches on the display of trace 2 (gain results).

```
DISP:TRAC2:Y:BOTT 1
```

Sets the minimum Y-axis display to 1 dB for trace 2.

**Characteristics**

\*RST value: 0 dB

SCPI: conform

**Mode**

NF

---

**DISPlay[:WINDow<1>]:TRACe<1|2>:Y[:SCALe]:RLEVel**

---

This command sets the reference level for the Y-axis display value for all trace displays. This command has no affect if automatic reference level detection is enabled (`DISPlay[:WINDow<1>]:TRACe<1|2>:Y[:SCALe]:RLEVel:AUTO` command).

The numeric suffixes <1|2> are irrelevant for this command.

**Parameter**

<numeric\_value> in dBm, range specified in data sheet

**Example**

```
DISP:TRAC:Y:RLEV 0  
Sets the reference level 0 dBm
```

**Characteristics**

\*RST value: -30 dBm

SCPI: conform

**Mode**

NF

---

**DISPlay[:WINDow<1>]:TRACe<1|2>:Y[:SCALe]:RLEVel:AUTO**

---

This command enables or disables the automatic reference level detection.

The numeric suffixes <1|2> are irrelevant for this command.

**Parameter**

ON | OFF

**Example**

```
DISP:TRAC:Y:RLEV:AUTO ON  
Turns on automatic reference level detection.
```

**Characteristics**

\*RST value: ON

SCPI: conform

**Mode**

NF

---

**DISPlay[:WINDow<1>]:TRACe<1|2>:Y[:SCALe]:TOP**

---

This command sets the maximum (top) Y-axis display value for the specified trace display. It has no affect if automatic scaling of the Y-axis is enabled or the specified trace is not currently active.

The numeric suffixes <1|2> indicate the measurement results: Trace 1 is always used for noise results, and trace 2 is always used for gain results.

**Parameter**

noise figure:            -75 dB to 75 dB  
noise temperature:      -999990000 K to 999990000 K  
gain:                    -75 dB to 75 dB

**Example 1**

```
DISP:DATA:TRAC1 NFIG
```

Sets the noise figure to trace1.

```
DISP:TRAC:Y:TOP 30
```

Sets the maximum Y-axis display to 30 dB for trace 1.

**Example 2**

```
DISP:DATA:TRAC1 TEF
```

Sets the noise temperature to trace1.

```
DISP:TRAC:Y:TOP 100
```

Sets the maximum Y-axis display to 100 K for trace 1.

**Example 3**

```
DISP:TRAC2:Y:TOP 10
```

Sets the maximum Y-axis display to 10 dB for trace 2.

**Characteristics**

\*RST value: 20 dB for noise and gain figure, 10000K for noise temperature

SCPI: conform

**Mode**

NF

---

## FETCh Subsystem (Noise Figure, K30)

The FETCh subsystem retrieves results for the most recently completed fixed frequency or frequency list measurements. Frequency list results are returned as a list of results where the result is that requested in the specific fetch command. Single frequency results are single numbers in the described units.

---

**Note:** Corrected measurements are only accessible after a calibration has been performed.

---

### Commands of the FETCh Subsystem

- FETCh:ARRay:MEMory<1...3>:NOISe:FIGure?
- FETCh:ARRay:MEMory<1...3>:NOISe:GAIN?
- FETCh:ARRay:MEMory<1...3>:NOISe:TEMPerature?
- FETCh:ARRay:NOISe:FIGure?
- FETCh:ARRay:NOISe:GAIN?
- FETCh:ARRay:NOISe:TEMPerature?
- FETCh:SCALar:NOISe:FIGure?
- FETCh:SCALar:NOISe:GAIN?
- FETCh:SCALar:NOISe:TEMPerature?

---

### FETCh:ARRay:MEMory<1...3>:NOISe:FIGure?

---

This command queries the noise measurement results of the selected memory. The results are returned as an array of up to 100 elements of noise figure results. This command produces an error if no data is held in the selected trace memory.

This command is only a query and therefore has no \*RST value.

#### Example

INIT

Starts a new measurement, if no measurement sequence is already in progress.

CONF:ARR:MEM2 ONCE

Copies the last recorded measurement result into the memory 2.

FETCh:ARR:MEM2:NOIS:FIG?

Returns an array of 100 noise figure results from the selected memory 2.

#### Characteristics

RST value: –

SCPI: device-specific

#### Mode

NF

---

### FETCh:ARRay:MEMory<1...3>:NOISe:GAIN?

---

This command queries the noise measurement results of the selected memory. The results are returned as an array of up to 100 elements of noise gain results. This command produces an error if no data is held in the selected trace memory.

This command is only a query and therefore has no \*RST value.

**Example**

```
INIT
```

Starts a new measurement, if no measurement sequence is already in progress.

```
CONF:ARR:MEM2 ONCE
```

Copies the last recorded measurement result into the memory 2.

```
FETC:ARR:MEM2:NOIS:GAIN?
```

Returns an array of 100 noise gain results from the selected memory 2.

**Characteristics**

RST value: –

SCPI: device-specific

**Mode**

NF

---

**FETCh:ARRay:MEMory<1...3>:NOISe:TEMPerature?**

This command queries the noise measurement results of the selected memory. The results are returned as an array of up to 100 elements of noise temperature results. This command produces an error if no data is held in the selected trace memory.

This command is only a query and therefore has no \*RST value.

**Example**

```
INIT
```

Starts a new measurement, if no measurement sequence is already in progress.

```
CONF:ARR:MEM2 ONCE
```

Copies the last recorded measurement result into the memory 2.

```
FETC:ARR:MEM2:NOIS:TEMP?
```

Returns an array of 100 noise temperature results from the selected memory 2.

**Characteristics**

RST value: –

SCPI: device-specific

**Mode**

NF

---

**FETCh:ARRay:NOISE:FIGure?**

This command queries the last recorded noise figure measurement results. The results are returned as an array of up to 100 elements of noise figure results.

This command is only a query and therefore has no \*RST value.

**Example**

```
FETCh:ARRay:NOISE:FIGure?
```

Returns an array of 100 measured elements associated with the last noise figure measurement.

**Characteristics**

\*RST value: –

SCPI: device-specific

**Mode**

NF

---

**FETCh:ARRay:NOISE:GAIN?**

---

This command queries the last recorded noise gain measurement results. The results are returned as an array of up to 100 elements of noise gain results.

This command is only a query and therefore has no \*RST value.

**Example**

```
FETCh:ARRay:NOISE:GAIN?
```

Returns an array of 100 measured elements associated with the last noise gain measurement.

**Characteristics**

\*RST value: –

SCPI: device-specific

**Mode**

NF

---

**FETCh:ARRay:NOISE:TEMPerature?**

---

This command queries the last recorded noise temperature measurement results. The results are returned as an array of up to 100 elements of noise temperature results.

This command is only a query and therefore has no \*RST value.

**Example**

```
FETCh:ARRay:NOISE:TEMPerature?
```

Returns an array of 100 measured elements associated with the last noise temperature measurement.

**Characteristics**

\*RST value: –

SCPI: device-specific

**Mode**

NF

---

**FETCh:SCALar:NOISE:FIGure?**

---

This command queries the last recorded noise figure measurement result for a fixed frequency measurement.

This command is only a query and therefore has no \*RST value.

**Example**

```
FETCh:SCAL:NOISE:FIGure?
```

Returns the last noise figure measurement obtained from a fixed frequency measurement.

**Characteristics**

\*RST value: –

SCPI: device-specific

**Mode**

NF

---

**FETCh:SCALar:NOISE:GAIN?**

---

This command queries the last recorded noise gain measurement result for a fixed frequency measurement.

This command is only a query and therefore has no \*RST value.

**Example**

```
FETCh:SCAL:NOISE:GAIN?
```

Returns the last noise gain measurement obtained from a fixed frequency measurement.

**Characteristics**

\*RST value: –

SCPI: device-specific

**Mode**

NF

---

**FETCh:SCALar:NOISE:TEMPerature?**

---

This command queries the last recorded noise temperature measurement result for a fixed frequency measurement.

This command is only a query and therefore has no \*RST value.

**Example**

```
FETCh:SCAL:NOISE:TEMPerature?
```

Returns the last noise temperature measurement obtained from a fixed frequency measurement.

**Characteristics**

\*RST value: –

SCPI: device-specific

**Mode**

NF

---



## INITiate Subsystem (Noise Figure, K30)

The INITiate subsystem configures the instrument prior to a measurement being carried out. It is basically used to tell the instrument which measurement is to be performed and takes any necessary step to set up the instrument for the measurement.

### Commands of the INPut Subsystem

- [INITiate\[:IMMediate\]](#)

#### **INITiate[:IMMediate]**

---

This command initiates the start of a new measurement sequence. If a measurement sequence is already in progress, the command is ignored.

This command is an event and therefore has no \*RST value and no query.

#### **Example**

```
INIT
```

Starts a new measurement, if no measurement sequence is already in progress.

#### **Characteristics**

\*RST value: –

SCPI: conform

#### **Mode**

NF

---

## **INPut Subsystem (Noise Figure, K30)**

The INPut subsystem controls the input characteristics of the RF inputs of the instrument.

### **Commands of the INPut Subsystem**

- [INPut<1|2>:ATTenuation](#)
- [INPut<1|2>:GAIN:STATe](#) (option RF Preamplifier, B22)

#### **INPut<1|2>:ATTenuation**

---

For details refer to "[INPut<1|2>:ATTenuation](#)" on page 6.128.

---

#### **INPut<1|2>:GAIN:STATe (option RF Preamplifier, B22)**

---

For details refer to "[INPut<1|2>:GAIN:STATe](#)" on page 6.130.

---

## INSTRument Subsystem (Noise Figure, K30)

### Commands of the INSTRument Subsystem

- [INSTRument\[:SElect\]](#)
- [INSTRument:NSElect](#)

#### **INSTRument[:SElect]**

---

**Parameter**

NOISe (Noise Figure Measurements option, R&S FSL–K30)

For further details refer to section "INSTRument Subsystem".

---

#### **INSTRument:NSElect**

---

**Parameter**

19 (Noise Figure Measurements option, R&S FSL–K30)

For further details refer to section "INSTRument Subsystem".

---

## SENSe Subsystem (Noise Figure, K30)

The SENSe subsystem is used to set and query the values of parameters in the remote instrument.

- :DEFault      If a parameter has a default a value, the command parameter can be substituted with :DEFault which loads the default (reset) value of the parameter.
- :UP/DOWN     In addition, all numeric values are able to take :UP or :DOWN in place of the parameter. This will increment or decrement the numeric value.
- :MIN/MAX     In addition, all numeric values are able to take either :MINimum or :MAXimum as arguments to determine the minimum or maximum range available for the command.

The SENSe subsystem is divided into equipment settings and measurement settings:

- ["Equipment Settings"](#) on page 6.320
- ["Measurement Settings"](#) on page 6.326

### Equipment Settings

#### Commands of the equipment settings

- [\[SENSe:\]CORRection\[:STATe\]](#)
- [\[SENSe:\]CORRection:ENR:MODE](#)
- [\[SENSe:\]CORRection:ENR:SPOT](#)
- [\[SENSe:\]CORRection:ENR\[:MEASurement\]:TABLE:DATA](#)
- [\[SENSe:\]CORRection:IREJection](#)
- [\[SENSe:\]CORRection:LOSS:INPut:MODE](#)
- [\[SENSe:\]CORRection:LOSS:INPut:SPOT](#)
- [\[SENSe:\]CORRection:LOSS:INPut:TABLE](#)
- [\[SENSe:\]CORRection:LOSS:OUTPut:MODE](#)
- [\[SENSe:\]CORRection:LOSS:OUTPut:SPOT](#)
- [\[SENSe:\]CORRection:LOSS:OUTPut:TABLE](#)
- [\[SENSe:\]CORRection:TEMPerature](#)

#### **[SENSe:]CORRection[:STATe]**

---

This command activates or deactivates the second stage correction.

##### **Parameter**

ON | OFF

##### **Example**

CORR ON

Activates the second stage correction.

##### **Characteristics**

\*RST value: OFF

SCPI: device-specific

##### **Mode**

NF

**[SENSe:]CORRection:ENR:MODE**

This command specifies whether a constant ENR value applies for all measured frequencies or an ENR table (ENR values specified at specific input frequencies). The constant ENR value is specified by the [SENSe:]CORRection:ENR:SPOT command.

**Parameter**

TABLE ENR table is used.  
 SPOT Constant ENR value is used.

**Example**

```
CORR:ENR:MODE SPOT
```

Uses the configured constant ENR value for all measured frequencies.

**Characteristics**

\*RST value: SPOT  
 SCPI: device-specific

**Mode**

NF

**[SENSe:]CORRection:ENR:SPOT**

This command sets the constant ENR value of the noise source that is used throughout the entire frequency range.

**Parameter**

–999.99 to 999.99 dB

**Example**

```
CORR:ENR:MODE SPOT
```

Uses the configured constant ENR value for all measured frequencies.

```
CORR:ENR:SPOT 30
```

Sets the constant ENR value to 30 dB for all input frequencies to be measured.

**Characteristics**

\*RST value: 15 dB  
 SCPI: device-specific

**Mode**

NF

**[SENSe:]CORRection:ENR[:MEASurement]:TABLE:DATA**

This command specifies a new ENR table to determine the correct ENR (excess noise ratio) figure to be used for the input frequencies. This new list completely overwrites all current ENR frequency list entries regardless of how many entries are present and how many entries are being supplied for the new list.

**Parameter**

<numeric\_value>, <numeric\_value>, ... (maximum of 100 argument pairs)

numeric value = a frequency ENR pair of arguments

frequency: 0 Hz to 999.99 GHz.

ENR figure: –999.99 to 999.99 (value in dB, accurate to two decimal places)

**Example**

```
CORR:ENR:MODE TABL
```

Uses the ENR table.

```
CORR:ENR:MEAS:TABL:DATA 1MHZ,10,2MHZ,12
```

Specifies a new ENR table and overwrites the current ENR table with the two entry pairs specified.

**Characteristics**

\*RST value: –

SCPI: device-specific

**Mode**

NF

**[SENSe:]CORRection:IREJection**

This command specifies an image rejection value for the selected DUT (`[SENSe:]CONFigure:MODE:DUT` command) which will be effective throughout the entire frequency range.

**Parameter**

0 dB to 999.99 dB

**Example**

```
CONF:MODE:DUT DOWN
```

The DUT converts the input frequency to a lower output frequency.

```
CORR:IREJ 100
```

Sets an image rejection value of 100 dB.

**Characteristics**

\*RST value: 999.99 dB

SCPI: device-specific

**Mode**

NF

**[SENSe:]CORRection:LOSS:INPut:MODE**

This command specifies whether a constant input loss value applies for all measured frequencies or an input loss list (loss input values specified at specific input frequencies). The constant loss input value is specified by the `[SENSe:]CORRection:LOSS:INPut:SPOT` command.

**Parameter**

SPOT The constant loss input value for all measurement frequencies is used.

TABLE The loss input table is used.

**Example**

```
CORR:LOSS:INP:MODE SPOT
```

Uses the configured constant loss input value for all input frequencies to be measured.

**Characteristics**

\*RST value: SPOT

SCPI: device-specific

**Mode**

NF

**[SENSe:]CORRection:LOSS:INPut:SPOT**

This command specifies the loss input constant for all input frequencies to be measured.

**Parameter**

-999.99 to 999.99 dB, accurate to two decimal places

**Example**

CORR:LOSS:INP:MODE SPOT

Uses the configured constant loss input value for all input frequencies to be measured.

CORR:LOSS:INP:SPOT 10

Sets the internal input loss constant value to 10 dB for all input frequencies to be measured.

**Characteristics**

\*RST value: 0 dB

SCPI: device-specific

**Mode**

NF

**[SENSe:]CORRection:LOSS:INPut:TABLE**

This command specifies a new input loss table to determine the correct input loss to be used for the input frequencies. This new list completely overwrites all current input loss list entries regardless of how many entries are present and how many entries are being supplied for the new list.

**Parameter**

&lt;numeric\_value&gt;,&lt;numeric\_value&gt;,... (maximum of 100 argument pairs)

&lt;numeric\_value&gt;,&lt;numeric\_value&gt; = a frequency loss pair of arguments

frequency: 0 Hz to 999.99 GHz (max. two decimal places)

loss figure: -999.99 to 999.99 (value in dB, accurate to two decimal places)

**Example**

CORR:LOSS:INP:MODE TABL

Uses the loss input table.

CORR:LOSS:INP:TABL 1MHz, 10, 2MHz, 12

Specifies a new input loss table and overwrites the current input loss table with the two entry pairs specified.

**Characteristics**

\*RST value: -

SCPI: device-specific

**Mode**

NF

**[SENSe:]CORRection:LOSS:OUTPut:MODE**

This command specifies whether a constant output loss value applies for all measured frequencies or an output loss list (loss output values specified at specific input frequencies). The constant loss output value is specified by the `[SENSe:]CORRection:LOSS:OUTPut:SPOT` command.

**Parameter**

**SPOT** The constant loss input value for all measurement frequencies is used.  
**TABLE** The loss input table is used.

**Example**

```
CORR:LOSS:OUTP:MODE SPOT
```

Uses the configured constant loss output value for all input frequencies to be measured.

**Characteristics**

\*RST value: SPOT  
 SCPI: device-specific

**Mode**

NF

**[SENSe:]CORRection:LOSS:OUTPut:SPOT**

This command specifies the loss output constant for all input frequencies to be measured.

**Parameter**

–999.99 to 999.99 dB, accurate to two decimal places

**Example**

```
CORR:LOSS:OUTP:MODE SPOT
```

Uses the configured constant loss output value for all input frequencies to be measured.

```
CORR:LOSS:OUTP:SPOT 10
```

Sets the internal output loss constant value to 10 dB for all input frequencies to be measured.

**Characteristics**

\*RST value: 0 dB  
 SCPI: device-specific

**Mode**

NF

**[SENSe:]CORRection:LOSS:OUTPut:TABLE**

This command specifies a new output loss table to determine the correct output loss to be used for the input frequencies. This new list completely overwrites all current output loss list entries regardless of how many entries are present and how many entries are being supplied for the new list.

**Parameter**

<numeric\_value>,<numeric\_value>,... (maximum of 100 argument pairs)

<numeric\_value>,<numeric\_value> = a frequency loss pair of arguments

frequency: 0 Hz to 999.99 GHz (max. two decimal places)

loss figure: –999.99 to 999.99 (value in dB, accurate to two decimal places)



**Example**

```
CORR:LOSS:OUTP:MODE TABL
```

Uses the loss output table.

```
CORR:LOSS:OUTP:TABL 1MHz,10,2MHz,12
```

Specifies a new output loss table and overwrites the current output loss table with the two entry pairs specified.

**Characteristics**

\*RST value: –

SCPI: device-specific

**Mode**

NF

---

**[SENSe:]CORRection:TEMPerature**

---

This command specifies the room temperature of the operating environment. This value is taken into account when calculating noise results.

**Parameter**

278.15 to 318.15 K; up to 2 decimal places can be specified.

**Example**

```
CORR:TEMP 291.50
```

Specifies the room temperature to 291.50 Kelvin (18.5 C).

**Characteristics**

\*RST value: 293 K

SCPI: device-specific

**Mode**

NF

---

## Measurement Settings

### Commands of the measurement settings

- [SENSe:]BANDwidth|BWIDth[:RESolution]
- [SENSe:]CONFigure:MODE:DUT
- [SENSe:]CONFigure:MODE:SYSTem:LOSCillator:FREQuency
- [SENSe:]FREQuency[:CW]:FIXed]
- [SENSe:]FREQuency:LIST:DATA
- [SENSe:]FREQuency:START
- [SENSe:]FREQuency:STEP
- [SENSe:]FREQuency:STOP
- [SENSe:]SWEep:COUNT
- [SENSe:]SWEep:TIME

#### [SENSe:]BANDwidth|BWIDth[:RESolution]

---

For details refer to "[SENSe<1|2>:]BANDwidth|BWIDth[:RESolution]" on page 6.138.

---

#### [SENSe:]CONFigure:MODE:DUT

---

This command defines the type of DUT. This setting determines the method that is used to create the frequency measurement list. Fixed local oscillator frequencies are taken from the settings supplied by [SENSe:]CONFigure:MODE:SYSTem:LOSCillator:FREQuency.

##### Parameter

AMPLifier	The DUT is an amplifier and not a frequency converting device.
DOWNconv	The DUT converts the input frequency to a lower output frequency: Fixed LO, $IF=RF+LO$
UPConv	The DUT converts the input frequency to a higher output frequency: Fixed LO, $IF=abs(RF-LO)$ .

##### Example

```
SENS:CONF:MODE:DUT DOWN
```

The DUT converts the input frequency to a lower output frequency.

##### Characteristics

\*RST value: AMPLifier

SCPI: device-specific

##### Mode

NF

---

**[SENSe:]CONFigure:MODE:SYSTem:LOSCillator:FREQuency**

---

This command specifies a fixed local oscillator frequency for a new frequency measurement list in frequency-converting measurement mode. If this value is altered, a new frequency list is generated.

**Parameter**

0 Hz to 999.99 GHz

**Example**

```
SENS:CONF:MODE:DUT DOWN
```

The DUT converts the input frequency to a lower output frequency.

```
SENS:CONF:MODE:SYST:LOSC:FREQ 1MHZ
```

Specifies the fixed local oscillator frequency for a new list to a value of 1 MHz.

**Characteristics**

\*RST value: – 0 Hz

SCPI: device-specific

**Mode**

NF

---

**[SENSe:]FREQuency[:CW]:FIXed]**

---

This command specifies a fixed frequency to measure noise and gain continuously (fixed frequency measurement).

**Parameter**

<numeric value>

**Example**

```
CONF:SING
```

Configures to run fixed frequency measurements.

```
FREQ 10MHz
```

Sets a fixed frequency of 10 MHz.

**Characteristics**

\*RST value: 550 MHz

SCPI: conform

**Mode**

NF

---

**[SENSe:]FREQuency:LIST:DATA**

---

This command specifies a new frequency list (for frequency list measurement). Each list entry consists of three separate frequency entities: a receive frequency (RF), a local oscillator frequency (LO), and an intermediate frequency (IF). The new list completely overwrites all the current frequency list entries regardless of how many entries are present and how many entries are being supplied for the new list. The new list is the active list until a new list is automatically created.

The values specified in this command are not used for a fixed frequency measurement ([CONFigure:SINGle](#) command).

**Parameter**

<numeric\_value>,<numeric\_value>, ... (max. of 100 argument)

numeric value = set of three frequency measurements in the following order: fixed frequency, local oscillator frequency, and intermediate frequency. The frequency range depends on the selected measurement mode:

direct measurement	RF: 0 Hz to $f_{\max}$
frequency-converting measurement	RF, LO: 0 Hz to 999.99 GHz IF: 0 Hz to $f_{\max}$

**Example**

```
FREQ:LIST:DATA 550MHz,300MHz,900MHz
```

Specifies one entry frequency list with a receive frequency of 550 MHz, a local oscillator frequency of 300 MHz, and an intermediate frequency of 900 MHz.

**Characteristics**

\*RST value: 550 MHz | 0 Hz | 550 MHz

SCPI: device-specific

**Mode**

NF

---

**[SENSe:]FREQuency:START**

This command specifies the start frequency for a new frequency measurement list. If this value is altered, a new frequency list is generated.

**Parameter**

<numeric value>

**Example**

```
FREQ:STAR 500MHZ
```

Sets the start frequency for a new list to a value of 500 MHz.

**Characteristics**

\*RST value: 550 MHz

SCPI: conform

**Mode**

NF

---

**[SENSe:]FREQuency:STEP**

This command specifies the step frequency for a new frequency measurement list. If this value is altered, a new frequency list is generated.

**Parameter**

<numeric value>

**Example**

```
FREQ:STEP 10MHZ
```

Sets the step frequency for a new list to a value of 10 MHz.

**Characteristics**

\*RST value: 2 MHz

SCPI: device-specific

**Mode**

NF

**[SENSe:]FREQuency:STOP**

---

This command specifies the stop frequency for a new frequency measurement list. If this value is altered, a new frequency list is generated.

**Parameter**

<numeric value>

**Example**

```
FREQ:STOP 700MHZ
```

Sets the stop frequency for a new list to a value of 700 MHz.

**Characteristics**

\*RST value: 560 MHz

SCPI: conform

**Mode**

NF

---

**[SENSe:]SWEep:COUNT**

---

This command specifies the number of sweeps over which the measurement results are averaged. The higher the number of sweeps, the more accurate the results. However, a high number of sweeps requires a longer measurement time.

**Parameter**

1 to 32767

**Example**

```
SWE:COUN 10
```

Sets the number of sweeps for averaging to 10.

**Characteristics**

\*RST value: 1

SCPI: conform

**Mode**

NF

---

**[SENSe:]SWEep:TIME**

---

For details refer to "[SENSe<1|2>:]SWEep:TIME" on page 6.200.

---

## STATus Subsystem (Noise Figure, K30)

The STATus subsystem contains the commands for the status reporting system (See Section ""). \*RST does not influence the status registers.

### Commands of the STATus subsystem

- STATus:QUEStionable:CORRection[:EVENT]?
- STATus:QUEStionable:CORRection:CONDition?
- STATus:QUEStionable:CORRection:ENABle
- STATus:QUEStionable:CORRection:NTRansition
- STATus:QUEStionable:CORRection:PTRansition
- STATus:QUEStionable:FREQuency[:EVENT]?
- STATus:QUEStionable:FREQuency:CONDition?
- STATus:QUEStionable:FREQuency:ENABle
- STATus:QUEStionable:FREQuency:NTRansition
- STATus:QUEStionable:FREQuency:PTRansition
- STATus:QUEStionable:LIMit<1|2> [:EVENT]?
- STATus:QUEStionable:LIMit<1|2>:CONDition?
- STATus:QUEStionable:LIMit<1|2>:ENABle
- STATus:QUEStionable:LIMit<1|2>:NTRansition
- STATus:QUEStionable:LIMit<1|2>:PTRansition

### STATus:QUEStionable:CORRection[:EVENT]?

---

This command queries the contents of the EVENT section of the STATus:QUEStionable:CORRection register. Readout deletes the contents of the EVENT section.

#### Example

```
STAT:QUES:CORR?
```

#### Characteristics

\*RST value: –

SCPI: conform

#### Mode

NF

---

---

**STATus:QUEStionable:CORRection:CONDition?**

---

This command queries the contents of the CONDition section of the STATus:QUEStionable:CORRection register. Readout does not delete the contents of the CONDition section.

**Example**

```
STAT:QUES:CORR:COND?
```

**Characteristics**

\*RST value: –

SCPI: conform

**Mode**

NF

---

---

**STATus:QUEStionable:CORRection:ENABLE**

---

This command sets the bits of the ENABle section of the STATus:QUEStionable:CORRection register. The ENABle register selectively enables the individual events of the associated EVENT section for the summary bit.

**Parameter**

0 to 65535

**Example**

```
STAT:QUES:CORR:ENAB 65535
```

All events bits are represented in the CORRection summary bit.

**Characteristics**

\*RST value: –

SCPI: conform

**Mode**

NF

---

---

**STATus:QUEStionable:CORRection:NTRansition**

---

This command determines what bits in the STATus:QUEStionable:CORRection Condition register set the corresponding bit in the STATus:QUEStionable:CORRection Event register if that bit has a negative transition (1 to 0). The variable <number> is the sum of the decimal values of the bits that are to be enabled.

**Parameter**

0 to 65535

**Example**

```
STAT:QUES:CORR:NTR 65535
```

All condition bits are summarized in the Event register if a positive transition occurs.

**Characteristics**

\*RST value: –

SCPI: conform

**Mode**

NF

---

**STATus:QUEStionable:CORRection:PTRansition**

This command determines what bits in the STATus:QUESionable:CORRection Condition register set the corresponding bit in the STATus:QUESionable:CORRection Event register if that bit has a positive transition (0 to 1). The variable <number> is the sum of the decimal values of the bits that are to be enabled.

**Parameter**

0 to 65535

**Example**

STAT:QUES:CORR:PTR 65535

All condition bits are summarized in the Event register if a positive transition occurs.

**Characteristics**

\*RST value: –

SCPI: conform

**Mode**

NF

**STATus:QUEStionable:FREQuency[:EVENT]?**

For details refer to "[STATus:QUEStionable:FREQuency\[:EVENT\]?](#)" on page 6.205.

**STATus:QUEStionable:FREQuency:CONDition?**

For details refer to "[STATus:QUEStionable:FREQuency:CONDition?](#)" on page 6.206.

**STATus:QUEStionable:FREQuency:ENABLE**

For details refer to "[STATus:QUEStionable:FREQuency:ENABLE](#)" on page 6.206.

**STATus:QUEStionable:FREQuency:NTRansition**

This command determines what bits in the STATus:QUESionable:FREQuency Condition register set the corresponding bit in the STATus:QUESionable:FREQuency Event register if that bit has a negative transition (1 to 0). The variable <number> is the sum of the decimal values of the bits that are to be enabled.

**Parameter**

0 to 65535

**Example**

STAT:QUES:FREQ:NTR 65535

All condition bits are summarized in the Event register if a positive transition occurs.

**Characteristics**

\*RST value: –

SCPI: conform

**Mode**

NF



**STATus:QUEStionable:FREQuency:PTRansition**

This command determines what bits in the STATus:QUESionable:FREQuency Condition register set the corresponding bit in the STATus:QUESionable:FREQuency Event register if that bit has a positive transition (0 to 1). The variable <number> is the sum of the decimal values of the bits that are to be enabled.

**Parameter**

0 to 65535

**Example**

```
STAT:QUES:FREQ:PTR 65535
```

All condition bits are summarized in the Event register if a positive transition occurs.

**Characteristics**

\*RST value: –

SCPI: conform

**Mode**

NF

**STATus:QUEStionable:LIMit<1|2> [:EVENT]?**

For details refer to "[STATus:QUEStionable:LIMit<1|2> \[:EVENT\]?](#)" on page 6.207.

**STATus:QUEStionable:LIMit<1|2>:CONDition?**

For details refer to "[STATus:QUEStionable:LIMit<1|2>:CONDition?](#)" on page 6.207.

**STATus:QUEStionable:LIMit<1|2>:ENABle**

For details refer to "[STATus:QUEStionable:LIMit<1|2>:ENABle](#)" on page 6.208.

**STATus:QUEStionable:LIMit<1|2>:NTRansition**

This command determines what bits in the STATus:QUESionable:LIMit Condition register set the corresponding bit in the STATus:QUESionable:LIMit Event register if that bit has a negative transition (1 to 0). The variable <number> is the sum of the decimal values of the bits that are to be enabled.

**Parameter**

0 to 65535

**Example**

```
STAT:QUES:NTR 65535
```

All condition bits are summarized in the Event register if a positive transition occurs.

**Characteristics**

\*RST value: –

SCPI: device-specific

**Mode**

NF

**STATus:QUEStionable:LIMit<1|2>:PTRansition**

---

This command determines what bits in the STATus:QUESionable:LIMit Condition register set the corresponding bit in the STATus:QUESionable:LIMit Event register if that bit has a positive transition (0 to 1). The variable <number> is the sum of the decimal values of the bits that are to be enabled.

**Parameter**

0 to 65535

**Example**

```
STAT:QUES:PTR 65535
```

All condition bits are summarized in the Event register if a positive transition occurs.

**Characteristics**

\*RST value: –

SCPI: device-specific

**Mode**

NF

---

## SYSTEM Subsystem (Noise Figure, K30)

This subsystem contains a series of commands for general functions.

### Commands of the SYSTEM subsystem

- [SYSTem:CONFigure:DUT:GAIN](#)
- [SYSTem:CONFigure:DUT:STIME](#)

---

#### SYSTem:CONFigure:DUT:GAIN

---

This command specifies the maximum gain of the DUT.

**Parameter**

10 dB to 999.99 dB

**Example**

```
SYST:CONF:DUT:GAIN 10
```

Specifies the gain of the DUT to be 10 dB.

**Characteristics**

\*RST value: 30 dB

SCPI: device-specific

**Mode**

NF

---

---

#### SYSTem:CONFigure:DUT:STIME

---

This command specifies the DUT settling time. It represents the time to wait for the DUT to settle after a noise source has been turned on or off.

**Parameter**

0 to 20 s

**Example**

```
SYST:CONF:DUT:STIM 1000MS
```

Specifies a period of one second for the DUT to settle down after exposure to the noise source has been removed.

**Characteristics**

\*RST value: 50 milliseconds

SCPI: device-specific

**Mode**

NF

---

## **Remote Control - Description of Basic Settings Commands**

In this section all remote control commands for basic settings are described in detail. For details on analyzer and receiver commands refer to section "Remote Commands of the Base Unit".

### **Subsystems for basic settings**

- ["Common Commands"](#) on page 6.337
- ["CALibration Subsystem"](#) on page 6.341
- ["DIAGnostic Subsystem"](#) on page 6.343
- ["DISPlay Subsystem"](#) on page 6.347
- ["FORMat Subsytem"](#) on page 6.354
- ["HCOPY Subsystem"](#) on page 6.355
- ["INSTrument Subsystem"](#) on page 6.362
- ["MMEMory Subsystem"](#) on page 6.363
- ["OUTPut Subsystem \(Option Additional Interfaces, B5\)"](#) on page 6.380
- ["SENSe Subsystem"](#) on page 6.381
- ["SOURce Subsystem"](#) on page 6.386
- ["STATus Subsystem"](#) on page 6.387
- ["SYSTem Subsystem"](#) on page 6.392

## Common Commands

The common commands are taken from the IEEE 488.2 (IEC 625-2) standard. A particular command has the same effect on different devices. The headers of these commands consist of an asterisk "\*" followed by three letters. Many common commands refer to the status reporting system which is described in detail in chapter 5 "Remote Control - Basics".

### Available Common Commands

- \*CAL?
- \*CLS
- \*ESE
- \*ESR?
- \*IDN?
- \*IST?
- \*OPC
- \*OPT?
- \*PCB
- \*PRE
- \*PSC
- \*RST
- \*SRE
- \*STB?
- \*TRG
- \*TST?
- \*WAI

#### \*CAL?

---

**CALIBRATION QUERY** initiates a calibration of the instrument and subsequently queries the calibration status. Responses > 0 indicate errors.

---

#### \*CLS

---

**CLEAR STATUS** sets the status byte (STB), the standard event register (ESR) and the EVENT part of the QUEStionable and the OPERation register to zero. The command does not alter the mask and transition parts of the registers. It clears the output buffer.

---

#### \*ESE

---

**EVENT STATUS ENABLE** sets the event status enable register to the value indicated. The query form \*ESE? returns the contents of the event status enable register in decimal form.

**Parameter**

0 to 255

---

**\*ESR?**

**STANDARD EVENT STATUS QUERY** returns the contents of the event status register in decimal form (0 to 255) and subsequently sets the register to zero.

**Parameter**

0 to 255

**\*IDN?**

**IDENTIFICATION QUERY** queries the instrument identification.

**Return values (examples)**

LEGacy format, example for R&S ESL6:  
Rohde&Schwarz,ESL-6,100005/016,1.82

NEW format, example for R&S ESL6:  
Rohde&Schwarz,ESL-6,1300.2502K16/100005,1.82

ESL-6	device name
100005/016	serial number/model
1300.2502K16/100005	part number/serial number
1.82	firmware version

**\*IST?**

**INDIVIDUAL STATUS QUERY** returns the contents of the IST flag in decimal form. The IST flag is the status bit which is sent during a parallel poll (see the Operating Manual on CD-ROM, chapter 5 "Remote Control - Basics").

**Parameter**

0 | 1

**\*OPC**

**OPERATION COMPLETE** sets bit 0 in the event status register after all preceding commands have been executed. This bit can be used to initiate a service request (see the Operating Manual on CD-ROM, chapter 5 "Remote Control - Basics").

**\*OPT?**

**OPTION IDENTIFICATION QUERY** queries the options included in the instrument and returns a list of the options installed. The options are separated from each other by means of commas.

**Parameter**

B<number>	hardware options
K<number>	software options

For a list of all available options and their description refer to the CD-ROM.

**Example**

B4,B5,B6,B7,B8,B10,B22,B30,B31,K7,K9

**\*PCB**

---

**PASS CONTROL BACK** indicates the controller address which the remote control is to be returned to after termination of the triggered action.

**Parameter**0 to 30

---

**\*PRE**

---

**PARALLEL POLL REGISTER ENABLE** sets the parallel poll enable register to the indicated value. The query form **\*PRE?** returns the contents of the parallel poll enable register in decimal form.

**Parameter**0 to 255

---

**\*PSC**

---

**POWER ON STATUS CLEAR** determines whether the contents of the ENABLE registers are preserved or reset during power-up.

The query form **\*PSC?** reads out the contents of the power-on-status-clear flag. The response can be 0 or 1.

**Parameter**

- |   |   |
|---|---|
| 0 | Causes the contents of the status registers to be preserved. Thus a service request can be generated when switching on the instrument, if the status registers ESE and SRE are suitably configured. |
| 1 | Resets the registers.   |
- 

**\*RST**

---

**RESET** sets the instrument to a defined default status. The command essentially corresponds to pressing the **PRESET** key. The default settings are described in section "Remote Commands of the Base Unit", "Initializing the Configuration - PRESET Key".

---

**\*SRE**

---

**SERVICE REQUEST ENABLE** sets the service request enable register to the indicated value. Bit 6 (MSS mask bit) remains 0. This command determines under which conditions a service request is generated. The query form **\*SRE?** reads the contents of the service request enable register in decimal form. Bit 6 is always 0.

**Parameter**0 to 255

---

**\*STB?**

---

**READ STATUS BYTE QUERY** reads out the contents of the status byte in decimal form.

---

**\*TRG**

---

**TRIGGER** initiates all actions in the currently active test screen expecting a trigger event. This command corresponds to the `INITiate:IMMEDIATE` command. For details refer to section "Remote Commands of the Base Unit", "TRIGger Subsystem".

---

**\*TST?**

---

**SELF TEST QUERY** initiates the self test of the instrument and outputs an error code in decimal form.

**Parameter**

0 = no error

---

**\*WAI**

---

**WAIT-to-CONTINUE** permits servicing of subsequent commands only after all preceding commands have been executed and all signals have settled (see chapter 5 "Remote Control - Basics", and `*OPC` command).

---



## CALibration Subsystem

The commands of the CALibration subsystem determine the data for system error correction in the instrument.

### Commands of the CALibration Subsystem

- CALibration[:ALL]?
- CALibration:ABORt
- CALibration:RESult?
- CALibration:STATe

---

### CALibration[:ALL]?

This command initiates the acquisition of system error correction data. A "0" is returned if the acquisition was successful.

**Note:** *During the acquisition of correction data the instrument does not accept any remote control commands.*

In order to recognize when the acquisition of correction data is completed, the MAV bit in the status byte can be used. If the associated bit is set in the Service Request Enable Register, the instrument generates a service request after the acquisition of correction data has been completed.

#### Example

\*CLS

Resets the status management.

\*SRE 16

Enables MAV bit in the Service Request Enable Register.

\*CAL?

Starts the correction data recording, and then a service request is generated.

#### Characteristics

\*RST value: -

SCPI: conform

#### Mode

all

---

### CALibration:ABORt

This command has no effect, but is implemented to provide compatibility with the FSP family. The collection of self alignment data can only be aborted via manual operation. For details refer to chapter 4 "Instrument Functions - Basic Settings", section "Instrument Setup and Interface Configuration - SETUP Key" - "Alignment".

This command is an event and therefore has no \*RST value and no query.

#### Example

CAL:ABOR

**Characteristics**

\*RST value: -

SCPI: device-specific

**Mode**

all

---

**CALibration:RESult?**

---

This command outputs the results of the correction data acquisition. The lines of the result table are output as string data separated by commas:

```
Total Calibration Status: PASSED, Date (dd/mm/yyyy): 12/07/2004,  
Time: 16:24:54, Runtime: 00.06
```

**Example**

```
CAL:RES?
```

**Characteristics**

\*RST value: -

SCPI: device-specific

**Mode**

all

---

**CALibration:STATe**

---

This command determines whether the current calibration data are taken into account by the instrument (ON) or not (OFF).

**Parameter**

ON | OFF

**Example**

```
CAL:STAT OFF
```

Sets up the instrument to ignore the calibration data.

**Characteristics**

\*RST value: -

SCPI: conform

**Mode**

all

---

## DIAGnostic Subsystem

The DIAGnostic subsystem contains the commands which support instrument diagnostics for maintenance, service and repair. In accordance with the SCPI standard, all of these commands are device-specific.

### Commands of the DIAGnostic Subsystem

- DIAGnostic<1|2>:SERVice:BIOSinfo?
- DIAGnostic<1|2>:SERVice:HWInfo?
- DIAGnostic<1|2>:SERVice:INPut[:SElect]
- DIAGnostic<1|2>:SERVice:INPut:PULSed[:STATe]
- DIAGnostic<1|2>:SERVice:INPut:PULSed:PRATe
- DIAGnostic<1|2>:SERVice:NSOource (option Additional Interfaces, B5)
- DIAGnostic<1|2>:SERVice:SFUNction
- DIAGnostic<1|2>:SERVice:STESt:RESult?

### DIAGnostic<1|2>:SERVice:BIOSinfo?

---

This command reads the CPU board BIOS version and returns it as ASCII string.  
The numeric suffixes <1|2> are irrelevant for this command.

#### Example

```
DIAG:SERV:BIOS?
Returns the BIOS version.
```

#### Return values (example)

```
47.11
```

#### Characteristics

\*RST value: -  
SCPI: device-specific

#### Mode

```
all
```

---

### DIAGnostic<1|2>:SERVice:HWInfo?

---

This command queries the hardware information.  
The numeric suffixes <1|2> are irrelevant for this command.

#### Return values

```
"<component 1>|<serial #>|<order #>|<model>|<hardware code>|<revision>|<subrevision>",
"<component 2>|<serial #>|<order #>|<model>|<hardware code>|<revision>|<subrevision>",
...
```

Table lines are output as string data and are separated by commas. The individual columns of the table are separated from each other by |.

**Example**

```
DIAG:SERV:HWIN?
```

Queries the hardware information.

```
"FRONTEND|100001/003|1300.3009|03|01|00|00",  
"MOTHERBOARD|123456/002|1300.3080|02|00|00|00",  
...
```

**Characteristics**

\*RST value: -

SCPI: device-specific

**Mode**

all

---

**DIAGnostic<1|2>:SERVice:INPut[:SELEct]**

This command toggles between the RF input on the front panel and the internal 65.83 MHz reference signal.

**Parameter**

CALibration | RF | TG

**Example**

```
DIAG:SERV:INP CAL
```

**Characteristics**

\*RST value: RF

SCPI: device-specific

**Mode**

all

---

**DIAGnostic<1|2>:SERVice:INPut:PULSed[:STATe]**

This command has no effect (only the comb generator is available), but is implemented to provide compatibility with the FSP family.

**Parameter**

ON | OFF

**Example**

```
DIAG:SERV:INP:PULS ON
```

**Characteristics**

\*RST value: ON

SCPI: conform

**Mode**

all

---

**DIAGnostic<1|2>:SERVice:INPut:PULSed:PRATe**

This command sets the comb generator frequency. This command only takes effect, if the internal reference signal is selected for calibration (`DIAGnostic<1|2>:SERVice:INPut[:SElect]`).

**Parameter**

COMB1 65.8333 MHz / 1  
 COMB64 65.8333 MHz / 64  
 COMB65 65.8333 MHz / 65

**Example**

```
DIAG:SERV:INP:PULS:PRAT COMB64
```

Sets the comb generator frequency to  $\frac{1}{64}$  of 65.8333 MHz.

**Characteristics**

\*RST value: COMB1  
 SCPI: conform

**Mode**

all

**DIAGnostic<1|2>:SERVice:NSOource (option Additional Interfaces, B5)**

This command switches the 28 V supply of the noise source at the rear panel on or off. The numeric suffixes <1|2> are irrelevant for this command.

**Parameter**

ON | OFF

**Example**

```
DIAG:SERV:NSO ON
```

**Characteristics**

\*RST value: OFF  
 SCPI: device-specific

**Mode**

all

**DIAGnostic<1|2>:SERVice:SFUNction**

This command activates a service function which can be selected by indicating the five parameters: function group number, board number, function number, parameter 1 and parameter 2 (see service manual). The contents of the parameter string are identical to the code to be entered in the edit dialog box of manual operation.

The entry of a service function is accepted only if the system password level 1 or level 2 has been entered previously (`SYSTem:PASSword[:CENable]`).

The numeric suffixes <1|2> are irrelevant for this command.

**Parameter**

<string>

**Example**

DIAG:SERV:SFUN 2.0.2.12.1

**Characteristics**

\*RST value: -

SCPI: device-specific

**Mode**

all

---

**DIAGnostic<1|2>:SERVice:STES:RESult?**

---

This command reads the results of the self test out of the instrument. The lines of the result table are output as string data separated by commas:

"Total Selftest Status: PASSED", "Date (dd/mm/yyyy): 09/07/2004  
TIME: 16:24:54", "Runtime: 00:06", "...

The numeric suffixes <1|2> are irrelevant for this command.

**Example**

DIAG:SERV:STES:RES?

**Characteristics**

\*RST value: -

SCPI: device-specific

**Mode**

all

---

## DISPlay Subsystem

The DISPlay subsystem controls the selection and presentation of textual and graphic information as well as of measurement data on the display.

### Commands of the DISPlay Subsystem

- DISPlay:ANNOtation:FREQuency
- DISPlay:CMAP<1...26>:DEFault<1|2>
- DISPlay:CMAP<1...26>:HSL
- DISPlay:CMAP<1...26>:PDEFined
- DISPlay:FORMat
- DISPlay:LOGO
- DISPlay:PSAVe[:STATe]
- DISPlay:PSAVe:HOLDoff
- DISPlay[:WINDow<1|2>]:TEXT[:DATA]
- DISPlay[:WINDow<1|2>]:TEXT:STATe
- DISPlay[:WINDow<1|2>]:TIME

### Further Information

- CMAP suffix assignment

### CMAP suffix assignment

Each numeric suffix of CMAP is assigned one or several graphical elements which can be modified by varying the corresponding color setting. The following assignment applies:

Suffix	Description
CMAP1	Background
CMAP2	Grid
CMAP3	Common Text
CMAP4	Check Status OK
CMAP5	Check Status Error
CMAP6	Text Special 1
CMAP7	Text Special 2
CMAP8	Trace 1
CMAP9	Trace 2
CMAP10	Trace 3
CMAP11	Marker Info Text
CMAP12	Limit Lines
CMAP13	Limit and Margin Check - "Pass"
CMAP14	Limit and Margin Check - "Fail"
CMAP15	Softkey Text
CMAP16	Softkey Background
CMAP17	Selected Field Text
CMAP18	Selected Field Background
CMAP19	Softkey 3D Bright Part

CMAP20	Softkey 3D Dark Part
CMAP21	Softkey State "On"
CMAP22	Softkey State "Dialog open"
CMAP23	Softkey Text Disabled
CMAP24	Logo
CMAP25	Trace 4
CMAP26	Grid - Minorlines
CMAP27	Bargraph PK+
CMAP28	Bargraph PK-
CMAP29	Bargraph QPK
CMAP30	Bargraph AVER
CMAP31	Bargraph CAV
CMAP32	Bargraph RMS
CMAP33	Bargraph CRMS
CMAP34	Final Meas

---

**DISPlay:ANNotation:FREQuency**

---

This command switches the x-axis annotation on or off.

**Parameter**

ON | OFF

**Example**

```
DISP:ANN:FREQ OFF
```

**Characteristics**

\*RST value: ON

SCPI: conform

**Mode**

all

---

**DISPlay:CMAP<1...26>:DEFault<1|2>**

---

This command resets the screen colors of all display items to their default settings. Two default settings DEFault1 and DEFault2 are available. The numeric suffix of CMAP is irrelevant.

This command is an event and therefore has no query and no \*RST value.

**Example**

```
DISP:CMAP:DEF2
```

Selects default setting 2 for setting the colors.

**Characteristics**

\*RST value: -

SCPI: conform

**Mode**

all

---



**DISPlay:CMAP<1...34>:DEFault<1|2>**

---

This command resets the screen colors of all display items to their default settings. Two default settings DEFault1 and DEFault2 are available. The numeric suffix of CMAP is irrelevant.

This command is an event and therefore has no query and no \*RST value.

**Example**

```
DISP:CMAP:DEF2
```

Selects default setting 2 for setting the colors.

**Characteristics**

\*RST value: -

SCPI: conform

**Mode**

all

---

**DISPlay:CMAP<1...26>:HSL**

---

This command defines the color table of the instrument.

For the numeric suffix assignment of CMAP refer to "[CMAP suffix assignment](#)" on page 6.347.

The set values are not changed by \*RST.

**Parameter**

hue = TINT

sat = SATURATION

lum = BRIGHTNESS

The value range is 0 to 1 for all parameters.

**Example**

```
DISP:CMAP2:HSL 0.3,0.8,1.0
```

Changes the grid color.

**Characteristics**

\*RST value: -

SCPI: conform

**Mode**

all

---

**DISPlay:CMAP<1...34>:HSL**

---

This command defines the color table of the instrument.

For the numeric suffix assignment of CMAP refer to "[CMAP suffix assignment](#)" on page 6.347.

The set values are not changed by \*RST.

**Parameter**

hue = TINT

sat = SATURATION

lum = BRIGHTNESS

The value range is 0 to 1 for all parameters.

**Example**

```
DISP:CMAP2:HSL 0.3,0.8,1.0
```

Changes the grid color.

**Characteristics**

\*RST value: -

SCPI: conform

**Mode**

all

---

**DISPlay:CMAP<1...26>:PDEFined**

This command defines the color table of the instrument using predefined color values. Each numeric suffix of CMAP is assigned to one or several graphical elements which can be modified by varying the corresponding color setting.

For the numeric suffix assignment of CMAP refer to "[CMAP suffix assignment](#)" on page 6.347.

The values set are not changed by \*RST.

**Parameter**

BLACK | BLUE | BROWN | GREEN | CYAN | RED | MAGENTA | YELLOW | WHITE | DGRAY | LGRAY | LBLUE | LGREEN | LCYAN | LRED | LMAGENTA

**Example**

```
DISP:CMAP2:PDEF GRE
```

**Characteristics**

\*RST value: -

SCPI: conform

**Mode**

all

---

**DISPlay:CMAP<1...34>:PDEFined**

This command defines the color table of the instrument using predefined color values. Each numeric suffix of CMAP is assigned to one or several graphical elements which can be modified by varying the corresponding color setting.

For the numeric suffix assignment of CMAP refer to "[CMAP suffix assignment](#)" on page 6.347.

The values set are not changed by \*RST.

**Parameter**

BLACK | BLUE | BROWN | GREEN | CYAN | RED | MAGENTA | YELLOW | WHITE | DGRAY | LGRAY | LBLUE | LGREEN | LCYAN | LRED | LMAGENTA

**Example**

```
DISP:CMAP2:PDEF GRE
```

**Characteristics**

\*RST value: -

SCPI: conform

**Mode**

all

---

**DISPlay:FORMat**

---

This command has no effect but is implemented for reasons of compatibility with the FSP family. It switches the measurement result display between FULL SCREEN and SPLIT SCREEN.

**Parameter**

SINGle | SPLit

**Example**

```
DISP:FORM SPL
```

Switches the display to 2 measurement windows.

**Characteristics**

\*RST value: SINGle

SCPI: device-specific

**Mode**

A

---

**DISPlay:LOGO**

---

This command switches the company logo on the screen on or off.

**Parameter**

ON | OFF

**Example**

```
DISP:LOGO OFF
```

**Characteristics**

\*RST value: ON

SCPI: device-specific

**Mode**

all

---

**DISPlay:PSAVe[:STATe]**

---

This command switches on or off the power-save mode of the display. With the power-save mode activated the display including backlight is completely switched off after the elapse of the response time (see [DISPlay:PSAVe:HOLDoff](#) command).

**Note:** *This mode is recommended for preserving the display especially if the instrument is exclusively operated via remote control.*

**Parameter**

ON | OFF

**Example**

```
DISP:PSAVe ON
```

Switches on the power-save mode.

**Characteristics**

\*RST value: OFF

SCPI: device-specific

**Mode**

all

---

---

**DISPlay:PSAVe:HOLDoff**

---

This command sets the holdoff time for the power-save mode of the display. The available value range is 1 to 60 minutes, the resolution 1 minute. The entry is dimensionless.

**Parameter**

1 to 60

**Example**

```
DISP:PSAV:HOLD 30
```

**Characteristics**

\*RST value: 15

SCPI: device-specific

**Mode**

all

---

**DISPlay[:WINDow<1|2>]:TEXT[:DATA]**

---

This command defines a comment (max. 20 characters) which can be displayed on the screen.

**Parameter**

<string>

**Example**

```
DISP:WIND:TEXT 'Noise Measurement'
```

Defines the screen title.

**Characteristics**

\*RST value: "" (empty)

SCPI: conform

**Mode**

all

---

**DISPlay[:WINDow<1|2>]:TEXT:STATe**

---

This command switches on or off the display of the comment (screen title).

**Parameter**

ON | OFF

**Example**

```
DISP:TEXT:STAT ON
```

Switches on the title.

**Characteristics**

\*RST value: OFF

SCPI: conform

**Mode**

all

---

**DISPlay[:WINDow<1|2>]:TIME**

---

This command switches on or off the screen display of date and time. The numeric suffix in WINDow<1| 2> is irrelevant.

**Parameter**

ON | OFF

**Example**

DISP:TIME ON

**Characteristics**

\*RST value: OFF

SCPI: device-specific

**Mode**

all

---

## FORMat Subsystem

The FORMat subsystem specifies the data format of the data transmitted from and to the instrument.

### Commands of the FORMat Subsystem

– [FORMat\[:DATA\]](#)

#### FORMat[:DATA]

---

This command specifies the data format for the data transmitted from the instrument to the control PC. The data format is either ASCII or REAL. ASCII data are transmitted in plain text, separated by commas. REAL data are transmitted as 32-bit IEEE 754 floating-point numbers in the "definite length block format".

The FORMat command is valid for the transmission of trace data and the results of the bar graph measurement

**Parameter**

ASCIi | REAL

**Example**

```
FORM REAL, 32  
FORM ASC
```

**Characteristics**

\*RST value: REAL

SCPI: conform

**Mode**

all

---

## HCOPY Subsystem

The HCOPY subsystem controls the output of display information for documentation purposes on output devices or files. The instrument allows two independent printer configurations which can be set separately with the numeric suffix <1|2>.

### Commands of the HCOPY Subsystem

- HCOPY[:IMMEDIATE<1|2>]
- HCOPY[:IMMEDIATE<1|2>]:NEXT
- HCOPY:ABORT
- HCOPY:CMAP<1...26>:DEFAULT
- HCOPY:CMAP<1...26>:HSL
- HCOPY:CMAP<1...26>:PDEFINED
- HCOPY:DESTINATION<1|2>
- HCOPY:DEVICE:COLOR
- HCOPY:DEVICE:LANGUAGE<1|2>
- HCOPY:ITEM:ALL
- HCOPY:ITEM:WINDOW<1|2>:TEXT
- HCOPY:ITEM:WINDOW<1|2>:TRACE:STATE
- HCOPY:PAGE:ORIENTATION<1|2>
- 

### HCOPY[:IMMEDIATE<1|2>]

This command starts a hardcopy output. The numeric suffix selects which printer configuration (device 1 or 2) is to be used for the hardcopy output. If there is no suffix, configuration 1 is automatically selected.

This command is an event and therefore has no \*RST value and no query.

#### Example

```
HCOPY:DEV:LANG BMP
```

Selects the data format.

```
HCOPY:DEST 'MMEM'
```

Directs the hardcopy to a file.

```
MMEM:NAME 'C:\R_S\instr\user\Print.bmp'
```

Selects the file name. If the file Print.bmp already exists, it is replaced.

```
HCOPY
```

Saves the hardcopy output into the file Print.bmp.

#### Characteristics

\*RST value: -

SCPI: conform

#### Mode

all

---

**HCOPy[:IMMEDIATE<1|2>]:NEXT**

---

This command starts a hardcopy output. The numeric suffix selects which printer configuration (device 1 or 2) is to be used for the hardcopy output. If there is no suffix, configuration 1 is automatically selected. If the output is printed to a file (see [HCOPy:DESTINATION<1|2>](#) command), the file name used in the last saving process is automatically counted up to the next unused name.

This command is an event and therefore has no \*RST value and no query.

**Example**

```
HCOP:DEV:LANG BMP
```

Selects the data format.

```
HCOP:DEST 'MMEM'
```

Directs the hardcopy to a file.

```
MMEM:NAME 'C:\R_S\instr\user\Print.bmp'
```

Selects the file name.

```
HCOP
```

Saves the hardcopy output into the file Print.bmp.

```
HCOP:NEXT
```

Saves the hardcopy output into the file Print\_001.bmp.

```
HCOP:NEXT
```

Saves the hardcopy output into the file Print\_002.bmp.

**Characteristics**

RST value: -

SCPI: device-specific

**Mode**

all

---

**HCOPy:ABORT**

---

This command aborts a running hardcopy output.

This command is an event and therefore has no \*RST value and no query.

**Example**

```
HCOP:ABOR
```

**Characteristics**

\*RST value: -

SCPI: conform

**Mode**

all

---



**HCOPY:CMAP<1...26>:DEFault**

---

This command sets the colors for a printout or hardcopy. The numeric suffix in CMAP is not significant.

This command is an event and therefore has no query and no \*RST value.

**Parameter**

- 1 current screen colors with the background in white and the grid in black.
- 2 optimized color set
- 3 user defined color set
- 4 current screen colors without any changes (setting for hardcopies)

**Example**

```
HCOP:CMAP:DEF2
```

Selects the optimized color set for the color settings of a printout or a hardcopy.

**Characteristics**

\*RST value: -

SCPI: conform

**Mode**

all

---

**HCOPY:CMAP<1...26>:HSL**

---

This command defines the color table in user defined colors.

To each numeric suffix of CMAP is assigned one or several picture elements which can be modified by varying the corresponding color setting. For details on the CMAP assignment refer to "[CMAP suffix assignment](#)" on page 6.347.

The values set are not changed by \*RST.

**Parameter**

hue = tint

sat = saturation

lum = brightness

The value range is 0 to 1 for all parameters.

**Example**

```
HCOP:CMAP2:HSL 0.3,0.8,1.0
```

Changes the grid color

**Characteristics**

\*RST value: -

SCPI: conform

**Mode**

all

---

**HCOPy:CMAP<1...26>:PDEFined**

This command defines the color table in user defined colors using predefined color values. To each numeric suffix of CMAP is assigned one or several picture elements which can be modified by varying the corresponding color setting. For details on the CMAP assignment refer to "[CMAP suffix assignment](#)" on page 6.347.

The values set are not changed by \*RST.

**Parameter**

BLACk | BLUE | BROWn | GREen | CYAN | RED | MAGenta | YELLow | WHITe | DGRAY | LGRAY | LBLUe | LGREen | LCYan | LRED | LMAGenta

**Example**

HCOP:CMAP2:PDEF GRE

**Characteristics**

\*RST value: -  
 SCPI: conform

**Mode**

all

**HCOPy:DESTination<1|2>**

This command selects the printer output medium (Disk, Printer or Clipboard) associated with configuration 1 or 2.

**Note:** *The type of instrument is selected with `SYSTEM:COMMunicate:PRINter:SElect <1|2>`, which will automatically select a default output medium. Therefore the `HCOPy:DESTination<1|2>` command should always be sent after setting the device type.*

**Parameter**

- MMEM Directs the hardcopy to a file. The `MMEMory:NAME` command defines the file name. All formats can be selected for `HCOPy:DEvice:LANGuage<1|2>`.
- SYST:COMM:PRIN Directs the hardcopy to the printer. The printer is selected with the `SYSTEM:COMMunicate:PRINter:SElect <1|2>` command.  
 GDI should be selected for `HCOPy:DEvice:LANGuage<1|2>`.
- SYST:COMM:CLIP Directs the hardcopy to the clipboard. EWMF should be selected for `HCOPy:DEvice:LANGuage<1|2>`.

**Example**

SYST:COMM:PRIN:SEL2 'LASER on LPT1'  
 Selects the printer and output medium for device 2.  
 HCOP:DEST2 'SYST:COMM:PRIN'  
 Selects the printer interface as device 2.

**Characteristics**

\*RST value: SYST:COMM:CLIP  
 SCPI: conform

**Mode**

all

**HCOPY:DEvIce:COLor**

This command selects between color and monochrome hardcopy of the screen.

**Parameter**

ON | OFF

**Example**

HCOP:DEV:COL ON

**Characteristics**

\*RST value: OFF

SCPI: conform

**Mode**

all

**HCOPY:DEvIce:LANGUage<1|2>**

This command determines the data format of the printout.

**Parameter**

GDI	Graphics Device Interface: Default format for the output to a printer configured under Windows. Must be selected for the output to the printer interface. Can be used for the output to a file. The printer driver configured under Windows is used in this case and a printer-specific file format is thus generated. (see also <a href="#">HCOPY:DESTination&lt;1 2&gt;</a> command)
WMF, EWMF	WINDOWS Metafile and Enhanced Metafile Format: Data formats for output files which can be integrated in corresponding programs for documentation purposes at a later time. WMF can only be used for output to a file and EWMF also for the output to the clipboard. (see also <a href="#">HCOPY:DESTination&lt;1 2&gt;</a> command)
BMP, JPG, PNG	Data format for output to files only.

**Example**

HCOP:DEV:LANG WMF

**Characteristics**

\*RST value: -

SCPI: conform

**Mode**

all

**HCOPy:ITEM:ALL**

This command selects the complete screen to be output.

The hardcopy output is always provided with comments, title, time and date. As an alternative to the whole screen, e.g. only traces ([HCOPy:ITEM:WINDow<1|2>:TRACe:STATe](#) command) can be output.

**Example**

HCOP:ITEM:ALL

**Characteristics**

\*RST value: -

SCPI: conform

**Mode**

all

**HCOPy:ITEM:WINDow<1|2>:TEXT**

This command defines the comment text for the printout.

The numeric suffixes <1|2> are irrelevant for this command.

**Parameter**

<string> with a maximum of 100 characters; line feed by means of character @

**Example**

HCOP:ITEM:WIND:TEXT 'comment'

**Characteristics**

RST value: -

SCPI: device-specific

**Mode**

all

**HCOPy:ITEM:WINDow<1|2>:TRACe:STATe**

This command selects the output of the currently displayed trace.

The numeric suffixes <1|2> are irrelevant for this command.

Both the [HCOPy:ITEM:WINDow<1|2>:TRACe:STATe](#) command and the [HCOPy:ITEM:ALL](#) command enable the output of the whole screen.

**Parameter**

ON | OFF

**Example**

HCOP:ITEM:WIND:TRACe:STAT ON

**Characteristics**

\*RST value: OFF

SCPI: device-specific

**Mode**

all

**HCOPY:PAGE:ORIENTATION<1|2>**

---

The command selects the format of the output (portrait and landscape) (hardcopy unit 1 or 2).

**Note:** *The command is only available provided that the output device "printer" (HCOPY:DESTINATION<1|2>) has been selected.*

**Parameter**

LANDscape | PORTrait

**Example**

```
HCOPY:PAGE:ORI LAND
```

**Characteristics**

\*RST value: PORT

SCPI: conform

**Mode**

all

---

**HCOPY:TDSTAMP::STATE<1|2>**

---

This command activates and deactivates if the time and date are on the printout.

The numeric suffixes <1|2> define the print device number.

**Parameter**

ON | OFF

**Example**

```
HCOPY:TDST:STAT OFF
```

Deactivates the time and time for printouts.

```
HCOPY:TDST:STAT?
```

Queries if time and date are activated or not.

**Characteristics**

\*RST value: OFF

SCPI: device-specific

**Mode**

all

---

## INSTRument Subsystem

The INSTRument subsystem selects the operating mode of the unit either via text parameters or fixed numbers.

### Commands of the INSTRument Subsystem

- INSTRument[:SElect]
- INSTRument:NSElect

---

#### INSTRument[:SElect]

This command switches between the measurement modes by means of text parameters.

##### Parameter

RECeiver     EMI Test Receiver  
SANalyzer    Spectrum Analyzer

The parameters of the other measurement modes are included in the option descriptions.

##### Example

```
INST SAN
```

Switches the instrument to spectrum analyzer mode.

##### Characteristics

\*RST value: SANalyzer  
SCPI: conform

##### Mode

all

---

#### INSTRument:NSElect

This command switches between the measurement modes by means of numbers.

##### Parameter

1     spectrum analyzer  
6     receiver

The parameters of the other measurement modes are included in the option descriptions.

##### Example

```
INST:NSEL 1
```

Switches the instrument to spectrum analyzer mode.

##### Characteristics

\*RST value: 1  
SCPI: conform

##### Mode

all

---

## MMEMory Subsystem

The MMEMory (mass memory) subsystem provides commands which allow for access to the storage media of the instrument and for storing and loading various instrument settings.

The various drives can be addressed via the "mass storage unit specifier" <msus> using the conventional DOS syntax. The internal hard disk is addressed by "C:". For details on drives refer to chapter 4 "Instrument Functions - Basic Settings", section "Saving and Recalling Settings Files - FILE Key".

The file names <file\_name> are indicated as string parameters with the commands being enclosed in quotation marks. They also comply with DOS conventions.

DOS file names consist of max. 8 ASCII characters and an extension of up to three characters separated from the file name by a dot "." Both, the dot and the extension are optional. The dot is not part of the file name. DOS file names do not distinguish between uppercase and lowercase notation. All letters and digits are permitted as well as the special characters "\_", "^", "\$", "~", "!", "#", "%", "&", "-", "{", "}", "(", ")", "@ and """. Reserved file names are CLOCK\$, CON, AUX, COM1 to COM4, LPT1 to LPT3, NUL and PRN.

The two characters "\*" and "?" have the function of so-called "wildcards", i.e., they are variables for selection of several files. The question mark "?" replaces exactly one character, the asterisk means any of the remaining characters in the file name. "\*.\*" thus means all files in a directory.

### Commands of the MMEMory Subsystem

- MMEMory:CATalog?
- MMEMory:CDIRectory
- MMEMory:CLEar:ALL
- MMEMory:CLEar:STATe
- MMEMory:COMMeNt
- MMEMory:COpy
- MMEMory:DATA
- MMEMory:DELeTe
- MMEMory:LOAD:AUTO
- MMEMory:LOAD:STATe
- MMEMory:MDIRectory
- MMEMory:MOVE
- MMEMory:MSIS
- MMEMory:NAME
- MMEMory:NETWork:MAP
- MMEMory:NETWork:DISConnect
- MMEMory:NETWork:UNUSeddrives?
- MMEMory:NETWork:USEDdrives?
- MMEMory:RDIRectory
- MMEMory:SELEct[:ITEM]:ALL
- MMEMory:SELEct[:ITEM]:CLISt
- MMEMory:SELEct[:ITEM]:DEFault

- MMEemory:SElect[:ITEM]:FINAl
- MMEemory:SElect[:ITEM]:HWSettings
- MMEemory:SElect[:ITEM]:LINes:ALL
- MMEemory:SElect[:ITEM]:NONE
- MMEemory:SElect[:ITEM]:SCData (models 13 and 16)
- MMEemory:SElect[:ITEM]:TRACe[:ACTive]
- MMEemory:SElect[:ITEM]:TRANsducer:ALL
- MMEemory:STORe:FINAl
- MMEemory:STORe:SPURious
- MMEemory:STORe<1|2>:LIST
- MMEemory:STORe<1|2>:PEAK
- MMEemory:STORe<1|2>:STATe
- MMEemory:STORe<1|2>:STATe:NEXT
- MMEemory:STORe<1|2>:TRACe

---

**MMEemory:CATalog?**

---

This command reads the indicated directory. According to DOS convention, wild card characters can be entered in order to query e.g. a list of all files of a certain type.

This command is an event and therefore has no \*RST value and no query.

**Parameter**

<path> = DOS Path name

The path name should be in conformance with DOS conventions and may also include the drive name.

**Example**

```
MMEemory:CAT? 'C:\R_S\Instr\user\*.DFL'
```

Returns all files in C:\R\_S\Instr\user with extension ".DFL"

```
MMEemory:CAT? 'C:\R_S\Instr\user\SPOOL?.WMF'
```

Returns all files in C:\R\_S\Instr\user whose names start with SPOOL, have 6 letters and the extension ".WMF".

**Response value**

List of file names in the form of strings separated by commas, i.e.

SPOOL1.WMF,SPOOL2.WMF,SPOOL3.WMF

**Characteristics**

\*RST value: -

SCPI: conform

**Mode**

all

---



**MMEMory:CDIRectory**

---

This command changes the current directory.

**Parameter**

<directory\_name> = DOS path name

In addition to the path name, the indication of the directory may contain the drive name. The path name complies with the DOS conventions.

**Example**

```
MMEM:CDIR 'C:\R_S\Instr\user'
```

Selects the directory C:\R\_S\Instr\user.

**Characteristics**

\*RST value: -

SCPI: conform

**Mode**

all

---

**MMEMory:CLEar:ALL**

---

This command deletes all settings files in the current directory. The current directory can be selected with the [MMEMory:CDIRectory](#) command. The default directory is C:\R\_S\Instr\user.

This command is an event and therefore has no \*RST value and no query.

**Example**

```
MMEM:CLEAR:ALL
```

**Characteristics**

\*RST value: -

SCPI: device-specific

**Mode**

all

---

**MMEMory:CLEar:STATe**

---

This command deletes the instrument settings file selected by <file\_name>. All associated files on the mass memory storage are cleared.

This command is an event and therefore has no \*RST value and no query.

**Parameter**

1,<file\_name>

with <file\_name> = DOS file name without extension

The file name includes indication of the path and may also include the drive. The path name complies with DOS conventions.

**Example**

```
MMEM:CLEAR:STAT 1, 'TEST'
```

**Characteristics**

\*RST value: -

SCPI: device-specific

**Mode**

all

---

**MMEMory:COMMeNT**

---

This command defines a comment (max. 60 characters) for a device setting to be stored.

**Example**

```
MMEM:COMM 'Setup for FM measurement'
```

**Characteristics**

\*RST value: blank comment

SCPI: device-specific

**Mode**

R, A

---

**MMEMory:COpy**

---

This command copies the files indicated in <file\_source> to the destination directory indicated with <file\_destination> or to the destination file indicated by <file\_destination> if <file\_source> is just a file.

This command is an event and therefore has no \*RST value and no query.

**Parameter**

<file\_source>, <file\_destination> = <file\_name> = DOS file name

The indication of the file name may include the path and the drive name. The file names and path information must be in accordance with the DOS conventions.

**Example**

```
MMEM:COpy 'C:\R_S\Instr\user\SETUP.CFG', 'E:'
```

**Characteristics**

\*RST value: -

SCPI: conform

**Mode**

all

---

**MMEMory:DATA**

---

This command writes the block data contained in <block> into the file characterized by <file\_name>. The delimiter must be set to EOI to obtain error-free data transfer.

The associated query command reads the indicated file from the mass memory and transfers it to the remote control computer. It should be noted that the buffer memory of the control computer should be large enough to store the file. The setting of the delimiter is irrelevant in this case.

The command is useful for reading stored settings files or trace data from the instrument or for transferring them to the instrument.

**Parameter**

<file\_name>[,<block>]

<file\_name> selects the file to be transferred

<block> binary data block with the following structure:

- character '#'
- digit for the length of the length information
- indicated number of digits as length information (number of bytes) for the binary data themselves
- binary data with the indicated number of bytes

**Example**

MMEM:DATA 'TEST01.HCP,#216This is the file'

means: #2: the next 2 characters are the length indication; 16: number of subsequent binary data bytes; This is the file: 16 bytes stored as binary data in the file TEST01.HCP.

MMEM:DATA? 'TEST01.HCP'

Transfers the file TEST01.HCP from the instrument to the control computer.

**Characteristics**

\*RST value: -

SCPI: conform

**Mode**

all

**MMEMory:DELeTe**

This command deletes the indicated files.

**Parameter**

<file\_name> = DOS file name

The indication of the file name contains the path and, optionally, the drive name. Indication of the path complies with DOS conventions.

**Example**

MMEM:DEL 'TEST01.HCP'

The file TEST01.HCP is deleted.

**Characteristics**

\*RST value: -

SCPI: conform

**Mode**

all

---

**MMEMemory:LOAD:AUTO**

---

This command defines which settings file is automatically loaded after the device is switched on. The contents of the file are read after switching on the device and used to define the new device state.

The settings file defined as auto recall set can also be restored by the \*RST command.

This command is an event and therefore has no \*RST value and no query.

**Parameter**

- 1,'FACTORY'       deactivates the startup recall function  
1,'<file\_name>'    activates the startup recall function and defines the settings file to be loaded

with <file\_name> = DOS file name without extension

The file name includes indication of the path and may also include the drive name. The path name complies with DOS conventions.

**Example**

```
MME:LOAD:AUTO 1, 'C:\R_S\Instr\user\TEST'
```

**Characteristics**

\*RST value: -

SCPI: device-specific

**Mode**

all

---

**MMEMemory:LOAD:STATe**

---

This command loads the device settings from \*.FSL.dfl files. The contents of the file are loaded and set as the new device state.

**Parameter**

1,<file\_name>

with <file\_name> = DOS file name without extension

The file name includes indication of the path and may also include the drive name. The path name complies with DOS conventions.

**Example**

```
MME:LOAD:STAT 1, 'C:\R_S\Instr\user\TEST01'
```

**Characteristics**

\*RST value: -

SCPI: conform

**Mode**

all

---

**MMEMemory:MDIRectory**

---

This command creates a new directory. The file name includes indication of the path and may also include the drive name. The path name complies with DOS conventions.

This command is an event and therefore has no \*RST value and no query.

**Parameter**

<directory\_name> = DOS path name

**Example**

```
MMEM:MDIR 'C:\R_S\Instr\user'
```

**Characteristics**

\*RST value: -

SCPI: device-specific

**Mode**

all

---

**MMEMory:MOVE**

This command renames existing files, if <file\_destination> contains no path indication. Otherwise the file is moved to the indicated path and stored under the file name specified there, if any.

This command is an event and therefore has no \*RST value and no query.

**Parameter**

<file\_source>, <file\_destination> = <file\_name> = DOS file name

The file name includes indication of the path and may also include the drive. The path name complies with DOS conventions.

**Example**

```
MMEM:MOVE 'C:\TEST01.CFG', 'SETUP.CFG'
```

Renames TEST01.CFG in SETUP.CFG in directory C:\.

```
MMEM:MOVE 'C:\TEST01.CFG', 'C:\R_S\Instr\user'
```

Moves TEST01.CFG from C:\ to C:\R\_S\Instr\user.

```
MMEM:MOVE 'C:\TEST01.CFG', 'C:\R_S\Instr\user\SETUP.CFG'
```

Moves TEST01.CFG from C:\ to C:\R\_S\Instr\user and renames the file in SETUP.CFG.

**Characteristics**

\*RST value: -

SCPI: conform

**Mode**

all

---

**MMEMory:MSIS**

This command changes to the drive indicated. The drive may be the internal hard disk C:.

**Parameter**

<device> = A: | C: ... Z:

The path name complies with DOS conventions.

**Example**

```
MMEM:MSIS 'C:'
```

**Characteristics**

\*RST value: "C:"

SCPI: conform

**Mode**

all

---

**MMEMory:NAME**

---

This command defines a destination file for the printout started with the `HCOPY[:IMMEDIATE<1|2>]` command. In this case the printer output must be routed to a file as destination.

This command is an event and therefore has no \*RST value and no query.

**Parameter**

<file\_name> = DOS file name

The file name includes indication of the path and may also include the drive name. The file name and path information comply with DOS conventions.

**Example**

```
MMEM:NAME 'C:\R_S\instr\user\PRINT1.BMP'
```

Selects the file name.

**Characteristics**

\*RST value: -

SCPI: conform

**Mode**

all

---

**MMEMory:NETWork:MAP**

---

This command maps a drive to a server or server folder of the network. As a prerequisite in Microsoft networks, sharing of this server or server folder must be enabled.

This command is an event and therefore has no \*RST value and no query.

**Parameter**

```
'<string>','<string>','<string>','<string>],[<Boolean>]
```

with     '<string>','<string>' = '<drive>','<\host name or IP address\share name>'  
          [,<string>','<string>],[<Boolean>] = '<user name>','<password>',ON | OFF for  
          connecting under a different user name, and enabling/disabling reconnect at logon.

The entry is optional. The Boolean parameter can be omitted.

**Example**

```
MMEM:NETW:MAP 'T:', '\\server\folder'
```

Maps drive T: to folder on server.

**Characteristics**

RST value: -

SCPI: device-specific

**Mode**

all

---

**MMEMory:NETWork:DISConnect**

---

This command disconnects the selected drive.

This command is an event and therefore has no \*RST value and no query.

**Parameter**

'<string>' = <drive name>

**Example**

```
MMEM:NETW:DISC 'T:'  
Disconnects network drive T:
```

**Characteristics**

RST value: -

SCPI: device-specific

**Mode**

all

---

**MMEMory:NETWork:UNUSeddrives?**

---

This command lists all unused network drive names.

This command is only a query and therefore has no \*RST value.

**Example**

```
MMEM:NETW:UNUS?  
Lists all unused network drive names.
```

**Characteristics**

RST value: -

SCPI: device-specific

**Mode**

all

---

**MMEMory:NETWork:USEDdrives?**

---

This command lists all mapped network drives.

**Parameter**

ON Lists all mapped network drives including the folder information.

OFF Lists all mapped network drive names.

**Example**

```
MMEM:NETW:USED ON  
Lists all mapped network drives including the folder information.
```

**Characteristics**

RST value: OFF

SCPI: device-specific

**Mode**

all

---

**MMEMemory:RDIRectory**

---

This command deletes the indicated directory. The directory name includes indication of the path and may also include the drive name. The path name complies with DOS conventions.

This command is an event and therefore has no \*RST value and no query.

**Parameter**

<directory\_name> = DOS path name

**Example**

```
MMEMemory:RDIR 'C:\TEST'
```

**Characteristics**

\*RST value: -

SCPI: device-specific

**Mode**

all

---

**MMEMemory:SElect[:ITEM]:ALL**

---

This command includes all data subsets in the list of device settings to be stored/loaded.

This command is an event and therefore has no \*RST value.

**Example**

```
MMEMemory:SEL:ALL
```

**Characteristics**

\*RST value: -

SCPI: device-specific

**Mode**

all

---

**MMEMemory:SElect[:ITEM]:FINal**

---

This command includes the final measurement data in the list of partial datasets of a device setting to be stored/loaded.

**Parameter**

ON | OFF

**Example**

```
"MMEMemory:SEL:FIN ON"
```

inserts the final measurement data in the list of partial data sets

**Characteristics:**

\*RST value: ON

SCPI: device-specific

**Mode**

R, A

---



**MMEMory:SElect[:ITEM]:DEFault**

---

This command includes the default list in the settings file to be stored/loaded. For details on hardware settings refer to the [MMEMory:SElect\[:ITEM\]:HWSettings](#) command.

**Example**

```
MMEM:SEL:DEFault
```

**Characteristics**

\*RST value: -

SCPI: device-specific

**Mode**

all

---

**MMEMory:SElect[:ITEM]:HWSettings**

---

This command includes the hardware settings in the settings file to be stored/loaded. The hardware settings include:

- current configuration of general device parameters (general setup)
- current setting of the measurement hardware including markers
- activated limit lines:

A settings file may include 8 limit lines at maximum. This number includes the activated limit lines and, if available, the de-activated limit lines last used.

Therefore the combination of the non-activated restored limit lines depends on the sequence of use with the [MMEMory:LOAD:STATE](#) command.

- user-defined color setting
- configuration for the hardcopy output
- tracking generator settings (models 13 and 16)
- correction data for source calibration (models 13 and 16)

**Parameter**

ON | OFF

**Example**

```
MMEM:SEL:HWS ON
```

**Characteristics**

\*RST value: ON

SCPI: device-specific

**Mode**

all

---

**MMEMemory:SElect[:ITEM]:LINes:ALL**

---

This command includes all limit lines (activated and de-activated) in the settings file to be stored/loaded.

**Parameter**

ON | OFF

**Example**

```
MMEM:SEL:LIN:ALL ON
```

**Characteristics**

\*RST value: ON

SCPI: device-specific

**Mode**

all

---

**MMEMemory:SElect[:ITEM]:NONE**

---

This command excludes all items from the settings file to be stored/loaded.

This command is an event and therefore has no \*RST value.

**Example**

```
MMEM:SEL:NONE
```

**Characteristics**

\*RST value: -

SCPI: device-specific

**Mode**

all

---

**MMEMemory:SElect[:ITEM]:CLISt**

---

This command includes the scan channel list to be stored/loaded.

**Parameter**

ON | OFF

**Example**

```
MMEM:SEL:CLIS ON
```

inserts the scan channel list to the list of partial data sets

**Characteristics:**

\*RST value: OFF

SCPI: device-specific

**Mode**

R, A

---

**MMEMory:SElect[:ITEM]:SCData (models 13 and 16)**

---

This command includes the tracking generator calibration data in the settings file to be stored/loaded.

This command is only available in conjunction with the tracking generator.**Parameter**  
ON | OFF

**Example**

```
MMEM:SEL:SCD ON
```

Adds the tracking generator correction data to the items list.

**Characteristics**

\*RST value: OFF

SCPI: device-specific

**Mode**

all

---

**MMEMory:SElect[:ITEM]:TRACe[:ACTive]**

---

This command includes the active traces in the settings file to be stored/loaded. Active traces are all traces whose state is not blank.

**Parameter**

ON | OFF

**Example**

```
MMEM:SEL:TRAC ON
```

**Characteristics**

\*RST value: OFF, i.e. no traces will be stored

SCPI: device-specific

**Mode**

all

---

**MMEMory:SElect[:ITEM]:TRANsducer:ALL**

---

This command includes all transducer factors and sets in the settings file to be stored/loaded.

**Parameter**

ON | OFF

**Example**

```
MMEM:SEL:TRAN:ALL ON
```

**Characteristics**

\*RST value: ON

SCPI: device-specific

**Mode**

all

---

**MMEMemory:STOR:FINal**

---

This command stores the final measurement data in an ASCII file. The file name includes indication of the path and may also include the drive. The path name corresponds to the DOS conventions.

This command is an event and therefore has no \*RST value and no query.

**Parameter**

<file\_name> := DOS file name

**Example**

```
" :MME:STOR:FIN 'A:\TEST.ASC' "
```

**Characteristics**

\*RST value: -

SCPI: device-specific

**Mode**

R

---

**MMEMemory:STOR:SPURious**

---

This command stores the peak list in an ASCII file to a file on a disk.

The file has a header containing important parameters for scaling, several data sections containing the sweep settings per range and a data section containing the peak list.

The header data is made up of three columns, separated by ';': parameter name; numeric value; base unit

The data section for the measurement values starts with the key word "TRACE <n>:", where <n> includes the number of the used trace. Next comes the peak list with several columns also separated by ';':

Spreadsheet programs such as MS Excel can read this format. Use ';' as the delimiter for the table cells.

**Note:** *Different language versions of evaluation programs may require different handling of the decimal point. Using the DECIM SEP softkey, you can thus choose between the delimiters '.' (decimal point) and ',' (comma).*

**Parameter**

<file\_name> := DOS file name

**Example**

```
MME:STOR:SPUR 'D:\TEST.ASC'
```

**Characteristics:**

\*RST value: -

SCPI: device-specific

**Mode:**

R

---

---

**MMEMory:STORe<1|2>:LIST**

---

This command stores the current list evaluation results in a \*.dat file. The file consists of a data section containing the list evaluation results.

The numeric suffixes <1|2> are not relevant.

This command is an event and therefore has no \*RST value and no query.

**Example**

```
MMEM:STOR:LIST 'test'
```

Stores the current list evaluation results in the a test.dat file.

**Characteristics**

RST value: -

SCPI: device-specific

**Mode**

A

---

---

**MMEMory:STORe<1|2>:PEAK**

---

This command stores the current marker peak list in a \*.dat file. The file consists of a data section containing the peak list.

The numeric suffixes <1|2> are irrelevant for this command.

This command is an event and therefore has no \*RST value and no query.

**Parameter**

<file\_name> = DOS file name without extension

The file name includes the indication of the path and may also include the drive name. The path name complies with DOS conventions.

**Example**

```
MMEM:STOR:PEAK 'test'
```

Saves the current marker peak list in the file test.dat.

**Characteristics**

RST value: -

SCPI: device-specific

**Mode**

all

---

---

**MMEMory:STORe<1|2>:STATe**

---

This command stores the current device settings in a \*.FSL.dfl file.

The numeric suffixes <1|2> are irrelevant for this command.

This command is an event and therefore has no \*RST value and no query.

**Parameter**

1,<file\_name>

with <file\_name> = DOS file name without extension

The file name includes the indication of the path and may also include the drive name. The path name complies with DOS conventions.

---

**Example**

MMEM:STOR:STAT 1, 'Save'

Saves the current device settings in the file Save.FSL.dfl.

**Characteristics**

\*RST value: -

SCPI: conform

**Mode**

all

**MMEMemory:STORe<1|2>:STATe:NEXT**

This command stores the current device settings in a \*.FSL.dfl file. The file name used in the last saving process is automatically counted up to the next unused name. The numeric suffix in STORe<1|2> is irrelevant with this command.

This command is an event and therefore has no \*RST value and no query.

**Example**

MMEM:STOR:STAT 1, 'Save'

Saves the current device settings in the file Save.FSL.dfl.

MMEM:STOR:STAT:NEXT

Saves the current device settings in the file Save\_001.FSL.dfl

MMEM:STOR:STAT:NEXT

Saves the current device settings in the file Save\_002.FSL.dfl

**Characteristics**

RST value: -

SCPI: device-specific

**Mode**

all

**MMEMemory:STORe<1|2>:TRACe**

This command stores the selected trace in a file with ASCII format. The file format is described in chapter 4 "Instrument Functions - Receiver", section "Selecting and Setting of Traces – TRACE Key", **ASCII File Export** softkey and "Instrument Functions - Analyzer", section "Setting Traces - TRACE Key", **ASCII File Export** softkey.

The decimal separator (decimal point or comma) for floating-point numerals contained in the file is defined with the `FORMat:DEXPort:DSEParator` command.

This command is an event and therefore has no \*RST value and no query.

**Parameter**

1 to 6, <file\_name>

with 1 to 6 = selected measurement curve trace 1 to 6 and <file\_name> = DOS file name

The file name includes indication of the path and the drive name. Indication of the path complies with DOS conventions.

**Example**

MMEM:STOR:TRAC 3, 'TEST.ASC'  
Stores trace 3 in the file TEST.ASC.

**Characteristics**

\*RST value: -  
SCPI: device-specific

**Mode**

all

---

## **OUTPut Subsystem (Option Additional Interfaces, B5)**

The OUTPut subsystem controls the output features of the instrument.

### **Commands of the OUTPut Subsystem**

- `OUTPut<1|2>:IF[:SOURce]`

#### **OUTPut<1|2>:IF[:SOURce]**

---

This command switches the source of the IF output between the demodulated signal (2 possible values) and the IF signal.

**Note:** *The AF output available at the frontpanel can only be used if the IF output source is set to video.*

#### **Parameter**

IF	intermediate frequency output
VIDeo	video output, 200 mV
HVIDeo	video output, 1V

#### **Example**

```
OUTP IF VID
```

Selects the video signal for the IF output connector.

#### **Characteristics**

\*RST value: IF

SCPI: conform

#### **Mode**

A

---



## SENSe Subsystem

The SENSe subsystem is organized in several subsystems. The commands of these subsystems directly control device-specific settings; they do not refer to the signal characteristics of the measurement signal.

The SENSe subsystem controls the essential parameters of the analyzer. In accordance with the SCPI standard, the keyword "SENSe" is optional for this reason, which means that it is not necessary to include the SENSe node in command sequences.

The following subsystems are included:

- "SENSe:CORRection Subsystem (Models 13 and 16)" on page 6.381
- "SENSe:ROSCillator Subsystem" on page 6.381

### SENSe:CORRection Subsystem (Models 13 and 16)

This subsystem controls calibration and normalization during operation with the tracking generator.

#### Commands of the SENSe:CORRection Subsystem

- [SENSe<1|2>:]CORRection:TRANsdUcer[:STATe]
- [SENSe<1|2>:]CORRection:TRANsdUcer:ADJust:RLEVel[:STATe]
- [SENSe<1|2>:]CORRection:TRANsdUcer:COMMent
- [SENSe<1|2>:]CORRection:TRANsdUcer:DATA
- [SENSe<1|2>:]CORRection:TRANsdUcer:DELeTe
- [SENSe<1|2>:]CORRection:TRANsdUcer:SCALing
- [SENSe<1|2>:]CORRection:TRANsdUcer:SELeCt
- [SENSe<1|2>:]CORRection:TRANsdUcer:UNIT
- [SENSe<1|2>:]CORRection:TRANsdUcer:VIEW

#### [SENSe<1|2>:]CORRection:TRANsdUcer[:STATe]

---

This command switches the selected transducer factor on or off.

**Note:** Prior to this command, the [SENSe<1|2>:]CORRection:TRANsdUcer:SELeCt command must be sent.

#### Parameter

ON | OFF

#### Example

CORR:TRAN ON

#### Characteristics

\*RST value: OFF

SCPI: device-specific

#### Mode A

---

**[SENSe<1|2>:]CORRection:TRANsducer:ADJust:RLEVeI[:STATe]**

This command switches the automatic adjustment of the reference level to the selected transducer factor on or off. For details refer to chapter 4, section "Instrument Setup and Interface Configuration - SETUP Key", **Ref Level Adjust Man/Auto** softkey.

**Note:** Prior to this command, the `[SENSe<1|2>:]CORRection:TRANsducer:SElect` command must be sent.

**Parameter**

ON | OFF

**Example**

```
CORR:TRAN:ADJ:RLEV ON
```

**Characteristics**

\*RST value: OFF

SCPI: device-specific

**Mode**

A

**[SENSe<1|2>:]CORRection:TRANsducer:COMMeNt**

This command defines the comment for the selected transducer factor.

**Note:** Prior to this command, the `[SENSe<1|2>:]CORRection:TRANsducer:SElect` command must be sent.

**Parameter**

<string>

**Example**

```
CORR:TRAN:COMM 'FACTOR FOR ANTENNA'
```

**Characteristics**

\*RST value: (empty comment)

SCPI: device-specific

**Mode A****[SENSe<1|2>:]CORRection:TRANsducer:DATA**

This command defines the reference values of the transducer factor selected. These values are entered as a sequence of frequency/level pairs. The frequencies must be sent in ascending order.

**Note:** Prior to this command, the `[SENSe<1|2>:]CORRection:TRANsducer:SElect` command must be sent. The level values are sent as dimensionless numbers; the unit is specified by means of the `[SENSe<1|2>:]CORRection:TRANsducer:UNIT` command.

**Parameter**

<freq>, <level>

**Example**

```
SENS:CORR:TRAN:SEL 'TRAN_1'
```

Selects the transducer factor

CORR:TRAN:UNIT 'DB'

Selects the unit for the transducer.

CORR:TRAN:DATA 1MHZ, -30, 2MHZ, -40

Defines the frequency/level pairs 1 MHz, -30 dB and 2 MHz, -40 dB.

#### Characteristics

\*RST value: -

SCPI: device-specific

#### Mode

A

### [SENSe<1|2>:]CORRection:TRANsdUCer:DELeTe

This command deletes the selected transducer factor.

This command is an event and therefore has no \*RST value.

**Note:** Prior to this command, the [SENSe<1|2>:]CORRection:TRANsdUCer:SELeCt command must be sent.

#### Example

CORR:TRAN:DEL

#### Characteristics

\*RST value: -

SCPI: device-specific

#### Mode

A

### [SENSe<1|2>:]CORRection:TRANsdUCer:SCALIng

This command defines whether the frequency scaling of the transducer factor is linear or logarithmic.

**Note:** Prior to this command, the [SENSe<1|2>:]CORRection:TRANsdUCer:SELeCt command must be sent.

#### Parameter

LINear | LOGarithmic

#### Example

CORR:TRAN:SCAL LOG

#### Characteristics

\*RST value: LINear

SCPI: device-specific

#### Mode

A

### [SENSe<1|2>:]CORRection:TRANsdUCer:SELeCt

This command selects the transducer factor designated by <name>. If <name> does not exist yet, a new transducer factor is created.

**Note:** This command must be sent prior to the subsequent commands for modifying/activating transducer factors.

**Parameter**

<name> = Name of the transducer factor in string data form with a maximum of 8 characters.

**Example**

```
CORR:TRAN:SEL 'FACTOR1'
```

**Characteristics**

\*RST value: -

SCPI: device-specific

**Mode**

A

---

**[SENSe<1|2>:]CORRection:TRANsducer:UNIT**

This command defines the unit of the transducer factor selected.

**Note:** Prior to this command, the `[SENSe<1|2>:]CORRection:TRANsducer:SElect` command must be sent.

**Parameter**

<string> = DB | DBM | DBMV | DBUV | DBUV/M | DBUA DBUA/M | DBPW | DBPT

**Example**

```
CORR:TRAN:UNIT 'DBUV'
```

**Characteristics**

\*RST value: DB

SCPI: device-specific

**Mode**

A

---

**[SENSe<1|2>:]CORRection:TRANsducer:VIEW**

This command switches on the display of the active transducer factor or set.

**Note:** Prior to this command, the `[SENSe<1|2>:]CORRection:TRANsducer:SElect` command must be sent.

**Parameter**

ON | OFF

**Example**

```
CORR:TRAN:VIEW ON
```

**Characteristics**

\*RST value: OFF

SCPI: device-specific

**Mode**

A

---

**SENSe:ROSCillator Subsystem**

This subsystem controls the reference oscillator. The numeric suffix in SENSe is irrelevant for the commands of this subsystem.

**Commands of the SENSe:ROSCillator Subsystem**

– [SENSe<1|2>:]ROSCillator:SOURce

**[SENSe<1|2>:]ROSCillator:SOURce**

---

This command controls selection of the reference oscillator.

If the external reference oscillator is selected, the reference signal must be connected to the rear panel of the instrument.

**Parameter**

INTernal | EXTernal

**Example**

ROSC:SOUR EXT

**Characteristics**

\*RST value: -

SCPI: conform

**Mode**

all

---

## SOURce Subsystem

The SOURce subsystem controls the output signals of the instrument.

### Commands of the SOURce Subsystem

- [SOURce<1|2>:EXTernal<1|2>:ROSCillator\[:SOURce\]](#)
- [SOURce:TEMPerature:APRobe?](#)

---

#### **SOURce<1|2>:EXTernal<1|2>:ROSCillator[:SOURce]**

---

This command switches between external and internal reference oscillator.

**Parameter**

INTernal | EXTernal

**Example**

```
SOUR:EXT:ROSC EXT
```

Switches to external reference oscillator

**Characteristics**

\*RST value: INT

SCPI: device-specific

**Mode**

all

---

---

#### **SOURce:TEMPerature:APRobe?**

---

This command queries the sensor temperature.

**Parameter**

1 (CPU)

**Example**

```
SOUR:TEMP:APR? 1
```

Queries the temperature of the CPU sensor.

**Characteristics**

RST value: -

SCPI: device-specific

**Mode**

all

---

## STATus Subsystem

The STATus subsystem contains the commands for the status reporting system (see the Operating Manual on CD-ROM, chapter 5 "Remote Control - Basics"). \*RST does not influence the status registers.

### Commands of the STATus Subsystem

- STATus:OPERation[:EVENT]?
- STATus:OPERation:CONDition?
- STATus:OPERation:ENABLE
- STATus:OPERation:PTRansition
- STATus:OPERation:NTRansition
- STATus:PRESet
- STATus:QUEStionable[:EVENT]?
- STATus:QUEStionable:CONDition?
- STATus:QUEStionable:ENABLE
- STATus:OPERation:PTRansition
- STATus:QUEStionable:NTRansition
- STATus:QUEue[:NEXT?]

#### STATus:OPERation[:EVENT]?

---

This command queries the contents of the EVENT section of the STATus:OPERation register. The contents of the EVENT section are deleted after readout.

##### Example

```
STAT:OPER?
```

##### Characteristics

\*RST value: -

SCPI: conform

##### Mode

all

---

#### STATus:OPERation:CONDition?

---

This command queries the CONDition section of the STATus:OPERation register. Readout does not delete the contents of the CONDition section. The value returned reflects the current hardware status.

##### Example

```
STAT:OPER:COND?
```

##### Characteristics

\*RST value: -

SCPI: conform

##### Mode

all

**STATus:OPERation:ENABle**

---

This command sets the bits of the ENABle section of the STATus:OPERation register. The ENABle register selectively enables the individual events of the associated EVENT section for the summary bit in the status byte.

**Parameter**

0 to 65535

**Example**

```
STAT:OPER:ENAB 65535
```

**Characteristics**

\*RST value: -

SCPI: conform

**Mode**

all

---

**STATus:OPERation:PTRansition**

---

This command sets the edge detectors of all bits of the STATus:OPERation register from 0 to 1 for the transitions of the CONDition bit.

**Parameter**

0 to 65535

**Example**

```
STAT:OPER:PTR 65535
```

**Characteristics**

\*RST value: -

SCPI: conform

**Mode**

all

---

**STATus:OPERation:NTRansition**

---

This command sets the edge detectors of all bits of the STATus:OPERation register from 1 to 0 for the transitions of the CONDition bit.

**Parameter**

0 to 65535

**Example**

```
STAT:OPER:NTR 65535
```

**Characteristics**

\*RST value: -

SCPI: conform

**Mode**

all

---



**STATus:PRESet**

---

This command resets the edge detectors and ENABle parts of all registers to a defined value. All PTRansition parts are set to FFFFh, i.e. all transitions from 0 to 1 are detected. All NTRansition parts are set to 0, i.e. a transition from 1 to 0 in a CONDition bit is not detected. The ENABle part of the STATus:OPERation and STATus:QUEStionable registers are set to 0, i.e. all events in these registers are not passed on.

**Example**

```
STAT:PRESet
```

**Characteristics**

\*RST value: -  
SCPI: conform

**Mode**

all

---

**STATus:QUEStionable[:EVENT]?**

---

This command queries the contents of the EVENT section of the STATus:QUEStionable register. The contents of the EVENT section are deleted after the readout.

**Example**

```
STAT:QUES?
```

**Characteristics**

\*RST value: -  
SCPI: conform

**Mode**

all

---

**STATus:QUEStionable:CONDition?**

---

This command queries the CONDition section of the STATus:QUEStionable register. Readout does not delete the contents of the CONDition section.

**Example**

```
STAT:QUES:COND?
```

**Characteristics**

\*RST value: -  
SCPI: conform

**Mode**

all

---

**STATus:QUEStionable:ENABle**

---

This command sets the bits of the ENABle section of the STATus:QUEStionable register. The ENABle register selectively enables the individual events of the associated EVENT section for the summary bit in the status byte.

**Parameter**

0 to 65535

---

**Example**

```
STAT:QUES:ENAB 65535
```

**Characteristics**

\*RST value: -

SCPI: conform

**Mode**

all

---

**STATus:QUEStionable:PTRansition**

---

This command sets the edge detectors of all bits of the STATus:QUEStionable register from 0 to 1 for the transitions of the CONDition bit.

**Parameter**

0 to 65535

**Example**

```
STAT:QUES:PTR 65535
```

**Characteristics**

\*RST value: -

SCPI: conform

**Mode**

all

---

**STATus:QUEStionable:NTRansition**

---

This command sets the edge detectors of all bits of the STATus:OPERation register from 1 to 0 for the transitions of the CONDition bit.

**Parameter**

0 to 65535

**Example**

```
STAT:QUES:NTR 65535
```

**Characteristics**

\*RST value: -

SCPI: conform

**Mode**

all

---

**STATus:QUEue[:NEXT?]**

---

This command queries the earliest error queue entry and deletes it.

Positive error numbers indicate device-specific errors, negative error numbers are error messages defined by SCPI. If the error queue is empty, the error number 0, "No error", is returned. This command is identical to the [SYSTem:ERRor\[:NEXT\]?](#) command.

**Example**

STAT:QUES?

**Characteristics**

\*RST value: -

SCPI: conform

**Mode**

all

---

## SYSTEM Subsystem

This subsystem contains a series of commands for general functions.

### Commands of the SYSTEM Subsystem

- SYSTem:COMMunicate:GPIB[:SELF]:ADDRess
- SYSTem:COMMunicate:GPIB[:SELF]:RTERminator
- SYSTem:COMMunicate:PRINter:ENUMerate[:NEXT?]
- SYSTem:COMMunicate:PRINter:ENUMerate:FIRSt?
- SYSTem:COMMunicate:PRINter:SElect <1|2>
- SYSTem:DATE
- SYSTem:DISPlay:FPANel
- SYSTem:DISPlay:UPDate
- SYSTem:ERRor[:NEXT]?
- SYSTem:ERRor:CLEar:ALL
- SYSTem:ERRor:LIST?
- SYSTem:FIRMware:UPDate
- SYSTem:FORMat:IDENT
- SYSTem:LANGuage
- SYSTem:PASSword[:CENable]
- SYSTem:PASSword:RESet
- SYSTem:PRESet
- SYSTem:TIME
- SYSTem:VERSion?

### SYSTem:COMMunicate:GPIB[:SELF]:ADDRess

---

This command changes the GPIB address of the unit.

**Parameter**

0 to 30

**Example**

```
SYST:COMM:GPIB:ADDR 18
```

**Characteristics**

\*RST value: - (no influence on this parameter, factory default 20)

SCPI: conform

**Mode**

all

---

**SYSTEM:COMMunicate:GPIB[:SELF]:RTERminator**

---

This command changes the GPIB receive terminator.

According to the standard the terminator in ASCII is <LF> and/or <EOI>. For binary data transfers (e.g. trace data) from the control computer to the instrument, the binary code (0AH) used for <LF> might be included in the binary data block, and therefore should not be interpreted as a terminator in this particular case. This can be avoided by changing the receive terminator to EOI.

Output of binary data from the instrument to the control computer does not require such a terminator change.

**Parameter**

LFEOI | EOI

**Example**

```
SYST:COMM:GPIB:RTER EOI
```

**Characteristics**

\*RST value: - (no influence on this parameter, factory default LFEOI)

SCPI: device-specific

**Mode**

all

---

**SYSTEM:COMMunicate:PRINter:ENUMerate[:NEXT?]**

---

This command queries the name of the next printer installed under Windows XP. After all available printer names have been output, an empty string enclosed by quotation marks (") is output for the next query. Further queries are answered by a query error.

The [SYSTEM:COMMunicate:PRINter:ENUMerate:FIRSt?](#) command should be sent previously to return to the beginning of the printer list and query the name of the first printer.

**Example**

```
SYST:COMM:PRIN:ENUM?
```

**Characteristics**

\*RST value: NONE

SCPI: device-specific

**Mode**

all

---

**SYSTEM:COMMunicate:PRINter:ENUMerate:FIRSt?**

---

This command queries the name of the first printer (in the list of printers) available under Windows XP.

The names of other installed printers can be queried with the [SYSTEM:COMMunicate:PRINter:ENUMerate\[:NEXT?\]](#) command.

If no printer is configured an empty string is output.

**Example**

```
SYST:COMM:PRIN:ENUM:FIRS?
```

**Characteristics**

\*RST value: NONE

SCPI: device-specific

**Mode**

all

---

**SYSTEM:COMMunicate:PRINter:SElect <1|2>**

---

This command selects one of the printers configured under Windows XP including the associated output destination.

The specified printer name must be a string as returned by the commands

`SYSTEM:COMMunicate:PRINter:ENUMerate:FIRSt?` or

`SYSTEM:COMMunicate:PRINter:ENUMerate[:NEXT?]`

**Note:** *The `HCOPY:DESTination<1|2>` command is used to select an output medium other than the default one.*

**Parameter**

<printer\_name>

**Example**

```
SYST:COMM:PRIN:SEL LASER on LPT1
```

**Characteristics**

\*RST value: NONE

SCPI: device-specific

**Mode**

all

---

**SYSTEM:DATE**

---

This command is used to enter the date for the internal calendar.

The sequence of entry is year, month, day.

**Parameter**

1980 to 2099, 1 to 12, 1 to 31

**Example**

```
SYST:DATE 2000,6,1
```

**Characteristics**

\*RST value: -

SCPI: conform

**Mode**

all

---

**SYSTem:DISPlay:FPANel**

---

This command activates or deactivates the display of the front panel keys on the screen. With the display activated, the instrument can be operated on the screen using the mouse by pressing the corresponding buttons.

**Parameter**

ON | OFF

**Example**

SYST:DISP:FPAN ON

**Characteristics**

\*RST value: OFF

SCPI: device-specific

**Mode**all

---

**SYSTem:DISPlay:UPDate**

---

In remote control mode, this command switches on or off the instrument display. If switched on, only the diagrams, traces and display fields are displayed and updated.

**Note:** *The best performance is obtained if the display output is switched off during remote control.*

**Parameter**

ON | OFF

**Example**

SYST:DISP:UPD ON

**Characteristics**

\*RST value: OFF

SCPI: device-specific

**Mode**all

---

**SYSTem:ERRor[:NEXT]?**

---

This command queries the earliest error queue entry and deletes it.

Positive error numbers indicate device-specific errors, negative error numbers are error messages defined by SCPI. If the error queue is empty, the error number 0, "No error", is returned.

This command is a query and therefore has no \*RST value.

**Example**

STAT:ERR?

**Characteristics**

\*RST value: -

SCPI: conform

**Mode**all

---

**SYSTEM:ERRor:CLEar:ALL**

---

This command deletes all entries in the table SYSTEM MESSAGES.

This command is an event and therefore has no query and no \*RST value.

**Example**

```
SYST:ERR:CLE:ALL
```

**Characteristics**

\*RST value: -

SCPI: device-specific

**Mode**

all

---

**SYSTEM:ERRor:LIST?**

---

This command reads all system messages and returns a list of comma separated strings. Each string corresponds to an entry in the table SYSTEM MESSAGES.

If the error list is empty, an empty string "" will be returned.

This command is a query and therefore has no \*RST value.

**Example**

```
SYST:ERR:LIST?
```

**Characteristics**

\*RST value: -

SCPI: device-specific

**Mode**

all

---

**SYSTEM:FIRMware:UPDate**

---

This command starts a firmware update using the \*.msi files in the selected directory. The default path is D:\FW\_UPDATE. The path is changed via the [MMEMoRY:CDIRectory](#) command. To store the update files the [MMEMoRY:DATA](#) command is used.

This command is an event and therefore has no query and no \*RST value.

**Example**

```
SYST:FIRM:UPD 'D:\FW_UPDATE'
```

Starts the firmware update from directory D:\FW\_UPDATE.

**Characteristics**

\*RST value: -

SCPI: device-specific

**Mode**

all

---



**SYSTem:FORMat:IDENt**

---

This command defines the response format to the \*IDN? command. This function is intended for re-use of existing control programs together with the R&S ESL.

**Parameter**

LEGacy    format is compatible to the R&S FSP/FSU/FSQ family  
NEW       R&S ESL format

**Example**

```
SYST:FORM:IDEN LEG
```

Adapts the return value of \*IDN? to the R&S FSP/FSU/FSQ family.

**Characteristics**

RST value: LEG  
SCPI: device-specific

**Mode**

all

---

**SYSTem:LANGuage**

---

This command defines the system language.

**Parameter**

SCPI

**Example**

```
SYST:LANG 'SCPI'
```

Sets the system language to SCPI.

**Characteristics**

RST value: SCPI  
SCPI: device-specific

**Mode**

all

---

**SYSTem:PASSword[:CENable]**

---

This command enables access to the service functions by means of the password.  
This command is an event and therefore has no \*RST value and no query.

**Parameter**

<password>

**Example**

```
SYST:PASS XXXX
```

**Characteristics**

\*RST value: -  
SCPI: conform

**Mode**

all

---

**SYSTEM:PASSword:RESet**

---

This command resets the service password.

This command is an event and therefore has no \*RST value and no query.

**Example**

```
SYST:PASS:RES
```

**Characteristics**

\*RST value: -

SCPI: conform

**Mode**

all

---

**SYSTEM:PRESet**

---

This command initiates an instrument reset.

The effect of this command corresponds to that of the **PRESET** key with manual operation or to the \*RST command. For details on preset settings refer to chapter 4 "Instrument Functions - Analyzer", section "Initializing the Configuration - PRESET Key".

**Example**

```
SYST:PRES
```

**Characteristics**

\*RST value: -

SCPI: conform

**Mode**

all

---

**SYSTEM:TIME**

---

This command sets the internal clock. The sequence of entry is hour, minute, second.

**Parameter**

0 to 23, 0 to 59, 0 to 59

**Example**

```
SYST:TIME 12,30,30
```

**Characteristics**

\*RST value: -

SCPI: conform

**Mode**

all

---

**SYSTEM:VERSion?**

---

This command queries the number of the SCPI version, which is relevant for the instrument.  
This command is a query and therefore has no \*RST value.

**Example**

```
SYST:VERS?
```

**Characteristics**

\*RST value: -

SCPI: conform

**Mode**

all

---

## Contents of Chapter 7

<b>7 Remote Control – Programming Examples .....</b>	<b>7.1</b>
<b>Analyzer Measurements – Programming Examples .....</b>	<b>7.1</b>
Service Request.....	7.1
Initiate Service Request .....	7.1
Waiting for the Arrival of a Service Request.....	7.2
Waiting Without Blocking the Keyboard and Mouse.....	7.3
Service Request Routine .....	7.4
Reading Out the Output Buffer .....	7.4
Reading Error Messages .....	7.5
Evaluation of SCPI Status Registers.....	7.5
Evaluation of Event Status Register.....	7.5
Using Marker and Delta Marker .....	7.6
Shape Factor Measurement (using n dB down) .....	7.6
Measuring the Third Order Intercept Point.....	7.7
Measuring the AM Modulation Depth.....	7.8
Limit Lines and Limit Test .....	7.9
Measuring the Channel and Adjacent Channel Power.....	7.11
Occupied Bandwidth Measurement .....	7.13
Time Domain Power Measurement.....	7.14
Fast Power Measurement on Power Ramps .....	7.15
Power Measurement with Multi-Summary Marker .....	7.15
Multi-Burst Power Measurement.....	7.17
Fast Level Measurement Using Frequency Lists .....	7.19
Level Correction of Transducers .....	7.20
Measuring the Magnitude and Phase of a Signal.....	7.21
Averaging I/Q Data.....	7.23
Reading and Writing Files .....	7.24
Reading a File from the Instrument.....	7.24
Creating a File on the Instrument.....	7.25
Spectrum Emission Mask Measurement .....	7.26
Using Predefined Standard Wibro .....	7.26
Defining 5 Ranges with all Parameters.....	7.27
Spurious Emissions Measurement.....	7.30

## 7 Remote Control – Programming Examples

The following programming examples have a hierarchical structure, i.e. subsequent examples are based on previous ones. It is thus possible to compile very easily an operational program from the modules of the given examples. VISUAL BASIC has been used as programming language. However, the programs can be translated into other languages.

---

**Note:** In programming languages as C, C++ or programmes as MATLAB, NI Interactive Control, a backslash starts an escape sequence (e.g. "\n" is used to start a new line). In these programming languages and programmes, two backslashes instead of one must be used in remote commands (for an example refer to the Quick Start Guide, chapter 6.)

---

### Analyzer Measurements – Programming Examples

In this chapter, more complex programming examples are given. In the Quick Start Guide, chapter 6, basic steps in remote control programming are provided.

#### Service Request

The service request routine requires an extended initialization of the instrument in which the relevant bits of the transition and enable registers are set. In addition the service request event must be enabled in the VISA session.

#### Initiate Service Request

**REM ---- Example of initialization of the SRQ in the case of errors -----**

**PUBLIC SUB SetupSRQ()**

CALL InstrWrite(analyzer, "\*CLS") 'Reset status reporting system

CALL InstrWrite(analyzer, "\*SRE 168") 'Enable service request for  
'STAT:OPER, STAT:QUES and ESR  
'register

CALL InstrWrite(analyzer, "\*ESE 60") 'Set event enable bit for  
'command, execution, device-  
'dependent and query error

CALL InstrWrite(analyzer, "STAT:OPER:ENAB 32767")  
'Set OPERation enable bit for  
'all events

CALL InstrWrite(analyzer, "STAT:OPER:PTR 32767")  
'Set appropriate OPERation  
'Ptransition bits

CALL InstrWrite(analyzer, "STAT:QUES:ENAB 32767")  
'Set questionable enable bits  
'for all events

```

CALL InstrWrite(analyzer,"STAT:QUES:PTR 32767")
                                'Set appropriate questionable
                                'Ptransition bits
CALL viEnableEvent(analyzer, VI_EVENT_SERVICE_REQ, VI_QUEUE, 0)
                                'Enable the event for service
                                'request
Status = viWaitOnEvent(analyzer, VI_EVENT_SERVICE_REQ, SRQWaitTimeout,
                        VI_NULL, VI_NULL)
IF (status = VI_SUCCESS) THEN CALL Srq    'If SRQ is recognized =>
                                        'subroutine for evaluation

END SUB
REM *****

```

## Waiting for the Arrival of a Service Request

There are basically two methods of waiting for the arrival of a service request:

### 1. Blocking (user inputs not possible):

This method is appropriate if the waiting time until the event to be signalled by an SRQ is short (shorter than the selected timeout), if no response to user inputs is required during the waiting time, and if – as the main criterion – the event is absolutely certain to occur.

Reason:

From the time the `viWaitOnEvent()` function is called until the occurrence of the expected event, it does not allow the program to respond to mouse clicks or key entries during the waiting time. Moreover, it returns an error if the SRQ event does not occur within the predefined timeout period. The method is, therefore, in many cases not suitable for waiting for measurement results, especially when using triggered measurements.

The following function calls are required:

```

Status = viWaitOnEvent(analyzer, VI_EVENT_SERVICE_REQ, SRQWaitTimeout,
                        VI_NULL, VI_NULL)
                                'Wait for service request user
                                'inputs are not possible during
                                'the waiting time!

IF (status = VI_SUCCESS) THEN CALL Srq
                                'If SRQ is recognized =>
                                'subroutine for evaluation

```

### 2. Non-blocking (user inputs possible):

This method is recommended if the waiting time until the event to be signalled by an SRQ is long (longer than the selected timeout), and user inputs should be possible during the waiting time, or if the event is not certain to occur. This method is, therefore, the preferable choice for waiting for the end of measurements, i.e. the output of results, especially in the case of triggered measurements.

The method necessitates a waiting loop that checks the status of the SRQ line at regular intervals and returns control to the operating system during the time the expected event has not yet occurred. In this way, the system can respond to user inputs (mouse clicks, key entries) during the waiting time.

It is advisable to employ the `Hold()` auxiliary function, which returns control to the operating system for a selectable waiting time (see section "[Waiting Without Blocking the Keyboard and Mouse](#)"), so enabling user inputs during the waiting time.

```

result% = 0
For i = 1 To 10           'Abort after max. 10 loop
                        'iterations
Status = viWaitOnEvent(analyzer, VI_EVENT_SERVICE_REQ,
                        VI_TMO_IMMEDIATE, VI_NULL,
                        VI_NULL)
                        'Check event queue

If (status = VI_SUCCESS) Then
    result% = 1
    CALL Srq           'If SRQ is recognized =>
                    'subroutine for evaluation

Else
    CALL Hold(20)     'Call hold function with
                    '20 ms 'waiting time. User inputs
                    'are possible.

Endif
Next i

If result% = 0 Then
    Debug.Print "Timeout Error; Program aborted"
                    'Output error message

    STOP           'Stop software

Endif

```

## Waiting Without Blocking the Keyboard and Mouse

A frequent problem with remote control programs using Visual Basic is to insert waiting times without blocking the keyboard and the mouse.

If the program is to respond to user inputs also during a waiting time, control over the program events during this time must be returned to the operating system. In Visual Basic, this is done by calling the *DoEvents* function. This function causes keyboard- or mouse-triggered events to be executed by the associated elements. For example, it allows the operation of buttons and input fields while the user waits for an instrument setting to be completed.

The following programming example describes the *Hold()* function, which returns control to the operating system for the period of the waiting time selectable in milliseconds.

```

Rem *****
Rem The waiting function below expects the transfer of the desired
Rem waiting time in milliseconds. The keyboard and the mouse remain
Rem operative during the waiting period, thus allowing desired elements
Rem to be controlled
Rem *****

Public Sub Hold(delayTime As Single)
    Start = Timer           'Save timer count on calling the
                        'function

    Do While Timer < Start + delayTime / 1000 'Check timer count

```

```

DoEvents                                     'Return control to operating
                                              'system to enable control of
                                              'desired elements as long as
                                              'timer has not elapsed

```

Loop

**End Sub**

**Rem \*\*\*\*\***

The waiting procedure is activated simply by calling *Hold(<Waiting time in milliseconds>)*.

### Service Request Routine

A service request is processed in the service request routine.

---

**Note:** *The variables userN% and userM% must be pre-assigned usefully!*

---

**REM ----- Service request routine -----**

**Public SUB Srq()**

```

ON ERROR GOTO noDevice                       'No user existing
CALL viReadSTB(analyzer, STB%)              'Serial poll, read status byte
IF STB% > 0 THEN                              'This instrument has bits set in
                                              'the STB

```

```

    SRQFOUND% = 1

```

```

    IF (STB% AND 16) > 0 THEN CALL Outputqueue
    IF (STB% AND 4) > 0 THEN CALL ErrorQueueHandler
    IF (STB% AND 8) > 0 THEN CALL Questionablestatus
    IF (STB% AND 128) > 0 THEN CALL Operationstatus
    IF (STB% AND 32) > 0 THEN CALL Esrread

```

```

END IF

```

noDevice:

```

END SUB                                     'End of SRQ routine

```

**REM \*\*\*\*\***

Reading out the status event registers, the output buffer and the error/event queue is effected in subroutines.

### Reading Out the Output Buffer

**REM ----- Subroutine for the individual STB bits -----**

**Public SUB Outputqueue()** 'Reading the output buffer

```

result$ = SPACE$(100)                       'Make space for response

```

```

CALL InstrRead(analyzer, result$)

```

```

Debug.Print "Contents of Output Queue : "; result$

```

**END SUB**

**REM \*\*\*\*\***



## Reading Error Messages

```

REM ----- Subroutine for reading the error queue -----
Public SUB ErrorQueueHandler()
ERROR$ = SPACE$(100)           'Make space for error variable
CALL InstrWrite(analyzer, "SYSTEM:ERROR?")
CALL InstrRead(analyzer, ERROR$)
Debug.Print "Error Description : "; ERROR$
END SUB
REM *****

```

## Evaluation of SCPI Status Registers

```

REM ----- Subroutine for evaluating Questionable Status Register -----
Public SUB Questionablestatus()
Ques$ = SPACE$(20)           'Preallocate blanks to text
                               'variable
CALL InstrWrite(analyzer, "STaTus:QUEStionable:EVENT?")
CALL InstrRead(analyzer, Ques$)
Debug.Print "Questionable Status: "; Ques$
END SUB
REM *****

```

```

REM ----- Subroutine for evaluating Operation Status Register -----
Public SUB Operationstatus()
Oper$ = SPACE$(20)           'Preallocate blanks to text
                               'variable
CALL InstrWrite(analyzer, "STaTus:OPERation:EVENT?")
CALL InstrRead(analyzer, Oper$)
Debug.Print "Operation Status: "; Oper$
END SUB
REM *****

```

## Evaluation of Event Status Register

```

REM ----- Subroutine for evaluating the Event Status Register -----
Public SUB Esrread()
Esr$ = SPACE$(20)           'Preallocate blanks to text
                               'variable
CALL InstrWrite(analyzer, "*ESR?")           'Read ESR
CALL InstrRead(analyzer, Esr$)
IF (VAL(Esr$) AND 1) > 0 THEN Debug.Print "Operation complete"

```

```

IF (VAL(Esr$) AND 2) > 0 THEN Debug.Print "Request Control"
IF (VAL(Esr$) AND 4) > 0 THEN Debug.Print "Query Error"
IF (VAL(Esr$) AND 8) > 0 THEN Debug.Print "Device dependent error"
IF (VAL(Esr$) AND 16) > 0 THEN
    Debug.Print "Execution Error; Program aborted"
                                'Output error message
    STOP                          'Stop software
    END IF
IF (VAL(Esr$) AND 32) > 0 THEN
    Debug.Print "Command Error; Program aborted"
                                'Output error message
    STOP                          'Stop software
    END IF
IF (VAL(Esr$) AND 64) > 0 THEN Debug.Print "User request"
IF (VAL(Esr$) AND 128) > 0 THEN Debug.Print "Power on"
END SUB
REM *****

```

## Using Marker and Delta Marker

### Shape Factor Measurement (using n dB down)

The n-dB-down function of the R&S ESL is used twice to determine the shape factor of a filter (ratio of bandwidths at 60 dB and 3 dB below the filter maximum).

The following example is again based on a signal with a level of -30 dBm at 100 MHz. The shape factor is determined for the 30 kHz resolution bandwidth. The default setting of the R&S ESL is used for measurements (SetupInstrument).

```

REM *****
Public Sub ShapeFactor()
result$ = Space$(100)
'----- R&S ESL default setting -----
CALL SetupInstrument                'Default setting
CALL InstrWrite(analyzer,"INIT:CONT OFF") 'Single sweep
'----- Set frequency -----
CALL InstrWrite(analyzer,"FREQ:SPAN 1MHz")
                                'Span
CALL InstrWrite(analyzer,"BAND:RES 30kHz")
                                'Resolution bandwidth
CALL InstrWrite(analyzer,"INIT;*WAI")
                                'Perform sweep with sync

```

```

'----- Measure 60 dB value -----
CALL InstrWrite(analyzer,"CALC:MARK:PEXC 6DB")
                                'Peak excursion
CALL InstrWrite(analyzer,"CALC:MARK:STAT ON")
                                'Marker1 on
CALL InstrWrite(analyzer,"CALC:MARK:TRAC 1")
                                'Assign marker1 to trace1
CALL InstrWrite(analyzer,"CALC:MARK:MAX") 'Set marker1 to 100 MHz
CALL InstrWrite(analyzer,"CALC:MARK:FUNC:NDBD 45dB")
                                'Read out bandwidth measured at
                                '45 dB

CALL InstrWrite(analyzer,"CALC:MARK:FUNC:NDBD:RES?")
CALL InstrRead(analyzer,result$)
result60 = Val(result$)

'----- Measure 3 dB down value-----
CALL InstrWrite(analyzer,"CALC:MARK:FUNC:NDBD 3dB")
                                'Read out bandwidth measured at
                                '3 dB

CALL InstrWrite(analyzer,"CALC:MARK:FUNC:NDBD:RES?")
CALL InstrRead(analyzer,result$)
result3 = Val(result$)

'----- Read out shape factor-----
Print "Shapfaktor 60dB/3dB: ";result60/result3
END SUB
REM *****

```

### Measuring the Third Order Intercept Point

The third order intercept point (TOI) is the (virtual) level of two adjacent useful signals at which the intermodulation products of third order have the same level as the useful signals.

The intermodulation product at  $f_{S2}$  is obtained by mixing the first harmonic of the useful signal  $P_{N2}$  with signal  $P_{N1}$ , the intermodulation product at  $f_{S1}$  by mixing the first harmonic of the useful signal  $P_{N1}$  with signal  $P_{N2}$ .

$$f_{S1} = 2 \times f_{n1} - f_{n2} \quad (1)$$

$$f_{S2} = 2 \times f_{n2} - f_{n1} \quad (2)$$

The following example is based on two adjacent signals with a level of  $-30$  dBm at 100 MHz and 110 MHz. The intermodulation products lie at 90 MHz and 120 MHz according to the above formula. The frequency is set so that the examined mixture products are displayed in the diagram. Otherwise, the default setting of the R&S ESL is used for measurements (SetupInstrument).

```

REM *****
Public Sub TOI()
result$ = Space$(100)
'----- R&S ESL default setting -----
CALL SetupStatusReg           'Set status registers
CALL InstrWrite(analyzer,"*RST") 'Reset instrument
CALL InstrWrite(analyzer,"INIT:CONT OFF") 'Single sweep
CALL InstrWrite(analyzer,"SYST:DISP:UPD ON")
                                'ON: display on
                                'OFF: off
'----- Set frequency -----
CALL InstrWrite(analyzer,"FREQ:START 85MHz;STOP 125 MHz")
                                'Span
'----- Set level -----
CALL InstrWrite(analyzer,"DISP:WIND:TRAC:Y:RLEV -20dBm")
                                'Reference level
CALL InstrWrite(analyzer,"INIT;*WAI") 'Perform sweep with sync
'----- TOI measurement -----
CALL InstrWrite(analyzer,"CALC:MARK:PEXC 6DB")
                                'Peak excursion
CALL InstrWrite(analyzer,"CALC:MARK:FUNC:TOI ON")
                                'Switch on TOI measurement
CALL InstrWrite(analyzer,"CALC:MARK:FUNC:TOI:RES?")
                                'and read out results
CALL InstrRead(analyzer,result$)
'----- Read out result -----
Print "TOI [dBm]: ";result$
END SUB
REM *****

```

## Measuring the AM Modulation Depth

The example below is based on an AM-modulated signal at 100 MHz with the following characteristics:

- Carrier signal level: -30 dBm
- AF frequency: 100 kHz
- Modulation depth: 50 %

The default setting of the analyzer for measurements can be used for the measurements described below (SetupInstrument).

```

REM *****
Public Sub AMMod()
result$ = Space$(100)
CALL SetupInstrument           'Default setting
CALL InstrWrite(analyzer,"BAND:RES 30kHz") 'Set appropriate RBW

```

```

'----- Peak search -----
CALL InstrWrite(analyzer,"INIT:CONT OFF") 'Single sweep
CALL InstrWrite(analyzer,"INIT;*WAI")      'Perform sweep with sync
CALL InstrWrite(analyzer,"CALC:MARK:PEXC 6DB")
                                         'Peak excursion
CALL InstrWrite(analyzer,"CALC:MARK:STAT ON")
                                         'Marker 1 on
CALL InstrWrite(analyzer,"CALC:MARK:TRAC 1")
                                         'Assign marker1 to trace1

'----- Measure modulation depth-----
CALL InstrWrite(analyzer,"CALC:MARK:MAX;FUNC:MDEP ON")
                                         'Marker to Peak;
CALL InstrWrite(analyzer,"CALC:MARK:FUNC:MDEP:RES?")
                                         'Measure mod. depth
CALL InstrRead(analyzer, result$)        'Read out result

'----- Read out result -----
Print "AM Mod Depth [%]: ";result$
END SUB
REM *****

```

## Limit Lines and Limit Test

The example below shows the definition and use of a new limit line 5 for trace 1 with the following characteristics:

- Upper limit line
- Absolute x-axis in the frequency range
- 5 reference values:
  - 120 MHz / -70 dB, 126 MHz/-40 dB, 127 MHz/-40 dB, 128 MHz/-10 dB,
  - 129 MHz/-40 dB, 130 MHz/-40 dB, 136 MHz / -70 dB
- Relative y-axis with unit dB
- Absolute threshold at -75 dBm
- No margin

The signal of the integrated calibration source (128 MHz, -30 dBm) is used to check the limit test.

```

REM *****
Public Sub LimitLine()
result$ = Space$(100)
'----- R&S ESL default setting -----
CALL SetupInstrument                    'Default setting
CALL InstrWrite(analyzer,"FREQUENCY:CENTER 128MHz;Span 10MHz")
                                         'Span
CALL InstrWrite(analyzer,"Diag:Serv:Inp Cal;CSO -30dBm")
                                         'Cal signal on

```

```

'----- Definition of limit lines -----
CALL InstrWrite(analyzer,"CALC:LIM5:NAME 'TEST1'")
                                'Define name
CALL InstrWrite(analyzer,"CALC:LIM5:COMM 'Upper limit'")
                                'Define comment
CALL InstrWrite(analyzer,"CALC:LIM5:TRAC 1")
                                'Assign trace
CALL InstrWrite(analyzer,"CALC:LIM5:CONT:DOM FREQ")
                                'Define x-axis range
CALL InstrWrite(analyzer,"CALC:LIM5:CONT:MODE ABS")
                                'Define x-axis scaling
CALL InstrWrite(analyzer,"CALC:LIM5:UNIT DB")
                                'Define y-axis unit
CALL InstrWrite(analyzer,"CALC:LIM5:UPP:MODE REL")
                                'Define y-axis scaling

'----- Definition of data points and threshold -----
xlimit$ = "CALC:LIM5:CONT 120MHZ,126MHZ,127MHZ,128MHZ,129MHZ,130MHZ,136MHZ"
CALL InstrWrite(analyzer, xlimit$)          'Set values for x-axis
CALL InstrWrite(analyzer,"CALC:LIM5:UPP -70,-40,-40,-20,-40,-40,-70")
                                'Set values for y-axis
CALL InstrWrite(analyzer,"CALC:LIM5:UPP:THR -75DBM")
                                'Set y threshold (only
                                'possible for relative
                                'y-axis)

'----- Definition of margin or x /y offset-----
'A margin or an x /y offset can be defined here.

'----- Activate and evaluate the limit line -----
CALL InstrWrite(analyzer,"CALC:LIM5:UPP:STAT ON")
                                'Activate line 5
CALL InstrWrite(analyzer,"CALC:LIM5:STAT ON")
                                'Activate limit check
CALL InstrWrite(analyzer,"INIT;*WAI")      'Perform sweep with sync
CALL InstrWrite(analyzer,"CALC:LIM5:FAIL?")
                                'Query result of limit check
CALL InstrRead(analyzer, result$)          'Result: 1 (= FAIL)

'----- Read out result -----
Print "Limit Result Line 5: ";result$

'----- Evaluate limit line by means of status register -----
CALL InstrWrite(analyzer,"*CLS")           'Reset status register

'----- Measure -----
CALL InstrWrite(analyzer,"INIT;*OPC")      'Perform sweep with sync
CALL viEnableEvent(analyzer, VI_EVENT_SERVICE_REQ, VI_QUEUE, 0)
Status = viWaitOnEvent(analyzer, VI_EVENT_SERVICE_REQ, SRQWaitTimeout,
VI_NULL, VI_NULL)
IF (status = VI_SUCCESS) THEN CALL Srq      'If SRQ is recognized =>
                                'subroutine for evaluation

```

```

'----- Read out result -----
IF (status% = 1) THEN
    CALL InstrWrite(analyzer,"STAT:QUES:LIM1:COND?")
                                'Read out STAT:QUES:LIMit
                                'register

    CALL InstrRead(analyzer, result$)

    IF ((Val(result$) And 16) <> 0) THEN
        Print "Limit5 failed"
    ELSE
        Print "Limit5 passed"
    END IF
END IF
END SUB
REM *****

```

## Measuring the Channel and Adjacent Channel Power

In the following example, the channel and adjacent channel power is first measured on a signal with a level of 0 dBm at 800 MHz to IS95. Then the channel and adjacent channel power is measured on a GSM signal at 935.2 MHz with fast ACP measurement (FAST ACP).

In addition, the limit test is activated.

```

REM *****
Public Sub ACP()
result$ = Space$(100)

'----- R&S ESL default setting -----
CALL SetupStatusReg                'Set status register
CALL InstrWrite(analyzer,"*RST")    'Reset instrument
CALL InstrWrite(analyzer,"INIT:CONT OFF") 'Single sweep
CALL InstrWrite(analyzer,"SYST:DISP:UPD ON")
                                'ON: display on
                                'OFF: off

'----- Set frequency -----
CALL InstrWrite(analyzer,"FREQ:CENT 800MHz")
                                'Set frequency

'----- Set level -----
CALL InstrWrite(analyzer,"DISP:WIND:TRAC:Y:RLEV 10dBm")
                                'Reference level

'----- Example 1: Configure CP/ACP for CDMA-----
CALL InstrWrite(analyzer,"CALC:MARK:FUNC:POW:SEL ACP")
                                'ACP measurement on
CALL InstrWrite(analyzer,"CALC:MARK:FUNC:POW:PRES F8CDMA")
                                'Select CDMA800 FWD
CALL InstrWrite(analyzer,"SENS:POW:ACH:ACP 2")
                                'Select 2 adjacent channels

```

```
CALL InstrWrite(analyzer,"SENS:POW:ACH:PRES ACP")
                                'Optimize settings
CALL InstrWrite(analyzer,"SENS:POW:ACH:PRES:RLEV")
                                'Optimize reference level
CALL InstrWrite(analyzer,"SENS:POW:ACH:MODE ABS")
                                'Absolute measurement
CALL InstrWrite(analyzer,"SENS:POW:HSP ON")
                                'Fast ACP measurement

'----- Perform measurement and query results -----
CALL InstrWrite(analyzer,"INIT;*WAI")      'Perform sweep with sync
CALL InstrWrite(analyzer,"CALC:MARK:FUNC:POW:RES? ACP")      'Query result
                                CALL InstrRead(analyzer, result$)

'----- Read out result -----
Print "Result (CP, ACP low, ACP up, Alt low, Alt up): "
Print result$

'----- Example 2: Configure CP/ACP manually for GSM -----
result$ = Space$(100)
CALL InstrWrite(analyzer,"FREQ:CENT 935.2MHz")
                                'Set frequency
CALL InstrWrite(analyzer,"CALC:MARK:FUNC:POW:SEL ACP")
                                'ACP measurement on
CALL InstrWrite(analyzer,"SENS:POW:ACH:ACP 1")
'1 adjacent channel
CALL InstrWrite(analyzer,"SENS:POW:ACH:BAND 200KHZ")
'Channel bandw. 200 kHz
CALL InstrWrite(analyzer,"SENS:POW:ACH:BAND:ACH 200KHZ")
                                'Adjacent channel band-
                                'width 200 kHz
CALL InstrWrite(analyzer,"SENS:POW:ACH:SPAC 200KHZ")
                                'Channel spacing 200 kHz
CALL InstrWrite(analyzer,"SENS:POW:ACH:PRES ACP")
                                'Optimize settings
CALL InstrWrite(analyzer,"SENS:POW:ACH:PRES:RLEV")
                                'Optimize reference level
CALL InstrWrite(analyzer,"SENS:POW:ACH:MODE ABS")
                                'Absolute measurement

'----- Start measurement and query result -----
CALL InstrWrite(analyzer,"INIT;*WAI")      'Perform sweep with sync
CALL InstrWrite(analyzer,"CALC:MARK:FUNC:POW:RES? ACP")
                                'Query result

CALL InstrRead(analyzer, result$)

'----- Read out result -----
Print "Result (CP, ACP low, ACP up): "
Print result$
```



```

'----- Active limit check -----
result$ = Space$(100)
CALL InstrWrite(analyzer,"CALC:LIM:ACP:ACH 30DB, 30DB")
                                     'Set relative limit
CALL InstrWrite(analyzer,"CALC:LIM:ACP:ACH:ABS -35DBM,-35DBM")
                                     'Set absolute limit
CALL InstrWrite(analyzer,"CALC:LIM:ACP:ACH:STAT ON")
                                     'Rel. limit check on
CALL InstrWrite(analyzer,"CALC:LIM:ACP:ACH:ABS:STAT ON")
                                     'Abs. limit check on
CALL InstrWrite(analyzer,"CALC:LIM:ACP ON")
                                     'Limit check on

'----- Start measurement and query result -----
CALL InstrWrite(analyzer,"INIT;*WAI")      'Perform sweep with sync
CALL InstrWrite(analyzer,"CALC:LIM:ACP:ACH:RES?")
                                     'Query result of limit check
CALL InstrRead(analyzer, result$)
'----- Read out result -----
Print "Result Limit Check: ";result$
END SUB
REM *****

```

## Occupied Bandwidth Measurement

In the following example, the bandwidth is to be found in which 95% of the power of a GSM signal is contained. Signal frequency is 935.2 MHz; channel bandwidth is 200 kHz.

```

REM *****
Public Sub OBW()
result$ = Space$(100)
'----- R&S ESL default setting -----
CALL SetupStatusReg                    'Set status register
CALL InstrWrite(analyzer,"*RST")        'Reset instrument
CALL InstrWrite(analyzer,"INIT:CONT OFF") 'Single sweep
CALL InstrWrite(analyzer,"SYST:DISP:UPD ON")
                                     'ON: display on
                                     'OFF: off

'----- Configure R&S ESL for OBW for GSM-----
CALL InstrWrite(analyzer,"FREQ:CENT 935.2MHz")
                                     'Set frequency
CALL InstrWrite(analyzer,"CALC:MARK:FUNC:POW:SEL OBW")
                                     'OBW measurement on
CALL InstrWrite(analyzer,"SENS:POW:ACH:BAND 200KHZ")
                                     'Channel bandw. 200 kHz

```

```

CALL InstrWrite(analyzer,"SENS:POW:BWID 95PCT")
                                'Percentage of power
CALL InstrWrite(analyzer,"SENS:POW:ACH:PRES OBW")
                                'Set frequency and optimize
                                reference level
CALL InstrWrite(analyzer,"SENS:POW:ACH:PRES:RLEV")
CALL InstrWrite(analyzer,"SENS:POW:NCOR OFF")
                                'Noise correction
                                'OFF: switch off
                                'ON:  switch on

'----- Perform measurement and query results -----
CALL InstrWrite(analyzer,"INIT;*WAI")      'Perform sweep with sync
CALL InstrWrite(analyzer,"CALC:MARK:FUNC:POW:RES? OBW")
                                'Query result

CALL InstrRead(analyzer, result$)
Print result$
END SUB
REM *****

```

## Time Domain Power Measurement

In the following example, the mean carrier power of a signal with 300 kHz bandwidth at 100 MHz is to be determined. In addition, the peak power, the rms value and the standard deviation are measured. To do this, the time-domain-power measurement functions are used.

```

REM *****
Public Sub TimeDomainPower()
result$ = Space$(100)
'----- R&S ESL default setting -----
CALL SetupStatusReg              'Set status register
CALL InstrWrite(analyzer,"*RST")  'Reset instrument
CALL InstrWrite(analyzer,"INIT:CONT OFF") 'Single sweep
CALL InstrWrite(analyzer,"SYST:DISP:UPD ON")
                                'ON: display on
                                'OFF: off

'----- Configure R&S ESL for time domain power measurement -----
CALL InstrWrite(analyzer,"FREQ:CENT 100MHz;SPAN 0Hz")
                                'Set frequency
CALL InstrWrite(analyzer,"BAND:RES 300kHz")
                                'Resolution bandwidth
CALL InstrWrite(analyzer,"SWE:TIME 200US") 'Sweep time
CALL InstrWrite(analyzer,"CALC:MARK:FUNC:SUMM:PPE ON")
                                'Peak measurement on
CALL InstrWrite(analyzer,"CALC:MARK:FUNC:SUMM:MEAN ON")
                                'Mean measurement on

```

```

CALL InstrWrite(analyzer,"CALC:MARK:FUNC:SUMM:RMS ON")
                                     'RMS measurement on
CALL InstrWrite(analyzer,"CALC:MARK:FUNC:SUMM:SDEV ON")
                                     'Standard deviation on

'----- Perform measurement and query results -----
CALL InstrWrite(analyzer,"INIT;*WAI")   'Perform sweep with sync
                                     'Query results:
query$ = " CALC:MARK:FUNC:SUMM:PPE:RES?;" 'Peak measurement
query$ = query$ + ":CALC:MARK:FUNC:SUMM:MEAN:RES?;"
                                     'Mean measurement
query$ = query$ + ":CALC:MARK:FUNC:SUMM:RMS:RES?;"
                                     'RMS measurement
query$ = query$ + ":CALC:MARK:FUNC:SUMM:SDEV:RES?"
                                     'Standard deviation

CALL InstrWrite(analyzer, query$)
CALL InstrRead(analyzer, result$)
Print result$
END SUB
REM *****

```

## Fast Power Measurement on Power Ramps

A frequent task in mobile radio tests is measurement of a DUT at various power control levels at the highest possible speed. The R&S ESL offers two test functions for this task, which can be used depending on the signal characteristics.

In the following, the two methods are presented by means of two examples.

### Power Measurement with Multi-Summary Marker

The multi-summary marker function is suitable for measuring the power of a sequence of pulses with the following characteristics:

- The pulses occur at identical time intervals, which is typical of GSM transmission in slots, for example.
- The level of the first signal is reliably above threshold.
- The subsequent pulses may have any levels.

The function uses the first pulse as a trigger signal. The power of the subsequent pulses is determined exclusively via the timing pattern selected for the pulse sequence. The function is, therefore, suitable for adjustments where the DUT output power varies considerably and is not reliably above the trigger threshold.

The measurement accuracy is determined by the ratio of pulse duration to total measurement time; this should not be below 1:50.

The function always uses TRACE 1.

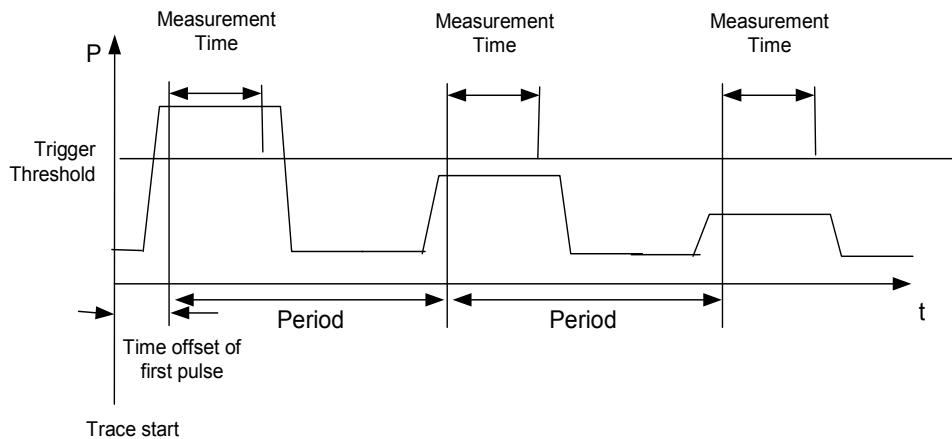

Fig. 7-1 Block diagram illustrating signal processing in analyzer

In the example below, a GSM puls sequence of 8 pulses is measured with an offset of 50  $\mu$ s of the first pulse, 450  $\mu$ s measurement time/pulse and 576.9  $\mu$ s pulse period.

```

REM *****
Public Sub MultiSumMarker()
result$ = Space$(200)
'----- R&S ESL default setting-----
CALL SetupStatusReg           'Configure status register
CALL InstrWrite(analyzer,"*RST") 'Reset instrument
CALL InstrWrite(analyzer,"INIT:CONT OFF") 'Single sweep mode
CALL InstrWrite(analyzer,"SYST:DISP:UPD ON")
                                'ON: switch display on
                                'OFF: switch display off
'----- Configure R&S ESL for power measurement in time domain -----
CALL InstrWrite(analyzer,"FREQ:CENT 935.2MHz;SPAN 0Hz")
                                'Frequency setting
CALL InstrWrite(analyzer,"DISP:WIND:TRAC:Y:RLEV 10dBm")
                                'Set reference level to 10 dB
CALL InstrWrite(analyzer,"INP:ATT 30 dB") 'Set input attenuation to 30 dB
CALL InstrWrite(analyzer,"BAND:RES 1MHz;VID 3MHz")
                                'Bandwidth setting
CALL InstrWrite(analyzer,"DET RMS") 'Select RMS detector
CALL InstrWrite(analyzer,"TRIG:SOUR VID") 'Trigger source: video
CALL InstrWrite(analyzer,"TRIG:LEV:VID 50 PCT")
                                'Trigger threshold: 50%
CALL InstrWrite(analyzer,"SWE:TIME 50ms") 'Sweep time  $\geq$  1 frame
'----- Perform measurement and query results -----
CALL InstrWrite(analyzer,"INIT;*WAI") 'Perform sweep with sync
                                'Query results:
cmd$ = "CALC:MARK:FUNC:MSUM? "
    
```

```

cmd$ = cmd$ + "50US,"           'Offset of first pulse
cmd$ = cmd$ + "450US,"        'Measurement time
cmd$ = cmd$ + "576.9US,"      'Pulse period
cmd$ = cmd$ + "8"             'Number of bursts
CALL InstrWrite(analyzer,cmd$)
CALL InstrRead(analyzer, result$) 'Read results
Print result$
END SUB
REM *****

```

## Multi-Burst Power Measurement

The multi-burst power measurement function is suitable for measuring the power of a sequence of pulses with the following characteristics:

- The pulses occur at variable time intervals.
- The levels of all pulses of the sequence are reliably above the trigger threshold, or an external trigger signal is used.

The function requires one trigger event per pulse. This means that if the video trigger or the IF power trigger is used, the levels of all pulses must be above the trigger threshold.

The function is, therefore, particularly suitable for re-measuring DUTs already adjusted and whose output power is within the specified range. The measurement is optimized for minimum overhead relative to the actual measurement time.

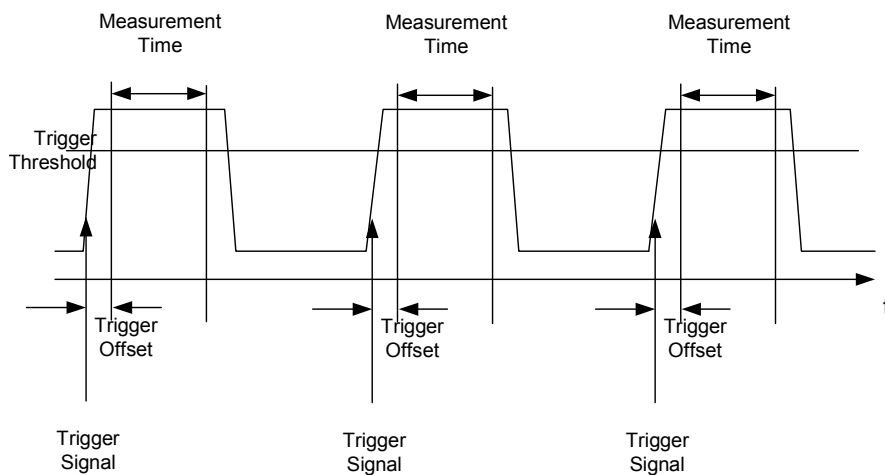

Fig. 7-2 Block diagram illustrating signal processing in analyzer

Either the root-mean-square power or the peak power is measured, depending on whether the RMS detector or the PEAK detector is selected. The function always uses TRACE 1.

The following parameters are to be set for this measurement:

- Analyzer frequency
- Resolution bandwidth
- Measurement time per single pulse
- Trigger source
- Trigger threshold
- Trigger offset

- Type of power measurement (PEAK, MEAN)
- Number of pulses to be measured

During the measurement, each pulse is mapped into a pixel of the screen, i.e. any change of the trace can be detected only at the left-hand edge of the screen. Maximum measurement speed is as usual achieved with the display switched off.

In the example below, a GSM pulse sequence of 8 pulses is measured with 5 μs trigger offset, 434 μs measurement time/pulse, video trigger with 50% trigger threshold, and peak detection:

```

REM *****
Public Sub MultiBurstPower()
result$ = Space$(200)
'----- R&S ESL default setting -----
CALL SetupStatusReg           'Configure status register
CALL InstrWrite(analyzer,"*RST") 'Reset instrument
CALL InstrWrite(analyzer,"INIT:CONT OFF") 'Single sweep mode
CALL InstrWrite(analyzer,"SYST:DISP:UPD OFF")
                                   'OFF: display off
'----- Perform measurement and query results -----
cmd$ = "MPOW? "
cmd$ = cmd$ + "935.2 MHZ,"          'Center frequency
cmd$ = cmd$ + "1MHZ,"              'Resolution bandwidth
cmd$ = cmd$ + "434US,"            'Measurement time
cmd$ = cmd$ + "VID,"              'Trigger source
cmd$ = cmd$ + "50PCT,"            'Trigger threshold
cmd$ = cmd$ + "1US,"              'Trigger offset, must be > 125 ns
cmd$ = cmd$ + "PEAK,"             'Peak detector
cmd$ = cmd$ + "8"                 'Number of bursts
CALL InstrWrite(analyzer, cmd$)
CALL InstrRead(analyzer, result$) 'Read results
Print result$
END SUB
REM *****

```

## Fast Level Measurement Using Frequency Lists

A typical task for the R&S ESL is power measurement at a number of frequency points, e.g. at multiples of the fundamental (harmonics measurement), or at frequencies defined by a mobile radio standard (e.g. spectrum due to transients at  $\pm 200$  kHz,  $\pm 400$  kHz, etc about the carrier frequency of a GSM signal). In many cases, different level and/or bandwidth settings are required for the different frequency points to match the channel spacing and meet the requirements of dynamic range.

Especially for this application, the R&S ESL offers a number of remote-control functions (commands available in SENSE:LIST subsystem) that allow level measurement based on a frequency list with different instrument settings assigned to different frequencies. Not only the frequency list can be programmed, but also the measurement types (PEAK, RMS, AVG) to be performed simultaneously can be selected.

The example below describes a harmonics measurement on a dual-band amplifier. The harmonics level in general decreases as the frequency increases. To boost measurement sensitivity, therefore, the reference level is lowered by 10 dB from the third harmonic.

The following settings are used:

Reference level: 10.00 dBm up to first harmonic, 0 dBm from 2nd harmonic  
 RF attenuation: 20 dB  
 Electronic attenuation: 0 dB (OFF)  
 Filter type: NORMAl  
 RBW: 1 MHz  
 VBW: 3 MHz  
 Measurement time: 300  $\mu$ s  
 Trigger delay: 100  $\mu$ s  
 Trigger: video, 45 %

Frequency	Type
935.2 MHz	GSM 900 fundamental
1805.2 MHz	GSM 1800 fundamental
1870.4 MHz	GSM 900 2nd harmonic
2805.6 MHz	GSM 900 3rd harmonic
3610.4 MHz	GSM 1800 2nd harmonic
3740.8 MHz	GSM 900 4th harmonic
5815.6 MHz	GSM 1800 3rd Harmonic

The frequencies are selected in ascending order to minimize system-inherent waiting times resulting from frequency changes.

At each frequency point the peak power and the rms power are measured. The peak power and the rms power values are stored alternately in the results memory.

REM \*\*\*\*\*

Public Sub FrequencyList()

result\$ = Space\$(500)

'----- R&S ESL default setting -----

CALL SetupStatusReg 'Configure status register

CALL InstrWrite(analyzer,"\*RST") 'Reset instrument

CALL InstrWrite(analyzer,"INIT:CONT OFF") 'Single sweep mode

CALL InstrWrite(analyzer,"SYST:DISP:UPD OFF")  
'Display off

```
'-----Configure R&S ESL for power measurement based on frequency list -
CALL InstrWrite(analyzer, "TRIG:LEV:IFP -20dBm")
                                     'Set IF power trigger level
CALL InstrWrite(analyzer, "LIST:POWer:SET ON,ON,OFF,IFP,POS,100us,0")
'----- Perform measurement and query results -----
cmd$ = "LIST:POWer?"
cmd$ = cmd$ + "935.2MHZ,10dBm,20dB,OFF,NORM,1MHz,3MHz,300us,0,"
cmd$ = cmd$ + "1805.2MHZ,10dBm,20dB,OFF,NORM,1MHz,3MHz,300us,0,"
cmd$ = cmd$ + "1870.4MHZ,10dBm,20dB,OFF,NORM,1MHz,3MHz,300us,0,"
cmd$ = cmd$ + "2805.6MHZ,0dBm,20dB,OFF,NORM,1MHz,3MHz,300us,0,"
cmd$ = cmd$ + "3610.4MHZ,10dBm,20dB,OFF,NORM,1MHz,3MHz,300us,0,"
cmd$ = cmd$ + "3740.8MHZ,0dBm,20dB,OFF,NORM,1MHz,3MHz,300us,0,"
cmd$ = cmd$ + "5815.6MHZ,0dBm,20dB,OFF,NORM,1MHz,3MHz,300us,0"
CALL InstrWrite(analyzer, cmd$)
CALL InstrRead(analyzer, result$)
Print result$
END SUB
REM *****
```

## Level Correction of Transducers

In more complex test systems, the frequency response of the test setup must be taken into account in all power measurements to avoid any measurement errors being introduced from sources other than the DUT.

The R&S ESL offers the possibility of defining a frequency-dependent attenuation correction factor (transducer factor).

In the example below, a factor with the following characteristics is defined:

```
Name:      Transtest
Unit:      dB
Scaling:   lin
Comment:   simulated cable correction

Frequency  Level
10 MHz    0 dB
100 MHz   3 dB
1 GHz     7 dB
3 GHz     10 dB
```

The factor is defined and can be activated as required.

```
REM *****
Public Sub TransducerFactor()
'----- Define transducer factor -----
CALL InstrWrite(analyzer,"CORR:TRAN:SEL 'TRANSTEST'")
                                     'Define "Transtest"
                                     'transducer factor
```



```

CALL InstrWrite(analyzer,"CORR:TRAN:UNIT 'DB'")
                                'Unit 'dB'
CALL InstrWrite(analyzer,"CORR:TRAN:SCAL LIN")
                                'Linear frequency-axis
CALL InstrWrite(analyzer,"CORR:TRAN:COMM 'Simulated cable correction'")
cmd$ = "CORR:TRAN:DATA "
                                'Enter frequency and level
cmd$ = cmd$ + "10MHz, 0,"
                                'values. Level values without
cmd$ = cmd$ + "100MHz, 3,"
                                'unit!
cmd$ = cmd$ + "1GHz, 7,"
cmd$ = cmd$ + "3GHz, 10"
CALL InstrWrite(analyzer,cmd$)
                                'Enter frequency and level values
'----- Activate transducer -----
CALL InstrWrite(analyzer,"CORR:TRAN:STAT ON")
                                'Activate transducer factor

END SUB
REM *****

```

## Measuring the Magnitude and Phase of a Signal

Due to the R&S ESL's internal architecture, it is capable of measuring and outputting the magnitude and phase of a signal in addition to its power values. This opens up a variety of possibilities for more in-depth analysis (FFT, demodulation, etc).

I/Q data is stored in memory areas each containing 512 k words. Hardware triggering controls the memory.

The following example shows the steps necessary to collect data at a predefined sampling rate and read it from the I/Q memory.

Data is output in the form of voltage values referred to the analyzer input. Data can be read in binary or ASCII format.

In binary format, the length information carried in the message header is evaluated and used for calculating the x-axis values.

In ASCII format, only a list of voltage values is output.

Binary data is read in three steps:

1. The number of digits carrying the length information is read.
2. The length information itself is read.
3. The trace data is read.

This procedure is necessary with programming languages like Visual Basic which support only structures of identical data types (arrays), whereas the binary data format uses different data types in the header and the data section.

**Note:** *The arrays for measured data are dimensioned in such a way that they can accommodate the I/Q data of the R&S ESL (2 x 512 k).*

```

REM *****
Public Sub ReadIQData()

```

```
'----- Create variables -----
Dim IData(131072) As Single      'Buffer for floating-point
                                'I data (= 512*1024 bytes)
Dim QData(131072) As Single      'Buffer for floating-point
                                'Q data (= 512*1024 bytes)
                                'Note:
                                'Visual Basic cannot read in
                                'data volumes larger than
                                '512 k words!
Dim digits As Byte              'No. of digits as length
Dim IQBytes As Long             'Length of trace data in bytes
Dim IQValues As Long           'No. of meas. values in buffer
Dim retCount As Integer         'Return count from read
asciiResult$ = Space$(6553600)  'Buffer for ASCII I/Q data
                                '(= 25*2*1024 bytes)
result$ = Space$(100)           'Buffer for simple results
'----- Default setting -----
CALL SetupInstrument             'Default setting
CALL InstrWrite(analyzer,"TRAC:IQ:STAT ON")
                                'Activate I/Q data
                                'acquisition mode; must be
                                'done before TRAC:IQ:SET !
                                'Select number of test points
                                '(= 512 * 1024 - 512) at
                                'RBW 10 MHz, 'sample rate 32 MHz,
                                'trigger free run, pos. trigger
                                'edge and 0 s trigger delay.
CALL InstrWrite(analyzer,"TRAC:IQ:SET NORM,10MHz,32MHz,IMM,POS,0,130560")
'----- Read-out in binary format-----
CALL InstrWrite(analyzer, "FORMAT REAL,32")
                                'Set binary format
CALL InstrWrite(analyzer, "TRAC:IQ:DATA?")
                                'Measure + read out I/Q data
CALL viRead(analyzer, result$, 2, retCount)
                                'Read and store length for
digits = Val(Mid$(result$, 2, 1)) 'number of digits
result$ = Space$(100)           'Re-initialize buffer
CALL viRead(analyzer, result$, digits, retCount)
                                'Read and store length
IQBytes = Val(Left$(result$, digits))
IQBytes = IQBytes / 2           'Divide no. per buffer in half
CALL viRead(analyzer, IData(0), IQBytes, retCount)
                                'Read I data in buffer
CALL viRead(analyzer, QData(0), IQBytes, retCount)
                                'Read Q data in buffer
CALL viRead(analyzer, result$, 1, retCount)
                                'Read in end character <NL>
```

```

'----- Output of binary data as frequency/level pair -----
IQValues = IQBytes/4           'Single Precision = 4 Bytes
For i = 0 To IQValues - 1
  Print "I-Value["; i; "] = "; IData(i)
  Print "Q-Value["; i; "] = "; QData(i)
Next i

'----- Read-out in ASCII format -----
CALL InstrWrite(analyzer,"FORMAT ASCII") 'Set ASCII format
CALL InstrWrite(analyzer, "TRAC:IQ:DATA?")
                                         'Re-measure and read out
                                         'I/Q data

CALL InstrRead(analyzer, asciiResult$)
CALL InstrWrite(analyzer,"TRAC:IQ:STAT OFF")
                                         'Stop I/Q data aquisition
                                         'mode if no further
                                         'measurements are to be
                                         'done

END SUB
REM *****

```

## Averaging I/Q Data

The R&S ESL has averaging capability also for I/Q measurements, i.e. I/Q data can be averaged over several test runs. This is subject to the following conditions:

1. An external trigger signal must be available for data measurement, and the trigger signal must be phase-locked to the signal measured.
2. The same reference-frequency signal must be used for the DUT and the R&S ESL.
3. The sampling rate must be 32 MHz, since only with this sampling frequency will the measurement be performed phase-synchronous with the trigger signal.

If all of the above conditions are fulfilled, no phase shift will occur between consecutive test runs. Phase shift may falsify the measured average so that in extreme cases a value of 0 is obtained.

The default setting of the instrument for data measurement without averaging has to be changed as follows:

```

REM *****
'----- R&S ESL default setting -----
CALL SetupInstrument           'Default setting
CALL InstrWrite(analyzer,"TRAC:IQ:STAT ON")
                               'Activate I/Q data acquisition
                               'mode; this must be
                               'done before TRAC:IQ:SET!

'Select max. number of test points (= 512 * 1024 - 512) at 10 MHz RBW,
                               '32 MHz sampling rate, external
                               'trigger, pos. trigger edge and
                               '0 s trigger delay.

CALL InstrWrite(analyzer,"TRAC:IQ:SET NORM,10MHz,32MHz,EXT,POS,0,130560")

```

```
CALL InstrWrite(analyzer,"TRAC:IQ:AVER ON") 'Switch on I/Q averaging
CALL InstrWrite(analyzer,"TRAC:IQ:AVER:COUN 10") 'Set 10 test runs
'----- Read data in binary format -----
...
REM *****
```

## Reading and Writing Files

### Reading a File from the Instrument

In the following example, the TEST1.FSL.DFL file stored under C:\R\_S\Instr\user is read from the instrument and stored in the controller.

```
REM *****
Public Sub ReadFile()
'----- Generate variables -----
Dim digits As Byte 'Number of digits of
                    'length information
Dim fileBytes As Long 'Length of file with trace data
                    'in bytes
result$ = Space$(100) 'Buffer for simple results
'----- Default setting of status register -----
CALL SetupStatusReg 'Configure status register
'----- Read out file -----
CALL InstrWrite(analyzer, "MMEM:DATA? 'C:\R_S\Instr\user\TEST1.FSL.DFL'")
                    'Select file
CALL ilrd(analyzer, result$, 2) 'Read and store number of
digits = Val(Mid$(result$, 2, 1)) 'digits of length information
CALL ilrd(analyzer, result$, digits) 'Read and store length
fileBytes = Val(Left$(result$, digits)) 'information
FileBuffer$ = Space$(fileBytes) 'Buffer for file
CALL ilrd(analyzer, FileBuffer, fileBytes) 'Read file into buffer
CALL ilrd(analyzer, result$, 1) 'Read terminator <NL>
'----- Store file to controller -----
Open "TEST1.FSL.DFL" For Output As #1
Print #1, FileBuffer; ' ; to avoid linefeed at
                    ' end of file

Close #1
END SUB
REM *****
```

## Creating a File on the Instrument

In the following example, the TEST1.FSL.DFL file available on the controller is stored in the instrument under C:\R\_S\Instr\user\DUPLICAT.FSL.DFL.

```

REM *****
Public Sub WriteFile()
'----- Generate variables -----
FileBuffer$ = Space$(100000)           'Buffer for file
Dim digits As Long                     'Number of digits of
                                       'length information
Dim fileBytes As Long                  'Length of file in bytes
fileSize$ = Space$(100)                'Length of file as a string
result$ = Space$(100)                 'Buffer for simple results
'----- Default setting of status register -----
CALL SetupStatusReg                    'Configure status register
'----- Prepare the definite length block data -----
fileBytes = FileLen("H:\work\vb\TEST1.FSL.DFL")
                                       'Determine length of file
fileSize$ = Str$(fileBytes)
digits = Len(fileSize$) - 1            'Determine number of digits of
fileSize$ = Right$(fileSize$, digits)  'length information
FileBuffer$ = "#" + Right$(Str$(digits), 1) + fileSize$
                                       'Store length information in
                                       'file buffer
'----- Read file from controller -----
Open "H:\work\vb\TEST1.FSL.DFL" For Binary As #1
FileBuffer$ = FileBuffer$ + Left$(Input(fileBytes, #1), fileBytes)
Close #1
'----- Write file -----
CALL InstrWrite(analyzer, "SYST:COMM:GPIB:RTER EOI") 'Set receive
                                                    'terminator on the
                                                    'instrument
CALL InstrWrite(analyzer, "MMEM:DATA 'DUPLICAT.FSL.DFL'," + FileBuffer$)
                                                    'Select file

END SUB
REM *****

```

## Spectrum Emission Mask Measurement

You can configure Spectrum Emission Mask measurements via XML files provided for different standards or by defining ranges and parameters. For both ways an example is given.

### Using Predefined Standard Wibro

In the following example, the Spectrum Emission Mask measurement is configured using a predefined standard XML file.

```

REM *****
'----- General settings of the instrument -----'
CALL InstrWrite(analyzer,"*RST")           'Reset instrument
CALL InstrWrite(analyzer,"INIT:CONT OFF")  'Switch to single sweep
CALL InstrWrite(analyzer,":SENSel:SWEep:MODE ESpectrum")
                                           'Set measurement mode

Rem After preset 3 ranges are available where the middle one is
Rem the reference range for calculating the TX power
CALL InstrWrite(analyzer,":SENSel:FREQuency:CENTer 2.2GHz")
                                           'Center frequency 2.2 GHz
CALL InstrWrite(analyzer,":SENSel:DETEctor1 RMS")
                                           'Set RMS detector

'----- Setting up the gated trigger -----'
CALL InstrWrite(analyzer,":SENSel:SWEep:EGATE ON")
                                           'Switch on the external gate mode
CALL InstrWrite(analyzer,":SENSel:SWEep:EGATE:SOURce EXTernal")
                                           'Set external gate source
CALL InstrWrite(analyzer,":SENSel:SWEep:EGATE:HOLDoff 0s")
                                           'Set delay time to 0 s
CALL InstrWrite(analyzer,":SENSel:SWEep:EGATE:LENGth 200 US")
                                           'Set time interval

'----- Setting the standard -----'
CALL InstrWrite(analyzer,"SENSel:ESpectrum:PRESet:STANdard
                                           'WIBRO\DL\PowerClass_29_40.xml'")
                                           'Set WiBro standard

'----- Measuring -----'
CALL InstrWrite(analyzer,"INIT;*WAI")      'Perform sweep, wait for sweep
                                           'end

'----- Reading out results -----'
CALL InstrWrite(analyzer,":TRACel:DATA? LIST")
                                           'Query list results
CALL InstrWrite(analyzer,":CALCulate:LIMit:FAIL?")
                                           'Query result of limit check

CALL InstrRead(analyzer, result$)
REM *****

```

## Defining 5 Ranges with all Parameters

In the following example, the Spectrum Emission Mask measurement is configured by defining ranges and parameters.

```

REM *****
'----- General settings of the instrument -----'
CALL InstrWrite(analyzer,"*RST")           'Reset instrument
CALL InstrWrite(analyzer,"INIT:CONT OFF")  'Switch to single sweep
CALL InstrWrite(analyzer,":SENSel:SWEep:MODE ESpectrum")
                                           'Set measurement mode
Rem After preset 3 ranges are available where the middle one is
Rem the reference range for calculating the TX power
CALL InstrWrite(analyzer,":SENSel:FREQuency:CENTer 2.2GHz")
                                           'Center frequency 2.2 GHz
CALL InstrWrite(analyzer,":SENSel:DETEctor1 RMS")
                                           'Set RMS detector
CALL InstrWrite(analyzer,":TRIGger1:SEQuence:SOURce IMMEDIATE")
                                           'Trigger setup

'----- Setting up the gated trigger -----'
Rem If a free run trigger is not appropriate a gated trigger can
Rem be set up (just comment in the following lines).
Rem CALL InstrWrite(analyzer,":SENSel:SWEep:EGATE ON")
Rem Switch on the external gate mode
Rem CALL InstrWrite(analyzer,":SENSel:SWEep:EGATE:SOURce EXTERNAL")
Rem Set external gate source
Rem CALL InstrWrite(analyzer,":SENSel:SWEep:EGATE:HOLDoff 0s")
Rem Set delay time to 0 s
Rem CALL InstrWrite(analyzer,":SENSel:SWEep:EGATE:LENGth 200 US")
Rem Set time interval

'----- Setting the span -----'
CALL InstrWrite(analyzer,":SENSel:FREQuency:SPAN 8 MHZ")
                                           'Set the span to 8 MHz

'----- Inserting new ranges -----'
Rem Enlarge number of ranges to 5 by adding one at the end
Rem and one at the beginning. This ensures that the reference range
Rem remains in the middle
CALL InstrWrite(analyzer,":SENSel:ESpectrum:RANGe2:INSert AFTEr")
                                           'Insert a range after range 2
CALL InstrWrite(analyzer,":SENSel:ESpectrum:RANGe1:INSert BEFOre")
                                           'Insert a range before range 1

'----- Defining the limit check for all ranges -----'
CALL InstrWrite(analyzer,":SENSel:ESpectrum:RANGe:LIMit:STATe AND")
                                           'Set check for absolute and
                                           'relative limit

```

```
'----- Defining the reference range settings -----  
Rem The bandwidth of the reference range limits the minimum span  
Rem of the reference range definition later in the script.  
CALL InstrWrite(analyzer,":SENSE1:ESPECTRUM:RTYPE CPOWER")  
                                     'Set power reference type  
CALL InstrWrite(analyzer,":SENSE1:ESPECTRUM:BWID 2 MHZ")  
                                     'Set bandwidth  
  
'----- Defining the settings of range 1 -----  
CALL InstrWrite(analyzer,":SENSE1:ESPECTRUM:RANGE1:FREQUENCY:START -4MHz")  
                                     'Set the start frequency  
CALL InstrWrite(analyzer,":SENSE1:ESPECTRUM:RANGE1:FREQUENCY:STOP -2MHz")  
                                     'Set the stop frequency  
CALL InstrWrite(analyzer,":SENSE1:ESPECTRUM:RANGE1:BANDWIDTH:RESOLUTION  
                                     1 MHZ")  
                                     'Set the resolution bandwidth  
CALL InstrWrite(analyzer,":SENSE1:ESPECTRUM:RANGE1:FILTER:TYPE CFILTER")  
                                     'Set the channel filters  
CALL InstrWrite(analyzer,":SENSE1:ESPECTRUM:RANGE1:BANDWIDTH:VIDEO 3 MHZ")  
                                     'Set the video bandwidth to 3 MHz  
CALL InstrWrite(analyzer,":SENSE1:ESPECTRUM:RANGE1:SWEPTIME 20 ms")  
                                     'Set the sweep time to 20 ms  
CALL InstrWrite(analyzer,":SENSE1:ESPECTRUM:RANGE1:RLEVEL 5 DBM")  
                                     'Set the reference level to 5 dBm  
CALL InstrWrite(analyzer,":SENSE1:ESPECTRUM:RANGE1:INPUT:ATTENUATION 20 DB")  
                                     'Set the attenuation to 20 dB  
CALL InstrWrite(analyzer,":SENSE1:ESPECTRUM:RANGE1:LIMIT:ABSOLUTE:START  
                                     -50")  
                                     'Set an absolute limit of -50 dBm  
CALL InstrWrite(analyzer,":SENSE1:ESPECTRUM:RANGE1:LIMIT:ABSOLUTE:STOP -50")  
                                     'Set an absolute limit of -50 dBm  
CALL InstrWrite(analyzer,":SENSE1:ESPECTRUM:RANGE1:LIMIT:RELATIVE:START  
                                     -70")  
                                     'Set a relative limit of -70 dBc  
CALL InstrWrite(analyzer,":SENSE1:ESPECTRUM:RANGE1:LIMIT:RELATIVE:STOP -60")  
                                     'Set a relative limit of -60 dBc  
  
'----- Defining the settings of range 2 -----  
CALL InstrWrite(analyzer,":SENSE1:ESPECTRUM:RANGE2:FREQUENCY:START -2MHz")  
CALL InstrWrite(analyzer,":SENSE1:ESPECTRUM:RANGE2:FREQUENCY:STOP -1MHz")  
CALL InstrWrite(analyzer,":SENSE1:ESPECTRUM:RANGE2:BANDWIDTH:RESOLUTION  
                                     100 kHz")  
CALL InstrWrite(analyzer,":SENSE1:ESPECTRUM:RANGE2:FILTER:TYPE NORM")  
CALL InstrWrite(analyzer,":SENSE1:ESPECTRUM:RANGE2:BANDWIDTH:VIDEO 300 kHz")  
CALL InstrWrite(analyzer,":SENSE1:ESPECTRUM:RANGE2:SWEPTIME 50 ms")  
CALL InstrWrite(analyzer,":SENSE1:ESPECTRUM:RANGE2:RLEVEL 10 DBM")  
CALL InstrWrite(analyzer,":SENSE1:ESPECTRUM:RANGE2:INPUT:ATTENUATION 30 DB")  
CALL InstrWrite(analyzer,":SENSE1:ESPECTRUM:RANGE2:LIMIT:ABSOLUTE:START  
                                     -40")
```



```

CALL InstrWrite(analyzer,":SENSE1:ESpectrum:RANGe2:LIMit:RELative:START
                        -60")
CALL InstrWrite(analyzer,":SENSE1:ESpectrum:RANGe2:LIMit:ABSolute:STOP -40")
CALL InstrWrite(analyzer,":SENSE1:ESpectrum:RANGe2:LIMit:RELative:STOP -40")
'----- Defining the settings of range 3 -----
CALL InstrWrite(analyzer,":SENSE1:ESpectrum:RANGe3:FREQuency:START -1MHz")
CALL InstrWrite(analyzer,":SENSE1:ESpectrum:RANGe3:FREQuency:STOP 1MHz")
CALL InstrWrite(analyzer,":SENSE1:ESpectrum:RANGe3:BANDwidth:RESolution
                        30 kHz")
CALL InstrWrite(analyzer,":SENSE1:ESpectrum:RANGe3:FILTer:TYPE NORM")
CALL InstrWrite(analyzer,":SENSE1:ESpectrum:RANGe3:BANDwidth:VIDeo 100 kHz")
CALL InstrWrite(analyzer,":SENSE1:ESpectrum:RANGe3:SWEep:TIME 5 ms")
CALL InstrWrite(analyzer,":SENSE1:ESpectrum:RANGe3:RLEVel 20 DBM")
CALL InstrWrite(analyzer,":SENSE1:ESpectrum:RANGe3:INPut:ATTenuation 30 DB")
CALL InstrWrite(analyzer,":SENSE1:ESpectrum:RANGe3:LIMit:ABSolute:START
                        200")
CALL InstrWrite(analyzer,":SENSE1:ESpectrum:RANGe3:LIMit:ABSolute:STOP 200")
CALL InstrWrite(analyzer,":SENSE1:ESpectrum:RANGe3:LIMit:RELative:START
                        200")
CALL InstrWrite(analyzer,":SENSE1:ESpectrum:RANGe3:LIMit:RELative:STOP 200")
'----- Defining the settings of range 4 -----
CALL InstrWrite(analyzer,":SENSE1:ESpectrum:RANGe4:FREQuency:START 1MHz")
CALL InstrWrite(analyzer,":SENSE1:ESpectrum:RANGe4:FREQuency:STOP 2MHz")
CALL InstrWrite(analyzer,":SENSE1:ESpectrum:RANGe4:BANDwidth:RESolution
                        100 kHz")
CALL InstrWrite(analyzer,":SENSE1:ESpectrum:RANGe4:FILTer:TYPE NORM")
CALL InstrWrite(analyzer,":SENSE1:ESpectrum:RANGe4:BANDwidth:VIDeo 300 kHz")
CALL InstrWrite(analyzer,":SENSE1:ESpectrum:RANGe4:SWEep:TIME 50 ms")
CALL InstrWrite(analyzer,":SENSE1:ESpectrum:RANGe4:RLEVel 10 DBM")
CALL InstrWrite(analyzer,":SENSE1:ESpectrum:RANGe4:INPut:ATTenuation 30 DB")
CALL InstrWrite(analyzer,":SENSE1:ESpectrum:RANGe4:LIMit:ABSolute:START
                        -40")
CALL InstrWrite(analyzer,":SENSE1:ESpectrum:RANGe4:LIMit:ABSolute:STOP -40")
CALL InstrWrite(analyzer,":SENSE1:ESpectrum:RANGe4:LIMit:RELative:START
                        -40")
CALL InstrWrite(analyzer,":SENSE1:ESpectrum:RANGe4:LIMit:RELative:STOP -60")
'----- Defining the settings of range 5 -----
CALL InstrWrite(analyzer,":SENSE1:ESpectrum:RANGe5:FREQuency:START 2MHz")
CALL InstrWrite(analyzer,":SENSE1:ESpectrum:RANGe5:FREQuency:STOP 4MHz")
CALL InstrWrite(analyzer,":SENSE1:ESpectrum:RANGe5:BANDwidth:RESolution
                        1 MHz")
CALL InstrWrite(analyzer,":SENSE1:ESpectrum:RANGe5:FILTer:TYPE CFILter")
CALL InstrWrite(analyzer,":SENSE1:ESpectrum:RANGe5:BANDwidth:VIDeo 3 MHz")

```

```
CALL InstrWrite(analyzer,":SENSE1:ESpectrum:RANGe5:SWEep:TIME 20 ms")
CALL InstrWrite(analyzer,":SENSE1:ESpectrum:RANGe5:RLEVel 5 DBM")
CALL InstrWrite(analyzer,":SENSE1:ESpectrum:RANGe5:INPut:ATTenuation 20 DB")
CALL InstrWrite(analyzer,":SENSE1:ESpectrum:RANGe5:LIMit:ABSolute:START
                    -50")
CALL InstrWrite(analyzer,":SENSE1:ESpectrum:RANGe5:LIMit:ABSolute:STOP -50")
CALL InstrWrite(analyzer,":SENSE1:ESpectrum:RANGe5:LIMit:RELative:START
                    -60")
CALL InstrWrite(analyzer,":SENSE1:ESpectrum:RANGe5:LIMit:RELative:STOP -70")
'----- Measuring -----
CALL InstrWrite(analyzer,"INIT;*WAI")      'Perform sweep, wait for sweep
                                           'end
'----- Reading out results -----
CALL InstrWrite(analyzer,":TRACe1:DATA? LIST")
                                           'Query list results
CALL InstrWrite(analyzer,":CALCulate:LIMit:FAIL?")
                                           'Query result of limit check
CALL InstrRead(analyzer, result$)
REM *****
```

**Spurious Emissions Measurement**

In the following example, the Spurious Emissions measurement is configured by defining ranges and parameters.

```
REM *****
'----- General settings of the instrument -----
CALL InstrWrite(analyzer,"*RST")          'Reset instrument
Rem After preset 4 ranges are available. Range settings can be questioned
Rem independent from the set measurement mode.
'----- Deleting all ranges -----
Rem Delete all ranges to prepare for setting up a new measurement
CALL InstrWrite(analyzer,"SENSE1:LIST:RANGe4:DELeTe")
                                           'Delete range 4
CALL InstrWrite(analyzer,"SENSE1:LIST:RANGe3:DELeTe")
CALL InstrWrite(analyzer,"SENSE1:LIST:RANGe2:DELeTe")
CALL InstrWrite(analyzer,"SENSE1:LIST:RANGe1:DELeTe")
'----- Defining the start frequency for all ranges -----
CALL InstrWrite(analyzer,"SENSE1:LIST:RANGe1:FREQuency:START 1000000")
Rem Setting the start frequency of range 1 will create the ranges and
Rem every other range value will be set to the default value.
CALL InstrWrite(analyzer,"SENSE1:LIST:RANGe2:FREQuency:START 2000000")
CALL InstrWrite(analyzer,"SENSE1:LIST:RANGe3:FREQuency:START 3000000")
```

```

CALL InstrWrite(analyzer,"SENSEl:LIST:RANGe4:FREQuency:START 4000000")
CALL InstrWrite(analyzer,"SENSEl:LIST:RANGe5:FREQuency:START 5000000")
CALL InstrWrite(analyzer,"SENSEl:LIST:RANGe:COUNT?")
                                     'Queries the number of defined
                                     'ranges
'----- Querying the parameters of range 1 -----
CALL InstrWrite(analyzer,"SENSEl:LIST:RANGe1:FREQuency:START?")
CALL InstrWrite(analyzer,"SENSEl:LIST:RANGe1:FREQuency:STOP?")
CALL InstrWrite(analyzer,"SENSEl:LIST:RANGe1:FILTer:TYPE?")
CALL InstrWrite(analyzer,"SENSEl:LIST:RANGe1:BANDwidth:RESolution?")
CALL InstrWrite(analyzer,"SENSEl:LIST:RANGe1:BANDwidth:VIDeo?")
CALL InstrWrite(analyzer,"SENSEl:LIST:RANGe1:SWEep:TIME:AUTO?")
CALL InstrWrite(analyzer,"SENSEl:LIST:RANGe1:DETEctor?")
CALL InstrWrite(analyzer,"SENSEl:LIST:RANGe1:RLEVel?")
CALL InstrWrite(analyzer,"SENSEl:LIST:RANGe1:INPut:ATTenuation:AUTO?")
CALL InstrWrite(analyzer,"SENSEl:LIST:RANGe1:INPut:GAIN:STATe?")
CALL InstrWrite(analyzer,"SENSEl:LIST:RANGe1:BREReak?")
CALL InstrWrite(analyzer,"SENSEl:LIST:RANGe1:TRANsducer?")
CALL InstrWrite(analyzer,"SENSEl:LIST:RANGe1:SWEep:TIME?")
CALL InstrWrite(analyzer,"SENSEl:LIST:RANGe1:INPut:ATTenuation?")
CALL InstrWrite(analyzer,"SENSEl:LIST:RANGe1:POINts?")
CALL InstrWrite(analyzer,"SENSEl:LIST:RANGe1:LIMit:START?")
CALL InstrWrite(analyzer,"SENSEl:LIST:RANGe1:LIMit:STOP?")
CALL InstrWrite(analyzer,"SENSEl:LIST:RANGe1:LIMit:STATe?")
'----- Changing into the Spurious Emissions measurement mode -----
CALL InstrWrite(analyzer,":SENSEl:SWEep:MODE LIST")
Rem In continuous sweep mode, editing the ranges is not allowed.
Rem You have to stop the measurement first.
Rem In single sweep mode, you can edit the ranges at the end of the sweep.
'----- Single sweep version -----
CALL InstrWrite(analyzer,"INIT:CONT OFF") 'Switch to single sweep
CALL InstrWrite(analyzer,"SENSEl:LIST:RANGe1:FREQuency:START 500000")
                                     'Change the start frequency
CALL InstrWrite(analyzer,"INIT;*WAI") 'Perform sweep, wait for sweep
                                     'end
'----- Continuous sweep version -----
CALL InstrWrite(analyzer,"INIT:CONT ON") 'Switch to continuous sweep
CALL InstrWrite(analyzer,"ABORT") 'Stop the measurement
CALL InstrWrite(analyzer,"SENSEl:LIST:RANGe1:FREQuency:START 500000")
                                     'Change the start frequency
CALL InstrWrite(analyzer,":INITiatel:SPURious") 'Restart the measurement
'----- Defining the range settings in single sweep mode -----

```

```
CALL InstrWrite(analyzer,"INIT:CONT OFF") 'Switch to single sweep
CALL InstrWrite(analyzer,"INIT;*WAI")      'Perform sweep, wait for sweep
                                           'end

Rem Edit one range at a time. Make sure to edit the ranges in a correct
Rem order to prevent limit violations. Ranges cannot overlap.
Rem The best way is to start with range 1.
CALL InstrWrite(analyzer,"SENSE1:LIST:RANGE1:FREQUENCY:START 500000")
CALL InstrWrite(analyzer,"SENSE1:LIST:RANGE1:FREQUENCY:STOP 550000")
CALL InstrWrite(analyzer,"SENSE1:LIST:RANGE1:FILTER:TYPE NORM")
CALL InstrWrite(analyzer,"SENSE1:LIST:RANGE1:BANDWIDTH:RESOLUTION 3000000")
CALL InstrWrite(analyzer,"SENSE1:LIST:RANGE1:BANDWIDTH:VIDEO 10000000")
CALL InstrWrite(analyzer,"SENSE1:LIST:RANGE1:SWEEP:TIME:AUTO ON")
CALL InstrWrite(analyzer,"SENSE1:LIST:RANGE1:DETECTOR RMS")
CALL InstrWrite(analyzer,"SENSE1:LIST:RANGE1:RLEVEL -10")
CALL InstrWrite(analyzer,"SENSE1:LIST:RANGE1:INPUT:ATTENUATION:AUTO ON")
CALL InstrWrite(analyzer,"SENSE1:LIST:RANGE1:POINTS 8001")
CALL InstrWrite(analyzer,"SENSE1:LIST:RANGE1:INPUT:GAIN:STATE OFF")
CALL InstrWrite(analyzer,"SENSE1:LIST:RANGE1:BREAK OFF")
CALL InstrWrite(analyzer,"SENSE1:LIST:RANGE1:LIMIT:START -20")
CALL InstrWrite(analyzer,"SENSE1:LIST:RANGE1:LIMIT:STOP -20")
CALL InstrWrite(analyzer,"SENSE1:LIST:RANGE1:LIMIT:STATE ON")
Rem Proceed with range 2.
CALL InstrWrite(analyzer,"SENSE1:LIST:RANGE2:FREQUENCY:START 1000000")
CALL InstrWrite(analyzer,"SENSE1:LIST:RANGE2:FREQUENCY:STOP 200000000")
CALL InstrWrite(analyzer,"SENSE1:LIST:RANGE2:FILTER:TYPE CFILTER")
CALL InstrWrite(analyzer,"SENSE1:LIST:RANGE2:BANDWIDTH:RESOLUTION 5000000")
CALL InstrWrite(analyzer,"SENSE1:LIST:RANGE2:DETECTOR POS")
CALL InstrWrite(analyzer,"SENSE1:LIST:RANGE2:RLEVEL -20")
CALL InstrWrite(analyzer,"SENSE1:LIST:RANGE2:INPUT:ATTENUATION 0")
CALL InstrWrite(analyzer,"SENSE1:LIST:RANGE2:POINTS 32001")
CALL InstrWrite(analyzer,"SENSE1:LIST:RANGE2:INPUT:GAIN:STATE ON")
Rem Proceed with range 3.
CALL InstrWrite(analyzer,"SENSE1:LIST:RANGE3:FREQUENCY:START 250000000")
CALL InstrWrite(analyzer,"SENSE1:LIST:RANGE3:FREQUENCY:STOP 1000000000")
CALL InstrWrite(analyzer,"SENSE1:LIST:RANGE3:FILTER:TYPE RRC")
CALL InstrWrite(analyzer,"SENSE1:LIST:RANGE3:POINTS 32001")
Rem Proceed with range 4.
CALL InstrWrite(analyzer,"SENSE1:LIST:RANGE4:FREQUENCY:START 1200000000")
CALL InstrWrite(analyzer,"SENSE1:LIST:RANGE4:FREQUENCY:STOP 4000000000")
CALL InstrWrite(analyzer,"SENSE1:LIST:RANGE4:FILTER:TYPE PULSE")
CALL InstrWrite(analyzer,"SENSE1:LIST:RANGE4:POINTS 251")
```

```

Rem Proceed with range 5.
CALL InstrWrite(analyzer,"SENSE1:LIST:RANGE5:FREQUENCY:START 5000000000")
CALL InstrWrite(analyzer,"SENSE1:LIST:RANGE5:FREQUENCY:STOP 6000000000")
CALL InstrWrite(analyzer,"SENSE1:LIST:RANGE5:POINTS 7001")
'----- Defining the limit check for all ranges -----
CALL InstrWrite(analyzer,"SENSE1:LIST:RANGE1:LIMIT:STATE ON")
                                     'Activate the limit check
'----- Setting the span to include all ranges -----
CALL InstrWrite(analyzer,":SENSE1:FREQUENCY:START 500000")
CALL InstrWrite(analyzer,":SENSE1:FREQUENCY:STOP 6000000000")
'----- Measuring -----
CALL InstrWrite(analyzer,"INIT;*WAI")      'Perform sweep, wait for sweep
                                     'end
'----- Reading out results -----
CALL InstrWrite(analyzer,":TRAC1:DATA? LIST")
                                     'Query list results
CALL InstrWrite(analyzer,":CALCULATE1:PSEARCH[:IMMEDIATE]")
                                     'Deactivate limit line and
                                     'just look for peaks

Rem Or set margin to 200 in order to find all peaks
CALL InstrWrite(analyzer,":TRAC1:DATA? SPUR")
                                     'Query just the peaks
CALL InstrWrite(analyzer,":CALCULATE:LIMIT:FAIL?")
                                     'Query result of limit check
CALL InstrRead(analyzer, result$)
REM *****

```

## Contents of Chapter 8

<b>8 Maintenance .....</b>	<b>8.1</b>
<b>Storing and Packing.....</b>	<b>8.1</b>
<b>List of Power Cables Available .....</b>	<b>8.1</b>

## 8 Maintenance

The following chapter contains information on the maintenance of the R&S ESL. The instrument does not need a periodic maintenance. What is necessary is essentially the cleaning of the instrument. However, it is recommended to check the rated data from time to time.

Follow the instructions in the service manual and the safety instructions when exchanging modules or ordering spares. The order no. for spare parts is included in the service manual. The service manual includes further information particularly on troubleshooting, repair, exchange of modules (including battery exchange, adjustment of the OCXO oscillator) and alignment.

The address of our support center and a list of all Rohde & Schwarz service centers can be found at the beginning of this manual.

### Storing and Packing

The storage temperature range of the instrument is given in the data sheet. If the instrument is to be stored for a longer period of time, it must be protected against dust.

Repack the instrument as it was originally packed when transporting or shipping. The two protective foam plastic parts prevent the control elements and connectors from being damaged. The antistatic packing foil avoids any undesired electrostatic charging to occur.

If you do not use the original packaging, provide for sufficient padding to prevent the instrument from slipping inside the package. Wrap antistatic packing foil around the instrument to protect it from electrostatic charging.

### List of Power Cables Available

**Table 8–1 List of power cables available**

Stock No.	Earthed–contact connector	Preferably used in
DS 006.7013.00	BS1363: 1967' complying with IEC 83: 1975 standard B2	Great Britain
DS 006.7020.00	Type 12 complying with SEV–regulation 1011.1059, standard sheet S 24 507	Switzerland
DS 006.7036.00	Type 498/13 complying with US–regulation UL 498, or with IEC 83	USA/Canada
DS 006.7107.00	Type SAA3 10 A, 250 V, complying with AS C112–1964 Ap.	Australia
DS 0025.2365.00 DS 0099.1456.00	DIN 49 441, 10 A, 250 V, angular DIN 49 441, 10 A, 250 V, straight	Europe (except Switzerland)

## Contents of Chapter 9

<b>9 Error Messages .....</b>	<b>9.2</b>
<b>SCPI-Specific Error Messages .....</b>	<b>9.2</b>
<b>Device-Specific Messages .....</b>	<b>9.7</b>
<b>Noise Figure Measurements Option Messages (K30) .....</b>	<b>9.8</b>



## 9 Error Messages

Error messages are entered in the error/event queue of the status reporting system in the remote control mode and can be queried with the command `SYSTem:ERRor?`. The answer format of R&S FSL to the command is as follows:

```
<error code>, "<error text with queue query>;
<remote control command concerned>"
```

The indication of the remote control command with prefixed semicolon is optional.

Example:

The command `"TEST:COMMAND"` generates the following answer to the query `SYSTem:ERRor?`

```
-113,"Undefined header;TEST:COMMAND"
```

The subsequent lists contain the description of error texts displayed on the instrument.

Distinction is made between error messages defined by SCPI, which are marked by negative error codes, and the device-specific error messages for which positive error codes are used:

- [SCPI-Specific Error Messages](#)
- [Device-Specific Messages](#)

The right-hand column in the following tables contains the error text in bold which is entered in the error/event queue and can be read out by means of query `SYSTem:ERRor?`. A short explanation of the error cause is given below. The left-hand column contains the associated error code.

Additionally, option-specific warnings and error messages displayed in the status bar are explained.

### SCPI-Specific Error Messages

**Table 9-1 No Error**

Error code	Error text in the case of queue poll Error explanation
0	<b>No error</b> This message is displayed if the error queue does not contain any entries.

**Table 9-2 Command Error – Faulty command; sets bit 5 in the ESR register.**

Error code	Error text in the case of queue poll Error explanation
-100	<b>Command Error</b> The command is faulty or invalid.

Error code	Error text in the case of queue poll Error explanation
-101	<b>Invalid Character</b> The command contains an invalid sign. Example: A header contains an ampersand, "SENSe&".
-102	<b>Syntax error</b> The command is invalid. Example: The command contains block data the instrument does not accept.
-103	<b>Invalid separator</b> The command contains an invalid sign instead of a separator. Example: A semicolon is missing after the command.
-104	<b>Data type error</b> The command contains an invalid value indication. Example: ON is indicated instead of a numeric value for frequency setting.
-105	<b>GET not allowed</b> A Group Execute Trigger (GET) is within a command line.
-108	<b>Parameter not allowed</b> The command contains too many parameters. Example: Command SENSe:FREQuency:CENTer permits only one frequency indication.
-109	<b>Missing parameter</b> The command contains too few parameters. Example: The command SENSe:FREQuency:CENTer requires a frequency indication.
-110	<b>Command header error</b> The header of the command is faulty.
-111	<b>Header separator error</b> The header contains an invalid separator. Example: the header is not followed by a "White Space", "*ESE255"
-112	<b>Program mnemonic too long</b> The header contains more than 12 characters.
-113	<b>Undefined header</b> The header is not defined for the instrument. Example: *XYZ is undefined for every instrument.
-114	<b>Header suffix out of range</b> The header contains an invalid numeric suffix. Example: SENSe3 does not exist in the instrument.
-120	<b>Numeric data error</b> The command contains a faulty numeric parameter.
-121	<b>Invalid character in number</b> A number contains an invalid character. Example: An "A" in a decimal number or a "9" in an octal number.
-123	<b>Exponent too large</b> The absolute value of the exponent is greater than 32000.
-124	<b>Too many digits</b> The number includes too many digits.
-128	<b>Numeric data not allowed</b> The command includes a number which is not allowed at this position. Example: The command INPut:COUPLing requires indication of a text parameter.

<b>Error code</b>	<b>Error text in the case of queue poll</b> Error explanation
-130	<b>Suffix error</b> The command contains a faulty suffix.
-131	<b>Invalid suffix</b> The suffix is invalid for this instrument. Example: nHz is not defined.
-134	<b>Suffix too long</b> The suffix contains more than 12 characters.
-138	<b>Suffix not allowed</b> A suffix is not allowed for this command or at this position of the command. Example: The command *RCL does not permit a suffix to be indicated.
-140	<b>Character data error</b> The command contains a faulty text parameter
-141	<b>Invalid character data</b> The text parameter either contains an invalid character or it is invalid for this command. Example: Write error with parameter indication;INPut:COUPling XC.
-144	<b>Character data too long</b> The text parameter contains more than 12 characters.
-148	<b>Character data not allowed</b> The text parameter is not allowed for this command or at this position of the command. Example: The command *RCL requires a number to be indicated.
-150	<b>String data error</b> The command contains a faulty string.
-151	<b>Invalid string data</b> The command contains a faulty string. Example: An END message has been received prior to the terminating apostrophe.
-158	<b>String data not allowed</b> The command contains an allowed string at an invalid position. Example: A text parameter is set in quotation marks, INPut:COUPling "DC"
-160	<b>Block data error</b> The command contains faulty block data.
-161	<b>Invalid block data</b> The command contains faulty block data. Example: An END message was received prior to reception of the expected number of data.
-168	<b>Block data not allowed</b> The command contains allowed block data at an invalid position. Example: The command *RCL requires a number to be indicated.
-170	<b>Expression error</b> The command contains an invalid mathematical expression.
-171	<b>Invalid expression</b> The command contains an invalid mathematical expression. Example: The expression contains mismatching parentheses.
-178	<b>Expression data not allowed</b> The command contains a mathematical expression at an invalid position.

Table 9–3 Execution Error – Error on execution of a command; sets bit 4 in the ESR register

Error code	Error text in the case of queue poll Error explanation
–200	<b>Execution error</b> Error on execution of the command.
–201	<b>Invalid while in local</b> The command is not executable while the device is in local due to a hard local control. Example: The device receives a command which would change the rotary knob state, but the device is in local so the command can not be executed.
–202	<b>Settings lost due to rtl</b> A setting associated with hard local control was lost when the device changed to LOCS from REMS or to LWLS from RWLS.
–210	<b>Trigger error</b> Error on triggering the device.
–211	<b>Trigger ignored</b> The trigger (GET, *TRG or trigger signal) was ignored because of device timing considerations. Example: The device was not ready to respond.
–212	<b>Arm ignored</b> An arming signal was ignored by the device.
–213	<b>Init ignored</b> Measurement initialization was ignored as another measurement was already in progress.
–214	<b>Trigger deadlock</b> The trigger source for the initiation of measurement is set to GET and subsequent measurement is received. The measurement cannot be started until a GET is received, but the GET would cause an interrupted–error)
–215	<b>Arm deadlock</b> The trigger source for the initiation of measurement is set to GET and subsequent measurement is received. The measurement cannot be started until a GET is received, but the GET would cause an interrupted–error.
–220	<b>Parameter error</b> The command contains a faulty or invalid parameter.
–221	<b>Settings conflict</b> There is a conflict between setting of parameter value and instrument state.
–222	<b>Data out of range</b> The parameter value lies out of the allowed range of the instrument.
–223	<b>Too much data</b> The command contains too many data. Example: The instrument does not have sufficient storage space.
–224	<b>Illegal parameter value</b> The parameter value is invalid. Example: The text parameter is invalid , <code>TRIGger : SWEp : SOURce TASTe</code>
–230	<b>Data corrupt or stale</b> The data are incomplete or invalid. Example: The instrument has aborted a measurement.
–231	<b>Data questionable</b> The measurement accuracy is suspect.
–240	<b>Hardware error</b> The command cannot be executed due to problems with the instrument hardware.

<b>Error code</b>	<b>Error text in the case of queue poll</b> Error explanation
-241	<b>Hardware missing</b> Hardware is missing. Example: An option is not fitted.
-250	<b>Mass storage error</b> A mass storage error occurred.
-251	<b>Missing mass storage</b> The mass storage is missing. Example: An option is not installed.
-252	<b>Missing media</b> The media is missing. Example: There is no floppy in the floppy disk drive.
-253	<b>Corrupt media</b> The media is corrupt. Example: The floppy is bad or has the wrong format.
-254	<b>Media full</b> The media is full. Example: There is no room on the floppy.
-255	<b>Directory full</b> The media directory is full.
-256	<b>File name not found</b> The file name cannot be found on the media.
-257	<b>File name error</b> The file name is wrong. Example: An attempt is made to copy to a duplicate file name.
-258	<b>Media protected</b> The media is protected. Example: The write-protect tab on the floppy is present.
-260	<b>Expression error</b> The expression contains an error.

**Table 9-4 Device Specific Error; sets bit 3 in the ESR register**

<b>Error code</b>	<b>Error test in the case of queue poll</b> Error explanation
-300	<b>Device-specific error</b> R&S ESL-specific error not defined in greater detail.
-310	<b>System error</b> This error message suggests an error within the instrument. Please inform the R&S Service.
-313	<b>Calibration memory lost</b> Loss of the non-volatile data stored using the *CAL? command. This error occurs when the correction data recording has failed.
-330	<b>Self-test failed</b> The self test could not be executed.

Error code	Error text in the case of queue poll Error explanation
-350	<b>Queue overflow</b> This error code is entered in the queue instead of the actual error code if the queue is full. It indicates that an error has occurred but not been accepted. The queue can accept 5 entries.

**Table 9–5 Query Error – Error in data request; sets bit 2 in the ESR register**

Error code	Error text in the case of queue poll Error explanation
-400	<b>Query error</b> General error occurring when data are requested by a query.
-410	<b>Query INTERRUPTED</b> The query has been interrupted. Example: After a query, the instrument receives new data before the response has been sent completely.
-420	<b>Query UNTERMINATED</b> The query is incomplete. Example: The instrument is addressed as a talker and receives incomplete data.
-430	<b>Query DEADLOCKED</b> The query cannot be processed. Example: The input and output buffers are full, the instrument cannot continue operation.
-440	<b>Query UNTERMINATED after indefinite response</b> A query is in the same command line after a query which requests an indefinite response.

## Device–Specific Messages

Error code	Error text in the case of queue poll Error explanation
1052	<b>Frontend LO is Unlocked</b> This message is displayed when the phase regulation of the local oscillator fails in the RF front–end.
1060	<b>Trigger–Block Gate Delay Error– gate length &lt; Gate Delay</b> This message is displayed when the gate signal length is not sufficient for the pull–in delay with a predefined gate delay.
1064	<b>Tracking LO is Unlocked</b> This message is displayed when the phase regulation of the local oscillator fails on the tracking generator module.

Error code	Error text in the case of queue poll Error explanation
2028	<p><b>Hardcopy not possible during measurement sequence</b> This message is displayed when a printout is started during scan sequences that cannot be interrupted. Such sequences are for example:</p> <ul style="list-style-type: none"> <li>• Recording the system error correction data (alignment)</li> <li>• Instrument self test</li> </ul> <p>In such cases synchronization to the end of the scan sequence should be performed prior to starting the printout.</p>
2033	<p><b>Printer Not Available</b> This message is displayed when the selected printer is not included in the list of available output devices. A possible cause is that the required printer driver is missing or incorrectly installed.</p>
2034	<p><b>CPU Temperature is too high</b> This message is displayed when the temperature of the processor exceeds 70 °C.</p>

## Noise Figure Measurements Option Messages (K30)

The list of possible warning & error messages for the Noise Figure Measurements option (K30) is shown below.

Status bar message	Description
Frequency list truncated, max 100 entries	The settings for start, stop and step frequencies would require a frequency list greater than 100 entries. The list calculated is terminated at the 100th entry. Try using a larger step size of splitting the test up into a series of frequency list tests.
Missing [ENR][,]&[LossIn][,]&[LossOut] for meas.freq.	No ENR, loss input and/or loss output can be determined for one or all of the measurement frequencies. This occurs when using tables of ENR, loss input and/or loss output values. Check that the frequency ranges of the tables covers the range of frequencies to be measured. For each measurement frequency, where ENR, loss input or loss output cannot be determined, 0 is used.

# Alphabetical list of remote commands

\*

*CAL?	6.337
*CLS	6.337
*ESE	6.337
*ESR?	6.338
*IDN?	6.338
*IST?	6.338
*OPC	6.338
*OPT?	6.338
*PCB	6.339
*PRE	6.339
*PSC	6.339
*RST	6.339
*SRE	6.339
*STB?	6.339
*TRG	6.340
*TST?	6.340
*WAI	6.340

## A

ABORT	6.6
-------	-----

## C

CALCulate<1 2>: UNIT:ANGLE (K7)	6.245
CALCulate<1 2>:DELTamarker<1...4>[:STATe]	6.8
CALCulate<1 2>:DELTamarker<1...4>:AOFF	6.8
CALCulate<1 2>:DELTamarker<1...4>:FUNctioN:FIXed[:STATe]	6.9
CALCulate<1 2>:DELTamarker<1...4>:FUNctioN:FIXed:RPOint:MAXimum[:PEAK]	6.9
CALCulate<1 2>:DELTamarker<1...4>:FUNctioN:FIXed:RPOint:X	6.10
CALCulate<1 2>:DELTamarker<1...4>:FUNctioN:FIXed:RPOint:Y	6.10
CALCulate<1 2>:DELTamarker<1...4>:FUNctioN:FIXed:RPOint:Y:OFFSet	6.11
CALCulate<1 2>:DELTamarker<1...4>:FUNctioN:PNOise[:STATe]	6.11
CALCulate<1 2>:DELTamarker<1...4>:FUNctioN:PNOise:RESult?	6.12
CALCulate<1 2>:DELTamarker<1...4>:MAXimum[:PEAK]	6.12
CALCulate<1 2>:DELTamarker<1...4>:MAXimum:LEFT	6.13
CALCulate<1 2>:DELTamarker<1...4>:MAXimum:NEXT	6.13
CALCulate<1 2>:DELTamarker<1...4>:MAXimum:RIGHT	6.13
CALCulate<1 2>:DELTamarker<1...4>:MINimum[:PEAK]	6.14
CALCulate<1 2>:DELTamarker<1...4>:MINimum:LEFT	6.14
CALCulate<1 2>:DELTamarker<1...4>:MINimum:NEXT	6.14
CALCulate<1 2>:DELTamarker<1...4>:MINimum:RIGHT	6.15
CALCulate<1 2>:DELTamarker<1...4>:MODE	6.15
CALCulate<1 2>:DELTamarker<1...4>:TRACe	6.15
CALCulate<1 2>:DELTamarker<1...4>:X	6.16
CALCulate<1 2>:DELTamarker<1...4>:X:RELative?	6.16
CALCulate<1 2>:DELTamarker<1...4>:Y?	6.17
CALCulate<1 2>:DLINe<1 2>	6.18
CALCulate<1 2>:DLINe<1 2>:STATe	6.18
CALCulate<1 2>:ESPEctrum:PSEarch PEAKsearch:PSHow	6.20
CALCulate<1 2>:ESPEctrum:PSEarch PEAKsearch:AUTO	6.19
CALCulate<1 2>:ESPEctrum:PSEarch PEAKsearch:MARGIn	6.19



CALCulate<1 2>:FLINe<1 2>.....	6.21
CALCulate<1 2>:FLINe<1 2>:STATe .....	6.21
CALCulate<1 2>:FORMat (K7) .....	6.238
CALCulate<1 2>:LIMit<1 ... 8>:CONTRol:SPACing.....	6.38
CALCulate<1 2>:LIMit<1...6>:CONTRol[:DATA] (K30).....	6.298
CALCulate<1 2>:LIMit<1...6>:CONTRol:SHIFt (K30) .....	6.298
CALCulate<1 2>:LIMit<1...6>:COPY (K30) .....	6.296
CALCulate<1 2>:LIMit<1...6>:DELete (K30).....	6.296
CALCulate<1 2>:LIMit<1...6>:FAIL? (K30).....	6.296
CALCulate<1 2>:LIMit<1...6>:LOWer[:DATA] (K30) .....	6.299
CALCulate<1 2>:LIMit<1...6>:LOWer:SHIFt (K30).....	6.299
CALCulate<1 2>:LIMit<1...6>:LOWer:STATe (K30).....	6.299
CALCulate<1 2>:LIMit<1...6>:NAME (K30) .....	6.296
CALCulate<1 2>:LIMit<1...6>:STATe (K30) .....	6.296
CALCulate<1 2>:LIMit<1...6>:UPPer[:DATA] (K30) .....	6.300
CALCulate<1 2>:LIMit<1...6>:UPPer:SHIFt (K30).....	6.300
CALCulate<1 2>:LIMit<1...6>:UPPer:STATe (K30).....	6.300
CALCulate<1 2>:LIMit<1...8>:ACPower[:STATe] .....	6.28
CALCulate<1 2>:LIMit<1...8>:ACPower:ACHannel[:RELative] .....	6.29
CALCulate<1 2>:LIMit<1...8>:ACPower:ACHannel[:RELative]:STATe .....	6.29
CALCulate<1 2>:LIMit<1...8>:ACPower:ACHannel:ABSolute .....	6.30
CALCulate<1 2>:LIMit<1...8>:ACPower:ACHannel:ABSolute:STATe.....	6.30
CALCulate<1 2>:LIMit<1...8>:ACPower:ACHannel:RESult? .....	6.31
CALCulate<1 2>:LIMit<1...8>:ACPower:ALTernate<1 2>[:RELative].....	6.32
CALCulate<1 2>:LIMit<1...8>:ACPower:ALTernate<1 2>[:RELative]:STATe.....	6.32
CALCulate<1 2>:LIMit<1...8>:ACPower:ALTernate<1 2>:ABSolute .....	6.33
CALCulate<1 2>:LIMit<1...8>:ACPower:ALTernate<1 2>:ABSolute:STATe .....	6.34
CALCulate<1 2>:LIMit<1...8>:ACPower:ALTernate<1 2>:RESult? .....	6.35
CALCulate<1 2>:LIMit<1...8>:ACTive?.....	6.24
CALCulate<1 2>:LIMit<1...8>:CLEAr[:IMMediate] .....	6.24
CALCulate<1 2>:LIMit<1...8>:COMMENT .....	6.24
CALCulate<1 2>:LIMit<1...8>:CONTRol[:DATA].....	6.36
CALCulate<1 2>:LIMit<1...8>:CONTRol:DOMain .....	6.36
CALCulate<1 2>:LIMit<1...8>:CONTRol:MODE .....	6.37
CALCulate<1 2>:LIMit<1...8>:CONTRol:OFFSet.....	6.37
CALCulate<1 2>:LIMit<1...8>:CONTRol:SHIFt.....	6.38
CALCulate<1 2>:LIMit<1...8>:COPY .....	6.25
CALCulate<1 2>:LIMit<1...8>:DELete .....	6.25
CALCulate<1 2>:LIMit<1...8>:FAIL?.....	6.25
CALCulate<1 2>:LIMit<1...8>:LOWer[:DATA] .....	6.39
CALCulate<1 2>:LIMit<1...8>:LOWer:MARGin .....	6.40
CALCulate<1 2>:LIMit<1...8>:LOWer:MODE .....	6.41
CALCulate<1 2>:LIMit<1...8>:LOWer:OFFSet .....	6.40
CALCulate<1 2>:LIMit<1...8>:LOWer:SHIFt.....	6.41
CALCulate<1 2>:LIMit<1...8>:LOWer:SPACing .....	6.42
CALCulate<1 2>:LIMit<1...8>:LOWer:STATe.....	6.40
CALCulate<1 2>:LIMit<1...8>:LOWer:THReshold.....	6.42
CALCulate<1 2>:LIMit<1...8>:NAME .....	6.26
CALCulate<1 2>:LIMit<1...8>:STATe .....	6.26
CALCulate<1 2>:LIMit<1...8>:TRACe.....	6.27
CALCulate<1 2>:LIMit<1...8>:TRACe (K30).....	6.297
CALCulate<1 2>:LIMit<1...8>:UNIT .....	6.27
CALCulate<1 2>:LIMit<1...8>:UPPer[:DATA] .....	6.43
CALCulate<1 2>:LIMit<1...8>:UPPer:MARGin .....	6.44
CALCulate<1 2>:LIMit<1...8>:UPPer:MODE .....	6.44
CALCulate<1 2>:LIMit<1...8>:UPPer:OFFSet.....	6.44
CALCulate<1 2>:LIMit<1...8>:UPPer:SHIFt.....	6.45
CALCulate<1 2>:LIMit<1...8>:UPPer:SPACing .....	6.45
CALCulate<1 2>:LIMit<1...8>:UPPer:STATe.....	6.46

CALCulate<1 2>:LIMit<1...8>:UPPer:THReshold .....	6.46
CALCulate<1 2>:MARKer<1...4>[:STATe] .....	6.48
CALCulate<1 2>:MARKer<1...4>:AOFF .....	6.48
CALCulate<1 2>:MARKer<1...4>:COUNT .....	6.48
CALCulate<1 2>:MARKer<1...4>:COUNT:FREQuency? .....	6.49
CALCulate<1 2>:MARKer<1...4>:COUNT:RESolution .....	6.50
CALCulate<1 2>:MARKer<1...4>:FUNCTion:CENTer .....	6.62
CALCulate<1 2>:MARKer<1...4>:FUNCTion:CSTep .....	6.62
CALCulate<1 2>:MARKer<1...4>:FUNCTion:DEModulation[:STATe] .....	6.61
CALCulate<1 2>:MARKer<1...4>:FUNCTion:DEModulation:CONTinuous .....	6.61
CALCulate<1 2>:MARKer<1...4>:FUNCTion:DEModulation:HOLDoff .....	6.61
CALCulate<1 2>:MARKer<1...4>:FUNCTion:DEModulation:SElect .....	6.62
CALCulate<1 2>:MARKer<1...4>:FUNCTion:FPEaks[:IMMediate] .....	6.63
CALCulate<1 2>:MARKer<1...4>:FUNCTion:FPEaks:COUNT? .....	6.64
CALCulate<1 2>:MARKer<1...4>:FUNCTion:FPEaks:SORT .....	6.64
CALCulate<1 2>:MARKer<1...4>:FUNCTion:FPEaks:X? .....	6.65
CALCulate<1 2>:MARKer<1...4>:FUNCTion:FPEaks:Y? .....	6.65
CALCulate<1 2>:MARKer<1...4>:FUNCTion:HARMonics[:STATe] .....	6.74
CALCulate<1 2>:MARKer<1...4>:FUNCTion:HARMonics:BANdwidth:AUTO .....	6.74
CALCulate<1 2>:MARKer<1...4>:FUNCTion:HARMonics:DISTortion? .....	6.75
CALCulate<1 2>:MARKer<1...4>:FUNCTion:HARMonics:LIST? .....	6.76
CALCulate<1 2>:MARKer<1...4>:FUNCTion:HARMonics:NHARmonics .....	6.76
CALCulate<1 2>:MARKer<1...4>:FUNCTion:HARMonics:PRESet .....	6.77
CALCulate<1 2>:MARKer<1...4>:FUNCTion:MDEPth[:STATe] .....	6.66
CALCulate<1 2>:MARKer<1...4>:FUNCTion:MDEPth:RESult? .....	6.66
CALCulate<1 2>:MARKer<1...4>:FUNCTion:MDEPth:SEARChsignal ONCE .....	6.67
CALCulate<1 2>:MARKer<1...4>:FUNCTion:NDBDown .....	6.67
CALCulate<1 2>:MARKer<1...4>:FUNCTion:NDBDown:FREQuency? .....	6.68
CALCulate<1 2>:MARKer<1...4>:FUNCTion:NDBDown:QFACTOR .....	6.68
CALCulate<1 2>:MARKer<1...4>:FUNCTion:NDBDown:RESult? .....	6.69
CALCulate<1 2>:MARKer<1...4>:FUNCTion:NDBDown:STATe .....	6.69
CALCulate<1 2>:MARKer<1...4>:FUNCTion:NDBDown:TIME? .....	6.70
CALCulate<1 2>:MARKer<1...4>:FUNCTion:NOISe[:STATe] .....	6.70
CALCulate<1 2>:MARKer<1...4>:FUNCTion:NOISe:RESult? .....	6.71
CALCulate<1 2>:MARKer<1...4>:FUNCTion:REFerence .....	6.71
CALCulate<1 2>:MARKer<1...4>:FUNCTion:SUMMery:MODE .....	6.92
CALCulate<1 2>:MARKer<1...4>:FUNCTion:SUMMery:REFerence:AUTO .....	6.95
CALCulate<1 2>:MARKer<1...4>:FUNCTion:TOI[:STATe] .....	6.72
CALCulate<1 2>:MARKer<1...4>:FUNCTion:TOI:RESult? .....	6.72
CALCulate<1 2>:MARKer<1...4>:FUNCTion:TOI:SEARChsignal ONCE .....	6.73
CALCulate<1 2>:MARKer<1...4>:FUNCTion:ZOOM .....	6.73
CALCulate<1 2>:MARKer<1...4>:LOEXclude .....	6.50
CALCulate<1 2>:MARKer<1...4>:MAXimum[:PEAK] .....	6.51
CALCulate<1 2>:MARKer<1...4>:MAXimum:AUTO .....	6.51
CALCulate<1 2>:MARKer<1...4>:MAXimum:LEFT .....	6.51
CALCulate<1 2>:MARKer<1...4>:MAXimum:NEXT .....	6.52
CALCulate<1 2>:MARKer<1...4>:MAXimum:RIGHT .....	6.52
CALCulate<1 2>:MARKer<1...4>:MINimum[:PEAK] .....	6.53
CALCulate<1 2>:MARKer<1...4>:MINimum:AUTO .....	6.53
CALCulate<1 2>:MARKer<1...4>:MINimum:LEFT .....	6.53
CALCulate<1 2>:MARKer<1...4>:MINimum:NEXT .....	6.54
CALCulate<1 2>:MARKer<1...4>:MINimum:RIGHT .....	6.54
CALCulate<1 2>:MARKer<1...4>:PEXCursion .....	6.55
CALCulate<1 2>:MARKer<1...4>:PEXCursion (K7) .....	6.239
CALCulate<1 2>:MARKer<1...4>:TRACe .....	6.56
CALCulate<1 2>:MARKer<1...4>:X .....	6.56
CALCulate<1 2>:MARKer<1...4>:X:SLIMits[:STATe] .....	6.56
CALCulate<1 2>:MARKer<1...4>:X:SLIMits:LEFT .....	6.57
CALCulate<1 2>:MARKer<1...4>:X:SLIMits:RIGHT .....	6.57

CALCulate<1 2>:MARKer<1...4>:X:SSize .....	6.58
CALCulate<1 2>:MARKer<1...4>:Y? .....	6.58
CALCulate<1 2>:MARKer<1...4>:Y? (K7) .....	6.239
CALCulate<1 2>:MARKer<1...4>:Y:PERCent .....	6.59
CALCulate<1 2>:MARKer<1...4>:COUPled[:STATe].....	6.50, 6.55
CALCulate<1 2>:MARKer:FUNcTion:ADEMod:AFRequency[:RESult<1...4>]? (K7).....	6.240
CALCulate<1 2>:MARKer:FUNcTion:ADEMod:AM[:RESult<1...4>]? (K7) .....	6.241
CALCulate<1 2>:MARKer:FUNcTion:ADEMod:CARRier[:RESult<1...6>]? (K7) .....	6.241
CALCulate<1 2>:MARKer:FUNcTion:ADEMod:FERRor[:RESult<1...6>]? (K7) .....	6.242
CALCulate<1 2>:MARKer:FUNcTion:ADEMod:FM[:RESult<1...6>]? (K7) .....	6.242
CALCulate<1 2>:MARKer:FUNcTion:ADEMod:PM[:RESult]? (K7) .....	6.243
CALCulate<1 2>:MARKer:FUNcTion:ADEMod:SINad:RESult<1...6>? (K7) .....	6.244
CALCulate<1 2>:MARKer:FUNcTion:ADEMod:THD:RESult<1...6>? (K7).....	6.244
CALCulate<1 2>:MARKer:FUNcTion:MSUMmary? .....	6.88
CALCulate<1 2>:MARKer:FUNcTion:POWER[:STATe].....	6.79
CALCulate<1 2>:MARKer:FUNcTion:POWER:MODE].....	6.79
CALCulate<1 2>:MARKer:FUNcTion:POWER:PRESet .....	6.80
CALCulate<1 2>:MARKer:FUNcTion:POWER:RESult?.....	6.80
CALCulate<1 2>:MARKer:FUNcTion:POWER:RESult:PHZ.....	6.83
CALCulate<1 2>:MARKer:FUNcTion:POWER:SElect .....	6.83
CALCulate<1 2>:MARKer:FUNcTion:STRack[:STATe].....	6.85
CALCulate<1 2>:MARKer:FUNcTion:STRack:BANDwidth.....	6.85
CALCulate<1 2>:MARKer:FUNcTion:STRack:BWIDth .....	6.85
CALCulate<1 2>:MARKer:FUNcTion:STRack:THReshold .....	6.86
CALCulate<1 2>:MARKer:FUNcTion:STRack:TRACe .....	6.86
CALCulate<1 2>:MARKer:FUNcTion:SUMMary[:STATe].....	6.89
CALCulate<1 2>:MARKer:FUNcTion:SUMMary:AOFF .....	6.89
CALCulate<1 2>:MARKer:FUNcTion:SUMMary:AVERage .....	6.89
CALCulate<1 2>:MARKer:FUNcTion:SUMMary:MEAN[:STATe] .....	6.90
CALCulate<1 2>:MARKer:FUNcTion:SUMMary:MEAN:AVERage:RESult?.....	6.90
CALCulate<1 2>:MARKer:FUNcTion:SUMMary:MEAN:PHOLd:RESult?.....	6.91
CALCulate<1 2>:MARKer:FUNcTion:SUMMary:MEAN:RESult?.....	6.92
CALCulate<1 2>:MARKer:FUNcTion:SUMMary:PHOLd .....	6.93
CALCulate<1 2>:MARKer:FUNcTion:SUMMary:PPEak[:STATe].....	6.93
CALCulate<1 2>:MARKer:FUNcTion:SUMMary:PPEak:AVERage:RESult?.....	6.93
CALCulate<1 2>:MARKer:FUNcTion:SUMMary:PPEak:PHOLd:RESult? .....	6.94
CALCulate<1 2>:MARKer:FUNcTion:SUMMary:PPEak:RESult? .....	6.95
CALCulate<1 2>:MARKer:FUNcTion:SUMMary:RMS[:STATe].....	6.96
CALCulate<1 2>:MARKer:FUNcTion:SUMMary:RMS:AVERage:RESult? .....	6.96
CALCulate<1 2>:MARKer:FUNcTion:SUMMary:RMS:PHOLd:RESult? .....	6.97
CALCulate<1 2>:MARKer:FUNcTion:SUMMary:RMS:RESult? .....	6.97
CALCulate<1 2>:MARKer:FUNcTion:SUMMary:SDEviation[:STATe] .....	6.98
CALCulate<1 2>:MARKer:FUNcTion:SUMMary:SDEviation:AVERage:RESult?.....	6.98
CALCulate<1 2>:MARKer:FUNcTion:SUMMary:SDEviation:PHOLd:RESult?.....	6.99
CALCulate<1 2>:MARKer:FUNcTion:SUMMary:SDEviation:RESult?.....	6.99
CALCulate<1 2>:MATH[:EXPRession][:DEFine] .....	6.100
CALCulate<1 2>:MATH:MODE .....	6.100
CALCulate<1 2>:MATH:POSition .....	6.101
CALCulate<1 2>:MATH:STATe .....	6.101
CALCulate<1 2>:PEAKsearch PSEarch:ADD .....	6.102
CALCulate<1 2>:PEAKsearch PSEarch:MARGin .....	6.103
CALCulate<1 2>:PEAKsearch PSEarch:METHod.....	6.104
CALCulate<1 2>:PMETer:RELative[:MAGNitude] (K9).....	6.282
CALCulate<1 2>:PMETer:RELative[:MAGNitude]:AUTO (K9).....	6.282
CALCulate<1 2>:PMETer:RELative:STATe (K9) .....	6.283
CALCulate<1 2>:PSEarch PEAKsearch[:IMMEDIATE] .....	6.102
CALCulate<1 2>:PSEarch PEAKsearch:AUTO .....	6.103
CALCulate<1 2>:PSEarch PEAKsearch:PSHow .....	6.104
CALCulate<1 2>:PSEarch PEAKsearch:SUBRanges .....	6.104

CALCulate<1 2>:PSEarch PEAKsearch:SUBRanges:PCOunt .....	6.105
CALCulate<1 2>:THReshold .....	6.111
CALCulate<1 2>:THReshold:STATe .....	6.111
CALCulate<1 2>:TLINe<1 2> .....	6.112
CALCulate<1 2>:TLINe<1 2>:STATe .....	6.112
CALCulate<1 2>:UNIT:POWer .....	6.113
CALCulate:MARKer:TRACe (K30) .....	6.302
CALCulate:MARKer:Y? (K30) .....	6.302
CALCulate:STATistics:APD[:STATe] .....	6.106
CALCulate:STATistics:CCDF[:STATe] .....	6.106
CALCulate:STATistics:NSAMples .....	6.107
CALCulate:STATistics:PRESet .....	6.107
CALCulate:STATistics:RESult<1...4>? .....	6.108
CALCulate:STATistics:SCALE:AUTO .....	6.108
CALCulate:STATistics:SCALE:X:RANGe .....	6.109
CALCulate:STATistics:SCALE:X:RLEVel .....	6.109
CALCulate:STATistics:SCALE:Y:LOWer .....	6.109
CALCulate:STATistics:SCALE:Y:UNIT .....	6.110
CALCulate:STATistics:SCALE:Y:UPPer .....	6.110
CALibration[:ALL]? .....	6.341
CALibration:ABORt .....	6.341
CALibration:PMETer:ZERO:AUTO (K9) .....	6.284
CALibration:RESult? .....	6.342
CALibration:STATe .....	6.342
CONFigure:CORRection (K30) .....	6.304
CONFigure:LIST:CONTInuous (K30) .....	6.305
CONFigure:LIST:SINGle (K30) .....	6.305
CONFigure:SINGle (K30) .....	6.305
<b>D</b>	
DIAGnostic<1 2>:SERVice:BIOSInfo? .....	6.343
DIAGnostic<1 2>:SERVice:HWINfo? .....	6.343
DIAGnostic<1 2>:SERVice:INPut[:SElect] .....	6.344
DIAGnostic<1 2>:SERVice:INPut:PULSed[:STATe] .....	6.344
DIAGnostic<1 2>:SERVice:INPut:PULSed:PRATe .....	6.345
DIAGnostic<1 2>:SERVice:NSOurce .....	6.345
DIAGnostic<1 2>:SERVice:SFUNction .....	6.345
DIAGnostic<1 2>:SERVice:STESt:RESult? .....	6.346
DISPlay[:WINDow<1 2>]:SIZE .....	6.115
DISPlay[:WINDow<1 2>]:SIZE (K7) .....	6.246
DISPlay[:WINDow<1 2>]:TEXT[:DATA] .....	6.352
DISPlay[:WINDow<1 2>]:TEXT:STATe .....	6.352
DISPlay[:WINDow<1 2>]:TIME .....	6.353
DISPlay[:WINDow<1 2>]:TRACe<1...6>[:STATe] .....	6.115
DISPlay[:WINDow<1 2>]:TRACe<1...6>:MODE .....	6.115
DISPlay[:WINDow<1 2>]:TRACe<1...6>:MODE:HCONtinuous .....	6.116
DISPlay[:WINDow<1 2>]:TRACe<1...6>:Y[:SCALE] .....	6.119
DISPlay[:WINDow<1 2>]:TRACe<1...6>:Y[:SCALE]:MODE .....	6.119
DISPlay[:WINDow<1 2>]:TRACe<1...6>:Y[:SCALE]:PDIVision (K7) .....	6.246
DISPlay[:WINDow<1 2>]:TRACe<1...6>:Y[:SCALE]:RLEVel .....	6.119
DISPlay[:WINDow<1 2>]:TRACe<1...6>:Y[:SCALE]:RLEVel:OFFSet .....	6.120
DISPlay[:WINDow<1 2>]:TRACe<1...6>:Y[:SCALE]:RPOSition .....	6.120
DISPlay[:WINDow<1 2>]:TRACe<1...6>:Y[:SCALE]:RPOSition (K7) .....	6.247
DISPlay[:WINDow<1 2>]:TRACe<1...6>:Y[:SCALE]:RVALue .....	6.121
DISPlay[:WINDow<1 2>]:TRACe<1...6>:Y[:SCALE]:RVALue (K7) .....	6.247
DISPlay[:WINDow<1 2>]:TRACe<1...6>:Y[:SCALE]:RVALue:AUTO .....	6.121

DISPlay[:WINDow<1 2>]:TRACe<1...6>:Y:SPACing.....	6.118
DISPlay[:WINDow<1 2>]:TRACe<1...6>:Y:SPACing (K7).....	6.247
DISPlay[:WINDow<1 2>]:TRACe<1...6>:X[:SCALE]:ZOOM .....	6.117
DISPlay[:WINDow<1 2>]:TRACe<1...6>:SYMBol .....	6.117
DISPlay[:WINDow<1 2>]:TRACe<1...6>:X:SPACing.....	6.117
DISPlay[:WINDow<1 2>]:TRACe<1...6>:Y[:SCALE]:BOTTOm .....	6.118
DISPlay[:WINDow<1 2>]:TRACe<1...6>:Y[:SCALE]:TOP .....	6.118
DISPlay[:WINDow<1>]:TABLe (K30).....	6.308
DISPlay[:WINDow<1>]:TRACe<1 2>[:STATe] (K30) .....	6.308
DISPlay[:WINDow<1>]:TRACe<1 2>:SYMBols (K30) .....	6.308
DISPlay[:WINDow<1>]:TRACe<1 2>:X[:SCALE] (K30).....	6.309
DISPlay[:WINDow<1>]:TRACe<1 2>:Y[:SCALE]:AUTO (K30).....	6.309
DISPlay[:WINDow<1>]:TRACe<1 2>:Y[:SCALE]:BOTTOm (K30) .....	6.310
DISPlay[:WINDow<1>]:TRACe<1 2>:Y[:SCALE]:RLEVel (K30).....	6.311
DISPlay[:WINDow<1>]:TRACe<1 2>:Y[:SCALE]:RLEVel:AUTO (K30).....	6.311
DISPlay[:WINDow<1>]:TRACe<1 2>:Y[:SCALE]:TOP (K30) .....	6.312
DISPlay:ANNOtation:FREQUency .....	6.348
DISPlay:BARGraph:LEVel:LOWer? .....	6.121
DISPlay:BARGraph:LEVel:UPPer? .....	6.122
DISPlay:BARGraph:PHOLd.....	6.122
DISPlay:BARGraph:PHOLd:RESet .....	6.122
DISPlay:CMAP<1...26>:DEFault<1 2> .....	6.348, 6.349
DISPlay:CMAP<1...26>:HSL .....	6.349
DISPlay:CMAP<1...26>:PDEFined .....	6.350
DISPlay:DATA:TRACe<1> (K30) .....	6.307
DISPlay:FORMat .....	6.351
DISPlay:FORMat (K30).....	6.307
DISPlay:LOGO.....	6.351
DISPlay:PSAVE[:STATe] .....	6.351
DISPlay:PSAVE:HOLDOff .....	6.352

**F**

FETCh<1 2>:PMETer? (K9) .....	6.285
FETCh:ARRay:MEMory<1...3>:NOISe:FIGure? (K30).....	6.313
FETCh:ARRay:MEMory<1...3>:NOISe:GAIN? (K30) .....	6.313
FETCh:ARRay:MEMory<1...3>:NOISe:TEMPerature? (K30) .....	6.314
FETCh:ARRay:NOISe:FIGure? (K30).....	6.314
FETCh:ARRay:NOISe:GAIN? (K30) .....	6.315
FETCh:ARRay:NOISe:TEMPerature? (K30).....	6.315
FETCh:SCALar:NOISe:FIGure? (K30) .....	6.315
FETCh:SCALar:NOISe:GAIN? (K30).....	6.316
FETCh:SCALar:NOISe:TEMPerature? (K30) .....	6.316

FORMat[:DATA].....	6.354
FORMat:DEXPort:DSEParator .....	6.123

**H**

HCOPy[:IMMEDIATE<1 2>].....	6.355
HCOPy[:IMMEDIATE<1 2>]:NEXT .....	6.356
HCOPy:ABORT.....	6.356
HCOPy:CMAP<1...26>:DEFault1 2 3 4.....	6.357
HCOPy:CMAP<1...26>:HSL .....	6.357
HCOPy:CMAP<1...26>:PDEFined .....	6.358
HCOPy:DESTination<1 2> .....	6.358
HCOPy:DEvice:COLor .....	6.359
HCOPy:DEvice:LANGUage<1 2> .....	6.359
HCOPy:ITEM:ALL.....	6.360
HCOPy:ITEM:WINDow<1 2>:TEXT .....	6.360
HCOPy:ITEM:WINDow<1 2>:TRACe:STATe .....	6.360

HCOPy:PAGE:ORientation<1 2> .....	6.361
HCOPy:TDSTamp:STATe<1 2> .....	6.361
HOLD .....	6.6
<b>I</b>	
INITiate[:IMMediate] (K30) .....	6.317
INITiate<1 2>[:IMMediate] .....	6.124
INITiate<1 2>:CONMeas .....	6.125
INITiate<1 2>:CONTinuous .....	6.125
INITiate<1 2>:DISPlay .....	6.126
INITiate<1 2>:EMItest .....	6.126
INITiate<1 2>:ESpectrum .....	6.127
INITiate<1 2>:FMEasurement .....	6.126
INITiate<1 2>:SPURious .....	6.127
INPut<1 2>:ATTenuation .....	6.128
INPut<1 2>:ATTenuation:AUTO .....	6.129
INPut<1 2>:ATTenuation:PROTection[:STATe] .....	6.129
INPut<1 2>:GAIN:AUTO .....	6.129, 6.130
INPut<1 2>:IMPedance .....	6.130
INPut<1 2>:LISN[:TYPE] .....	6.131
INPut<1 2>:LISN:FILTer:HPAS[:STATe] .....	6.131
INPut<1 2>:LISN:PHASe .....	6.132
INPut<1 2>:UPORt[:VALue]? .....	6.132
INPut<1 2>:UPORt:STATe .....	6.132
INSTRument[:NSElect] (K7) .....	6.248
INSTRument[:SElect] .....	6.362
INSTRument[:SElect] (K30) .....	6.319
INSTRument[:SElect] (K7) .....	6.248
INSTRument:NSElect .....	6.362
<b>M</b>	
MMEMory:CATalog? .....	6.364
MMEMory:CDIRectory .....	6.365
MMEMory:CLEar:ALL .....	6.365
MMEMory:CLEar:STATe .....	6.365
MMEMory:COpy .....	6.366
MMEMory:DATA .....	6.366
MMEMory:DELeTe .....	6.367
MMEMory:LOAD:AUTO .....	6.368
MMEMory:LOAD:STATe .....	6.368
MMEMory:MDIRectory .....	6.368
MMEMory:MOVE .....	6.369
MMEMory:MSIS .....	6.369
MMEMory:NAME .....	6.370
MMEMory:NETWork:DISConnect .....	6.371
MMEMory:NETWork:MAP .....	6.370
MMEMory:NETWork:UNUSeddrives? .....	6.371
MMEMory:NETWork:USEDdrives? .....	6.371
MMEMory:RDIRectory .....	6.372
MMEMory:SElect[:ITEM]:ALL .....	6.372
MMEMory:SElect[:ITEM]:DEFault .....	6.373
MMEMory:SElect[:ITEM]:HWSettings .....	6.373
MMEMory:SElect[:ITEM]:LINes:ALL .....	6.374
MMEMory:SElect[:ITEM]:NONE .....	6.374
MMEMory:SElect[:ITEM]:SCData .....	6.375
MMEMory:SElect[:ITEM]:TRACe[:ACTive] .....	6.375

MMEMory:SElect[:ITEM]:TRANsducer:ALL ..... 6.375  
 MMEMory:STORe<1|2>:LIST ..... 6.377  
 MMEMory:STORe<1|2>:PEAK ..... 6.377  
 MMEMory:STORe<1|2>:STATe:NEXT ..... 6.378  
 MMEMory:STORe<1|2>:TRACe..... 6.378

**O**

OUTPut<1|2>[:STATe] ..... 6.133  
 OUTPut<1|2>:IF[:SOURce] ..... 6.380  
 OUTPut:UPORt[:VALue]..... 6.134  
 OUTPut:UPORt:STATe ..... 6.134

**R**

READ<1|2>:PMETer? (K9)..... 6.286

**S**

[SENSe]:CONFigure:MODE:DUT (K30)..... 6.326  
 [SENSe]:CONFigure:MODE:SYSTem:LOSCillator:FREQuency (K30)..... 6.327  
 [SENSe]:CORRection[:STATe] (K30)..... 6.320  
 [SENSe]:CORRection:ENR[:MEASurement]:TABLe:DATA (K30) ..... 6.321  
 [SENSe]:CORRection:ENR:MODE (K30)..... 6.321  
 [SENSe]:CORRection:ENR:SPOT (K30)..... 6.321  
 [SENSe]:CORRection:IREJection (K30)..... 6.322  
 [SENSe]:CORRection:LOSS:INPut:MODE (K30)..... 6.322  
 [SENSe]:CORRection:LOSS:INPut:SPOT (K30)..... 6.323  
 [SENSe]:CORRection:LOSS:INPut:TABLe (K30) ..... 6.323  
 [SENSe]:CORRection:LOSS:OUTPut:MODE (K30) ..... 6.324  
 [SENSe]:CORRection:LOSS:OUTPut:SPOT (K30) ..... 6.324  
 [SENSe]:CORRection:LOSS:OUTPut:TABLe (K30) ..... 6.324  
 [SENSe]:CORRection:TEMPerature (K30)..... 6.325  
 [SENSe]:FREQuency[:CW]:FIXed] (K30)..... 6.327  
 [SENSe]:FREQuency:LIST:DATA (K30) ..... 6.327  
 [SENSe]:FREQuency:STARt (K30)..... 6.328  
 [SENSe]:FREQuency:STEP (K30)..... 6.328  
 [SENSe]:FREQuency:STOP (K30)..... 6.329  
 [SENSe]:SWEep:COUNT (K30) ..... 6.329  
 [SENSe<1|2>:]ADEMod:ZOOM[:STATe>] (K7)..... 6.270  
 [SENSe<1|2>:]ADEMod:ZOOM:STARt (K7) ..... 6.271  
 [SENSe<1|2>:]AVERAge[:STATe<1...4>]..... 6.136  
 [SENSe<1|2>:]AVERAge:COUNT..... 6.136  
 [SENSe<1|2>:]AVERAge:COUNT:AUTO..... 6.137  
 [SENSe<1|2>:]AVERAge:TYPE ..... 6.137  
 [SENSe<1|2>:]BANDwidth|BWIDth[:RESolution] ..... 6.138  
 [SENSe<1|2>:]BANDwidth|BWIDth[:RESolution]:AUTO ..... 6.139  
 [SENSe<1|2>:]BANDwidth|BWIDth[:RESolution]:RATio ..... 6.139  
 [SENSe<1|2>:]BANDwidth|BWIDth[:RESolution]:TYPE ..... 6.140  
 [SENSe<1|2>:]BANDwidth|BWIDth:DEMod (K7) ..... 6.272  
 [SENSe<1|2>:]BANDwidth|BWIDth:VIDeo ..... 6.140  
 [SENSe<1|2>:]BANDwidth|BWIDth:VIDeo:AUTO ..... 6.141  
 [SENSe<1|2>:]BANDwidth|BWIDth:VIDeo:RATio ..... 6.141  
 [SENSe<1|2>:]BANDwidth:VIDeo:TYPE ..... 6.142  
 [SENSe<1|2>:]CORRection[:STATe] ..... 6.143  
 [SENSe<1|2>:]CORRection:COLLect[:ACQuire]..... 6.143  
 [SENSe<1|2>:]CORRection:EGAIN:INPut[:MAGNitude]..... 6.144  
 [SENSe<1|2>:]CORRection:METhod..... 6.144  
 [SENSe<1|2>:]CORRection:RECall..... 6.145  
 [SENSe<1|2>:]CORRection:TRANsducer[:STATe]..... 6.381  
 [SENSe<1|2>:]CORRection:TRANsducer:ADJust:RLEVel[:STATe]..... 6.382

[SENSe<1 2>:]CORRection:TRANsducer:COMMeNt.....	6.382
[SENSe<1 2>:]CORRection:TRANsducer:DATA .....	6.382
[SENSe<1 2>:]CORRection:TRANsducer:DELeTe .....	6.383
[SENSe<1 2>:]CORRection:TRANsducer:SCALing .....	6.383
[SENSe<1 2>:]CORRection:TRANsducer:SELeCt .....	6.383
[SENSe<1 2>:]CORRection:TRANsducer:UNIT .....	6.384
[SENSe<1 2>:]CORRection:TRANsducer:VIEW .....	6.384
[SENSe<1 2>:]DEMod .....	6.146
[SENSe<1 2>:]DEMod:SQUelch:LEVeL .....	6.146
[SENSe<1 2>:]DETeCtor<1...4>[:FUNcTION]:AUTo .....	6.147
[SENSe<1 2>:]DETeCtor<1...6>[:FUNcTION].....	6.147
[SENSe<1 2>:]DETeCtor<1...6>:FMEaSurement .....	6.148
[SENSe<1 2>:]DETeCtor<1...6>:RECeiver[:FUNcTION].....	6.148
[SENSe<1 2>:]ESPeCtrum:BWID .....	6.150
[SENSe<1 2>:]ESPeCtrum:FILTeR[:RRC][:STATe].....	6.150
[SENSe<1 2>:]ESPeCtrum:FILTeR[:RRC]:ALPHa .....	6.151
[SENSe<1 2>:]ESPeCtrum:PRESeT[:STANdard] .....	6.151
[SENSe<1 2>:]ESPeCtrum:PRESeT:REStOre .....	6.152
[SENSe<1 2>:]ESPeCtrum:RANGe<1...20>[:FREQuency]:StARt .....	6.153
[SENSe<1 2>:]ESPeCtrum:RANGe<1...20>[:FREQuency]:StOP .....	6.154
[SENSe<1 2>:]ESPeCtrum:RANGe<1...20>:BANDwidth .....	6.152
[SENSe<1 2>:]ESPeCtrum:RANGe<1...20>:BANDwidth:RESolution .....	6.152
[SENSe<1 2>:]ESPeCtrum:RANGe<1...20>:BANDwidth:VIDeo .....	6.152
[SENSe<1 2>:]ESPeCtrum:RANGe<1...20>:COUNt? .....	6.153
[SENSe<1 2>:]ESPeCtrum:RANGe<1...20>:DELeTe .....	6.153
[SENSe<1 2>:]ESPeCtrum:RANGe<1...20>:FILTeR:TYPE .....	6.154
[SENSe<1 2>:]ESPeCtrum:RANGe<1...20>:INPUt:ATTenuation .....	6.155
[SENSe<1 2>:]ESPeCtrum:RANGe<1...20>:INPUt:ATTenuation:AUTO .....	6.155
[SENSe<1 2>:]ESPeCtrum:RANGe<1...20>:INPUt:GAIN:STATe .....	6.155
[SENSe<1 2>:]ESPeCtrum:RANGe<1...20>:INSert .....	6.156
[SENSe<1 2>:]ESPeCtrum:RANGe<1...20>:LIMit:ABSolute:StARt .....	6.156
[SENSe<1 2>:]ESPeCtrum:RANGe<1...20>:LIMit:ABSolute:StOP .....	6.156
[SENSe<1 2>:]ESPeCtrum:RANGe<1...20>:LIMit:RELative:StARt .....	6.157
[SENSe<1 2>:]ESPeCtrum:RANGe<1...20>:LIMit:RELative:StOP .....	6.157
[SENSe<1 2>:]ESPeCtrum:RANGe<1...20>:LIMit:STATe .....	6.158
[SENSe<1 2>:]ESPeCtrum:RANGe<1...20>:RLeVeL .....	6.158
[SENSe<1 2>:]ESPeCtrum:RANGe<1...20>:SWEep:TIME .....	6.159
[SENSe<1 2>:]ESPeCtrum:RANGe<1...20>:SWEep:TIME:AUTO .....	6.159
[SENSe<1 2>:]ESPeCtrum:RANGe<1...20>:TRANsducer .....	6.159
[SENSe<1 2>:]ESPeCtrum:RRANGe?.....	6.160
[SENSe<1 2>:]ESPeCtrum:RTYPE .....	6.160
[SENSe<1 2>:]FILTeR:DEMPHasiS (K7).....	6.273
[SENSe<1 2>:]FILTeR:DEMPHasiS:TCONStant (K7).....	6.273
[SENSe<1 2>:]FILTeR:HPASs[:STATe] (K7) .....	6.274
[SENSe<1 2>:]FILTeR:HPASs:FREQuency (K7) .....	6.274
[SENSe<1 2>:]FILTeR:LPASs[:STATe] (K7).....	6.274
[SENSe<1 2>:]FILTeR:LPASs:FREQuency[:ABSolute] (K7) .....	6.275
[SENSe<1 2>:]FILTeR:LPASs:FREQuency:RELative (K7) .....	6.275
[SENSe<1 2>:]FMEaSurement:AUTO .....	6.161
[SENSe<1 2>:]FMEaSurement:LISN[:TYPE].....	6.131, 6.161
[SENSe<1 2>:]FMEaSurement:LISN:FILTeR:HPAS[:STATe].....	6.131, 6.162
[SENSe<1 2>:]FMEaSurement:LISN:PHASe.....	6.162
[SENSe<1 2>:]FMEaSurement:TIME.....	6.162
[SENSe<1 2>:]FREQuency:CENTer .....	6.163
[SENSe<1 2>:]FREQuency:CENTer:StEP .....	6.163
[SENSe<1 2>:]FREQuency:CENTer:StEP:AUTO .....	6.164
[SENSe<1 2>:]FREQuency:CENTer:StEP:LINK .....	6.164
[SENSe<1 2>:]FREQuency:CENTer:StEP:LINK (K7) .....	6.276
[SENSe<1 2>:]FREQuency:CENTer:StEP:LINK:FACTor .....	6.165



[SENSe<1 2>:]FREQuency:MODE.....	6.165
[SENSe<1 2>:]FREQuency:OFFSet.....	6.166
[SENSe<1 2>:]FREQuency:SPAN.....	6.166
[SENSe<1 2>:]FREQuency:SPAN:FULL.....	6.166
[SENSe<1 2>:]FREQuency:STARt.....	6.167
[SENSe<1 2>:]FREQuency:STOP.....	6.167
[SENSe<1 2>:]LIST:POWer[:SEQuence].....	6.170
[SENSe<1 2>:]LIST:POWer:RESult?.....	6.172
[SENSe<1 2>:]LIST:POWer:SET.....	6.172
[SENSe<1 2>:]LIST:POWer:STATe.....	6.173
[SENSe<1 2>:]LIST:RANGe<1...20>[:FREQuency]:STARt.....	6.176
[SENSe<1 2>:]LIST:RANGe<1...20>[:FREQuency]:STOP.....	6.176
[SENSe<1 2>:]LIST:RANGe<1...20>:BANDwidth.....	6.174
[SENSe<1 2>:]LIST:RANGe<1...20>:BANDwidth:RESolution.....	6.174
[SENSe<1 2>:]LIST:RANGe<1...20>:BANDwidth:VIDeo.....	6.174
[SENSe<1 2>:]LIST:RANGe<1...20>:BREAk.....	6.175
[SENSe<1 2>:]LIST:RANGe<1...20>:COUNt?.....	6.175
[SENSe<1 2>:]LIST:RANGe<1...20>:DELeTe.....	6.175
[SENSe<1 2>:]LIST:RANGe<1...20>:DETector.....	6.175
[SENSe<1 2>:]LIST:RANGe<1...20>:FILTer:TYPE.....	6.176
[SENSe<1 2>:]LIST:RANGe<1...20>:INPut:ATTenuation.....	6.176
[SENSe<1 2>:]LIST:RANGe<1...20>:INPut:ATTenuation:AUTO.....	6.176
[SENSe<1 2>:]LIST:RANGe<1...20>:INPut:GAIN:STATe.....	6.176
[SENSe<1 2>:]LIST:RANGe<1...20>:LIMit:STARt.....	6.177
[SENSe<1 2>:]LIST:RANGe<1...20>:LIMit:STATe.....	6.177
[SENSe<1 2>:]LIST:RANGe<1...20>:LIMit:STOP.....	6.177
[SENSe<1 2>:]LIST:RANGe<1...20>:POINts.....	6.176
[SENSe<1 2>:]LIST:RANGe<1...20>:RLEVel.....	6.177
[SENSe<1 2>:]LIST:RANGe<1...20>:SWEep:TIME.....	6.177
[SENSe<1 2>:]LIST:RANGe<1...20>:SWEep:TIME:AUTO.....	6.177
[SENSe<1 2>:]LIST:RANGe<1...20>:TRANsducer.....	6.177
[SENSe<1 2>:]MPOWer[:SEQuence].....	6.179
[SENSe<1 2>:]MPOWer:FTYPe.....	6.181
[SENSe<1 2>:]MPOWer:RESult[:LIST]?.....	6.181
[SENSe<1 2>:]MPOWer:RESult:MIN?.....	6.182
[SENSe<1 2>:]PMETer[:STATe] (K9).....	6.287
[SENSe<1 2>:]PMETer:FREQuency (K9).....	6.288
[SENSe<1 2>:]PMETer:FREQuency:LINK (K9).....	6.288
[SENSe<1 2>:]PMETer:MTIME (K9).....	6.288
[SENSe<1 2>:]PMETer:MTIME:AVERAge[:STATe].....	6.289
[SENSe<1 2>:]PMETer:MTIME:AVERAge:COUNt.....	6.289
[SENSe<1 2>:]PMETer:ROFFset[:STATe] (K9).....	6.290
[SENSe<1 2>:]PMETer:TRIGger:LEVel (K9).....	6.291
[SENSe<1 2>:]PMETer:TRIGger:STATe (K9).....	6.290
[SENSe<1 2>:]POWer:ACHannel:ACPairs.....	6.183
[SENSe<1 2>:]POWer:ACHannel:BANDwidth BWIDth[:CHANnel].....	6.184
[SENSe<1 2>:]POWer:ACHannel:BANDwidth BWIDth:ACHannel.....	6.184
[SENSe<1 2>:]POWer:ACHannel:BANDwidth BWIDth:ALTErnate<1...11>.....	6.184
[SENSe<1 2>:]POWer:ACHannel:MODE.....	6.185
[SENSe<1 2>:]POWer:ACHannel:PRESet.....	6.185
[SENSe<1 2>:]POWer:ACHannel:PRESet:RLEVel.....	6.186
[SENSe<1 2>:]POWer:ACHannel:REFerence:AUTO.....	6.186
[SENSe<1 2>:]POWer:ACHannel:REFerence:TXCHannel:AUTO.....	6.187
[SENSe<1 2>:]POWer:ACHannel:REFerence:TXCHannel:MANual.....	6.187
[SENSe<1 2>:]POWer:ACHannel:SPACing:ALTErnate<1...11>.....	6.188
[SENSe<1 2>:]POWer:ACHannel:SPACing:CHANnel<1...11>.....	6.189
[SENSe<1 2>:]POWer:ACHannel:TXCHannel:COUNt.....	6.189
[SENSe<1 2>:]POWer:BANDwidth BWIDth.....	6.189
[SENSe<1 2>:]POWer:HSPeed.....	6.190

[SENSe<1 2>:]POWer:TRACe .....	6.190
[SENSe<1 2>:]ROSCillator:SOURce.....	6.385
[SENSe<1 2>:]SCAN<1... 10>:BANDwidth:RESolution .....	6.191
[SENSe<1 2>:]SCAN<1... 10>:INPut:ATTenuation.....	6.191
[SENSe<1 2>:]SCAN<1... 10>:INPut:ATTenuation:AUTO .....	6.192
[SENSe<1 2>:]SCAN<1... 10>:INPut:GAIN[:STATe] .....	6.192
[SENSe<1 2>:]SCAN<1... 10>:INPut:GAIN:AUTO .....	6.192
[SENSe<1 2>:]SCAN<1... 10>:RANGES:COUNT .....	6.193
[SENSe<1 2>:]SCAN<1... 10>:START.....	6.193
[SENSe<1 2>:]SCAN<1... 10>:STEP .....	6.194
[SENSe<1 2>:]SCAN<1... 10>:STOP .....	6.193
[SENSe<1 2>:]SCAN<1... 10>:TIME.....	6.194
[SENSe<1 2>:]SWEEp:COUNT.....	6.195
[SENSe<1 2>:]SWEEp:COUNT:CURRent?.....	6.196
[SENSe<1 2>:]SWEEp:EGATe.....	6.196
[SENSe<1 2>:]SWEEp:EGATe:HOLDoff.....	6.197
[SENSe<1 2>:]SWEEp:EGATe:LENGth .....	6.197
[SENSe<1 2>:]SWEEp:EGATe:POLarity .....	6.197
[SENSe<1 2>:]SWEEp:EGATe:SOURce.....	6.198
[SENSe<1 2>:]SWEEp:EGATe:TYPE .....	6.198
[SENSe<1 2>:]SWEEp:MODE.....	6.199
[SENSe<1 2>:]SWEEp:POINts .....	6.199
[SENSe<1 2>:]SWEEp:SPACing .....	6.199
[SENSe<1 2>:]SWEEp:TIME .....	6.200
[SENSe<1 2>:]SWEEp:TIME (K7) .....	6.276
[SENSe<1 2>:]SWEEp:TIME:AUTO .....	6.200
[SENSe:]ADEMod[:STATe] (K7).....	6.251
[SENSe:]ADEMod:AF:CENTer (K7).....	6.251
[SENSe:]ADEMod:AF:COUPling (K7) .....	6.252
[SENSe:]ADEMod:AF:SPAN (K7) .....	6.252
[SENSe:]ADEMod:AF:SPAN:FULL (K7).....	6.253
[SENSe:]ADEMod:AF:START (K7).....	6.253
[SENSe:]ADEMod:AF:STOP (K7) .....	6.254
[SENSe:]ADEMod:AM[:TDOMain][:TYPE] (K7).....	6.254
[SENSe:]ADEMod:AM[:TDOMain]:RESult? (K7).....	6.255
[SENSe:]ADEMod:AM:RELative[:TDOMain][:TYPE] (K7) .....	6.255
[SENSe:]ADEMod:AM:RELative[:TDOMain]:RESult? (K7) .....	6.256
[SENSe:]ADEMod:AM:RELative:AFSPectrum[:TYPE] (K7) .....	6.257
[SENSe:]ADEMod:AM:RELative:AFSPectrum:RESult? (K7) .....	6.257
[SENSe:]ADEMod:BANDwidth   BWIDth:DEModulation (K7) .....	6.258
[SENSe:]ADEMod:FM[:TDOMain][:TYPE] (K7).....	6.259
[SENSe:]ADEMod:FM[:TDOMain]:RESult? (K7) .....	6.259
[SENSe:]ADEMod:FM:AFSPectrum[:TYPE] (K7).....	6.260
[SENSe:]ADEMod:FM:AFSPectrum:RESult? (K7).....	6.260
[SENSe:]ADEMod:FM:OFFSet? (K7) .....	6.261
[SENSe:]ADEMod:MTIME (K7).....	6.262
[SENSe:]ADEMod:PM[:TDOMain][:TYPE] (K7).....	6.263
[SENSe:]ADEMod:PM[:TDOMain]:RESult? (K7) .....	6.263
[SENSe:]ADEMod:PM:AFSPectrum[:TYPE] (K7).....	6.264
[SENSe:]ADEMod:PM:AFSPectrum:RESult? (K7).....	6.264
[SENSe:]ADEMod:PM:RPOint[:X] (K7) .....	6.265
[SENSe:]ADEMod:RLENgth? (K7) .....	6.266
[SENSe:]ADEMod:SET (K7).....	6.266
[SENSe:]ADEMod:SPECTrum[:TYPE] (K7) .....	6.267
[SENSe:]ADEMod:SPECTrum:BANDwidth BWIDth[:RESolution] (K7) .....	6.268
[SENSe:]ADEMod:SPECTrum:RESult? (K7).....	6.268
[SENSe:]ADEMod:SPECTrum:SPAN:ZOOM (K7) .....	6.270
[SENSe:]ADEMod:SRATE? (K7) .....	6.270

SOURce<1 2>:EXTernal<1 2>:ROSCillator[:SOURce]	6.386
SOURce<1 2>:POWER[:LEVel][:IMMEDIATE][:AMPLitude]	6.201
SOURce<1 2>:POWER[:LEVel][:IMMEDIATE]:OFFSet	6.201
SOURce:TEMPerature:APRobe?	6.386
STATus:ERRor	6.395
STATus:OPERation[:EVENT]?	6.387
STATus:OPERation:CONDition?	6.387
STATus:OPERation:ENABle	6.388
STATus:OPERation:NTRansition	6.388
STATus:OPERation:PTRansition	6.388
STATus:PRESet	6.389
STATus:QUEStionable:CORRection[:EVENT]?(K30)	6.330
STATus:QUEStionable:CORRection:CONDition?(K30)	6.331
STATus:QUEStionable:CORRection:ENABle(K30)	6.331
STATus:QUEStionable:CORRection:NTRansition(K30)	6.331
STATus:QUEStionable:CORRection:PTRansition(K30)	6.332
STATus:QUEStionable[:EVENT]?	6.389
STATus:QUEStionable:ACPLimit[:EVENT]?	6.204
STATus:QUEStionable:ACPLimit:CONDition?	6.204
STATus:QUEStionable:ACPLimit:ENABle	6.204
STATus:QUEStionable:ACPLimit:NTRansition	6.205
STATus:QUEStionable:ACPLimit:PTRansition	6.205
STATus:QUEStionable:CONDition?	6.389
STATus:QUEStionable:ENABle	6.389
STATus:QUEStionable:FREQuency[:EVENT]?	6.205
STATus:QUEStionable:FREQuency:CONDition?	6.206
STATus:QUEStionable:FREQuency:ENABle	6.206
STATus:QUEStionable:FREQuency:NTRansition	6.206
STATus:QUEStionable:FREQuency:NTRansition(K30)	6.332
STATus:QUEStionable:FREQuency:PTRansition	6.207
STATus:QUEStionable:FREQuency:PTRansition(K30)	6.333
STATus:QUEStionable:LIMit<1 2>[:EVENT]?	6.207
STATus:QUEStionable:LIMit<1 2>:CONDition?	6.207
STATus:QUEStionable:LIMit<1 2>:ENABle	6.208
STATus:QUEStionable:LIMit<1 2>:NTRansition	6.208
STATus:QUEStionable:LIMit<1 2>:NTRansition(K30)	6.333
STATus:QUEStionable:LIMit<1 2>:PTRansition	6.208
STATus:QUEStionable:LIMit<1 2>:PTRansition(K30)	6.334
STATus:QUEStionable:LMARgin<1 2>[:EVENT]?	6.209
STATus:QUEStionable:LMARgin<1 2>:CONDition?	6.209
STATus:QUEStionable:LMARgin<1 2>:ENABle	6.209
STATus:QUEStionable:LMARgin<1 2>:NTRansition	6.210
STATus:QUEStionable:LMARgin<1 2>:PTRansition	6.210
STATus:QUEStionable:NTRansition	6.390
STATus:QUEStionable:POWER[:EVENT]?	6.210
STATus:QUEStionable:POWER:CONDition?	6.211
STATus:QUEStionable:POWER:ENABle	6.211
STATus:QUEStionable:POWER:NTRansition	6.211
STATus:QUEStionable:POWER:PTRansition	6.212
STATus:QUEStionable:PTRansition	6.390
STATus:QUEStionable:SYNC[:EVENT]?	6.212
STATus:QUEStionable:SYNC:CONDition?	6.212
STATus:QUEStionable:SYNC:ENABle	6.213
STATus:QUEStionable:SYNC:NTRansition	6.213
STATus:QUEStionable:SYNC:PTRansition	6.213
STATus:QUEue	6.391
SYSTem:COMMunicate:GPIB[:SELF]:ADDRess	6.392

SYSTem:COMMunicate:GPIB[:SELF]:RTERminator.....	6.393
SYSTem:COMMunicate:PRINter:ENUMerate:FIRSt? .....	6.393
SYSTem:COMMunicate:PRINter:ENUMerate:NEXt? .....	6.393
SYSTem:COMMunicate:PRINter:SElect <1 2> .....	6.394
SYSTem:CONFigure:DUT:GAIN (K30) .....	6.335
SYSTem:CONFigure:DUT:STIME (K30) .....	6.335
SYSTem:DATE .....	6.394
SYSTem:DISPlay:FPANel .....	6.395
SYSTem:DISPlay:UPDate .....	6.395
SYSTem:ERRor:CLEar:ALL .....	6.396
SYSTem:ERRor:LIST? .....	6.396
SYSTem:FIRMware:UPDate .....	6.396
SYSTem:FORMat:IDENT .....	6.397
SYSTem:LANGuage .....	6.397
SYSTem:PASSword[:CENable] .....	6.397
SYSTem:PASSword:RESet] .....	6.398
SYSTem:PRESet .....	6.398
SYSTem:SPEaker:VOLume .....	6.214
SYSTem:TIME .....	6.398
SYSTem:VERSion? .....	6.399

**T**

TRACe<1 2>[:DATA] .....	6.215
TRACe<1 2>[:DATA] (K7) .....	6.277
TRACe<1 2>:FEED:CONTRol .....	6.217
TRACe<1 2>:IQ[:STATe] .....	6.225
TRACe<1 2>:IQ:AVERAge[:STATe] .....	6.225
TRACe<1 2>:IQ:AVERAge:COUNt .....	6.226
TRACe<1 2>:IQ:DATA? .....	6.226
TRACe<1 2>:IQ:DATA:MEMory? .....	6.227
TRACe<1 2>:IQ:SET .....	6.228
TRACe<1 2>:IQ:SRATe 15.625kHz to 32MHz .....	6.229
TRACe<1 2>:POINTS .....	6.217
TRACe:COPY .....	6.216

TRIGger<1 2>[:SEQuence]:HOLDoff .....	6.230
TRIGger<1 2>[:SEQuence]:IFPower:HOLDoff .....	6.230
TRIGger<1 2>[:SEQuence]:IFPower:HYSteresis .....	6.231
TRIGger<1 2>[:SEQuence]:LEVel:AM[:ABSolute] (K7) .....	6.278
TRIGger<1 2>[:SEQuence]:LEVel:AM:RELative (K7) .....	6.278
TRIGger<1 2>[:SEQuence]:LEVel:FM (K7) .....	6.279
TRIGger<1 2>[:SEQuence]:LEVel:IFPower .....	6.231
TRIGger<1 2>[:SEQuence]:LEVel:PM (K7) .....	6.279
TRIGger<1 2>[:SEQuence]:LEVel:VIDeo .....	6.231
TRIGger<1 2>[:SEQuence]:SLOPe .....	6.232
TRIGger<1 2>[:SEQuence]:SOURce .....	6.232
TRIGger<1 2>[:SEQuence]:SOURce (K7) .....	6.279
TRIGger<1 2>[:SEQuence]:TIME:RINTerval .....	6.233

**U**

UNIT<1 2>:PMETer:POWER (K9) .....	6.292
UNIT<1 2>:PMETer:POWER:RATio (K9) .....	6.292
UNIT<1 2>:POWER .....	6.234
UNIT:ANGLE (K7) .....	6.280

# Index

- \*
  - \* (enhancement label).....4.115
- 1**
  - 10 dB setting.....4.10
- 3**
  - 3 dB bandwidths .....4.13
- 6**
  - 6 dB bandwidths .....4.13
- A**
  - addressed command .....5.33
  - adjacent-channel power
    - number of channels .....4.161
  - AF trigger (K7) .....4.205
  - alignment results.....4.268
  - AM demodulation.....4.57, 4.132
  - AM modulation depth.....4.158
  - amplitude menu
    - base unit.....4.92
    - K7 option .....4.217
  - Amplitude menu.....4.9
  - AMPT key .....4.9, 4.91
  - analog demodulation
    - AF trigger (K7).....4.205
    - bandwidth (K7).....4.205
    - circuit description (K7).....4.204
    - measurement results (K7).....4.205
    - measurement time (K7) .....4.206
    - sample rate (K7).....4.206
    - trigger offset (K7) .....4.206
  - analog demodulation (K7).....4.203
  - analog demodulation menu (K7).....4.203, 4.207
  - Analog Demodulation mode (K7).....4.78, 4.194
  - annotation .....4.272
  - ASCII # .....5.10
  - ASCII file export.....4.122
    - scan data.....4.38
  - attenuation
    - automatic.....4.93
    - manual .....4.93
  - Auto Peak detector .....4.116
  - automatic peak search after prescan (remote control) .....6.103
  - Average detector .....4.29, 4.116
  - Average trace mode .....4.115
  - averaging
    - continuous sweep .....4.115
    - single sweep .....4.115
  - sweep count .....4.115
- axis
  - adjustment.....4.24
- B**
  - Band filter
    - digital .....4.16
  - bandwidth
    - occupied .....4.147
    - resolution .....4.99
    - resolution (K7) .....4.219
    - video .....4.99
  - bandwidth menu
    - base unit .....4.99
    - K7 option .....4.219
  - Bandwidth menu .....4.13
  - bargraph
    - Continuous Bargraph.....4.64
    - detector.....4.55
    - Detector (remote control) .....6.148
    - maxhold .....4.65
    - maxhold (remote control) .....6.122
    - measurement time (remote control).....6.200
    - query of lower level (remote control) ....6.121
    - query of upper level (remote control)....6.122
    - reset.....4.65
    - reset (remote control).....6.122
    - Single Bargraph.....4.65
  - Blank trace mode .....4.115
  - block data.....5.9
  - Boolean parameter.....5.9
  - BW key.....4.13, 4.95
- C**
  - calibration
    - transmission measurement.....4.201
  - calibration (K30) .....4.228
  - center frequency .....4.85
    - step size .....4.86
  - channel
    - bandwidth .....4.160, 4.163, 4.168
    - number .....4.161, 4.162
    - spacing .....4.163
  - channel filter, list of .....4.13, 4.97
  - characters
    - special .....6.3
  - CISPR average detector .....4.29
  - CISPR RMS detector .....4.29
  - Clear Write trace mode.....4.114
  - colon.....5.10
  - color printout .....4.273
  - color settings
    - default.....4.272

- Color Setup dialog box ..... 4.272
- comma ..... 5.10
- command
  - # 5.10
  - addressed ..... 5.33
  - colon ..... 5.10
  - comma ..... 5.10
  - description ..... 6.2
  - header ..... 5.5
  - line ..... 5.7
  - long form ..... 5.6
  - overlapping execution ..... 5.12
  - query ..... 5.8
  - question mark ..... 5.8, 5.10
  - quotation mark ..... 5.10
  - recognition ..... 5.11
  - sequence ..... 5.12
  - short form ..... 5.6
  - structure ..... 5.5
  - suffix ..... 5.7
  - syntax elements ..... 5.10
  - universal ..... 5.33
  - white space ..... 5.10
- command tracking ..... 4.271
- common commands ..... 6.337
- CONDition register part ..... 5.14
- continuous sweep ..... 4.103
- control
  - output level ..... 4.200
- copy trace ..... 4.37
- coupling
  - resolution bandwidth ..... 4.99
  - sweep time ..... 4.100
  - video bandwidth ..... 4.100
- create folder ..... 4.284
- D**
- Data reduction ..... 4.50
- date ..... 4.271
- DCL ..... 5.11
- default color settings ..... 4.272
- default scalings of x- and y-axis ..... 4.170
- default scan table ..... 4.18
- delay
  - gate signal ..... 4.112
- delimiter ..... 5.11
- delta marker ..... 4.40, 4.124
- Demodulation ..... 4.56
- demodulation bandwidth (K7) ..... 4.205
- detector
  - Auto Peak ..... 4.119
  - auto select ..... 4.119
  - average ..... 4.29
  - Average ..... 4.120
  - Average (bargraph) ..... 4.55
  - Average (scan) ..... 4.35
  - bargraph ..... 4.55
  - CISPR Average ..... 4.29
  - CISPR Average (bargraph) ..... 4.56
  - CISPR RMS ..... 4.29
  - CISPR RMS (bargraph) ..... 4.56
  - Final Average ..... 4.36
  - Final CISPR RMS ..... 4.37
  - final measurement ..... 4.36
  - Final Min Peak ..... 4.36
  - Final Peak ..... 4.36
  - Final Quasipeak ..... 4.36
  - Final RMS ..... 4.36
  - Min Peak ..... 4.29
  - Min Peak (bargraph) ..... 4.55
  - Min Peak (scan) ..... 4.35
  - Negative Peak ..... 4.119
  - Peak ..... 4.29
  - Peak (bargraph) ..... 4.55
  - peak (scan) ..... 4.35
  - Positive Peak ..... 4.119
  - Quasi Peak ..... 4.120
  - quasipeak ..... 4.30
  - Quasipeak (bargraph) ..... 4.56
  - Quasipeak (scan) ..... 4.35
  - RMS ..... 4.29, 4.119
  - RMS (bargraph) ..... 4.56
  - RMS (scan) ..... 4.35
  - Sample ..... 4.119
  - scan ..... 4.35
  - selection ..... 4.29, 4.30
- Detector
  - Final CISPR AV ..... 4.37
- detector overview ..... 4.116
- diagram title ..... 4.271
- direct measurement (K30) ..... 4.243
- display
  - date ..... 4.271
  - power-save mode ..... 4.274
  - time ..... 4.271
- display lines ..... 4.72, 4.76, 4.187, 4.191
- display range
  - frequency ..... 4.85
  - level ..... 4.92
- double dagger ..... 5.10
- E**
- Edit Limit Line dialog box ..... 4.70, 4.71, 4.185, 4.186
- Edit Scan Table
  - Meas Time (remote control) ..... 6.194
  - number of ranges (remote control) ..... 6.193
  - Start Frequency (remote control) ..... 6.193
  - Step Mode (remote control) ..... 6.199
  - Step Size (remote control) ..... 6.194
  - Stop Frequency (remote control) ..... 6.193
- Edit Scan Table dialog box ..... 4.21
  - Auto Preamp (remote control) ..... 6.192
  - Auto Ranging (remote control) ..... 6.192
  - Preamp (remote control) ..... 6.192
  - Res BW (remote control) ..... 6.191
  - RF Attn (remote control) ..... 6.191
- ESE (event status enable register) ..... 5.18

- ESR (event status register).....5.18  
 EVENT register part.....5.15  
 event status enable register (ESE).....5.18  
 event status register (ESR).....5.18  
 external noise source.....4.267  
 external trigger.....4.108
- F**
- FFT filter .....4.16  
 file  
   copying.....4.284  
   deleting.....4.285  
   renaming.....4.284  
 FILE key.....4.279  
 File Manager dialog box .....4.284  
 file menu .....4.280  
 filter  
   Channel.....4.16  
   EMI (6 dB).....4.16  
   Gaussian.....4.16  
   RRC.....4.17  
 Filter  
   band filter .....4.16  
   FFT.....4.16  
 filter Type .....4.16  
 final measurement  
   automatic.....4.60  
   Automatic (remote control).....6.161  
   Automatic Run Final after Prescan .....6.126  
   continuation.....4.64  
   Detector (remote control).....6.148  
   Interactive (remote control).....6.161  
   interactive routine.....4.60  
   LISN.....4.58  
   margin.....4.59  
   Margin (remote control).....6.103  
   number of peaks.....4.59  
   number of peaks (remote control).....6.104  
   number of subranges.....4.59  
   number of subranges (remote control) ..6.104  
   Peak Search.....4.59  
   Peak Search (remote control).....6.104  
   peaks per subrange (remote control)....6.105  
   run final test after prescan .....4.60  
   settings.....4.59  
   Settings .....4.58  
   time.....4.60  
   time (remote control).....6.162  
 Final measurement  
   interruption .....4.63  
   start .....4.60, 4.63  
 firmware  
   update .....4.274  
   version.....4.276  
 fixed reference.....4.130  
 FM demodulation.....4.57, 4.132  
 folder  
   renaming.....4.284  
 FREQ key .....4.6, 4.83  
 frequency  
   axis.....4.83  
   center.....4.85  
   display.....4.272  
   line.....4.76, 4.192  
   offset.....4.87  
   power meter.....4.224  
   specify frequency axis .....4.83  
   start.....4.85  
   stop.....4.86  
 frequency menu .....4.6  
   base unit.....4.85  
   K30 option .....4.232  
   K7 option .....4.214  
   receiver.....4.6  
 Frequency Settings dialog box (K30).....4.232  
 frequency–converting measurement (K30)4.243
- G**
- gate  
   delay.....4.112  
   external/internal.....4.111  
   length.....4.112  
   mode.....4.111  
 GET (Group Execute Trigger).....5.11  
 GPIB  
   interface.....5.31  
   interface functions .....5.32  
 Graphic dialog box (K30) .....4.234
- H**
- Hardware Information dialog box .....4.275  
 harmonics measurement .....4.181  
 header .....5.5
- I**
- IEC/IEEE bus  
   command description .....6.2  
 IF bandwidth.....4.13  
 impedance  
   input.....4.94  
 initial configuration .....4.4, 4.81  
   spectrum analyzer .....4.81  
 instrument functions.....4.79, 4.260  
 interface functions  
   GPIB.....5.32  
 interrupt .....5.24  
 IST flag.....5.17  
 IVI driver.....5.2
- K**
- key  
   AMPT.....4.9, 4.91  
   BW.....4.13, 4.95  
   ESC.....6.24  
   FILE.....4.279  
   FREQ.....4.6, 4.83  
   LINES.....4.68, 4.183

- MEAS ..... 4.144  
 MENU ..... 4.195  
 MKR ..... 4.40, 4.125  
 MKR→ ..... 4.44, 4.136  
 MODE ..... 4.78, 4.194  
 MODE (remote control) ..... 6.362  
 PRESET ..... 4.4, 4.81, 6.339, 6.398  
 PRINT ..... 4.288  
 RUN ..... 4.66  
 RUN (remote control) ..... 6.124  
 SETUP ..... 4.262  
 SPAN ..... 4.89  
 SWEEP ..... 4.18, 4.102  
 TRACE ..... 4.28, 4.113  
 TRIG ..... 4.26, 4.105
- Key  
 MEAS ..... 4.48  
 Sweep ..... 4.20
- L**
- LAN ..... 5.27  
 interface ..... 5.27  
 RSIB protocol ..... 5.29  
 VXI protocol ..... 5.27
- level  
 axis ..... 4.94  
 display range ..... 4.9, 4.92  
 range ..... 4.92  
 reference ..... 4.92  
 trigger ..... 4.27, 4.110
- limit  
 ACP measurement ..... 4.165  
 evaluation range ..... 4.159
- limit check  
 ACP measurement ..... 4.165
- limit line ..... 4.73, 4.188  
 copying ..... 4.76, 4.191  
 deleting ..... 4.76, 4.191  
 editing ..... 4.76, 4.191  
 new ..... 4.74, 4.190  
 scaling ..... 4.70, 4.185  
 shift ..... 4.71, 4.186  
 span setting ..... 4.70, 4.185  
 unit ..... 4.70, 4.185
- Limit Lines dialog box (K30) ..... 4.227
- line  
 display ..... 4.72, 4.187  
 frequency (Frequency Line 1, 2) ..... 4.76, 4.192  
 limit ..... 4.73, 4.188  
 threshold ..... 4.142  
 time (Time Line 1, 2) ..... 4.192
- Line impedance stabilization networks ..... 4.51
- LINES key ..... 4.68, 4.183
- lines menu  
 base unit ..... 4.74, 4.189  
 K30 option ..... 4.248
- LISN ..... 4.51  
 ENV 216 ..... 4.61  
 ENV 4200 ..... 4.61
- ESH2-Z5 ..... 4.61  
 ESH3-Z5 ..... 4.61  
 Final Phase selection ..... 4.61  
 Final Phase selection (remote control) ..... 6.132, 6.162  
 high pass filter ..... 4.62  
 high pass filter (remote control) ..... 6.131, 6.162  
 network selection ..... 4.61  
 Network selection (remote control) ..... 6.131, 6.161  
 Prescan Phase selection ..... 4.61  
 Prescan Phase selection (remote control) ..... 6.132, 6.162  
 Settings ..... 4.61
- LO exclude ..... 4.143
- local menu ..... 4.287
- logo ..... 4.271
- Loss dialog box (K30) ..... 4.238
- lower-case (commands) ..... 5.6, 6.2
- M**
- maintenance ..... 8.1
- manual operation ..... 4.287  
 changing to ..... 4.287  
 return to ..... 5.4
- marker ..... 4.40, 4.124  
 center frequency to ..... 4.141  
 deactivate limits ..... 4.47  
 limit search ..... 4.46  
 minimum ..... 4.46  
 off ..... 4.42  
 peak ..... 4.45, 4.140  
 reference level to ..... 4.141  
 search limit ..... 4.142  
 signal track ..... 4.88  
 to trace ..... 4.42, 4.131  
 zoom ..... 4.42, 4.133  
 zoom deactivation ..... 4.43
- marker field  
 base unit ..... 4.40, 4.124
- marker menu  
 base unit ..... 4.128  
 K30 option ..... 4.247
- marker→ menu  
 base unit ..... 4.140  
 K30 option ..... 4.248
- Max Hold trace mode ..... 4.114
- maximum search ..... 4.140
- maximum value ..... 4.158
- mean power (GSM burst) ..... 4.159
- MEAS key ..... 4.48, 4.144
- measurement  
 functions ..... 4.39, 4.123  
 parameters ..... 4.3, 4.80  
 reflection ..... 4.198  
 time ..... 4.224  
 transmission ..... 4.198
- measurement forms (K30) ..... 4.228
- measurement menu ..... 4.48



- base unit ..... 4.155
- K30 option ..... 4.239
- measurement mode
  - Analog Demodulation (K7) ..... 4.78, 4.194
  - available modes ..... 4.78, 4.194
  - changing ..... 4.78, 4.194
  - displaying main menus ..... 4.195
  - K30 option ..... 4.227
  - Noise (K30) ..... 4.78, 4.194
  - Receiver ..... 4.78
  - Spectrum Analyzer ..... 4.78, 4.194
- measurement results (K30) ..... 4.229
- Measurement Settings dialog box (K30) ..... 4.239
- measurement time ..... 4.48
- menu
  - amplitude ..... 4.92
  - amplitude (K7) ..... 4.217
  - analog demodulation (K7) ..... 4.203, 4.207
  - bandwidth ..... 4.99
  - bandwidth (K7) ..... 4.219
  - file ..... 4.280
  - frequency ..... 4.6, 4.85
  - frequency (K30) ..... 4.232
  - frequency (K7) ..... 4.214
  - frequency (receiver) ..... 4.6
  - lines ..... 4.74, 4.189
  - lines (K30) ..... 4.248
  - marker ..... 4.128
  - marker (K30) ..... 4.247
  - marker→ ..... 4.140
  - marker→ (K30) ..... 4.248
  - measurement (K30) ..... 4.239
  - measurement (K7) ..... 4.207
  - menu ..... 4.195
  - noise figure measurements (K30) ..... 4.226, 4.231
  - power measurement ..... 4.155
  - power meter (K9) ..... 4.222, 4.223
  - print ..... 4.288
  - run ..... 4.66
  - setup ..... 4.262
  - span ..... 4.89
  - span (K7) ..... 4.216
  - sweep ..... 4.102
  - sweep (K30) ..... 4.245
  - sweep (K7) ..... 4.219
  - trace ..... 4.117
  - trace (K30) ..... 4.246
  - tracking generator ..... 4.200
  - trigger ..... 4.109
  - trigger (K7) ..... 4.220
- MENU key ..... 4.195
- menu menu ..... 4.195
- Min Hold trace mode ..... 4.114
- Min Peak detector ..... 4.29
- minimum search ..... 4.141
- MKR key ..... 4.40, 4.125
- MKR→ key ..... 4.44, 4.136
- mode
  - see also measurement mode ..... 4.78, 4.194
  - trigger ..... 4.26, 4.110
- Mode
  - receiver ..... 4.2
- MODE key ..... 4.78, 4.194
- model ..... 4.196
  - 13, 16 and 28 – tracking generator ..... 4.197
- modulation depth ..... 4.158
- N**
- Negative Peak detector ..... 4.116
- noise
  - source, external ..... 4.267
- noise figure measurements menu (K30) ..... 4.226, 4.231
- Noise mode (K30) ..... 4.78, 4.194
- normalization ..... 4.201
- NTRansition register part ..... 5.14
- numerical values (command) ..... 5.8
- O**
- occupied bandwidth ..... 4.147
- offset
  - frequency ..... 4.87
  - gate signal ..... 4.112
  - reference level ..... 4.93
  - trigger ..... 4.110
- Operating mode
  - Receiver ..... 4.2
- option ..... 4.196
  - Additional Interfaces (B5) ..... 4.222
  - Analog Demodulation (K7) ..... 4.203
  - Gated Sweep (B8) ..... 4.105
  - Power Meter (K9) ..... 4.222
  - RF Preamplifier (B22) ..... 4.93
- options
  - installed ..... 4.276
- output level
  - control ..... 4.200
- overlapping execution ..... 5.11
- overwrite mode ..... 4.114
- Overwrite mode ..... 4.34
- P**
- packing ..... 8.1
- parallel poll ..... 5.25
  - enable register (PPE) ..... 5.18
- parameter
  - block data ..... 5.9
  - boolean ..... 5.9
  - numerical values ..... 5.8
  - string ..... 5.9
  - text ..... 5.9
- path ..... 4.282
- Peak
  - search ..... 4.60
- Peak detector ..... 4.29
- peak list ..... 4.62

- activation ..... 4.37
  - add receiver frequency ..... 4.63
  - add receiver frequency (remote control) ..... 6.102
  - add to ..... 4.45, 4.55
  - automatic peak search after prescan ..... 4.60
  - export ..... 4.64
  - generation of ..... 4.62
  - generation of (remote control) ..... 6.102
  - peak search ..... 4.140
    - automatic peak search after prescan (remote control) ..... 6.103
    - margin ..... 4.59
    - margin (remote control) ..... 6.103
    - method of ..... 4.59
    - method of (remote control) ..... 6.104
    - number of peaks ..... 4.59
    - number of peaks (remote control) ..... 6.104
    - number of subranges ..... 4.59
    - number of subranges (remote control) ..... 6.104
    - peaks per subrange (remote control) ..... 6.105
  - Peak Search After Prescan ..... 4.60
  - polarity
    - external trigger/gate ..... 4.27, 4.110
    - trigger edge ..... 4.110
  - Positive Peak detector ..... 4.116
  - power
    - bandwidth percentage ..... 4.168
    - mean ..... 4.159
  - power cables ..... 8.1
  - power measurement ..... 4.144
    - occupied bandwidth ..... 4.147
    - trace ..... 4.166
    - zero span ..... 4.147
  - power measurement menu
    - base unit ..... 4.155
  - power meter (K9) ..... 4.222
    - frequency ..... 4.224
    - menu ..... 4.222, 4.223
  - power sensor support (K9) ..... 4.222
  - PPE (parallel poll enable register) ..... 5.18
  - preset instrument ..... 4.81
  - PRESET key ..... 4.4, 4.81
  - preset receiver ..... 4.4
  - preset spectrum analyzer ..... 4.81
  - pre-trigger ..... 4.110
  - print
    - screen ..... 4.289
  - PRINT key ..... 4.288
  - print menu ..... 4.288
  - Printers and Faxes window ..... 4.290
  - protocol
    - RSIB ..... 5.29
    - VXI ..... 5.27
  - PTRansition register part ..... 5.14
- Q**
- Quasipeak detector ..... 4.30
  - query ..... 5.8, 5.25, 5.34
  - question mark ..... 5.8, 5.10
  - quotation mark ..... 5.10
- R**
- Recall dialog box ..... 4.283
  - Receiver ..... 4.2
  - Receiver mode ..... 4.78
  - reference
    - external ..... 4.264
    - fixed ..... 4.130
    - internal ..... 4.264
    - level to marker level ..... 4.141
    - value ..... 4.225
  - reference level ..... 4.92
    - channel power ..... 4.167
    - offset ..... 4.93
    - to marker level ..... 4.141
  - reference point
    - frequency ..... 4.130
    - level ..... 4.130
    - peak search ..... 4.130
    - time ..... 4.130
  - reflection measurement ..... 4.198
  - remote control
    - basics ..... 5.1
    - changing to ..... 4.287
    - IP address ..... 5.3
    - starting ..... 5.4
  - reset
    - status reporting system ..... 5.26
    - switch on or off ..... 4.120
  - resolution bandwidth ..... 4.99
    - K7 option ..... 4.219
  - RFI reception ..... 4.2
  - RMS detector ..... 4.29, 4.116
  - RMS value ..... 4.159
  - RSIB protocol ..... 5.29
  - RUN
    - key ..... 4.66
  - Run Final Test ..... 4.60
  - run menu
    - receiver mode ..... 4.66
- S**
- Sample detector ..... 4.116
  - sample number ..... 4.169
  - Save dialog box ..... 4.281
  - scalar reflection measurement ..... 4.198
  - scaling ..... 4.92
    - level axis ..... 4.94
    - x- and y-axis (signal statistic) ..... 4.169
  - scan ..... 4.66
    - Auto Preamp ..... 4.24
    - count ..... 4.37
    - default setup ..... 4.18
    - frequency domain ..... 4.18
    - interruption ..... 4.66
    - measurement time ..... 4.23
    - Preamp ..... 4.24
    - ranging ..... 4.24

- Res BW ..... 4.23
- resume at hold ..... 4.67
- resume at receiver frequency..... 4.67
- RF Attenuation ..... 4.24
- settings..... 4.21
- start frequency ..... 4.22, 4.23
- step mode ..... 4.22
- step size ..... 4.23
- Stepped scan ..... 4.18
- stop frequency..... 4.22, 4.23
- stop scan..... 4.67
- Scan
  - Detector (remote control)..... 6.147
  - entry ..... 4.20
- Scan Control dialog box..... 4.21
- scan table ..... 4.21
  - delete range ..... 4.25
  - Insert Range..... 4.25
- SCPI
  - conformity information..... 6.2
  - introduction..... 5.5
  - version..... 5.1
- search
  - bandwidth ..... 4.88
  - minimum ..... 4.141
  - peak ..... 4.140
  - range ..... 4.142
- Select Limit Line dialog box..... 4.71, 4.186
- Select Screen Color Set dialog box ..... 4.272
- self test ..... 4.277
- sensitivity
  - APD measurement..... 4.170
  - CCDF measurement ..... 4.170
- serial poll..... 5.25
- service request (SRQ) ..... 5.17, 5.24
- service request enable register (SRE)..... 5.17
- setting command ..... 5.34
- setup
  - general ..... 4.268
- SETUP key ..... 4.262
- setup menu ..... 4.262
- signal count..... 4.131
- signal tracking..... 4.88
  - search bandwidth ..... 4.88
- softkey
  - # of Adj Chan ..... 4.162
  - # of Adj Chan (remote control)..... 6.183
  - # of Samples ..... 4.169
  - # of Samples (remote control)..... 6.107
  - # of TX Chan ..... 4.161
  - # of TX Chan (remote control) ..... 6.189
  - % Power Bandwidth ..... 4.168
  - % Power Bandwidth (remote control)..... 6.189
  - \*IDN Format Legacy..... 4.271
  - = Center ..... 4.87
  - = Marker..... 4.87
  - = Marker (remote control) ..... 6.62
  - 0.1 \* RBW ..... 4.86
  - 0.1 \* RBW (remote control)..... 6.164, 6.165
  - 0.1 \* Span..... 4.86
  - 0.1 \* Span (remote control) ..... 6.164, 6.165
  - 0.1\*Demod BW (K7)..... 4.214
  - 0.5 \* RBW..... 4.86
  - 0.5 \* RBW (remote control)..... 6.164, 6.165
  - 0.5 \* Span..... 4.86
  - 0.5 \* Span (remote control) ..... 6.164, 6.165
  - 0.5\*Demod BW (K7)..... 4.214
  - 1 MHz ..... 4.16
  - 10 dB Min On Off..... 6.129
  - 10 dB Min ON/OFF..... 4.10
  - 120 kHz ..... 4.16
  - 150 kHz High Pass on Off (remote control)
    - ..... 6.131
  - 150 kHz High Pass On Off (remote control)
    - ..... 6.162
  - 200 Hz ..... 4.15
  - 9 kHz ..... 4.15
  - ACP Abs/Rel..... 4.167
  - ACP Abs/Rel (remote control) ..... 6.185
  - ACP Ref Setting (remote control)..... 6.187
  - ACP Ref Settings..... 4.165
  - ACP Ref Spacing (remote control) ..... 6.187
  - Active On/Off ..... 4.265
  - Active On/Off (remote control).... 6.381, 6.383
  - Add To Peak List ..... 4.45, 4.55
  - Adjust Axis..... 4.24
  - Adjust Ref Level ..... 4.167
  - Adjust Ref Level (remote control)..... 6.186
  - Adjust Ref Lvl ..... 4.168
  - Adjust Settings..... 4.160, 4.166, 4.170, 4.182
  - Adjust Settings (remote control) . 6.108, 6.185
  - Adjust X-Axis ..... 4.180
  - AF Center (K7) ..... 4.215
  - AF Center (remote control, K7) ..... 6.251
  - AF Coupling AC/DC (K7)..... 4.210
  - AF Coupling AC/DC (remote control, K7)
    - ..... 6.252
  - AF Filter (K7) ..... 4.211
  - AF Full Span (K7) ..... 4.216
  - AF Full Span (remote control, K7)..... 6.253
  - AF Range (K7)..... 4.209
  - AF Span Manual (K7) ..... 4.216
  - AF Span Manual (remote control, K7)... 6.252
  - AF Spectrum (K7)..... 4.208
  - AF Start (K7)..... 4.215
  - AF Start (remote control, K7) ..... 6.253
  - AF Stop (K7)..... 4.215
  - AF Stop (remote control, K7)..... 6.254
  - AF Time Domain (K7)..... 4.208
  - Alignment..... 4.267
  - All Functions off ..... 4.157
  - All Functions off (remote control) ..... 6.89
  - All Marker Off ..... 4.42, 4.133
  - All Marker Off (K30)..... 4.248
  - All Marker Off (remote control, K30) .... 6.301
  - AM ..... 4.57, 4.132
  - AM (remote control)..... 6.62
  - AM Mod Depth..... 4.158

AM Mod Depth (remote control).....	6.66
Annotation On/Off .....	4.272
Annotation On/Off (remote control).....	6.348
APD .....	4.168
APD (remote control) .....	6.106, 6.108
ASCII File Export.....	4.121, 4.134, 4.178
ASCII FILE Export.....	4.38
ASCII File Export (remote control) .....	6.377
Auto Coarse .....	4.7
Auto Fine.....	4.7
Auto Max Peak.....	4.143
Auto Max Peak (remote control) .....	6.51
Auto Min Peak.....	4.143
Auto Min Peak (remote control).....	6.53
Auto Range On Off (remote control).....	6.129
Auto Range On/Off.....	4.10
Automatic (remote control).....	6.161
Autopreamp On Off.....	6.129, 6.130
Autopreamp On/Off.....	4.10
Average.....	4.55, 4.118
Average (scan).....	4.35
Average Mode (remote control) .....	6.100
Bargraph Maxhold .....	4.65
Bargraph Reset.....	4.65
Blank .....	4.34, 4.119
Build Tbl (K30) .....	4.244
C/N .....	4.160
C/N (remote control) .....	6.79, 6.80, 6.83
C/N, C/No .....	4.160
C/No .....	4.160
C/No (remote control) .....	6.79, 6.80, 6.83
Cal (K30) .....	4.245
Cal (remote control, K30).....	6.304
Cal Refl Open.....	4.201
Cal Refl Open (remote control) ...	6.143, 6.144
Cal Refl Short.....	4.201
Cal Refl Short (remote control) .....	6.144
Cal Trans.....	4.201
Cal Trans (remote control).....	6.144
Cal Type Sine/Comb .....	4.277
Cal Type Sine/Comb (remote control) ...	6.344
CCDF .....	4.170
CCDF (remote control).....	6.106, 6.108
Center .....	4.85
Center (remote control).....	6.163
Center =Mkr Freq.....	4.141
Center =Mkr Freq (remote control) .....	6.62
CF Stepsize.....	4.86
CF Stepsize (remote control) .....	6.163
Chan Pwr/Hz .....	4.164
Chan Pwr/Hz (remote control).....	6.83
Channel Bandwidth .....	4.160, 4.163, 4.168
Channel Bandwidth (remote control).....	6.184
Channel Settings.....	4.162
Channel Spacing.....	4.163
Channel Spacing (remote control) .....	6.188, 6.189
CISPR Average.....	4.56
CISPR RBW Uncoupled .....	4.16
CISPR RMS.....	4.56
Clear All Messages.....	4.276
Clear All Messages (remote control) ....	6.395, 6.396
Clear Write .....	4.34, 4.118
Clear/Write .....	4.166
Close Sweep List.....	4.176
Color On/Off .....	4.272, 4.273, 4.290
Color On/Off (remote control).....	6.359
Colors .....	4.272, 4.289
Comment.....	4.290
Computer Name .....	4.269
Cont At Hold .....	4.67
Cont At Rec Freq.....	4.67
Cont Demod .....	4.132
Cont Demod (remote control).....	6.61
Cont Meas (remote control).....	6.124, 6.125
Continue Single Sweep .....	4.103
Continue Single Sweep (remote control) .....	6.124, 6.125
Continuous Bargraph.....	4.64
Continuous Sweep .....	4.103
Continuous Sweep (remote control).....	6.124, 6.125
Copy .....	4.284
Copy (remote control).....	6.366
Copy to .....	4.76, 4.191, 4.266
Copy to (remote control).....	6.25
Copy Trace .....	4.37, 4.121
Copy Trace (remote control) .....	6.216
Corr Data On/Off .....	4.268
Corr Data On/Off (remote control).....	6.342
CP / ACP Config.....	4.161
CP / ACP Standard.....	4.161
CP / ACP Standard (remote control) .....	6.80
CP, ACP, MC-ACP .....	4.161
CP, ACP, MC-ACP (remote control).....	6.79, 6.80, 6.83
Current File List 1/2 .....	4.285
Cut .....	4.284
Data → Mem1 (K30).....	4.246
Data → Mem1 (remote control, K30) ....	6.304
Data → Mem2 (K30).....	4.246
Data → Mem2 (remote control, K30)....	6.304
Data → Mem3 (K30).....	4.246
Data → Mem3 (remote control, K30)....	6.304
Data On/Off (K30) .....	4.247
Data On/Off (remote control, K30) .....	6.307, 6.308
Date .....	4.285
dB per Division (K7).....	4.209
dB per Division (remote control, K7) ....	6.246
dBμA.....	4.11
dBμV.....	4.11
dBm .....	4.11
dBmV.....	4.11
dBpT .....	4.11
dBpW.....	4.11
Decim Sep.....	4.38, 4.121

- Decim Sep (remote control) ..... 6.123
- Deemphasis (K7) ..... 4.212
- Deemphasis (remote control, K7) ..... 6.273
- Default Colors 1 (remote control) 6.348, 6.349
- Default Colors 2 (remote control) 6.348, 6.349
- Default Settings ..... 4.170
- Default Settings (remote control) 6.107, 6.109
- Delete ..... 4.76, 4.191, 4.266, 4.285
- Delete (K30) ..... 4.244, 4.250
- Delete (remote control) ..... 6.25, 6.367, 6.372, 6.383
- Delete File ..... 4.283
- Delete File (remote control) ..... 6.365
- Delete Line ..... 4.265
- Delete Range ..... 4.25, 4.176
- Delete Range (remote control) ..... 6.153
- Delete Value ..... 4.75, 4.191
- Demod ..... 4.56
- Demod Bandwidth (K7) ..... 4.216
- Demod BW (K7) ..... 4.209
- Demod BW (remote control, K7) ..... 6.272
- Demod On Off (remote control) ..... 6.146
- Demod ON/OFF ..... 4.57
- Demod Settings (K7) ..... 4.210
- Deselect All ..... 4.74, 4.189
- Details On/Off ..... 4.180
- Detector ..... 4.55
- Detector (remote control) ..... 6.148
- Detector Auto Peak ..... 4.119
- Detector Auto Select ..... 4.119
- Detector Auto Select (remote control) ..... 6.147
- Detector Average ..... 4.120
- Detector Manual Select ..... 4.119
- Detector Negative Peak ..... 4.119
- Detector Positive Peak ..... 4.119
- Detector Quasi Peak ..... 4.120
- Detector RMS ..... 4.119
- Detector Sample ..... 4.119
- Dev per Division (K7) ..... 4.209
- Deviation Lin/Log (K7) ..... 4.210
- Deviation Lin/Log (remote control, K7) ..... 6.247
- Device 1/2 ..... 4.289
- Device 1/2 (remote control) ..... 6.370
- Device Setup ..... 4.289
- Device Setup (remote control) ..... 6.358, 6.359, 6.361, 6.393, 6.394
- DHCP On/Off ..... 4.269
- Diagram Full Size (K7) ..... 4.208
- Diagram Full Size (remote control, K7) ..... 6.246
- Disable all Items ..... 4.283
- Disable all Items (remote control) ..... 6.374
- Disconnect Network Drive ..... 4.286
- Disconnect Network Drive (remote control) ..... 6.371
- Display Line 1 ..... 4.76, 4.191
- Display Line 1 (remote control) ..... 6.18
- Display Line 2 ..... 4.76, 4.191
- Display Line 2 (remote control) ..... 6.18
- Display Lines ..... 4.76, 4.191
- Display List/Graph (K30) ..... 4.234
- Display List/Graph (remote control, K30) ..... 6.308
- Display Pwr Save ..... 4.274
- Display Pwr Save (remote control) ..... 6.351, 6.352
- Display Settings (K30) ..... 4.234
- Display Settings (remote control, K30) ..... 6.307, 6.308, 6.309, 6.310, 6.312
- Display Update On/Off ..... 4.270
- Edit ..... 4.76, 4.191, 4.265
- Edit (K30) ..... 4.250
- Edit (remote control) ..... 6.24, 6.27, 6.36, 6.37, 6.38, 6.41, 6.42, 6.43, 6.44, 6.45, 6.382
- Edit ACP Limit ..... 4.165
- Edit ACP Limit (remote control) ..... 6.29, 6.30, 6.32, 6.33, 6.34
- Edit Comment ..... 4.75, 4.190, 4.282
- Edit File Name ..... 4.282
- Edit Margin ..... 4.75, 4.190
- Edit Name ..... 4.75, 4.190, 4.266
- Edit Name (remote control) ..... 6.383
- Edit Path ..... 4.284
- Edit Path (remote control) ..... 6.365, 6.369
- Edit Peak List ..... 4.62
- Edit Reference Range ..... 4.177
- Edit Reference Range (remote control) ..... 6.150, 6.151, 6.160
- Edit Scan Table ..... 4.21
- Edit Unit ..... 4.266
- Edit Unit (remote control) ..... 6.384
- Edit Values ..... 4.266
- Edit Values (remote control) ..... 6.382
- Enable all Items ..... 4.283
- Enable all Items (remote control) ..... 6.372
- Enable/Disable (K30) ..... 4.250
- ENR Settings (K30) ..... 4.237
- ENR Settings (remote control, K30) ..... 6.321, 6.325
- ENV216 (remote control) ..... 6.131, 6.161
- ENV4200 (remote control) ..... 6.131, 6.161
- eRECSkIdMarkerToMarkerToStepSize .. 4.47
- ESH2-Z5 (remote control) ..... 6.131, 6.161
- ESH3-Z5 (remote control) ..... 6.131, 6.161
- Exclude LO ..... 4.143
- Exclude LO (remote control) ..... 6.50
- Exit (K30) ..... 4.244, 4.249
- Export ..... 4.286
- Ext Power Trigger (remote control, K9) ..... 6.290, 6.291
- Extension ..... 4.285
- Fast ACP On/Off ..... 4.167
- Fast ACP On/Off (remote control) ..... 6.190
- File Lists 1/2 ..... 4.285
- File Manager ..... 4.284
- Filter Type ..... 4.16, 4.101
- Filter Type (remote control) ..... 6.140
- Final Average ..... 4.36
- Final CISPR AV ..... 4.37

Final CISPR RMS .....	4.37
Final Detector (remote control) .....	6.148
Final Meas Settings .....	4.58
Final measurement detector .....	4.36
Final Min Peak .....	4.36
Final Peak .....	4.36
Final Quasipeak .....	4.36
Final RMS .....	4.36
Firmware Update .....	4.274
Firmware Update (remote control) .....	6.396
Fix Freq (K30) .....	4.245
Fix Freq (remote control, K30) .....	6.305, 6.327
FM .....	4.57, 4.132
FM (remote control) .....	6.62
Freq Axis Lin/Log .....	4.25
Freq Axis Lin/Log (remote control) .....	6.117
Freq Axis Lin/Log (spectrum analyzer) .....	4.90
Freq Settings (K30) .....	4.232
Freq Settings (remote control, K30) .....	6.322, 6.326, 6.327, 6.328, 6.329
Frequency Coupling (K9) .....	4.224
Frequency Coupling (remote control, K9) .....	6.288
Frequency Line 1 .....	4.76, 4.192
Frequency Line 1 (remote control) .....	6.21
Frequency Line 2 .....	4.76, 4.192
Frequency Line 2 (remote control) .....	6.21
Frequency Manual (K9) .....	4.224
Frequency Manual (remote control, K9) .....	6.288
Frequency Offset .....	4.87
Frequency Offset (remote control) .....	6.166
Full Size Diagram .....	4.182
Full Size Diagram (remote control) .....	6.115
Full Span .....	4.90
Full Span (K7) .....	4.216
Full Span (remote control) .....	6.166
Full Span (remote control, K7) .....	6.270
Gate Delay .....	4.112
Gate Delay (remote control) .....	6.197
Gate Length .....	4.112
Gate Length (remote control) .....	6.197
Gate Mode Lvl/Edge .....	4.111
Gate Mode Lvl/Edge (remote control) .....	6.198
Gate Settings .....	4.111
Gated Trigger .....	4.111
Gated Trigger (remote control) .....	6.196, 6.198
General Setup .....	4.268
GPIO .....	4.269
GPIO Address .....	4.270
GPIO Address (remote control) .....	6.392
GPIO Language .....	4.270
GPIO Terminator LFEOI/EOI .....	4.270
GPIO Terminator LFEOI/EOI (remote control) .....	6.393
Grid Abs / Rel .....	4.94
Grid Abs / Rel (remote control) .....	6.119
Grid Level .....	4.11
Grid Min Level .....	4.12
Grid Min Level (remote control) .....	6.118
Grid Range Log 100 dB .....	4.11
Grid Range Log Manual .....	4.11
Hardcopy .....	4.286
Hardware Info .....	4.275
Hardware Info (remote control) .....	6.338, 6.343
Harmonic Distort .....	4.181
Harmonic On/Off .....	4.181
Harmonic RBW Auto .....	4.181
Harmonic Sweep Time .....	4.181
High Pass AF Filter (K7) .....	4.212
High Pass AF Filter (remote control, K7) .....	6.274
Hold Final Meas .....	4.63
Hold Scan .....	4.66
Hold Scan (remote control) .....	6.6
Hold/Cont .....	4.120
I/O Logging On/Off .....	4.271
ID String Factory .....	4.270
ID String User .....	4.270
IF Output IF/Video .....	4.267
IF Output IF/Video (remote control) .....	6.380
IF Power Retrigger Holdoff .....	4.112
IF Power Retrigger Holdoff (remote control) .....	6.230
IF Power Retrigger Hysteresis .....	4.112
IF Power Retrigger Hysteresis (remote control) .....	6.231
Import .....	4.286
Input 50 Ω / 75 Ω .....	4.94
Input 50 Ω / 75 Ω (remote control) .....	6.130
Input RF/Cal/TG .....	4.277
Input RF/Cal/TG (remote control) .....	6.344
Insert (K30) .....	4.244, 4.250
Insert after Range .....	4.176
Insert after Range (remote control) .....	6.156
Insert before Range .....	4.176
Insert before Range (remote control) .....	6.156
Insert Line .....	4.265
Insert Range .....	4.25
Insert Value .....	4.75, 4.190
Install Option .....	4.275
Install Printer .....	4.290
Installed Options (remote control) .....	6.338, 6.343
Interactive (remote control) .....	6.161
Interpolation Lin/Log .....	4.266
Interpolation Lin/Log (remote control) .....	6.383
IP Address .....	4.269
Last Span .....	4.90
Left Limit .....	4.46, 4.142, 4.159
Left Limit (remote control) .....	6.57
Limit Checking .....	4.165
Limit Chk On/Off .....	4.165
Limit Chk On/Off (remote control) .....	6.28, 6.31, 6.35
Limit Line Select dialog box (remote control) .....	6.40, 6.46
Limits On/Off .....	4.159
Limits On/Off (remote control) .....	6.56
LISN .....	4.267

- List Down .....4.178  
List Evaluation .....4.177  
List Evaluation On/Off .....4.178  
List Evaluation On/Off (remote control)....6.19  
List Full Screen .....4.178  
List Up .....4.178  
Local .....4.287  
Logo On/Off.....4.271  
Logo On/Off (remote control) .....6.351  
Loss Settings (K30).....4.238  
Loss Settings (remote control, K30).....6.322,  
6.323, 6.324  
Low Pass AF Filter (K7) .....4.211  
Low Pass AF Filter (remote control, K7)  
.....6.274, 6.275  
Manual .....4.87  
Manual (remote control).....6.163  
Map Network Drive.....4.286  
Map Network Drive (remote control) .....6.370,  
6.371  
Margin .....4.178  
Margin (remote control).....6.19  
Marker 1 .....4.41, 4.129  
Marker 1 (K30) .....4.247  
Marker 1 (remote control) .....6.8  
Marker 1 (remote control, K30) ...6.301, 6.302  
Marker 1 to 4 (remote control) .....6.16, 6.17,  
6.48, 6.56, 6.58  
Marker 2 .....4.41, 4.129  
Marker 2 (remote control) .....6.8  
Marker 3 .....4.41, 4.129  
Marker 3 (remote control) .....6.8  
Marker 4 .....4.41, 4.129  
Marker 4 (remote control) .....6.8  
Marker Demod .....4.131  
Marker Demod Volume .....4.195  
Marker List (remote control).....6.63  
Marker Norm Delta.....4.41  
Marker Norm/Delta.....4.129  
Marker Norm/Delta (remote control) .....6.8  
Marker Peak List .....4.133  
Marker Stepsize .....4.134  
Marker Stepsize (remote control).....6.58  
Marker to Stepsize .....4.47  
Marker to Trace.....4.131  
Marker to Trace (K30).....4.247  
Marker to Trace (remote control) ...6.15, 6.56  
Marker to Trace (remote control, K30) ...6.302  
Marker Track (remote control) .....6.50, 6.55  
Marker Zoom.....4.42, 4.133  
Marker Zoom (remote control) .....6.73  
Marker Zoom Off.....4.43  
Marker Zoom Off (remote control) .....6.117  
Max Hold .....4.34, 4.118, 4.166  
Mean .....4.159  
Mean (remote control).....6.90, 6.92  
Meas Display.....4.271  
Meas Settings (K30).....4.239  
Meas Settings (remote control, K30).... 6.311,  
6.320, 6.329, 6.335  
Meas Start/Stop.....4.179  
Meas Start/Stop (remote control) .....6.127  
Meas Time (K7).....4.209  
Meas Time (remote control, K7). 6.262, 6.276  
Meas Time/Average (K9) .....4.224  
Meas Time/Average (remote control, K9)  
.....6.288, 6.289  
Meas to Ref (K9) .....4.225  
Meas to Ref (remote control, K9) .....6.282  
Measure.....4.64  
Mem1 On/Off (K30).....4.247  
Mem1 On/Off (remote control, K30).....6.306  
Mem2 On/Off (K30).....4.247  
Mem2 On/Off (remote control, K30).....6.306  
Mem3 On/Off (K30).....4.247  
Mem3 On/Off (remote control, K30).....6.306  
Min .....4.141  
Min (K30) .....4.248  
Min (marker to) .....4.46  
Min (remote control) .....6.14, 6.53  
Min (remote control, K30).....6.303  
Min Hold .....4.34, 4.118  
Min Peak.....4.55  
Min Peak (scan) .....4.35  
Mkr Demod On/Off .....4.131  
Mkr Demod On/Off (remote control).....6.61  
Mkr List On/Off (remote control).....6.63  
Mkr Stop Time .....4.132  
Mkr Stop Time (remote control) .....6.61  
MKR->Trace .....4.42  
Modulation AM/FM/PM (remote control, K7)  
.....6.237  
Modulation FM/PM/AM (K7) .....4.207  
Monitor Int/Ext .....4.274  
n dB down.....4.132  
n dB down (remote control) .. 6.67, 6.68, 6.69,  
6.70  
Name .....4.285  
Name (remote control) .....6.26  
Name (remote control, K30).....6.296  
Network Address .....4.269  
Network Drive .....4.285  
New .....4.74, 4.190, 4.266  
New (K30).....4.249  
New (remote control) ... 6.24, 6.27, 6.36, 6.37,  
6.38, 6.41, 6.42, 6.43, 6.44, 6.45  
New (remote control, K30) .....6.297  
New Folder .....4.284  
New Folder (remote control).....6.368  
New Search .....4.133  
Next Min .....4.46, 4.141  
Next Min (remote control).....6.14, 6.53, 6.54  
Next Min Mode .....4.46  
Next Min Mode < abs > .....4.142  
Next Peak .....4.45, 4.141  
Next Peak (remote control) .. 6.13, 6.14, 6.15,  
6.51, 6.52, 6.53, 6.54

- Next Peak Mode.....4.45  
Next Peak Mode < abs >.....4.141  
No. of Harmonics .....4.181  
Noise Meas On/Off .....4.130  
Noise Meas On/Off (remote control).....6.70, 6.71  
Noise Src On/Off.....4.267  
Noise Src On/Off (remote control) .....6.345  
Normalize .....4.201  
Normalize (remote control) .....6.143  
Number of Readings (K9) .....4.225  
Number of Readings (remote control, K9) .....6.289  
OBW .....4.168  
OBW (remote control).....6.79, 6.83  
Option expiry .....4.275  
Option Licenses .....4.274  
Other LAN Settings .....4.268  
Password .....4.278  
Password (remote control).....6.397  
Paste .....4.285  
Peak .....4.55, 4.140, 4.158  
Peak (K30) .....4.248  
Peak (marker to) .....4.45  
Peak (remote control) ...6.12, 6.51, 6.93, 6.95  
Peak (remote control, K30) .....6.303  
Peak (scan) .....4.35  
Peak Excursion .....4.47, 4.143  
Peak Excursion (remote control).....6.55  
Peak List Export .....4.64  
Peak List Off .....4.134  
Peak List On Off.....4.37  
Peak List On Off (remote control) .....6.117  
Peak Search.....4.62, 4.130  
Peak Search (remote control) .6.9, 6.63, 6.64, 6.65, 6.102  
Peaks per Range .....4.181  
Percent Marker.....4.169  
Percent Marker (remote control).....6.59  
Ph Noise On/Off (remote control) ....6.9, 6.11, 6.12  
Ph Noise/Ref Fixed (remote control) .6.9, 6.11  
Phase L1 (remote control) .....6.132, 6.162  
Phase L2 (remote control) .....6.132, 6.162  
Phase L3 (remote control) .....6.132, 6.162  
Phase N (remote control).....6.132, 6.162  
Phase Noise 1 2 3 4 .....4.131  
Phase Noise On/Off .....4.130  
Phase Noise/Ref Fixed .....4.130  
Phase Unit Rad/Deg (K7).....4.213  
Phase Unit Rad/Deg (remote control, K7) .....6.280  
Phase Wrap On/Off (K7).....4.213  
Phase Wrap On/Off (remote control, K7) .....6.238  
Polarity Pos / Neg.....4.27  
Power Meter .....4.195  
Power Mode .....4.166  
Power Mode (remote control).....6.79  
Power Offset.....4.201, 6.201  
Powermeter On/Off (K9).....4.223  
Powermeter On/Off (remote control, K9) .....6.287  
Preamp On/Off .....4.10, 4.93  
Predefined Colors.....4.272, 4.290  
Predefined Colors (remote control) .....6.350, 6.358  
Prev Zoom Range .....4.43  
Print Colors.....4.273  
Print Screen.....4.289  
Print Screen (remote control) ....6.355, 6.356, 6.360, 6.370  
QP RBW Uncoupled (remote control) ...6.139  
Quaispeak .....4.56  
Quasipeak (scan) .....4.35  
Range Lin. Unit.....4.93  
Range Lin. Unit (remote control) .....6.118  
Range Linear .....4.92  
Range Linear %.....4.93  
Range Linear % (remote control) .....6.118  
Range Linear (K7) .....4.217  
Range Log .....4.92  
Range Log (K7) .....4.217  
Range Log (remote control) .....6.118, 6.119  
Recall.....4.202, 4.283  
Recall (remote control) .....6.145  
Recall File.....4.282  
Recall File (remote control) .....6.368  
Receiver Frequency .....4.6  
Receiver Frequency (remote control)....6.163  
Ref Level .....4.92  
Ref Level (remote control).....6.109, 6.119  
Ref Level Adjust Man/Auto .....4.267  
Ref Level Adjust Man/Auto (remote control) .....6.382  
Ref Level Offset.....4.93  
Ref Level Offset (remote control) .....6.120  
Ref Level Position.....4.94  
Ref Level Position (remote control) .....6.120  
Ref Lvl =Mkr Lvl.....4.141  
Ref Lvl =Mkr Lvl (remote control) .....6.71  
Ref Point Frequency.....4.130  
Ref Point Frequency (remote control) ....6.10  
Ref Point Level .....4.130  
Ref Point Level (remote control).....6.10  
Ref Point Time (remote control) .....6.10  
Ref Value.....4.202  
Ref Value (remote control) .....6.121  
Ref Value Position .....4.202  
Ref Value Position (remote control) .....6.120  
Reference Fixed .....4.131  
Reference Fixed On/Off .....4.131  
Reference Int/Ext.....4.264  
Reference Int/Ext (remote control) .....6.385, 6.386  
Reference Position (K7) .....4.210  
Reference Position (remote control, K7) 6.247  
Reference Value (K7) .....4.210



Reference Value (K9).....	4.225
Reference Value (remote control, K7) ...	6.247
Reference Value (remote control, K9) ...	6.282
Rename.....	4.284
Rename (remote control).....	6.369
Repetition Intervall.....	4.111
Res BW .....	4.169
RES BW .....	4.15
Res BW (K7).....	4.219
Res BW (remote control, K7).....	6.268
Res BW 1 MHz (remote control).....	6.138
Res BW 120 kHz (remote control).....	6.138
Res BW 200 Hz (remote control).....	6.138
Res BW 9 kHz (remote control).....	6.138
Res BW Auto .....	4.99
Res BW Auto (remote control).....	6.139
Res BW Manual .....	4.99
Res BW Manual (remote control) .....	6.138
Reset Password .....	4.277
Restore Standard Files .....	4.179
Result Display (K7).....	4.208
RF Atten Auto.....	4.93
RF Atten Auto (remote control).....	6.129
RF Atten Manual .....	4.9, 4.93, 6.128
RF Spectrum (K7).....	4.208
RF Time Domain (K7).....	4.208
Right Limit .....	4.46, 4.142, 4.159
Right Limit (remote control).....	6.57
RMS .....	4.56, 4.159
RMS (remote control).....	6.96, 6.97
RMS (scan).....	4.35
Run Final Meas .....	4.63, 6.126
Save .....	4.281
Save (remote control).....	6.378
Save Evaluation List.....	4.178
Save Evaluation List (remote control) ...	6.377
Save Factor .....	4.266
Save File .....	4.282
Save File (remote control).....	6.377, 6.378
Save Limit Line.....	4.76, 4.191
Scaling .....	4.169
Scan Control .....	4.21
Scan Count .....	4.37
Scan Count (remote control).....	6.195
Scan detector .....	4.35
Scan Detector (remote control).....	6.147
Schematic (K30).....	4.243
Screen Colors (remote control).....	6.349, 6.357
Screen Title .....	4.271
Screen Title (remote control) .....	6.352
Search Lim Off .....	4.142
Search Lim Off (remote control) ...	6.56, 6.111
Search Limit Off .....	4.47
Search Limits .....	4.46, 4.142
Search Limits (remote control).....	6.56
Search Signals .....	4.158
Select 1 2 3 4 .....	4.140
Select 1 2 3 4 (remote control).....	6.48, 6.58
Select Color Set .....	4.272, 4.273
Select Directory .....	4.267
Select Directory (remote control).....	6.383
Select File.....	4.282
Select Items.....	4.282, 4.283
Select Items (remote control)....	6.373, 6.374, 6.375
Select Marker .....	4.45
Select Object .....	4.272, 4.290
Select Path .....	4.282
Select Print Color Set .....	4.290
Select Print Color Set (remote control)..	6.357
Select Trace .....	4.34, 4.88, 4.166
Select Trace (K7) .....	4.208
Select Trace (remote control).....	6.86, 6.190
Select Traces to check .....	4.74, 4.189
Select Traces to check (remote control)	6.26, 6.27
Self Align .....	4.268
Self Align (remote control).....	6.341
Selftest.....	4.277
Selftest (remote control).....	6.340
Selftest Results.....	4.277
Selftest Results (remote control).....	6.346
Service.....	4.276
Service Function .....	4.278
Service Function (remote control) .....	6.345
Set Standard.....	4.179
Set Standard (remote control).....	6.151
Set to Default.....	4.273, 4.290
Set to Default (remote control) ..	6.348, 6.349, 6.357
Settings Coupled .....	4.47
Shift X Limit Line (remote control).....	6.38
Shift Y Limit Line (remote control) ..	6.41, 6.45
Show Align Results.....	4.268
Show Align Results (remote control) ...	6.341, 6.342
Show Peaks.....	4.178
Show Peaks (remote control).....	6.20
Shutdown Off/Standby.....	4.275
Sig Count On/Off .....	4.131
Sig Count On/Off (remote control)..	6.48, 6.49
Signal Track .....	4.87
Signal Track (remote control).....	6.85
Single Bargraph.....	4.65
Single Meas (remote control) ....	6.124, 6.125
Single Sweep.....	4.103
Single Sweep (remote control) ...	6.124, 6.125
Size.....	4.285
Skip Frequency.....	4.64
Soft Frontpanel .....	4.274
Soft Frontpanel (remote control) .....	6.395
Sort Mode .....	4.285
Sort Mode Freq/Lvl .....	4.134
Sort Mode Freq/Lvl (remote control) .....	6.64
Source Cal.....	4.201
Source On/Off .....	4.200
Source On/Off (remote control).....	6.133
Source Power .....	4.200, 6.201

- Span Manual .....4.90  
Span Manual (K7) .....4.216  
Span Manual (remote control).....6.166  
Span Manual (remote control, K7) .....6.270  
Spectrum Emission Mask .....4.171  
Spurious Emissions.....4.180  
Squelch .....4.57  
Squelch On Off (remote control).....6.146  
Start.....4.85, 4.90  
Start (remote control) .....6.167  
Start Frequency.....4.7  
Start Frequency (remote control) .....6.167  
Startup Recall.....4.283  
Startup Recall (remote control) .....6.368  
Startup Recall Setup .....4.284  
Std Dev .....4.159  
Std Dev (remote control).....6.98, 6.99  
Stepsize.....4.7  
Stepsize = FREQ .....4.7  
Stepsize Manual.....4.7  
Stepsize Standard .....4.134  
Stepsize Standard (remote control) .....6.58  
Stepsize Sweep Points.....4.135  
Stepsize Sweep Points (remote control) ..6.58  
Stop .....4.86, 4.90  
Stop (remote control) .....6.167  
Stop Frequency.....4.8  
Stop Frequency (remote control) .....6.167  
Stop Scan.....4.67  
Subnet Mask .....4.269  
Sweep Count.....4.103, 4.120  
Sweep Count (remote control) .....6.195  
Sweep List.....4.171  
Sweep List (remote control) .....6.152, 6.153,  
6.154, 6.155, 6.156, 6.157, 6.158, 6.159,  
6.174, 6.175, 6.176, 6.177  
Sweep Points .....4.104  
Sweep Points (remote control).....6.199  
Sweep Single/Cont (K30).....4.245  
Sweep Single/Cont (remote control, K30)  
.....6.305  
Sweep Time .....4.112, 4.166  
Sweep Time (remote control).....6.200  
Sweeptime Auto .....4.100, 4.103  
Sweeptime Auto (remote control) .....6.200  
Sweeptime Manual.....4.100, 4.103  
Sweeptime Manual (remote control) .....6.200  
System Info .....4.275  
System Messages.....4.276  
System Messages (remote control) .....6.395,  
6.396  
Threshold .....4.47, 4.142  
Threshold (remote control).....6.111  
Time Domain Power .....4.158  
Time Domain Power (remote control).....6.89  
Time Line 1 .....4.192  
Time Line 1 (remote control).....6.112  
Time Line 2 .....4.192  
Time Line 2 (remote control).....6.112  
Time+Date.....4.271  
Time+Date (remote control) .....6.394, 6.398  
Time+Date On/Off .....4.271  
Time+Date On/Off (remote control) .....6.353  
TOI.....4.158  
TOI (remote control).....6.72  
Trace 1 2 3 4 5 6 .....4.118  
Trace 1 2 3 4 5 6 (remote control).....6.115  
Trace Math .....4.121  
Trace Math (remote control).....6.100, 6.101  
Trace Math Position.....4.121  
Trace Mode .....4.34, 4.118  
Trace Mode (remote control) 6.89, 6.90, 6.91,  
6.93, 6.94, 6.96, 6.97, 6.98, 6.99, 6.115,  
6.119  
Track BW .....4.88  
Track BW (remote control).....6.85  
Track On/Off.....4.88  
Track On/Off (remote control) .....6.85  
Track Threshold .....4.88  
Track Threshold (remote control).....6.86  
Tracking Generator .....4.195  
Transducer .....4.265  
Trg / Gate Level.....4.27, 4.110  
Trg / Gate Level (remote control) .....6.231  
Trg / Gate Polarity Pos/Neg.....4.110  
Trg / Gate Polarity Pos/Neg (remote control)  
.....6.197, 6.232  
Trg / Gate Source.....4.110  
Trg / Gate Source (remote control) .....6.198,  
6.231, 6.232  
Trg/Gate Source.....4.26  
Trigger Offset .....4.110  
Trigger Offset (K7).....4.221  
Trigger Offset (remote control).....6.230  
Trigger Source (K7).....4.220  
Trigger Source (remote control, K7).....6.279  
Tune To Marker.....4.45  
Unit .....4.11, 4.94  
Unit (remote control).....6.113, 6.234  
Unit/Scale (K9) .....4.224  
Unit/Scale (remote control, K9) ..6.283, 6.292  
Update Path (remote control).....6.396  
Use Ref Lev Offset (K9) .....4.225  
Use Ref Lev Offset (remote control, K9)6.290  
User Def'd Colors .....4.290  
User Defined Colors .....4.273  
User Defined Colors (remote control)....6.357  
Value .....4.75, 4.190  
Value (remote control).....6.36, 6.39, 6.43  
Versions+Options .....4.276  
Versions+Options (remote control) .....6.338  
Video BW Auto .....4.100  
Video BW Auto (remote control) .....6.141  
Video BW Manual.....4.99  
Video BW Manual (remote control) .....6.140  
View.....4.34, 4.118  
Volume .....4.57, 4.132  
Volume (remote control).....6.214

- X \* RBW .....4.87
- X \* RBW (remote control) .....6.164, 6.165
- X \* Span .....4.87
- X \* Span (remote control) .....6.164, 6.165
- x Offset (remote control) .....6.37
- x\*Demod BW (K7).....4.215
- x–Axis Range .....4.169
- x–Axis Range (remote control) .....6.109
- x–Axis Ref Level .....4.169
- x–Axis Ref Level (remote control).....6.109
- y Offset (remote control) .....6.40, 6.44
- y–Axis Max Value .....4.170
- y–Axis Max Value (remote control) .....6.110
- y–Axis Min Value.....4.170
- y–Unit %/Abs.....4.170
- y–Unit %/Abs (remote control) .....6.110
- Zero (K9).....4.224
- Zero (remote control, K9).....6.284
- Zero Phase Reference Point (K7).....4.212
- Zero Phase Reference Point (remote control, K7).....6.265
- Zero Span .....4.90
- Zero Span (remote control).....6.166
- Zoom (K7) .....4.213
- Zoom (remote control, K7) .....6.270, 6.271
- SPAN key.....4.89
- span menu
  - base unit.....4.89
  - K7 option .....4.216
- special characters .....6.3
- Spectrum Analyzer mode .....4.78, 4.194
- Snell activation.....4.57
- Snell level.....4.57
- SRE (service request enable register).....5.17
- SRQ (service request) .....5.17, 5.24
- start frequency .....4.85
- status bar
  - K30 option .....4.231
- status byte (STB) .....5.16
- STATus OPERation register.....5.19
- STATus QUEStionable register .....5.19
  - ACPLimit register .....5.20
  - FREQuency register .....5.21
  - LIMit register .....5.21
  - LMARgin register .....5.22
  - POWer register .....5.23
  - SYNC .....5.23
- status register
  - CONDition part.....5.14
  - ENABle part .....5.15
  - ESE .....5.18
  - ESR .....5.18
  - EVENt part .....5.15
  - NTRansition part .....5.14
  - overview .....5.16
  - PPE .....5.18
  - PTRansition part .....5.14
  - SRE .....5.17
  - STATus OPERation .....5.19
  - STATus QUEStionable .....5.19
  - STATus QUEStionable ACPLimit.....5.20
  - STATus QUEStionable FREQuency .....5.21
  - STATus QUEStionable LIMit.....5.21
  - STATus QUEStionable LMARgin .....5.22
  - STATus QUEStionable POWer.....5.23
  - STATus QUEStionable SYNC.....5.23
  - STB.....5.16
  - structure.....5.14
  - sum bit .....5.15
  - status reporting system .....5.13
  - resetting values .....5.26
  - STB (status byte) .....5.16
  - step size
    - center frequency.....4.86
  - Stepped Scan Table
    - Meas Time (remote control) .....6.194
    - number of ranges (remote control).....6.193
    - Start Frequency (remote control) .....6.193
    - Step Mode (remote control).....6.199
    - Step Size (remote control).....6.194
    - Stop Frequency (remote control).....6.193
  - Stepped Scan Table dialog box .....4.21
    - Auto Preamplifier (remote control).....6.192
    - Auto Ranging (remote control) .....6.192
    - Preamplifier (remote control) .....6.192
    - Res BW (remote control).....6.191
    - RF Attn (remote control).....6.191
  - stop frequency.....4.86
  - storing .....8.1
  - string .....5.9
  - Subrange maxima list .....4.62
  - suffix.....5.7
  - sum bit.....5.15
  - supply voltage, external noise source .....4.267
  - sweep
    - continue single sweep .....4.103
    - continuous .....4.103
    - count.....4.103, 4.120
    - Free Run.....4.108
    - gated.....4.105, 4.111
    - single .....4.103
    - time.....4.103
  - SWEEP key .....4.18, 4.102
  - sweep menu.....4.18
    - base unit.....4.102
    - K30 option .....4.245
    - K7 option .....4.219
  - sweep time
    - coupling .....4.100
  - syntax elements of commands .....5.10
  - System Messages dialog box .....4.276

**T**

  - test
    - self test .....4.277
  - Test Automation dialog box .....4.58
    - Final Meas Settings .....4.59
    - LISN Settings.....4.61

- Test receiver .....4.2
- text parameter.....5.9
- threshold .....4.47
- line.....4.142
- signal tracking .....4.88
- time .....4.271
- line.....4.192
- title
- diagram .....4.271
- trace .....4.118
- Clear Write .....4.114
- copy.....4.37
- power measurement .....4.166
- signal tracking .....4.88
- Trace.....4.28, 4.34
- select.....4.28
- TRACE key .....4.28, 4.113
- trace menu
- base unit.....4.117
- K30 option .....4.246
- trace mode.....4.118
- Average.....4.115, 4.118
- Blank .....4.34, 4.115, 4.119
- Clear Write .....4.34, 4.114, 4.118
- Max Hold .....4.34, 4.114, 4.118
- Min Hold .....4.34, 4.114, 4.118
- View.....4.34, 4.115, 4.118
- tracking generator.....4.197
- menu .....4.197, 4.200
- transducer .....4.265
- activating .....4.265
- transmission measurement .....4.198
- TRIG key.....4.26, 4.105
- trigger
- external .....4.108
- external gate .....4.111
- gated sweep.....4.111
- level .....4.27, 4.110
- offset.....4.110
- slope .....4.27, 4.110
- trigger menu
- base unit.....4.109
- K7 option .....4.220
- trigger mode .....4.26, 4.110
- External .....4.26, 4.108
- Free Run.....4.26, 4.108
- IF power.....4.108
- Video .....4.27, 4.108
- trigger source .....4.26
- U**
- unit .....4.224
- universal command.....5.33
- upper-case (commands) .....5.6, 6.2
- V**
- Versions/Options dialog box .....4.276
- video bandwidth .....4.99
- video triggering.....4.108
- View trace mode .....4.115
- VXI interface messages .....5.28
- VXI protocol.....5.27
- W**
- Weighting modes .....4.49
- white space .....5.10
- Z**
- zero span .....4.90
- zeroing (K9).....4.222
- zoom .....4.133
- amplitude .....4.115