

R&S®CMW270

Wireless Connectivity Tester

User Manual



1173.9470.02 – 11

This user manual applies to the following R&S®CMW models:

- R&S®CMW270 1201.0002K75 (with display, selection R&S®CMW-S600D)
- R&S®CMW270 1201.0002K75 (without display, selection R&S®CMW-S600C)

The manual describes the base software, common features of the firmware applications and basic principles for manual operation and remote control. The firmware applications are described in separate documents.

© 2014 Rohde & Schwarz GmbH & Co. KG
Mühlhofstr. 15, 81671 München, Germany
Phone: +49 89 41 29 - 0
Fax: +49 89 41 29 12 164
E-mail: info@rohde-schwarz.com

Internet: www.rohde-schwarz.com

Subject to change – Data without tolerance limits is not binding.

R&S® is a registered trademark of Rohde & Schwarz GmbH & Co. KG.

Trade names are trademarks of the owners.

The following abbreviations are used throughout this manual: R&S®CMW270 is abbreviated as R&S CMW270.

Contents

1	Preface	9
1.1	What's New in this Revision	9
1.2	Documentation Map	9
1.2.1	Help System.....	9
1.2.2	Quick Start Guide.....	9
1.2.3	Documentation CD-ROM.....	10
1.2.4	Documentation Update via Internet.....	10
1.3	Note about Faceless Instruments	10
2	Getting Started	11
2.1	Putting the Instrument into Operation	11
2.1.1	Unpacking and Checking the Instrument.....	11
2.1.2	Positioning the Instrument.....	12
2.1.3	Starting the Instrument.....	15
2.1.4	EMI Suppression.....	16
2.1.5	Optional Cabling.....	16
2.2	Instrument Tour	17
2.2.1	Front Panel Tour.....	17
2.2.2	Rear Panel Tour.....	24
2.2.3	Connecting External Devices.....	26
2.3	Trying Out the Instrument	28
2.3.1	Generating an RF Signal.....	28
2.3.2	Measuring an RF Signal.....	30
2.3.3	Performing Signaling Measurements.....	32
2.4	Operating the Instrument	33
2.4.1	Accessing Applications and Dialogs.....	34
2.4.2	Entering Data via Front Panel Keys.....	35
2.4.3	Entering Data via an External Keyboard.....	37
2.4.4	Using the Soft-Front Panel and Keyboard Shortcuts.....	38
2.5	Administrative Tasks	39
2.5.1	Windows XP.....	40
2.5.2	Software Update.....	40

2.5.3	Remote Operation in a LAN.....	46
2.6	Maintenance.....	49
2.6.1	Cleaning.....	49
2.6.2	Storing and Packing.....	50
2.6.3	Replacing Fuses.....	50
3	System Overview.....	51
3.1	Generators.....	51
3.1.1	Generator Control.....	51
3.1.2	RF Path Settings (Generators).....	52
3.1.3	Real-Time and Arbitrary (ARB) Generators.....	53
3.2	Measurements.....	54
3.2.1	Measurement Control.....	54
3.2.2	Connection Control (Measurements).....	54
3.2.3	Statistical Settings.....	56
3.2.4	Statistical Results.....	57
3.2.5	Limit Check.....	61
3.2.6	Measurement Triggers.....	62
3.2.7	TX Measurements.....	64
3.2.8	RX Measurements.....	73
3.2.9	Markers.....	74
3.3	Signaling Applications.....	74
3.3.1	RF Path Settings.....	75
3.3.2	Control of the Cell State.....	75
3.3.3	Connection States.....	76
3.4	Sub-Instruments.....	77
3.4.1	One Sub-Instrument.....	77
3.4.2	Two Sub-Instruments.....	78
4	Basic Instrument Functions.....	80
4.1	Startup Dialog.....	80
4.2	Reset Dialog.....	81
4.3	Save/Recall Dialog.....	83
4.4	Setup Dialog.....	85
4.4.1	System Settings.....	86

4.4.2	Remote Settings.....	88
4.4.3	Option Activation and Deactivation.....	91
4.4.4	SW/HW Equipment.....	95
4.4.5	Selftests.....	96
4.4.6	Sync Settings.....	102
4.4.7	Trigger.....	104
4.4.8	Logging.....	105
4.4.9	IP Subnet Configuration.....	106
4.4.10	Digital IQ.....	109
4.4.11	Frequency-Dependent Correction Tables.....	110
4.4.12	Fan Control.....	113
4.5	Print Dialog.....	114
4.6	Info Dialog.....	115
4.6.1	Current State View.....	115
4.6.2	Problem Reporting.....	117
4.7	Instrument Setup Dialog.....	119
4.8	Measurement Controller Dialog.....	120
4.9	Generator/Signaling Controller Dialog.....	120
4.10	Blockview Dialog.....	121
4.10.1	Show Active Routing.....	122
4.10.2	Show Selectable Routing.....	122
4.11	System Messages.....	124
5	Remote Control.....	126
5.1	Remote Control Operation.....	126
5.1.1	Drivers for Graphical Programming Interfaces.....	128
5.1.2	Establishing and Testing a LAN Connection.....	128
5.1.3	Switching between Manual and Remote Control.....	129
5.1.4	Monitoring the Remote Control Interface.....	131
5.1.5	Multiple Channels for Remote Access.....	132
5.2	Messages.....	133
5.2.1	HiSLIP and VXI-11 Interface Messages.....	133
5.2.2	GPIB Bus Interface Messages.....	133
5.2.3	Device Messages (Commands and Device Responses).....	133

5.2.4	SCPI Command Structure and Syntax.....	134
5.3	R&S CMW Command Structure.....	141
5.3.1	General Command Structure.....	142
5.3.2	Firmware Applications.....	142
5.3.3	Measurement Contexts and Views.....	143
5.4	Control of the Instrument.....	144
5.4.1	Generator Control.....	144
5.4.2	Measurement Control.....	146
5.4.3	Signaling Generator Control.....	155
5.4.4	Reliability and Error Indicators.....	157
5.4.5	Signal Path Settings.....	161
5.4.6	Resource and Path Management.....	168
5.5	Command Processing.....	173
5.5.1	Input Unit.....	174
5.5.2	Command Recognition.....	174
5.5.3	Data Base and Instrument Hardware.....	175
5.5.4	Status Reporting System.....	175
5.5.5	Output Unit.....	176
5.6	Status Reporting System.....	176
5.6.1	Overview of Status Registers.....	177
5.6.2	Structure of an SCPI Status Register.....	177
5.6.3	Contents of the Status Registers.....	179
5.6.4	Application of the Status Reporting System.....	186
5.6.5	Reset Values of the Status Reporting System.....	189
5.6.6	Regular Expressions.....	190
5.7	Command Macros.....	191
5.7.1	Macro Contents and Macro Commands.....	191
5.7.2	Macro Programming Examples.....	192
5.8	Response Buffers.....	194
5.8.1	Buffer Contents and Buffer Commands.....	194
5.8.2	Buffer Programming Example.....	195
5.9	LXI Configuration.....	196
5.9.1	LXI Classes and LXI Functionality.....	196

5.9.2	LXI Browser Interface.....	197
5.9.3	LAN Configuration.....	198
5.9.4	SCPI Remote Trace.....	201
5.10	Monitoring the Instrument via SNMP.....	203
6	Command Reference - Base Software.....	204
6.1	Common Commands.....	204
6.2	Emulation Codes.....	206
6.3	Instrument-Control Commands.....	207
6.3.1	Macro Commands.....	207
6.3.2	Buffer Commands.....	211
6.3.3	High Resolution Timer.....	214
6.3.4	Error Queue.....	215
6.3.5	Reset and Preset.....	217
6.3.6	Tracing the Remote Control Interface.....	219
6.3.7	Mass Memory Commands.....	223
6.3.8	Hardcopy Commands.....	237
6.3.9	Frequency-Dependent Correction.....	239
6.3.10	Setup Commands.....	248
6.3.11	Sub-Instruments.....	268
6.3.12	Calibration Commands.....	269
6.3.13	Status Reporting System.....	271
6.3.14	System Date and Time.....	294
6.3.15	Miscellaneous Commands.....	297
6.4	List of Commands.....	301
7	Annexes.....	308
7.1	Interfaces and Connectors.....	308
7.1.1	Rear Panel Connectors.....	308
7.1.2	LAN Interface.....	311
7.1.3	GPIB Bus Interface.....	313
7.2	Windows XP Recovery and Backup.....	316
7.2.1	Accessing the Recovery and Backup Dialog.....	317
7.2.2	Recovering the Factory Default Settings.....	317
7.2.3	Handling User-Defined Images.....	318

Index.....319

Basic Safety Instructions

Always read through and comply with the following safety instructions!

All plants and locations of the Rohde & Schwarz group of companies make every effort to keep the safety standards of our products up to date and to offer our customers the highest possible degree of safety. Our products and the auxiliary equipment they require are designed, built and tested in accordance with the safety standards that apply in each case. Compliance with these standards is continuously monitored by our quality assurance system. The product described here has been designed, built and tested in accordance with the EC Certificate of Conformity and has left the manufacturer's plant in a condition fully complying with safety standards. To maintain this condition and to ensure safe operation, you must observe all instructions and warnings provided in this manual. If you have any questions regarding these safety instructions, the Rohde & Schwarz group of companies will be happy to answer them.



Furthermore, it is your responsibility to use the product in an appropriate manner. This product is designed for use solely in industrial and laboratory environments or, if expressly permitted, also in the field and must not be used in any way that may cause personal injury or property damage. You are responsible if the product is used for any purpose other than its designated purpose or in disregard of the manufacturer's instructions. The manufacturer shall assume no responsibility for such use of the product.

The product is used for its designated purpose if it is used in accordance with its product documentation and within its performance limits (see data sheet, documentation, the following safety instructions). Using the product requires technical skills and, in some cases, a basic knowledge of English. It is therefore essential that only skilled and specialized staff or thoroughly trained personnel with the required skills be allowed to use the product. If personal safety gear is required for using Rohde & Schwarz products, this will be indicated at the appropriate place in the product documentation. Keep the basic safety instructions and the product documentation in a safe place and pass them on to the subsequent users.











Observing the safety instructions will help prevent personal injury or damage of any kind caused by dangerous situations. Therefore, carefully read through and adhere to the following safety instructions before and when using the product. It is also absolutely essential to observe the additional safety instructions on personal safety, for example, that appear in relevant parts of the product documentation. In these safety instructions, the word "product" refers to all merchandise sold and distributed by the Rohde & Schwarz group of companies, including instruments, systems and all accessories. For product-specific information, see the data sheet and the product documentation.

Safety labels on products

The following safety labels are used on products to warn against risks and dangers.

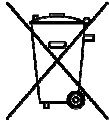
Symbol	Meaning	Symbol	Meaning
	Notice, general danger location Observe product documentation	○	ON/OFF supply voltage
	Caution when handling heavy equipment	⏻	Standby indication
	Danger of electric shock	— — —	Direct current (DC)

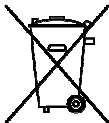
Basic Safety Instructions

Symbol	Meaning	Symbol	Meaning
	Warning! Hot surface		Alternating current (AC)
	Protective conductor terminal		Direct/alternating current (DC/AC)
	Ground		Device fully protected by double (reinforced) insulation
	Ground terminal		EU labeling for batteries and accumulators For additional information, see section "Waste disposal/Environmental protection", item 1.
	Be careful when handling electrostatic sensitive devices		EU labeling for separate collection of electrical and electronic devices For additional information, see section "Waste disposal/Environmental protection", item 2.
	Warning! Laser radiation For additional information, see section "Operation", item 7.		

Signal words and their meaning

The following signal words are used in the product documentation in order to warn the reader about risks and dangers.



Indicates a hazardous situation which, if not avoided, will result in death or serious injury.



Indicates a hazardous situation which, if not avoided, could result in death or serious injury.



Indicates a hazardous situation which, if not avoided, could result in minor or moderate injury.



Indicates information considered important, but not hazard-related, e.g. messages relating to property damage.
In the product documentation, the word ATTENTION is used synonymously.

These signal words are in accordance with the standard definition for civil applications in the European Economic Area. Definitions that deviate from the standard definition may also exist in other economic areas or military applications. It is therefore essential to make sure that the signal words described here are always used only in connection with the related product documentation and the related product. The use of signal words in connection with unrelated products or documentation can result in misinterpretation and in personal injury or material damage.

Basic Safety Instructions

Operating states and operating positions

The product may be operated only under the operating conditions and in the positions specified by the manufacturer, without the product's ventilation being obstructed. If the manufacturer's specifications are not observed, this can result in electric shock, fire and/or serious personal injury or death. Applicable local or national safety regulations and rules for the prevention of accidents must be observed in all work performed.

1. Unless otherwise specified, the following requirements apply to Rohde & Schwarz products: predefined operating position is always with the housing floor facing down, IP protection 2X, use only indoors, max. operating altitude 2000 m above sea level, max. transport altitude 4500 m above sea level. A tolerance of $\pm 10\%$ shall apply to the nominal voltage and $\pm 5\%$ to the nominal frequency, overvoltage category 2, pollution severity 2.
2. Do not place the product on surfaces, vehicles, cabinets or tables that for reasons of weight or stability are unsuitable for this purpose. Always follow the manufacturer's installation instructions when installing the product and fastening it to objects or structures (e.g. walls and shelves). An installation that is not carried out as described in the product documentation could result in personal injury or even death.
3. Do not place the product on heat-generating devices such as radiators or fan heaters. The ambient temperature must not exceed the maximum temperature specified in the product documentation or in the data sheet. Product overheating can cause electric shock, fire and/or serious personal injury or even death.

Electrical safety

If the information on electrical safety is not observed either at all or to the extent necessary, electric shock, fire and/or serious personal injury or death may occur.

1. Prior to switching on the product, always ensure that the nominal voltage setting on the product matches the nominal voltage of the AC supply network. If a different voltage is to be set, the power fuse of the product may have to be changed accordingly.
2. In the case of products of safety class I with movable power cord and connector, operation is permitted only on sockets with a protective conductor contact and protective conductor.
3. Intentionally breaking the protective conductor either in the feed line or in the product itself is not permitted. Doing so can result in the danger of an electric shock from the product. If extension cords or connector strips are implemented, they must be checked on a regular basis to ensure that they are safe to use.
4. If there is no power switch for disconnecting the product from the AC supply network, or if the power switch is not suitable for this purpose, use the plug of the connecting cable to disconnect the product from the AC supply network. In such cases, always ensure that the power plug is easily reachable and accessible at all times. For example, if the power plug is the disconnecting device, the length of the connecting cable must not exceed 3 m. Functional or electronic switches are not suitable for providing disconnection from the AC supply network. If products without power switches are integrated into racks or systems, the disconnecting device must be provided at the system level.
5. Never use the product if the power cable is damaged. Check the power cables on a regular basis to ensure that they are in proper operating condition. By taking appropriate safety measures and carefully laying the power cable, ensure that the cable cannot be damaged and that no one can be hurt by, for example, tripping over the cable or suffering an electric shock.

Basic Safety Instructions

6. The product may be operated only from TN/TT supply networks fuse-protected with max. 16 A (higher fuse only after consulting with the Rohde & Schwarz group of companies).
7. Do not insert the plug into sockets that are dusty or dirty. Insert the plug firmly and all the way into the socket provided for this purpose. Otherwise, sparks that result in fire and/or injuries may occur.
8. Do not overload any sockets, extension cords or connector strips; doing so can cause fire or electric shocks.
9. For measurements in circuits with voltages $V_{rms} > 30$ V, suitable measures (e.g. appropriate measuring equipment, fuse protection, current limiting, electrical separation, insulation) should be taken to avoid any hazards.
10. Ensure that the connections with information technology equipment, e.g. PCs or other industrial computers, comply with the IEC60950-1/EN60950-1 or IEC61010-1/EN 61010-1 standards that apply in each case.
11. Unless expressly permitted, never remove the cover or any part of the housing while the product is in operation. Doing so will expose circuits and components and can lead to injuries, fire or damage to the product.
12. If a product is to be permanently installed, the connection between the protective conductor terminal on site and the product's protective conductor must be made first before any other connection is made. The product may be installed and connected only by a licensed electrician.
13. For permanently installed equipment without built-in fuses, circuit breakers or similar protective devices, the supply circuit must be fuse-protected in such a way that anyone who has access to the product, as well as the product itself, is adequately protected from injury or damage.
14. Use suitable overvoltage protection to ensure that no overvoltage (such as that caused by a bolt of lightning) can reach the product. Otherwise, the person operating the product will be exposed to the danger of an electric shock.
15. Any object that is not designed to be placed in the openings of the housing must not be used for this purpose. Doing so can cause short circuits inside the product and/or electric shocks, fire or injuries.
16. Unless specified otherwise, products are not liquid-proof (see also section "Operating states and operating positions", item 1). Therefore, the equipment must be protected against penetration by liquids. If the necessary precautions are not taken, the user may suffer electric shock or the product itself may be damaged, which can also lead to personal injury.
17. Never use the product under conditions in which condensation has formed or can form in or on the product, e.g. if the product has been moved from a cold to a warm environment. Penetration by water increases the risk of electric shock.
18. Prior to cleaning the product, disconnect it completely from the power supply (e.g. AC supply network or battery). Use a soft, non-linting cloth to clean the product. Never use chemical cleaning agents such as alcohol, acetone or diluents for cellulose lacquers.

Operation

1. Operating the products requires special training and intense concentration. Make sure that persons who use the products are physically, mentally and emotionally fit enough to do so; otherwise, injuries or material damage may occur. It is the responsibility of the employer/operator to select suitable personnel for operating the products.

Basic Safety Instructions

2. Before you move or transport the product, read and observe the section titled "Transport".
3. As with all industrially manufactured goods, the use of substances that induce an allergic reaction (allergens) such as nickel cannot be generally excluded. If you develop an allergic reaction (such as a skin rash, frequent sneezing, red eyes or respiratory difficulties) when using a Rohde & Schwarz product, consult a physician immediately to determine the cause and to prevent health problems or stress.
4. Before you start processing the product mechanically and/or thermally, or before you take it apart, be sure to read and pay special attention to the section titled "Waste disposal/Environmental protection", item 1.
5. Depending on the function, certain products such as RF radio equipment can produce an elevated level of electromagnetic radiation. Considering that unborn babies require increased protection, pregnant women must be protected by appropriate measures. Persons with pacemakers may also be exposed to risks from electromagnetic radiation. The employer/operator must evaluate workplaces where there is a special risk of exposure to radiation and, if necessary, take measures to avert the potential danger.
6. Should a fire occur, the product may release hazardous substances (gases, fluids, etc.) that can cause health problems. Therefore, suitable measures must be taken, e.g. protective masks and protective clothing must be worn.
7. Laser products are given warning labels that are standardized according to their laser class. Lasers can cause biological harm due to the properties of their radiation and due to their extremely concentrated electromagnetic power. If a laser product (e.g. a CD/DVD drive) is integrated into a Rohde & Schwarz product, absolutely no other settings or functions may be used as described in the product documentation. The objective is to prevent personal injury (e.g. due to laser beams).
8. EMC classes (in line with EN 55011/CISPR 11, and analogously with EN 55022/CISPR 22, EN 55032/CISPR 32)
 - Class A equipment:
Equipment suitable for use in all environments except residential environments and environments that are directly connected to a low-voltage supply network that supplies residential buildings
Note: Class A equipment is intended for use in an industrial environment. This equipment may cause radio disturbances in residential environments, due to possible conducted as well as radiated disturbances. In this case, the operator may be required to take appropriate measures to eliminate these disturbances.
 - Class B equipment:
Equipment suitable for use in residential environments and environments that are directly connected to a low-voltage supply network that supplies residential buildings

Repair and service

1. The product may be opened only by authorized, specially trained personnel. Before any work is performed on the product or before the product is opened, it must be disconnected from the AC supply network. Otherwise, personnel will be exposed to the risk of an electric shock.

Basic Safety Instructions

- Adjustments, replacement of parts, maintenance and repair may be performed only by electrical experts authorized by Rohde & Schwarz. Only original parts may be used for replacing parts relevant to safety (e.g. power switches, power transformers, fuses). A safety test must always be performed after parts relevant to safety have been replaced (visual inspection, protective conductor test, insulation resistance measurement, leakage current measurement, functional test). This helps ensure the continued safety of the product.

Batteries and rechargeable batteries/cells

If the information regarding batteries and rechargeable batteries/cells is not observed either at all or to the extent necessary, product users may be exposed to the risk of explosions, fire and/or serious personal injury, and, in some cases, death. Batteries and rechargeable batteries with alkaline electrolytes (e.g. lithium cells) must be handled in accordance with the EN 62133 standard.

- Cells must not be taken apart or crushed.
- Cells or batteries must not be exposed to heat or fire. Storage in direct sunlight must be avoided. Keep cells and batteries clean and dry. Clean soiled connectors using a dry, clean cloth.
- Cells or batteries must not be short-circuited. Cells or batteries must not be stored in a box or in a drawer where they can short-circuit each other, or where they can be short-circuited by other conductive materials. Cells and batteries must not be removed from their original packaging until they are ready to be used.
- Cells and batteries must not be exposed to any mechanical shocks that are stronger than permitted.
- If a cell develops a leak, the fluid must not be allowed to come into contact with the skin or eyes. If contact occurs, wash the affected area with plenty of water and seek medical aid.
- Improperly replacing or charging cells or batteries that contain alkaline electrolytes (e.g. lithium cells) can cause explosions. Replace cells or batteries only with the matching Rohde & Schwarz type (see parts list) in order to ensure the safety of the product.
- Cells and batteries must be recycled and kept separate from residual waste. Rechargeable batteries and normal batteries that contain lead, mercury or cadmium are hazardous waste. Observe the national regulations regarding waste disposal and recycling.

Transport

- The product may be very heavy. Therefore, the product must be handled with care. In some cases, the user may require a suitable means of lifting or moving the product (e.g. with a lift-truck) to avoid back or other physical injuries.
- Handles on the products are designed exclusively to enable personnel to transport the product. It is therefore not permissible to use handles to fasten the product to or on transport equipment such as cranes, fork lifts, wagons, etc. The user is responsible for securely fastening the products to or on the means of transport or lifting. Observe the safety regulations of the manufacturer of the means of transport or lifting. Noncompliance can result in personal injury or material damage.
- If you use the product in a vehicle, it is the sole responsibility of the driver to drive the vehicle safely and properly. The manufacturer assumes no responsibility for accidents or collisions. Never use the product in a moving vehicle if doing so could distract the driver of the vehicle. Adequately secure the product in the vehicle to prevent injuries or other damage in the event of an accident.

Instrucciones de seguridad elementales

Waste disposal/Environmental protection

1. Specially marked equipment has a battery or accumulator that must not be disposed of with unsorted municipal waste, but must be collected separately. It may only be disposed of at a suitable collection point or via a Rohde & Schwarz customer service center.
2. Waste electrical and electronic equipment must not be disposed of with unsorted municipal waste, but must be collected separately.
Rohde & Schwarz GmbH & Co. KG has developed a disposal concept and takes full responsibility for take-back obligations and disposal obligations for manufacturers within the EU. Contact your Rohde & Schwarz customer service center for environmentally responsible disposal of the product.
3. If products or their components are mechanically and/or thermally processed in a manner that goes beyond their intended use, hazardous substances (heavy-metal dust such as lead, beryllium, nickel) may be released. For this reason, the product may only be disassembled by specially trained personnel. Improper disassembly may be hazardous to your health. National waste disposal regulations must be observed.
4. If handling the product releases hazardous substances or fuels that must be disposed of in a special way, e.g. coolants or engine oils that must be replenished regularly, the safety instructions of the manufacturer of the hazardous substances or fuels and the applicable regional waste disposal regulations must be observed. Also observe the relevant safety instructions in the product documentation. The improper disposal of hazardous substances or fuels can cause health problems and lead to environmental damage.

For additional information about environmental protection, visit the Rohde & Schwarz website.

Instrucciones de seguridad elementales

¡Es imprescindible leer y cumplir las siguientes instrucciones e informaciones de seguridad!

El principio del grupo de empresas Rohde & Schwarz consiste en tener nuestros productos siempre al día con los estándares de seguridad y de ofrecer a nuestros clientes el máximo grado de seguridad. Nuestros productos y todos los equipos adicionales son siempre fabricados y examinados según las normas de seguridad vigentes. Nuestro sistema de garantía de calidad controla constantemente que sean cumplidas estas normas. El presente producto ha sido fabricado y examinado según el certificado de conformidad de la UE y ha salido de nuestra planta en estado impecable según los estándares técnicos de seguridad. Para poder preservar este estado y garantizar un funcionamiento libre de peligros, el usuario deberá atenerse a todas las indicaciones, informaciones de seguridad y notas de alerta. El grupo de empresas Rohde & Schwarz está siempre a su disposición en caso de que tengan preguntas referentes a estas informaciones de seguridad.

Además queda en la responsabilidad del usuario utilizar el producto en la forma debida. Este producto está destinado exclusivamente al uso en la industria y el laboratorio o, si ha sido expresamente autorizado, para aplicaciones de campo y de ninguna manera deberá ser utilizado de modo que alguna persona/cosa pueda sufrir daño. El uso del producto fuera de sus fines definidos o sin tener en cuenta las instrucciones del fabricante queda en la responsabilidad del usuario. El fabricante no se hace en ninguna forma responsable de consecuencias a causa del mal uso del producto.















Instrucciones de seguridad elementales

Se parte del uso correcto del producto para los fines definidos si el producto es utilizado conforme a las indicaciones de la correspondiente documentación del producto y dentro del margen de rendimiento definido (ver hoja de datos, documentación, informaciones de seguridad que siguen). El uso del producto hace necesarios conocimientos técnicos y ciertos conocimientos del idioma inglés. Por eso se debe tener en cuenta que el producto solo pueda ser operado por personal especializado o personas instruidas en profundidad con las capacidades correspondientes. Si fuera necesaria indumentaria de seguridad para el uso de productos de Rohde & Schwarz, encontraría la información debida en la documentación del producto en el capítulo correspondiente. Guarde bien las informaciones de seguridad elementales, así como la documentación del producto, y entréguelas a usuarios posteriores.



Tener en cuenta las informaciones de seguridad sirve para evitar en lo posible lesiones o daños por peligros de toda clase. Por eso es imprescindible leer detalladamente y comprender por completo las siguientes informaciones de seguridad antes de usar el producto, y respetarlas durante el uso del producto. Deberán tenerse en cuenta todas las demás informaciones de seguridad, como p. ej. las referentes a la protección de personas, que encontrarán en el capítulo correspondiente de la documentación del producto y que también son de obligado cumplimiento. En las presentes informaciones de seguridad se recogen todos los objetos que distribuye el grupo de empresas Rohde & Schwarz bajo la denominación de "producto", entre ellos también aparatos, instalaciones así como toda clase de accesorios. Los datos específicos del producto figuran en la hoja de datos y en la documentación del producto.

Señalización de seguridad de los productos

Las siguientes señales de seguridad se utilizan en los productos para advertir sobre riesgos y peligros.

Símbolo	Significado	Símbolo	Significado
	Aviso: punto de peligro general Observar la documentación del producto		Tensión de alimentación de PUESTA EN MARCHA / PARADA
	Atención en el manejo de dispositivos de peso elevado		Indicación de estado de espera (standby)
	Peligro de choque eléctrico		Corriente continua (DC)
	Advertencia: superficie caliente		Corriente alterna (AC)
	Conexión a conductor de protección		Corriente continua / Corriente alterna (DC/AC)
	Conexión a tierra		El aparato está protegido en su totalidad por un aislamiento doble (reforzado)
	Conexión a masa		Distintivo de la UE para baterías y acumuladores Más información en la sección "Eliminación/protección del medio ambiente", punto 1.

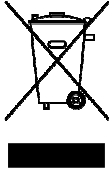
Instrucciones de seguridad elementales

Símbolo	Significado	Símbolo	Significado
	Aviso: Cuidado en el manejo de dispositivos sensibles a la electrostática (ESD)		Distintivo de la UE para la eliminación por separado de dispositivos eléctricos y electrónicos Más información en la sección "Eliminación/protección del medio ambiente", punto 2.
	Advertencia: rayo láser Más información en la sección "Funcionamiento", punto 7.		

Palabras de señal y su significado

En la documentación del producto se utilizan las siguientes palabras de señal con el fin de advertir contra riesgos y peligros.



Indica una situación de peligro que, si no se evita, causa lesiones graves o incluso la muerte.



Indica una situación de peligro que, si no se evita, puede causar lesiones graves o incluso la muerte.



Indica una situación de peligro que, si no se evita, puede causar lesiones leves o moderadas.



Indica información que se considera importante, pero no en relación con situaciones de peligro; p. ej., avisos sobre posibles daños materiales.

En la documentación del producto se emplea de forma sinónima el término CUIDADO.

Las palabras de señal corresponden a la definición habitual para aplicaciones civiles en el área económica europea. Pueden existir definiciones diferentes a esta definición en otras áreas económicas o en aplicaciones militares. Por eso se deberá tener en cuenta que las palabras de señal aquí descritas sean utilizadas siempre solamente en combinación con la correspondiente documentación del producto y solamente en combinación con el producto correspondiente. La utilización de las palabras de señal en combinación con productos o documentaciones que no les correspondan puede llevar a interpretaciones equivocadas y tener por consecuencia daños en personas u objetos.

Estados operativos y posiciones de funcionamiento

El producto solamente debe ser utilizado según lo indicado por el fabricante respecto a los estados operativos y posiciones de funcionamiento sin que se obstruya la ventilación. Si no se siguen las indicaciones del fabricante, pueden producirse choques eléctricos, incendios y/o lesiones graves con posible consecuencia de muerte. En todos los trabajos deberán ser tenidas en cuenta las normas nacionales y locales de seguridad del trabajo y de prevención de accidentes.

Instrucciones de seguridad elementales

1. Si no se convino de otra manera, es para los productos Rohde & Schwarz válido lo que sigue: como posición de funcionamiento se define por principio la posición con el suelo de la caja para abajo, modo de protección IP 2X, uso solamente en estancias interiores, utilización hasta 2000 m sobre el nivel del mar, transporte hasta 4500 m sobre el nivel del mar. Se aplicará una tolerancia de $\pm 10\%$ sobre el voltaje nominal y de $\pm 5\%$ sobre la frecuencia nominal. Categoría de sobrecarga eléctrica 2, índice de suciedad 2.
2. No sitúe el producto encima de superficies, vehículos, estantes o mesas, que por sus características de peso o de estabilidad no sean aptos para él. Siga siempre las instrucciones de instalación del fabricante cuando instale y asegure el producto en objetos o estructuras (p. ej. paredes y estantes). Si se realiza la instalación de modo distinto al indicado en la documentación del producto, se pueden causar lesiones o, en determinadas circunstancias, incluso la muerte.
3. No ponga el producto sobre aparatos que generen calor (p. ej. radiadores o calefactores). La temperatura ambiente no debe superar la temperatura máxima especificada en la documentación del producto o en la hoja de datos. En caso de sobrecalentamiento del producto, pueden producirse choques eléctricos, incendios y/o lesiones graves con posible consecuencia de muerte.

Seguridad eléctrica

Si no se siguen (o se siguen de modo insuficiente) las indicaciones del fabricante en cuanto a seguridad eléctrica, pueden producirse choques eléctricos, incendios y/o lesiones graves con posible consecuencia de muerte.

1. Antes de la puesta en marcha del producto se deberá comprobar siempre que la tensión preseleccionada en el producto coincida con la de la red de alimentación eléctrica. Si es necesario modificar el ajuste de tensión, también se deberán cambiar en caso dado los fusibles correspondientes del producto.
2. Los productos de la clase de protección I con alimentación móvil y enchufe individual solamente podrán enchufarse a tomas de corriente con contacto de seguridad y con conductor de protección conectado.
3. Queda prohibida la interrupción intencionada del conductor de protección, tanto en la toma de corriente como en el mismo producto. La interrupción puede tener como consecuencia el riesgo de que el producto sea fuente de choques eléctricos. Si se utilizan cables alargadores o regletas de enchufe, deberá garantizarse la realización de un examen regular de los mismos en cuanto a su estado técnico de seguridad.
4. Si el producto no está equipado con un interruptor para desconectarlo de la red, o bien si el interruptor existente no resulta apropiado para la desconexión de la red, el enchufe del cable de conexión se deberá considerar como un dispositivo de desconexión. El dispositivo de desconexión se debe poder alcanzar fácilmente y debe estar siempre bien accesible. Si, p. ej., el enchufe de conexión a la red es el dispositivo de desconexión, la longitud del cable de conexión no debe superar 3 m). Los interruptores selectores o electrónicos no son aptos para el corte de la red eléctrica. Si se integran productos sin interruptor en bastidores o instalaciones, se deberá colocar el interruptor en el nivel de la instalación.
5. No utilice nunca el producto si está dañado el cable de conexión a red. Compruebe regularmente el correcto estado de los cables de conexión a red. Asegúrese, mediante las medidas de protección y de instalación adecuadas, de que el cable de conexión a red no pueda ser dañado o de que nadie pueda ser dañado por él, p. ej. al tropezar o por un choque eléctrico.

Instrucciones de seguridad elementales

6. Solamente está permitido el funcionamiento en redes de alimentación TN/TT aseguradas con fusibles de 16 A como máximo (utilización de fusibles de mayor amperaje solo previa consulta con el grupo de empresas Rohde & Schwarz).
7. Nunca conecte el enchufe en tomas de corriente sucias o llenas de polvo. Introduzca el enchufe por completo y fuertemente en la toma de corriente. La no observación de estas medidas puede provocar chispas, fuego y/o lesiones.
8. No sobrecargue las tomas de corriente, los cables alargadores o las regletas de enchufe ya que esto podría causar fuego o choques eléctricos.
9. En las mediciones en circuitos de corriente con una tensión $U_{\text{eff}} > 30 \text{ V}$ se deberán tomar las medidas apropiadas para impedir cualquier peligro (p. ej. medios de medición adecuados, seguros, limitación de tensión, corte protector, aislamiento etc.).
10. Para la conexión con dispositivos informáticos como un PC o un ordenador industrial, debe comprobarse que éstos cumplan los estándares IEC60950-1/EN60950-1 o IEC61010-1/EN 61010-1 válidos en cada caso.
11. A menos que esté permitido expresamente, no retire nunca la tapa ni componentes de la carcasa mientras el producto esté en servicio. Esto pone a descubierto los cables y componentes eléctricos y puede causar lesiones, fuego o daños en el producto.
12. Si un producto se instala en un lugar fijo, se deberá primero conectar el conductor de protección fijo con el conductor de protección del producto antes de hacer cualquier otra conexión. La instalación y la conexión deberán ser efectuadas por un electricista especializado.
13. En el caso de dispositivos fijos que no estén provistos de fusibles, interruptor automático ni otros mecanismos de seguridad similares, el circuito de alimentación debe estar protegido de modo que todas las personas que puedan acceder al producto, así como el producto mismo, estén a salvo de posibles daños.
14. Todo producto debe estar protegido contra sobretensión (debida p. ej. a una caída del rayo) mediante los correspondientes sistemas de protección. Si no, el personal que lo utilice quedará expuesto al peligro de choque eléctrico.
15. No debe introducirse en los orificios de la caja del aparato ningún objeto que no esté destinado a ello. Esto puede producir cortocircuitos en el producto y/o puede causar choques eléctricos, fuego o lesiones.
16. Salvo indicación contraria, los productos no están impermeabilizados (ver también el capítulo "Estados operativos y posiciones de funcionamiento", punto 1). Por eso es necesario tomar las medidas necesarias para evitar la entrada de líquidos. En caso contrario, existe peligro de choque eléctrico para el usuario o de daños en el producto, que también pueden redundar en peligro para las personas.
17. No utilice el producto en condiciones en las que pueda producirse o ya se hayan producido condensaciones sobre el producto o en el interior de éste, como p. ej. al desplazarlo de un lugar frío a otro caliente. La entrada de agua aumenta el riesgo de choque eléctrico.
18. Antes de la limpieza, desconecte por completo el producto de la alimentación de tensión (p. ej. red de alimentación o batería). Realice la limpieza de los aparatos con un paño suave, que no se deshilache. No utilice bajo ningún concepto productos de limpieza químicos como alcohol, acetona o diluyentes para lacas nitrocelulósicas.

Instrucciones de seguridad elementales

Funcionamiento

1. El uso del producto requiere instrucciones especiales y una alta concentración durante el manejo. Debe asegurarse que las personas que manejen el producto estén a la altura de los requerimientos necesarios en cuanto a aptitudes físicas, psíquicas y emocionales, ya que de otra manera no se pueden excluir lesiones o daños de objetos. El empresario u operador es responsable de seleccionar el personal usuario apto para el manejo del producto.
2. Antes de desplazar o transportar el producto, lea y tenga en cuenta el capítulo "Transporte".
3. Como con todo producto de fabricación industrial no puede quedar excluida en general la posibilidad de que se produzcan alergias provocadas por algunos materiales empleados —los llamados alérgenos (p. ej. el níquel)—. Si durante el manejo de productos Rohde & Schwarz se producen reacciones alérgicas, como p. ej. irritaciones cutáneas, estornudos continuos, enrojecimiento de la conjuntiva o dificultades respiratorias, debe avisarse inmediatamente a un médico para investigar las causas y evitar cualquier molestia o daño a la salud.
4. Antes de la manipulación mecánica y/o térmica o el desmontaje del producto, debe tenerse en cuenta imprescindiblemente el capítulo "Eliminación/protección del medio ambiente", punto 1.
5. Ciertos productos, como p. ej. las instalaciones de radiocomunicación RF, pueden a causa de su función natural, emitir una radiación electromagnética aumentada. Deben tomarse todas las medidas necesarias para la protección de las mujeres embarazadas. También las personas con marcapasos pueden correr peligro a causa de la radiación electromagnética. El empresario/operador tiene la obligación de evaluar y señalizar las áreas de trabajo en las que exista un riesgo elevado de exposición a radiaciones.
6. Tenga en cuenta que en caso de incendio pueden desprenderse del producto sustancias tóxicas (gases, líquidos etc.) que pueden generar daños a la salud. Por eso, en caso de incendio deben usarse medidas adecuadas, como p. ej. máscaras antigás e indumentaria de protección.
7. Los productos con láser están provistos de indicaciones de advertencia normalizadas en función de la clase de láser del que se trate. Los rayos láser pueden provocar daños de tipo biológico a causa de las propiedades de su radiación y debido a su concentración extrema de potencia electromagnética. En caso de que un producto Rohde & Schwarz contenga un producto láser (p. ej. un lector de CD/DVD), no debe usarse ninguna otra configuración o función aparte de las descritas en la documentación del producto, a fin de evitar lesiones (p. ej. debidas a irradiación láser).
8. Clases de compatibilidad electromagnética (conforme a EN 55011 / CISPR 11; y en analogía con EN 55022 / CISPR 22, EN 55032 / CISPR 32)
 - Aparato de clase A:
Aparato adecuado para su uso en todos los entornos excepto en los residenciales y en aquellos conectados directamente a una red de distribución de baja tensión que suministra corriente a edificios residenciales.
Nota: Los aparatos de clase A están destinados al uso en entornos industriales. Estos aparatos pueden causar perturbaciones radioeléctricas en entornos residenciales debido a posibles perturbaciones guiadas o radiadas. En este caso, se le podrá solicitar al operador que tome las medidas adecuadas para eliminar estas perturbaciones.
 - Aparato de clase B:
Aparato adecuado para su uso en entornos residenciales, así como en aquellos conectados directamente a una red de distribución de baja tensión que suministra corriente a edificios residenciales.

Instrucciones de seguridad elementales

Reparación y mantenimiento

1. El producto solamente debe ser abierto por personal especializado con autorización para ello. Antes de manipular el producto o abrirlo, es obligatorio desconectarlo de la tensión de alimentación, para evitar toda posibilidad de choque eléctrico.
2. El ajuste, el cambio de partes, el mantenimiento y la reparación deberán ser efectuadas solamente por electricistas autorizados por Rohde & Schwarz. Si se reponen partes con importancia para los aspectos de seguridad (p. ej. el enchufe, los transformadores o los fusibles), solamente podrán ser sustituidos por partes originales. Después de cada cambio de partes relevantes para la seguridad deberá realizarse un control de seguridad (control a primera vista, control del conductor de protección, medición de resistencia de aislamiento, medición de la corriente de fuga, control de funcionamiento). Con esto queda garantizada la seguridad del producto.

Baterías y acumuladores o celdas

Si no se siguen (o se siguen de modo insuficiente) las indicaciones en cuanto a las baterías y acumuladores o celdas, pueden producirse explosiones, incendios y/o lesiones graves con posible consecuencia de muerte. El manejo de baterías y acumuladores con electrolitos alcalinos (p. ej. celdas de litio) debe seguir el estándar EN 62133.

1. No deben desmontarse, abrirse ni triturarse las celdas.
2. Las celdas o baterías no deben someterse a calor ni fuego. Debe evitarse el almacenamiento a la luz directa del sol. Las celdas y baterías deben mantenerse limpias y secas. Limpiar las conexiones sucias con un paño seco y limpio.
3. Las celdas o baterías no deben cortocircuitarse. Es peligroso almacenar las celdas o baterías en estuches o cajones en cuyo interior puedan cortocircuitarse por contacto recíproco o por contacto con otros materiales conductores. No deben extraerse las celdas o baterías de sus embalajes originales hasta el momento en que vayan a utilizarse.
4. Las celdas o baterías no deben someterse a impactos mecánicos fuertes indebidos.
5. En caso de falta de estanqueidad de una celda, el líquido vertido no debe entrar en contacto con la piel ni los ojos. Si se produce contacto, lavar con agua abundante la zona afectada y avisar a un médico.
6. En caso de cambio o recarga inadecuados, las celdas o baterías que contienen electrolitos alcalinos (p. ej. las celdas de litio) pueden explotar. Para garantizar la seguridad del producto, las celdas o baterías solo deben ser sustituidas por el tipo Rohde & Schwarz correspondiente (ver lista de recambios).
7. Las baterías y celdas deben reciclarse y no deben tirarse a la basura doméstica. Las baterías o acumuladores que contienen plomo, mercurio o cadmio deben tratarse como residuos especiales. Respete en esta relación las normas nacionales de eliminación y reciclaje.

Transporte

1. El producto puede tener un peso elevado. Por eso es necesario desplazarlo o transportarlo con precaución y, si es necesario, usando un sistema de elevación adecuado (p. ej. una carretilla elevadora), a fin de evitar lesiones en la espalda u otros daños personales.

Instrucciones de seguridad elementales

2. Las asas instaladas en los productos sirven solamente de ayuda para el transporte del producto por personas. Por eso no está permitido utilizar las asas para la sujeción en o sobre medios de transporte como p. ej. grúas, carretillas elevadoras de horquilla, carros etc. Es responsabilidad suya fijar los productos de manera segura a los medios de transporte o elevación. Para evitar daños personales o daños en el producto, siga las instrucciones de seguridad del fabricante del medio de transporte o elevación utilizado.
3. Si se utiliza el producto dentro de un vehículo, recae de manera exclusiva en el conductor la responsabilidad de conducir el vehículo de manera segura y adecuada. El fabricante no asumirá ninguna responsabilidad por accidentes o colisiones. No utilice nunca el producto dentro de un vehículo en movimiento si esto pudiera distraer al conductor. Asegure el producto dentro del vehículo debidamente para evitar, en caso de un accidente, lesiones u otra clase de daños.

Eliminación/protección del medio ambiente

1. Los dispositivos marcados contienen una batería o un acumulador que no se debe desechar con los residuos domésticos sin clasificar, sino que debe ser recogido por separado. La eliminación se debe efectuar exclusivamente a través de un punto de recogida apropiado o del servicio de atención al cliente de Rohde & Schwarz.
2. Los dispositivos eléctricos usados no se deben desechar con los residuos domésticos sin clasificar, sino que deben ser recogidos por separado. Rohde & Schwarz GmbH & Co.KG ha elaborado un concepto de eliminación de residuos y asume plenamente los deberes de recogida y eliminación para los fabricantes dentro de la UE. Para desechar el producto de manera respetuosa con el medio ambiente, dirijase a su servicio de atención al cliente de Rohde & Schwarz.
3. Si se trabaja de manera mecánica y/o térmica cualquier producto o componente más allá del funcionamiento previsto, pueden liberarse sustancias peligrosas (povos con contenido de metales pesados como p. ej. plomo, berilio o níquel). Por eso el producto solo debe ser desmontado por personal especializado con formación adecuada. Un desmontaje inadecuado puede ocasionar daños para la salud. Se deben tener en cuenta las directivas nacionales referentes a la eliminación de residuos.
4. En caso de que durante el trato del producto se formen sustancias peligrosas o combustibles que deban tratarse como residuos especiales (p. ej. refrigerantes o aceites de motor con intervalos de cambio definidos), deben tenerse en cuenta las indicaciones de seguridad del fabricante de dichas sustancias y las normas regionales de eliminación de residuos. Tenga en cuenta también en caso necesario las indicaciones de seguridad especiales contenidas en la documentación del producto. La eliminación incorrecta de sustancias peligrosas o combustibles puede causar daños a la salud o daños al medio ambiente.

Se puede encontrar más información sobre la protección del medio ambiente en la página web de Rohde & Schwarz.

Quality management and environmental management

Certified Quality System
ISO 9001

Certified Environmental System
ISO 14001

Sehr geehrter Kunde,

Sie haben sich für den Kauf eines Rohde&Schwarz Produktes entschieden. Sie erhalten damit ein nach modernsten Fertigungsmethoden hergestelltes Produkt. Es wurde nach den Regeln unserer Qualitäts- und Umweltmanagementsysteme entwickelt, gefertigt und geprüft. Rohde&Schwarz ist unter anderem nach den Managementsystemen ISO9001 und ISO 14001 zertifiziert.

Der Umwelt verpflichtet

- Energie-effiziente, RoHS-konforme Produkte
- Kontinuierliche Weiterentwicklung nachhaltiger Umweltkonzepte
- ISO 14001-zertifiziertes Umweltmanagementsystem

Dear customer,

You have decided to buy a Rohde&Schwarz product. This product has been manufactured using the most advanced methods. It was developed, manufactured and tested in compliance with our quality management and environmental management systems. Rohde&Schwarz has been certified, for example, according to the ISO9001 and ISO 14001 management systems.

Environmental commitment

- Energy-efficient products
- Continuous improvement in environmental sustainability
- ISO 14001-certified environmental management system

Cher client,

Vous avez choisi d'acheter un produit Rohde&Schwarz. Vous disposez donc d'un produit fabriqué d'après les méthodes les plus avancées. Le développement, la fabrication et les tests de ce produit ont été effectués selon nos systèmes de management de qualité et de management environnemental. La société Rohde&Schwarz a été homologuée, entre autres, conformément aux systèmes de management ISO9001 et ISO 14001.

Engagement écologique

- Produits à efficience énergétique
- Amélioration continue de la durabilité environnementale
- Système de management environnemental certifié selon ISO 14001



Customer Support

Technical support – where and when you need it

For quick, expert help with any Rohde & Schwarz equipment, contact one of our Customer Support Centers. A team of highly qualified engineers provides telephone support and will work with you to find a solution to your query on any aspect of the operation, programming or applications of Rohde & Schwarz equipment.

Up-to-date information and upgrades

To keep your instrument up-to-date and to be informed about new application notes related to your instrument, please send an e-mail to the Customer Support Center stating your instrument and your wish. We will take care that you will get the right information.

Europe, Africa, Middle East

Phone +49 89 4129 12345
customersupport@rohde-schwarz.com

North America

Phone 1-888-TEST-RSA (1-888-837-8772)
customer.support@rsa.rohde-schwarz.com

Latin America

Phone +1-410-910-7988
customersupport.la@rohde-schwarz.com

Asia/Pacific

Phone +65 65 13 04 88
customersupport.asia@rohde-schwarz.com

China

Phone +86-800-810-8228 /
+86-400-650-5896
customersupport.china@rohde-schwarz.com



1 Preface

This chapter provides an overview of new features and an overview of the R&S CMW270 operating documentation.

1.1 What's New in this Revision

This revision describes version 3.2.60 and higher of the R&S CMW270 base software. Compared to version 3.2.50 it provides the new features listed below. For extensions of a firmware application please refer to the "What's New" in the description of the firmware application.

- Configuration dialogs for frequency-dependent attenuation correction tables, see [Frequency-Dependent Correction Tables](#)
- New reliability indicator value 60, see [Reliability Indicator](#)
- SNMP agent, see [Monitoring the Instrument via SNMP](#)



Software Version

To check your R&S CMW270 software version, open the "Setup" dialog and click "HW/SW Equipment". The initial software version for each remote control command is quoted in the reference description.

1.2 Documentation Map

The R&S CMW270 documentation is delivered as help system, printed Quick Start Guide and on CD-ROM.

1.2.1 Help System

The help system is embedded in the instrument, offering quick, context-sensitive reference to the information needed for operation and programming.

You can use the help also if you control the instrument from an external monitor. Furthermore you can transfer the help to your PC and use it as a standalone help.

1.2.2 Quick Start Guide

The Quick Start Guide describes everything that is needed to put the instrument into operation and helps you to get familiar with the R&S CMW270. It gives an introduction to the instrument's functionality and provides procedures for typical measurement tasks. The Quick Start Guide is delivered with each R&S CMW270.

1.2.3 Documentation CD-ROM

The CD-ROM provides the complete user documentation for the R&S CMW270:

- the online help system
- the Quick Start Guide in printable form
- the User Manuals in printable form
- the Service Manual in printable form
- links to different useful sites in the R&S internet

1.2.4 Documentation Update via Internet

You can find general information about Rohde & Schwarz and our products on the R&S Internet: <http://www.rohde-schwarz.com>.

Furthermore, Rohde & Schwarz provides registered users a "CMW Customer Web" section on GLORIS, the Global Rohde & Schwarz Information System: <https://extra-net.rohde-schwarz.com>. From this resource you can download software updates, waveform library updates and documentation updates, e.g. updates of this document.

You do not need to update the help system manually. When you perform a software update, the corresponding part of the help system is updated automatically.

1.3 Note about Faceless Instruments

The measurement functionality of an R&S CMW270 with and without display is identical. This manual applies to both instrument types.

An R&S CMW270 without display is controlled via a connected monitor, mouse and/or keyboard or via a "Remote Desktop" connection. In both cases a soft-front panel is displayed in addition to the GUI. It emulates the front panel control elements of an instrument with display.

Thus descriptions involving front panel keys are applicable to instruments with display (operation via front panel or soft-front panel) as well as to instruments without display (operation via soft-front panel).

For specific information concerning faceless instruments, refer to your Quick Start Guide.

2 Getting Started

This chapter describes the first steps required to put the instrument into operation and to get familiar with the control elements, connectors and the basic principles of manual operation. Several sample sessions help you to get familiar with the instrument. Administrative tasks like software update are described and hints for maintenance are given.

The sections of this chapter are also contained in the Quick Start Guides. There are variants for instruments with and without display. This chapter provides the variant for instruments with display, see also [chapter 1.3, "Note about Faceless Instruments"](#), on page 10.

The remaining chapters of this manual describe the base software, common features of the firmware applications and basic principles for remote control.

The individual firmware applications are described in separate User Manuals. Please refer to these User Manuals for all application-specific reference information. Alternatively refer to the online help system. It describes both the base software and the installed firmware applications.

2.1 Putting the Instrument into Operation

This chapter describes the basic steps to be taken when setting up the R&S CMW270 for the first time.

WARNING

Risk of injury and instrument damage

The instrument must be used in an appropriate manner to prevent electric shock, fire, personal injury, or damage.

- Do not open the instrument casing.
 - Read and observe the "Basic Safety Instructions" at the beginning of this manual or on the documentation CD-ROM, in addition to the safety instructions in the following sections. Notice that the data sheet may specify additional operating conditions.
-

2.1.1 Unpacking and Checking the Instrument

To remove the instrument from its packaging and check the equipment for completeness, proceed as follows:

1. Pull off the polyethylene protection pads from the instrument's rear feet and then carefully remove the pads from the instrument handles at the front.
2. Pull off the corrugated cardboard cover that protects the rear of the instrument.

3. Carefully unthread the corrugated cardboard cover at the front that protects the instrument handles and remove it.
4. Check the equipment for completeness using the delivery note and the accessory lists for the various items.
5. Check the instrument for any damage. If there is damage, immediately contact the carrier who delivered the instrument. Make sure not to discard the box and packing material.



Packing material

Retain the original packing material. If the instrument needs to be transported or shipped at a later date, you can use the material to protect the control elements and connectors.

2.1.2 Positioning the Instrument

The R&S CMW270 is designed for use under laboratory conditions. It can be used in standalone operation on a bench top or can be installed in a rack.

The general ambient conditions required at the operating site are as follows:

- The temperature must be in the ranges specified for operation and for compliance with specifications (see data sheet).
- All fan openings including the rear panel perforations must be unobstructed. The distance between the walls and the left and right side and the rear panel of the instrument should be at least 10 cm. When placing several instruments side by side, keep a minimum distance of 20 cm and ensure that the instrument(s) on the left do not draw in the preheated air from their neighbors on the right.

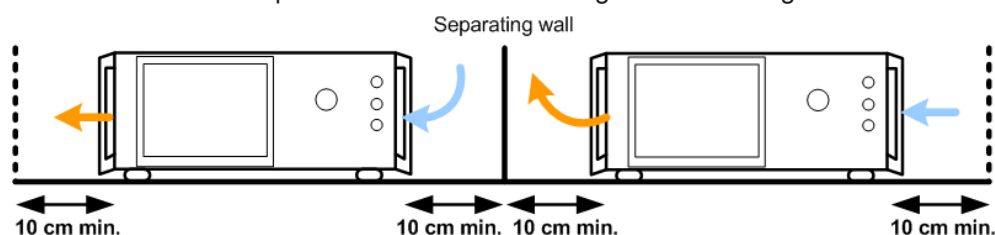

- Operation in a standard 19" instrument rack according to the instructions of the manufacturer avoids overheating; see [chapter 2.1.2.2, "Rackmounting"](#), on page 14.

2.1.2.1 Standalone Operation

For standalone operation, place the instrument on a horizontal bench with even, flat surface. The instrument can be used in horizontal or vertical position, standing on its feet, or with the support feet on the bottom expanded.

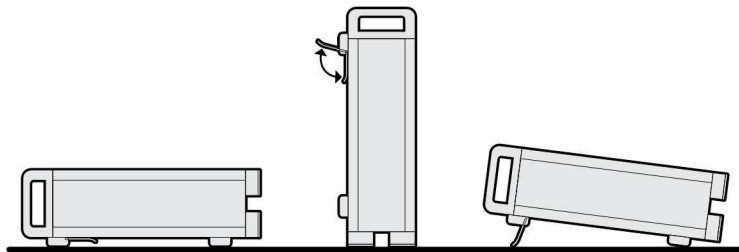
**⚠ CAUTION****Risk of injury if feet are folded out**

The feet may fold in if they are not folded out completely or if the instrument is shifted. This may cause damage or injury.

- Fold the feet completely in or completely out to ensure stability of the instrument. Never shift the instrument when the feet are folded out.
- When the feet are folded out, do not work under the instrument or place anything underneath.
- The feet can break if they are overloaded. The overall load on the folded-out feet must not exceed 500 N.

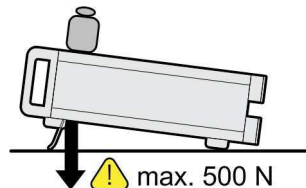

CAUTION**Risk of injury and instrument damage if stacking instruments**

A stack of instruments may tilt over and cause injury. Furthermore, the instruments at the bottom of the stack may be damaged due to the load imposed by the instruments on top.

Observe the following instructions when stacking instruments:

- Never stack more than three instruments. If you need to stack more than three instruments, install them in a rack.
- The overall load imposed on the lowest instrument must not exceed 500 N.
- All instruments must have the same dimensions (width and length).
- If the instruments have foldable feet, fold them in completely.

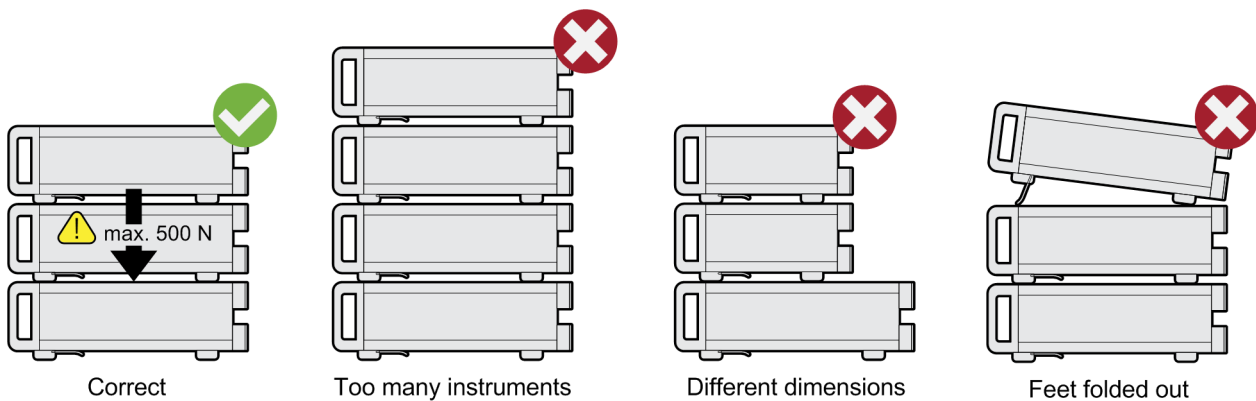
**2.1.2.2 Rackmounting**

The instrument can be mounted in 19" racks using an R&S ZZA-411 adapter (order number 1096.3283.00). Please note the mounting instructions supplied with the rack adapter.

NOTICE**Risk of instrument damage in a rack**

An insufficient airflow can cause the R&S CMW270 to overheat, which may impair the measurement results, disturb the operation, and even cause damage.

For operation in a rack, note the conditions described in [chapter 2.1.2, "Positioning the Instrument"](#), on page 12.

2.1.3 Starting the Instrument

NOTICE

Risk of instrument damage during operation

An unsuitable operating site or test setup can cause damage to the instrument and to connected devices. Ensure the following operating conditions before you switch on the instrument:

- Instrument casing is closed.
- The instrument is dry and shows no sign of condensation.
- The instrument is positioned as described in the preceding sections.
- The ambient temperature does not exceed the range specified in the data sheet.
- Signal levels at the input connectors are all within the specified ranges.
- Signal outputs are correctly connected and are not overloaded.

2.1.3.1 Powering On

The R&S CMW270 is automatically adapted to the AC supply voltage. The nominal voltage and frequency ranges are displayed on the rear panel and quoted in the data sheet.

The AC power connector and the main power switch are located in the upper left corner of the rear panel.

1. Connect the instrument to the AC power supply using the AC power cable delivered with the instrument.
2. Switch the main power switch at the rear of the instrument to position I.

The AC power switch can be permanently on. Switching off is required only if the instrument must be completely removed from the AC power supply.

The R&S CMW270 is protected by two fuses located in the fuse holder to the right of the AC power switch; see [chapter 2.6.3, "Replacing Fuses"](#), on page 50.

2.1.3.2 Starting Up and Shutting Down

The standby key is located in the bottom left corner of the front panel.



To start up the instrument

1. Make sure that the instrument is connected to the AC power supply and the power switch on the rear panel is in position I (On).
2. If the right, amber LED is on, press the standby key on the front panel to switch the instrument to ready state (indicated by the left, green LED).

The tester automatically performs a system check, boots the Windows operating system and starts the CMW application. If the previous session was terminated regularly, the CMW application uses the last setup with the relevant instrument settings.

Once the startup procedure has been terminated, the dialog opened in the previous session is displayed.

To shut down the instrument

- ▶ Press the standby key.

The instrument saves the current setup, closes the CMW application, shuts down the operating system and sets the instrument to standby state. Of course you can also perform this procedure step by step like in any Windows session.

NOTICE

Risk of losing data

If you switch off the running instrument using the rear panel switch or by disconnecting the power cord, the instrument loses its current settings. Furthermore, program data may be lost.

Always press the standby key first to shut down the application properly.

2.1.4 EMI Suppression

Electromagnetic interference (EMI) may affect the measurement results.

To suppress electromagnetic radiation,

- Use suitable shielded cables of high quality. For example use double-shielded RF cables and double-shielded CAT6 or CAT7 LAN cables.
- Always terminate open cable ends.
- Ensure that external USB devices comply with EMC regulations.
- Note the EMC classification in the data sheet.

2.1.5 Optional Cabling

Option R&S CMW-B661A, "Ethernet Switch H661A", is delivered with a separate ethernet cable (patch cable).

This patch cable must be connected if the selftest "Unit Test > IP Access Test External" shall be executed on an R&S CMW270 with a Signaling Unit Wideband (SUW). For other applications the patch cable is only required if no Data Application Unit (DAU) is installed.

Plug the cable into connector 1 of the LAN SWITCH and into the LAN REMOTE connector as shown in the following figure.

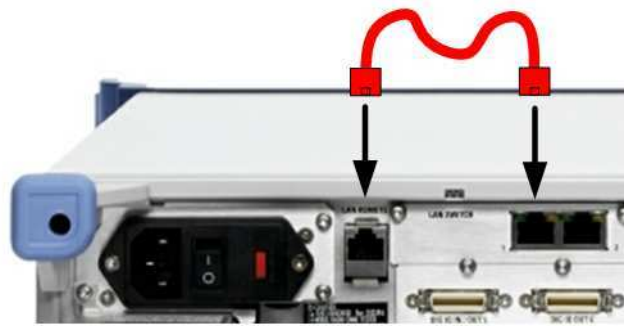

Fig. 2-1: Ethernet connection between LAN SWITCH and LAN REMOTE connectors

The patch cable is only functional if the "Lan Remote" network adapter is integrated into the internal IPv4 subnet of the instrument.

For configuration of a compatible "Lan Remote" IP address, see [chapter 4.4.9, "IP Subnet Configuration"](#), on page 106.

2.2 Instrument Tour

This chapter provides an overview of the control elements and connectors of the instrument and explains how to connect external devices.

2.2.1 Front Panel Tour

The front panel of the R&S CMW270 with display consists of the VGA display with the softkey and hotkey areas, the utility keys to the left, the hardkey area to the right, the RF/AF connectors and the control interfaces.

Brief explanations on the controls and connectors of the front panel can be found in the following sections.

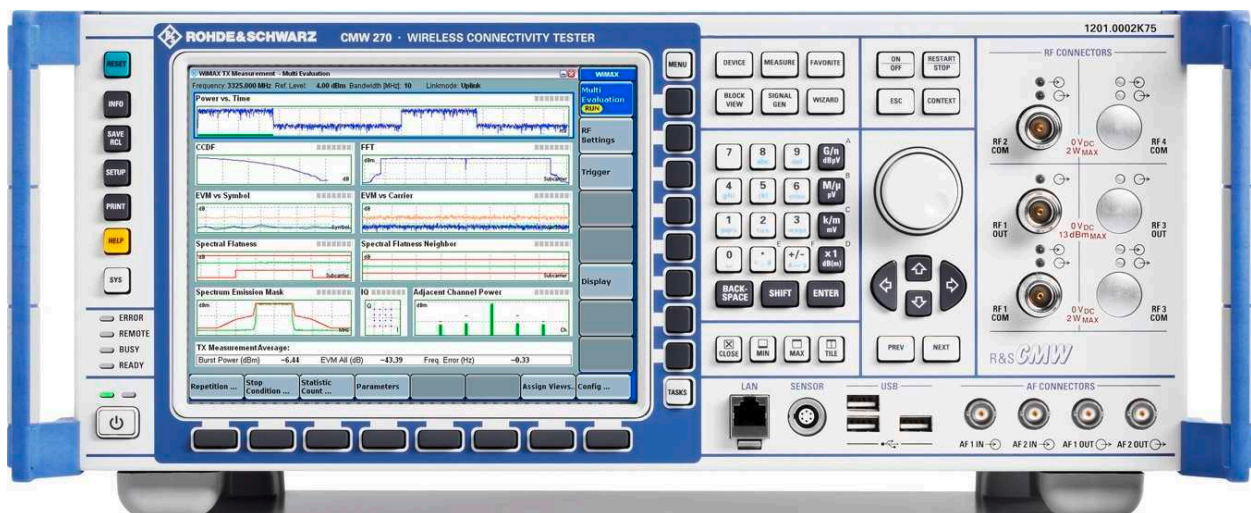



Soft-Front Panel

When using a remote desktop connection or an external monitor a soft-front panel is available.

See also [chapter 2.4.4, "Using the Soft-Front Panel and Keyboard Shortcuts"](#), on page 38.

2.2.1.1 Utility Keys

The utility keys to the left of the display provide access to the utility dialogs, to the help system and to the operating system. Utility dialogs are used to perform administrative tasks and to reset the instrument to a definite state.



- **RESET** – restores a definite instrument state.
See also [chapter 4.2, "Reset Dialog"](#), on page 81
- **INFO** – provides an overview of firmware application states and allows to prepare files for problem reporting.
See also [chapter 4.6, "Info Dialog"](#), on page 115
- **SAVE RCL** – stores or recalls instrument settings.
See also [chapter 4.3, "Save/Recall Dialog"](#), on page 83
- **SETUP** – opens the "Setup" dialog. Use this dialog to perform administrative tasks, define basic instrument settings, enable options, view the startup results and access service functions.
See also [chapter 4.4, "Setup Dialog"](#), on page 85
- **PRINT** – stores a hardcopy of the screen contents.
See also [chapter 4.5, "Print Dialog"](#), on page 114
- **HELP** – opens the help system.
- **SYS** – minimizes the R&S CMW270 software application and gives access to the Windows XP desktop and start menu (toggle function). Use the operating system level to perform system configurations and call up additional software utilities.

2.2.1.2 Status LEDs

The status LEDs are located above the standby key in the bottom left corner of the front panel.

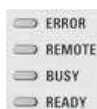

They light to indicate the following instrument states:

- **ERROR:** An error (e.g. a hardware error) occurred during operation. The error impairs the correct functioning and must be eliminated before correct instrument operation can be ensured.
The LED **blinks** to indicate that the reference frequency is not locked. This happens e.g. if the R&S CMW270 is switched from internal to external reference while no external reference signal is available, or if synchronization to the reference signal is lost. Use the "Setup" dialog to check the frequency and level of the external reference signal.
See also [chapter 4.4.6, "Sync Settings"](#), on page 102.
- **REMOTE:** The instrument is controlled via its remote interface.

- **BUSY:** The instrument is booted, or a software module is loaded.
- **READY:** The instrument is ready for use, the startup procedure is finished.

2.2.1.3 Standby Key

The standby key is located in the bottom left corner of the front panel.



The standby key serves two main purposes:

- Switch from standby state to ready state in order to initiate the startup procedure
- Shut down the instrument

The LEDs indicate the standby state and the ready state:

- Left, green LED:
Indicates the ready state. The R&S CMW270 is ready for operation. All modules are power-supplied.
- Right, amber LED:
Indicates the standby state. The standby power only supplies the power switch circuits and the optional oven quartz (Timebase OCXO, option R&S CMW-B690A). In this state it is safe to switch off the AC power and disconnect the instrument from the power supply.

See also [chapter 2.1.3.2, "Starting Up and Shutting Down"](#), on page 15.

2.2.1.4 Display, Softkeys and Hotkeys

The R&S CMW270 with selection R&S CMW-S600B, R&S CMW-S600D or R&S CMW-S600F is equipped with a color display providing control elements for the applications and output elements for measurement results. Refer to the data sheet for the technical characteristics of the display.

Softkeys and hotkeys are located in two bars next to the display:

- The "softkey bar" on the right side consists of 8 softkeys. Pressing a softkey at the front panel has the same effect as clicking the button to the left of the softkey, using a mouse. The buttons are adapted dynamically depending on the current application and the context.
- The "hotkey bar" across the bottom of the display contains 8 hotkeys. Pressing a hotkey at the front panel has the same effect as clicking the button above the hotkey, using a mouse. The buttons are adapted dynamically depending on the current application, the context and the active softkey.

The following keys are located above and below the softkey bar:

- MENU – for future extensions
- TASKS – displays or hides the task bar across the bottom of the GUI (toggle function). The task bar may contain up to 14 entries (two times 7 entries plus a toggle hotkey to switch between the two sets). Each task bar entry allows to access a generator, measurement or signaling control application. See also [chapter 2.4.1, "Accessing Applications and Dialogs"](#), on page 34.

2.2.1.5 Setup Keys

The upper keys to the right of the display provide access to dialogs for basic instrument setup. Additional dialogs can be accessed via the utility keys to the left of the display.

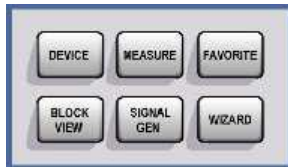

- **DEVICE** – selects the device type (one or several sub-instruments) or changes the active sub-instrument.
See also [chapter 4.7, "Instrument Setup Dialog"](#), on page 119.
- **MEASURE** – loads measurement firmware applications.
See also [chapter 4.8, "Measurement Controller Dialog"](#), on page 120.
- **FAVORITE** – for future extensions
- **BLOCK VIEW** – provides an overview of the signal routing settings of all active firmware applications and allows to reconfigure these settings.
See also [chapter 4.10, "Blockview Dialog"](#), on page 121.
- **SIGNAL GEN** – loads generator and signaling firmware applications
See also [chapter 4.9, "Generator/Signaling Controller Dialog"](#), on page 120.
- **WIZARD** – opens the wizard provided by the active firmware application (only supported by selected applications)

2.2.1.6 Application Control Keys

The keys above the rotary knob control measurements, generators, signaling applications, and control elements in dialogs.



- **ON/OFF** – starts a measurement from the OFF state or aborts a running measurement. Switches generators or signaling generators on or off and selects/clears checkboxes in dialogs (toggle function).
- **RESTART / STOP** – restarts a measurement in the RDY state or stops a running measurement.
- **ESC** – terminates the current stage of a session, e.g. by closing a dialog.
- **CONTEXT** – for future extensions

2.2.1.7 Data Entry Keys

The keys in the data entry keypad are used to enter numeric values and character data. They are only enabled while the cursor is placed in a data input field.



- 0 to 9 – enter numbers (in numeric input fields) or characters (character input fields).
- DOT, PLUS/MINUS:
 - In numeric input fields, the keys enter the decimal point and change the sign of the entered numeric value. Multiple decimal points are not allowed.
 - In hexadecimal input fields, the keys enter the hex values E and F.
 - In character input fields, the keys enter special characters and switch between upper and lower case, respectively.
- G/n, M/μ, k/m, x1:
 - In numeric input fields, these keys multiply the entered value with factors of $10^{(-9)}$, $10^{(-6)}$, $10^{(-3)}$ or 1 and add the appropriate physical unit.
 - In hexadecimal input fields, the keys enter the hex values A to D.
 - In character input fields, the keys have no effect.
- BACKSPACE – deletes the last character before the cursor position or the selected character sequence.
- SHIFT – for future extensions
- ENTER – activates the edit mode for the selected input field or confirms and terminates the entry.

2.2.1.8 Rotary Knob and Navigation Keys

The rotary knob, the ARROW keys and the PREV and NEXT keys are alternative control elements for data variation and navigation in the graphical user interface.



- Rotary knob:
 - Increases or decreases numeric values in editing mode
 - Moves the cursor, e.g. to a function block in the block view
 - Scrolls within lists, tables or tree views
 - Confirms entries (press the rotary knob, equivalent to ENTER)
- ARROW keys:
 - UP / DOWN – vary numeric values and scroll within lists, dialogs, or tables
 - LEFT / RIGHT – move the cursor in input fields and scroll within lists, dialogs or tables
- PREV and NEXT – in a dialog with several tabs, switch between the tabs

2.2.1.9 Window Control Keys

The keys below the numeric key pad arrange windows on the display.



- CLOSE – closes the active window, e.g. a configuration dialog
- MIN – reduces the active window to an icon
- MAX – for future extensions
- TILE – for future extensions

2.2.1.10 RF Connectors

The SNAP N-type connectors on the front panel are used as inputs and outputs for RF signals.

They are labeled RF 1 OUT, RF 1 COM, RF 2 COM, RF 3 OUT, RF 3 COM and RF 4 COM (the RF 3 and 4 connectors are optional).

The impedance of all RF connectors is 50 Ω . The frequency ranges vary depending on the installed hardware options; input and output level ranges depend on the firmware applications (refer to the data sheet). The command reference sections state the maximum frequency ranges available with a fully equipped instrument (including optional parts).

The connectors are assigned to firmware application instances, see [chapter 3.4, "Sub-Instruments"](#), on page 77.



COM connector

COM connectors are bidirectional connectors. The two LEDs above a connector indicate the connector state:

- The upper LED is lit as long as the R&S CMW270 is ready to receive signals.
- The lower LED is lit as long as it transmits an RF signal.



OUT connector

OUT connectors are unidirectional output connectors. Compared to COM connectors, OUT connectors can provide higher output powers. The LED is lit as long as the R&S CMW270 transmits an RF signal.

NOTICE**Risk of instrument damage**

The maximum input levels at all bidirectional RF connectors according to the front panel labeling or the data sheet must not be exceeded.

In addition, the maximum input voltages of other input connectors at the front and rear panel must not be exceeded.

RF connectors may warm up very much when high RF power is fed in!

2.2.1.11 Other Front Panel Connectors

Various control interface connectors and the AF connectors are located at the bottom of the front panel.

**USB Connectors**

Single Universal Serial Bus connectors of type A (master USB), used to connect e.g. a keyboard, mouse or other pointing devices, a printer or an external storage device (USB stick, CD-ROM drive etc.). All front panel USB connectors comply with standard USB 2.0; refer to the data sheet.

NOTICE**Risk of instrument damage**

Never connect a device providing two USB connectors (e.g. Y-shaped cable) to the single USB connector at the right side of the front panel. Connect such a device to two USB connectors located on top of each other (front panel or rear panel).

**NOTICE****Risk of instrument damage**

USB devices with external power supply must never feed back current into the 5 V power supply of the USB interface. Before using a device with external power supply, verify that there is no connection between the positive pole of the power supply and the +5 V power pin of the USB interface (VBUS).



The length of passive connecting USB cables should not exceed 1 m. The maximum current per USB port is 500 mA.



LAN Connector

8-pin connector RJ-45 used to connect the R&S CMW270 to a Local Area Network (LAN). It supports up to 100 Mbit/s. A second LAN connector labeled LAN REMOTE is available on the rear panel of the instrument.

See also [chapter 2.5.3, "Remote Operation in a LAN"](#), on page 46.



SENSOR Connector

Lemosa 6-pin socket for NRP-Z27/-Z28 power sensors. An external power sensor can be used to monitor the power of an external signal or calibrate an RF source.

The SENSOR connector controls the power sensor but also provides the power supply and trigger signals.

AF Connectors



The Audio Frequency (AF) BNC connectors are installed together with an audio board (option R&S CMW-B400B or R&S CMW-U400).

They are used for input and output of analog audio signals in the context of audio measurements.

2.2.2 Rear Panel Tour

This section gives an overview of the rear panel controls and connectors of the R&S CMW270.

The rear panel connectors and interfaces are described in detail in the Annex of the User Manual and the help system.

See [chapter 7.1.1, "Rear Panel Connectors"](#), on page 308



Available on all instruments

- AC power connector and ground screw: Use the AC power connector to connect the instrument to an AC power supply. If desired, ground the instrument additionally via the ground screw (labeled \perp) and an appropriate cable. For power switch, see [chapter 2.1.3.1, "Powering On"](#), on page 15. For fuses, see [chapter 2.6.3, "Replacing Fuses"](#), on page 50.
- "LAN REMOTE" is an RJ-45 connector. Use this connector to integrate the instrument to a Local Area Network, primarily for remote control purposes.
- "REF IN" is a BNC input for an external reference frequency. Use this connector to synchronize the R&S CMW270 to another device.
- "REF OUT 1" is a BNC output for the internal reference frequency of the R&S CMW270. Use this connector to synchronize other instruments to the tester.
- The USB connectors can be used to connect e.g. a keyboard, mouse or other pointing devices, a printer or an external storage device (USB stick, CD-ROM drive etc.). To prevent instrument damage, observe the hints given in ["USB Connectors"](#) on page 23.
- The "USB REMOTE" connector can be used for remote control of the instrument.
- "TRIG A" and "TRIG B" are two BNC connectors for external trigger signals.

Optional connectors

- A "LAN SWITCH" with two RJ-45 connectors is available as option R&S CMW-B660A and R&S CMW-B661A. The connectors provide access to the internal IP network (CMW subnet), e.g. for message logging.
- The BNC connectors "SYS SYNC OUT n" and "SYS SYNC IN" are provided with option R&S CMW-S55xM. They are used to provide or receive time information.
- An I/Q board is available as option R&S CMW-B510F. It provides four digital connectors (labeled "DIG IQ IN 1", "DIG IQ OUT 2", "DIG IQ IN 3", and "DIG IQ OUT 4") for input and output of digital IQ data plus two bidirectional BNC connectors (labeled "AUX A" and "AUX B") for control, clock and trigger signals. A second I/Q board is available as option R&S CMW-B520F. It provides the digital connectors "DIG IQ IN 5", "DIG IQ OUT 6", "DIG IQ IN 7", and "DIG IQ OUT 8" and the BNC connectors "AUX C" and "AUX D".
- "IEEE 488 CH 1" and "IEEE 488 CH 2" are two equivalent GPIB bus connectors according to standard IEEE 488/IEC 625. The connectors are available as options R&S CMW-B612A and R&S CMW-B612B, respectively. Use these connectors for remote control of the instrument in a GPIB bus system.
- "SPDIF IN" and "SPDIF OUT" are installed together with an audio board (option R&S CMW-B400B or R&S CMW-U400). They are used for input and output of digital audio signals in the context of audio measurements.
- "DVI" is an external monitor connector which is available as option R&S CMW-B620A.

NOTICE**Risk of instrument damage**

The maximum input levels and voltages of the input connectors at the front and rear panel must not be exceeded.

2.2.3 Connecting External Devices

The equivalent USB ports on the front and rear panel of the R&S CMW270 can be used to connect a variety of devices:

- A mouse simplifies operation of the instrument using the controls and dialogs of the Graphical User Interface (GUI).
- A keyboard simplifies the entry of data.
- A printer generates hard copies of the GUI displayed on the optional built-in display or a connected monitor.

In addition the R&S CMW270 provides an interface for monitor connection:

- An external monitor shows the magnified GUI with all diagram areas and controls.

2.2.3.1 Connecting a Mouse

A USB mouse can be connected to one of the USB connectors on the front panel or on the rear panel.

The mouse is detected automatically when it is connected. It is safe to connect or disconnect a mouse during measurements.

To configure the mouse, use the Windows XP dialog "Mouse Properties" (Start menu > Settings > Control Panel > Mouse).

To access Windows XP via a front panel with display, press the SYS key. Note that operating a tester with display does not require a mouse. You can access all essential functions using the keys on the front panel.

2.2.3.2 Connecting a Keyboard

A keyboard can be connected to one of the USB connectors on the front panel or on the rear panel.

The keyboard is detected automatically when it is connected. The default input language is English - US. It is safe to connect or disconnect the external keyboard during measurements.

To configure the keyboard, use the Windows XP dialogs "Keyboard Properties" and "Regional and Language Options" (Start menu > Settings > Control Panel > Keyboard / Regional and Language Options).

To access Windows XP via a front panel with display, press the SYS key. Note that operating a tester with display does not require a keyboard. You can access all essential functions using the keys on the front panel.

2.2.3.3 Connecting a Printer

A printer can be connected to one of the USB connectors on the front panel or on the rear panel. It is safe to connect or disconnect the printer during measurements.

To install a printer driver or configure a printer, use the Windows XP dialog "Printers and Faxes" (Start menu > Settings > Control Panel > Printers and Faxes).

To access Windows XP via a front panel with display, press the SYS key.

A great variety of printer drivers is already available on the R&S CMW270. You can load updated driver versions or new drivers e.g. from a USB memory stick or from a network directory available via LAN. Use the "Add Printer Wizard" to complete the installation.

2.2.3.4 Connecting a Monitor



A standard monitor can be connected to the DVI-D connector of the R&S CMW270.

For instruments with display this connector is optional (R&S CMW-B620A).

NOTICE

Risk of instrument damage due to missing grounding conductor

Before connecting an external monitor to the DVI connector, ensure that the monitor and the R&S CMW270 are connected to a ground contact.

Otherwise the R&S CMW270 may be damaged.

The monitor must be connected while the instrument is switched off or in standby mode. Otherwise correct operation cannot be guaranteed.

The external monitor displays the magnified GUI with all dialogs, measurement results and control elements. Additionally it shows a soft-front panel, emulating front panel control elements. See also [chapter 2.4.4, "Using the Soft-Front Panel and Keyboard Shortcuts"](#), on page 38.

With an additional mouse or keyboard connected to the tester, you can control applications from the external monitor.

If the instrument is equipped with a display, you can activate the internal display (and deactivate the external monitor) by pressing CTRL + ALT + F3 at a connected keyboard. To activate the external monitor (and deactivate the internal display) press CTRL + ALT + F4.

You can also use the internal display and the external monitor in parallel, so that both displays show the same image (dual display clone). For this configuration you must modify the display driver settings. They can be accessed for example via the Windows

XP Quick Launch Toolbar. Select "Digital Display" (the external monitor) as primary device and "Notebook" (the internal display) as secondary device. A reboot may be required after modification of the driver settings.

Please note that the default resolution configured for the external monitor equals 800 x 600 pixel. You can modify this value in the Windows XP settings. But the resolution is reset to 800 x 600 pixel by each reboot.

2.3 Trying Out the Instrument

This chapter helps you to get familiar with the R&S CMW270. It provides sample sessions with a generator, a measurement and a signaling application.

In the sample sessions you control the instrument manually, using a mouse and keyboard. You display the GUI on the built-in display (if available) or on an external monitor or access it via a "Remote Desktop" connection.

As a prerequisite the instrument must be set up, connected to the mains system, and started up. The required devices must be connected.

For additional information see:

- [chapter 2.1, "Putting the Instrument into Operation"](#), on page 11
- [chapter 2.2.3, "Connecting External Devices"](#), on page 26
- [chapter 2.5.3.3, "Remote Desktop Connection"](#), on page 48



Reset

To obtain predictable results it is recommendable to reset the R&S CMW270 to a definite state before you try out the examples in this chapter. Press RESET to open the "Reset" dialog and perform a preset.

2.3.1 Generating an RF Signal

Generators provide RF signals for test purposes. All generators are controlled in an analogous manner. The following example uses the General Purpose RF (GPRF) generator.

The GPRF generator provides an RF signal at constant frequency or at a series of configurable frequencies and levels. It is also possible to generate an RF signal that is modulated using a waveform file. All RF signals are configured in a similar way.

As an example we generate a dual-tone signal at constant frequency. Proceed as follows:

1. Open the "GPRF Generator" application, e.g. from the task bar (press "TASKS" to open the task bar).
If the application is not present in the task bar, enable it in the "Generator/Signaling Controller" dialog (press "SIGNAL GEN" to open the dialog).

As a result the "General Purpose RF - Generator" dialog is opened. Configure the following settings as described in the next steps.

The screenshot shows the 'General Purpose RF - Generator' dialog box with the following settings:

- Scenario:** StandAlone
- Routing:** Connector: RF1COM, Converter: RFTX1
- Ext. Att. (Output):** 0.00 dB
- Frequency:** 1200.000000 MHz, Baseband Offset: ---
- Level (RMS):** -30.00 dB, Peak Envelope Power: ---
- Digital Gain:** 0.00 dB
- List Mode:** Off
- Baseband Mode:** Dual Tone
- Baseband Configuration > Dual Tone:**

Source 1	Source 2
Offset Frequency: -2.0000 kHz	1.0000 kHz
Ratio: 5.00 dB (Source 1 - Source 2)	
Level (RMS): -31.19 dBm	-36.19 dBm

Fig. 2-2: Settings in General Purpose RF Generator dialog

- Click "Routing > Connector" and select your RF output connector. In the following we assume that RF 1 COM is used.
- If your test setup contains a known, frequency-independent attenuation, enter the value as "Ext. Att. (Output)".
- Select the "Frequency" (1200 MHz) and "Level (RMS)" (-30 dBm) of the RF output signal.
- Ensure that the "List Mode" is disabled (Off).
- Select the "Baseband Mode" "Dual Tone".
- In the "Baseband Configuration > Dual Tone" section, configure the properties of the dual-tone signal. To superimpose two CW signals at different frequencies and levels, set the "Offset Frequency" of both signals and define a "Ratio" that is different from 0 dB; see figures above and below.
- Press ON | OFF to switch the RF generator on.

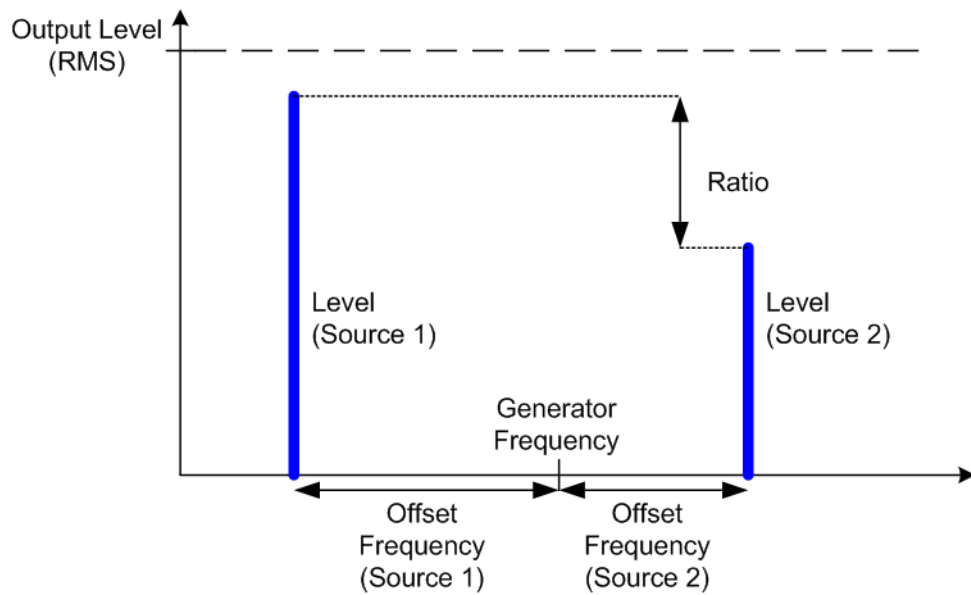

Fig. 2-3: Dual-tone generator signal

To tap the resulting RF generator signal at the RF 1 COM connector, proceed with [Measuring an RF Signal](#).



ARB generator

The GPRF dual-tone signal is an example for a real-time generator signal. As an alternative, the GPRF generator application provides the arbitrary ("ARB") baseband mode. The ARB generator signal is based on a "waveform file" which is loaded and processed at runtime. For details refer to the "GPRF Generator" description.

2.3.2 Measuring an RF Signal

The R&S CMW270 provides various general purpose and network-specific measurements. All measurements are controlled in an analogous manner. The following example uses the General Purpose RF (GPRF) Power measurement.

The GPRF Power measurement measures a series of power steps at (possibly) different powers and frequencies and performs a statistical evaluation. As a simple example we can measure the RF signal generated by the GPRF generator of the R&S CMW270. The signal is tapped at the RF 1 COM connector and measured at RF 2 COM.

To perform the measurement,

1. Configure the GPRF generator as described in [chapter 2.3.1, "Generating an RF Signal"](#), on page 28.
2. Connect a coax cable between the RF connectors RF 1 COM and RF 2 COM at the front panel of the R&S CMW270 to feed the generator signal to RF 2 COM.

3. Open the "GPRF Measurements" application, e.g. from the task bar (press "TASKS" to open the task bar).
If the application is not present in the task bar, enable it in the "Measurement Controller" dialog (press "MEASURE" to open the dialog).
As a result the "General Purpose RF - Measurement" dialog is opened. The tab "Power" is selected by default.
4. Press the softkey-hotkey combination "RF Settings > RF Routing" and ensure that RF 2 COM is selected as an input connector.
5. Press ON / OFF (or RESTART / STOP) to start the power measurement.
6. In the "Settings" panel of the measurement dialog, adjust the "Frequency", the "Expected Nominal Power", and the filter "Bandwidth" to the properties of your input signal.
7. Observe the measurement result on the screen.

In the present example, the upper tone (at 1200.001 MHz) of the generated dual-tone signal is observed in a 1 kHz bandwidth. Due to the cable loss, the measured power is smaller than the -36.19 dBm shown in [figure 2-2](#).

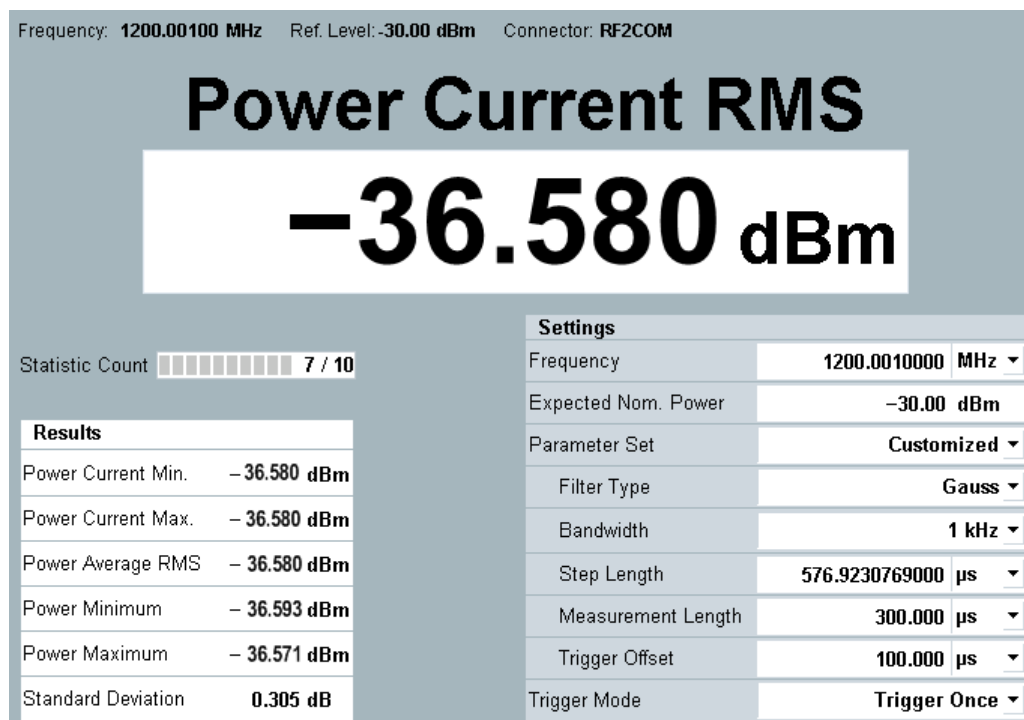

Fig. 2-4: RF Power Results

2.3.3 Performing Signaling Measurements

The purpose of a signaling application is to establish a network connection to a Mobile Station (MS) in order to perform various tests. All signaling applications are controlled in an analogous manner. The following example uses the WiMAX signaling application.

To perform a WiMAX signaling measurement,

1. Connect your MS to the R&S CMW270, preferably using one of the bidirectional RF connectors RF 1 COM or RF 2 COM at the front panel.
2. Open the signaling application and click/press ON | OFF until the signaling control softkey indicates the ON state.
3. Wait until the "Connection Info" panel shows "Network Entry Completed".
4. Double-click the "Mobile Capabilities" panel to view information that the DUT and the base station/R&S CMW exchange during initial ranging.
5. Perform any of the measurements included in the "WiMAX Signaling" application or WiMAX TX tests.

A more detailed measurement procedure is reported at the beginning of the "WiMAX Signaling" documentation; refer to section "General Description > Performing Measurements".

The following figure shows the "WiMAX Signaling" main view with the extended "Mobile Capabilities" panel.

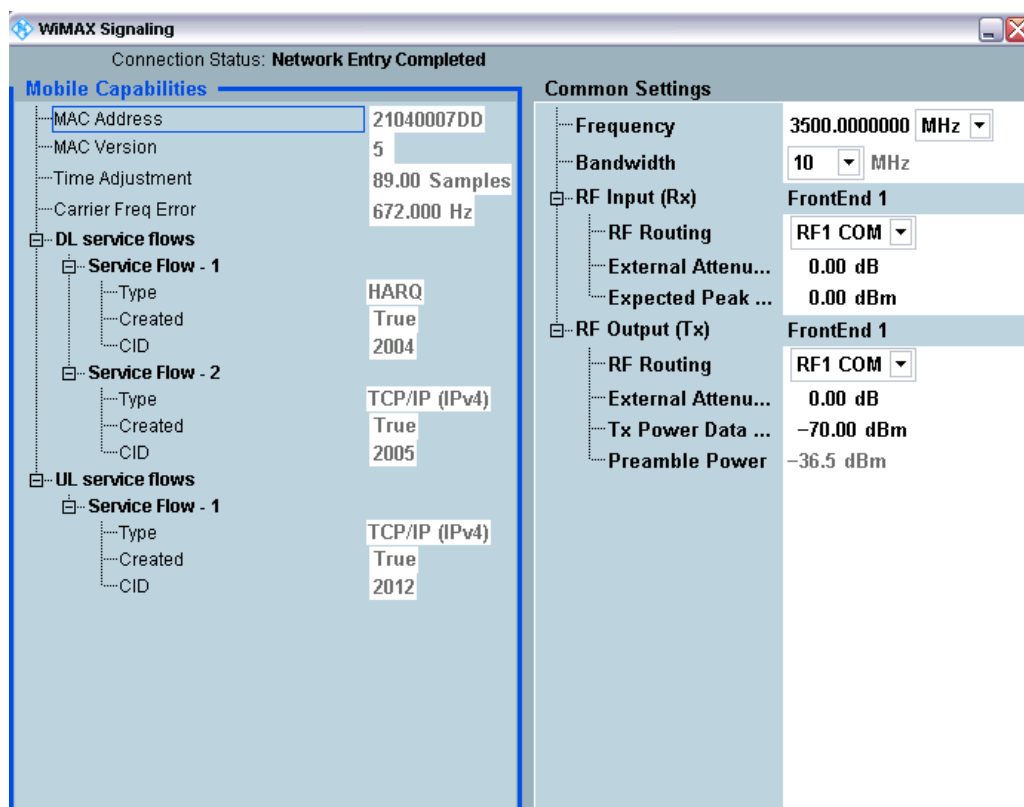

Fig. 2-5: WiMAX Mobile Capabilities

2.4 Operating the Instrument

You can operate the instrument manually or via remote control:

- Remote control:
You create scripts to automate repeating settings, tests and measurements. The instrument is connected to a computer that is running the program. For an introduction see [chapter 5, "Remote Control"](#), on page 126.
- Manual operation:
You control the instrument via a Graphical User Interface (GUI), using a mouse and a keyboard. If your instrument is equipped with a display, you can also control it via the front panel control elements.
You display the GUI on a built-in display or on an external monitor or access it via a "Remote Desktop" connection.
The principles of manual operation are explained in this chapter.

To connect a mouse, keyboard or monitor, see [chapter 2.2.3, "Connecting External Devices"](#), on page 26.

To establish a "Remote Desktop" connection see [chapter 2.5.3.3, "Remote Desktop Connection"](#), on page 48.



Contents and scope

This chapter describes the operation of an instrument with display and front panel control keys. Control of an instrument without display using emulated front panel controls is analogous; see [chapter 2.4.4, "Using the Soft-Front Panel and Keyboard Shortcuts"](#), on page 38.

2.4.1 Accessing Applications and Dialogs

Measurement applications, generator applications and signaling applications are accessed via the task bar. As the task bar is empty by default, you must add applications to the task bar, before you can use them.

Configuring the task bar: adding or removing applications

There is one dialog for adding/removing measurement applications and a second dialog for adding/removing generator and signaling applications. Both dialogs are used in the same way.

1. Press MEASURE to open the "Measurement Controller" dialog or SIGNAL GEN to open the "Generator/Signaling Controller" dialog.

The dialog lists the individual measurement applications or generator and signaling applications available on your instrument.

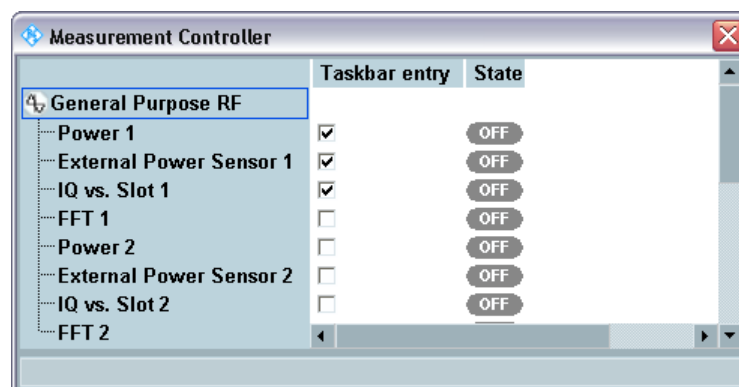

2. Select the applications for which an entry shall be displayed in the task bar.
3. To close the dialog press MEASURE or ESC.
Alternatively select an application at the bottom of the GUI. As a result the dialog closes and the main view of the selected application is opened.

Accessing an application via the task bar

1. To display the task bar across the bottom of the GUI, press the TASKS key. Alternatively, move a connected mouse to the lower border of the GUI.

The task bar contains a hotkey for each assigned measurement, generator, and signaling application.

The color of the icon in a hotkey corresponds to the state of the application (OFF / RUN / RDY for measurements or OFF / ON for generators and signaling generators).



2. Press one of the hotkeys to access the associated application.

Accessing dialogs within an application

Depending on the application, dialogs are accessed via softkey-hotkey combinations, via the "Config" hotkey or via buttons within the GUI.

The following statements hold for most applications: Generator applications present most settings directly in the main view. Measurement and signaling applications provide a single configuration dialog containing most settings. In the main view measurement applications present measurement results and signaling applications present the most important settings.

- ▶ Press the "Config" hotkey in the bottom right corner of the GUI to open the configuration dialog of a measurement or signaling application.

Using softkeys and hotkeys

The softkeys are located on the right of the GUI, the hotkeys at the bottom of the GUI. The present softkeys and hotkeys are adapted dynamically, depending on the application and the context, e.g. configured parameters or signaling states. Hotkeys also change depending on the active softkey.

Together with the navigation keys and the data entry keys, softkeys and hotkeys ensure that you can access any instrument function without a mouse or an external keyboard.

To use a softkey-hotkey combination proceed as follows:

1. Press the softkey.

The hotkeys associated with the softkey are displayed across the bottom of the screen.
2. Press the hotkey.

The hotkey may e.g. open a dialog or toggle a setting.

2.4.2 Entering Data via Front Panel Keys

This section describes how to access input fields, enter numeric values or character data, and toggle checkboxes. This is done via the ON | OFF key and the front panel keys shown below.



Navigating within a dialog

- ▶ Use either the rotary knob or the ARROW keys below the knob to step through the elements in the dialog.
 - a) Turn the rotary knob clockwise or counterclockwise.
 - b) Press the UP / DOWN and LEFT / RIGHT ARROW keys.

Navigating between tabs

- ▶ Use the PREV / NEXT keys to switch to the previous tab to the left or to the next tab to the right.

Selecting a value from a pull-down list

1. Press the rotary knob or press ENTER to activate the pull-down list.
2. Turn the rotary knob clockwise or counterclockwise to step through the list. Alternatively, use the UP / DOWN ARROW keys.
3. Press the rotary knob or press ENTER to select the current entry and deactivate the pull-down list.

Entering a numeric value

1. Press the rotary knob or press ENTER to activate the input field.
2. Enter/modify the number:
 - Use the keys 0 to 9 to enter these digits.
 - Use the UP / DOWN ARROW keys to increment/decrement a digit.
 - Use the LEFT / RIGHT ARROW keys to move the cursor within the input field.
 - Use the dot key to enter a decimal point.
 - Use the plus/minus key to change the sign of the number.
 - Press the G/n, M/m, k/m and x1 keys to multiply the entered value with factors of $10^{(-)9}$, $10^{(-)6}$, $10^{(-)3}$ or 1 and add the appropriate physical unit.
 - In hexadecimal input fields, use the unit keys, the dot key and the plus/minus key to enter the digits A to F.
 - Press BACKSPACE to correct an entry.
3. Press ENTER or the rotary knob to confirm the number and deactivate the input field.

Entering characters

1. Press the rotary knob or press ENTER to activate the input field.

2. Enter/modify characters:
 - Press 0 to 9 repeatedly to enter one of the characters assigned to the key.
 - Press the dot key repeatedly to enter one of the special characters assigned to the key.
 - Press plus/minus to switch between upper and lower case.
 - Use the LEFT / RIGHT ARROW keys to move the cursor within the input field.
 - Press BACKSPACE to correct an entry.
3. Press ENTER or the rotary knob to confirm the character sequence and deactivate the input field.

Selecting or clearing a checkbox

Two types of checkboxes must be distinguished. There are standalone checkboxes and checkboxes combined with a data input field.

1. To select or clear a combined checkbox:
 - a) Press ENTER or the rotary knob to activate the data input field.
 - b) Press ON | OFF to select or clear the checkbox.
2. To select or clear a standalone checkbox, press ENTER or the rotary knob.

2.4.3 Entering Data via an External Keyboard

This section describes how to access input fields, enter numeric values or character data and toggle checkboxes using an external keyboard.

Navigating within a dialog

- ▶ Press the UP / DOWN and LEFT / RIGHT ARROW keys on the keyboard to step through the elements in the dialog.

Navigating between tabs

- ▶ Press SHIFT + TAB / TAB to switch to the previous tab to the left or to the next tab to the right.

Selecting a value from a pull-down list

1. Press ENTER to activate the pull-down list.
2. Use the UP / DOWN ARROW keys to step through the list.
3. Press ENTER to select the current entry and deactivate the pull-down list.

Entering a numeric value or character data

1. Press ENTER to activate the input field.
2. Enter/modify the field contents:
 - Use the corresponding keys to enter characters or numbers.
 - Use the UP / DOWN ARROW keys to increment/decrement a digit.

- Use the LEFT / RIGHT ARROW keys to move the cursor within the input field.
 - Use the minus key to change the sign of a number.
 - Press CTRL + F9 / F10 / F11 / F12 to multiply a numeric value with factors of 1, $10^{(-3)}$, $10^{(-6)}$, $10^{(-9)}$ and add the appropriate physical unit.
 - Press BACKSPACE to correct an entry.
3. Press ENTER to confirm the entry and deactivate the input field.

Selecting or clearing a checkbox

Two types of checkboxes must be distinguished. There are standalone checkboxes and checkboxes combined with a data input field.

1. To select or clear a combined checkbox:
 - a) Press ENTER to activate the data input field.
 - b) Press CTRL + ENTER to select or clear the checkbox.
2. To select or clear a standalone checkbox, press ENTER.

2.4.4 Using the Soft-Front Panel and Keyboard Shortcuts

The front panel of an instrument with display contains a number of important control elements. When you operate the instrument via a "Remote Desktop" connection, you don't have access to these control elements. In that case, the controls are emulated by a soft-front panel displayed at the remote monitor in addition to the GUI.

The soft-front panel is also available when you display the GUI at an external monitor directly connected to the instrument. It is identical for instruments with and without display.

Two versions of the soft-front panel are available:

- The compact soft-front panel is displayed as a vertical toolbar to the right of the GUI. It contains the most important front panel keys. The data entry keys are not available. Use a mouse and keyboard instead.
- The extended soft-front panel emulates all front panel controls of an R&S CMW270 equipped with a display. It provides a graphical presentation of the front panel. A horizontal screen resolution of 1280 pixels or higher is required to display the extended soft-front panel.

To switch between compact and extended soft-front panel:

- ▶ Press F11 on an external keyboard.

The compact soft-front panel is even available at the built-in instrument display. Use it if you prefer to use a connected mouse instead of front panel keys. To show the soft-front panel, move your mouse to the right border of the display.

The compact soft-front panel is displayed below. Each key on the soft-front panel has an equivalent keyboard shortcut. The following table lists these shortcuts (and some additional ones).



Table 2-1: (Soft-)front panel keys and keyboard shortcuts

Key	Shortcut
RESET	CTRL + R
INFO	CTRL + I
SAVE	CTRL + S
SETUP	CTRL + E
PRINT	CTRL + P
HELP	F1
SYSTEM	Windows logo key + D, CTRL + ALT + D
DEVICE	CTRL + D
WIZARD	CTRL + W
BLOCK VIEW	CTRL + B
MEASURE	CTRL + M
SIGNAL GEN	CTRL + G
ON OFF	CTRL + ENTER
RESTART STOP	CTRL + SHIFT + ENTER
TASKS	CTRL + TAB
PREV	SHIFT + TAB
NEXT	TAB
hotkeys, left to right	ALT + 1 to 8
softkeys, top down	CTRL + 1 to 8
G/n	CTRL + F12
M/μ	CTRL + F11
k/m	CTRL + F10
x1	CTRL + F9
CLOSE	CTRL + F4
MIN	CTRL + F5

2.5 Administrative Tasks

This chapter describes administrative tasks like software update and preparation of the instrument for remote control or for control via a "Remote Desktop" connection.

2.5.1 Windows XP

The R&S CMW270 is equipped with a Windows XP operating system which has been configured according to the instrument's features and needs.

Changes in the system configuration can be necessary in order to:

- allow "Remote Desktop" connections, see [chapter 2.5.3.3, "Remote Desktop Connection"](#), on page 48
- customize the properties of external devices connected to the R&S CMW270, see [chapter 2.2.3, "Connecting External Devices"](#), on page 26
- call up additional software tools

NOTICE

Configuration of the operating system, updates

The operating system is adapted to the R&S CMW270. To avoid impairment of instrument functions, only change the settings described in this documentation. Existing software must be modified only with software updates released by Rohde & Schwarz. Likewise, only programs authorized by Rohde & Schwarz for use on the instrument must be executed.

NOTICE

Files in D:\Rohde-Schwarz\CMW

This directory contains files that are part of the R&S CMW270 installation. To avoid impairment of instrument functions, always use functions offered by the instrument to modify or delete files in directory D:\Rohde-Schwarz\CMW and its subdirectories. Never use other programs e.g. the Windows Explorer to modify or delete files in this directory.

To access the Windows operating system via a front panel with display, press the SYS key.

Use e.g. the "Control Panel" to configure Windows settings (Start menu > Settings > Control Panel).

2.5.2 Software Update

The following sections are related to software updates.

- [Software Packages](#)..... 41
- [Compatibility of SW Versions and Parallel Installation](#).....41
- [Update Procedure](#)..... 42
- [R&S Software Distributor](#)..... 44
- [R&S Version Selector](#)..... 45

2.5.2.1 Software Packages

The R&S CMW270 software consists of the mandatory CMW base software package plus optional packages for firmware applications and utilities. These packages are integrated in setup files named "Setup_CMW_<Scope>(Release)_<Version>.exe".

For the base software package <Scope> equals BASE, resulting in the filename "Setup_CMW_BASE(Release)_<Version>.exe".

Other examples for <Scope> are GPRF, FM_STEREO, BLUETOOTH, WiMAX and WLAN.

A setup file related to a network standard allows to install all available firmware applications related to that standard (generator, measurement and signaling applications). The individual firmware application packages within one file can be selected or deselected for installation.

Additional waveform (ARB) files are grouped into library packages and provided as self-extracting files or zip-files. They are only relevant if you want to use the functionality of the "Arbitrary RF Generator". Unpack the desired libraries to the hard disk of the R&S CMW270. The preferred file location is

```
D:\Rohde-Schwarz\CMW\Data\waveform.
```

Software options must be enabled in the "Setup" dialog before they can be executed.

2.5.2.2 Compatibility of SW Versions and Parallel Installation

For software versions \geq V2.0.10 the version indicator consists of three numbers. The first two numbers indicate the so-called software branch, e.g. 2.0, 3.0 or 3.1.

For the initial release of a software branch all software packages have the same version. For update packages compatible to this branch the third number of the version indicator is increased. Example: An installation for branch 2.0 may comprise e.g. software packages with version V2.0.10 (initial release), V2.0.11 and V2.0.20 (update packages). Within one software branch, only one version of each software package can be installed, not several versions in parallel.

Several software branches can be installed in parallel, e.g. 2.0 and 3.0. All software branches are stored on the hard disk of the instrument. But only one of the installed software branches is active at a time, i.e. really used by the instrument. To change the active software branch, see [chapter 2.5.2.5, "R&S Version Selector"](#), on page 45.

Software versions $<$ V2.0.10 cannot be installed in parallel to any other software version. So any software version $<$ V2.0.10 must be uninstalled before one or several software branches \geq V2.0.10 can be installed.

2.5.2.3 Update Procedure

NOTICE

Connection to power supply

Ensure that the instrument remains connected to the power supply during software modifications (uninstall or update).

Disconnecting the instrument during a software modification may result in an inoperable state of the instrument that can only be resolved by Rohde & Schwarz.

To install a software update, follow the steps below. They apply to a complete update of all packages as well as to the update of only a selected package.

1. Shut down a running R&S CMW270 software using an external keyboard and "Alt + F4".
2. Copy all relevant setup file(s) to one directory on any storage medium accessible from the R&S CMW270. This may be the internal hard disk (preferably, drive D:), an external storage medium (USB memory stick, CD-ROM with external drive) or a network connection (LAN).
3. If a software version < V2.0.10 is installed, uninstall it completely:
 - a) Open Windows XP's "start" menu, click "All Programs" and start the uninstall tool "Uninstall_cmw.bat".
The uninstall tool opens a dialog where you can select the program components to be uninstalled.
 - b) Press "Select/Deselect All" and "Uninstall" to remove all components.
 - c) During the uninstall process, confirm possible popup dialogs and wait until the uninstall process is complete.
4. If you want to update software packages within an installed branch, uninstall the old packages using the following steps.
You can use these steps also to uninstall a complete software branch. Note that several software branches can be installed in parallel.
 - a) Open the "R&S Version Selector", e.g. via the corresponding icon on the desktop.
 - b) In the "R&S Version Selector" disable the option "with Restart".
 - c) Select the branch or package to be uninstalled and press "Uninstall".
During the uninstall process, confirm possible popup dialogs and wait until the uninstall process is complete.
 - d) If you want to uninstall additional software, repeat the previous step.
 - e) Close the "R&S Version Selector".See also [chapter 2.5.2.5, "R&S Version Selector"](#), on page 45.
5. Double-click the setup file to be executed, e.g. "Setup_CMW_BASE(Release)_<Version>.exe".

In the "R&S Software Distributor" opened, select either "Local Installation" or "Remote Installation", depending on the location of your setup files.

If you want to install additional packages provided by other setup files, enable "Add other setups from current directory".

See also [chapter 2.5.2.4, "R&S Software Distributor"](#), on page 44.

6. In the next screen, select which packages you want to install. You may e.g. deselect firmware application packages for which you have no software option.
7. The next steps depend on the installation type:
 - a) **Local installation:** Click "Install".
 - b) **Remote installation:** Click "Next" to initiate a hardware scan and wait until the "R&S Software Distributor" has drawn up a list of all R&S instruments which are connected to the LAN.
If the hardware scan does not yield the desired results, check the "Options..." settings and refer to the online help of the "R&S Software Distributor" for troubleshooting.
 - c) **Remote installation:** Select your R&S CMW270 (or several instruments) from the list and click "Install".
8. Follow the instructions of the "R&S Software Distributor" until the installation is finished.
9. Perform a restart of the instrument (if no automatic restart is performed).
10. Shut down the instrument a second time. Switch-off the instrument using the AC power switch at the rear of the instrument.
11. Switch-on and start the instrument.

The R&S CMW270 is now ready to operate with the installed software.

Already installed software packages can be reinstalled using the repair function of the "R&S Version Selector", see also [chapter 2.5.2.5, "R&S Version Selector"](#), on page 45.

Tests during type approval

It is not required to perform a recalibration of the R&S CMW270 after a software upgrade or downgrade.

To ensure that the R&S CMW270 TX and RX is working according to the specification after a software change the following tests are performed during the type approval of every new software release:

Test 1:

- Adjustment (measurement of correction values) and verification with the latest official software.
- Upgrade to the new software and verification.

Test 2:

- Adjustment and verification with the new software.

- Downgrade to the latest official software and verification.

The tests are passed if all verification results show comparable values.

Rohde & Schwarz is certified according to ISO 9001 since May 1995.

2.5.2.4 R&S Software Distributor

The "R&S Software Distributor" is a software utility that is opened when a R&S CMW270 setup file is started.

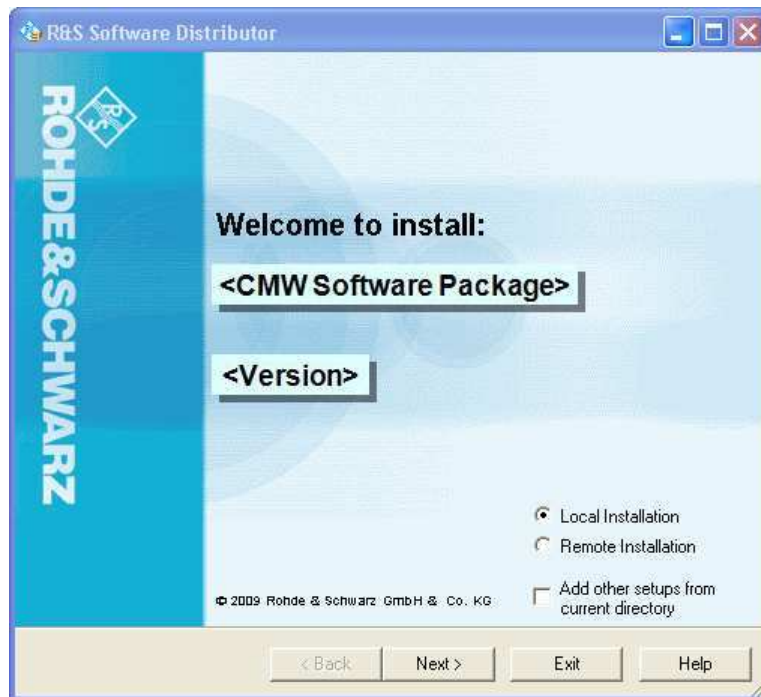

Fig. 2-6: R&S Software Distributor

The software distributor can initiate a local or a remote installation.

1. Select "Local Installation" if you start your setup file from the R&S CMW270 hard disk or an external storage medium (USB memory stick, CD-ROM with external drive) connected to the instrument.
2. Select "Remote Installation" if your setup files are on an external host computer that is connected to your R&S CMW270.
Note that a remote installation also allows you to update several instruments simultaneously.

If you want to install packages contained in several setup files, proceed as follows:

1. Store all setup files in the same directory.
2. Start one setup file.

- In the "R&S Software Distributor" dialog enable "Add other setups from current directory".

As a result the packages of all setup files in the same directory are offered for installation when you press "Next".

The installation process itself is self-explanatory. For additional information, especially concerning the options for remote installation, please refer to the online-help of the software distributor.

2.5.2.5 R&S Version Selector

Several software branches can be installed in parallel, but only one of the installed software branches is active at a time. The active software is not only stored on the hard disk, but also present in the flash memory of relevant hardware, e.g. baseband boards and signaling units. This software branch is started when the instrument is switched on or via the "CMW" icon on the desktop.

The "R&S Version Selector" allows to change the active software branch, to uninstall optional software packages and to repair (reinstall) software packages. It can be opened via an icon on the desktop.

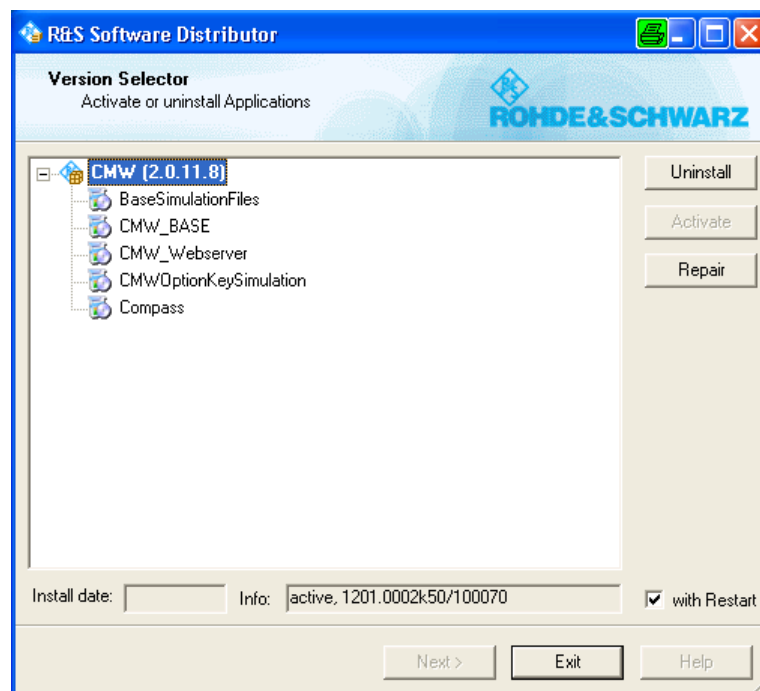

Fig. 2-7: R&S Version Selector

To perform an uninstall, activate or repair action, follow these steps:

- Select the relevant software branch or software package to the left.
If you want to perform an automatic restart of the instrument when the action is complete, enable "with Restart".

2. Click the relevant action button to the right and follow any instructions of the "R&S Version Selector" until the action is finished.

2.5.3 Remote Operation in a LAN

A LAN connection is used to integrate the R&S CMW270 into a home/company network or to connect it directly to another PC or instrument. This offers several applications, for example:

- Transfer data between a controller and the tester, e.g. in order to run a remote control program.
- Transfer data from a remote computer and back, in particular waveform files (ARB files).
- Access or control the R&S CMW270 from a remote computer using the "Remote Desktop" application (or a similar tool).
- Use external network devices (e.g. printers).

NOTICE

Virus protection

An efficient virus protection is a prerequisite for secure operation in a network. Please notice the following recommendations when using anti-virus software on the R&S CMW270:

- To avoid adverse effects on the performance of the instrument, download of signature files from the internet and hard disk scans must not be performed during the use of testing capabilities.
- Real-time virus protection of the hard disk should be disabled during tests.

R&S excludes any liability in respect of the use of anti-virus software on the R&S CMW270.

2.5.3.1 Connecting a LAN Cable

Connect a commercial RJ-45 cable to a LAN port of the R&S CMW270. The LAN REMOTE connector at the rear panel and the LAN connector at the front panel are suitable for this purpose (front panel connector not available for R&S CMW280).

Do not use other connectors, for example LAN SWITCH or LAN DAU for remote operation of the instrument. These optional connectors are used for other purposes, e.g. IP data tests or logging of signaling messages.

Dedicated vs. non-dedicated network connections

There are two methods to establish a LAN connection of the R&S CMW270:

- A non-dedicated network (Ethernet) connection from the tester to an existing network. The tester is assigned an IP address and can coexist with a computer and with other hosts on the same network.

- A dedicated network connection between the tester and a single computer. The computer must be equipped with a network adapter and is directly connected to the tester. The use of hubs, switches, or gateways is not needed, however, data transfer is still made using the TCP/IP protocol.

NOTICE**Avoid parallel connection**

Never use more than one LAN connector to connect the R&S CMW270 in parallel to the same network as this will result in connection errors.

2.5.3.2 Assigning an IP Address

Depending on the network capacities, the TCP/IP address information for the R&S CMW270 can be obtained in different ways:

- If the network supports dynamic TCP/IP configuration using the Dynamic Host Configuration Protocol (DHCP), all address information can be assigned automatically.
By default, the R&S CMW270 is configured to use DHCP. This means that it is safe to establish a physical connection to the LAN without any previous R&S CMW270 configuration.
- If the network does not support DHCP, or a specific TCP/IP configuration is requested, the addresses must be set manually.
See "[Manual TCP/IP Configuration](#)" on page 48

NOTICE**Valid IP addresses**

If your network does not support DHCP, or if you choose to disable dynamic TCP/IP configuration, you must assign valid address information before connecting the R&S CMW270 to the LAN. Contact your network administrator to obtain a valid IP address, because connection errors can affect the entire network.

On instruments equipped with a signaling unit and an "Ethernet Switch H661A" (option R&S CMW-B661A), some applications require a special IP configuration of the "Lan Remote" network adapter. In these scenarios the network adapter belongs to the internal IPv4 subnet of the instrument and can not be used for remote control.

For configuration of a compatible "Lan Remote" IP address, see [chapter 4.4.9, "IP Subnet Configuration"](#), on page 106.

Manual TCP/IP Configuration

To disable dynamic TCP/IP configuration and enter the TCP/IP address information manually proceed as follows:

1. Obtain the IP address and subnet mask for the R&S CMW270 and the IP address for the local default gateway from your network administrator. If needed, also obtain the name of your DNS domain and the IP addresses of the DNS and WINS servers on your network.
2. Perform the startup procedure.
3. Press the SETUP key to open the "Setup" dialog.
4. In the "Lan Services" section, select the network adapter "Lan Remote".
5. Disable DHCP and enter your address information, for example:

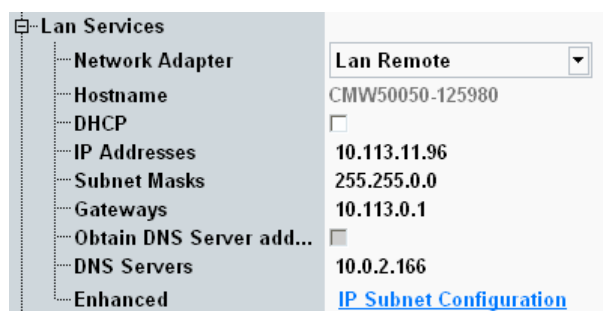

2.5.3.3 Remote Desktop Connection

"Remote Desktop" is a Windows application which can be used to access and control the R&S CMW270 from a remote computer through a LAN connection. The R&S CMW270 GUI is then displayed on the remote computer together with an additional soft-front panel, see [chapter 2.4.4, "Using the Soft-Front Panel and Keyboard Shortcuts"](#), on page 38).

To set up the first "Remote Desktop" connection to the instrument, proceed as follows:

1. Access the Windows operating system of the instrument. To do this you can either press the Windows logo key on an external keyboard connected to the instrument or you can press the SYS key on the front panel (only instruments with display).
2. Open the control panel (Start menu > Settings > Control Panel).
3. Double-click "System".
The "System Properties" dialog opens.
4. Select the "Remote" tab and enable "Allow users to connect remotely to this computer".
5. Close the dialog and display the R&S CMW270 GUI (R&S CMW application).

6. Connect the tester to the network; see [chapter 2.5.3.1, "Connecting a LAN Cable"](#), on page 46.
7. Assign an IP address to the tester; see [chapter 2.5.3.2, "Assigning an IP Address"](#), on page 47.
8. At a remote computer integrated in the LAN, create a "Remote Desktop" connection using the tester's IP address. You can also use other utilities providing remote PC access, e.g. VNC.



Password protection

Remote access to the R&S CMW270 requires a user name and password. In the factory configuration, "instrument" is preset both for the user name and for the password. To protect the tester from unauthorized access, it is recommended to change the password.

2.6 Maintenance

The instrument does not require any special maintenance.

To contact a Rohde & Schwarz support center see <http://www.customersupport.rohde-schwarz.com>.

For service centers see <http://www.services.rohde-schwarz.com>.

2.6.1 Cleaning

The outside of the instrument is suitably cleaned using a soft, lint-free dust cloth.

WARNING

Shock hazard

Before cleaning the instrument, make sure that the instrument is switched off and disconnected from all power supplies.

NOTICE

Instrument damage caused by cleaning agents

Cleaning agents contain substances that may damage the instrument, e.g. cleaning agents that contain a solvent may damage the front panel labeling or plastic parts.

Never use cleaning agents such as solvents (thinners, acetone, etc.), acids, bases, or other substances.

NOTICE**Risk of instrument damage due to obstructed fans**

If the instrument is operated in dusty areas, the fans may become obstructed by dust or other particles in the process of time. Make sure to check and, if necessary, clean the fans regularly to ensure they operate properly at all times. If the instrument is run with obstructed fans for a longer period, it may become overheated which may cause damage.

2.6.2 Storing and Packing

The storage temperature range of the instrument is given in the data sheet. If the instrument is to be stored for a longer period of time, it must be protected against dust.

Repack the instrument as it was originally packed when transporting or shipping. If the original packing is no longer available, use a sturdy cardboard box of suitable size. Wrap antistatic packing foil around the instrument to protect it from electrostatic charging. Provide for sufficient padding to protect the instrument against mechanical damage.

2.6.3 Replacing Fuses

The instrument is protected by two fuses located in the fuse holder to the right of the AC power switch on the rear panel.

Type of fuses: T10 IEC 127-2/V, stock no. 0606.3136.00

⚠ WARNING**Shock hazard**

Before replacing a fuse, make sure that the instrument is switched off and disconnected from all power supplies.

Always use fuses supplied by Rohde & Schwarz as spare parts, or fuses of the same type and rating.

To replace the fuses

1. Open the lid of the AC power connector.
2. Lift the fuse holder out of its slot.
3. Exchange the two fuses.
4. Put the fuse holder back in its slot and close the lid.

3 System Overview

This chapter provides an overview of the capabilities of the R&S CMW270 and their use. This includes a description of the basic concepts that the tester uses to organize, process and display measurement data. These basic concepts are valid for all firm-ware applications.

3.1 Generators

A generator provides a configurable RF signal for test purposes. The R&S CMW270 provides the "General Purpose RF" (GPRF) generator and generators for various network standards.

All generator applications are similar in structure, although the generated signals differ in many of their properties. The following topics describe common features of the generators. For a sample session refer to [chapter 2.3.1, "Generating an RF Signal"](#), on page 28.

3.1.1 Generator Control

Generators can be in the "ON" or "OFF" states. In the default configuration, all generators are switched off; no output signal is available. The generator state is shown in the generator control softkey.



- ▶ To turn the generator on or off, select the generator control softkey and press ON | OFF.

As soon as an output signal is available at the selected connector, the control softkey indicates the "ON" state:





"Generator pending" state

Depending on the generator type and configuration, the R&S CMW270 may require some time to provide the generator signal. E.g. the ARB generator signal is available only after a waveform file has been loaded:



While the generator is turned on but still waiting for resource allocation, adjustment, hardware switching, a yellow sandglass symbol in the generator control softkey indicates the "generator pending" state.



The yellow symbol disappears as soon as the generator signal is available.

The "pending" state is also indicated while the generator is turned off but the resources have not yet been released.

3.1.2 RF Path Settings (Generators)

The R&S CMW270 provides a number of settings that are very similar in different generators but can be configured independently. These settings control the routing of signals and the generator level.

Signal Routing Settings (Output)

The R&S CMW270 provides several RF connectors at the front panel. The RF output connector and the TX module to be used are selected in the "RF Routing" section at the beginning of the generator configuration dialogs.

External Attenuation (Output)

Defines the value of an external attenuation (or gain, if the value is negative) in the output path. This is suitable if the RF generator is to compensate for the effect of a frequency-independent attenuating component in the test setup (e.g. a non-ideal cable, a test fixture or an RF shielding chamber used to hold the DUT), or an amplifier.

Additional settings for compensation of a frequency-dependent attenuation/gain are provided by the base system of the instrument. They allow to define correction tables containing pairs of frequencies and associated attenuation/gain values.

If a table is activated for an output connector, the correction value associated with the current carrier frequency and the frequency-independent "External Attenuation" defined in the generator settings are added. Correction values for intermediate frequencies between two frequency entries are calculated using linear interpolation. For frequencies higher than the highest frequency entry in the table, or lower than the lowest frequency entry, the correction value associated with the highest / lowest frequency entry is used.

With a total external attenuation of x dB, the generator power is increased by x dB so that the actual generator power differs from the output power shown in the dialog. The output power in the dialog is available at the input of the DUT. Negative values of the external attenuation decrease the effective generator power.

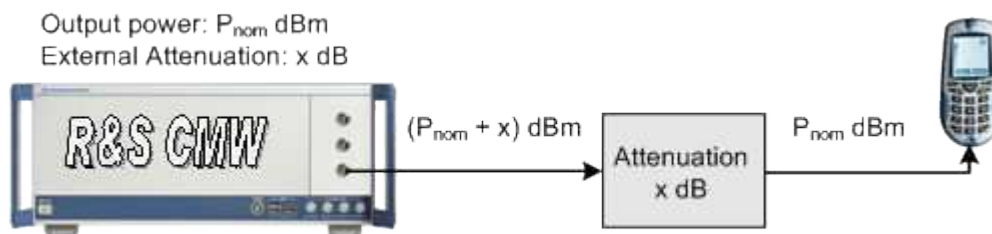

Frequency-independent attenuations are defined as part of the generator settings, refer to the description of the generator application. Frequency-dependent correction tables are administrated in the setup dialog or via remote commands (...:FDCorrection:...).

While a correction table is active for the connector currently used by an application, the GUI of the application displays the table name together with the frequency-independent attenuation setting.

External Attenuation 0.0 dB **FDCorr!** TableName: mytable

The table entries can be displayed by clicking the button "FDCorr!".

3.1.3 Real-Time and Arbitrary (ARB) Generators

The properties of real-time generator signals are based on the settings in the generator configuration dialogs. An example for a real-time signal (dual-tone GPRF signal) is described in section [chapter 2.3.1, "Generating an RF Signal"](#), on page 28.

In contrast, the arbitrary (ARB) generator signal is based on a "waveform file" (typically, a file generated with R&S WinIQSIM) which is loaded and processed at runtime. For details refer to the "GPRF Generator" description.

The R&S CMW270 provides real-time and ARB generator signals for many network standards. Both generator types have their specific advantages.

Use an ARB generator if you wish to:

- Utilize the flexibility of R&S WinIQSIM2 in configuring the signal properties
- Re-use signal that you have once configured
- Quickly alternate between signals with different properties (multi-segment files)

Use a real-time generator if you wish to:

- Quickly re-configure signals and test the effects without loading a new waveform file
- Generate signals with arbitrary length (e.g. for the transmission of long PRBS sequences)
- Use dynamic features such as TPC sequences for WCDMA tests

3.2 Measurements

The R&S CMW270 provides several measurements for each of the supported network standards or general purpose applications. All measurements are controlled in an analogous way. The following topics describe the principles of measurement control and measurement results that are similar in many measurement contexts. For a sample session refer to [chapter 2.3.2, "Measuring an RF Signal"](#), on page 30.

3.2.1 Measurement Control

Measurements can be in the "RUN", "RDY", or "OFF" states. In the default configuration, all measurements are switched off; no results are available. The measurement state is shown in the measurement control softkey.



- ▶ To turn the measurement on or off, select the measurement control softkey and press ON | OFF or RESTART | STOP.

The behavior of the measurement control softkey depends on the "Repetition" mode selected in the configuration dialog:

- If the measurement is turned on in "Single-Shot" repetition mode, it enters the "RUN" state and returns to "RDY" as soon as a single-shot result has been acquired.

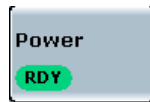

- If the measurement is turned on in "Continuous" repetition mode, it remains in the "RUN" state until it is turned off explicitly using the measurement control softkey or the front panel keys (ON/OFF or RESTART/STOP).



3.2.2 Connection Control (Measurements)

The R&S CMW270 provides a number of settings that are very similar in different measurements but can be configured independently. These settings control the routing of input signals, the correction of the input power, the RF analyzer and trigger system.

Signal Routing Settings (Input)

The R&S CMW270 provides several RF connectors at the front panel. The RF input connector and the RX module to be used are selected in the "RF Routing" section at the beginning of the measurement configuration dialogs.

External Attenuation (Input)

Defines the value of an external attenuation (or gain, if the value is negative) in the input path. This is suitable if the test setup contains a frequency-independent attenuating component (e.g. a non-ideal cable, a test fixture or an RF shielding chamber used to hold the DUT), or an amplifier.

Additional settings for compensation of a frequency-dependent attenuation/gain are provided by the base system of the instrument. They allow to define correction tables containing pairs of frequencies and associated attenuation/gain values.

If a table is activated for an input connector, the correction value associated with the current carrier frequency and the frequency-independent "External Attenuation" defined in the measurement settings are added. Correction values for intermediate frequencies between two frequency entries are calculated using linear interpolation. For frequencies higher than the highest frequency entry in the table, or lower than the lowest frequency entry, the correction value associated with the highest / lowest frequency entry is used.

The total correction value (frequency-independent "External Attenuation" + frequency-dependent correction) modifies the power reading of the measurement and ensures that the measured powers are referenced to the output of the DUT.

- Positive values increase the power reading, compensating for an attenuation.
- Negative values reduce the power reading, compensating for an amplification factor (gain).

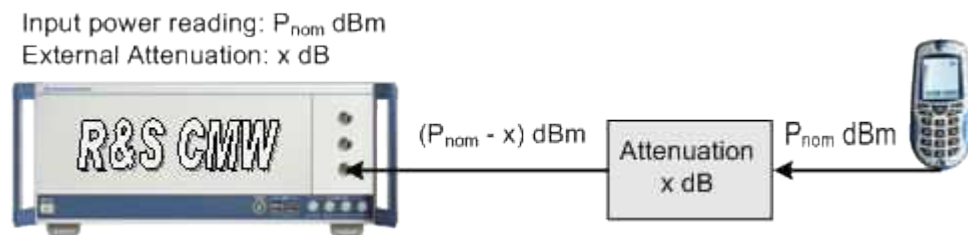

The external attenuation also enters into the internal calculation of the maximum input power that the R&S CMW270 can measure (see "Expected Nominal Power" below).

Frequency-independent attenuations are defined as part of the measurement settings, refer to the description of the measurement application. Frequency-dependent correction tables are administrated in the setup dialog or via remote commands (...:FDCorrection:...).

While a correction table is active for the connector currently used by an application, the GUI of the application displays the table name together with the frequency-independent attenuation setting.

External Attenuation 0.0 dB **FDCorr!** TableName: mytable

The table entries can be displayed by clicking the button "FDCorr!".

Expected Nominal Power

Defines the nominal power of the RF signal to be measured. The nominal power should be set in accordance with the actual transmitter output power of the DUT; an additional "External Attenuation" (see above) can be used to compensate for the loss in the test setup. Some measurements provide additional parameters to account for variations of the signal power (e.g. the "User Margin" for the GPRF Power measurement).

With an inappropriate setting of the expected nominal power, the measurement results generally deteriorate:

- If the "Expected Nominal Power" setting is too low, the RF input connector is overdriven. This can cause unwanted responses in the input path.
- If the "Expected Nominal Power" setting is too high, the RF input connector is underdriven, which also impairs the accuracy of the measurements.

Analyzer Frequency

Sets the center frequency of the RF analyzer. This value must be in accordance with the measured RF signal in order to obtain meaningful measurement results.

3.2.3 Statistical Settings

Measurements generally cover a basic time interval and can be repeated periodically. The measurement interval depends on the measurement context.

The number of measurement intervals that the R&S CMW270 repeats in order to calculate statistical results is termed "statistic count" or "statistic length" (multi-measurement count). After one statistic count, the instrument has terminated a basic measurement cycle ("single-shot" measurement). Measurement cycles can be repeated for an unlimited number of times, resulting in the "continuous" repetition mode.

Most measurement contexts provide different sets of measurement results. They are calculated as described in [chapter 3.2.4, "Statistical Results"](#), on page 57.

The statistical settings described below are set in the configuration dialogs assigned to each measurement.

Statistic Count / Measurement Cycle

The statistic count (also termed statistic length) is the integer number of measurement intervals per measurement cycle (statistics cycle, single-shot measurement). The length of a measurement interval is measurement-specific. Conformance measurement specifications often request a certain number of repetitions of a particular measurement. Select the statistic count accordingly. The required statistics for the measurement is then reached after one measurement cycle (single shot).

Measurement interval examples:

- The measurement interval for the GPRF Power measurement is a configurable time interval termed the Measurement Length/Step Length. This corresponds to either a single power step (if no sequence mode is active) or a step sequence.
- The measurement interval for the GPRF External Power Sensor measurement is the time to request and obtain a single power result from the power sensor.
- The measurement interval in most network test applications is related to a network-specific periodic time interval, e.g. a timeslot or burst.

Depending on the repetition mode (see below), a measurement may extend over one or several measurement cycles.



Statistic length in continuous measurement

The statistic length has an impact on continuous measurements because it enters into the averaging procedures, see [chapter 3.2.4.4, "Averaging"](#), on page 60.

Repetition Mode

The repetition mode defines how many statistics cycles are measured. Two modes are available for all measurements:

- **Single-Shot:** The measurement is stopped after one statistics cycle.
- **Continuous:** The measurement is continued until explicitly terminated by the user; the results are periodically updated.



Manual and remote control

In contrast to other instrument settings, the repetition modes in manual and remote control are independent and do not overwrite each other. The default repetition mode in manual control is "Continuous" (observe results over an extended period of time). The default mode in remote control is "Single-Shot" (perform one measurement and retrieve results).

Stop Condition

For measurements providing a limit check, two stop conditions can be selected:

- **None:** The measurement is performed according to its "Repetition" mode and "Statistic Length", irrespective of the limit check results.
- **On Limit Failure:** The measurement is stopped as soon as one of the limits is exceeded, irrespective of the repetition mode set. If no limit failure occurs, it is performed according to its "Repetition" mode and "Statistic Length". Use this setting for measurements that are essentially intended for checking limits, e.g. production tests.

3.2.4 Statistical Results

The R&S CMW270 repeats the measurements according to the selected statistic count and repetition mode.

Consecutive measurement values are stored and used to calculate statistical results. The following sections describe the calculation of statistical results in detail.

3.2.4.1 Statistics Type

The statistics type defines how the R&S CMW270 calculates the displayed values if the measurement extends over several measurement intervals. Assume that a trace or a bar graph contains a series of different measurement points. After n consecutive measurement intervals, the instrument has collected n complete traces, corresponding to n measurement results at each point.

The different statistics types are calculated as follows:

- **Current:** the current trace, i.e. the last result at all measurement points
- **Minimum:** the smallest of the n collected values at each measurement point
- **Maximum:** the largest of the n collected values at each measurement point
- **Average:** a suitably defined average over all collected values at each measurement point
- **Standard Deviation:** the root mean square deviation of all collected values at each measurement point from the "Average" value

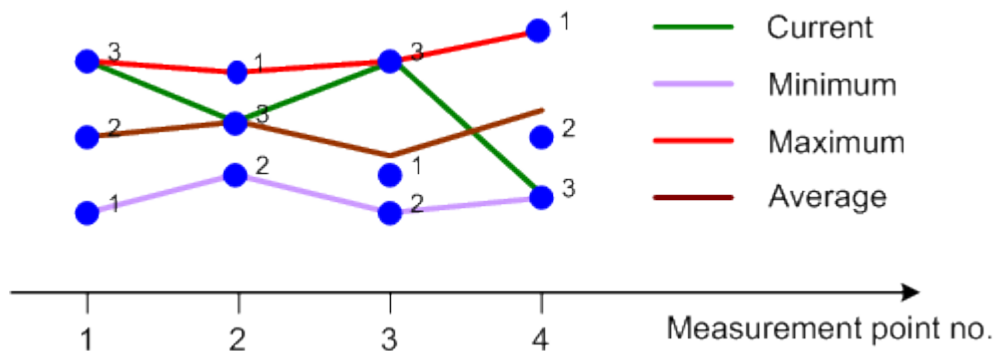

Fig. 3-1: Statistics Types



Differences between statistical calculations

Minimum/Maximum and Average results are calculated differently if the measurement extends over more than one statistics cycle (repetition mode "Continuous", measurement time longer than one statistics cycle):

- The "Minimum" and "Maximum" values represent the smallest and largest values ever measured.
- The "Average" result is referenced to the last statistics cycle.

The statistics type of the displayed trace generally belongs to the display configuration settings in the measurement configuration dialogs. For single measurement results, the R&S CMW270 often displays a table with all statistics types.

The statistics type is often combined with detector settings.

3.2.4.2 Detectors

The detector setting specifies how a single measurement result is calculated from a set of adjacent measurement points:

- **RMS:** The displayed result represents the RMS average (e.g. the mean power) in a specified measurement interval. Over-estimation of stochastic signals (noise) is avoided.
- **Minimum:** The displayed result represents the minimum value in a specified measurement interval. Narrow peaks cannot be smoothed out due to averaging.
- **Maximum:** The displayed result represents the maximum value in a specified measurement interval.

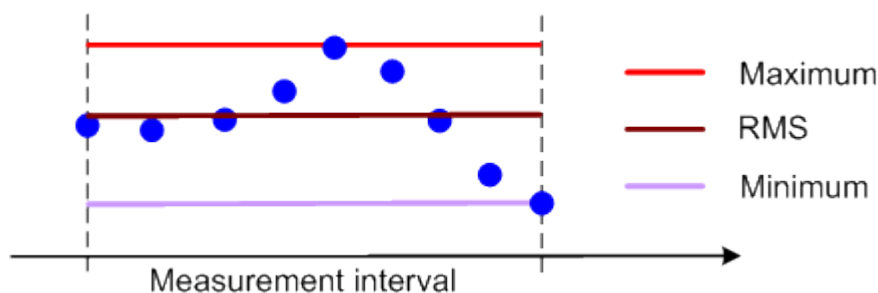

Fig. 3-2: Detector Type

The measurement interval varies from one measurement to another; it is typically a particular time or frequency interval.

Detector and statistics type settings can be combined. E.g. in the GPRF Power measurement, the following results are available:

- **Statistics type: Current, Detector: RMS:**
The current trace, calculated from RMS-averaged values over the specified "Measurement Length".
- **Statistics type: Current, Detector: Minimum:**
The current trace, calculated from minimum values within the "Measurement Length".
- **Statistics type: Current, Detector: Maximum:**
The current trace, calculated from maximum values within the "Measurement Length".
- **Statistics type: Average, Detector: RMS:**
The average trace, calculated from RMS-averaged values over the "Measurement Length".
- **Statistics type: Minimum, Detector: Minimum:**
The minimum trace, calculated from minimum values within the "Measurement Length".
- **Statistics type: Maximum, Detector: Maximum:**
The maximum trace, calculated from maximum values within the "Measurement Length".

3.2.4.3 Peak Values

"Peak" values are calculated as the maximum of the magnitude times the sign:

- For positive quantities such as the EVM, the peak value is equal to the maximum.
- For negative quantities such as the I/Q offset and the I/Q imbalance, expressed in dB, the peak value is equal to the minimum.
- For symmetric quantities with alternating sign such as the phase, frequency or timing error, the peak value is either the maximum or minimum, whichever has the larger magnitude.

3.2.4.4 Averaging

In single-shot measurements, "Average" values (traces and single values) are calculated as the arithmetic mean value over all measurement intervals since the start of the measurement. Assume that n measurement intervals have been measured. The average result at each measurement point is obtained recursively from the preceding $(n - 1)^{\text{st}}$ average result and the n^{th} current result.

Equation 1:

$$Avg(n) = \frac{n-1}{n} \cdot Avg(n-1) + \frac{1}{n} \cdot Cur(n)$$

To obtain average traces, the R&S CMW270 calculates the average of consecutive measurement intervals at each trace point.

The formula above is modified for the magnitude error and the phase error, where positive and negative contributions tend to compensate each other. The "Average" of these quantities is obtained as the average of the absolute values.

Equation 2:

$$Avg(n) = \frac{n-1}{n} \cdot Avg(n-1) + \frac{1}{n} \cdot |Cur(n)|$$

Logarithmic quantities are first averaged and then converted to a dB-value.

Note that the frequency error and timing error, although symmetric, is averaged according to Equation 1.

For continuous measurements after the first statistic cycle, Equation 1 and Equation 2 above are modified in order to ensure that the statistical weight of the last trace measured does not fall below the "statistic length". For a statistic length c (c measurement intervals per cycle) and $n > c$, Equation 1 is replaced by:

$$Avg(n) = \frac{c-1}{c} \cdot Avg(n-1) + \frac{1}{c} \cdot Cur(n) \quad (n > c)$$

As a consequence, the statistic length has an impact on average results obtained in continuous measurements.

3.2.4.5 Standard Deviation

The "Standard Deviation" σ_n indicates the spread of the n values at each measurement point. It is defined as the square root of the variance, which is the mean square of the deviation of the values from their own arithmetic mean.

$$\sigma_n^2 = \frac{\sum_{i=1}^n (x_i - \bar{x}_n)^2}{n}; \quad \sigma_n = \sqrt{\sigma_n^2}$$

The variance can be calculated using the following recursive equation:

$$\sigma_n^2 = \left[(x_n - \bar{x}_{n-1})^2 \cdot \frac{1}{n} + \sigma_{n-1}^2 \right] \cdot \frac{n-1}{n}$$

with the arithmetic mean value:

$$\bar{x}_n = \frac{\sum_{i=1}^n x_i}{n} = x_n \cdot \frac{1}{n} + \bar{x}_{n-1} \cdot \frac{n-1}{n}$$

The formula above is modified for the magnitude error and the phase error, where positive and negative contributions tend to compensate each other. The arithmetic mean value and the standard deviation of these quantities is obtained from the absolute values.

3.2.5 Limit Check

Limits specify the allowed range for a particular set of measurement results. Typically, limits are used to check whether a DUT conforms to the rated specifications (conformance testing):

- An upper limit L_{upp} defines the maximum value for the measurement result R : $L_{\text{upp}} > R$.
- A lower limit L_{low} defines the minimum value for the measurement result R : $L_{\text{low}} < R$.
- A symmetric limit L_{sym} defines the maximum value for the absolute value of the measurement result R : R must be in the symmetric range $-L_{\text{sym}} < R < L_{\text{sym}}$.

A limit check consists of comparing the measurement results to the limits and displaying a pass/fail indication.

The R&S CMW270 provides different tools for viewing limits and limit check results.

- Limit lines show the upper, lower, or symmetric limits for a series of measurement results (measurement trace). In the measurement diagrams, limit lines are displayed in red color. A limit line consisting of different sections is termed a template.
- A pass/fail indication in a table of measurement results shows the limit check result for a single or a statistical result.

The following example shows the template for an 8PSK-modulated GSM burst: To pass the limit check all "Power vs. Time" results must be between the upper and the lower limit lines.

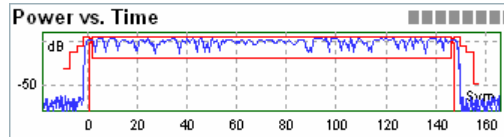

Fig. 3-3: Example of limit lines (GSM)

The pass/fail indication in the result tables have the following meaning.

Table 3-1: Pass/fail indication in tables

Symbol	Meaning
(no indication)	Result passed
▲ 83.62	Result too large, exceeds upper limit
▼ 63.42	Result too small, below lower limit
▲ 60.35	Result too large but not reliable, e.g. because <ul style="list-style-type: none"> the analyzer is overdriven or underdriven the raw measurement data is possibly invalid
▼ 29.30	Result too small but not reliable; see above
▲ ---	Result (probably) too large, but no valid result available
▼ ---	Result (probably) too small, but no valid result available

3.2.6 Measurement Triggers

The trigger system synchronizes a particular measurement with events.

The following sources of trigger events are used in many different measurements:

- The meaning of a "Free Run" trigger is measurement-specific. In most cases, a "Free Run" measurement is not related to any trigger events: The R&S CMW270 measures as fast as possible. However, there are exceptions (e.g. WCDMA measurements) where "Free Run" trigger implies a synchronization to the RF input signal.
- With an "IF Power" trigger, the measurement is started when the level of the measured signal crosses a definite "Trigger Threshold" value. This trigger setting requires an RF input signal with variable power (power ramp, bursts). The trigger event can be set to occur at the rising or falling edge of the bursts.
- An "External" trigger is used to synchronize a measurement to external events. E.g. a DUT providing a frame-periodic RF signal may generate an additional trigger signal to indicate its frame timing. External trigger signals may be fed to one of the trigger connectors "TRIG A" or "TRIG B" at the rear panel of the instrument. For configuration of the connectors see [chapter 4.4.7, "Trigger"](#), on page 104.

- Real-time or ARB generators can generate marker signals, to be used for synchronization of a measurement.
- Signaling applications provide trigger events which are synchronized to their downlink (forward link) signals. Due to the known downlink/uplink timing of the mobile station under test, a signaling trigger is generally appropriate for TX measurements running in parallel. Some measurement results (e.g. the timing error) require a signaling trigger as a timing reference.

Many measurements provide additional, specific trigger settings to improve their flexibility and performance.

3.2.6.1 Marker Signals

A marker signal provides events at specific points in time that can be used to synchronize the measurement. A typical example is a marker signal that is included in the waveform files generated by R&S WinIQSIM2.

Marker signals can be selected as trigger sources for measurements. The number and type of available marker signals depends on the installed firmware applications. The R&S CMW270 detects all available marker signals, depending on its hardware/software equipment, and adds them to the list of available trigger sources.

3.2.6.2 Trigger Settings

Trigger settings enhance the flexibility of the trigger system and can help to avoid accidental trigger events. The trigger settings depend on the selected trigger source. No trigger settings apply to most "Free Run" measurements.

The following trigger settings are used in many firmware applications:

- The "Trigger Slope" setting specifies the edge (rising or falling edge) of the trigger signal that is to provide the trigger event. This trigger parameter is applicable to power trigger sources.
- The "Trigger Threshold" defines the power of the trigger signal where the R&S CMW270 generates a trigger event. Trigger signals below the trigger threshold are ignored by the trigger system. This trigger parameter is used for power trigger sources.
- A "Trigger Delay" delays the start of the measurement relative to the trigger event. Typically, a trigger delay is used to compensate for known propagation delays in the test setup or a known timing offset of the measured signal relative to the trigger signal.
- A "Trigger Timeout" is the maximum time after which an initiated measurement must have received a trigger event. If no trigger event is received, a trigger timeout is indicated in manual operation mode. In remote control mode the measurement is automatically stopped.
- The "Minimum Trigger Gap" defines the minimum duration of the power-down periods (gaps) between two triggered power pulses. It can be used to prevent unwanted trigger events due to fast power variations.

3.2.7 TX Measurements

The purpose of a TX measurement is to assess the performance of an RF transmitter. Despite the differences in detail, TX measurements for different network standards have many properties in common.

3.2.7.1 Power Results

Power measurements are essential, e.g. for checking whether the transmitter output power complies with the power class of the device under test, or testing various power control mechanisms.

The R&S CMW270 provides two different types of power results:

- Most of the power results are averaged over an appropriate time/frequency interval (e.g. a WiMAX burst). Average powers are used to check whether a transmitter produces the correct output power.
- Traces for the power versus time show a series of consecutive power steps or give detailed insight into the transmitted power, including the structure of power ramps and possible effects of the modulation.

For details refer to the description of the measurement firmware application.

3.2.7.2 Modulation Accuracy

Modulation accuracy is the ability of the UE transmitter to generate an ideally modulated signal. Modulation accuracy is assessed by a number of quantities which are analogous for all digital phase modulation schemes.

The modulation parameters are acquired in a single measurement process. The calculation is based on the comparison of the actual output signal Z of the transmitter under test with a reference signal R that is generated by the R&S CMW270 and represents an ideal error-free received signal.

An example for the process (WCDMA signals) is described in specification 3GPP TS 34.121, Annex B.

For a detailed description for WIMAX signals refer to the description of the "WiMAX Measurement" firmware application.

Timing and Frequency Error

The R&S CMW270 must establish time synchronization with the input RF signal and estimate its timing, carrier frequency and power. The frequency error is the offset of the measured carrier frequency from the nominal RF frequency of the measured radio channel.

The calculated reference signal R is modified using the estimated timing, frequency error and power. The resulting corrected reference signal R' is used to determine the error vector magnitude, magnitude error and phase error.

The timing error is the deviation of the measured signal timing from the expected timing, which is generally derived from a trigger event.

Error Vector Magnitude (EVM), Phase Error, Magnitude Error, Code Domain Error

The error vector $E = Z - R'$ is calculated as an array at each sample in the measurement interval. From E and Z the following arrays can be calculated:

$ E = Z - R' $	Magnitude of the error vector , calculated at each sample in the measurement interval.
$\Delta\phi$	Phase error
$ Z - R' $	Magnitude error

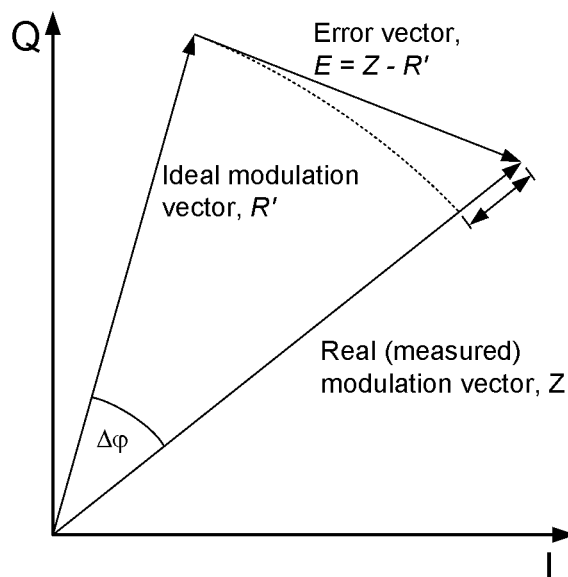

In general the measurement dialogs show the relative magnitude error and the relative EVM, i.e. the quantities defined above divided by the magnitude of the ideal modulation vector $|R'|$.

The **Error Vector Magnitude** is calculated as the ratio of the RMS value of E to the RMS value of R' in percent or in dB:

$$EVM [\%] = RMS (E) / RMS (R') * 100\%$$

$$EVM [dB] = 20 \log (EVM [\%]/100\%)$$

The **Code Domain Error** (CDE) is calculated as follows: The error vector $E = Z - R'$ is descrambled and projected onto all code channels of a specific spreading factor (SF). For each of the resulting projected error vectors E_k ($k = 0$ to $SF - 1$), the RMS value is calculated. The CDE is calculated as the ratio of this RMS value to the RMS value of R' in dB, i.e. $PCDE = 20 * \log [RMS (E_k) / RMS (R')] dB$.

The **Peak Code Domain Error** (PCDE) is the maximum code domain error. It is calculated as the ratio of the maximum of the RMS values of E_k to the RMS value of R' in dB, i.e. $PCDE = 20 * \log [\max RMS (E_k) / RMS (R')] dB$.

The EVM is averaged over a WiMAX burst as described in section "Measurement Results" in the description of the "WiMAX measurement" firmware application.

I/Q Offset, I/Q Imbalance, Waveform Quality

The following figure is an idealized representation of the modulation errors where the effects of a pure origin offset (first diagram) and of a pure I/Q imbalance (second diagram) are completely disentangled.

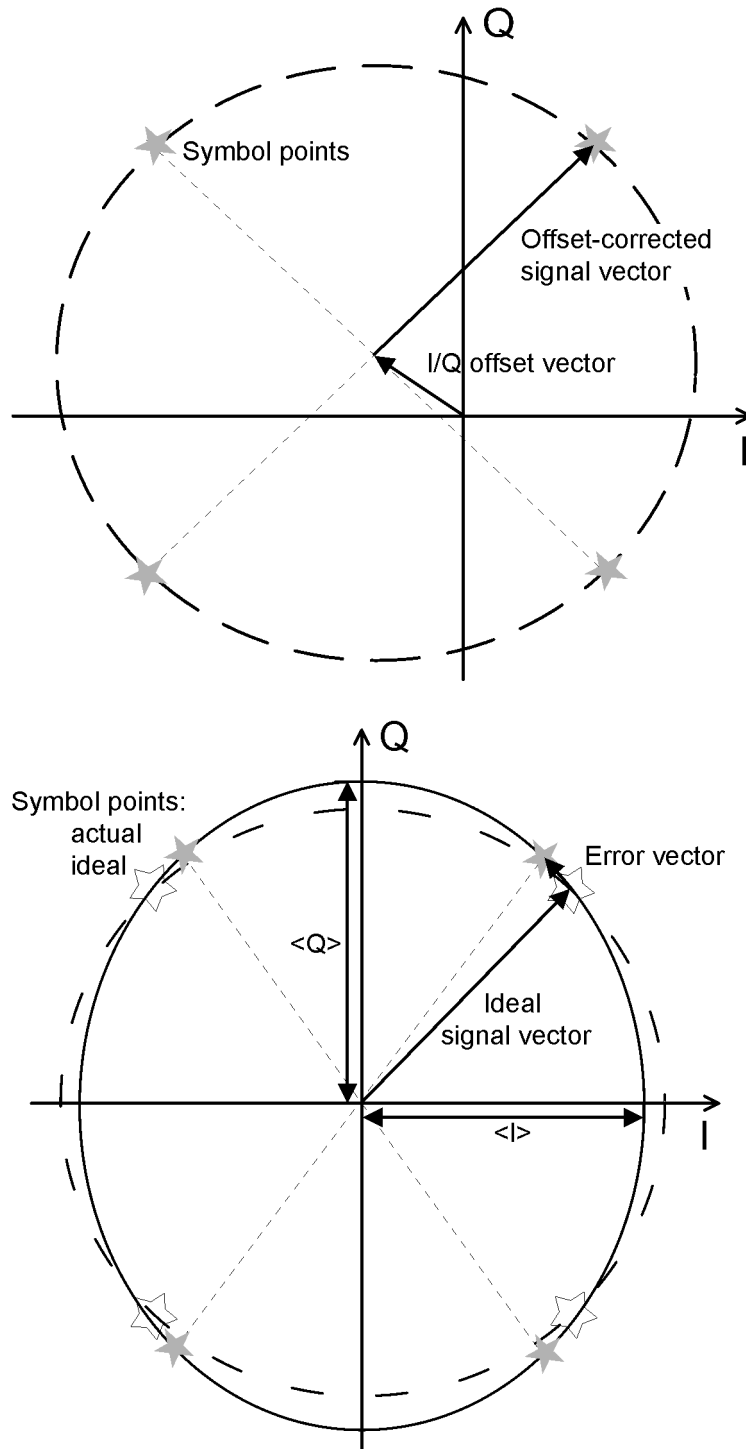

The **I/Q offset** in dB (or dBc, according to some network standards) is the logarithmic ratio of the I/Q offset vector (i.e. the estimated DC-offset of the measured signal) to the average offset-corrected signal vector:

$$\text{Origin Offset} = 20 \log \frac{|\text{I/Q offset vector}|}{|\text{Offset-corrected signal vector}|_{\text{RMS}}}$$

In the equation above, $|\text{Offset-corrected signal vector}|_{\text{RMS}}$ denotes the magnitude of the offset-corrected signal vector that is RMS-averaged over all samples.

The **I/Q imbalance** in dB is equal to the difference between the estimated I and Q amplitudes of the measured signal, which are normalized and logarithmized as follows:

$$\text{I/Q Imbalance} = 20 \log \frac{|\langle I \rangle - \langle Q \rangle|}{|\langle I \rangle + \langle Q \rangle|}$$

From the I/Q imbalance the R&S CMW270 derives the gain imbalance and quadrature mismatch as described in section "Measurement Results" in the description of the "WiMAX measurement" firmware application.

The **waveform quality** or rho factor is a measure for the modulation accuracy and corresponds to the normalized correlated power between the actual waveform and the ideal waveform sampled at the constellation points. It is defined as:

$$\text{Waveform Quality} = \frac{|\sum_k R'_k Z_k^*|^2}{\sum_k |R'_k|^2 \sum_k |Z_k|^2}$$

where R'_k is the k^{th} sample of the ideal signal, Z_k is the k^{th} sample of the measured signal (both in complex representation) and the sums run over all samples. For an ideal transmitter ($Z_k = R_k$ for all k), the waveform quality is equal to 1. For real transmitters, the waveform quality is a positive real number smaller than 1.

In some network applications (e.g. WCDMA), it is possible to select different algorithms for the modulation analysis:

- In the analysis "With Origin Offset", the modulation vectors R and Z for the EVM calculation are measured from the origin of the I/Q plane, so the results for the EVM, phase error and magnitude error include a possible origin offset.
- In the analysis "Without Origin Offset", the modulation vectors R and Z for the EVM calculation are measured from the coordinates of the I/Q offset vector, so the origin offset is subtracted out in the EVM, phase error and magnitude error results.

3.2.7.3 Adjacent Channel Power (Spectrum)

The R&S CMW270 measures the transmitter output spectrum emissions in a symmetric frequency range centered on the nominal RF carrier frequency. The spectrum emissions are a measure of the amount of energy that spills outside the designated radio channel. An excess amount of off-carrier power increases the interference with adjacent channels and decreases the system capacity.

The off-carrier power can be assessed by several complementary quantities:

- The Adjacent Channel Leakage power Ratio (**ACLR**) is the ratio of the power measured in an adjacent channel (Adjacent Channel Power, **ACP**) to the transmitted carrier power, expressed in dB.
- In GSM networks, the "ACP Modulation" is measured on a portion of the useful part of the burst, excluding the power ramps and the training sequence. The result is a measure for the part of the spectrum that is due to the modulation of the GSM signal. In contrast, the "ACP switching" result is the peak power within a minimum number of bursts. This result assesses the switching transients, i.e. the part of the spectrum that is due to the power ramp-up and down of the signal.



Sign conventions

According to the definition above, the sign of the ACLR values is usually negative. This is in line with the ACLR definition for networks like GSM and TDMA but differs from the sign convention for WCDMA (3GPP/FDD); see specification 3GPP TS 34.121. To make results comparable, the R&S CMW270 uses the GSM sign convention for all network standards.

Spectrum Emission Mask

The "Spectrum Emission Mask" is a template to limit the out-of-band emissions in a frequency range around the center carrier frequency. Spectrum emission mask conformance tests are specified e.g. for CDMA standards. The spectrum emission mask complements the requirements for the adjacent channel power.

In the figure below, the red lines represent the spectrum emission mask for UL WCDMA signals (3GPP/FDD 3.84 MHz). The emission mask comprises different sections. In addition to the limit lines the standard specifies IF filter settings for each section.

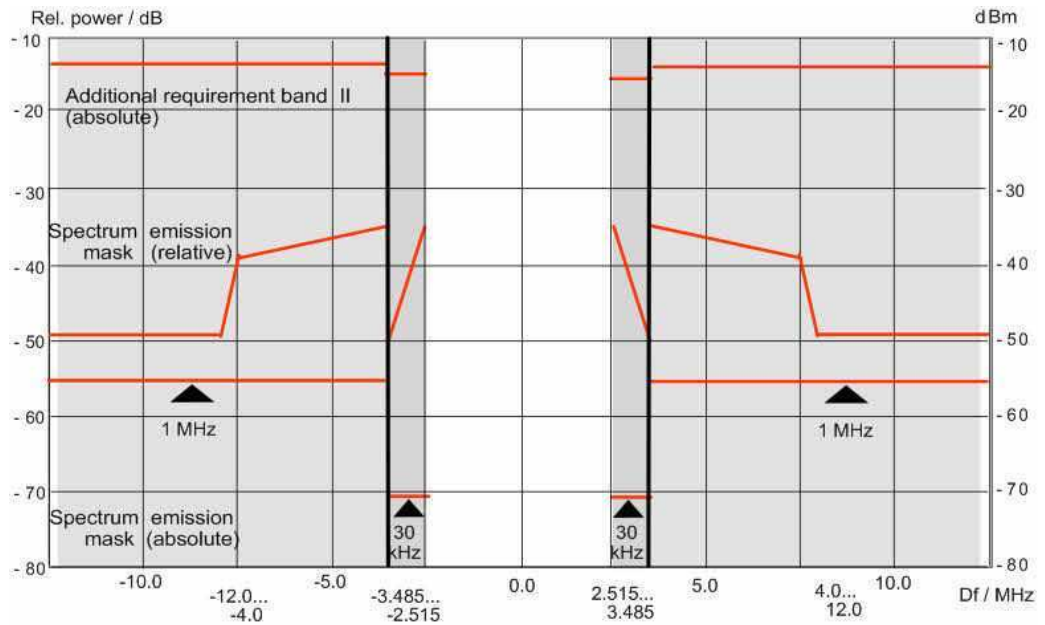

Fig. 3-4: Spectrum emission mask (WCDMA/FDD 3.84 MHz)

Occupied Bandwidth (OBW)

For wideband and OFDM(A) signals, the "Occupied Bandwidth" is the width of a symmetric frequency interval around the nominal RF carrier frequency that contains 99 % of the total integrated power of the transmitted spectrum. The occupied bandwidth shows whether the signal is confined to the assigned bandwidth of the channel. The following figure shows the occupied bandwidth for a WCDMA signal. The dark shaded area corresponds to the nominal bandwidth of 5 MHz.

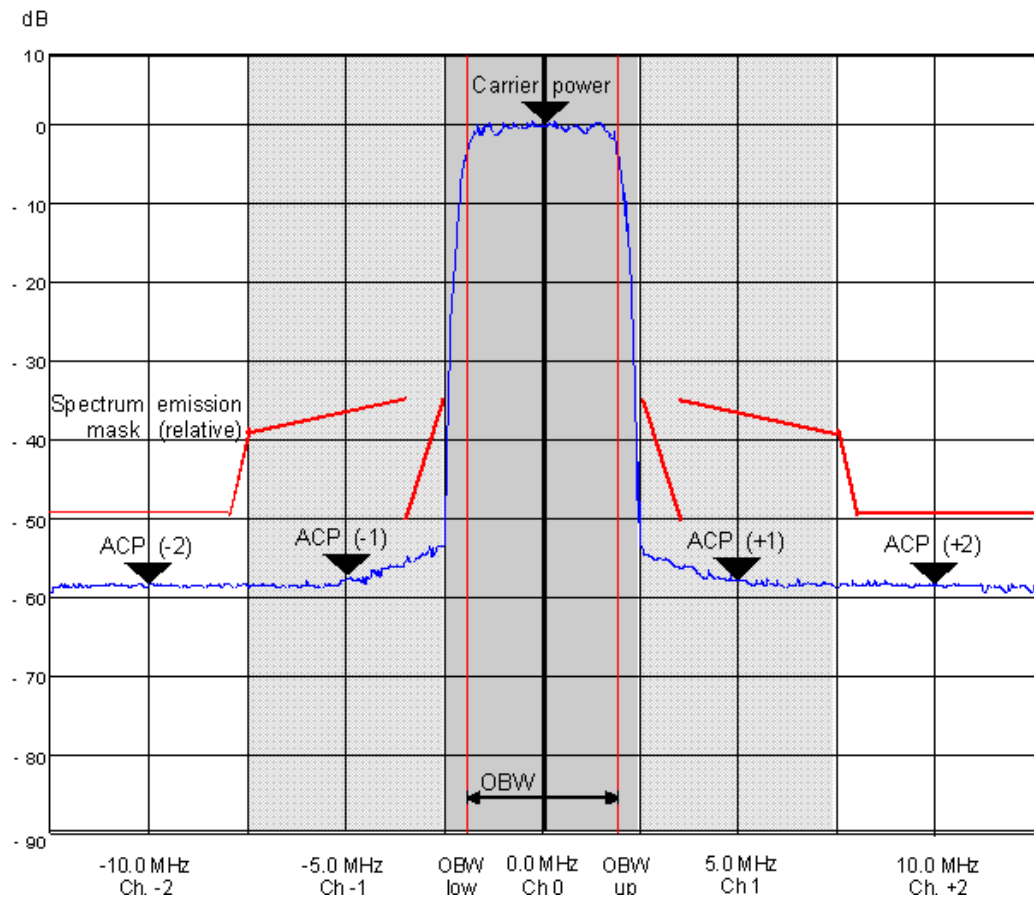

Fig. 3-5: Occupied bandwidth (WCDMA/FDD 3.84 MHz)

3.2.7.4 Code Domain Power

A Code Domain Power (CDP) measurement provides the power of the individual code channels of a CDMA signal. The power in each code channel is averaged over a suitable time interval (e.g. a slot) and expressed in dB, relative to the power of the total, composite CDMA signal.

Typically, the following measurement tasks can be performed:

- Compare different physical channel powers within a CDMA signal
- Compare the observed channel powers with the signaled values (gain factors)
- Monitor active and inactive channels

In the following figure, the CDP of the DPCCH and the DPDCH in an uplink WCDMA signal is displayed over a measurement period of 120 WCDMA slots. The average DPDCH power is approximately 1 dB above the average DPCCH power.

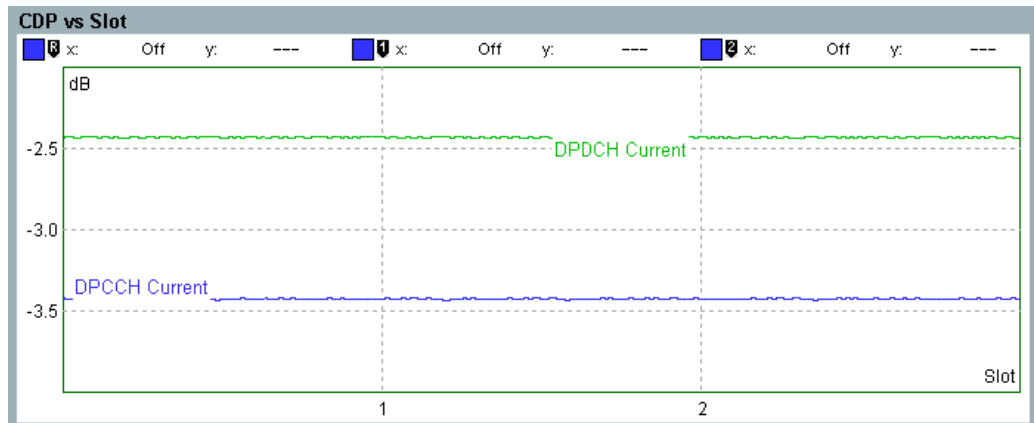

3.2.7.5 I/Q Constellation Diagram

The constellation diagram shows the modulation symbols as points in the I/Q plane.

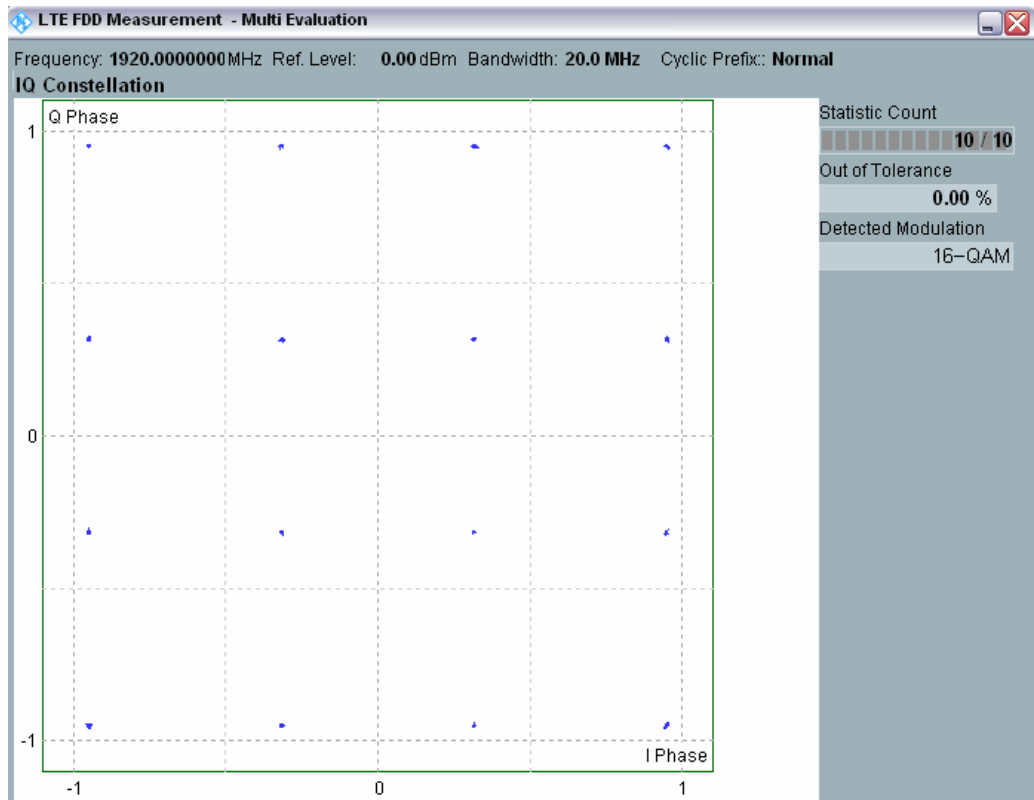

Fig. 3-6: LTE Multi Evaluation: I/Q Constellation diagram

The constellation diagrams depend on the modulation type; for details refer to the description of the individual firmware applications. The diagrams are normalized such that the average distance of all points from the origin is 1.

Constellation diagrams give a graphical representation of the signal quality and can help to reveal typical modulation errors causing signal distortions, as shown in the

table below. In practice, the received signal will show a combination of the modulation errors listed.

Modulation error	Description / cause	Effect in the constellation diagram
I/Q imbalance	Caused by different gains of the I and Q components	One of the components is expanded, the other compressed
I/Q origin offset	Caused by an interfering signal at the RF carrier frequency	All constellation points are shifted by the same vector
Interferer	Non-coherent single-frequency spurious signal in the frequency band, superimposed on the modulated signal	Rotating pointer superimposed on each constellation point, causes circular constellation points
Gaussian noise	Uncorrelated interfering signals	Fuzzy constellation points
Phase error	Phase shift between I and Q components different from 90 deg	Non-orthogonal I and Q components
Phase noise	Uncorrelated phase error	Rotationally spreading constellation points
Amplitude compression	Large amplitudes below the nominal value, caused by non-linear components in the transmission path	Corner points move towards the center
Unused detected subcarriers (in OFDMA systems)	An unused/inactive subcarrier is measured, most likely due to a mismatch between the TX measurement settings and the measured signal	Unexpected constellation close to the origin (zero signal power)

3.2.7.6 Multi Evaluation Measurements

In a multi evaluation measurement, the R&S CMW270 acquires a wide range of measurement results at once.

For example, the GSM multi evaluation measurement provides the most important GSM mobile transmitter test results described in specification 3GPP TS 51.010:

- The transmitter output power versus time
- Results that describe the modulation accuracy: Error vector magnitude (EVM), phase error, frequency error for each symbol, normalized I/Q vector at and between the decision points (I/Q constellation, vector and phase diagrams)
- Results that describe the output RF spectrum: adjacent channel power (ACP) due to modulation and due to switching, ACP versus time

The WiMAX multi evaluation measurement assesses the modulation accuracy, frequency error, power, crest factor, and spectral flatness in the measured burst as described in section "Measurement Results" in the description of the "WiMAX measurement" firmware application.

Compared to independent TX measurements, multi evaluation measurements provide several advantages:

- They ensure highest measurement speed.

- They provide a comprehensive picture of the performance of a tested RF transmitter with a minimum of effort for configuring the R&S CMW270.
- They provide "linked" results: The different measured quantities are all based on the same set of raw measurement data.

In remote control, it is possible to control each multi evaluation measurement as a whole but retrieve the different types of results separately.

Controlling multi evaluation measurements

A multi evaluation measurement is controlled like any other measurement using the measurement control softkey.



Measurement results and settings

Multi evaluation measurement results are displayed in a common measurement dialog which may comprise several diagrams (views) and other output elements. In general, it is possible to modify the display settings, e.g. in order to zoom in on a single diagram.

Measurement settings for the different views are also part of a common configuration dialog. Many parameters (e.g. the connection control settings and statistical parameters) affect the entire multi evaluation measurement.

Measurement speed considerations

A multi evaluation measurement ensures that the entire set of results is acquired and processed as quickly as possible. If only a part of the results is needed, it can be preferable to restrict the scope of the measurement in order to gain additional speed.

Example: Disabling the ACLR results in the GSM multi evaluation measurement speeds up the measurement of the modulation accuracy.

3.2.8 RX Measurements

The purpose of an RX measurement is to assess the performance of an RF receiver. The R&S CMW270 transmits a definite bit pattern on the downlink (forward) RF signal. The device under test demodulates the received signals; the percentage of bits or data blocks received in error is counted.

There are different methods of assessing the receiver quality:

- In a single-ended receiver quality test, the received bit sequence is evaluated at the DUT. The measurement requires a real-time or ARB RF generator; no R&S CMW270 measurement application is needed.
- In a loop test the DUT is commanded into an operating mode where it loops back the received data. The R&S CMW270 demodulates the uplink (reverse) signal and compares the received bits with the original pattern. The bit error rate is calculated, assuming no transmission errors in the uplink. The loop test requires an RF gener-

ator in combination with a measurement application. No signaling functionality is required.

- Signaling applications provide integrated receiver quality tests. The receiver quality is assessed with an established network connection; the details are network-dependent. The R&S CMW270 controls the DUT such that it can either loop back the received data or send acknowledge (ACK) or not acknowledge (NACK) messages to indicate whether it could successfully receive a data packet or frame.

The Bit Error Rate (BER) is defined as the percentage of bits that the DUT received in error:

$$BER = \langle \text{No. of Bits received in error} \rangle / \langle \text{Total no. of bits} \rangle * 100 \%$$

Similar definitions apply to the Packet Error Rate (PER), Frame Error Rate (FER) etc., refer to the relevant applications.

3.2.9 Markers

Markers are tools for numerical readout of measured data in diagrams. A marker is displayed with a symbol on the trace. At the same time, the coordinates are displayed above the diagram.

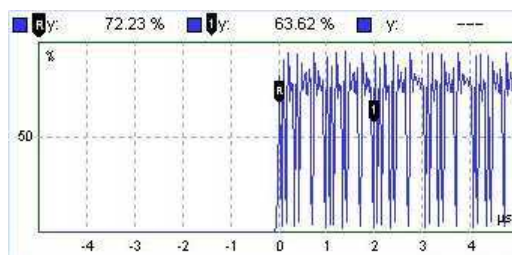

In many views, the R&S CMW270 provides a reference marker (R) and additional markers labeled (1) and (2):

- The reference marker (R) indicates the coordinates of a trace point and defines the reference values for all relative markers.
- The markers (1) and (2) can be configured as absolute or relative markers. Absolute markers indicate the coordinates of a trace point. Relative markers indicate the coordinates relative to the position of the reference marker.

The "Trace Mode" defines whether all markers are always set to the same trace in the view ("Collective" mode) or positioned individually ("Individual" mode).

The marker settings are accessed via the "Marker" softkey. No remote control for markers is provided.

3.3 Signaling Applications

While a signaling application is active, the R&S CMW270 transmits a downlink (forward link) signal to which the mobile station under test can synchronize in order to establish a network connection. With an established connection, the R&S CMW270 can

exchange control messages with the mobile, request the mobile capabilities, and perform various TX and RX tests.

The R&S CMW270 supports the WiMAX and WLAN signaling applications. The following topics describe common features of the signaling applications.

For a sample session refer to [chapter 2.3.3, "Performing Signaling Measurements"](#), on page 32.

3.3.1 RF Path Settings

The R&S CMW270 provides a number of settings that are very similar in different signaling applications but can be configured independently. These settings control the routing of signals and the signal levels.

The R&S CMW270 provides various RF connectors at the front panel. The standard test setup uses a bidirectional connection between the mobile under test and one of the bidirectional (COM) connectors of the R&S CMW270.

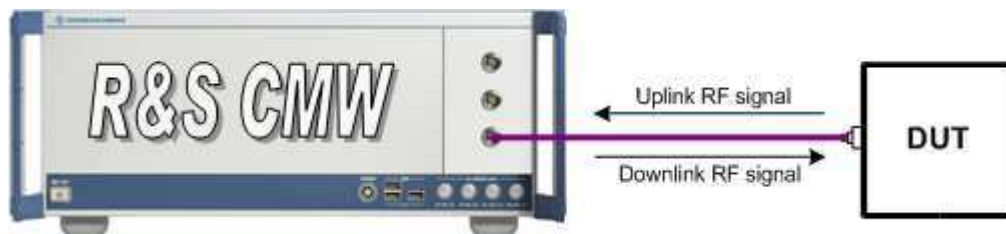

The RF connectors and other basic signal settings are configured in the "RF Settings" section at the beginning of the configuration dialogs. In contrast to generator or (TX) measurement applications, signaling applications provide output **and** input signal settings.

The RF settings are analogous to the settings in the generator applications (output) and measurement applications (input).

For details refer to:

- [chapter 3.1.2, "RF Path Settings \(Generators\)"](#), on page 52
- [chapter 3.2.2, "Connection Control \(Measurements\)"](#), on page 54

3.3.2 Control of the Cell State

A downlink signal generator can be in the "ON", "OFF" or "RDY" state. In the default configuration, all signaling generators are switched off; no cell signals are available. The cell state is shown in the signaling control softkey.



- ▶ To turn the signaling generator on or off, select the signaling control softkey and press ON | OFF.

As soon as an output signal is available at the selected connector, the control softkey indicates the "ON" state:



The "RDY" state indicates that the signaling application is ready to receive a handover from another signaling application.



This state is entered when the signaling application has been selected as handover target in another signaling application and all preparations for reception of the handover have been completed. In the "RDY" state, an output signal may be available or not, depending on whether both signaling applications use the same or different resources.



"Pending" state

Depending on the signaling application and its configuration, the R&S CMW270 may require some time to provide the generator signal.

While the signaling generator is turned on but still waiting for resource allocation, adjustment, hardware switching, a yellow sandglass symbol in the control softkey indicates the "pending" state.



The yellow symbol disappears as soon as the signaling generator signal is available.

The "pending" state is also indicated while the signaling generator is turned off but the resources have not yet been released.

3.3.3 Connection States

After the cell signal is available, the mobile station under test can synchronize to the signal and attempt a registration so that it is possible to set up a network connection. The connection states and state transitions are network-specific; refer to the description of the individual signaling application.

When the connection is established, the R&S CMW270 is ready to perform signaling tests.

3.4 Sub-Instruments

An instrument with several RX and TX signal paths can either be used as one (sub-)instrument or it can be split into several sub-instruments which operate independently. This section provides basic information related to both modes.

In the factory default configuration, all resources are grouped together in a single sub-instrument. Splitting the instrument can help to run tasks in parallel, and minimize the risk of resource conflicts between these tasks.

Related topics:

- [chapter 4.7, "Instrument Setup Dialog"](#), on page 119
- [chapter 5.4.6, "Resource and Path Management"](#), on page 168
- [chapter 5.4.5, "Signal Path Settings"](#), on page 161

3.4.1 One Sub-Instrument

This section describes an instrument with all resources grouped together in a single sub-instrument. As an example, the instrument provides two RX and TX signal paths and two firmware application instances.

The instances are distinguished by the suffixes 1 and 2, e.g. in the "Measurement Controller" dialog or in window titles.

For remote control the instances are also distinguished by these suffixes. All firmware applications can be controlled using the same remote channel. In the "Remote Settings" of the "Setup" dialog the sub-instrument is identified as "Assigned Instrument" = 1.

The table below summarizes these assignments. The firmware applications GPRF Generator and GPRF Power are listed as examples. The instances of all other firmware applications are assigned in the same way.

Table 3-2: Assignments for one sub-instrument with two firmware application instances

	Instance 1	Instance 2
Generator Controller entry	"GPRF Generator 1"	"GPRF Generator 2"
Measurement Controller entry	"GPRF Power 1"	"GPRF Power 2"
Remote commands	...:GPRF:GEN1:... ...:GPRF:MEAS1:POW:...	...:GPRF:GEN2:... ...:GPRF:MEAS2:POW:...
Remote Settings	Assigned Instrument = 1	

Depending on the installed baseband link option each firmware application instance can access an arbitrary RX and TX signal path or only a fixed signal path. The available baseband link options are the flexible link (R&S CMW-S550B/M) and the fixed link (R&S CMW-S550A).

The following table lists the accessible RX and TX modules for an instrument with two RX and TX signal paths.

Table 3-3: Accessible RX/TX modules depending on baseband link

	Instance 1	Instance 2
Flexible link	RX 1, RX 2, TX 1, TX 2	RX 1, RX 2, TX 1, TX 2
Fixed link	RX 1, TX 1	RX 2, TX 2

Each RX and TX module is fix connected to one frontend and can only access the RF connectors of this frontend.

For an instrument with two RX and TX signal paths and two frontends this results in the following assignments:

- RX 1: RF 1 COM, RF 2 COM
- RX 2: RF 3 COM, RF 4 COM
- TX 1: RF 1 COM, RF 1 OUT, RF 2 COM
- TX 2: RF 3 COM, RF 3 OUT, RF 4 COM

Instrument with two RX and TX signal paths and one advanced frontend:

- RX 1 / RX 2: RF 1 COM, RF 2 COM
- TX 1 / TX 2: RF 1 COM, RF 1 OUT, RF 2 COM

Instrument with four RX and TX signal paths and two advanced frontends:

- RX 1 / RX 3: RF 1 COM, RF 2 COM
- TX 1 / TX 3: RF 1 COM, RF 1 OUT, RF 2 COM
- RX 2 / RX 4: RF 3 COM, RF 4 COM
- TX 2 / TX 4: RF 3 COM, RF 3 OUT, RF 4 COM

3.4.2 Two Sub-Instruments

This section describes an instrument split into two sub-instruments. Each sub-instrument is addressed separately and equipped with independent hardware and software resources in order to run the tasks assigned to it.

As an example, the instrument provides two RX and TX signal paths and two firmware application instances. Each sub-instrument provides one RX and TX signal path and one firmware application instance.

In manual operation mode one sub-instrument is visible at a time. The other sub-instrument is active in the background but not visible at the GUI. This applies to all dialogs and views. The "Measurement Controller" dialog and the "Generator/Signaling Controller" dialog show and administrate only the firmware applications assigned to the current sub-instrument.

The current sub-instrument can be identified by the string "Instrument 1" or "Instrument 2" in the window title and by the background color. In order to change the current sub-instrument use the [Instrument Setup Dialog](#).

In remote operation mode a remote channel addresses one sub-instrument. To control two sub-instruments in parallel, two remote channels have to be set up.

The table below summarizes these assignments. All assignments are fixed. The firm-ware application instances of the two sub-instruments are named identically, but are independent of each other.

Table 3-4: Assignments for two sub-instruments

	Sub-instrument 1	Sub-instrument 2
Generator Controller entry	"GPRF Generator"	"GPRF Generator"
Measurement Controller entry	"GPRF Power"	"GPRF Power"
Remote commands	...:GPRF:GEN:... ...:GPRF:MEAS:POW:...	...:GPRF:GEN:... ...:GPRF:MEAS:POW:...
Remote Settings	Assigned Instrument = 1	Assigned Instrument = 2

Each signal path and RF connector is fix assigned to one specific sub-instrument. The RX and TX modules of both sub-instruments are named identically but refer to different physical modules.

For an instrument with two RX and TX signal paths and two frontends, each sub-instrument contains one RX module, one TX module and three RF connectors. If two RX and TX signal paths and only one advanced frontend are available, one sub-instrument contains two RF connectors and the other sub-instrument one RF connector. For more details refer to the following table.

Table 3-5: Signal path resources for two sub-instruments, two RX and TX signal paths

	Sub-instrument 1	Sub-instrument 2
RX/TX module names	RX 1, TX 1 (physically: RX 1, TX 1)	RX 1, TX 1 (physically: RX 2, TX 2)
RF connectors (2 frontends)	RF 1 COM, RF 1 OUT, RF 2 COM	RF 3 COM, RF 3 OUT, RF 4 COM
RF connectors (1 frontend)	RF 1 COM, RF 1 OUT	RF 2 COM

For an instrument with four RX and TX signal paths two frontends are required. Each sub-instrument contains two RX modules, two TX modules and three RF connectors.

Table 3-6: Signal path resources for two sub-instruments, four RX and TX signal paths

	Sub-instrument 1	Sub-instrument 2
RX/TX module names	RX 1, TX 1, RX 2, TX 2 (physically: RX/TX 1/3)	RX 1, TX 1, RX 2, TX 2 (physically: RX/TX 2/4)
RF connectors	RF 1 COM, RF 1 OUT, RF 2 COM	RF 3 COM, RF 3 OUT, RF 4 COM

4 Basic Instrument Functions

The following sections describe dialogs and settings for general use. The dialogs are not related to a particular general purpose or network test application.

4.1 Startup Dialog

The "Startup" dialog shows the progress of the startup procedure and the available options. Once the startup procedure has been terminated, it is automatically replaced by the dialog opened in the last session.

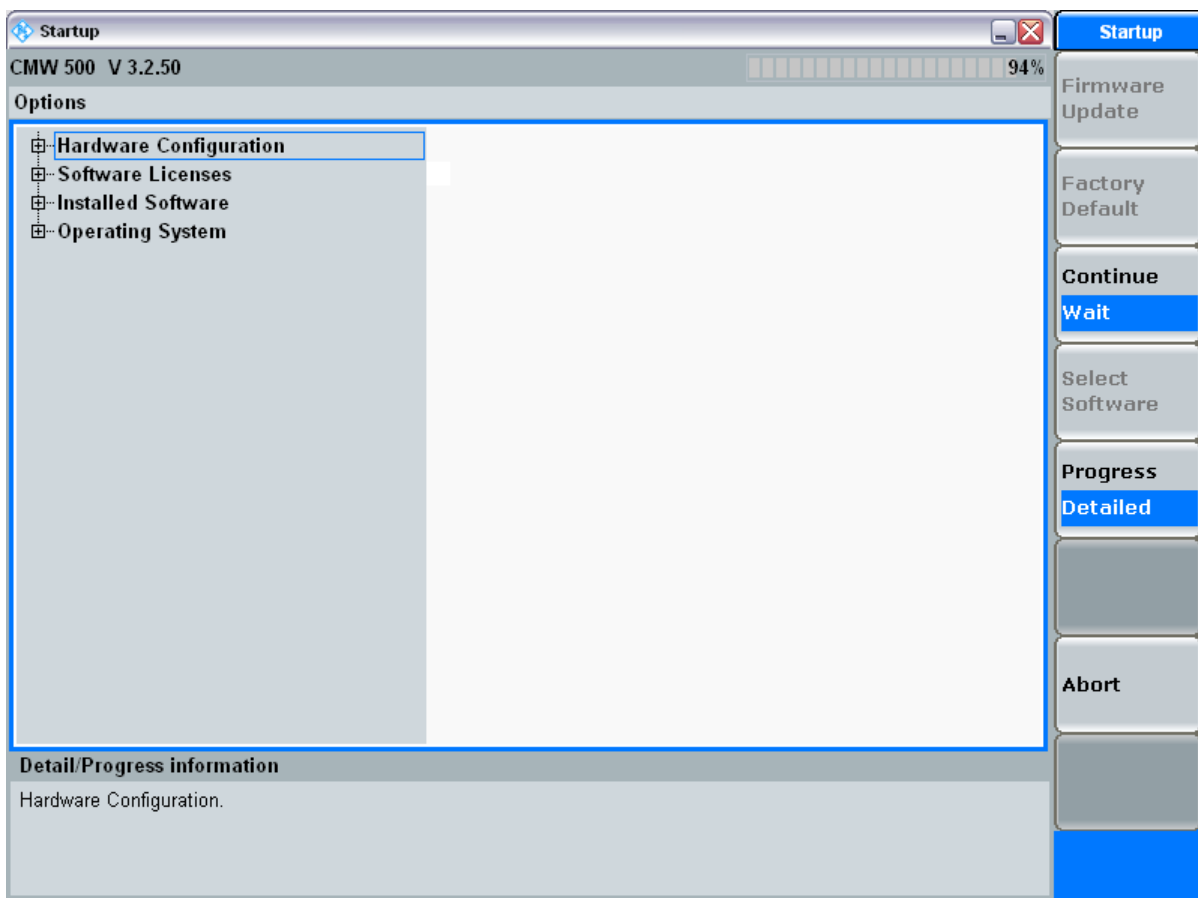

Fig. 4-1: Startup dialog

The "Startup" dialog provides the following control softkeys that you can activate while the startup is in progress.

Firmware Update

Copies new firmware-specific data to the internal hardware of the R&S CMW270. This is required for example after a board change.

Factory Default

Sets the instrument to its factory default state.

This state comprises the following settings:

- All [Preset](#) settings: The instrument is optimized for local/manual operation.
- The address information assigned to the instrument (e.g. the IP address or USB product ID/vendor ID/device ID).
- The instrument setup: One sub-instrument.

Continue / Wait

Resume or interrupt the startup procedure. "Wait" is appropriate e.g. for a check of the installed hardware and software options; see "Progress Info / Detailed Info" below.

Progress / Detailed

Toggles between alternative information types in the "Option/progress information" panel across the bottom of the screen.

- The "Progress Info" is a log of the startup procedure including the loaded software components.
- The "Detailed Info" describes the selected hardware or software option. It may contain the name, version, product code and essential technical data of the option.

It is preferable to press "Continue / Wait" in order to view the "Detailed Info". After the startup procedure is finished and the startup dialog is closed, the detailed option information can be accessed via the "Setup" dialog, see [chapter 4.4.4, "SW/HW Equipment"](#), on page 95.

Abort

Aborts the startup procedure. The R&S CMW270 returns to standby state. Press the standby key on the front panel to re-initialize the startup. See also [chapter 2.2.1.3, "Standby Key"](#), on page 19.

4.2 Reset Dialog

The "Reset" dialog forces the instrument to return to a definite reset/preset state.

To open the dialog press the RESET key at the (soft-)front panel.



Fig. 4-2: Dialog for 1 sub-instrument

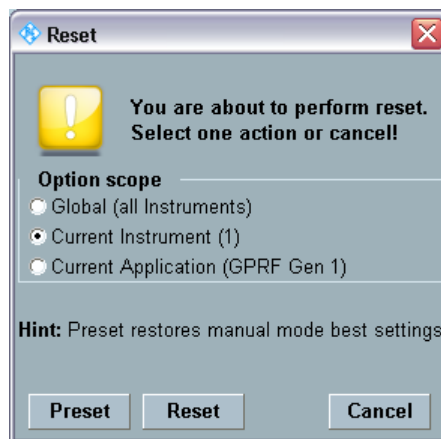

Fig. 4-3: Dialog for several sub-instruments

The reset/preset can be performed for the entire R&S CMW270 or it can be limited to the current firmware application.

If the R&S CMW270 has been split into sub-instruments, the reset/preset can also be limited to the current sub-instrument.

In addition to the reset and preset states described here, the instrument supports also a factory default state, see "[Factory Default](#)" on page 81.

Preset

Sets the instrument parameters to values suitable for local/manual interaction.

In particular, the preset state comprises the following settings:

- All measurements are repeated continuously ("Repetition: Continuous").
- The R&S CMW270 uses long statistics cycles (for reliable statistical evaluations).

The following R&S CMW270 settings are not affected by a preset:

- Address information assigned to the instrument (e.g. the IP address)
- The instrument setup

Remote command:

SYSTem:PRESet etc.

See [chapter 6.3.5, "Reset and Preset"](#), on page 217

Reset

Sets the instrument parameters to values suitable for remote operation.

In particular, the reset state comprises the following settings:

- All measurements are performed in Single-Shot mode ("Repetition: Single-Shot").
- The R&S CMW270 uses short statistics cycles (for benchmarks).
- In multi evaluation measurements, some time-consuming evaluations are skipped to gain measurement speed.

The following R&S CMW270 settings are not affected by a reset:

- Address information assigned to the instrument (e.g. the IP address)
- The instrument setup
- The contents of the status registers

Remote command:

```
*RST
```

```
SYSTem:RESet etc.
```

See [chapter 6.3.5, "Reset and Preset"](#), on page 217

4.3 Save/Recall Dialog

The "Save/Recall" dialog stores the current instrument setup and recalls setups.

To open the dialog press the SAVE key at the (soft-)front panel.

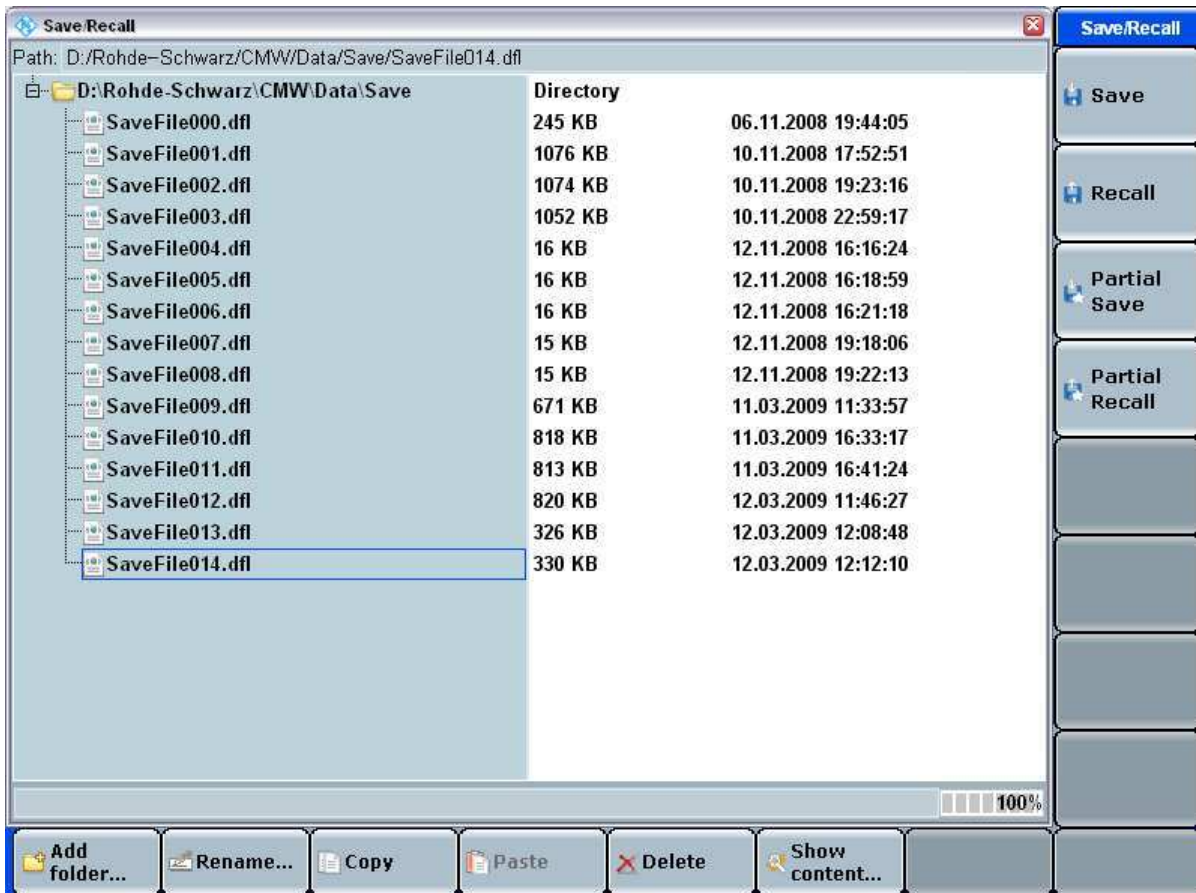

Fig. 4-4: Save/Recall dialog

The "Save/Recall" dialog provides the following control softkeys and hotkeys.

Save / Partial Save

Saves the current configuration (or a part of it) to a file. Save files are stored in a default directory on drive D: of the internal hard disk.

- If a folder is selected, a new save file SaveFile<no>.dfl is created. <no> is 000 or the number of the last save file plus one.
- If a save file is selected, this file is overwritten.

"Partial Save" opens a dialog for selection of the information to be saved. For a description of selectable parts see "Show content" on page 85.

Remote command:

MMEMory:SAV

MMEMory:STORe:ITEM

Recall / Partial Recall

Recalls the selected save file (or a part of it) and activates the stored settings.

"Partial Recall" opens a dialog for selection of the information to be recalled. For a description of selectable parts see "Show content" on page 85.

Remote command:

`MMEMoRY:RCL`

`MMEMoRY:LOAD:ITEM`

Add Folder

Adds a new subfolder to the selected folder.

Rename / Delete

Renames / deletes the selected folder or file.

Copy / Paste

Copies / pastes a folder or file. An object can only be copied from one folder to another. The destination folder must not yet contain an object of the same type with the same name.

Show content

Opens a dialog showing which information is contained in the currently selected file.

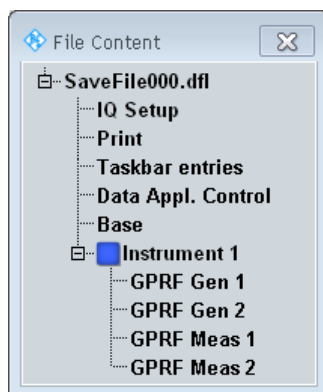

- IQ Setup: "Digital IQ" settings in the "Setup" dialog
- Print: "Print" dialog settings
- Taskbar entries: information which firmware applications are active, i.e. are listed in the task bar
- Data Appl.Control: settings of the "Data Application Control" software
- Base: most settings in the base system (except the settings listed above)
- Instrument <n> – <Firmware Application>: all settings of the firmware application

4.4 Setup Dialog

The "Setup" dialog helps you to perform various basic and administrative tasks.

To open the dialog press the SETUP key at the (soft-)front panel.

4.4.1 System Settings

The "System" section of the "Setup" dialog configures the display, the network adapters, settings for remote software update and startup of the instrument. It also provides access to a configuration dialog of the data application unit (if installed).

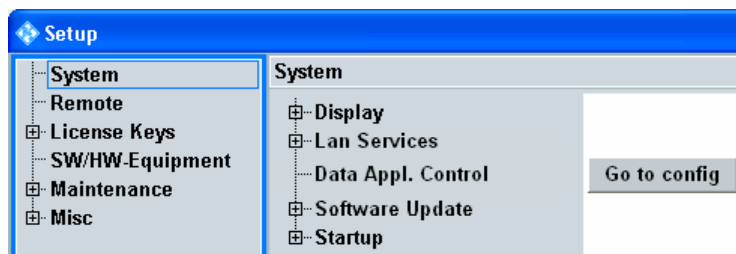
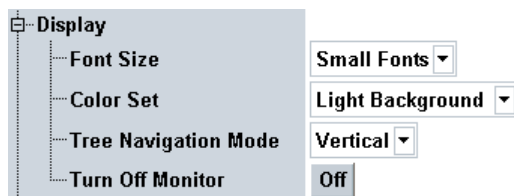

Fig. 4-5: Setup - System

Display.....	86
L Font Size, Color Set.....	86
L Tree Navigation Mode.....	86
L Turn Off Monitor.....	87
Lan Services.....	87
Data Appl. Control.....	87
Software Update.....	87
Startup.....	88
User Mode.....	88

Display

The "Display" section contains the following settings.



Font Size, Color Set ← Display

Configure the look of the GUI at the display.

Remote command:

```
SYSTem:BASE:DISPlay:FONTset
```

Tree Navigation Mode ← Display

Selects how trees are traversed when you turn the rotary knob.

- Zigzag: Traverse trees in a zigzag way, moving through all elements line by line.
- Vertical: Traverse trees vertically. You can use the LEFT / RIGHT ARROW keys to traverse horizontally.
- Cursors: The LEFT / RIGHT ARROW keys change to "Zigzag" mode, the UP / DOWN ARROW keys to "Vertical" mode.

Remote command:

```
SYSTem:DISPlay:ROLLkeymode
```

Turn Off Monitor ← Display

Press "Off" to turn off the built-in display of the instrument or an external monitor at the DVI connector of the R&S CMW270.

You can reactivate the monitor/display via a connected keyboard, a connected mouse or via the front panel keys.

Remote command:

`SYSTem:DISPlay:MONitor`

Lan Services

The "Lan Services" section contains the following settings.

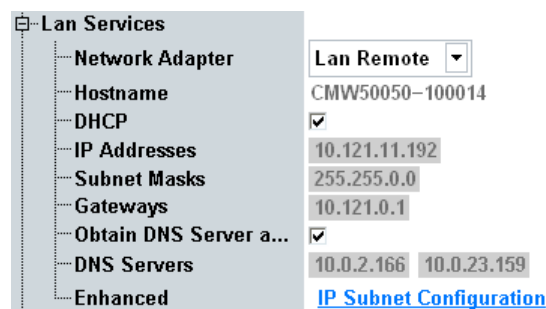

The available network adapters can be configured independently. One is accessed via the LAN connector on the front panel, the other via the LAN REMOTE connector on the rear panel. The names of the network adapter are "Lan Front" and "Lan Remote".

Some applications provided by the instrument need a specific "Lan Remote" IP address. For details see [chapter 4.4.9, "IP Subnet Configuration"](#), on page 106.

Remote command:

`SYSTem:COMMunicate:NET:...`

See [chapter 6.3.10.1, "System Settings"](#), on page 248

Data Appl. Control

If a Data Application Unit (DAU) is installed, "Go to config" opens the "Data Application Control" dialog which lets you configure data testing IP services of the DAU. For more details, refer to the description of the "Data Application Unit".

The DAU is only available for R&S CMW500.

Remote command:

n/a

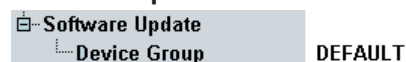
Software Update

The "Device Group" must match the settings in the "R&S Software Distributor" in order to perform a remote software update.

Remote command:

`SYSTem:UPDate:DGRoup`

Startup

If "Boot Factory Default" is enabled, the instrument is booted with factory default settings.

Enabling this setting has the same effect as pressing the "Factory Default" softkey each time the instrument is started, see [chapter 4.1, "Startup Dialog"](#), on page 80.

Remote command:

`SYSTEM:STARTup:PREPare:FDEFault`

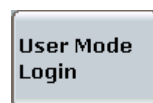
User Mode

The user mode can be changed using the softkey "User Mode Login".

- The "User" mode provides the complete measurement functionality of the R&S CMW270 and most selftests.
- The "User (Extended)" mode provides additional RAM and cable selftests; see e.g. ["External Tests"](#) on page 99.
- The remaining user modes are for service purposes.

Remote command:

n/a

4.4.2 Remote Settings

The "Remote" section of the "Setup" dialog lists all available interface and protocol types for remote control of the instrument and their parameters.

The highest level lists the interface and protocol types:

- HI-SLIP (LAN connector, HiSLIP protocol)
- VXI-11 (LAN connector, VXI-11 protocol)
- IEC (GPIB bus interface, option R&S CMW-B612A or R&S CMW-B612B)
- USB2 ("USB Remote" connector)
- TCPIP (LAN connector, VISA socket resource)

For remote control via LAN it is recommended to use the HiSLIP protocol.

The entries at the second level correspond to one remote channel each. Each channel is assigned to one sub-instrument. Several channels can be used in parallel. The number of available channels depends on the protocol type and on the installed options.

See also [chapter 5.1.5, "Multiple Channels for Remote Access"](#), on page 132

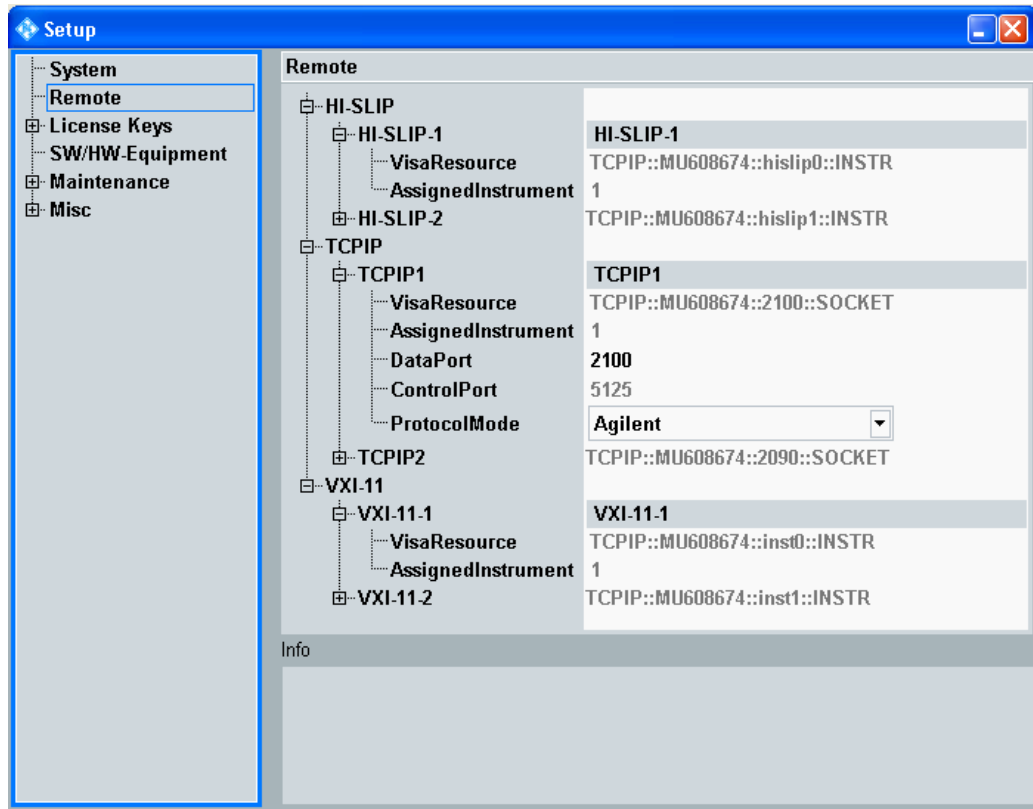

Fig. 4-6: Setup - Remote

Most connection parameters are fixed and displayed for information only. The most important parameters are described below.

Visa Resource (all protocol types).....	89
Assigned Instrument (all protocol types).....	90
Data Port (TCPIP only).....	90
Control Port (TCPIP only).....	90
Protocol Mode (TCPIP only).....	90
Board Name (IEC only).....	91
Primary Address (IEC only).....	91
Enabled (IEC only).....	91

Visa Resource (all protocol types)

The "Visa Resource" string depends on the protocol type and the assigned address information. Each remote channel is identified by a different VISA resource string.

See also [chapter 5.1, "Remote Control Operation"](#), on page 126

Remote command:

```

SYSTEM:COMMunicate:HISLip<i>:VRESource?
SYSTEM:COMMunicate:SOCKET<i>:VRESource?
SYSTEM:COMMunicate:USB:VRESource?
SYSTEM:COMMunicate:VXI<i>:VRESource?
SYSTEM:COMMunicate:GPIB<i>:VRESource?
    
```

Assigned Instrument (all protocol types)

Identifies the sub-instrument to be controlled. This parameter is fixed. If only one sub-instrument is available, it is addressed as "Assigned Instrument 1".

See also [chapter 3.4, "Sub-Instruments"](#), on page 77.

Via USB only sub-instrument 1 can be controlled in the present software version. Use another protocol type to control other sub-instruments.

For VXI-11 and HiSLIP the "Assigned Instrument" number is also part of the VISA resource string, with instrument 1 mapped to "inst0", instrument 2 mapped to "inst1" and so on.

Remote command:

n/a

Data Port (TCPIP only)

The data port number is part of the TCPIP VISA resource string. Different data ports have to be used for different channels (to address different sub-instruments). The data port is used for all protocol modes.

Consider the following rules:

- In order to modify the port number it is recommended to enter a 0. A free port in the range 1024 to 32767 is then assigned automatically.
- Alternatively you may enter a port number in that range manually.
- Never configure a port number between 1 and 1023. These "well-known ports" are reserved for specific services.

Remote command:

```
SYSTem:COMMunicate:SOCKet<i>:PORT
```

Control Port (TCPIP only)

The control port is only relevant for protocol mode "Agilent". It can be used to set up an optional control connection for transfer of emulation codes. The control port number is displayed for information. It cannot be modified.

Remote command:

n/a

Protocol Mode (TCPIP only)

The protocol mode defines the support of control messages, e.g. polling or service request:

- **RAW**: no support for polling and service request (but best performance)
- **Agilent**: emulation codes via control connection (control port)
- **IEEE1174**: emulation codes via data connection (data port)

Remote command:

```
SYSTem:COMMunicate:SOCKet<i>:MODE
```

Board Name (IEC only)

One or two optional GPIB bus interfaces can be installed (options R&S CMW-B612A and R&S CMW-B612B). The two interfaces have different board names. Board number 0 is related to connector "IEEE 488 CH 1", board number 1 to connector "IEEE 488 CH 2".

Remote command:

n/a

Primary Address (IEC only)

The primary address is part of the GPIB VISA resource string. Different primary addresses have to be used for different channels (to address different sub-instruments).

Remote command:

```
SYSTem:COMMunicate:GPIB<i>[:SELF]:ADDR
```

Enabled (IEC only)

Enables or disables a GPIB remote channel. Up to four channels are available. Two sub-instruments can be controlled using/enabling either two channels of one board or one channel per board.

Remote command:

```
SYSTem:COMMunicate:GPIB<i>[:SELF]:ENABLE
```

4.4.3 Option Activation and Deactivation

The "License Keys" section of the "Setup" dialog allows to manage licenses. You can for example apply a delivered activation key or deactivation key. You can also perform steps required to move a portable license to another instrument.

If you install a new software option, you must enable the option via an activation key, before you can use the option.

**Unregistered licenses**

The instrument accepts only registered licenses. If your license is delivered unregistered, use the online tool R&S License Manager to register the license for your instrument. Note that the registration of a non-portable license is irreversible, so ensure that you register it for the correct instrument. The address of the tool is <https://extra-net.rohde-schwarz.com/service>.

The R&S License Manager allows also to move a portable license to another instrument.

For detailed step-by-step instructions, refer to the installation instructions delivered together with the license and to the documentation available in the R&S License Manager (in the online tool, press .

For an example, see [chapter 4.4.3.2, "Moving a Portable License"](#), on page 94.

The "License Keys" section provides the following subsections:

- **Active License Keys:** lists non-portable active licenses. The list can be sorted alphabetically or by category (toggle parameter "Show Category View").
- **Portable License Keys:** lists portable active licenses
- **Deactivation Keys:** lists applied deactivation keys
- **Inactive License Keys:** lists licenses that have been explicitly deactivated by a deactivation key or are for any other reason inactive, for example expired licenses

The "Device Identification" at the top of the sections is required for identification of the instrument in the online tool R&S License Manager.

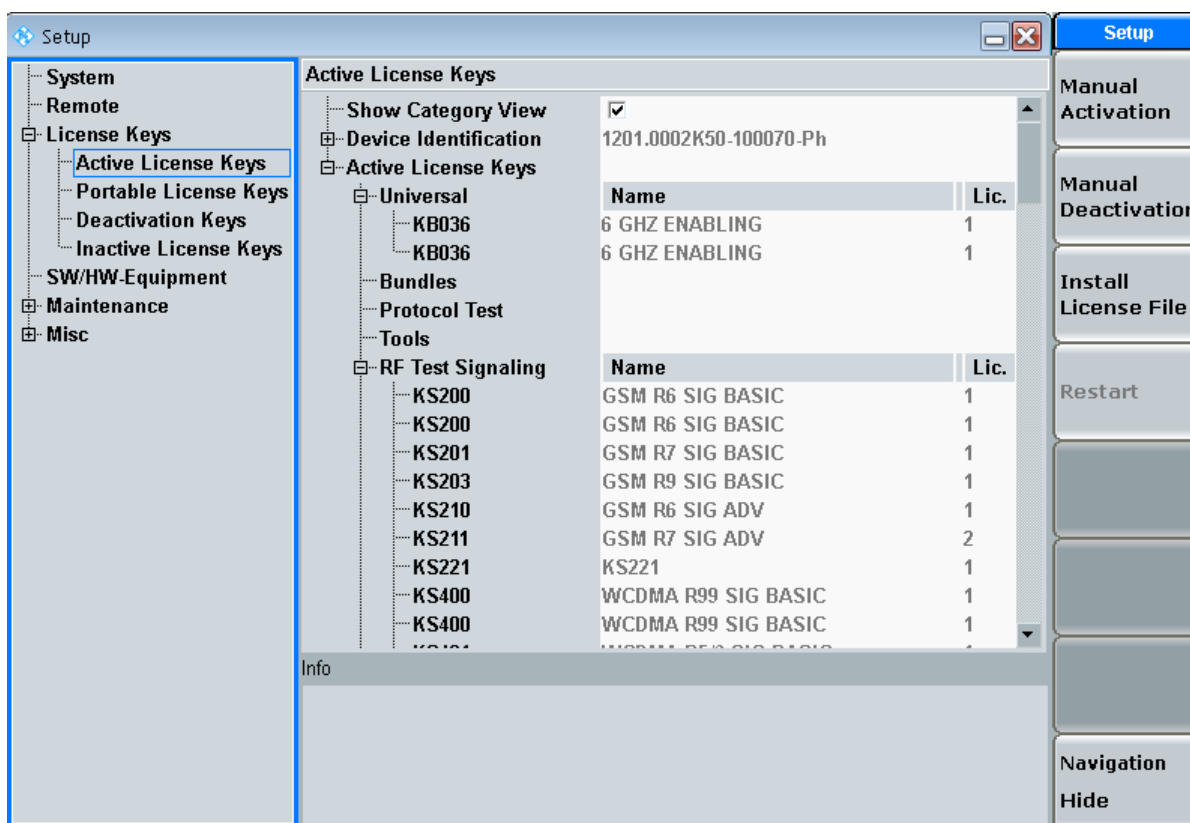

Fig. 4-7: Setup – License Keys

4.4.3.1 Softkeys

The "License Keys" section provides the following softkeys.

Manual Activation

Use this softkey to apply an activation key by manually typing in the activation key code.

A dialog box is opened for this purpose. The separating dots are entered automatically.

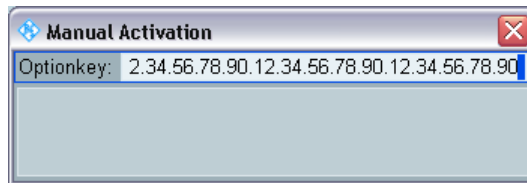

Manual Deactivation

Use this softkey to apply a deactivation key by manually typing in the deactivation key code.

A dialog box is opened. Enter the deactivation key code and save the response key to a file.

You can save the response key from the dialog box, or alternatively later on, see ["Save Response Key to File"](#) on page 93.

Save the response key to a USB memory stick or to the internal hard disk, directory `D:\Rohde-Schwarz\CMW\Data\ResponseKeys`.

The key confirms that you have deactivated the license. The online tool R&S License Manager requests the key for example when moving a portable license.

Install License File

Use this softkey to apply an activation or deactivation key via a registered license file instead of typing in the key code manually.

You can open registered license files from a USB memory stick or from the internal hard disk, directory `D:\Rohde-Schwarz\CMW\Data`.

Press the softkey to open a dialog box, navigate to the file location and select one of the listed keys. Press "Apply" or "OK" to install the key. "OK" closes the dialog box, while "Apply" keeps it open, so that you can install additional licenses.

Restart

Restarts the CMW software. Perform this action after you have applied license keys.

Save to License File

This softkey is available in subsection "Portable License Keys" only.

First select a portable license in the list, then press the softkey to save the license to a file. You can save it to a USB memory stick or to the internal hard disk, directory `D:\Rohde-Schwarz\CMW\Data\ExportedLicenseKeys`.

The online tool R&S License Manager requests the license file to identify a portable license to be moved.

Save Response Key to File

This softkey is available in subsection "Deactivation Keys" only.

First select a deactivation key in the list, then press the softkey to save the response key for this deactivation key.

Usually the response key is saved at the end of the deactivation procedure. This softkey allows to save it later on.

4.4.3.2 Moving a Portable License

As an example for license management, the following procedure describes how to move an active portable license to another instrument.

The example procedure involves the transfer of files between the R&S License Manager and the instruments. You can either use a USB memory stick for this transfer, or a LAN connection. Alternatively you can enter the key codes manually, both in the R&S License Manager dialogs and in the instrument dialogs. The example procedure uses a USB memory stick.

At the beginning of each step, a keyword indicates where the action must be performed:

- Source: instrument from which the license is moved
- Target: instrument to which the license is moved
- Manager: R&S License Manager, opened in a browser

Proceed as follows:

1. Source: Saving the portable license to a file.
 - a) Open the setup dialog, section "License Keys", subsection "Portable License Keys".
 - b) Select the portable license to be moved.
 - c) Press the softkey "Save to License File" and store the portable license to a USB stick.
2. Manager: Identifying the source and target instruments.
 - a) Open the R&S License Manager: <https://extranet.rohde-schwarz.com/service>
 - b) Select "Move Portable License".
 - c) Enter the device identifications of the source and target instruments.
You find the IDs in the setup dialogs of the instruments, section "License Keys".
3. Manager: Identifying the portable license to be moved and creating a deactivation key for the source instrument.
 - a) Open the portable license file saved in [step 1](#).
 - b) Generate and save a deactivation key file. Store it on the USB stick.
4. Source: Deactivating the license and generating a response key.
 - a) Press the softkey "Install License File" and install the deactivation key file generated in the previous step.
 - b) Save the deactivation response key to a file on the USB stick.
You can do this at the end of the key installation process. If the dialog box closes without saving the response, open the subsection "Deactivation Keys", select the applied deactivation key in the list and press the softkey "Save Response Key to File" to save the response key to the USB stick.
5. Manager: Verifying that the license has been deactivated and generating an activation key for the target instrument.

- a) Enter the deactivation response key generated in the previous step. You can copy the key from the stored response key file.
As a result, a portable license file registered for the target instrument is generated.
 - b) Store the license file on the USB stick.
6. Target: Press the softkey "Install License File" and install the activation key file generated in the previous step.
- The portable license is now active at the target instrument.

4.4.4 SW/HW Equipment

The "SW/HW Equipment" section of the "Setup" dialog shows the software and hardware that is installed on your R&S CMW270 and lists the available options.

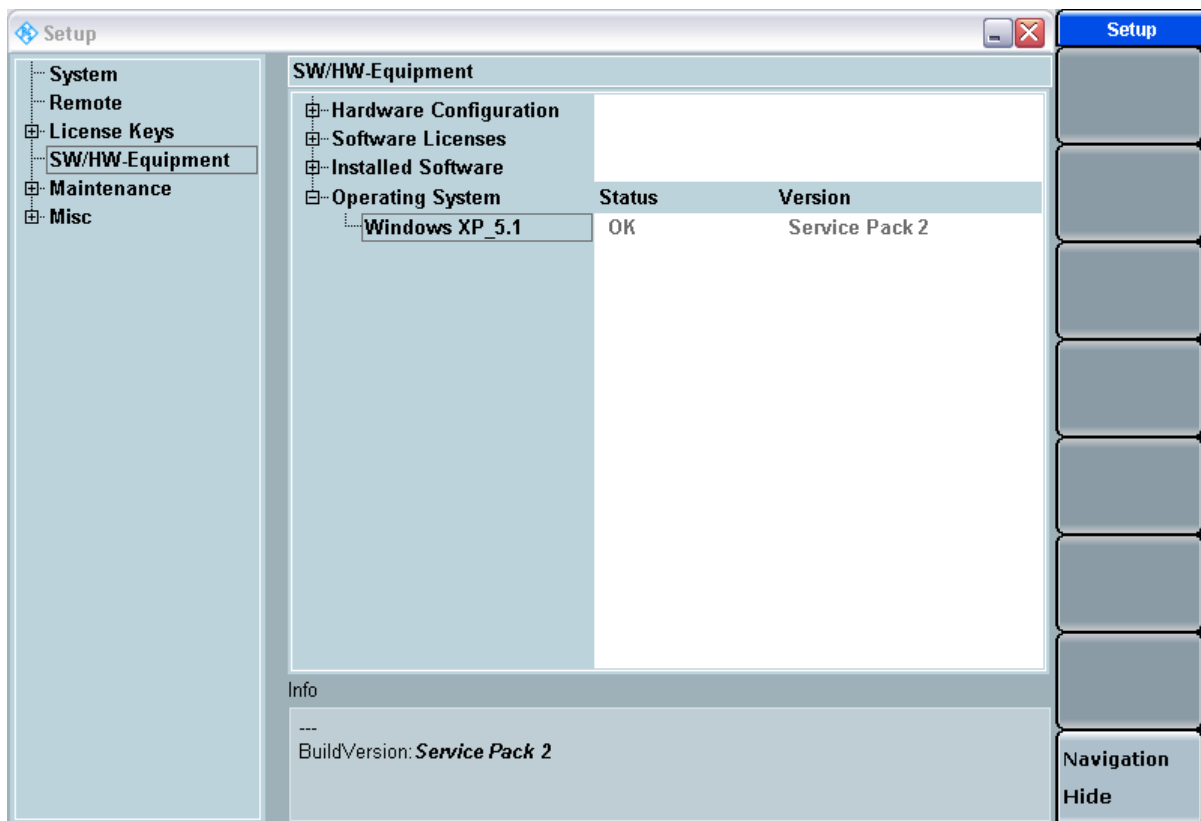

Fig. 4-8: Setup - SW/HW Equipment

Related Commands

Most contents of the "SW/HW Equipment" section can also be queried via remote commands.

Remote command:

`SYSTEM:BASE:OPTION:LIST?`

`SYSTEM:BASE:OPTION:VERSION?`

4.4.5 Selftests

The R&S CMW270 provides extensive selftest procedures on module and system level. The selftests are primarily intended for production and service purposes; they are not needed during normal operation of the instrument. The following description serves as a general overview.

4.4.5.1 General Test Features

All selftests are arranged in the "Setup" dialog, section "Maintenance > Selftest".

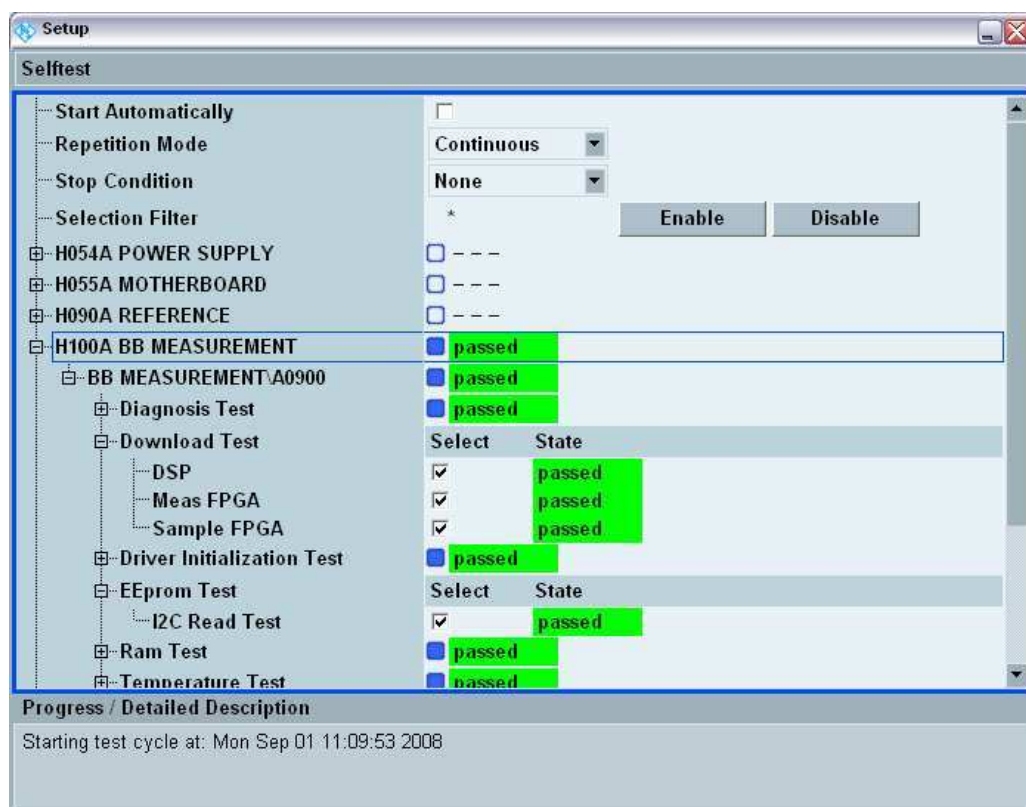

Fig. 4-9: Selftest dialog

In the dialog you can select one or several tests. Each selftest may be performed once or continuously. Moreover you can save any configuration of the "Selftest" dialog to a "profile" for later reuse.

The result of each test ("State") is displayed in the individual test section:

- **Invalid:** No test performed yet, no result available
- **In progress:** Test running, no result available yet
- **Passed:** Test passed, all measurements within the factory-set tolerances
- **Failed:** Test failed, one or more measurements out of tolerances
- **Skipped:** Test skipped because it could not be performed with the current instrument configuration (this happens e.g. if you try to initiate an OXCO test while "Frequency Source: External" is active).



TCXO / OCXO selftest

To perform a selftest on the Temperature Controlled Crystal Oscillator (TCXO) or on the optional oven quartz (Timebase OCXO, option R&S CMW-B690A), you have to switch the R&S CMW270 to internal reference frequency source, see [chapter 4.4.6, "Sync Settings"](#), on page 102.

This ensures that the oscillators are power-supplied.

4.4.5.2 Board Tests

A board test verifies that a particular hardware module works properly. Depending on the board, the R&S CMW270 may provide different types of board tests described below.

Diagnosis Test

The R&S CMW270 measures a series of selectable diagnostic voltages and checks whether they are within the permitted range. The permitted minimum and maximum voltages are stored in the EEPROM of the tested board.

Diagnosis Test	Select	State	Value	Min	Max
└─ GND_REF	<input checked="" type="checkbox"/>	passed	0.001	-0.040	0.040
└─ +VTT_DDR	<input checked="" type="checkbox"/>	passed	0.900	0.850	0.950
└─ +VREF_DDR	<input checked="" type="checkbox"/>	passed	0.907	0.850	0.950
└─ +1V8	<input checked="" type="checkbox"/>	passed	1.807	1.700	1.900

A diagnoses test is provided for most of the R&S CMW270 modules.

RAM Test

The R&S CMW270 tests one or more of the memories (SRAM, SSRAM, ASRAM, DDR) on the board. Two different types of memory tests are provided.

└─ Ram Test	<input checked="" type="checkbox"/>	passed
└─ ASRAM	Select	State
└─ Pseudo Random Sequ...	<input checked="" type="checkbox"/>	passed
└─ DDR	Select	State
└─ Pseudo Random Sequ...	<input checked="" type="checkbox"/>	passed

- For an Address Line Test, the individual address lines of the RAM are activated one after another in order to transfer a definite number to the RAM. If the instrument can read the transferred and stored numbers correctly after testing all address lines, the address lines must be independent (not interconnected), as required.
- For a Pseudorandom (RRAN) Test, the R&S CMW270 generates a pseudo-random bit sequence (PRBS) which is first written to the RAM and then read. The R&S CMW270 checks whether the read PRBS is equal to the generated PRBS.

An address line test is generally faster than a PRAN test. Notice that a failed address line test does not necessarily prove that two address lines are connected; the problem may be due to one of the other components involved in data transmission and storage.

Download Test

The R&S CMW270 loads program data into a DSP or FPGA module and verifies that the module responds properly.

Download Test	Select	State
DSP	<input checked="" type="checkbox"/>	passed
Meas FPGA	<input checked="" type="checkbox"/>	passed
Sample FPGA	<input checked="" type="checkbox"/>	passed

EEprom Test

The R&S CMW270 verifies that the I2C EEprom data of the board is well-formed (i.e. the syntax is correct, the contents are logically compatible). If no access to the EEprom data is possible, the board is not displayed in the Selftest dialog.

EEprom Test	Select	State
I2C Read Test	<input checked="" type="checkbox"/>	passed

An EEprom test is provided for all modules.

Driver Init Test

The R&S CMW270 checks whether the operating system has properly initialized the hardware driver for a specific board.

H661A ETHERNET SWITCH	<input type="checkbox"/>	---
ETHERNET SWITCH/A1500	<input type="checkbox"/>	---
Driver Init Test	<input type="checkbox"/>	---
EEprom Test	<input type="checkbox"/>	---

If driver initialization failed, or if the board is defective, the "Driver Init Test" is the only board test shown. The test status is "failed". Contact your Rohde & Schwarz service representative for assistance.

Temperature Test

The R&S CMW270 measures the temperature at different test points on a board and compares the measured "Value" to the "Max" temperature limit.

- A value below the "Max" limit means that the board operates under acceptable temperature conditions. The board test is passed.
- A value below the "Max" limit causes a failed temperature test.

Temperature Test	Select	State	Value °C	Max °C
TEMP_MRAM	<input checked="" type="checkbox"/>	passed	29.500	85.000
TEMP_+1V8	<input checked="" type="checkbox"/>	passed	26.000	75.000
TEMP_+VTT	<input checked="" type="checkbox"/>	passed	32.800	75.000
TEMP_+1V2F	<input checked="" type="checkbox"/>	passed	38.400	75.000
TEMP_+1V2U	<input checked="" type="checkbox"/>	passed	34.300	75.000
TEMP_PCIE	<input checked="" type="checkbox"/>	passed	42.000	85.000
TEMP_MEAS	<input checked="" type="checkbox"/>	passed	46.000	85.000

Detailed Test

Detailed tests are board-specific tests that cannot be grouped into one of the previous categories. In general, detailed tests are intended to be performed by R&S service representatives.

4.4.5.3 Unit Tests

A unit test verifies that the communication between several internal modules of the instrument is uninterrupted. A passed unit test usually proves that several modules (e.g. boards and bus systems connecting these boards) work properly.



Unit tests and board tests

A unit test represents an efficient method for testing the instrument's overall functioning. After a failed unit test, you can use one of the module tests to pin down the source of the malfunction. Some examples of unit tests are described below.

RF Loop Test

A signal which is generated on one of the installed TRX modules is routed to a front-end connector RF <n> COM and back to the TRX module. The main purpose of the test is to verify the connections between the TRX module and the frontend. The RF loop is measured at different frequencies and TX levels using an additional BB measurement module.

The header row of the overall loop test shows the output levels in dBm at the RF <n> COM connectors. The actual levels measured are approx. 6 dB above the equivalent RF <n> COM levels.

Unit Test	<input checked="" type="checkbox"/>	---				
Control/Sync Test	<input type="checkbox"/>	---				
RF Loop Test	<input checked="" type="checkbox"/>	---				
BB 800, TRX 600, RF1COM	Select	State	-5 dBm	-25 dBm	-45 dBm	-65 dBm
100MHz	<input checked="" type="checkbox"/>	---	---	---	---	---
200MHz	<input type="checkbox"/>	---	---	---	---	---

Sample Bus Test

A pseudo-random bit sequence (PRBS) is transferred over the sample bus between two hardware modules. The R&S CMW270 compares the transmitted PRBS with the received PRBS and verifies that no bit errors occur in the transmission path.

Samplebus Test	Select	State
BB MEASUREMENT\A0900\Por...	<input checked="" type="checkbox"/>	---
BB MEASUREMENT\A0900\Por...	<input checked="" type="checkbox"/>	---
BB MEASUREMENT\A0900\Por...	<input type="checkbox"/>	---

External Tests

One or more R&S CMW270 connectors are tested using external cable connections. External tests require the "User (Extended)" mode; see "User Mode" on page 88.

Unit Test	<input checked="" type="checkbox"/>	---
Control/Sync Test	<input type="checkbox"/>	---
IP Access Test External	Select	State
FMR - LAN REMOTE - LAN SWITCH - SUU\A1300	<input checked="" type="checkbox"/>	---

Note: The "IP Access Test External" shown above requires a subnet conform IP address for the "Lan Remote" network adapter; see chapter 4.4.9, "IP Subnet Configuration", on page 106.

When the test is started, the R&S CMW270 prompts for the appropriate cable connection, e.g.:

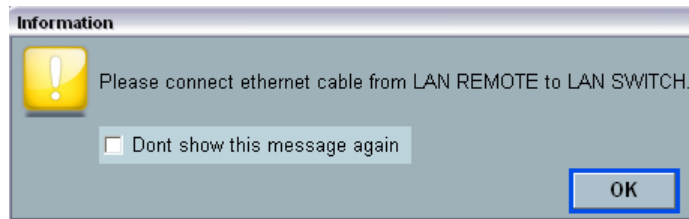

A similar message ("Please disconnect...") is displayed after the test is finished.

4.4.5.4 Performing Selftests

Selftests are controlled like any other measurement. The following example shows an "RF Loop Test" which is appropriate for a general check of the RF path.

RF Loop Test

The "RF Loop Test" is a special unit test that measures the RF path from a TRX module to a frontend connector and back using an additional BB measurement module.

To perform the overall loop test at RF 1 COM:

1. Press the SETUP key and select "Maintenance - Selftest" from the "Setup" dialog. The "Selftest" dialog is opened.
2. Select "Repetition Mode: Single-Shot" to perform the test only once.
3. Click the "Disable all" hotkey to clear the predefined selftest selection.
4. Open the "Unit Test > RF Loop Test > BB800 TRX 600, RF 1 COM" section and select the RF frequencies you want to measure. Each frequency is measured at different RF output levels.
5. Press the "ON | OFF" key to start the selftest.

Unit Test	<input checked="" type="checkbox"/>	---	---	---	---	
Control/Sync Test	<input type="checkbox"/>	---	---	---	---	
RF Loop Test	<input checked="" type="checkbox"/>	---	---	---	---	
BB 800, TRX 600, RF1COM	Select	State	-5 dBm	-25 dBm	-45 dBm	-65 dBm
100MHz	<input checked="" type="checkbox"/>	---	---	---	---	---
200MHz	<input type="checkbox"/>	---	---	---	---	---

The LEDs at the RF 1 COM connector light to indicate that an output/input signal is applied. After the selftest is completed, the result at each frequency is shown in the "State" column. The measured levels should be approx. 6 dB above the RF output levels.

4.4.5.5 Selftest Control Softkeys

The selftest is turned on or off using the ON | OFF or RESTART | STOP keys. The measurement control softkey shows the current measurement state.



Save Profile, Load Profile

A profile is a particular selftest configuration that you store for later reuse. The profile contains all enabled selftests together with their user-defined parameters (if there are any) and the [Selftest Configuration](#) parameters.

4.4.5.6 Selftest Configuration

The selftest measurement is configured using the parameters at the beginning of the "Selftest" section in the "Setup" dialog.



Fig. 4-10: Selftest configuration

Start Automatically

Starts the selected selftests automatically when the R&S CMW270 software is started next time (service feature).

Repetition Mode

Defines how often the selftest measurement is repeated if it is not stopped explicitly or by a stop condition "Halt on Failure".

- In "Continuous" mode all selected selftests are repeated until the selftest is explicitly aborted; the results are updated after each test cycle: The R&S CMW270 performs a long-term test.
- A "Single Shot" measurement is stopped after all selected tests have been completed. This mode is appropriate for verifying the correct functioning of the instrument.

Stop Condition

Specifies the conditions for an early termination of the selftest measurement.

"None"	All selftests are executed according to the selected "Repetition" mode, irrespective of their state.
"Halt On Failure"	Test execution is stopped as soon as one of the selected selftests has reached the "Failed" state, irrespective of the repetition mode set. If none of the test fails, selftest execution is continued according to the selected "Repetition" mode.

Selection Filter

Enables or disables a particular selftest specified with its name. To enable or disable groups of selftests, use wildcards? (substitutes for any one character) or * (substitutes for any zero or more characters).

Examples:

"*" enables or disables all selftests

"*EEProm*" enables or disables the EEPROM tests for all boards

As an alternative to the selection filter, use the "Enable/Disable All" or "Enable/Disable Subtree" hotkeys.

Enable/Disable All, Enable/Disable Subtree

Selects all or a current group (subtree) of selftests for execution or clears the current selection.

4.4.6 Sync Settings

The R&S CMW270 can be synchronized either to its fixed internal reference frequency or to an external reference.

For multi-CMW setups a system synchronization signal has to be provided by one instrument to the other instruments of the setup.

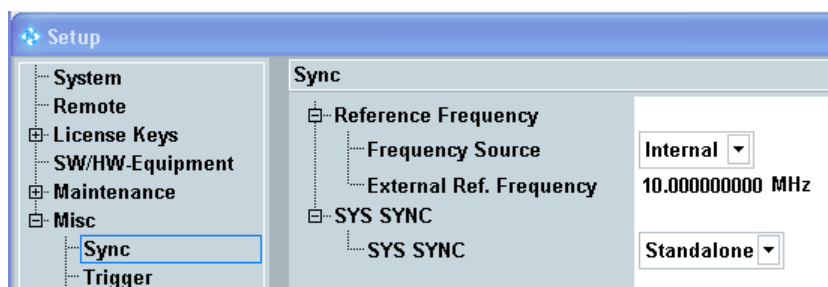

Fig. 4-11: Setup - Sync Settings

Frequency Source..... 102
 External Ref. Frequency..... 103
 SYS SYNC..... 103

Frequency Source

Sets the R&S CMW270 to internal or external reference.

"Internal" The internal 800 MHz reference frequency is generated using a Temperature Controlled Crystal Oscillator (TCXO) or an optional oven quartz (Timebase OCXO, option R&S CMW-B690A).
 A 10 MHz reference signal which is derived from the internal reference can be tapped at the output connector REF OUT 1 in order to synchronize other devices. The R&S CMW270 then acts as a master, providing the reference clock for other devices.

"External" With external synchronization, the internal reference frequency is not used. Instead, the R&S CMW270 is synchronized to an external reference signal with variable frequency. The external reference signal is also routed to the output connector REF OUT 1 in order to synchronize other devices. The external reference signal must meet the specifications of the data sheet.

Remote command:

```
SYSTem:BASE:REFerence:FREQuency:SOURce
```

External Ref. Frequency

Value of the external reference frequency. If "Frequency Source: External" is used this value must be equal to the frequency of the signal fed in at the rear panel connector REF IN. Besides the external reference signal must meet the specifications of the data sheet.

Note: If synchronization fails, or if no external signal with the correct frequency is available, the red "ERROR" LED at the front panels lights. The "frequency locked" state can also be checked via command.

Remote command:

```
SYSTem:BASE:REFerence:FREQuency
```

```
SENSe:BASE:REFerence:FREQuency:LOCKed?
```

SYS SYNC

This setting is only present if the R&S CMW270 is equipped with a "Multibox Flexible Link Sample Bus Board with external SysSync Support" (option R&S CMW-S55xM).

The parameter specifies the mode of system time synchronization. It is essential when switching between single-CMW and multi-CMW setups. A multi-CMW setup will use two or more interconnected R&S CMW270 instruments. Several instruments communicate with each other using a LAN connection between the rear panel LAN SWITCH connectors.

All connected instruments have to share the reference frequency and the system synchronization signal. If the time information is not synchronized between instruments, test runs may fail or logging information cannot be evaluated, for example.

Note: Only use the cables labeled SYS SYNC which are included in the delivery. If synchronization fails or if no synchronization signal is available, the red "ERROR" LED at the front panels blinks. See the error message in the "CMW" application for error details.

For example multi-CMW test setups, refer to the "Protocol Testing - Test Setups and Use Cases" manual.

"Standalone" The instrument will use its internal synchronization signal.

"Generator" The instrument provides an identical system synchronization signal at all SYS SYNC OUT rear panel connectors. One SYS SYNC OUT connector is connected to the SYS SYNC IN connector. Thus the instrument synchronizes itself and all other connected R&S CMW270 instruments.

"Listener" The instrument receives a time synchronization signal at SYS SYNC IN from another R&S CMW270 that is configured as "Generator".

Remote command:

```
SYSTem:BASE:SSYNc:MODE
```

4.4.7 Trigger

This dialog configures the connectors TRIG A and TRIG B at the rear panel of the instrument and allows to initiate the generation of a "User Initiated Trigger" signal.

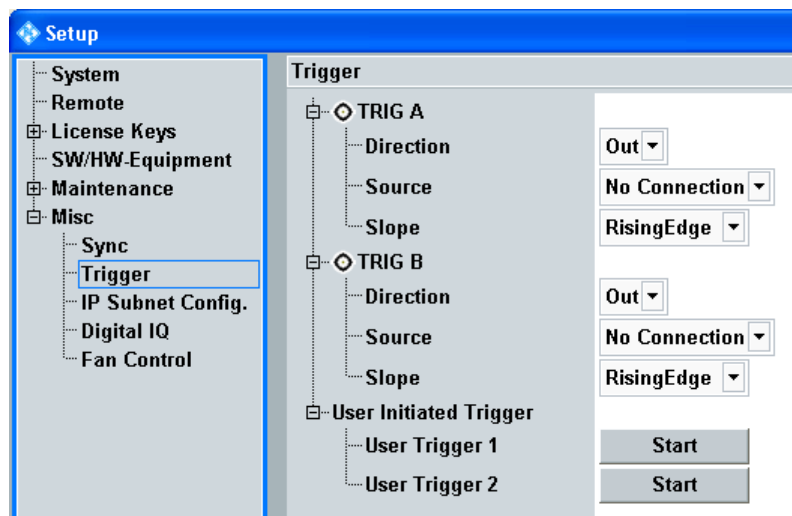

Fig. 4-12: Setup - External Trigger

TRIG A, TRIG B.....	104
L Direction.....	104
L Source.....	105
L Slope.....	105
User Initiated Trigger.....	105

TRIG A, TRIG B

The bidirectional BNC connectors TRIG A and TRIG B support input and output trigger signals:

- An input trigger signal is used to synchronize an R&S CMW270 measurement to an external event. For example a DUT providing a frame-periodic RF signal may generate an additional trigger signal to indicate its frame timing. The related trigger source strings are "Base1: External TRIG A" and "Base1: External TRIG B".
- An output trigger signal is generated by the R&S CMW270 in order to synchronize external devices.

Direction ← TRIG A, TRIG B

Selection of input or output trigger signal at the connector.

Remote command:

```
TRIGger:BASE:EXTB:DIRection etc.
```

Source ← TRIG A, TRIG B

Source for output trigger signal. "No Connection" means that no output trigger signal is fed to the trigger connector. The listed trigger sources include also input trigger signals fed in at TRIG A (TRIG B) that you can use as output trigger signals at TRIG B (TRIG A).

Most trigger sources depend on the installed options. For example the ARB generator provides several output trigger signals to synchronize external devices to a processed waveform file.

Remote command:

`TRIGger:BASE:EXTB:CATalog:SOURce?` etc.

`TRIGger:BASE:EXTB:SOURce` etc.

Slope ← TRIG A, TRIG B

Slope to be used for output trigger signals. The trigger event can either be marked by a rising edge or by a falling edge.

Remote command:

`TRIGger:BASE:EXTB:SLOPe` etc.

User Initiated Trigger

A user initiated trigger signal is useful if several applications shall be triggered simultaneously and the absolute trigger timing is irrelevant.

You can for example start waveform files (ARB files) in several GPRF generators simultaneously to generate a MIMO signal. To do so, select one of the user initiated triggers as trigger source in the relevant GPRF generator instances and initiate the trigger event by pressing the "Start" button.

Related trigger source strings: "Base1: User Trigger 1" and "Base1: User Trigger 2"

Remote command:

`TRIGger:BASE:UINitiated<n>:EXECute`

4.4.8 Logging

If supported by a signaling application, messages exchanged between the signaling application and the DUT can be monitored.

For this purpose an external logging PC is connected to the LAN SWITCH connector provided by the "Ethernet Switch H661A" (option R&S CMW-B661A). The messages are sent to the logging PC, where the R&S Message Recorder (option R&S CMW-KT011) is installed. It generates log files of the messages which can then be analyzed using the R&S Message Analyzer (also option R&S CMW-KT011). For more information please refer to the documentation delivered with the R&S Message Recorder, e.g. the MCT Tools Manual.

If your instrument is not equipped with a Data Application Unit (DAU, option R&S CMW-B450x), message monitoring requires a specific IP address assigned to the "Lan Remote" network adapter; see [chapter 4.4.9, "IP Subnet Configuration"](#), on page 106.

The "Logging" section of the "Setup" dialog provides general settings, applicable to all signaling applications supporting message monitoring.

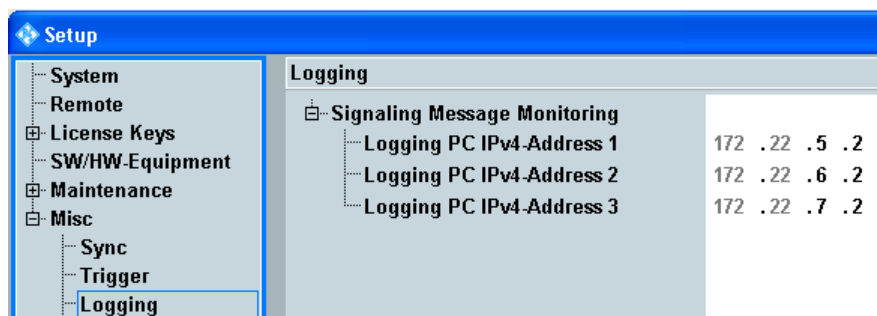

Fig. 4-13: Setup - Logging

Signaling Message Monitoring

Configures the logging PC address pool. In the signaling application you select the pool entry to be used, so different signaling applications can use different logging PCs.

The logging PCs are connected to the internal subnet of the instrument. Thus the first two address segments are determined by the subnet configuration. The other parts support only a limited range. Assign compatible addresses to the logging PCs.

See also [chapter 4.4.9, "IP Subnet Configuration"](#), on page 106

Remote command:

```
CONFigure:BASE:MMONitor:IPAddress<n>
```

4.4.9 IP Subnet Configuration

This section configures the internal IPv4 subnet of the instrument. This is only relevant for instruments equipped with an "Ethernet Switch H661A" (option R&S CMW-B661A). The option includes two LAN SWITCH connectors at the rear panel, providing access to the internal subnet. This is for example required for signaling message monitoring via an external PC. The external PC is connected via the LAN SWITCH to the internal subnet and thus to the signaling units.

The R&S CMW270 subnet uses the subnet mask 255.255.0.0. IP addresses belonging to the subnet are structured as follows.

IPv4 address = w.x.y.z:

- w.x:
Network ID, identifying the network segment used by the subnet. The network ID is identical for all IP addresses belonging to the subnet. Example: 172.22.y.z.
- y:
Node ID, identifying a network node within the subnet (subnet node). You must configure a different node ID for each instrument and PC belonging to the subnet.
- z:
Adapter ID, identifying a network adapter within a subnet node.

Some applications provided by the R&S CMW270 require that you establish a direct connection between the LAN REMOTE connector and the LAN SWITCH and assign a specific IP address to the "Lan Remote" network adapter. To do so, plug the patch cable delivered with option R&S CMW-B661 into the LAN REMOTE connector and

connector 1 of the LAN SWITCH. Assign the subnet conform IP address w.x.y.3 to the "Lan Remote" network adapter via the configuration dialog, see "Network Adapter" on page 108.

The patch cable and the subnet conform "Lan Remote" IP address are required by the following applications:

- Selftest "Unit Test > IP Access Test External" (requires "User (Extended)" mode, see "External Tests" on page 99)
- Monitoring of signaling messages via an external PC without using a Data Application Unit

The elements of the subnet configuration dialog are described below.

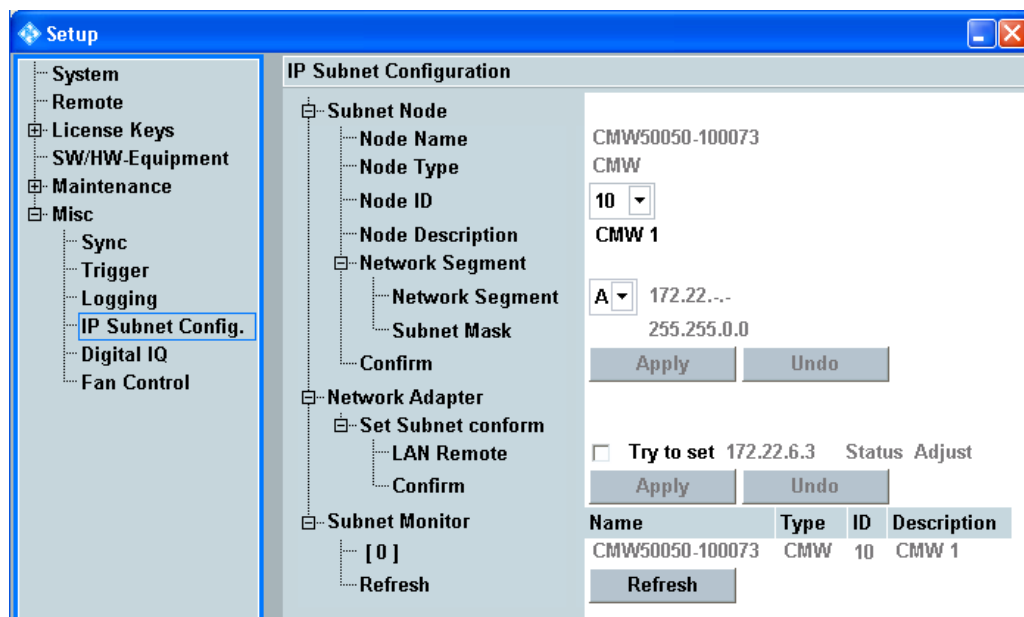

Fig. 4-14: Setup - IP Subnet Configuration

Subnet Node..... 107

 L Node Name..... 107

 L Node Type..... 108

 L Node ID..... 108

 L Node Description..... 108

 L Network Segment..... 108

 L Confirm..... 108

Network Adapter..... 108

Subnet Monitor..... 109

Subnet Node

This section configures the internal IPv4 subnet of the instrument.

Node Name ← Subnet Node

Displays the fixed name assigned to the subnet node, i.e. to the instrument.

Remote command:

```
SENSe:BASE:IPSet:SNODE:NNAMe?
```

Node Type ← Subnet Node

Displays the type of the subnet node (always CMW).

Remote command:

```
SENSe:BASE:IPSet:SNODE:NTYPE?
```

Node ID ← Subnet Node

Selects the ID of the subnet node, used as third octet of the IPv4 address.

Example: Node ID = 10 results in w.x.10.z.

Remote command:

```
CONFigure:BASE:IPSet:SNODE
```

Node Description ← Subnet Node

Specifies a description for easy identification of the subnet node, for example in the subnet monitor output.

Remote command:

```
CONFigure:BASE:IPSet:SNODE
```

Network Segment ← Subnet Node

Selects the network segment to be used for the subnet. The subnet mask always equals 255.255.0.0.

The first two IP address octets depend on the selected network segment:

- **A:** 172.22.y.z
- **B:** 172.18.y.z

Remote command:

```
CONFigure:BASE:IPSet:SNODE
```

```
SENSe:BASE:IPSet:SNODE:NSEGment?
```

Confirm ← Subnet Node

Applies or cancels changes of the subnet node configuration.

Applying a changed "Node ID" or "Network Segment" initiates a reboot of the instrument.

Remote command:

```
CONFigure:BASE:IPSet:SNODE
```

Network Adapter

Allows to assign a subnet conform IP address to the "Lan Remote" network adapter of the instrument.

To do so, enable the checkbox and press the "Apply" button.

As a consequence, DHCP is disabled, any IP addresses already assigned to the "Lan Remote" network adapter are removed and the displayed fixed IP address is assigned instead.

The displayed state indicates whether the displayed address has been successfully assigned to the network adapter ("Status Adjust") or not ("Status Not Adjust").

Remote command:

```
CONFigure:BASE:IPSet:NWADapter<n>
```

Subnet Monitor

List of all nodes detected in the subnet, including the instrument itself. The list indicates the name, the type, the ID and the description of each node. For the R&S CMW270 this information corresponds to the values in section "Subnet Node" on page 107.

Detected subnet nodes can for example be other R&S CMW270 (Type = CMW) or external PCs (Type = PC).

Press the "Refresh" button to initiate a new scan of the subnet.

The subnet monitor is especially useful for troubleshooting. When you have connected a network node to the internal subnet, check whether it is detected and whether there are address conflicts (same ID used by several nodes).

Remote command:

```
SENSe:BASE:IPSet:SMONitor:NAME?
SENSe:BASE:IPSet:SMONitor:TYPE?
SENSe:BASE:IPSet:SMONitor:ID?
SENSe:BASE:IPSet:SMONitor:DESCription?
SYSTem:BASE:IPSet:SMONitor:REFresh
```

4.4.10 Digital IQ

The "Digital IQ" section is only present if the R&S CMW270 is equipped with an I/Q board (option R&S CMW-B510x/-B520x).

The settings are not relevant for "external fading" scenarios of signaling applications. But they apply for example to "IQ out - RF in" scenarios.

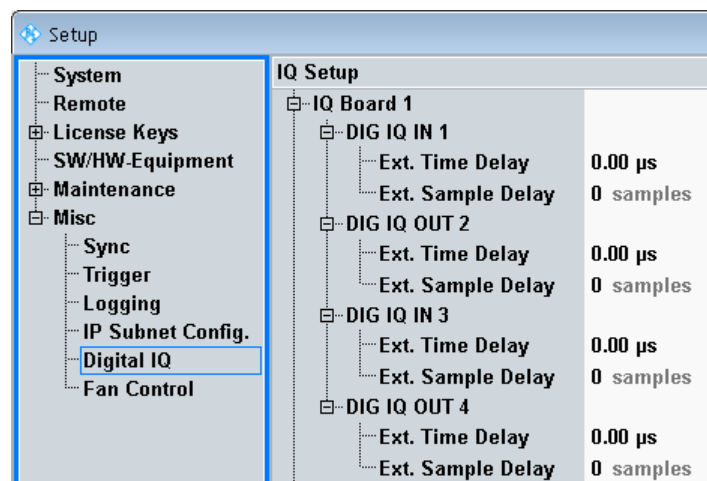

Fig. 4-15: Setup - Digital IQ

Ext. Time Delay / Ext. Sample Delay

Inform the instrument about the delays in the individual external I/Q paths. For each I/Q connector you can enter the delay either in time units or in samples. Relevant delays can be caused by instruments or devices inserted into the external path, e.g. an R&S EX-IQ-BOX or an R&S SMU200A.

The entered delay is e.g. used to correct measured round-trip times, the timing of trigger events or the time relation between downlink and uplink signals.

For background information on the digital I/Q board and many possible test setups (including fading tests) refer to the User Manual "R&S CMW500 Protocol Testing – Test Setups and Use Cases".

Remote command:
n/a

4.4.11 Frequency-Dependent Correction Tables

This section administrates correction tables for frequency-dependent attenuation/gain. For additional information concerning the usage of the tables, refer to [RF Path Settings \(Generators\)](#) and [Connection Control \(Measurements\)](#).

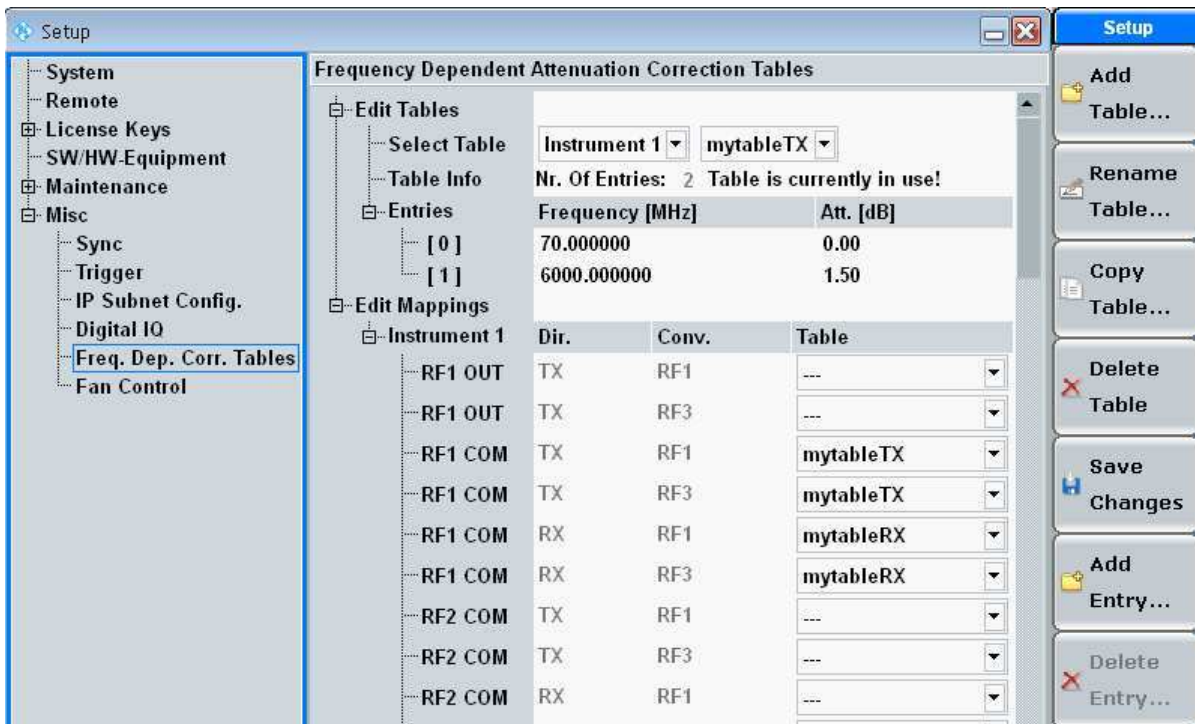

Fig. 4-16: Setup - Frequency-Dependent Correction Tables

- Edit Tables..... 111
 - └ Select Table..... 111
 - └ Table Info..... 111
 - └ Entries..... 111
- Edit Mappings..... 111
- Softkeys..... 112
 - └ Add Table..... 112
 - └ Rename Table..... 112
 - └ Copy Table..... 112
 - └ Delete Table..... 112

L Save Changes.....	112
L Add Entry.....	113
L Delete Entry.....	113

Edit Tables

This section selects a correction table and displays its entries.

You can edit existing table entries directly. To add or delete entries, use the corresponding softkeys.

To rename, copy or delete a table, use the softkeys.

All correction tables are sub-instrument specific. If your instrument is not split into sub-instruments, only "Instrument 1" is relevant. But you can also configure tables for other sub-instruments, as preparation for a later instrument-split.

Within each sub-instrument, the table names are unique. You can create two tables with the same name in different sub-instruments, but not in the same sub-instrument.

Select Table ← Edit Tables

Selects the correction table to be edited, copied, renamed or deleted.

To select a table, select first the sub-instrument ("Instrument n"), then select the table name.

Remote command:

`CONFigure:BASE:FDCorrection:CTABLE:CATalog?`

`CONFigure:BASE:FDCorrection:CTABLE:COUNT?`

Table Info ← Edit Tables

Displays the number of entries in the selected table.

If "Table is currently in use!" is displayed, this means that the table is assigned to at least one RF path in section "Edit Mappings".

Remote command:

`CONFigure:BASE:FDCorrection:CTABLE:LENGTH?`

Entries ← Edit Tables

Displays the entries of the selected table. Each entry consists of a frequency and an attenuation value.

The table is sorted automatically with increasing frequencies. Each entry must have a different frequency.

Remote command:

`CONFigure:BASE:FDCorrection:CTABLE:DEtails?`

Edit Mappings

This section configures the assignment of correction tables to RF signal paths.

The section lists all currently available RF signal paths, one path per line. For each path, it indicates the RF connector, the direction (TX or RX) and the RX or TX module (RF1 to RF4).

In column "Table", you can assign a correction table to each RF path.

A global reset or preset deletes all assignments. A reset or preset of a sub-instrument or application does not affect the assignments.

Remote command:

`CONFigure:FDCorrection:ACTivate`

`CONFigure:FDCorrection:DEACTivate`

`CONFigure:FDCorrection:USAGe?`

Softkeys

The following softkeys are related to the correction tables.

Most softkeys are only active if the section "Edit Tables" is selected.

Add Table ← Softkeys

Creates a new correction table without any entries. A dialog box opens for selection of the sub-instrument and specification of the table name.

Remote command:

`CONFigure:BASE:FDCorrection:CTABLE:CREate`

Rename Table ← Softkeys

Renames the table selected in section "Edit Tables". A dialog box opens for specification of the new table name.

If the table is in use, section "Edit Mappings" is updated automatically.

Remote command:

n/a

Copy Table ← Softkeys

Creates a copy of the table selected in section "Edit Tables".

A dialog box opens for selection of the sub-instrument for the new table and specification of the new table name.

Remote command:

n/a

Delete Table ← Softkeys

Deletes the table selected in section "Edit Tables".

If the table is in use, the corresponding assignments in section "Edit Mappings" are removed.

Remote command:

`CONFigure:BASE:FDCorrection:CTABLE:DELeTe`

Save Changes ← Softkeys

Saves the correction tables in the RAM to the hard disk.

When the application software is started, all correction tables are loaded from the hard disk into the RAM. Changes performed in section "Edit Tables" are applied to the tables in the RAM.

When the application software is closed (e.g. by pressing the standby key), all correction tables in the RAM are stored to the hard disk automatically. The softkey performs this action immediately.

Remote command:

`CONFigure:BASE:FDCorrection:SAV`

Add Entry ← Softkeys

Adds a new entry to the table selected in section "Edit Tables".

A dialog box opens for specification of the frequency and the attenuation.

Remote command:

`CONFigure:BASE:FDCorrection:CTABLE:ADD`

Delete Entry ← Softkeys

Deletes the entry selected in section "Edit Tables > Entries".

Remote command:

`CONFigure:BASE:FDCorrection:CTABLE:ERASe`

4.4.12 Fan Control

The fan of the R&S CMW270 is temperature-controlled. The speed of the fan is adapted dynamically depending on the temperature within the instrument. Three fan control modes are available.

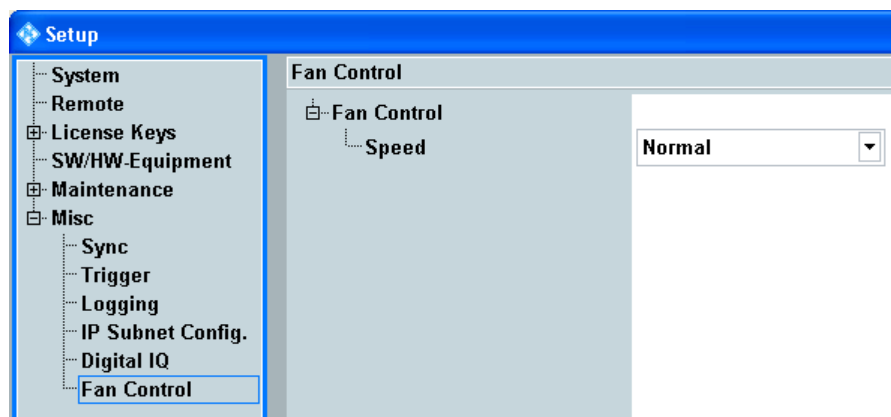

Fig. 4-17: Setup - Fan Control

Speed

Available modes:

"Normal" This is the default mode.

"Low (Laboratory)"

The temperature thresholds for fan speed control are higher than in normal mode. Generally this results in higher temperatures and less noise emission.

So this mode can be used to minimize the noise emission, for example in a laboratory environment.

"High (Production Line)"

The temperature thresholds for fan speed control are lower than in normal mode. Generally this results in lower temperatures and more noise emission.

So this mode can be used to maximize the cooling and thus the lifetime of the instrument components. This makes sense in an environment where the noise emission of the instrument is irrelevant, for example at a production line.

Remote command:

`CONFigure:BASE:FCONtrol`

4.5 Print Dialog

The "Print" dialog prints the current "CMW" window to a file, to be saved on partition D: of the internal hard disk or a USB memory stick. Other elements besides the "CMW" window are not captured (e.g. the desktop of the operating system or a running program).

To open the dialog press the PRINT key at the (soft-)front panel.

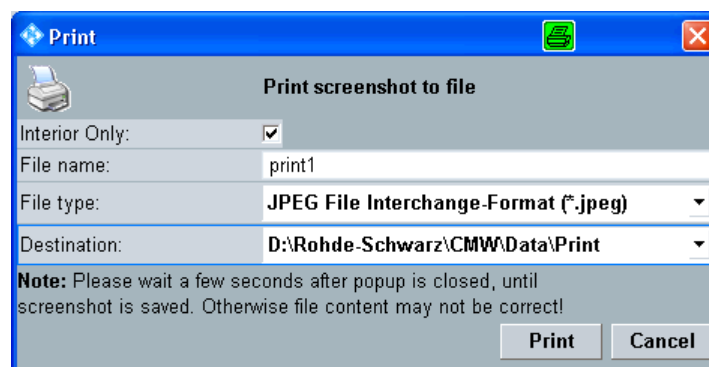

Fig. 4-18: Print dialog

Interior Only

If this setting is disabled, the entire "CMW" window is captured. The window may contain the main part called "interior", the hotkey bar below the interior, the softkey bar to the right of the interior and at an external monitor / remote monitor the soft-frontpanel at the very right.

If this setting is enabled, only the interior is captured. The hotkey bar, softkey bar and soft-frontpanel are not captured.

File Type

The R&S CMW270 supports a variety of bitmap data formats for print files, for example .bmp, .emf, .jpeg, .pbm, .pgm, .png, .ppm, .wmf, .xbm and .xpm.

The default file format (for file names entered without extension) is .jpeg.

Remote command:

`HCOPY:DEvice:FORMat`

Print

You can trigger a screenshot via the "Print" button or via one of the following commands.

Remote command:

HCOPY:FILE

HCOPY:INTerior:FILE

HCOPY:DATA?

HCOPY:INTerior:DATA?

4.6 Info Dialog

The "Info" dialog is subdivided into the following sections, accessible via softkeys:

- Current state – displays information about the current state of installed firmware applications
- Messaging – for future extensions
- Problem Reporting – allows to prepare collected logging information for problem reporting to Rohde & Schwarz

To open the dialog press the INFO key at the (soft-)front panel.

4.6.1 Current State View

The "Current State" view provides information concerning the current state of all installed firmware applications. Additionally it displays the software version at the top. At the bottom it displays the most important address settings for remote control and information related to calibration and RF path correction.

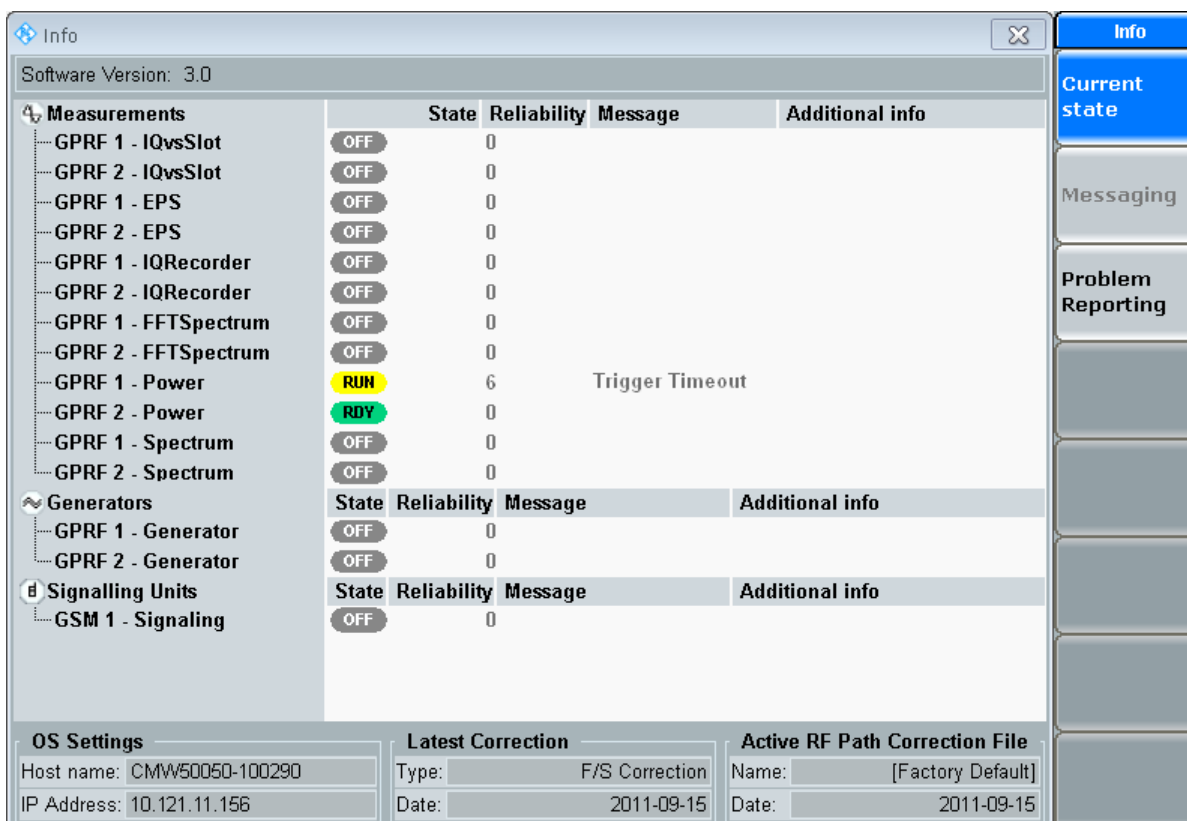

Fig. 4-19: Info – Current State

State

Generator state, signaling generator state or measurement state, see [Generator Control](#), [Measurement Control](#) and [Control of the Cell State](#).

Reliability, Message, Additional Info

The reliability indicator describes the validity of measurement results and the possible source of inaccuracies or errors.

The displayed reliability values indicate the most severe error that has been detected by a measurement, generator or signaling application since it has been started or switched on. A measurement returns this value also when measurement results are queried via remote control command. When an application is stopped or switched off, the available error information is kept. When it is re-started or switched on again, the "old" error information is deleted.

To display all errors detected by an application, not only the most severe one, select the application to the left and press the hotkey "Reliability List" at the bottom.

A zero in column "Reliability" indicates that no error has been detected. A detected error is indicated via a non-zero value in column "Reliability", the corresponding text message in column "Message" and optionally additional information like a file name or a specific option in the last column.

For a description of all reliability indicator values, refer to [chapter 5.4.4.1, "Reliability Indicator"](#), on page 157.

OS Settings

Displays the most important address settings for remote control. For configuration see [chapter 4.4.1, "System Settings"](#), on page 86.

Latest Correction

Displays the type and date of the last correction of the instrument. Remote commands allow also to query information about previous corrections.

Possible types are:

- **F/S Correction:** Correction performed in factory or service
- **TPM Correction:** Correction performed by the user (third party maintenance)
- **Calibration:** Verification in the factory
- **Outgoing Calibration:** Verification by the service

Remote command:

`CALibration:BASE:ALL?`

`CALibration:BASE:LATest?`

`CALibration:BASE:LATest:SPECific?`

Active RF Path Correction File

Displays the name and creation date/time of the currently active RF path correction file.

Remote command:

`CALibration:BASE:ACFile?`

4.6.2 Problem Reporting

The "Problem Reporting" section of the "Info" dialog allows to prepare collected logging information for problem reporting to Rohde & Schwarz.

In the case that you encounter problems with your instrument, proceed as follows to send the generated log files to Rohde & Schwarz:

1. Press the INFO key at the (soft-)front panel to open the "Info" dialog.
2. Press the softkey "Problem Reporting". A list of logging sessions is displayed as shown in the figure below.
3. If required (e.g. because of limitations in the electronic mail system) use the hotkey **"Max. File Size"** to adjust the maximum size of the compressed log files to be transferred to Rohde & Schwarz.
4. Select the directory of the session where the problem occurred. The date and time of the log session refer to the start of the instrument.
5. Press the hotkey **"Prepare for sending"**. The selected log files are packed into one or more compressed files located in folder "Output".
6. Send the files to Rohde & Schwarz for analysis. You can copy the files from folder "Output" using the hotkey "Copy" or you can navigate to the directory "D:\Rohde-Schwarz\CMW\Log\output" and copy the files stored there. To transfer the files from the instrument to a PC you can e.g. transfer them via LAN or use a USB stick.

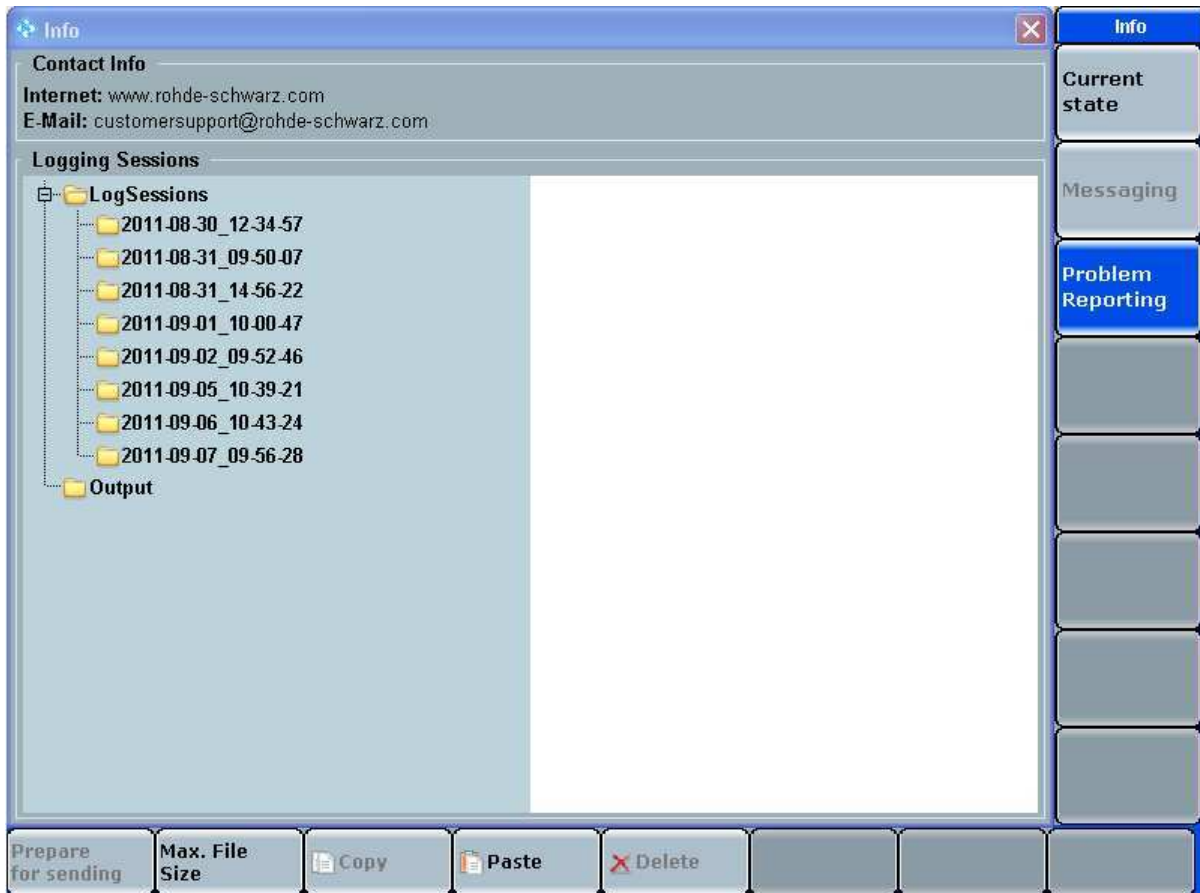

Fig. 4-20: Info – Problem Reporting

The dialog provides the following hotkeys.

Prepare for sending

Stores the selected log file directory into one or more compressed files, located in the "Output" directory.

Max. File Size

Sets a maximum file size for the compressed files resulting from the "Prepare for sending" action.

Copy

Copies the selected folder or file to the clipboard. This hotkey can be used e.g. to copy a compressed file located in the output folder.

Paste

Pastes the folder or file located in the clipboard to the selected folder.

Delete

Deletes the selected folder or file.

4.7 Instrument Setup Dialog

The "Instrument Setup" dialog is only relevant for instruments with several RX and TX signal paths. These instruments are equipped with six RF connectors at the front panel, while instruments with one path provide only three RF connectors.

The dialog allows to split the instrument into two sub-instruments which operate independently. Each sub-instrument is addressed separately and equipped with independent hardware and software resources in order to run the tasks assigned to it.

See also [chapter 3.4, "Sub-Instruments"](#), on page 77.

To open the dialog press the DEVICE key at the (soft-)front panel.

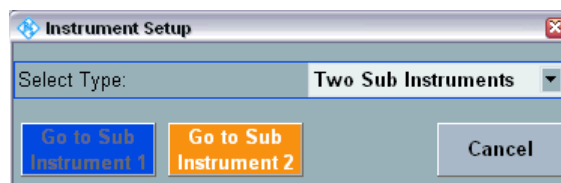

Fig. 4-21: Instrument Setup dialog

Select Type

Selects the number of sub-instruments. The physical instrument can be split into two sub-instruments or all resources can be assigned to a single (sub-)instrument.

Changing this setting also affects the assignment of firmware applications to the sub-instrument(s). The task bar is reset (cleared).

In the factory default configuration, all resources are grouped together in a single (sub-)instrument. Splitting the instrument can help to run tasks in parallel, and minimize the risk of resource conflicts between these tasks.

Remote command:

```
SYSTem:BASE:DEVIce:COUNt
SYSTem:BASE:DEVIce:RESet
SYSTem:BASE:DEVIce:SUBinst?
```

Go to Sub Instrument 1/2

These buttons are available if "Two Sub Instruments" is selected. They select the current sub-instrument for manual control. Remote control of the sub-instruments is independent of this setting.

In order to facilitate the distinction between the two sub-instruments, the GUIs of the sub-instruments use different colors for the background and the active softkeys and hotkeys. These colors correspond to the colors of the "Go to Instrument 1/2" buttons.

Remote command:

n/a

4.8 Measurement Controller Dialog

The "Measurement Controller" dialog lists the available measurement firmware applications and allows to add measurement applications to the task bar.

To open the dialog press the MEASURE key at the (soft-)front panel.

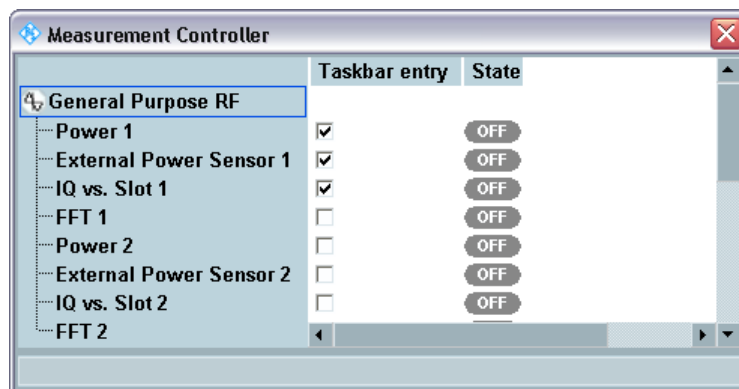

Fig. 4-22: Measurement Controller dialog

Use the checkboxes in the dialog to add or remove a task bar entry for a measurement.

For manual control of a firmware application, the application must be added to the task bar. Remote control of a firmware application is possible without a corresponding task bar entry.

4.9 Generator/Signaling Controller Dialog

The "Generator/Signaling Controller" dialog lists the available generator and signaling firmware applications and allows to add the applications to the task bar.

To open the dialog press the SIGNAL GEN key at the (soft-)front panel.



Fig. 4-23: Generator/Signaling Controller dialog

Use the checkboxes in the dialog to add or remove a task bar entry for a generator or signaling application.

For manual control of a firmware application, the application must be added to the task bar. Remote control of a firmware application is possible without a corresponding task bar entry.

4.10 Blockview Dialog

The "Blockview" dialog provides an overview of the configured signal routing settings.

It allows to:

- display the current allocation of signal path resources to firmware applications
- display the signal path configured for a firmware application
- reconfigure the signal path of a firmware application

To open the dialog press the BLOCKVIEW key at the (soft-)front panel.

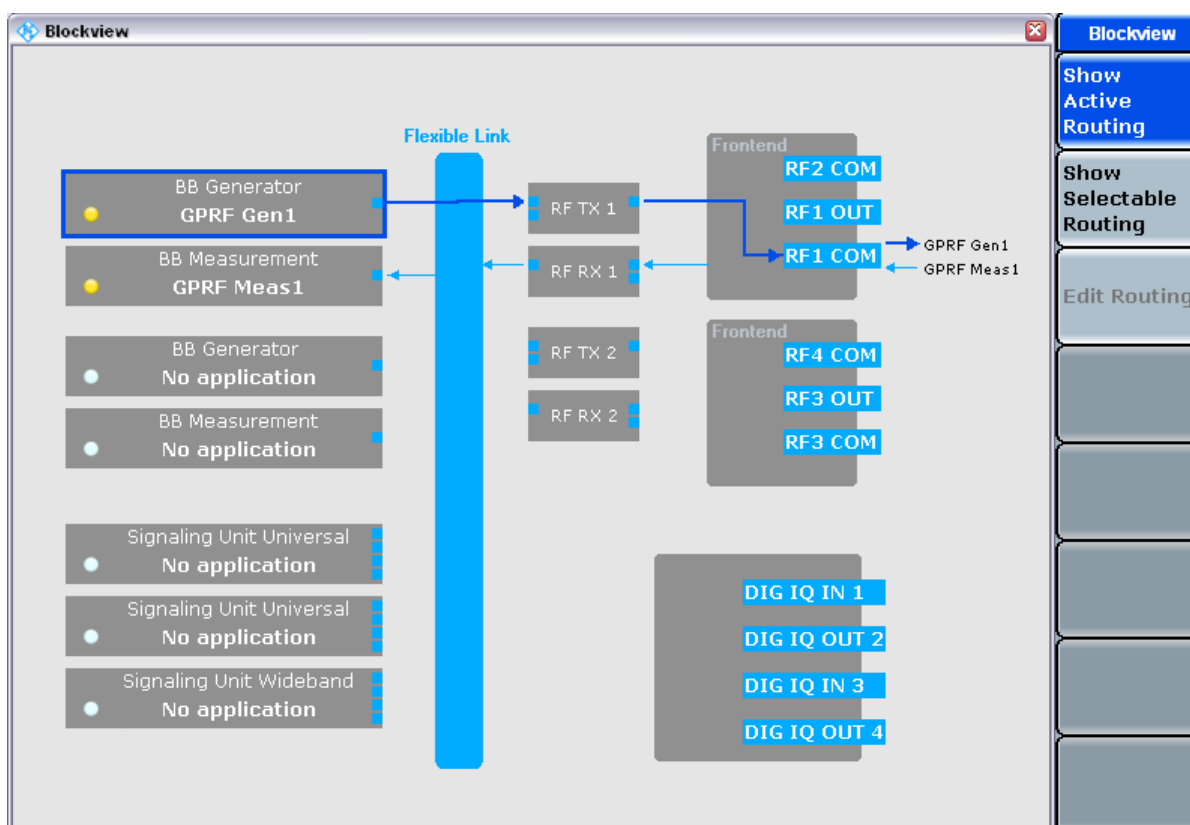

Fig. 4-24: Blockview dialog - Active Routing

The blockview dialog shows the most important hardware blocks relevant for RF and baseband signal paths. If the instrument is split into several sub-instruments, the blockview dialog displays only the resources assigned to the currently selected sub-instrument.

Displayed blocks (from left to right):

- Baseband boards and signaling units
A generator instance is running on a baseband generator module, a measurement instance on a baseband measurement module and a signaling application on a signaling unit universal or wideband (SUU, SUW).
Each installed unit is represented by one block. If e.g. two generator modules are installed, two blocks "BB Generator" are displayed. One block can be used by only one firmware application at a time.

Each block provides the graphical presentation of an LED, indicating the state of the displayed firmware application. A yellow LED indicates "RUN" or "ON", a green LED indicates "RDY" and a red LED indicates started ("RUN") but error occurred (e.g. trigger timeout). "OFF" is indicated by a switched off LED.

- **Baseband link**
The blockview indicates which type of baseband link is installed: a fixed link (R&S CMW-S550A) or a flexible link (R&S CMW-S550B/M).
- **TX and RX modules**
All installed TX and RX modules are displayed. For configuration the modules are distinguished by their type (RX or TX) and by a number. The numbering is done per sub-instrument which means that the same name (e.g. "RF TX 1") in different sub-instruments addresses physically different modules.
One module can be used by only one firmware application at a time.
- **Connectors**
The connectors displayed to the right are located at the front panel or rear panel of the instrument. The RF connectors belong to a basic or advanced frontend, the DIG IQ connectors to an I/Q board (optional).

The blockview dialog provides two modes, switchable via the softkeys "Show Active Routing" and "Show Selectable Routing". These modes are described in the following sections.

4.10.1 Show Active Routing

In this mode the blockview displays all allocated signal paths. Signal path resources are e.g. allocated to a generator while it provides a signal at an output connector or to a measurement while it is active. Resources are e.g. not allocated to queued firmware applications or applications in state "OFF".

The "Show Active Routing" mode is active by default when the blockview is opened. For a screenshot see [figure 4-24](#).

The following actions are possible in this mode.

Highlighting the signal path of one running application

- ▶ Select the block with the running application to the left.
The currently selected block is marked by a border and the related signal path is highlighted. This is especially useful if several applications are running in parallel, so that the segments of several paths are shown.

Switching to "Selectable Routing" mode

- ▶ Use the softkey "Show Selectable Routing" to switch to this mode.

4.10.2 Show Selectable Routing

In this mode the blockview displays the signal paths configured for the firmware applications selected to the left. It allows also to reconfigure signal paths.

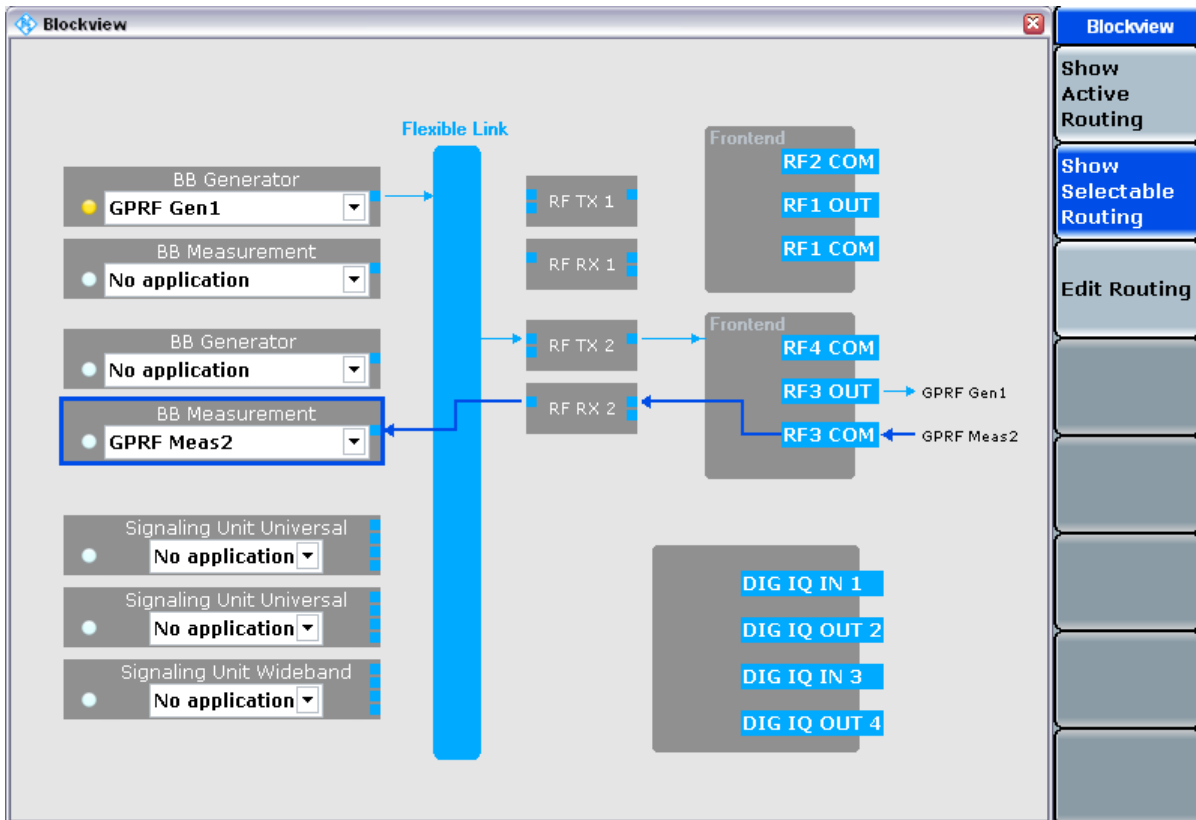

Fig. 4-25: Blockview dialog - Selectable Routing

Note that each drop-down menu to the left lists only the installed firmware applications supported by the block. The first (uppermost) "BB Generator" supports the first instance of generator applications, the second "BB Generator" the second instance. The same applies to "BB Measurement" for measurement applications. Signaling applications require a certain type of signaling unit - either universal or wideband.

The following actions are possible in "Show Selectable Routing" mode.

Displaying the signal path configured for an application

- Use the drop-down menus to the left to select the firmware application.

The signal path currently configured for the selected application is displayed and highlighted. This action has no impact on the allocation of resources, especially of baseband boards or signaling units. It only shows the signal path that would be used if the application would be running.

Highlighting the signal path of one block / application

- Select a block to the left.

The currently selected block is marked by a border and the related signal path is highlighted. This is especially useful if you have selected applications in several drop-down menus, so that the segments of several paths are shown in parallel.

Reconfiguring a signal path for a specific application

1. Select a block to the left supporting the firmware application to be configured.
Example: For the first instance of a measurement select the uppermost "BB Measurement" block.
2. Press the softkey "Edit Routing".
The "Edit Routing" dialog opens.



3. Select the application and configure the signal routing settings top down.
The available parameters depend on the application and can also be accessed via the configuration dialog of the application. For a description of individual parameters and values please refer to the documentation of the application.
Usually there are dependencies between the parameters. Configuring a parameter may modify the set of supported values for parameters below and to the right. For that reason configure the parameters top down and from left to right.
4. Close the dialog.

Switching to "Active Routing" mode

- Use the softkey "Show Active Routing" to switch to this mode.

4.11 System Messages

System messages give information about exceptional states of the instrument. If possible, the messages also describe necessary user interactions. The R&S CMW270 uses different types of messages, depending on the source and nature of the described situation.

Tooltips

Tooltips are short pieces of text that are displayed in a yellow, rectangular field.

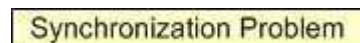

Fig. 4-26: Example of a tooltip

If used as a system message, a tooltip usually informs about unusual measurement conditions, e.g. due to a missing signal or inappropriate measurement settings. Check the preconditions for the measurement at the beginning of each measurement description.

System Information

System information boxes describe the effects of an action that is about to be performed. The information box still allows you to "Cancel" the action.

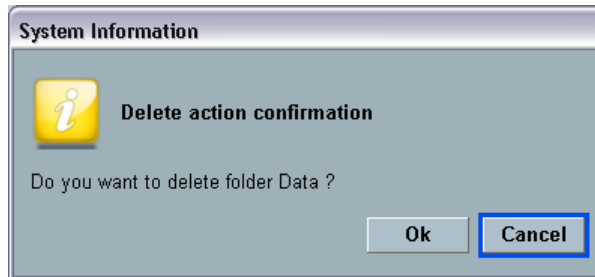

Fig. 4-27: System information

System information boxes use different icons, depending on the consequences of the performed action.



Fig. 4-28: System warning

System Error Message

System error messages are displayed when the R&S CMW270 software needs to be restarted to continue operation. In general the message box describes the cause of the exception and contains two buttons to shutdown or restart the software.



Fig. 4-29: Error message

5 Remote Control

This chapter provides instructions on how to set up the tester for remote control, a general introduction to remote control of programmable instruments, and the description of the tester's remote control concept.

For reference information about all remote control commands implemented by the instrument, complemented by comprehensive programming examples, refer to section "Command Reference" and "Programming" in the documentation of the individual firmware applications.

Programming examples, software tool

The programming examples in the reference chapters have been tested with the aid of a simple software tool which provides an environment for the development and execution of remote tests.

Tool-specific program syntax has been omitted, with the exception of some simple elements:

- //: Remark, command line not executed
- WAITKEY <Text>: Display a dialog containing the text and wait for user interaction before the program is continued

This chapter is organized as follows.

• Remote Control Operation	126
• Messages	133
• R&S CMW Command Structure	141
• Control of the Instrument	144
• Command Processing	173
• Status Reporting System	176
• Command Macros	191
• Response Buffers	194
• LXI Configuration	196
• Monitoring the Instrument via SNMP	203

5.1 Remote Control Operation

The instrument supports several interfaces for remote control. The following table gives an overview.

Table 5-1: Remote control interfaces and protocols

Interface	Protocols, VISA ^{*)} resource string	Remarks
LAN	HiSLIP protocol "TCPIP[board]::host address[::HiSLIP device name[,HiSLIP port]]::INSTR"	The LAN REMOTE connector is located on the rear panel. The HiSLIP device name for sub-instrument n equals hislip<n-1>. Example: hislip0 for sub-instrument 1. The default HiSLIP port is port 4880. HiSLIP (High Speed LAN Instrument Protocol) is the successor protocol for VXI-11 for TCP-based instruments specified by the IVI foundation. It is the recommended protocol for remote control via LAN. For a description of the protocol and the interface commands refer to chapter 7.1.2.1, "HiSLIP Protocol" , on page 312.
	VXI-11 protocol "TCPIP[board]::host address[::LAN device name]::INSTR"	The LAN device name for sub-instrument n equals inst<n-1>. Example: inst0 for sub-instrument 1. VXI-11 is a protocol that has been specifically developed for test and measurement instruments. For a description of the protocol and the interface commands refer to chapter 7.1.2.1, "HiSLIP Protocol" , on page 312.
	VISA socket resource "TCPIP[board]::host address::Data Port[::SOCKET]"	LAN connection with pure TCP/IP protocol, refer to your VISA user documentation. For a description of the protocol modes and interface commands refer to chapter 7.1.2.3, "Direct Socket Communication" , on page 312.
USB	"USB[board]::2733::87::serial number[::USB interface number]::INSTR"	A USB type B connector (USB REMOTE) is located on the rear panel of the instrument. 2733 (0xAAD) is the manufacturer ID of Rohde & Schwarz 87 (0x57) is the R&S CMW270 model code The serial number is device-specific.
GPIB	"GPIB[board]::primary address[::INSTR]" (no secondary address)	Two optional GPIB bus interfaces according to standard IEC 625.1/IEEE 488.1 (options R&S CMW-B612A and R&S CMW-B612B). The GPIB bus connectors for connection to a controller are located on the rear panel of the instrument. For a description of the interface and interface commands refer to chapter 7.1.3, "GPIB Bus Interface" , on page 313.
<p>*) VISA is a standardized software interface library providing input and output functions to communicate with instruments. The I/O channel (LAN or TCP/IP, USB, ...) is selected at initialization time by means of the channel-specific resource string (also termed address string) quoted above or by an appropriately defined VISA alias (short name). A VISA installation is a prerequisite for remote control over LAN or USB interface. All VISA address resource strings are displayed and defined in the "Setup" dialog.</p>		



Multiple remote access

You can configure and use up to four remote channels simultaneously, see [chapter 5.1.5, "Multiple Channels for Remote Access"](#), on page 132.

LAN connection

Remote control via LAN requires a VISA installation but no additional hardware at the controller. VISA provides the TCPIP interface type and several protocol types to communicate with LAN-connected devices.

USB connection

A USB connection requires the VISA library to be installed. VISA will detect and configure the R&S CMW270 automatically when it is plugged to the computer. No separate driver installation is necessary.

SCPI compatibility

SCPI (Standard Commands for Programmable Instruments) instrument-control commands are used for remote control.

The SCPI standard is based on standard IEEE 488.2 and aims at the standardization of device-specific commands, error handling and the status registers. The R&S CMW270 is compatible with the final SCPI version 1999.0.

SCPI-confirmed commands are explicitly marked in the command reference chapters. Commands without SCPI label are device-specific, however, their syntax follows SCPI rules. The tutorial "Automatic Measurement Control - A tutorial on SCPI and IEEE 488.2" from John M. Pieper (R&S order number 0002.3536.00) offers detailed information on concepts and definitions of SCPI.



Reset states for manual and remote control

The R&S CMW270 provides different reset states for manual control (Preset) and remote control (Reset).

Remote control programs should always start from a well-defined initial state (e.g. with the command *RST) and then implement the required settings in order to keep full control over the instrument.

5.1.1 Drivers for Graphical Programming Interfaces

Many Rohde & Schwarz customers prefer graphical programming interfaces when writing applications for the R&S CMW270. Examples for such interfaces are LabVIEW and LabWindows/CVI from National Instruments or VEE from Agilent.

As a service, Rohde & Schwarz provides software device drivers free of charge for this purpose. The drivers are available for download from <http://www.rohde-schwarz.com>.

5.1.2 Establishing and Testing a LAN Connection

In the following example, a direct LAN connection is set up to the R&S CMW270. The connection is tested using a simple test script.

The steps in detail depend on the test environment in use. The present example is based on a test tool which requires an additional VISA installation.

1. Connect your R&S CMW270 to the controller or to the home/company network using the LAN REMOTE connector at the rear panel.
2. Switch on the R&S CMW270, wait until the startup procedure is complete and press the SETUP key.
The "Setup" dialog opens.
3. To the left, select section "Remote". Note the VISA address string displayed for HiSLIP and close the dialog.
In the following, we assume that the following string is displayed:
"TCPIP::10.121.11.192::hislip0::INSTR"
4. Start your test tool. Configure the connection to the instrument using the VISA address string and an alias, e.g. "CMW".
5. Write a test script using the alias and run the script.



Hostname and IP address

The VISA address strings displayed in the "Setup" dialog contain the hostname of the R&S CMW270 instead of the IP address. Use the address string type that is most convenient for you.

The following test script queries the identification string of the connected R&S CMW270 and returns the contents of the error queue:

```
*IDN?
SYSTem:ERRor?
```

On test script execution, the test tool generates the following result log:

```
: Opening new VISA channel: TCPIP::10.121.11.192::hislip0::INSTR
: Connection to TCPIP::10.121.11.192::hislip0::INSTR established!
: Session handle: 0
: VISA Resource-Identifier: TCPIP::10.121.11.192::hislip0::INSTR
: send_Query(0, "*IDN?")
: [-->TCPIP::10.121.11.192::hislip0::INSTR] *IDN?
: read_Answer(0, ..., False)
: [--TCPIP::10.121.11.192::hislip0::INSTR] Rohde&Schwarz,CMW,
1201.0002k50/624376,1.0.0.0
: send_Query(0, "SYSTem:ERRor?")
: [-->TCPIP::10.121.11.192::hislip0::INSTR] SYSTem:ERRor?
: read_Answer(0, ..., False)
: [--TCPIP::10.121.11.192::hislip0::INSTR] 0,"No error"
```

5.1.3 Switching between Manual and Remote Control

On power-up, the instrument is always in the manual operating state. It can be operated via the Graphical User Interface (GUI) and the (soft-)front panel controls.

The instrument is switched to remote control as soon as it receives a command from the controller.

While remote control is active, the instrument settings are optimized for maximum measurement speed. The normal display is "switched off", i.e. it shows a "Remote" dialog with hotkeys described in the following sections. All other operation via the front panel is disabled.

5.1.3.1 Using the Display during Remote Control

It is possible to switch on the display during remote control. This allows to observe the screen, e.g. measurement results, while a remote control script is executed and the control elements on the front panel are still disabled.

You can switch on the display manually or via remote control:

- Manually: Press the "Hide Remote Screen" hotkey



- Remote command: `SYSTem:DISPlay:UPDate ON`

It is recommended to switch off the display again before closing the remote connection:

- Manually: Press the "Show Remote Screen" hotkey



- Remote command: `SYSTem:DISPlay:UPDate OFF`

Switching on the display is ideal for programming test purposes but tends to slow down the measurement. Therefore it is recommended to switch off the display in real measurement applications where a tested script is to be executed repeatedly.

5.1.3.2 Returning to Manual Operation

The R&S CMW270 returns to manual operation when the remote connection is closed.

The return to manual operation can also be initiated manually or via remote control:

- Manually: Press the "Go To Local" hotkey

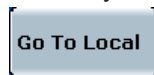

If an instrument with several RX and TX signal paths is split into sub-instruments, you can return to any of these sub-instruments. The remote screen displays several hotkeys for this purpose.



- Via GPIB bus or HiSLIP protocol: GTL interface message
- Via VXI-11 protocol: >L interface message

A "Go To Local" can be useful while a remote program pauses, e.g. to check the current instrument state on the display. When the program continues sending messages, the R&S CMW270 will switch back to remote control immediately.

Local lockout

You can prevent the instrument from returning to manual control using a Local Lockout Message:

- Via GPIB bus or HiSLIP protocol: LLO interface message
- Via VXI-11 protocol: &LLO interface message
- Many instrument driver commands, e.g. the NI commands SetRWLS (Set Remote With Lockout State) or SendLLO, also contain a local lockout command.

In the local lockout state an unintentional return to manual control is not possible. All "Go To Local" options listed above are blocked (hotkey and remote control). The "Go To Local" hotkey is replaced by a disabled "Local Lockout" hotkey.

The local lockout can be disabled as follows:

- Via GPIB bus or HiSLIP protocol: deactivate the REN control line
- Via VXI-11 protocol: &NREN interface message

5.1.4 Monitoring the Remote Control Interface

You have several possibilities to monitor the control interface:

- Use the SCPI remote trace functionality integrated in the LXI homepage of the instrument, see [chapter 5.9.2, "LXI Browser Interface"](#), on page 197.
- Create a report file. To enable or disable the creation of report files use the "Report File" hotkey displayed while remote control is active.



Remote command:

```
TRACe:REMOte:MODE:FILE<inst>:...
```

See [chapter 6.3.6, "Tracing the Remote Control Interface"](#), on page 219

- Access the SCPI remote trace directly via the "Remote" dialog, displayed while remote control is active. To configure the display use the "Report Display" hotkey.



The hotkey toggles between the following modes:

- OFF: tracing is disabled
- LIVE: messages are traced and displayed
- ANALYSE: stop tracing to analyse already traced messages

The displayed remote trace is similar to the remote trace displayed via the LXI homepage, with the softkeys provided in ANALYSE mode corresponding to toolbar buttons of the LXI remote trace.

For a detailed description of the LXI remote trace see [chapter 5.9.4, "SCPI Remote Trace"](#), on page 201.

Remote command:

```
TRACe:REMOte:MODE:DISPlay:...
```

See [chapter 6.3.6, "Tracing the Remote Control Interface"](#), on page 219

5.1.5 Multiple Channels for Remote Access

Several remote channels can be used simultaneously. The R&S CMW270 supports up to four parallel channels. No restriction is placed upon the combination of channels: It is possible to combine several channels of the same type (e.g. two LAN channels), or channels of different types (e.g. a USB channel and a LAN channel).

The channels can address the same sub-instrument or different sub-instruments, see also [chapter 3.4, "Sub-Instruments"](#), on page 77.

Example:

Suppose you are executing a remote script to perform a relatively time-consuming measurement, and that you wish to query the instrument state while the measurement is running. You can do this without changing your script if you open a second remote channel for status register handling and monitoring.

The following remote control resources are channel-specific:

- Error Queue
- Input and output buffer
- All programmable parts of the status registers



Instrument settings and system resources

Instrument settings may affect several active remote channels. You should be particularly cautious in using scripts containing reset (*RST), save (*SAV) or recall (*RCL) commands, as a sudden change of the instrument settings may impair processes controlled through other channels.

Please also keep in mind that processes controlled through different remote channels may still share the same instrument resources.

5.1.5.1 Status Registers for Different Channels

Each status register consists of five different parts:

- The CONDition parts of the lowest-level registers are continuously updated by the instrument. These register parts are not programmable; they are an instrument resource which is shared by all remote channels.
- The PTRansition and NTRansiton parts, the EVENT parts, and the ENABLE parts determine how the CONDition bits from the lower-level registers are passed on to higher registers. These status register parts can be programmed individually for each remote channel.

Examples for channel-dependent registers

The Event Status Register (ESR) is similar to the EVENT part of an SCPI register; it indicates instrument events. This register is channel dependent and cleared upon reading it.

The Event Status Enable (ESE) register can be programmed individually for different remote channels. The contents of the status byte (STB) and the conditions for the R&S CMW270 to initiate a service request (SRQ) are also channel-specific.

5.2 Messages

The messages transferred between the controller and the R&S CMW270 can be either interface messages or device messages.

The general structure of the device messages is defined by the SCPI standard. For specific features of the R&S CMW270 command set refer to section [R&S CMW Command Structure](#).

5.2.1 HiSLIP and VXI-11 Interface Messages

The HiSLIP protocol and the VXI-11 protocol allows the instrument to be controlled in a Local Area Network. For a short introduction and a list of interface functions refer to [chapter 7.1.2, "LAN Interface"](#), on page 311.

5.2.2 GPIB Bus Interface Messages

GPIB interface messages are transferred on the data lines of the GPIB bus, the ATN control line being active. They are used for communication between controller and instrument and can only be sent by a computer which has the function of a GPIB bus controller.

GPIB interface messages can be further subdivided into:

- Universal commands: act on all devices connected to the GPIB bus without previous addressing
- Addressed commands: only act on devices previously addressed as listeners

The interface messages relevant to the instrument are listed in section [GPIB Bus Interface](#).

5.2.3 Device Messages (Commands and Device Responses)

Device messages are transferred via the USB interface, the LAN interface (VXI-11 protocol) or on the data lines of the GPIB bus, the "ATN" control line not being active.

The ASCII character set is used. A distinction is made according to the direction in which device messages are transferred:

- **Commands**
are messages the controller sends to the instrument. They operate the device functions and request information.
- **Device responses**
are messages the instrument sends to the controller after a query. They can contain measurement results, instrument settings and information on the instrument status.

Commands are subdivided according to two criteria:

1. According to the effect they have on the instrument:
 - **Setting commands**
cause instrument settings such as a reset of the instrument or setting the output level to some value.
 - **Queries**
cause data to be provided for output, e.g. for identification of the device or polling the active input.
2. According to their definition in standard IEEE 488.2:
 - **Common commands**
have a function and syntax that is exactly defined in standard IEEE 488.2. Typical tasks are the management of the standardized status registers and reset.
 - **Instrument-control commands**
are functions that depend on the features of the instrument such as frequency settings. A majority of these commands has also been standardized by the SCPI consortium.

The device messages have a characteristic structure and syntax, see [SCPI Command Structure and Syntax](#). In the command reference chapters all commands are listed and explained in detail.

5.2.4 SCPI Command Structure and Syntax

SCPI commands consist of a so-called header and, in most cases, one or more parameters. The header and the parameters are separated by a "white space" (ASCII code 0 to 9, 11 to 32 decimal, e.g. blank). The headers may consist of several mnemonics which are separated by colons. Queries are formed by appending a question mark to the header.

SCPI defines two command types with different syntax: common commands and instrument control commands.

5.2.4.1 Common Commands

Common commands are device-independent and consist of a header preceded by an asterisk "*" and possibly one or more parameters.

The following table shows some examples. For a comprehensive list refer to [Common Commands](#).

Command	Description
*RST	RESET, resets the sub-instrument.
*ESE 253	EVENT STATUS ENABLE, sets the bits of the event status enable registers.
*IDN?	IDENTIFICATION QUERY, queries the instrument identification string.

5.2.4.2 Instrument-Control Commands

Instrument-control commands are based on a hierarchical structure and can be represented in a command tree. The command headers are built with one or several mnemonics (keywords). The first level (root level) mnemonic identifies a complete command system.

Example:

`SOURce . . .` This mnemonic identifies the `SOURce` command system which provides generator settings.

For commands of lower levels, the complete path must be specified, starting on the left with the highest level, the individual keywords being separated by a colon ":".

Example:

```
SOURce:GPRF:GENerator:STATe ON
```

This command is located on the fourth level of the `SOURce` system. It turns on the RF generator signal.

Below some rules are described that simplify / abbreviate the command syntax and help to read the command reference sections.

Repeated mnemonics with different meaning

The same mnemonics may be used on different command levels, not necessarily with the same meaning. The actual meaning of a mnemonic depends on its position in the command header.

Example:

```
SOURce:GPRF:GENerator:RFSettings:FREQuency 1GHZ
```

This command contains the mnemonic `SOURce` in the first command level ("define RF generator settings"). The command defines the frequency of the GPRF generator signal.

```
CONFigure:GPRF:MEASurement:POWer:TRIGger:SOURce
```

This command contains the mnemonic `SOURce` in the sixth command level. It selects the source of the trigger events for the GPRF Power measurement.

Special characters

- | A vertical stroke in the parameter list characterizes alternative parameter settings. Only one of the parameters separated by | must be selected.
Example: The following command has three alternative settings:
`ROUTe:GPRF:GENErator:SCENario:SALone RF10 | RF1C | RF2C`
- [] Parts in square brackets can be omitted when composing the command header. The complete command must be recognized by the instrument for reasons of compatibility with the SCPI standard. Parameters in square brackets are optional as well. They may be entered in the command or omitted.
Example: The following two commands have the same effect
`SOURce:GPRF:GENErator[:STATe] ON`
`SOURce:GPRF:GENErator ON`
- { } Braces or curly brackets enclose one or more parameters that may be included zero or more times.



Optional mnemonics with suffixes

An optional mnemonic must not be omitted if its effect is further specified by a numeric suffix.

Long and short form

The key words have a long form and a short form. The short form consists of all upper-case characters, the long form of all upper case plus all lower case characters. The R&S CMW270 recognizes both the short form and the long form.

Example:

```
SOUR:GPRF:GEN:STAT ON
SOURce:GPRF:GENErator:STATe ON
```



Case insensitivity

The short form is marked by upper case letters, the long form corresponds to the complete word. Upper case and lower case notation only serves to distinguish the two forms in the manual, the instrument itself is case-insensitive.

Parameters

Many commands are supplemented by a parameter or a list of parameters. Parameters either provide alternative options (setting a or setting b or setting c ..., see special character "|"), or they form a list separated by commas (setting x,y).

In the command reference parameters are generally described by a name (literal) written in angle brackets (<>). This literal merely serves as a parameters description; in an application program it must be replaced by one of the possible settings reported in the detailed parameter description.

For a description of the parameter types, refer to section [SCPI Parameters](#).

Example: `SOURce:GPRF:GENErator:STATe <Boolean>`

with <Boolean> = ON | OFF

possible command syntax: `SOURce:GPRF:GENerator:STATe ON`

Numeric suffixes

Symbols in angular brackets (<ch>, <i>, <n>,...) denote numeric suffixes. Numeric suffixes have to be replaced by integer numbers to distinguish various items of the same type. The R&S CMW270 provides numeric suffixes for firmware application instances, signal sources etc. If unspecified, a numeric suffix is replaced by 1.

Example:

```
SOURce:GPRF:GENerator:DTONe:OFRequency2 1MHz
```

This command specifies an offset frequency for the second (Source 2) component of the dual-tone GPRF generator signal. `GENerator` (without suffix or with suffix 1) denotes the first instance of the GPRF generator.

Information in the command reference sections

All commands are described according to the same scheme. The following information is provided:

- Complete command syntax and parameter list
- Description of the command and its relationship with other commands
- List and description of the parameters with their numerical ranges, default values and default units
- Supported command types (setting command, query)
- Program example (optional)

The commands are arranged according to the order of parameters in the corresponding dialogs of the Graphical User Interface. This means that related commands are generally grouped together. Groups of commands with similar function (e.g. several `READ...?` and `FETCh...?` queries for a single measurement application) are listed with a common command description.

5.2.4.3 Structure of a Command Line

A command line may consist of one or several commands. It is terminated by a <New Line>, a <New Line> with EOI or an EOI together with the last data byte. Some programming languages automatically produce an EOI together with the last data byte.

Several commands in a command line must be separated by a semicolon ";". If the next command belongs to a different command system, the semicolon is followed by a colon.

Example:

```
ROUTe:GPRF:GENerator:SCENario:SALone RF1C; :SOURce:GPRF:
GENerator:RFSettings:FREQuency 1GHZ
```

This command line contains two commands. The first command belongs to the `ROUTe` system and selects the output connector for the GPRF generator. The second com-

mand belongs to the `SOURCE` system and defines the frequency of the GPRF generator signal.

If the successive commands belong to the same system, having one or several levels in common, the command line can be abbreviated. To this end, the second command after the semicolon starts with the level that lies below the common levels. The colon following the semicolon must be omitted in this case.

Example:

```
SOURCE:GPRF:GENERator:RFSettings:FREQuency 1GHz; :SOURCE:GPRF:
GENERator:RFSettings:LEVel -80
```

This command line is written in its full length and contains two commands separated from each other by the semicolon. Both commands are part of the `SOURCE:GPRF:GENERator:RFSettings` command subsystem, i.e. they have four levels in common.

When abbreviating the command line, the second command begins with the level below `SOURCE:GPRF:GENERator:RFSettings`. The colon after the semicolon is omitted. The abbreviated form of the command line reads as follows:

```
SOURCE:GPRF:GENERator:RFSettings:FREQuency 1GHz;LEVel -80
```

A new command line must always begin with the complete path.

Example:

```
SOURCE:GPRF:GENERator:RFSettings:FREQuency 1GHz
SOURCE:GPRF:GENERator:RFSettings:LEVel -80
```

5.2.4.4 Responses to Queries

A query is defined for each setting command unless explicitly specified otherwise. It is formed by adding a question mark to the associated setting command. The following rules apply to the responses:

- The requested parameter is transmitted without header.
Example: `ROUTE:GPRF:GENERator:SCENario:SALone?`
Response: `RF1C`
- Maximum values, minimum values and all further quantities which are requested via a special text parameter are returned as numerical values.
Example: `SOURCE:GPRF:GENERator:RFSettings:FREQuency? MAX`
Response: `6.000000E+009`
- Numerical values are returned without their unit. The default unit for each command is reported in the command reference description.
If you add a unit to the query, this unit is used instead of the default unit.
Example: `SOURCE:GPRF:GENERator:RFSettings:FREQuency?`
Response: `3.000000E+009` for 3 GHz, default unit Hz used
Example: `SOURCE:GPRF:GENERator:RFSettings:FREQuency? GHz`
Response: `3.000000E+000` for 3 GHz, specified unit GHz used

- Boolean values are returned as 0 (for OFF/FALSE) and 1 (for ON/TRUE). Possible exceptions to this rule are reported in the command reference description.
Example: `SENSe:BASE:REfERENCE:FREQuency:LOCKed?`
Response: 1
- Text (character data) is returned in short form (see also next section).
Example: `SOURce:GPRF:GENerator:BBMode?`
Response: `DTON` (for `DTONe`, dual tone)

5.2.4.5 SCPI Parameters

Most commands require one or more parameters to specify their function. The parameters must be separated from the header by a "white space". Permissible parameters are numeric values, boolean parameters, text, character strings and block data. The parameter types and the permissible ranges of values are specified in the command description.

Numeric Values

Numeric values can be entered in any form, i.e. with sign, decimal point and exponent. Values exceeding the resolution of the instrument are rounded up or down. The mantissa may comprise up to 255 characters, the values must be in the value range $-9.9E37$ to $9.9E37$. The exponent is introduced by an "E" or "e". Entry of the exponent alone is not allowed. In the case of physical quantities, the unit can be entered. Permissible unit prefixes are G (giga), MA (mega), MOHM and MHZ are also permissible), K (kilo), M (milli), U (micro) and N (nano). If the unit is omitted, the default unit is used.

Example:

`SOURce:GPRF:GENerator:RFSettings:FREQuency 1.5GHz` is equivalent to
`SOURce:GPRF:GENerator:RFSettings:FREQuency 1.5E9`

Special numeric values

The texts `MINimum`, `MAXimum`, `DEFault` and `KEEP` are interpreted as special numeric values. A query returns the associated numerical value.

Example:

`SOURce:GPRF:GENerator:RFSettings:FREQuency MINimum`

The query `SOURce:GPRF:GENerator:RFSettings:FREQuency?` returns
70000000.

The following special values can be used on the R&S CMW270:

- `MIN/MAX`: denote the minimum and maximum value of a range of numeric values.
- `DEF`: denotes the reset value. This value is set by the `*RST` command.
- `KEEP`: can be used within a list of values to "keep" a value unchanged, e.g. to set the third value in a list of five parameters to 10 use `KEEP,KEEP,10,KEEP,KEEP`
- `NAN`: represents the value $9.91E37$. Not a Number (NAN) is only sent as device response. This value is not defined. Possible causes are division by zero, subtraction or addition of infinite values, or missing values.

Unless it is explicitly stated in the command description you can use the special numeric parameters described above for all commands of the R&S CMW270. Other special parameters are generally not supported.

Boolean Parameters

Boolean parameters represent two states. The ON state (logically true) is represented by ON. The OFF state (logically false) is represented by OFF. Replacement of ON or OFF by 1 or 0 is not supported.

Example:

Setting command: `SOURce:GPRF:GENerator:STATe ON`

Query: `SOURce:GPRF:GENerator:STATe?` returns ON

Some of the remote control commands in the `SYSTem...` and `STATus...` subsystems are not implemented as described above. These commands are not needed to perform measurements or generate RF signals.

Text Parameters

Text parameters observe the syntax rules for keywords, i.e. they can be entered using a short or long form. Like any parameter, they have to be separated from the header by a white space. In the case of a query, the short form of the text is provided.

Example:

Setting command: `SOURce:GPRF:GENerator:BBMode DTONE`

Query: `SOURce:GPRF:GENerator:BBMode?` returns DTON

Strings

Strings must be entered within single or double quotation marks (' or ").

Example: `MMEM:MDIR 'C:\test scripts'` or `MMEM:MDIR "C:\test scripts"`

Block Data Format

Block data is a transmission format which is suitable for the transmission of large amounts of data. A command using a block data parameter with definite length has the following structure:

Example: `HEADer:HEADer #45168xxxxxxxx`

The hash symbol # introduces the data block. The next number indicates how many of the following digits describe the length of the data block. In the example above the 4 following digits indicate the length to be 5168 bytes. The data bytes follow. During the transmission of these data bytes all End or other control signs are ignored until all bytes are transmitted.

A #0 combination introduces a data block of indefinite length. The use of the indefinite format requires a `NL^END` message to terminate the data block. This format is useful when the length of the transmission is not known or if speed or other considerations prevent segmentation of the data into blocks of definite length.

Overview of Syntax Elements

Element	Usage
:	The colon separates the keywords of a command. In a command line the separating semicolon marks the uppermost command level.
;	The semicolon separates two commands of a command line. It does not alter the path.
,	The comma separates several parameters of a command.
?	The question mark forms a query.
*	The asterisk marks a common command.
' , "	Quotation marks introduce a string and terminate it.
#	The hash sign # introduces block data. Block: #21312
	A "white space" (ASCII-Code 0 to 9, 11 to 32 decimal, e.g. blank) separates header and parameter.

5.2.4.6 Use of SCPI Subsystems

The structure of the instrument-control commands implemented by the R&S CMW270 is described in sections [General Command Structure](#) and [Control of the Instrument](#). Due to this structure, some SCPI subsystems are used in a specific manner. The following list gives an overview.

Command	Usage
ABORt...	Stop measurement, release resources; see ABORt:<Application>:MEASurement<i>
CONFIgure...	Specify measurement settings
FETCh...	Retrieve measurement results (running measurement; see FETCh...? Command), measurement or generator states
INITiate...	Start measurement; see INITiate:<Application>:MEASurement<i>
READ...	Start new measurement and retrieve results; see READ...? Command
ROUTE...	Select output connectors and signal paths
SOURce...	Specify generator settings
STOP...	Stop measurement, do not release resources; see STOP:<Application>:MEASurement<i>

5.3 R&S CMW Command Structure

The syntax of the remote commands for the R&S CMW270 reflects the instrument's basic software modules. The header of each instrument-control command contains the

logical software entity the command is assigned to, eliminating the need of addressing the entities (e.g. firmware applications) separately.

5.3.1 General Command Structure

The instrument-control command headers for the R&S CMW270 firmware applications consist of four parts.

SCPI subsystem (1 mnemonic)	Firmware application (2 mnemonics)	Instance (numeric suffix)	Setting/Result (1 or several mnemonics)
SOURce	:GPRF:GENerator	1 2 3 4	[:STATe]

The purpose and format of the four command parts is as follows:

- SCPI Subsystem**
 One of the root mnemonics specified in the SCPI standard, indicating the SCPI subsystem. Commands within the same subsystem serve a similar purpose; see [Use of SCPI Subsystems](#). Some root mnemonics may be optional.
- Firmware application (FWA)**
 Two non-optional mnemonics indicating a combination of network standard or general purpose (GP) measurement and generator/measurement function group; see [Firmware Applications](#).
- Instance**
 Numeric suffix used to distinguish several FWAs of the same type (e.g. several GPRF generators). In principle the values can range from 1 to 4. However the range for a specific FWA can be limited (e.g. only 1 and 2) depending on the FWA, the installed hardware and the installed software options. A suffix 1 can be omitted according to SCPI rules.
- Setting/Result**
 One or several possibly optional mnemonics indicating the purpose of the command.

Extensions for measurement firmware applications

Many of the measurement firmware applications provide several [Measurement Contexts and Views](#). They are identified by fourth- and fifth/sixth-level mnemonics.

Due to the general structure described above, most R&S CMW270 commands are not SCPI confirmed, however, they follow SCPI syntax rules (see also [Remote Control Operation](#)).

5.3.2 Firmware Applications

The R&S CMW270 supports three different types of applications:

- GENerator**: Generator application, controls and configures RF generators. Examples: The GPRF generator generates a flexible RF signal for test purposes. The GSM generator generates a GSM-specific signal.

- **MEASurement:** Measurement application, provides a set of measurements for a specific network standard or general purpose tests. Example: The GPRF measurement application comprises different RF measurements, e.g. Power, External Power Sensor etc. The GSM measurement application provides transmitter tests on GSM signals.
- **SIGNaling:** Signaling application, provides a network-specific cell signal in order to establish a network connection with a mobile phone and perform various tests. Example: The GSM signaling application provides signaling tests for GSM mobile phones.

Generator, measurement, and signaling applications are termed "firmware applications" (FWA). In the remote control commands, the FWA is addressed by the second and third-level mnemonics; see [General Command Structure](#). A possible numeric suffix <i> (short for <instance>) behind the FWA mnemonics distinguishes several FWAs of the same type.

See also [Sub-Instruments](#).

The following table provides examples of FWAs of the R&S CMW270 and their mnemonics:

Firmware Application	Description
BLUetooth:MEASurement<i>	Bluetooth network standard, measurements
FMSTereo:MEASurement<i>	FM-modulated RF signals, measurements
GPRF:GENerator<i>	RF general purpose application, generator
GPRF:MEASurement<i>	RF general purpose application, measurements
WIMax:MEASurement<i>	WiMAX network standard, measurements
WIMax:SIGNaling<i>	WiMAX network standard, signaling
WLAN:MEASurement<i>	WLAN network standard, measurements
WLAN:SIGNaling<i>	WLAN network standard, signaling

5.3.3 Measurement Contexts and Views

Most measurement [Firmware Applications](#) are further subdivided into different measurement contexts. In manual control, a measurement context may consist of several views, providing different types of measurement results. In remote control, measurement contexts and views are identified by the fourth- and fifth/sixth-level mnemonics in the command headers, respectively.

Measurement contexts and views are addressed by different types of commands:

- Measurement control commands affect the entire measurement context. The same holds for most measurement configurations.
- Measurement results are assigned to a particular view. The commands used to define the measurement statistics and to retrieve results are also view-specific, which makes it possible to transfer a subset of results actually needed.

Example for context-specific commands

The following measurement control command affects the `EPSensor` measurement context (external power sensor measurement) in the `GPRF:MEASurement` firmware application:

```
INITiate:GPRF:MEASurement:EPSensor
```

The `EPSensor` measurement context appears as a fourth-level mnemonic. No view type is specified.

Example for view-specific commands

The following command retrieves the results in the `EVMagnitude:DSSS` view (EVM for DSSS signals) which is part of the `MEvaluation` measurement context in the `WLAN:MEASurement<i>` firmware application:

```
FETCh:WLAN:MEASurement<i>:MEvaluation:TRACe:EVMagnitude:DSSS:
CURRent?
```

The `EVMagnitude:DSSS` view is selected via the sixth- and seventh-level mnemonics.



READ...? and FETCh...? queries

The `READ...?` query is view-specific and calculates only the results needed for a particular view. This can result in a performance improvement compared to the context-specific command sequence `INITiate...; FETCh...?`.

5.4 Control of the Instrument

The following sections describe the control of measurement, generator, and signaling applications.

5.4.1 Generator Control

The commands used to control the different RF signal generators of the R&S CMW270 are analogous to the commands explained in section [Measurement Control](#). A generator is in one of the following generator states:

- **OFF:** Generator turned off, resources either released or (partially) reserved from the last time the generator was turned on.
- **PENDING:** Generator turned on, but still waiting for resource allocation, adjustment, hardware switching. No output signal is available at the selected output connector.
- **ON:** Generator turned on, with all necessary adjustments finished. An output signal is available at the selected output connector.

The OFF and PENDING/ON states correspond to the status indication "Off" and "On" in the generator softkeys. The relationship between generator commands and generator states is shown in the following diagram:

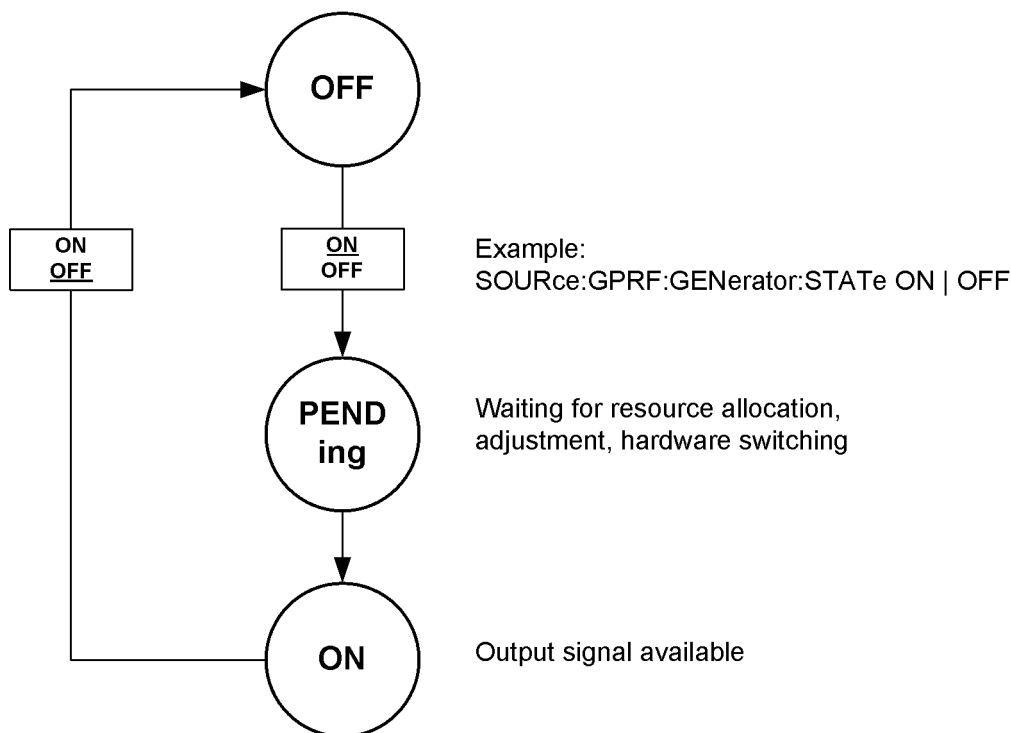

Generator control commands are of the following type (see also [Firmware Applications](#)):

SCPI subsystem	<Application>, e.g.	Generator instance	State
SOURce	:GPRF	:GENerator<i>	:STATe ON OFF

Example: SOURce:GPRF:GENerator:STATe ON | OFF

SOURce:<Application>;GENerator<i>;STATe ON

Starts the generator, reserves all necessary hardware and system resources and changes to the generator state "PENDING", then "ON". If the generator is already turned on the command has no effect.

If the hardware and system resources are already assigned to another firmware application, this firmware application is released in order to start the generator; see [Resource and Path Management](#).

If the generator cannot be started due to an unrecoverable resource conflict (e.g. a missing software option) it remains in the OFF state. The SCPI error "-213, Init ignored, ...", is generated. See also [Causes for Task Conflicts](#).



Command synchronization

Before you use the generator signal, use the query SOURce:<Application>;GENerator<i>;STATe? to ensure that the generator has reached its ON state and that the generator signal is available.

SOURce:<Application>:GENerator<i>:STATe OFF

Switches the generator off, releases the hardware resources for other generators, and changes to the generator state "OFF". If the generator is already turned off the command has no effect.

5.4.2 Measurement Control

The R&S CMW270 provides a variety of measurements (also termed measurement contexts) for each of the supported network standards or general purpose applications. All measurements are identified by a fourth level mnemonic and controlled in an analogous way. The benefit of this structure lies in the close analogy of all measurements. Commands for the different measurements have a similar structure and syntax.

The following topics describe the principles of measurement control.

**Measurement contexts**

Measurement control commands affect the entire measurement context, which may include several views (see [Measurement Contexts and Views](#)). This means that the measurement states of all views within the same context are always equal. In contrast, the results of each view can be retrieved separately.

5.4.2.1 Measurement States and Measurement Control Commands

Measurement control commands are used to switch over between the following main measurement states:

- **OFF:** Measurement switched off, no resources allocated, no results available (when entered after `STOP...`). OFF corresponds to the SCPI trigger state IDLE.
- **RDY:** Measurement has been terminated, valid results may be available. RDY corresponds to the SCPI trigger state IDLE.
- **RUN:** Measurement running (after `INITiate...`, `READ...`), synchronization pending or adjusted, resources active or queued (see [Measurement Substates](#)). RUN corresponds to the SCPI trigger state INITiated.

Querying the main measurement state

The main measurement state can be queried using `FETCh:<FWA>:<context>:STATe?` where `<FWA>` denotes the firmware application and `<context>` is to be replaced by the name of the measurement.

Example: `FETCh:GPRF:MEASurement:POWer:STATe?` (possible response: RDY).

The relationship between measurement states and measurement control commands is shown in the following diagram:

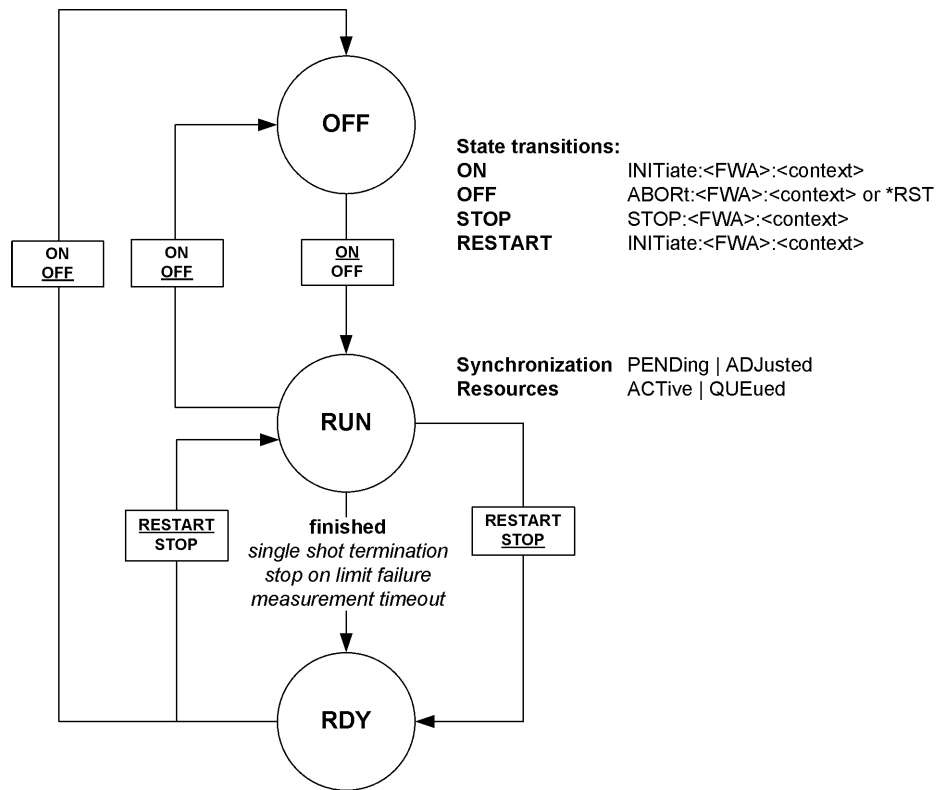

Measurement control commands are of the following type (see also [Firmware Applications](#)):

SCPI sub-system	<Application>, e.g.	Measurement instance	Context
INITiate ABORT STOP	:WIMax :GPRF	:MEASurement<i>	:POWER :EPSensor :MEValuation ... (depending on <Application>)

Example: INITiate:GPRF:MEASurement:POWER

INITiate:<Application>:MEASurement<i>

Starts the measurement in the repetition mode set via CONFigure:<Application>:MEASurement<i>:<Context>:REPetition (single-shot or continuous, see [Statistical Settings](#)). The command resets the counters for the evaluation period and statistics cycle to zero and starts a timer. If the measurement has not completed the first measurement cycle when the timer expires, the measurement is stopped. The timeout value can be configured individually for each measurement.

INITiate... can be used irrespective of the current measurement state. An initiated measurement reserves all necessary system resources and enters the "RUN" state. If the hardware and system resources are already assigned to another firmware applica-

tion, this firmware application is released in order to start the measurement; see [Resource and Path Management](#).

If a previously initiated measurement (which may be of the same type) is still running, the new measurement remains in the "PENDING" or "QUEUED" [Measurement Substates](#) (see [Queuing of Measurements](#)) and is activated only after the previous measurement has completed the current measurement cycle. After the new measurement has entered the "RUN" state, the previous results are discarded.

If the measurement cannot be started due to an unrecoverable resource conflict (e.g. a missing software option) it remains in the OFF state. The SCPI error "-213, Init ignored, ...", is generated. See also [Causes for Task Conflicts](#).

Conflicting settings cause restart of the measurement

Many measurement parameters (e.g. RF path settings, filter settings, etc.) have a direct impact on the measurement results. Changing these parameters while the measurement is running results in wrong results.

To avoid misleading results, a running measurement is re-started if a parameter with direct impact on the results is changed. All values acquired so far are discarded; the statistics counters are re-set to zero.

READ...? command

READ...? can be used instead of INITiate... to start a (single-shot) measurement. READ...? also returns the results; see [Retrieving Measurement Results](#).

ABORT:<Application>:MEASurement<i>

Aborts the current measurement immediately and causes the measurement to enter the OFF state. All measurement values are set to NAV; the hardware resources are released for other measurements.

STOP:<Application>:MEASurement<i>

Halts the measurement immediately. The measurement enters the RDY state; the R&S CMW270 retains all valid measurement results. Moreover, the hardware and system resources continue to be allocated to the measurement.

5.4.2.2 Measurement Substates

Each running measurement can be in one of the following substates:

Substate	Description
PENDING	Waiting for resource allocation, adjustment, hardware switching
ADJUSTed	All necessary adjustments finished, measurement running
INV	No substate (invalid)
QUEUED	Measurement without resources, no results available

Substate	Description
ACTive	Resources allocated, acquisition of results in progress but not complete
INV	No substate (invalid)

Querying substates

The main measurement state and the substates can be queried using `FETCh:<FWA>:<context>:STATe:ALL?` where `<FWA>` denotes the firmware application and `<context>` is to be replaced by the name of the measurement.

Example: `FETCh:GPRF:MEAS<i>:POWer:STATe:ALL?` (possible response: RUN, ADJ, ACT).

5.4.2.3 Statistical Settings

Measurements generally cover a basic time interval and can be repeated periodically. The measurement interval depends on the measurement context.

The number of measurement intervals that the R&S CMW270 repeats in order to calculate statistical results is termed "statistic count" (multi-measurement count). After one statistic count, the instrument has terminated a basic measurement cycle ("single-shot" measurement). Measurement cycles can be repeated for an unlimited number of times, resulting in the "continuous" repetition mode.

Most measurement contexts provide different sets of measurement results (single/ scalar values and traces) corresponding to the current measurement interval, and the maximum, minimum, and average over a number of consecutive measurement intervals (see section [Statistical Results](#)). In remote control these statistical results can be retrieved independently.

Statistic Count

Integer number of measurement intervals per measurement cycle (single-shot measurement). The statistic count can be set independently for any measurement context or view; see [Measurement Contexts and Views](#).

```
CONFigure:<FWA>:<Context>:SCOut: <View> <Count>
```

```
e.g. CONFigure:WiMax:MEASurement:MEValuation:SCOut 10
```

(sets the statistic count for WiMAX "Multi Evaluation" measurements).

Repetition Mode

Single-shot: The measurement is stopped after the number of measurement intervals defined by the "statistic count".

Continuous: The measurement is continued until it is stopped explicitly. Average results are calculated according to the rules given in section [Statistical Results](#).



Manual and remote control

In contrast to other instrument settings, the repetition modes in manual and remote control are independent and do not overwrite each other. The default repetition mode in manual control is Continuous (observe results over an extended period of time), the default mode in remote control is Single-Shot (perform one measurement and retrieve results).

```
CONFigure:<FWA>:<Context>:REPetition <Count>
```

e.g. CONFigure:GPRF:MEASurement<i>:POWer:REPetition CONT

Statistics Type

In general the following types of statistical results are available for scalar results (single values) and traces:

Current: Result of the current measurement interval

Minimum/Maximum: Minimum or maximum of all evaluation periods since the measurement was started

Average: Average referenced to one single-shot measurement length

```
FETCh:<FWA>:<Context>:<View>:CURRent...?
```

```
READ:<FWA>:<Context>:<View>:CURRent...?
```

```
FETCh:<FWA>:<Context>:<View>:MINimum...?
```

```
READ:<FWA>:<Context>:<View>:MINimum...?
```

```
FETCh:<FWA>:<Context>:<View>:MAXimum...?
```

```
READ:<FWA>:<Context>:<View>:MAXimum...?
```

```
FETCh:<FWA>:<Context>:<View>:AVERage...?
```

```
READ:<FWA>:<Context>:<View>:AVERage...?
```

e.g. FETCh:GPRF:MEAS<i>:POWer:CURRent:RMS?

Detector

Some measurements provide different detector settings to calculate the returned results from the raw measurement data. An example is the GPRF Power measurement which evaluates the maximum, minimum, and RMS (average) power within the current measurement interval (see [Detectors](#)). The detector is identified by means of an additional mnemonic preceding the statistics type:

```
FETCh:<FWA>:<Context>:<View>:CURRent?
```

```
FETCh:<FWA>:<Context>:<View>:MINimum:CURRent?
```

```
FETCh:<FWA>:<Context>:<View>:MAXimum:CURRent?
```

```
READ:<FWA>:<Context>:<View>:CURRent?
```

```
READ:<FWA>:<Context>:<View>:MINimum:CURRent?
```

```
READ:<FWA>:<Context>:<View>:MAXimum:CURRent?
```



Simplified statistics

Some measurement contexts provide simplified statistical settings. Refer to the measurement and remote control description for details.

5.4.2.4 Retrieving Measurement Results

The results of a measurement can be retrieved by means of `FETCh...?` or `READ...?` queries. Limit check results are retrieved by `CALCulate...?` queries. All command types have the same structure:

```
FETCh:<FWA>:<Context>:<View>:<Statistics>...?
READ:<FWA>:<Context>:<View>:<Statistics>...?
CALCulate:<FWA>:<Context>:<View>:<Statistics>...?
```

e.g. `FETCh:GPRF:MEASurement<i>:POWer:CURRent?`

The three identifiers `<FWA>`, `<Context>`, `<View>` and `<Statistics>` denote the [Firmware Applications](#), [Measurement Contexts and Views](#), and the [Statistics Type](#), respectively. `<View>` is only required for measurement contexts providing several views.

The number and type of measurement results depends on the measurement context and view; refer to the relevant reference documentation.

FETCh...? Command

Waits until the end of the current measurement cycle (if the measurement is running) and returns the results including the [Reliability and Error Indicators](#). `FETCh...?` is similar to the [READ...? Command](#), however, it does not start a new measurement. The measurement must have been started (`INITiate...?`; see [Measurement Control](#)) before a `FETCh...?` command can be executed.

Measurement states

A `FETCh...?` command can be used in the RUN state as described above or in the RDY state, provided that the R&S CMW270 has stored valid results. If no valid results are available, NCAP, NAV or INV are returned for each unavailable valid result, see also [Return Values NCAP, NAV and INV](#).

The following table gives an overview of the behavior depending on the measurement state.

State	Valid results?	Effect of FETCh...?
OFF	No	<code>FETCh...?</code> should not be used in the OFF state as valid results are never available.
RUN	Yes/No	R&S CMW270 waits until the current measurement cycle is complete and returns the results. In continuous repetition mode the R&S CMW270 continues acquiring results without reaching the RDY state.
RDY	Yes/No	Returns the results immediately.

Repeated FETCh...? commands

It is possible to use repeated FETCh...? commands without re-starting the measurement, e.g. in order to monitor the variation in time of a measured quantity in continuous measurement mode.

- In single-shot mode where the measurement reaches the RDY state and is stopped before the first FETCh...? is executed, the results of repeated FETCh...? commands will be identical.
- In continuous mode, the first FETCh...? is executed after the end of the current measurement cycle. The following FETCh...? commands are executed as quickly as possible, no matter whether the R&S CMW270 has acquired new results.

READ...? Command

Aborts the current measurement (if a measurement is running), starts a new measurement in single-shot mode, and returns the results including the [Reliability and Error Indicators](#) at the end of the measurement cycle.

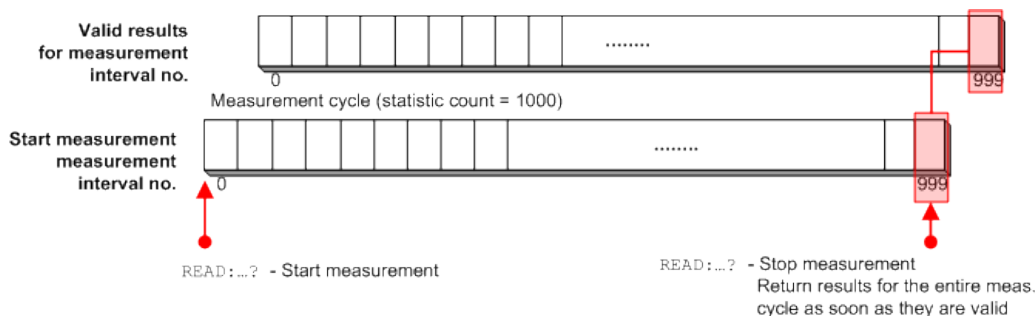

READ...? does not change any of the measurement control settings. The measurement initiated by READ...? is stopped after one single-shot (→ measurement state RDY), however, the repetition mode itself is not changed.

READ...? can be used in all measurement states.



Performance considerations, multi evaluation measurements

The READ...? query is view-specific and calculates only the results needed for a particular view. This can result in a performance improvement compared to the context-specific command sequence INITiate...; FETCh...?

In contrast to FETCh...? queries, READ...? commands also provide valid results for disabled views in multi evaluation measurements; see [Retrieving results for disabled views](#).

CALCulate...? Command

Waits until the end of the current measurement cycle (if the measurement is running) and returns the limit check results including the [Reliability and Error Indicators](#).

CALCulate...? analyzes the results that would be returned by the corresponding FETCh...? Command and returns the single-value error indicators, see [Error Indicators](#)

for **Single Results**. A typical application is the limit check, where the error indicators are set to one of the following values:

- **OK**: The result is located within the limits or no limit has been defined/enabled for this result.
- **ULEU** (User limit exceeded upper): An upper limit is violated. The result value is located above the limit.
- **ULEL** (User limit exceeded lower): A lower limit is violated. The result is located below the limit.

The `CALCulate...?` command returns exactly the same number of results as the corresponding `FETCh...?` command, including the reliability indicator as first value.

Return Values NCAP, NAV and INV

If no valid result is available, the value returned by `FETCh...?`, `READ...?` and `CALCulate...?` depends on the reason for the unavailability. Possible values are NCAP ("Not Captured"), NAV ("Not Available") and INV ("Invalid"). For each unavailable result value one of these values is returned.

The following table provides some examples.

Situation	Returned Value
Measurement state OFF	NAV returned by <code>FETCh...?</code> and <code>CALCulate...?</code>
Disabled view	NCAP returned by <code>FETCh...?</code> and <code>CALCulate...?</code>
Unsuitable settings for a certain part of the measurement. Example: The measurement of some results requires a specific trigger type.	NCAP returned by <code>FETCh...?</code> , <code>READ...?</code> and <code>CALCulate...?</code>
Object to be measured not available in signal (e.g. certain physical channel missing)	NCAP returned by <code>FETCh...?</code> , <code>READ...?</code> and <code>CALCulate...?</code>
Underflow, Overflow, Sync Error, Trigger Timeout	INV returned by <code>FETCh...?</code> , <code>READ...?</code> and <code>CALCulate...?</code>

Retrieving Single Values and Traces

The R&S CMW270 provides two different types of measurement results:

- Tables or output fields contain a (usually) small number of single, mostly statistical values. Many of these values are relevant for limit checks. For these values `CALCulate...?` commands are provided.
- Traces in diagrams consist of a larger number of measurement points. They usually depend on a parameter such as the time or frequency.

Single results and traces can be retrieved separately. To distinguish the result type, the mnemonic `:TRACe` is included in the commands headers:

```
FETCh:<FWA>:<Context>:<View>:<Statistics>...?
READ:<FWA>:<Context>:<View>:<Statistics>...?
CALCulate:<FWA>:<Context>:<View>:<Statistics>...?
```

```
FETCh:<FWA>:<Context>:TRACe:<View>:<Statistics>...?
READ:<FWA>:<Context>:TRACe:<View>:<Statistics>...?
```

e.g.

```
FETCh:GSM:MEASurement:MEValuation:EVMagnitude?
FETCh:GSM:MEASurement:MEValuation:TRACe:EVMagnitude:CURRent?
```

The <View> mnemonic is used in multi evaluation measurements where it distinguishes different subsets of results. For detailed information about the returned values refer to the command reference description. See also [Multi Evaluation Measurements](#).

5.4.2.5 Multi Evaluation Measurements

In a multi evaluation measurement, the R&S CMW270 acquires a wide range of measurement results at once.

The WiMAX multi evaluation measurement assesses the modulation accuracy, frequency error, power, crest factor, and spectral flatness in the measured burst.

Multi evaluation measurements offer maximum speed and performance, even if only a subset of the measurement results is needed. In remote control, it is possible to control each multi evaluation measurement as a whole but retrieve the different types of results separately.

Controlling multi evaluation measurements

A multi evaluation measurement is controlled like any other measurement; see [Measurement Control](#). The following commands start, stop and abort a multi evaluation measurement within a particular firmware application (<FWA>):

```
INITiate:<FWA>:MEValuation
STOP:<FWA>:MEValuation
ABORT:<FWA>:MEValuation
```

The following commands query the measurement state and the substates:

```
FETCh:<FWA>:MEValuation:STATe?
FETCh:<FWA>:MEValuation:STATe:ALL?
```

Example: INITiate:WiMax:MEASurement<i>:MEValuation

Retrieving measurement results

The commands for retrieving the results of a multi evaluation measurement follow general syntax rules (see [Retrieving Measurement Results](#)). In general it is possible to specify the subset of results needed using an additional <View> mnemonic:

```
READ:<FWA>:MEValuation:<View>:<Statistics>...?
FETCh:<FWA>:MEValuation:<View>:<Statistics>...?
```

The result subsets are closely related to the different views that the multi evaluation measurement provides in manual control.

Example: `READ:WIMax:MEASurement<i>:MEValuation:EVM:DATA:AVERage?`



Retrieving results for disabled views

In some measurements it is possible to disable individual views and results in order to gain measurement speed. The `READ...?` and `FETCh...?` queries act differently on disabled views:

- A `FETCh...?` command leaves the view in the unchanged (disabled) state and returns NCAP (not captured) results. The view must be enabled explicitly to obtain valid results.
- A `READ...?` command enables the view implicitly and returns valid results. After program execution, the view returns to the disabled state.

5.4.3 Signaling Generator Control

The commands used to control the RF generators of the different signaling applications are analogous to the generator control commands explained in section [chapter 5.4.1, "Generator Control"](#), on page 144. A signaling generator is in one of the following cell states:

- **OFF:** Signaling generator turned off, resources either released or (partially) reserved from the last time the generator was turned on.
- **PENDING:** Signaling generator turned on, but still waiting for resource allocation, adjustment, hardware switching. No cell signal is available at the selected output connector.
- **ON:** Signaling generator turned on, with all necessary adjustments finished. A cell signal to which a mobile station can synchronize is available at the selected output connector.

The OFF and PENDING/ON states correspond to the status indication "Off" and "On" in the generator softkeys. The relationship between generator commands and generator states is shown in the following diagram:

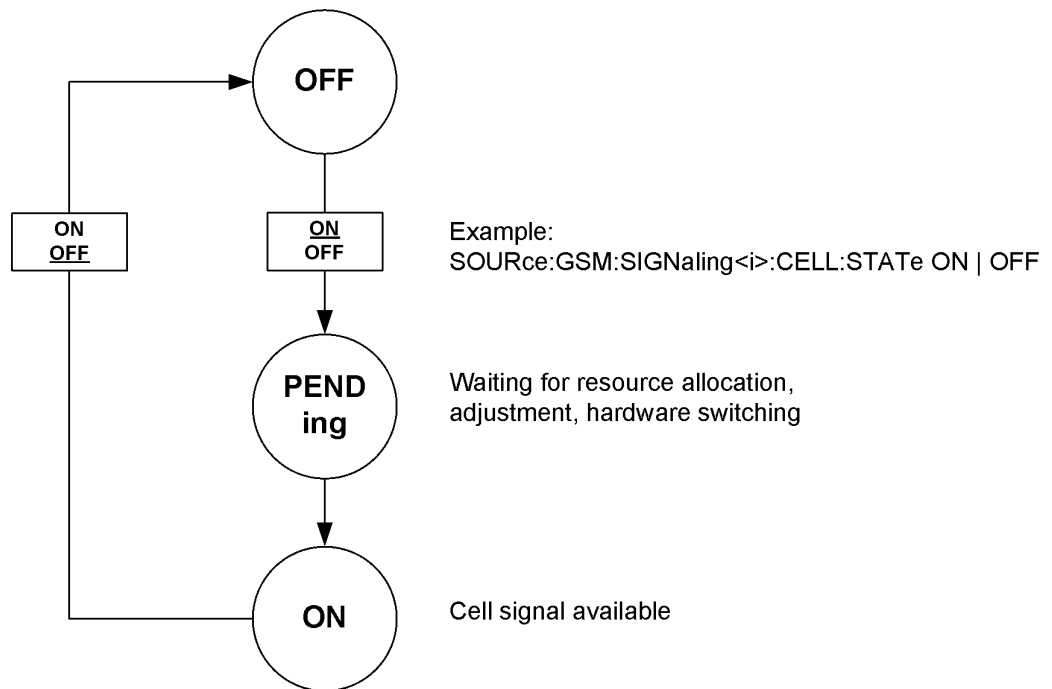

Signaling generator control commands are of the following type (see also [Firmware Applications](#)):

SCPI subsystem	<Application>, e.g.	Generator instance	State
SOURce	:GSM	:SIGNaling<i>	:CELL:STATe ON OFF

Example: SOURce:GSM:SIGNaling:CELL:STATe ON | OFF



The :CELL mnemonic is omitted in some signaling applications.

SOURce:<Application>:SIGNaling<i>:CELL:STATe ON

Starts the signaling generator, reserves all necessary hardware and system resources and changes to the generator state "PENDING", then "ON". If the cell signal is already turned on the command has no effect.

If the hardware and system resources are already assigned to another firmware application, this firmware application is released in order to start the signaling generator; see [Resource and Path Management](#).

If the signaling generator cannot be started due to an unrecoverable resource conflict (e.g. a missing software option) it remains in the OFF state. The SCPI error "-213, Init ignored, ...", is generated. See also [Causes for Task Conflicts](#).



Command synchronization

Before you use the generator signal, use the query

SOURce:<Application>:SIGNaling<i>:CELL:STATe:ALL? to ensure that the signaling generator is turned on and that the cell signal is available (response: ON, ADJ; see below).

SOURce:<Application>:SIGNaling<i>:CELL:STATe OFF

Switches the generator off, releases the hardware resources for other generators, and changes to the generator state "OFF". If the generator is already turned off the command has no effect.

SOURce:<Application>:SIGNaling<i>:CELL:STATe:ALL?

Returns detailed information about the signaling generator state. The first returned value (main state) indicates whether the signaling generator has been turned on previously (ON or OFF). The second returned value indicates whether a cell signal is actually available at the RF output connector (ADJ, if the main state is ON) or not (PEND or ADJ, if the main state is OFF).



Connection states

After the cell signal is available, the mobile station under test can attempt a registration so that it is possible to set up a network connection. The connection states and state transitions are network-specific; refer to the description of the individual signaling applications.

5.4.4 Reliability and Error Indicators

Reliability and error indicators describe the validity of measurement results and the possible source of inaccuracies or errors.

5.4.4.1 Reliability Indicator

Reliability indicators are provided by all types of applications, including measurements, generators and signaling applications. The R&S CMW270 returns a numerical reliability indicator value for each measurement result query. This indicator value allows to judge the reliability of the returned measurement results.

The value returned by a result query indicates the most severe error that has occurred during the measurement. Tooltips indicate the most severe current error. They are displayed by measurements as well as by generators and signaling applications. The "Info" dialog provides an overview of all applications and a list of all occurred errors per application. For some error types the list provides also additional information on the cause of an error. See also [chapter 4.6, "Info Dialog"](#), on page 115.

Reliability indicator values

The reliability indicator has one of the following values:

- **0 (OK):**
Measurement values available, no error detected.
- **1 (Measurement Timeout):**
The measurement has been stopped after the (configurable) measurement time-out. Measurement results may be available, however, at least a part of the measurement provides only INValid results or has not completed the full statistic count.
- **2 (Capture Buffer Overflow):**
The measurement configuration results in a capture length, exceeding the available memory.
- **3 (Overdriven) / 4 (Underdriven):**
The accuracy of measurement results may be impaired because the input signal level was too high / too low.
- **6 (Trigger Timeout):**
The measurement could not be started or continued because no trigger event was detected.
- **7 (Acquisition Error):**
The R&S CMW270 could not properly decode the RF input signal.
- **8 (Sync Error):**
The R&S CMW270 could not synchronize to the RF input signal.
- **9 (Uncal):**
Due to an inappropriate configuration of resolution bandwidth, video bandwidth or sweep time, the measurement results are not within the specified data sheet limits.
- **15 (Reference Frequency Error):**
The instrument has been configured to use an external reference signal but the reference oscillator could not be phase locked to the external signal (e.g. signal level too low, frequency out of range or reference signal not available at all).
- **16 (RF Not Available):**
The measurement could not be started because the configured RF input path was not active. This problem may occur e.g. when a measurement is started in combined signal path mode and the master application has not yet activated the input path. The LEDs above the RF connectors indicate whether the input and output paths are active.
- **17 (RF Level not Settled) / 18 (RF Frequency not Settled):**
The measurement could not be started because the R&S CMW270 was not yet ready to deliver stable results after a change of the input signal power / the input signal frequency.
- **19 (Call not Established):**
For measurements: The measurement could not be started because no signaling connection to the DUT was established.
For DAU IMS service: Establishing a voice over IMS call failed.
- **20 (Call Type not Usable):**
For measurements: The measurement could not be started because the established signaling connection had wrong properties.
For DAU IMS service: The voice over IMS settings could not be applied.

- **21 (Call Lost):**
For measurements: The measurement was interrupted because the signaling connection to the DUT was lost.
For DAU IMS service: The voice over IMS call was lost.
- **23 (Missing Option):**
The ARB file cannot be played by the GPRF generator due to a missing option.
- **26 (Resource Conflict):**
The application could not be started or has been stopped due to a conflicting hardware resource or software option that is allocated by another application.
Stop the application that has allocated the conflicting resources and try again.
- **27 (No Sensor Connected):**
The GPRF External Power Sensor measurement could not be started due to missing power sensor.
- **30 (File not Found):**
The specified file could not be found.
- **40 (ARB File CRC Error):**
The ARB file CRC check failed. The ARB file is corrupt and not reliable.
- **42 (ARB Header Tag Invalid):**
The ARB file selected in the GPRF generator contains an invalid header tag.
- **43 (ARB Segment Overflow):**
The number of segments in the multi-segment ARB file is higher than the allowed maximum.
- **44 (ARB File not Found):**
The selected ARB file could not be found.
- **45 (ARB Memory Overflow):**
The ARB file length is greater than the available memory.
- **50 (Startup Error):**
The Data Application Unit (DAU), a DAU service or a DAU measurement could not be started. Please execute a DAU selftest.
- **51 (No Reply):**
The DAU has received no response, for example for a ping request.
- **52 (Connection Error):**
The DAU could not establish a connection to internal components. Please restart the instrument.
- **53 (Configuration Error):**
The current DAU configuration by the user is incomplete or wrong and could not be applied. Check especially the IP address configuration.
- **54 (Filesystem Error):**
The hard disk of the DAU is full or corrupt. Please execute a DAU selftest.
- **60 (Invalid RF-Connector Setting)**
The individual segments of a list mode measurement with R&S CMWS use different connector benches. This is not allowed. All segments must use the same bench.
Check the "Info" dialog for the relevant segment numbers.
- **101 (Firmware Error):**

Indicates a firmware or software error. If you encounter this error for the first time, restart the instrument.

If the error occurs again, consider the following hints:

- Firmware errors can often be repaired by restoring the factory default settings. To restore these settings, restart your instrument and press the "Factory Default" softkey during startup.
- If a software package (update) has not been properly installed this is often indicated in the "Setup" dialog, section "SW/HW-Equipment > Installed Software".
- A software update correcting the error may be available. Updates are e.g. provided in the "CMW Customer Web" on GLORIS (registration required): <https://extranet.rohde-schwarz.com>.

If you get firmware errors even with the properly installed latest software version, please send a problem report including log files to Rohde & Schwarz.

- **102 (Unidentified Error):**
Indicates an error not covered by other reliability values. For troubleshooting please follow the steps described for "101 (Firmware Error)".
- **103 (Parameter Error):**
Indicates that the measurement could not be performed due to internal conflicting parameter settings.
A good approach to localize the conflicting settings is to start with a reset or preset or even restore the factory default settings. Then reconfigure the measurement step by step and check when the error occurs for the first time.
If you need assistance to localize the conflicting parameter settings, please contact Rohde & Schwarz (see <http://www.service.rohde-schwarz.com>).

5.4.4.2 Error Indicators for Single Results

Some applications provide error indicators for single results, in addition to the reliability indicator. Single-value error indicators are retrieved using a [CALCulate...? Command](#).

e.g. `CALCulate:GPRF:MEAS<i>:POWer:CURRent?`

Response: 3, OK, OK, OK, OFL, OFL, OK, OK, OK (global reliability: 3 (for "Overdriven"), 8 power results in 8 power steps, 2 results overdriven)

The error indicator has one of the following values.

Returned value	Meaning	Description
OK	OK	Measurement result available, no error detected
ULEU	User limit violation upper	An upper limit is violated. The measurement result is above the limit.
ULEL	User limit violation lower	A lower limit is violated. The measurement result is below the limit.
OFL	Overflow	Measurement result available, however, the accuracy of the result may be impaired because the input signal level was too high

Returned value	Meaning	Description
UFL	Underflow	Measurement result available, however, the accuracy of the result may be impaired because the input signal level was too low
INV	Invalid	Measurement was performed but a single result is invalid, e.g. because it cannot be measured under the special conditions of the measurement
NAV	Not available	No measurement result available, e. g. because the measurement could not be started

Some measurements provide only a subset of values.

Example: in the "GPRF Power" measurement, no user limits are defined and no underflow is indicated. The values ULEL, ULEU, and UFL are never returned.

5.4.5 Signal Path Settings

The signal path for input signals comprises an RF connector on a frontend, an RX module connected to this frontend, a fixed or flexible baseband link and a baseband board or signaling unit. Output signals use a reverse path with a TX module instead of an RX module.

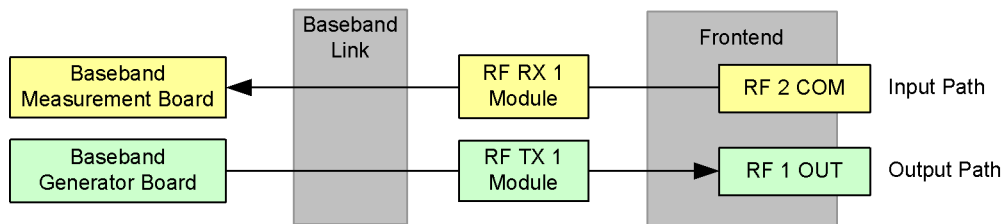

To define a signal path the RF connector and the RX/TX module must be selected. The baseband board or signaling unit to be used is selected implicitly via the type of the firmware application and the firmware application instance or used sub-instrument.

Typical commands for selection of RF connector and RX/TX module look like this:

- ROUTe:<Application>:GENERATOR<i>:SCENARIO:SAalone
- ROUTe:<Application>:MEASUREMENT<i>:SCENARIO:SAalone
- ROUTe:<Application>:SIGNaling<i>:SCENARIO:SCELL



ROUTE commands changed in V2.0.10

Routing commands of the type

`ROUTE:<Application>:<Instance>:RFSettings:CONNECTor` are no longer supported for software versions \geq V2.0.10. The old routing commands select only an RF connector but no RX/TX module and must no longer be used.

Furthermore the selection of connectors RF 3 COM, RF 3 OUT and RF 4 COM has changed in software version V2.0.10. From V2.0.10 on these connectors are identified via their correct names `RF3C`, `RF3O` and `RF4C` or via virtual names. The old values `RF1C`, `RF1O` and `RF2C` always identify the connectors RF 1 COM, RF 1 OUT and RF 2 COM.

For command script conversion see GPRF examples below.

Example: Script conversion for two instances in one sub-instrument

Use RF 1 OUT for instance 1 and RF 3 OUT for instance 2 of the GPRF generator.

- Old commands ($<$ V2.0.10):
`ROUTE:GPRF:GEN1:RFSettings:CONNECTor RF1O`
`ROUTE:GPRF:GEN2:RFSettings:CONNECTor RF1O`
- New commands (\geq V2.0.10):
`ROUTE:GPRF:GEN1:SCENario:SALone RF1O, TX1`
`ROUTE:GPRF:GEN2:SCENario:SALone RF3O, TX2`

Example: Script conversion for two sub-instruments with one instance each

Use RF 2 COM for sub-instrument 1 and RF 4 COM for sub-instrument 2 to run a GPRF measurement.

- Old command to be sent to both sub-instruments:
`ROUTE:GPRF:MEAS:RFSettings:CONNECTor RF2C`
or `ROUTE:GPRF:MEAS:SCENario:SALone RF2C, RX1`
- New command to be sent to both sub-instruments (virtual connector name):
`ROUTE:GPRF:MEAS:SCENario:SALone RFBC, RX1`
- Or new commands with individual connector names (same effect):
sub-instrument 1: `ROUTE:GPRF:MEAS:SCENario:SALone RF2C, RX1`
sub-instrument 2: `ROUTE:GPRF:MEAS:SCENario:SALone RF4C, RX1`

5.4.5.1 Supported Signal Paths

The signal path configuration is straightforward if the instrument provides only one RF path (one RX/TX module). If the instrument provides several RF paths, the supported paths depend on the installed hardware and differ for instruments split into sub-instruments and instruments assigning all resources to a single sub-instrument.

Thus also the values supported for RF path configuration vary depending on your instrument setup. To understand the signal paths supported at your instrument you may consult the [Blockview Dialog](#) or the RF path settings at the GUI. Both provide only supported values for selection.

You may also use the following rules and the subsequent sections to determine the supported signal paths:

- One frontend provides three RF connectors at the front panel: either RF 1 COM + RF 1 OUT + RF 2 COM or RF 3 COM + RF 3 OUT + RF 4 COM.
- One TX or RX module can be connected to one frontend only.
- Basic frontend:
A basic RF frontend (R&S CMW-B590A) provides a connection to one TX module and one RX module. It connects either RF 1/2 to TX/RX 1 or RF 3/4 to TX/RX 2.
- Advanced frontend:
An advanced RF frontend (R&S CMW-B590D) provides a connection to up to two TX and RX modules. If two advanced frontends are installed, one half of the installed TX/RX modules is connected to the first frontend, the other half to the second frontend.
If two TX and RX modules are connected to one advanced frontend, the following rules apply:
 - Both TX modules can be connected to the same RF connector (sum signal).
This allows e.g. to provide two cell signals at one connector.
It is also possible to connect the two TX modules to different RF connectors of the same frontend. Exception: It is not possible to connect TX 1 to RF 2 and at the same time TX 2 to RF 1.
 - Both RX modules can be connected to the same RF connector (split signal).
This allows e.g. to measure the same signal with two applications in parallel.
It is also possible to connect the two RX modules to different RF connectors of the same frontend. Exception: It is not possible to connect RX 1 to RF 2 and at the same time RX 2 to RF 1.
 - The two previous rules can be combined. It is for example possible to connect both TX modules and both RX modules to the same RF COM connector.
- Fixed and flexible baseband link
 - A fixed link (R&S CMW-S550A) provides connections between TX/RX 1 and baseband boards used for firmware application instance 1. It supports also connections between TX/RX 2 and baseband boards used for firmware application instance 2.
Thus firmware application instance 1 can only use TX/RX 1 and instance 2 can only use TX/RX 2.
 - A flexible link (R&S CMW-S550B/M) allows connections between all TX/RX modules and all baseband boards/signaling units.
Thus all firmware application instances can use all TX/RX modules.
- One baseband module, signaling unit, TX module or RX module can be used by only one firmware application at a time.
- The number of instances available for a certain firmware application depends on the installed hardware and the active software licenses:
 - If no software license is available for a firmware application, the application is not visible at all.
 - If at least one software license is available for the application, the number of visible/configurable instances depends on the number of installed hardware units on which the application can be executed. Depending on the type of the

application these hardware units are baseband generator boards, baseband measurement boards or signaling units.

- The number of active software licenses limits the number of instances that can be run in parallel.

5.4.5.2 RF Connector Values

The following list contains all parameter values generally available for selection of an RF connector. A parameter may support only a subset of these values, depending on the signal direction and the installed options (see the following sections):

- RF1C | RF1O | RF2C:
RF 1 COM, RF 1 OUT, RF 2 COM (RF connectors of the first frontend)
- RF3C | RF3O | RF4C:
RF 3 COM, RF 3 OUT, RF 4 COM (RF connectors of optional second frontend)
- RFAC | RFAO | RFBC:
Use these virtual RF connector names if you want to send the same command sequence to different sub-instruments of your instrument. For mapping to the physical connectors refer to the following sections. To query the mapping via remote command see [SYSTem:CONNector:TRANslation?](#) on page 297.
Command scripts using virtual connector names are also compatible with instruments providing one sub-instrument and one frontend. For configurations with one sub-instrument and two frontends, only the first frontend can be accessed via virtual connector names.

5.4.5.3 Instrument with One RF Path

This section applies to an instrument with one RF path, one frontend and one instance per firmware application. All resources are grouped in one sub-instrument.

The following table lists the supported parameter values and used *RST values for selection of RF connectors and TX/RX boards.

	Instance 1
Input connector	RF1C RF2C RFAC RFBC
Output connector	RF1C RF1O RF2C RFAC RFAO RFBC
Mapping RFAC, RFAO, RFBC	RF1C, RF1O, RF2C
TX module	TX1
RX module	RX1
*RST connectors	RF1C
*RST TX/RX	TX1, RX1

5.4.5.4 Two RF Paths, Two Frontends, Flexible Link, One Sub-Instrument

This section applies to an instrument with two RF paths, two frontends, a flexible link (R&S CMW-S550B/M) and two instances per firmware application. All resources are grouped in one sub-instrument.

All instances can access both frontends. The following table lists the supported parameter values and used *RST values for selection of RF connectors and TX/RX boards.

	Instance 1	Instance 2
Input connector	RF1C RF2C RF3C RF4C RFAC RFBC	
Output connector	RF1C RF1O RF2C RF3C RF3O RF4C RFAC RFAO RFBC	
Mapping RFAC, RFAO, RFBC	RF1C, RF1O, RF2C	
TX module	TX1 (for RF1/RF2 connectors only) TX2 (for RF3/RF4 connectors only)	
RX module	RX1 (for RF1/RF2 connectors only) RX2 (for RF3/RF4 connectors only)	
*RST connectors	RF1C	RF3C
*RST TX/RX	TX1, RX1	TX2, RX2

5.4.5.5 Two RF Paths, Two Frontends, Fixed Link, One Sub-Instrument

This section applies to an instrument with two RF paths, two frontends, a fixed link (R&S CMW-S550A) and two instances per firmware application. All resources are grouped in one sub-instrument.

Each instance is fix assigned to one frontend. The following table lists the supported parameter values and used *RST values for selection of RF connectors and TX/RX boards.

	Instance 1	Instance 2
Input connector	RF1C RF2C RFAC RFBC	RF3C RF4C RFAC RFBC
Output connector	RF1C RF1O RF2C RFAC RFAO RFBC	RF3C RF3O RF4C RFAC RFAO RFBC
Mapping RFAC, RFAO, RFBC	RF1C, RF1O, RF2C	RF1C, RF1O, RF2C Virtual connector names cannot be used (result in a settings conflict).
TX module	TX1	TX2
RX module	RX1	RX2

	Instance 1	Instance 2
*RST connectors	RF1C	RF3C
*RST TX/RX	TX1, RX1	TX2, RX2

5.4.5.6 Two RF Paths, Two Frontends, Two Sub-Instruments

This section applies to an instrument with two RF paths, two frontends and two instances per firmware application. The instrument is split into two sub-instruments.

Each sub-instrument uses one specific frontend and supports one instance per firmware application. The TX and RX module numbering is a logical numbering per sub-instrument, not per instrument. That means e.g. that within sub-instrument 1 the value TX1 refers to another physical TX module than within sub-instrument 2.

The following table lists the supported parameter values and used *RST values for selection of RF connectors and TX/RX boards.

	Sub-Instrument 1	Sub-Instrument 2
Input connector	RF1C RF2C RFAC RFBC	RF3C RF4C RFAC RFBC
Output connector	RF1C RF1O RF2C RFAC RFAO RFBC	RF3C RF3O RF4C RFAC RFAO RFBC
Mapping RFAC, RFAO, RFBC	RF1C, RF1O, RF2C	RF3C, RF3O, RF4C
TX module	TX1	TX1
RX module	RX1	RX1
*RST connectors	RF1C	RF3C
*RST TX/RX	TX1, RX1	TX1, RX1

5.4.5.7 Two RF Paths, One Frontend, One Sub-Instrument

This section applies to an instrument with two RF paths, one advanced frontend and two instances per firmware application. All resources are grouped in one sub-instrument.

All instances can access all connectors of the frontend. The following table lists the supported parameter values and used *RST values for selection of RF connectors and TX/RX boards.

	Instance 1	Instance 2
Input connector	RF1C RF2C RFAC RFBC	
Output connector	RF1C RF1O RF2C RFAC RFAO RFBC	
Mapping RFAC, RFAO, RFBC	RF1C, RF1O, RF2C	
TX module	TX1	TX2
RX module	RX1	RX2

	Instance 1	Instance 2
*RST connectors	RF1C	RF2C
*RST TX/RX	TX1, RX1	TX2, RX2

5.4.5.8 Two RF Paths, One Frontend, Two Sub-Instruments

This section applies to an instrument with two RF paths, one advanced frontend and two instances per firmware application. The instrument is split into two sub-instruments.

Each sub-instrument can access only a part of the frontend and supports one instance per firmware application. The TX and RX module numbering is a logical numbering per sub-instrument, not per instrument. That means e.g. that within sub-instrument 1 the value TX1 refers to another physical TX module than within sub-instrument 2.

The following table lists the supported parameter values and used *RST values for selection of RF connectors and TX/RX boards.

	Sub-Instrument 1	Sub-Instrument 2
Input connector	RF1C RFAC	RF2C RFAC
Output connector	RF1C RF1O RFAC RFAO	RF2C RFAC
Mapping RFAC, RFAO	RF1C, RF1O	RF2C, n/a
TX module	TX1	TX1
RX module	RX1	RX1
*RST connectors	RF1C	RF2C
*RST TX/RX	TX1, RX1	TX1, RX1

5.4.5.9 Four RF Paths, Two Frontends, One Sub-Instrument

This section applies to an instrument with four RF paths, two advanced frontends and up to four instances per firmware application. All resources are grouped in one sub-instrument.

All firmware application instances can access both frontends. The following table lists the supported parameter values and used *RST values for selection of RF connectors and TX/RX boards.

	Instance 1	Instance 2	Instance 3	Instance 4
Input connector	RF1C RF2C RF3C RF4C RFAC RFBC			
Output connector	RF1C RF1O RF2C RF3C RF3O RF4C RFAC RFAO RFBC			
Mapping RFAC, RFAO, RFBC	RF1C, RF1O, RF2C			

	Instance 1	Instance 2	Instance 3	Instance 4
TX module	TX1, TX3 (for RF1/RF2 connectors only) TX2, TX4 (for RF3/RF4 connectors only)			
RX module	RX1, RX3 (for RF1/RF2 connectors only) RX2, RX4 (for RF3/RF4 connectors only)			
*RST connectors	RF1C	RF3C	RF2C	RF4C
*RST TX/RX	TX1, RX1	TX2, RX2	TX3, RX3	TX4, RX4

5.4.5.10 Four RF Paths, Two Frontends, Two Sub-Instruments

This section applies to an instrument with four RF paths, two advanced frontends and up to four instances per firmware application. The instrument is split into two sub-instruments.

Each sub-instrument uses one specific frontend. The TX and RX module numbering is a logical numbering per sub-instrument, not per instrument. That means e.g. that within sub-instrument 1 the value TX1 refers to another physical TX module than within sub-instrument 2.

The following table lists the supported parameter values and used *RST values for selection of RF connectors and TX/RX boards.

	Sub-Instrument 1		Sub-Instrument 2	
	Instance 1	Instance 2	Instance 1	Instance 2
Input connector	RF1C RF2C RFAC RFBC		RF3C RF4C RFAC RFBC	
Output connector	RF1C RF10 RF2C RFAC RFAO RFBC		RF3C RF30 RF4C RFAC RFAO RFBC	
Mapping RFAC, RFAO, RFBC	RF1C, RF10, RF2C		RF3C, RF30, RF4C	
TX module	TX1, TX2		TX1, TX2	
RX module	RX1, RX2		RX1, RX2	
*RST connectors	RF1C	RF2C	RF3C	RF4C
*RST TX/RX	TX1, RX1	TX2, RX2	TX1, RX1	TX2, RX2

5.4.6 Resource and Path Management

The R&S CMW270 is a modular platform supporting a wide range of measurement, generator, and signaling applications. For the remainder of this section, all these applications are termed "tasks".

In general, the instrument is capable of running several tasks in parallel. E.g. the GPRF generator can be used to generate a test signal, while the GPRF Power measurement analyzes the input signal at different powers and frequencies, and the External Power Sensor measurement is used to monitor the signal power at a particular

point in the test setup. Conflicts between different tasks may occur if they rely upon the same system resources.

The Resource and Path Management (RPM) of the R&S CMW270 represents a control mechanism for conflicting tasks, deciding whether and for how long a running task will persist.



Remote and manual control

The RPM principles described in this section are valid in remote as well as in manual control. In remote control, running different tasks in parallel enhances the speed and performance of the tester. In manual control, it allows you to monitor different measurements simultaneously and compare the results.

5.4.6.1 Basic RPM Principles

The principles of R&S CMW270 Resource and Path Management can be summarized very briefly:

- Non-conflicting tasks can run in parallel without restriction.
- A new measurement or generator that is in conflict with a running task replaces the running task. **Exception:** Measurements cannot replace generator or signaling applications. A new, conflicting measurement is blocked until a running generator or signaling application is switched off by other means.
- Generator and signaling applications are released immediately, measurements are released after the current measurement cycle.

According to the last rule, conflicting measurements are queued, see [Queuing of Measurements](#). A new measurement is started only after all previous measurements have been terminated in a regular way.

The RPM principles can be visualized as follows:

Two measurements in conflict, second measurement queued

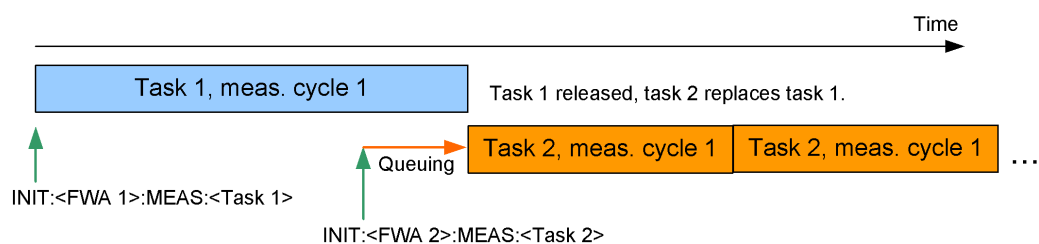

Generator and measurement in conflict

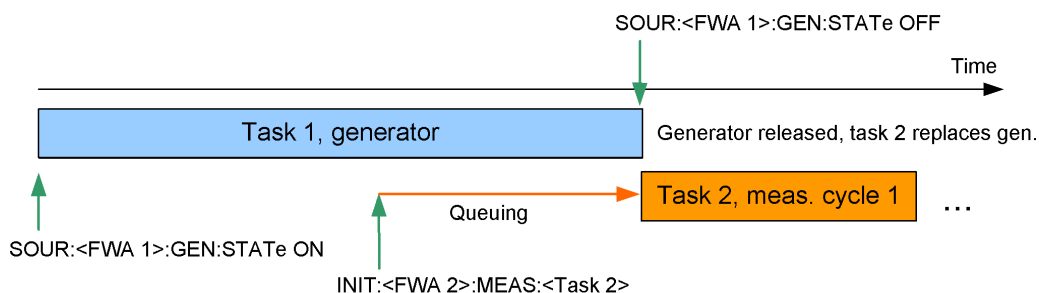

Signaling applications behave like generators and must be turned off explicitly.

Two non-conflicting measurements, executed in parallel

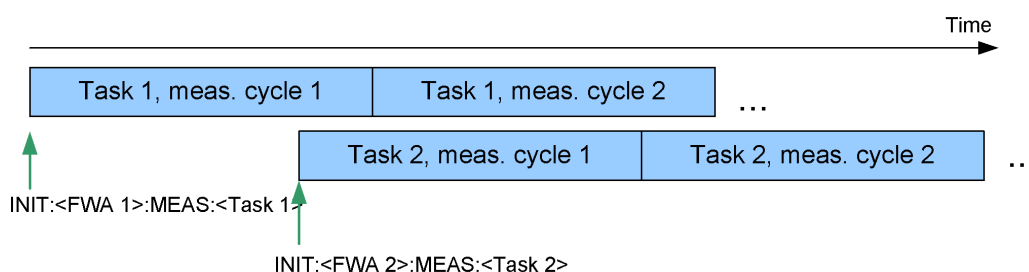

RPM acts on sub-instrument level

If the R&S CMW270 is split into several sub-instruments, each of them is equipped with independent hardware and software resources in order to run the tasks assigned to it. The RPM principles apply to each sub-instrument separately. Due to the independence of sub-instruments, hardware and software resource conflicts between units cannot occur.

This does not apply to software license keys. **Example:** To run two instances of a measurement in parallel requires two license keys. If only one license key is active the RPM mechanisms apply even if the two instances of the measurement are run on different sub-instruments.

See also [Sub-Instruments](#).

5.4.6.2 Queuing of Measurements

The R&S CMW270 queues conflicting measurements in order to ensure that no results are lost when a new measurement is started. Adding a new measurement to the queue switches the preceding measurement into single-shot mode (if it is a continuous measurement). As a result, the instrument can acquire a valid set of measurement results for every measurement in the queue.

Example for queued conflicting measurements

Command	Comment
*RST INITiate:<FWA>:<Meas1>	Start measurement 1 in single-shot mode (default setting for remote control)
INITiate:<FWA>:<Meas2>	Start a new measurement 2. The new measurement will be queued.
FETCh:<FWA>:<Meas1>:STATe:ALL?	Query the measurement substates of measurement 1. The response (RUN, ADJ, ACT) indicates that the measurement is running with all necessary adjustments finished, that the necessary resources are allocated and that results are being acquired.
FETCh:<FWA>:<Meas2>:STATe:ALL?	Query the measurement substates of measurement 2. The response (RUN, PEND, QUE) indicates that the measurement is running but still queued, waiting for resource allocation.
FETCh:<FWA>:<Meas1>...CURRent? (or similar command syntax for reading measurement results)	Wait until the end of the statistics cycle of measurement 1 and retrieve the results.
FETCh:<FWA>:<Meas2>:STATe:ALL?	Query the measurement substates of measurement 2. The response (RUN, ADJ, ACT) indicates that measurement 2 is now active.

Extension: Queued continuous measurements

Command	Comment
CONFigure:<FWA>:<Meas1>:REPetition CONT Initiate:<FWA>:<Meas1>	Start measurement 1 in continuous mode
CONFigure:<FWA>:<Meas2>:REPetition CONT Initiate:<FWA>:<Meas2>	Start a new measurement 2 in continuous mode. The new measurement will be queued, the old measurement is set to "single-shot mode".
FETCh:<FWA>:<Meas1>:STATe:ALL?	Query the measurement substates of measurement 1. The response (RUN, ADJ, ACT) indicates that the measurement is running with all necessary adjustments finished, that the necessary resources are allocated and that results are being acquired.
FETCh:<FWA>:<Meas2>:STATe:ALL?	Query the measurement substates of measurement 2. The response (RUN, PEND, QUE) indicates that the measurement is running but still queued, waiting for resource allocation.
FETCh:<FWA>:<Meas1>...CURRent? (or similar command syntax for reading measurement results)	Wait until the end of the statistics cycle of measurement 1 and retrieve the results.

Command	Comment
FETCh:<FWA>:<Meas2>:STATe:ALL?	Query the measurement substates of measurement 2. The response (RUN, ADJ, ACT) indicates that measurement 2 is now active.
CONFigure:<FWA>:<Meas1>:REPetition? CONFigure:<FWA>:<Meas1>:REPetition?	Query the repetition mode of measurements 1 and 2. Measurement 1 is in single-shot mode (SING), measurement 2 is still in continuous mode (CONT).

5.4.6.3 Causes for Task Conflicts

Resource conflicts can be categorized as follows.

Hardware resource conflicts

A generator requires an independent output path (digital and analog RF transmitter stages). Mobile transmitter measurements (TX measurements) generally require their own input path (analog and digital RF receiver stages), and each signaling application depends on a signaling unit tailored to fit the needs of the network standard.

The number of tasks that the instrument can service in parallel depends on the number of independent paths. The R&S CMW270 can be equipped with up to 2 independent input/output paths.

System resource conflicts

In addition to the hardware resources required for TX and RX paths, other system resources may cause limitations: memory size, possible connections between modules (e.g. trigger lines, I/Q data lines etc.)

Software license key conflicts

Many R&S CMW270 features must be enabled using a software license key. To be run in parallel, several measurements of the same type may require several active software license keys. A resource conflict arises whenever the required number of software options is not available.

5.4.6.4 Monitoring States of Tasks

The state of each task can be queried with commands of the following types:

```
FETCh:<Meas_FWA>:<Measurement>:STATe?
```

```
FETCh:<Meas_FWA>:<Measurement>:STATe:ALL?
```

```
SOURce:<Gen_FWA>:STATe?
```

```
SOURce:<Sig_FWA>:STATe?
```

```
SOURce:<Sig_FWA>:STATe:ALL?
```

For a detailed description see [Measurement Substates](#) and [Generator Control](#).

Example 1: Conflicting generator and signaling applications

Command	Comment
SOURce:<Gen_FWA 1> ON SOURce:<Gen_FWA 1>?	Switch on the first generator and query its state. After hardware adjustment, the response is ON, i.e. the generator is running and an output signal is available.
SOURce:<Gen_FWA 2> ON SOURce:<Gen_FWA 2>?	Switch on the second generator and query its state. Again, the response is ON, i.e. the generator is running.
SOURce:<Gen_FWA 1>?	Check the state of the first generator. The generator state should be OFF, i.e. the second generator has replaced the first generator.

Signaling applications behave like generators and can replace each other. Both are not replaced by measurements.

Example 2: Conflicting measurements

Two conflicting measurements will be queued; the first one is set to single-shot mode; see examples in section [Queuing of Measurements](#).

5.5 Command Processing

The block diagram below shows how remote commands are serviced in the instrument.

The individual components work independently and simultaneously. They communicate with each other by means of so-called "messages".

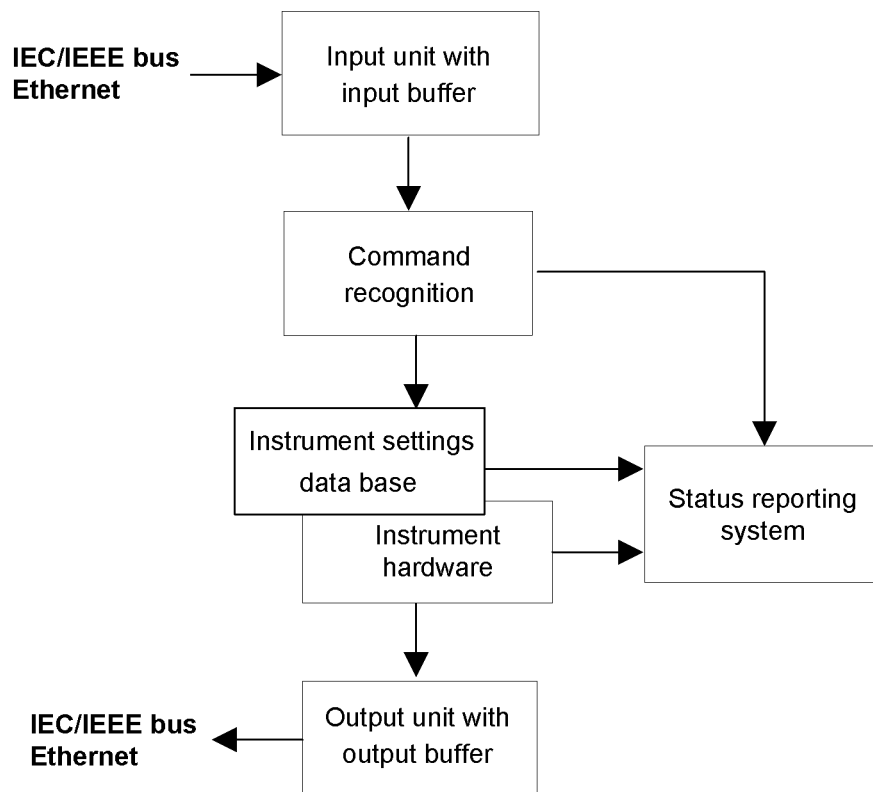

The instrument model consists of the following components.

- [Input Unit](#)..... 174
- [Command Recognition](#)..... 174
- [Data Base and Instrument Hardware](#)..... 175
- [Status Reporting System](#)..... 175
- [Output Unit](#)..... 176

5.5.1 Input Unit

The input unit receives commands character by character from the controller and collects them in the input buffer. The input unit sends a message to the command recognition as soon as the input buffer is full or as soon as it receives a delimiter, <PROGRAM MESSAGE TERMINATOR>, as defined in IEEE 488.2, or the interface message DCL.

If the input buffer is full, the message data traffic is stopped and the data received up to then is processed. Subsequently the traffic is continued. If, however, the buffer is not yet full when receiving the delimiter, the input unit can already receive the next command during command recognition and execution. The receipt of a DCL clears the input buffer and immediately initiates a message to the command recognition.

5.5.2 Command Recognition

The command recognition stage analyzes the data received from the input unit. It proceeds in the order in which it receives the data. Only a DCL is serviced with priority,

e.g. a `GET` (Group Execute Trigger) is only executed after the commands received before. Each recognized command is immediately transferred to the data set but not executed immediately.

The command recognition detects syntax errors in the commands and transfers them to the status reporting system. The rest of a command line after a syntax error is still executed, if possible. After the syntax check, the range of the numerical parameters is checked, if required.

If the command recognition detects a delimiter or a `DCL`, it also requests the data set to perform the necessary instrument hardware settings. Subsequently it is immediately prepared to process further commands. This means that new commands can already be serviced while the hardware is still being set ("overlapping execution").

5.5.3 Data Base and Instrument Hardware

The expression "instrument hardware" denotes the part of the instrument fulfilling the actual instrument function - signal generation, measurement etc. The controller is not included. The data base manages all the parameters and associated settings required for the instrument hardware.

Setting commands lead to an alteration in the data set. The data set management enters the new values (e.g. frequency) into the data set, however, it only passes them on to the hardware when requested by the command recognition. This can only occur at the end of a command line, therefore the order of the setting commands in the command line is not relevant.

The commands are only checked for their compatibility among each other and with the instrument hardware immediately before they are transmitted to the instrument hardware. If the instrument detects that execution is not possible, an "execution error" is signaled to the status reporting system. All alterations of the data set are canceled, the instrument hardware is not reset. Due to the delayed checking and hardware setting, however, impermissible instrument states can be set for a short period of time within one command line without this leading to an error message (example: simultaneous routing of the same generator signal to different output connectors). At the end of the command line, however, a permissible instrument state must have been reached again.

Before passing on the data to the hardware, the settling bit in the `STATus:OPERation` register is set (cf. section [STATus:OPERation](#)). The hardware executes the settings and resets the bit again as soon as the new state has settled. This fact can be used to synchronize command servicing.

Queries induce the data set management to send the desired data to the output unit.

5.5.4 Status Reporting System

The status reporting system collects information on the instrument state and makes it available to the output unit on request. The exact structure and function are described in section [Status Reporting System](#).

5.5.5 Output Unit

The output unit collects the information requested by the controller, which it receives from the data set management. It processes it according to the SCPI rules and makes it available in the output buffer. If the information requested is longer, it is made available "in portions" without this being recognized by the controller.

If the instrument is addressed as a talker without the output buffer containing data or awaiting data from the data set management, the output unit sends the error message "Query UNTERMINATED" to the status reporting system. No data is sent on the GPIB bus or via the Ethernet, the controller waits until it has reached its time limit. This behavior is specified by SCPI.

5.6 Status Reporting System

The status reporting system stores all information on the present operating state of the instrument, and on errors which have occurred. This information is stored in the status registers and in the error queue. Both can be queried via remote control commands, see [chapter 6.3.13, "Status Reporting System"](#), on page 271.

Hierarchy of status registers

As shown in section [Overview of Status Registers](#), the status information is of hierarchical structure.

- STB, SRE:
The STatus Byte (STB) register and its associated mask register Service Request Enable (SRE) form the highest level of the status reporting system. The STB provides a rough overview of the instrument status, collecting the information of the lower-level registers.
- The STB receives its information from:
The Event Status Register (ESR) with the associated mask register standard Event Status Enable (ESE).
The STATus:OPERation and STATus:QUESTionable registers which are defined by SCPI and contain detailed information on the instrument.
- IST, PPE:
The IST flag ("Individual STatus"), like the SRQ, combines the entire instrument status in a single bit. The PPE is associated to the IST flag. It fulfills an analogous function for the IST flag as the SRE does for the service request.
- Output buffer:
contains the messages the instrument returns to the controller. It is not part of the status reporting system but determines the value of the MAV bit in the STB.

All status registers have the same internal structure, see [Structure of an SCPI Status Register](#).

For more information on the individual status registers see [Contents of the Status Registers](#).



SRE register

The service request enable register SRE can be used as ENABLE part of the STB if the STB is structured according to SCPI. By analogy, the ESE can be used as the ENABLE part of the ESR.

5.6.1 Overview of Status Registers

The status registers of the R&S CMW270 are implemented as shown below.

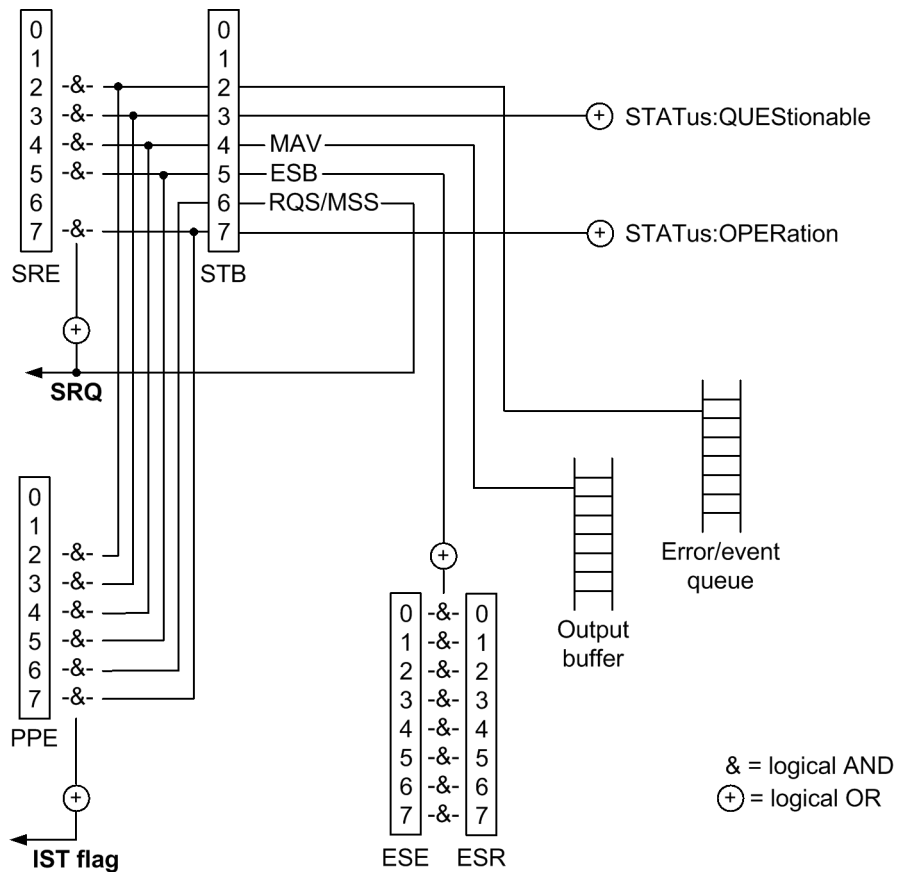

5.6.2 Structure of an SCPI Status Register

Each standard SCPI register consists of 5 parts which each have a width of 16 bits and have different functions. The individual bits are independent of each other, i.e. each hardware status is assigned a bit number which is valid for all five parts. Bit 15 (the most significant bit) is set to zero for all parts. Thus the contents of the register parts can be processed by the controller as positive integer.

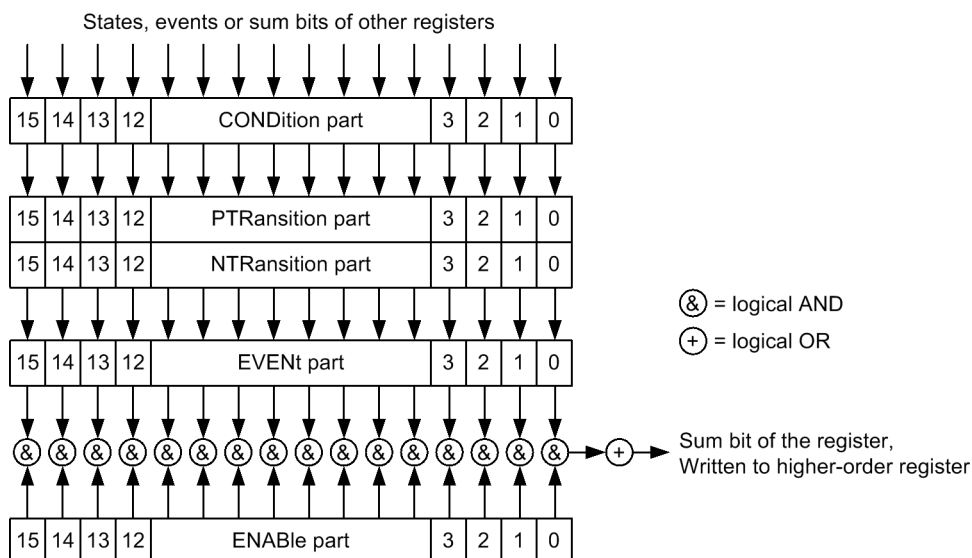

The sum bit is obtained from the EVENT and ENABLe part for each register. The result is then entered into a bit of the CONDition part of the higher-order register.

The instrument automatically generates the sum bit for each register. Thus an event can lead to a [Service Request](#) throughout all levels of the hierarchy.

The five parts of an SCPI register have different properties and function as described below.

CONDition

The CONDition part is permanently overwritten by the hardware or the sum bit of the next lower register. Its contents always reflect the current instrument state.

This register part can only be read, but not overwritten or cleared. Reading the CONDition register is nondestructive.

PTRansition

The two transition register parts define which state transition of the condition part (none, 0 to 1, 1 to 0 or both) is stored in the EVENT part.

The Positive TRansition part acts as a transition filter. When a bit of the CONDition part is changed from 0 to 1, the associated PTR bit decides whether the EVENT bit is set to 1:

- PTR bit = 1: the EVENT bit is set
- PTR bit = 0: the EVENT bit is not set

This status register part can be overwritten and read at will. Reading the PTRansition register is nondestructive.

NTRansition

The Negative TRansition part also acts as a transition filter. When a bit of the CONDition part is changed from 1 to 0, the associated NTR bit decides whether the EVENT bit is set to 1.

- NTR bit = 1: the EVENT bit is set.
- NTR bit = 0: the EVENT bit is not set.

This part can be overwritten and read at will. Reading the PTRansition register is non-destructive.

EVENT

The EVENT part indicates whether an event has occurred since the last reading, it is the "memory" of the condition part. It only indicates events passed on by the transition filters. It is permanently updated by the instrument. This part can only be read by the user. Reading the register clears it. This part is often equated with the entire register.

ENABLE

The ENABLE part determines whether the associated EVENT bit contributes to the sum bit (cf. below). Each bit of the EVENT part is ANDed with the associated ENABLE bit (symbol '&'). The results of all logical operations of this part are passed on to the sum bit via an OR function (symbol '+').

- ENAB bit = 0: The associated EVENT bit does not contribute to the sum bit.
- ENAB bit = 1: If the associated EVENT bit is "1", the sum bit is set to "1" as well.

This part can be overwritten and read by the user at will. Its contents are not affected by reading.

5.6.3 Contents of the Status Registers

The individual status registers are used to report different classes of instrument states or errors. The following status registers belong to the general model described in IEEE 488.2:

- The STatus Byte (STB) gives a rough overview of the instrument status.
- The IST flag combines the entire status information into a single bit that can be queried in a [Parallel Poll](#).
- The Event Status Register (ESR) indicates general instrument states.

The status registers below belong to the device-dependent SCPI register model:

- The STATus:OPERation register contains conditions which are part of the instrument's normal operation.
- The STATus:QUESTIONable register indicates whether the data currently being acquired is of questionable quality.

5.6.3.1 STB and SRE

The STatus Byte (STB) provides a rough overview of the instrument status by collecting the pieces of information of the lower registers. The STB represents the highest level within the SCPI hierarchy. A special feature is that bit 6 acts as the summary bit of the remaining bits of the status byte.

The Status Byte (STB) is linked to the Service Request Enable (SRE) register on a bit-by-bit basis.

- The STB corresponds to the EVENT part of an SCPI register, it indicates general instrument events. This register is cleared when it is read.
- The SRE corresponds to the ENABLE part of an SCPI register. If a bit is set in the SRE and the associated bit in the STB changes from 0 to 1, a [Service Request \(SRQ\)](#) is generated.

Bit 6 of the SRE is ignored, because it corresponds to the summary bit of the STB.

The bits in the STB are defined as follows:

Bit No.	Meaning
2	Error Queue not empty This bit is set when an entry is made in the error queue.
3	QUESTionable status summary bit The bit indicates a questionable instrument status, which can be further pinned down by polling the QUESTionable register.
4	MAV bit (message available) This bit is set if a message is available and can be read from the output buffer. This bit can be used to automatically transfer data from the instrument to the controller.
5	ESB bit Sum bit of the event status register. It is set if one of the bits in the event status register is set and enabled in the event status enable register. Setting of this bit implies an error or an event which can be further pinned down by polling the event status register.
6	MSS bit (master status summary bit) This bit is set if the instrument triggers a service request. This is the case if one of the other bits of this registers is set together with its mask bit in the service request enable register SRE.
7	OPERation status register summary bit This bit is set if an EVENT bit is set in the OPERation-Status register and the associated ENABLE bit is set to 1.

Related common commands

The STB is read out using the command `*STB?` / `*XSTB?` or a [Serial Poll](#).

The SRE can be set using command `*SRE` / `*XSRE` and read using `*SRE?` / `*XSRE?`.

5.6.3.2 IST Flag and PPE

In analogy to the [Service Request \(SRQ\)](#), the IST flag combines the entire status information in a single bit. It can be queried by means of a [Parallel Poll](#).

The Parallel Poll Enable (PPE) register determines which bits of the STB contribute to the IST flag. The bits of the STB are ANDed with the corresponding bits of the PPE, with bit 6 being used as well in contrast to the SRE. The IST flag results from the ORing of all results.

Related common commands

The IST flag is queried using the command `*IST?`.

The PPE can be set using `*PRE / *XPRE` and read using command `*PRE? / *XPRE?`.

See also [Common Commands](#)

5.6.3.3 ESR and ESE

The Event Status Register (ESR) indicates general instrument states. It is linked to the Event Status Enable (ESE) register on a bit-by-bit basis.

- The ESR corresponds to the CONDition part of an SCPI register indicating the current instrument state (although reading is destructive).
- The ESE corresponds to the ENABLE part of an SCPI register. If a bit is set in the ESE and the associated bit in the ESR changes from 0 to 1, the ESB bit in the SStatus Byte is set.

The bits in the ESR are defined as follows:

Bit No.	Meaning
0	<p>Operation Complete</p> <p>This bit is set on receipt of the command <code>*OPC</code> after all previous commands have been executed.</p>
1	<p>Request Control</p> <p>This bit is set if the instrument requests the controller function. This is the case when a hardcopy is sent to a printer or a plotter via the IEC-bus.</p>
2	<p>Query Error</p> <p>This bit is set if either the controller wants to read data from the instrument without having sent a query, or if it does not fetch requested data and sends new instructions to the instrument instead. The cause is often a query which is faulty and hence cannot be executed.</p>
3	<p>Device-Dependent Error</p> <p>This bit is set if a device-dependent error occurs. An error message with a number between -300 and -399 or a positive error number, which describes the error in greater detail, is entered into the error queue.</p>
4	<p>Execution Error</p> <p>This bit is set if a received command is syntactically correct, but cannot be performed for other reasons. An error message with a number between -200 and -300, which describes the error in greater detail, is entered into the error queue.</p>
5	<p>Command Error</p> <p>This bit is set if a command which is undefined or syntactically incorrect is received. An error message with a number between -100 and -200, which describes the error in greater detail, is entered into the error queue.</p>

Bit No.	Meaning
6	User Request This bit is set on pressing the <i>LOCAL</i> key, i. e. when the instrument is switched over to manual control.
7	Power On (supply voltage on) This bit is set when the instrument is switched on.

Related common commands

The Event Status Register (ESR) can be queried using `*ESR?` / `*XESR?`.

The Event Status Enable (ESE) register can be set using the command `*ESE` / `*XESE` and read using `*ESE?` / `*XESE?`.

See also [Common Commands](#)

5.6.3.4 STATus:OPERation

The STATus:OPERation register provides an overview of state transitions of the tasks (e.g. GPRF:MEASurement1:POWer) by collecting the information of lower registers. The STATus:OPERation register hierarchy is shown below. The paths can also be queried via remote command, see [SYSTem:HELP:STATus\[:REGister\]?](#) on page 274 and [SYSTem:HELP:STATus:BITS?](#) on page 274.

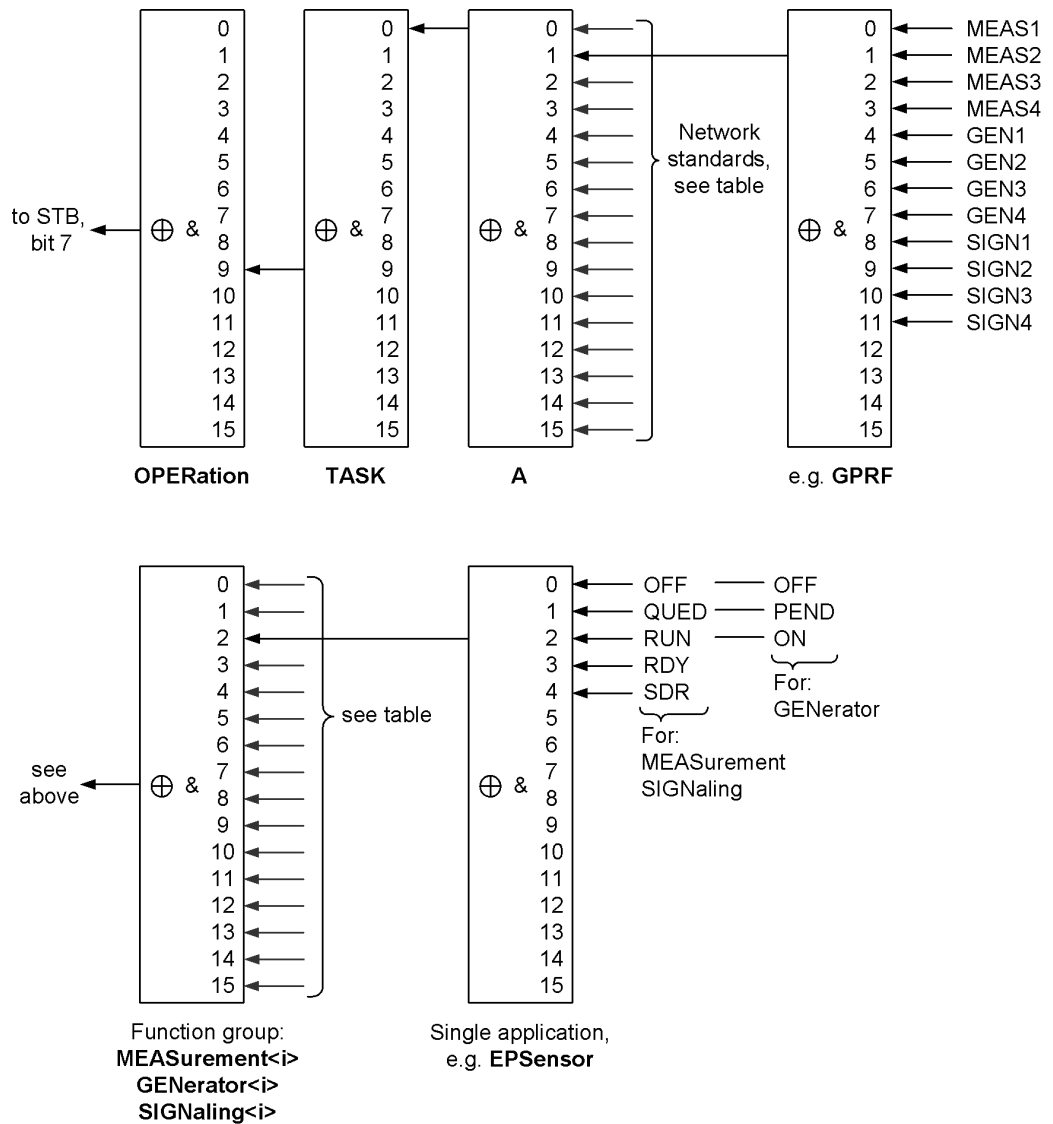

Fig. 5-1: STATUS:OPERation register hierarchy

Each single status register in the figure above consists of five parts as described in section [Structure of an SCPI Status Register](#). The following simplified presentation is used:

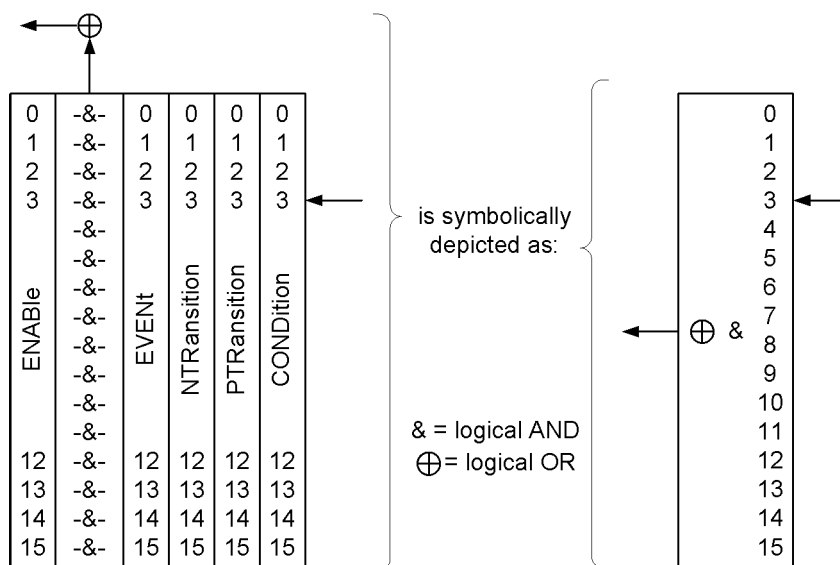

Fig. 5-2: Legend for figure above

The following table lists the assignment of network standards (and GPRF, DAU) to the bits of the register STATUS:OPERation:TASK:A. The mnemonics used to indicate the network standards are identical to the mnemonics used in remote commands (see [Firmware Applications](#)).

Table 5-2: Bit definition for register STATUS:OPERation:TASK:A

Bit No.	Network Standard
1	GPRF
4	WLAN
5	BLUetooth
6	WIMax

The following table lists the assignment of the individual measurement, signaling and generator applications to the bits of a function group register (STATUS:OPERation:TASK:A:<network standard>:MEASurement<i> / ...:SIGNaling<i> / ...:GENerator<i>).

The mnemonics for measurement and signaling applications are as far as possible identical to the mnemonics used in remote commands (see [Firmware Applications](#)).

Generator function groups contain only one application which is not explicitly identified in remote commands. For the status register of this application the mnemonic UNIVERSal is used (e.g. STATUS:OPERation:TASK:A:GPRF:GENerator1:UNIVERSal).

Table 5-3: Bit definition for function group registers

Bit No.	MEASurement	SIGNaling	GENerator
0	POWer, MEValuation, PING	BERCswitched, BER, PER, TDATa, EBLer	UNIVERSal
1	IQVSlot, PRACH, IPERf, TPC, OLTR	THROUGHput, BERPswitched, HACK	not used

Bit No.	MEASurement	SIGNaling	GENerator
2	EPSensor, SRS, THROughtput	BLER	not used
3	IQRecorder	not used	not used
4	FFTSanalyzer	not used	not used

The status registers at the lowest level indicate state transitions to the following states:

Table 5-4: Bit definition for application register

Bit No.	MEASurement / Signaling State	GENerator State
0	OFF	OFF
1	QUED (queued)	PEND (pending)
2	RUN (running)	ON
3	RDY (ready)	not used
4	SDR (statistical depth reached)	not used

The reporting structures of the register hierarchy are administrable using the following commands:

- `STATUS:OPERation:TASK:A:ENABle etc.`
- `STATUS:OPERation:TASK:A:ESRQ etc.`
- `STATUS:OPERation:TASK:A:NTRansition etc.`
- `STATUS:OPERation:TASK:A:PTRansition etc.`

The states and state transitions of a specific task can be queried using the following commands:

- `STATUS:OPERation:TASK:A:GPRF:GENerator1:UNIVersal:CONDition? etc.`
- `STATUS:OPERation:TASK:A:GPRF:GENerator2:UNIVersal:EVENT? etc.`

Waiting until a certain state is reached or a certain state transition occurs is possible using the following commands:

- `STATUS:OPERation:TASK:A:GPRF:GENerator1:UNIVersal:WCONDition? etc.`
- `STATUS:OPERation:TASK:A:GPRF:GENerator2:UNIVersal:WEVENT? etc.`

These commands are also available as extended versions, providing more comfort:

- `...:XENable, ...:XESRq, ...:XNTRansition, ...:XPTRansition`
- `...:XCONDition, ...:XEVENT`
- `...:XWCondition, ...:XWEVENT`

More sophisticated evaluations of the hierarchy are possible using e.g.:

- `STATUS:CONDition:BITS:ALL?`
- `STATUS:EVENT:BITS:ALL?`
- `STATUS:MEASurement:CONDition:RDY? etc.`

For command descriptions refer to:

- [chapter 6.3.13.2, "STATus:OPERation \(Elementary Commands\)"](#), on page 272
- [chapter 6.3.13.3, "STATus:OPERation \(Extended Commands\)"](#), on page 280
- [chapter 6.3.13.4, "STATus:OPERation \(Overall Evaluation\)"](#), on page 287

5.6.3.5 STATus:QUEStionable

The STATus:QUEStionable register indicates whether the data currently being acquired is of questionable quality.

The R&S CMW270 does not use the STATus:QUEStionable register.

5.6.4 Application of the Status Reporting System

The purpose of the status reporting system is to monitor the status of one or several devices in a measuring system. To do this and react appropriately, the controller must receive and evaluate the information of all devices. The following standard methods described in the following sections are used:

- Service request (SRQ) initiated by the measuring device
- Serial poll of all devices in the bus system, initiated by the controller in order to find out who sent a SRQ and why
- Parallel poll of all devices
- Query of a specific instrument status by means of commands
- Query of the error queue

5.6.4.1 Service Request

The measuring device can send a service request (SRQ) to the controller. Usually this service request causes an interrupt, to which the control program can react appropriately. It is also possible to wait until an SRQ is generated, see `*SRQ?` in [chapter 6.1, "Common Commands"](#), on page 204).

Initiating an SRQ

As shown in section [Overview of Status Registers](#), an SRQ is initiated if one or several of bits 2, 3, 4, 5 or 7 of the status byte are set and enabled in the SRE. Each of these bits summarizes the information of a further register, the error queue or the output buffer.

The ENABLE parts of the status registers can be set such that arbitrary bits in an arbitrary status register initiate an SRQ. To use the possibilities of the service request effectively, all bits in the enable registers SRE and ESE should be set to "1".

Example: Use *OPC to generate an SRQ

1. Set bit 0 in the ESE (Operation Complete).

2. Set bit 5 in the SRE (ESB).
3. Insert *OPC in the command sequence

As soon as all commands preceding *OPC have been completed, the instrument generates an SRQ.

Example: Indicate measurement state via SRQ

In this example the reporting path is enabled for a specific measurement state, so that an SRQ will be generated when this state is reached. Then the instrument is commanded to wait until an SRQ is generated.

1. Enable reporting for the state RDY of the GPRF power measurement:
`STATus:OPERation:TASK:A:GPRF:MEASurement:POWer:XESRq (RDY)`
2. Start the GPRF measurement:
`INITiate:GPRF:MEASurement:POWer`
3. Wait until the measurement reaches the state RDY and an SRQ is generated. If no SRQ has been generated after 1 minute (60000 ms), continue nevertheless:
`*SRQ? 60000`
 Evaluate the returned value: 0 indicates that a timeout occurred, 1 indicates that an SRQ was generated.

The following steps show an alternative way to achieve the same result without SRQ generation.

1. Start the GPRF measurement:
`INITiate:GPRF:MEASurement:POWer`
2. Wait until the measurement reaches the state RDY. If the state has not been reached after 1 minute (60000 ms), continue nevertheless:
`STAT:OPER:TASK:A:GPRF:MEAS:POW:XWEVent? (RDY), 60000`
 Evaluate the returned value: () indicates that a timeout occurred, (RDY) indicates that the state has been reached.



The SRQ is the only possibility for the instrument to become active on its own. Each controller program should set the instrument such that a service request is initiated in the case of malfunction. The program should react appropriately to the service request.

5.6.4.2 Serial Poll

In a serial poll, the controller queries the STatus Bytes of the devices in the bus system one after another. The query is made via interface messages, so it is faster than a poll by means of *STB?.

The serial poll method is defined in IEEE 488.1 and used to be the only standard possibility for different instruments to poll the status byte. The method also works for instruments which do not adhere to SCPI or IEEE 488.2.

The serial poll is mainly used to obtain a fast overview of the state of several instruments connected to the controller.

5.6.4.3 Parallel Poll

In a parallel poll, up to eight instruments are simultaneously requested by the controller by means of a single command to transmit 1 bit of information each on the data lines, i.e., to set the data line allocated to each instrument to a logical "0" or "1".

In addition to the SRE register, which determines the conditions under which an SRQ is generated, there is a Parallel Poll Enable register (PPE). This register is ANDed with the STB bit by bit, considering bit 6 as well. The results are ORed, the result is possibly inverted and then sent as a response to the parallel poll of the controller. The result can also be queried without parallel poll by means of the command "*IST?".

The parallel poll method is mainly used to find out quickly which one of the instruments connected to the controller has sent a service request. To this effect, SRE and PPE must be set to the same value.

5.6.4.4 Query of an Instrument Status

Each part of any status register can be read by means of queries. There are two types of commands:

- Common commands query the higher-level registers. Examples are *ESR?, *ESE?, *IST? and *STB?, see also [chapter 6.1, "Common Commands"](#), on page 204.
- The commands of the STATus system query the SCPI registers (e.g. STATus:OPERation...).

All queries return a decimal number which represents the bit pattern of the status register. This number is evaluated by the controller program.

Queries are usually used after an SRQ in order to obtain more detailed information on the cause of the SRQ.

Decimal representation of a bit pattern

The STB and ESR registers contain 8 bits, the SCPI registers 16 bits. The contents of a status register is keyed and transferred as a single decimal number. To make this possible, each bit is assigned a weighted value. The decimal number is calculated as the sum of the weighted values of all bits in the register that are set to 1.

Bits	0	1	2	3	4	5	6	7	...
Weight	1	2	4	8	16	32	64	128	...

Example: The decimal value 40 = 32 + 8 indicates that bits no. 3 and 5 in the status register (e.g. the QUESTIONable status summary bit and the ESB bit in the STB) are set.

5.6.4.5 Error Queue

Each error state in the instrument leads to an entry in the error queue. The entries of the error queue are detailed plain text error messages that can be queried via remote control using `SYSTem:ERRor[:NEXT]?` or `SYSTem:ERRor:ALL?`. Each call of `SYSTem:ERRor[:NEXT]?` provides one entry from the error queue. If no error messages are stored there any more, the instrument responds with 0, "No error".

The error queue should be queried after every SRQ in the controller program as the entries describe the cause of an error more precisely than the status registers. Especially in the test phase of a controller program the error queue should be queried regularly since faulty commands from the controller to the instrument are recorded there as well.

5.6.5 Reset Values of the Status Reporting System

The table below indicates the effects of various commands upon the status reporting system of the R&S CMW270.

Event	Switching on supply voltage Power-On-Status-Clear		DCL, SDC (Device Clear, Selected Device Clear)	*RST or SYS- Tem:PRE- Set:ALL	STA- Tus:PRE- Set	*CLS
	0	1				
Effect	0	1				
Clear STB,ESR		yes				yes
Clear SRE,ESE		yes				
Clear PPE		yes				
Clear EVENT parts of the registers		yes				yes
Clear ENABLE parts of all OPERATION-and QUESTIONable registers, Fill ENABLE parts of all other registers with "1".		yes			yes	
Fill PTRansition parts with "1" Clear NTRansition parts		yes			yes	
Clear error queue	yes	yes				yes
Clear output buffer	yes	yes	yes	1)	1)	1)
Clear command processing and input buffer	yes	yes	yes			

1) Every command being the first in a command line, i.e. immediately following a `<PROGRAM MESSAGE TERMINATOR>` clears the output buffer.

5.6.6 Regular Expressions

Some remote control commands (for examples see [STATus:OPERation \(Overall Evaluation\)](#)) support the application of filters. A filter allows to limit the results returned by the command (or the objects affected by the command) to a specific set of strings. This set can be defined via a regular expression without having to list all elements.

The most basic filter expression consists of a simple string containing no meta characters, e.g. 'CDM'. Strings match to this filter if they contain the defined filter string. Matching examples: 'CDMA2000', 'WCDMA', 'WCDMA network standard'.

More sophisticated filter expressions can be defined using the meta characters listed in the following table. A string matches to a filter example given in the table if it contains any of the given matching strings.

Meta Character	Meaning
.	Matches any single character.
[]	Matches a single character given within the brackets. Example: '[ABC]' matches 'A', 'B' and 'C'. [-] specifies a range. Example: '[ABCX-Z]' matches 'A', 'B', 'C', 'X', 'Y' and 'Z', as does '[A-CX-Z]'.
[^]	Matches a single character not given within the brackets. Example: '[^ABC]' matches any character other than 'A', 'B' and 'C'.
^	If given at the beginning of a filter, matches the beginning of the string. Example: '^[ABC]' matches any string starting with 'A', 'B' or 'C'.
\$	If given at the end of a filter, matches the end of the string. Example: '[ABC]\$' matches any string ending with 'A', 'B' or 'C'.
?	Matches the preceding element zero or one time. Example: 'M[0-9][0-9]?' matches 'M1', 'M25', 'M0', 'M00', ...
+	Matches the preceding element one or more times. Example: 'TR[AB]+' matches 'TRA', 'TRB', 'TRABBBABA', ...
*	Matches the preceding element zero or more times. Example: 'A*B' matches 'B', 'AB', 'AAAAAAB', ...
()	Groups the content for other operators. Example: 'A(BCD)?E' matches 'AE' and 'ABCDE'.
\	Interpret the next character literally, not as meta character. Example: '[A\C]' matches 'A', '\ ' and 'C', while '[A-C]' matches 'A', 'B' and 'C'.
	Alternation operator, matching the expression before or after the operator. Example: 'NOT R' matches 'NOT' and 'NOR'.
!	Negation operator. The expression following the ! does not match. Example: '!01' matches '111', '121' etc. but not '101'.

Additionally character sets can be represented by abbreviations indicated in the following table.

Abbreviation	Matches
\a	Any alphanumeric character ([a-zA-Z0-9])
\b	White space (blank)
\c	Any alphabetic character ([a-zA-Z])
\d	Any decimal digit ([0-9])
\h	Any hexadecimal digit ([a-fA-F0-9])
\w	A simple word ([a-zA-Z]+)
\z	An integer ([0-9]+)

5.7 Command Macros

A macro is a sequence of remote commands which can be referenced in a remote control program. Macros are kept in the R&S CMW270's RAM while a remote connection is active; therefore they are a means of saving transfer time and speed up the measurement. The gain is most noticeable if the macros contain many commands and if they are executed repeatedly. Macros are particularly suited for the configuration sections of a program, e.g. in order to combine a group of settings which is repeated in a loop.

Macros must be defined at the beginning of a remote script. In general, they remain valid until the active remote control connection is closed. Macros are not directly transferable from one remote channel to another. It is possible though to save macros to files in order to re-use them in other remote connections or sessions. It is also possible to use different macros with the same label for different connections.



Queries in macros, response buffers

A query in a macro sequence suspends program execution until the controller has retrieved the response. The R&S CMW270 provides response buffers to avoid delays; see [chapter 5.8, "Response Buffers"](#), on page 194.

5.7.1 Macro Contents and Macro Commands

Macros can be defined in the RAM of the instrument using the IEEE 488.2 common command `*DMC`.

It supports two formats for macro contents:

- Contents can be defined in IEEE 488.2 block data format with defined or indefinite length. "#0" introduces a data block of indefinite length. `*GMC?` returns the macro contents in block data format.
See also ["Block Data Format"](#) on page 140.
- As an alternative, `*DMC` accepts strings with a maximum length of 1023 characters.

Macros present in the RAM can be saved to macro files using `MMEMemory:STORe:MACRo`. Macro files can be loaded into the RAM using `MMEMemory:LOAD:MACRo`.

Macro files can also be recorded. Start macro recording via `SYSTem:RECOrd:MACRo:FILE:START`. Then submit the commands to be stored into the macro file and stop recording via `SYSTem:RECOrd:MACRo:FILE:STOP`. Ensure that only one remote control interface of the instrument is used during recording of a macro file.

Macro files are identified via their path and filename on the instrument. Macros within the RAM are identified via a label.



Memory size

The block data size of any single macro (and the size of a macro file) must not exceed 1 MB. The R&S CMW270 can process macros with a combined size of up to 16 MB.

5.7.2 Macro Programming Examples

The following examples show you how to use macros, macro parameters, and macro files. For a command reference see [chapter 6.3.1, "Macro Commands"](#), on page 207.

Macro handling using common control commands

```
// *****
// Reset the instrument.
// Define a macro to set the GPRF generator frequency to 1 GHz.
// Query the contents of the macro (should be
// #247SOURCE:GPRF:GENerator:RFSettings:FREQuency 1GHz).
// Query labels of existing macros.
// *****
*RST
*DMC 'SetFrequency', 'SOURCE:GPRF:GENerator:RFSettings:FREQuency 1 GHz'
*GMC? 'SetFrequency'
*LMC?

// *****
// Query the GPRF generator frequency.
// Enable macro execution.
// Execute the macro.
// Check whether the generator frequency has actually been changed.
// *****
SOURCE:GPRF:GENerator:RFSettings:FREQuency?
*EMC ON
SetFrequency
SOURCE:GPRF:GENerator:RFSettings:FREQuency?

// *****
// Delete the macro.
// Delete all macros in the active connection.
// Check whether all macros have been deleted (response: "").
```



```
// *****
*RMC 'SetFrequency'
*PMC
*LMC?
```

Macros with parameters

```
// *****
// Reset the instrument.
// Define a macro to set the GPRF generator frequency and level to arbitrary
// values using macro parameters.
// Execute the macro and check the results.
// *****
*RST
*DMC 'RF_Settings', 'SOURCE:GPRF:GENERATOR:RFSettings:FREQUENCY $1; LEVEL $2'
*EMC ON
SOURCE:GPRF:GENERATOR:RFSettings:FREQUENCY?; LEVEL?
RF_Settings 1 GHz,-10 dBm
SOURCE:GPRF:GENERATOR:RFSettings:FREQUENCY?; LEVEL?
```

Using macro files and block data format

```
// *****
// Store the macro to a file on the hard disk of the instrument.
// Delete the macro, check whether all macros have been deleted (response: "").
// *****
MMEMORY:STORE:MACRO 'RF_Settings', 'D:/macros/RF_Settings.txt'
*PMC
*LMC?

// *****
// Re-load the macro contents from the macro file, assigning the old label.
// Query the contents.
// *****
MMEMORY:LOAD:MACRO 'RF_Settings', 'D:/macros/RF_Settings.txt'
*GMC? 'RF_Settings'
*LMC?

// *****
// Re-define the macro using block data format. Check and store the macro.
// *****
*DMC 'RF_Settings', #0SOURCE:GPRF:GENERATOR:RFSettings:FREQUENCY $1; LEVEL $2
*GMC? 'RF_Settings'
MMEMORY:STORE:MACRO 'RF_Settings', 'D:/macros/RF_Settings.txt'
```

Recording macro files

```
// *****
// Start recording.
// Submit commands to be recorded.
// Stop recording.
```

```
// Load the recorded macro and check its contents.
// *****
SYSTem:RECOrd:MACRO:FILE:START 'D:/macros/GPRF.txt'
SOURCE:GPRF:GENerator:RFSettings:FREQuency 1 GHz
SOURCE:GPRF:GENerator:RFSettings:EATTenuation 2
SOURCE:GPRF:GENerator:RFSettings:LEVel -70
SYSTem:RECOrd:MACRO:FILE:STOP
MMEMory:LOAD:MACRO 'RF_Settings1', 'D:/macros/GPRF.txt'
*GMC? 'RF_Settings1'
```

5.8 Response Buffers

A response buffer is a region of memory in the R&S CMW270's RAM used to store device responses, in particular measurement data, which the R&S CMW270 generates while executing queries. If no buffer is enabled, a query in a remote script suspends program execution until the controller has retrieved the response. The main purpose of response buffers is to avoid these delays. Results are stored while program execution continues and can be read at the end of the program.

Response buffers improve the efficiency of command macros containing queries. Similar to command macros, the buffers are created at the beginning of a remote script. Buffers remain valid until the active remote control connection is closed; they are not transferable from one remote channel to another. It is possible though to assign buffers with the same name (but generally different contents) to different connections.

See also [chapter 5.7, "Command Macros"](#), on page 191.



DCL, troubleshooting

A device clear (DCL) interface message does not deactivate the buffer. Errors in the response buffers can be monitored using the status reporting system and the error queue (SYSTem:ERRor...?).

5.8.1 Buffer Contents and Buffer Commands

Response buffers are defined and activated using a `START:BASE:BUFFER '<BufferLabel>'` command. The buffer label serves as a reference in all other buffer commands. It is possible to define several buffers, however, only one buffer can be active at any time.

When a response buffer is active, the complete contents of the R&S CMW270's output buffer are copied to the active buffer instead of being transferred over the remote interface. **Every** program line in a command script containing queries generates a single new buffer line. This includes the responses to system commands such as `SYSTem:ERRor?`. The queries are not stored together with the results.

Buffers may be temporarily deactivated, e.g. to exclude a response to `SYSTem:ERRor?` from the buffer. It is also possible to clear the buffer contents or

delete the buffer during program execution. The buffer contents can be read line by line. The syntax of buffer commands follows general R&S CMW270 syntax rules; see [chapter 6.3.2, "Buffer Commands"](#), on page 211.



Memory size

The buffer size must not exceed 16 MB. When the maximum buffer size is reached, a "Buffer Deadlock" error message is created and no additional data is appended to the buffer. The previously stored data is retained.

5.8.2 Buffer Programming Example

The following example shows you how to work with response buffers. For a command reference see [chapter 6.3.2, "Buffer Commands"](#), on page 211.

```
// Define a macro containing a query and create a buffer to record the responses
*RST; *CLS
*DMC 'Query_macro', 'SOURCE:GPRF:GENERATOR:RFSettings:FREQUENCY $1; *WAI;
      :SOURCE:GPRF:GENERATOR:RFSettings:FREQUENCY?'
START:BASE:BUFFER 'Frequency_Buffer'

// Execute the macro repeatedly, stop recording in order to query the number of
// buffer lines (3) and the buffer line contents
// (the responses should be 3 GHz, 2 GHz, 1GHz)
Query_macro 1 GHz
Query_macro 2 GHz
Query_macro 3 GHz
STOP:BASE:BUFFER
FETCH:BASE:BUFFER:LINEcount? 'Frequency_Buffer'
FETCH:BASE:BUFFER? 'Frequency_Buffer',3
FETCH:BASE:BUFFER? 'Frequency_Buffer',2
FETCH:BASE:BUFFER? 'Frequency_Buffer',1

// With stopped buffer, no further lines are appended.
// The line count query still returns 3.
Query_macro 1 GHz
FETCH:BASE:BUFFER:LINEcount? 'Frequency_Buffer'

// Re-activate the buffer to appended further lines.
// The line count query returns 4.
CONTINUE:BASE:BUFFER 'Frequency_Buffer'
Query_macro 4 GHz
STOP:BASE:BUFFER
FETCH:BASE:BUFFER:LINEcount? 'Frequency_Buffer'

// Clear the buffer contents: the line count query returns 0
// Delete the buffer: the line count query times out and the error queue
// contains an entry with code -273 "Illegal macro label"
CLEAR:BASE:BUFFER 'Frequency_Buffer'
```

```

FETCh:BASE:BUFFer:LINEcount? 'Frequency_Buffer'
DELEte:BASE:BUFFer 'Frequency_Buffer'
FETCh:BASE:BUFFer:LINEcount? 'Frequency_Buffer'
SYSTem:ERRor?

```

5.9 LXI Configuration

LAN eXtensions for Instrumentation (LXI) is an instrumentation platform for measuring instruments and test systems that is based on standard Ethernet technology. LXI is intended to be the LAN-based successor to GPIB, combining the advantages of Ethernet with the simplicity and familiarity of GPIB.

5.9.1 LXI Classes and LXI Functionality

LXI-compliant instruments are divided into three classes, A, B and C, with the functionality of the classes hierarchically based one upon the other:

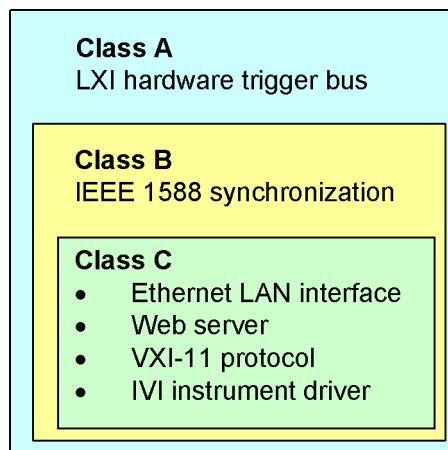

- **Class C** instruments are characterized by a common LAN implementation, including an ICMP ping responder for diagnostics, see [Ping Client](#). The instruments can be configured via the [LXI Browser Interface](#); a LAN Configuration Initialize (LCI) mechanism resets the LAN configuration. The LXI class C instruments shall also support automatic detection in a LAN via the VXI-11 discovery protocol and programming by means of IVI drivers.
- **Class B** adds IEEE 1588 Precision Time Protocol (PTP) and peer-to-peer communication to the base class. IEEE 1588 allows all instruments on the same network to automatically synchronize to the most accurate clock available and then provide time stamps or time-based synchronization signals to all instruments with exceptional accuracy.
- **Class A** instruments are additionally equipped with the eight-channel hardware trigger bus (LVDS interface) defined in the LXI standard.

Instruments of classes A and B can generate and receive software triggers via LAN messages and communicate with each other without involving the controller.

The R&S CMW270 supports some LXI class C features, but it is not LXI class C compliant (e.g. LCI mechanism not implemented). In addition to general class C features, it provides additional functionality, e.g. tracing of remote SCPI commands, see [LXI Browser Interface](#).



For information about the LXI standard refer to the LXI website at <http://www.lxistandard.org>.

5.9.2 LXI Browser Interface

The instrument's LXI browser interface works correctly with all W3C compliant browsers. Typing the instrument's host name or IP address in the address field of the browser on your PC (e.g. <http://10.113.10.203>) opens the instrument home page.

The screenshot displays the LXI browser interface for an R&S CMW270 instrument. The interface is divided into a navigation pane on the left and a main content area on the right. The navigation pane includes sections for 'Ixi', 'Home', 'Lan Configuration', 'Status', 'Help', 'Manual', 'Diagnostics', 'Instrument Control', and 'License Manager'. The main content area shows 'Instrument Properties' with a table of device information and a 'Status' section indicating 'No error'.

Property	Value
Instrument Model	R&S CMW
Manufacturer	Rohde & Schwarz GmbH & Co. KG
Serial Number	116625
Description	Rohde & Schwarz R&S CMW (3.0.10.4) 116625
LXI Class	C
LXI Version	1.3
Host Name	10.121.13.151
MAC Address	00:E0:33:9A:01:80
TCP/IP Address	10.121.13.151
Firmware Revision	3.0.10.4
Current Time	Wednesday, 2012/04/18, 12:39:14
Current Time source	Operating System
VISA resource string	TCPIP::10.121.13.151::INST0::INSTR
Device Indicator	INACTIVE (press to toggle)

Status: No error

© 2010 ROHDE&SCHWARZ. All rights reserved.

The instrument home page displays the device information required by the LXI standard including the VISA resource string in read-only format.

The navigation pane of the browser interface contains the following elements:

- "Ixi"

- "Home" opens the instrument home page.
- [LAN Configuration](#) allows to configure LAN parameters and to initiate a ping.
- "Status" displays information about the LXI status of the instrument.
- "Help"
 - "Manual" provides access to the online help system stored on the instrument.
 - "www.rohde-schwarz.com" opens the R&S home page.
- "Diagnostics"
 - "SCPI Command Shell" provides a simple shell for sending SCPI commands to the instrument.
 - [SCPI Remote Trace](#) allows to record messages exchanged via the remote control interface of the instrument.
- "Instrument Control"
 - "File Download" allows to download files from the instrument.
 - "File Upload" allows to upload files to the instrument.
 - "Web Control" provides remote access to the instrument via VNC. Enter "VNC" both as user name and as password.
- "License Manager"
 - "Manage Licenses" allows to install or uninstall license keys and to activate, register or unregister licenses.

5.9.3 LAN Configuration

Comprises the following navigation entries.

• IP Configuration	198
• Advanced Config	199
• Ping Client	200

5.9.3.1 IP Configuration

The LAN configuration parameters required by the LXI standard can be accessed via the navigation entry "IP Configuration".

LXI

Home

▶ Lan Configuration

IP Configuration

Advanced Config

Ping Client

Status

Help

Manual

www.rohde-schwarz.com

Diagnostics

SCPI Remote Trace

Instrument Control

File Download

File Upload

Web Control

LAN Parameters

Hostname

Domain

Description

TCP/IP Mode

IP Address

Subnet Mask

Default Gateway

DNS Server(s)

Dynamic DNS Disabled Enabled

(Password required!)

The "TCP/IP Mode" configuration field controls how the IP address for the instrument gets assigned (see also [System Settings](#)). For the manual configuration mode, the static IP address, subnet mask, and default gateway are used to configure the LAN. The automatic configuration mode uses DHCP server or Dynamic Link Local Addressing (Automatic IP) to obtain the instrument IP address.



Password protection

Changing the LAN configuration is password-protected. The password reads **LxiWeblfc** (notice upper and lower case characters). This password cannot be changed in the current software version.

5.9.3.2 Advanced Config

The navigation entry "Advanced Config" provides access to additional LAN parameters that are not declared mandatory by the LXI standard.

The advanced LAN configuration parameters are used as follows:

- "Negotiation": The negotiation configuration field provides different Ethernet speed and duplex mode settings. In general, the Auto Detect mode is sufficient.
- "ICMP Ping": If you disable this setting, the instrument does not answer ping requests. So it can not be pinged.
The setting does not affect the LXI ping client. You can ping other hosts from the instrument, even if the setting is disabled.
- "VXI-11 Discovery": If you disable this setting, remote control of the instrument via the VXI-11 protocol is not possible. According to the standard, LXI devices must use VXI-11 to provide a discovery mechanism. Other additional discovery mechanisms are permitted.
- "mDNS and DNS-SD": Multicast DNS and DNS Service Discovery. These functions are not yet supported.



Password protection

Changing the LAN configuration is password-protected. The password reads **LxiWebIfc** (notice upper and lower case characters). This password cannot be changed in the current software version.

5.9.3.3 Ping Client

Ping is a utility that verifies the connection between the LXI-compliant instrument and another device. The ping is initiated from the instrument. It uses the ICMP echo request and echo reply packets to determine whether the LAN connection to another device is functional. Ping is useful for diagnosing IP network or router failures.

The ping utility is not password-protected. To initiate a ping at the instrument:

1. Enter the IP address of the host to be pinged into the "Destination Address" field (e.g. 10.123.11.22).
2. Click Submit.

Ping Parameter

Destination Address:

Result

```
Pinging 10.123.11.22 with 32 bytes of data:
Reply from 10.123.11.22: bytes=32 time<1ms TTL=127
Reply from 10.123.11.22: bytes=32 time<1ms TTL=127
Reply from 10.123.11.22: bytes=32 time<1ms TTL=127
Reply from 10.123.11.22: bytes=32 time<1ms TTL=127

Ping statistics for 10.123.11.22:
    Packets: Sent = 4, Received = 4, Lost = 0 (0% loss),
```

5.9.4 SCPI Remote Trace

The remote trace functionality allows to trace input and output strings at the remote control interface of the R&S CMW270.

A recorded trace (message log) can be evaluated directly in the dialog. Use the highlighting and navigation functions provided by the lower toolbar to locate error messages and messages containing arbitrary search strings. You can also export the message log to a csv file and evaluate the file using a suitable program.

In order to trace and display messages, switch on "logging" and "live mode" via the toolbar.

LXI

- Home
- Lan Configuration
- Status
- Utilities

Help

- Datasheet
- Manual
- www.rohde-schwarz.com

Diagnostics

- SCPI Remote Trace

Instrument Control

- File Download
- File Upload
- Web Control

SCPI Remote Trace

live mode: on off logging: on off filter: details:

log file:

rec	MT	I	message
10	T	1	▶ 1956µs : CONFigure:GPRF:MEASurement:RFSettings:UMARgin 5
11	>	2	CONFigure:GPRF:MEASurement:RFSettings:FREQuency 890.2E+6
12	T	2	▶ 1040µs : CONFigure:GPRF:MEASurement:RFSettings:FREQuenc...
13	>	2	CONFigure:GPRF:MEASurement:POWer:SLENgth 577.9230769E-6
14	T	2	▶ 730µs : CONFigure:GPRF:MEASurement:POWer:SLENgth 577.9...
15	>	2	CONFigure:GPRF:MEASurement:POWer:MLENgth 400E-6
16	T	2	▶ 586µs : CONFigure:GPRF:MEASurement:POWer:MLENgth 400E-6
17	>	2	CONFigure:GPRF:MEASurement:POWer:SCOUnt 5
18	T	2	▶ 1502µs : CONFigure:GPRF:MEASurement:POWer:SCOUnt 5
19	>	2	CONFigure:GPRF:MEASurement:POWer:FILTer:TYPE GAUSSsss
20	E	2	-141: Invalid character data, CONFigure:GPRF:MEASurement:POWer...
21	>	2	CONFigure:GPRF:MEASurement:POWer:FILTer:GAUSS:BWDItH 30E...

IFpower

Toolbars

The toolbar at the top of the dialog provides basic settings and functions.



- **live mode / logging:** If logging is switched on, messages are traced. They are stored in an internal database and can be displayed upon request, using the refresh button (live mode off) or they can be displayed automatically (live mode on).
- **filter:** applies a filter to columns and/or rows
- **refresh:** reads the message log from the internal database and displays it
- **download:** stores the message log database to a csv file
- **clear:** deletes all message log entries in the database and at the screen
- **details:** shows all fields of the selected message (also possible by double-clicking a message)

If the displayed log contains messages, a second toolbar is displayed at the bottom of the dialog. It facilitates navigation within comprehensive message logs.



- **double arrow buttons:** show the previous or next page
- **red arrow buttons:** navigate to the previous or next error message
- **green arrow buttons:** navigate to the previous or next message containing the entered search string (e.g. IFPower)
- **text field:** The entered search string is highlighted in the entire message log by green color. The scroll bar indicates the message positions by green bars.
- **scroll bar:** The scroll bar to the right of the buttons covers the entire message log, while the rectangle marks the currently displayed section. You can move the rectangle to scroll through the message log. The position of certain messages is indicated by colored bars:
 - red bar: indicates an error message
 - orange bar: indicates an error message containing the search string
 - green bar: indicates another message containing the search string

Columns

The following columns are available if no column filter is applied:

- **rec:** record number of the message within the message log
- **time stamp:** date and time of the message with a resolution of 1 ms, e.g. time when the error indicated by an error message occurred
- **channel:** VISA string of the traced remote control channel
- **MT / message:** MT indicates the type of the message. Possible values and related message contents are:
 - > = incoming command
 - < = outgoing response to a query

- E = error message, highlighted by red color
- T = execution time, i.e. time required by the instrument to process the command internally
- I: number of the sub-instrument

5.10 Monitoring the Instrument via SNMP

The R&S CMW270 is equipped with an SNMP agent. SNMP stands for Simple Network Management Protocol.

Use an SNMP management application of your choice to query instrument information from the SNMP agent via SNMP messages. The computer where the management application is running and the R&S CMW270 must be connected via LAN.

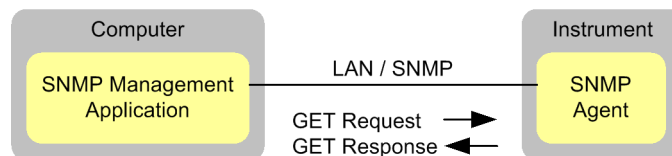

A Management Information Base (MIB) file for the management application is provided by Rohde & Schwarz.

You can query the following variables from the SNMP agent, for example via GET requests:

- rsCmwActiveTasks
Number of active tasks as integer number. A zero indicates that the instrument is idle. An active task is for example a running measurement, an ongoing reset, a save/recall operation or remote control command processing.
- rsCmwRemoteConnections
Number of established SCPI remote control connections as integer number
- rsCmwIDN
Instrument identification string as returned by the SCPI command `*IDN?`

A possible use case of SNMP monitoring is to search for an idle instrument in a network with many instruments. Search for an instrument that has zero active tasks and no remote control connections.

Processing SNMP messages is completely independent from other tasks. You can query variables from the SNMP agent at any time, without disturbing running measurements or interfering with manual control or remote control of the instrument.

6 Command Reference - Base Software

This chapter lists all commands for the R&S CMW270 platform.



Contents of this chapter

The commands listed in this chapter control the R&S CMW270 platform. Application-specific commands (e.g. GPRF commands) are listed in the relevant sections.

- [Common Commands](#)..... 204
- [Emulation Codes](#)..... 206
- [Instrument-Control Commands](#)..... 207
- [List of Commands](#)..... 301

6.1 Common Commands

Common commands are described in the IEEE 488.2 (IEC 625-2) standard. These commands have the same effect on different devices. The headers of these commands consist of "*" followed by three letters. Many common commands are related to the status reporting system.

Some of the commands in the following list are R&S CMW270-specific but use the same syntax as common commands. They are marked "not IEEE 488.2-confirmed".

For commands related to macros see [chapter 6.3.1, "Macro Commands"](#), on page 207.

Command	Parameters/ Remarks	Short Description
*CLS – CLear Status	– no query	Sets the status byte (STB), the standard event register (ESR) and the EVENT part of the QUESTIONable and the OPERATION register to zero. The command does not alter the mask and transition parts of the registers. It clears the output buffer. To perform this command for all sub-instruments use *GCLS instead.
*DEV? – DEVice	– query only	Queries the R&S CMW270 device number. The device number is shown in the Remote Settings section of the setup dialog as "Assigned Instrument".
*ESE – Event Status Enable	0...255	Sets the event status enable register to the value indicated. The query *ESE? returns the contents of the event status enable register in decimal form. Alternatively *XESE can be used with a comma separated list of mnemonics enclosed in brackets. Mapping for bit 7 to 0: PON,URQ,CME,EXE,DDE,QYE,RQC,OPC. Example: *XESE (QYE,OPC) sets bit 2 and 0 (Query Error and Operation Complete).

Command	Parameters/ Remarks	Short Description
*ESR? – Event Status Read	– query only	Returns the contents of the event status register in decimal form (0 to 255) and subsequently sets the register to zero. Alternatively *XESR? can be used to return the result as comma separated list of mnemonics enclosed in brackets. For values see *XESE.
*IDN? – IDentification Query	– query only	Queries the instrument identification string of the R&S CMW270.
*IST? – Individual SStatus query	– query only	Returns the contents of the IST flag in decimal form (0 1). The IST-flag is the status bit which is sent during a parallel poll.
*OPC – OPeration Complete	– event	Sets bit 0 in the event status register when all preceding commands have been executed. This bit can be used to initiate a service request. The query form writes a "1" into the output buffer as soon as all preceding commands have been executed. This is used for command synchronization. To perform this command for all sub-instruments use *GOPC instead.
*OPT? – OPTion identification query	– query only	Queries the options included in the instrument and returns a list of the options installed. The response consists of arbitrary ASCII response data according to IEEE 488.2. The options are returned at fixed positions in a comma separated string. A zero is returned for options that are not installed. Using this common command is not recommended, because an improved instrument-specific command is available, see SYSTem:BASE:OPTion:LIST? on page 257.
*PRE – Parallel poll Register Enable	0...255	Sets parallel poll enable register to the value indicated. Query *PRE? returns the contents of the parallel poll enable register in decimal form. Alternatively *XPRE can be used with a comma separated list of mnemonics enclosed in brackets. Mapping for bit 7 to 2: OPER,RQS,ESBit,MAV,QUES,ERR. Example: *XPRE (ESBit,MAV) sets bit 5 and 4 (ESB bit and MAV bit).
*PSC – Power on Status Clear	0 1	Determines whether the contents of the ENABLE registers is maintained or reset when the instrument is switched on. *PSC = 0 causes the contents of the status registers to be maintained. Thus a service request can be triggered on switching on in the case of a corresponding configuration of status registers ESE and SRE. *PSC = 0 resets the registers. Query *PSC? reads out the contents of the power-on-status-clear flag. The response can be 0 or 1.
*RCL – ReCaLI	0...99 no query, not IEEE 488.2-confirmed	Recalls the instrument settings from an intermediate memory identified via the specified number. The instrument settings can be stored to this memory using the command *SAV with the associated number. To load instrument settings from a file to the memory see MMEMory:LOAD:STATe on page 232. See also MMEMory:RCL on page 234 and chapter 4.3, "Save/Recall Dialog" , on page 83.
*RST – ReSeT	– no query	Sets the instrument parameters to values for good remote operation. The command affects only the current sub-instrument.

Command	Parameters/ Remarks	Short Description
*SAV – SAVE	0...99 no query, not IEEE 488.2-confirmed	Stores the current instrument settings under the specified number in an intermediate memory. The settings can be recalled using the command *RCL with the associated number. To transfer the stored instrument settings to a file see MMEMory: STORe: STATe on page 237. See also MMEMory: SAV on page 235 and chapter 4.3, "Save/Recall Dialog" , on page 83.
*SRE – Service Request Enable	0...255	Sets the service request enable register to the value indicated. Bit 6 (MSS mask bit) remains 0. This command determines under which conditions a service request is triggered. The query *SRE? returns the contents of the service request enable register in decimal form. Bit 6 is always 0. Alternatively *XSRE can be used with a comma separated list of mnemonics enclosed in brackets. Mapping for bit 7, 5, 4, 3, 2: OPER,ESBit,MAV,QUES,ERR. Example: *XSRE (ESBit,MAV) sets bit 5 and 4 (ESB bit and MAV bit).
*SRQ? – Service ReQuest	[timeout in ms] query only, not IEEE 488.2-confirmed	Waits until a service request is generated (or the timeout expires) and returns a status information: <ul style="list-style-type: none"> • 1 indicates that a service request has been generated • 0 indicates that the timer has expired (no service request) If no timeout is specified and no service request is generated, the command waits infinitely. Other timers e.g. of the remote control interface may expire in that case.
*STB? – SStatus Byte query	– query only	Reads the contents of the status byte in decimal form. Alternatively *XSTB? can be used to return the result as comma separated list of mnemonics enclosed in brackets. For values see *XPRES .
*WAI – WAIt to continue	– no query	Prevents servicing of the subsequent commands until all preceding commands have been executed and all signals have settled (see also *OPC). To perform this command for all sub-instruments use *GWAI instead.

6.2 Emulation Codes

Remote control connections via USB, HiSLIP, VXI-11 or GPIB support low-level control messages (e.g. for polling) via interface functions. In contrast, a VISA socket resource provides no protocol functions for this purpose. Instead emulation codes can be transferred to emulate interface messages.

Most emulation codes are described in the IEEE 1174 standard. The following table provides an overview. Some messages depend on the protocol mode, see also [Direct Socket Communication](#).

Code	Meaning	Effect on the instrument
&ABO &BRK &DCL	(Abort) (Break) (Device Clear)	Aborts processing of the commands just received and sets the command processing software to a defined initial state. Does not change the instrument setting.
>L	(Go to Local)	Transition to the "Local" state (manual control).
&GET	(Group Execute Trigger)	Triggers a previously active device function (e.g. a sweep). The effect of the command is the same as with that of a pulse at the external trigger signal input.
>R	(Go to Remote)	Transition to the "Remote" state (remote control).
&LLO	(Local Lockout)	Disables switchover from remote control to manual control by means of the front panel keys or remote commands.
&NREN &RLSD	(Not Remote Enable)	Enables switchover from remote control to manual control by means of the front panel keys or remote commands.
&POL	(Serial Poll)	Starts a serial poll.

6.3 Instrument-Control Commands

The instrument-control commands for the R&S CMW270 platform give access to the mass memory, control the status structures, and perform various administrative tasks. The platform commands are divided into the command groups listed below.

• Macro Commands	207
• Buffer Commands	211
• High Resolution Timer	214
• Error Queue	215
• Reset and Preset	217
• Tracing the Remote Control Interface	219
• Mass Memory Commands	223
• Hardcopy Commands	237
• Frequency-Dependent Correction	239
• Setup Commands	248
• Sub-Instruments	268
• Calibration Commands	269
• Status Reporting System	271
• System Date and Time	294
• Miscellaneous Commands	297

6.3.1 Macro Commands

The following remote control commands are related to macro files and macro execution. All macro commands are SCPI-confirmed.



R&S CMW270-specific command properties

The following macro command properties differ from SCPI stipulations:

- The `*RST` state of `*EMC` is `OFF`. Macro execution must be enabled deliberately for every remote connection.
- Normal remote control execution has priority over macro execution. Macros which have the same name as a remote command supported by the R&S CMW270 are ignored.

<code>*DMC</code>	208
<code>*EMC</code>	209
<code>*GMC?</code>	209
<code>*LMC?</code>	209
<code>*PMC</code>	210
<code>*RMC</code>	210
<code>MMEMory:LOAD:MACRo</code>	210
<code>MMEMory:STORe:MACRo</code>	210
<code>SYSTem:RECORD:MACRo:FILE:START</code>	211
<code>SYSTem:RECORD:MACRo:FILE:STOP</code>	211

`*DMC` '<MacroLabel>', <MacroSequence>

Creates a macro, defined by an identifier string '<MacroLabel>' and the macro contents <MacroSequence>. If the macro label exists already, the macro contents are overwritten. Macro execution must be enabled using `*EMC ON`. Macros are deleted when a remote connection is closed but can be saved to a macro file (`MMEMory:STORe:MACRo`) for later re-use.

Note: Avoid using macro labels which are identical with any of the remote control commands supported by the R&S CMW270. In contrast to SCPI stipulations, remote commands have priority over macros.

Parameters:

'<MacroLabel>' String parameter, used to execute the created macro and to reference it in other macro commands (e.g. `MMEMory:STORe:MACRo`, `*GMC?`, `*RMC`).

<MacroSequence> Block data element defining the macro contents, typically a sequence of remote control commands. #0 introduces a data block of indefinite length. See [chapter 5.7.1, "Macro Contents and Macro Commands"](#), on page 191.

Alternative data format: Shorter command sequences may be entered as strings with a maximum length of 1023 characters.

Example: See [Macro Programming Examples](#)

Usage: Event

Firmware/Software: V2.1.10

***EMC** <Boolean>

Enables or disables the execution of all macros that are defined for the active remote connection.

Note: In contrast to SCPI specifications, macro execution is disabled by default.

Parameters:

<Boolean>

Boolean value to enable or disable macro execution. In the disabled ("OFF") state, macros in a command sequence are not expanded. The R&S CMW270 will generally issue an error message -113, "Undefined header;<MacroLabel>".

*RST: OFF

Example: See [Macro Programming Examples](#)

Firmware/Software: V2.1.10

***GMC?** '<MacroLabel>'

Returns the contents of a macro identified by its <MacroLabel>.

Query parameters:

'<MacroLabel>'

String parameter, also used to execute the macro and to reference it in other macro commands (e.g. [MMEMory:STORe:MACRO](#), *DMC, *RMC).

Return values:

<MacroSequence>

<dblock>

Block data element containing the macro contents. See [chapter 5.7.1, "Macro Contents and Macro Commands"](#), on page 191.

Example: See [Macro Programming Examples](#)

Usage: Query only

Firmware/Software: V2.1.10

***LMC?**

Returns the macro labels of all macros of the active connection.

Return values:'<Macro Label 1>',
'<Macro Label 2>' ...

Comma-separated list of string parameters. An empty string indicates that no macros are defined for the active connection. The macro labels are also used to execute the macros and to reference them in other macro commands (e.g. [MMEMory:STORe:MACRO](#), *DMC, *RMC).

Example: See [Macro Programming Examples](#)

Usage: Query only

Firmware/Software: V2.1.10

***PMC**

Deletes all macros of the active remote connection.

Example: See [Macro Programming Examples](#)

Usage: Event

Firmware/Software: V2.1.10

***RMC '<MacroLabel>'**

Deletes a macro identified by its <MacroLabel>.

Parameters:

'<MacroLabel>' String parameter, used to execute the macro and to reference it in other macro commands (e.g. [MMEMory:STORe:MACRo](#), *GMC?, *DMC).

Example: See [Macro Programming Examples](#)

Usage: Event

Firmware/Software: V2.1.10

MMEMory:LOAD:MACRo '<MacroLabel>', '<MacroFile>'

Loads a macro file, assigning an identifier <MacroLabel> to the macro file contents. Macros are deleted when the remote connection is closed. Macro files can be created e.g. using the [MMEMory:STORe:MACRo](#) command.

Note: Avoid using macro labels which are identical with any of the remote control commands supported by the R&S CMW270. In contrast to SCPI specifications, remote commands have priority over macros.

Parameters:

'<MacroLabel>' String parameter, used to execute the loaded macro and to reference it in other macro commands (e.g. *DMC, *GMC?, *RMC).

'<MacroFile>' String parameter specifying path and filename of the source file (on the instrument)

Example: See [Macro Programming Examples](#)

Usage: Event

Firmware/Software: V2.1.10

MMEMory:STORe:MACRo '<MacroLabel>', '<MacroFile>'

Stores the contents of a macro identified by its <MacroLabel> to a file.

Parameters:

'<MacroLabel>'	String parameter, used to execute the loaded macro and to reference it in other macro commands (e.g. *DMC, *GMC?, *RMC).
'<MacroFile>'	String parameter specifying path and filename of the destination file (on the instrument)

Example: See [Macro Programming Examples](#)

Usage: Event
SCPI confirmed

Firmware/Software: V2.1.10

SYSTem:RECOrd:MACRo:FILE:START '<MacroFile>'

Starts recording of submitted commands into the specified macro file. To stop recording, see [SYSTem:RECOrd:MACRo:FILE:STOP](#).

Parameters:

'<MacroFile>'	String parameter specifying path and filename of the destination file (on the instrument)
---------------	---

Example: See [Macro Programming Examples](#)

Usage: Event

Firmware/Software: V2.1.10

SYSTem:RECOrd:MACRo:FILE:STOP

Stops recording of commands into a macro file. To start recording, see [SYSTem:RECOrd:MACRo:FILE:START](#).

Example: See [Macro Programming Examples](#)

Usage: Event

Firmware/Software: V2.1.10

6.3.2 Buffer Commands

The following remote control commands are related to response buffers. The command syntax follows the general R&S CMW270 syntax rules; the commands are not SCPI confirmed.

CLEar:BASE:BUFFer	212
CONTInue:BASE:BUFFer	212
DELete:BASE:BUFFer	212
FETCh:BASE:BUFFer?	212
FETCh:BASE:BUFFer:LINecount?	213
STARt:BASE:BUFFer	213
STOP:BASE:BUFFer	213

CLEar:BASE:BUFFer '<BufferLabel>'

Clears the contents of a buffer, maintaining the buffer for further program execution. Use [DELeTe:BASE:BUFFer](#) to delete the buffer.

Parameters:

'<BufferLabel>' String parameter, used to identify the buffer in all buffer commands

Example: See [Buffer Programming Example](#)

Usage: Event

Firmware/Software: V2.1.10

CONTinue:BASE:BUFFer '<BufferLabel>'

Re-activates a buffer which was intermediately de-activated ([STOP:BASE:BUFFer](#)). The R&S CMW270 will continue writing data to the buffer.

Parameters:

'<BufferLabel>' String parameter, used to identify the buffer in all buffer commands

Example: See [Buffer Programming Example](#)

Usage: Event

Firmware/Software: V2.1.10

DELeTe:BASE:BUFFer '<BufferLabel>'

Deletes a buffer. Use [CLEar:BASE:BUFFer](#) to delete the buffer contents, maintaining the buffer for further program execution.

Parameters:

'<BufferLabel>' String parameter, used to identify the buffer in all buffer commands

Example: See [Buffer Programming Example](#)

Usage: Event

Firmware/Software: V2.1.10

FETCH:BASE:BUFFer? '<BufferLabel>', <LineNo>

Reads the contents of the buffer line with number <LineNo>. Buffer contents are stored line by line: Every program line in a command macro containing queries generates a single new buffer line. The queries are not stored together with the results.

Reading buffer contents is non-destructive. The lines can be read in arbitrary order.

Query parameters:

'<BufferLabel>'	String parameter, used to identify the buffer in all buffer commands
<LineNo>	Line of results in the buffer

Return values:

<LineContents>	Returned line contents
----------------	------------------------

Example: See [Buffer Programming Example](#)

Usage: Query only

Firmware/Software: V2.1.10

FETCH:BASE:BUFFER:LINEcount? '<BufferLabel>'

Returns the size (number of lines) of a buffer.

Query parameters:

'<BufferLabel>'	String parameter, used to identify the buffer in all buffer commands
-----------------	--

Return values:

<Size>	Number of lines in the buffer
--------	-------------------------------

Example: See [Buffer Programming Example](#)

Usage: Query only

Firmware/Software: V2.1.10

START:BASE:BUFFER '<BufferLabel>'

Creates and activates a buffer. If the buffer exists already, it is cleared (equivalent to [CLEAR:BASE:BUFFER](#)).

Parameters:

'<BufferLabel>'	String parameter, used to identify the buffer in all buffer commands
-----------------	--

Example: See [Buffer Programming Example](#)

Usage: Event

Firmware/Software: V2.1.10

STOP:BASE:BUFFER

De-activates the active buffer. Only one buffer can be active at one time. The buffer and buffer contents are maintained, however, data recording is discontinued. Use [CONTINUE:BASE:BUFFER](#) to re-activate a buffer.

Example: See [Buffer Programming Example](#)

Usage: Event

Firmware/Software: V2.1.10

6.3.3 High Resolution Timer

After execution of a command it may be required to wait a well defined time before proceeding with command script processing, e.g. because the DUT needs some time to stabilize after a modification. This can be achieved using the following commands.

SYSTem:TIME:HRTimer:ABSolute	214
SYSTem:TIME:HRTimer:ABSolute:SET	214
SYSTem:TIME:HRTimer:RELative	215

SYSTem:TIME:HRTimer:ABSolute <Timeout>

This command starts a timer. The timeout is specified relative to an already set timestamp, see [SYSTem:TIME:HRTimer:ABSolute:SET](#).

When the timer expires, "Operation Complete" is indicated. This event can be evaluated by polling, via a *OPC? or via *WAI.

Setting parameters:

<Timeout>	Range: 0 ms to 4294967295 ms
	Default unit: ms

Example:

```
SYST:TIME:HRT:ABS:SET
SYST:TIME:HRT:ABS 1000
*OPC?
```

The three commands have the following effects:
 Set a timestamp with the current system time.
 Start a timer with a timeout value of 1 second relative to the timestamp.
 Wait until the timer expires before processing the next command.

Usage: Event
 Asynchronous command

Firmware/Software: V2.1.10

SYSTem:TIME:HRTimer:ABSolute:SET

This command sets a timestamp with the current system time. A timer can be started with a timeout relative to this timestamp, see [SYSTem:TIME:HRTimer:ABSolute](#) on page 214.

An existing timestamp is overwritten.

Return values:

<Timestamp>	A query returns seven values, separated by commas: year, month, day, hour, minutes, seconds, milliseconds
-------------	--

Example: `SYSTem:TIME:HRTimer:ABSolute:SET`
 Set a timestamp with the current system time.
`SYSTem:TIME:HRTimer:ABSolute:SET?`
 Query the timestamp. Possible result:
`2011,3,20,12,5,30,999`

Firmware/Software: V2.1.10

SYSTem:TIME:HRTimer:RELative <Timeout>

This command starts a timer. After the specified timeout, an OPC is generated.

When the timer expires, "Operation Complete" is indicated. This event can be evaluated by polling, via a *OPC? or via *WAI.

Setting parameters:

<Timeout> Range: 0 ms to 4294967295 ms
 Default unit: ms

Example: `SYST:TIME:HRT:REL 1000`
`*OPC?`
 The commands have the following effects:
 Start the timer with a timeout value of 1 second.
 Wait until the timer expires before processing the next command.

Usage: Event
 Asynchronous command

Firmware/Software: V2.1.10

6.3.4 Error Queue

The following commands query (and delete) the error queue.

<code>SYSTem:ERRor:ALL?</code>	215
<code>SYSTem:ERRor:CODE:ALL?</code>	216
<code>SYSTem:ERRor:CODE[:NEXT]?</code>	216
<code>SYSTem:ERRor:COUNt?</code>	216
<code>SYSTem:ERRor[:NEXT]?</code>	217

SYSTem:ERRor:ALL?

Queries and at the same time deletes all entries in the error queue.

The entry consists of an error number and a short description of the error. Positive error numbers are instrument-dependent. Negative error numbers are reserved by the SCPI standard.

Example: `SYSTem:ERRor:ALL?`
 Query all entries in the error queue. 0, "No error" is returned if the error queue is empty.

Usage: Query only
SCPI confirmed

Firmware/Software: V1.0.0.4

SYSTem:ERRor:CODE:ALL?

Queries and at the same time deletes all entries in the error queue.

The command returns the error numbers without any description of the errors. Positive error numbers are instrument-dependent. Negative error numbers are reserved by the SCPI standard.

Example: `SYSTem:ERRor:CODE:ALL?`
Query all entries in the error queue. "0" is returned if the error queue is empty.

Usage: Query only
SCPI confirmed

Firmware/Software: V1.0.0.4

SYSTem:ERRor:CODE[:NEXT]?

Queries and at the same time deletes the oldest entry in the error queue.

The command returns the error number without any description of the error. Positive error numbers are instrument-dependent. Negative error numbers are reserved by the SCPI standard.

Example: `SYSTem:ERRor:CODE?`
Query the oldest entry in the error queue. "0" is returned if the error queue is empty.

Usage: Query only
SCPI confirmed

Firmware/Software: V1.0.0.4

SYSTem:ERRor:COUNT?

Queries the number of entries in the error queue.

Example: `SYSTem:ERRor:COUNT?`
If the queue is empty, 0 is returned.

Usage: Query only
SCPI confirmed

Firmware/Software: V1.0.0.4

SYSTem:ERRor[:NEXT]?

Queries and at the same time deletes the oldest entry in the error queue. Operation is identical to that of [STATus:QUEue\[:NEXT\]?](#).

The entry consists of an error number and a short description of the error. Positive error numbers are instrument-dependent. Negative error numbers are reserved by the SCPI standard.

Example: `SYSTem:ERRor?`
Query the oldest entry in the error queue. 0,"No error" is returned if the error queue is empty.

Usage: Query only
SCPI confirmed

Firmware/Software: V1.0.0.4

6.3.5 Reset and Preset

The following commands reset or preset the instrument or specific software parts.

SYSTem:PRESet:ALL	217
SYSTem:RESet:ALL	217
SYSTem:PRESet:BASE	217
SYSTem:RESet:BASE	217
SYSTem:PRESet	218
SYSTem:RESet	218

SYSTem:PRESet:ALL**SYSTem:RESet:ALL**

A PRESet sets the parameters of all sub-instruments and the base settings to default values suitable for local/manual interaction. A RESet sets them to default values suitable for remote operation.

Example: `SYSTem:PRESet:ALL`
Force the entire R&S CMW270 to a preset state optimized for manual operation.

Usage: Event

Firmware/Software: V1.0.5.3

SYSTem:PRESet:BASE**SYSTem:RESet:BASE**

A PRESet sets the base settings to default values suitable for local/manual interaction. A RESet sets them to default values suitable for remote operation.

Example: `SYSTem:PRESet:BASE`
Force the base settings to a preset state optimized for manual operation.

Usage: Event

Firmware/Software: V1.0.5.3

SYSTem:PRESet ['<Application>']

SYSTem:RESet ['<Application>']

A PRESet sets the parameters of the current sub-instrument to default values suitable for local/manual interaction. A RESet sets them to default values suitable for remote operation.

The commands can be applied to the complete sub-instrument or to a specific application instance of the sub-instrument.

Parameters:

'<Application>' String specifying an application and instance to be reset/preset
 Example: 'LTE Meas1' for LTE UE measurements instance 1
 Omitting the instance (e.g. 'LTE Meas') selects instance 1.
 The strings for the individual applications are listed in the table below.

Example: `SYSTem:PRESet 'GPRF Meas2'`
 Force the GPRF measurement instance 2 to a preset state optimized for manual operation.

Usage: Event

Firmware/Software: V1.0.5.3
 V3.0.10: [<Application>] added

Group	'<Application>' strings without instance
1xEV-DO	'1xEV-DO Meas' '1xEV-DO Sig'
Audio	'Audio'
Bluetooth	'Bluetooth Meas' 'Bluetooth Sig'
CDMA2000	'CDMA2000 Gen' 'CDMA2000 Meas' 'CDMA2000 Sig'
DAU	'Data Appl. Measurements'
FM Stereo Radio	'FM Stereo Radio Meas'
GPRF	'GPRF Gen' 'GPRF Meas'
GSM	'GSM Gen' 'GSM Meas' 'GSM Sig'

Group	'<Application>' strings without instance
LTE	'LTE eNodeB Meas' 'LTE Meas' (for LTE UE Measurements) 'LTE Sig'
TD-SCDMA	'TD-SCDMA Meas' 'TD-SCDMA Sig'
WCDMA	'WCDMA Gen' 'WCDMA Meas' 'WCDMA Sig'
WiMAX	'WiMAX Meas' 'WiMAX Sig'
WLAN	'WLAN Meas' 'WLAN Sig'

6.3.6 Tracing the Remote Control Interface

The commands in this section configure and control tracing of the remote interface and events into a file and enable/disable the display of the SCPI remote trace.

Before you start tracing, configure all settings as desired. Modifying settings while tracing is active may result in loss of already traced data. Useful exception: Selecting a new target file while tracing is allowed. For start mode "EXPLicit" a restart of the instrument resets the settings to the documented default values.

If you want to start tracing already during start of the instrument, configure all settings (including start mode "AUTO"). Then restart your instrument. Tracing will be started automatically during the restart, using the already configured settings.

If you use an XML file as trace file, ensure that tracing is stopped properly. If tracing is aborted instead of stopped, e.g. by shutting down the instrument for stop mode "EXPLicit", the XML file will be invalid, because some tags are not closed.

When the maximum file size is reached (except for stop mode "BUFFerfull") or if tracing is started with an already existing trace file, a backup of the trace file is created and the file itself is reset and overwritten. When the file is full for the second time or tracing is started the next time, the first backup file is lost because it is overwritten by the next backup. In order to prevent loss of data, set a sufficient file size, select an appropriate stop mode and archive/copy completed trace files if you want to keep them.

TRACe:REMOte:MODE:FILE<inst>:ENABle.....	220
TRACe:REMOte:MODE:FILE<inst>:FILTer.....	220
TRACe:REMOte:MODE:FILE<inst>:FORMat.....	221
TRACe:REMOte:MODE:FILE<inst>:NAME.....	221
TRACe:REMOte:MODE:FILE<inst>:SIZE.....	221
TRACe:REMOte:MODE:FILE<inst>:STARtmode.....	222
TRACe:REMOte:MODE:FILE<inst>:STOPmode.....	222
TRACe:REMOte:MODE:DISPlay:ENABle.....	223
TRACe:REMOte:MODE:DISPlay:CLEar.....	223

TRACe:REMOte:MODE:FILE<inst>:ENABle <Enable>

Enable or disable tracing of the remote interface to a file for the specified sub-instrument.

Suffix:

<inst> 1..2
Selects the sub-instrument

Parameters:

<Enable> Boolean value (ON | OFF | 1 | 0)
Default value: OFF

Example:

```
TRACe:REMOte:MODE:FILE1:ENABle ON
TRACe:REMOte:MODE:FILE2:ENABle OFF
```

Enable tracing for sub-instrument 1 and disable it for sub-instrument 2.

Firmware/Software: V2.0.10

TRACe:REMOte:MODE:FILE<inst>:FILTer <Input>, <Output>, <Error>, <Trigger>, <DeviceClear>, <StatusRegister>, <Connection>, <RemoteLocal>

Specifies a filter for tracing of the specified sub-instrument. The filter defines which message types and events are traced into a file.

The default setting is ON,ON,ON,OFF,OFF,OFF,OFF,OFF. All parameters support ON | OFF | 1 | 0.

Suffix:

<inst> 1..2
Selects the sub-instrument

Parameters:

<Input> Trace incoming commands
 <Output> Trace outgoing responses to queries
 <Error> Trace SCPI error messages
 <Trigger> Trace trigger events
 <DeviceClear> Trace device clear messages
 <StatusRegister> Trace status register changes
 <Connection> Trace remote connection changes
 <RemoteLocal> Trace transitions between local and remote operation mode

Example:

```
TRACe:REMOte:MODE:FILE1:FILTer
ON, ON, ON, OFF, OFF, OFF, OFF, ON
```

Trace incoming commands, outgoing responses to queries, error messages and remote-local transitions for sub-instrument 1.

Firmware/Software: V2.0.10

TRACe:REMOte:MODE:FILE<inst>:FORMat <Format>

Specifies the format of the target file for tracing of the remote interface for the specified sub-instrument. The trace can be stored as ASCII file or as XML file.

Suffix:

<inst> 1..2
Selects the sub-instrument

Parameters:

<Format> ASCII | XML
Default value: XML

Example:

TRACe:REMOte:MODE:FILE1:FORMat XML
Select XML as file format for sub-instrument 1.

Firmware/Software: V2.0.10

TRACe:REMOte:MODE:FILE<inst>:NAME '<FilePath>'

Specify path and name of the target file for tracing of the remote interface. For different sub-instruments specify different files.

If you specify a new target file while tracing, the old target file is closed, the new file is created and tracing is continued with the new file.

Suffix:

<inst> 1..2
Selects the sub-instrument

Parameters:

'<FilePath>' String parameter specifying path and name of the file
Default values: "@LOG\RemoteTrace-Inst0.xml" and "@LOG
\RemoteTrace-Inst1.xml"

Example:

TRACe:REMOte:MODE:FILE1:NAME "@LOG\tracel.xml"
Specifies the file `tracel.xml` in the log directory as target file for tracing (sub-instrument 1).

Firmware/Software: V2.0.10

TRACe:REMOte:MODE:FILE<inst>:SIZE <FileSize>

Specifies the maximum size of the trace file in bytes.

Suffix:

<inst> 1..2
Selects the sub-instrument

Parameters:

<FileSize> Recommended minimum value: 40000 bytes
Maximum value: 1000000000 bytes (1 GB)
Default value: 1000000000 bytes (1 GB)

Example: `TRACe:REMOte:MODE:FILE1:SIZE 100000000`
Set 100 MB as maximum size for the trace file of sub-instrument 1.

Firmware/Software: V2.0.10

TRACe:REMOte:MODE:FILE<inst>:STARtmode <StartMode>

Specifies whether tracing shall be started automatically or manually.

Suffix:

<inst> 1..2
Selects the sub-instrument

Parameters:

<StartMode> AUTO | EXPLicit
AUTO: Start tracing automatically when the instrument is started
EXPLicit: Start tracing via the command `TRACe:REMOte:MODE:FILE<inst>:ENABle`
Default value: EXPLicit

Example: `TRACe:REMOte:MODE:FILE1:STARtmode AUTO`
Enable automatic start of tracing for the next (re-)start of the instrument.

Firmware/Software: V2.0.10

TRACe:REMOte:MODE:FILE<inst>:STOPmode <StopMode>

Specifies how / when tracing shall be stopped and the trace file be closed.

Suffix:

<inst> 1..2
Selects the sub-instrument

Parameters:

<StopMode> AUTO | EXPLicit | ERRor | BUFFerfull
AUTO: Stop tracing automatically when the instrument is shut down
EXPLicit: Stop tracing via the command `TRACe:REMOte:MODE:FILE<inst>:ENABle`
ERRor: Stop tracing when an SCPI error occurs
BUFFerfull: Stop tracing when the maximum file size is reached
Default value: EXPLicit

Example: `TRACe:REMOte:MODE:FILE1:STOPmode BUFFerfull`
Stop tracing when the maximum file size is reached (sub-instrument 1).

Firmware/Software: V2.0.10

TRACe:REMOte:MODE:DISPlay:ENABle <Enable>

Enables or disables the display of the SCPI remote trace. Two modes are available when the display is enabled: a live mode and an analysis mode.

Parameters:

<Enable> ANALysis | LIVE | OFF
ANALysis: stop tracing to analyse already traced messages
LIVE: trace messages and display them
OFF: disable the report display
 Default value: OFF

Example: TRACe:REMOte:MODE:DISPlay:ENABle LIVE
 Activate the live mode.

Firmware/Software: V2.1.10

TRACe:REMOte:MODE:DISPlay:CLEar

Clears the display of the SCPI remote trace in analysis mode.

Usage: Event

Firmware/Software: V3.0.10

6.3.7 Mass Memory Commands

The MMEMory subsystem provides mass storage capabilities for the R&S CMW270. For MMEMory commands related to command macros see [chapter 6.3.1, "Macro Commands"](#), on page 207.

The following rules apply to parameters specifying files or directories:

- Parameters for specification of file names and directory names are strings.
- You can specify complete absolute paths including the drive name and all subdirectories. For locations in a network use the Universal Naming Convention (UNC) format '\\server\share'.
 Examples: 'C:\TEMP\TRASH\test.txt' specifies the file named test.txt in the directory TEMP\TRASH of the internal hard disk drive C:\.
 '\\myserver\data\archive\test.txt' specifies the file named test.txt in the subdirectory archive of the share data on the server myserver.
- If you specify a string containing an absolute path but no drive or server, the default storage unit is prefixed automatically (see [MMEMory:MSIS](#) on page 234).
- If you specify a string containing a relative path, the current directory is prefixed automatically (see [MMEMory:CDIRectory](#) on page 228).
- Alias strings facilitate the entry of paths. To display the predefined alias strings and the assigned paths see [MMEMory:ALIases?](#) on page 225. The defined strings can be combined with normal text to specify file paths. Example:
 '@SAVE\myfile.dfl' specifies the file myfile.dfl in the save directory, assigned to the alias @SAVE.

- The use of wildcards ? and * is only allowed if explicitly stated for a command. Wildcards are only allowed in the last component of the string.
Example: 'archive*test*' allowed, 'archi*\test1.txt' not allowed
- A file name itself may contain the period as a separator for extensions.
- A single period represents the current directory
- A double period represents the parent of the current directory
- Example: Assume that the default storage unit equals 'D:' and the current directory equals '\user\data'. Then the following commands yield the same result:
MMEM:CAT?
MMEM:CAT? '*'
MMEM:CAT? '*.*'
MMEM:CAT? '.*.*'
MMEM:CAT? '..\data*.*'
MMEM:CAT? '..\data'
MMEM:CAT? '\user\data*.*'
MMEM:CAT? 'D:\user\data*.*'

File and directory names can be chosen according to Windows™ conventions; the restrictions placed on file names known from DOS systems do not apply. All letters and numbers are allowed, as well as the special characters "_", "^", "\$", "~", "!", "#", "%", "&", "-", "{", "}", ("", ")"), "@", and ". Reserved file names are CON, AUX, COM1, ..., COM4, LPT1, ..., LPT3, NUL and PRN.

Mass memory commands are marked as "SCPI confirmed" if they provide at least the functionality defined by SCPI and can be used as specified by SCPI. Nevertheless these commands may provide additional features not specified by SCPI, like wildcards. The functionality can also be enhanced via additional optional parameters.

List of commands:

MMEMory:ALlases?	225
MMEMory:ATTRibute	225
MMEMory:CATalog?	226
MMEMory:CATalog:LENGth?	227
MMEMory:CDIRectory	228
MMEMory:COPIE	228
MMEMory:DATA	228
MMEMory:DCATalog?	229
MMEMory:DCATalog:LENGth?	230
MMEMory:DELeTe	230
MMEMory:DRIVes?	230
MMEMory:LOAD:ITEM	231
MMEMory:LOAD:STATe	232
MMEMory:MDIRectory	233
MMEMory:MOVE	233
MMEMory:MSIS	234
MMEMory:RCL	234
MMEMory:RDIRectory	234
MMEMory:SAV	235
MMEMory:STORe:ITEM	235
MMEMory:STORe:STATe	237

MMEMory:ALlases?

Returns the defined alias entries and the assigned directories. These settings are pre-defined and can not be configured.

Example: `MMEM:ALlases?`

Possible response:

```
"@SAVE", "D:\Rohde-Schwarz\CMW\Data\Save",
"@PRINT", "D:\Rohde-Schwarz\CMW\Data\Print",
"@USERDATA", "D:\Rohde-Schwarz\CMW\Data"
```

Example: When you specify a file destination, an alias can be used instead of the corresponding path. With the definition of the alias @SAVE listed above, the following two strings identify the same file:

```
"@SAVE\A\myfile.dfl"
"D:\Rohde-Schwarz\CMW\Data\Save\A\myfile.dfl"
```

Usage: Query only

Firmware/Software: V2.0.10

MMEMory:ATTRibute '<FileName>', '<Action>'**MMEMory:ATTRibute? ['<FileName>']**

Sets or removes file attributes for files and directories.

Parameters:

'<Action>'

Attribute actions to be performed. The attributes are R (read-only), A (archive), S (system), H (hidden).

Set an attribute with a plus or clear an attribute with a minus as prefix. Separate several actions with a blank, see example.

Parameters for setting and query:

'<FileName>'

String parameter to specify the name and/or path of the objects for which the attributes shall be modified or returned.

The wildcards * and ? are allowed.

If a directory is specified instead of a file, the directory itself and all files and subdirectories contained in that directory are modified/returned.

If the parameter is omitted completely for a query, the current directory is used as default value (see [MMEMory:CDIRectory](#)).

Return values:

'<Information_1>' ...

Information strings are returned for the directories "." and "..", for files and for subdirectories.

'<Information_n>'

Each string has the format '<ObjectName>,<Attributes>'.

Example:

```
MMEM:ATTR 'D:\USER\DATA\*.LOG', '-R +A -H'
```

Clears attributes R and H and sets attribute A for all files with the extension LOG in directory D:\USER\DATA.

Example: `MMEM:ATTR? 'D:\USER\DATA'`
 Returns attribute information for all files and subdirectories of directory `D:\USER\DATA`.
 Possible Response:
`".,","..","myfile.txt,RA","mysubdirectory,"`

Firmware/Software: V1.0.0.4

MMEMory:CATalog? [`<DirectoryName>`][`<Mode>`]

Returns information on the contents of the current or of a specified directory.

Parameters:

`<DirectoryName>` String parameter to specify the directory. If this parameter is omitted, the command queries the contents of the current directory (see [MMEMory:CDIRectory](#)).
 If the wildcards `?` or `*` are used, only files and directories matching this pattern are returned.

`<Mode>` ALL | WTIme
ALL: output enhanced with date, time and file attributes
WTIme: output enhanced with date and time

Return values:

`<UsedSize>` Disk space in bytes used by the listed files, excluding subdirectories

`<FreeDiskSpace>` Available free disk space in bytes

`<Information_1>` ...
`<Information_n>` Information strings are returned for the directories `"."` and `".."`, for files and for subdirectories.
 Each string contains the following contents:
`<Name>`,`<Type>`,`<Size>`[`<DateTime>`][`<Attributes>`]

<Name>
 Name of the object (file or directory)

<Type>
 Type of the object: DIRectory | BINary | ASCii | STATe

<Size>
 File size in bytes (0 for directories)

<DateTime>
 Date and time of last modification
 Only returned for `<Mode>` = ALL or WTIme

<Attributes>
 Object attributes, only returned for `<Mode>` = ALL
 Values: R = read-only, A = archive, S = system, H = hidden

- Example:** MMEM:CAT?
Possible response:
156673,5195137024,
".,DIR,0","..,DIR,0",
"SaveFile001.xml,BIN,78335",
"SaveFile002.xml,BIN,78338"
- Example:** MMEM:CAT? 'D:\User\Data*.jpg'
Possible response:
300928,511337022,
"fig1.jpg,BIN,259395",
"screen.jpg,BIN,41533"
Considers all jpg files located in directory D:\User\Data.
- Example:** MMEM:CAT? 'D:\User\Data*.jpg',ALL
Possible response:
300928,511337022,
"fig1.jpg,BIN,259395,14-01-2011 10:54,A",
"screen.jpg,BIN,41533,10-01-2011 11:13,AR"
Displays all information for the jpg files located in directory D:\User\Data.
- Usage:** Query only
SCPI confirmed
- Firmware/Software:** V1.0.0.4

MMEMory:CATalog:LENGth? ['<DirectoryName>']

Returns the number of files and subdirectories of the current or of a specified directory. The number includes the directory strings "." and ".." so that it corresponds to the number of strings returned by the [MMEMory:CATalog?](#) command after the initial numeric parameters.

Parameters:

'<DirectoryName>' String parameter to specify the directory. If the directory is omitted, the command queries the contents of the current directory (see [MMEMory:CDIRectory](#)).
If the wildcards ? or * are used, the number of files and subdirectories matching this pattern are returned.

Example: MMEM:CAT:LENG?
Response: 4 (corresponding to the [MMEMory:CATalog?](#) example)

Example: MMEM:CAT:LENG? 'D:\User\Data\session*'
Returns the number of files and subdirectories starting with session which are located in directory D:\User\Data.

Usage: Query only

Firmware/Software: V1.0.5.3

MMEMory:CDIRectory ['<DirectoryName>']

Changes the current directory for mass memory storage.

If '<DirectoryName>' is omitted, the current directory is set to '\'. If '<DirectoryName>' contains not only a directory, but also a drive letter or server name, the command `MMEM:MSIS` is also executed automatically.

Parameters:

'<DirectoryName>' String parameter to specify the directory. Wildcards are not allowed.

*RST: a *RST does not change the current directory

Example:

`MMEM:CDIR 'D:\User\Data'`

Changes the current directory to `D:\User\Data`

Usage:

SCPI confirmed

Firmware/Software: V1.0.0.4

MMEMory:COPY '<FileSource>',['<FileDestination>']

Copies an existing file. The target directory must exist.

Parameters:

'<FileSource>' String parameter to specify the name of the file to be copied. Wildcards ? and * are allowed if '<FileDestination>' contains a path without filename.

'<FileDestination>' String parameter to specify the path and/or name of the new file. If no file destination is specified the source file is written to the current directory (see [MMEMory:CDIRectory](#)). Wildcards are not allowed.

Example:

`MMEM:COPY 'D:\USER\DATA\File1.pdf', 'D:\Archive'`
Copies `File1.pdf` in directory `D:\USER\DATA` to directory `D:\Archive`.

Example:

`MMEM:COPY 'D:\USER\File1.pdf', 'D:\File2.pdf'`
Copies `File1.pdf` in directory `D:\USER` to `D:\` and renames the file to `File2.pdf`.

Usage:

Event
SCPI confirmed

Firmware/Software: V1.0.0.4

MMEMory:DATA '<FileName>', <Data>**MMEMory:DATA?** '<FileName>'

Stores the specified block data into the specified file.

Parameters:

<Data> <dblock>
 Data in 488.2 block data format. The delimiter EOI must be selected to achieve correct data transfer. See also [Block Data Format](#).

Parameters for setting and query:

'<FileName>' String parameter to specify the name of the file. Wildcards are not allowed.

Example: MMEM:DATA 'C:\TEMP\TEST01.HCP', #219Content of the file
 Stores the data Content of the file to the indicated file. #2 indicates that the next two characters (19) indicate the data length.

Example: MMEM:DATA? 'C:\TEMP\TEST01.HCP'
 Returns the data contained in file TEST01.HCP in block data format

Usage: SCPI confirmed

Firmware/Software: V1.0.0.4

MMEMory:DCATalog? [<DirectoryName>]

Returns the subdirectories of the current or of a specified directory.

Parameters:

'<DirectoryName>' String parameter to specify the directory. If this parameter is omitted, the command queries the contents of the current directory (see [MMEMory:CDIRECTory](#)).
 If the wildcards ? or * are used, only the subdirectories matching this pattern are returned.

Return values:

'<Directory_1>' ... Names of the subdirectories as comma-separated list
 '<Directory_n>'

Example: MMEM:DCAT?
 Response: ".","..","temp","test","mydirectory"

Example: MMEM:DCAT? 'D:\User\Data\session*'
 Response: "session1","session5","sessiontest"
 These are the subdirectories located in directory D:\User\Data which start with session.

Usage: Query only

Firmware/Software: V1.0.5.3

MMEMory:DCATalog:LENGth? [<DirectoryName>]

Returns the number of subdirectories of the current or of a specified directory. The number includes the directory strings "." and ".." so that it corresponds to the number of strings returned by the [MMEMory:DCATalog?](#) command.

Parameters:

'<DirectoryName>' String parameter to specify the directory. If the directory is omitted, the command queries the contents of the current directory (see [MMEMory:CDIRectory](#)).
If the wildcards ? or * are used, the number of subdirectories matching this pattern are returned.

Example:

MMEM:DCAT:LENG?

Response: 5 (corresponding to the [MMEMory:DCATalog?](#) example)

Example:

MMEM:DCAT:LENG? 'D:\User\Data\session*'

Returns the number of subdirectories starting with `session` which are located in directory `D:\User\Data`.

Usage:

Query only

Firmware/Software: V1.0.5.3

MMEMory:DELeTe '<FileName>'

Deletes the specified file(s).

Parameters:

'<FileName>' String parameter specifying the file to be deleted. The wildcards * and ? are allowed. Specifying a directory instead of a file is not allowed.

Example:

MMEM:DEL 'C:\TEMP\TEST01.HCP'

Deletes file `TEST01.HCP` in directory `C:\TEMP`

Example:

MMEM:DEL 'C:\TEMP*.*'

Deletes all files in directory `C:\TEMP`

Usage:

Event
SCPI confirmed

Firmware/Software: V1.0.0.4

MMEMory:DRIVes?

Returns a list of the drives of the instrument.

Example:

MMEM:DRIV?

Possible response: "C:\", "D:\"

Usage:

Query only

Firmware/Software: V1.0.5.3

MMEMory:LOAD:ITEM '<ItemName>', '<FileSource>'

Executes a partial recall, i.e. restores a selected part of a save file.

You can restore all settings of a specific application instance, for example of the LTE signaling application instance 1.

Or you can restore the list mode settings of a specific measurement application instance, for example the list mode settings of the LTE multi evaluation measurement instance 2.

Parameters:

'<ItemName>'	String parameter identifying the part to be restored <ItemName> = <Application>[<i>][:MEV:LIST] For <Application> see table below. <i> is the instance of the application (1 to 4). Omitting <i> restores instance 1. Appending :MEV:LIST restores only the list mode settings.
'<FileSource>'	String parameter specifying the path and filename of the source file. Wildcards are not allowed.

Example:

```
MMEM:LOAD:ITEM 'GPRF Meas',
 '@SAVE\mysavefile.dfl'
```

Restores the settings of the GPRF measurement instance 1 from the file `mysavefile.dfl` located in the directory assigned to the @SAVE alias.

Example:

```
MMEM:LOAD:ITEM 'GSM Meas2:MEV:LIST',
 '@SAVE\mysavefile1.dfl'
```

Restores the list mode settings of the GSM measurement instance 2 from the file `mysavefile1.dfl` located in the directory assigned to the @SAVE alias.

Usage: Event

Firmware/Software: V3.0.10

Table 6-1: Examples for '<ItemName>' strings

Group	<Application>	Examples for '<ItemName>'
1xEV-DO	1xEV-DO Meas 1xEV-DO Sig	'1xEV-DO Meas' '1xEV-DO Meas2:MEV:LIST' '1xEV-DO Sig'
Audio	Audio	'Audio2'
Bluetooth	Bluetooth Meas Bluetooth Sig	'Bluetooth Meas2' 'Bluetooth Meas:MEV:LIST' 'Bluetooth Sig1'
CDMA2000	CDMA2000 Gen CDMA2000 Meas CDMA2000 Sig	'CDMA2000 Gen1' 'CDMA2000 Meas2' 'CDMA2000 Meas:MEV:LIST' 'CDMA2000 Sig'

Group	<Application>	Examples for '<ItemName>'
DAU	Data Appl. Measurements	'Data Appl. Measurements2'
FM Stereo Radio	FM Stereo Radio Meas	'FM Stereo Radio Meas2'
GPRF	GPRF Gen GPRF Meas	'GPRF Gen2' 'GPRF Meas'
GSM	GSM Gen GSM Meas GSM Sig	'GSM Gen' 'GSM Meas2' 'GSM Meas:MEV:LIST' 'GSM Sig1'
LTE	LTE eNodeB Meas LTE Meas LTE Sig	'LTE eNodeB Meas2' 'LTE Meas2' (for LTE UE Meas.) 'LTE Meas:MEV:LIST' 'LTE Sig1'
TD-SCDMA	TD-SCDMA Meas TD-SCDMA Sig	'TD-SCDMA Meas' 'TD-SCDMA Meas2:MEV:LIST' 'TD-SCDMA Sig'
WCDMA	WCDMA Gen WCDMA Meas WCDMA Sig	'WCDMA Gen1' 'WCDMA Meas3' 'WCDMA Meas2:MEV:LIST' 'WCDMA Sig2'
WiMAX	WiMAX Meas WiMAX Sig	'WiMAX Meas1' (:MEV:LIST not supported) 'WiMAX Sig1'
WLAN	WLAN Meas WLAN Sig	'WLAN Meas2' 'WLAN Meas1:MEV:LIST' 'WLAN Sig1'

MMEMory:LOAD:STATe <MemoryNumber>, '<FileSource>'

Loads the instrument settings from the specified file to the specified internal memory. After the file has been loaded, the settings must be activated using a *RCL command.

For more convenience see [MMEMory:RCL](#) on page 234.

Parameters:

<MemoryNumber> Number of the internal memory to which the settings shall be loaded

'<FileSource>' String parameter specifying the source file. Wildcards are not allowed.

Example:

```
MMEM:LOAD:STATe 4, '@SAVE\mysavefile.dfl'
*RCL 4
```

Loads instrument settings from file `mysavefile.dfl` located in the directory assigned to the `@SAVE` alias to the internal memory number 4. Activates the settings in internal memory number 4.

Usage: Event
SCPI confirmed

Firmware/Software: V1.0.0.4

MMEMory:MDIRectory '<DirectoryName>'

Creates a new directory. If required, an entire path consisting of several subdirectories is created.

Parameters:

'<DirectoryName>' String parameter to specify the directory. Wildcards are not allowed.

Example: `MMEM:MDIR 'D:\User\Data\Images\Recent'`
Assuming that `D:\User\Data` already exists, the subdirectories `Images` and `Recent` are created.

Usage: Event

Firmware/Software: V1.0.0.4

MMEMory:MOVE '<FileSource>', '<FileDestination>'

Moves or renames an existing object (file or directory) to a new location.

Parameters:

'<FileSource>' String parameter to specify the name of the object to be moved or renamed.
Wildcards `?` and `*` are only allowed for moving files without renaming.

'<FileDestination>' String parameter to specify the new name and/or path of the object. Wildcards are not allowed.
If a new object name without path is specified, the object is renamed.
If a new path without object name is specified, the object is moved to this path.
If a new path and a new object name are specified, the object is moved to this path and renamed.

Example: `MMEM:MOVE 'D:\Temp\Setup.cfg', 'D:\Archive'`
Moves file `Setup.cfg` from `D:\Temp` to `D:\Archive`

Example: `MMEM:MOVE 'D:\Temp\Setup.cfg', 'Test.cfg'`
Renames file `Setup.cfg` in directory `D:\Temp` to `Test.cfg`

Example: `MMEM:MOVE 'D:\Setup.cfg', 'D:\Archive\Test.cfg'`
Moves file `Setup.cfg` from `D:\` to `D:\Archive` and renames it to `Test.cfg`

Usage: Event
SCPI confirmed

Firmware/Software: V1.0.0.4

MMEMory:MSIS ['<StorageUnit>']

Changes the default storage unit (drive or server) for mass memory storage.

If '<StorageUnit>' is omitted, the storage unit is set to D:.

When the default storage unit is changed, it is checked whether the current directory (see [MMEMory:CDIRectory](#)) is also available on the new storage unit. If not, the current directory is automatically set to '\ '.

Parameters:

'<StorageUnit>' String parameter to specify the default storage unit
 *RST: a *RST does not change the default storage unit

Example:

MMEM:MSIS 'E:'
 Sets the default storage unit to drive E

Example:

MMEM:MSIS '\\Server\Share'
 Sets the default storage unit to the specified server

Usage:

SCPI confirmed

Firmware/Software: V1.0.0.4

MMEMory:RCL '<FileSource>'

Restores the instrument settings from the specified file.

This command has the same effect as the combination of `MMEMory:LOAD:STATE` and `*RCL`.

Parameters:

'<FileSource>' String parameter specifying the path and filename of the source file. Wildcards are not allowed.

Example:

MMEM:RCL '@SAVE\mysavefile.dfl'
 Loads and activates the instrument settings from the file `mysavefile.dfl` located in the directory assigned to the `@SAVE` alias.

Usage:

Event

Firmware/Software: V2.0.10

MMEMory:RDIRectory '<DirectoryName>'

Removes an existing empty directory from the mass memory storage system.

Parameters:

'<DirectoryName>' String parameter to specify the directory. Wildcards are not allowed.

Example:

MMEM:RDIR 'D:\Rohde-Schwarz\CMW\Data\User1'
 Removes the directory `User1`

Usage:

Event

Firmware/Software: V1.0.0.4

MMEMory:SAV '<FileDestination>'

Stores the current instrument settings to the specified file.

This command has the same effect as the combination of *SAV and
MMEMory:STORe:STATe.

Parameters:

'<FileDestination>' String parameter specifying path and filename of the target file.
Wildcards are not allowed.

Example: MMEM:SAV '@SAVE\mysavefile.dfl'
Saves the current instrument settings to the file
mysavefile.dfl located in the directory assigned to the
@SAVE alias.

Usage: Event

Firmware/Software: V2.0.10

MMEMory:STORe:ITEM '<ItemName>', '<FileDestination>'

Executes a partial save, i.e. stores a part of the instrument settings to the specified file.

You can store all settings of a specific application instance, for example of the LTE sig-
naling application instance 1.

Or you can store the list mode settings of a specific measurement application instance,
for example the list mode settings of the LTE multi evaluation measurement instance 2.

Parameters:

'<ItemName>' String parameter identifying the part to be saved
<ItemName> = <Application>[<i>][:MEV:LIST]
For <Application> see table below.
<i> is the instance of the application (1 to 4). Omitting <i> stores
instance 1.
Appending :MEV:LIST stores only the list mode settings.

'<FileDestination>' String parameter specifying the path and filename of the target
file. Wildcards are not allowed.

Example: MMEM:STOR:ITEM 'GPRF Meas',
'@SAVE\mysavefile.dfl'
Saves the settings of the GPRF measurement instance 1 to the
file mysavefile.dfl located in the directory assigned to the
@SAVE alias.

Example: MMEM:STOR:ITEM 'GSM Meas2:MEV:LIST',
'@SAVE\mysavefile1.dfl'
Saves the list mode settings of the GSM measurement instance
2 to the file mysavefile1.dfl located in the directory
assigned to the @SAVE alias.

Usage: Event

Firmware/Software: V3.0.10

Table 6-2: Examples for '<ItemName>' strings

Group	<Application>	Examples for '<ItemName>'
1xEV-DO	1xEV-DO Meas 1xEV-DO Sig	'1xEV-DO Meas' '1xEV-DO Meas2:MEV:LIST' '1xEV-DO Sig'
Audio	Audio	'Audio2'
Bluetooth	Bluetooth Meas Bluetooth Sig	'Bluetooth Meas2' 'Bluetooth Meas:MEV:LIST' 'Bluetooth Sig1'
CDMA2000	CDMA2000 Gen CDMA2000 Meas CDMA2000 Sig	'CDMA2000 Gen1' 'CDMA2000 Meas2' 'CDMA2000 Meas:MEV:LIST' 'CDMA2000 Sig'
DAU	Data Appl. Measurements	'Data Appl. Measurements2'
FM Stereo Radio	FM Stereo Radio Meas	'FM Stereo Radio Meas2'
GPRF	GPRF Gen GPRF Meas	'GPRF Gen2' 'GPRF Meas'
GSM	GSM Gen GSM Meas GSM Sig	'GSM Gen' 'GSM Meas2' 'GSM Meas:MEV:LIST' 'GSM Sig1'
LTE	LTE eNodeB Meas LTE Meas LTE Sig	'LTE eNodeB Meas2' 'LTE Meas2' (for LTE UE Meas.) 'LTE Meas:MEV:LIST' 'LTE Sig1'
TD-SCDMA	TD-SCDMA Meas TD-SCDMA Sig	'TD-SCDMA Meas' 'TD-SCDMA Meas2:MEV:LIST' 'TD-SCDMA Sig'
WCDMA	WCDMA Gen WCDMA Meas WCDMA Sig	'WCDMA Gen1' 'WCDMA Meas3' 'WCDMA Meas2:MEV:LIST' 'WCDMA Sig2'
WiMAX	WiMAX Meas WiMAX Sig	'WiMAX Meas1' (:MEV:LIST not supported) 'WiMAX Sig1'
WLAN	WLAN Meas WLAN Sig	'WLAN Meas2' 'WLAN Meas1:MEV:LIST' 'WLAN Sig1'

MMEMoRY:STORe:STATe <MemoryNumber>, '<FileDestination>'

Stores the instrument settings from the specified internal memory to the specified file.

To store the current instrument settings to a file, use first `*SAV <MemoryNumber>` to store the settings to the memory and then this command to store the settings from the memory to a file.

For more convenience see [MMEMoRY:SAV](#) on page 235.

Parameters:

<MemoryNumber>	Number of the internal memory to which the settings have been stored using <code>*SAV</code>
'<FileDestination>'	String parameter specifying path and filename of the target file. Wildcards are not allowed.

Example:

```
*SAV 4
```

```
MMEM:STORe:STATe 4, '@SAVE\mysavefile.dfl'
```

Saves the current instrument settings to the internal memory number 4. Stores the settings from the internal memory number 4 to the file `mysavefile.dfl` located in the directory assigned to the `@SAVE` alias.

Usage:

Event
SCPI confirmed

Firmware/Software: V1.0.0.4

6.3.8 Hardcopy Commands

The following `HCOPY` commands allow to create screenshots of the "CMW" window. The formats BMP, JPEG and PNG are supported. You can save screenshots into files or return them as block data.

HCOPY:DEVIce:FORMat	237
HCOPY:INTerior:FILE	238
HCOPY:FILE	238
HCOPY:INTerior:DATA?	238
HCOPY:DATA?	238

HCOPY:DEVIce:FORMat <Format>

Specifies the format of screenshots created via the commands [HCOPY:FILE](#), [HCOPY:DATA?](#), [HCOPY:INTerior:FILE](#) or [HCOPY:INTerior:DATA?](#).

Parameters:

<Format>	BMP JPG PNG
	BMP: Windows Bitmap format
	JPG: JPEG format
	PNG: PNG format

Example: `HCOPY:DEVIce:FORMat PNG`
Screenshots are created in PNG format.

Firmware/Software: V3.0.10

HCOPY:INTerior:FILE '<FileName>'

HCOPY:FILE '<FileName>'

Captures a screenshot and stores it to the specified file.

`HCOPY:FILE` captures the entire window, `HCOPY:INTerior:FILE` only the interior of the window.

If a "Remote" dialog is displayed instead of the normal display contents, this command switches the display on before taking a screenshot, and afterwards off again.

Parameters:

'<FileName>' String parameter specifying the absolute path and name of the file. The file name extension is added automatically according to the configured format (see [HCOPY:DEVIce:FORMat](#) on page 237).
Aliases are allowed (see [MMEMory:ALIases?](#) on page 225).
Wildcards are not allowed.

Example: The following commands have the same effect:
`HCOPY:FILE 'D:\Rohde-Schwarz\CMW\Data\image1'`
`HCOPY:FILE '@USERDATA\image1'`

Usage: Event

Firmware/Software: V3.0.10
V3.2.20: `INTerior` command

HCOPY:INTerior:DATA?

HCOPY:DATA?

Captures a screenshot and returns the result in block data format, see also [Block Data Format](#).

`HCOPY:DATA` captures the entire window, `HCOPY:INTerior:DATA` only the interior of the window.

It is recommended to "switch on" the display before sending this command, see [SYSTEM:DISPlay:UPDate](#) on page 299.

Return values:

<Data> <dblock>
Screenshot in 488.2 block data format

Usage: Query only

Firmware/Software: V3.0.10
V3.2.20: `INTerior` command

6.3.9 Frequency-Dependent Correction

The commands described in this section administrate and activate/deactivate correction tables for frequency-dependent attenuation/gain. For additional information concerning the usage of the tables refer to [RF Path Settings \(Generators\)](#) and [Connection Control \(Measurements\)](#).

Sub-Instruments

If the instrument is split into sub-instruments, each correction table is assigned to one sub-instrument and valid for this sub-instrument only. Thus all commands described in this section are sub-instrument specific.

To create, configure or delete a table for a particular sub-instrument, use the remote channel associated with the sub-instrument. There is no copy mechanism for correction tables between sub-instruments. However, you can use identical command sequences (even with identical table names but different attenuation values) for both sub-instruments, addressed by different remote channels.

Sub-instrument 1 uses the same correction table database like an instrument with only a single sub-instrument. When an instrument is split into several sub-instruments (e.g. via `SYSTEM:BASE:DEVICE:COUNT 2`), the correction tables created for the instrument are assigned to sub-instrument 1, and vice-versa when the split is canceled. The correction tables of the other sub-instruments are maintained in the background when the split is canceled. So they are still available, when the instrument is split again. The connector and path assignment of correction tables is lost upon a change of the instrument setup.

Storage of correction tables

While the R&S CMW270 application software is active, all correction tables are stored in the RAM for fast access. When the application software is closed (e.g. by pressing the standby key), all correction tables in the RAM are stored to the hard disk. When the application software is started, all correction tables on the hard disk are loaded into the RAM. The following commands allow to initiate the transfer of correction tables manually: `CONFIGURE:BASE:FDCORRECTION:SAV` and `CONFIGURE:BASE:FDCORRECTION:RCL`.

Maximum amount of correction table data

The number of entries in each correction table has an upper limit, depending on the firmware application. In most firmware applications, the upper limit is 1000.

Up to 100 correction tables can be assigned to each sub-instrument.



Reset / Preset of base settings

Please note that a reset or preset of the base settings deactivates all correction tables. A reset or preset of a sub-instrument or application does not affect the correction tables.

Commands deactivating correction tables:

- `SYSTEM:RESet:BASE`, `SYSTEM:PRESet:BASE`
- `SYSTEM:RESet:ALL`, `SYSTEM:PRESet:ALL`

Commands without impact on correction tables:

- `*RST`
- `SYSTEM:RESet`, `SYSTEM:PRESet`

List of commands:

<code>CONFigure:BASE:FDCorrection:CTABLE:CREate</code>	240
<code>CONFigure:BASE:FDCorrection:CTABLE:ADD</code>	241
<code>CONFigure:BASE:FDCorrection:CTABLE:ERASE</code>	242
<code>CONFigure:BASE:FDCorrection:CTABLE:EXIST?</code>	242
<code>CONFigure:BASE:FDCorrection:CTABLE:DELeTe</code>	242
<code>CONFigure:BASE:FDCorrection:CTABLE:DELeTe:ALL</code>	243
<code>CONFigure:BASE:FDCorrection:CTABLE:COUNT?</code>	243
<code>CONFigure:BASE:FDCorrection:CTABLE:CATalog?</code>	243
<code>CONFigure:BASE:FDCorrection:CTABLE:DETailS?</code>	243
<code>CONFigure:BASE:FDCorrection:CTABLE:LENGth?</code>	244
<code>CONFigure:BASE:FDCorrection:SAV</code>	244
<code>CONFigure:BASE:FDCorrection:RCL</code>	245
<code>CONFigure:FDCorrection:ACTivate</code>	245
<code>CONFigure:FDCorrection:DEACTivate</code>	246
<code>CONFigure:FDCorrection:USAGe?</code>	247

CONFigure:BASE:FDCorrection:CTABLE:CREate <TableName>{, <Frequency>, <Correction>}...

Creates a new correction table for frequency-dependent attenuation and stores it on the hard disk. If a table with the given name already exists for the addressed sub-instrument, it is overwritten.

The parameter pairs <Frequency>, <Correction> are used to fill the table. At least one parameter pair has to be entered. A command with an incomplete pair (e.g. <Frequency> without <Correction>) is ignored completely. To add entries to an existing table see `CONFigure:BASE:FDCorrection:CTABLE:ADD`.

You can enter parameter pairs in any order. The table entries (pairs) are automatically sorted from lowest to highest frequency.

Setting parameters:

<TableName>	String parameter used to identify the table by other commands and to store the table on the hard disk. The string must comply to Windows™ file name conventions, see Mass Memory Commands .
<Frequency>	Range: 100E+6 Hz to 6E+9 Hz Increment: 0.1 Hz Default unit: Hz
<Correction>	Range: -50 dB to 90 dB Increment: 0.01 dB Default unit: dB

Example:

```
CONFigure:BASE:FDCorrection:CTABLE:CREate
'mytable', 1900000000, 0.5, 2000000000, 0.7
Create the table 'mytable' with two entries: 0.5 dB at 1900
MHz and 0.7 dB at 2000 MHz
```

Usage: Event

Firmware/Software: V1.0.5.3

CONFigure:BASE:FDCorrection:CTABLE:ADD <TableName>{, <Frequency>, <Correction>}...

Adds entries to an existing correction table. At least one parameter pair has to be specified. A command with an incomplete pair (e.g. <Frequency> without <Correction>) is ignored completely.

You can add parameter pairs in any order. The table entries (pairs) are automatically sorted from lowest to highest frequency.

Setting parameters:

<TableName>	String parameter identifying the table. To display a list of existing tables use the command <code>CONFigure:BASE:FDCorrection:CTable:CATalog?</code> .
<Frequency>	Range: 100E+6 Hz to 6E+9 Hz Increment: 0.1 Hz Default unit: Hz
<Correction>	Range: -50 dB to 90 dB Increment: 0.01 dB Default unit: dB

Example:

```
CONFigure:BASE:FDCorrection:CTABLE:ADD
'mytable', 1925000000, 0.55, 1975000000, 0.65
Add two entries to the table 'mytable': 0.55 dB at 1925 MHz
and 0.65 dB at 1975 MHz
```

Usage: Event

Firmware/Software: V1.0.5.3

CONFigure:BASE:FDCorrection:CTABLE:ERASe <TableName>, <Frequency>...

Removes one or more selected entries from a correction table. Each table entry consists of a frequency value and a correction value. Entries to be removed are selected via their frequency values.

Setting parameters:

<TableName> String parameter identifying the table. To display a list of existing tables use the command
`CONFigure:BASE:FDCorrection:CTABLE:CATalog?`

<Frequency> Selects the table entry to be removed. The value must match the frequency of an existing table entry. To remove several entries, specify a comma-separated list of frequencies.

Range: 100E+6 Hz to 6E+9 Hz
 Increment: 0.1 Hz
 Default unit: Hz

Example: `CONFigure:BASE:FDCorrection:CTABLE:ERASe 'mytable', 1925000000, 1975000000`
 The two entries with the frequencies 1925 MHz and 1975 MHz are removed from the table 'mytable'.

Usage: Event

Firmware/Software: V2.1.27

CONFigure:BASE:FDCorrection:CTABLE:EXIST? <TableName>

Queries whether a correction table with the specified name exists or not.

Query parameters:

<TableName> Table name as string parameter

Return values:

<Exists> 0 | 1
 0: table does not exist
 1: table exists

Example: `CONFigure:BASE:FDCorrection:CTABLE:EXIST? 'mytable'`
 Check whether a correction table with the name 'mytable' already exists or not.

Usage: Query only

Firmware/Software: V3.2.20

CONFigure:BASE:FDCorrection:CTABLE:DELeTe <TableName>

Deletes a correction table from the hard disk.

Setting parameters:

<TableName> String parameter identifying the table. To display a list of existing tables use the command

```
CONFigure:BASE:FDCorrection:CTABLE:CATalog?.
```

Example:

```
CONFigure:BASE:FDCorrection:CTABLE:DElete  
'mytable'
```

Usage: Event

Firmware/Software: V1.0.5.3

CONFigure:BASE:FDCorrection:CTABLE:DElete:ALL

Deletes all correction tables for the addressed sub-instrument from the hard disk.

Usage: Event

Firmware/Software: V2.1.27

CONFigure:BASE:FDCorrection:CTABLE:COUNT?

Returns the number of correction tables currently stored on the hard disk for the addressed sub-instrument.

Return values:

<TableCount> Number of tables

Example:

```
CONFigure:BASE:FDCorrection:CTABLE:COUNT?  
Returns: 3
```

Usage: Query only

Firmware/Software: V2.1.27

CONFigure:BASE:FDCorrection:CTABLE:CATalog?

Returns the names of all correction tables currently stored on the hard disk for the addressed sub-instrument.

Return values:

<TableName> Comma separated list of table names as strings

Example:

```
CONFigure:BASE:FDCorrection:CTABLE:CATalog?  
Returns: 'mytable', 'setup 1', 'setup 3G'.
```

Usage: Query only

Firmware/Software: V1.0.5.3

CONFigure:BASE:FDCorrection:CTABLE:DEtails? <TableName>[, <StartIndex>[, <Count>]]

Returns the entries of a correction table.

Query parameters:

<TableName>	String parameter identifying the table. To display a list of existing tables use the command <code>CONFigure:BASE:FDCorrection:CTABLE:CATalog?</code>
<StartIndex>	Index number of the first entry to be listed. The first entry of a table has index number 0. Default: 0
<Count>	Maximum number of entries to be listed. By default all entries from <StartIndex> to the end of the table are listed.

Return values:

<ValuePairs>	Table entry pairs. Each pair consists of a frequency [Hz] and an attenuation [dB].
--------------	--

Example:

```
CONFigure:BASE:FDCorrection:CTABLE:DEtails?
'mytable', 3, 1
Returns the entry with index number 3, e.g.: 2000000000,0.7
```

Usage:

Query only

Firmware/Software: V1.0.5.3

CONFigure:BASE:FDCorrection:CTABLE:LENGth? <TableName>

Returns the number of entries (i.e. pairs of frequency and attenuation) of a correction table.

Query parameters:

<TableName>	String parameter identifying the table. To display a list of existing tables use the command <code>CONFigure:BASE:FDCorrection:CTABLE:CATalog?</code> on page 243.
-------------	--

Return values:

<TableLength>	Number of table entries
---------------	-------------------------

Example:

```
CONFigure:BASE:FDCorrection:CTABLE:LENGth?
'mytable'
For 'mytable' containing 4 frequency/attenuation pairs, the
result is 4.
```

Usage:

Query only

Firmware/Software: V1.0.5.3

CONFigure:BASE:FDCorrection:SAV

Saves all correction tables of the addressed sub-instrument from the RAM to the hard disk.

This action is performed automatically when the R&S CMW270 application software is closed, e.g. by pressing the standby key. However, you can use the command to save your work manually after creating, configuring or deleting correction tables.

Usage: Event

Firmware/Software: V2.1.25

CONFigure:BASE:FDCorrection:RCL

Loads all correction tables of the addressed sub-instrument from the hard disk into the RAM.

This action is performed automatically when the R&S CMW270 application software is started. However, you can use the command to retrieve the correction tables after the disk contents have been modified. Or you can use it to undo changes and fall back to the tables stored on the hard disk.

Usage: Event

Firmware/Software: V2.1.25

CONFigure:FDCorrection:ACTivate <Connector>, <TableName>[, <Direction>[, <RFConverter>]]

Activates a correction table for one or more signal paths using a specific RF connector.

For bidirectional connectors the table can be applied to both directions or to one direction. It is possible to assign different tables to the directions of a bidirectional connector, see example.

A table can be assigned to all paths using the connector or to paths with a specific connector / converter combination.

Depending on the installed hardware and the active sub-instrument only a subset of the listed values is allowed. The mapping of virtual connector names to physical connectors also depends on the active sub-instrument. For details see [Signal Path Settings](#).

Setting parameters:

<Connector> RF1C | RF1O | RF2C | RF3C | RF3O | RF4C | RFAO | RFAC | RFBC

RF1C, RF2C, RF3C, RF4C, RF1O, RF3O:

RF 1 COM to RF 4 COM and RF 1/3 OUT front panel connectors

RFAC, RFBC, RFAO:

Virtual names for the RF COM and RF OUT connectors

<TableName> String parameter identifying the table. To display a list of existing tables use the command

CONFigure:BASE:FDCorrection:CTABLE:CATalog?.

<Direction>	<p>RXTX RX TX</p> <p>Specifies the direction to which the correction table shall be applied. RX means input and TX means output. For a pure output connector RX is ignored.</p> <p>RXTX: both directions (for output connector only output)</p> <p>RX: input (not allowed for output connector)</p> <p>TX: output</p> <p>Default: RXTX</p>
<RFConverter>	<p>RF1 RF2 RF3 RF4</p> <p>RX or TX module in the path (RFn = RXn / TXn)</p> <p>If omitted, the table is activated for any paths using the specified connector, independent of the used RX/TX module.</p>
Example:	<pre>CONFigure:FDCorrection:ACTivate RF1C, 'mytable_in', RX CONFigure:FDCorrection:ACTivate RF1C, 'mytable_out', TX</pre> <p>Different tables are activated for the input and output direction of the connector RF1C.</p>
Example:	<pre>CONFigure:FDCorrection:ACTivate RF1C, 'mytable', RXTX, RF1</pre> <p>The table is activated for paths using RF1C and RX1 or TX1.</p>
Usage:	Event
Firmware/Software:	<p>V1.0.5.3</p> <p>V2.1.25: parameter <RFConverter> added</p>

CONFigure:FDCorrection:DEACTivate <Connector>[, <Direction>[, <RFConverter>]]

Deactivates any correction tables for a specific RF connector or a specific connector / converter combination. For bidirectional connectors the tables can be deactivated for both directions or for one direction.

Depending on the installed hardware and the active sub-instrument only a subset of the listed values is allowed. The mapping of virtual connector names to physical connectors also depends on the active sub-instrument. For details see [Signal Path Settings](#).

Setting parameters:

<Connector>	<p>RF1C RF1O RF2C RF3C RF3O RF4C RFAO RFAC RFBC</p> <p>RF1C, RF2C, RF3C, RF4C, RF1O, RF3O: RF 1 COM to RF 4 COM and RF 1/3 OUT front panel connectors</p> <p>RFAC, RFBC, RFAO: Virtual names for the RF COM and RF OUT connectors</p>
--------------------------	---

<Direction>	RXTX RX TX Specifies the direction for which the tables shall be deactivated. RX means input and TX means output. For a pure output connector RX is ignored. RXTX : both directions (for output connector only output) RX : input (not allowed for output connector) TX : output Default: RXTX
<RFConverter>	RF1 RF2 RF3 RF4 RX and TX module in the path (RFn = RXn, TXn)
Example:	<code>CONFigure:FDCorrection:DEACTivate RF1C</code> Deactivates all correction tables for the connector RF1C.
Example:	<code>CONFigure:FDCorrection:DEACTivate RF1C, RX</code> Deactivates all correction tables for the input direction of connector RF1C.
Example:	<code>CONFigure:FDCorrection:DEACTivate RF1C, RXTX, RF1</code> Deactivates all correction tables for paths using RF1C and RX1 or TX1.
Usage:	Event
Firmware/Software:	V1.0.5.3 V2.1.25: parameters <Direction> and <RFConverter> added

CONFigure:FDCorrection:USAGe? <Connector>[, <RFConverter>]

Lists the correction tables assigned to a specific RF connector or a specific connector / converter combination.

Depending on the installed hardware and the active sub-instrument only a subset of the query parameter values is allowed. The mapping of virtual connector names to physical connectors also depends on the active sub-instrument. For details see [Signal Path Settings](#).

Query parameters:

<Connector>	RF1C RF1O RF2C RF3C RF3O RF4C RFAO RFAC RFBC RF1C, RF2C, RF3C, RF4C, RF1O, RF3O: RF 1 COM to RF 4 COM and RF 1/3 OUT front panel connectors RFAC, RFBC, RFAO: Virtual names for the RF COM and RF OUT connectors
<RFConverter>	RF1 RF2 RF3 RF4 RX and TX module in the path (RFn = RXn, TXn) If the specified converter value is incompatible with the connector or the results are ambiguous because this parameter is omitted, NAV is returned.

Return values:

<RXTableName> String identifying the table assigned to the RX direction. If no table is active, an empty string is returned. For pure output connectors the RX string is empty.

<TXTableName> String identifying the table assigned to the TX direction. If no table is active, an empty string is returned. For pure input connectors the TX string is empty.

Example: CONFigure:FDCorrection:USAGe? RF10
Result: "", "mytable"

Usage: Query only

Firmware/Software: V1.0.5.3
V2.1.25: parameter <RFConverter> added

6.3.10 Setup Commands

The commands described in this section configure or query parameters that are also present in the "Setup" dialog of the instrument.

See also [chapter 4.4, "Setup Dialog"](#), on page 85.

6.3.10.1 System Settings

The following commands configure settings related to the display, the LAN connection and software updates. The settings are also available in the "System" section of the "Setup" dialog.

SYSTem:BASE:DISPlay:FONTset.....	248
SYSTem:DISPlay:MONitor.....	249
SYSTem:DISPlay:ROLLkeymode.....	249
SYSTem:COMMunicate:NET:ADAPter.....	249
SYSTem:COMMunicate:NET:HOSTname?.....	250
SYSTem:COMMunicate:NET:DHCP.....	250
SYSTem:COMMunicate:NET:IPADdress.....	250
SYSTem:COMMunicate:NET:SUBNet:MASK.....	251
SYSTem:COMMunicate:NET:GATeway.....	251
SYSTem:COMMunicate:NET:DNS:ENABLE.....	251
SYSTem:COMMunicate:NET:DNS.....	252
SYSTem:UPDate:DGRoup.....	252
SYSTem:STARtup:PREPare:FDEFault.....	252

SYSTem:BASE:DISPlay:FONTset <FontSize>

Selects the font size for the GUI labels.

Parameters:

<FontSize> DEF | LRG
DEF: Small fonts
LRG: Large fonts
***RST:** DEF

Example: `SYSTem:BASE:DISPlay:FONTset LRG`
 Select large fonts.

Firmware/Software: V1.0.5.3

SYSTem:DISPlay:MONitor <Enable>

Turns the built-in display / the external monitor on or off.

Parameters:

<Enable> ON | OFF

Example: `SYSTem:DISPlay:MONitor ON`
 Turn the monitor on.

Usage: Event

Firmware/Software: V3.2.20

SYSTem:DISPlay:ROLLkeymode <Mode>

Selects the tree traversal mode of the rotary knob.

Parameters:

<Mode> ZIGZag | CURSors | VERTical

ZIGZag: always zigzag

CURSors: LEFT / RIGHT ARROW keys change to "zigzag" mode, UP / DOWN ARROW keys change to "vertical" mode

VERTical: always vertical

Example: `SYSTem:DISPlay:ROLLkeymode ZIGZag`
 Use zigzag movement

Firmware/Software: V3.2.10

SYSTem:COMMunicate:NET:ADAPter '<Adapter>'

Selects the network adapter and thus the connection type to be modified. All `SYSTem:COMMunicate:NET:...` commands affect the selected network adapter. This command does not activate or deactivate a network adapter. At present only LAN connections are supported.

Parameters:

'<Adapter>' String parameter, 'Lan Remote' or 'Lan Front'

***RST:** a *RST does not affect the LAN service settings

Example: `SYSTem:COMMunicate:NET:ADAPter "Lan Remote"`
Selects the "Lan Remote" network adapter.

Firmware/Software: V1.0.0.4

SYSTem:COMMunicate:NET:HOSTname?

Queries the host name (computer name) of the R&S CMW270. The host name is part of the VISA address string for LAN-based connections.

Return values:

'<Host>' Host name as string

Usage: Query only

Firmware/Software: V1.0.0.4

SYSTem:COMMunicate:NET:DHCP <Boolean>

Enables or disables the Dynamic Host Configuration Protocol (DHCP).

Parameters:

<Boolean> -1 | 0

-1: DHCP enabled, automatic TCP/IP address setting

0: DHCP disabled, manual address setting

***RST:** a *RST does not affect the LAN service settings

Example: `SYSTem:COMMunicate:NET:DHCP 0`
Disable DHCP, enable manual setting of the IP address information

Firmware/Software: V1.0.0.4

SYSTem:COMMunicate:NET:IPADdress '<Address>'...

Assigns one or more IPv4 addresses to the network adapter. This is only relevant if DHCP is disabled (`SYSTem:COMMunicate:NET:DHCP`).

A query returns the currently assigned addresses, irrespective of whether they have been assigned manually or via DHCP.

Parameters:

'<Address>' String parameter, IP address consisting of four blocks (octets) separated by dots
Several strings separated by commas can be entered or several addresses separated by commas can be included in one string.

***RST:** a *RST does not affect the LAN service settings

Example: `SYSTem:COMMunicate:NET:IPADdress '10.113.10.38'`
Select a private IP address (characterized by 10 in the first octet).

Firmware/Software: V1.0.0.4
V3.0.10: support of more than one address

SYSTem:COMMunicate:NET:SUBNet:MASK '<Mask>'...

Defines the subnet masks to be used for the network adapter addresses. This is only relevant if DHCP is disabled ([SYSTem:COMMunicate:NET:DHCP](#)).

A query returns the currently used subnet masks, irrespective of whether they have been assigned manually or via DHCP.

Parameters:

'<Mask>' String parameter, subnet mask consisting of four blocks separated by dots
Several strings separated by commas can be entered or several masks separated by commas can be included in one string.
*RST: a *RST does not affect the LAN service settings

Example: SYSTem:COMMunicate:NET:SUBNet:MASK
'255.255.0.0'
Sets subnet mask 255.255.0.0.

Firmware/Software: V1.0.0.4
V3.0.10: support of more than one subnet mask

SYSTem:COMMunicate:NET:GATeway '<Address>'...

Defines IPv4 addresses of default gateways. This is only relevant if DHCP is disabled ([SYSTem:COMMunicate:NET:DHCP](#)).

A query returns the currently defined addresses, irrespective of whether they have been specified manually or via DHCP.

Parameters:

'<Address>' String parameter, gateway IP address consisting of four blocks separated by dots
Several strings separated by commas can be entered or several addresses separated by commas can be included in one string.
*RST: a *RST does not affect the LAN service settings

Example: SYSTem:COMMunicate:NET:GATeway '10.113.0.1'
Sets the default gateway address to 10.113.0.1.

Firmware/Software: V1.0.0.4
V3.0.10: support of more than one address

SYSTem:COMMunicate:NET:DNS:ENABLE <Boolean>

Enables or disables dynamic configuration of DNS server addresses.

Parameters:

<Boolean> -1 | 0
 -1: Enabled, automatic configuration
 0: Disabled, manual configuration
 *RST: a *RST does not affect the LAN service settings

Example:

SYSTem:COMMunicate:NET:DNS:ENABle 0
 Disables dynamic/automatic DNS server address configuration.

Firmware/Software: V1.0.0.4

SYSTem:COMMunicate:NET:DNS '<Address>'...

Defines the DNS server IPv4 addresses to be used. The addresses are valid if dynamic configuration is disabled ([SYSTem:COMMunicate:NET:DNS:ENABle](#)).

A query returns the defined DNS addresses, irrespective of whether they have been specified manually or via DHCP.

Parameters:

'<Address>' String parameters, DNS server addresses consisting of four blocks separated by dots
 Several strings separated by commas can be entered or several addresses separated by commas can be included in one string.
 *RST: a *RST does not affect the LAN service settings

Example:

SYSTem:COMMunicate:NET:DNS '10.0.2.166',
 '10.0.23.159'
 Use 10.0.2.166 for primary DNS server and 10.0.23.159 for secondary DNS server.

Firmware/Software: V1.0.0.4
 V3.0.10: support of more than two addresses

SYSTem:UPDate:DGRoup <DeviceGroup>

Sets the "Device Group" the instrument belongs to. For remote installation, this setting must match the corresponding setting in the R&S Software Distributor options.

Parameters:

<DeviceGroup> Device group as string.

Example:

SYSTem:UPDate:DGRoup "MyInstrument"
 Set the device group to "MyInstrument".

Firmware/Software: V1.0.0.4

SYSTem:STARtup:PREPare:FDEFault <Enable>

Enables startup with factory default state.

Parameters:

<Enable> 0 | 1
 Behavior during startup:
 0: restore previous settings
 1: set instrument to its factory default state

Example:

SYSTem:STARtup:PREPare:FDEFault 1
 Set factory default during startup.

Firmware/Software: V3.2.20

6.3.10.2 Remote Settings

The following commands define the address information for the different remote-control interfaces of the R&S CMW270. The settings are also available in the "Remote" section of the "Setup" dialog.

SYSTem:COMMunicate:HISLip<i>:VRESource?	253
SYSTem:COMMunicate:SOCKet<i>:MODE	254
SYSTem:COMMunicate:SOCKet<i>:PORT	254
SYSTem:COMMunicate:SOCKet<i>:VRESource?	254
SYSTem:COMMunicate:GPIB<i>[:SELF]:ADDR	255
SYSTem:COMMunicate:GPIB<i>[:SELF]:ENABLE	255
SYSTem:COMMunicate:GPIB<i>:VRESource?	255
SYSTem:COMMunicate:USB:VRESource?	256
SYSTem:COMMunicate:VXI<i>:GTR	256
SYSTem:COMMunicate:VXI<i>:VRESource?	257

SYSTem:COMMunicate:HISLip<i>:VRESource?

Queries the VISA resource string for the HiSLIP protocol; see [Remote Control Operation](#).

Suffix:

<i> 1..2
 Selects the remote channel.

Return values:

'<String>' VISA address string; see example below.
 *RST: *RST has no effect on the value. The address string depends on the host name; see example below.

Example:

```
SYSTem:COMMunicate:NET:HOSTname 'hh346999'
SYSTem:COMMunicate:HISLip2:VRESource?
Define a host name and query the VISA resource string for the
HiSLIP protocol (channel 2). The response is
'TCPIP::hh346999::hislip1::INSTR'.
```

Usage: Query only

Firmware/Software: V3.0.10

SYSTem:COMMunicate:SOCKet<i>:MODE <Mode>

Sets the protocol operation mode for direct socket communication.

Suffix:

<i> 1..2
Selects the remote channel.

Parameters:

<Mode> RAW | AGILent | IEEE1174
RAW: no support of control messages, e.g. polling or service request
AGILent: emulation codes via control connection (control port)
IEEE1174: emulation codes via data connection (data port)
***RST:** a *RST has no effect on this parameter

Example:

SYSTem:COMMunicate:SOCKet:MODE RAW
Set the operation mode to raw TCP/IP.

Firmware/Software: V1.0.5.3

SYSTem:COMMunicate:SOCKet<i>:PORT <Port>

Sets the port number for direct socket communication.

Suffix:

<i> 1..2
Selects the remote channel.

Parameters:

<Port> Range: 1024 to 32767
***RST:** a *RST has no effect on the value

Example:

SYSTem:COMMunicate:SOCKet:PORT 1025
Set the port number to 1025 (channel 1).

Firmware/Software: V1.0.5.3

SYSTem:COMMunicate:SOCKet<i>:VRESource?

Queries the VISA resource string of the socket resource (direct socket communication); see [Remote Control Operation](#).

Suffix:

<i> 1..2
Selects the remote channel.

Return values:

'<String>' VISA address string; see example below.
***RST:** *RST has no effect on the value. The address string depends on the host name and on the port number; see example below.

Example: `SYSTem:COMMunicate:NET:HOSTname`
`'hh346999.domain.net'`
`SYSTem:COMMunicate:SOCKET2:PORT 1500`
`SYSTem:COMMunicate:SOCKET2:VRESource?`
 Define a host name, set a port and query the VISA resource string of the socket resource (channel 2). The response is `'TCPiP::hh346999.domain.net::1500::SOCKET'`.

Usage: Query only

Firmware/Software: V1.0.5.3

SYSTem:COMMunicate:GPIB<i>[:SELF]:ADDR <AddressNo>

Sets the primary GPIB address of the analyzer.

Suffix:

<i> 1..4 (depending on installed options)
 Selects the remote channel.

Parameters:

<AddressNo> GPIB address; integer number
 Range: 0 to 30
 *RST: a *RST has no effect on the value

Example: `SYSTem:COMMunicate:GPIB:ADDRess 10`
 Set the GPIB address to 10 (channel 1).

Firmware/Software: V1.0.0.4

SYSTem:COMMunicate:GPIB<i>[:SELF]:ENABLE <State>

Enables or disables the GPIB interface.

Suffix:

<i> 1..4 (depending on installed options)
 Selects the remote channel.

Parameters:

<State> **ON | 1:** GPIB enabled
OFF | 0: GPIB disabled
 *RST: a *RST has no effect on the value

Example: `SYSTem:COMMunicate:GPIB:ENABLE ON`
 Enable GPIB interface (channel 1).

Firmware/Software: V1.0.0.4

SYSTem:COMMunicate:GPIB<i>:VRESource?

Queries the VISA resource string of the GPIB interface; see [Remote Control Operation](#).

Suffix:

<i> 1..4 (depending on installed options)
Selects the remote channel.

Return values:

'<String>' VISA address string; see example below.
*RST: *RST has no effect on the value. The address string depends on the GPIB address and on the host name; see example below.

Example:

```
SYSTem:COMMunicate:GPIB:ADDRes 10
SYSTem:COMMunicate:GPIB:VRESource?
Set the GPIB address to 10 and query the VISA resource string of the GPIB interface (channel 1). The response is 'GPIB : : 10 : : INSTR'
```

Usage: Query only

Firmware/Software: V1.0.0.4

SYSTem:COMMunicate:USB:VRESource?

Queries the VISA resource string of the USB interface; see [Remote Control Operation](#).

Return values:

'<String>' VISA address string; see example below.
*RST: *RST has no effect on the value. The address string is fixed; see example below.

Example:

```
SYSTem:COMMunicate:USB:VRESource?
Query the VISA resource string of the USB interface. The response is 'USB : : 0x0AAD : : 0x57 : : 0000000 : : INSTR'.
```

Usage: Query only

Firmware/Software: V1.0.0.4

SYSTem:COMMunicate:VXI<i>:GTR <State>

Enables or disables the VXI-11 interface.

Suffix:

<i> 1..2
Selects the remote channel.

Parameters:

<State> **ON | 1:** VXI-11 enabled
OFF | 0: VXI-11 disabled
*RST: a *RST has no effect on the value

Example:

```
SYSTem:COMMunicate:VXI:GTR ON
Enable VXI-11 interface for channel 1.
```

Firmware/Software: V1.0.0.4

SYSTem:COMMunicate:VXI<i>:VRESource?

Queries the VISA resource string for the VXI-11 protocol; see [Remote Control Operation](#).

Suffix:

<i> 1..2
Selects the remote channel.

Return values:

'<String>' VISA address string; see example below
*RST: *RST has no effect on the value. The address string depends on the host name; see example below.

Example:

```
SYSTem:COMMunicate:NET:HOSTname 'hh346999'
SYSTem:COMMunicate:VXI2:VRESource?
Define a host name and query the VISA resource string for the
VXI-11 protocol (channel 2). The response is
'TCPIP::hh346999::inst1::INSTR'.
```

Usage: Query only

Firmware/Software: V1.0.0.4

6.3.10.3 Installed Software and Device ID

The following commands provide information about the installed software, hardware, licenses and the device ID. The "Setup" dialog provides this information in sections "License Keys" and "SW/HW-Equipment".

```
SYSTem:BASE:OPTion:LIST?..... 257
SYSTem:BASE:OPTion:VERSion?..... 258
SYSTem:DEVIce:ID?.....259
```

SYSTem:BASE:OPTion:LIST? [<OptionType>[, <Validity>]]

Returns a list of installed software options (licenses), hardware options, software packages and firmware applications.

The list can be filtered using the described parameters. If this results in an empty list, a "0" is returned.

The meaning of the filter <Validity> depends on the <OptionType> as follows:

- A software option is valid if there is an active license key for it. The value "FUNCTIONAL" is not relevant.
- A hardware option is functional if the corresponding hardware and all its components can be used (no defect detected). The value "VALID" is not relevant.
- A firmware application is functional if the required hardware, software and license keys are available and functional. The value "VALID" is not relevant.
- For software packages the filter has no effect.

Parameters:

<OptionType>	SWOption HWOption SWPackage FWA ALL List only software options, hardware options, software packages or firmware applications. By default or if ALL is selected, all types are listed.
<Validity>	FUNctional VALid ALL List only functional entries or only valid entries. By default or if ALL is selected, the list is not filtered according to the validity.

Example:

SYSTem:BASE:OPTion:LIST?
Returns an unfiltered list.
SYSTem:BASE:OPTion:LIST? SWOption, VALid
Returns all valid software options.
SYSTem:BASE:OPTion:LIST? FWA, FUNctional
Returns all functional firmware applications.

Usage:

Query only

Firmware/Software:

V1.0.10.1
V2.0.10: Query parameters <OptionType> and <Validity> added

SYSTem:BASE:OPTion:VERSion? [<Application>]

Returns version information for installed software packages. The "Setup" dialog provides this information in section "SW/HW-Equipment > Installed Software".

You can either query a list of all installed packages and their versions or you can query the version of a single package specified via parameter <Application>:

- <Application> specified: A string is returned, indicating the version of the <Application>. If the specified <Application> is unknown / not installed, "0" is returned.
- <Application> omitted: A string is returned, containing a list of all installed software packages and their version in the format "<PackageName1>,<Version1>;<PackageName2>,<Version2>;..."

Query parameters:

<Application>	String selecting the software package for which the version shall be queried
---------------	--

Return values:

<SoftwareVersion>	String containing a single version or a list of applications and versions
-------------------	---

Example:

SYSTem:BASE:OPTion:VERSion?
Returns a list of all packages, for example
"CMW BASE,V3.0.10;CMW GPRF Gen,V3.0.10;CMW GPRF Meas,V3.0.10"

Example:

SYSTem:BASE:OPTion:VERSion? "CMW GPRF Gen"
Returns the version of the GPRF generator software, for example "V3.0.10"

Example: `SYSTem:BASE:OPTion:VERsion? "nonsense"`
 Returns "0"

Usage: Query only

Firmware/Software: V2.1.25

SYSTem:DEvice:ID?

Queries the device identification.

Return values:
 '<DeviceID>' Device ID string.

Usage: Query only

Firmware/Software: V1.0.10.1

6.3.10.4 Reference Frequency and System Synchronization Settings

The following commands configure the reference frequency and the system synchronization settings. The settings are also available in the "Misc > Sync" section of the "Setup" dialog.

<code>SYSTem:BASE:REFerence:FREQuency:SOURce</code>	259
<code>SYSTem:BASE:REFerence:FREQuency</code>	259
<code>SENSe:BASE:REFerence:FREQuency:LOCKed?</code>	260
<code>SYSTem:BASE:SSYNc:MODE</code>	260

SYSTem:BASE:REFerence:FREQuency:SOURce <FrequencySource>

Sets the R&S CMW270 to internal or external reference.

Parameters:
 <FrequencySource> INTernal | EXTernal
 INTernal: Internal reference frequency
 EXTernal: External reference frequency
 *RST: INT

Example: `SYST:REF:FREQ:SOUR EXT`
 Set the R&S CMW270 to an external reference frequency.
 `SYST:REF:FREQ 10E+6 Hz`
 Define an external reference frequency of 10 MHz.

Firmware/Software: V1.0.5.3

SYSTem:BASE:REFerence:FREQuency <ExtRefFrequency>

Sets the R&S CMW270 external reference frequency.

Parameters:

<ExtRefFrequency> Range: 1E+6 Hz to 80E+6 Hz
 *RST: 10E+6 Hz
 Default unit: Hz

Example: see `SYSTem:BASE:REFerence:FREQuency:SOURce`

Firmware/Software: V1.0.5.3

SENSe:BASE:REFerence:FREQuency:LOCKed?

Queries whether the reference frequency is locked or not. A not locked reference frequency is also indicated via the red "ERROR" LED at the front panel.

Return values:

<Locked> 1 | 0
1: frequency is locked
0: frequency is not locked

Usage: Query only

Firmware/Software: V1.0.5.3

SYSTem:BASE:SSYNc:MODE <Mode>

Specifies the role of the instrument in a multi-CMW setup, concerning the system time synchronization signal.

Parameters:

<Mode> LIST | GEN | STAN
LISTener: The instrument receives a time synchronization signal at SYS SYNC IN
GENerator: The instrument provides a system synchronization signal at the rear panel
STANdalone: The instrument uses its internal synchronization signal

Example: `SYST:BASE:SSYN:MODE GEN`
 Use the R&S CMW270 to generate a system synchronization signal.

Firmware/Software: V2.1.10

6.3.10.5 Trigger Settings

The following commands configure the connectors TRIG A and TRIG B at the rear panel of the instrument and allows to initiate the generation of a "User Initiated Trigger" signal.

The settings are also available in the "Misc > Trigger" section of the "Setup" dialog.



Contents of this chapter

The commands in this section belong to the R&S CMW270 base system; they are not related to specific firmware applications.

Most of the R&S CMW270 measurement firmware applications provide their own, specific trigger settings. For details refer to the documentation of the `TRIGger...` subsystems in the different firmware application chapters.

<code>TRIGger:BASE:EXTA:CATalog:SOURce?</code>	261
<code>TRIGger:BASE:EXTB:CATalog:SOURce?</code>	261
<code>TRIGger:BASE:EXTA:DIRection</code>	261
<code>TRIGger:BASE:EXTB:DIRection</code>	261
<code>TRIGger:BASE:EXTA:SOURce</code>	262
<code>TRIGger:BASE:EXTB:SOURce</code>	262
<code>TRIGger:BASE:EXTA:SLOPe</code>	262
<code>TRIGger:BASE:EXTB:SLOPe</code>	262
<code>TRIGger:BASE:UINitiated<n>:EXECute</code>	262

TRIGger:BASE:EXTA:CATalog:SOURce?

TRIGger:BASE:EXTB:CATalog:SOURce?

Lists all trigger source values that can be set using

`TRIGger:BASE:EXTA|EXTB:SOURce`. The returned values depend on the installed hardware options and firmware applications.

Return values:

'<Source_1>' ... Comma separated list of all supported values. Each value is represented as a string.
'<Source_n>'

Example:

`TRIGger:BASE:EXTB:CATalog:SOURce?`

Query the available output trigger signals for connector TRIG B.

A possible response is

"No Connection", "Basel:

External TRIG A", "Basel: External TRIG B".

Usage: Query only

Firmware/Software: V1.0.4.11

TRIGger:BASE:EXTA:DIRection <Direction>

TRIGger:BASE:EXTB:DIRection <Direction>

Selects the TRIG A and TRIG B connectors as either input or output connectors.

Parameters:

<Direction> IN | OUT

IN: Input connector

OUT: Output connector

*RST: IN

Example:

`TRIGger:BASE:EXTB:DIRection OUT`

Use TRIG B as an output connector.

Firmware/Software: V1.0.4.11

TRIGger:BASE:EXTA:SOURce '<Source>'

TRIGger:BASE:EXTB:SOURce '<Source>'

Selects the output trigger signals to be routed to the TRIG A and TRIG B connectors. The signals listed below are always available. Depending on the installed options additional values may be available. A complete list of all supported values can be retrieved using TRIGger:....:CATalog:SOURce?.

Parameters:

'<Source>'

'No Connection': No output trigger signal available

'Base1: External TRIG A': Input trigger signal from the TRIG A connector

'Base1: External TRIG B': Input trigger signal from the TRIG B connector

*RST: 'No Connection'

Example:

TRIGger:BASE:EXTB:SOURce "Base1: External TRIG A"

Select the input signal from TRIG A as an output trigger signal for connector TRIG B.

Firmware/Software: V1.0.4.11

TRIGger:BASE:EXTA:SLOPe <Slope>

TRIGger:BASE:EXTB:SLOPe <Slope>

Specifies whether the rising edge or the falling edge of the trigger pulse shall be generated at the trigger event.

The setting applies to output trigger signals provided at the TRIG A (EXTA) or TRIG B (EXTB) connector.

Parameters:

<Slope>

REDGe | FEDGe

REDGe: Rising edge

FEDGe: Falling edge

*RST: REDG

Example:

TRIGger:BASE:EXTB:SLOPe FEDGe

Generate a falling edge for TRIG B.

Firmware/Software: V3.0.10

TRIGger:BASE:UINitiated<n>:EXECute

Initiates the generation of a "User Initiated Trigger" signal. The corresponding trigger source string is "Base1: User Trigger <n>".

Suffix:	
<n>	1..2 User Trigger 1 or User Trigger 2
Example:	TRIGger:BASE:UINitiated2:EXECute Generates a trigger pulse for the trigger source "Base1: User Trigger 2".
Usage:	Event
Firmware/Software:	V3.0.10

6.3.10.6 Message Monitoring

The following command configures settings related to message monitoring. The settings are also available in the "Misc > Logging" section of the "Setup" dialog.

CONFigure:BASE:MMONitor:IPADdress<n> <FirstSegment>, <SecondSegment>, <NodeID>, <LocalID>

Configures the IP address pool for logging of signaling messages via an external PC. The pool contains three IP addresses of external logging PCs.

The first two octets can not be configured. For a setting command you can specify any values within the allowed range - they are ignored. A query returns the active values resulting from the subnet configuration, see [CONFigure:BASE:IPSet:SNODE](#) on page 264.

Suffix:	
<n>	1..3 Selects the pool entry to be configured or queried

Parameters:	
<FirstSegment>	First octet of the IP address, not configurable Range: 0 to 255
<SecondSegment>	Second octet of the IP address, not configurable Range: 0 to 255
<NodeID>	Third octet of the IP address Range: 5 to 255 *RST: 5, 6, 7 for <n> = 1 to 3
<LocalID>	Fourth octet of the IP address Range: 1 to 254 *RST: 2

Example: CONFigure:BASE:MMONitor:IPADdress3 1,1,10,50
Sets the third address of the pool to x.x.10.50. The first two octets depend on the subnet configuration.

Firmware/Software: V3.0.10

6.3.10.7 IP Subnet Configuration

The following commands configure settings related to the IPv4 subnet the instrument belongs to. The settings are also available in the "Misc > IP Subnet Config" section of the "Setup" dialog.

SENSe:BASE:IPSet:SNODE:NNAME?	264
SENSe:BASE:IPSet:SNODE:NTYPE?	264
CONFigure:BASE:IPSet:SNODE	264
SENSe:BASE:IPSet:SNODE:NSEGment?	265
CONFigure:BASE:IPSet:NWADapter<n>	265
SYSTem:BASE:IPSet:SMONitor:REFresh	266
SENSe:BASE:IPSet:SMONitor:NAME?	266
SENSe:BASE:IPSet:SMONitor:TYPE?	266
SENSe:BASE:IPSet:SMONitor:ID?	267
SENSe:BASE:IPSet:SMONitor:DESCription?	267

SENSe:BASE:IPSet:SNODE:NNAME?

Queries the subnet node name of the R&S CMW270.

Return values:

<Name> Name as string

Usage: Query only

Firmware/Software: V3.0.10

SENSe:BASE:IPSet:SNODE:NTYPE?

Queries the subnet node type of the R&S CMW270.

Return values:

<Type> 'CMW'

Usage: Query only

Firmware/Software: V3.0.10

CONFigure:BASE:IPSet:SNODE <ID>, <Description>, <NetworkSegment>

Configures the internal IPv4 subnet of the instrument.

Changing the <ID> or the <NetworkSegment> initiates a reboot of the instrument.

Parameters:

<ID> N1 | N2 | ... | N253 | N254

Selects the node ID, used as third octet of the IPv4 address.

N1 to N254 results in the IP address x.x.1.x to x.x.254.x.

Assign different IDs to all subnet nodes.

*RST: N1

<Description> String for easy identification of the subnet node, for example in the subnet monitor output

*RST: 'My CMW'

<NetworkSegment> A | B

Selects the network segment to be used for the subnet

A: address range 172.22.y.z

B: address range 172.18.y.z

*RST: A

Example:

CONFigure:BASE:IPSet:SNODE N5, 'CMW room 5', A
The address range of the subnet equals 172.22.y.z. The node itself uses IP addresses 172.22.5.z. In the subnet monitor the node is listed as 'CMW room 5'.

Firmware/Software: V3.0.10

SENSe:BASE:IPSet:SNODE:NSEGment?

Queries information about the selected network segment and the resulting subnet properties.

Return values:

<SelectedSegment> A | B

Selected network segment

*RST: A

<IPAddress> String indicating the first two IP address octets for the subnet

*RST: '172.22.x.x'

<SubnetMask> String indicating the used subnet mask (fixed value)

*RST: '255.255.0.0'

Usage: Query only

Firmware/Software: V3.0.10

CONFigure:BASE:IPSet:NWADapter<n> <SetSubnetConform>

Assigns a subnet conform IP address to a network adapter of the instrument, selected via index <n> or returns information about this network adapter.

A query returns <NWAdapterName>, <SetSubnetConform>, <IPAddress>, <Status>.

Suffix:

<n> 1..5

Parameters:

<SetSubnetConform> To assign a subnet conform IP address, send 1 or ON. To try again, send first 0 or OFF, then again 1 or ON.

A query returns whether the last sent value was 0 or 1.

*RST: *RST has no effect on the value

Return values:

<NWAdapterName>	Name of the network adapter as a string, e.g. "LAN Remote" for <n> = 1 If OFF is returned, the selected value <n> is currently not assigned to a network adapter.
<IPAddress>	String containing the IP address (to be) assigned, see <Status>
<Status>	NADJust ADJust State indicating whether the returned IP address has been successfully assigned to the network adapter (ADJust) or not (NADJust)

Example:

```
CONFigure:BASE:IPSet:NWADapter1 ON
CONFigure:BASE:IPSet:NWADapter1?
Assign a subnet conform IP address to network adapter 1 and
query information about the adapter, e.g. "LAN Remote", 1,
"172.22.1.3", ADJ.
```

Firmware/Software: V3.0.10

SYSTem:BASE:IPSet:SMONitor:REFResh

Initiates an update of the information provided by the subnet monitor.

Usage: Event

Firmware/Software: V3.0.10

SENSe:BASE:IPSet:SMONitor:NAME?

Queries the name of all network nodes detected by the subnet monitor.

Return values:

<Names> Comma separated list of strings, one per network node

Example:

```
SENSe:BASE:IPSet:SMONitor:NAME?
Returns for example 'CMW50050-123456', 'PC1483'
```

Usage: Query only

Firmware/Software: V3.0.10

SENSe:BASE:IPSet:SMONitor:TYPE?

Queries the type of all network nodes detected by the subnet monitor.

Return values:

<Types> Comma separated list of strings, one per network node

Example:

```
SENSe:BASE:IPSet:SMONitor:TYPE?
Returns for example 'CMW', 'PC'
```

Usage: Query only

Firmware/Software: V3.0.10

SENSe:BASE:IPSet:SMONitor:ID?

Queries the ID (third segment of IP address) of all network nodes detected by the subnet monitor.

Return values:

<IDs> Comma separated list of values, one per network node
 Range: 1 to 254

Example: SENSe:BASE:IPSet:SMONitor:ID?
 Returns for example 1, 77

Usage: Query only

Firmware/Software: V3.0.10

SENSe:BASE:IPSet:SMONitor:DESCription?

Queries the description of all network nodes detected by the subnet monitor.

Return values:

<Descriptions> Comma separated list of strings, one per network node

Example: SENSe:BASE:IPSet:SMONitor:DESCription?
 Returns for example 'CMW room 5', 'Logging PC 4'

Usage: Query only

Firmware/Software: V3.0.10

6.3.10.8 Fan Control

The following command configures the speed control of the fan. The setting is also available in the "Misc > Fan Control" section of the "Setup" dialog.

CONFigure:BASE:FCONtrol <Mode>

Selects a fan control mode.

Parameters:

<Mode> LOW | NORMal | HIGH
LOW: less cooling than in normal mode
NORMal: default mode
HIGH: more cooling than in normal mode
 *RST: NORM

Example: CONFigure:BASE:FCONtrol HIGH
 Selects the high mode for maximum cooling.

Firmware/Software: V3.0.10

6.3.11 Sub-Instruments

The following commands configure/cancel the split of the instrument into sub-instruments.

<code>SYSTem:BASE:DEvice:COUnT</code>	268
<code>SYSTem:BASE:DEvice:RESet</code>	268
<code>SYSTem:BASE:DEvice:SUBInst?</code>	268

SYSTem:BASE:DEvice:COUnT <Count>

Selects the number of sub-instruments. The physical instrument can be split into two sub-instruments or all hardware resources can be assigned to a single sub-instrument.

To assign/distribute the available hardware resources to the sub-instrument(s) enter `SYSTem:BASE:DEvice:RESet` after you have changed the number of sub-instruments from 1 to 2.

Parameters:

<Count>	Range:	1 to 2
	*RST:	n/a (factory default is 1)

Example:

```
SYSTem:BASE:DEvice:COUnT 2
SYSTem:BASE:DEvice:RESet
```

Split the instrument into two sub-instruments and distribute the available resources to these sub-instruments.

Firmware/Software: V1.0.5.3

SYSTem:BASE:DEvice:RESet

Assigns the available hardware resources to the sub-instrument(s). This command has to be entered after the number of sub-instruments has been changed via `SYSTem:BASE:DEvice:COUnT 2`.

Usage: Event

Firmware/Software: V1.0.5.3

SYSTem:BASE:DEvice:SUBInst?

Queries the number of the addressed sub-instrument and the total number of sub-instruments.

Return values:

<CurSubInst>	Number of the addressed sub-instrument, as indicated in a VISA resource string for VXI-11
	0: instrument 1
	1: instrument 2

<SubInstCount>	Total number of sub-instruments 1: all hardware resources are assigned to a single sub-instrument 2: the physical instrument is split into two sub-instruments
Example:	SYSTem:BASE:DEVIce:SUBInst? Returns 0, 1 or 0, 2 or 1, 2.
Usage:	Query only
Firmware/Software:	V2.0.10

6.3.12 Calibration Commands

The following commands query information related to performed calibrations of the R&S CMW270.

CALibration:BASE:ALL?	269
CALibration:BASE:LATest?	269
CALibration:BASE:LATest:SPECific?	270
CALibration:BASE:ACFile?	270

CALibration:BASE:ALL?

Query the stored calibration information. A comma separated list is returned, containing three parameters per calibration, as described below.

Return values:

<Date>	Date of the calibration as string
<Time>	Time of the calibration as string
<Type>	FSCorrection UCORrection CALibration OGCal Type of the calibration FSCorrection: Correction performed in factory or service UCORrection: Correction performed by the user CALibration: Verification in the factory OGCal: Verification by the service (outgoing calibration)

Example: CALibration:BASE:ALL?
Possible result:
"2009-09-28", "14:10:20", CAL, "2010-08-20", "13:55:12", FSC

Usage: Query only

Firmware/Software: V2.0.10

CALibration:BASE:LATest? [<Type>]

Query the stored information about the latest calibration. Optionally <Type> can be specified to query information about the latest calibration of this type. The information is returned as "<Date>",<Time>",<Type>".

Parameters:

<Type> FSCorrection | UCORrection | CALibration | OGCal
 Type of the calibration. Can be specified to query the last calibration of a specific type and is returned as last value.
FSCorrection: Correction performed in factory or service
UCORrection: Correction performed by the user
CALibration: Verification in the factory
OGCal: Verification by the service (outgoing calibration)

Return values:

<Date> Date of the calibration as string

<Time> Time of the calibration as string

Example:

CALibration:BASE:LATest? OGC

Queries information about the latest outgoing calibration. Possible result: "2009-09-28", "14:10:20", OGC

CALibration:BASE:LATest?

Queries information about the latest calibration, irrespective of its type. Possible result: "2010-06-28", "13:55:12", UCOR

Usage: Query only

Firmware/Software: V2.0.10

CALibration:BASE:LATest:SPECific? <Mode>

Query date and time of the latest calibration of the specified type.

Query parameters:

<Mode> FSCorrection | UCORrection | CALibration | OGCal
 Type of the calibration for which information is queried
FSCorrection: Correction performed in factory or service
UCORrection: Correction performed by the user
CALibration: Verification in the factory
OGCal: Verification by the service (outgoing calibration)

Return values:

<Date> Date of the calibration as string

<Time> Time of the calibration as string

Example:

CALibration:BASE:LATest:SPECific? OGC

Queries information about the latest outgoing calibration. Possible result: "2009-09-28", "14:10:20"

Usage: Query only

Firmware/Software: V2.0.10

CALibration:BASE:ACFile?

Query name and creation date of the currently active RF path correction file.

Return values:**<Name>** Name of the file as string**<Date>** Creation date as string**Example:**

CALibration:BASE:ACFile?

Possible result: "[Factory Default]", "2012-09-28"

Usage: Query only**Firmware/Software:** V3.0.12

6.3.13 Status Reporting System

The STATus subsystem controls the SCPI-defined status reporting structures. For a description of the status registers see [chapter 5.6, "Status Reporting System"](#), on page 176.

The command description is structured as follows:

- [General STATus Commands](#).....271
- [STATus:OPERation \(Elementary Commands\)](#).....272
- [STATus:OPERation \(Extended Commands\)](#).....280
- [STATus:OPERation \(Overall Evaluation\)](#).....287
- [STATus:QUEStionable](#).....291

6.3.13.1 General STATus Commands

The following commands preset the status registers and query the error queue.

STATus:PRESet	271
STATus:QUEuef:NEXTJ?	272

STATus:PRESet

Configures the status reporting system such that device-dependent events are not reported at a higher level.

The command affects only the transition filter registers, the ENABLE registers, and queue enabling:

- The ENABLE parts of the STATus:OPERation and STATus:QUEStionable... registers are set to all 0's.
- The PTRansition parts are set all 1's, the NTRansition parts are set to all 0's, so that only positive transitions in the CONDition part are recognized.

The status reporting system is also affected by other commands, see [Reset Values of the Status Reporting System](#).

Example:

STAT:PRES

Preset the status registers.

Usage:

Setting only

Firmware/Software: V1.0.0.4

STATus:QUEue[:NEXT]?

Queries and at the same time deletes the oldest entry in the error queue. Operation is identical to that of [SYSTem:ERRor\[:NEXT\]?](#).

The entry consists of an error number and a short description of the error. Positive error numbers are instrument-dependent. Negative error numbers are reserved by the SCPI standard.

Example: STAT:QUE?
Query the oldest entry in the error queue. 0, "No error" is returned if the error queue is empty.

Usage: Query only

Firmware/Software: V1.0.0.4

6.3.13.2 STATus:OPERation (Elementary Commands)

The STATus:OPERation subsystem controls the status reporting structures of the STATus:OPERation register, see [chapter 5.6.3.4, "STATus:OPERation"](#), on page 182.

The commands listed below control all levels of the STATus:OPERation register hierarchy. They require the knowledge of the register hierarchy at bit level. For additional commands refer to the following sections:

- To control the registers based on register names instead of bit numbers, see [chapter 6.3.13.3, "STATus:OPERation \(Extended Commands\)"](#), on page 280.
- For comfortable overall evaluation of the registers, see [chapter 6.3.13.4, "STATus:OPERation \(Overall Evaluation\)"](#), on page 287.

The lowest three levels of the STATus:OPERation register hierarchy depend on the installed firmware applications. The syntax description of the related commands uses the following variables:

Table 6-3: Variables in STATus:OPERation commands

Variable	Description
<netw_std>	network standard: BLUetooth GPRF WIMax WLAN
<func_grp>	function group: MEASurement<i> SIGNaling<i> GENERator<i> with instance <i> = 1 2 3 4
<appl>	application: for GENERator: UNIVersal for MEASurement: EPSensor FFTSanalyzer IPERf IQRecorder IQVSlot MEvaluation OLTR PING POWer PRACH SRS THROUGHput TPC for SIGNaling: EBLer BER BERCSwitched BERPSwitched BLER HACK PER TDATA THROUGHput

Example: if a multi evaluation measurement for GSM is installed at your instrument, this results in the combination `GSM:MEASurement:MEValuation`. Command example: `STATus:OPERation:TASK:A:GSM:MEASurement:MEValuation:ENABLE?`.

All commands related to the highest level (`STATus:OPERation`) are SCPI-confirmed. Note that *RST does not influence the status registers (see also [chapter 5.6.5, "Reset Values of the Status Reporting System"](#), on page 189).

<code>SYSTem:HELP:STATus:BITS?</code>	274
<code>SYSTem:HELP:STATus[:REGister]?</code>	274
<code>STATus:OPERation:CONDition?</code>	274
<code>STATus:OPERation:TASK:CONDition?</code>	274
<code>STATus:OPERation:TASK:A:CONDition?</code>	274
<code>STATus:OPERation:TASK:A:<netw_std>:CONDition?</code>	274
<code>STATus:OPERation:TASK:A:<netw_std>:<func_grp>:CONDition?</code>	274
<code>STATus:OPERation:TASK:A:<netw_std>:<func_grp>:<appl>:CONDition?</code>	274
<code>STATus:OPERation:ENABle</code>	275
<code>STATus:OPERation:TASK:ENABle</code>	275
<code>STATus:OPERation:TASK:A:ENABle</code>	275
<code>STATus:OPERation:TASK:A:<netw_std>:ENABle</code>	275
<code>STATus:OPERation:TASK:A:<netw_std>:<func_grp>:ENABle</code>	275
<code>STATus:OPERation:TASK:A:<netw_std>:<func_grp>:<appl>:ENABle</code>	275
<code>STATus:OPERation:ESRQ</code>	275
<code>STATus:OPERation:TASK:ESRQ</code>	275
<code>STATus:OPERation:TASK:A:ESRQ</code>	275
<code>STATus:OPERation:TASK:A:<netw_std>:ESRQ</code>	275
<code>STATus:OPERation:TASK:A:<netw_std>:<func_grp>:ESRQ</code>	275
<code>STATus:OPERation:TASK:A:<netw_std>:<func_grp>:<appl>:ESRQ</code>	275
<code>STATus:OPERation[:EVENT]?</code>	276
<code>STATus:OPERation:TASK[:EVENT]?</code>	276
<code>STATus:OPERation:TASK:A[:EVENT]?</code>	276
<code>STATus:OPERation:TASK:A:<netw_std>[:EVENT]?</code>	276
<code>STATus:OPERation:TASK:A:<netw_std>:<func_grp>[:EVENT]?</code>	276
<code>STATus:OPERation:TASK:A:<netw_std>:<func_grp>:<appl>[:EVENT]?</code>	276
<code>STATus:OPERation:NTRansition</code>	276
<code>STATus:OPERation:TASK:NTRansition</code>	276
<code>STATus:OPERation:TASK:A:NTRansition</code>	276
<code>STATus:OPERation:TASK:A:<netw_std>:NTRansition</code>	276
<code>STATus:OPERation:TASK:A:<netw_std>:<func_grp>:NTRansition</code>	277
<code>STATus:OPERation:TASK:A:<netw_std>:<func_grp>:<appl>:NTRansition</code>	277
<code>STATus:OPERation:PTRansition</code>	277
<code>STATus:OPERation:TASK:PTRansition</code>	277
<code>STATus:OPERation:TASK:A:PTRansition</code>	277
<code>STATus:OPERation:TASK:A:<netw_std>:PTRansition</code>	277
<code>STATus:OPERation:TASK:A:<netw_std>:<func_grp>:PTRansition</code>	277
<code>STATus:OPERation:TASK:A:<netw_std>:<func_grp>:<appl>:PTRansition</code>	277
<code>STATus:OPERation:WCONDition?</code>	277
<code>STATus:OPERation:TASK:WCONDition?</code>	277
<code>STATus:OPERation:TASK:A:WCONDition?</code>	277
<code>STATus:OPERation:TASK:A:<netw_std>:WCONDition?</code>	277
<code>STATus:OPERation:TASK:A:<netw_std>:<func_grp>:WCONDition?</code>	278

STATus:OPERation:TASK:A:<netw_std>:<func_grp>:<appl>:WCONDition?	278
STATus:OPERation:WEVEnt?	278
STATus:OPERation:TASK:WEVEnt?	278
STATus:OPERation:TASK:A:WEVEnt?	278
STATus:OPERation:TASK:A:<netw_std>:WEVEnt?	278
STATus:OPERation:TASK:A:<netw_std>:<func_grp>:WEVEnt?	278
STATus:OPERation:TASK:A:<netw_std>:<func_grp>:<appl>:WEVEnt?	278
STATus:OPERation:BIT<n>:CONDition?	279
STATus:OPERation:BIT<n>[:EVENT]?	279
STATus:OPERation:BIT<n>:ENABLE	280
STATus:OPERation:BIT<n>:NTRansition	280
STATus:OPERation:BIT<n>:PTRansition	280

SYSTem:HELP:STATus:BITS?

Returns a list of paths for the bits of the STATus:OPERation registers at the lowest level of the hierarchy.

Each path is represented by a string containing all registers from highest to lowest level separated by colons.

Example: "STATus:OPERation:TASK:A:GPRF:MEASurement:POWer:OFF"

Usage: Query only

Firmware/Software: V2.0.10

SYSTem:HELP:STATus[:REGister]?

Returns a list of paths for the STATus:OPERation registers.

Each path is represented by a string containing all registers from highest level down to the individual register, separated by colons.

For the GPRF power measurement for example the following paths are listed:

"STATus:OPERation", "STATus:OPERation:TASK", "STATus:OPERation:TASK:A", "STATus:OPERation:TASK:A:GPRF", "STATus:OPERation:TASK:A:GPRF:MEASurement", "STATus:OPERation:TASK:A:GPRF:MEASurement:POWer"

Usage: Query only

Firmware/Software: V2.0.10

STATus:OPERation:CONDition?

STATus:OPERation:TASK:CONDition?

STATus:OPERation:TASK:A:CONDition?

STATus:OPERation:TASK:A:<netw_std>:CONDition?

STATus:OPERation:TASK:A:<netw_std>:<func_grp>:CONDition?

STATus:OPERation:TASK:A:<netw_std>:<func_grp>:<appl>:CONDition?

Returns the contents of the CONDition part of the status register, see [Structure of an SCPI Status Register](#). Reading the CONDition registers is nondestructive.

For a description of the variables <netw_std>, <func_grp> and <appl> refer to [table 6-3](#).

Return values:

<ConditionBits> Range: 0 to 65535 (decimal representation)

Example:

STAT:OPER:TASK:A:GPRF:GEN:UNIV:COND?

Query the CONDition part of the GPRF generator status register to check the current generator state.

Usage: Query only

Firmware/Software: V1.0.4.11

STATus:OPERation:ENABLE <MaskBits>

STATus:OPERation:TASK:ENABLE <MaskBits>

STATus:OPERation:TASK:A:ENABLE <MaskBits>

STATus:OPERation:TASK:A:<netw_std>:ENABLE <MaskBits>

STATus:OPERation:TASK:A:<netw_std>:<func_grp>:ENABLE <MaskBits>

STATus:OPERation:TASK:A:<netw_std>:<func_grp>:<appl>:ENABLE <MaskBits>

Sets the enable mask which allows true conditions in the EVENT part of the status register to be reported in the summary bit. If a bit is 1 in the enable register and its associated event bit transitions to true, a positive transition will occur in the summary bit reported to the next higher level. See also [Structure of an SCPI Status Register](#).

For a description of the variables <netw_std>, <func_grp> and <appl> refer to [table 6-3](#).

Parameters:

<MaskBits> Range: 0 to 65535 (decimal representation)

Example:

STAT:OPER:TASK:A:GPRF:MEAS:ENAB 1536

Set bits no. 9 and 10 of the ENABLE part of the status register for GPRF measurements ($1536 = 512 + 1024 = 2^9 + 2^{10}$).

Firmware/Software: V1.0.4.11

STATus:OPERation:ESRQ <MaskBits>

STATus:OPERation:TASK:ESRQ <MaskBits>

STATus:OPERation:TASK:A:ESRQ <MaskBits>

STATus:OPERation:TASK:A:<netw_std>:ESRQ <MaskBits>

STATus:OPERation:TASK:A:<netw_std>:<func_grp>:ESRQ <MaskBits>

STATus:OPERation:TASK:A:<netw_std>:<func_grp>:<appl>:ESRQ <MaskBits>

Sets the enable mask for the register to the specified value. Also sets the relevant bit in the enable mask of all higher registers up to the STATus:OPERation register and the SRE. Thus the entire reporting path from the register up to the SRE is enabled so that an SRQ can be generated.

If the enable mask is set to 0, the higher registers are not modified.

For a description of the variables <netw_std>, <func_grp> and <appl> refer to [table 6-3](#).

Parameters:

<MaskBits> Range: 0 to 65535 (decimal representation)

Example:

```
STAT:OPER:TASK:A:GPRF:MEAS:POW:ESRQ 4
```

Sets bit no. 2 (decimal 4) and disables all other bits in the ENABLE part of the following status register:

```
STAT:OPER:TASK:A:GPRF:MEAS:POW
```

Also sets the relevant bit in the ENABLE part of the following status registers, without changing the other bits of these ENABLE parts:

```
STAT:OPER:TASK:A:GPRF:MEAS: set bit no. 0
```

```
STAT:OPER:TASK:A:GPRF: set bit no. 0
```

```
STAT:OPER:TASK:A: set bit no. 1
```

```
STAT:OPER:TASK: set bit no. 0
```

```
STAT:OPER: set bit no. 9
```

```
SRE: set bit no. 7
```

Firmware/Software: V2.0.10

STATus:OPERation[:EVENT]?

STATus:OPERation:TASK[:EVENT]?

STATus:OPERation:TASK:A[:EVENT]?

STATus:OPERation:TASK:A:<netw_std>[:EVENT]?

STATus:OPERation:TASK:A:<netw_std>:<func_grp>[:EVENT]?

STATus:OPERation:TASK:A:<netw_std>:<func_grp>:<appl>[:EVENT]?

Returns the contents of the EVENT part of the status register. Reading an EVENT part clears it. See also [Structure of an SCPI Status Register](#).

For a description of the variables <netw_std>, <func_grp> and <appl> refer to [table 6-3](#).

Return values:

<EventBits> Range: 0 to 65535 (decimal representation)

Example:

```
STAT:OPER:TASK:A:GPRF:MEAS:POW?
```

Query the EVENT part of the status register for the GPRF power measurement to check whether an event has occurred since the last reading.

Usage:

Query only

Firmware/Software: V1.0.4.11

STATus:OPERation:NTRansition <FilterBits>

STATus:OPERation:TASK:NTRansition <FilterBits>

STATus:OPERation:TASK:A:NTRansition <FilterBits>

STATus:OPERation:TASK:A:<netw_std>:NTRansition <FilterBits>

STATus:OPERation:TASK:A:<netw_std>:<func_grp>:NTRansition <FilterBits>
STATus:OPERation:TASK:A:<netw_std>:<func_grp>:<appl>:NTRansition
 <FilterBits>

Sets the negative transition filter. If a bit is set, a 1 to 0 transition in the corresponding bit of the associated condition register causes a 1 to be written in the associated bit of the corresponding event register. See also [Structure of an SCPI Status Register](#).

For a description of the variables <netw_std>, <func_grp> and <appl> refer to [table 6-3](#).

Parameters:

<FilterBits> Range: 0 to 65535 (decimal representation)

Example:

STAT:OPER:TASK:A:GPRF:NTR 1536

Set bits no. 9 and 10 of the NTRansition part of the GPRF status register ($1536 = 512 + 1024 = 2^9 + 2^{10}$).

Firmware/Software: V1.0.4.11

STATus:OPERation:PTRansition <FilterBits>
STATus:OPERation:TASK:PTRansition <FilterBits>
STATus:OPERation:TASK:A:PTRansition <FilterBits>
STATus:OPERation:TASK:A:<netw_std>:PTRansition <FilterBits>
STATus:OPERation:TASK:A:<netw_std>:<func_grp>:PTRansition <FilterBits>
STATus:OPERation:TASK:A:<netw_std>:<func_grp>:<appl>:PTRansition
 <FilterBits>

Sets the positive transition filter. If a bit is set, a 0 to 1 transition in the corresponding bit of the associated condition register causes a 1 to be written in the associated bit of the corresponding event register. See also [Structure of an SCPI Status Register](#).

For a description of the variables <netw_std>, <func_grp> and <appl> refer to [table 6-3](#).

Parameters:

<FilterBits> Range: 0 to 65535 (decimal representation)

Example:

STAT:OPER:PTR 1536

Set bits no. 9 and 10 of the PTRansition part for STATus:OPERation register ($1536 = 512 + 1024 = 2^9 + 2^{10}$).

Firmware/Software: V1.0.4.11

STATus:OPERation:WCONdition? <WaitBits>[, <Timeout>]
STATus:OPERation:TASK:WCONdition? <WaitBits>[, <Timeout>]
STATus:OPERation:TASK:A:WCONdition? <WaitBits>[, <Timeout>]
STATus:OPERation:TASK:A:<netw_std>:WCONdition? <WaitBits>[, <Timeout>]

STATus:OPERation:TASK:A:<netw_std>:<func_grp>:WCONdition? <WaitBits>[, <Timeout>]

STATus:OPERation:TASK:A:<netw_std>:<func_grp>:<appl>:WCONdition? <WaitBits>[, <Timeout>]

Waits until at least one bit is set to true in the CONdition part of the status register, that has also been set in the <WaitBits>. In other words, waits until an AND operation between the bit patterns yields a positive result.

An optional timeout can be defined. When the AND operation yields a positive result or the timeout is reached, the command returns the result of the AND operation.

The command can be used e.g. to wait until a measurement has been finished before querying the measurement results.

For a description of the variables <netw_std>, <func_grp> and <appl> refer to [table 6-3](#).

Query parameters:

<WaitBits> Range: 0 to 65535 (decimal representation)

<Timeout> Timeout in ms

Return values:

<Result> Result of the AND operation. A 0 indicates that a timeout occurred.

Range: 0 to 65535 (decimal representation)

Example:

INIT:GPRF:MEAS:POW

STAT:OPER:TASK:A:GPRF:MEAS:POW:WCON? 9,1000

Initiate a GPRF power measurement and wait until it has reached the state OFF or RDY. OFF is indicated by bit number 0 (decimal 1) and RDY by bit number 3 (decimal 8). The decimal sum equals 9. The timeout is set to 1000 ms.

The returned value is 0, 1 or 8 (timeout occurred, state OFF reached or state RDY reached).

Usage: Query only

Firmware/Software: V2.0.10

STATus:OPERation:WEVent? <WaitBits>[, <Timeout>]

STATus:OPERation:TASK:WEVent? <WaitBits>[, <Timeout>]

STATus:OPERation:TASK:A:WEVent? <WaitBits>[, <Timeout>]

STATus:OPERation:TASK:A:<netw_std>:WEVent? <WaitBits>[, <Timeout>]

STATus:OPERation:TASK:A:<netw_std>:<func_grp>:WEVent? <WaitBits>[, <Timeout>]

STATus:OPERation:TASK:A:<netw_std>:<func_grp>:<appl>:WEVent? <WaitBits>[, <Timeout>]

Waits until at least one bit is set in the EVent part of the status register, that has also been set in the <WaitBits>. In other words, waits until an AND operation between the bit patterns yields a positive result.

An optional timeout can be defined. When the AND operation yields a positive result or the timeout is reached, the command returns the result of the AND operation. The bits corresponding to this result are cleared in the EVENT part.

For a description of the variables <netw_std>, <func_grp> and <appl> refer to [table 6-3](#).

Query parameters:

<WaitBits> Range: 0 to 65535 (decimal representation)
 <Timeout> Timeout in ms

Return values:

<Result> Result of the AND operation. A 0 indicates that a timeout occurred.
 Range: 0 to 65535 (decimal representation)

Example:

```
STAT:OPER:TASK:A:GPRF:MEAS:POW:PTR 0
STAT:OPER:TASK:A:GPRF:MEAS:POW:NTR 65535
```

Configure the transition registers so that the EVENT part of the status register reports only transitions from 1 to 0.

```
INIT:GPRF:MEAS:POW
STAT:OPER:TASK:A:GPRF:MEAS:POW:WEV? 4,1000
```

Initiate a GPRF power measurement and wait until it has left the state RUN (bit number 2, decimal 4). The timeout is set to 1000 ms.

The returned value is 0 or 4 (timeout occurred or state RUN left).

Usage: Query only

Firmware/Software: V2.0.10

STATus:OPERation:BIT<n>:CONDition?

STATus:OPERation:BIT<n>[:EVENT]?

Returns bit no. <n> of the CONDition or EVENT part of the STATus:OPERation register, see also [Structure of an SCPI Status Register](#). To return the entire parts see [STATus:OPERation:CONDition?](#) and [STATus:OPERation\[:EVENT\]?](#).

Suffix:

<n> 8 to 12
 Number of the bit

Return values:

<BitValue> 0 | 1

Example:

```
STAT:OPER:BIT9:COND?
```

Query bit no. 9 of the CONDition part of the STATus:OPERation register.

Usage: Query only

Firmware/Software: V1.0.4.11

STATus:OPERation:BIT<n>:ENABLE <BitValue>

STATus:OPERation:BIT<n>:NTRansition <BitValue>

STATus:OPERation:BIT<n>:PTRansition <BitValue>

Sets bit no. <n> of the ENABLE, NTRansition or PTRansition part of the STATus:OPERation register, see also [Structure of an SCPI Status Register](#). To set the entire parts see [STATus:OPERation:ENABLE](#), [STATus:OPERation:NTRansition](#) and [STATus:OPERation:PTRansition](#).

Suffix:

<n> 8 to 12
Number of the bit

Parameters:

<BitValue> 0 | 1

Example:

STAT:OPER:BIT9:ENAB 1

Set bit no. 9 of the ENABLE part of the STATus:OPERation register.

Firmware/Software: V1.0.4.11

6.3.13.3 STATus:OPERation (Extended Commands)

The commands listed in this section serve the same purpose as the elementary commands, see [chapter 6.3.13.2, "STATus:OPERation \(Elementary Commands\)"](#), on page 272.

However the extended commands provide more comfort by mapping bit values to the corresponding status register mnemonics whenever possible. Thus they allow to control the STATus:OPERation register hierarchy without knowing it by heart at bit level.

For a complete overview of the mnemonics used in the register hierarchy see [STATus:OPERation](#) and [SYSTEM:HELP:STATus\[:REGister\]?](#), [SYSTEM:HELP:STATus:BITS?](#).

Settings

Assume that you want to set the enable mask for the states OFF and RDY of the GPRF external power sensor measurement 1, up to the highest level of the hierarchy. You can do this by studying the hierarchy and setting the correct bits using the following elementary commands:

```
STATus:OPERation:TASK:A:GPRF:MEAS1:EPSensor:ENABle 9
STATus:OPERation:TASK:A:GPRF:MEAS1:ENABle 4
STATus:OPERation:TASK:A:GPRF:ENABle 1
STATus:OPERation:TASK:A:ENABle 2
STATus:OPERation:TASK:ENABle 1
STATus:OPERation:ENABle 512
```

Or you use the following extended commands. Knowing the first command is sufficient to write down all subsequent commands correctly, because the first (lowest level) command reflects the entire register path up to the highest level and contains all mnemonics:

```

STATus:OPERation:TASK:A:GPRF:MEAS1:EPSensor:XENable (OFF, RDY)
STATus:OPERation:TASK:A:GPRF:MEAS1:XENable (EPSensor)
STATus:OPERation:TASK:A:GPRF:XENable (MEAS1)
STATus:OPERation:TASK:A:XENable (GPRF)
STATus:OPERation:TASK:XENable (A)
STATus:OPERation:XENable (TASK)

```

Extended commands accept also decimal numbers in addition to mnemonics. If you use a mixture of numbers and mnemonics, both the decimal numbers and the mnemonics are internally translated into bits and the sum of all bits is set. Example: To set the enable mask for the GPRF measurements POWER (bit 0), EPSensor (bit 2) and IQRecorder (bit 3) you can e.g. use one the following commands. All commands yield the same result.

```

STATus:OPERation:TASK:A:GPRF:MEAS1:XENable (POWER, EPSensor, IQRecorder)
STATus:OPERation:TASK:A:GPRF:MEAS1:XENable (POWER, EPSensor, 8)
STATus:OPERation:TASK:A:GPRF:MEAS1:XENable (POWER, EPSensor, 12)
STATus:OPERation:TASK:A:GPRF:MEAS1:XENable (POWER, 12)
STATus:OPERation:TASK:A:GPRF:MEAS1:XENable (13)

```

Queries

A query using an extended command returns a list of mnemonics, i.e. the returned bit pattern is translated into the corresponding mnemonics. If the bit pattern contains also bits set to true that can not be translated because they have no mnemonics assigned in the register hierarchy, these bits are summed up and listed as an additional decimal number. If no bit at all is set, empty brackets are returned.

Example: Assume that the bits number 1, 2, 10 and 12 have been set for the ENABLE part of register STATus:OPERation:TASK:A:GPRF:POW. Bit 1 and 2 can be translated into QUED and RUN, but bits 10 and 12 have no mnemonics. These two bits are presented as $2^{10}+2^{12} = 1024+4096 = 5120$.

The query STATus:OPERation:TASK:A:GPRF:MEAS:POW:XENable? returns (QUE, RUN, 5120).

Example: Assume that no event has occurred since the last query. The event register equals 0. No bit is set to true.

The query STATus:OPERation:TASK:A:GPRF:MEAS:POW:XEvent? returns ().

STATus:OPERation:XCONdition?	282
STATus:OPERation:TASK:XCONdition?	282
STATus:OPERation:TASK:A:XCONdition?	282
STATus:OPERation:TASK:A:<netw_std>:XCONdition?	282
STATus:OPERation:TASK:A:<netw_std>:<func_grp>:XCONdition?	282
STATus:OPERation:TASK:A:<netw_std>:<func_grp>:<appl>:XCONdition?	282
STATus:OPERation:XENable	283
STATus:OPERation:TASK:XENable	283
STATus:OPERation:TASK:A:XENable	283
STATus:OPERation:TASK:A:<netw_std>:XENable	283
STATus:OPERation:TASK:A:<netw_std>:<func_grp>:XENable	283
STATus:OPERation:TASK:A:<netw_std>:<func_grp>:<appl>:XENable	283
STATus:OPERation:XESRq	283

STATus:OPERation:TASK:XESRq.....	283
STATus:OPERation:TASK:A:XESRq.....	283
STATus:OPERation:TASK:A:<netw_std>:XESRq.....	283
STATus:OPERation:TASK:A:<netw_std>:<func_grp>:XESRq.....	283
STATus:OPERation:TASK:A:<netw_std>:<func_grp>:<appl>:XESRq.....	283
STATus:OPERation:XEVEnt?.....	284
STATus:OPERation:TASK:XEVEnt?.....	284
STATus:OPERation:TASK:A:XEVEnt?.....	284
STATus:OPERation:TASK:A:<netw_std>:XEVEnt?.....	284
STATus:OPERation:TASK:A:<netw_std>:<func_grp>:XEVEnt?.....	284
STATus:OPERation:TASK:A:<netw_std>:<func_grp>:<appl>:XEVEnt?.....	284
STATus:OPERation:XNTRansition.....	284
STATus:OPERation:TASK:XNTRansition.....	284
STATus:OPERation:TASK:A:XNTRansition.....	284
STATus:OPERation:TASK:A:<netw_std>:XNTRansition.....	284
STATus:OPERation:TASK:A:<netw_std>:<func_grp>:XNTRansition.....	285
STATus:OPERation:TASK:A:<netw_std>:<func_grp>:<appl>:XNTRansition.....	285
STATus:OPERation:XPTRansition.....	285
STATus:OPERation:TASK:XPTRansition.....	285
STATus:OPERation:TASK:A:XPTRansition.....	285
STATus:OPERation:TASK:A:<netw_std>:XPTRansition.....	285
STATus:OPERation:TASK:A:<netw_std>:<func_grp>:XPTRansition.....	285
STATus:OPERation:TASK:A:<netw_std>:<func_grp>:<appl>:XPTRansition.....	285
STATus:OPERation:XWCondition?.....	285
STATus:OPERation:TASK:XWCondition?.....	285
STATus:OPERation:TASK:A:XWCondition?.....	285
STATus:OPERation:TASK:A:<netw_std>:XWCondition?.....	285
STATus:OPERation:TASK:A:<netw_std>:<func_grp>:XWCondition?.....	286
STATus:OPERation:TASK:A:<netw_std>:<func_grp>:<appl>:XWCondition?.....	286
STATus:OPERation:XWEVEnt?.....	286
STATus:OPERation:TASK:XWEVEnt?.....	286
STATus:OPERation:TASK:A:XWEVEnt?.....	286
STATus:OPERation:TASK:A:<netw_std>:XWEVEnt?.....	286
STATus:OPERation:TASK:A:<netw_std>:<func_grp>:XWEVEnt?.....	286
STATus:OPERation:TASK:A:<netw_std>:<func_grp>:<appl>:XWEVEnt?.....	286

STATus:OPERation:XCONdition?**STATus:OPERation:TASK:XCONdition?****STATus:OPERation:TASK:A:XCONdition?****STATus:OPERation:TASK:A:<netw_std>:XCONdition?****STATus:OPERation:TASK:A:<netw_std>:<func_grp>:XCONdition?****STATus:OPERation:TASK:A:<netw_std>:<func_grp>:<appl>:XCONdition?**

Returns the contents of the CONdition part of the status register, see [Structure of an SCPI Status Register](#). Reading the CONdition registers is nondestructive.

For a description of the variables <netw_std>, <func_grp> and <appl> refer to [table 6-3](#).

Return values:

<List> Comma separated list of mnemonics (and/or decimal numbers between 0 and 65535) enclosed in brackets

Example:

```
STAT:OPER:TASK:A:GPRF:GEN:UNIV:XCON?
Query the CONDition part of the status register for the GPRF
generator. The result is (OFF) or (PEND) or (ON).
```

Usage:

Query only

Firmware/Software: V2.0.10

STATus:OPERation:XENable <List>

STATus:OPERation:TASK:XENable <List>

STATus:OPERation:TASK:A:XENable <List>

STATus:OPERation:TASK:A:<netw_std>:XENable <List>

STATus:OPERation:TASK:A:<netw_std>:<func_grp>:XENable <List>

STATus:OPERation:TASK:A:<netw_std>:<func_grp>:<appl>:XENable <List>

Sets the enable mask which allows true conditions in the EVENT part of the status register to be reported in the summary bit. If a bit is 1 in the enable register and its associated event bit transitions to true, a positive transition will occur in the summary bit reported to the next higher level. See also [Structure of an SCPI Status Register](#).

For a description of the variables <netw_std>, <func_grp> and <appl> refer to [table 6-3](#).

Parameters:

<List> Comma separated list of mnemonics (and/or decimal numbers between 0 and 65535) enclosed in brackets

Example:

```
STAT:OPER:TASK:A:GPRF:MEAS:XEN (EPS,IQR)
Set the enable mask bits corresponding to the measurements
EPSensor (bit 2) and IQRecorder (bit 3) to true.
```

Firmware/Software: V2.0.10

STATus:OPERation:XESRq <List>

STATus:OPERation:TASK:XESRq <List>

STATus:OPERation:TASK:A:XESRq <List>

STATus:OPERation:TASK:A:<netw_std>:XESRq <List>

STATus:OPERation:TASK:A:<netw_std>:<func_grp>:XESRq <List>

STATus:OPERation:TASK:A:<netw_std>:<func_grp>:<appl>:XESRq <List>

Sets the enable mask for the register according to the specified list. Also sets the relevant bit in the enable mask of all higher registers up to the STATus:OPERation register and the SRE. Thus the entire reporting path from the register up to the SRE is enabled so that an SRQ can be generated.

If an empty list is specified (set enable mask to 0), the higher registers are not modified.

For a description of the variables <netw_std>, <func_grp> and <appl> refer to [table 6-3](#).

Parameters:

<List> Comma separated list of mnemonics (and/or decimal numbers between 0 and 65535) enclosed in brackets

Example:

```
STAT:OPER:TASK:A:GPRF:MEAS:POW:XESRq (RUN)
```

Sets the RUN bit (bit 2) and disables all other bits in the ENABLE part of the following status register:

```
STAT:OPER:TASK:A:GPRF:MEAS:POW
```

Also sets the relevant bit in the ENABLE part of the following status registers, without changing the other bits of these ENABLE parts:

```
STAT:OPER:TASK:A:GPRF:MEAS: set POW bit
```

```
STAT:OPER:TASK:A:GPRF: set MEAS1 bit
```

```
STAT:OPER:TASK:A: set GPRF bit
```

```
STAT:OPER:TASK: set A bit
```

```
STAT:OPER: set TASK bit
```

```
SRE: set OPER bit
```

Firmware/Software: V2.0.10

STATus:OPERation:XEvent?

STATus:OPERation:TASK:XEvent?

STATus:OPERation:TASK:A:XEvent?

STATus:OPERation:TASK:A:<netw_std>:XEvent?

STATus:OPERation:TASK:A:<netw_std>:<func_grp>:XEvent?

STATus:OPERation:TASK:A:<netw_std>:<func_grp>:<appl>:XEvent?

Returns the contents of the EVENT part of the status register. Reading an EVENT part clears it. See also [Structure of an SCPI Status Register](#).

For a description of the variables <netw_std>, <func_grp> and <appl> refer to [table 6-3](#).

Return values:

<List> Comma separated list of mnemonics (and/or decimal numbers between 0 and 65535) enclosed in brackets

Example:

```
STAT:OPER:TASK:A:GPRF:MEAS:POW:XEV?
```

Query the EVENT part of the status register for the GPRF power measurement to check whether an event has occurred since the last reading.

Usage:

Query only

Firmware/Software: V2.0.10

STATus:OPERation:XNTRansition <List>

STATus:OPERation:TASK:XNTRansition <List>

STATus:OPERation:TASK:A:XNTRansition <List>

STATus:OPERation:TASK:A:<netw_std>:XNTRansition <List>

STATus:OPERation:TASK:A:<netw_std>:<func_grp>:XNTRansition <List>

STATus:OPERation:TASK:A:<netw_std>:<func_grp>:<appl>:XNTRansition <List>

Sets the negative transition filter. If a bit is set, a 1 to 0 transition in the corresponding bit of the associated condition register causes a 1 to be written in the associated bit of the corresponding event register. See also [Structure of an SCPI Status Register](#).

For a description of the variables <netw_std>, <func_grp> and <appl> refer to [table 6-3](#).

Parameters:

<List> Comma separated list of mnemonics (and/or decimal numbers between 0 and 65535) enclosed in brackets

Example:

STAT:OPER:TASK:A:GPRF:MEAS1:POW:XNTR (OFF,RDY)

Set the negative transition filter bits corresponding to the GPRF power measurement states OFF (bit 0) and RDY (bit 3) to 1.

Firmware/Software: V2.0.10

STATus:OPERation:XPTRansition <List>

STATus:OPERation:TASK:XPTRansition <List>

STATus:OPERation:TASK:A:XPTRansition <List>

STATus:OPERation:TASK:A:<netw_std>:XPTRansition <List>

STATus:OPERation:TASK:A:<netw_std>:<func_grp>:XPTRansition <List>

STATus:OPERation:TASK:A:<netw_std>:<func_grp>:<appl>:XPTRansition <List>

Sets the positive transition filter. If a bit is set, a 0 to 1 transition in the corresponding bit of the associated condition register causes a 1 to be written in the associated bit of the corresponding event register. See also [Structure of an SCPI Status Register](#).

For a description of the variables <netw_std>, <func_grp> and <appl> refer to [table 6-3](#).

Parameters:

<List> Comma separated list of mnemonics (and/or decimal numbers between 0 and 65535) enclosed in brackets

Example:

STAT:OPER:TASK:A:GPRF:MEAS1:POW:XPTR (OFF,RDY)

Set the positive transition filter bits corresponding to the GPRF power measurement states OFF (bit 0) and RDY (bit 3) to 1.

Firmware/Software: V2.0.10

STATus:OPERation:XWCondition? <Wait>[, <Timeout>]

STATus:OPERation:TASK:XWCondition? <Wait>[, <Timeout>]

STATus:OPERation:TASK:A:XWCondition? <Wait>[, <Timeout>]

STATus:OPERation:TASK:A:<netw_std>:XWCondition? <Wait>[, <Timeout>]

STATus:OPERation:TASK:A:<netw_std>:<func_grp>:XWCondition? <Wait>[, <Timeout>]

STATus:OPERation:TASK:A:<netw_std>:<func_grp>:<appl>:XWCondition? <Wait>[, <Timeout>]

Waits until at least one bit is set to true in the CONDition part of the status register, that is also set to true in the bit pattern corresponding to the <Wait> list. In other words, waits until an AND operation between the bit patterns yields a positive result.

An optional timeout can be defined. When the AND operation yields a positive result or the timeout is reached, the command returns the result of the AND operation.

The command can be used e.g. to wait until a measurement has been finished before querying the measurement results.

For a description of the variables <netw_std>, <func_grp> and <appl> refer to [table 6-3](#).

Query parameters:

<Wait> Comma separated list of mnemonics (and/or decimal numbers between 0 and 65535) enclosed in brackets

<Timeout> Timeout in ms

Return values:

<Result> Result of the AND operation, as a comma separated list of mnemonics (and/or decimal numbers between 0 and 65535) enclosed in brackets. Empty brackets indicate that a timeout occurred.

Example:

```
INIT:GPRF:MEAS:POW
STAT:OPER:TASK:A:GPRF:MEAS:POW:XWC?(RDY),1000
```

Initiate a GPRF power measurement and wait until it has reached the state RDY. The timeout is set to 1000 ms. The returned value is () or RDY (timeout occurred or state RDY reached).

Usage: Query only

Firmware/Software: V2.0.10

STATus:OPERation:XWEVent? <Wait>[, <Timeout>]

STATus:OPERation:TASK:XWEVent? <Wait>[, <Timeout>]

STATus:OPERation:TASK:A:XWEVent? <Wait>[, <Timeout>]

STATus:OPERation:TASK:A:<netw_std>:XWEVent? <Wait>[, <Timeout>]

STATus:OPERation:TASK:A:<netw_std>:<func_grp>:XWEVent? <Wait>[, <Timeout>]

STATus:OPERation:TASK:A:<netw_std>:<func_grp>:<appl>:XWEVent? <Wait>[, <Timeout>]

Waits until at least one bit is set to true in the EVEnt part of the status register, that is also set to true in the bit pattern corresponding to the <Wait> list. In other words, waits until an AND operation between the bit patterns yields a positive result.

An optional timeout can be defined. When the AND operation yields a positive result or the timeout is reached, the command returns the result of the AND operation. The bits corresponding to this result are cleared in the EVENT part.

For a description of the variables <netw_std>, <func_grp> and <appl> refer to [table 6-3](#).

Query parameters:

<Wait> Comma separated list of mnemonics (and/or decimal numbers between 0 and 65535) enclosed in brackets

<Timeout> Timeout in ms

Return values:

<Result> Result of the AND operation, as a comma separated list of mnemonics (and/or decimal numbers between 0 and 65535) enclosed in brackets. Empty brackets indicate that a timeout occurred.

Example:

```
STAT:OPER:TASK:A:GPRF:MEAS:POW:XPTR ( )
STAT:OPER:TASK:A:GPRF:MEAS:POW:YNTR (RUN)
Configure the transition registers so that the EVENT part of the
status register reports only transitions from 1 to 0 for the bit cor-
responding to the measurement state RUN.
INIT:GPRF:MEAS:POW
STAT:OPER:TASK:A:GPRF:MEAS:POW:XWEV? (RUN),1000
Initiate a GPRF power measurement and wait until it has left the
state RUN. The timeout is set to 1000 ms.
The returned value is ( ) or (RUN) (timeout occurred or state
RUN left).
```

Usage: Query only

Firmware/Software: V2.0.10

6.3.13.4 STATus:OPERation (Overall Evaluation)

Information about the current state of tasks and state transitions of tasks can be derived from evaluation of the STATus:OPERation register hierarchy. This can be a laborious task if you have to query the registers one by one, tracing events top down and interpreting the decimal representation of bit values.

The commands listed below offer a much more comfortable way to evaluate the STATus:OPERation register hierarchy. They allow to query the current states or state transitions of all tasks. You can even display all measurement or generator tasks being in a certain state. And you can use the command `STATus:EVENT:BITS:NEXT?` within programs reacting on state transitions.

Most commands return a single string or a comma separated list of strings. Each string is composed of the complete path of the status register plus the state. Example of a result list (with additional line breaks for better readability):

```
"STAT:OPER:TASK:A:GPRF:MEAS1:POW:OFF",
"STAT:OPER:TASK:A:GPRF:MEAS1:IQVS:QUED",
```

```
"STAT:OPER:TASK:A:GPRF:MEAS1:EPS:RUN",
"STAT:OPER:TASK:A:GPRF:MEAS1:IQR:OFF",
"STAT:OPER:TASK:A:GPRF:GEN1:UNIV:ON"
```

The available commands are listed below.

STATus:CONDition:BITS:ALL?	288
STATus:CONDition:BITS:COUNt?	289
STATus:CONDition:BITS:CATalogue?	289
STATus:EVENT:BITS:ALL?	289
STATus:EVENT:BITS:CLEar	290
STATus:EVENT:BITS:COUNt?	290
STATus:EVENT:BITS:NEXt?	290
STATus:GENerator:CONDition:OFF?	291
STATus:GENerator:CONDition:PENDING?	291
STATus:GENerator:CONDition:ON?	291
STATus:MEASurement:CONDition:OFF?	291
STATus:MEASurement:CONDition:QUED?	291
STATus:MEASurement:CONDition:RDY?	291
STATus:MEASurement:CONDition:RUN?	291
STATus:MEASurement:CONDition:SDReached?	291

STATus:CONDition:BITS:ALL? [<RegExp>]

This command offers a comfortable way to get an overview of all task states, without querying each register individually.

It evaluates the CONDition parts of the lowest level OPERation status registers. The result consists of a comma separated list of strings. Each string indicates the state of one task and is composed of the complete path of the status register plus the state. The command is nondestructive.

In most situations the returned list shows all task states of the installed firmware applications. However it may happen that a task is not listed if currently no resources at all are assigned to that task (e.g. directly after installation). In that case you could say that the state of the task is less than "OFF".

Query parameters:

'<RegExp>' Optional regular expression filtering the returned results, see also [Regular Expressions](#).

Example:

```
STATus:CONDition:BITS:ALL? '(POW)|(IQV)'
```

List the current task states of the installed firmware applications. Limit the results to strings containing 'POW' (GPRF power measurement) or 'IQV' (GPRF IQ vs slot measurement).

Usage: Query only

Firmware/Software: V1.0.4.11

STATus:CONDition:BITS:COUNT? [<RegExp>]

Returns the number of task states listed by `STATus:CONDition:BITS:ALL?`.

Query parameters:

'<RegExp>' Optional regular expression filtering the task states before they are counted, see also [Regular Expressions](#).

Example:

```
STATus:CONDition:BITS:COUNT?
List the number of task states returned by
STATus:CONDition:BITS:ALL?.
```

Usage: Query only

Firmware/Software: V1.0.4.11

STATus:CONDition:BITS:CATaloge? [<RegExp>]

Returns a list of all possible task states for the installed firmware applications. The current task states returned by `STATus:CONDition:BITS:ALL?` form a subset of the list returned by this command.

Query parameters:

'<RegExp>' Optional regular expression filtering the returned results, see also [Regular Expressions](#).

Example:

```
STATus:CONDition:BITS:CATaloge?
List all possible task states of the installed firmware applications.
```

Usage: Query only

Firmware/Software: V1.0.4.11

STATus:EVENT:BITS:ALL? [<RegExp>]

Evaluates the `EVENT` parts of all lowest level `OPERation` status registers. The result consists of a comma separated list of strings. Each string is composed of the complete path of the status register plus the state. The command is nondestructive.

This command offers a comfortable way to get an overview of the `EVENT` parts of all lowest level registers, without querying each register individually.

Query parameters:

'<RegExp>' Optional regular expression filtering the returned results, see also [Regular Expressions](#).

Example:

```
STATus:EVENT:BITS:ALL? '[RDY] $'
List the EVENT parts of the lowest level status registers. Limit the
results to strings ending with 'RDY'.
```

Usage: Query only

Firmware/Software: V1.0.4.11

STATus:EVENT:BITS:CLEAr ['<RegExp>']

Clears the EVENT parts of all status registers of the STATus:OPERation register hierarchy. If a regular expression is defined, the command is only applied to the registers matching the filter criteria.

Query parameters:

'<RegExp>' Optional regular expression. The EVENT part is only cleared for registers matching the regular expression. See also [Regular Expressions](#).

Example:

```
STAT:EVENT:BITS:CLEAr '! [IQR]'
```

Clear all status registers except the IQ recorder registers (clear if string does not contain 'IQR').

Usage: Event

Firmware/Software: V1.0.4.11

STATus:EVENT:BITS:COUNT? ['<RegExp>']

Returns the number of events listed by STATus:EVENT:BITS:ALL?.

Query parameters:

'<RegExp>' Optional regular expression filtering the events before they are counted, see also [Regular Expressions](#).

Example:

```
STATus:EVENT:BITS:COUNT?
```

List the number of events returned by

```
STATus:EVENT:BITS:ALL?.
```

Usage: Query only

Firmware/Software: V1.0.4.11

STATus:EVENT:BITS:NEXT? ['<RegExp>']

Searches, returns and deletes the next event at the lowest level of the STATus:OPERation register hierarchy. An entry consists of a string composed of the complete path of the status register reporting the event and the state.

This command can be used to supply state transitions to a remote control program one by one. The program can then react on the transitions, e.g. fetch the results of a measurement that reached the RDY or SDR state, or start a new measurement after a measurement has been finished.

A list of all events in the STATus:OPERation register hierarchy can be returned using STATus:EVENT:BITS:ALL?.

Query parameters:

'<RegExp>' Optional regular expression. Events not matching the regular expression are ignored when searching for the next event. See also [Regular Expressions](#).

Example: `STATus:EVENT:BITS:NEXT?`
Query and delete the next event.

Usage: Query only

Firmware/Software: V1.0.4.11

`STATus:GENerator:CONDition:OFF? [<RegExp>]`
`STATus:GENerator:CONDition:PENDING? [<RegExp>]`
`STATus:GENerator:CONDition:ON? [<RegExp>]`
`STATus:MEASurement:CONDition:OFF? [<RegExp>]`
`STATus:MEASurement:CONDition:QUED? [<RegExp>]`
`STATus:MEASurement:CONDition:RDY? [<RegExp>]`
`STATus:MEASurement:CONDition:RUN? [<RegExp>]`
`STATus:MEASurement:CONDition:SDReached? [<RegExp>]`

Lists all generator tasks or measurement tasks whose current state equals the state indicated by the last mnemonic.

The results are collected from the CONDition parts of the lowest level registers of the STATus:OPERation register hierarchy. They are returned as a comma separated list of strings. Each string is composed of the complete path of the status register plus the current state.

Query parameters:

'<RegExp>' Optional regular expression filtering the returned results, see also [Regular Expressions](#).

Example: `STATus:MEASurement:CONDition:RDY? 'GPRF'`
List all tasks with current state "Ready". Limit the results to strings containing 'GPRF'.

Usage: Query only

Firmware/Software: V1.0.4.11

6.3.13.5 STATus:QUEStionable

The STATus:QUEStionable subsystem controls the status reporting structures of the STATus:QUEStionable register, see [STATus:QUEStionable](#).

Unless otherwise stated, all of the following commands are SCPI-confirmed. Note that *RST does not influence the status registers (see also [Reset Values of the Status Reporting System](#)).

The available commands are listed below.

STATus:QUEStionable:CONDition?	292
STATus:QUEStionable:ENABle	292
STATus:QUEStionable[:EVENT]?	292
STATus:QUEStionable:NTRansition	293
STATus:QUEStionable:PTRansition	293
STATus:QUEStionable:BIT<n>:CONDition?	293
STATus:QUEStionable:BIT<n>[:EVENT]?	293

STATus:QUEStionable:BIT<n>:ENABle	294
STATus:QUEStionable:BIT<n>:NTRansition	294
STATus:QUEStionable:BIT<n>:PTRansition	294

STATus:QUEStionable:CONDition?

Returns the contents of the CONDition part of the status register. Reading the CONDition registers is nondestructive. See also [Structure of an SCPI Status Register](#).

Return values:

<ConditionBits> Range: 0 to 65535 (decimal representation)

Example:

STAT:QUES:COND?

Query the CONDition part of the QUEStionable register to check for questionable instrument states.

Usage: Query only

Firmware/Software: V1.0.0.4

STATus:QUEStionable:ENABle <MaskBits>

Sets the enable mask which allows true conditions in the EVENT part of the status register to be reported in the summary bit. If a bit is 1 in the enable register and its associated event bit transitions to true, a positive transition will occur in the summary bit reported to the next higher level. See also [Structure of an SCPI Status Register](#).

Parameters:

<MaskBits> Range: 0 to 65535 (decimal representation)

Example:

STAT:QUES:ENAB 1536

Set bits no. 9 and 10 of the QUEStionable:ENABle register (1536 = 512 + 1024 = 2⁹ + 2¹⁰).

Firmware/Software: V1.0.0.4

STATus:QUEStionable[:EVENT]?

Returns the contents of the EVENT part of the status register. Reading an EVENT register clears it. See also [Structure of an SCPI Status Register](#).

Return values:

<EventBits> Range: 0 to 65535 (decimal representation)

Example:

STAT:QUES?

Query the EVENT part of the QUEStionable register to check whether an event has occurred since the last reading.

Usage: Query only

Firmware/Software: V1.0.0.4

STATus:QUEStionable:NTRansition <FilterBits>

Sets the negative transition filter. If a bit is set, a 1 to 0 transition in the corresponding bit of the associated condition register causes a 1 to be written in the associated bit of the corresponding event register. See also [Structure of an SCPI Status Register](#).

Parameters:

<FilterBits> Range: 0 to 65535 (decimal representation)

Example:

STAT:QUES:NTR 1536

Set bits no. 9 and 10 of the QUEStionable:NTRansition register ($1536 = 512 + 1024 = 2^9 + 2^{10}$).

Firmware/Software: V1.0.0.4

STATus:QUEStionable:PTRansition <FilterBits>

Sets the positive transition filter. If a bit is set, at 0 to 1 transition in the corresponding bit of the associated condition register causes a 1 to be written in the associated bit of the corresponding event register. See also [Structure of an SCPI Status Register](#).

Parameters:

<FilterBits> Range: 0 to 65535 (decimal representation)

Example:

STAT:QUES:PTR 1536

Set bits no. 9 and 10 of the QUEStionable:PTRansition register ($1536 = 512 + 1024 = 2^9 + 2^{10}$).

Firmware/Software: V1.0.0.4

STATus:QUEStionable:BIT<n>:CONDition?**STATus:QUEStionable:BIT<n>[:EVENT]?**

Returns bit no. <n> of the CONDition or EVENT part of the STATus:QUEStionable register, see [Structure of an SCPI Status Register](#). To return the entire parts see [STATus:QUEStionable:CONDition?](#) and [STATus:QUEStionable\[:EVENT\]?](#).

Suffix:

<n> 8 to 12
Number of the bit

Return values:

<BitValue> 0 | 1

Example:

STAT:QUES:BIT9:COND?

Query bit no. 9 of the CONDition part of the STATus:QUEStionable register.

Usage:

Query only

Firmware/Software: V1.0.4.11

STATus:QUEStionable:BIT<n>:ENABle <BitValue>
STATus:QUEStionable:BIT<n>:NTRAnsiTion <BitValue>
STATus:QUEStionable:BIT<n>:PTRAnsiTion <BitValue>

Sets bit no. <n> of the ENABle, NTRAnsiTion or PTRAnsiTion part of the STATus:QUEStionable register, see also [Structure of an SCPI Status Register](#). To set the entire parts see [STATus:QUEStionable:ENABle](#), [STATus:QUEStionable:NTRAnsiTion](#) and [STATus:QUEStionable:PTRAnsiTion](#).

Suffix:

<n> 8 to 12
 Number of the bit

Parameters:

<BitValue> 0 | 1

Example:

STAT:QUES:OPER:BIT9:ENAB 1

Set bit no. 9 of the ENABle part of the STATus:QUEStionable register.

Firmware/Software: V1.0.4.11

6.3.14 System Date and Time

The following commands configure or query the date and time settings of the operating system. Note that *RST does not affect these settings.

SYSTem:DATE[:UTC]	294
SYSTem:DATE:LOCal	295
SYSTem:TIME[:UTC]	295
SYSTem:TIME:LOCAl	295
SYSTem:TIME:DSTime:MODE	295
SYSTem:TIME:DSTime:RULE:CATalog?	296
SYSTem:TIME:DSTime:RULE	296
SYSTem:TZONE	297

SYSTem:DATE[:UTC] <Year>, <Month>, <Day>

Sets the UTC date of the operating system calendar.

Parameters:

<Year> Range: four-digit number

<Month> Range: 1 to 12

<Day> Range: 1 to n (depending on the <Month>)

Example:

SYSTem:DATE:UTC?

Query the UTC date. Possible response: 2012, 09, 19

Firmware/Software: V3.0.12

SYSTem:DATE:LOCal <Year>, <Month>, <Day>

Sets the local date of the operating system calendar.

Parameters:

<Year>	Range:	four-digit number
<Month>	Range:	1 to 12
<Day>	Range:	1 to n (depending on the <Month>)

Example:

SYSTem:DATE:LOCAl?
Query the local date. Possible response: 2012, 09, 20

Firmware/Software: V3.0.12

SYSTem:TIME[:UTC] <Hour>, <Minute>, <Second>

Sets the Universal Time Coordinated (UTC) of the operating system clock.

Parameters:

<Hour>	Range:	0 to 23
<Minute>	Range:	0 to 59
<Second>	Range:	0 to 59

Example:

SYSTem:TIME:UTC?
Query the UTC. Possible response: 13, 09, 20

Firmware/Software: V3.0.12

SYSTem:TIME:LOCAl <Hour>, <Minute>, <Second>

Sets the local time of the operating system clock.

Parameters:

<Hour>	Range:	0 to 23
<Minute>	Range:	0 to 59
<Second>	Range:	0 to 59

Example:

SYSTem:TIME:LOCAl?
Query the local time. Possible response: 15, 09, 20

Firmware/Software: V3.0.12

SYSTem:TIME:DSTime:MODE

Configures whether the operating system automatically adjusts its clock for Daylight Saving Time (DST) or not.

If the automatism is enabled, the operating system adjusts its internal clock in autumn to non DST and in spring to DST. The rules defining when exactly the clock must be adjusted by which offset depend on the configured time zone, see [SYSTem:TIME:DSTime:RULE](#).

If the automatism is disabled, the local time is calculated as:

local time = UTC + time zone offset (no DST offset)

Parameters:

<Enable> **1**: automatism enabled
 0: automatism disabled

Example:

SYSTem:TIME:DSTime:MODE 1

The clock is automatically adjusted in autumn and spring.

Firmware/Software: V3.0.12

V3.0.14: support of setting (before: query only)

SYSTem:TIME:DSTime:RULE:CATalog?

Returns all time zone values that can be set using [SYSTem:TIME:DSTime:RULE](#).

Return values:

<TimeZoneList> Comma separated list of all supported values. Each value is represented as a string.

Usage: Query only

Firmware/Software: V3.0.14

SYSTem:TIME:DSTime:RULE <TimeZone>

Sets the time zone in the date and time settings of the operating system.

The used Daylight Saving Time (DST) rules depend on the configured time zone. So this setting influences the automatic adjustment of the local time and date for DST. See also [SYSTem:TIME:DSTime:MODE](#).

Modifying the time zone modifies also the configured time zone offset, see [SYSTem:TZONE](#).

Parameters:

<TimeZone> Time zone as string
 To query a list of all supported strings, use [SYSTem:TIME:DSTime:RULE:CATalog?](#).

Example:

SYSTem:TIME:DSTime:RULE "W. Europe Standard Time"

The Western Europe time zone is set and the related DST rule set is used.

Firmware/Software: V3.0.14

SYSTem:TZONE <Hour>, <Minute>

Specifies the offset of the local time to the Universal Time Coordinated (UTC) due to the time zone. There may be an additional offset due to Daylight Saving Time (DST).

Changing the time zone (offset) does neither affect an eventual DST offset nor the time zone configured via `SYSTem:TIME:DSTime:RULE`.

The local time is calculated as: $local\ time = UTC + time\ zone\ offset + DST\ offset$

Parameters:

<Hour> Range: -12 to 15

<Minute> Range: -59 to 59

Example:

`SYSTem:TZONE?`

Query the time zone information. Possible response: -3, -30

Meaning: local time = UTC - 3 hours - 30 minutes + DST offset

Firmware/Software: V3.0.12

6.3.15 Miscellaneous Commands

<code>SYSTem:CONNector:TRANslation?</code>	297
<code>FORMat:BASE[:DATA]</code>	298
<code>SYSTem:BASE:RELIability?</code>	299
<code>SYSTem:GENERator:ALL:OFF</code>	299
<code>SYSTem:MEASurement:ALL:OFF</code>	299
<code>SYSTem:SIGNaling:ALL:OFF</code>	299
<code>SYSTem:DISPlay:UPDate</code>	299
<code>SYSTem:KLOCK</code>	300
<code>SYSTem:VERsion?</code>	300
<code>SENSe:BASE:TEMPerature:OPERating:INTernal?</code>	300

SYSTem:CONNector:TRANslation? <Connector>

Queries the relation between absolute and virtual connector names. You can query this relation for either an absolute or a virtual name. As a result both absolute and virtual name are returned. For background information see [chapter 5.4.5.2, "RF Connector Values"](#), on page 164.

Query parameters:

<Connector> RF10 | RF1C | RF2C | RF30 | RF3C | RF4C | RFAO | RFAC | RFBC

RF1C, RF2C, RF3C, RF4C, RF10, RF30:

RF 1 COM to RF 4 COM and RF 1/3 OUT front panel connectors

RFAC, RFBC, RFAO:

Virtual names for the RF COM and RF OUT connectors

Return values:

<VirtualConnector> RFAO | RFAC | RFBC

<AbsoluteConnector> RF10 | RF1C | RF2C | RF30 | RF3C | RF4C

Example: SYSTem:CONNector:TRANslation? RFAC
 Returns e.g. RFAC, RF1C
 SYSTem:CONNector:TRANslation? RF2C
 Returns e.g. RFBC, RF2C

Usage: Query only

Firmware/Software: V2.0.10

FORMat:BASE[:DATA] <DataType>[, <DataLength>]

Selects the format for numeric data transferred to and from the R&S CMW270, for example query results.

Parameters:

<DataType> ASCII | REAL | BINary | HEXadecimal | OCTal

ASCII

Numeric data is transferred as ASCII bytes. Floating point numbers are transferred in scientific E notation.

REAL

Numeric data is transferred in a definite length block as IEEE floating point numbers, see [Block Data Format](#).

BINary | HEXadecimal | OCTal

Numeric data is transferred in binary, hexadecimal or octal format.

*RST: ASC

<DataLength> The meaning depends on the <DataType> as listed below. A zero returned by a query means that the default value is used.

For ASCII

Decimal places of floating point numbers. That means, number of "b" digits in the scientific notation a.bbbbbbbE+ccc.

Default: 6 decimal places

For REAL

Length of floating point numbers in bits:

32 bits = 4 byte, format #14...

64 bits = 8 byte, format #18...

Default: 64 bits

For BINary, HEXadecimal, OCTal

Minimum number of digits. If the number is longer, more digits are used. If it is shorter, leading zeros are added.

Default: 0, no leading zeros

*RST: 0 (6 decimal places)

Example: The following examples show the number 123456 in different formats.

```

FORMat:BASE ASC,3 Result: 1.235E+005
FORMat:BASE ASC,6 Result: 1.234560E+005
FORMat:BASE REAL,32 Result: #14...
FORMat:BASE BIN,20 Result: #B00011110001001000000
FORMat:BASE BIN,2 Result: #B11110001001000000
FORMat:BASE HEX,8 Result: #H0001E240
FORMat:BASE OCT,10 Result: #Q0000361100

```

Usage: SCPI confirmed

Firmware/Software: V1.0.5.3
V3.2.50: <Length> configurable for ASCi

SYSTem:BASE:RELIability?

Returns a reliability value indicating errors detected by the base software.

Return values:

<Value> For reliability indicator values, see [chapter 5.4.4.1, "Reliability Indicator"](#), on page 157

Usage: Query only

Firmware/Software: V2.0.10

SYSTem:GENerator:ALL:OFF SYSTem:MEASurement:ALL:OFF SYSTem:SIGNaling:ALL:OFF

Switch off all generators, measurements or signaling applications.

Example: `SYSTem:SIGNaling:ALL:OFF`
Switches off all signaling applications. Same effect like pressing ON | OFF for all signaling applications currently generating a signal.

Usage: Event

Firmware/Software: V2.1.26

SYSTem:DISPlay:UPDate <Enable>

Defines whether the display shall be updated or not while the instrument is in the remote state. If the display (update) is switched off, the normal GUI is replaced by a static image while the instrument is in the remote state. Switching off the display can speed up the measurement. This is the recommended state.

See also [chapter 5.1.3.1, "Using the Display during Remote Control"](#), on page 130

Parameters:

<Enable> **ON | 1:** Display is shown and updated during remote control
OFF | 0: Display shows static image during remote control

Example:

SYSTem:DISPlay:UPDate ON
 Switch on the display update.

Firmware/Software: V1.0.5.3

SYSTem:KLOCK <State>

Locks or unlocks the local controls of the instrument. This includes the front panel keys, the keyboard, or other local interfaces.

Parameters:

<State> ON | OFF
ON: Local key locked (key lock enabled)
OFF: Local keys unlocked
 *RST: OFF

Example:

SYSTem:KLOCK ON
 Lock the local keys.

Usage:

SCPI confirmed

Firmware/Software: V1.0.0.4

SYSTem:VERSion?

Queries the SCPI version number to which the instrument complies. The instrument complies to the final SCPI version 1999.0.

Usage:

Query only
 SCPI confirmed

Firmware/Software: V1.0.0.4

SENSe:BASE:TEMPerature:OPERating:INTernal?

Queries the temperature within the instrument. The returned value indicates the average of the temperatures measured at the individual RF modules.

The recommended temperature range is illustrated in the following figure.

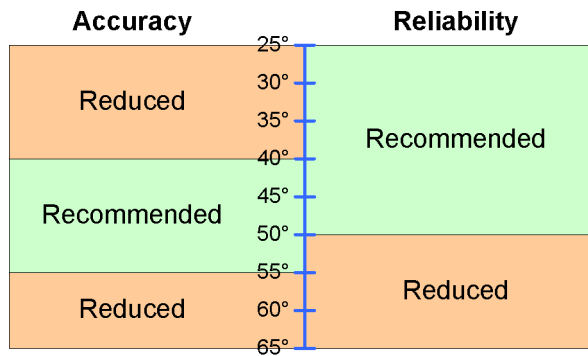
**Return values:**

<Temperature> Temperature in degrees
 Default unit: °C

Usage: Query only

Firmware/Software: V3.2.20

6.4 List of Commands

*DMC.....	208
*EMC.....	209
*GMC?.....	209
*LMC?.....	209
*PMC.....	210
*RMC.....	210
CALibration:BASE:ACFile?.....	270
CALibration:BASE:ALL?.....	269
CALibration:BASE:LATest:SPECific?.....	270
CALibration:BASE:LATest?.....	269
CLear:BASE:BUFFer.....	212
CONFigure:BASE:FCONtrol.....	267
CONFigure:BASE:FDCorrection:CTABLE:ADD.....	241
CONFigure:BASE:FDCorrection:CTABLE:CATalog?.....	243
CONFigure:BASE:FDCorrection:CTABLE:COUNT?.....	243
CONFigure:BASE:FDCorrection:CTABLE:CREate.....	240
CONFigure:BASE:FDCorrection:CTABLE:DELeTe.....	242
CONFigure:BASE:FDCorrection:CTABLE:DELeTe:ALL.....	243
CONFigure:BASE:FDCorrection:CTABLE:DETAils?.....	243
CONFigure:BASE:FDCorrection:CTABLE:ERASe.....	242
CONFigure:BASE:FDCorrection:CTABLE:EXISt?.....	242
CONFigure:BASE:FDCorrection:CTABLE:LENGTh?.....	244
CONFigure:BASE:FDCorrection:RCL.....	245
CONFigure:BASE:FDCorrection:SAV.....	244
CONFigure:BASE:IPSet:NWADapter<n>.....	265
CONFigure:BASE:IPSet:SNODE.....	264
CONFigure:BASE:MMONitor:IPADdress<n>.....	263

CONFigure:FDCorrection:ACTivate.....	245
CONFigure:FDCorrection:DEACTivate	246
CONFigure:FDCorrection:USAGe?.....	247
CONTInue:BASE:BUFFer.....	212
DELete:BASE:BUFFer.....	212
FETCH:BASE:BUFFer:LINecount?.....	213
FETCH:BASE:BUFFer?.....	212
FORMat:BASE[:DATA].....	298
HCOPY:DATA?.....	238
HCOPY:DEVice:FORMat.....	237
HCOPY:FILE.....	238
HCOPY:INTerior:DATA?.....	238
HCOPY:INTerior:FILE.....	238
MMEMory:ALlases?.....	225
MMEMory:ATTRibute.....	225
MMEMory:CATalog:LENGth?.....	227
MMEMory:CATalog?.....	226
MMEMory:CDIRectory.....	228
MMEMory:COPIY.....	228
MMEMory:DATA.....	228
MMEMory:DCATalog:LENGth?.....	230
MMEMory:DCATalog?.....	229
MMEMory:DELEte.....	230
MMEMory:DRIVes?.....	230
MMEMory:LOAD:ITEM.....	231
MMEMory:LOAD:MACRo.....	210
MMEMory:LOAD:STATe.....	232
MMEMory:MDIRectory.....	233
MMEMory:MOVE.....	233
MMEMory:MSIS.....	234
MMEMory:RCL.....	234
MMEMory:RDIRectory.....	234
MMEMory:SAV.....	235
MMEMory:STORE:ITEM.....	235
MMEMory:STORE:MACRo.....	210
MMEMory:STORE:STATe.....	237
SENSe:BASE:IPSet:SMONitor:DESCRiption?.....	267
SENSe:BASE:IPSet:SMONitor:ID?.....	267
SENSe:BASE:IPSet:SMONitor:NAME?.....	266
SENSe:BASE:IPSet:SMONitor:TYPE?.....	266
SENSe:BASE:IPSet:SNODE:NNAME?.....	264
SENSe:BASE:IPSet:SNODE:NSEGment?.....	265
SENSe:BASE:IPSet:SNODE:NTYPE?.....	264
SENSe:BASE:REFerence:FREQuency:LOCKed?.....	260
SENSe:BASE:TEMPerature:OPERating:INTernal?.....	300
STARt:BASE:BUFFer.....	213
STATus:CONDition:BITS:ALL?.....	288
STATus:CONDition:BITS:CATaloge?.....	289
STATus:CONDition:BITS:COUNT?.....	289
STATus:EVENT:BITS:ALL?.....	289

STATus:EVENT:BITS:CLEAr.....	290
STATus:EVENT:BITS:COUNT?.....	290
STATus:EVENT:BITS:NEXT?.....	290
STATus:GENerator:CONDition:OFF?.....	291
STATus:GENerator:CONDition:ON?.....	291
STATus:GENerator:CONDition:PENDING?.....	291
STATus:MEASurement:CONDition:OFF?.....	291
STATus:MEASurement:CONDition:QUED?.....	291
STATus:MEASurement:CONDition:RDY?.....	291
STATus:MEASurement:CONDition:RUN?.....	291
STATus:MEASurement:CONDition:SDReached?.....	291
STATus:OPERation:BIT<n>:CONDition?.....	279
STATus:OPERation:BIT<n>:ENABLE.....	280
STATus:OPERation:BIT<n>:NTRansition.....	280
STATus:OPERation:BIT<n>:PTRansition.....	280
STATus:OPERation:BIT<n>[:EVENT]?.....	279
STATus:OPERation:CONDition?.....	274
STATus:OPERation:ENABLE.....	275
STATus:OPERation:ESRQ.....	275
STATus:OPERation:NTRansition.....	276
STATus:OPERation:PTRansition.....	277
STATus:OPERation:TASK:A:<netw_std>:<func_grp>:<appl>:CONDition?.....	274
STATus:OPERation:TASK:A:<netw_std>:<func_grp>:<appl>:ENABLE.....	275
STATus:OPERation:TASK:A:<netw_std>:<func_grp>:<appl>:ESRQ.....	275
STATus:OPERation:TASK:A:<netw_std>:<func_grp>:<appl>:NTRansition.....	277
STATus:OPERation:TASK:A:<netw_std>:<func_grp>:<appl>:PTRansition.....	277
STATus:OPERation:TASK:A:<netw_std>:<func_grp>:<appl>:WCONDition?.....	278
STATus:OPERation:TASK:A:<netw_std>:<func_grp>:<appl>:WEVENT?.....	278
STATus:OPERation:TASK:A:<netw_std>:<func_grp>:<appl>:XCONDition?.....	282
STATus:OPERation:TASK:A:<netw_std>:<func_grp>:<appl>:XENABLE.....	283
STATus:OPERation:TASK:A:<netw_std>:<func_grp>:<appl>:XESRq.....	283
STATus:OPERation:TASK:A:<netw_std>:<func_grp>:<appl>:XEVENT?.....	284
STATus:OPERation:TASK:A:<netw_std>:<func_grp>:<appl>:XNTRansition.....	285
STATus:OPERation:TASK:A:<netw_std>:<func_grp>:<appl>:XPTRansition.....	285
STATus:OPERation:TASK:A:<netw_std>:<func_grp>:<appl>:XWCONDition?.....	286
STATus:OPERation:TASK:A:<netw_std>:<func_grp>:<appl>:XWEVENT?.....	286
STATus:OPERation:TASK:A:<netw_std>:<func_grp>:<appl>[:EVENT]?.....	276
STATus:OPERation:TASK:A:<netw_std>:<func_grp>:CONDition?.....	274
STATus:OPERation:TASK:A:<netw_std>:<func_grp>:ENABLE.....	275
STATus:OPERation:TASK:A:<netw_std>:<func_grp>:ESRQ.....	275
STATus:OPERation:TASK:A:<netw_std>:<func_grp>:NTRansition.....	277
STATus:OPERation:TASK:A:<netw_std>:<func_grp>:PTRansition.....	277
STATus:OPERation:TASK:A:<netw_std>:<func_grp>:WCONDition?.....	278
STATus:OPERation:TASK:A:<netw_std>:<func_grp>:WEVENT?.....	278
STATus:OPERation:TASK:A:<netw_std>:<func_grp>:XCONDition?.....	282
STATus:OPERation:TASK:A:<netw_std>:<func_grp>:XENABLE.....	283
STATus:OPERation:TASK:A:<netw_std>:<func_grp>:XESRq.....	283
STATus:OPERation:TASK:A:<netw_std>:<func_grp>:XEVENT?.....	284
STATus:OPERation:TASK:A:<netw_std>:<func_grp>:XNTRansition.....	285
STATus:OPERation:TASK:A:<netw_std>:<func_grp>:XPTRansition.....	285

STATus:OPERation:TASK:A:<netw_std>:<func_grp>:XWCondition?.....	286
STATus:OPERation:TASK:A:<netw_std>:<func_grp>:XWEVent?.....	286
STATus:OPERation:TASK:A:<netw_std>:<func_grp>[:EVENT]?.....	276
STATus:OPERation:TASK:A:<netw_std>:CONDition?.....	274
STATus:OPERation:TASK:A:<netw_std>:ENABle.....	275
STATus:OPERation:TASK:A:<netw_std>:ESRQ.....	275
STATus:OPERation:TASK:A:<netw_std>:NTRansition.....	276
STATus:OPERation:TASK:A:<netw_std>:PTRansition.....	277
STATus:OPERation:TASK:A:<netw_std>:WCONDition?.....	277
STATus:OPERation:TASK:A:<netw_std>:WEVent?.....	278
STATus:OPERation:TASK:A:<netw_std>:XCONDition?.....	282
STATus:OPERation:TASK:A:<netw_std>:XENABle.....	283
STATus:OPERation:TASK:A:<netw_std>:XESRq.....	283
STATus:OPERation:TASK:A:<netw_std>:XEVent?.....	284
STATus:OPERation:TASK:A:<netw_std>:XNTRansition.....	284
STATus:OPERation:TASK:A:<netw_std>:XPTRansition.....	285
STATus:OPERation:TASK:A:<netw_std>:XWCondition?.....	285
STATus:OPERation:TASK:A:<netw_std>:XWEVent?.....	286
STATus:OPERation:TASK:A:<netw_std>[:EVENT]?.....	276
STATus:OPERation:TASK:A:CONDition?.....	274
STATus:OPERation:TASK:A:ENABle.....	275
STATus:OPERation:TASK:A:ESRQ.....	275
STATus:OPERation:TASK:A:NTRansition.....	276
STATus:OPERation:TASK:A:PTRansition.....	277
STATus:OPERation:TASK:A:WCONDition?.....	277
STATus:OPERation:TASK:A:WEVent?.....	278
STATus:OPERation:TASK:A:XCONDition?.....	282
STATus:OPERation:TASK:A:XENABle.....	283
STATus:OPERation:TASK:A:XESRq.....	283
STATus:OPERation:TASK:A:XEVent?.....	284
STATus:OPERation:TASK:A:XNTRansition.....	284
STATus:OPERation:TASK:A:XPTRansition.....	285
STATus:OPERation:TASK:A:XWCondition?.....	285
STATus:OPERation:TASK:A:XWEVent?.....	286
STATus:OPERation:TASK:A[:EVENT]?.....	276
STATus:OPERation:TASK:CONDition?.....	274
STATus:OPERation:TASK:ENABle.....	275
STATus:OPERation:TASK:ESRQ.....	275
STATus:OPERation:TASK:NTRansition.....	276
STATus:OPERation:TASK:PTRansition.....	277
STATus:OPERation:TASK:WCONDition?.....	277
STATus:OPERation:TASK:WEVent?.....	278
STATus:OPERation:TASK:XCONDition?.....	282
STATus:OPERation:TASK:XENABle.....	283
STATus:OPERation:TASK:XESRq.....	283
STATus:OPERation:TASK:XEVent?.....	284
STATus:OPERation:TASK:XNTRansition.....	284
STATus:OPERation:TASK:XPTRansition.....	285
STATus:OPERation:TASK:XWCondition?.....	285
STATus:OPERation:TASK:XWEVent?.....	286
STATus:OPERation:TASK:A[:EVENT]?.....	276
STATus:OPERation:TASK:CONDition?.....	274
STATus:OPERation:TASK:ENABle.....	275
STATus:OPERation:TASK:ESRQ.....	275
STATus:OPERation:TASK:NTRansition.....	276
STATus:OPERation:TASK:PTRansition.....	277
STATus:OPERation:TASK:WCONDition?.....	277
STATus:OPERation:TASK:WEVent?.....	278
STATus:OPERation:TASK:XCONDition?.....	282
STATus:OPERation:TASK:XENABle.....	283
STATus:OPERation:TASK:XESRq.....	283
STATus:OPERation:TASK:XEVent?.....	284
STATus:OPERation:TASK:XNTRansition.....	284
STATus:OPERation:TASK:XPTRansition.....	285
STATus:OPERation:TASK:XWCondition?.....	285
STATus:OPERation:TASK:XWEVent?.....	286

STATus:OPERation:TASK[:EVENT]?	276
STATus:OPERation:WCONdition?	277
STATus:OPERation:WEVent?	278
STATus:OPERation:XCONdition?	282
STATus:OPERation:XENable	283
STATus:OPERation:XESRq	283
STATus:OPERation:XEVent?	284
STATus:OPERation:XNTRansition	284
STATus:OPERation:XPTRansition	285
STATus:OPERation:XWCondition?	285
STATus:OPERation:XWEVent?	286
STATus:OPERation[:EVENT]?	276
STATus:PRESet	271
STATus:QUEStionable:BIT<n>:CONDiTion?	293
STATus:QUEStionable:BIT<n>:ENABle	294
STATus:QUEStionable:BIT<n>:NTRansition	294
STATus:QUEStionable:BIT<n>:PTRansition	294
STATus:QUEStionable:BIT<n>[:EVENT]?	293
STATus:QUEStionable:CONDiTion?	292
STATus:QUEStionable:ENABle	292
STATus:QUEStionable:NTRansition	293
STATus:QUEStionable:PTRansition	293
STATus:QUEStionable[:EVENT]?	292
STATus:QUEue[:NEXT]?	272
STOP:BASE:BUFFer	213
SYSTem:BASE:DEVice:COUnT	268
SYSTem:BASE:DEVice:RESet	268
SYSTem:BASE:DEVice:SUBInst?	268
SYSTem:BASE:DISPlay:FONTset	248
SYSTem:BASE:IPSet:SMONitor:REFResh	266
SYSTem:BASE:OPTion:LIST?	257
SYSTem:BASE:OPTion:VERSiON?	258
SYSTem:BASE:REFerence:FREQUency	259
SYSTem:BASE:REFerence:FREQUency:SOURce	259
SYSTem:BASE:RELiability?	299
SYSTem:BASE:SSYNc:MODE	260
SYSTem:COMMunicate:GPIB<i>:VRESource?	255
SYSTem:COMMunicate:GPIB<i>[:SELf]:ADDR	255
SYSTem:COMMunicate:GPIB<i>[:SELf]:ENABle	255
SYSTem:COMMunicate:HISLip<i>:VRESource?	253
SYSTem:COMMunicate:NET:ADAPter	249
SYSTem:COMMunicate:NET:DHCP	250
SYSTem:COMMunicate:NET:DNS	252
SYSTem:COMMunicate:NET:DNS:ENABle	251
SYSTem:COMMunicate:NET:GATeway	251
SYSTem:COMMunicate:NET:HOSTname?	250
SYSTem:COMMunicate:NET:IPADdress	250
SYSTem:COMMunicate:NET:SUBNet:MASK	251
SYSTem:COMMunicate:SOCKet<i>:MODE	254
SYSTem:COMMunicate:SOCKet<i>:PORT	254

SYSTem:COMMunicate:SOCKet<i>:VRESource?	254
SYSTem:COMMunicate:USB:VRESource?	256
SYSTem:COMMunicate:VXI<i>:GTR	256
SYSTem:COMMunicate:VXI<i>:VRESource?	257
SYSTem:CONNector:TRANslation?	297
SYSTem:DATE:LOCal	295
SYSTem:DATE[:UTC]	294
SYSTem:DEVice:ID?	259
SYSTem:DISPlay:MONitor	249
SYSTem:DISPlay:ROLLkeymode	249
SYSTem:DISPlay:UPDate	299
SYSTem:ERRor:ALL?	215
SYSTem:ERRor:CODE:ALL?	216
SYSTem:ERRor:CODE[:NEXT]?	216
SYSTem:ERRor:COUNt?	216
SYSTem:ERRor[:NEXT]?	217
SYSTem:GENerator:ALL:OFF	299
SYSTem:HELP:STATus:BITS?	274
SYSTem:HELP:STATus[:REGister]?	274
SYSTem:KLOCK	300
SYSTem:MEASurement:ALL:OFF	299
SYSTem:PRESet	218
SYSTem:PRESet:ALL	217
SYSTem:PRESet:BASE	217
SYSTem:RECOrd:MACRO:FILE:START	211
SYSTem:RECOrd:MACRO:FILE:STOP	211
SYSTem:RESet	218
SYSTem:RESet:ALL	217
SYSTem:RESet:BASE	217
SYSTem:SIGNaling:ALL:OFF	299
SYSTem:STARtup:PREPare:FDEFault	252
SYSTem:TIME:DSTime:MODE	295
SYSTem:TIME:DSTime:RULE	296
SYSTem:TIME:DSTime:RULE:CATalog?	296
SYSTem:TIME:HRTimer:ABSolute	214
SYSTem:TIME:HRTimer:ABSolute:SET	214
SYSTem:TIME:HRTimer:RELative	215
SYSTem:TIME:LOCAl	295
SYSTem:TIME[:UTC]	295
SYSTem:TZONE	297
SYSTem:UPDate:DGRoup	252
SYSTem:VERSion?	300
TRACe:REMote:MODE:DISPlay:CLEar	223
TRACe:REMote:MODE:DISPlay:ENABLE	223
TRACe:REMote:MODE:FILE<inst>:ENABLE	220
TRACe:REMote:MODE:FILE<inst>:FILTer	220
TRACe:REMote:MODE:FILE<inst>:FORMat	221
TRACe:REMote:MODE:FILE<inst>:NAME	221
TRACe:REMote:MODE:FILE<inst>:SIZE	221
TRACe:REMote:MODE:FILE<inst>:STARtmode	222

TRACe:REMOte:MODE:FILE<inst>:STOPmode.....	222
TRIGger:BASE:EXTA:CATalog:SOURce?.....	261
TRIGger:BASE:EXTA:DIRection.....	261
TRIGger:BASE:EXTA:SLOPe.....	262
TRIGger:BASE:EXTA:SOURce.....	262
TRIGger:BASE:EXTB:CATalog:SOURce?.....	261
TRIGger:BASE:EXTB:DIRection.....	261
TRIGger:BASE:EXTB:SLOPe.....	262
TRIGger:BASE:EXTB:SOURce.....	262
TRIGger:BASE:UINIiated<n>:EXECute.....	262

7 Annexes

The following sections cover mostly hardware and service-related topics.

7.1 Interfaces and Connectors

This chapter provides a detailed description of the rear panel connectors of the R&S CMW270. For a graphical overview of the rear panel refer to [Rear Panel Tour](#).

The front panel is described in section [Front Panel Tour](#).

7.1.1 Rear Panel Connectors

The rear panel of the R&S CMW270 provides various connectors for external devices and control signals.

7.1.1.1 LAN REMOTE



8-pin connector RJ-45 used to connect the R&S CMW270 to a Local Area Network (LAN), e.g. for remote control of the instrument. Refer to [Remote Operation in a LAN](#) and [LAN Interface](#). It supports up to 1 Gbit/s. The pin assignment of the RJ-45 connector supports category 5 UTP/STP (Unshielded/Shielded Twisted Pair) cables.

7.1.1.2 LAN SWITCH (Options R&S CMW-B660A and R&S CMW-B661A)

The LAN switch provides six internal and two external ports. The external ports are accessed via two 8-pin RJ-45 connectors located to the right of the [LAN REMOTE](#) connector. They provide access to the internal IP network of the instrument (CMW subnet), e.g. for logging of signaling messages.



The LAN switch connectors are not suitable for connection to an LAN, e.g. for remote control. Use the LAN REMOTE connector or the LAN connector at the front panel for this purpose (not available for R&S CMW280).

7.1.1.3 USB REMOTE



Universal Serial Bus connector of type B (instrument acts as device), used for remote control of the instrument; see [Remote Control Operation](#).

The USB connector complies with standard USB 2.0; also refer to the "Specifications".



USB Connection

The length of passive connecting USB cables should not exceed 1 m. The maximum current per USB port is 500 mA.

7.1.1.4 USB



Double Universal Serial Bus connectors of type A (instrument acts as master), used to connect e.g. a keyboard, mouse or other pointing devices, a printer or an external storage device (USB stick, CD-ROM drive etc.).

The USB connectors comply with standard USB 2.0; also refer to the "Specifications".

NOTICE

Risk of instrument damage

USB devices with external power supply must never feed back current into the 5 V power supply of the USB interface. Before using a device with external power supply, verify that there is no connection between the positive pole of the power supply and the +5 V power pin of the USB interface (VBUS).



The length of passive connecting USB cables should not exceed 1 m. The maximum current per USB port is 500 mA.

7.1.1.5 DIG IQ and AUX (I/Q Board)

An I/Q board (option R&S CMW-B510x / -B520x) provides four digital connectors (labeled "DIG IQ ...", e.g. "DIG IQ OUT 4") plus two BNC connectors (labeled "AUX ...", e.g. "AUX A").

The IQ connectors are used for input and output of digital IQ data. The bidirectional high-impedance BNC connectors are used for input of the start source signal and input/output of clock source signal/enable source signal. They are suited for TTL signals in a level range from 2.5 V to 5 V.

The I/Q board is required for certain protocol test use cases and for some signaling scenarios (e.g. external fading, IQ out - RF in).

7.1.1.6 REF IN, REF OUT 1



BNC connectors used as input and output connectors for the external or internal reference signals; see [Sync Settings](#).

The function of the connectors depends on the "Frequency Source" setting in the "Sync" section of the setup dialog:

- If the "Internal" reference frequency is active, REF OUT 1 is used as an output connector for the 10 MHz internal reference clock signal of the R&S CMW270.

- If the "External" reference frequency is active, REF IN is used as an input connector for an external reference clock signal. The R&S CMW270 is synchronized to the external reference signal. The external reference signal is also routed to the output connector REF OUT 1.

The external reference signal must meet the specifications of the data sheet.

NOTICE

REF OUT1, RF1 COM, RF2 COM, RF1 OUT, RF3 COM, RF4 COM, RF3 OUT

Use double-shielded cables and match signal with 50 Ω in order to comply with EMC (electromagnetic compatibility) directives.

7.1.1.7 SYS SYNC OUT, SYS SYNC IN



BNC connectors used as input and output connectors for the system synchronization signal; see [Sync Settings](#). The connectors are optional and only present if a "Multibox Flexible Link Sample Bus Board with external SysSync Support" (option R&S CMW-S55xM) is equipped.

The function of the connectors depends on the "SYS SYNC" setting in the "Sync" section of the setup dialog:

- Standalone: The connectors are not used.
- Generator: The instrument provides an identical system synchronization signal at all SYS SYNC OUT connectors. One SYS SYNC OUT connector must be connected to the SYS SYNC IN connector. The other SYS SYNC OUT connectors can be connected to the SYS SYNC IN connector of other instruments.
- Listener: SYS SYNC IN is used as input connector for a time synchronization signal generated by another R&S CMW270.



Only use the cables labeled SYS SYNC which are included in the delivery.

7.1.1.8 TRIG A, TRIG B



BNC connectors for trigger input or output signals; see [Trigger](#).

Input signal: An external trigger input signal must be an LVTTTL/LVCMOS (3.3 V) signal with a rise/fall time below 5 ns. The trigger input is high impedance.

Output signal: The CMW trigger output has an LVTTTL/LVCMOS (3.3 V) signal. The output impedance is approximately 50 Ohm. Evaluate the rising edge of the generated positive pulses.



Trigger cables

Be aware that long trigger cables may cause signal reflections!

7.1.1.9 SPDIF IN, SPDIF OUT



BNC connectors used for input and output of digital audio signals in the context of audio measurements.

The Sony/Philips Digital Interface (SPDIF) connectors are in line with IEC 60958-3:2010 Consumer. They are installed together with an audio board (option R&S CMW-B400B or R&S CMW-U400).

7.1.1.10 DVI



DVI-D Dual-link connector for external monitor connection; see [Connecting a Monitor](#).

For instruments with display optional (R&S CMW-B620A).

7.1.2 LAN Interface

To be integrated in a LAN, the instrument is equipped with a LAN interface, consisting of a RJ-45 connector, a network interface card and protocols. The network interface card supports IEEE 802.3 for a 10 Mbps Ethernet and IEEE 802.3u for a 100 Mbps Ethernet.

Instrument access is possible via the HiSLIP protocol (recommended), the VXI-11 protocol or via direct socket communication. Of these three possibilities, HiSLIP is the recommended one. The following table provides a comparison of important features.

	Socket	VXI-11	HiSLIP
GPIB Emulation	–	✓	✓
Instrument Locking	–	✓	✓
Support of Message Exchange Protocol	–	✓	✓
IPv6 Support	✓	–	✓
High Performance	✓	–	✓

The remote control instructions (SCPI commands) are delivered by a test application, usually using VISA as an intermediate abstraction layer. VISA encapsulates the low level function calls and thus makes the transport interface transparent for the user. The necessary VISA library is available as a separate product. For details contact your local R&S sales representative.

7.1.2.1 HiSLIP Protocol

The High Speed LAN Instrument Protocol (HiSLIP) is the successor protocol for VXI-11. It was defined by the IVI Foundation and was adopted by the LXI Consortium as the recommended LAN protocol. For the R&S CMW270 it is the recommended protocol for control via the LAN interface.

The HiSLIP protocol uses two TCP sockets for a single connection - one for fast data transfer, the other for non-sequential control commands (e.g. `Device Clear` or `SRQ`).

HiSLIP has the following characteristics:

- High performance as with raw socket network connections
- Compatible IEEE 488.2 support for Message Exchange Protocol, Device Clear, Serial Poll, Remote/Local, Trigger, and Service Request
- Uses a single IANA registered port (4880), which simplifies the configuration of fire-walls
- Supports simultaneous access of multiple users by providing versatile locking mechanisms
- Usable for IPv6 or IPv4 networks



Note that HiSLIP data is sent to the device using the "fire and forget" method with immediate return, as opposed to VXI-11, where each operation is blocked until a VXI-11 device handshake returns. Thus, a successful return of a VISA operation such as `viWrite()` does not guarantee that the instrument has finished or started the requested command, but is delivered to the TCP/IP buffers.

7.1.2.2 VXI-11 Protocol

The VXI-11 standard is based on the ONC RPC (Open Network Computing Remote Procedure Call) protocol which in turn relies on TCP/IP as the network/transport layer. The TCP/IP network protocol and the associated network services are preconfigured. TCP/IP ensures connection-oriented communication, where the order of the exchanged messages is adhered to and interrupted links are identified. With this protocol, messages cannot be lost.

7.1.2.3 Direct Socket Communication

With direct socket communication the test application communicates directly with the TCP transport layer.

Direct socket communication supports the transport of program messages (control commands sent to the instrument) and response messages (returned values received from the instrument). Service requests and polling are not supported in the raw socket mode. The additional socket modes "Agilent" and "IEEE1174" are available for compatibility reasons. The emulation codes for polling, service request and device clear messages differ for these modes, as listed in the following table. See also: [Emulation Codes](#)

Table 7-1: Emulation codes supported by the compatibility modes

Purpose	Direction (Controller)	Agilent Codes	IEEE1174 Codes
Poll Status Byte	send receive	POL\n POL +stb\n	&POL\cr\n &stb\cr\n
Service Request	receive	SRQ\n	&SRQ\cr\n
Device Clear	send receive (DCL complete)	DCL\n DCL\n	&DCL\cr\n &DCL\cr\n
\n = newline, CHR\$(10) \cr = carriage return, CHR\$(13)			

For each socket two ports are defined for communication between instrument and controller. They are called "Data Port" and "Control Port". The ports are used as follows:

- "Raw" mode uses only the "Data Port". This mode provides the best performance.
- "IEEE1174" mode uses only the "Data Port", even for transfer of emulation codes. This implies that the controller must listen for service requests and emulation code responses at the data port.
- "Agilent" mode supports both "Data Port" and "Control Port". The setup of a second connection via the control port is optional and recommended. It can be used for transfer of emulation codes. Alternatively only one connection can be set up via the "Data Port" and used for all messages.

Refer to the [Remote Settings](#) of the "Setup" menu for related instrument settings.

7.1.3 GPIB Bus Interface

The instrument can be equipped with one or two GPIB bus (IEC/IEEE bus) interfaces which are available as options R&S CMW-B612A and R&S CMW-B612B, respectively. The two interface connectors labeled "IEEE 488 CH 1" and "IEEE 488 CH 2" are located on the rear panel of the instrument.

- The "IEEE 488 CH 1" connector is intended for remote control of the R&S CMW270 from a controller.
- The "IEEE 488 CH 2" can also be used to control further devices from the R&S CMW270.



In order to be compliant with EMC regulations open IEEE cables should be avoided. IEEE cables have to be connected on both sides.

Characteristics of the interface

- 8-bit parallel data transfer
- Bidirectional data transfer
- Three-line handshake
- High data transfer rate of max. 1 MByte/s

- Up to 15 devices can be connected
- Maximum length of the connecting cables 15 m. The length of a single connecting cable should not exceed 2 m, if many devices are used, it should not exceed 1 m.
- Wired OR if several instruments are connected in parallel

Pin assignment

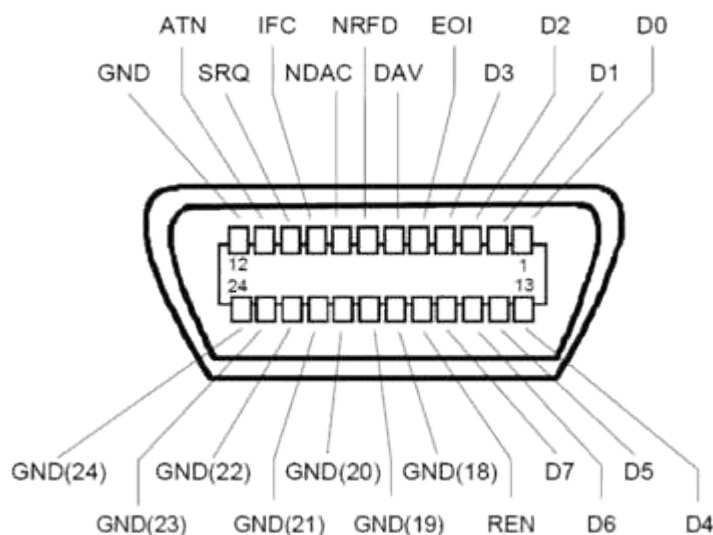

Bus lines

- Data bus with 8 lines D0 to D7:
The transmission is bit-parallel and byte-serial in the ASCII/ISO code. D0 is the least significant bit, D7 the most significant bit.
- Control bus with five lines:
 - IFC** (Interface Clear): active LOW resets the interfaces of the instruments connected to the default setting.
 - ATN** (Attention): active LOW signals the transmission of interface messages, inactive HIGH signals the transmission of device messages.
 - SRQ** (Service Request): active LOW enables the connected device to send a service request to the controller.
 - REN** (Remote Enable): active LOW permits switchover to remote control.
 - EOI** (End or Identify): has two functions in connection with ATN:
 - ATN=HIGH active LOW marks the end of data transmission.
 - ATN=LOW active LOW triggers a parallel poll.
- Handshake bus with three lines:
 - DAV** (Data Valid): active LOW signals a valid data byte on the data bus.
 - NRFD** (Not Ready For Data): active LOW signals that one of the connected devices is not ready for data transfer.
 - NDAC** (Not Data Accepted): active LOW signals that the instrument connected is accepting the data on the data bus.

The R&S CMW270 provides several functions to communicate via GPIB bus. They are described in the following sections.

7.1.3.1 Interface Functions

Instruments which can be controlled via GPIB bus can be equipped with different interface functions. The interface function for the R&S CMW270 are listed in the following table.

Control character	Interface function
SH1	Handshake source function (source handshake), full capability
AH1	Handshake sink function (acceptor handshake), full capability
L4	Listener function, full capability, de-addressed by MTA.
T6	Talker function, full capability, ability to respond to serial poll, de-addressed by MLA
SR1	Service request function (Service Request), full capability
PP1	Parallel poll function, full capability
RL1	Remote/Local switch over function, full capability
DC1	Reset function (Device Clear), full capability
DT1	Trigger function (Device Trigger), full capability

7.1.3.2 Interface Messages

Interface messages are transmitted to the instrument on the data lines, with the attention line being active (LOW). They serve to communicate between controller and instrument.

Universal commands

Universal commands are encoded in the range 10 through 1F hex. They are effective for all instruments connected to the bus without previous addressing.

Command	QuickBASIC command	Effect on the instrument
DCL (Device Clear)	IBCMD (controller %, CHR\$(20))	Aborts the processing of the commands just received and sets the command processing software to a defined initial state. Does not change the instrument settings.
IFC (Interface Clear)	IBSIC (controller%)	Resets the interfaces to the default setting.
LLO (Local Lockout)	IBCMD (controller %, CHR\$(17))	The LOC/IEC ADDR key is disabled.
SPE (Serial Poll Enable)	IBCMD (controller %, CHR\$(24))	Ready for serial poll.

Command	QuickBASIC command	Effect on the instrument
SPD (Serial Poll Disable)	IBCMD (controller %, CHR\$(25))	End of serial poll.
PPU (Parallel Poll Unconfigure)	IBCMD (controller %, CHR\$(21))	End of the parallel-poll state.

Addressed commands

Addressed commands are encoded in the range 00 through 0F hex. They are only effective for instruments addressed as listeners.

Command	QuickBASIC command	Effect on the instrument
GET (Group Execute Trigger)	IBTRG (device%)	Triggers a previously active device function (e.g. a sweep). The effect of the command is the same as with that of a pulse at the external trigger signal input.
GTL (Go to Local)	IBLOC (device%)	Transition to the "Local" state (manual control).
PPC (Parallel Poll Configure)	IBPPC (device%, data%)	Configures the instrument for parallel poll. Additionally, the QuickBASIC command executes PPE/PPD.
SDC (Selected Device Clear)	IBCLR (device%)	Aborts the processing of the commands just received and sets the command processing software to a defined initial state. Does not change the instrument setting.

7.1.3.3 Instrument Messages

Instrument messages (commands) are transferred on the data lines of the GPIB bus while the ATN line is not active. ASCII code is used.

For structure and syntax of the instrument messages refer to [Command Reference - Base Software](#). The chapter also provides a detailed description of all messages implemented by the tester.

7.2 Windows XP Recovery and Backup

The internal hard disk of the R&S CMW270 is partitioned as follows:

- The **system firmware partition** contains the Windows XP operating system and the instrument software. This software is used for normal operation of the R&S CMW270.
- The **data partition** contains user data.

- The **backup/recovery partition** contains a backup version (image) of the complete instrument software. You can replace the system image by this "Factory Default" image and thus restore the initial state of the instrument, e.g. in case that the operating system is damaged after a system crash.

The backup/recovery partition also allows you to save and restore additional backup versions, e.g. in order to have different instrument configurations available.

7.2.1 Accessing the Recovery and Backup Dialog

From the "Recovery and Backup" dialog, you can initiate all actions which are related to backup images.

To access the dialog,

1. Connect an external keyboard and switch on the R&S CMW270.
2. While the boot menu is displayed, select "Backup/Recovery" using the cursor keys.
3. Press "Enter" to open the dialog.

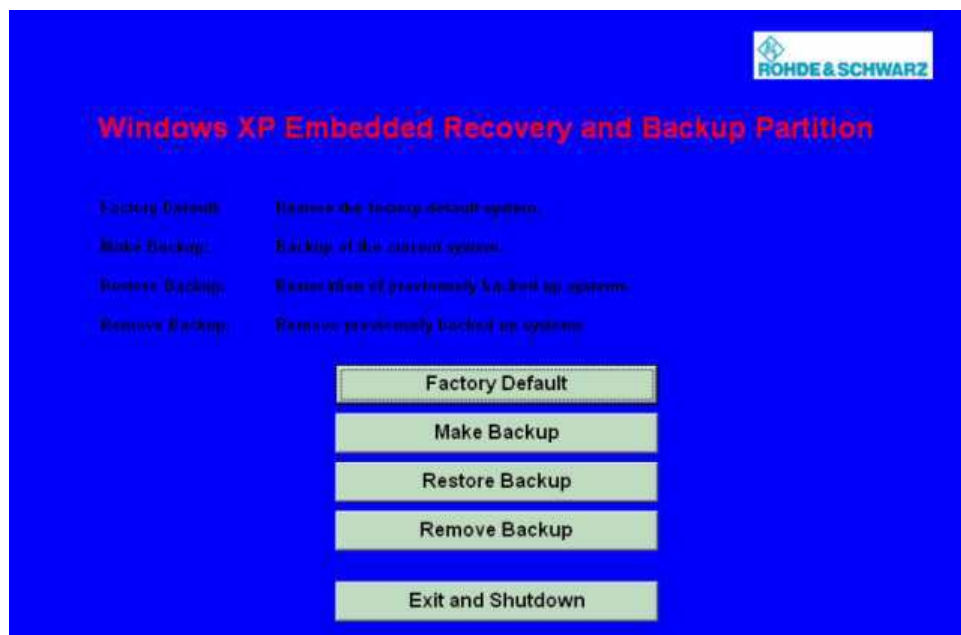

Fig. 7-1: Recovery and Backup dialog

7.2.2 Recovering the Factory Default Settings

The "Factory Default" image is always available on the backup/restore partition; it cannot be deleted.

To restore the initial state of the instrument, recover the "Factory Default" image.

1. In the "Recovery an Backup" dialog, activate "Factory Default".
2. In the dialog opened, confirm recovery and wait until the system image has been replaced by the "Factory Default" image.

7.2.3 Handling User-Defined Images

Creating backup versions of the sytem image, restoring and removing backup versions is self-explanatory. Use the buttons in the "Recovery an Backup" dialog.

Index

Symbols

:Setup	85
*CLS	189, 204
*DEV?	204
*ESE	204
*ESR?	205
*IDN?	205
*IST?	205
*OPC	205
*OPC (use)	186
*OPT?	205
*PRE	205
*PSC	205
*RCL	205
*RST	205
*SAV	206
*SRE	206
*SRQ	206
*STB?	206
*WAI	206

A

Abort	81
Accessing applications	34
Accessing dialogs	34
ACLR	68
ACP	68
Activate option	91
Address settings	
remote	253
Addressed command	133, 315
Adjacent Channel Leakage power Ratio (ACLR)	68
Adjacent Channel Power (ACP)	67
AF connectors	24
Analyzer Frequency	56
Annexes	308
Application control keys	20
Arbitrary (ARB) generator	53
ARROW keys	21
ATN	314
Attention	314
AUX A/B	309
Average	150
Averaging procedures	60

B

Base software	40
Bench top operation	12
Block data format	140
Blockview	121
Board test	97
Boolean parameter	140
Brace	136
BUSY	18

C

CALCulate...?	152
CD-ROM	10
Channel	
remote access	126

Cleaning	49
CMW-B661A	16
CMW-B690A (OCXO)	102
Code domain error	65
Code Domain Power	70
Command	
common	134
general structure	142
instrument-control	135
processing	173
recognition	174
Command line	137
Command macro	191
Command reference	204
Common commands	204
CONDition	177, 178
CONFigure	141
Connection control	
remote	161
Connection states	76
Connector selection	
generator	52
measurement	55
Connectors	308
front panel	22
rear panel	25
Continue / Wait	81
Continuous measurement	149
Control bus	314
Control lines (GPIB bus)	313
Current	150
Current State	115

D

Data Appl. Control	87
Data base	175
Data bus (GPIB)	313
Data entry	
keys	20
Data entry via front panel	35
Data entry via keyboard	37
Data Valid	314
DAV	314
DC Inputs	308
DCL	315
DCL,SDC	189
DEFault	139
Detailed Test	98
Detectors	59
Device	119
Device message	133
Device response	133
DHCP	47
Diagnosis Test	97
DIG IQ IN	309
DIG IQ OUT	309
Digital IQ (dialog)	109
Display	19, 86
Documentation Map	9
Documentation update	10
Download Test	98
Driver Init Test	98

DVI	311
E	
EEProm Test	98
EMI suppression	16
Emulation codes	206
ENABLE	176, 177
Enable/Disable All (selftest)	102
Enable/Disable Subtree (selftest)	102
EOI	314
Error	65
ERROR	18
Error code	160
Error message	125
Error queue	176, 189, 215
ESB	179
ESE	176, 181
ESR	181
EVENT register	177
Execution (command)	
overlapping	175
Expected Nominal Power	56
External Attenuation	
input	55
output	52
External Devices	26
External Reference Frequency	103
External trigger	
commands	260
F	
Factory Default	81
Fan control	
remote	267
Fan Control (dialog)	113
FETCh...?	151
Firmware application	142
Firmware update	40
FPRINT	126
Frequency error	64
Frequency Source	102
Frequency-dependent correction	110, 239
Front panel	17
connectors	22
Fuses	50
FWA	143
G	
General purpose measurement	142
Generator configuration (example)	28
Generator control	
remote	144
Generator control (manual)	51
Generator control keys	20
Generator/Signaling Controller	120
Generators	51
GET	315
Go to config	
button	87
GP (general purpose) measurement	142
GPIB	
remote control interface	126
GPIB bus interface	313
GTL	315

H	
Handshake bus	313
Hardware (connectors)	308
Header (command)	135
High resolution timer	214
HiSLIP protocol	312
Hotkey	19
I	
I/Q Constellation Diagram	71
I/Q imbalance	66
I/Q offset	66
IEC/IEEE Bus Interface	313
IEEE 488 CH 1	313
IEEE 488 CH 2	313
IFC	314, 315
Information Dialog	115
Input unit	174
Installed software	
remote	257
Instance	143
Instrument	
putting into operation	11
Instrument hardware	175
Instrument Messages	316
Instrument Setup	119
Instrument-Control Commands	207
Interface	
functions (GPIB bus)	315
messages (GPIB bus)	315
Interface Clear	314
Interface message	133
Interfaces	308
INV	153
IP address	47
assign	48
IP subnet configuration	
remote	264
IP Subnet Configuration	106
IST flag	176, 180
K	
KEEP	139
Keyboard	26
Keyboard shortcuts	38
Keys	
application control	20
data entry	20
hotkeys	19
navigation	21
rotary knob	21
setup	20
softkeys	19
standby	19
utility	18
window control	22
L	
LAN	
cable	46
connection	46
connection (example)	128
DHCP	47

LAN REMOTE connector	308
LAN switch	308
remote control interface	126
remote operation	46
LAN connector	24
Lan Services	87
LAN Services	
remote	248
LED	19
License keys	91
Limit check (introduction)	61
LLO	315
Load Profile (Selftest)	101
Log files	117
Logging	105
Long form (command)	136
LXI Configuration	196

M

Macro (remote control)	191, 207
Magnitude error	65
Maintenance	49
Marker	74
Marker signal (trigger)	63
Mass Memory Commands	223
Maximum	150
MAXimum	139
Measurement	
resources	148
substate	148
synchronization	148
Measurement configuration (example)	30
Measurement context	143
Measurement control	
manual	54
remote	146
Measurement control keys	20
Measurement Controller	120
Measurement cycle	56
Measurement interval	56, 149
Measurement results	151
Measurements	54
Message boxes	124
Message monitoring	
remote	263
Minimum	150
MINimum	139
Mnemonic	135
Modulation accuracy	64
Monitor connection and use	27
Mouse	26
Multi-evaluation measurement	72, 154

N

NAN (not a number)	139
NAV	153
Navigation keys	21
NCAP	153
NDAC	314
Network standard	142
NEXT	21
NRFD	314
NTR	176
NTRansition	177, 178
Numeric suffix	137

O

OBW	69
Occupied bandwidth	69
OCXO	19, 102
selftest	97
Operation Complete	181
OPERation register	176, 182
Output unit	175, 176
Overlapped command execution	173

P

Packing	50
Parallel Poll	188
Parameter (SCPI)	136
Peak code domain error	65
Peak values	60
Phase error	65
Power results	64
PPC	315
PPE	176, 180
PPU	315
Preset	82, 189
PREV	21
Print	114
Printer	27
Problem Reporting	117
Progress Info / Detailed Info	81
PTR	178
PTRansition	177

Q

Query	133, 134, 138
QUEStionable register	176, 186
Summary bit	179
Queuing (of measurements)	170
Quick Start Guide	9

R

R&S CMW-620 A (option)	27
R&S CMW-B661A	16
R&S Software Distributor	44
R&S Version Selector	45
Rackmounting	14
RAM Test	97
READ...?	152
READY	18
Real-time generator	53
Rear panel	24
Recall	84
REF IN	309
REF OUT 1	309
Reference Frequency	102
Reference frequency not locked	18
Reference frequency settings	
remote	259
Reliability	157
REM	126
REMOTE	18
Remote channels	126
multiple	132

- Remote control 126
 - interfaces and protocols 126
 - introduction 126
 - multiple channels 132
 - Remote Desktop 48
 - Remote settings 88
 - Remote trace 201
 - REN 314
 - Repetition 101
 - Repetition mode 57, 149
 - Replacing
 - AC Fuse Board 50
 - fuses 50
 - Reset 81
 - Reset Values
 - Status Reporting System 189
 - Resource and path management 168
 - Resource conflicts 172
 - Response (to queries) 138
 - Response buffer (remote control) 194
 - Revision 9
 - RF connectors 22
 - RF Loop Test 99
 - RF path settings
 - generators 52, 75
 - measurements 54
 - Rotary knob 21
 - ROUTE 141
 - RPM (Resource and Path Management) 168
 - RSI file 93
 - RX measurement 73
- S**
- Sample Bus Test 99
 - Sample session 28
 - Save 84
 - Save Profile (Selftest) 101
 - Save/Recall 83
 - SCPI
 - command structure 134
 - SCPI compatibility 128
 - SCPI Status Register 177
 - event status register 181
 - IST flag 180
 - parallel poll enable register 180
 - service request enable register 179
 - status byte 179
 - STATus:OPERation register 182
 - STATus:QUESTionable register 186
 - Structure 176
 - SCPI subsystems (overview) 141
 - SDC 315
 - Selection Filter (selftest) 101
 - Selftest 96
 - Selftest configuration 101
 - Selftest Ctrl. (softkey) 100
 - SENSOR connector 24
 - Sequential command execution 173
 - Serial Poll 187
 - Service request 186
 - Service Request Enable 176, 179
 - Setup dialog
 - remote 248
 - Setup file 40
 - Setup keys 20
 - Short form (command) 136
 - Shutting down the instrument 15
 - Signaling applications 74
 - Signaling configuration (example) 32
 - Signaling control
 - remote 155
 - Signaling control (manual) 75
 - Single (scalar) value 153
 - Single-shot 149
 - Socket communication 312
 - Soft-front panel 38
 - Softkey 19
 - Software update 40
 - Software Update 87
 - SOURce 141
 - SPD 315
 - SPDIF connectors 311
 - SPE 315
 - SRE 176, 179
 - SRQ 176, 186, 314
 - Standalone operation 12
 - Standard deviation 61
 - Standby
 - key 19
 - state 19
 - Start Automatically (selftest) 101
 - Startup dialog 80
 - Startup procedure 15
 - Statistic count 149
 - Statistic Count 56
 - Statistic length 56
 - Statistical results 57
 - Statistical settings
 - remote control 149
 - Statistics cycle 56
 - Statistics type 58, 150
 - STATus Commands 271
 - Status Registers 176
 - Status reporting system
 - Error queue 189
 - Parallel poll 188
 - Queries 188
 - Reset Values 189
 - Serial poll 187
 - Service request 186
 - STB 176, 179
 - Stop condition 57
 - Stop Condition 101
 - Storing 50
 - String 140
 - Sub-instrument 77
 - SW/HW Equipment 95
 - Switching on the instrument 15
 - Sync settings
 - remote 259
 - Syntax elements (SCPI, overview) 141
 - SYS SYNC 103
 - SYS SYNC IN 310
 - SYS SYNC OUT 310
 - System (Setup) 86
 - System messages 124
- T**
- Task bar 34
 - TASKS 19
 - TCP/IP 47, 311

TCXO	102
selftest	97
Temperature Test	98
Text parameters	140
Timing	64
Tooltips	124
Trace	153
TRACe Commands	219
TRIG A/B	310
Trigger (dialog)	104
Trigger (introduction)	62
Trigger settings	63
TX measurement	64

U

Unit test	99
Universal command	133, 315
Update of documentation	10
Upper/lower case	136
USB	308
remote control interface	126
USB connector	23, 308
User Mode	88
Utility keys	18

V

View	143
VXI-11 protocol	312

W

WAITKEY	126
What's New	9
Window control keys	22
Windows XP	40
backup and recovery	316