

R&S® HMP Series Power Supplies User Manual



1178.6833.02 – 02

This manual describes the following models and options of the R&S®HMP Series:

- R&S®HMP2020 Two-Channel Power Supply (3629.6718.02)
- R&S®HMP2030 Three-Channel Power Supply (3629.6718.03)
- R&S®HMP4030 Three-Channel Power Supply (3629.6776.03)
- R&S®HMP4030 Four-Channel Power Supply (3629.6776.04)

This manual describes firmware version FW V2.61 and later for the instruments of the of the R&S®HMP Series.

© 2021 Rohde & Schwarz GmbH & Co. KG

Mühlhofstr. 15, 81671 München, Germany

Phone: +49 89 41 29 - 0

Fax: +49 89 41 29 12 164

Email: info@rohde-schwarz.com

Internet: www.rohde-schwarz.com

Subject to change – Data without tolerance limits is not binding.

R&S® is a registered trademark of Rohde & Schwarz GmbH & Co. KG.

Trade names are trademarks of their owners.

Throughout this manual, the products from Rohde & Schwarz are indicated without the ® symbol, e.g. R&S®HMP2020 is abbreviated as R&S HMP2020, or R&S HMP.

Basic Safety Instructions

Always read through and comply with the following safety instructions!

All plants and locations of the Rohde & Schwarz group of companies make every effort to keep the safety standards of our products up to date and to offer our customers the highest possible degree of safety. Our products and the auxiliary equipment they require are designed, built and tested in accordance with the safety standards that apply in each case. Compliance with these standards is continuously monitored by our quality assurance system. The product described here has been designed, built and tested in accordance with the EC Certificate of Conformity and has left the manufacturer's plant in a condition fully complying with safety standards. To maintain this condition and to ensure safe operation, you must observe all instructions and warnings provided in this manual. If you have any questions regarding these safety instructions, the Rohde & Schwarz group of companies will be happy to answer them.







Furthermore, it is your responsibility to use the product in an appropriate manner. This product is designed for use solely in industrial and laboratory environments or, if expressly permitted, also in the field and must not be used in any way that may cause personal injury or property damage. You are responsible if the product is used for any purpose other than its designated purpose or in disregard of the manufacturer's instructions. The manufacturer shall assume no responsibility for such use of the product.

The product is used for its designated purpose if it is used in accordance with its product documentation and within its performance limits (see data sheet, documentation, the following safety instructions). Using the product requires technical skills and, in some cases, a basic knowledge of English. It is therefore essential that only skilled and specialized staff or thoroughly trained personnel with the required skills be allowed to use the product. If personal safety gear is required for using Rohde & Schwarz products, this will be indicated at the appropriate place in the product documentation. Keep the basic safety instructions and the product documentation in a safe place and pass them on to the subsequent users.











Observing the safety instructions will help prevent personal injury or damage of any kind caused by dangerous situations. Therefore, carefully read through and adhere to the following safety instructions before and when using the product. It is also absolutely essential to observe the additional safety instructions on personal safety, for example, that appear in relevant parts of the product documentation. In these safety instructions, the word "product" refers to all merchandise sold and distributed by the Rohde & Schwarz group of companies, including instruments, systems and all accessories. For product-specific information, see the data sheet and the product documentation.

Safety labels on products

The following safety labels are used on products to warn against risks and dangers.

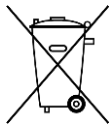
Symbol	Meaning	Symbol	Meaning
	Notice, general danger location Observe product documentation		ON/OFF Power
	Caution when handling heavy equipment		Standby indication
	Danger of electric shock		Direct current (DC)

Basic Safety Instructions

Symbol	Meaning	Symbol	Meaning
	Caution ! Hot surface		Alternating current (AC)
	Protective conductor terminal To identify any terminal which is intended for connection to an external conductor for protection against electric shock in case of a fault, or the terminal of a protective earth		Direct/alternating current (DC/AC)
	Earth (Ground)		Class II Equipment to identify equipment meeting the safety requirements specified for Class II equipment (device protected by double or reinforced insulation)
	Frame or chassis Ground terminal		EU labeling for batteries and accumulators For additional information, see section "Waste disposal/Environmental protection", item 1.
	Be careful when handling electrostatic sensitive devices		EU labeling for separate collection of electrical and electronic devices For additional information, see section "Waste disposal/Environmental protection", item 2.
	Warning! Laser radiation For additional information, see section "Operation", item 7.		

Signal words and their meaning

The following signal words are used in the product documentation in order to warn the reader about risks and dangers.



Indicates a hazardous situation which, if not avoided, will result in death or serious injury.



Indicates a hazardous situation which, if not avoided, could result in death or serious injury.



Indicates a hazardous situation which, if not avoided, could result in minor or moderate injury.



Indicates information considered important, but not hazard-related, e.g. messages relating to property damage.

In the product documentation, the word ATTENTION is used synonymously.

These signal words are in accordance with the standard definition for civil applications in the European Economic Area. Definitions that deviate from the standard definition may also exist in other economic areas or military applications. It is therefore essential to make sure that the signal words described here are always used only in connection with the related product documentation and the related product. The use of signal words in connection with unrelated products or documentation can result in misinterpretation and in personal injury or material damage.

Basic Safety Instructions

Operating states and operating positions

The product may be operated only under the operating conditions and in the positions specified by the manufacturer, without the product's ventilation being obstructed. If the manufacturer's specifications are not observed, this can result in electric shock, fire and/or serious personal injury or death. Applicable local or national safety regulations and rules for the prevention of accidents must be observed in all work performed.

1. Unless otherwise specified, the following requirements apply to Rohde & Schwarz products: predefined operating position is always with the housing floor facing down, IP protection 2X, use only indoors, max. operating altitude 2000 m above sea level, max. transport altitude 4500 m above sea level. A tolerance of $\pm 10\%$ shall apply to the nominal voltage and $\pm 5\%$ to the nominal frequency, overvoltage category 2, pollution degree 2.
2. Do not place the product on surfaces, vehicles, cabinets or tables that for reasons of weight or stability are unsuitable for this purpose. Always follow the manufacturer's installation instructions when installing the product and fastening it to objects or structures (e.g. walls and shelves). An installation that is not carried out as described in the product documentation could result in personal injury or even death.
3. Do not place the product on heat-generating devices such as radiators or fan heaters. The ambient temperature must not exceed the maximum temperature specified in the product documentation or in the data sheet. Product overheating can cause electric shock, fire and/or serious personal injury or even death.

Electrical safety

If the information on electrical safety is not observed either at all or to the extent necessary, electric shock, fire and/or serious personal injury or death may occur.

1. Prior to switching on the product, always ensure that the nominal voltage setting on the product matches the nominal voltage of the mains-supply network. If a different voltage is to be set, the power fuse of the product may have to be changed accordingly.
2. In the case of products of safety class I with movable power cord and connector, operation is permitted only on sockets with a protective conductor contact and protective conductor.
3. Intentionally breaking the protective conductor either in the feed line or in the product itself is not permitted. Doing so can result in the danger of an electric shock from the product. If extension cords or connector strips are implemented, they must be checked on a regular basis to ensure that they are safe to use.
4. If there is no power switch for disconnecting the product from the mains, or if the power switch is not suitable for this purpose, use the plug of the connecting cable to disconnect the product from the mains. In such cases, always ensure that the power plug is easily reachable and accessible at all times. For example, if the power plug is the disconnecting device, the length of the connecting cable must not exceed 3 m. Functional or electronic switches are not suitable for providing disconnection from the AC supply network. If products without power switches are integrated into racks or systems, the disconnecting device must be provided at the system level.
5. Never use the product if the power cable is damaged. Check the power cables on a regular basis to ensure that they are in proper operating condition. By taking appropriate safety measures and carefully laying the power cable, ensure that the cable cannot be damaged and that no one can be hurt by, for example, tripping over the cable or suffering an electric shock.

Basic Safety Instructions

6. The product may be operated only from TN/TT supply networks fuse-protected with max. 16 A (higher fuse only after consulting with the Rohde & Schwarz group of companies).
7. Do not insert the plug into sockets that are dusty or dirty. Insert the plug firmly and all the way into the socket provided for this purpose. Otherwise, sparks that result in fire and/or injuries may occur.
8. Do not overload any sockets, extension cords or connector strips; doing so can cause fire or electric shocks.
9. For measurements in circuits with voltages $V_{rms} > 30$ V, suitable measures (e.g. appropriate measuring equipment, fuse protection, current limiting, electrical separation, insulation) should be taken to avoid any hazards.
10. Ensure that the connections with information technology equipment, e.g. PCs or other industrial computers, comply with the IEC 60950-1 / EN 60950-1 or IEC 61010-1 / EN 61010-1 standards that apply in each case.
11. Unless expressly permitted, never remove the cover or any part of the housing while the product is in operation. Doing so will expose circuits and components and can lead to injuries, fire or damage to the product.
12. If a product is to be permanently installed, the connection between the protective conductor terminal on site and the product's protective conductor must be made first before any other connection is made. The product may be installed and connected only by a licensed electrician.
13. For permanently installed equipment without built-in fuses, circuit breakers or similar protective devices, the supply circuit must be fuse-protected in such a way that anyone who has access to the product, as well as the product itself, is adequately protected from injury or damage.
14. Use suitable overvoltage protection to ensure that no overvoltage (such as that caused by a bolt of lightning) can reach the product. Otherwise, the person operating the product will be exposed to the danger of an electric shock.
15. Any object that is not designed to be placed in the openings of the housing must not be used for this purpose. Doing so can cause short circuits inside the product and/or electric shocks, fire or injuries.
16. Unless specified otherwise, products are not liquid-proof (see also section "Operating states and operating positions", item 1). Therefore, the equipment must be protected against penetration by liquids. If the necessary precautions are not taken, the user may suffer electric shock or the product itself may be damaged, which can also lead to personal injury.
17. Never use the product under conditions in which condensation has formed or can form in or on the product, e.g. if the product has been moved from a cold to a warm environment. Penetration by water increases the risk of electric shock.
18. Prior to cleaning the product, disconnect it completely from the power supply (e.g. AC supply network or battery). Use a soft, non-linting cloth to clean the product. Never use chemical cleaning agents such as alcohol, acetone or diluents for cellulose lacquers.

Operation

1. Operating the products requires special training and intense concentration. Make sure that persons who use the products are physically, mentally and emotionally fit enough to do so; otherwise, injuries or material damage may occur. It is the responsibility of the employer/operator to select suitable personnel for operating the products.

Basic Safety Instructions

2. Before you move or transport the product, read and observe the section titled "Transport".
3. As with all industrially manufactured goods, the use of substances that induce an allergic reaction (allergens) such as nickel cannot be generally excluded. If you develop an allergic reaction (such as a skin rash, frequent sneezing, red eyes or respiratory difficulties) when using a Rohde & Schwarz product, consult a physician immediately to determine the cause and to prevent health problems or stress.
4. Before you start processing the product mechanically and/or thermally, or before you take it apart, be sure to read and pay special attention to the section titled "Waste disposal/Environmental protection", item 1.
5. Depending on the function, certain products such as RF radio equipment can produce an elevated level of electromagnetic radiation. Considering that unborn babies require increased protection, pregnant women must be protected by appropriate measures. Persons with pacemakers may also be exposed to risks from electromagnetic radiation. The employer/operator must evaluate workplaces where there is a special risk of exposure to radiation and, if necessary, take measures to avert the potential danger.
6. Should a fire occur, the product may release hazardous substances (gases, fluids, etc.) that can cause health problems. Therefore, suitable measures must be taken, e.g. protective masks and protective clothing must be worn.
7. Laser products are given warning labels that are standardized according to their laser class. Lasers can cause biological harm due to the properties of their radiation and due to their extremely concentrated electromagnetic power. If a laser product (e.g. a CD/DVD drive) is integrated into a Rohde & Schwarz product, absolutely no other settings or functions may be used as described in the product documentation. The objective is to prevent personal injury (e.g. due to laser beams).
8. EMC classes (in line with EN 55011/CISPR 11, and analogously with EN 55022/CISPR 22, EN 55032/CISPR 32)
 - Class A equipment:
Equipment suitable for use in all environments except residential environments and environments that are directly connected to a low-voltage supply network that supplies residential buildings
Note: Class A equipment is intended for use in an industrial environment. This equipment may cause radio disturbances in residential environments, due to possible conducted as well as radiated disturbances. In this case, the operator may be required to take appropriate measures to eliminate these disturbances.
 - Class B equipment:
Equipment suitable for use in residential environments and environments that are directly connected to a low-voltage supply network that supplies residential buildings

Repair and service

1. The product may be opened only by authorized, specially trained personnel. Before any work is performed on the product or before the product is opened, it must be disconnected from the AC supply network. Otherwise, personnel will be exposed to the risk of an electric shock.

Basic Safety Instructions

- Adjustments, replacement of parts, maintenance and repair may be performed only by electrical experts authorized by Rohde & Schwarz. Only original parts may be used for replacing parts relevant to safety (e.g. power switches, power transformers, fuses). A safety test must always be performed after parts relevant to safety have been replaced (visual inspection, protective conductor test, insulation resistance measurement, leakage current measurement, functional test). This helps ensure the continued safety of the product.

Batteries and rechargeable batteries/cells

If the information regarding batteries and rechargeable batteries/cells is not observed either at all or to the extent necessary, product users may be exposed to the risk of explosions, fire and/or serious personal injury, and, in some cases, death. Batteries and rechargeable batteries with alkaline electrolytes (e.g. lithium cells) must be handled in accordance with the EN 62133 standard.

- Cells must not be taken apart or crushed.
- Cells or batteries must not be exposed to heat or fire. Storage in direct sunlight must be avoided. Keep cells and batteries clean and dry. Clean soiled connectors using a dry, clean cloth.
- Cells or batteries must not be short-circuited. Cells or batteries must not be stored in a box or in a drawer where they can short-circuit each other, or where they can be short-circuited by other conductive materials. Cells and batteries must not be removed from their original packaging until they are ready to be used.
- Cells and batteries must not be exposed to any mechanical shocks that are stronger than permitted.
- If a cell develops a leak, the fluid must not be allowed to come into contact with the skin or eyes. If contact occurs, wash the affected area with plenty of water and seek medical aid.
- Improperly replacing or charging cells or batteries that contain alkaline electrolytes (e.g. lithium cells) can cause explosions. Replace cells or batteries only with the matching Rohde & Schwarz type (see parts list) in order to ensure the safety of the product.
- Cells and batteries must be recycled and kept separate from residual waste. Rechargeable batteries and normal batteries that contain lead, mercury or cadmium are hazardous waste. Observe the national regulations regarding waste disposal and recycling.
- Follow the transport stipulations of the carrier (IATA-DGR, IMDG-Code, ADR, RID) when returning lithium batteries to Rohde & Schwarz subsidiaries.

Transport

- The product may be very heavy. Therefore, the product must be handled with care. In some cases, the user may require a suitable means of lifting or moving the product (e.g. with a lift-truck) to avoid back or other physical injuries.
- Handles on the products are designed exclusively to enable personnel to transport the product. It is therefore not permissible to use handles to fasten the product to or on transport equipment such as cranes, fork lifts, wagons, etc. The user is responsible for securely fastening the products to or on the means of transport or lifting. Observe the safety regulations of the manufacturer of the means of transport or lifting. Noncompliance can result in personal injury or material damage.

Instrucciones de seguridad elementales

3. If you use the product in a vehicle, it is the sole responsibility of the driver to drive the vehicle safely and properly. The manufacturer assumes no responsibility for accidents or collisions. Never use the product in a moving vehicle if doing so could distract the driver of the vehicle. Adequately secure the product in the vehicle to prevent injuries or other damage in the event of an accident.

Waste disposal/Environmental protection

1. Specially marked equipment has a battery or accumulator that must not be disposed of with unsorted municipal waste, but must be collected separately. It may only be disposed of at a suitable collection point or via a Rohde & Schwarz customer service center.
2. Waste electrical and electronic equipment must not be disposed of with unsorted municipal waste, but must be collected separately.
Rohde & Schwarz GmbH & Co. KG has developed a disposal concept and takes full responsibility for take-back obligations and disposal obligations for manufacturers within the EU. Contact your Rohde & Schwarz customer service center for environmentally responsible disposal of the product.
3. If products or their components are mechanically and/or thermally processed in a manner that goes beyond their intended use, hazardous substances (heavy-metal dust such as lead, beryllium, nickel) may be released. For this reason, the product may only be disassembled by specially trained personnel. Improper disassembly may be hazardous to your health. National waste disposal regulations must be observed.
4. If handling the product releases hazardous substances or fuels that must be disposed of in a special way, e.g. coolants or engine oils that must be replenished regularly, the safety instructions of the manufacturer of the hazardous substances or fuels and the applicable regional waste disposal regulations must be observed. Also observe the relevant safety instructions in the product documentation. The improper disposal of hazardous substances or fuels can cause health problems and lead to environmental damage.

For additional information about environmental protection, visit the Rohde & Schwarz website.

Instrucciones de seguridad elementales

¡Es imprescindible leer y cumplir las siguientes instrucciones e informaciones de seguridad!

El principio del grupo de empresas Rohde & Schwarz consiste en tener nuestros productos siempre al día con los estándares de seguridad y de ofrecer a nuestros clientes el máximo grado de seguridad. Nuestros productos y todos los equipos adicionales son siempre fabricados y examinados según las normas de seguridad vigentes. Nuestro sistema de garantía de calidad controla constantemente que sean cumplidas estas normas. El presente producto ha sido fabricado y examinado según el certificado de conformidad de la UE y ha salido de nuestra planta en estado impecable según los estándares técnicos de seguridad. Para poder preservar este estado y garantizar un funcionamiento libre de peligros, el usuario deberá atenerse a todas las indicaciones, informaciones de seguridad y notas de alerta. El grupo de empresas Rohde & Schwarz está siempre a su disposición en caso de que tengan preguntas referentes a estas informaciones de seguridad.

Instrucciones de seguridad elementales











Además queda en la responsabilidad del usuario utilizar el producto en la forma debida. Este producto está destinado exclusivamente al uso en la industria y el laboratorio o, si ha sido expresamente autorizado, para aplicaciones de campo y de ninguna manera deberá ser utilizado de modo que alguna persona/cosa pueda sufrir daño. El uso del producto fuera de sus fines definidos o sin tener en cuenta las instrucciones del fabricante queda en la responsabilidad del usuario. El fabricante no se hace en ninguna forma responsable de consecuencias a causa del mal uso del producto.

Se parte del uso correcto del producto para los fines definidos si el producto es utilizado conforme a las indicaciones de la correspondiente documentación del producto y dentro del margen de rendimiento definido (ver hoja de datos, documentación, informaciones de seguridad que siguen). El uso del producto hace necesarios conocimientos técnicos y ciertos conocimientos del idioma inglés. Por eso se debe tener en cuenta que el producto solo pueda ser operado por personal especializado o personas instruidas en profundidad con las capacidades correspondientes. Si fuera necesaria indumentaria de seguridad para el uso de productos de Rohde & Schwarz, encontraría la información debida en la documentación del producto en el capítulo correspondiente. Guarde bien las informaciones de seguridad elementales, así como la documentación del producto, y entréguelas a usuarios posteriores.







Tener en cuenta las informaciones de seguridad sirve para evitar en lo posible lesiones o daños por peligros de toda clase. Por eso es imprescindible leer detalladamente y comprender por completo las siguientes informaciones de seguridad antes de usar el producto, y respetarlas durante el uso del producto. Deberán tenerse en cuenta todas las demás informaciones de seguridad, como p. ej. las referentes a la protección de personas, que encontrarán en el capítulo correspondiente de la documentación del producto y que también son de obligado cumplimiento. En las presentes informaciones de seguridad se recogen todos los objetos que distribuye el grupo de empresas Rohde & Schwarz bajo la denominación de "producto", entre ellos también aparatos, instalaciones así como toda clase de accesorios. Los datos específicos del producto figuran en la hoja de datos y en la documentación del producto.

Señalización de seguridad de los productos

Las siguientes señales de seguridad se utilizan en los productos para advertir sobre riesgos y peligros.

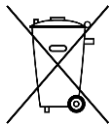
Símbolo	Significado	Símbolo	Significado
	Aviso: punto de peligro general Observar la documentación del producto		Tensión de alimentación de PUESTA EN MARCHA / PARADA
	Atención en el manejo de dispositivos de peso elevado		Indicación de estado de espera (standby)
	Peligro de choque eléctrico		Corriente continua (DC)
	Advertencia: superficie caliente		Corriente alterna (AC)
	Conexión a conductor de protección		Corriente continua / Corriente alterna (DC/AC)

Instrucciones de seguridad elementales

Símbolo	Significado	Símbolo	Significado
	Conexión a tierra		El aparato está protegido en su totalidad por un aislamiento doble (reforzado)
	Conexión a masa		Distintivo de la UE para baterías y acumuladores Más información en la sección "Eliminación/protección del medio ambiente", punto 1.
	Aviso: Cuidado en el manejo de dispositivos sensibles a la electrostática (ESD)		Distintivo de la UE para la eliminación por separado de dispositivos eléctricos y electrónicos Más información en la sección "Eliminación/protección del medio ambiente", punto 2.
	Advertencia: rayo láser Más información en la sección "Funcionamiento", punto 7.		

Palabras de señal y su significado

En la documentación del producto se utilizan las siguientes palabras de señal con el fin de advertir contra riesgos y peligros.



Indica una situación de peligro que, si no se evita, causa lesiones graves o incluso la muerte.



Indica una situación de peligro que, si no se evita, puede causar lesiones graves o incluso la muerte.



Indica una situación de peligro que, si no se evita, puede causar lesiones leves o moderadas.



Indica información que se considera importante, pero no en relación con situaciones de peligro; p. ej., avisos sobre posibles daños materiales.

En la documentación del producto se emplea de forma sinónima el término CUIDADO.

Las palabras de señal corresponden a la definición habitual para aplicaciones civiles en el área económica europea. Pueden existir definiciones diferentes a esta definición en otras áreas económicas o en aplicaciones militares. Por eso se deberá tener en cuenta que las palabras de señal aquí descritas sean utilizadas siempre solamente en combinación con la correspondiente documentación del producto y solamente en combinación con el producto correspondiente. La utilización de las palabras de señal en combinación con productos o documentaciones que no les correspondan puede llevar a interpretaciones equivocadas y tener por consecuencia daños en personas u objetos.

Instrucciones de seguridad elementales

Estados operativos y posiciones de funcionamiento

El producto solamente debe ser utilizado según lo indicado por el fabricante respecto a los estados operativos y posiciones de funcionamiento sin que se obstruya la ventilación. Si no se siguen las indicaciones del fabricante, pueden producirse choques eléctricos, incendios y/o lesiones graves con posible consecuencia de muerte. En todos los trabajos deberán ser tenidas en cuenta las normas nacionales y locales de seguridad del trabajo y de prevención de accidentes.

1. Si no se convino de otra manera, es para los productos Rohde & Schwarz válido lo que sigue: como posición de funcionamiento se define por principio la posición con el suelo de la caja para abajo, modo de protección IP 2X, uso solamente en estancias interiores, utilización hasta 2000 m sobre el nivel del mar, transporte hasta 4500 m sobre el nivel del mar. Se aplicará una tolerancia de $\pm 10\%$ sobre el voltaje nominal y de $\pm 5\%$ sobre la frecuencia nominal. Categoría de sobrecarga eléctrica 2, índice de suciedad 2.
2. No sitúe el producto encima de superficies, vehículos, estantes o mesas, que por sus características de peso o de estabilidad no sean aptos para él. Siga siempre las instrucciones de instalación del fabricante cuando instale y asegure el producto en objetos o estructuras (p. ej. paredes y estantes). Si se realiza la instalación de modo distinto al indicado en la documentación del producto, se pueden causar lesiones o, en determinadas circunstancias, incluso la muerte.
3. No ponga el producto sobre aparatos que generen calor (p. ej. radiadores o calefactores). La temperatura ambiente no debe superar la temperatura máxima especificada en la documentación del producto o en la hoja de datos. En caso de sobrecalentamiento del producto, pueden producirse choques eléctricos, incendios y/o lesiones graves con posible consecuencia de muerte.

Seguridad eléctrica

Si no se siguen (o se siguen de modo insuficiente) las indicaciones del fabricante en cuanto a seguridad eléctrica, pueden producirse choques eléctricos, incendios y/o lesiones graves con posible consecuencia de muerte.

1. Antes de la puesta en marcha del producto se deberá comprobar siempre que la tensión preseleccionada en el producto coincida con la de la red de alimentación eléctrica. Si es necesario modificar el ajuste de tensión, también se deberán cambiar en caso dado los fusibles correspondientes del producto.
2. Los productos de la clase de protección I con alimentación móvil y enchufe individual solamente podrán enchufarse a tomas de corriente con contacto de seguridad y con conductor de protección conectado.
3. Queda prohibida la interrupción intencionada del conductor de protección, tanto en la toma de corriente como en el mismo producto. La interrupción puede tener como consecuencia el riesgo de que el producto sea fuente de choques eléctricos. Si se utilizan cables alargadores o regletas de enchufe, deberá garantizarse la realización de un examen regular de los mismos en cuanto a su estado técnico de seguridad.
4. Si el producto no está equipado con un interruptor para desconectarlo de la red, o bien si el interruptor existente no resulta apropiado para la desconexión de la red, el enchufe del cable de conexión se deberá considerar como un dispositivo de desconexión. El dispositivo de desconexión se debe poder alcanzar fácilmente y debe estar siempre bien accesible. Si, p. ej., el enchufe de conexión a la red es el dispositivo de desconexión, la longitud del cable de conexión no debe superar 3 m).
Los interruptores selectores o electrónicos no son aptos para el corte de la red eléctrica. Si se

Instrucciones de seguridad elementales

integran productos sin interruptor en bastidores o instalaciones, se deberá colocar el interruptor en el nivel de la instalación.

5. No utilice nunca el producto si está dañado el cable de conexión a red. Compruebe regularmente el correcto estado de los cables de conexión a red. Asegúrese, mediante las medidas de protección y de instalación adecuadas, de que el cable de conexión a red no pueda ser dañado o de que nadie pueda ser dañado por él, p. ej. al tropezar o por un choque eléctrico.
6. Solamente está permitido el funcionamiento en redes de alimentación TN/TT aseguradas con fusibles de 16 A como máximo (utilización de fusibles de mayor amperaje solo previa consulta con el grupo de empresas Rohde & Schwarz).
7. Nunca conecte el enchufe en tomas de corriente sucias o llenas de polvo. Introduzca el enchufe por completo y fuertemente en la toma de corriente. La no observación de estas medidas puede provocar chispas, fuego y/o lesiones.
8. No sobrecargue las tomas de corriente, los cables alargadores o las regletas de enchufe ya que esto podría causar fuego o choques eléctricos.
9. En las mediciones en circuitos de corriente con una tensión $U_{\text{eff}} > 30 \text{ V}$ se deberán tomar las medidas apropiadas para impedir cualquier peligro (p. ej. medios de medición adecuados, seguros, limitación de tensión, corte protector, aislamiento etc.).
10. Para la conexión con dispositivos informáticos como un PC o un ordenador industrial, debe comprobarse que éstos cumplan los estándares IEC60950-1/EN60950-1 o IEC61010-1/EN 61010-1 válidos en cada caso.
11. A menos que esté permitido expresamente, no retire nunca la tapa ni componentes de la carcasa mientras el producto esté en servicio. Esto pone a descubierto los cables y componentes eléctricos y puede causar lesiones, fuego o daños en el producto.
12. Si un producto se instala en un lugar fijo, se deberá primero conectar el conductor de protección fijo con el conductor de protección del producto antes de hacer cualquier otra conexión. La instalación y la conexión deberán ser efectuadas por un electricista especializado.
13. En el caso de dispositivos fijos que no estén provistos de fusibles, interruptor automático ni otros mecanismos de seguridad similares, el circuito de alimentación debe estar protegido de modo que todas las personas que puedan acceder al producto, así como el producto mismo, estén a salvo de posibles daños.
14. Todo producto debe estar protegido contra sobretensión (debida p. ej. a una caída del rayo) mediante los correspondientes sistemas de protección. Si no, el personal que lo utilice quedará expuesto al peligro de choque eléctrico.
15. No debe introducirse en los orificios de la caja del aparato ningún objeto que no esté destinado a ello. Esto puede producir cortocircuitos en el producto y/o puede causar choques eléctricos, fuego o lesiones.
16. Salvo indicación contraria, los productos no están impermeabilizados (ver también el capítulo "Estados operativos y posiciones de funcionamiento", punto 1). Por eso es necesario tomar las medidas necesarias para evitar la entrada de líquidos. En caso contrario, existe peligro de choque eléctrico para el usuario o de daños en el producto, que también pueden redundar en peligro para las personas.

Instrucciones de seguridad elementales

17. No utilice el producto en condiciones en las que pueda producirse o ya se hayan producido condensaciones sobre el producto o en el interior de éste, como p. ej. al desplazarlo de un lugar frío a otro caliente. La entrada de agua aumenta el riesgo de choque eléctrico.
18. Antes de la limpieza, desconecte por completo el producto de la alimentación de tensión (p. ej. red de alimentación o batería). Realice la limpieza de los aparatos con un paño suave, que no se deshilache. No utilice bajo ningún concepto productos de limpieza químicos como alcohol, acetona o diluyentes para lacas nitrocelulósicas.

Funcionamiento

1. El uso del producto requiere instrucciones especiales y una alta concentración durante el manejo. Debe asegurarse que las personas que manejen el producto estén a la altura de los requerimientos necesarios en cuanto a aptitudes físicas, psíquicas y emocionales, ya que de otra manera no se pueden excluir lesiones o daños de objetos. El empresario u operador es responsable de seleccionar el personal usuario apto para el manejo del producto.
2. Antes de desplazar o transportar el producto, lea y tenga en cuenta el capítulo "Transporte".
3. Como con todo producto de fabricación industrial no puede quedar excluida en general la posibilidad de que se produzcan alergias provocadas por algunos materiales empleados —los llamados alérgenos (p. ej. el níquel)—. Si durante el manejo de productos Rohde & Schwarz se producen reacciones alérgicas, como p. ej. irritaciones cutáneas, estornudos continuos, enrojecimiento de la conjuntiva o dificultades respiratorias, debe avisarse inmediatamente a un médico para investigar las causas y evitar cualquier molestia o daño a la salud.
4. Antes de la manipulación mecánica y/o térmica o el desmontaje del producto, debe tenerse en cuenta imprescindiblemente el capítulo "Eliminación/protección del medio ambiente", punto 1.
5. Ciertos productos, como p. ej. las instalaciones de radiocomunicación RF, pueden a causa de su función natural, emitir una radiación electromagnética aumentada. Deben tomarse todas las medidas necesarias para la protección de las mujeres embarazadas. También las personas con marcapasos pueden correr peligro a causa de la radiación electromagnética. El empresario/operador tiene la obligación de evaluar y señalar las áreas de trabajo en las que exista un riesgo elevado de exposición a radiaciones.
6. Tenga en cuenta que en caso de incendio pueden desprenderse del producto sustancias tóxicas (gases, líquidos etc.) que pueden generar daños a la salud. Por eso, en caso de incendio deben usarse medidas adecuadas, como p. ej. máscaras antigás e indumentaria de protección.
7. Los productos con láser están provistos de indicaciones de advertencia normalizadas en función de la clase de láser del que se trate. Los rayos láser pueden provocar daños de tipo biológico a causa de las propiedades de su radiación y debido a su concentración extrema de potencia electromagnética. En caso de que un producto Rohde & Schwarz contenga un producto láser (p. ej. un lector de CD/DVD), no debe usarse ninguna otra configuración o función aparte de las descritas en la documentación del producto, a fin de evitar lesiones (p. ej. debidas a irradiación láser).
8. Clases de compatibilidad electromagnética (conforme a EN 55011 / CISPR 11; y en analogía con EN 55022 / CISPR 22, EN 55032 / CISPR 32)
 - Aparato de clase A:
Aparato adecuado para su uso en todos los entornos excepto en los residenciales y en aquellos conectados directamente a una red de distribución de baja tensión que suministra corriente a edificios residenciales.
Nota: Los aparatos de clase A están destinados al uso en entornos industriales. Estos aparatos

Instrucciones de seguridad elementales

pueden causar perturbaciones radioeléctricas en entornos residenciales debido a posibles perturbaciones guiadas o radiadas. En este caso, se le podrá solicitar al operador que tome las medidas adecuadas para eliminar estas perturbaciones.

- Aparato de clase B:
Aparato adecuado para su uso en entornos residenciales, así como en aquellos conectados directamente a una red de distribución de baja tensión que suministra corriente a edificios residenciales.

Reparación y mantenimiento

1. El producto solamente debe ser abierto por personal especializado con autorización para ello. Antes de manipular el producto o abrirlo, es obligatorio desconectarlo de la tensión de alimentación, para evitar toda posibilidad de choque eléctrico.
2. El ajuste, el cambio de partes, el mantenimiento y la reparación deberán ser efectuadas solamente por electricistas autorizados por Rohde & Schwarz. Si se reponen partes con importancia para los aspectos de seguridad (p. ej. el enchufe, los transformadores o los fusibles), solamente podrán ser sustituidos por partes originales. Después de cada cambio de partes relevantes para la seguridad deberá realizarse un control de seguridad (control a primera vista, control del conductor de protección, medición de resistencia de aislamiento, medición de la corriente de fuga, control de funcionamiento). Con esto queda garantizada la seguridad del producto.

Baterías y acumuladores o celdas

Si no se siguen (o se siguen de modo insuficiente) las indicaciones en cuanto a las baterías y acumuladores o celdas, pueden producirse explosiones, incendios y/o lesiones graves con posible consecuencia de muerte. El manejo de baterías y acumuladores con electrolitos alcalinos (p. ej. celdas de litio) debe seguir el estándar EN 62133.

1. No deben desmontarse, abrirse ni triturarse las celdas.
2. Las celdas o baterías no deben someterse a calor ni fuego. Debe evitarse el almacenamiento a la luz directa del sol. Las celdas y baterías deben mantenerse limpias y secas. Limpiar las conexiones sucias con un paño seco y limpio.
3. Las celdas o baterías no deben cortocircuitarse. Es peligroso almacenar las celdas o baterías en estuches o cajones en cuyo interior puedan cortocircuitarse por contacto recíproco o por contacto con otros materiales conductores. No deben extraerse las celdas o baterías de sus embalajes originales hasta el momento en que vayan a utilizarse.
4. Las celdas o baterías no deben someterse a impactos mecánicos fuertes indebidos.
5. En caso de falta de estanqueidad de una celda, el líquido vertido no debe entrar en contacto con la piel ni los ojos. Si se produce contacto, lavar con agua abundante la zona afectada y avisar a un médico.
6. En caso de cambio o recarga inadecuados, las celdas o baterías que contienen electrolitos alcalinos (p. ej. las celdas de litio) pueden explotar. Para garantizar la seguridad del producto, las celdas o baterías solo deben ser sustituidas por el tipo Rohde & Schwarz correspondiente (ver lista de recambios).
7. Las baterías y celdas deben reciclarse y no deben tirarse a la basura doméstica. Las baterías o acumuladores que contienen plomo, mercurio o cadmio deben tratarse como residuos especiales. Respete en esta relación las normas nacionales de eliminación y reciclaje.

Instrucciones de seguridad elementales

8. En caso de devolver baterías de litio a las filiales de Rohde & Schwarz, debe cumplirse las normativas sobre los modos de transporte (IATA-DGR, código IMDG, ADR, RID).

Transporte

1. El producto puede tener un peso elevado. Por eso es necesario desplazarlo o transportarlo con precaución y, si es necesario, usando un sistema de elevación adecuado (p. ej. una carretilla elevadora), a fin de evitar lesiones en la espalda u otros daños personales.
2. Las asas instaladas en los productos sirven solamente de ayuda para el transporte del producto por personas. Por eso no está permitido utilizar las asas para la sujeción en o sobre medios de transporte como p. ej. grúas, carretillas elevadoras de horquilla, carros etc. Es responsabilidad suya fijar los productos de manera segura a los medios de transporte o elevación. Para evitar daños personales o daños en el producto, siga las instrucciones de seguridad del fabricante del medio de transporte o elevación utilizado.
3. Si se utiliza el producto dentro de un vehículo, recae de manera exclusiva en el conductor la responsabilidad de conducir el vehículo de manera segura y adecuada. El fabricante no asumirá ninguna responsabilidad por accidentes o colisiones. No utilice nunca el producto dentro de un vehículo en movimiento si esto pudiera distraer al conductor. Asegure el producto dentro del vehículo debidamente para evitar, en caso de un accidente, lesiones u otra clase de daños.

Eliminación/protección del medio ambiente

1. Los dispositivos marcados contienen una batería o un acumulador que no se debe desechar con los residuos domésticos sin clasificar, sino que debe ser recogido por separado. La eliminación se debe efectuar exclusivamente a través de un punto de recogida apropiado o del servicio de atención al cliente de Rohde & Schwarz.
2. Los dispositivos eléctricos usados no se deben desechar con los residuos domésticos sin clasificar, sino que deben ser recogidos por separado.
Rohde & Schwarz GmbH & Co.KG ha elaborado un concepto de eliminación de residuos y asume plenamente los deberes de recogida y eliminación para los fabricantes dentro de la UE. Para desechar el producto de manera respetuosa con el medio ambiente, diríjase a su servicio de atención al cliente de Rohde & Schwarz.
3. Si se trabaja de manera mecánica y/o térmica cualquier producto o componente más allá del funcionamiento previsto, pueden liberarse sustancias peligrosas (polvos con contenido de metales pesados como p. ej. plomo, berilio o níquel). Por eso el producto solo debe ser desmontado por personal especializado con formación adecuada. Un desmontaje inadecuado puede ocasionar daños para la salud. Se deben tener en cuenta las directivas nacionales referentes a la eliminación de residuos.
4. En caso de que durante el trato del producto se formen sustancias peligrosas o combustibles que deban tratarse como residuos especiales (p. ej. refrigerantes o aceites de motor con intervalos de cambio definidos), deben tenerse en cuenta las indicaciones de seguridad del fabricante de dichas sustancias y las normas regionales de eliminación de residuos. Tenga en cuenta también en caso necesario las indicaciones de seguridad especiales contenidas en la documentación del producto. La eliminación incorrecta de sustancias peligrosas o combustibles puede causar daños a la salud o daños al medio ambiente.

Se puede encontrar más información sobre la protección del medio ambiente en la página web de Rohde & Schwarz.

Customer Support

Technical support – where and when you need it

For quick, expert help with any Rohde & Schwarz equipment, contact one of our Customer Support Centers. A team of highly qualified engineers provides telephone support and will work with you to find a solution to your query on any aspect of the operation, programming or applications of Rohde & Schwarz equipment.

Up-to-date information and upgrades

To keep your instrument up-to-date and to be informed about new application notes related to your instrument, please send an e-mail to the Customer Support Center stating your instrument and your wish. We will take care that you will get the right information.

Europe, Africa, Middle East

Phone +49 89 4129 12345
customersupport@rohde-schwarz.com

North America

Phone 1-888-TEST-RSA (1-888-837-8772)
customer.support@rsa.rohde-schwarz.com

Latin America

Phone +1-410-910-7988
customersupport.la@rohde-schwarz.com

Asia/Pacific

Phone +65 65 13 04 88
customersupport.asia@rohde-schwarz.com

China

Phone +86-800-810-8228 /
+86-400-650-5896
customersupport.china@rohde-schwarz.com



Contents

1	Preface	7
1.1	Key Features	7
1.2	Documentation Overview	7
1.2.1	Getting Started Manual.....	7
1.2.2	User Manual.....	7
1.2.3	Basic Safety Instructions.....	8
1.2.4	Brochure and Specifications.....	8
1.2.5	Release Notes.....	8
1.2.6	Remote Control Drivers.....	8
1.3	For Your Safety	8
2	Welcome to the R&S HMP Series	10
3	Getting Started	11
3.1	Preparing for Use	11
3.1.1	Putting into Operation.....	11
3.1.1.1	Safety.....	11
3.1.1.2	Unpacking and Checking the Instrument.....	14
3.1.1.3	Delivery List.....	15
3.1.1.4	Placing or Mounting the Instrument.....	15
3.1.1.5	Starting the Instrument	17
3.1.1.6	Starting Up and Shutting Down.....	18
3.1.2	Setting Up a Network (LAN) Connection.....	19
3.2	Instrument Tour	21
3.2.1	Front Panel Views of the R&S HMP2030 and the R&S HMP2020.....	21
3.2.2	Front Panel Views of the R&S HMP4040 and the R&S HMP4030.....	22
3.2.3	Rear Panel Views of the R&S HMP2030 and the R&S HMP2020.....	23
3.2.4	Rear Panel Views of the R&S HMP4030 and the R&S HMP4040.....	24
3.3	Trying Out the Instrument	25
3.4	Instrument Control	27
3.4.1	Ways to Operate the Instrument.....	27
3.4.2	Means of Manual Interaction.....	28
3.4.3	Remote Control.....	30

4	Instrument Functions.....	31
4.1	About the Output Modes of the R&S HMP.....	31
4.2	Basic Functions.....	33
4.2.1	Setting the Voltage, Current and Fuse Parameters and Activating an Output.....	33
4.2.2	Using the Tracking Function.....	33
4.2.3	Saving and Recalling Instrument Configurations.....	35
4.3	Advanced Functions.....	35
4.3.1	Fuse Settings.....	35
4.3.2	Overvoltage Protection Settings.....	37
4.3.3	Arbitrary Settings.....	38
4.4	General Instrument Functions.....	43
4.4.1	Interface.....	43
4.4.2	Key & Display Functions.....	44
4.4.3	Beeper.....	45
4.4.4	Information.....	46
4.4.5	Reset Device.....	46
5	Application Examples.....	47
5.1	Compensating Voltage Drops on the Supply Lines	47
5.2	Operating in Parallel and Serial Mode.....	47
5.2.1	Serial Mode.....	48
5.2.2	Parallel Mode.....	48
5.3	Multi-Quadrant Operation.....	49
6	Maintenance.....	51
6.1	Cleaning.....	51
6.2	Storing and Packing.....	52
7	Network Operation and Remote Control.....	53
7.1	Remote Control Interfaces.....	53
7.1.1	Ethernet / USB Dual Interface R&S HO732.....	53
7.1.2	USB Interface.....	54
7.1.3	RS-232 Interface.....	55
7.1.4	GPIB Interface (IEC/IEEE Bus Interface).....	56
8	Remote Control Commands.....	57

8.1	Common Setting Commands	57
8.2	System Setting Commands	60
8.3	Configuration Commands	62
8.3.1	Channel Selection Commands.....	62
8.3.2	Voltage Setting Commands.....	63
8.3.3	Current Setting Commands.....	65
8.3.4	Combined Voltage and Current Commands.....	67
8.3.5	Output Setting Commands.....	68
8.3.6	Fuse Setting Commands.....	69
8.3.7	Overvoltage Protection Setting Commands.....	72
8.4	Measurement Commands	75
8.5	Arbitrary Setting Commands	75
8.6	Status Reporting	79
8.6.1	STATus:QUEStionable Registers.....	79
	Annex	81
A	Additional Basics on Remote Control	81
A.1	Messages and Command Structure	81
A.1.1	Messages.....	81
A.1.2	SCPI Command Structure.....	82
A.2	Command Sequence and Synchronization	86
A.2.1	Preventing Overlapping Execution.....	86
A.3	Status Reporting System	86
A.3.1	Structure of a SCPI Status Register.....	87
B	Hardware Interfaces	91
B.1	GPIB	91
B.2	RS-232	92
	Glossary: List of the Often Used Terms and Abbreviations	94
	List of Commands	96
	Index	98

1 Preface

1.1 Key Features

The R&S HMP Series power supplies sets standards in performance and usability. Outstanding key features are:

- High output power within a minimum space, high efficiency and low residual ripple.
- High programming and readback resolution for applications with the highest demands.
- Realtime voltage, current and power values.
- EasyArb function for programming voltage and current processes directly on the instrument.
- Individual electronic fuses freely combinable for all channels, with a fuse delay from 10 to 250 ms.
- Adjustable overvoltage protection (OVP) independently for each channel.
- Advanced parallel and serial operation via V/I tracking.
- Remote control via dual Ethernet/USB interface, USB/RS-232 dual interface or IEEE-488 (GPIB) using SCPI-based commands.

For a detailed specification, refer to the data sheet.

1.2 Documentation Overview

This section provides an overview of the R&S HMP user documentation. Unless specified otherwise, you find the documents on the R&S HMP product page at:

www.rohde-schwarz.com/manual/hmp

1.2.1 Getting Started Manual

Introduces the R&S HMP and describes how to set up and start working with the product. Includes basic operations, and general information, e.g. safety instructions, etc. A printed version is delivered with the instrument.

1.2.2 User Manual

Contains the description of all instrument modes and functions. It also provides an introduction to remote control, a complete description of the remote control commands with programming examples, and information on maintenance and instrument interfaces. Includes the contents of the Getting Started manual.

1.2.3 Basic Safety Instructions

Contains safety instructions, operating conditions and further important information. The printed document is delivered with the instrument.

1.2.4 Brochure and Specifications

The brochure provides an overview of the instrument and deals with the specific characteristics. It contains the technical specifications of the R&S HMP, and provides ordering information for the base units, available options and accessories. See www.rohde-schwarz.com/brochure-datasheet/hmp.

1.2.5 Release Notes

The release notes list new features, improvements and known issues of the current firmware version, and describe the firmware installation.

The release notes are part of the download up-to-date firmware at www.rohde-schwarz.com/firmware/hmp.

1.2.6 Remote Control Drivers

The instrument drivers enable remote control via the corresponding interfaces. The drivers and installation instructions are available for download on the product page at www.rohde-schwarz.com/driver/hmp.

1.3 For Your Safety

The instruments of the R&S HMP series are designated for use in industrial, administrative, and laboratory environments, and residential, business, commercial and small business areas. The instruments comply with protection class II.

Use an R&S HMP only for its designated purpose. Observe the safety and usage instructions documented in the user manual, and operating conditions and performance limits stated in the data sheet.

The product documentation helps you to use the R&S HMP safely and efficiently. Keep the product documentation in a safe place and pass it on to the subsequent users.

Safety information is part of the product documentation. It warns you about the potential dangers and gives instructions how to prevent personal injury or damage caused by dangerous situations. Safety information is provided as follows:

- In the "Basic Safety Instructions", safety issues are grouped according to subjects. For example, one subject is electrical safety. The "Basic Safety Instructions" are delivered with the R&S HMP in different languages in print.

- Throughout the documentation, safety instructions are provided when you need to take care during setup or operation. Always read the safety instructions carefully. Make sure to comply fully with them. Do not take risks and do not underestimate the potential danger of small details such as a damaged power cable.

2 Welcome to the R&S HMP Series

The programmable 2-, 3- or 4-channel high-performance power supplies are based on a classical transformer concept with high efficiency electronic pre-regulators and secondary linear regulators. This concept allows the instrument to achieve the high output power within a minimum space, high efficiency and lowest residual ripple.

Depending on the instrument type, up to 4 galvanically isolated and hence combinable channels are available.

The R&S HMP2030 includes three identical channels with a continuous voltage range of 0 V to 32 V. Up to 16 V, the channels can be charged with 5 A and, with the intelligent power management, with as much as 2.5 A at 32 V. Like the R&S HMP2030, the R&S HMP2020 provides an output power of 188 W. The R&S HMP4030 includes three identical channels with a continuous voltage range of 0 V to 32 V. Up to 16 V the channels can be charged with 10 A and at 32 V with as much as 5 A. Like the R&S HMP4030, the R&S HMP4040 provides an output power of 384 W (160 W per channel). Four identical 32 V channels are available.

The high setting and readback resolution of up to 1 mV/0.1 mA (R&S HMP4030/4040 1 mV/0.2 mA) is suitable for applications with extremely high requirements.

An arbitrary function allows you to define freely programmable waveforms for voltage and current, on a timeframe down to 10 ms. You can set an arbitrary waveform with the control panel or transfer an externally created waveform to the R&S HMP.

The R&S HMP series features galvanically isolated, floating overload and short-circuit proof outputs. The outputs can be connected in series or in parallel, thus making high currents and voltages available.

Individual electronic fuses can be logically linked according to user specifications. The fuse linking feature turns off all interlinked channels in case an error occurs.

3 Getting Started

This section contains the information you have received as a printed book together with your instrument. The information is provided again to enable you to search throughout the complete description.

3.1 Preparing for Use

3.1.1 Putting into Operation

This section describes the basic steps to be taken when setting up the R&S HMP for the first time.

3.1.1.1 Safety

This instrument is built in compliance with DIN EN 61010-1 (VDE 0411 part 1), safety regulations for electrical measuring instruments, control units and Laboratory equipment. It has been tested and shipped from the plant in safe condition. It complies to the regulations of the European standard EN 61010-1 and the international standard IEC 61010-1.

To maintain this condition and ensure safe operation, you must observe all instructions and warnings given in this user manual.

DANGER

Risk of electric shock

Casing and all chassis parts are connected to a protective earth conductor.

It is prohibited to disconnect the earthed protective connection inside or outside the instrument.

DANGER

Risk of electric shock due to exceeding low voltage protection

For the series connection of all output voltages, it is possible to exceed the low voltage protection. In this case, any contact with live components is life-threatening. It is assumed that only qualified and trained personnel operate the power supplies and the connected loads.

⚠ WARNING**Risk of injury due to disregarding safety information**

Observe the information on appropriate operating conditions provided in the data sheet to prevent personal injury or damage to the instrument. Read and observe the basic safety instructions provided with the instrument, in addition to the safety instructions in the following sections. In particular:

- Do not open the instrument casing.
- Operate the instrument in the positions specified by the manufacturer without obstructing the ventilation of the product.

If the manufacturer's specifications are not observed, electric shock, fire, and / or serious injury, and even death can occur.

NOTICE**Risk of instrument damage due to inappropriate operating conditions**

Specific operating conditions are required to ensure accurate measurements and to avoid damage to the instrument. Observe the information on appropriate operating conditions provided in the basic safety instructions and the instrument's data sheet.

NOTICE**Risk of interference by electrostatic discharge**

When the front and rear connectors are connected simultaneously, interferences due to electrostatic discharge can occur. To prevent interferences, leave the output sockets at the front disconnected, when using the rear panel outputs.

NOTICE**Risk of instrument damage during operation**

An unsuitable operating site or test setup can damage the instrument and connected devices. Ensure the following operating conditions before you switch on the instrument:

- Make sure that the nominal voltage setting on the product matches the nominal voltage of the AC supply network. If you have a different line voltage, it can be necessary that you have to change the power fuse of the product.
- It is hazardous and not permitted to repair a defective fuse or to use other tools to bypass the fuse. Resulting damage to the instrument are not covered by the warranty.
- Never use the instrument in dusty or damp conditions, in an explosion hazard area, or near aggressive chemicals. The ambient temperature and humidity must not exceed the ranges specified in the data sheet.
- The instrument is dry and shows no sign of condensation.
- The instrument can only be used indoors and is positioned as described in the following sections, see [Chapter 3.1.1.4, "Placing or Mounting the Instrument"](#), on page 15.
Always position the instrument that you can disconnect the unit from the mains at any time and without restrictions.
- All fan openings are unobstructed and the airflow perforations are unimpeded. Make sure that there is sufficient space on both sides for the heat exchange. If the temperature inside the instrument exceeds the value specified in the data sheet, the channel-specific overheat protections turn off the corresponding outputs.
- The ambient temperature does not exceed the range specified in the data sheet.
- The instrument can only be operated with a properly grounded safety socket outlet. Never use a cheater plug or other means to defeat or disconnect the protective ground lead.
- Check the power cable for damage, and replace it if necessary. The power cord must be plugged in before signal circuits are connected.
- Use the instrument only with authentic Rohde & Schwarz test accessories, signal cables and power cords. Never use power cords with insufficient ratings.
- Before each measurement, check the instrument for proper operation using a known signal source or sample.
- Signal levels at the input connectors are all within the specified ranges.
- Signal outputs are correctly connected and are not overloaded.

If it is assumed that a safe operation is no longer possible, the instrument must be shut down and secured against any unintended operation.

Note: To disconnect from the mains, unplug the IEC socket on the back panel.

Also remove the instrument from operation if:

- The instrument shows visible damage
- The instrument includes loose parts
- The cables show damage

- The fuse holder shows damage
- The instrument is no longer working
 - After an extended period of storage under unfavorable conditions (e.g. outdoors or in damp rooms)
 - After rough handling during transport (e.g. packaging that does not meet the minimum requirements by post office, railway or forwarding agency)



EMI impact on measurement results

Electromagnetic interference (EMI) can affect the measurement results.

To suppress the generated electromagnetic interference (EMI):

- Use suitable shielded cables of high quality which must not exceed the maximum cable length, and must not be outside of buildings.
We recommend that you use double-shielded data cables with a length of 3 m at a maximum, e.g. the IEEE bus data cable R&S HZ72 (GPIB-cable 2 m, Order No. 3594.4269.02).
- Always terminate open cable ends.
- Note the EMC classification in the data sheet.

3.1.1.2 Unpacking and Checking the Instrument

To remove the instrument from its packaging and check the equipment for completeness, proceed as follows:

- Check the package for damage.
- Carefully unpack the instrument and the accessories.
- Check the package contents for completeness using the delivery list see ([Chapter 3.1.1.3, "Delivery List"](#), on page 15) and package contents.
- Check the equipment for any visible shipping-related damage or other mechanical problems, e.g. loose parts inside.

If there is damage or anything missing, contact the supplier and the carrier who delivered the instrument.

Do not operate the instrument in this case.



Packing material

Retain the original packing material. If the instrument needs to be transported or shipped later, you can use the material to protect the control elements and connectors.

The instrument must be stored in dry, closed indoor premises. If the instrument was transported under extreme temperatures, it is recommended that you allow a minimum of two hours to reach the appropriate temperature before operating the instrument.

3.1.1.3 Delivery List

The instrument comes with the following components:

- R&S HMP power supply preloaded with two main fuses (230 V)
- Fuses for 115 V operation
- Universal cable set
- Getting Started manual
- Document folder containing safety instructions and information on the instruments calibration

3.1.1.4 Placing or Mounting the Instrument

The R&S HMP is designed for use under both, industry and laboratory conditions, either on a bench top or in a rack.

Bench Top Operation

If the R&S HMP is operated on a bench top, the surface must be flat. You can place the instrument horizontally, or in a slope position by unfolding the front feet.

WARNING

Risk of injury if feet are folded out

The feet can fold in if they are not folded out completely or if the instrument is shifted. Collapsing feet can cause injury or damage the instrument.

- Fold the feet completely in or out to ensure stability of the instrument. Never shift the instrument when the feet are folded out.
- When the feet are folded out, do not work under the instrument or place anything underneath.
- The feet can break if they are overloaded. The overall load on the folded-out feet must not exceed 500 N.

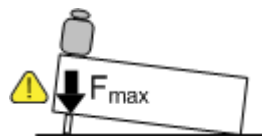

If the front support feet are folded in, it is possible to stack the instrument with other Rohde & Schwarz instruments securely.

⚠ WARNING**Risk of injury when stacking instruments**

A stack of instruments can tilt over and cause injury if not stacked correctly. Furthermore, the instruments at the bottom of the stack can be damaged due to the load imposed by the instruments on top.

Observe the following instructions when stacking instruments:

- Never stack more than three instruments. If you need to stack more than three instruments, install them in a rack.
- The overall load imposed on the lowest instrument must not exceed 500 N.
- It is best if all instruments have the same dimensions (width and length). If you need to stack smaller instruments on the top, the overall load imposed on the lowest instrument must not exceed 250 N.
- If the instruments have foldable feet, fold them in completely.

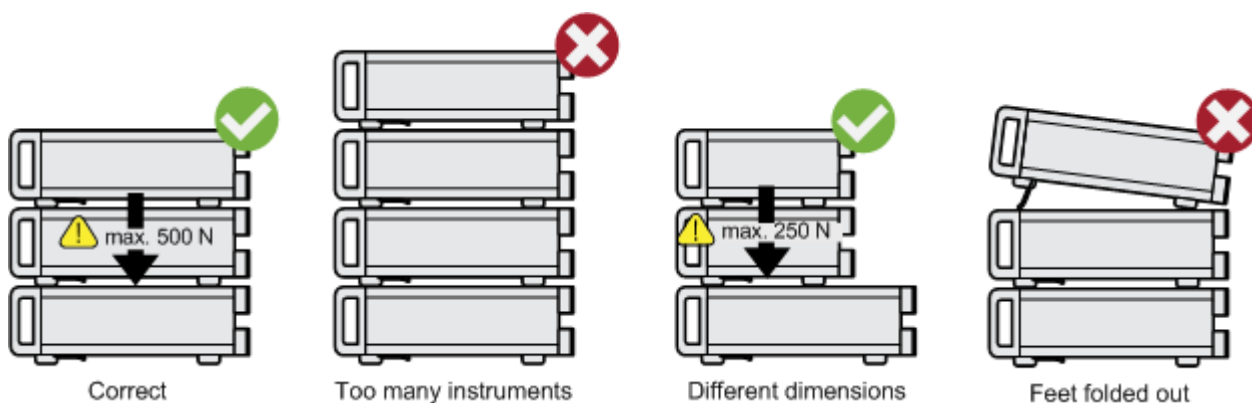

If multiple instruments are stacked, the collapsed support feet are positioned in the locking mechanism of the instrument beneath, preventing unintended movement.

Mounting in a Rack

You can install the R&S HMP in a rack using a rack adapter kit (R&S HZ42 for R&S HMP20xx instruments, and R&S HZP91 for R&S HMP40xx). The installation instructions are part of the adapter kit.

To prepare the R&S HMP for installation in a rack, you can remove the feet on the bottom:

1. Unscrew the mounting screws on the bottom of the instrument.
2. Remove the feet.

Tip: Save the feet with the screws if you want to operate the R&S HMP as bench top later.

NOTICE**Risk of instrument damage due to insufficient airflow in a rack**

If the instrument is run with insufficient airflow for a longer period, the instrument overheats, which can disturb the operation or turn off the R&S HMP.

Make sure that all fan openings are unobstructed, that the airflow perforations are unimpeded, and that the minimum distance from the wall is 10 cm.

3.1.1.5 Starting the Instrument

The R&S HMP is equipped with an AC power supply connector, which can be used with different AC power voltages. The voltage is adjusted by a switch. The AC power connector is located at the rear panel of the instrument.

Refer to the data sheet for the requirements of voltage and frequency.

Powering On**To connect the AC supply**

Note: The instrument must only be connected to an outlet that has a ground contact

1. Check the available line voltage.
2. If necessary, adjust the line voltage with the voltage selector at the rear panel.

Notice:

When changing the line voltage, it is essential to check and replace the fuse if necessary. Otherwise the instrument can be destroyed.

3. Check the fuse type.
4. If necessary, replace the fuse type suitable for the line voltage (see ["To replace the fuses"](#) on page 18).
5. Connect the R&S HMP to the power source using the supplied power cable.

The instrument must only be connected to an outlet that has a ground contact, according to the specifications for safety class EN 61010.

Replacing the Fuses

The instrument has main power fuses, which are located on the rear panel of the unit. Depending on the line voltage setting, the fuses of the correct type must be installed.

⚠ WARNING**Risk of electric shock**

The fuses are part of the main power supply. Therefore, handling the fuses while power is on can lead to electric shock. Before opening the fuse holder, make sure that the instrument is switched off and disconnected from all power sources.

Always use fuses supplied by Rohde & Schwarz as spare parts, or fuses of the same type and rating.

The nominal current of the fuse depends on the line voltage, and the R&S HMP model:

Table 3-1: Fuse types

Line Voltage	R&S HMP2020 / R&S HMP2030	R&S HMP4030 / R&S HMP4040
115 V	2 x T6.3H/250 V	2 x T10H/250 V
230 V	2 x T3.15H/250 V	2 x T5H/250 V

To replace the fuses

The instrument has an externally accessible fuse holder combined with the IEC socket at the rear panel.

1. Select the fuses according to the voltage of the AC line, see [Table 3-1](#).
2. Press the plastic locks on the sides of the fuse holder inwards using a screwdriver (with a blade width of approximately 2 mm).
The insertion points are marked by two slanted guides on the casing.
When unlocking the mechanism, the fuse holder is pushed outwards by compression springs.
3. Remove the fuse holder.
4. Exchange the fuses.
5. **Note:** The protruding contact springs must not be deformed, therefore:
Align the fuse holder with the guide bar facing the socket.
6. Carefully slide the fuse holder against the spring pressure into the slot until both plastic locks latch.

3.1.1.6 Starting Up and Shutting Down

An instrument of the R&S HMP series saves all instrument settings (nominal values) in non volatile memory when it is turned off, and retrieved when it is powered on again.

To start up the instrument

1. Make sure that you have connected the R&S HMP to the AC power supply.

2. Turn on the instrument with the main Power key in the upper left corner at the front panel.

The R&S HMP starts up using the same operating mode that was in use at the time the unit was last turned off.

The instrument turns off the output signals at the beginning of operation. This function prevents a connected load from being supplied unintentionally at startup. It also prevents the load from being destroyed caused by an exceedingly high voltage or power, e.g due to the last instrument settings.

After booting, the instrument is ready for operation.

To shut down the instrument

- ▶ Press the Power key at the front panel.

All current settings are saved, and the firmware shuts down.

3.1.2 Setting Up a Network (LAN) Connection

If the R&S HMP is equipped with the optional combined LAN/USB network interface, you can connect it to a LAN (Ethernet). Provided the appropriate rights are assigned, you can use the interface for remote control and data transfer from a remote PC.

This section describes how to set up and configure the LAN interface.

See [Chapter 7, "Network Operation and Remote Control"](#), on page 53.

NOTICE

Risk of network failure

Consult your network administrator before performing the following tasks:

- Connecting the instrument to the network
- Configuring the network
- Changing IP addresses
- Exchanging hardware

Errors can affect the entire network.

You can establish either a non-dedicated LAN connection from the instrument to an existing network, or a dedicated network connection between the instrument and a single computer.

For addressing, the instrument and the remote PC require an IP address, which is usually assigned automatically, depending on the network capabilities.



Risk of network connection failure

Network cables and cable connectors of poor quality, or failures in the autonegotiation process, can cause network connection failures.

If the network connection to the instrument fails, check the network infrastructure and contact your network administrator.

To set up a network (LAN) connection

- ▶ Connect the instrument to the network or a single PC.

Depending on the network capacities, the TCP/IP address information for the instrument can be obtained in different ways.

- If the network supports dynamic TCP/IP configuration using the DHCP (Dynamic Host Configuration Protocol), the address information is assigned automatically.
- If the network does not support DHCP, you can set the IP address manually, see [To assign the IP address manually on the instrument](#).

To assign the IP address manually on the instrument

To assign the IP address, first select the interface. In addition, check if DHCP is not active. Otherwise, you cannot edit the IP address.

1. To disable DHCP, perform the following steps:

Tip: Skip these steps, if DHCP is not supported.

- a) Press the Menu key.
- b) Select "Interface > Interface Settings > Port Settings /DHCP".
- c) Select "DHCP: > OFF".
- d) Return with the left arrow key.

When DHCP is turned off, the instrument enables you to set the IP address manually.

2. To set the IP address, select "Interface > Select Interface > LAN".
3. Return with the left arrow key.
4. Select "Settings > IP Settings".
5. Assign the IP address.

The IP address is part of the VISA resource string used by the program to identify the instrument. The resource string has the form:

```
TCPIP::\IP_address>:\IP_port::INSTR
```

The default port for socket communication is 5025.

Example: If the IP address of the instrument is 192.1.2.3, the valid resource string is: TCPIP::192.1.2.3::5025::INSTR

The R&S HMP displays the IP address and port number in the "IP Settings" dialog.

Switching to remote control

When you turn on the instrument, it always starts in manual operation state ("local" mode) to be operated via the front panel.

1. To establish communication via remote control, send a SCPI command.

The R&S HMP switches to remote control mode automatically. The Remote key illuminates.

The remote control mode disables all front panel keys on the instrument.

2. To return to local mode, press the Remote key.

Checking the LAN connection

To verify the connection, you can use the `ping` command.

- ▶ In the command prompt on the remote PC, enter `ping <ip_address>`

When the connection is working, the command returns the reply from the instrument.

3.2 Instrument Tour

The following sections explain the control elements and the connectors of the R&S HMP Series instruments by their front and rear views.



- The control elements on the front panel illuminate when you turn them on. In addition, the instrument illuminates keys for navigating or entering settings automatically if necessary.
- The channel keys also change their color. They indicate whether you are in setting mode, have the constant voltage supplied at the outputs, or the channel is in constant current mode.

See [Chapter 3.4.2, "Means of Manual Interaction"](#), on page 28 for details.

- [Front Panel Views of the R&S HMP2030 and the R&S HMP2020](#).....21
- [Front Panel Views of the R&S HMP4040 and the R&S HMP4030](#).....22
- [Rear Panel Views of the R&S HMP2030 and the R&S HMP2020](#)..... 23
- [Rear Panel Views of the R&S HMP4030 and the R&S HMP4040](#)..... 24

3.2.1 Front Panel Views of the R&S HMP2030 and the R&S HMP2020



For the R&S HMP2020, channel 3 is omitted.



Figure 3-1: Front view of the R&S HMP2030

- 1 = Power key: Turning the instrument on and off
- 2 = Display (LCD): Parameter display
- 3 = Arrow keys and Rotary knob: Navigating on the display, setting and confirming the parameters
- 4 = Ch1, Ch2, Ch3 keys: Selecting Channels
- 5 = Output key: Turning on or off the selected channels
- 6 = Voltage key: Setting the output voltage
- 7 = Track key: Activating the tracking function
- 8 = Store key: Saving a measurement configuration
- 9 = Menu key: Accessing the list of functions
- 10 = Current key: Setting the current limit
- 11 = Fuse key: Activating the electronic fuse function
- 12 = Recall key: Loading a saved measurement configuration
- 13 = Remote key: Switching between manual and external control
- 14 = Ground socket: Reference potential connection (connected to protective earth)
- 15 = Ch1, Ch2, Ch3 sockets: Output channels; 0 V to 32 V / 5 A (HMP2020 0...32 V / 10 A)
- 16 = Sense sockets (2 x per channel): Compensating the lead resistances

3.2.2 Front Panel Views of the R&S HMP4040 and the R&S HMP4030



For the R&S HMP4030, channel 4 is omitted.

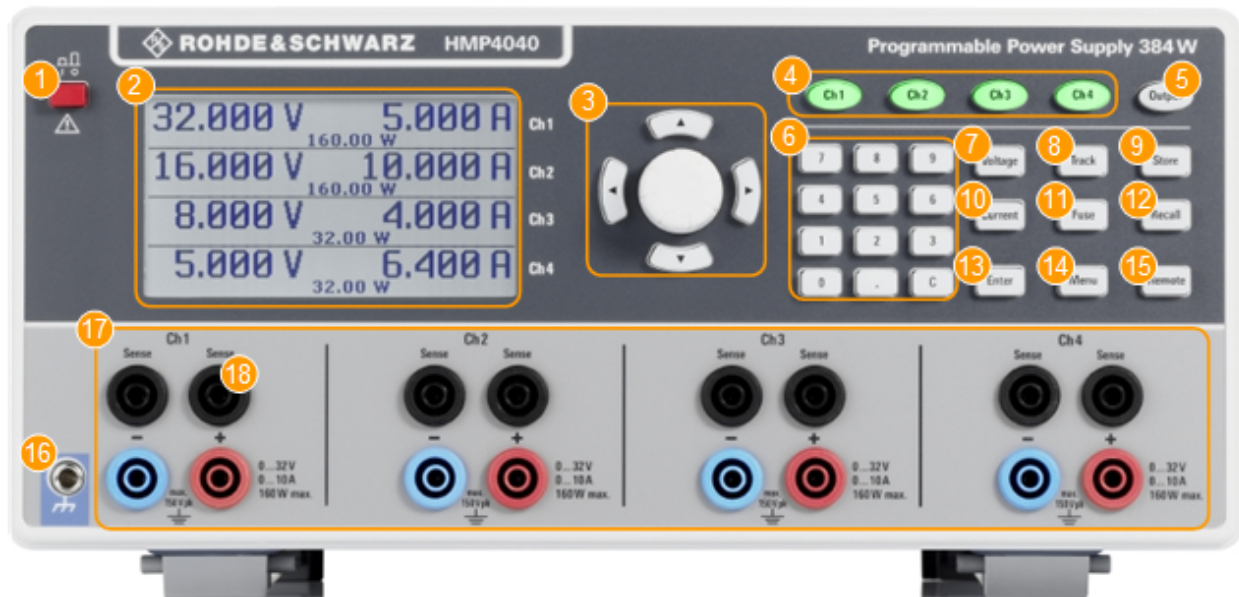

Figure 3-2: Front view of the R&S HMP4040

- 1 = Power key: Turning the instrument on and off
- 2 = Display (LCD): Parameter display
- 3 = Arrow keys and Rotary knob: Navigating on the display, setting and confirming the parameters
- 4 = Ch1, Ch2, Ch3, Ch4 keys: Selecting Channels
- 5 = Output key: Turning on or off the selected channels
- 6 = Keypad keys: Setting the nominal values
- 7 = Voltage key: Setting the output voltage
- 8 = Track key: Activating the tracking function
- 9 = Store key: Saving a measurement configuration
- 10 = Current key: Setting the current limit
- 11 = Fuse key: Activating the electronic fuse function
- 12 = Recall key: Loading a saved measurement configuration
- 13 = Enter key: Confirming values via keypad
- 14 = Menu key: Accessing the list of functions
- 15 = Remote key: Switching between manual and external control
- 16 = Ground socket: Reference potential connection (connected to protective earth)
- 17 = Ch1, Ch2, Ch3, Ch4 sockets: Output channels; 0 V to 32 V / 5 A
- 18 = Sense sockets (2 x per channel): Compensating the lead resistances

3.2.3 Rear Panel Views of the R&S HMP2030 and the R&S HMP2020

The interface for remote control varies depending on the equipped option.



Figure 3-3: Rear view of the HMP20x0 series

- 17 = Interface: (Ethernet / USB dual interface R&S HO732 shown)
- 18 = Output connector: Rear panel outputs for integration into rack systems (2 to 3 channels)
- 19 = Voltage selector: Selecting the line voltage 115 V or 230 V
- 20 = Power supply connector: IEC socket and fuse holder

3.2.4 Rear Panel Views of the R&S HMP4030 and the R&S HMP4040

The interfaces on the rear panel vary depending on the instrument model.



Figure 3-4: Rear view of the HMP40x0 series

- 19 = Interface: (Ethernet / USB dual interface R&S HO732 shown)
- 20 = Output connectors: Rear panel outputs for integration into rack systems (3 to 4 channels, depending on the R&S HMP40x0 model)
- 21 = Power supply connector: IEC socket and fuse holder
- 22 = Voltage selector: Selecting the line voltage 115 V or 230 V

NOTICE**Risk of interference by electrostatic discharge**

When the front and rear connectors are connected simultaneously, interferences due to electrostatic discharge can occur. To prevent interferences, leave the output sockets at the front disconnected, when using the rear panel outputs.

3.3 Trying Out the Instrument

This chapter describes the first steps with the R&S HMP. It shows a simple configuration for providing the power at the output. For basics on operating the instrument, see [Chapter 3.4, "Instrument Control"](#), on page 27.

Prerequisites

- The instrument is set up, connected to the mains, and started up as described in [Chapter 3.1.1.6, "Starting Up and Shutting Down"](#), on page 18.
- Before you connect and activate a load:
 - Make sure that you have deactivated the corresponding output of the R&S HMP to prevent unintended transient currents. Follow this order to get an optimal transition behavior when activating the output.
 - Set the current limit to prevent damage to the test circuit in case any error occurs (e.g. as a short circuit), see ["Setting the current limit"](#) on page 26.
- Make sure to operate highly sensitive semiconductors, such as laser diodes, only as specified by the manufacturer.
- Before trying out the instrument, note the maximum voltage, current and power ranges given in the data sheet.
See also [Chapter 4.1, "About the Output Modes of the R&S HMP"](#), on page 31.

We recommend that you follow the sequence of steps given in this description before you activate an output.

The instructions describe the manual control with the rotary knob and the arrow keys, setting the channel 1. For information on alternative controls, see [Chapter 3.4.2, "Means of Manual Interaction"](#), on page 28. Before trying out, observe the safety instructions and maximum specification.

For information on the settings and the corresponding remote control commands, see [Chapter 4, "Instrument Functions"](#), on page 31.

Selecting the channels

- ▶ Press the channel key, e.g. Ch1.
An active channel key is illuminated in green.

Selecting the output voltage

1. Press the Voltage key.

The Voltage key and the arrow keys are illuminated, indicating that they are active.

2. Press the channel key, e.g. Ch1.
Activates the voltage setting. The Ch1 key illuminates blue.
3. Set the output voltage value by turning the rotary knob.
The R&S HMP applies the setting immediately.
4. To terminate the setting, press the Voltage key.
The Ch1 key illuminates green again.

Tip: If you do not terminate with the Voltage key, the instrument exits the setting mode after the key fallback time has elapsed, see "[Key Fallback Time](#)" on page 45.

Setting the current limit

1. Press the Current key.
2. Press the Ch1 key.
The current setting in the display is in edit mode.
3. Set the current limit value.
The R&S HMP applies the setting immediately.
4. Press the Current key to terminate the setting mode.
If you do not press the Current key, the instrument automatically exits the setting mode after the key fallback time expires.
See "[Key Fallback Time](#)" on page 45.

Activating the fuse

The R&S HMP series includes an electronic fuse function that enables you to protect a connected sensitive test circuit even better from damage.

1. Press the Fuse key.
The R&S HMP activates the fuse function.
2. Press the Ch1 key to activate the fuse.
The R&S HMP immediately applies the setting and indicates the activated fuse in the display.
After the fallback time has elapsed, the instrument exits the setting mode.
See "[Key Fallback Time](#)" on page 45.
3. Repeat step 1 and step 2 to disable the fuse function.

Activating the output

You can turn on and off the output voltages regardless of the operating mode the instrument is in.

1. Press the Ch1 key.

2. Press the Output key.

The Output key turns on the outputs of all activated channels and supplies the connected loads.

Saving instrument settings

You can save up to 10 measurement configurations in the memory locations provided by the instrument.

1. Press the Store key.
The "Store Settings" dialog opens.
2. Use the rotary knob to select the memory location.
3. Confirm with the rotary knob.
4. Return with the Store key.

The R&S HMP saves the settings. Previous settings are overwritten.

Recalling instrument settings

To retrieve a saved configuration:

1. Press the Recall key.
2. Use the rotary knob to select the memory location.
3. Press the rotary knob again to load the configuration.
4. To exit the "Recall Settings" dialog, press the Recall key.

3.4 Instrument Control

This chapter provides an overview on how to work with the R&S HMP. It covers the following topics:

- [Ways to Operate the Instrument](#)..... 27
- [Means of Manual Interaction](#).....28
- [Remote Control](#).....30

3.4.1 Ways to Operate the Instrument

You can operate an R&S HMP in two ways:

- Manual operation
Use the front panel controls to configure your test setup. The principles of manual operation are explained in [Chapter 3.4.2, "Means of Manual Interaction"](#), on page 28.
- Remote control
Create programs to automatize repeating settings, tests and measurements. The instrument is connected to a computer running the program. [Chapter 3.4.3,](#)

"Remote Control", on page 30 provides a brief overview of the interfaces provided for remote control.

See [Chapter 3.1.2, "Setting Up a Network \(LAN\) Connection"](#), on page 19 and [Chapter 7, "Network Operation and Remote Control"](#), on page 53.

3.4.2 Means of Manual Interaction

To configure the R&S HMP manually, use the front panel controls, see [Chapter 3.2, "Instrument Tour"](#), on page 21. The display shows the current settings, menus and dialogs, when you perform your settings.

This section briefly explains the controls and some additional features, e.g.:

- The use of the arrow keys or alternatively the rotary knob to adjust settings.
- The meaning of the color of the channel keys (Ch1, ...).

Understanding the display information

Brief overview of the displayed elements:

- **Home screen:** Displays the channel parameters.
- **Menus:** Lists functions leading to the setting dialogs.
- **Dialogs:** Provide the settings of the specific functions.

Illuminated keys

The illuminated front panel keys provide access to the instrument settings and to activate functions and operating modes. The channel keys illuminate in varying colors indicating their current activities or states.

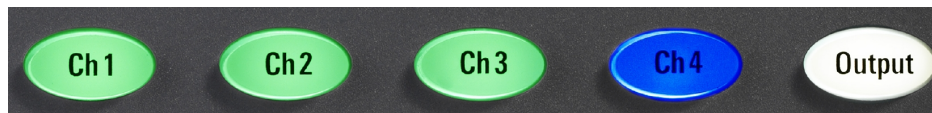

Figure 3-5: Example of the illuminated channel and output keys of the R&S HMP4040

Meaning of the key colors:

- **White:** the function or operating mode is activated.
- **Green** (channel key): the channel is in constant voltage mode (CV).
- **Red** (channel key): the channel is in constant current mode (CC), i.e. the current limit is active.
- **Blue** (channel key): the channel is in setting mode, i.e. a function is activated.
- **Flashing** (channel key): if the Output key and the Voltage key are active, and you change a setting of a channel, the color changes depending on the operating mode:
 - **Blue / Green** flashing: CV = constant voltage.
 - **Blue / Red** flashing: CC = constant current.
- **Off:** the channel, function, or operating mode are not active.

The navigation controls include a rotary knob and arrow keys. They allow you to navigate within a setting, menus or dialogs.

- Rotary knob
 - The rotary knob has several functions:
 - Moves the selection, e.g. to a parameter in a settings dialog
 - Activates the edit mode of a parameter
 - Increments (clockwise direction) or decrements (counterclockwise direction) the instrument parameter at a defined step size in the case of a numeric entry
 - Acts like the Enter key, when it is pressed
- Arrow keys
 - Move the selection up and down, or forward and backward, e.g. to a parameter in a settings dialog
 - Return to a previous menu level (left arrow key)
 - In a numeric entry field, increase or decrease the value, or move between the digits.

Settings controls

Alternative methods for setting parameters:

- Rotary knob, Arrow keys
 - The rotary knob and arrow keys also enable you to set nominal values by:
 - Navigating to the corresponding parameter and activating the edit mode
 - Increasing or decreasing the value.
 - Note:** If you enter the voltage or current limit value using the rotary knob, the R&S HMP immediately applies the set value. You can terminate the entry by pressing the corresponding key, e.g. Voltage, but for these parameters, the instrument also exits the setting mode after the fallback time has elapsed.
See "[Key Fallback Time](#)" on page 45 .
Settings in menus are not affected by the fallback time. Either you confirm a setting, or return using the arrow keys.
- Numerical Keypad (R&S HMP40x0 only), enables you to:
 - Directly enter values ("0...9")
 - Insert a decimal point (".")
 - Delete a value ("C")- Note:** If you enter a value using the keypad, you must press Enter to confirm your entry. Otherwise, the instrument disables the edit mode without the changes taking effect.



Throughout the user documentation, the instructions for configuring settings use the rotary knob and arrow keys. The alternative operating methods are only noted here.

3.4.3 Remote Control

In addition to operating the R&S HMP directly on the instrument, it is also possible to operate and control it from a remote PC.

Remote Control Interfaces

The R&S HMP supports various interfaces for remote control:

- Dual interface Ethernet / USB (option)
- Dual interface USB / RS232 (option)
- GPIB Interface IEEE-488 (option)

Remote control via USB / RS232 or GPIB Interface IEEE-488 requires that the corresponding options are installed. Drivers and information on their installation are provided for download on the product pages www.rohde-schwarz.com/product/hmp and www.rohde-schwarz.com/product/hmp4000.

See [Chapter 3.1.2, "Setting Up a Network \(LAN\) Connection"](#), on page 19 for an example on how to set up a remote control connection via LAN.

4 Instrument Functions

This section explains the operating modes, and the operating procedures and advanced functions of the R&S HMP.

The display and the controls on the front of the R&S HMP form the user interface for controlling the instrument manually. The display shows the current settings, and leads you to the dialogs of the corresponding functions.

4.1 About the Output Modes of the R&S HMP

Depending on the connected DUT (load), the R&S HMP works automatically either in the operating mode constant voltage (CV) or constant current (CC). The colors of the channel keys show the current output mode, see "Illuminated keys" on page 28.

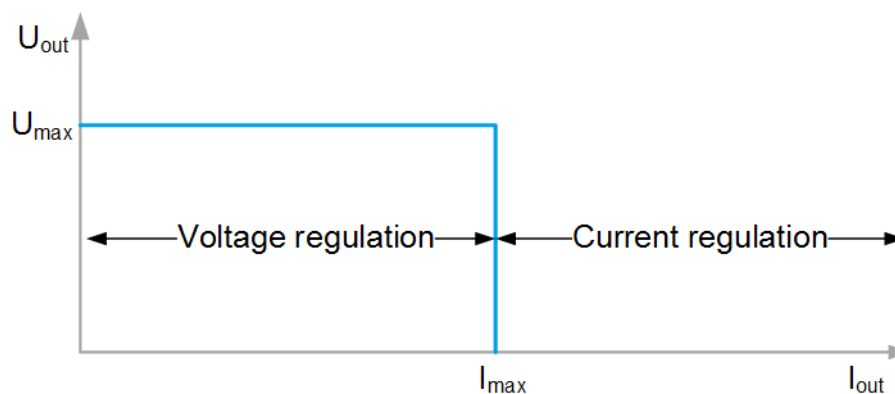

Figure 4-1: R&S HMP output modes

CV mode

The CV mode is the standard output mode at power on.

In this mode, the R&S HMP keeps the voltage U_{out} constant, while the current can increase to its maximum value I_{max} (see [Setting \$I_{max}\$, the current limit](#)) if the connected load increases.

CC mode

The R&S HMP switches to the CC mode automatically, when the output current exceeds the maximum value I_{max} . The output mode switches from voltage regulation to current regulation. It keeps the current constant at the limited I_{max} and decreases the output voltage U_{out} , i.e. $U_{out} < U_{set}$.

Setting I_{\max} , the current limit

The current limit determines the maximum value I_{\max} of the output current. Limiting the output current prevents damage to a connected DUT in case of failure, i.e. short circuit.



Always set I_{\max} before you take a DUT into operation.

The maximum current I_{\max} corresponds to the setting with the Current key, see "[Setting the current limit](#)" on page 26. The R&S HMP retains this value and automatically restores it at instrument startup.

Maximum voltage, power and current values

The output voltage ranges from 0 V to 32 V for each channel. Depending on the instrument model, the maximum power and current values vary, see the R&S HMP product brochure for the specification in detail.

In brief, the maximum output current for each channel is 5 A, respectively 10 A, and the maximum output power is 80 W, respectively 160 W.

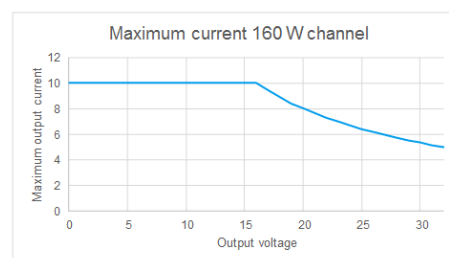
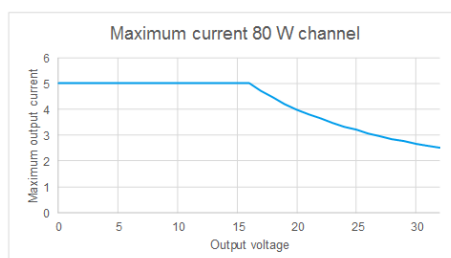

In addition, the maximum output of all channels is limited to 188 W for the HMP2000 series, and 384 W for the HMP4000 series.

If $U_{\text{out}} > 16$ V, the maximum current decreases according to the formula:

$$I = P / U$$

Example: Maximum current of an R&S HMP4040 versus an R&S HMP2030

$$U_{\text{out}} = 24 \text{ V}$$

- R&S HMP4040 with 160 W: $I_{\max} = 6,67 \text{ A}$
- R&S HMP2030 with 80 W: $I_{\max} = 3,33 \text{ A}$

Electronic fuses

For optimum protection of a sensitive DUT, the instruments of the R&S HMP series are equipped with electronic fuses. In addition, you can logically link the electronic fuses of several channels. For information on how to activate fuses, see "[Activating the fuse](#)" on page 26, and [Chapter 4.3.1, "Fuse Settings"](#), on page 35 for fuse linking.

4.2 Basic Functions

4.2.1 Setting the Voltage, Current and Fuse Parameters and Activating an Output

Select the channel

Selects one or more channels for setting the parameters. See ["Selecting the channels"](#) on page 25.

Remote command:

`INSTRument[:SElect]` on page 63

`INSTRument:NSElect` on page 63

Set the voltage

Sets the voltage for selected channel. See ["Selecting the output voltage"](#) on page 25.

Remote command:

`[SOURce:]VOLTage[:LEVel][:IMMediate][:AMPLitude]` on page 64

`[SOURce:]VOLTage[:LEVel]:STEP[:INCRement]` on page 65

Set the current limit

Sets the current for the selected channels. See ["Setting the current limit"](#) on page 26.

Remote command:

`[SOURce:]CURRent[:LEVel][:IMMediate][:AMPLitude]` on page 66

`[SOURce:]CURRent[:LEVel]:STEP[:INCRement]` on page 67

Activate the fuse

Enables the electronic fuse for the selected channel. See ["Activating the fuse"](#) on page 26.

Remote command:

`FUSE[:STATe]` on page 72

Activating the channel output

Activates the output of the selected channel. See ["Activating the output"](#) on page 26.

Remote command:

`OUTPut[:STATe]` on page 69

4.2.2 Using the Tracking Function

The tracking function allows you to interlink multiple channels. You can adjust the voltage and the current limit values for the linked channels by the same amount simultaneously (see the 1-V position of 3 channels in [Figure 4-2](#)).



Devices with keypad (R&S HMP 40xx series) allow you to set the same value for all linked channels in addition to the amount change.

To change the voltage or current values by the same amount

1. Press the Track key.
2. Press the Voltage key.
3. Press the channel keys of the channels you want to adjust simultaneously.

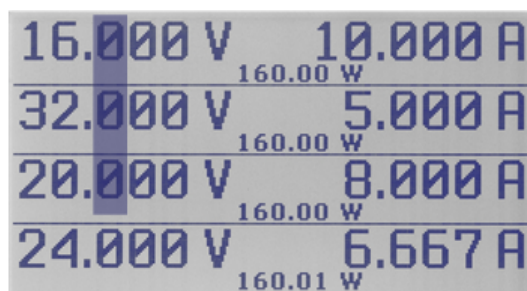

Figure 4-2: Changing the 100 mV position for three channels with the tracking function

With the tracking function activated, the display highlights the digits of the value in all linked channels.

4. On the display, select the digit of the value with the left/right arrow keys.
5. Adjust the value using the rotary knob or the up/down arrow keys.
6. Press the Current key.
7. Repeat steps 3 to 5 to adjust the current limit values.

During tracking, the R&S HMP power supply retains the previously selected voltage and current difference between the channels until a channel has reached the minimum or maximum value of the voltage or current. The Track key remains activated until it is pressed again. It is not affected by the "Key Fallback Time".

To set the same voltage or current value for all linked channels

Performing this setting is only provided by instruments equipped with a keypad:

1. Press the Track key.
2. Press the Voltage key.
3. Press the channel keys of the channels you want to adjust simultaneously.

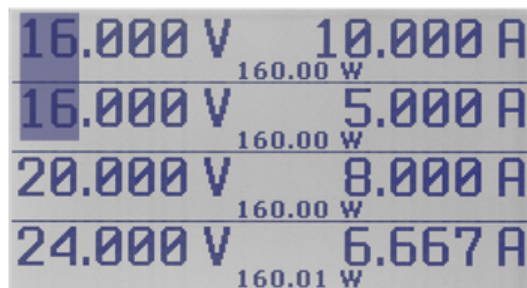

Figure 4-3: Setting the same voltage for two channels with the tracking function

4. Set the value using the keypad.
5. Confirm with Enter.
6. Press the Current key.
7. Repeat steps 3 to 5 to adjust the current limit values.

During tracking, the R&S HMP power supply retains the previously selected voltage and current difference between the channels until a channel has reached the minimum or maximum value of the voltage or current. The Track key remains activated until it is pressed again. It is not affected by the "Key Fallback Time".

4.2.3 Saving and Recalling Instrument Configurations

The remote commands for saving and recalling are described in [Chapter 8.1, "Common Setting Commands"](#), on page 57.

Store

Saves up to 10 instrument settings. See ["Saving instrument settings"](#) on page 27.

Remote command:

*[SAV](#) on page 59

Recall

Recalls a previously saved instrument setting. See ["Recalling instrument settings"](#) on page 27.

Remote command:

*[RCL](#) on page 59

4.3 Advanced Functions

4.3.1 Fuse Settings

Fuse delay and fuse linking settings enable you to handle a fuse tripped event when it occurs.

Fuse Linking

The fuse linking function allows you to interlink channels with their electronic fuses logically.

Access:

1. Press the Menu key.
2. Select "Fuse Linking" by pressing the rotary knob or the right arrow key.
3. Select the channel by turning the rotary knob.
4. Select the channel on the right to link with the selected channel.

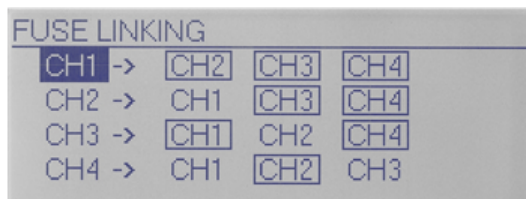

Figure 4-4: Fuse linking (example R&S HMP4040)

5. Press the Menu key to return to the display screen.

With an activated fuse link, the interlinked channels are switched off, if the current exceeds the current limit.

Fuse Delay

1. Press the Menu key.
2. Select "Fuse Delay" by pressing the rotary knob or the right arrow key.
3. Select the channel.
4. Set the delay time.

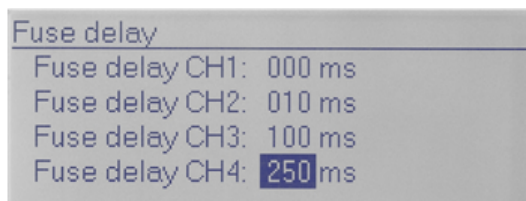

Figure 4-5: Fuse delay (example R&S HMP4040)

The remote commands for setting the fuse parameters are described in [Chapter 8.3.6, "Fuse Setting Commands"](#), on page 69.

[Fuse Linking](#).....36
[Fuse Delay](#).....37

Fuse Linking

Sets the channel to interlink the fuse of the selected channel.

When the current for a channel exceeds the value I_{\max} and the electronic fuse trips, all channels interlinked with this channel are turned off also. The Output key remains active.

See "Activate the fuse" on page 33 on how to activate a fuse in general.

At any time, you can reactivate the channels via the corresponding keys. If any excess current remains, the R&S HMP immediately turns off the output again.

Remote command:

`FUSE:LINK` on page 71

`FUSE:UNLink` on page 72

Fuse Delay

Sets a delay for the selected fuse.

The time delay prevents the fuse to trip immediately, e.g. when current peaks above the set current limit occur due to a connected capacitive load.

The range of the fuse delay is 0 ms to 250 ms.

Remote command:

`FUSE:DELAy` on page 71

4.3.2 Overvoltage Protection Settings

Overvoltage protection enables you to protect the DUT from damage due to exceeding output voltage. It turns off the output when the voltage exceeds the set U_{\max} in the corresponding channel. Preset to 33 V (factory preset), you can set the OVP to match the requirements of your application.

With firmware version 2.0 and higher, the R&S HMP provides two OVP modes:

- "Measured" mode
The R&S HMP takes the measured voltage value as a reference threshold for the OVP.
- "Protected" mode
The R&S HMP takes the voltage value set on the instrument as reference threshold for the OVP.

Access:

1. Press the Menu key.
2. Select "Over Voltage Protection" by pressing the rotary knob or the right arrow key.
3. Select the corresponding channel.
4. Set the OVP value using the rotary knob.
5. Select the OVP mode.
6. Return to the display with the left arrow key.

When OVP is activated and the output voltage exceeds the set OVP value, the R&S HMP indicates a flashing "OVP" in the corresponding channel and turns off the output of this channel.



Figure 4-6: Overvoltage protection (example R&S HMP2030)

The remote commands for setting the overvoltage parameters are described in [Chapter 8.3.7, "Overvoltage Protection Setting Commands"](#), on page 72.

OVP Level.....	38
OVP Mode.....	38

OVP Level

Sets the OVP level for the selected channel.

Remote command:

`VOLTage:PROTection[:LEVel]` on page 74

OVP Mode

Sets the OVP mode for the selected channel.

Remote command:

`[SOURce:]VOLTage:PROTection:MODE` on page 74

4.3.3 Arbitrary Settings

The arbitrary function allows you to define freely programmable waveforms for voltage and current within the limits set by the instrument.

A waveform consists of up to 255 voltage and current value pairs, and a dwell time definable for each value pair. These base parameters enable you to create any of the common waveforms (step function, sawtooth, sine, etc.).



A signal with three specified value pairs leads to a staircase curve, e.g. issued by an A/D converter. To create a sawtooth signal for instance, you must define additional value pairs.

To generate complex voltage sequences, the R&S HMP is suitable to only a limited extent due to the limited number of 128 value pairs and the minimum delay of 10 ms.

The repetition factor allows you to determine how often the waveform is played. If you have the repetition rate set to 000, the R&S HMP repeats the arbitrary function infinitely.

Each channel covers a memory for saving a waveform. To configure a waveform, you can use the control panel or an externally created waveform, e.g. created with the R&S

HME Explorer software, available for download on the Internet, see www.rohde-schwarz.com/software/hmp/.

The EasyArb editor of the R&S HME Explorer software enables you to create any point of a waveform conveniently, by adding or deleting individual points.

Duration (s)	Voltage (V)	Current (A)	Interpolation
0,00	0,000	1,0000	<input type="checkbox"/>
0,01	0,640	1,0000	<input type="checkbox"/>
0,02	1,280	1,0000	<input type="checkbox"/>
0,03	1,920	1,0000	<input type="checkbox"/>
0,04	2,560	1,0000	<input type="checkbox"/>
0,05	3,200	1,0000	<input type="checkbox"/>
0,06	3,840	1,0000	<input type="checkbox"/>
0,07	4,480	1,0000	<input type="checkbox"/>

Figure 4-7: Arbitrary-Editor example (excerpt) HME Explorer Software

To activate an arbitrary waveform, transfer the waveforms to the output channels of the R&S HMP, and activate the output. For externally created waveforms, the R&S HMP provides transfer of the data via the interface.

The instrument generates the waveform signal subsequently in each activated channel with a delay of approximately 100 ms from start.



The arbitrary function is intended for use in the individual channels. Synchronization of the arbitrary waveforms across all channels is hardly possible, but they deviate only slightly from each other.

To confirm the created signal, you can issue the signal at the output and view it on an oscilloscope as shown in [Figure 4-8](#).

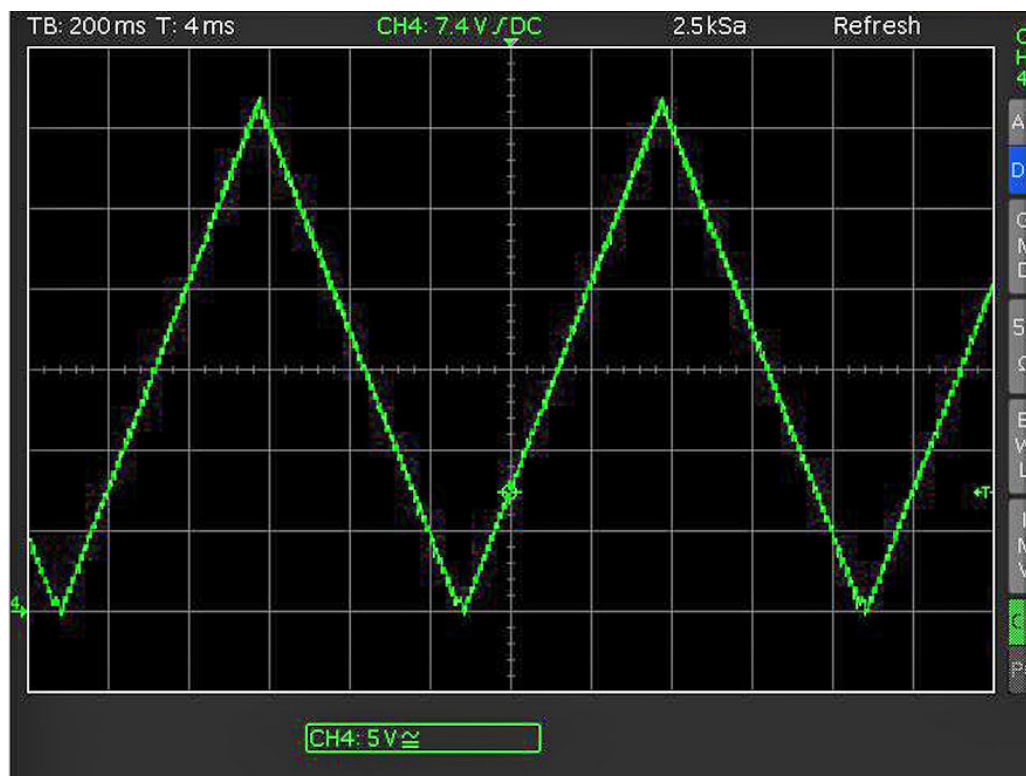

Figure 4-8: Output arbitrary example on an oscilloscope

The following description creates a waveform via the control panel, transmits the waveform to the channels and starts signal generation.

Creating and saving a waveform

Access:

1. Press the Menu key.
2. Select "Arbitrary" by pressing the rotary knob or the right arrow key.
3. In the arbitrary menu, select "Edit Waveform".



Figure 4-9: Arbitrary settings

The "Arbitrary Editor" covers the parameters required to configure the waveform for playback.

4. Select the parameters by pressing the rotary knob or the right arrow key.
5. Enter the values for the corresponding parameters.
6. Repeat the settings for each index entry.

7. When completed, return with the left arrow key.
8. Select "Save Waveform" to save the data in the internal memory.
Each channel provides three internal memories for saving waveforms.
9. Select the memory location.
10. Confirm your selection by pressing the rotary knob.
The R&S HMP confirms with a message when the waveform data is saved.
11. Select the corresponding parameter, e.g. "Voltage" by pressing the rotary knob or the down arrow key.

Assigning waveforms to the channels and starting signal generation

To start signal generation based on an arbitrary waveform, proceed as follows:

1. Press the Menu key.
2. Select "Arbitrary" and confirm with the rotary knob.
3. If you have not defined an arbitrary waveform:
 - a) Create a waveform as described in ["Creating and saving a waveform"](#) on page 40
 - b) Load a previously saved waveform from the internal memory with "Recall Waveform".
4. To transfer the waveform to the corresponding channels:
 - a) Select "Transfer Waveform"
 - b) Press the rotary knob.
 - c) In the "Transfer Arbitrary" dialog, select the channel , e.g. "Channel1"
 - d) Press the rotary knob.
 - e) Proceed the same way to transfer the waveform to further channels, if necessary.

The R&S HMP confirms the transfer and returns to the "Arbitrary" menu.
5. To start signal generation, select "Start Waveform".
6. Return to the display using the left arrow key.
7. Turn on the output of the corresponding channel.
The R&S HMP replays the arbitrary waveform and an icon denotes the active arbitrary function.

The remote commands for setting the arbitrary waveform parameters are described in [Chapter 8.5, "Arbitrary Setting Commands"](#), on page 75.

Transfer Waveform	42
Start Waveform	42
Stop Waveform	42
Edit Waveform	42
L Index	42

L Time.....	42
L Voltage.....	42
L Current.....	42
L Repetitions.....	43
Clear Waveform.....	43
Save Waveform.....	43
Recall Waveform.....	43

Transfer Waveform

Selects the channel and assigns the defined waveform.

Remote command:

[ARbitrary:TRANSfer](#) on page 78

Start Waveform

Starts the arbitrary waveform for the selected channel.

Remote command:

[ARbitrary:START](#) on page 78

Stop Waveform

Stops the arbitrary waveform for the selected channel.

Remote command:

[ARbitrary:STOP](#) on page 78

Edit Waveform

Opens the "Arbitrary Editor" to insert the parameters for defining the waveform.

Remote command:

[ARbitrary:DATA](#) on page 77

Index ← Edit Waveform

Sets the counter for the value pairs (0...128).

Remote command:

[ARbitrary:DATA](#) on page 77

Time ← Edit Waveform

Sets the dwell time for a value pairs.

The dwell time defines the duration of the signal of a value pair at the output.

Remote command:

[ARbitrary:DATA](#) on page 77

Voltage ← Edit Waveform

Sets the voltage value for the current index entry.

Remote command:

[ARbitrary:DATA](#) on page 77

Current ← Edit Waveform

Sets the current value for the index entry.

Remote command:

[ARbitrary:DATA](#) on page 77

Repetitions ← **Edit Waveform**

Sets the repetition rate for the current index entry.

Remote command:

[ARbitrary:DATA](#) on page 77

Clear Waveform

Deletes any previously made settings.

Remote command:

[ARbitrary:Clear](#) on page 76

Save Waveform

Saves up to 3 settings (waveforms)

Remote command:

[ARbitrary:SAVE](#) on page 78

Recall Waveform

Recalls a previously saved waveform.

Remote command:

[ARbitrary:REStore](#) on page 77

4.4 General Instrument Functions

4.4.1 Interface

Settings for establishing a remote connection to the instrument. See [Chapter 7, "Network Operation and Remote Control"](#), on page 53.

Access

1. Press the Menu key.
2. Select "Interface" by pressing the rotary knob or the right arrow key.

Select Interface	44
HO720 USB/RS-232	44
HO732	44
HO740	44
Settings	44
Information	44

Select Interface

Selects the interface used to establish a remote connection. Options depend on the installed remote control interface.

HO720 USB/RS-232

Provides parameters for the dual USB/RS-232 remote control interface.

"Baud Rate" Sets the data transmission rate in seconds for the serial remote control interface.

"Number of Stop Bits" Sets the number of stop bits for the serial remote control interface.

"Parity" Sets the parity for the serial remote control interface.

"Handshake On/Off" Activates handshaking for the serial remote control interface.

HO732

Provides the parameters for configuring the LAN remote control interface.

"IP Address" Sets the IP address of the R&S HMP.

"Subnet Mask" Sets the subnet mask of the R&S HMP.

HO740

Provides the parameters for configuring the IEEE-488 GPIB remote control interface.

"GPIB address" Sets the GPIB address of the R&S HMP.

Settings

Access the settings dialog for the selected remote control interface.

Information

Displays information about the selected remote control interface.

4.4.2 Key & Display Functions

Access:

1. Press the Menu key.
2. For the R&S HMP4030/4040, select "Display & Key"
3. Select the corresponding function with the rotary knob.

The menu contains a list of functions, that enable you to access the advanced functions, see [Chapter 4.3, "Advanced Functions"](#), on page 35. It also provides access to general functions, e.g. to customize the user interface, reset the instrument or retrieve information on the firmware. The following section deals with the general setting functions.

Key Brightness (R&S HMP2020/2030).....	45
Key Fallback Time.....	45
Display Contrast.....	45
Display and Key Brightness (R&S HMP4030/4040).....	45
Brightness Fallback Time (R&S HMP4030/4040).....	45

Key Brightness (R&S HMP2020/2030)

Sets the intensity of the key illumination by turning the rotary knob.

Key Fallback Time

Sets the "Key Fallback Time".

This parameter determines the time period when the instrument automatically applies a changed value.

Example:

If you change the voltage value of a channel, you can confirm the new value manually, by pressing the rotary knob. Alternatively, you can wait until the specified "Key fallback time" has elapsed, and the HMP confirms the value automatically.

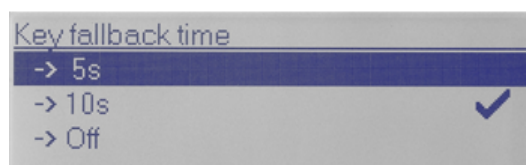

Figure 4-10: Key Fallback Time (R&S HMP2030)

Display Contrast

Sets the "Display Contrast" by turning the rotary knob.

Display and Key Brightness (R&S HMP4030/4040)

Regulates the intensity of the key and display illumination by turning the rotary knob.

Brightness Fallback Time (R&S HMP4030/4040)

Sets the "Brightness Fallback Time".

This parameter determines the time period after the instrument reduces the light intensity of the display and keys when you have not done any instrument settings.

4.4.3 Beeper

Access

1. Press the Menu key.
2. Select "Beeper" by pressing the rotary knob or the right arrow key.

Beeper

Selects the mode for the output of an acoustic signal.

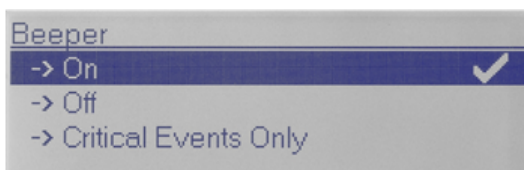

Figure 4-11: Fig. 5.9: Beeper (R&S HMP2030)

"On" Beeps every time the key is pressed.

"Off" Does not beep on any occasion.

"Critical Events Only"
 Beeps when an error occurs.

Remote command:

[SYSTem:BEEPer\[:IMMediate\]](#) on page 60

4.4.4 Information

Access:

1. Press the Menu key.
2. Select "Information" by pressing the rotary knob or the right arrow key.

This dialog displays instrument information such as instrument model, firmware version and version of the channel firmware.



Deviations of the firmware versions between the instrument firmware and the channel firmware require a firmware update.

4.4.5 Reset Device

Access:

1. Press the Menu key.
2. Select "Reset Device" by pressing the rotary knob or the right arrow key.
3. Select "Yes" by pressing the rotary knob or the right arrow key.

Reset Device

Reset the instrument to its original condition (factory settings). All selected instrument settings are erased.

Remote command:

[*RST](#) on page 58

5 Application Examples

5.1 Compensating Voltage Drops on the Supply Lines

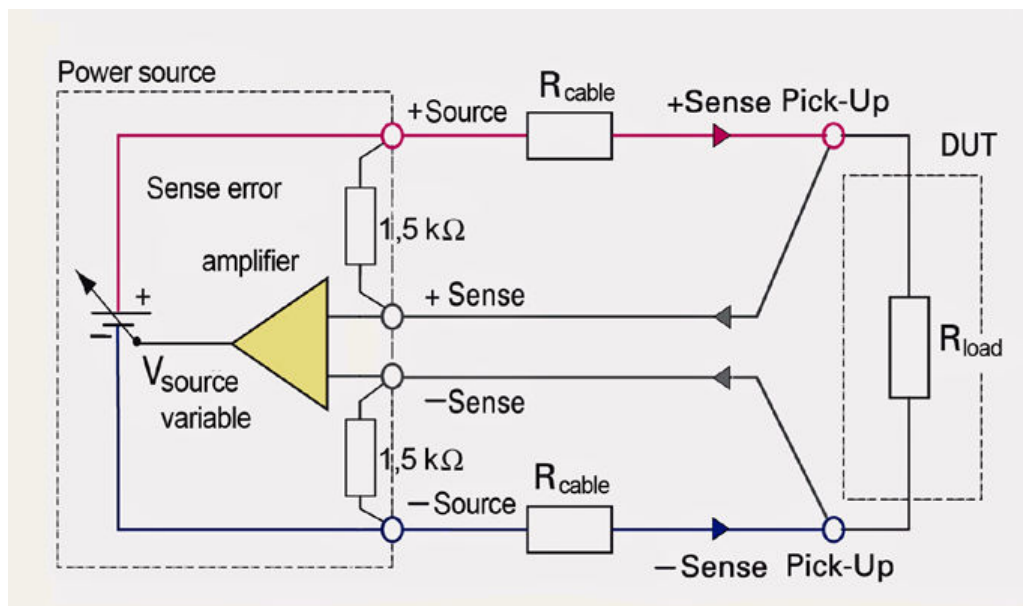

Figure 5-1: Compensating the voltage drops in diagram

The two `SENSE` lines allow you to compensate voltage drops on the supply lines to the load so that the selected voltage is applied to the load. Use two separate measuring lines to connect the load to the two external black safety sockets of the respective channel (see Figure 5-1).

5.2 Operating in Parallel and Serial Mode

It is assumed that only qualified and trained personnel operates the power supplies with the connected loads.

To increase the output voltage or current, you can interconnect the channels and even the outputs of one or several power supplies in serial or parallel mode.

The sections [Serial Mode](#) and [Parallel Mode](#) describe the channel connection by the example of one power supply of the HMP series.



If the maximum total instrument power is exceeded, the R&S HMP turns off the Output automatically, and shows a warning on the display.

5.2.1 Serial Mode

⚠ DANGER

Risk of electric shock due to exceeding low voltage protection

For the series connection of all output voltages, it is possible to exceed the low voltage protection. In this case, any contact with live components is life-threatening. It is assumed that only qualified and trained personnel operate the power supplies and the connected loads.

The following interconnection adds the individual output voltages. The same current flows through all outputs. The current limits for the outputs wired in series must be set to the identical value. If one of the outputs exceeds the current limit, the total voltage collapses. It is recommended that you set all voltages to the same value to distribute the loads evenly.

Activate all connected channels, especially, when you have connected a load with low resistance. Otherwise, the protective diodes of a deactivated channel can be overloaded and damage the instrument.

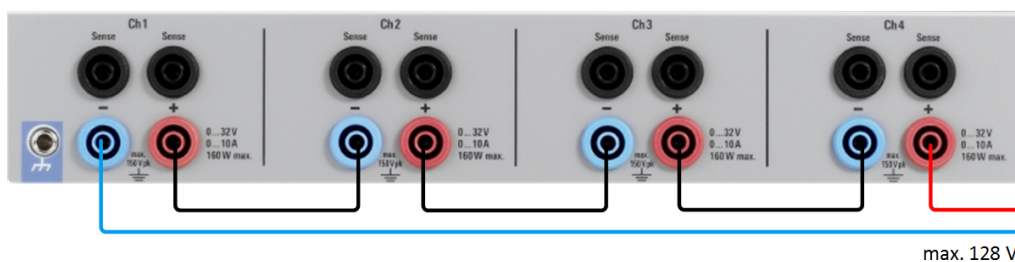

Figure 5-2: Example of a serial connection

5.2.2 Parallel Mode

If it is necessary to increase the total current, the power supply outputs must be wired in parallel. The output voltages for the individual outputs must be set to the same voltage value as precisely as possible. For slight voltage differences, it is common in this operating mode to first charge a voltage output up to the current limit; the other voltage output provides the remaining current.

The maximum total current is the sum of the individual currents of all sources connected in parallel. For power supplies that are connected in parallel, it is possible that compensating currents flow within the power supplies. The use of power supplies by other manufacturers, which are potentially not overload proof, can cause destruction of these units as currents can be distributed unevenly.

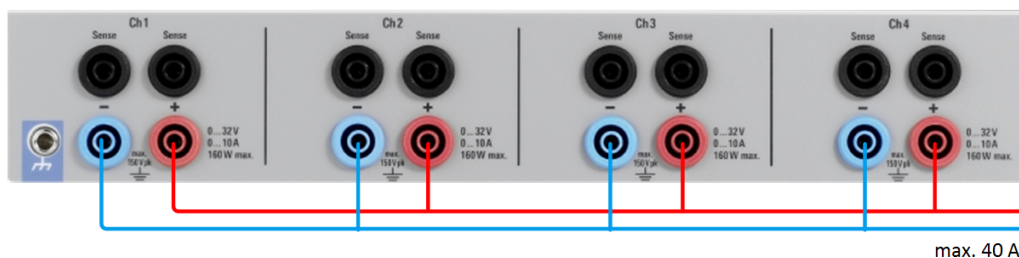

Figure 5-3: Example of a parallel connection

Generally, the channel with the highest output voltage provides the highest current. When this channel reaches the current limit, the channel connected in parallel supplies the remaining current.

Note, that the voltages in the individual channels differ slightly due to tolerances.

By increasing the voltage slightly, you can distribute the load more evenly. If the voltage for a channel is to be increased by some mV, for instance (by a set of identical cables), the current is initially provided by this channel.

We also recommend, that you use the current limit settings to distribute the load to multiple channels evenly. Distribute the total current proportionately to the current limits of the connected channels. This procedure also distributes the power loss more evenly, thus improving the heat dissipation and protecting the semiconductors from damage.

5.3 Multi-Quadrant Operation

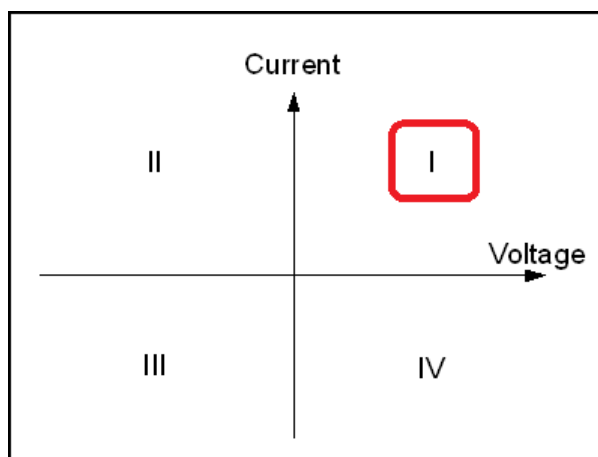

Figure 5-4: Power supply quadrants diagram

In general, operating in multi-quadrant mode requires a multi-quadrant power supply. The R&S HMP power supply is only a 1-quadrant power supply which is able to provide positive voltage or positive current (quadrant I). However, a negative voltage can be generated by connecting two channels (common GND). Figure 5-5 shows a connection example for a R&S HMP power supply. This type of connection can generally

reach a range between -32 V and +32 V. It does not refer to a negative display on the screen, but rather to a connection with an identical voltage range. However, a negative current (current sink) is not possible.

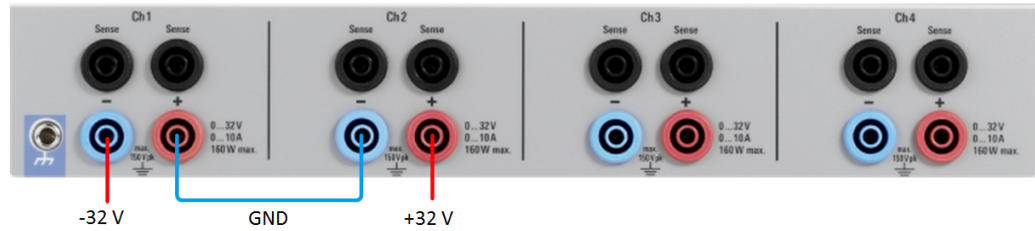

Figure 5-5: Example of a multi-quadrant connection

6 Maintenance

The instrument does not need periodic maintenance. Only the cleaning of the instrument is essential.

Any adjustments, replacements of parts, maintenance and repair must be done only by authorized Rohde & Schwarz technical personnel. Original parts must be used for replacing parts relevant to safety (e.g. power switches, power transformers, fuses). After replacement of safety relevant parts, e.g. visual inspection, PE conductor test, insulation resistance measurement, leakage current measurement, functional test, a safety test must be performed.

NOTICE

Risk of damage during transportation and shipment

Insufficient protection against mechanical and electrostatic effects during transportation and shipment can damage the instrument.

- Always make sure that sufficient mechanical and electrostatic protection is provided.
 - When shipping an instrument, use the original packaging. If you do not have the original packaging, use sufficient padding to prevent the instrument from moving around inside the box. Pack the instrument in antistatic wrap to protect it from electrostatic charging.
 - Secure the instrument to prevent any movement and other mechanical effects during transportation.
 - Observe the information on transporting heavy instruments in the basic safety instructions included at the front of the printed manual.
-

6.1 Cleaning

WARNING

Risk of electric shock

If moisture enters the casing, for example if you clean the instrument using a moist cloth, contact with the instrument can lead to electric shock. Before cleaning the instrument other than with a dry cloth, make sure that the instrument is switched off and disconnected from all power supplies.

NOTICE**Instrument damage caused by cleaning agents**

Cleaning agents contain substances such as solvents (thinners, acetone, etc.), acids, bases, or other substances. Solvents can damage the front panel labeling, plastic parts, or screens, for example.

Never use cleaning agents to clean the outside of the instrument. Use a soft, dry, lint-free dust cloth instead.

NOTICE**Risk of instrument damage due to obstructed fans**

If the instrument is operated in dusty areas, the fans become obstructed by dust or other particles over time. Check and clean the fans regularly to ensure that they always operate properly. If the instrument is run with obstructed fans for a longer period, the instrument overheats, which can disturb the operation and even cause damage.

1. Clean the outside of the instrument using a soft, dry, lint-free dust cloth.
2. Check and clean the fans regularly to ensure that they always operate properly.
3. Clean the touchscreen as follows:
 - a) Apply a small amount of standard screen cleaner to a soft cloth.
 - b) Wipe the screen gently with the moist, but not wet, cloth.
 - c) If necessary, remove any excess moisture with a dry, soft cloth.

6.2 Storing and Packing

The storage temperature range of the instrument is given in the product brochure, including specifications. If the instrument is to be stored for a longer period of time, it must be protected against dust.

Repack the instrument as it was originally packed when transporting or shipping. The two protective foam plastic parts prevent the control elements and connectors from being damaged. The antistatic packing foil avoids any undesired electrostatic charging to occur.

If you do not use the original packaging, use a sturdy cardboard box of suitable size and provide for sufficient padding to prevent the instrument from slipping inside the package. Wrap antistatic packing foil around the instrument to protect it from electrostatic charging.

7 Network Operation and Remote Control

This chapter provides basic information on operating an instrument via remote control.

For additional information on remote control basics, and the SCPI command structure, see [Chapter A, "Additional Basics on Remote Control"](#), on page 81.

7.1 Remote Control Interfaces

The R&S HMP Series provides the following interfaces for remote control:

- Ethernet (LAN) / USB Dual Interface (optional HO732)
- RS-232 / USB Dual Interface (optional HO720)
- IEE-488 (GPIB) Interface (optional HO740)

For information on the pin assignment of the interface connectors, see [Chapter B, "Hardware Interfaces"](#), on page 91.

SCPI (Standard Commands for Programmable Instruments)

SCPI commands - messages - are used for remote control. Commands that are not taken from the SCPI standard follow the SCPI syntax rules. The instrument supports the SCPI version 1999. The SCPI standard is based on standard IEEE 488.2 and aims at the standardization of device-specific commands, error handling and the status registers. The tutorial "Automatic Measurement Control - A tutorial on SCPI and IEEE 488.2" from John M. Pieper (Rohde & Schwarz order number 0002.3536.00) offers detailed information on concepts and definitions of SCPI.

Tables provide a fast overview of the bit assignment in the status registers. The tables are supplemented by a comprehensive description of the status registers, see [Chapter A.3, "Status Reporting System"](#), on page 86.

- [Ethernet / USB Dual Interface R&S HO732](#)..... 53
- [USB Interface](#)..... 54
- [RS-232 Interface](#)..... 55
- [GPIB Interface \(IEC/IEEE Bus Interface\)](#)..... 56

7.1.1 Ethernet / USB Dual Interface R&S HO732

To be integrated in a LAN, the instrument must be equipped with a LAN interface, consisting of a connector, a network interface card and protocols.

For remote control via a network, the PC and the instrument must be connected via the LAN interface to a common network with TCP/IP network protocol. The TCP/IP network protocol and the associated network services are preconfigured on the instrument.

The resource string is required to establish a communication session between the controller and the instrument in a LAN. The resource string is a unique identifier, composed of the specific IP address of the instrument and some network and specific keywords.

IP address

To set up the connection, you require the IP address of the instrument. It is part of the resource string used by the program to identify and control the instrument. The resource string has the format: `TCPIP::<IP_address>:<IP_port>::INSTR`

The default port number for SCPI socket communication is 5025. IP address and port number are listed in the "Ethernet Settings" of the R&S HMP series.

Example:

If the instrument has the IP address 192.1.2.3, the valid resource string is `TCPIP0::192.1.2.3::inst0::INSTR`

If the LAN is supported by a DNS server, you can use the host name instead of the IP address. The DNS server (Domain Name System server) translates the host name to the IP address.

The resource string has the form: `TCPIP::<host_name>:<IP_port>::INSTR`



For information on how to set up a network LAN connection, see [Chapter 3.1.2, "Setting Up a Network \(LAN\) Connection"](#), on page 19.

7.1.2 USB Interface

If you are using USB, you need to install a USB driver which is available on the Rohde & Schwarz Website.



All descriptions regarding the USB interface are true for the R&S HO732 interface card and for the optional R&S HO720 USB part. All currently available USB drivers are fully tested, functional and released for Windows XP™, Windows Vista™ or Windows 7™ or Windows 8™, both as 32Bit and 64Bit versions.

To select the USB interface:

1. Press Menu key.
2. Select "Select Interface > USB".
3. Return with the left arrow key.

The USB interface does not need any further configuration.



If you use the virtual COM port, you have to install the "HO720 / HO730 Virtual COM Port" driver, available for download on the product page at www.rohde-schwarz.com/driver/hmp. Activate the virtual COM port (VCP) in the PC device explorer.

7.1.3 RS-232 Interface

If you use the classic RS-232 interface (R&S HO720 RS232 part), you do not need any driver.

There are two options for the RS-232 communication:

- Handshake disabled
Without handshake, the interface buffer can overflow (e.g. missing commands) and thus cause problems.
Consider sufficient delays between the commands to make sure that all commands are executed correctly (approx. 50 ms to 100 ms).
- Handshake enabled
If you are working with interface handshake (set on both, the R&S HMP and PC), you do not need to insert delays.

In the interface settings of the R&S HMP, you can set the interface handshake on/off. You can choose the menu item "Handshake" in the "Interface" settings. You can choose "NONE" or "CTS/RTS". "CTS/RTS" activates the interface handshake. Please note that you choose the same settings in your appropriate software.



If you want to use the RS-232 interface, we recommend activating the interface handshake to avoid timing problems.

To set the interface parameter at the R&S HMP:

1. Press the Menu key.
2. Select the menu item "Interface"
3. Select "Select Interface > RS-232".
4. Return with the left arrow key.
5. Select "Settings" to access the parameters for configuring the interface.
6. Select the "Handshake" mode.
When enabled, the instrument provides you "CTS/RTS" and "CTS/RTS" handshake modes.
7. Set all parameters accordingly.

The settings of the RS-232 must match the corresponding PC COM port.

7.1.4 GPIB Interface (IEC/IEEE Bus Interface)

To control the instrument via the GPIB bus (R&S HO740 GPIB Interface IEEE-488), the instrument and the controller must be connected by a GPIB bus cable. A GPIB bus card, the card drivers and the program libraries for the programming language used must be provided in the controller.

The controller addresses the instrument within the GPIB bus channel. GPIB provides channel addresses from 0 to 30.

Characteristics

The GPIB interface has the following characteristics:

- Up to 15 instruments can be connected
- The total cable length is restricted to a maximum of 15 m; the cable length between two instruments must not exceed 2 m.
- A wired "OR"-connection is used if several instruments are connected in parallel.

GPIB Instrument Address

The GPIB address is preset to 30, but you can change it as follows:

1. Press the Menu key.
2. Select the menu item "Interface"
3. Select "Select Interface > GPIB".
4. Return with the left arrow key.
5. Select "Settings > GPIB Address".
6. Set the "GPIB Address" using the rotary knob.



The GPIB address is reset affected by an instrument preset.

8 Remote Control Commands

This chapter provides the description of all remote commands available for the R&S HMP series. The commands are sorted according to the menu structure of the instrument. A list of commands in alphabetical order is given in the "List of Commands" at the end of this documentation.

8.1 Common Setting Commands

Common commands are described in the IEEE 488.2 (IEC 625-2) standard. These commands have the same effect and are employed in the same way on different devices. The headers of these commands consist of "*" followed by three letters.

Many common commands are related to the Status Reporting System.

*CLS.....	57
*ESE.....	57
*ESR?.....	58
*IDN?.....	58
*OPC.....	58
*RST.....	58
*SRE.....	58
*STB?.....	59
*TST?.....	59
*WAI.....	59
*SAV.....	59
*RCL.....	59

*CLS

Clear status

Sets the status byte (STB), the standard event register (ESR) and the `EVENT` part of the `QUESTIONABLE` and the `OPERATION` registers to zero. The command does not alter the mask and transition parts of the registers. It clears the output buffer.

Usage: Setting only

*ESE <Value>

Event status enable

Sets the event status enable register to the specified value. The query returns the contents of the event status enable register in decimal form.

Parameters:

<Value> Range: 0 to 255

***ESR?**

Event status read

Returns the contents of the event status register in decimal form and subsequently sets the register to zero.

Return values:

<Contents> Range: 0 to 255

Usage: Query only

***IDN?**

Identification

Returns the instrument identification.

Return values:

<ID> "Rohde&Schwarz,<device type>,<part number>/<serial number>,<firmware version>"

Usage: Query only

***OPC**

Operation complete

Sets bit 0 in the event status register when all preceding commands have been executed. This bit can be used to initiate a service request. The query form writes a "1" into the output buffer as soon as all preceding commands have been executed. This is used for command synchronization.

***RST**

Reset

Sets the instrument to a defined default status. The default settings are indicated in the description of commands.

Usage: Setting only

Manual operation: See "[Reset Device](#)" on page 46

***SRE <Contents>**

Service request enable

Sets the service request enable register to the indicated value. This command determines under which conditions a service request is triggered.

Parameters:

<Contents> Contents of the service request enable register in decimal form.
Bit 6 (MSS mask bit) is always 0.
Range: 0 to 255

***STB?**

Status byte query

Reads the contents of the status byte in decimal form.

Usage: Query only

***TST?**

Self-test query

Initiates self-tests of the instrument and returns an error code

Return values:

<ErrorCode> **integer > 0 (in decimal format)**
An error occurred.
0
No errors occurred.

Usage: Query only

***WAI**

Wait to continue

Prevents servicing of the subsequent commands until all preceding commands have been executed and all signals have settled (see also command synchronization and [*OPC](#)).

Usage: Event

***SAV <Number>**

Save

Stores the current instrument settings under the specified number in an internal memory. The settings can be recalled using the command [*RCL](#) with the associated number.

Manual operation: See "[Store](#)" on page 35

***RCL <Number>**

Recall

Loads the instrument settings from an internal memory identified by the specified number. The instrument settings can be stored to this memory using the command `*SAV` with the associated number.

Manual operation: See "Recall" on page 35

8.2 System Setting Commands

The `SYSTem` subsystem contains the commands for general functions, which do not affect signal generation directly.

<code>SYSTem:BEEPer[:IMMEDIATE]</code>	60
<code>SYSTem:ERRor[:NEXT]?</code>	60
<code>SYSTem:LOCal</code>	61
<code>SYSTem:MIX</code>	61
<code>SYSTem:REMote</code>	61
<code>SYSTem:RWLock</code>	61
<code>SYSTem:VERSion?</code>	61

`SYSTem:BEEPer[:IMMEDIATE]`

Returns a single beep immediately.

Example: `SYST:BEEP`

Usage: Event

Manual operation: See "Beeper" on page 45

`SYSTem:ERRor[:NEXT]?`

Queries the error/event queue of the oldest item and removes it from the queue. The response is an error number and a short description of the error.

Positive error numbers are instrument-dependent. Negative error numbers are reserved by the SCPI standard. If the queue is empty the response is 0, "No error".

Parameters:

<code><error></code>	0 No error
	-100 Command error
	-102 Syntax error
	-350 Queue overflow

Example:

```
SYST:ERR?
// queries the oldest entry in the error queue
// Response: 0, "no error"
```

Usage: Query only

SYSTem:LOCal

Enables manual (front panel) control.

The command switches from remote control to manual control, and is required, when you have locked manual control before, see [SYSTem:RWLock](#) on page 61.

Example:

```
SYST:LOC
// returns from remote control to manual control
```

Usage: Event

SYSTem:MIX

Enables remote control without locking manual control.

You can control the instrument in both modes simultaneously (mixed mode).

Example:

```
SYST:MIX
```

Usage: Setting only

SYSTem:REMOte

Sets the system to remote state.

The manual (front panel) control is locked.

To unlock manual control, press the Remote key.

Example:

```
SYST:REM
```

Usage: Event

SYSTem:RWLock

Locks the front panel (manual) control.

You can operate the instrument via remote control only. To return to manual control, use the command [SYSTem:LOCal](#) on page 61. The Remote key is locked also.

Example:

```
SYST:RWL
// locks the control of all front panel elements,
// including the Remote key
SYST:LOC
// unlocks front panel control
```

Usage: Event

SYSTem:VERSion?

Queries the SCPI version the instrument's command set complies with.

Example: `SYST:VERS?`
 // queries the SCPI version
 // response: "1996"

Usage: Query only

8.3 Configuration Commands

8.3.1 Channel Selection Commands

The `INSTrument:Select` subsystem contains the commands for selecting the output channels.

Each channel of the power supply is considered as separate "instrument", which is required by the SCPI standard. Therefore, the SCPI commands use the `INSTrument` node to select a channel.



You can only address the number of channels a device is equipped with, e.g. a maximum of three channels for the R&S HMP4030, or two channels for the R&S HMP2020.

Example: Selecting a channel

You can select a channel either with an `OUTput` parameter, or just by the channel number. This example lists all ways how you can select and query a selected channel.

```
// *****
// Select a channel
// *****
INST OUT1
// selects channel 1
INST?
// queries the channel selection
// response: "OUT1"

// *****
// Select a channel by its number
// *****
INST:NSEL 1
// selects channel number 1
INST:NSEL?
// queries number of the channel selection
// response: 1
```

`INSTrument:NSElect`..... 63
`INSTrument[:SElect]`..... 63

INSTRument:NSElect <Channel>

Selects a channel by number.

Parameters:

<Channel> {1 | 2 | 3 | 4}

Example: See [Example "Selecting a channel"](#) on page 62.

Manual operation: See ["Select the channel"](#) on page 33

INSTRument[:SElect] <Channel>

Selects the channel.

Parameters:

<Channel> OUTPut1 | OUTPut2 | OUTPut3 | OUTPut4 | OUTP1 | OUTP2 |
OUTP3 | OUTP4 | OUT1 | OUT2 | OUT3 | OUT4

OUTPut1 | OUTP1 | OUT1

Channel 1 (Ch1)

OUTPut2 | OUTP2 | OUT2

Channel 2 (Ch2)

OUTPut3 | OUTP3 | OUT3

Channel 3 (Ch3), for R&S HMP2030 and R&S HMP40x0 instruments

OUTPut4 | OUTP4 | OUT4

Channel 4 (Ch4), for R&S HMP4040 instruments

Example: See [Example "Selecting a channel"](#) on page 62.

Manual operation: See ["Select the channel"](#) on page 33

8.3.2 Voltage Setting Commands

The `SOURCE:VOLTage` subsystem contains the commands for setting the voltage of the output channels. The default unit is V.

Example: Configuring the output voltage

This example contains all commands to configure and query the output voltage.

```
// *****
// Set the voltage value
// *****
INST OUT1
VOLT 10
// selects a channel and sets the voltage

VOLT MAX
VOLT MIN
// sets the voltage to maximum or minimum respectively

VOLT?
// queries the output voltage of a channel
// response: "10.000"

// *****
// Query the range of the voltage values
// *****
VOLT? MIN
// response: "0.000"
VOLT? MAX
// queries the upper and lower limit of the output voltage
// response: "32.050"

// *****
// Increase or decrease the voltage stepwise
// *****
INST OUT1
VOLT:STEP 4
VOLT UP
// selects the output channel, sets the step width
// and increases the voltage in the selected channel
// by the set 4 Volts
VOLT DOWN
// decreases the voltage in the selected channel
// by the set 4 Volts
VOLT:STEP?
// queries the voltage step size
// response: "4.000"
```

[SOURce:]VOLTage[:LEVel][:IMMediate][:AMPLitude]..... 64
[SOURce:]VOLTage[:LEVel]:STEP[:INCRement].....65

[SOURce:]VOLTage[:LEVel][:IMMediate][:AMPLitude] <Voltage>

Sets the voltage value of the selected channel.

Parameters:

<Voltage> MINimum | MAXimum | UP | DOWN

<Voltage>

Range: 0.000 to 32.050

Increment: 0.001

Default unit: V

Example:

See [Example "Configuring the output voltage"](#) on page 64.

Manual operation: See ["Set the voltage"](#) on page 33

[SOURce:]VOLTage[:LEVel]:STEP[:INCRement]

Sets the voltage step size for the [VOLT UP](#) | [VOLT DOWN](#) command.

Parameters:

<Step>

Range: 0.000 to 32.050

*RST: 1.000

Default unit: V

Example:

See [Example "Configuring the output voltage"](#) on page 64.

Manual operation: See ["Set the voltage"](#) on page 33

8.3.3 Current Setting Commands

The `SOURce:CURRent` subsystem contains the commands for setting the current limit of the output channels. The default unit is A.

Example: Configuring the current limit

This example contains all commands to configure and query the output voltage.

```
// *****
// Set the voltage value
// *****
INST OUT1
CURR 2
// selects a channel and sets the current
CURR?
// queries the current of he selected channel
// response: 2.000

// *****
// Query the range of the current values
// *****
CURR? MIN
// reponse: 0.0005
CURR? MAX
// reponse: 5.000
// queries the upper and lower limit of the current

// *****
// Increase or decrease the current stepwise
// *****
INST OUT1
CURR:STEP 2
CURR DOWN
// selects the output channel, sets the step width
// and decreases the voltage in the selected channel
// by the set 2 Ampere
CURR UP
// increases the voltage in the selected channel
// by the set 2 Ampere
CURR:STEP?
// queries the current step size
// repsonse: 2.000
```

[SOURce:]CURRent[:LEVel][:IMMediate][:AMPLitude]	66
[SOURce:]CURRent[:LEVel]:STEP[:INCRement]	67

[SOURce:]CURRent[:LEVel][:IMMediate][:AMPLitude] <Current>

Sets the current value of the selected channel.

Parameters:

<Current>	<Current>
	Range: Depends on the instrument type, see the data sheet.
	Default unit: A

Example: See [Example "Configuring the current limit"](#) on page 66.

Manual operation: See ["Set the current limit"](#) on page 33

[SOURce:]CURRENT[:LEVel]:STEP[:INCRement] <Step>

Sets the current step size for the [CURR UP](#) | [CURR DOWN](#) command.

Parameters:

<Step> Range: 0.005 / 0.001 to 10.0100A
 *RST: 0.100 A
 Default unit: A

Example: See [Example "Configuring the current limit"](#) on page 66.

Manual operation: See ["Set the current limit"](#) on page 33

8.3.4 Combined Voltage and Current Commands

The `APPLY` subsystem provides a command that enables you to set the current and voltage of a channel in one step.



The combined voltage and current setting command takes approximately 100 ms, i.e. longer than the setting of a single value.

`APPLY`..... 67

APPLY <Voltage>, <Current>

Sets the voltage and current value of the selected channel.

Parameters:

<Voltage> {<Voltage> | DEF | MIN | MAX}
 Range: 0.000 to 32.050
 *RST: 1.000
 Default unit: V

<Current> {<Current> | DEF | MIN | MAX}
 Range: depends on instrument type
 *RST: 1.000
 Default unit: A

Example:

```
INST OUT1
APPL 6,2
// sets the output of channel 1 to 6 V and 2 A

APPL?
// queries the voltage and current the selected channel
// response: 6.000,2.000
```

8.3.5 Output Setting Commands

The `OUTPut` subsystem contains the commands for activating the output channels.

Example: Activating the channels

You can activate a selected channel and turn on or off the outputs either individually or all outputs simultaneously. This example lists all ways how you can activate and query the outputs.

```
// *****
// Activate a channel
// *****
INST OUT1
OUTP:SEL 1
// activates the selected channel

OUTP 1
// activates channel 1 and its output

OUTP?
// queries the output state
// response: 1

// *****
// Turn on all selected channels simultaneously
// *****
INST:OUT1
VOLT 12
CURR 0.1
OUTP:SEL 1

INST:OUT2
VOLT 12
CURR 0.2
OUTP:SEL 1
// selects channels 1 and 2
// sets the voltage and current values for both channels
// activates both channels

OUTP:GEN 1
// turns on the output of both channels
```

OUTPut:GENeral	68
OUTPut:SElect	69
OUTPut[:STATe]	69

OUTPut:GENeral <State>

Turns on all selected channels simultaneously.

Parameters:

<State> {OFF | ON | 0 | 1}
 *RST: 0

Example: See [Example "Activating the channels"](#) on page 68.

Usage: Setting only

OUTPut:SElect <State>

Activates the selected channel.

Parameters:

<State> {OFF | ON | 0 | 1}
 *RST: 0

Example: See [Example "Activating the channels"](#) on page 68.

Usage: Setting only

OUTPut[:STATe] <State>

Activates the selected channel and turns on the output.

Parameters:

<State> {OFF | ON | 0 | 1}
 *RST: 0

Example: See [Example "Activating the channels"](#) on page 68.

Manual operation: See ["Activating the channel output"](#) on page 33

8.3.6 Fuse Setting Commands

The FUSE subsystem contains the commands for activating fuses and setting fuse parameters of the output channels.



The delay function of the fuses takes effect when the corresponding channel is activated (Output On).

Example: Configuring fuses

This example contains all commands to configure and query the fuse states and settings.

```
// *****
// Activate a fuse
// *****
INST OUT1
FUSE 1
// selects a channel and activates the fuse
FUSE?
// queries the state of the fuse in the selected channel
// response: 1

// *****
// Set a delay time for the fuse. The delay time
// takes effect when the channel output is turned on.
// *****
FUSE:DEL 50
// sets 50 ms delay for the fuse and
// turns on the output of the channel

FUSE:DEL?
// queries the currently set delay time of the fuse
// in the selected channel
// response: 50

FUSE:DEL MAX
FUSE:DEL MIN
// sets the delay time to maximum, minimum respectively

// *****
// Query the range of the fuse delay time
// *****
FUSE:DEL? MIN
// response: 0
FUSE:DEL? MAX
// queries the upper and lower limit of the
// fuse delay time in ms
// response: 250

// *****
// Link the electronic fuses of the channels logically
// *****
INST OUT1
FUSE:LINK 2
// links the fuse of channel 1 with channel 2

FUSE:LINK?2
// queries the combined fuses of the selected channel
```

```

// response: 1 when the fuse is linked
// response: 0 when the fuse is not linked

// *****
// Dissolve the link of the electronic fuses
// *****
INST OUT1
FUSE:LINK 2
FUSE:UNL 2
// links the fuse of channel 1 with channel2
// dissolves the fuse link

// *****
// Query a tripped fuse
// *****
INST OUT1
FUSE:TRIP?
// queries whether the fuse in channel 1 has tripped

```

FUSE:DElay.....	71
FUSE:LINK.....	71
FUSE:TRIPped?.....	72
FUSE:UNLink.....	72
FUSE[:STATe].....	72

FUSE:DElay <Delay>

Sets a delay time for the fuse to take effect.

Parameters:

<Delay> {<Delay> | MIN | MAX}
Range: 0 to 250
Increment: 10
Default unit: ms

Example: See [Example "Configuring fuses "](#) on page 70.

Manual operation: See ["Fuse Delay"](#) on page 37

FUSE:LINK <Channel>

Combines the fuses of several selected channels (fuse linking).

Parameters:

<Channel> {1 | 2 | 3 | 4}

Example: See [Example "Configuring fuses "](#) on page 70.

Manual operation: See ["Fuse Linking"](#) on page 36

FUSE:TRIPped?

Queries whether the fuse has tripped in the selected channel.

Return values:

<State> {ON | OFF | 0 | 1}
 1
 Fuse is tripped.
 0
 Fuse is not tripped.

Example: See [Example "Configuring fuses "](#) on page 70.

Usage: Query only

FUSE:UNLink <Channel>

Dissolves linked fuses.

Parameters:

<Channel> {1 | 2 | 3 | 4}

Example: See [Example "Configuring fuses "](#) on page 70.

Usage: Setting only

Manual operation: See ["Fuse Linking"](#) on page 36

FUSE[:STATe] <State>

Activates the fuse function in the selected channel.

Parameters:

<State> {0 | 1 | OFF | ON}
 *RST: 0

Example: See [Example "Configuring fuses "](#) on page 70.

Manual operation: See ["Activate the fuse"](#) on page 33

8.3.7 Overvoltage Protection Setting Commands

The `VOLTage:PROTection` subsystem contains the commands for setting the over-voltage protection parameters for the output channels. The default unit is V.

Example: Configuring the overvoltage protection

This example contains all commands to configure and query the protection of the output voltage.

```
// *****
// Set the overvoltage protection value
// *****
INST OUT1
VOLT:PROT 5
// selects a channel and sets the OVP
VOLT:PROT?
// queries the output overvoltage value of a channel
// response: 5

VOLT:PROT MAX
VOLT:PROT MIN
// sets the overvoltage protection to maximum,
// or minimum respectively

// *****
// Query the range of the overvoltage protection values
// *****
VOLT:PROT? MIN
// response: 0.100
VOLT:PROT? MAX
// queries the upper and lower limit
// response: 32.500

// *****
// Query a tripped overvoltage protection
// *****
INST OUT1
VOLT:PROT:TRIP?
// queries whether the OVP in channel 1 has tripped
// response: 1 OVP is tripped
// response: 0 OVP is not tripped
VOLT:PROT:CLEAR
// resets a tripped OVP in the selected channel

// *****
// Set the overvoltage protection mode
// *****
INST OUT1
VOLT:PROT:MODE PROT
// sets OVP protected mode for channel1

VOLT:PROT:MODE PROT?
// queries the OVP mode
// response: "protected"
```

VOLTage:PROTection[:LEVel].....	74
VOLTage:PROTection:CLEar.....	74
[SOURce:]VOLTage:PROTection:MODE.....	74
VOLTage:PROTection:TRIPped?.....	74

VOLTage:PROTection[:LEVel] <Voltage>

Sets the overvoltage protection value of the selected channel.

Parameters:

<Voltage> {<Voltage> | MIN | MAX}
 Range: 0.100 to 32.500
 Increment: 0.100
 Default unit: V

Example: See [Example "Configuring the overvoltage protection"](#) on page 73.

Manual operation: See ["OVP Level"](#) on page 38

VOLTage:PROTection:CLEar

Resets the OVP state of the selected channel.

If an OVP event has occurred before, the reset also erases the message on the display.

Example: See [Example "Configuring the overvoltage protection"](#) on page 73.

Usage: Setting only

[SOURce:]VOLTage:PROTection:MODE <Mode>

Sets the OVP mode for the previously selected channel.

Parameters:

<Mode> MEASured | PROTected

MEASured

The OVP turns off if the measured value exceeds the threshold.

PROTected

If the adjusted threshold is exceeded, you cannot turn on the output of the instrument. In addition, the measured value is monitored.

Manual operation: See ["OVP Mode"](#) on page 38

VOLTage:PROTection:TRIPped?

Queries the OVP state of the selected channel.

Return values:	
<state>	{OFF ON 0 1}
Example:	See Example "Configuring the overvoltage protection" on page 73.
Usage:	Query only

8.4 Measurement Commands

The MEASure subsystem provides commands to query the voltage and current values of a channel.

MEASure[:SCALar]:CURRent[:DC]?.....	75
MEASure[:SCALar]:VOLTage[:DC].....	75

MEASure[:SCALar]:CURRent[:DC]?

Queries the current value of the selected channel.

Return values:	
<Current>	<numeric_value> Returns current reading. Default unit: A

Example:

```
INST OUT1
MEAS:CURR?
// response: 1.000
```

Usage: Query only

MEASure[:SCALar]:VOLTage[:DC]

Queries the voltage value of the selected channel.

Return values:	
<Voltage>	<numeric_value> Returns voltage reading. Default unit: V

Example:

```
INST OUT1
MEAS:VOLT?
// response: 1.000
```

8.5 Arbitrary Setting Commands

The ARBitrary subsystem contains the commands for configuring an arbitrary sequence for the output channels.

Example: Configuring an arbitrary sequence

This programming example generates an arbitrary sequence for a selected channel. The sequence starts at 1 V and 1 A for 1 sec, and both values are incremented each second by 1. The generated arbitrary waveform is transferred to CH1. When activated, the R&S HMP provides the arbitrary waveform at the output of the selected channel, and repeats it 10 times.

```
// *****
// Define and start the arbitrary sequence
// *****
INST OUT1
ARB:DATA 1,1,1,2,2,1,3,3,1
// selects channel1
// defines the sequence, i.e. starting at 1V, 1A for 1sec,
// and increments the voltage and current each second by 1
ARB:REP 10
// sets the repetition rate
// ARB:REP? queries the set number of repetitions
ARB:TRAN 1
// transfers the arbitrary points to channel1
ARB:STAR 1
// starts the sequence
// ARB:STOP 1 stops the sequence in the selected channel
OUTP ON
// turns on the output

INST OUT1
ARB:CLEAR 1
// deletes the arbitrary waveform data of the selected channel

// *****
// Save and recall an arbitrary sequence
// *****
ARB:SAVE 1
// saves the sequence into the internal memory
ARB:REST
// loads a previously saved sequence from the internal memory
```

ARbitrary:Clear.....	76
ARbitrary:DATA.....	77
ARbitrary:REPetitions?.....	77
ARbitrary:REStore.....	77
ARbitrary:SAVE.....	78
ARbitrary:STARt.....	78
ARbitrary:STOP.....	78
ARbitrary:TRANsfer.....	78

ARbitrary:Clear <Channel>

Deletes the arbitrary waveform data of the selected channel.

Parameters:

<Channel> 1 | 2 | 3 | 4

Example:See [Example "Configuring an arbitrary sequence"](#) on page 76.**Usage:**

Setting only

Manual operation:See ["Clear Waveform"](#) on page 43**ARbitrary:DATA** <Data>

Defines the arbitrary voltage, current and time value points for the selected channel.

The dwell time between two arbitrary points is specified from 10 ms to 60 s.

Parameters:

<Data> <Voltage1, Current1, Time1, Voltage2, Current2, Time2,..., Voltage128, Current128, Time128>

Voltage1 ... Voltage128

Defines the arbitrary points of the voltage.

Current1 ... Current128

Defines the arbitrary points of the current.

Time1 ... Time128

Defines the arbitrary points of the time.

Range: Dwell time: 10 ms to 60 s; arbitrary points: 1 to 128

Example:See [Example "Configuring an arbitrary sequence"](#) on page 76.**Manual operation:**See ["Edit Waveform"](#) on page 42**ARbitrary:REPetitions?** <Channel>

Sets the repetition rate for the arbitrary waveform for the selected channel. If you set the rate to 0, the R&S HMP repeats the waveform infinitely.

Parameters:

<Channel> 0 | 1 | 2 | ... | 255

Example:See [Example "Configuring an arbitrary sequence"](#) on page 76.**Usage:**

Query only

ARbitrary:REStore <Memory>

Loads a saved arbitrary waveform from the internal memory.

Parameters:

<Memory> 1 | 2 | 3

Example:See [Example "Configuring an arbitrary sequence"](#) on page 76.**Usage:**

Setting only

Manual operation:See ["Recall Waveform"](#) on page 43

ARbitrary:SAVE <Memory>

Saves the arbitrary waveform data in the internal memory. You can save up to three waveforms in the internal memory.

Parameters:

<Memory> 1 | 2 | 3

Example: See [Example "Configuring an arbitrary sequence"](#) on page 76.

Usage: Setting only

Manual operation: See ["Save Waveform"](#) on page 43

ARbitrary:START <Channel>

Starts the arbitrary sequence in the selected channel.

Parameters:

<Channel> 1 | 2 | 3 | 4

Example: See [Example "Configuring an arbitrary sequence"](#) on page 76.

Usage: Setting only

Manual operation: See ["Start Waveform"](#) on page 42

ARbitrary:STOP <Channel>

Stops the arbitrary sequence in the selected channel.

Parameters:

<Channel> 1 | 2 | 3 | 4

Example: See [Example "Configuring an arbitrary sequence"](#) on page 76.

Usage: Setting only

Manual operation: See ["Stop Waveform"](#) on page 42

ARbitrary:TRANSfer <Channel>

Transfers the defined arbitrary points to the selected channel.

Parameters:

<Channel> 1 | 2 | 3 | 4

Example: See [Example "Configuring an arbitrary sequence"](#) on page 76.

Usage: Setting only

Manual operation: See ["Transfer Waveform"](#) on page 42

8.6 Status Reporting

8.6.1 STATus:QUEStionable Registers

The commands of the STATus:QUEStionable subsystem control the status reporting structures of the STATus:QUEStionable registers.

See also:

- [Chapter A.3.1, "Structure of a SCPI Status Register"](#), on page 87
- ["STATus:QUEStionable Register"](#) on page 89

STATus:QUEStionable:ENABLE	79
STATus:QUEStionable:INSTRument:ENABLE	79
STATus:QUEStionable:INSTRument:ISUMmary:ENABLE	79
STATus:QUEStionable[:EVENT]?	79
STATus:QUEStionable:INSTRument[:EVENT]?	79
STATus:QUEStionable:INSTRument:ISUMmary[:EVENT]?	79
STATus:QUEStionable:INSTRument:ISUMmary:CONDition?	80

STATus:QUEStionable:ENABLE

STATus:QUEStionable:INSTRument:ENABLE

STATus:QUEStionable:INSTRument:ISUMmary:ENABLE <Enable_Value>

Sets the enable mask that allows true conditions in the EVENT part to be reported in the summary bit.

If a bit in the ENABLE part is 1, and the corresponding EVENT bit is true, a positive transition occurs in the summary bit. This transition is reported to the next higher level.

Parameters:

<Enable_Value> Bit mask in decimal representation
 Range: 0 to 65535

STATus:QUEStionable[:EVENT]?

STATus:QUEStionable:INSTRument[:EVENT]?

STATus:QUEStionable:INSTRument:ISUMmary[:EVENT]? <Event>

Queries the contents of the EVENT part of the status register to check if an event has occurred since the last reading. Reading an EVENT register deletes its contents.

Parameters:

<Event> Event bits in decimal representation
 Range: 0 to 65535

Usage: Query only

STATus:QUEStionable:INSTrument:ISUMmary:CONDition? <Condition>

Returns the contents of the CONDition part of the status register to check the actual instrument states. Reading the CONDition registers does not delete the contents.

Return values:

<Condition> Condition bits in decimal representation
Range: 0 to 65535

Usage: Query only

Annex

A Additional Basics on Remote Control

A.1 Messages and Command Structure

A.1.1 Messages

Instrument messages are employed in the same way for all interfaces, if not indicated otherwise in the description.

See also:

- Structure and syntax of the instrument messages: [Chapter A.1.2, "SCPI Command Structure"](#), on page 82
- Detailed description of all messages: [Chapter 8, "Remote Control Commands"](#), on page 57

There are different types of instrument messages:

- Commands
- Instrument responses

Commands

Commands (program messages) are messages which the controller sends to the instrument. They operate the instrument functions and request information. The commands are subdivided according to two criteria:

Effects on the instrument:

- Setting commands cause instrument settings such as a reset of the instrument or setting the output voltage.
- Queries return data for remote control, e.g. for identification of the instrument or polling a parameter value. Queries are formed by appending a question mark to the command header.

Applied standards:

- The function and syntax of the common commands are precisely defined in standard IEEE 488.2. If implemented, they are used identically on all instruments. They refer to functions such as management of the standardized status registers, reset and self-test.
- Instrument control commands refer to functions depending on the features of the instrument such as voltage settings. Many of these commands have also been standardized by the SCPI committee. These commands are marked as "SCPI compliant" in the command reference chapters. Commands without this SCPI label

are device-specific, however, their syntax follows SCPI rules as permitted by the standard.

Instrument responses

Instrument responses (response messages and service requests) are messages which the instrument sends to the controller after a query. They can contain measurement results, instrument settings and information on the instrument status.

GPIB Interface Messages

Interface messages are transmitted to the instrument on the data lines with the attention line (ATN) being active (LOW). They are used for communication between the controller and the instrument and can only be sent by a PC which has the function of a GPIB bus controller. GPIB interface messages can be further subdivided into:

- **Universal commands** act on all instruments connected to the GPIB bus without previous addressing; universal commands are encoded in the range 10 through 1F hex. They affect all instruments connected to the bus and do not require addressing.
- **Addressed commands** only act on instruments previously addressed as listeners; addressed commands are encoded in the range 00 through 0F hex. They only affect instruments addressed as listeners.

A.1.2 SCPI Command Structure

SCPI commands consist of a so-called header and, usually, one or more parameters. The header and the parameters are separated by a whitespace. The headers can consist of several mnemonics (keywords). Queries are formed by appending a question mark directly to the header. The commands can be either device-specific or device-independent (common commands). Common and device-specific commands differ in their syntax.

Syntax for Common Commands

Common (= device-independent) commands consist of a header preceded by an asterisk (*) and possibly one or more parameters.

Table A-1: Examples of Common Commands

Command	Command Name	Description
*RST	Reset	Resets the instrument.
*ESE	Event Status Enable	Sets the bits of the event status enable registers.
*ESR?	Event Status Query	Queries the content of the event status register.
*IDN?	Identification Query	Queries the instrument identification string.

Syntax for Device-Specific Commands

For demonstration purposes only, assume the existence of the following commands for this section:

- MEASure:CURRent[:DC]?
- MEASure:VOLTage[:DC]?
- FUSE[:STATE] {ON | OFF | 0 | 1}
- FUSE[:STATE]?

Long and short form

The mnemonics feature a long form and a short form. The short form is marked by uppercase letters, the long form corresponds to the complete word. You can enter either the short form or the long form; other abbreviations are not permitted.

Example:

MEASure:CURRent? is equivalent to MEAS:CURR?



Case-insensitivity

Uppercase and lowercase notation only serves to distinguish the two forms in the manual, the instrument itself is case-insensitive.

Optional mnemonics

Some command systems permit inserting or omitting certain mnemonics in the header. These mnemonics are marked by square brackets. The instrument must recognize the long command to comply with the SCPI standard. Some commands are shortened by these optional mnemonics.

Example:

FUSE[:STATE] { ON }

FUSE:STAT ON is equivalent to FUSE ON

Special characters

Table A-2: Special characters

	<p>A vertical stroke in parameter definitions indicates alternative possibilities in the sense of "or". The effect of the command differs, depending on the used parameter.</p> <p>Example:</p> <ul style="list-style-type: none"> • FUSE:LINK {1 2 3} • FUSE:LINK 1 sets the fuse link CH1 for the selected channel FUSE:LINK 2 sets the fuse link of CH2 for the selected channel
[]	<p>Mnemonics in square brackets are optional and can be inserted into the header or be omitted.</p> <p>Example:</p> <ul style="list-style-type: none"> • FUSE[:STATe] { ON } • FUSE:STAT ON is equivalent to FUSE ON
{ }	<p>Parameters in curly brackets are optional and can be inserted once or several times, or be omitted.</p> <p>Example:</p> <ul style="list-style-type: none"> • VOLTage[:LEVel][:IMMediate][:AMPLitude] {<voltage> MIN MAX UP DOWN } <p>The following are valid commands:</p> <ul style="list-style-type: none"> - VOLT MAX - VOLT MIN VOLT 10

SCPI Parameters

Many commands are supplemented by a parameter or a list of parameters. The parameters must be separated from the header by a whitespace (ASCII code 0 to 9, 11 to 32 decimal, e.g. blank).

Allowed parameters are:

- Numeric values
- Special numeric values
- Boolean parameters
- Text
- Character strings
- Block data

The required parameters and the allowed value range are specified in the command description.

Numeric values

You can enter numeric values in the following form. Values exceeding the resolution of the instrument are rounded up or down.

Example:

VOLT 10V = VOLT 10

VOLT 100mV = VOLT 0.1

Special numeric values

The text listed below are interpreted as special numeric values. In the case of a query, the numeric value is provided.

- MIN/MAX

- **MINimum** and **MAXimum** denote the minimum and maximum value.

Example:

```
VOLT:PROT? MAX
```

Returns the maximum numeric value.

Boolean parameters

Boolean parameters represent two states:

- **On** (logically true), is represented by "On" or the numeric value "1"
- **Off** (logically false), is represented by "Off" or the numeric value "0"

The instrument returns the numerical value when queried.

Example:

```
OUTP:STAT ON
```

```
OUTP:STAT?, Response: 1
```

Overview of Syntax Elements

The following table provides an overview of the syntax elements:

Table A-3: Syntax Elements

:	A colon separates the mnemonics of a command.
,	A comma separates several parameters of a command.
?	A question mark forms a query.
*	An asterisk marks a common command.
"	Quotation marks introduce a string and terminate it.
	A whitespace (ASCII-Code 0 to 9, 11 to 32 decimal, e.g. blank) separates the header from the parameters.

Responses to Queries

You can query each setting command by adding a question mark. According to SCPI, the responses to queries are partly subject to stricter rules than in the standard IEEE 488.2.

- The requested parameter is transmitted without a header.
VOLTage:PROTection:MODE?, Response: "measured"
- Maximum values, minimum values and all other quantities that are requested via a special text parameter are returned as numeric values.
VOLT:PROT? MAX, Response: 32.500
- Boolean values are returned as 0 (for Off) and 1 (for On).
OUTPut:STATe?, Response: 1

A.2 Command Sequence and Synchronization

A sequential command finishes the execution before the next command is starting. To make sure that commands are actually carried out in a certain order, each command must be sent in a separate command line.



As a rule, send commands and queries in different program messages.

A.2.1 Preventing Overlapping Execution

Table A-4: Synchronization using *OPC, *OPC? and *WAI

Command	Action	Programming the controller
*OPC	Sets the Operation Complete bit in the ESR after all previous commands have been executed.	<ul style="list-style-type: none"> Setting bit 0 in the ESE Setting bit 5 in the SRE Waiting for service request (SRQ)
*OPC?	Stops command processing until 1 is returned. It occurs after the Operation Complete bit has been set in the ESR. This bit indicates that the previous setting has been completed.	Sending *OPC? directly after the command whose processing should be terminated before other commands can be executed.
*WAI	Stops further command processing until all commands have been executed before *WAI.	Sending *WAI directly after the command whose processing should be terminated before other commands are executed

To prevent an overlapping execution of commands the commands *OPC, *OPC? or *WAI can be used. All three commands cause a certain action only to be carried out after the hardware has been set. The controller can be forced to wait for the corresponding action.



The HMP series does not support parallel processing of remote commands. If OPC? returns a "1", the device is able to process new commands.

A.3 Status Reporting System

The status reporting system stores all information on the current operating state of the instrument and errors which have occurred. This information is stored in the status registers and in the error queue. You can query both via RS-232, USB, GPIB or LAN interface (STATus... commands).

A.3.1 Structure of a SCPI Status Register

Each standard SCPI register consists of 2 or 3 parts (Event, Condition and Enable register). Each part has a width of 16 bits and has different functions. The individual bits are independent of each other, i.e. each hardware status is assigned a bit number which is valid for all 2 or 3 parts. Bit 15 (the most significant bit) is set to zero for all parts. Thus the controller can process contents of the register parts as positive integers.

A `STATUS:QUESTIONable:INSTrument:ISUMmary1` exists as often as device channels are available (e.g. HMP4030 = 3 channels = 3 status register). Accordingly, the description text of the channel information changes in [Figure A-1](#) (e.g. instrument 1 = channel 1, instrument 2 = channel 2 etc.).



Depending on the value of the read register, you can draw conclusions on the current status of the device. For example, when the unit operates in constant voltage, the result of the returned ISUM register is a decimal "2" which corresponds the binary value of "0000000000000010".

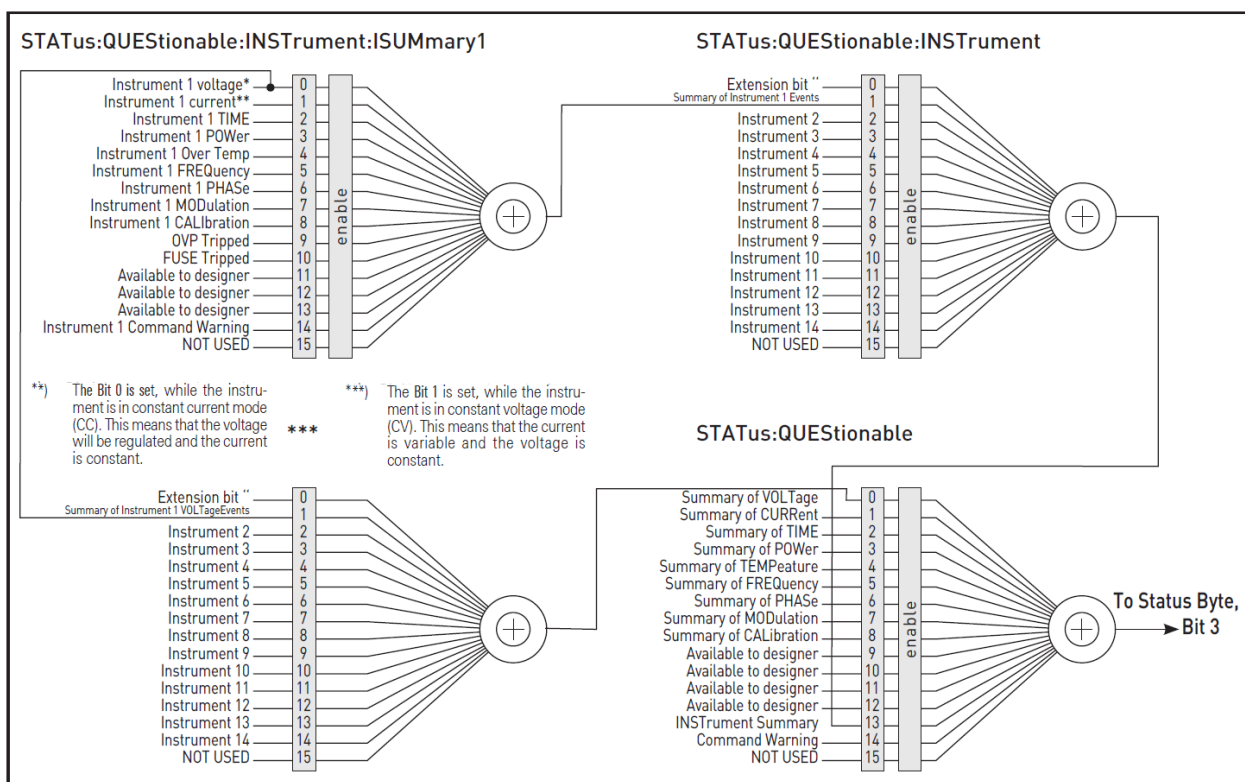

Figure A-1: Structure of the status register

Any part of a status register system can be read by query commands. A decimal value is returned and represents the bit pattern of the requested register. Each SCPI register is 16 bits wide and has various functions. The individual bits are independent, i.e. each hardware status is assigned to a bit number.

Bits 11 to 13 are still "free" resp. unused (always return a "0"). Certain areas of the registers are not used. The SCPI standard defines only the "basic functions". Some devices offer an advanced functionality.

Each channel of the power supply is considered as separate "instrument" (SCPI standard definition). Therefore, e.g. the register "Status: Questionable: Instrument: Summary" of the HMP4030 is also present three times (Isummary1-3).

Description of the status register parts

Please refer to [Figure A-1](#).

The SCPI standard provides two different status registers:

CONDition

- The `CONDition` register queries the actual state of the instrument. If you want to query the constant voltage or current mode, you have to use the `CONDition` register.



The `CONDition` register delivers a "1" (first bit set) in constant current mode (CC) and a "2" (second bit set) in constant voltage mode (CV).

If the correct channel is selected and the red LED of the channel button lights up (CC mode), the query of the `CONDition` register must deliver a "1".

Example:

```
STAT:QUES:ISUM1:COND?
```

EVENT

- The `EVENT` status register is set (1) until it is queried. After reading (query), the `EVENT` status register is set to zero.



The description of registers is only used for general explanation. Due to the complexity, we recommend the general accessible SCPI standard document for more detailed information.

Event Status Register (ESR) and Event Status Enable Register (ESE)

The ESR is defined in IEEE 488.2. It can be compared with the `EVENT` part of an SCPI register. The event status register can be read out using the command `*ESR?`. The ESE corresponds to the `ENABLE` part of an SCPI register. If a bit is set in the ESE and the associated bit in the ESR changes from 0 to 1, the ESB bit in the STB is set. The ESE register can be set using the command `*ESE` and read using the command `*ESE?`.

STATus:QUEStionable Register

This register contains information about different states which can occur. It can be read using the commands `STATus:QUEStionable:CONDition?` and `STATus:QUEStionable[:EVENT]?`. See also [Figure A-1](#).

Table A-5: Bits of the STATus:QUEStionable register

Bit No.	Meaning
0	Voltage This bit is set while the instrument is in constant current mode (CC). The voltage is regulated and the current is constant.
1	Current This bit is set while the instrument is in constant voltage mode (CV). The current is variable and the voltage is constant.
2	Not used
3	Not used
4	Temperature overrange This bit is set if an over temperature occurs.
5-8	Not used
9	OVP Tripped This bit is set if the over voltage protection has tripped.
10	Fuse Tripped This bit is set if the fuse protection has tripped.
11 to 15	Not used

Query of an instrument status

Each part of any status register can be read using queries.

There are two types of commands:

- The common commands `*ESR?`, `*IDN?`, `*STB?` query the higher-level registers.
- The commands of the `STATus` system query the SCPI registers (`STATus:QUEStionable`)

The returned value is always a decimal number that represents the bit pattern of the queried register. This number is evaluated by the controller program.

Decimal representation of a bit pattern (binary weights)

The `STB` and `ESR` registers contain 8 bits, the status registers 16 bits. The contents of a status register are specified and transferred as a single decimal number. To make this possible, each bit is assigned a weighted value. The decimal number is calculated as the sum of the weighted values of all bits in the register that are set to 1.

Bits	0	1	2	3	4	5	6	7	...
Weight	1	2	4	8	16	32	64	128	...

Figure A-2: Decimal representation of a bit pattern

Error Queue

Each error state in the instrument leads to an entry in the error queue. The entries of the error queue are detailed plain text error messages. You can look them up in the error log or via remote control using `SYSTem:ERRor[:NEXT]?`. Each call of `SYSTem:ERRor[:NEXT]?` provides one entry from the error queue. If no error messages are stored, the instrument responds with 0, "No error".

B Hardware Interfaces

This section covers hardware-related topics, like pin assignment of the IEC 625/IEEE 488 interface.

The remote control interfaces are described in details in [Chapter 7.1, "Remote Control Interfaces"](#), on page 53.

All other interfaces and connectors are described briefly in [Chapter 3.2, "Instrument Tour"](#), on page 21

For specifications, refer to the data sheet.

B.1 GPIB

Pin assignment

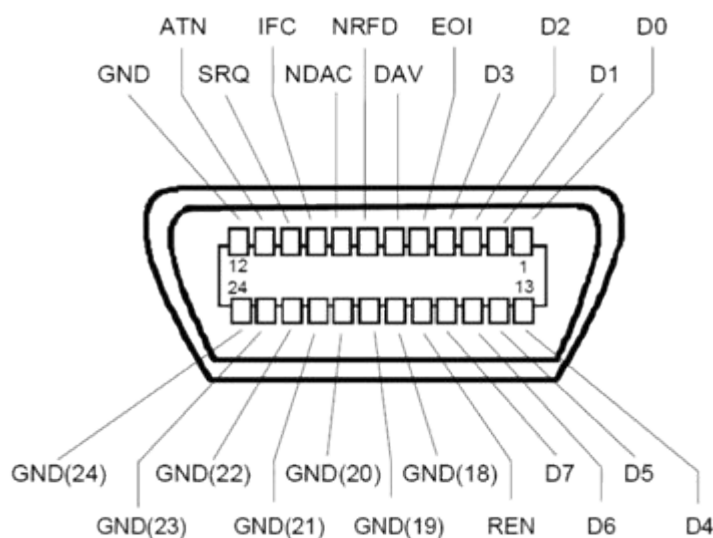

Figure B-1: Pin assignment of GPIB-bus (IEEE 488) interface

Bus lines

- Data bus with 8 lines D0 to D7:
The transmission is bit-parallel and byte-serial in the ASCII/ISO code. D0 is the least significant bit, D7 the most significant bit.
- Control bus with five lines:
IFC (Interface Clear): active LOW resets the interfaces of the instruments connected to the default setting.
ATN (Attention): active LOW signals the transmission of interface messages, inactive HIGH signals the transmission of device messages.

SRQ (Service Request): active LOW enables the connected device to send a service request to the controller.

REN (Remote Enable): active LOW permits switchover to remote control.

EOI (End or Identify): has two functions in connection with ATN:

- ATN=HIGH active LOW marks the end of data transmission.
- ATN=LOW active LOW triggers a parallel poll.

- Handshake bus with three lines:

DAV (Data Valid): active LOW signals a valid data byte on the data bus.

NRFD (Not Ready For Data): active LOW signals that one of the connected devices is not ready for data transfer.

NDAC (Not Data Accepted): active LOW signals that the instrument connected is accepting the data on the data bus.

Interface functions

Instruments which can be controlled via GPIB-bus interface can be equipped with different interface functions. [Table B-1](#) lists the interface functions for the R&S HMP.

Table B-1: GPIB-bus interface functions

Control character	Interface function
SH1	Handshake source function (source handshake), full capability
AH1	Handshake sink function (acceptor handshake), full capability
L4	Listener function, full capability, de-addressed by MTA.
T6	Talker function, full capability, ability to respond to serial poll, de-addressed by MLA
SR1	Service request function (Service Request), full capability
PP1	Parallel poll function, full capability
RL1	Remote/Local switch over function, full capability
DC1	Reset function (Device Clear), full capability
DT1	Trigger function (Device Trigger), full capability

B.2 RS-232

The RS-232 interface is built with a 9-pin D-SUB connector. This bidirectional interface allows the transfer of setup parameters, data and screenshots from an external device (e.g. PC) to the power supply or vice versa.

It is possible to establish a direct connection from the PC (serial port) to the interface via 9-pin shielded cable (1:1 wired). The maximum length must not exceed 3 m.

Pin Assignment



Figure B-2: RS232 Pin Assignment

- 1 = unused
- 2 = Tx data (data from power supply to external device)
- 3 = Rx data (data from external device to power supply)
- 4 = unused
- 5 = Ground (reference potential, connected with power supply (safety class II) and power cable to the grounding conductor)
- 6 = unused
- 7 = CTS (Clear To Send)
- 8 = RTS (Request To Send)
- 9 = +5 V supply voltage for external devices (max. 400 mA)

The maximum voltage variation at the Tx, Rx, RTS and CTS connections is ± 12 Volt.

The RS-232 standard parameters for the interface are as follows:

- 8-N-1 (8 data bits, no parity bit, 1 stop bit)
- RTS/CTS hardware protocol: none

To set the parameters, see [Chapter 7.1.3, "RS-232 Interface"](#), on page 55.

Glossary: List of the Often Used Terms and Abbreviations

C

CC: Constant current output mode

Computer name: An unambiguous indication of the instrument a LAN that uses a DNS server.

Synonym: [Hostname](#)

See [Serial number](#).

CP: Constant voltage output mode

D

DHCP: Dynamic host configuration protocol

E

e.g.: For example

G

Glossary: List of the often used terms and abbreviations

H

Hostname: [Computer name](#)

I

i.e.: That is

O

OVP: Overvoltage protection switches off the output when voltage exceeds the maximum value.

P

PC: Personal computer

Product page: A designation of the R&S HMP product page www.rohde-schwarz.com/product/HMP.html

R

Remote control: The operation of the R&S HMP by remote control commands or programs to perform automated tests.

The instrument is connected to a system controller via LAN, GPIB or USB. The instrument is controlled directly or supported by instrument drivers.

S

Serial number: Unique instrument identification, provided on the rear panel of the instrument and required to build the [Computer name](#).

The serial number are the last 6 digits in the string `<stock no.>-<serial number>`.

T

TCP/IP: Transmission Control Protocol / Internet Protocol. The network protocol defines the details of how data is sent and received through network adapters, hubs, switches, routers and other network communications hardware.

List of Commands

[SOURce:]CURRent[:LEVel]:STEP[:INCRement]	67
[SOURce:]CURRent[:LEVel][:IMMediate][:AMPLitude]	66
[SOURce:]VOLTage:PROTection:MODE	74
[SOURce:]VOLTage[:LEVel]:STEP[:INCRement]	65
[SOURce:]VOLTage[:LEVel][:IMMediate][:AMPLitude]	64
*CLS	57
*ESE	57
*ESR?	58
*IDN?	58
*OPC	58
*RCL	59
*RST	58
*SAV	59
*SRE	58
*STB?	59
*TST?	59
*WAI	59
APPLY	67
ARBitrary:Clear	76
ARBitrary:DATA	77
ARBitrary:REPetitions?	77
ARBitrary:REStore	77
ARBitrary:SAVE	78
ARBitrary:START	78
ARBitrary:STOP	78
ARBitrary:TRANsfer	78
FUSE:DELAy	71
FUSE:LINK	71
FUSE:TRIPped?	72
FUSE:UNLink	72
FUSE[:STATe]	72
INSTRument:NSElect	63
INSTRument[:SElect]	63
MEASure[:SCALar]:CURRent[:DC]?	75
MEASure[:SCALar]:VOLTage[:DC]	75
OUTPut:GENeral	68
OUTPut:SElect	69
OUTPut[:STATe]	69
STATus:QUEStionable:ENABle	79
STATus:QUEStionable:INSTRument:ENABle	79
STATus:QUEStionable:INSTRument:ISUMmary:CONDition?	80
STATus:QUEStionable:INSTRument:ISUMmary:ENABle	79
STATus:QUEStionable:INSTRument:ISUMmary[:EVENT]?	79
STATus:QUEStionable:INSTRument[:EVENT]?	79
STATus:QUEStionable[:EVENT]?	79
SYSTem:BEEPer[:IMMediate]	60
SYSTem:ERRor[:NEXT]?	60

SYSTem:LOCal.....	61
SYSTem:MIX.....	61
SYSTem:REMOte.....	61
SYSTem:RWLock.....	61
SYSTem:VERSion?.....	61
VOLTage:PROTection:CLEar.....	74
VOLTage:PROTection:TRIPped?.....	74
VOLTage:PROTection[:LEVel].....	74

Index

A

Activating the fuse	26
Activating the output	26
Application examples	8
Application notes	8
ATN	91
Attention	91

B

Bench top operation	15
Brochure	8
Brochures	8

C

Checking the LAN connection	21
Cleaning	51
Clear status	
Remote	57
Command sequence	
Remote	59
Control bus	91

D

Data sheet	8
Data valid	91
DAV	91
Default values	
Remote	58
Delivery list	15
Display information	28
Drivers for remote control	8

E

Electrostatic discharge	12, 25
EOI	91
ESD	12, 25
Event status enable register (ESE)	
Remote	57
Event status register (ESR)	
Remote	58

F

Failure	
Network connection	20
Front panel	
HMP20x0	21
HMP40x0	22
Fuse replacing	18

G

Getting started manual	7
------------------------------	---

I

Identification	
Remote	58
IFC	91

Illuminated keys	21, 28
Instrument control	27
Manual operation	27
Remote control	27
Ways of operation	27
Instrument tour	21
Interface	
functions (GPIB bus)	92
Interface clear	91

K

Key features	7
--------------------	---

L

LAN connection	
Not working	20

M

Maintenance	
Cleaning	51
Storing and packing	52
Manual interaction	28
Manual operation	27

N

Navigation controls	29
NDAC	91
Network connection	
Error	20
NRFD	91

O

Operation	
Manually	28
Remotely	30
Operation complete	
Remote	58

P

Packing	52
Ping	21
Placing the instrument	15
Power on	17
Preparing for use	11
Putting into operation	11
Bench top operation	15
Delivery list	15
Fuse replacing	18
Placing the instrument	15
Power on	17
Rack mounting	15
Safety	11
Setting up a LAN connection	19
Shut down	19
Start up	18
Starting	17
Unpacking	14

R

Rack mounting	15, 16
Rear panel	
HMP2020	23
HMP2030	23
HMP4030	24
HMP4040	24
Recalling instrument settings	27
Release notes	8
Remote connection	
Not working	20
Remote control	27, 30
Drivers	8
Interfaces	30
REN	91
Reset values	
Remote	58

S

Safety	8, 11
Safety instructions	8
Saving instrument settings	27
SCPI programmers manual	7
Selecting a channel	25
Selecting the current limit	26
Selecting the output voltage	25
Self-test	
Remote	59
Service request enable register (SRE)	
Remote	58
Setting up a LAN connection	19
Checking the LAN connection	21
Switching to remote control	21
To assign the IP address manually	20
To set up a network (LAN) connection	20
Settings controls	29
Shut down	19
Specifications	8
SRQ	91
Start up	18
Starting the instrument	17
Status byte	
Remote	57, 59
Storing	52
Switching to remote control	21

T

To assign the IP address manually	20
To set up a network (LAN) connection	20
Trying out	25
Activating the fuse	26
Activating the output	26
Prerequisites	25
Recalling instrument settings	27
Saving instrument settings	27
Selecting a channel	25
Selecting the current limit	26
Selecting the output voltage	25

U

Unpacking	14
User manual	7

W

Wait	
Remote	59
Ways of operation	27