

R&S® ETL

TV Analyzer

Getting Started



2118413002

This document describes the following R&S®ETL model:

- 2112.0004.13

U.S. Patent Nos. 4,631,603; 4,819,098; 4,907,093; 5,315,448; 6,381,747; and 6,516,132. Used for the video and audio hardware decoder option (R&S ETL-B281).

The software contained in this product uses several valuable open source software packages. For information, see the "Open Source Acknowledgment" document, which is available for download from the R&S ETL product page at www.rohde-schwarz.com/product/etl.html > "Downloads" > "Firmware".

Rohde & Schwarz would like to thank the open source community for their valuable contribution to embedded computing.

© 2018 Rohde & Schwarz GmbH & Co. KG

Mühlhofstr. 15, 81671 München, Germany

Phone: +49 89 41 29 - 0

Fax: +49 89 41 29 12 164

Email: info@rohde-schwarz.com

Internet: www.rohde-schwarz.com

Subject to change – Data without tolerance limits is not binding.

R&S® is a registered trademark of Rohde & Schwarz GmbH & Co. KG.

Trade names are trademarks of the owners.

2118.4130.02 | Version 04 | R&S®ETL

Throughout this manual, products from Rohde & Schwarz are indicated without the ® symbol, e.g. R&S®ETL is indicated as R&S ETL.

Safety Instructions

Instrucciones de seguridad

Sicherheitshinweise

Consignes de sécurité

WARNING

Risk of injury and instrument damage

The instrument must be used in an appropriate manner to prevent electric shock, fire, personal injury or instrument damage.

- Do not open the instrument casing.
 - Read and observe the "Basic Safety Instructions" delivered as printed brochure with the instrument.
 - Read and observe the safety instructions in the following sections. Note that the data sheet may specify additional operating conditions.
 - Keep the "Basic Safety Instructions" and the product documentation in a safe place and pass them on to the subsequent users.
-

ADVERTENCIA

Riesgo de lesiones y daños en el instrumento

El instrumento se debe usar de manera adecuada para prevenir descargas eléctricas, incendios, lesiones o daños materiales.

- No abrir la carcasa del instrumento.
 - Lea y cumpla las "Instrucciones de seguridad elementales" suministradas con el instrumento como folleto impreso.
 - Lea y cumpla las instrucciones de seguridad incluidas en las siguientes secciones. Se debe tener en cuenta que las especificaciones técnicas pueden contener condiciones adicionales para su uso.
 - Guarde bien las instrucciones de seguridad elementales, así como la documentación del producto, y entréguelas a usuarios posteriores.
-

⚠️ WARNUNG**Gefahr von Verletzungen und Schäden am Gerät**

Betreiben Sie das Gerät immer ordnungsgemäß, um elektrischen Schlag, Brand, Verletzungen von Personen oder Geräteschäden zu verhindern.

- Öffnen Sie das Gerätegehäuse nicht.
 - Lesen und beachten Sie die "Grundlegenden Sicherheitshinweise", die als gedruckte Broschüre dem Gerät beiliegen.
 - Lesen und beachten Sie die Sicherheitshinweise in den folgenden Abschnitten; möglicherweise enthält das Datenblatt weitere Hinweise zu speziellen Betriebsbedingungen.
 - Bewahren Sie die "Grundlegenden Sicherheitshinweise" und die Produktdokumentation gut auf und geben Sie diese an weitere Benutzer des Produkts weiter.
-

⚠️ AVERTISSEMENT**Risque de blessures et d'endommagement de l'appareil**

L'appareil doit être utilisé conformément aux prescriptions afin d'éviter les électrocutions, incendies, dommages corporels et matériels.

- N'ouvrez pas le boîtier de l'appareil.
 - Lisez et respectez les "consignes de sécurité fondamentales" fournies avec l'appareil sous forme de brochure imprimée.
 - Lisez et respectez les instructions de sécurité dans les sections suivantes. Il ne faut pas oublier que la fiche technique peut indiquer des conditions d'exploitation supplémentaires.
 - Gardez les consignes de sécurité fondamentales et la documentation produit dans un lieu sûr et transmettez ces documents aux autres utilisateurs.
-

Contents

1	Preface	7
1.1	For Your Safety.....	7
1.2	Information Provided on the Instrument.....	7
1.3	Conventions Used in the Documentation.....	8
2	Documentation Overview	10
2.1	Getting Started Manual.....	10
2.2	User Manuals and Help.....	10
2.3	Tutorials.....	10
2.4	Basic Safety Instructions.....	10
2.5	Data Sheets and Brochures.....	11
2.6	Release Notes and Open Source Acknowledgment (OSA).....	11
2.7	Application Notes, Application Cards, White Papers, etc.....	11
3	System Overview	12
4	Setting Up the Instrument	13
4.1	Unpacking the Instrument.....	13
4.1.1	Inspecting for Shipping Damage.....	13
4.1.2	Unpacking the Cardboard Box.....	13
4.1.3	Checking the Accessories.....	14
4.1.4	Warranty Conditions.....	14
4.2	Putting Up the Instrument.....	14
4.2.1	Placing the Instrument on a Bench Top.....	14
4.2.2	Mounting the Instrument in a Rack.....	16
5	Interfaces and Connectors	17
5.1	Front Panel.....	17
5.1.1	ON/STANDBY Key.....	18
5.1.2	Keys for Frequently-Used Functions.....	18
5.1.3	Keys for Operating Softkeys.....	19
5.1.4	Keys for Changing Softkey Menus.....	19
5.1.5	RUN Key.....	21
5.1.6	Keypad.....	21

5.1.7	Rotary Knob.....	22
5.1.8	Cursor Keys.....	23
5.1.9	GEN OUT 50 Ω Output.....	24
5.1.10	USB Interfaces.....	24
5.1.11	AF OUT Output.....	24
5.1.12	RF IN 75 Ω Input (B203 Option).....	25
5.1.13	RF IN 50 Ω Input.....	25
5.1.14	Display.....	25
5.2	Rear Panel.....	26
5.2.1	Standard Rear Panel Connectors.....	26
5.2.2	DC Power Supply (B230).....	28
5.2.3	GPIB Interface (B10).....	29
5.2.4	OCXO Reference Frequency (B4).....	30
5.2.5	Universal DTV, ATV, FM Interface (B201).....	30
5.2.6	Additional Interfaces (B5).....	32
5.2.7	AV Decoder and TS Processing (B380).....	33
5.2.8	MPEG Processing Board (B280).....	34
5.2.9	Li-Ion Battery Pack (B235).....	35
6	Connecting the Instrument.....	37
6.1	Preventing Electromagnetic Interference.....	37
6.2	Connecting to the Power Supply.....	38
6.2.1	Connecting to the AC Power Supply.....	38
6.3	Connecting USB External Devices.....	39
6.3.1	External Keyboard.....	39
6.3.2	Mouse.....	40
6.3.3	Memory Stick.....	40
6.3.4	External Drive.....	40
7	Switching On or Off the Instrument.....	41
7.1	Instrument States.....	41
7.2	Switching On the Instrument.....	42
7.3	Switching Off the Instrument.....	42
7.3.1	Switching to Standby.....	42
7.3.2	Switching Off.....	43

7.4	Behavior of the ON/STANDBY Key.....	43
7.5	Checking the Provided Options.....	44
7.6	Turn-On Tests.....	45
7.6.1	Performing a Self-Alignment.....	45
7.6.2	Performing a Self-Test.....	45
8	Sample Application.....	46
8.1	Test Setup.....	46
8.2	Setting the TV Analyzer/Receiver Mode.....	46
8.3	Performing the Measurement.....	46
9	Operating the Instrument in a LAN.....	48
9.1	Computer Name.....	48
9.2	IP Address.....	49
9.3	Connecting the Instrument to the Network.....	50
9.4	Connecting the Instrument to a Computer.....	50
9.4.1	Windows 7 or Later.....	51
9.4.2	Other Operating Systems.....	51
9.5	Firewall Settings.....	51
10	Installed Software.....	52
10.1	Operating System.....	52
10.1.1	Logon.....	52
10.1.1.1	Automatic Logon.....	53
10.1.2	Access to Windows Settings.....	54
10.2	Additional Software.....	54
10.3	Backup and Restore Application.....	55
10.3.1	Creating a Backup.....	57
10.3.2	Restoring a Selected Backup Version.....	58
10.3.3	Deleting a Backup.....	58
11	Maintenance.....	59
11.1	Recommended Calibration Interval.....	59
11.2	Cleaning.....	59

11.3 Replacing the Fuses..... 59

11.4 Storing.....60

Index.....61

1 Preface

This chapter provides information related to safety issues and the product documentation.

1.1 For Your Safety

The R&S ETL is designated to develop, produce and verify electronic components and devices in an industrial environment. An overview of its designated purpose is given in [Chapter 3, "System Overview"](#), on page 12; details are provided throughout the product documentation. Observe the operating conditions and performance limits stated in the data sheet (specifications).

The product documentation helps you to use the R&S ETL safely and efficiently. Keep the product documentation in a safe place and pass it on to the subsequent users.

Safety information is part of the product documentation. It warns you about the potential dangers and gives instructions how to prevent personal injury or damage caused by dangerous situations. Safety information is provided as follows:

- In the "Basic Safety Instructions", safety issues are grouped according to subjects. For example, one subject is electrical safety. The "Basic Safety Instructions" are delivered with the R&S ETL in different languages.
- Throughout the documentation, safety instructions are provided when you need to take care during setup or operation.

Always read the safety instructions carefully. Make sure to comply fully with them. Do not take risks and do not underestimate the potential danger of small details such as a damaged power cable.

1.2 Information Provided on the Instrument

The context-sensitive help provides quick user assistance, see [Chapter 2.2, "User Manuals and Help"](#), on page 10.

The open source acknowledgment is stored in PDF format under:

```
C:\R_S\Instr\doc
```

On R&S ETLs with SSD/HDD, the product documentation in PDF format is also stored there. On these R&S ETLs, you can display the PDFs using the Foxit Reader that is already installed.

To update the PDFs

The PDFs provided on the R&S ETL originate from the date of delivery. For up-to-date downloads, visit the product site described at:

www.rohde-schwarz.com/product/etl

- ▶ If you install a new firmware version, the information in the `C:\R_S\Instr\doc` directory is updated also.

1.3 Conventions Used in the Documentation

The following conventions are used throughout the product documentation.

Typography

Convention	Description
"Graphical user interface elements"	All names of graphical user interface elements on the screen, such as dialogs, menus, options, buttons, and softkeys are enclosed by parentheses.
KEYS	Key names are written in capital letters.
File names, commands, program code	File names, commands, coding samples and screen output are distinguished by their font.
<i>Input</i>	Input to be entered by the user is displayed in italics.
Links	Links are displayed in blue font.
"References"	References to other parts of the documentation are enclosed by parentheses.

Softkey descriptions

The description of a softkey (user manual and help) always starts with the softkey name, and is followed by explaining text and one or more remote control commands. Each remote command is placed in a single line.

Remote command descriptions

The description of remote control commands (user manual and help) always starts with the command itself. It is followed by explaining text including an example, the characteristics and the mode (standard or only with certain options). The remote commands follow the SCPI syntax rules. All parts of the command that have to be entered are in capital letters, the rest is added in small letters to complete the words and transport their meaning.

Conventions for procedure descriptions

In manual operation, several alternative methods can be available to perform the same task. If possible, the procedure using the front panel is described. Any elements that can be activated by pressing a key can also be clicked using an also connected mouse.

The alternative procedure using an external keyboard is only described if it deviates from the standard operating procedures as described in the user manual, chapter "Operating Concepts", or the help.

The terms "select" and "press" can refer to any of the described methods, for using a key on the device or on a keyboard, or a mouse pointer in the display.

2 Documentation Overview

This chapter provides an overview of the R&S ETL user documentation. Unless specified otherwise, you find the documents on the R&S ETL product page at:

www.rohde-schwarz.com/manual/etl

2.1 Getting Started Manual

Introduces the R&S ETL and describes how to set up and start working with the product. Includes a sample application and general information, e.g. safety instructions, etc. A printed version is delivered with the instrument.

2.2 User Manuals and Help

Contains the description of all instrument modes and functions. Also provides an introduction to remote control, a complete description of the remote control commands with programming examples, and information on maintenance, instrument interfaces and error messages. Includes the contents of the getting started manual.

The contents of the user manual is available as help in the R&S ETL. The help offers quick, context-sensitive access to the complete information for the base unit and the software options.

For detailed information on how to use the help, refer to "Operating Concepts".

Further information:

- [Chapter 1.2, "Information Provided on the Instrument"](#), on page 7

2.3 Tutorials

Tutorials offer guided examples and demonstrations on operating the R&S ETL. They are provided on the product page of the internet.

2.4 Basic Safety Instructions

Contains safety instructions, operating conditions and further important information. The printed document is delivered with the instrument.

2.5 Data Sheets and Brochures

The data sheet contains the technical specifications of the R&S ETL. It also lists the options and their order numbers, and optional accessories.

The brochure provides an overview of the instrument and deals with the specific characteristics.

See www.rohde-schwarz.com/brochure-datasheet/etl

2.6 Release Notes and Open Source Acknowledgment (OSA)

The release notes list new features, improvements and known issues of the current firmware version, and describe the firmware installation.

The open source acknowledgment document provides verbatim license texts of the used open source software. On the R&S ETL, the open source acknowledgment document is provided as PDF file in the same directory as the user manual.

See www.rohde-schwarz.com/firmware/etl

2.7 Application Notes, Application Cards, White Papers, etc.

These documents deal with special applications or background information on particular topics.

See www.rohde-schwarz.com/application/etl

3 System Overview

The R&S ETL TV analyzer stands for all-in-one. The R&S ETL combines the functionality of a TV and FM (radio) signal analyzer, a video and MPEG TS analyzer and a spectrum analyzer in a single instrument. The R&S ETL also contains generators to create analog video signals, audio signals and MPEG-2 transport streams.

The innovative instrument concept facilitates the flexible integration of demodulators for analog and digital TV standards as well as sound broadcasting. All of the demodulators work in realtime; fast signal processing allows comprehensive, extremely accurate measurements.

Its wide range of functions and flexible configuration make the R&S ETL TV analyzer the universal reference for the analysis of TV signals - for TV and cable network operators, transmitter manufacturers, service technicians and regulatory authorities.

The R&S ETL has primarily been designed to provide reproducible, high-quality analysis of TV and sound broadcasting signals such as are needed at the transmitter site, at the cable headend or for quality assurance during production.

The R&S ETL is ideal for both stationary and portable use. The compact, rugged housing makes outdoor use possible, e.g. for coverage measurements within a terrestrial TV or sound broadcasting transmitter network.

Visit the product site (<https://www.rohde-schwarz.com/product/etl/>) for information on available hardware and software options.

4 Setting Up the Instrument

WARNING

Risk of injuries

To avoid injuries to yourself or others, always follow the instructions provided in the following chapters. Furthermore, observe the general safety instructions delivered with the R&S ETL.

4.1 Unpacking the Instrument

The R&S ETL is shipped together with its mandatory accessories in a cardboard box.

4.1.1 Inspecting for Shipping Damage

Check the following. If anything is damaged, immediately notify the carrier.

1. Check the shipping container and cushioning material for damage.
2. Unpack the cardboard box, see [Chapter 4.1.2, "Unpacking the Cardboard Box"](#), on page 13.
3. Check the housing and handle for visible damages or loose parts.

4.1.2 Unpacking the Cardboard Box

Proceed as follows:

1. Open the cardboard box.
2. Remove the accessories packed into the box.
3. Take the R&S ETL out of the packaging.
4. Remove the shock protectors attached to the R&S ETL.



Retain the original packing material. If the R&S ETL needs to be transported or shipped later, you can use the material to prevent control elements and connectors from being damaged. Rohde & Schwarz accepts claims of warranty only if the R&S ETL is shipped with sufficient packaging.

4.1.3 Checking the Accessories

The R&S ETL comes with the following accessories:

- Power cable
- Getting started manual

4.1.4 Warranty Conditions

For information on warranty conditions for the R&S ETL, refer to the terms of the delivery documents.

4.2 Putting Up the Instrument

The R&S ETL is designed for interior use only. For details on temperature range and climatic loading, refer to the data sheet.

The R&S ETL can be used in standalone operation or can be installed in a rack.

NOTICE

Risk of material damage

Make sure that the following conditions are met at the operation site:

- The ambient temperature does not exceed the range specified in the data sheet.
- All fan openings are unobstructed and the airflow perforations are unimpeded. The minimum distance from the wall is at least 10 cm.

Failure to meet these conditions can damage the R&S ETL or other devices in the test setup.

If necessary, use proper protective equipment to protect DUTs against electrostatic discharge caused by human contact.

4.2.1 Placing the Instrument on a Bench Top

Always place the R&S ETL on a stable, flat and level surface with the bottom of the instrument facing down. The R&S ETL can be used in horizontal position, standing on its feet, or propped up on the handle as described in "[To adjust the handle position](#)" on page 15. Do not place anything on top of the R&S ETL, if the R&S ETL is not in a level position. Keep in mind that the R&S ETL can cause injury to you or others if not set up securely.

⚠ WARNING**Risk of injury when stacking instruments**

A stack of instruments can tilt over and cause injury if not stacked correctly. Furthermore, the instruments at the bottom of the stack can be damaged due to the load imposed by the instruments on top.

Observe the following instructions when stacking instruments:

- Place the bottom instrument on a stable, flat and level surface with the bottom of the instrument facing down.
- Stack the instruments according to their size and weight, with the largest and heaviest instrument at the bottom.
- Never stack more than three instruments. If you need to stack more than three instruments, install them in a rack.

To adjust the handle position

1. Pull at both side knobs and turn the handle as shown in [Figure 4-1](#).
2. When the handle is in the desired position, loose your hold on both side knobs.

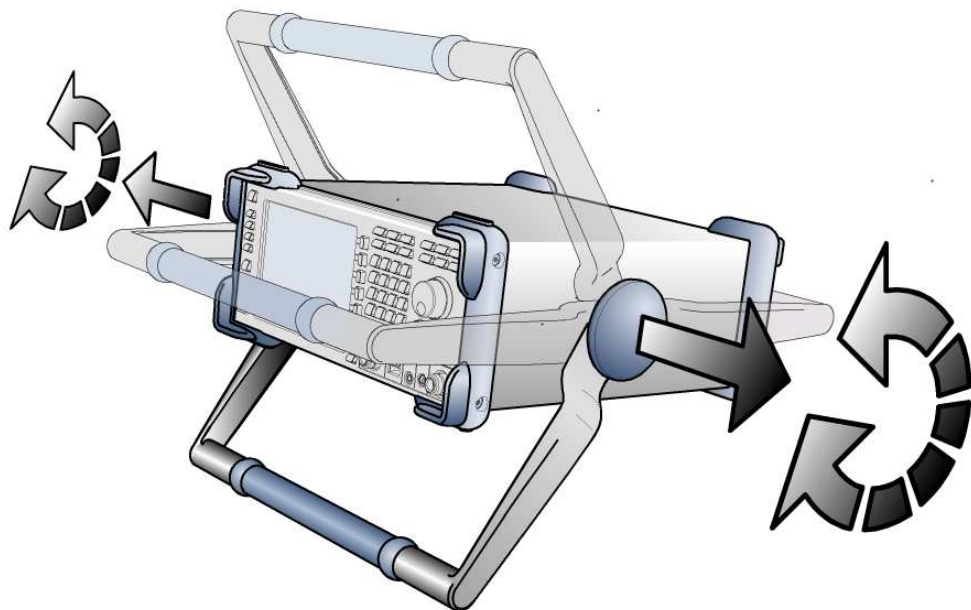

Figure 4-1: Moving the handle of the R&S ETL

4.2.2 Mounting the Instrument in a Rack

The R&S ETL can be installed in a 19" rack mount by using a rack adapter kit (for order no. see data sheet). Follow the installation instructions that are part of the adapter kit.

5 Interfaces and Connectors

This chapter describes the front panel and the rear panel of the R&S ETL, including all function keys and connectors.



When using the interfaces and connectors, take care to avoid electromagnetic interference. For details, see [Chapter 6.1, "Preventing Electromagnetic Interference"](#), on page 37.

5.1 Front Panel

This chapter gives a short overview of the keys and connectors on the front panel.

A detailed description of the function keys and softkeys is provided in the user manual or the help. For instructions on using the keys for operation and data entry, refer to the user manual, chapter "Operating Concepts", or the help.

All connectors on the front panel are placed on the bottom of the right-hand side. The inscriptions on your R&S ETL match the captions of the connector descriptions.

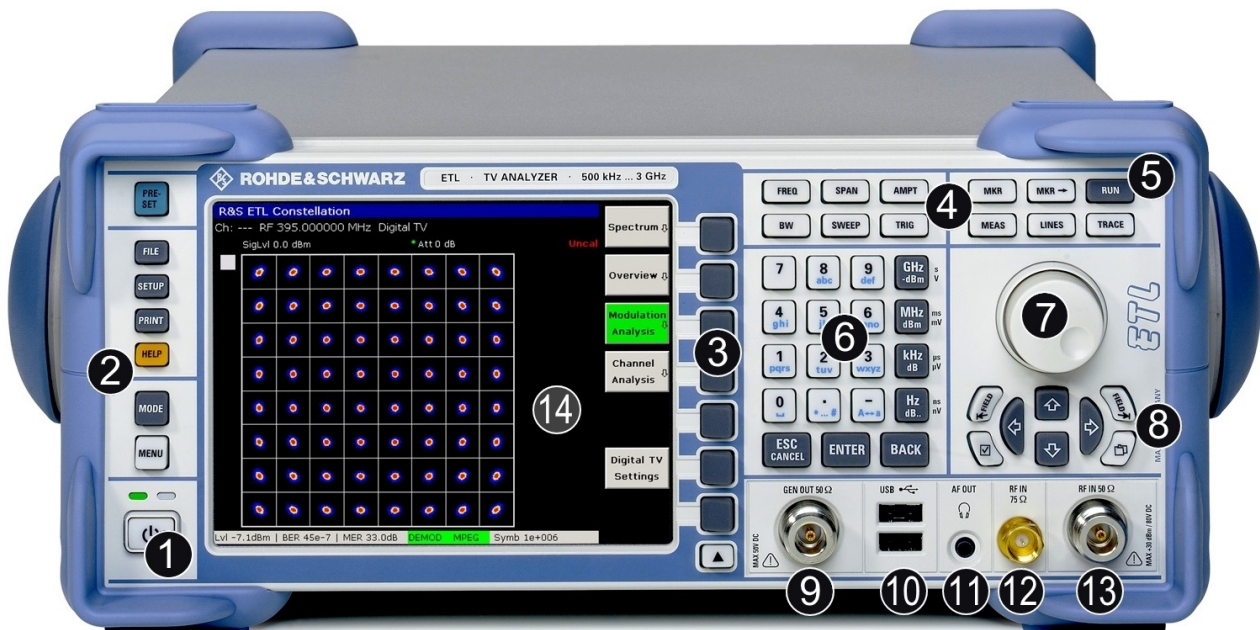

Figure 5-1: Front panel view

- 1 = On/standby key
- 2 = Keys for frequently-used functions
- 3 = Keys for operating softkeys
- 4 = Keys for changing softkey menus
- 5 = RUN key
- 6 = Keypad
- 7 = Rotary knob
- 8 = Cursor keys

- 9 = GEN OUT 50 Ω output
- 10 = USB interfaces
- 11 = AF OUT output
- 12 = RF IN 75 Ω input
- 13 = RF IN 50 Ω input
- 14 = Display

5.1.1 ON/STANDBY Key

See (1) in [Figure 5-1](#).

The [ON/STANDBY] key works only if the AC power switch on the back of the R&S ETL is switched on. It switches the R&S ETL from standby to on and back.

For details on switching on or off and the instrument states, refer to [Chapter 7, "Switching On or Off the Instrument"](#), on page 41.

5.1.2 Keys for Frequently-Used Functions

See (2) in [Figure 5-1](#).

These basic functions are provided independently from the selected measurement mode.

For detailed information, see the user manual or the help.

PRESET key

Sets a defined instrument state.

FILE key

Displays the softkeys of the file menu used for:

- Storing/loading instrument settings.
- Managing stored files.

SETUP key

Displays the softkeys of the setup menu used for basic instrument configuration:

- Frequency reference (ext/int), noise source, video/IF output (Additional Interfaces option, R&S FSL-B5), transducer factors
- Date, time, display configuration
- LAN interface, remote control (GPIB Interface option, R&S FSL-B10)
- Self-alignment
- Firmware update and enabling of options
- Information about instrument configuration incl. firmware version and system error messages
- Service support functions, for example self-test

PRINT key

Displays the softkeys of the print menu for:

- Customizing the screen printout.
- Selecting and configuring the printer.

HELP key

Displays the context-sensitive help.

MODE key

Opens a dialog box to change between measurement modes.

MENU key

Displays the highest softkey menu level of the current measurement mode.

5.1.3 Keys for Operating Softkeys

See (3) in [Figure 5-1](#).

The label (function) of the keys is displayed on the left as so-called softkeys. The softkeys change dynamically according to the current selection.

5.1.4 Keys for Changing Softkey Menus

See (4) in [Figure 5-1](#).



The softkey menus differ according to the selected measurement mode. Here, the softkeys of the default "Spectrum Analyzer" mode are described roughly.

For detailed information on the softkey menus of all measurement modes, refer to the user manual or the help.

[FREQ] key

Displays the softkeys of the frequency menu for the following settings:

- Center frequency for the frequency range under consideration
- Start and stop frequencies for the frequency range under consideration
- Frequency offset
- Signal track function

[SPAN] key

Displays the softkeys of the span menu. Used to set the frequency span to be analyzed.

[AMPT] key

Displays the softkeys of the amplitude menu for the following settings:

- Reference level
- Displayed dynamic range
- RF attenuation
- Unit for the level display
- Level offset
- Input impedance
- Activating the preamplifier

[BW] key

Displays the softkeys of the bandwidth menu for the following settings:

- Resolution bandwidth
- Video bandwidth

SWEEP key

Displays the softkeys of the sweep menu for:

- Setting the sweep time.
- Setting the number of measurement points.
- Selecting continuous measurement or single measurement.

TRIG key

Displays the softkeys of the trigger menu for the following settings:

- Trigger mode
- Trigger threshold
- Trigger delay

[MKR] key

Displays the softkeys of the marker menu to set and position the absolute and relative measurement markers (markers and delta markers). Additionally, the following measurement functions are made available:

- Frequency counter
- Noise marker
- Phase noise marker
- Fixed reference point for relative measurement markers
- n dB down function
- AF demodulation
- Marker list

[MKR->] key

Displays the softkeys of the marker -> menu for:

- Using for search functions of the measurement markers (maximum/minimum of the trace).
- Assigning the marker frequency to the center frequency.
- Assigning the marker level to the reference level.
- Restricting the search area.
- Characterizing the maximum points and minimum points.

[MEAS] key

Displays the softkeys of the measurement menu to perform advanced measurements:

- Time domain power
- Channel, adjacent channel and multicarrier adjacent channel power
- Occupied bandwidth
- Signal statistics: amplitude probability distribution (APD) and cumulative complementary distribution function (CCDF)
- Carrier to noise spacing
- AM modulation depth
- Third-order intercept point (TOI)
- Harmonics

[LINES] key

Displays the softkeys of the lines menu to configure the display lines and limit lines.

[TRACE] key

Displays the softkeys of the trace menu to configure the measured data acquisition and the analysis of the measurement data.

5.1.5 RUN Key

See (5) in [Figure 5-1](#).

Starts a new measurement.

5.1.6 Keypad

See (6) in [Figure 5-1](#).

Used to enter alphanumeric parameters:

- Alphanumeric keys
Enters numbers and (special) characters in edit dialog boxes.
For details, refer to the user manual, chapter "Operating Concepts", or the help.
- Decimal point

Inserts a decimal point "." at the cursor position.

- Sign key
Changes the sign of a numeric parameter. In the case of an alphanumeric parameter, inserts a "." at the cursor position.
- Unit keys
These keys add the selected unit to the entered numeric value and complete the entry. In the case of level entries (e.g. in dB) or dimensionless values, all units have the value "1" as multiplying factor. Thus, they have the same function as an [ENTER] key. The same is true for an alphanumeric entry.

[ESC/CANCEL] key

- Closes all kinds of dialog boxes, if the edit mode is not active.
- Quits the edit mode, if the edit mode is active.
- In dialog boxes that contain a "Cancel" button, it activates that button.

[ENTER] key

- Concludes the entry of dimensionless entries. The new value is accepted.
- For other entries, this key can be used instead of the [Hz/dB] unit key.
- In a dialog box, presses the default or focused button.
- In a dialog box, activates the edit mode for the focused area, if available.
For details on the edit mode, refer to the user manual, chapter "Operating Concepts", or the help.
- In a dialog box, activates or deactivates the selected option of the focused area, if the edit mode is active.

[BACK] key

If an alphanumeric entry has already been started, this key deletes the character to the left of the cursor.

If an entry has been completed or not yet started, this key toggles between the currently and the previously entered value (undo function).

5.1.7 Rotary Knob

See (7) in [Figure 5-1](#).

- Increments (clockwise direction) or decrements (counter. clockwise direction) the instrument parameter at a defined step width in the case of a numeric entry.
- Moves the focus from one element of the graphical user interface to another like the [FIELD RIGHT] and [FIELD LEFT] keys.
- Shifts the selection bar within focused areas (e.g. lists), if the edit mode is activated.
- Shifts markers, limit lines, etc on the screen.
- Acts like the [ENTER] key, when it is pressed.
For details, refer to the user manual, chapter "Operating Concepts", or the help.

- Moves the scroll bar vertically, if the scroll bar is focused and the edit mode is activated.

For details on the edit mode, refer to the user manual, chapter "Operating Concepts", or the help.

5.1.8 Cursor Keys

See (8) in [Figure 5-1](#).

[UP ARROW] / [DN ARROW] keys

- In a numeric edit dialog box, increases or decreases the instrument parameter.
- In a list, scrolls forward and backward through the list entries.
- In a table, moves the selection bar vertically.
- In windows or dialog boxes with vertical scroll bar, moves the scroll bar.

[LEFT ARROW] / [RIGHT ARROW] keys

- In an alphanumeric edit dialog box, moves the cursor.
- In a list, scrolls forward and backward through the list entries.
- In a table, moves the selection bar horizontally.
- In windows or dialog boxes with horizontal scroll bar, moves the scroll bar.



In "TV Analyzer/Receiver" mode, the arrow keys provide additionally scaling functionality.

For details, refer to the user manual, chapter "TV/Radio Analyzer/Receiver".

[FIELD LEFT] key

Used to navigate in dialog boxes if in edit mode. Moves the focus to the previous element of the graphical user interface (e.g. fields, buttons).

The corresponding Windows function is [BACK TAB].

[FIELD RIGHT] key

Used to navigate in dialog boxes if in edit mode. Moves the focus to the next element of the graphical user interface (e.g. fields, buttons).

[CHECKMARK] key

- Inserts a blank in an edit dialog box. The corresponding Windows function is [SPACE].
- Selects the option on which the focus is set without closing the dialog box. If more than one option can be chosen, it also deselects a selected option.
- Presses the button on which the focus is set.

[NEXT TAB] key

Opens the next tab of the dialog box.

5.1.9 GEN OUT 50 Ω Output

See (9) in [Figure 5-1](#).

Output of the tracking generator. Connect the DUT using a cable equipped with a male N connector.

NOTICE**Risk of damaging the tracking generator**

See the data sheet for the limits of the DC voltage and reverse RF power. Do not exceed these limits. Exceeding these limits can cause instrument damage.



For DUTs with sensitive RF characteristics with regard to matching (VSWR) at the input, insert a 10 dB attenuator between the DUT and the tracking generator.

5.1.10 USB Interfaces

See (10) in [Figure 5-1](#).

USB (universal serial bus) interfaces of the type A (host USB). Used to connect external devices as described in [Chapter 6.3, "Connecting USB External Devices"](#), on page 39.

The USB version depends on the serial number of the R&S ETL:

- < 205 000: USB 1.1
- \geq 205 000: USB 2.0



Electromagnetic interference (EMI) can affect the measurement results. To avoid any impact, make sure that the conditions described in [Chapter 6.1, "Preventing Electromagnetic Interference"](#), on page 37 are met.

5.1.11 AF OUT Output

See (11) in [Figure 5-1](#).

AF output female connector. Connect headphones equipped with a miniature jack plug.

To use the AF OUTPUT, in the setup menu ([SETUP] key), select video output.

CAUTION**Danger of injuries**

If the volume is turned up fully, you may damage your hearing.

Before putting on the headphones, check the volume setting (output voltage) carefully using the marker menu or the [MENU] key.



This connector cannot be used simultaneously to the IF/Video output connector on the rear panel.

5.1.12 RF IN 75 Ω Input (B203 Option)

See (12) in [Figure 5-1](#).

Optional AC-coupled RF input with 75 Ω impedance. Male F connector.

NOTICE**Risk of instrument damage**

Do not overload the input. See the data sheet for the limits of the input DC voltage and the maximum continuous power at the RF input. Do not exceed these limits. Exceeding these limits can cause instrument damage.

5.1.13 RF IN 50 Ω Input

See (13) in [Figure 5-1](#).

AC-coupled RF input with 50 Ω impedance. Female N connector.

NOTICE**Risk of instrument damage**

Do not overload the input. See the data sheet for the limits of the input DC voltage and the maximum continuous power at the RF input. Do not exceed these limits. Exceeding these limits can cause instrument damage.

When connecting the DUT, do not exceed a maximum torque of 60 Ncm. A higher torque may destroy the mating components.

5.1.14 Display

See (14) in [Figure 5-1](#).

Screen displaying the graphical user interface.

5.2 Rear Panel

All standard connectors are located at the bottom of the rear panel (slot 1 in [Figure 5-2](#)). All slots above are used for options. Each slot is specifically designed for one or several options, as listed in the legend of [Figure 5-2](#). The labeling on your R&S ETL provides the short name of the option.

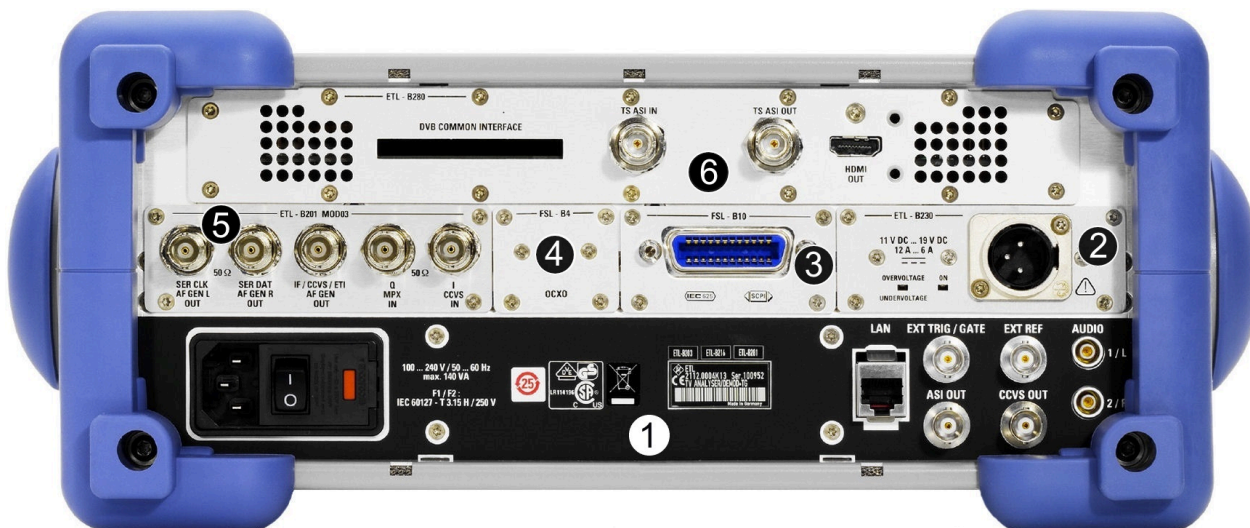

Figure 5-2: Rear panel view (example)

- Slot 1 = Standard rear panel connectors
- Slot 2 = DC Power Supply (R&S ETL-B230)
- Slot 3 = GPIB Interface (R&S FSL-B10)
- Slot 4 = OCXO Reference Frequency (R&S FSL-B4)
- Slot 5 = Universal DTV, ATV, FM Interface R&S ETL-B201), or Additional Interfaces (R&S FSL-B5)
- Slot 6 = MPEG Processing Board (R&S ETL-B280) or AV Decoder and TS Processing (R&S ETL-B380) or Li-Ion Battery Pack (R&S ETL-B235)

5.2.1 Standard Rear Panel Connectors

Installed in slot 1, see [Figure 5-2](#).

AC power supply connector and switch

The AC power switch is located left from the AC power supply connector. For the ratings of the power supply, refer to the data sheet.

Switch positions:

- I: Depending on the setting of the [ON/STANDBY] function key on the front panel, the R&S ETL is either in standby or in operation.
- O: The entire R&S ETL is disconnected from the AC power supply.

For details on switching on and off, refer to [Chapter 7, "Switching On or Off the Instrument"](#), on page 41.



The AC power switch also interrupts the power supply of the OCXO (OCXO Reference Frequency option, R&S FSL-B4). When switching the R&S ETL back on, be sure to comply with the extended warm up phase specified in the data sheet.

For details on connecting to the AC power supply, refer to [Chapter 6.2, "Connecting to the Power Supply"](#), on page 38.

For instructions how to replace the fuses, refer to the user manual, chapter "Maintenance", or the help.

LAN interface

Used to connect the R&S ETL to a local network for remote control, remote operation, printouts and data transfer. The assignment of the RJ.45 connector supports twisted pair category 5 UTP/STP cables in a star configuration (UTP stands for "unshielded twisted pair", and STP for "shielded twisted pair").



Do not connect or disconnect the network cable until the R&S ETL is switched off. Otherwise, the network connection cannot be reliably detected.

Electromagnetic interference (EMI) can affect the measurement results. To avoid any impact, make sure that the conditions described in [Chapter 6.1, "Preventing Electromagnetic Interference"](#), on page 37 are met.

EXT TRIG/GATE

Female connector for external trigger/gate input. Here, you can provide an external signal for controlling the measurement.

The voltage levels are TTL levels (low < 0.7 V; high > 1.4 V). The typical input impedance is 10 k Ω .

EXT REF

Female connector to input an external reference signal of 10 MHz. The required input level is listed in the data sheet. The input is active if, in the setup menu, "Reference Ext" is selected.

If the OCXO Reference Frequency (R&S FSLB4 option) is installed, the EXT REF connector can also be used as output. Use the setup menu to define its use:

- Input: "Reference Ext"
- Output: "Reference Int"

For further details, refer to [Chapter 5.2.4, "OCXO Reference Frequency \(B4\)"](#), on page 30.

ASI OUT

In "TV Analyzer/Receiver" mode, used as digital TV: MPEG transport stream serial output 75 Ω .

CCVS OUT

Used in "TV Analyzer/Receiver" mode:

- Video source 75 Ω CCVS 1 Vpp
 - Analog TV: demodulated video signal
With the Video Generator option (R&S ETL-K203) installed and the video generator enabled: Video generator output 75 Ω CCVS 1 Vpp
 - Digital TV, only with R&S ETL-B281: decoded video signal
- Audio source for radio (FM Stereo / FM Mono, R&S ETL-K110). Provides one of the following demodulated signals: MPX, pilot, RDS/DARC carrier, or digital audio in the AES/EBU format.

AUDIO

Audio source 1/L output 600 Ω balanced.

Audio source 2/R output 600 Ω balanced.

5.2.2 DC Power Supply (B230)

Optional; installed in slot 2, see [Figure 5-2](#).

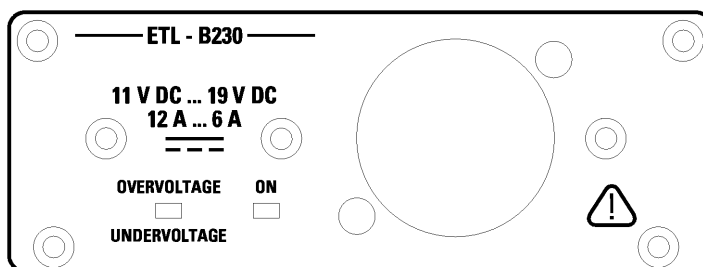

Used as alternative power supply. For the ratings of the power supply, refer to the data sheet. The connector is supplied with the accessories.

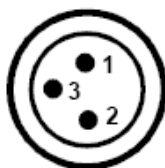

Table 5-1: Pin assignment

Pin	Description
1	Plus
2	Ground
3	Not used

⚠ WARNING**Shock hazard**

The used power supply (SELV) must fulfill the requirements for reinforced/double insulation for main supply circuits in accordance to DIN/EN/IEC 61010 (UL 61010B.1, CSA C22.2 No. 1010.1) or DIN/EN/IEC 60950 (UL 1950, CSA C22.2 No. 950). It is recommended to fuse the DC power supply according to [Table 5-2](#). Before switching on the R&S ETL, check the connection for correct polarity.

NOTICE**Operation in a DC network is not authorized**

According to EN 61326:1997 + A1:1998 + A2:2001 + A3:2003, the DC input is not authorized for operation in a DC network.

The DC cable length must not exceed 30 m.

In continuous operation, the current breaking current can differ from the rated breaking current. For fuse selection, take the characteristics of the fuse into account.

Table 5-2: Fuse selection

Input voltage	Max. current or power
11 V to 12.5 V	max. 145 VA
12.5 V to 18.7 V	max. 12 A

For information on switching the R&S ETL on or off, refer to [Chapter 7, "Switching On or Off the Instrument"](#), on page 41. For an overview on available power supplies, refer to [Chapter 6.2, "Connecting to the Power Supply"](#), on page 38.

5.2.3 GPIB Interface (B10)

Optional; installed in slot 3, see [Figure 5-2](#).

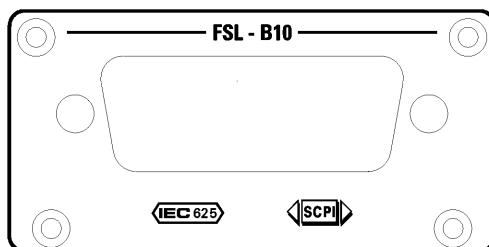

In compliance with IEEE488 and SCPI. Used to connect a computer for remote control, see also [Chapter 6.1, "Preventing Electromagnetic Interference"](#), on page 37.

For more details, refer to the user manual, chapter "Operating Concepts", or the help.

5.2.4 OCXO Reference Frequency (B4)

Optional; installed in slot 4, see [Figure 5-2](#).

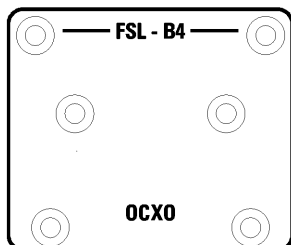

Generates a very precise 10 MHz reference signal. The signal is output at the EXT REF standard connector, see page "[EXT TRIG/GATE](#)" on page 27. The output level is listed in the data sheet.



The AC power switch also interrupts the power supply of the OCXO (OCXO Reference Frequency option, R&S FSL-B4). When switching the R&S ETL back on, be sure to comply with the extended warm-up phase specified in the data sheet.

5.2.5 Universal DTV, ATV, FM Interface (B201)

Optional; installed in slot 5, see [Figure 5-2](#).

1

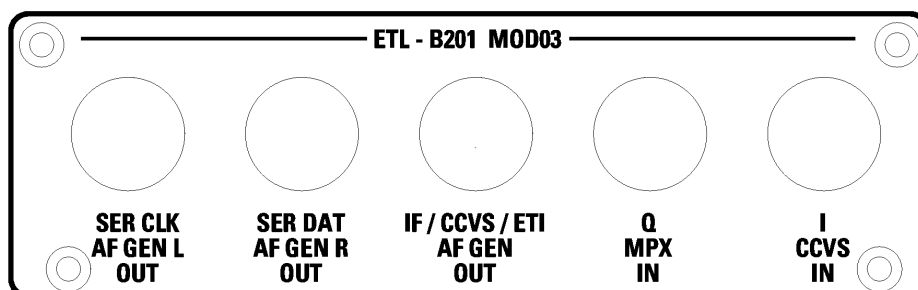

SER CLK / AF GEN L OUT

The output signal depends on the selected standard:

- Provides the serial clock after demapper. Used in combination with SER DAT OUT. For the following digital TV standards, this interface is intended for external BER measurement.
 - ATSC/8VSB (R&S ETL-K220)
 - DVB-T/H (R&S ETL-K240)
 - T-DMB/DAB (R&S ETL-K250)
 - ISDB-T (R&S ETL-K260)

- Provides an analog audio generator signal intended to feed the “left signal” (L) or the multiplex (MPX) input of a FM stereo radio transmitter.
 - FM Stereo / FM Mono (R&S ETL-K110/111)

SER DAT / AF GEN R OUT

The output signal depends on the selected standard:

- Provides the serial data after demapper. Used in combination with SER CLK OUT for the same digital TV standards.
- Provides an analog audio generator signal intended to feed the “right signal” (R) input of an FM stereo radio transmitter.
 - FM Stereo (R&S ETL-K110/111)

IF / CCVS / ETI / AF GEN OUT

The output signal depends on the selected standard:

- Provides the demodulated video signal if the video generator is enabled:
 - Analog TV, only with R&S ETL-K203
- Provides an IF output signal:
 - DVB C (R&S ETL-K210): IF = 4.571428 MHz
 - J.83/B (R&S ETL-K213): IF = 4.571428 MHz
 - DTMB (R&S ETL-B211/212/215/216): IF = 5.000000 MHz
- Provides an ETI output signal:
 - DMB T/DAB (R&S ETL-K250)
- Provides an analog audio generator signal intended to feed the multiplex (MPX), the mono (M), or the SCA input of an FM radio transmitter. Alternatively, it provides a digital stereo generator signal in the AES/EBU format.
 - FM Stereo / FM Mono (R&S ETL-K110/111)

Q / MPX IN

The input signal depends on the selected standard:

- Accepts an analog Q baseband signal. Used in combination with I IN.
 - All digital TV standards

You can apply a small frequency offset to the I/Q signal. This offset will be eliminated by the R&S ETL.

The I/Q signal is internally filtered (low pass filter, according to channel settings). Activate the I/Q input in the [AMPT] > "More" menu. If I/Q input is selected, the spectrum measurement is not available.

- Accepts an analog multiplex baseband signal.
 - FM Stereo / FM Mono (R&S ETL-K110/111)

Activate the MPX input in the [AMPT] > "More" menu. If MPX input is selected, the spectrum measurement is not available.

I IN

Accepts an analog I baseband signal. Used in combination with Q IN for all digital TV standards.

5.2.6 Additional Interfaces (B5)

Optional; installed in slot 5, see [Figure 5-2](#).

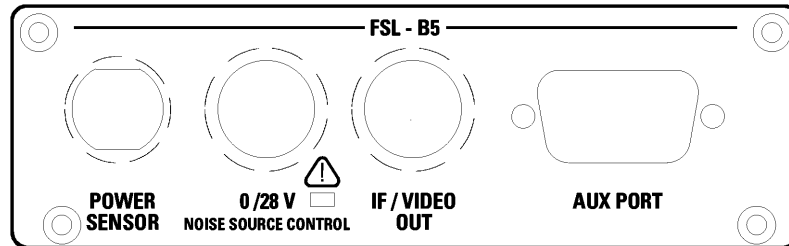
**POWER SENSOR**

LEMOSA female connector for connecting power sensors of the R&S NRP-Zxy family. Alternatively, the USB port on the front panel can be used for this purpose, if an adapter cable R&S NRP-Z4 is supplied.

NOISE SOURCE CONTROL

Female connector for supplying voltage for an external noise source, e.g., to measure the noise figure and gain of amplifiers and frequency converting DUTs.

Conventional noise sources require a voltage of +28 V in order to be switched on and 0 V to be switched off. The output supports a maximum load of 100 mA.

An LED indicates the status: green for +28 V, red for overload and off for 0 V.

IF/VIDEO OUT

Female BNC output for an intermediate frequency (IF) of approximately 20 MHz or for video at the set video and resolution bandwidth. The setup menu ([SETUP] key) is used to select between the IF and video output.



This connector cannot be used simultaneously with the AF output connector on the front panel.

AUX PORT

9-pole SUB-D male connector for providing control signals for external devices. The voltage levels are of the TTL type (max. 5 V).

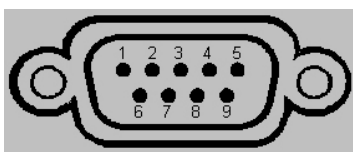

Figure 5-3: Pin assignment

Pin	Signal	Description
1	+5 V / max. 250 mA	Supply voltage for external circuits
2 to 7	I/O	Reserved for future use
8	GND	Ground
9	READY FOR TRIGGER	Signal indicating that the R&S ETL is ready to receive trigger signal (low active = 0 V).

NOTICE

Risk of instrument damage

A short-circuit may damage the R&S ETL. Take care to assign the pins correctly.

5.2.7 AV Decoder and TS Processing (B380)

Optional; installed in slot 6, see [Figure 5-2](#).

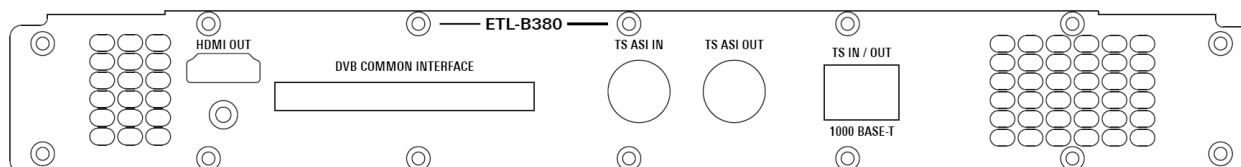

Decodes TV programs and displays them either on the R&S ETL display or on an external monitor. Additionally enables software options for:

- Analyzing MPEG2 transport streams (MPEGTS Analyzer/Monitoring option, R&S ETL-K282)
- Generating and recording MPEG2 transport streams (MPEGTS Generator/Recorder option, R&S ETL-K280)
- Inputting and outputting transport streams using a 1000 BASE-T Ethernet connector and RTP/UDP protocol (IP Input and Output option, R&S ETL-K386).

HDMI OUT

19 pin, female HDMI (high-definition multimedia interface) connector, in line with the HDMI 2.0 standard.

At this output, digital video and audio signals are provided for an external monitor. It is not possible to simultaneously display the video on the R&S ETL display.



Electromagnetic interference (EMI) can affect the measurement results. To avoid any impact, make sure that the conditions described in [Chapter 6.1, "Preventing Electromagnetic Interference"](#), on page 37 are met.

DVB COMMON INTERFACE

Receptacle for a conditional access module (CAM) in line with the European EN50221 standard.

A suitable CAM inserted here decrypts a service for decoding, playing and outputting protected video and audio content.

TS ASI IN

Female BNC connector for an asynchronous serial interface (ASI) in line with EN50083-9 or a SMPTE 310 M interface.

At this connector, an external MPEG2 transport stream can be input for decoding, analysis (R&S ETL-K282) and recording (R&S ETL-K280).

TS ASI OUT

Female BNC connector for an asynchronous serial interface (ASI) in line with EN50083-9.

At this output, an MPEG2 transport stream is provided from the following sources:

- TS generator/recorder (R&S ETL-K280)
- TS IN / OUT 1000 BASE-T connector (R&S ETL-K386)
- TS ASI IN connector.
- Internal demodulator

TS IN / OUT 1000 BASE-T

1000 BASE-T Ethernet connector to input and output transport streams in line with the SMPTE2022-1/2 standard (R&S ETL-K386).

At this connector, up to two transport streams can be input for decoding, analysis (R&S ETL-K282) and recording (R&S ETL-K280).

Simultaneously, up to two transport streams can be output from the following sources:

- TS Generator/Recorder (R&S ETL-K280)
- TS IN / OUT 1000 BASE-T connector (R&S ETL-K386)
- TS ASI IN connector
- Internal demodulator

5.2.8 MPEG Processing Board (B280)

Optional, installed in slot 6, see [Figure 5-2](#).

Legacy option, replaced by [Chapter 5.2.7, "AV Decoder and TS Processing \(B380\)"](#), on page 33.

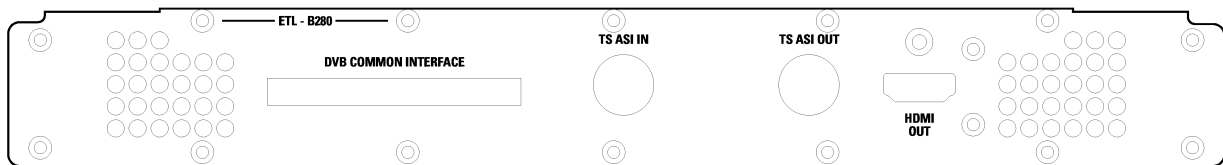

Extends the functionality of the R&S ETL to analyze (R&S ETL-K282) and generate (R&S ETL-K280) MPEG-2 Transport Streams. Additionally, the MPEG Processing Board option can include the R&S ETL-B281 (Video/ Audio Hardware Decoder) option. An R&S ETL also fitted with this option provides functionality to decode TV programs (SDTV and HDTV) within an MPEG-2 Transport Stream.

DVB COMMON INTERFACE

Ready for future applications. The pin assignment is conform to the European standard EN50221.

TS ASI IN

The female BNC connector is used as ASI (Asynchronous Serial Interface) conform to EN50083-9.

For the MPEG analysis (MPEG-TS Analyzer/Monitoring option, R&S ETL-K282), the external MPEG-2 Transport Stream is input at this connector.

TS ASI OUT

The female BNC connector is used as ASI (Asynchronous Serial Interface) conform to EN50083-9.

The MPEG-2 Transport Stream (output signal) is generated by the MPEG-TS Generator / Recorder option (R&S ETL-K280).

HDMI OUT

The 19 pin, female HDMI (High-Definition Multimedia Interface) is the interface for digital video and audio output. The pin assignment is conform to the HDMI 1.1 standard.



Electromagnetic interference (EMI) can affect the measurement results. To avoid any impact, make sure that the conditions described in [Chapter 6.1, "Preventing Electromagnetic Interference"](#), on page 37 are met.

The output signal is generated by the Video/ Audio Hardware Decoder option (R&S ETL-B281).

5.2.9 Li-Ion Battery Pack (B235)

Optional; installed in slot 6, see [Figure 5-2](#).

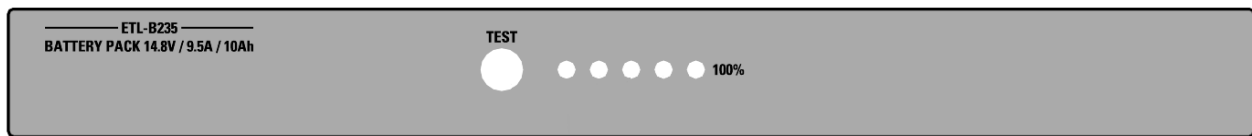

Used alternatively as power supply. The Battery Pack is described in a separate manual (2112.1069.32) provided with the option. For the ratings of the power supply, refer also to the data sheet.

For information on switching the R&S ETL on or off, refer to [Chapter 7, "Switching On or Off the Instrument"](#), on page 41. For an overview on available power supplies, refer to [Chapter 6.2, "Connecting to the Power Supply"](#), on page 38.

⚠ WARNING

Risk of injuries

To avoid injuries to yourself or others, always follow the instructions provided in the Battery Pack manual. Furthermore, observe the general safety instructions delivered with the R&S ETL.

6 Connecting the Instrument

This chapter describes the power supply options and how to connect the R&S ETL to the power supply and external devices.

6.1 Preventing Electromagnetic Interference

To prevent electromagnetic interference, the R&S ETL must be operated with all shielding covers fitted. Only suitable and shielded signal and control cables may be used.

Inputs and outputs for RF/trigger/gate/reference/tracking generator/ASI/video source/audio source

In particular cables that are connected to these inputs/outputs can cause EMI problems. Therefore these cables should have at least 80 dB to 1 GHz shielding. This is usually achieved by means of double-shielded cables.

HDMI output

Use an HDMI cable with appropriate ferrite shielding.

For details on the interface see [Chapter 5.2.7, "AV Decoder and TS Processing \(B380\)"](#), on page 33.

USB interfaces

Connect only USB devices that remain within the permissible EMI limits. To avoid any impact, use cables that are:

- Double-shielded
- Not longer than 1 m

For details on the interface see [Chapter 5.1.10, "USB Interfaces"](#), on page 24.

LAN interface

Use a category 5 cable.

For details on the interface see [Chapter 5.2.1, "Standard Rear Panel Connectors"](#), on page 26.

GPIB interface

Use a shielded cable.

For details on the interface see [Chapter 5.2.3, "GPIB Interface \(B10\)"](#), on page 29.

All other cables can be single-shielded. The AC cable is unshielded.

6.2 Connecting to the Power Supply

By standard, the R&S ETL uses an AC power supply. In order to use the R&S ETL independently from an AC power supply, the R&S ETL can be additionally fitted with a DC power supply (DC Power Supply option, R&S ETL-B230) and/or a battery pack (Battery Pack option, R&S ETL-B235). For details on the different power supplies, refer to [Chapter 5.2, "Rear Panel"](#), on page 26.

From the available power supplies, the R&S ETL selects the one to use according to the following priority scheme:

Priority	Power supply
1	AC power supply
2	DC power supply
3	battery pack

For example, if the R&S ETL is connected to both an AC and a DC power supply, it uses the AC power supply. If it is suddenly disconnected from the AC power supply, it switches to the DC power supply.

6.2.1 Connecting to the AC Power Supply

The R&S ETL can be used with different AC power voltages and adapts itself automatically to it. Refer to the datasheet for the requirements of voltage and frequency. The AC power connector is located on the rear panel of the R&S ETL.



Figure 6-1: AC power connector

WARNING

Shock hazard

Observe the basic safety instructions delivered with the R&S ETL, especially the instructions on electrical safety.

Take care that the AC voltage lies within the limits printed on the AC power connector of the R&S ETL and listed in the data sheet.

- ▶ Connect the R&S ETL to the AC power supply, using the power cable that is supplied. The AC power connector is located on the rear panel of the R&S ETL. The R&S ETL complies with safety class EN61010. The power supply must be connected to a socket with protective conductor.

6.3 Connecting USB External Devices

Using the two USB interfaces on the front panel of the R&S ETL, you can directly connect USB devices to the R&S ETL. This number can be increased as necessary by using USB hubs.

Due to the large number of available USB devices, there is almost no limit to the expansions that are possible with the R&S ETL. In the following, USB devices that can be useful are listed:

- Power sensors of the R&S NRP-Zxy family
Using an adapter cable (R&S NRP-Z4), you can connect a power sensor as an alternative to the power sensor connector on the rear panel that is only available with Additional Interfaces option, R&S FSL-B5.
- Keyboard for entering comments, file names, etc. or easy access to Windows settings.
See [Chapter 6.3.1, "External Keyboard"](#), on page 39.
- Mouse for easy operation of Windows dialog boxes.
See [Chapter 6.3.2, "Mouse"](#), on page 40.
- Memory stick for easy transfer of data to/from a computer, for example firmware updates.
See [Chapter 6.3.3, "Memory Stick"](#), on page 40.
- External drives for easy installation of firmware applications.
See [Chapter 6.3.4, "External Drive"](#), on page 40.
- Printer for printing out measurement results.

To install a USB device

1. Connect the USB device to the R&S ETL. You can do this during operation because all USB devices are Plug and Play.
Windows automatically searches for a suitable device driver.
2. If Windows does not find a suitable driver, it will prompt you to specify a directory that contains the driver software. If the driver software is on a CD-ROM, connect a USB CD-ROM drive to the R&S ETL before proceeding.

To uninstall a USB device

- ▶ Disconnect the USB device to the R&S ETL. You can do this during operation.
Windows immediately detects the change in the hardware configuration and deactivates the corresponding driver.

6.3.1 External Keyboard

Connect the keyboard to one of the USB interfaces (type A). The default language setting is for a UK keyboard. You can change the language and modify other settings such as the repetition rate in Windows. For details on how to change these settings, refer to the Windows documentation.

6.3.2 Mouse

You can change settings such as the speed of the mouse cursor in Windows. For details, refer to the Windows documentation.

6.3.3 Memory Stick

The R&S ETL has a disk drive. You can exchange data by using a memory stick which you plug into one of the USB interfaces. The memory stick is automatically assigned a free drive letter and you can use Windows Explorer to transfer data.

6.3.4 External Drive

You can use the USB interface to supply the power for an external hard disk drive (HDD). Make sure that the maximum current suffices the power requirement of the HDD. For USB 2.0, the maximum current is limited to 500 mA. With a Y cable, you can use a second USB port as additional power supply.

7 Switching On or Off the Instrument

WARNING

Shock hazard

Observe the basic safety instructions delivered with the R&S ETL, especially the instructions on electrical safety.

Be aware that in standby, the R&S ETL is still power-supplied.

For an overview on available power supplies, refer to [Chapter 6.2, "Connecting to the Power Supply"](#), on page 38.

7.1 Instrument States

Three different instrument states exist:

On (ready)

The R&S ETL is supplied with power by one of the available power supplies (see also [Chapter 6.2, "Connecting to the Power Supply"](#), on page 38). After booting, the R&S ETL is ready for operation. A green LED above the [ON/STANDBY] key indicates this state.

Standby

Only available if the R&S ETL is connected to the AC power supply (AC power switch in position I; for details, refer to [Chapter 5, "Interfaces and Connectors"](#), on page 17). A yellow LED above the [ON/STANDBY] key indicates this state. Parts of the R&S ETL are still active, e.g. the oven of the OCXO unit (OCXO Reference Frequency option, R&S FSL-B4) is kept active. To prevent the R&S ETL from overheating, the fan remains active.

If switched on in this state, the R&S ETL will rapidly resume operation. It preserves the current settings and when switched back on, the last measurement is displayed.

Off

The R&S ETL is switched off completely. Both LEDs are off. When switched on again, the R&S ETL starts booting. If the OCXO unit (OCXO Reference Frequency option, R&S FSL-B4) is used, an extended warm-up phase as specified in the data sheet is required.

7.2 Switching On the Instrument

NOTICE

Risk of instrument damage

Before switching on the R&S ETL, make sure that the following conditions are met:

- The R&S ETL is set up as described in [Chapter 4, "Setting Up the Instrument"](#), on page 13.
- Signal levels at the input connectors are all within the specified ranges.
- Signal outputs are correctly connected and are not overloaded.

The values are specified in the data sheet. Failure to meet these conditions may cause damage to the R&S ETL or other devices in the test setup.

- ▶ AC power supply: Press the AC power switch on the rear panel into position I.
- ▶ DC power supply/battery pack or standby state: Press the [ON/STANDBY] key on the front panel.

7.3 Switching Off the Instrument

Depending on the used power supply, the R&S ETL changes to different states when pressing the [ON/STANDBY] key on the front panel or switching off the AC power at the rear panel. An overview is given in [Chapter 7.4, "Behavior of the ON/STANDBY Key"](#), on page 43.

NOTICE

Risk of losing data

If switched off using the [ON/STANDBY] key, the R&S ETL preserves its current settings.

If switched off at the rear panel or if the power cord is disconnected without pressing the [ON/STANDBY] key first, the R&S ETL loses its settings. In this case, the last settings that were stored on the SSD are loaded when you switch the R&S ETL back on.

7.3.1 Switching to Standby



Do not press the [ON/STANDBY] key longer than 3 seconds.

Prerequisites:

- The R&S ETL is in operation.
- The R&S ETL is connected to the AC power supply.
- The AC power switch on the rear panel is in position I.
- The shutdown behavior is configured accordingly using the [SETUP] key. For details, refer to the user manual or the help.

- ▶ Press the [ON/STANDBY] key on the front panel.

The R&S ETL stores the current settings on its SSD and switches to standby (for details on standby, refer to [Chapter 7.1, "Instrument States"](#), on page 41).

⚠ WARNING**Shock hazard**

Be aware that in standby, the R&S ETL is still power-supplied.

7.3.2 Switching Off

DC power supply/battery pack

- ▶ Press the [ON/STANDBY] key on the front panel. The R&S ETL changes into off state.

AC power supply

Prerequisite: The shutdown behavior is configured accordingly using the [SETUP] key.

For details, refer to the user manual or the help.

1. Press the [ON/STANDBY] key on the front panel.
2. Change the AC power switch on the rear panel to position O, or disconnect the R&S ETL from the AC power supply.

The R&S ETL changes into off state, if no alternative power supply is available.



The AC power switch also interrupts the power supply of the OCXO (OCXO Reference Frequency option, R&S FSL-B4). When you switch the R&S ETL back on, be sure to comply with the extended warm-up phase specified in the data sheet.

7.4 Behavior of the ON/STANDBY Key

Depending on the used power supply, the [ON/STANDBY] key on the front panel leads to different states (see also [Chapter 7.1, "Instrument States"](#), on page 41). For details

on the power supply options, refer to [Chapter 6.2, "Connecting to the Power Supply"](#), on page 38.

Power supply	Instrument state	Action	Instrument reaction
AC	On	Press the [ON/STANDBY] key.	Changes into standby or off state, depending on the status of the "Shutdown Off/Standby" softkey ([SETUP] key).
	On	Disconnect R&S ETL from AC power supply or switching AC power switch in position 0 (not recommended).	Changes into off state without saving the current settings.
	Standby	Press the [ON/STANDBY] key.	Changes into on state.
	Standby	Disconnect R&S ETL from AC power supply or switching AC power switch in position 0.	Changes into off state.
	Off	Connect R&S ETL to AC power supply and/or switching AC power switch at the rear panel in position I.	Starts booting.
DC	On	Press the [ON/STANDBY] key.	Changes into off state.
	Off	Press the [ON/STANDBY] key.	Starts booting.
	On/off	Switch the AC power switch at the rear panel in position I.	No action
Battery	On	Press the [ON/STANDBY] key.	Changes into off state.
	Off	Press the [ON/STANDBY] key.	Starts booting.
	On/off	Switch the AC power switch at the rear panel in position I.	No action

If switched on from standby, the R&S ETL directly displays the measurement screen and resume operation after a few moments. Otherwise, after being switched on, the R&S ETL starts booting. It displays the BIOS screen and performs a self-test of the computer hardware. The firmware starts as soon as Windows has resumed operation.

7.5 Checking the Provided Options

The R&S ETL can be equipped with both hardware and firmware options. In order to check whether the installed options correspond to the options indicated on the delivery note, proceed as follows.

1. Press the [SETUP] key.
2. Press the "More ↓" key.
3. Press the "System Info" softkey.
4. Press the "Versions + Options" softkey.

A list with hardware and firmware information is displayed.

5. Check the availability of the hardware options as indicated in the delivery note.
6. Check the options enabled using license keys as indicated in the delivery note.

For an overview of the all options available for the R&S ETL, refer to the product site at: <https://www.rohde-schwarz.com/product/etl/>

7.6 Turn-On Tests



Only perform these functional tests when the operating temperature is reached (approx. 15 minutes after the R&S ETL is switched on, refer to the data sheet for details).

7.6.1 Performing a Self-Alignment

1. Press the [SETUP] key.
2. Press the "Alignment" softkey.
3. Press the "Self Alignment" softkey.

Once the system correction values have been calculated successfully, a message is displayed.

7.6.2 Performing a Self-Test

1. Press the [SETUP] key.
2. Press the "More ↓" key.
3. Press the "Service" softkey.
4. Press the "Selftest" softkey.

Once the modules have been checked successfully, a message is displayed. Once both steps have been completed successfully, the R&S ETL is ready for operation.



You do not need to repeat the self-test every time you switch on the R&S ETL. It is only necessary if instrument malfunction is suspected.

8 Sample Application

Follow the instructions in this chapter to perform your first measurement with the R&S ETL.

For an expanded selection of measurement examples and background information, refer to the user manual or the help.

The chosen example applies to the DVBC and J.83/A/C TV standard. It gives an overview of the active measurement channel. All parameters are set according to the modulation standard, referenced in the channel table or by the default digital TV modulation standard. The spectrum is displayed in a full screen trace.

8.1 Test Setup

Use a digital TV generator as signal source (e.g. R&S BTC).

1. Connect the generator directly to the R&S ETL.
2. Set the TV generator to the following parameters:
 - a) Center frequency: 100 MHz
 - b) Single carrier 64QAM modulation
 - c) Root raised cosine transmit filter with a roll-off factor of 0.15
 - d) Symbol rate: 6.9 MSymbols/s

8.2 Setting the TV Analyzer/Receiver Mode

After preset, the R&S ETL is in the "Spectrum Analyzer" mode. To perform TV measurements, change into the "TV Analyzer/Receiver" mode:

1. Press the [MODE] key.
2. Activate the "TV Analyzer/Receiver" option.

For further information on measurement modes, refer to the user manual or the help.

8.3 Performing the Measurement

1. Press the [FREQ] key.
2. Enter *100 MHz* for the center frequency.
3. Press the [MENU] key.

4. Press the "Digital TV" softkey.
5. Press the [MEAS] key.
6. Select the "Digital TV Settings" softkey.
7. Compare the modulation parameters.
8. Select the correct modulation standard.
9. Press the "Spectrum" softkey.
10. To adjust the input attenuator, press the "Adjust Attenuation" softkey.

The spectrum of the input signal is displayed.

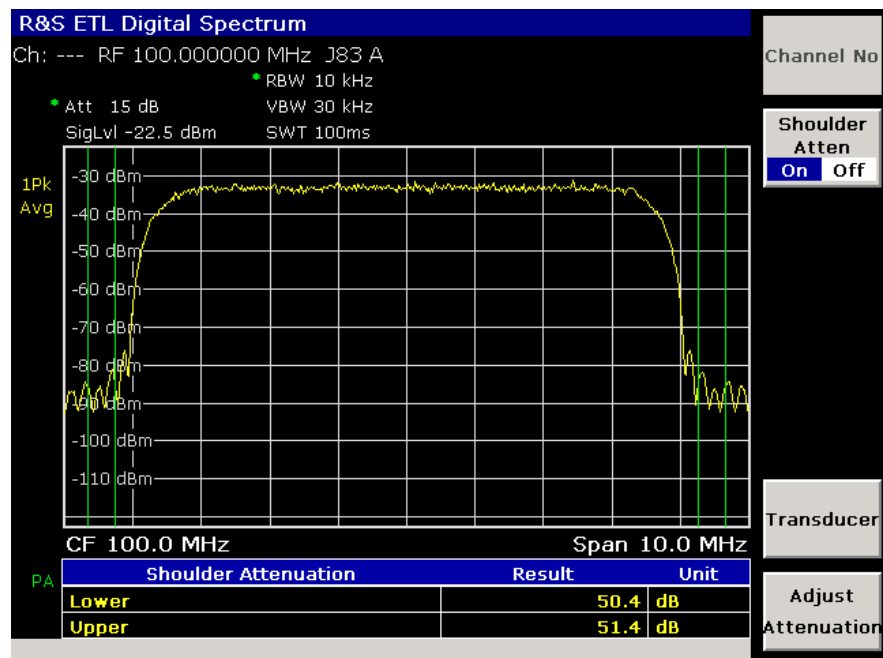

Figure 8-1: Digital TV Spectrum measurement

9 Operating the Instrument in a LAN

The R&S ETL is equipped with a network interface and can be connected to an Ethernet LAN (local area network). The network card operates with a 10 MHz Ethernet IEEE 802.3 or a 100 MHz Ethernet IEEE 802.3u interface. The TCP/IP network protocol and the associated network services are preconfigured.

To be able to exchange data within a local area network (LAN), every computer or R&S ETL that is connected must have a unique IP address or a unique computer name. Access between different users is managed with access authorizations.

Provided the appropriate rights have been assigned and the Windows firewall configuration is adapted accordingly, the interface can be used e.g. for transferring data, printing on network printers, operating/controlling the R&S ETL from a remote computer.

To use network resources, access must be granted. To share files on the R&S ETL with other network users, access to R&S ETL resources, e.g. the hard drives, must also be granted. All these administration tasks are normally performed by a network administrator. For details, refer to the Windows documentation. Contact your network administrator for access authorizations.

User name and password of the R&S ETL are factory-set, see [Chapter 10.1.1, "Logon"](#), on page 52. The user name is used for auto login, access authorization and remote operation.

For further information on networks, refer to the user manual or the help.

9.1 Computer Name

Default computer name

The default computer name is composed as follows:

<instrument short name>-<serial number>

Example: ETL-100104

The serial number consists of 6 digits and is printed on the cabinet of the R&S ETL.

To read out the computer name

If the R&S ETL has a default computer name, the computer name is displayed in the title bar of the application. If no default computer name is displayed, do the following:

1. Press the [SETUP] key.
2. Press the "General Setup" softkey.
3. Press the "Network Address" softkey.
The submenu is displayed.
4. Press the "Computer Name" softkey.

5. Read out the name.

To change the computer name

1. Access as above: [SETUP] > "General Setup" > "Network Address" > "Computer Name"
2. Enter the computer name.
3. If you have entered an invalid name, in the status line, an out of range message is displayed. The edit dialog box remains open, and you can start afresh.
If the settings are correct, the configuration is saved, and you are prompted to restart the R&S ETL.
4. Confirm the displayed message to restart the R&S ETL.

9.2 IP Address

If you want to address an R&S ETL in a network or in a remote control session, you need to know the IP address.

The access to the IP address depends on the version of the operating system.

To read out the IP address (Windows 8)

1. Press the [SETUP] key.
2. Press the "General Setup" softkey.
3. Press the "Network Address" softkey.
The submenu is displayed.
4. Double-click "Ethernet".
The Windows "Ethernet Status" dialog box is displayed.
5. Click the "Details" button.
The Windows "Network Connection Details" dialog box is displayed. The IP address is listed under "IPv4 Address", example:

IPv4 Address	172.29.202.13
--------------	---------------

To read out the IP address (Windows XP)

1. Press the [SETUP] key.
2. Press the "General Setup" softkey.
3. Press the "Network Address" softkey.
The submenu is displayed.

4. Press the "IP address" softkey.

9.3 Connecting the Instrument to the Network

NOTICE

Risk of network failure/virus infection

Before connecting the R&S ETL to a network or configuring a network, do the following:

- Consult your network administrator.
- If your network does not support DHCP or if you choose to disable dynamic TCP/IP configuration, you must assign valid address information before connecting the R&S ETL to the LAN.

Errors may affect the entire network.

Efficient virus protection is a prerequisite for secure operation in the network. Never connect the R&S ETL to a network without proper protection against a virus infection, as doing so may cause damage to the R&S ETL firmware.

To connect the R&S ETL to a network

1. Fulfill all prerequisites mentioned above.
2. Make sure that the R&S ETL is switched off. This is the only way to ensure that the network connection is reliably detected and any disruptions during the operation of the R&S ETL are avoided.
3. Connect the R&S ETL to the network using a CAT-5e cable or better.
4. Switch on the R&S ETL.

To disconnect the R&S ETL from a network

1. Make sure that the R&S ETL is switched off.
2. Disconnect the R&S ETL from the network.

9.4 Connecting the Instrument to a Computer

How to set up a LAN connection between an R&S ETL and a single computer without integration into a larger network depends on the operating system installed on the computer.

9.4.1 Windows 7 or Later

If Windows 7 or a later Windows version is installed on the computer, you can set up a LAN connection really fast.

1. Activate DHCP on both the computer and the R&S ETL.
2. Connect the computer and the R&S ETL with a standard RJ.45 cross-over cable (LAN cable).

After approx. 16 seconds, the connection is established.

3. To address the R&S ETL, use the computer name.
See [Chapter 9.1, "Computer Name"](#), on page 48.

9.4.2 Other Operating Systems

If another operating system than Windows 7 or later is installed on the computer, you need to assign IP addresses.

1. Assign an IP address to the R&S ETL and the computer.
The IP addresses *192.168.xxx.yyy* are available for use here. *xxx* and *yyy* can assume values of *1* to *255*. The value for the subnet mask is *255.255.255.0*.
2. Connect the R&S ETL and the computer with a standard RJ.45 cross-over cable (LAN cable).
3. To address the R&S ETL, use the assigned IP address.

9.5 Firewall Settings

By default, the Windows Firewall is activated to protect the R&S ETL from an attack of hostile users and programs. The Windows Firewall suppresses all network communication which is not initialized by the R&S ETL itself or which is not defined as an exception.

To enable data transfer or to allow access to the R&S ETL, define exceptions. For details, refer to the Windows documentation or contact your network administrator for support.

10 Installed Software

The firmware and the operating system are already installed on the R&S ETL.

Further information

- Performing a firmware update:
See the release notes.
- Installing software options:
See the document delivered with the option key.

10.1 Operating System

The R&S ETL has a Windows Embedded operating system with one of the following versions:

- Windows 8
The serial number of the R&S ETL is $\geq 205\ 000$ or an upgrade kit (R&S ETL-U80/U81/U82) is installed.
- Windows XP
The serial number of the R&S ETL is $< 205\ 000$. No upgrade kit is installed.

When the R&S ETL is delivered, the operating system is configured for optimum operation. Changes to the system settings are required only if you install peripherals such as a keyboard and printer, or if you configure the network and the settings do not conform to the default settings.

NOTICE

Risk of causing instrument unusability

To prevent malfunctions and to avoid instrument repair, only install service packs approved by Rohde & Schwarz. In particular, do not use service packs for other Windows editions.

Only install and execute programs tested by Rohde & Schwarz with regard to their compatibility with the R&S ETL software. The tested program packages are listed in [Chapter 10.2, "Additional Software"](#), on page 54.

10.1.1 Logon

Windows requires that you identify yourself by entering a user name and password in a logon window.



User name and password are factory-set as follows:

- User name: *instrument*
- Password: *894129*

If the R&S ETL is connected to a network, and if the user name and the password are identical under Windows and on the network, you log on to Windows and the network at the same time.

10.1.1.1 Automatic Logon

Due to an automatic logon function that is activated when shipped, the R&S ETL automatically logs on to Windows. You can deactivate this function. If activated, the automatic logon comprises:

- The logon is automatically carried out in the background.
- After logon, the user has administrator rights.



Changing the automatic logon settings requires a mouse and an external keyboard.

To deactivate the automatic logon

1. The first step depends on the version of the operating system:
 - Windows 8: In the taskbar, right-click the "Start" charm.
 - Windows XP: In the left corner of the taskbar, click the Windows start icon.

2. Under "Start", select "Run".

The "Run" dialog box is displayed.

3. Enter the `C:\R_S\INSTR\USER\NOAUTOLOGIN.REG` command.

4. Press the [ENTER] key to confirm.

The automatic logon mechanism is deactivated. The next time you switch on the R&S ETL, you are prompted to enter your user name and password before the firmware is started.

To activate the automatic logon

1. For the first step, see [step 1](#).

2. Under "Start", select "Run".

The "Run" dialog box is displayed.

3. Enter the `C:\R_S\INSTR\USER\AUTOLOGIN.REG` command.

4. Press the [ENTER] key to confirm.

The automatic logon mechanism is activated. It applies the next time you switch on the R&S ETL.

10.1.2 Access to Windows Settings

The Windows settings are grouped in the Windows "Control Panel". For details, refer to the Windows documentation.



Changing Windows settings requires a mouse and an external keyboard.

To display the Windows desktop

1. Press the [FILE] key.
2. Press the "More ↓" softkey.
3. Press the "Desktop" softkey.

To access the Windows 8 control panel

1. On the Windows desktop, move the mouse pointer in the upper or lower right corner and then down.

The charm window is displayed on the right side of the screen.

2. Select the "Settings" charm.
3. Select "Control Panel".

To access the Windows XP control panel

1. Display the Windows desktop.
2. On the external keyboard:
 - Press the Windows key.
 - Press the [CTRL+ESC] key combination.

To return to the measurement screen

- ▶ On the R&S ETL, press any hardkey.
- ▶ On the external keyboard, press the [ALT+TAB] key combination.
- ▶ On the taskbar, click the R&S Analyzer Interface icon.

10.2 Additional Software

The driver software and the system settings of Windows have been fine-tuned to support the measurement functions of the R&S ETL. Thus, for flawless instrument function, use only software and hardware approved or offered by Rohde & Schwarz.

Using other software or hardware can cause the R&S ETL to perform improperly or faulty. The following program packages have been successfully tested for compatibility with the measurement instrument software:

- R&S ETL TxCheck

10.3 Backup and Restore Application

Using the backup and restore application, you can back up the instrument installations and their configuration so that they can be restored if necessary. When restoring, you can choose between various states.

- Factory default state
If, for example, the system crashes, you can restore the factory default state.
- Intermediate states that you have saved
For example, you can back up the current system partition before a firmware update or provide different system configurations for different environments.

In the restore process, the system partition is deleted, formatted and written newly. The data partition is not affected.



Connect an external keyboard.

If the instrument does not have a monitor, connect also an external monitor.

To display the main dialog for backup and restore

1. Restart the R&S ETL.

The boot screen is displayed. By default, "System" is selected. If you do not perform the next step within 4 seconds, the dialog vanishes and the booting process continues.

2. Select the "Backup" partition and press [ENTER].

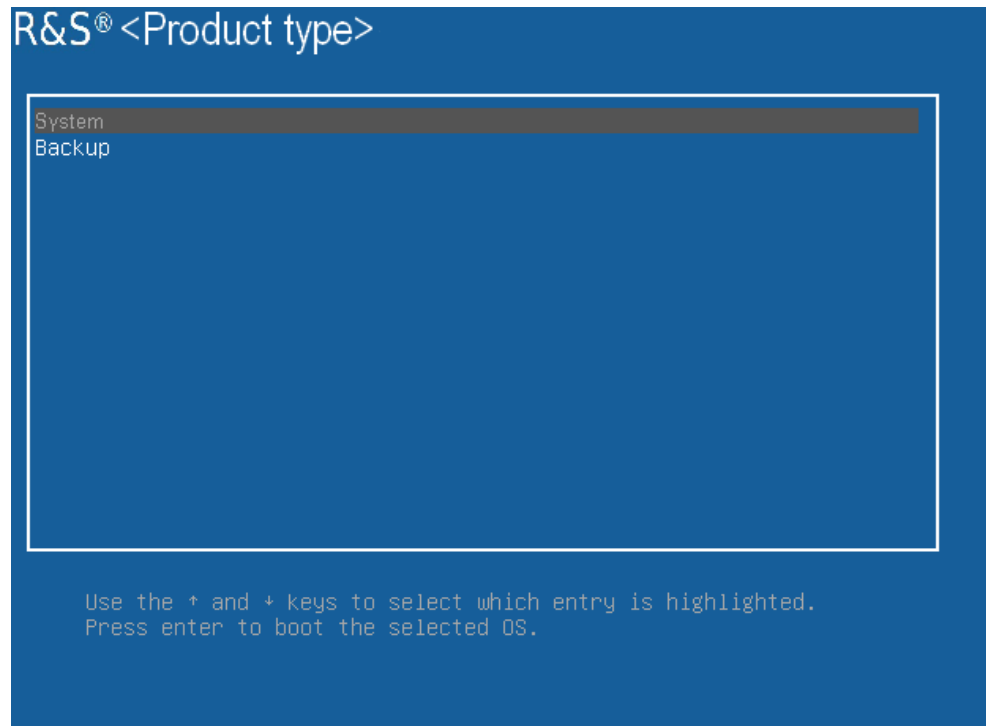

The main dialog is displayed. It provides access to all functions of the backup and restore application.

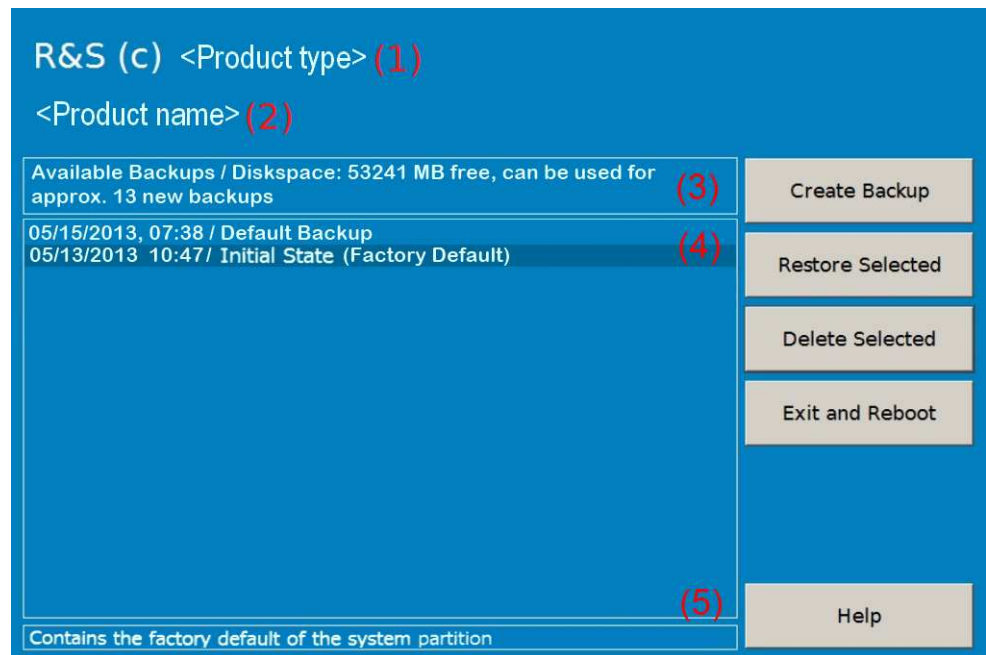

Figure 10-1: Main dialog (example)

- (1) = Header showing instrument type
- (2) = Header showing instrument name
- (3) = Free memory space on backup partition
- (4) = List of backups already created
- (5) = Description of currently selected backup

To continue, see one of the following chapters:

- [Chapter 10.3.1, "Creating a Backup"](#), on page 57
- [Chapter 10.3.2, "Restoring a Selected Backup Version"](#), on page 58
- [Chapter 10.3.3, "Deleting a Backup"](#), on page 58

10.3.1 Creating a Backup

Using this function, you can create a backup of the current instrument installation and its configuration.

1. In the main dialog (see [Figure 10-1](#)), select "Create Backup".

The "Create Backup" dialog is displayed. Under "Description", the current version of the firmware is displayed.

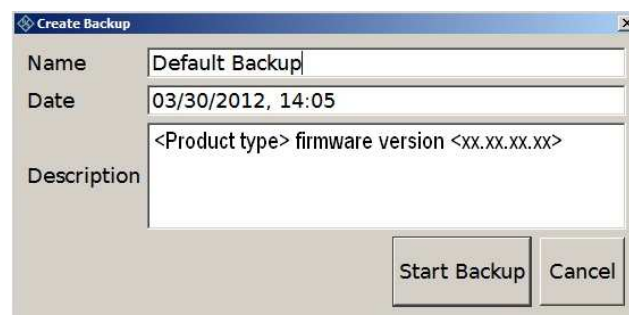

2. Enter a name for the backup and the date. If necessary, you can add information to the description.
3. Select "Start Backup".

During the backup process, a progress information dialog is displayed. You can terminate at any time ("Cancel").

After the process has been finished, the dialog is closed automatically, and the main dialog is displayed again.

Note: If you activate "Keep open when finished", the progress information dialog remains open until you close it.

4. In the main dialog, select "Exit and Reboot".

The backup and restore application is closed, and the R&S ETL is restarted.

10.3.2 Restoring a Selected Backup Version

Using this function, you can restore the selected instrument installation and its configuration.



Malware protection

When restoring a backup, the Windows operating system and installed anti-malware software are probably outdated. To minimize the risk of malware threats after restoring a backup, verify and adjust the "Windows Update" settings. Follow the recommendations from Rohde & Schwarz applicable to your instrument. Also, install all Windows security updates that have been published in the meanwhile.

1. In the main dialog (see [Figure 10-1](#)), select the backup you want to restore.
2. Select "Restore Selected".
3. In the "Restore Selected" dialog, select "Yes".

During the restoring process, a progress information dialog is displayed. You can terminate at any time ("Cancel").

After the process has been finished, the application is closed automatically, and the R&S ETL is restarted.

Note: If you activate "Keep open when finished", the progress information dialog remains open until you close it.

10.3.3 Deleting a Backup

Using this function, you can delete the selected instrument installation and its configuration.

To provide space for new backups, you can remove older backups. The factory default cannot be deleted.

1. In the main dialog (see [Figure 10-1](#)), select the backup you want to delete.
2. Select "Delete Selected".
3. In the "Delete Selected" dialog, select "Yes".

Note: You are not authorized to delete a factory default backup. If you have selected one, an error message is displayed and the backup is not deleted.

4. In the main dialog, select "Exit and Reboot", or continue with [Chapter 10.3.1, "Creating a Backup"](#), on page 57.

11 Maintenance

The R&S ETL does not need a periodic maintenance. What is necessary is essentially the cleaning of the R&S ETL. However, it is recommended to check the rated data from time to time.

The address of our support center and a list of all Rohde & Schwarz service centers are provided at www.customersupport.rohde-schwarz.com.

11.1 Recommended Calibration Interval

For information on the recommended calibration interval for the R&S ETL, refer to the data sheet.

11.2 Cleaning

WARNING

Shock hazard

Before cleaning the R&S ETL, ensure that the R&S ETL is switched off and disconnected from all power supplies.

-
1. Clean the outside of the R&S ETL using a soft, lint-free dust cloth.
 2. Make sure that vents are not obstructed.

NOTICE

Instrument damage caused by cleaning agents

Cleaning agents contain substances that may damage the R&S ETL, e.g. solvent-containing cleaning agents may damage the front panel labeling or plastic parts.

Never use cleaning agents such as solvents (thinners, acetone, etc), acids, bases, or other substances.

11.3 Replacing the Fuses

The R&S ETL is protected by two fuses (IEC 127 - T 3.15 H / 250 V) located on the rear panel at the right side of the AC power switch.

⚠ WARNING**Shock hazard**

For fuse replacement, ensure that the R&S ETL is switched off and disconnected from all power supplies.

1. Open the lid of the AC power connector.
2. Lift the fuse holder out of its slot.
3. Exchange the two fuses.
4. Put the fuse holder back in its slot.
5. Close the lid.

11.4 Storing

The storage temperature range of the R&S ETL is given in the data sheet. If the R&S ETL is to be stored for a longer period of time, it must be protected against dust.

Repack the R&S ETL as it was originally packed when transporting or shipping. The two protective foam plastic parts prevent the control elements and connectors from being damaged. The antistatic packing foil avoids any undesired electrostatic charging to occur.

If you do not use the original packaging, provide for sufficient padding to prevent the R&S ETL from slipping inside the package. Wrap antistatic packing foil around the R&S ETL to protect it from electrostatic charging.

Index

A

AC power connector	26
AC power supply connecting to	38
accessories	14
administrator rights	53
AF OUT connector	24
aligning	45
AMPT key	20
Application cards	11
Application notes	11
arrow keys	23
ASI OUT connector	27
AUDIO connector	28
automatic logon activate	53
deactivate	53
AUX PORT connector	32

B

BACK key	22
Backup Creating	57
Deleting	58
Main dialog	55
Restoring	58
bench operation	14
Brochures	11
BW key	20

C

calibration interval	59
cardboard box unpacking	13
CCVS OUT connector	28
CHECKMARK key	23
cleaning the outside	59
computer name	48
connector AC power	26
AF OUT	24
ASI OUT	27
AUDIO	28
AUX PORT	32
CCVS OUT	28
DC power	28
DVB COMMON INTERFACE	34, 35
EXT REF	27
EXT TRIG/GATE	27
GEN OUT	24
GPIB	29
HDMI OUT	33, 35
I IN	31, 32
IF / CCVS / ETI / AF GEN OUT	31
IF/VIDEO OUT	32
LAN	27
NOISE SOURCE CONTROL	32
POWER SENSOR	32
Q / MPX IN	31
RF IN	25

SER CLK / AF GEN L OUT	30
SER DAT / AF GEN R OUT	31
TS ASI IN	34, 35
TS ASI OUT	34, 35
TS IN / OUT 1000 BASE-T	34
USB	24
control panel	54
conventions	8

D

Data sheets	11
DC power connector	28
default computer name	48
documentation conventions	8
on the R&S ETL	7
Documentation overview	10
DVB COMMON INTERFACE connector	34, 35

E

electromagnetic interference	37
EMI	37
ENTER key	22
ESC/CANCEL key	22
EXT REF connector	27
EXT TRIG/GATE connector	27
external devices	39
connecting	39

F

FIELD keys	23
FILE key	18
firewall settings	51
firmware options	44
FREQ key	19
front panel	17
functional test	45
fuses replacing	59

G

GEN OUT connector	24
Getting started	10
GPIB connector	29

H

hardware options	44
HDMI OUT connector	33, 35
help	19
Help	10
HELP key	19

I

I IN connector	31, 32
IF / CCVS / ETI / AF GEN OUT connector	31
IF/VIDEO OUT connector	32
information safety issues	7

- Information
 Safety issues 7
instrument states 41
IP address 49
- K**
- key
 AMPT 20
 BACK 22
 BW 20
 CHECKMARK 23
 DN ARROW 23
 ENTER 22
 ESC/CANCEL 22
 FIELD LEFT 23
 FIELD RIGHT 23
 FILE 18
 FREQ 19
 HELP 19
 LEFT ARROW 23
 LINES 21
 MEAS 21
 MENU 19
 MKR 20
 MKR-> 21
 MODE 19
 NEXT TAB 24
 ON/STANDBY 18, 43
 PRESET 18
 PRINT 19
 RIGHT ARROW 23
 RUN 21
 SETUP 18
 SPAN 19
 SWEEP 20
 TRACE 21
 TRIG 20
 UP ARROW 23
keypad 21
- L**
- LAN connector 27
LAN operation 48
LINES key 21
logon
 automatic 52, 53
 Windows 52
- M**
- maintenance 59
manual
 conventions 8
 on the R&S ETL 7
Manual
 Getting started 10
 User manual 10
MEAS key 21
measurement
 example 46
 mode 19, 46
 test setup 46
MENU key 19
MKR key 20
MKR-> key 21
- mode
 TV Analyzer 46
MODE key 19
- N**
- network 48
 automatic logon 52
 connecting to 50
NEXT TAB key 24
NOISE SOURCE CONTROL connector 32
- O**
- OCXO reference frequency 30
off state 41
on state 41
ON/STANDBY key 18, 43
Open source acknowledgment (OSA) 11
operating system
 Windows 52
option
 Additional Interfaces 32
 AV Decoder and TS Processing 33
 B4 30
 B5 32
 B10 29
 B201 30
 B230 28
 B280 34
 B380 33
 DC Power Supply 28
 GPIO Interface 29
 MPEG Processing Board 34
 OCXO Reference Frequency 30
 Universal DTV, ATV, FM Interface 30
options
 checking 44
 firmware 44
 hardware 44
- P**
- packing 60
password
 Windows 52
POWER SENSOR connector 32
power supply
 connecting to 38
 connector (AC) 26
 connector(DC) 28
PRESET key 18
PRINT key 19
Product documentation 10
provided options
 checking 44
- Q**
- Q / MPX IN connector 31
- R**
- rack mounting 16
recommended calibration interval 59
Release notes 11
replacing fuses 59

Restore		
Main dialog	55	
RF IN connector	25	
rotary knob	22	
RUN key	21	
S		
safety information	7	
Safety information	7	
Safety instructions	10	
sample application	46	
self-alignment	45	
self-test	45	
SER CLK / AF GEN L OUT connector	30	
SER DAT / AF GEN R OUT connector	31	
Settings charm	54	
SETUP key	18	
ship damage inspection	13	
software		
additional	54	
SPAN key	19	
SSD	42	
standby state	41	
start charm	53	
start menu	53	
state		
off	41	
on	41	
standby	41	
storing	60	
SWEEP key	20	
switching into standby	43	
switching off the R&S ETL	43	
switching on the R&S ETL	42	
system overview	12	
System partition		
Backup	57	
Deleting selected version	58	
Restoring selected version	58	
T		
test setup	46	
TRACE key	21	
TRIG key	20	
TS ASI IN connector	34, 35	
TS ASI OUT connector	34, 35	
TS IN / OUT 1000 BASE-T connector	34	
Tutorials	10	
U		
unpacking the R&S ETL	13	
USB connector	24	
external devices	39	
User manual	10	
W		
warranty conditions	14	
White papers	11	
Windows		
additional software	54	
control panel	54	
logon	52	
password	52	
settings	54	
Windows 8	52	
Windows XP	52	