



RIGOL

DSG5000 Series

Microwave Signal Generator

DataSheet
DSG04100-1110
Jun.2022

DSG5000 Series

Microwave Signal Generator



Highlights

- Multi-channel with up to 8 channels, support multi-device rack mount
- Channel-to-channel phase stability $< 1^\circ @ 10\text{GHz}$, resolution of phase offset setting adjustable in 0.01° steps
- Fast switching speed 3 ms
- Output max. available power up to 25 dBm
- Low phase noise below $-133 \text{ dBc/Hz} @ 1 \text{ GHz}$, 10 kHz offset

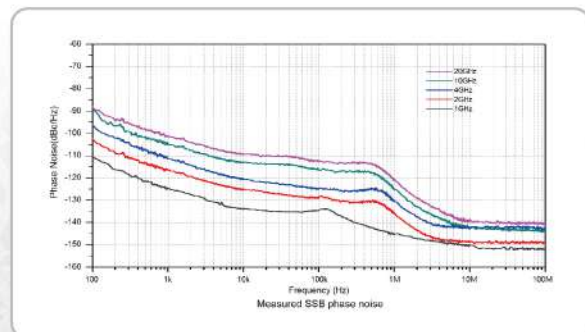
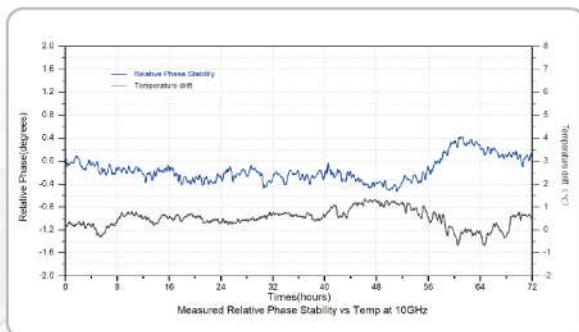

Superb Long-term Phase Stability and Low Phase Noise

RF 50Ω

RF 50Ω

RF 50Ω

RF 50Ω



DSG5000 series microwave signal generator can generate high quality signals, accurate signal level and wide output power range, capable of meeting the complex test scenarios such as superconducting quantum computation, radar signal generation, MIMO, and EMS.

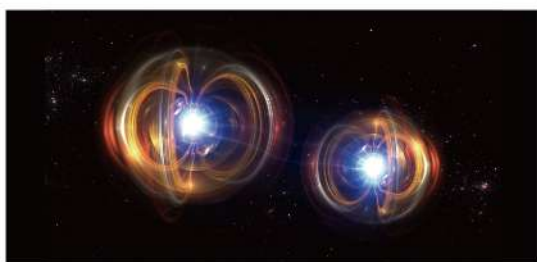

Superconducting Quantum Computation



MIMO



Radar Signal Generation

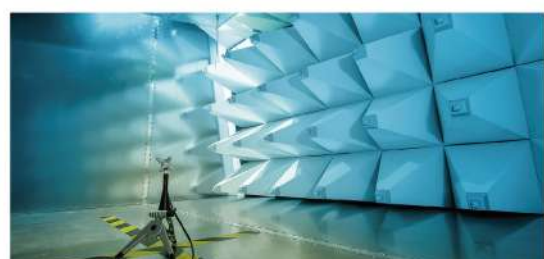

EMS

Technical Advantage

High Performance

- Excellent channel-to-channel phase stability, low phase noise, and high power output
- AM, FM, PM, and pulse modulation (Opt.); pulse train generator enables users to generate the user-defined pulse list
- Frequency sweep, level sweep, and Freq & Level sweep (Std.); list sweep mode enables users to generate the user-defined sweep list

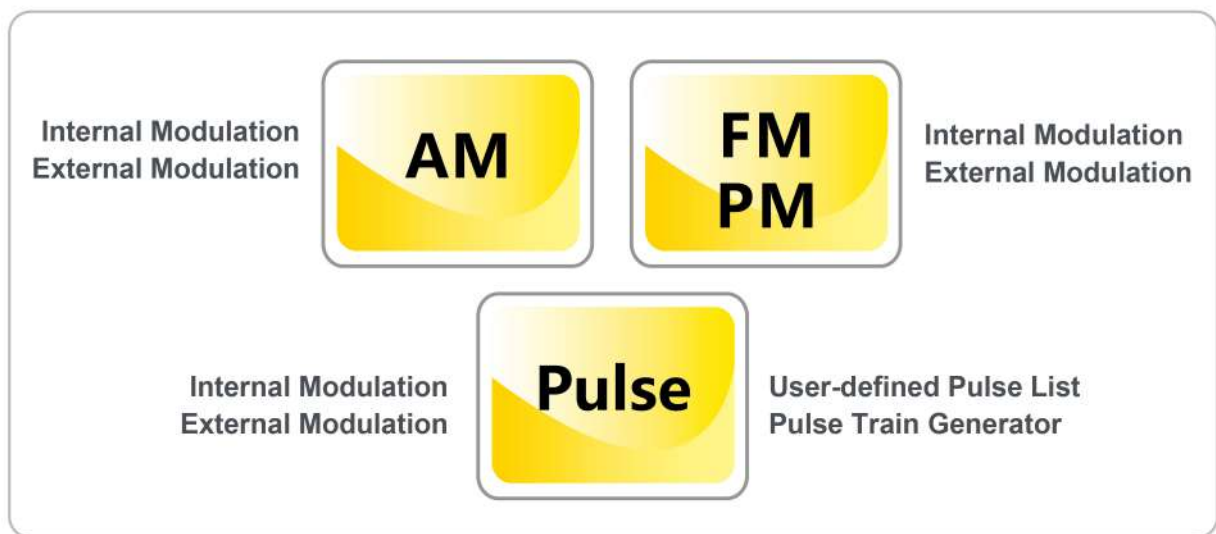

Compact Design

The instrument model supports up to 8 channels, with each channel independent of each other and independently controlled. Multiple devices can be integrated in rack mount installation, saving space and time.



High Expansion

- With a standard 2U rack size and rack mount kit, you can extend the channels of the DSG5000 series microwave signal generator.
- The front and rear-panel ventilation design provides adequate ventilation to ensure the signal accuracy and stability even if multiple devices are stacked in the cabinet.
- The DSG5000 series is equipped with a standard configuration of the PC software to realize integrated control of multiple instruments. With the PC software, you can operate the instrument in remote control and make a global parameter configuration for multiple channels to meet the integrated test application scenarios.



User-friendly Operation

The DSG5000 series microwave signal generator is equipped with the touch screen. It also allows you to connect an external display to operate the instrument. You can also use the Web Control software to realize remote control of the instrument or use the SCPI commands to control the instrument.

● Self-equipped Touch Screen

The DSG5000 series is equipped with a touch screen, which enables you to operate and control the instrument with touch-enabled gestures. It does not have any physical keys on the front panel to operate except the power key.

● Externally Connected Display

The DSG5000 series allows you to externally connect the display (e.g. PAD, monitor, and projector) via the HDMI interface to enjoy user-friendly operation and viewing experience with a greater choice of the display devices.

● Web Control Remote Operation

You only need to input the IP address of the DSG5000 series into the address bar of the Web browser to open the Web Control software.

The display of the current user interface shown in the web control page is consistent with that in the DSG5000 series. You can use the mouse to click the menus in the Web Control interface to operate the instrument in remote control way. In the Web Control interface, you can click to view the basic information of the instrument, and you can also set or modify the network status.

● Control with the SCPI Command Set

The DSG5000 series supports the standard SCPI command set. You can send the SCPI commands via the USB or LAN interface to realize remote control of the instrument. Moreover, you can use the Excel, LabVIEW, Visual Basic, Visual C++, and relevant programming tools to send commands in batches automatically, to meet the demands of automation test scenarios.



Product Appearance

DSG5000 Series Microwave Signal Generator

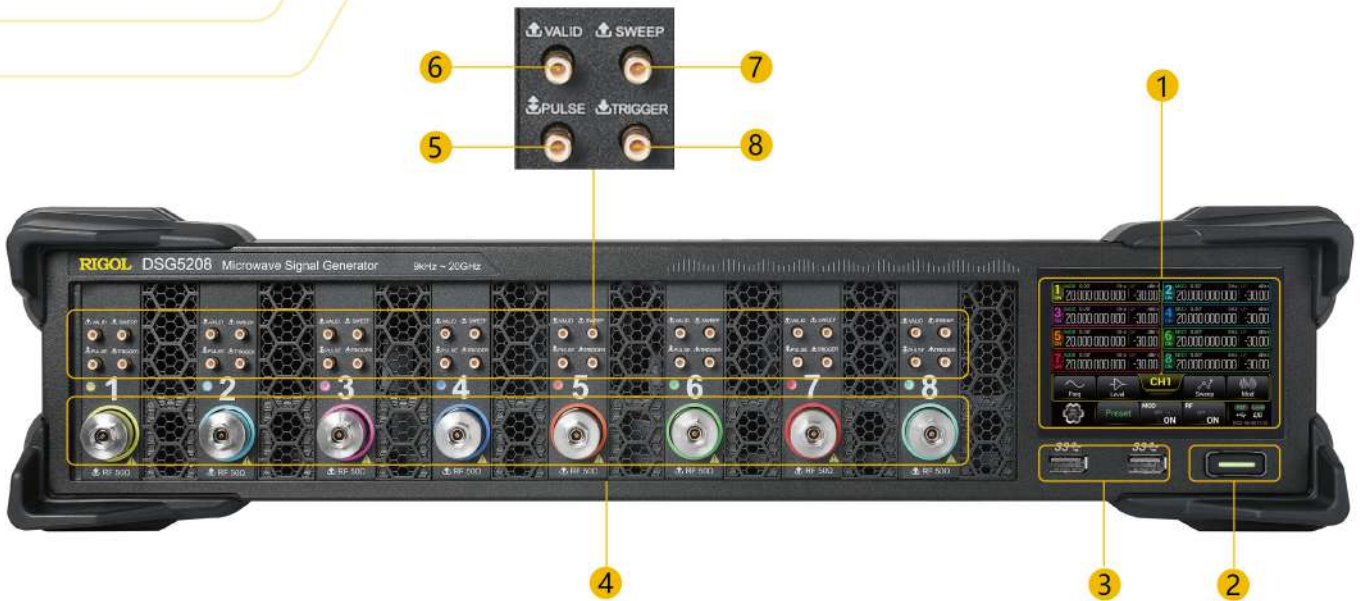

No.	Description	No.	Description
1	Touch Screen	5	Pulse Signal Input/Output Connector
2	Power Key	6	Valid Signal Output Connector
3	USB HOST Interface	7	Sweep Output Connector
4	RF Signal Output Connector	8	External Trigger Input Connector

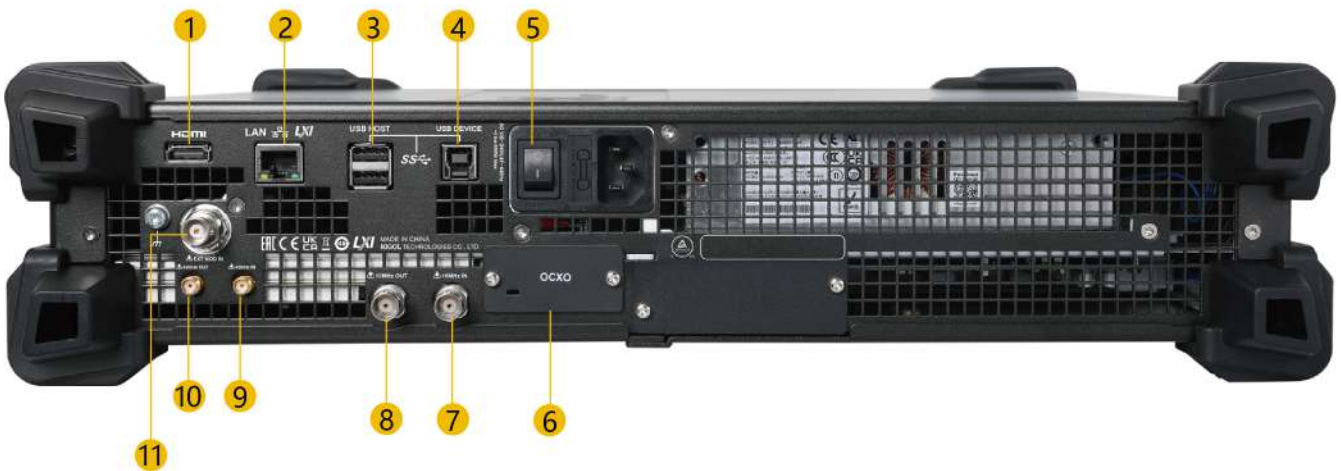

No.	Description	No.	Description
1	HDMI Interface	7	10MHz IN
2	LAN Interface	8	10MHz OUT
3	USB HOST Interface	9	4.8GHz IN
4	USB DEVICE Interface	10	4.8GHz OUT
5	Power Switch	11	EXT MOD IN
6	High Stability Clock (OCXO)		

Specifications

Specifications are valid under the following conditions: the instrument is within the calibration period; stored for at least two hours at 0°C to 50°C temperature; 40-minute warm-up. Unless otherwise noted, the specifications in the manual include the measurement uncertainty.

- **Typical (typ.):** typical performance, which 80 percent of the measurement results will meet at room temperature (approximately 25°C). The data are not warranted and do not include the measurement uncertainty.
- **Nominal (nom.):** the expected mean or average performance or a designed attribute (such as the 50Ω connector). The data are not warranted and are measured at room temperature (approximately 25°C).
- **Measured (meas.):** an attribute measured during the design phase which can be compared to the expected performance, i.g. the amplitude drift varies with time. The data are not warranted and are measured at room temperature (approximately 25°C).

Note: All charts in this manual are the measurement results of multiple instruments at room temperature unless otherwise noted.

Number of Channels

Number of Channels				
Model	DSG5122	DSG5124	DSG5126	DSG5128
	DSG5202	DSG5204	DSG5206	DSG5208
Number of Channels	2	4	6	8

Frequency

Frequency		
Frequency Range	DSG5122/DSG5124/DSG5126/ DSG5128	DSG5202/DSG5204/DSG5206/ DSG5208
	9 kHz to 12 GHz	9 kHz to 20 GHz
Frequency Resolution	0.01 Hz	
Setting Time ^[1]	CW mode, temperature range 20°C to 30°C	
	<3 ms (typ.)	

Note:[1] Time from receipt of SCPI command to within 0.1 ppm of final frequency.

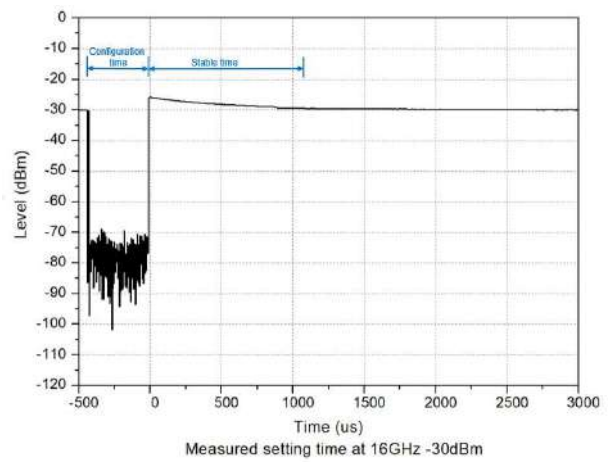
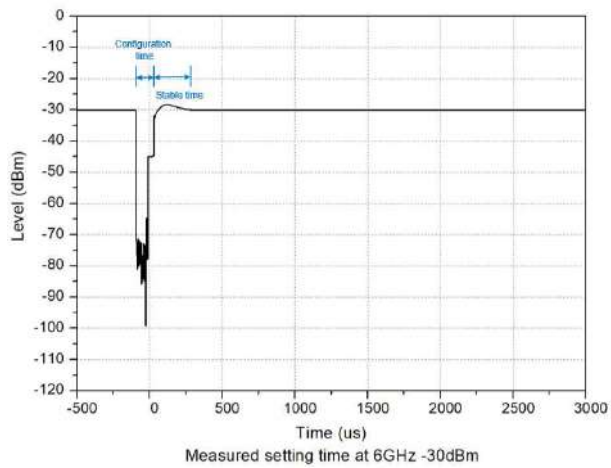

Frequency Band

Band	Frequency Range	N ^[1]
1	$9 \text{ kHz} \leq f \leq 1.5 \text{ GHz}$	1
2	$1.5 \text{ GHz} < f \leq 2.825 \text{ GHz}$	0.25
3	$2.825 \text{ GHz} < f \leq 5.65 \text{ GHz}$	0.5
4	$5.65 \text{ GHz} < f \leq 11.3 \text{ GHz}$	1
5	$11.3 \text{ GHz} < f \leq 20 \text{ GHz}$	2

Note:[1] N is a factor used to help define certain specifications in this manual.

Channel-to-Channel Phase Stability

	$f = 10 \text{ GHz}$, temperature variation $\leq 1^\circ\text{C}$
Channel-to-Channel Phase Stability	$\pm 1^\circ$

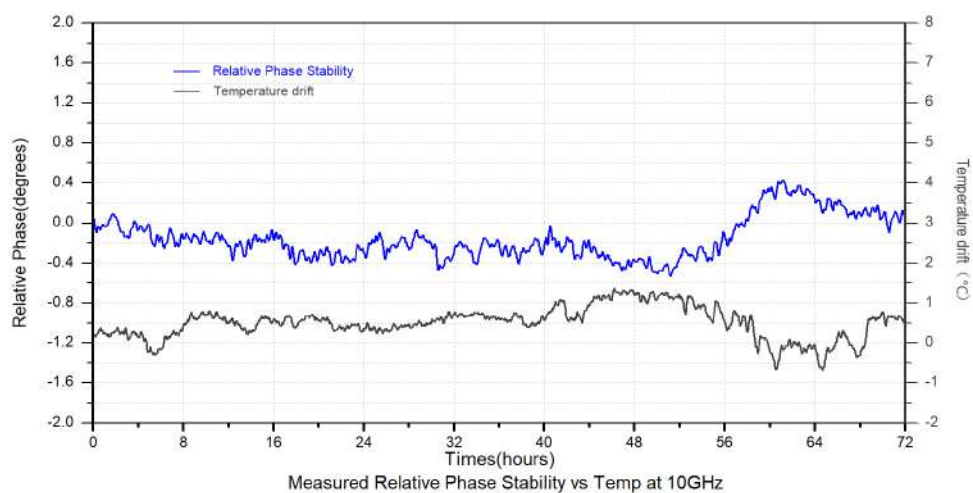

Frequency Reference

Clock Reference Output	Frequency	10 MHz
	Initial Calibration Accuracy	± 0.1 ppm
		± 10 ppb (with option OCXO-D08)
	Temperature Stability, temperature range 0°C to 50°C, reference to 25°C	± 0.5 ppm
		± 5 ppb (with option OCXO-D08)
	Aging Rate (after 30 consecutive days of working)	± 1 ppm/year
		± 30 ppb/year (with option OCXO-D08)
Output Amplitude	+5 dBm to +10 dBm	
Interface	BNC female	
External Reference Input	Frequency	10 MHz
	Input Amplitude	0 dBm to +10 dBm
	Max. Deviation	± 1 ppm
	Interface	BNC female
Sync Ref Frequency Output/Input	Freq	4.8 GHz
	Amplitude	-3 dBm to +3 dBm
	Interface	SMA female

Phase Setting

Phase Deviation Range	$\pm 180^\circ$
Phase Deviation Resolution	0.01°

Spectral Purity

Harmonic ^[1]	CW mode		
	10 MHz ≤ f ≤ 4 GHz	output level ≤ +10 dBm	<-30 dBc
	4 GHz < f ≤ 10 GHz	output level ≤ +10 dBm	<-50 dBc
	10 GHz < f ≤ 20 GHz	output level ≤ +7 dBm	<-30 dBc
Sub-harmonic	CW mode		
	11.3 GHz < f ≤ 20 GHz	<-60 dBm, <-70 dBc (typ.)	
Non-harmonic ^[2]	CW mode, output level > -10 dBm, carrier offset > 10 kHz		
	1 MHz ≤ f ≤ 1.5 GHz	<-60 dBm, <-70 dBc (typ.)	
	1.5 GHz < f ≤ 2.825 GHz	<-70 dBm, <-75 dBc (typ.)	
	2.825 GHz < f ≤ 5.65 GHz	<-64 dBm, <-69 dBc (typ.)	
	5.65 GHz < f ≤ 11.3 GHz	<-58 dBm, <-63 dBc (typ.)	
	11.3 GHz < f ≤ 20 GHz	<-52 dBm, <-57 dBc (typ.)	

Note:

[1] Applicable when the analog modulation is disabled.

[2] Exclude the frequency points related to 4800 MHz reference clock.

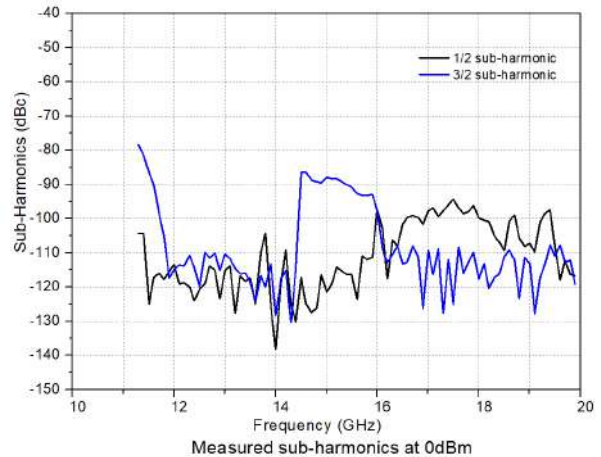
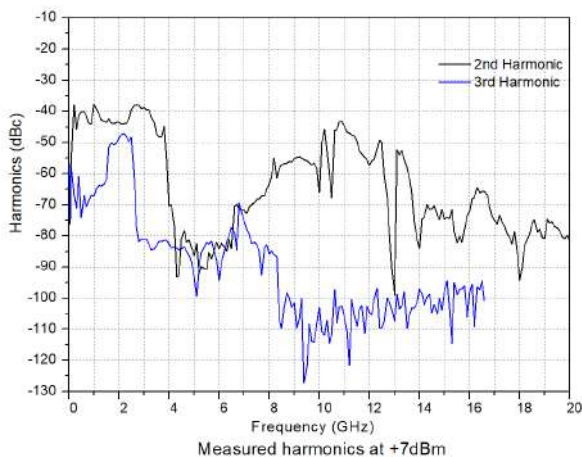

Sideband Noise

	CW mode, carrier offset = 10 kHz, 1 Hz measurement bandwidth	
SSB Phase Noise ^[1]	f = 1 GHz	< -130 dBc/Hz, < -133 dBc/Hz (typ.)
	f = 2 GHz	< -120 dBc/Hz, < -123 dBc/Hz (typ.)
	f = 4 GHz	< -114 dBc/Hz, < -117 dBc/Hz (typ.)
	f = 10 GHz	< -108 dBc/Hz, < -111 dBc/Hz (typ.)
	f = 20 GHz	< -102 dBc/Hz, < -105 dBc/Hz (typ.)
	CW mode, amplitude +10 dBm, carrier offset = 10 MHz, 1 Hz measurement bandwidth	
Wideband Noise	50 MHz ≤ f ≤ 1 GHz	< -140 dBc/Hz
	1 GHz < f ≤ 10 GHz	< -135 dBc/Hz
	10 GHz < f ≤ 20 GHz	< -130 dBc/Hz

Note:[1] Applicable when the analog modulation is disabled.

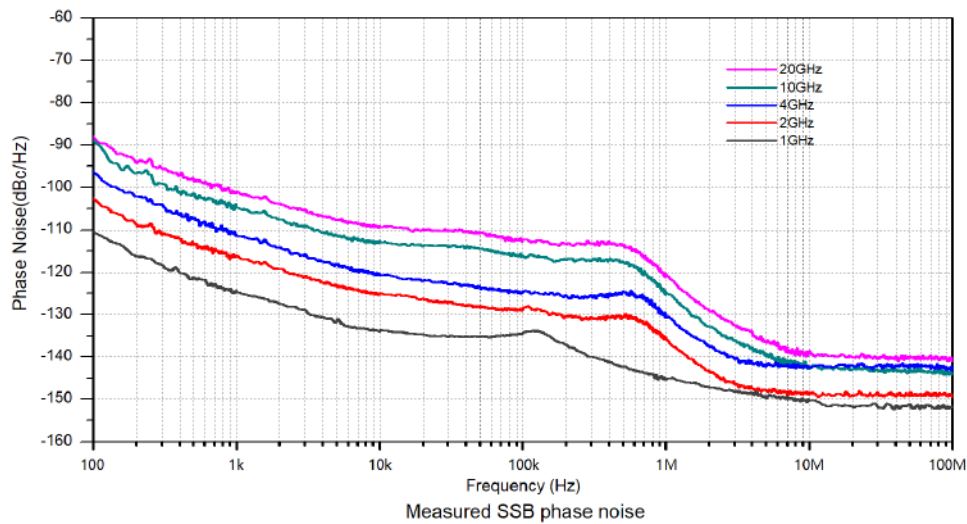

Amplitude

Output Level Setting Range

Frequency	Minimum Output Specification Level	Minimum Output Setting Level	Maximum Output Specification Level	Maximum Output Setting Level
$9 \text{ kHz} \leq f < 100 \text{ kHz}$	-	-30 dBm	-	+10 dBm
$100 \text{ kHz} \leq f < 2 \text{ MHz}$	-30 dBm	-30 dBm	+5 dBm	+15 dBm
$2 \text{ MHz} \leq f \leq 10 \text{ GHz}$	-30 dBm	-30 dBm	+13 dBm	+25 dBm
$10 \text{ GHz} < f \leq 17 \text{ GHz}$	-30 dBm	-30 dBm	+13 dBm	+20 dBm
$17 \text{ GHz} < f \leq 20 \text{ GHz}$	-30 dBm	-30 dBm	+10 dBm	+20 dBm

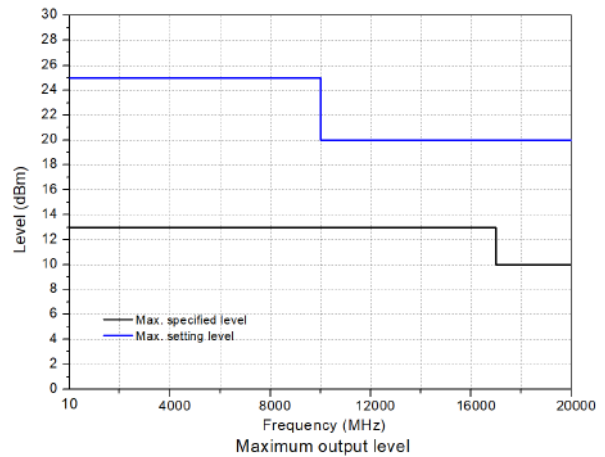
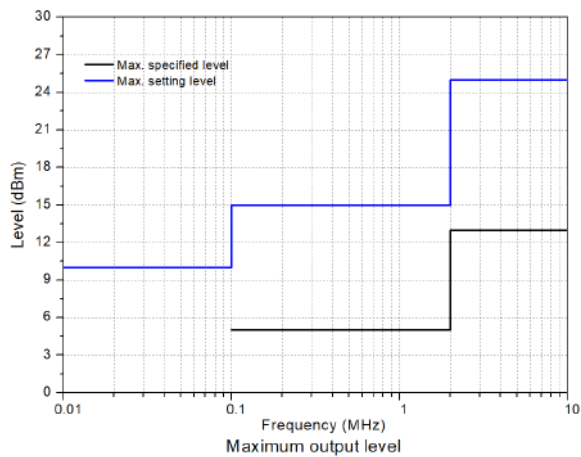

Setting Resolution

Setting Resolution	0.01 dB
--------------------	---------

Setting Time

Setting Time ^[1]	CW mode, temperature range 20°C to 30°C, fixed frequency
	<3 ms (typ.)

Note:[1] Time from receipt of SCPI command to within 0.1 dB of final level.

Absolute Level Uncertainty

	Temperature range 20°C to 30°C, output level -30 dBm to max. specification level	
Frequency	Specification	Typical
100 kHz ≤ f ≤ 1.5 GHz	±0.7 dB	± 0.5 dB
1.5 GHz < f ≤ 10 GHz	±0.9 dB	±0.7 dB
10 GHz < f ≤ 17 GHz	±1.1 dB	±0.9 dB
17 GHz < f ≤ 20 GHz	±1.3 dB	±1.1 dB

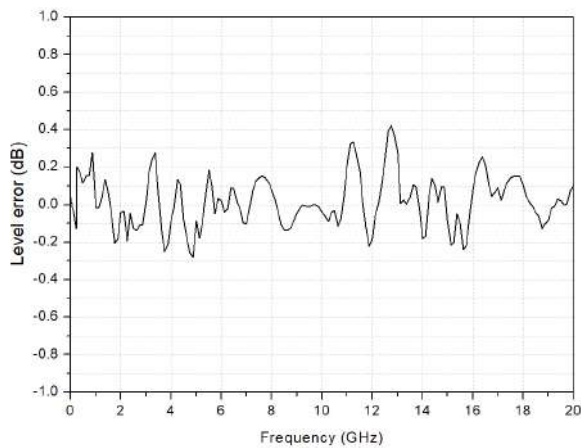

Measured at +10dBm, level error vs frequency

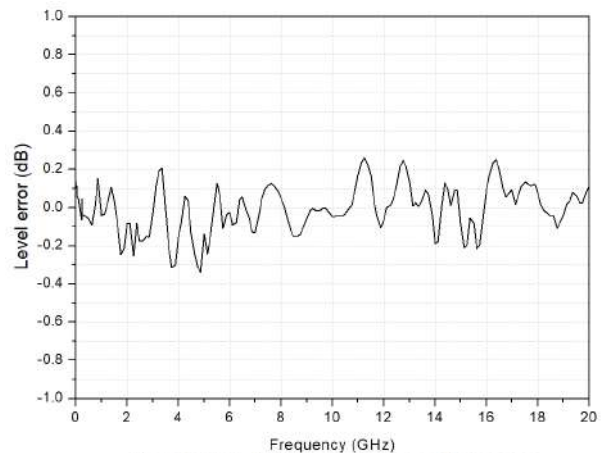

Measured at -30dBm, level error vs frequency

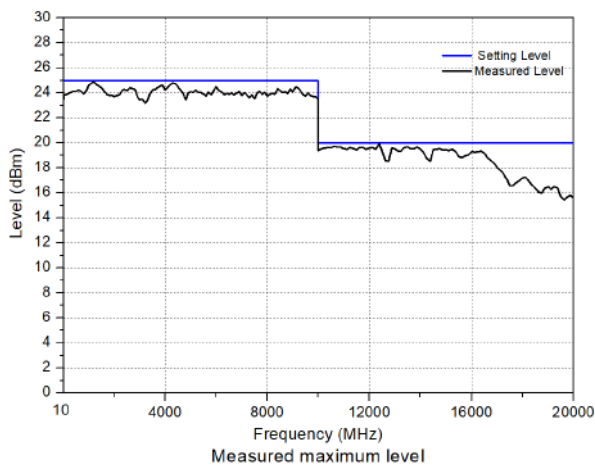

Measured maximum level

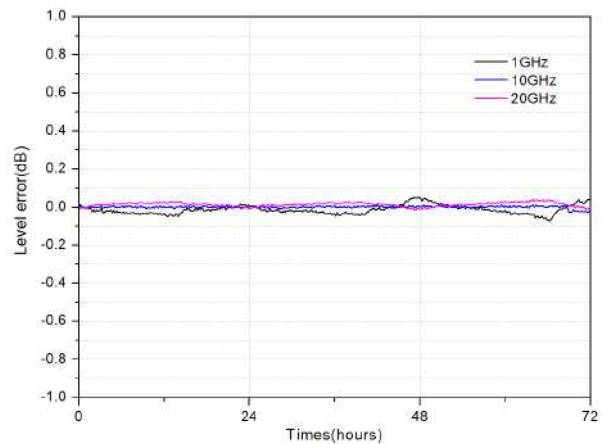

Measured level repeatability at 0dBm

Channel-to-Channel Isolation

Frequency	channel-to-channel isolation, output level= 0 dBm
$9 \text{ kHz} \leq f < 4 \text{ GHz}$	>85 dB (typ.)
$4 \text{ GHz} \leq f \leq 10 \text{ GHz}$	>80 dB (typ.)
$10 \text{ GHz} < f \leq 20 \text{ GHz}$	>75 dB (typ.)

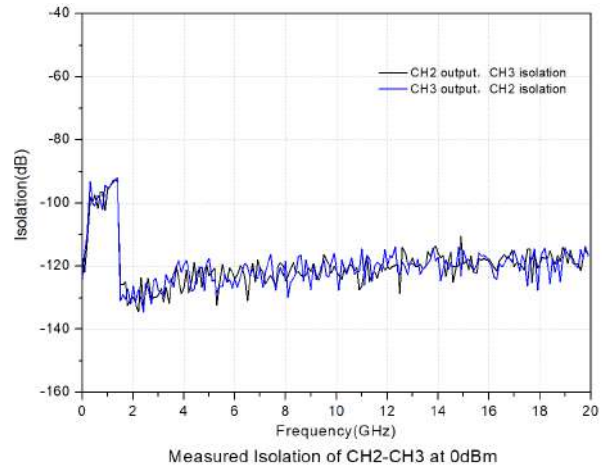
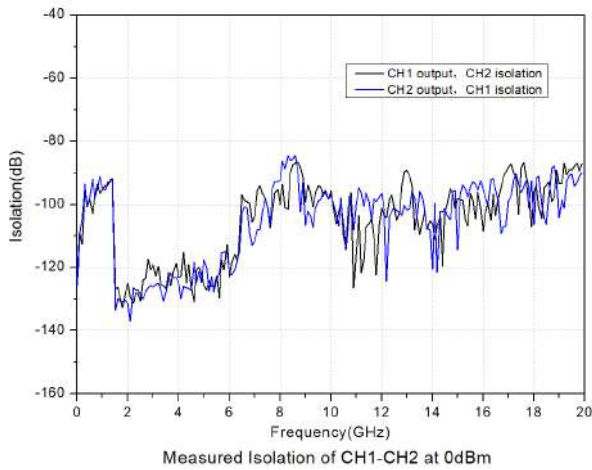

VSWR

	Temperature range 20°C to 30°C, output level < 0 dBm
$10 \text{ MHz} \leq f \leq 3 \text{ GHz}$	≤ 1.8 (nom.)
$3 \text{ GHz} < f \leq 6 \text{ GHz}$	≤ 2.0 (nom.)
$6 \text{ GHz} < f \leq 10 \text{ GHz}$	≤ 1.8 (nom.)
$10 \text{ GHz} < f \leq 20 \text{ GHz}$	≤ 2.2 (nom.)

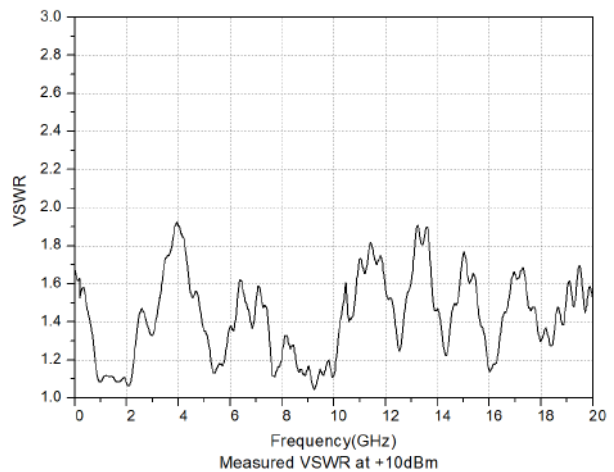
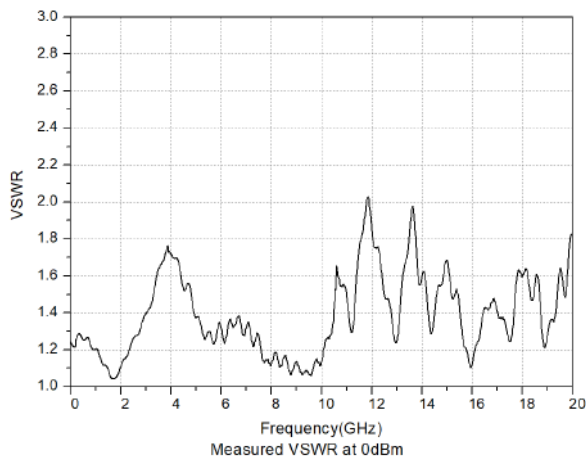

Max. Reverse Power		
Max. Reverse Power	Max. DC voltage	0V
	10 MHz < f ≤ 20 GHz	0.5 W

Sweep^[1]

Frequency Sweep	
Sweep Type	Step Sweep, List Sweep
Sweep Mode	Single, Continuous
Sweep Range	Within Full Frequency Range
Sweep Shape	Triangle and Ramp
Step Change	Linear or Log
Sweep Points ^[2]	2 to 1,001
Dwell Time	5 ms to 100 s
Trigger Type ^[3]	Auto, key, external, bus (USB and LAN)

Note:

[1] To optimize the sweep performance, you may find that when the dwell time is short, the displayed sweep state may not be synchronously updated with the output.

[2] Applicable to step sweep and list sweep.

[3] In external trigger, the trigger delay time is equal to the setting time.

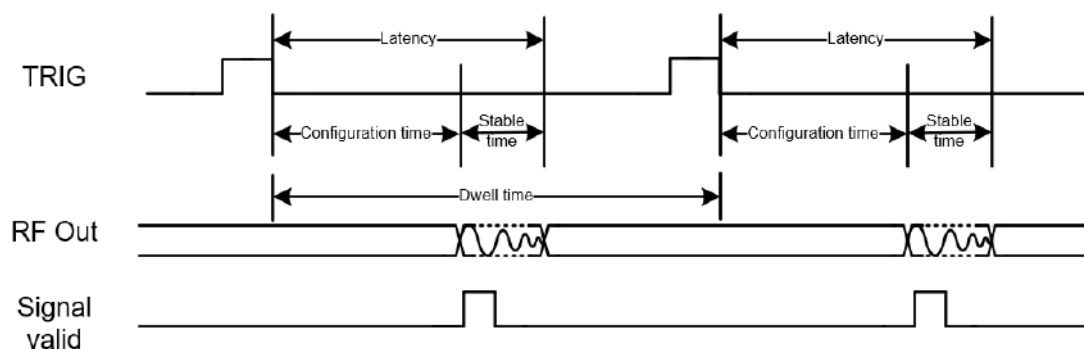

Time Definitions Triggered Pulse

Level Sweep

Sweep Type	Step Sweep, List Sweep
Sweep Mode	Single, Continuous
Sweep Range	Within Full Level Range
Sweep Shape	Triangle and Ramp
Step Change	Lin
Sweep Points ^[1]	2 to 1,001
Dwell Time	5 ms to 100 s
Trigger Type	Auto, key, external, bus (USB and LAN)

Note:[1] Applicable to step sweep and list sweep.

Modulation^[1]

Simultaneous Modulation

	Amplitude Modulation	Frequency Modulation	Phase Modulation	Pulse Modulation
Amplitude Modulation	-	○	○	△
Frequency Modulation	○	-	×	○
Phase Modulation	○	×	-	○
Pulse Modulation	△	○	○	-

NOTE:

○:compatible; ×: incompatible; △: compatible with AM performance reduced when pulse modulation is enabled

Note:[1] Unless otherwise specified, the specifications are applicable to the situation when the modulation source is Sine. Temperature range 20°C to 30°C, carrier frequency ≥ 1 MHz.

Amplitude Modulation (Option DSG5000-AMD)

Modulation Source	Internal, External
Modulation Depth ^[1]	0% to 100%
Resolution	0.1%
Setting Uncertainty	$f_c \leq 1.5 \text{ GHz}$, $f_{\text{mod}} = 1 \text{ kHz}$, $m < 30\%$, level = 0 dBm
	< 4% of setting + 1%
Distortion	$f_c \leq 1.5 \text{ GHz}$, $f_{\text{mod}} = 1 \text{ kHz}$, $m < 30\%$, level = 0 dBm
	< 3% (typ.)
Modulation Frequency Response	$m < 80\%$, DC/10 Hz to 100 kHz
	<3 dB (nom.)

Note:[1] The envelop peak power shall not be greater than the maximum value of the specification output range.

Frequency Modulation (Option DSG5000-AMD)

Modulation Source	Internal, External
Max. Deviation ^[1]	$f \leq 1.5 \text{ GHz}$
	2 MHz (nom.)
Resolution	<0.1% of deviation, or 1 Hz, whichever is greater (nom.)
Setting Uncertainty	$f \leq 1.5 \text{ GHz}$, $f_{\text{mod}} = 1 \text{ kHz}$, internal mode
	< 2% of setting + 20 Hz
Distortion	$f \leq 1.5 \text{ GHz}$, $f_{\text{mod}} = 1 \text{ kHz}$, deviation = 50 kHz
	< 2% (typ.)
Modulation Frequency Response ^[2]	DC/10 Hz to 100 kHz
	<3 dB (nom.)

Note:

[1] The settable max. frequency offset for other frequency bands is $N \times 2\text{MHz}$.

[2] External modulation, measured at 100 kHz offset.

Phase Modulation (Option DSG5000-AMD)

Modulation Source	Internal, External
Max. Deviation ^[1]	$f \leq 1.5$ GHz
	5 rad (nom.)
Resolution	<0.1% of deviation, or 0.01 rad, whichever is greater (nom.)
Setting Uncertainty	$f \leq 1.5$ GHz, $f_{\text{mod}} = 1$ kHz, internal mode
	<1% of setting + 0.1 rad
Distortion	$f \leq 1.5$ GHz, $f_{\text{mod}} = 1$ kHz, deviation = 5 rad
	< 1% (typ.)
Modulation Frequency Response ^[2]	DC/10 Hz to 100 kHz
	<3 dB (nom.)

Note:

[1] The settable max. frequency deviation for other frequency bands is $N \times 5$ rad.

[2] External modulation, measured at 5 rad deviation.

Pulse Modulation (Option DSG5000-PUL)

Modulation Source	Internal, External	
On/Off Ratio	$f \leq 6$ GHz	>80 dB (typ.)
	$6 \text{ GHz} < f \leq 11 \text{ GHz}$	>70 dB (typ.)
	$f > 11 \text{ GHz}$	>60 dB (typ.)
Rise/Fall Time (10%/90%)	<50 ns, 20 ns (typ.)	
Pulse Repetition Frequency	DC to 1 MHz	

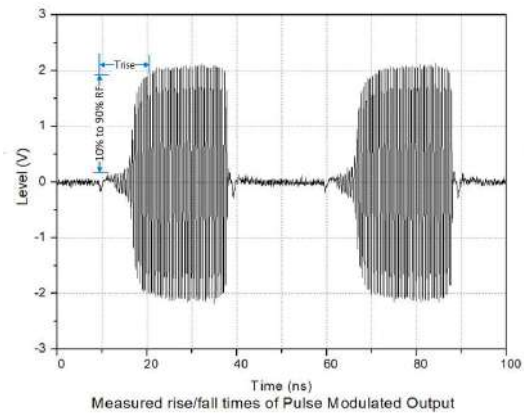
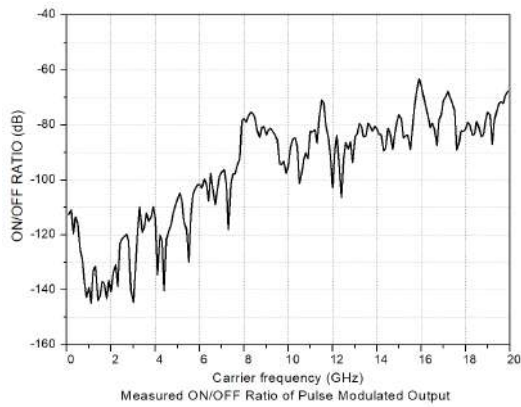

Pulse Generator

Operating Mode	Single, Train ^[1]	
Pulse Period	Setting Range	40 ns to 170 s
	Resolution	10 ns
Pulse Width	Setting Range	10 ns to (170 s - 10 ns)
	Resolution	10 ns
Trigger Delay	Setting Range	10 ns to 170 s
	Resolution	10 ns
Trigger Type	Auto, external trigger, external gate, trigger key, bus (USB and LAN)	

Note:[1] Required to install the option DSG5000-PUG.

Pulse Train Generator (Option DSG5000-PUG)

Pulse Train Generator	Number of Pulse Patterns	1 to 2,047
	On/Off Time Range	20 ns to 170 s
	Repetition Per Pattern	1 to 256

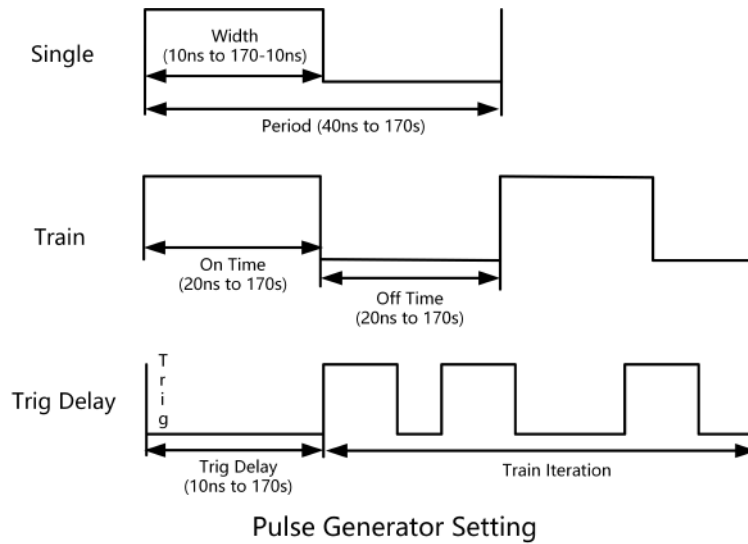

General Specifications

Front Panel Connector (independent of each other)		
RF Output	Impedance	50 Ω (nom.)
	Connector	3.5 mm male
External Trigger Input	Impedance	1 k Ω (nom.)
	Connector	SMB male
	Trigger Voltage	3.3 V TTL Level
Signal Valid Output	Connector	SMB male
	Output Voltage	0 V/3.3 V (nom.)
Pulse Input or Output	Impedance	50 Ω (nom.)
	Input/Output Voltage	0 V/3.3 V (nom.)
	Connector	SMB male
Sweep Output	Connector	SMB male
	Output Voltage	0 V to 10 V (nom.)

Rear Panel Connector

External Modulation Signal Input	Impedance	100 k Ω /600 Ω / 50 Ω (nom.)
	Coupling Mode	AC/DC
	Sensitivity	1 V _{pp} for indicated depth (nom.)
	Connector	BNC female
10 MHz IN (External Frequency Reference Input)	Impedance	50 Ω (nom.)
	Connector	BNC female
10 MHz OUT (External Frequency Reference Output)	Impedance	50 Ω (nom.)
	Connector	BNC female
4.8 GHz IN (Sync Reference Clock Input)	Impedance	50 Ω (nom.)
	Connector	SMA female
4.8 GHz OUT (Sync Reference Clock Output)	Impedance	50 Ω (nom.)
	Connector	SMA female

Communication Interface

USB3.0 HOST	Connector	A plug
	Protocol	3.0
	Qty.	4 (2 on the front panel and 2 on the rear panel)
USB3.0 DEVICE	Connector	B plug
	Protocol	Support TMC protocol
LAN	Connector	RJ-45
	Protocol	10/100/1000Base-T, LXI-C
HDMI	Connector	A plug
	Protocol	HDMI 1.4

Display	
Type	TFT LCD
Resolution	480×320
Dimensions	3.5-inch
Display Extension	Supports HDMI display extension

Mass Storage		
Mass Storage	Flash non-volatile memory (internal); USB storage device (not supplied)	
Data Storage Space	Flash non-volatile memory (internal)	10 GB (nom.)

Electromagnetic Compatibility and Safety

EMC	Conform to EMC Directive 2014/30/EU	
	Conform to or above IEC61326-1: 2013/EN61326-1: 2013, EN IEC 61000-3-2:2019+A1, EN 61000-3-3:2013+A1:2019	
	CISPR11:2009+A1 Class A	
	EN IEC 61000-3-2:2019+A1	harmonic, Class A
	EN 61000-3-3:2013+A1:2019	Voltage Flickers
	EN61000-4-2:2009	±4.0 kV (contact discharge) ±8.0 kV (air discharge)
	EN61000-4-3:2006+A1+A2	10 V/m (80 MHz to 1 GHz) 3V/m (1.4 GHz to 6 GHz)
	EN61000-4-4:2004+A1	2 kV power line
	EN61000-4-5:2006	1 kV (phase-to-neutral voltage) 2 kV (phase-to-earth voltage) 2 kV (neutral-to-earth voltage)
	EN61000-4-6:2009	10 V, 0.15-80MHz
EN61000-4-11:2004	Voltage dip: 0% UT during half cycle 0% UT during 1 cycle 70% UT during 25 cycles Short interruption: 0% UT during 250 cycles	
Safety	EN 61010-1:2010+A1:2019	
	IEC 61010-1:2010+A1:2016	
	UL 61010-1: 2012 R7.19	
	CAN/CSA-C22.2 NO. 61010-1-12 + GI1 + GI2 (R2017) + A1	

Power Supply

Input Voltage Range, AC	100 V to 240 V (nom.)	
AC Frequency Range	45 Hz to 440 Hz	
Power Consumption	With all the options working	<650 W

Environment

Temperature Range	Operating Temperature Range	0°C to +50°C
	Storage Temperature Range	-20°C to +70°C
Humidity Range	0°C to 30°C	≤ 90% RH
	30°C to 40°C	≤ 75% RH
	40°C to 50°C	≤ 45% RH
Altitude	Operating Height	below 3,000

Dimensions

(W x H x D)	435 mm x 88 mm x 486.3 mm (without pads, with the connector)	
	459 mm x 112 mm x 511 mm (with pads)	

Weight

Weight (Package Excluded)	<14 kg
---------------------------	--------

Calibration Interval

Recommended Calibration Interval	18 months
----------------------------------	-----------

Order Information and Warranty Period

Order Information

	Description	Order No.
Model	2-CH microwave signal generator, 9 kHz to 12 GHz	DSG5122
	4-CH microwave signal generator, 9 kHz to 12 GHz	DSG5124
	6-CH microwave signal generator, 9 kHz to 12 GHz	DSG5126
	8-CH microwave signal generator, 9 kHz to 12 GHz	DSG5128
	2-CH microwave signal generator, 9 kHz to 20 GHz	DSG5202
	4-CH microwave signal generator, 9 kHz to 20 GHz	DSG5204
	6-CH microwave signal generator, 9 kHz to 20 GHz	DSG5206
	8-CH microwave signal generator, 9 kHz to 20 GHz	DSG5208
Standard Accessories	Power Cord	-
Options	Pulse Modulation	DSG5000-PUL
	Pulse Train Generator	DSG5000-PUG
	Analog Modulation	DSG5000-AMD
	High Stability Clock (OCXO)	OCXO-D08
	Rack Mount Kit	RM2031

NOTE:

For all the mainframes, accessories, and options, please contact the local office of **RIGOL**.

Warranty Period

Three years for the mainframe, excluding the accessories.

HEADQUARTER

RIGOL TECHNOLOGIES CO., LTD.
No.8 Keling Road, New District, Suzhou,
JiangSu, P.R.China
Tel: +86-400620002
Email: info@rigol.com

EUROPE

RIGOL TECHNOLOGIES EU GmbH
Carl-Benz-Str.11
82205 Gilching
Germany
Tel: +49(0)8105-27292-0
Email: info-europe@rigol.com

NORTH AMERICA

RIGOL TECHNOLOGIES, USA INC.
10220 SW Nimbus Ave.
Suite K-7
Portland, OR 97223
Tel: +1-877-4-**RIGOL**-1
Fax: +1-877-4-**RIGOL**-1
Email: info@rigol.com

JAPAN

RIGOL TECHNOLOGIES JAPAN, LLC
501, LATORRETTA, 2-37-1,
Numabukuro,
Nakano-Ku, Tokyo, Japan
Tel: +81-3-6262-8932
Fax: +81-3-6262-8933
Email: info-japan@rigol.com

RIGOL® is the trademark of **RIGOL TECHNOLOGIES CO., LTD.** Product information in this document subject to update without notice. For the latest information about **RIGOL**'s products, applications and services, please contact local **RIGOL** channel partners or access **RIGOL** official website: www.rigol.com