



RIGOL

# DP900 Series

Programmable  
Linear DC Power Supply

Quick Guide  
Apr.2022

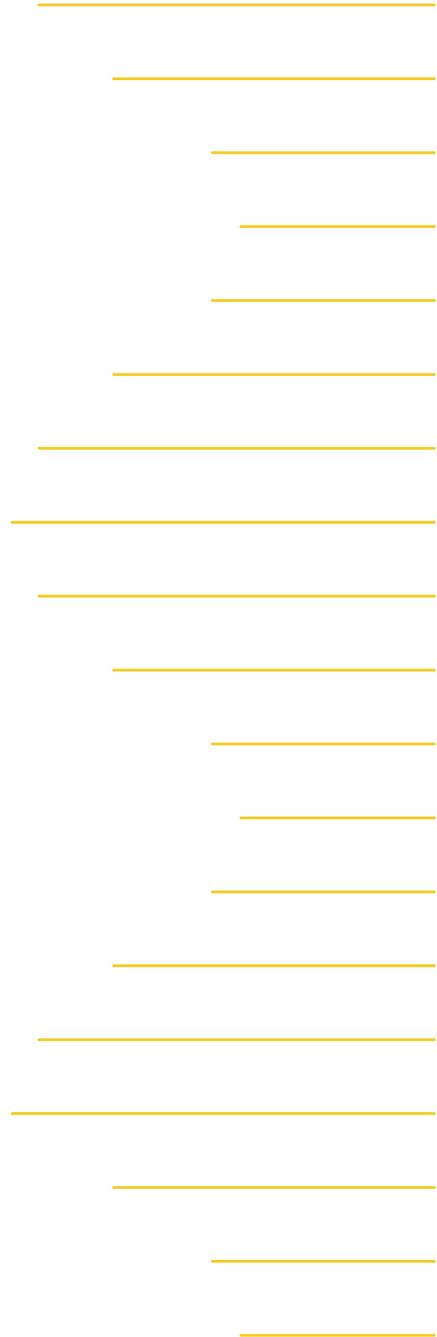

## **Guaranty and Declaration**

### **Copyright**

© 2022 RIGOL TECHNOLOGIES CO., LTD. All Rights Reserved.

### **Trademark Information**

RIGOL® is the trademark of RIGOL TECHNOLOGIES CO., LTD.

### **Software Version**

Software upgrade might change or add product features. Please acquire the latest version of the manual from **RIGOL** website or contact **RIGOL** to upgrade the software.

### **Notices**

- RIGOL products are covered by P.R.C. and foreign patents, issued and pending.
- RIGOL reserves the right to modify or change parts of or all the specifications and pricing policies at the company's sole decision.
- Information in this publication replaces all previously released materials.
- Information in this publication is subject to change without notice.
- RIGOL shall not be liable for either incidental or consequential losses in connection with the furnishing, use, or performance of this manual, as well as any information contained.
- Any part of this document is forbidden to be copied, photocopied, or rearranged without prior written approval of RIGOL.

### **Product Certification**

RIGOL guarantees that this product conforms to the national and industrial standards in China as well as the ISO9001:2015 standard and the ISO14001:2015 standard. Other international standard conformance certifications are in progress.

### **Contact Us**

If you have any problem or requirement when using our products or this manual, please contact RIGOL.

E-mail: [service@rigol.com](mailto:service@rigol.com)

Website: <http://www.rigol.com>

# 1 Safety Requirement

## 1.1 General Safety Summary

Please review the following safety precautions carefully before putting the instrument into operation so as to avoid any personal injury or damage to the instrument and any product connected to it. To prevent potential hazards, please follow the instructions specified in this manual to use the instrument properly.

- |   |  |    |  |
|---|--|----|--|
| 1 | Only the exclusive power cord designed for the instrument and authorized for use within the destination country could be used. | 9  | Do not operate the instrument with suspected failures. |
| 2 | Ensure that the instrument is safely grounded.   | 10 | Provide adequate ventilation.                          |
| 3 | Observe all terminal ratings.  | 11 | Do not operate in wet conditions.                      |
| 4 | Use proper overvoltage protection.   | 12 | Do not operate in an explosive atmosphere.             |
| 5 | Do not operate without covers.   | 13 | Keep instrument surfaces clean and dry.                |
| 6 | Do not insert objects into the air outlet.   | 14 | Prevent electrostatic impact.                          |
| 7 | Use the proper fuse.   | 15 | Handle with caution.                                   |
| 8 | Avoid circuit or wire exposure.  |    |  |



### WARNING

Equipment meeting Class A requirements may not offer adequate protection to broadcast services within residential environment.

## 1.2 Safety Notices and Symbols

Safety Notices in this Manual:



### WARNING

Indicates a potentially hazardous situation or practice which, if not avoided, will result in serious injury or death.



### CAUTION

Indicates a potentially hazardous situation or practice which, if not avoided, could result in damage to the product or loss of important data.

**Safety Symbols on the Product:**

- **DANGER**

It calls attention to an operation, if not correctly performed, could result in injury or hazard immediately.

- **WARNING**

It calls attention to an operation, if not correctly performed, could result in potential injury or hazard.

- **CAUTION**

It calls attention to an operation, if not correctly performed, could result in damage to the product or other devices connected to the product.

**Safety Symbols on the Product:**

**Hazardous Voltage**



**Safety Warning**



**Protective Earth Terminal**

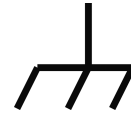

**Chassis Ground**



**Test Ground**

## 1.3 Measurement Category

**Measurement Category**

This instrument can make measurements in Measurement Category I.

**WARNING**

**This instrument can only be used for measurements within its specified measurement categories.**

**Measurement Category Definitions**

- **Measurement category I** is for measurements performed on circuits not directly connected to MAINS. Examples are measurements on circuits not derived from MAINS, and specially protected (internal) MAINS derived circuits. In the latter case, transient stresses are variable. Thus, you must know the transient withstand capability of the equipment.
- **Measurement category II** is for measurements performed on circuits directly connected to low voltage installation. Examples are measurements on household appliances, portable tools and similar equipment.
- **Measurement category III** is for measurements performed in the building installation. Examples are measurements on distribution boards, circuit-breakers, wiring (including cables, bus-bars, junction boxes, switches and socket-outlets) in the fixed installation, and equipment for industrial use and some other

equipment. For example, stationary motors with permanent connection to a fixed installation.

- **Measurement category IV** is for measurements performed at the source of a low-voltage installation. Examples are electricity meters and measurements on primary overcurrent protection devices and ripple control units.

## 1.4 Ventilation Requirement

This instrument uses a fan to force cooling. Please make sure that the air inlet and outlet areas are free from obstructions and have free air. When using the instrument in a bench-top or rack setting, provide at least 10 cm clearance beside, above and behind the instrument for adequate ventilation.



### CAUTION

Inadequate ventilation may cause an increase of temperature in the instrument, which would cause damage to the instrument. So please keep the instrument well ventilated and inspect the air outlet and the fan regularly.

## 1.5 Working Environment

### Temperature

Operating: 0°C to +50°C

Non-operating: -30°C to +70°C

### Humidity

- **Operating:**
  - Below +30°C: ≤90%RH (without condensation)
  - +30°C to +40°C: ≤75% RH (without condensation)
  - +40°C to +50°C: ≤45%RH (without condensation)
- **Non-operating:**
  - Below +65°C: ≤90%RH (without condensation)



### WARNING

To avoid short circuit inside the instrument or electric shock, never operate the instrument in a humid environment.

### Altitude

- **Operating:** below 3 km
- **Non-operating:** below 15 km

### Protection Level Against Electric Shock

ESD  $\pm 8\text{kV}$

### Installation (Overvoltage) Category

This product is powered by mains conforming to installation (overvoltage) category II.



#### WARNING

Ensure that no overvoltage (such as that caused by a bolt of lightning) can reach the product. Otherwise, the operator might be exposed to the danger of an electric shock.

### Installation (Overvoltage) Category Definitions

Installation (overvoltage) category I refers to signal level which is applicable to equipment measurement terminals connected to the source circuit. Among these terminals, precautions are done to limit the transient voltage to a low level.

Installation (overvoltage) category II refers to the local power distribution level which is applicable to equipment connected to the AC line (AC power).

### Pollution Degree

Pollution Degree 2

#### Pollution Degree Definition

- **Pollution Degree 1:** No pollution or only dry, nonconductive pollution occurs. The pollution has no effect. For example, a clean room or air-conditioned office environment.
- **Pollution Degree 2:** Normally only nonconductive pollution occurs. Temporary conductivity caused by condensation is to be expected. For example, indoor environment.
- **Pollution Degree 3:** Conductive pollution or dry nonconductive pollution that becomes conductive due to condensation occurs. To be found in industrial environment or construction sites (harsh environments). For example, sheltered outdoor environment.
- **Pollution Degree 4:** The pollution generates persistent conductivity caused by conductive dust, rain, or snow. For example, outdoor areas.

### Safety Class

Class 1 – Grounded Product

## 1.6 Care and Cleaning

### Care

Do not store or leave the instrument where it may be exposed to direct sunlight for long periods of time.

## Cleaning

Clean the instrument regularly according to its operating conditions.

1. Disconnect the instrument from all power sources.
2. Clean the external surfaces of the instrument with a soft cloth dampened with mild detergent or water. Avoid having any water or other objects into the chassis via the heat dissipation hole. When cleaning the LCD, take care to avoid scarifying it.



### CAUTION

To avoid damage to the instrument, do not expose it to caustic liquids.



### WARNING

To avoid short-circuit resulting from moisture or personal injuries, ensure that the instrument is completely dry before connecting it to the power supply.

## 1.7 Environmental Considerations

The following symbol indicates that this product complies with the WEEE Directive 2002/96/EC.



The equipment may contain substances that could be harmful to the environment or human health. To avoid the release of such substances into the environment and avoid harm to human health, we recommend you to recycle this product appropriately to ensure that most materials are reused or recycled properly. Please contact your local authorities for disposal or recycling information.

You can click on the following link <https://int.rigol.com/services/services/declaration> to download the latest version of the RoHS&WEEE certification file.

## 2 Document Overview

This manual gives you a quick overview of the front and rear panel, user interface, and basic operation methods of DP900 Series Programmable DC Power Supply.



### TIP

For the latest version of this manual, download it from the official website of RIGOL (<http://www.rigol.com>).

### Publication Number

QGH08100-1110

### Format Conventions in this Manual



#### 1. Key

The front-panel key is denoted by the menu key icon. For example, the  indicates the "Utility" shortcut key.

#### 2. Menu

The menu function key is denoted by the format of "Menu Name (Bold) + Character Shading" in the manual. For example, **System** indicates the "System" menu option in the operation interface. Tap **System** to access the "System" function menu.

#### 3. Operation Procedures

The ">" denotes the next step of the operation. For example,  > **Store** indicates first tapping , and then tapping **Store**.

### Content Conventions in this Manual

The following DP900 series power supply models are available. Unless otherwise specified, this manual takes DP932A as an example to illustrate the functions and operation methods of DP900 series power supply.

Model	Number of Channels	Output Voltage/Current
DP932A	3	32 V/3 A, 32 V/3 A, 6 V/3 A
DP932U	3	32 V/3 A, 32 V/3 A, 6 V/3 A
DP932E	3	30 V/3 A, 30 V/3 A, 6 V/3 A



## 3 General Inspection

---

### 1. Inspect the packaging

If the packaging has been damaged, do not dispose the damaged packaging or cushioning materials until the shipment has been checked for completeness and has passed both electrical and mechanical tests.

The consigner or carrier shall be liable for the damage to the instrument resulting from shipment. RIGOL would not be responsible for free maintenance/rework or replacement of the instrument.

### 2. Inspect the instrument

In case of any mechanical damage, missing parts, or failure in passing the electrical and mechanical tests, contact your RIGOL sales representative.

### 3. Check the accessories

Please check the accessories according to the packing lists. If the accessories are damaged or incomplete, please contact your RIGOL sales representative.

### Recommended Calibration Interval

RIGOL suggests that the instrument should be calibrated every 12 months.

## 4 Production Introduction

### 4.1 Appearance and Dimensions

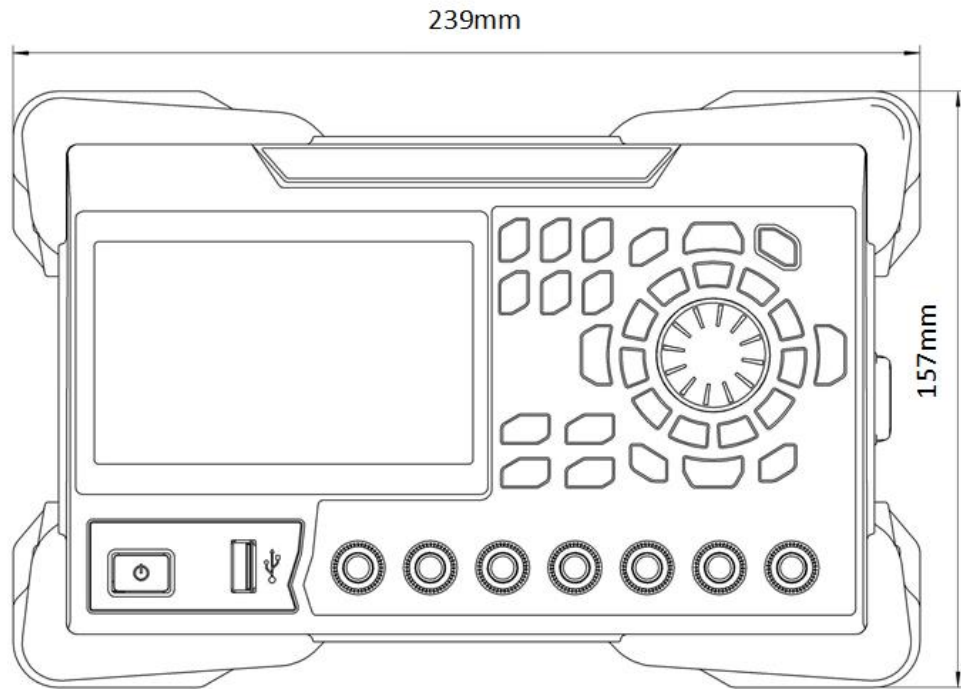

Figure 4.1 Front View

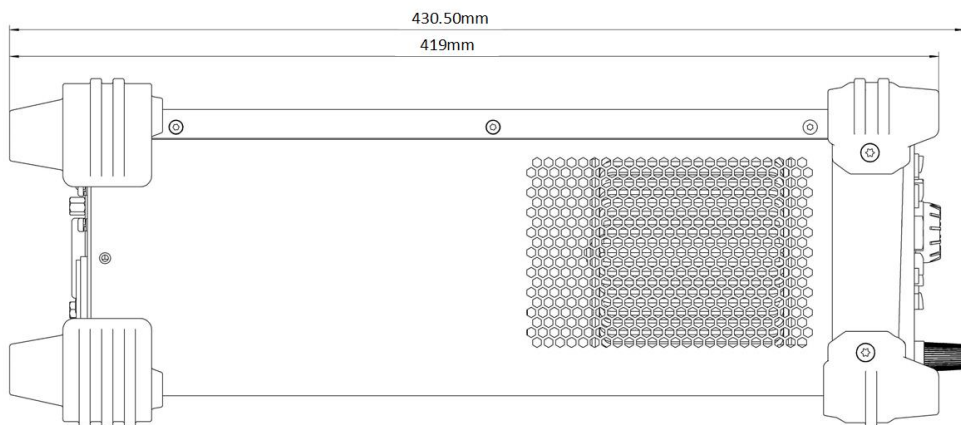
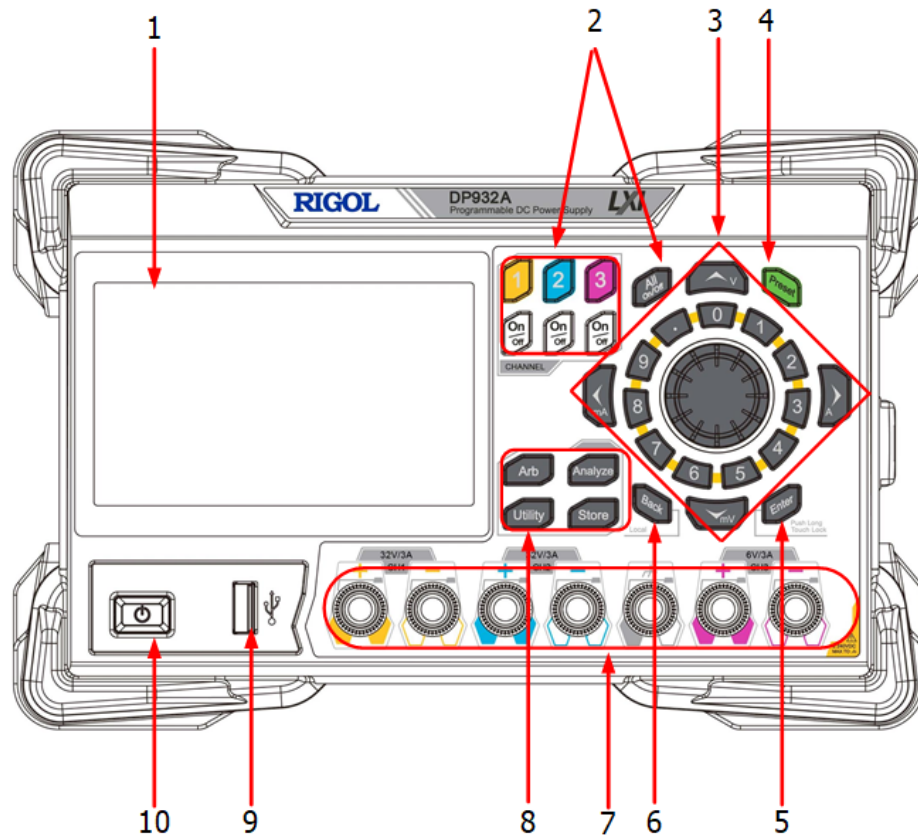

Figure 4.2 Side View

## 4.2 Front Panel

This section introduces the front panel of the DP900 series by taking DP932A (as shown in the figure below) as an example. The model-specific features will be introduced in particular.



**Figure 4.3 DP900 Front Panel**

### 1. LCD

4.3-inch TFT touch screen to display the the system parameter settings, output state, menu items, prompt messages, etc.

### 2. Channel Selection Keys and Output On/Off Keys

The keys are channel selection keys and output on/off keys.

**1** Press this key to select CH1 to control. You can set the parameters of this channel, such as voltage, current, and overvoltage/overcurrent protection.

**2** Press this key to select CH2 to control. You can set the parameters of this channel, such as voltage, current, and overvoltage/overcurrent protection.

**3** Press this key to select CH3 to control. You can set the parameters of this channel, such as voltage, current, and overvoltage/overcurrent protection.



Pressing this key can turn the corresponding channel on or off.



Press this key and a prompt message will be displayed asking whether to turn all channels on. Tap **OK** to turn all channels on. Pressing this key again can turn all channels off.

### 3. Parameter Input Area

As shown in the figure below, the parameter input area includes the arrow keys (unit selection keys), numeric keypad, and knob.

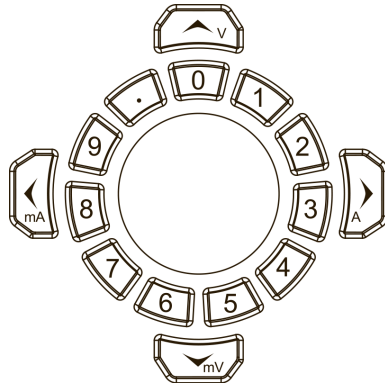

- Arrow keys/unit selection keys

Arrow keys: In normal mode, you can use the keys to navigate through the menu items; in parameter editing mode, you can use the left/right key to select the digit place or the up/down key to increment or decrement the value at the selected digit place. You can press the knob to enter or quit the parameter editing mode.

Unit selection keys: When setting parameters with front-panel numeric keypad, you can also use the arrow keys to select the unit of voltage (V/mV) or the unit of current (A/mA).

- Numeric keypad

Ring-type numeric keypad: The keypad is composed of numeric values from 0 to 9 and the decimal point. Pressing the corresponding key can directly input the number or decimal point.

- Rotary Knob

Press: When in normal mode, pressing the knob can switch to the editing mode; pressing the knob again can disable the editing mode.

Rotate: You can rotate the knob either clockwise or counter-clockwise. In normal mode, rotating the knob can navigate through the menu or menu items; after selecting an item to control, you can rotate the knob to increment or decrement the value or select options from a drop-down button.

### 4. Preset Key

 Press the key to restore the instrument to factory default (refer to *Factory Default Values*).

### 5. Enter Key

 Press the key to confirm your value.

Long pressing the key can lock the touch screen, for which you cannot configure the instrument using the touch screen. Long pressing the key again can unlock the touch screen.

### 6. Back Key

 Press the key to delete the character currently before the cursor.

When the instrument is in remote control, pressing this key can return to local (front panel) operation.

### 7. Output terminals

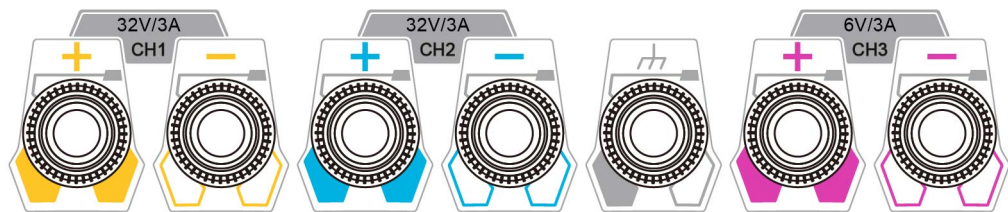



**Figure 4.4 DP900 Output Terminals**

- Channel output terminals: used to output voltage and current of the channel. Please refer to *Document Overview* for available output voltage/current range of the model.
- Earth ground terminal: be connected to the instrument chassis and earth ground (the ground terminal of the power cord) and is grounded.
- The output terminals of DP932U are safety sockets.

### 8. Function Menu

 Press this key to enter the Arb interface, in which you can set Arb parameters, and enable/disable the Arb function.

 Press this key to set the Analyzer interface, in which you can select the object to analyze and turn on/off the Logger.

 Press this key to enter the Utility setting interface, in which you can set parameters related to remote interface, system, outputs, and options. Besides, you can also set the display.



Press this key to enter the Store and Recall interface, in which you can save, read, delete, copy, or paste files. The file types available for storage include state file, log file, Arb file, calibration file, option installation verification file, and bitmap file. You are allowed to store a file to internal or external memory and also recall the file from internal or external memory.

**9. USB HOST Port**

The instrument only supports the flash memory USB storage device of FAT32 format.

**10. Power Switch Key**



Press this key to power on or off the instrument.

### 4.3 Rear Panel

This section introduces the rear panel of DP900 series by taking DP932A (as shown in the figure below) as an example.

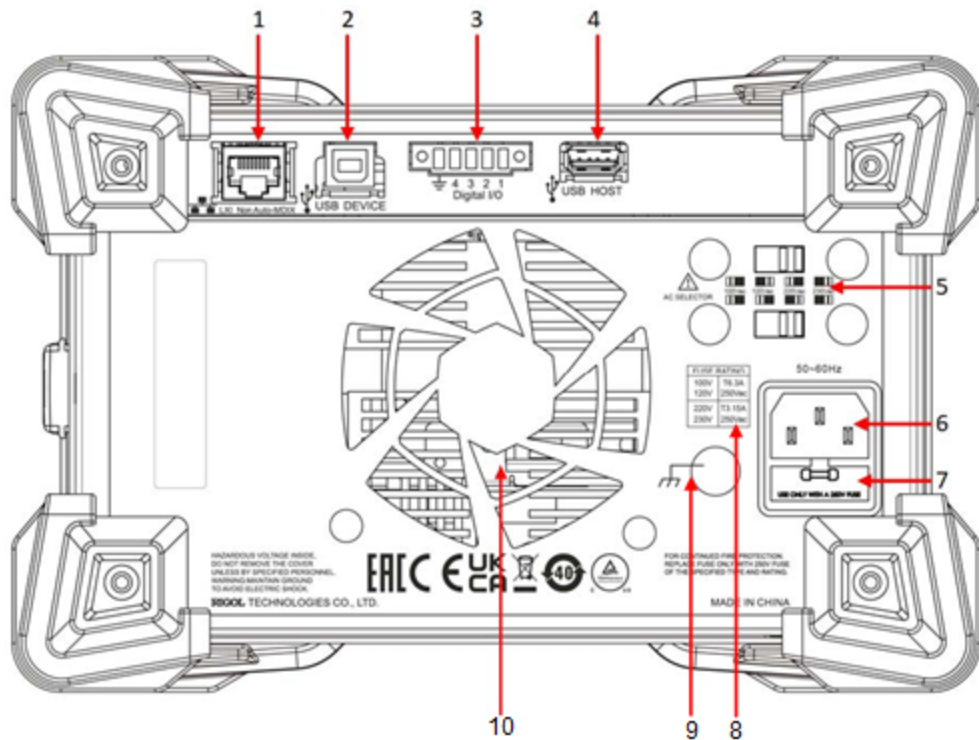



Figure 4.5 DP900 Rear Panel

Table 4.1 DP900 Rear Panel Description

No.	Name	Description
1	LAN port	The instrument is connected to the LAN network via RJ45 interface.
2	USB DEVICE	Connect the instrument (as "slave" device) to external USB device (such as PC).
3	Digital I/O <sup>[1]</sup>	Digital I/O port
4	USB HOST	Connect the instrument (as "host" device) to external USB device (such as USB storage device).
5	AC selector	Select the specification of the input voltage: 100, 120, 220, or 230 (please refer to <i>Connecting to Power</i> ).
6	AC power inlet socket	AC inlet power connector
7	Fuse	The fuse rating is related to the instrument model and actual input voltage (please refer to <i>Table 5.2 Fuse Rating</i> ).
8	AC input power requirement	The table describes the relationship between the frequency and voltage of the input power, and fuse rating.
9	Ground terminal	-
10	Fan ventilation hole	-

**Note[1]:** Digital I/O is optional for DP932U and not available for DP932E

## 4.4 User Interface

Tap  > **Display** to assess the interface as shown in the figure below. This section introduces the meter-view display of the power supply.

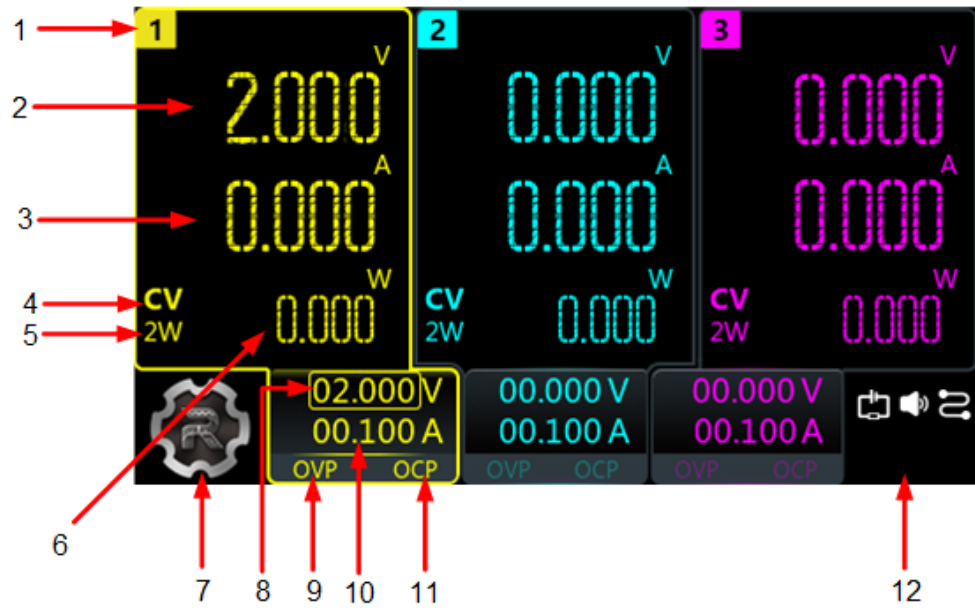













Figure 4.6 User Interface

Table 4.2 User Interface Description

No.	Description
1	Channel identifier
2	Actual output voltage
3	Actual output current
4	Output mode CV: The output is in constant voltage mode. CC: The output is in constant current mode. UR: The output is unregulated.
5	2-Wire sense connection
6	Actual output power
7	Navigation icon
8	Voltage setting value
9	Over-voltage protection (OVP) status indicator, indicating the present OVP on/off state



No.	Description
10	Current setting value
11	Over-current protection (OCP) status indicator, indicating the present OCP on/off state
12	<p>The following icons indicate the system status.</p> <p>: CH1 and CH2 are independent of each other.</p> <p>: CH1 and CH2 are connected in series.</p> <p>: CH1 and CH2 are connected in parallel.</p> <p>: over-temperature protection is tripped.</p> <p>: the screen is locked.</p> <p>: network connected.</p> <p>: a USB device is detected.</p> <p>: the instrument is in remote control.</p> <p>: the beeper is turned off.</p> <p>: the beeper is turned on.</p> <p>: downloading the firmware upgrade file.</p>

## 5 To Prepare for Use

### 5.1 Connecting to Power

DP900 series power supply supports various AC power inputs. The AC selector setting on the rear panel differs when input power is different, as shown in the table below.

**Table 5.1 AC input power specifications (including AC selector setting)**

AC input power	AC selector
100 Vac $\pm$ 10%, 50 Hz to 60 Hz	100
120 Vac $\pm$ 10%, 50 Hz to 60 Hz	120
220 Vac $\pm$ 10%, 50 Hz to 60 Hz	220
230 Vac $\pm$ 10% (Max. 250 Vac), 50 Hz to 60 Hz	230

Please connect the power strictly following the steps below.

#### 1. Check the Input Power

Please make sure that the input AC power fulfills the requirements in [Table 5.1 AC input power specifications \(including AC selector setting\)](#).

#### 2. Check the AC Voltage Selector on the Rear Panel

Please make sure that the AC voltage selector (100, 120, 220, or 230) on the rear panel is set to match the actual input voltage. To change the input AC voltage selector on the power supply, use the two AC selector switches on the rear panel of the power supply as shown below.

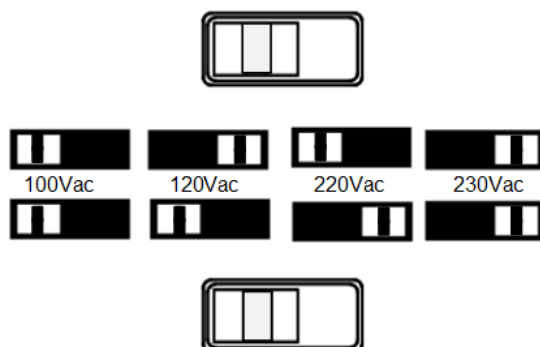

Please set the switches following the diagram above. For example, to select 100 V, slide both switches to the left; to select 220 V, slide the upper switch to the left and the lower switch to the right.

### 3. Check the Fuse

The instrument has been equipped with the specified fuse when it leaves factory. Please make sure that the fuse matches the actual input voltage by referring to "Input power requirement" or *Replacing the Fuse*.

### 4. Connect to AC Power

Please connect the instrument to AC power using the power cord provided in the accessories.



#### WARNING

To avoid electric shock, please make sure that the instrument is correctly grounded.

## 5.2 Power-on Inspection

Press the power key on the front panel to switch on the instrument. During the start-up process, the instrument performs a series of self-tests. If the instrument passes the self-test, the welcome interface will be displayed; otherwise, the corresponding self-test failure information will be displayed.



#### TIP

If you want to power on the instrument again after powering it off, please make sure that the time interval between the two power-on operations is greater than 5 s.

## 5.3 Connecting the Outputs

This series power supply provides three-channel outputs, which share the same connection method. Please follow the instructions below to connect the outputs.

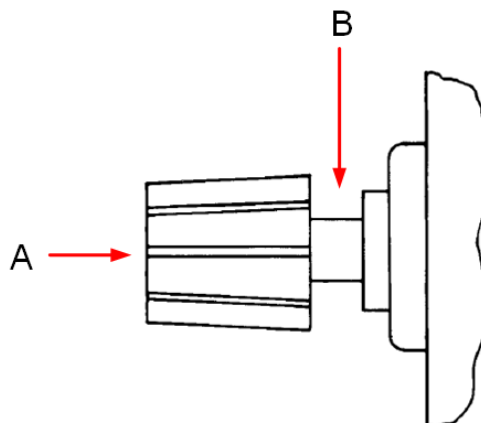

Method 1: Connect wires to the front of the terminals as shown in (A).

Method 2: Rotate the terminal block screws counter-clockwise and connect wires to the terminals in location (B). Then rotate the screws clockwise to tighten the wires. This method can help avoid errors caused by the terminal resistance.

**TIP**

As the output terminals of DP932U are safety sockets, “Method 2” is not supported.

**CAUTION**

**Turn off AC power before making front panel connections. All wires and straps must be properly connected to prevent currents from damaging the loads.**

## 5.4 Replacing the Fuse

The fuse rating required depends on the instrument model and actual input voltage, as shown in the table below. You can also refer to [Table 5.1 AC input power specifications \(including AC selector setting\)](#).

**Table 5.2 Fuse Rating**

AC Input Voltage	Fuse Rating
100 Vac/120 Vac	T6.3 A 250 Vac
220 Vac/230 Vac	T3.15 A 250 Vac

If you need to replace the fuse, please follow the steps below.

1. Power off the instrument and remove the power cord.
2. Insert a small straight screwdriver into the slot at the power socket and pry out the fuse holder gently.

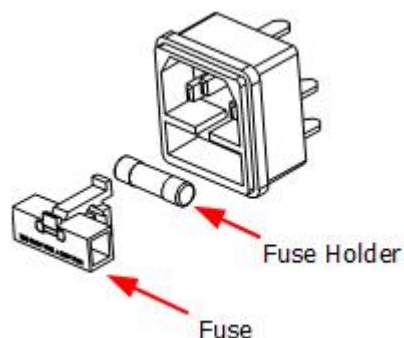

3. If necessary, please adjust the AC selector setting manually to select the voltage that matches the actual input voltage (please refer to [Connecting to Power](#)).
4. Remove the original fuse and insert the proper fuse into the fuse holder (please refer to the “Input power requirement” or [Replacing the Fuse](#)).

5. Re-insert the fuse holder into the power socket (please pay attention to the direction).

**WARNING**

**To avoid personal injury, please power off the power supply before replacing the fuse; to avoid electric shock or fire, select the input power that matches the actual input voltage and use the correct fuse before connecting to power.**

## 6 Using the Built-in Help System

Tap  > **Help** to enter the help interface as shown in the figure below. The built-in help system can help you learn about the instrument, obtain a list of help topics, and update instrument firmware.

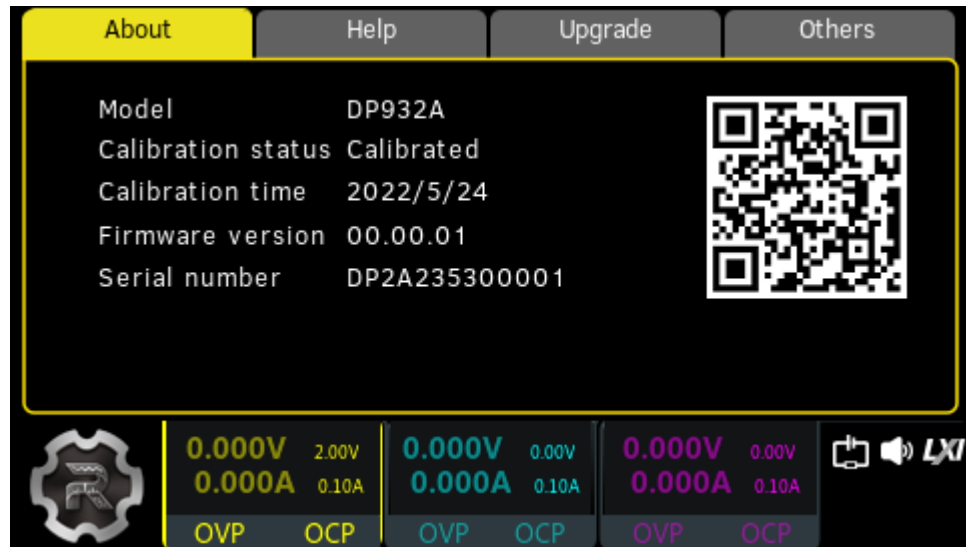

Figure 6.1 Help Interface

### About

Tap **About** to view the system information of the instrument, including the instrument model number, serial number, firmware version, and calibration time.

### Help

Tap **Help** to view the help information for front-panel keys or menu keys. You can tap a function key topic at the left side to obtain a detailed description of its function.

### Upgrade

Tap **Upgrade** to access the software upgrade interface. You can read the USB storage device and tap **Upgrade** to update instrument firmware. You can also connect the instrument to network and then tap **Remote** to download the firmware upgrade file ( is displayed in the notification area in the process). After the file is downloaded, the instrument restarts in 2 seconds and starts to upgrade.

### Others

Tap **Others** to enter the interface in which you can obtain the following help topics:

- View the last displayed message
- View remote command error queue

- [Contact RIGOL Technical Support](#)
- [Open source statement](#)

## 7 Troubleshooting

The following failures may occur during the use of the instrument. Please first try to handle the problem according to the following methods; if the problem remains unsolved, please contact RIGOL and provide the device information of your

instrument (by tapping  > **Help** > **About**).

### 1. The instrument does not start.

- a. Check whether the power cord is correctly connected.
- b. Check whether the power switch on the front panel is turned on.
- c. Unplug the power cord, and check whether the voltage selector is at the proper scale, whether the fuse specification is correct and the fuse is in good condition.

To replace the fuse, please refer to *Replacing the Fuse*.

- d. If the problem still persists, please contact RIGOL.

### 2. The constant voltage output is abnormal.

- a. Check whether the maximum output power of the selected meets the load requirement. If the load requirement is met, go to the next step.
- b. Check whether the cable connecting the load and power supply is short-circuited and whether it is in good contact.
- c. Check whether the load works normally.
- d. Check whether the current setting value of this scale is proper; if it is too low, increase the current setting value properly.
- e. If the problem still persists, please contact RIGOL.

### 3. The constant current output is abnormal.

- a. Check whether the maximum output power of the selected meets the load requirement. If the load requirement is met, go to the next step.
- b. Check whether the cable connecting the load and power supply is short-circuited and whether it is in good contact.
- c. Check whether the load works normally.



- d. Check whether the voltage setting value of this scale is proper; if it is too low, increase the voltage setting value properly.
- e. If the problem still persists, please contact RIGOL.

#### **4. The USB storage device cannot be recognized.**

- a. Check whether the USB storage device can work normally.
- b. Make sure that a flash memory USB storage device of FAT32 format is used, as this instrument does not support hard disk USB storage device.
- c. Restart the instrument and insert the USB storage device to check.
- d. If the USB storage device still cannot work normally, please contact RIGOL.

## 8 Remote Control

The instrument can be remotely controlled by the following three methods:

- **User-defined Programming**

You can program and control the instrument by using the SCPI (Standard Commands for Programmable Instruments) commands. For details about the SCPI commands and programming, please refer to the *Programming Guide* of the series.

- **PC Software**

You can use the PC software to send commands to control the instrument remotely. Ultra Sigma of RIGOL is recommended. You can log in to RIGOL official website (<http://www.rigol.com>) to download the software.

Operation Procedures:

- Set up communication between the instrument and PC.
- Run Ultra Sigma and search for the instrument resources.
- Open the remote command control panel to send commands.

- **Web Control**

This instrument supports Web Control. When connected to the network, the Web Control will display the real-time interface displayed on the instrument screen. Through the Web Control method, you can migrant the device control to the control terminals (e.g. PC, Mobile, iPad, and other smart terminals) to realize remote control of the instrument. When you first log in to the Web Control, the user name is "admin" and password is "rigol".

This instrument can be connected to the PC via the USB or LAN interface to set up communication and realize remote control through the PC. The remote control is realized via SCPI commands.

**TIP**

Before setting up communication, please turn off the instrument to avoid causing damage to the communication interfaces.

## 9 More Product Information

---

### 1. Obtain the Device Information

Click or tap  > **Help** > **About** to obtain the information of the instrument, such as the model, serial number, firmware version number, and calibration time.

### 2. View the Option Information and Install the Option

In the **Utility** menu, click or tap **Option** to view the installation status of all options.

For more information about this instrument, please refer to the relevant manuals by logging in to the official website of RIGOL (<http://www.rigol.com>) to download them.

- *DP900 User Guide*: introduces the functions of the instrument and the operation methods, remote control methods, possible failures and solutions in using the instrument, specifications, and order information.
- *DP900 Programming Guide*: provides detailed descriptions of SCPI commands and programming examples of the instrument.
- *DP900 Datasheet*: provides the main features and technical specifications of the instrument.

#### HEADQUARTER

**RIGOL TECHNOLOGIES CO., LTD.**  
No.8 Keling Road, New District, Suzhou,  
JiangSu, P.R.China  
Tel: +86-400620002  
Email: info@rigol.com

#### EUROPE

**RIGOL TECHNOLOGIES EU GmbH**  
Carl-Benz-Str.11  
82205 Gilching  
Germany  
Tel: +49(0)8105-27292-0  
Email: info-europe@rigol.com

#### NORTH AMERICA

**RIGOL TECHNOLOGIES, USA INC.**  
10220 SW Nimbus Ave.  
Suite K-7  
Portland, OR 97223  
Tel: +1-877-4-**RIGOL**-1  
Fax: +1-877-4-**RIGOL**-1  
Email: info@rigol.com

#### JAPAN

**RIGOL JAPAN CO., LTD.**  
501, LATORRETTA, 2-37-1,  
Numabukuro,  
Nakano-Ku, Tokyo, Japan  
Tel: +81-3-6262-8932  
Fax: +81-3-6262-8933  
Email: info-japan@rigol.com

---

**RIGOL®** is the trademark of **RIGOL TECHNOLOGIES CO., LTD.** Product information in this document subject to update without notice. For the latest information about **RIGOL's** products, applications and services, please contact local **RIGOL** channel partners or access **RIGOL** official website: [www.rigol.com](http://www.rigol.com)