User's Guide

RIGOL

Publication number DM3-070920

September 2007

DM3000 Series Digital Multimeter

DM3061/2/3/4

DM3051/2/3/4

© Copyright RIGOL Technologies, Inc. 2007

All Rights Reserved

- Copyright © **RIGOL** TECHNOLOGIES, INC. 2007 All Rights Reserved.
- **RIGOL** products are protected by patent law in and outside of P.R. China.
- Information in this publication replaces that in all previously corresponding material.
- **RIGOL** Technologies, Inc. reserves the right to modify or change part of or all the specifications and pricing policies at company's sole decision.

NOTE: **RIGOL** is the registered trademark of **RIGOL** TECHNOLOGIES, INC.

Safety Notices

Review the following safety precautions carefully before operate the instrument to avoid any personal injury or to damage the instrument and any products connected to it.

To avoid potential hazards use the instrument in a manner only as specified by this user's guide.

The instrument should be serviced only by qualified personnel.

To Avoid Fire or Personal Injury.

Use proper power cord. Use only the power cord designed for your oscilloscope and authorized in your country.

Connect and Disconnect accessories properly. Do not connect or disconnect probes or test leads while they are connected to a voltage source.

Ground the instrument. This product is grounded through the protective terra conductor of the power cord. To avoid electric shock the grounding conductor must be connected to earth ground. Before making connections to the input or output terminals of the oscilloscope ensure that the instrument is properly grounded.

Connect the probe properly. The probes' ground terminals are at the same voltage level with earth terminal of the instrument. Do not connect the ground terminals to a high voltage.

Observe All Terminal Ratings. To avoid fire or shock hazard, observe all ratings and marks on the instrument. Follow the User's Guide for further ratings information before making connections to the instrument.

Do not operate without Covers. Do not operate your oscilloscope with covers or panels removed.

Use Proper Fuse. Use only the fuse type and rating specified for this product.

Avoid Circuit or Wire Exposure. Do not touch exposed connections and components when power is on.

Do not operate with suspected failures. If you suspect damage with this product, have it inspected by qualified service personnel who were authorized by **RIGOL** before further operations.

Provide Proper Ventilation. Refer to the manual's installation instructions for details as to the oscilloscope has proper ventilation.

Do not operate in wet/damp conditions.

Do not operate in an explosive atmosphere.

Keep product surfaces clean and dry.

The disturbance test of all the models can meet the limit values of A in the standard of EN 61326: 1997+A1+A2+A3, but can't meet the limit values of B.

Safety Terms and Symbols

Terms in This Guide. These terms may appear in this guide:



WARNING: Warning statements identify conditions or practices that could result in injury or loss of life.



CAUTION: Caution statements identify conditions or practices that could result in damage to this product or other property.



CAT II (300V): IEC Measurement Category II. Inputs may be connected to mains (up to 300 VAC) under Category II overvoltage conditions.

Terms on the Product: These terms may appear on the product:

DANGER indicates an injury hazard may happen immediately.

WARNING indicates an injury hazard may not happen immediately.

CAUTION indicates that a potential damage to the instrument or other property might occur.

Symbols on the Product: These symbols may appear on the Instrument:



Hazardous Voltage



Refer to Instructions



Protective Earth Terminal



Grounding Terminal of Chassis



Test Grounding Terminal

General-Purpose Multimeter

The book covers the following description and eight models DM3000 Series Digital Multimeter:

DM3061, DM3062, DM3063, DM3064;

DM3051, DM3052, DM3053, DM3054.

DM3000 Series Digital Multimeter desktop naming rules:

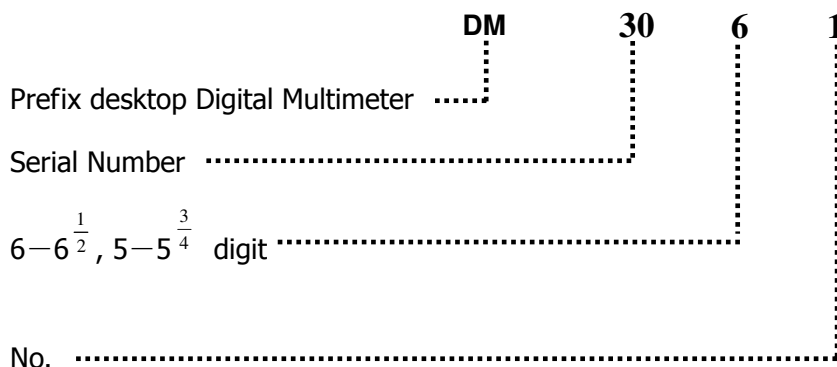

1—Basic; 2—Interface models with expansion board;

3—Inspection plate with the model;

4—Inspection plate with the model and interface extended board.

Application examples:

DM3061— $6^{\frac{1}{2}}$ DM3000 series, Basic type.

DM3062— $6^{\frac{1}{2}}$ DM3000 series, Basic type. Append the interface board with LAN/GPIB module.

DM3063— $6^{\frac{1}{2}}$ DM3000 Series, Basic type. Append the inspection board.

DM3064— $6^{\frac{1}{2}}$ DM3000 series, Basic type. Append the interface board with LAN/GPIB and inspection board.

RIGOL DM3000-Series Digital Multimeter is a high-precision, multifunction, multi-automatic measurement for user's designment of products, including $6\frac{1}{2}$ digits multimeter, high-speed data acquisition, automatic measurement and inspection, many mathematical transform, in one of sensor measurements and other functions. In support RS-232, USB, LAN and GPIB interface. It supports U disk storage and print.

In performance, the DM3000 has high-resolution monochrome LCD display system, supports a simple waveform display and data recording waveform display; clear and easy to operate the button backlight keyboard layout and operation make it more flexible, user-friendly operating features; 50k/s high data sampling rate, can be used, such as the rapidly changing high-precision audio waveform data; depth 2Mbyte of internal storage, external storage can be arbitrary depth; adopt true RMS AC voltage and current measurement; virtual terminal display and control, and remote network access.

From the performance and characteristics are given below, you will Understand how can DM3000 satisfy your measurement requirements.

- 50k/s data sampling rate can be used, such as the rapidly changing high-precision audio waveform data. Meanwhile waveform can be displayed on LCD Screen
- Measurement accuracy: more than $6\frac{1}{2}$ and 2,400,000 Count
- 26 measurement functions
 - ◇ DC voltage and current, AC voltage and current, two-wire and four-wire resistance, capacitance, continuity test, diode test, frequency, cycle ratio measurements, arbitrary sensor measurement, And so on.
 - ◇ Upper limit and lower limit on the threshold measurement
 - ◇ Arithmetic include: maximum, minimum, average, dBm, dB
 - ◇ Data acquisition functions include : data records, inspection, automatic measurement
- True RMS AC voltage and current measurement
- 16- Road inspection functional measurement and control software (optional)
- DC voltage $>10G\Omega$ input impedance to achieve the scope of 48V ($\pm 24V$)
- With data acquisition function, the maximum sampling rate support to 50kSP/s
- 10 groups measuring set-up storage and embedded PC measuring set up

unlimited storage

- Saturating responses of 256 x 64 pixel monochrome LCD
- I/O: RS-232, USB, LAN and GPIB
- Built-in USB Host to support USB disk and USB printer
- Simple, convenient, flexible control software: Ultralogger, Supports for Microsoft® Windows 98/2000/Me/XP

Content

Safety Notices	II
General-Purpose Multimeter	V
CHAPTER 1 BASIC MULTIMETER OPERATIONS	1-1
General Inspection	1-2
Handle Adjustment.....	1-3
The Front/Rear Panel and User Interface.....	1-4
To Measure DC Voltage.....	1-7
To Measure AC Voltage	1-9
To Measure DC Current.....	1-11
To Measure AC Current	1-13
To Measure Resistance.....	1-15
To Measure Capacitance	1-19
To Test Continuity.....	1-21
To Check Diodes.....	1-23
To Measure Frequency and Period	1-25
To Measure Arbitrary Sensor	1-29
To Choose Digits resolving index	1-34
To Choose Data Digit Display	1-35
To Choose Range Options.....	1-36
To Control Trigger Options	1-38
CHAPTER 2 OPERATING YOUR MULTIMETER	2-1
To Set up Measurement Parameters.....	2-2
Math Functions	2-12
To Set Up Triggering Parameter Function.....	2-19
Store and Recall.....	2-27
To Set Up the Utility.....	2-32
High-speed Data Logger	2-46
Multi-route Scanning.....	2-53
How to Use the Built-in Help System	2-61
CHAPTER 3 APPLICATION & EXAMPLES	3-1
Example 1: Reading Statistic Functions	3-1
Example 2: Elimination Test Leads Resistance Error.....	3-3
Example 3: dB Measurement.....	3-4
Example 4: dBm Measurement	3-5

Example 5: Limit Test.....	3-6
Example 6: Temperature Sensor	3-7
Example 7: Reading Hold	3-11
CHAPTER 4 PROMPT MESSAGES& TROUBLESHOOTING	4-1
Prompting Message	4-1
Troubleshooting	4-3
CHAPTER 5 SUPPORT & SERVICE	5-4
CHAPTER 6 APPENDIX.....	6-1
Appendix A: Specifications	6-1
Appendix B: DM3000 Series Accessories	6-7
Appendix C: General Care and Cleaning	6-8

Chapter 1 Basic Multimeter Operations

This chapter covers the following topics:

- General Inspection
- Handle Adjustment
- The Front Panel and User Interface
- To Measure DC Voltage
- To Measure AC Voltage
- To Measure DC Current
- To Measure AC Current
- To Measure Resistance
- To Measure Capacitance
- To Test Continuity
- To Check Diodes
- To Measure Frequency and Period
- To Make an Arbitrary Sensor measurement
- To Choose Digits resolving index
- To Choose Data Digit Display
- To Choose Range Options
- To Control Trigger Options

General Inspection

After you get a new DM3000 Digital Multimeter, you are suggested the following steps to inspect the instrument.

1. Inspect the shipping container for damage.

Keep a damaged shipping container or cushioning material until the contents of the shipment have been checked for completeness and the instrument has been checked mechanically and electrically.

2. Check the accessories.

Accessories supplied with the instrument are listed in "Appendix B" in Chapter 6. If the contents are incomplete or damaged, please notify your **RIGOL** Sales Representative.

3. Inspect the instrument.

In case any mechanical damage or defect, or if the instrument does not operate properly or pass performance tests, notify your **RIGOL** Sales Representative.

If the shipping container is damaged, or the cushioning materials show signs of stress, notify the carrier as well as your **RIGOL** sales office. Keep the shipping materials for the carrier's inspection.

RIGOL offices will arrange for reparation or replacement at **RIGOL**'s option without waiting for claim settlement.

Handle Adjustment

To adjust the handle position of DM3000 Digital Multimeter, please grip the handle by the sides and pull it outward. Then, make the handle rotate to the desired position. The operation methods are shown in the graphs 1-1, 1-2, 1-3.

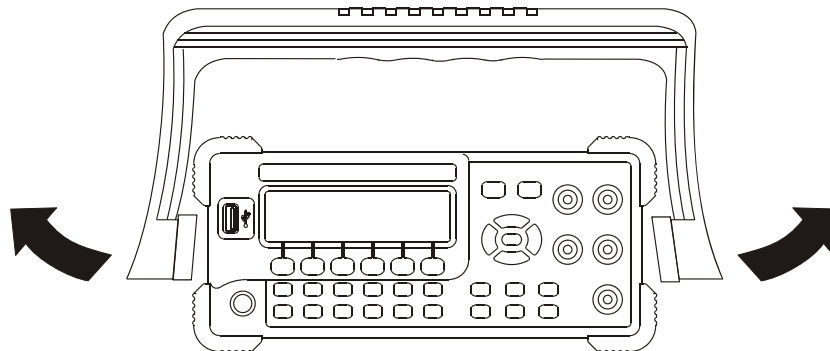

Figure 1-1

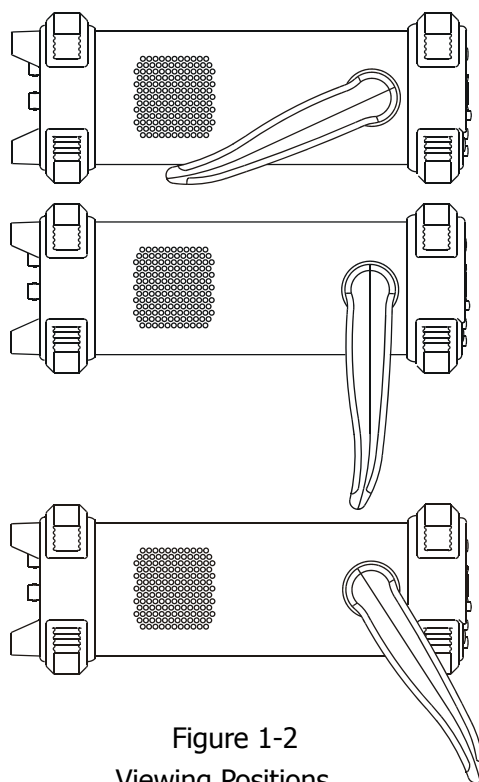

Figure 1-2
Viewing Positions

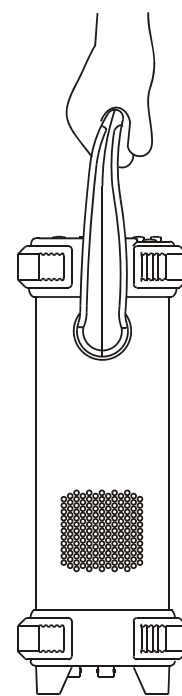

Figure 1-3
Carrying Position

The Front/Rear Panel and User Interface

After you get a new DM3000 Digital Multimeter, first, you need to clear how to operate the front panel of the DM3000 correctly. This chapter will make a brief introduction and description for the operation and functions of the Front Panel.

The front panel of the DM3000 is very simple and clear for users operation. The front panel include direction buttons and functions buttons.

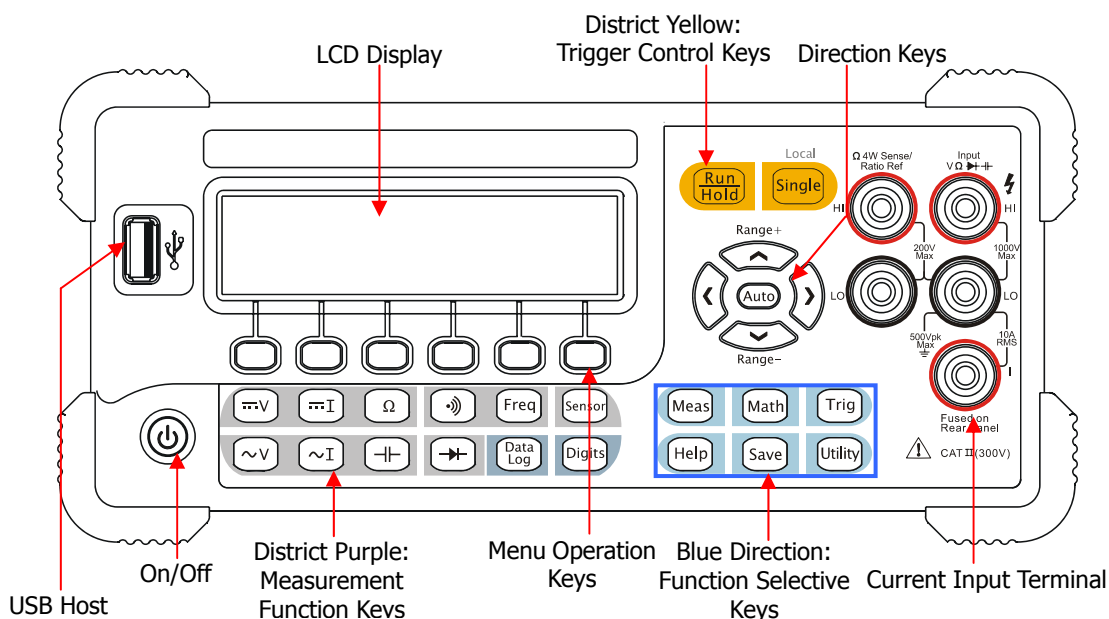

Figure 1-4

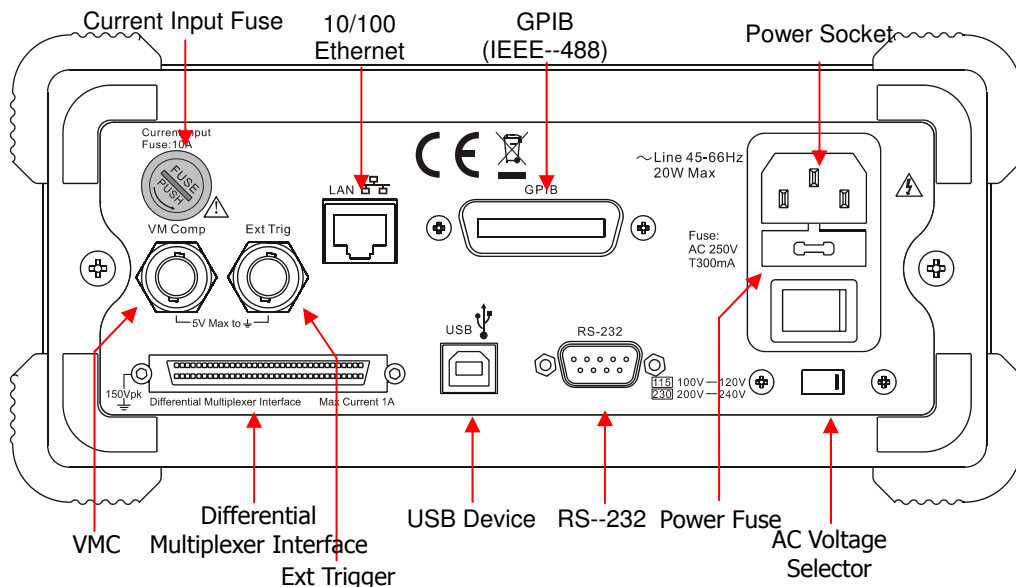

Figure 1-5

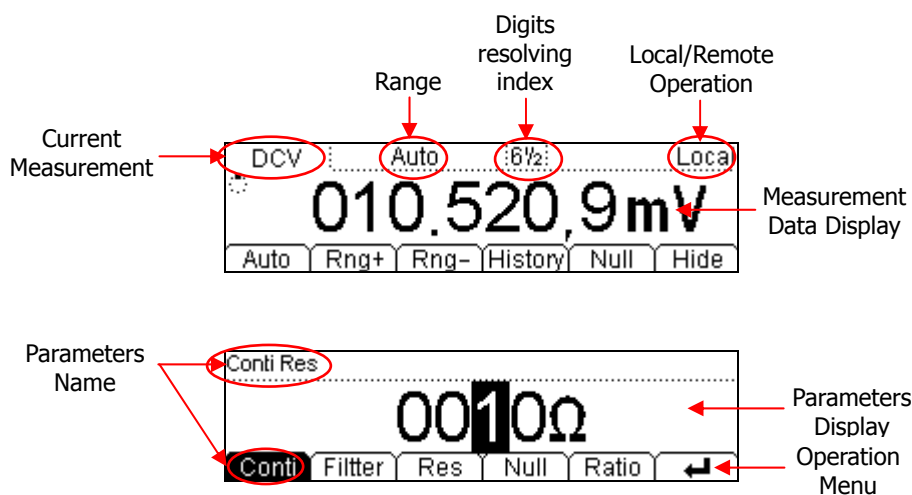

Figure 1-6
The interface explanation

How the definitions express in this book:

In this book, the regarding keys writing expression has the same log with the keys on the front panel. It is noteworthy that the menu operates keys, marking with the belt shadow. For example, Conti indicates the short circuit option in menu Meas.

To Measure DC Voltage

In view of DC voltage measurement function, the following part demonstrated how to link the measurement connection and how to choose measurement functions. The following practice will gradually guide you to be familiar with the DC Voltage measurement technique.

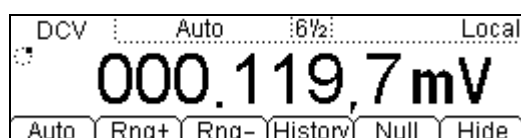





Figure 1-7

DC Voltage measurement data interface

Table 1-1 DC Voltage measurement characteristics

Five Range	200mV, 2V, 20V, 200V, 1000V
Max Resolution	100nV
Import Protection	1000V on all ranges (HI Terminal)
Configurable Parameters	Range, DC impedance, Null value

Basic measurement:

1. Connect test leads as Figure 1-8 shown. Red test lead connects the HI Terminal, Black test lead connects the LO Terminal.
2. Press  to select the DC Voltage measurement function.
3. According to the voltage measuring scope, choose the correct range.
4. Setup the DC impedance.
Press  → , to setup the DC input impedance. Default value of the DC input impedance will be 10MΩ, this parameter had been setup, and users may carry on the DC Voltage measurement directly without modification.
5. Set the Null value.

Null computing will be an option operation; it could be setup in accordance with user demand. If user does not implement Null computing, this parameter is not

required, direct implementation of the next step.
 (To know the specific setting methods of the Null value setting, please refer to Chapter 2 "To Set Up Measurement Parameters", Null computing)
 6. Lead test leads into circuit, start to measure.

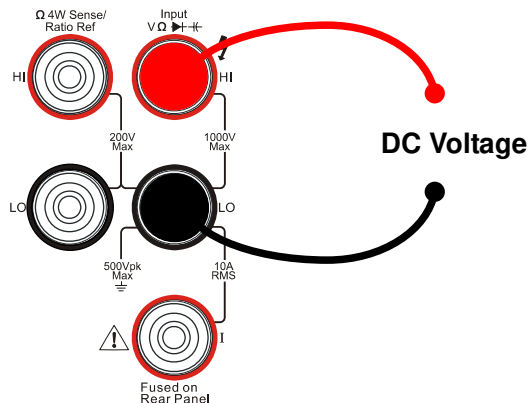

Figure 1-8
 DC Voltage measurement instruction chart

7. Measurement history data processing.
 Press **History**, enter the menu shown below:

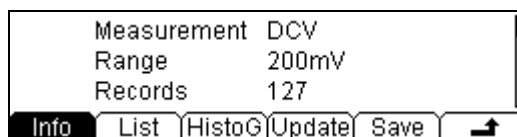

Figure 1-9

To check or save the data that has measured by current measurement function, you can use the history function. In this function you can get the "Info" (information), "List" and "Graph" of this measurement. Also, you can save this information data with press **Save** softkey.

Note
 If the users cannot predict the scope of the measurement, please choose Auto range to obtain more accurate measurement data.

To Measure AC Voltage

In view of AC voltage measurement function, the following part demonstrated how to link the measurement connection and how to choose measurement functions. The following practice will gradually guide you to be familiar with the AC Voltage measurement technique. (The AC functions only support $5\frac{1}{2}$ digits measurement.)

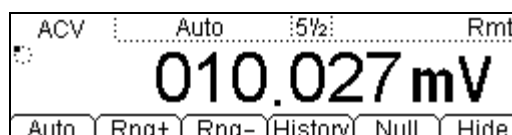

Figure 1-10

AC Voltage measurement data interface

Table 1-2 DC Voltage measurement characteristics

Five Range	200mV, 2V, 20V, 200V, 750V
Max Resolution	100nV
Import Protection	750V _{RMS} on all ranges (HI Terminal)
Configurable Parameters	Range, DC impedance, Null value

Basic measurement:

1. Connect test leads as Figure 1-11 shown. Red test lead connects the HI Terminal, Black test lead connects the LO Terminal.
2. Press $\sim V$ to select the AC Voltage measurement function.
3. According to the voltage measuring scope, choose the correct range.
4. Setup the DC impedance.
Press Meas \rightarrow Filter, to setup the AC Filter Bandwidth. Default value of the AC Filter Bandwidth will be 10M Ω , this parameter had been setup, and users may carry on the AC Voltage measurement directly without modification.
5. Set the Null value.

Null computing will be an option operation, could be setup in accordance with

users' demand. If user does not implement Null computing, this parameter is not required, direct implementation of the next step.

(To know the specific setting methods of the Null value setting, please refer to Chapter 2 "To Set Up Measurement Parameters", Null computing)

6. Lead test leads into circuit, start to measure.

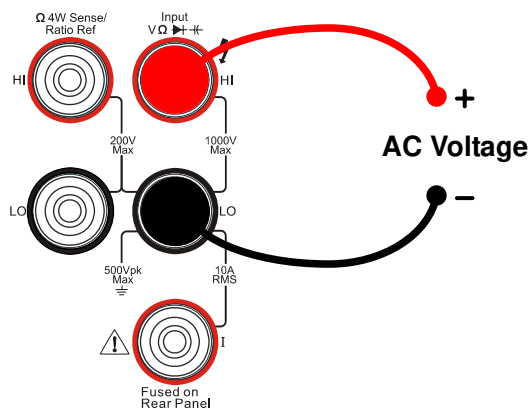

Figure 1-11
AC Voltage measurement instruction chart

7. Measurement history data processing.
Press **History**, enter the menu shown below:

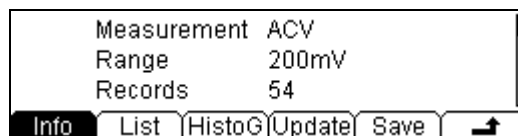

Figure 1-12

To check or save the data that has measured by current measurement function, you can use the history function. In this function you can get the "Info" (information), "List" and "Graph" of this measurement. Also, you can save this information data with press **Save** softkey.

To Measure DC Current

In view of DC current measurement function, the following part demonstrated how to link the measurement connection and how to choose measurement functions. The following practice will gradually guide you to be familiar with the DC Current measurement technique.

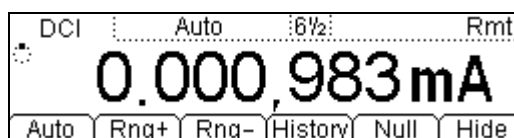



Figure 1-13

DC Current measurement data interface

Table 1-3 DC Current measurement characteristics

Five Range	2mA, 20mA, 200mA, 1A, 10A
Max Resolution	10nA
Import Protection	10A, 250V Current Input Fuse on rear panel
Configurable Parameters	Range, Null value

Basic measurement:

1. Connect test leads as Figure 1-14 shown. Red test lead connects the HI Terminal, Black test lead connects the LO terminal.
2. Press  to select the DC Current measurement function.
3. According to the current measuring scope, choose the correct range.
4. Set the Null value.

Null computing will be an option operation, could be setup in accordance with user demand. If user does not implement Null computing, this parameter is not required, direct implementation of the next step.

(To know the specific setting methods of the Null value setting, please refer to Chapter 2 "To Set Up Measurement Parameters", Null computing)

5. Lead test leads into circuit, start to measure.

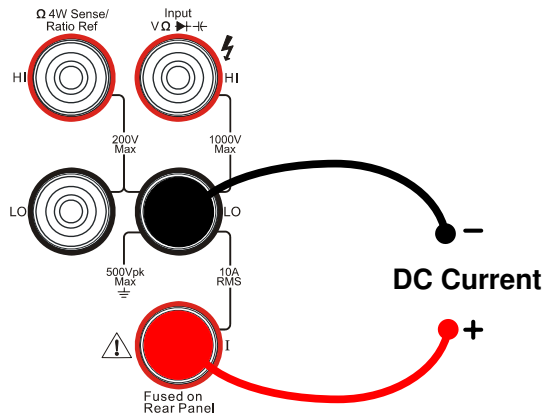

Figure 1-14
DC Current measurement instruction chart

6. Measurement history data processing.
Press **History**, enter the menu shown below:

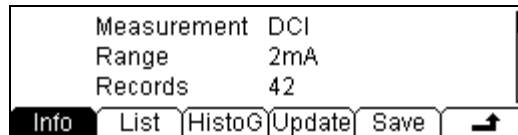

Figure 1-15
The history data

To check or save the data that has measured by current measurement function, you can use the history function. In this function you can get the "Info" (information), "List" and "Graph" of this measurement. Also, you can save this information data with pressing the **Save** softkey.

To Measure AC Current

In view of AC current measurement function, the following part demonstrated how to link the measurement connection and how to choose measurement functions. The following practice will gradually guide you to be familiar with the AC Current measurement technique. (The AC functions only support $5\frac{1}{2}$ digits measurement.)



Figure 1-16

AC Current measurement data interface

Table 1-4 AC Current measurement characteristics

Five Range	20mA, 200mA, 1A, 10A
Max Resolution	100nA
Import Protection	10A, 250V Current Input Fuse on rear panel
Configurable Parameters	Range, Null value

Basic measurement:

1. Connect test leads as Figure 1-17 shown. Red test lead connects the HI Terminal, Black test lead connects the LO terminal.
2. Press $\sim I$ to select the DC Current measurement function.
3. According to the current measuring scope, choose the correct range.
4. Setup the DC impedance.
Press Meas \rightarrow Filter , to setup the AC Filter Bandwidth. Default value of the AC Filter Bandwidth will be "Mid"(Middle), this parameter had been setup, and the users may carry on the AC Voltage measurement directly without modification.

5. Set the Null setting value.

Null computing will be an option operation, could be setup in accordance with user demand. If user does not implement Null computing, this parameter is not required, direct implementation of the next step.

(To know the specific setting methods of the Null value setting, please refer to Chapter 2 "To Set Up Measurement Parameters", Null computing)

6. Lead test leads into circuit, start to measure.

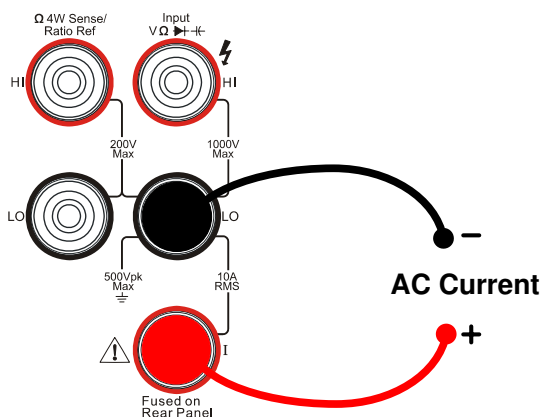

Figure 1-17
AC Current measurement instruction chart

7. Measurement history data processing.

Press **History**, enter the menu shown below:

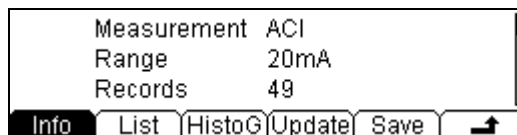

Figure 1-18
The history data

To check or save the data that has measured by current measurement function, you can use the history function. In this function you can get the "Info" (information), "List" and "Graph" of this measurement. Also, you can save this information data with pressing the **Save** softkey.

To Measure Resistance

In view of Resistance measurement function, the following part demonstrated how to link the measurement connection and how to choose measurement functions. The following practice will gradually guide you to be familiar with the Resistance measurement technique. Resistance measurement methods include **2-Wire Resistances Measurement and 4-Wire Resistances Measurement**; we will perform to explain separately.

2-Wire Resistance Measurement



Figure 1-19

Table 1-5 Resistance measurement characteristics

Seven Range	200Ω, 2kΩ, 20kΩ, 200kΩ, 1MΩ, 10MΩ, 100MΩ
Max Resolution	100uΩ
Open-circuit Voltage	<5V
Import Protection	1000V on all ranges (HI Terminal)
Configurable Parameters	Range, Null value

Basic measurement:

1. Connect test leads as Figure 1-20 shown. Red test lead connects the HI Terminal, Black test lead connects the LO Terminal.
2. Press Ω to select the 2-Wire Resistance Measurement.
3. According to the resistance measuring scope, choose the correct range.
4. Set the Null value

Null computing will be an option operation, could be setup in accordance with user demand. If user does not implement Null computing, this parameter is not

required, direct implementation of the next step.
 (To know the specific setting methods of the Null value setting, please refer to Chapter 2 "To Set Up Measurement Parameters", Null computing)
 5. Lead test leads into circuit, start to measure.

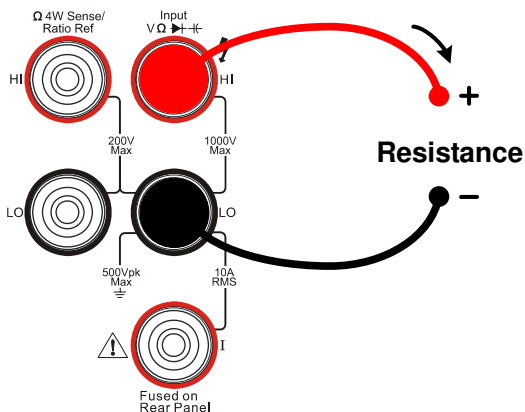

Figure 1-20
 2-Wire Resistance Measurement instruction chart

6. Measurement history data processing.
 Press **History**, enter the menu shown below:

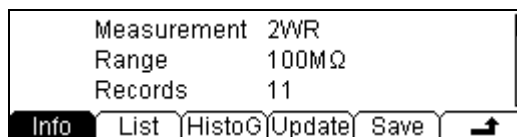

Figure 1-21
 The history data

To check or save the data that has measured by current measurement function, you can use the history function. In this function you can get the "Info" (information), "List" and "Graph" of this measurement. Also, you can save this information data with pressing the **Save** softkey.

NOTE
 When measuring small value resistance, Null operation will be recommended, the test wire impedance error could be eliminated.

4-Wire Resistance Measurement

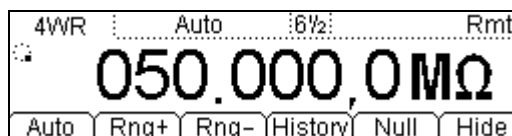

Figure 1-22

Table 1-6 Resistance measurement characteristics

Seven Range	200Ω, 2kΩ, 20kΩ, 200kΩ, 1MΩ, 10MΩ, 100MΩ
Max Resolution	100uΩ
Open-circuit Voltage	<5V
Import Protection	(1). 200V _{PK} (2). 1000V on all ranges (HI Terminal) (3). 200V on all ranges (HI Sense, LO Sense)
Configurable Parameters	Range, Null value

Basic measurement:

1. Connect test leads as Figure 1-23 shown. Red test leads connect the HI Terminal, Black test leads connect the LO Terminal.
2. Press Ω twice to select the 4-Wire Resistance Measurement.
3. According to the resistance measuring scope, choose the correct range.
4. Set the Null setting value.

Null computing will be an optional operation, it could be setup in accordance with users' demand. If user does not implement Null computing, this parameter is not required, direct implementation of the next step.

(To know the specific setting methods of the Null value setting, please refer to Chapter 2 "To Set Up Measurement Parameters", Null computing)

5. Lead test leads into circuit, start to measure.

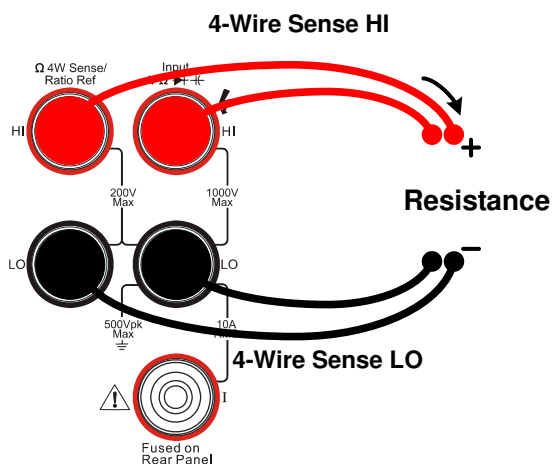

Figure 1-23

4-Wire Resistance Measurement instruction chart

6. Measurement history data processing.

Press **History**, enter the menu shown below:

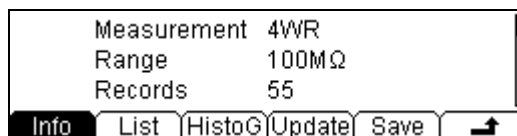

Figure 1-24

To check or save the data that has measured by current measurement function, you can use the history function. In this function you can get the "Info" (information), "List" and "Graph" of this measurement. Also, you can save this information data with pressing the **Save** softkey.

NOTE

When measuring resistances, you could not touch both ends of the resistance. It will cause the measurement inaccurate.

To Measure Capacitance

In view of DC voltage measurement function, the following part demonstrated how to link the measurement connection and how to choose measurement functions. The following practice will gradually guide you to be familiar with the DC Voltage measurement technique.



Figure 1-25

Capacitance measurement data interface

Table 1-7 Capacitance measurement characteristics

Six Range	2nF, 20nF, 200nF, 2uF, 20uF, 200uF
Max Resolution	0.1pF
Import Protection	1000V on all ranges (HI Terminal)
Configurable Parameters	Range, Null value

Basic measurement:

1. Connect test leads as Figure 1-26 shown. Red test lead connects the HI Terminal, Black test lead connects the LO Terminal.
2. Press  to select the Capacitance measurement function.
3. According to the capacitance measuring scope, choose the correct range.
4. Set the Null value.

Null computing will be an optional operation, could be setup in accordance with user demand. If user does not implement Null computing, this parameter is not required, direct implementation of the next step.

(To know the specific setting methods of the Null value setting, please refer to Chapter 2 "To Set Up Measurement Parameters", Null computing)

5. Lead test leads into circuit, start to measure.

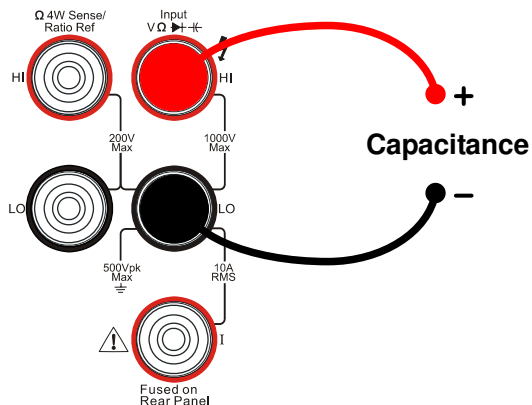

Figure 1-26
Capacitance measurement instruction chart

6. Measurement history data processing.
Press **History**, enter the menu shown below:

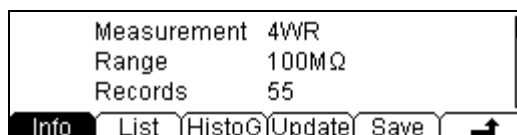

Figure 1-27

To check or save the data that has measured by current measurement function, you can use the history function. In this function you can get the "Info" (information), "List" and "Graph" of this measurement. Also, you can save this information data with pressing the **Save** softkey.

NOTE

Before measuring the electrolytic capacitance, you should make the two legs of the electrolytic capacitance short circuit and let it be discharged, and then you can measure it.

To Test Continuity

In view of Continuity measurement function, the following part demonstrated how to link the measurement connection and how to choose measurement functions. The following practice will gradually guide you to be familiar with the Continuity measurement technique.

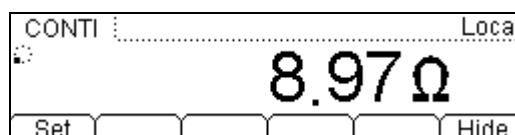



Figure 1-28

Table 1-8 Continuity measurement characteristics

Tests Current	1mA
Max Resolution	Range fixed at 2KΩ
Open-circuit Voltage	<5V
Import Protection	1000V (HI Terminal)
Configurable Parameters	$0 \leq R_{\text{testing}} \leq \text{Short-circuit impedance}$ ($0\Omega \leq \text{Short-circuit impedance} \leq 2k\Omega$)

Basic measurement:

1. Connect test leads as Figure 1-29 shown. Red test lead connects the HI Terminal, Black test lead connects the LO Terminal.
2. Press  to select the Continuity Measurement.
3. Setup the Short-circuit resistance.
Press  → **Res**, to set up the Short-circuit Impedance. Default value of the Short-circuit Impedance will be 10MΩ, this parameter had been setup, and the user may carry on the Continuity measurement directly without modification.

4. Lead test leads into circuit, start to measure.

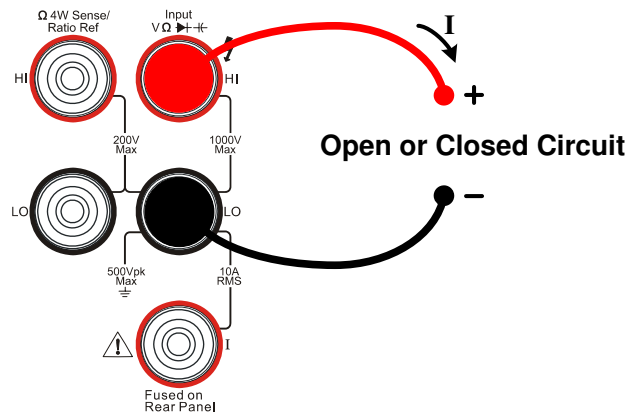

Figure 1-29
Continuity Measurement instruction chart

To Check Diodes

In view of Check Diodes function, the following part demonstrated how to link the measurement connection and how to choose measurement functions. The following practice will gradually guide you to be familiar with the Check Diodes technique.

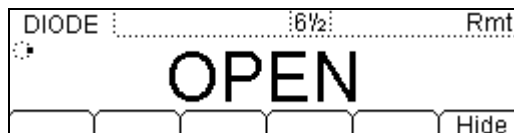



Figure 1-30

Table 1-9 Check Diodes characteristics

Tests Current	1mA
Max Resolution	Range fixed at 2V _{DC}
Open-circuit Voltage	<5V
Import Protection	1000V (HI Terminal)
Configurable Parameters	$0.3V \leq V_{\text{measured}} \leq 2V$

Basic measurement:

1. Connect test leads as Figure 1-31 shown. Red test lead connects the HI Terminal, Black test lead connects the LO Terminal.
2. Press  to select the Check Diodes.

3. Lead test leads into circuit, start to check.

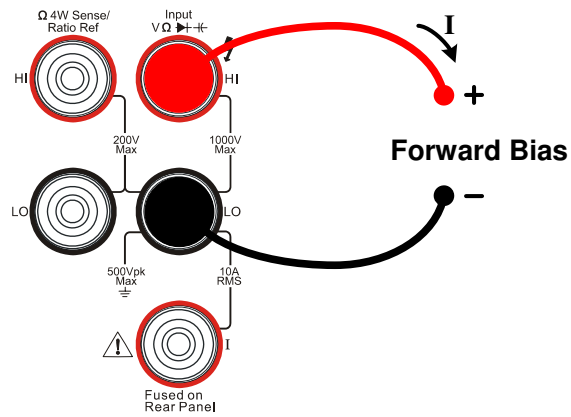

Figure 1-31
Check Diodes instruction chart

To Measure Frequency and Period

In view of Frequency and Period Measurement function, the following part demonstrated how to link the measurement connection and how to choose measurement functions. The following practice will gradually guide you to be familiar with the Frequency and Period Measurement technique.

Frequency Test

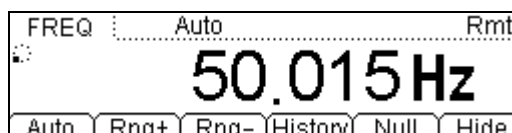

Figure 1-32

Table 1-10 Frequency Test characteristics

Range	200mV, 2V, 20V, 200V, 750V
Measurement Range	3Hz~300kHz
Input Signal Range	100mVAC ~ 750VAC
Import Protection	750V _{RMS} on all ranges (HI Terminal)
Configurable Parameters	Null value

Basic measurement:

1. Connect test leads as Figure 1-33 shown. Red test lead connects the HI Terminal, Black test lead connects the LO Terminal.
2. Press **Freq** to select the Frequency Test.
3. Set the Null value.

Null computing will be an option operation, could be setup in accordance with user demand. If user does not implement Null computing, this parameter is not required, direct implementation of the next step.

(To know the specific setting methods of the Null value setting, please refer to Chapter 2 "To Set Up Measurement Parameters", Null computing)

4. Lead test leads into circuit, start to check.

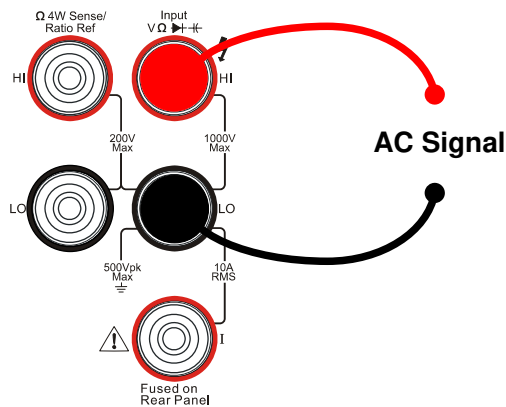

Figure 1-33
Frequency Test instruction chart

5. Measurement history data processing.
Press **History**, enter the menu shown below:

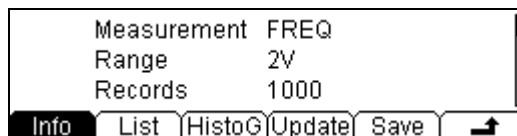

Figure 1-34

To check or save the data that has measured by current measurement function, you can use the history function. In this function you can get the "Info" (information), "List" and "Graph" of this measurement. Also, you can save this information data with pressing the **Save** softkey.

Period Test



Figure 1-35

Table 1-10 Period Test characteristics

Range	200mV, 2V, 20V, 200V, 750V
Measurement Range	0.33s ~ 3.3us
Input Signal Range	100mVAC~750VAC
Import Protection	750VRMS on all ranges (HI Terminal)
Configurable Parameters	Null value

Basic measurement:

1. Connect test leads as Figure 1-36 shown. Red test lead connects the HI Terminal, Black test lead connects the LO Terminal.
2. Press **Freq** twice to select the Period Test.
3. Set the Null value.

Null computing will be an optional operation, could be setup in accordance with users' demand. If user does not implement Null computing, this parameter is not required, direct implementation of the next step.

(To know the specific setting methods of the Null value setting, please refer to Chapter 2 "To Set Up Measurement Parameters", Null computing)

4. Lead test leads into circuit, start to check.

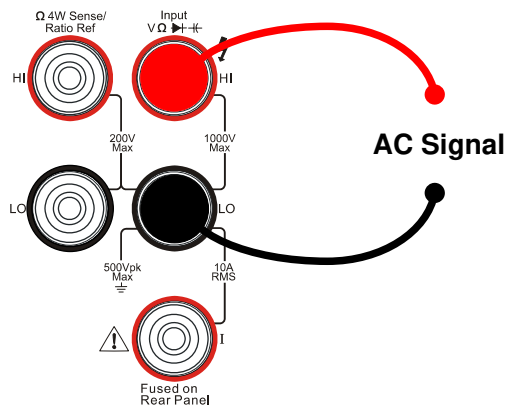

Figure 1-36
Period Test instruction chart

5. Measurement history data processing.
Press **History**, enter the menu shown below:

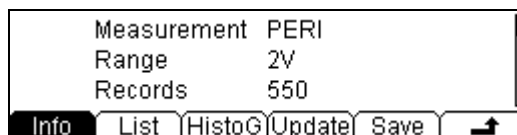

Figure 1-37

To check or save the data that has measured by current measurement function, you can use the history function. In this function you can get the "Info" (information), "List" and "Graph" of this measurement. Also, you can save this information data with pressing the **Save** softkey.

To Measure Arbitrary Sensor

To set an arbitrary sensor, you will need to set the sensor name, sensor type, sensor physical unit, sensor reference data, and arithmetic.

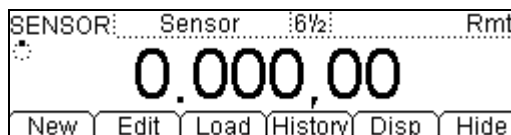

Figure 1-38

Table 1-11 Period Test characteristics

New	Newly built sensor reference data file
Edit	Edit a sensor reference data file
Load	Load a sensor reference data file
Display	Set display mode

Basic measurement:

1. Connect test leads as Figure 1-54, 1-55 shown. Red test leads connect the HI Terminal, Black test leads connect the LO Terminal.
2. Press **Sensor** to select the Sensor function.
3. Press **New**, enter the newly- built sensor reference data file interface.

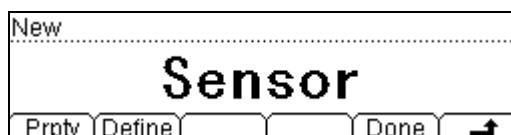

Figure 1-39

(1). In New function interface, you are allowed to edit the sensor Name, sensor Type and physical value Unit of the sensor.

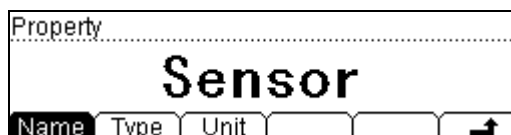

Figure 1-40

Press **Name** button, you are allowed to create a name for the sensor reference value document.

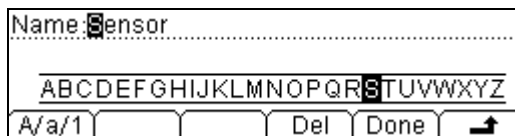

Figure 1-41

Press **Type** button, you are allowed to select the sensor type, include: DCV, DCI, 2-Wire resistance, and frequency.

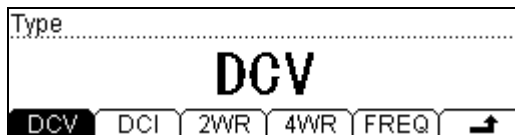

Figure 1-42

Press **Unit** button, you are allowed to select the physical unit, include: °C, Pa, % , °, and F.

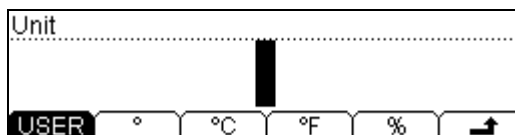

Figure 1-43

In **New** interface, press **Define** button to build the reference value table. The reference value documents for each kind of sensor are different, so you need input reference value in abundance.

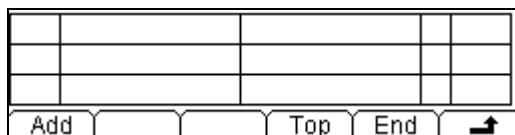

Figure 1-43

Press **Add** button, you are allowed to input the **Measured** and **Corresponding** value to reference value data. In order be suitable for the different type sensor, the reference value is able to separate into several **SEG**ment in accordance with the different algorithms.



Figure 1-44



Figure 1-45

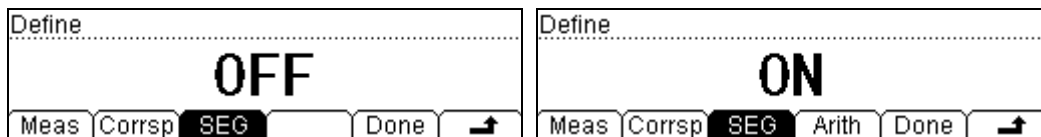

Figure 1-46

Press **SEG** button, you are allowed to segment the reference value with different arithmetic.

Press **Arith** button select the algorithms to **Line** or **Curve**.

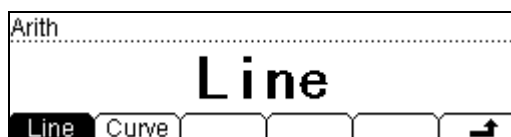

Figure 1-47

1	0.0000mV	0.0000°	<input type="checkbox"/>	Line
2	1.0000mV	10.0000°	<input type="checkbox"/>	
3	2.0000mV	30.0000°	<input checked="" type="checkbox"/>	Curve
<input type="button" value="Add"/> <input type="button" value="Del"/> <input type="button" value="Edit"/> <input type="button" value="Top"/> <input type="button" value="End"/> <input type="button" value="Return"/>				

Figure 1-48

Press **Return** return to New interface then press **Done** button, you have finished the input work, then you can use this sensor reference immediately, or you can save it into the built-in storage space or your U-disk for the future work.

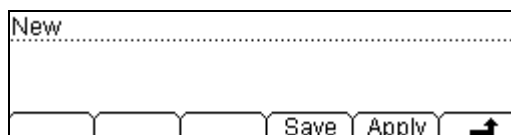

Figure 1-49

Press **Apply** button, to use this reference value file.

Press **Save** to save the file.



Figure 1-50

Press **Save** button, to finish the save operation.

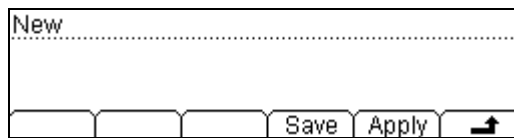

Figure 1-51

Press **Apply** button, to start the sensor measurement.

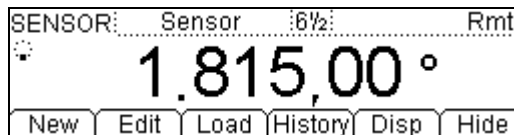

Figure 1-52

- (2). Press **Edit** button, enter the edit function. With this function you can edit the sensor reference value file that you had saved.
- (3). Press **Load** button, enter the store function interface, you can load the sensor reference file you had saved.
- (4). Press **Disp** button, you can choose which value will be shown on the display interface.
- (5). Press **History**, enter the menu shown below:

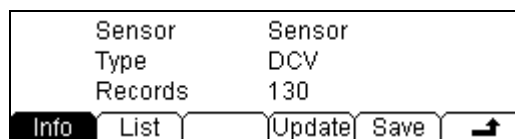

Figure 1-53

To check or save the data that has measured by current measurement function, you can use the history function. In this function you can get the "Info" (information), "List" of this measurement. Also, you can save this information data with pressing the **Save** button.

4. Lead test leads into circuit, start to check.

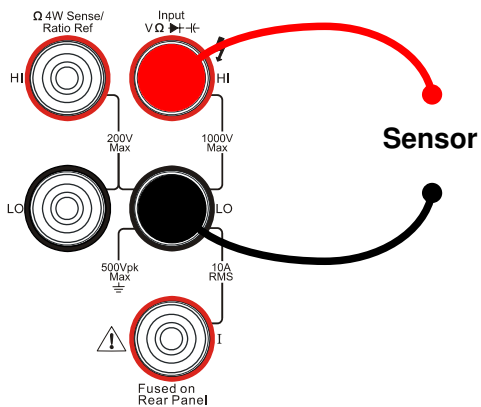

Figure 1-54

Voltage, Resistance, and Frequency mode sensor instruction chart

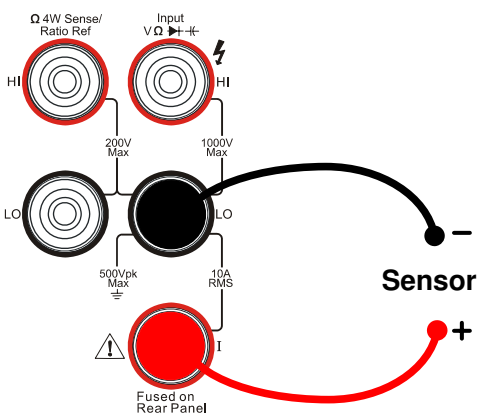

Figure 1-55

Current mode sensor instruction chart

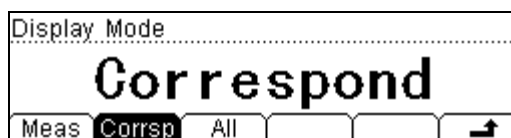

Figure 1-56

Choosing interfaces of measure and correspond value

To Choose Digits resolving index

The digits resolving index (the accurate of reading) differentiates 4 1/2, 5 1/2, 6 1/2 three kinds. Three kinds of digits resolving index are suitable for all measurement function.

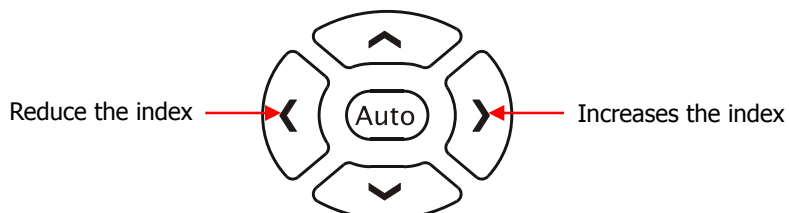

Figure 1-57
The digits resolving index Choice Keys

Methods:

In the main interface, use left and right direction key to adjust the digits resolving index. Press left button to lower accuracy, press right button to upper accuracy.

The digits resolving index Selection

- (1). Each precision of the measure function can be set separately without influence.
- (2). Choose the reading precision of 6 1/2 bit when measuring AC for the best.
- (3). Store the digits resolving index in volatile memory.

To Choose Data Digit Display

Digits Function is used to set up data display digit. It has 5, 6, 7 three kinds of data digit display choice. The default display digit is 5.



Figure 1-58
The data digits is 7



Figure 1-59
The data digits is 6

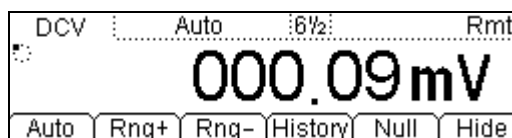

Figure 1-60
The data digits is 5

NOTE

In high-accuracy measurement, if users need to show less data digit, it can show fewer digits for user-friendly reading.

Choose Range Options

To choose measurement range may complete through the manual choice and the automatic determination two methods. The automatic determination is user-friendly, but if you want to obtain a better performance you should choose the range in manual choice.

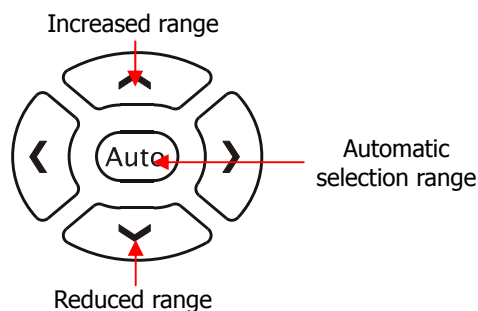

Figure 1-61
Choice Range Options Keys

Methods 1:

In the main interface, use up and down direction key to adjust the Range. Press Up to increase the range, press Down to reduce the range.

Press **Auto** key, start the automatic determination.

Methods 2:

In the main interface, use the menu option keys to adjust the range.



Figure 1-62
Choice Range Options Menu

Table 1-12 Choice Range Option Menu

Option Menu	Explain
Auto	Started automatically adjustment range, and banned manually adjustment range.
Manually+	Started manually increased range, and banned automatically adjustment range.
Manually-	Started manually reduced range, and banned automatically adjustment range.
Quit	Save all changes, end the current operation, hidden the menu. When the menu was hidden, press this key to show the menu.

Operation Explanation:

- When the input signal is beyond the current scope of the measurement range, the multimeter will show "OVER RANGE".
- After restarting and remote- replacement, range options will turn back default option "Automatic choice range".
- When testing the Continuity and Checking the diodes, the range option are fixed. The range of Continuity is 2K Ω while the diodes are 2V_{DC}.

NOTE

Other functions of the direction keys:

In measurement parameters setting menu, press the up and down keys to choose setting areas.

In data input interface, press up and down keys to change the number.

In data input interface, press left and right keys to change the different digits.

To Control Trigger Options



Press  or  to trigger the multimeter. When you start the multimeter, the key will turn light, it means this function is running.



Figure 1-63

Trigger Control Keys

Multimeter triggering options include Automatically, Single and Hold.

Auto Triggering

Press  key once, it will take continuous readings at the fastest rate possible for the specified measurement configuration.

Single Triggering

Press  key, The multimeter takes one reading, or a number of readings specified by a sample count you enter.

Holding Triggering

Press  key. The reading-hold mode allows you to capture and hold a stable reading on the front panel display.

NOTE

Press  key, in Remote Mode, by switching back to the local mode.

Chapter 2 Operating Your Multimeter

By now you have got a brief understanding of DM3000 series with the front/rear panel, every function control area and keys. You should also know how to determine the setup of the multimeters by viewing the status bar.

This chapter takes you through all groups of front-panel buttons and menus. You will also further your knowledge of the operation instruction by reading this guide.

We recommend you perform all of the following exercises, so that you could get the most of the powerful measurement capabilities of your multimeters.

This chapter covers the following topics:

- To Set up Measurement Parameters (Meas)
- To Make Mathematics Operation (Math)
- To Set up Trigger System (Trig)
- To Save and Recall (Save)
- To Set up Utility (Utility)
- To Set up High-speed data acquisition (Data Log)
- Use the built-in help system (Help)

To Set up Measurement Parameters

Press **Meas** key to operate the Measurement Parameters Menu. Use the measurement parameters menu to set up the measurement parameters. The default parameters had been set up by RIGOL, users may carry on any measurement operation directly, and users also can set up any measurement parameters as their wish.

The measurement parameters menu include: Conti, Filter, Res, Null, and Ratio. To change these parameters, satisfy the dissimilar condition of the measurement request.

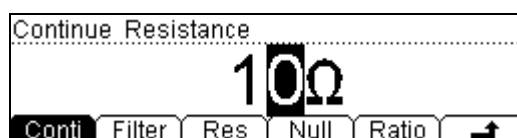

Figure 2-1

Table 2-1 **Meas** Menu Explanation

Function Menu	Explanation
Conti	Set up the resistance value in short test.
Filter	Choose the AC filter bandwidth.
Res	Choose the DC voltage input resistance.
Null	Set up null value.
Ratio	Measured the ratio of two DC voltage signal.
Freq	Measured the frequency of AC signal.
↗	Save all changes, and end the current operation.

Continue Resistance

To set up the continue resistance value in the short test, when the test resistance below the continue resistance value, the DM3000 will judge whether the circuit is connected or not. The continue resistance is only using at Continue Test.

Press **Meas** → **Conti**, enter the menu shown below:

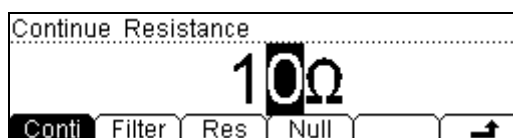

Figure 2-2

Use direction keys to change the parameter values:

Press left and right key to choose different digits. Press up and down key to change the current digital value.

Continue Resistance

The range of continue resistance is $1\Omega\sim 1000\Omega$. The default value is 10Ω .
The continue resistance stored in the easy-lost memorizer, the resistance still keep when the power is off.

AC Filter

There are three kinds of AC Filter. Choose correct filter may make the measurement more accuracy. This function could only be used in AC Voltage and AC Current measurement.

Press **Meas** → **Filter**, enter the menu shown below:

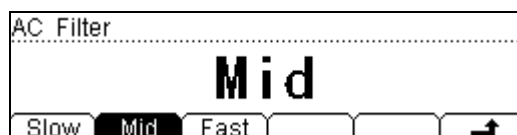

Figure 2-3

Table 2-2 AC Filter Menu Explanation

Function Menu	Explanation
Slow	Set up the filter with low speed.
Mid	Set up the filter with to middle speed.
Fast	Set up the filter with high speed.
↗	Save all changes, back to a higher level menu.

Table 2-3 AC Filter Parameters Characteristics

AC Filter Options	Input Frequency	Setting Timer
Slow	3Hz~300kHz	1.2 reading/s
Mid	20Hz~300kHz	0.5 reading/s
Fast	200Hz~300kHz	0.3 reading/s

AC Filter

The AC Filter Parameters are saved in the volatile memory, the data will lose when the power is off.

The default value of AC Filter Parameters is "Mid" (middle).

DC Input Resistance

To choose DC voltage current measuring input resistance value. The parameters include $10\text{M}\Omega$ and $>10\text{G}\Omega$. The default resistance is $10\text{M}\Omega$, but for 200mV, 2V, 20V measuring ranges may choose $>10\text{M}\Omega$ for getting a greater measurement value.

Press **Meas** → **Res**, enter the menu shown below:

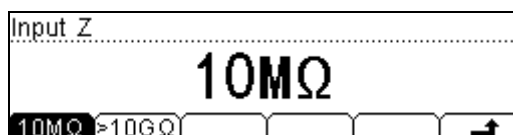

Figure 2-4

Table 2-4 DC Input Resistance Menu Explanation

Function Menu	Explanation
10MΩ	Set up the DC Input Resistance to 10MΩ.
>10GΩ	Set up the DC Input Resistance to >10GΩ.
↗	Save all changes, back to a higher level menu.

DC input resistance selection:

- (1). While the DC input resistance is selected to $10\text{M}\Omega$, the input resistance of all measurement range is $10\text{M}\Omega$;
- (2). While the DC input resistance is selected to $>10\text{G}\Omega$, the input resistance of 200mV, 2V and 20V measurement range is $>10\text{G}\Omega$; 200V and 1000V measurement range will be still keep $10\text{M}\Omega$ input resistance.

Null Measurement

The DM3000 allows separate null settings to be saved for each of the following measurement functions: dc voltage, ac voltage, dc current, ac current, resistance, frequency/period, and capacitance.

When making null measurements, each reading is different between a stored (selected or measured) null value and the input signal. One possible application is to increase the accuracy of two-wire resistance measurements by nulling the test lead resistance. Null the leads are particularly important prior to making capacitance measurements. The formula used for calculating null measurements is:

Result = reading - null value

The null value is adjustable, and you can set it to any value between 0 and $\pm 120\%$ of the highest range, for the present function.

Press **Meas** → **Null**, enter the menu shown below:

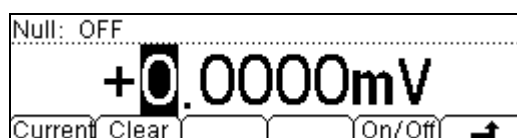

Figure 2-5

Table 2-5 Null Measurement Menu Explanation

Function Menu	Explanation
Current	The current measured value will be the setting value.
Clear	Set the value to be zero.
On/Off	Turn the Null function on or off.
↗	Save all changes, back to a higher level menu.

Null measurement parameters setting methods:

- (1). In operation interface press **Null** button, use the current value to Null value;
- (2). To select Zero function. Start null function, the multimeter will use the current value to Null value.
- (3). In Null setting display interface, it uses the Direction Keys to input the setting null value.

Ratio Measurement

Ratio measurement is used to measure the ratio of 2 directions DC voltage signal. Ratio measurement is only for measuring DC voltage.

Press **Meas** → **Ratio**, enter the menu shown below:

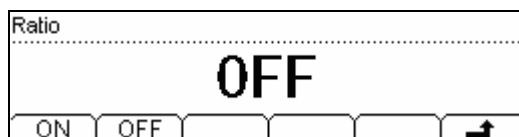

Figure 2-6

Table 2-6 Ratio Measurement Menu Explanation

Function Menu	Explanation
ON	Open the Ratio Measurement Function.
OFF	Close the Ratio Measurement Function.
→	Save all changes, back to a higher level menu.

The method of the ratio measurement:

$$\text{Ratio} = \frac{\text{DC Voltage}}{\text{DC Reference Voltage}}$$

- (1). Measuring Sense Terminal, for measuring reference DC voltage. Default range option is auto.
- (2). Measuring Input Terminal, for measuring DC voltage. The measuring voltage scope is 0V~1000V.
- (3). Input LO Terminal and Sense LO Terminal must have a common reference value, and the voltage difference cannot surpass $\pm 2V$.

Basic measurement:

1. Connect test leads as Figure 2-7 shown. Red test leads connect the HI Terminal, Black test leads connect the LO Terminal.
2. Press \overline{DCV} to select the DC Voltage measurement function.
3. According to the voltage measuring scope, choose the correct range.
4. Set up the DC Ratio Measurement.
Press \overline{Meas} → \overline{Ratio} → \overline{On} , to start the DC Ratio Measurement.
Press \overline{Enter} to save all changes, back to a higher level menu.
5. Lead test leads into circuit, start to measure.

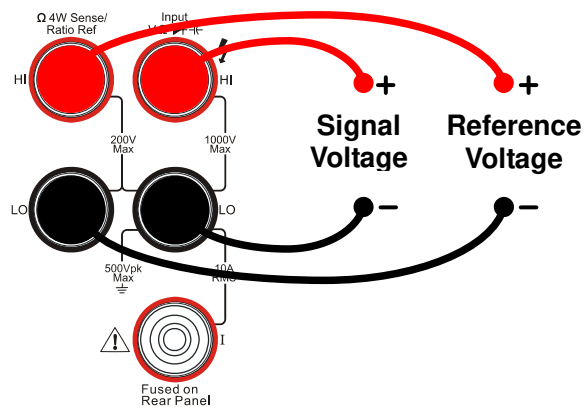

Figure 2-7
Ratio Measurement instruction chart

Frequency Measurement

Frequency measurement function is only used for measuring the frequency of an AC signal (AC voltage and AC current).

Press **Meas** → **Freq**, enter the menu shown below:

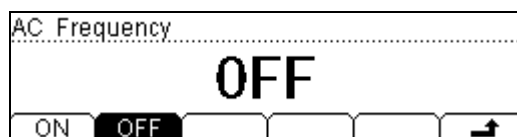

Figure 2-8

Table 2-7 Ratio Measurement Menu Explanation

Function Menu	Explanation
ON	Open the Frequency Measurement Function
OFF	Close the Frequency Measurement Function
↗	Save all changes, back to a higher level menu.

Basic measurement:

1. Connect test leads as Figure 2-9 shown. Red test lead connects the HI Terminal, Black test lead connects the LO Terminal.
2. Press **~V** or **~I** to select the AC voltage or current measurement function.
3. According to the voltage measuring scope, choose the correct range.
4. Set up the DC Ratio Measurement.
 Press **Meas** → **Freq** → **On**, to start the AC Frequency Measurement.
 Press **↗** to save all changes, back to a higher level menu.

5. Lead test leads into circuit, start to measure.

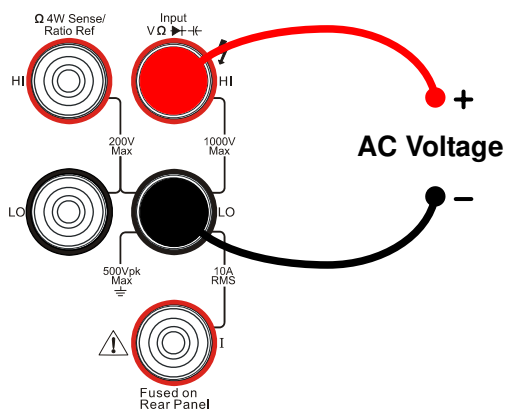

Figure 2-9

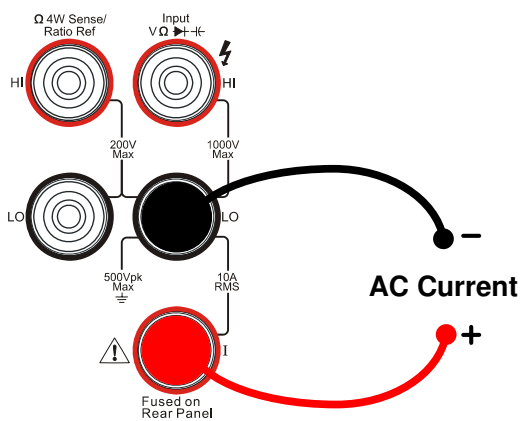

Figure 2-10

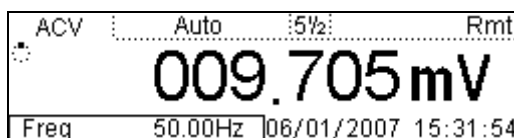

Figure 2-11

Frequency measurement display interface

Math Functions

Press **Math** key, enter the menu shown below:



Figure 2-12

The DM3000 provides five math functions: Null, statistic, dB, dBm and Limit testing. Only one of these math functions can be enabled at a time and remains in effect until you turn it off or change it.

In Math function interface, you could choose the math function that you want to use. Then press **On** to start the Math function that you have chosen.

Math functions are used by union basic measurement function. However, not all combinations are effective. If the math function you selected does not support the measurement function you have just choose, the math function will automatic turn off.

Table 2-8 Math Function Menu Explanation

Function Menu	Settings	Explanation
Statistic		Reading statistic functions, including: Max, Min, Average, and Reading Count.
dB		The dB measurement is the difference between the input signal and a stored relative value.
dBm		The dBm function is logarithmic, and is based on a calculation of power delivered to a reference resistance.
Limit		The limit test function enables you to perform pass/fail testing to upper and lower limits that you specify.
ON/OFF	ON OFF	Turn on Math function. Turn off Math function.
↗		Save all changes, back to a higher level menu.

The Math function does not used for all basic measurement function. The table 2-9 showed the effective functions combination.

Table 2-9 Math Functions is used for basic measuring function applicable scope

Measurement Function	Supported the Math function			
	Total	dB	dBm	Limit
DC Voltage	Support	Support	Support	Support
AC Voltage	Support	Support	Support	Support
DC Current	Support			Support
AC Current	Support			Support
2-Wire Resistance	Support			Support
4-Wire Resistance	Support			Support
Frequency	Support			Support
Period	Support			Support
Continuity				
Diodes				
Ratio	Support			Support
Capacitance	Support			Support

Math Functions Selective

The DM3000 provides five math functions: Null measurements, Total measurements, dB measurements, dBm measurements, and Limit testing. Only one of these math functions can be enabled at the same time, and remains in effect until you turn it off or change it.

Press **Math** key, enter the menu shown below:



Figure 2-13

Table 2-10 Math Functions Menu Function Explanation

Function Menu	Settings	Explanation
Statistic		Reading statistic functions, including: Max, Min, Average, and Reading Count.
dB		The dB measurement is the difference between the input signal and a stored relative value.
dBm		The dBm function is logarithmic, and is based on a calculation of power delivered to a reference resistance.
Limit		The limit test function enables you to perform pass/fail testing to upper and lower limits that you specify.
ON/OFF	ON OFF	Turn on Math function. Turn off Math function.
↗		Save all changes, back to a higher level menu.

1. Statistic Measurement

The Statistic function allows to measure the following measurement functions: dc voltage, ac voltage, dc current, ac current, resistance, frequency/period, and capacitance.

From the front panel, you can view the following statistical data for any set of readings: average (Ave), maximum (Max), minimum (Min), and you can read all of these with All functions and the number of samples taken (Count).

Press **Math** → **Stats**, enter the menu shown below:

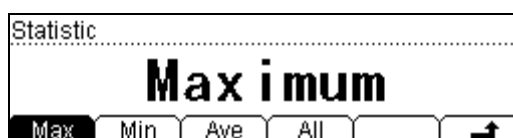

Figure 2-14

Table 2-11 Statistic Measurement Menu Function Explanation

Function Menu	Explanation
Max (Maximum)	Statistical measurement all reading Max value.
Min (Minimum)	Statistical measurement all reading Min value.
Ave (Average)	Statistical measurement all reading Average value.
All	Statistical measurement all the number of readings.
↗	Save all changes, back to a higher level menu.

2. Limit Measurement

The Limit test function enables you to perform pass/fail testing to upper and lower limits that you specify. You can set the upper and lower limits to any value between 0 and $\pm 120\%$ of the highest range, for the present function. The upper limit you select must be a more positive number than the lower limit.

Press **(Math)** → **Limit**, enter the menu shown below:

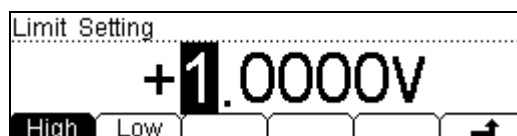

Figure 2-15

Table 2-12 Limit Measurement Menu Function Explanation

Function Menu	Settings	Explanation
High	/	Set the desired Upper limit.
Low	/	Set the desired Lower limit.
↗	/	Save all changes, back to a higher level menu.

The parameters value scope of Limit function:

- (1). The limit value scope is $0\% \sim \pm 120\%$ of the current measurement range.
- (2). The upper limit value should be always bigger than the lower limit value.

3. dB Measurement

The dB function applies to AC voltage and DC voltage measurements only. Each dB measurement is different between the input signal and a stored relative value, with both values converted to dBm.

Press **Math** → **dB**, enter the menu shown below:

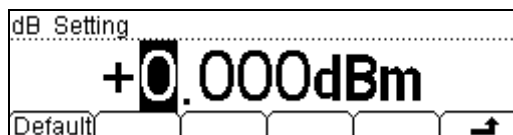

Figure 2-16

Table 2-13 dB Measurement Function Menu Function Explanation

Function Menu	Explanation
Default	Use the default value.
↗	Save all changes, back to a higher level menu.

$$\mathbf{dB} = 10 \times \log_{10} \left[\left(\text{Reading}^2 / R_{\text{REF}} \right) / 0.001\text{W} \right] - (\text{dB setting value})$$

The relative value can take any value between 0 dBm and ± 200.0 dBm. The default relative value is 10 dBm. You can either let the instrument automatically measure this value, or you can enter a specified value.

4. dBm Measurement

This function applies to AC voltage and DC voltage measurements only. The dBm function is logarithmic, and is based on a calculation of power delivered to a reference resistance, relative to 1 milliwatt.

Press **Math** → **dBm**, enter the menu shown below:

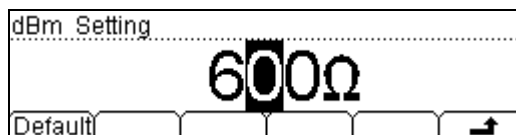

Figure 2-17

Table 2-14 dB Measurement Function Menu Function Explanation

Function Menu	Explanation
Default	Use the default value.
↗	Save all changes, back to a higher level menu.

The computation method of the dBm:

$$\text{dBm} = 10 \times \text{Log}_{10} [(\text{Reading}^2 / R_{\text{REF}}) / 0.001\text{W}]$$

R_{REF} expressed measuring the resistance value in the actual electric circuit.

To Set Up Triggering Parameter Function

The DM3000 triggering system allows you to generate triggers either manually or automatically, take multiple readings per trigger. The DM3000 also allows you to set a level for internal triggering, and to set up pre-triggering.

Selecting a Trigger Source

Specify the source from which the multimeter will accept a trigger. The power-on default is auto triggering from the front panel. Several types of triggering are described in the sections that follow.

The power-on trigger default mode was auto trigger (RUN) mode. Press **Run/Hold** to go to the hold trigger mode. Press **Single** to go to the single trigger mode. A single reading is taken, and another reading is taken each time you press **Single**, or when a hardware trigger is received on the **Ext Trig** connector.



Figure 2-18

Table 2-15 Trigger Parameters Setting Menu Function Explanation

Function Menu	Explanation
Auto	Setting system fixed time Auto trigger and reading Hold scope parameters.
Single	Setting Single manual trigger parameter.
Ext	Setting the reading Hold scope.
VMC	Setting the pulse width of sampling ending signal.
↗	Save all changes, back to a higher level menu.

Auto Triggering

Auto triggering takes continuous readings at the fastest rate possible for the specified measurement configuration (function, range, resolution, and so forth). Auto trigger is a default trigger mode when the multimeter power-on.

Press **Trig** → **Auto**, enter the menu shown below:

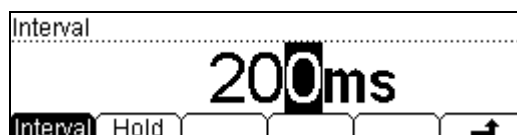

Figure 2-19

Table 2-16 Auto Trigger Function Menu Explanation

Function Menu	Setting	Explanation
Interval		Set interval time in 400~2000ms.
Hold		
↗		Save all changes, back to a higher level menu.

Interval time:

You can manually specify a delay between the trigger signal and the first sample that follows. This may be useful in applications where you want to allow the input signal to settle before taking a reading, or for pacing a burst of readings.

- The trigger delay may be set from 400 to 2000 ms.
- The continuity and diode test functions ignore the trigger delay segment.
- If a trigger delay is not manually set, the default trigger delay is automatically set.
- If you manually specify a trigger delay, that delay is used for all measurement functions (except continuity and diode test).

Reading Hold

The reading hold mode allows you to capture and hold a stable reading on the front panel display. This is useful in situations when you want to take a reading, remove the test probes, and have the reading remain on the display. When a stable reading is detected the reading will hold on the display. Hold scope include 0.01%, 0.1%, 1%, and 10%.

Press **Trig** → **Auto** → **Hold**, enter the menu shown below:

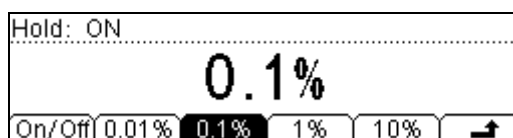

Figure 2-20

Table 2-17 Reading Hold Function Menu Explanation

Function Menu	Explanation
On/Off	Turn on/off the reading hold function.
0.01%	Set the hold scope is 0.01%.
0.1%	Set the hold scope is 0.1%.
1%	Set the hold scope is 1%.
10%	Set the hold scope is 10%.
↗	Save all changes, back to a higher level menu.

Reading Hold Function

Start the Reading Hold Function, the hold measurement use the following rules judge the reading count:

When $\text{Max}() - \text{Min}() \leq \text{hold scope} \times \text{ReadingN}$, the multimeter hold ReadingN on the display.

The display update a new reading was based on the current value of reading and the following three readings before the reading was hold:

Max (ReadingN, ReadingN-1, ReadingN-2, ReadingN-3)

Min (ReadingN, ReadingN-1, ReadingN-2, ReadingN-3)

NOTE

When reading hold started, the input resistance was automatism set to 10M Ω for all DC voltage range. This set-up is conducive to reducing noise arising from the open-loop testing.

Single Triggering

The multimeter takes one reading, or a number of readings specified by a sample count you enter, each time you press.

Press **Trig** → **Single**, enter the menu shown below:

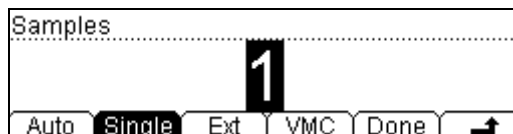

Figure 2-21

Table 2-18 Single Trigger Function Menu Explanation

Function Menu	Explanation
Single	Set a sample count, the default sample count is 1.
↗	Save all changes, back to a higher level menu.

Sample Count

While the multimeter receives a single trigger single, the multimeter takes one reading or a number of readings.

The number of sample count scope from 1 to 50,000. The factory default is 1.

External Triggering

Trig is used to set the parameter which accomplish the triggering function, the external triggering function needs to set the following parameter: the **Rise** edge, the **Fall** edge, **HiLev** (high level) and **LoLev** (low level). After ensuring the setting is correct, press **Done** to startup the external triggering, the key **Run/Hold** and **Single** on the front panel will wink out, it means that the instrument has been working in the external triggering mode.

Press **Trig** → **Ext**, enter the following menu.

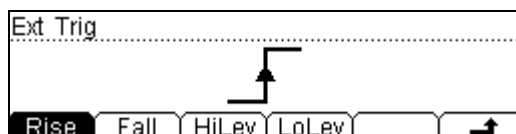

Figure 2-22
The interface of the external triggering

Users could set the triggering mod as the following: the rise edge, the fall edge, high level and low level.

To start up the triggering function

Auto, hold and Single trigger can switch by using **Run/Hold** and **Single**, press **↗** on the triggering interface to startup the external triggering.

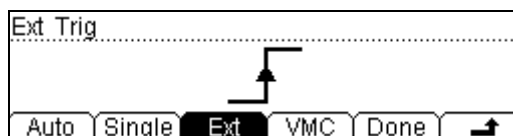

Figure 2-23

The interface of the external triggering

After the external triggering start, the key **Run/Hold** and **Single** on the front panel both will wink out.

To Set up the VMC

Once in the external triggering mode, when the data sampling is over, the instrument outputs a pulse signal pass the signal over-put port (VM Comp) on the rear panel. By setting the output, the pulse width can be intercalated.

Press **Trig** → **VMC**, enter the following menu. Output the export Terminal.

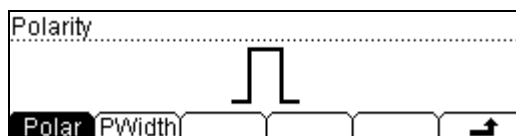

Figure 2-24

Table 2-19 The interface of the external triggering(polarity: positive)

Function Menu	Setting	Explanation
Polar	Pos Neg	Setting the pulse signal's polarity.
PWidth		Setting the pulse width.
↗		Store the changing and return.

Export the VMC function setting range

- (1). Once in the external triggering mode, when the data sampling is over, the instrument will export a pulse signal and hint over.
- (2). Once in the external triggering mode, when operate the math limited value, the instrument will export a pulse signal and hint it has over pass.

Store and Recall

To use the Storage and Recall function, you can save, load, and delete the measurement data, parameters and sensor documents in the local storage. And also you can do the same operation in USB storage.

Press **Save** key, and enter the menu shown below:

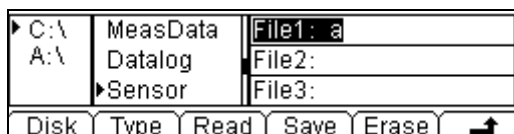

Figure 2-25

Table 2-20 Storage and Recall Function Menu Explanation

Function Menu	Setting	Explanation
Disk	C:\ (Local) A:\ (U-Disk)	Choose Local or U-Disk storage.
Type	Data/ Parameters/ Sensor ...	Choose the type of the files shown.
Read		Load the documents you have selected.
Save		Save the document to the location which you have selected.
Erase		Delete the document which you have selected.
↵		Save all changes, back to a higher level menu.

Local/U-Disk Storage

Local storage block is built-in the multimeter. The U-Disk storage will be a USB flash disk.

Press **Save** key, enter the menu shown below:

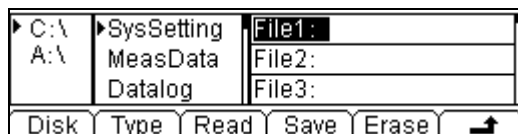

Figure 2-26

Table 2-21 Storage and Recall Function Menu Explanation

Function Menu	Setting	Explanation
Explore		Choose Local storage or U-Disk rout.
Type	Sys Setting/ Meas Data/ Data log/ Sensor/ Sensor Data/ Scan Task	Choose the type of the files shown.
Read		Load the document you have selected.
Save		Save the document to the location which you have selected.
Erase		Delete the document which you have selected.
↶		Save all changes, back to a higher level menu.

Document Storage

In local/U-disk storage area, you allowed to save, load and delete parameter, data and sensor documents.

Choose the storage area of the files

Press **Save** → **Disk**, choose Local storage or U-Disk rout. Choose C:\, and the default fype is "SysSetting".

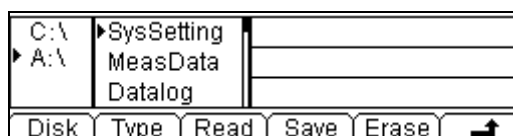

Figure 2-27

Choose the storage type of the files

Press **Save** → **Type**, choose the type "MeasData" of the files, into the menu shown below:



Figure 2-28

Press **Save** → **Type**, choose the type "Datalog" of the files, into the menu shown below:

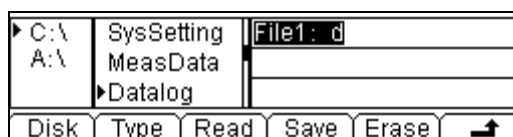

Figure 2-29

Press **Save** → **Type**, choose the type "Sensor", "SensorData", "ScanTask" of the files, into the menu shown below:

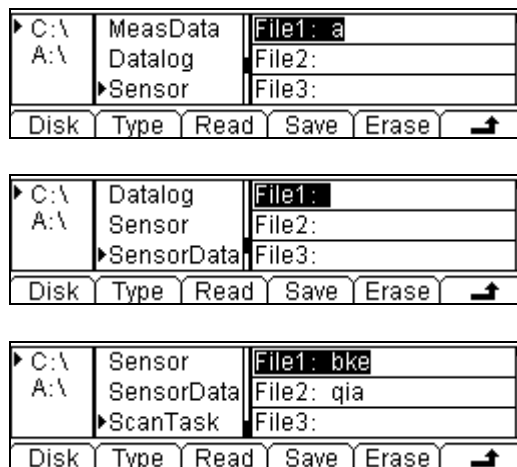

Figure 2-30

NOTE

Store, recall and delete use the same interface.

- 1) When choose different **storage locations**, Press **Disk**, to switch the store location (C:\(Local) and A:\(U-Disk)).
- 2) When choose different **files types**, Press **Type**, to switch the file type (Data, Parameter, and Sensor).
- 3) When operating the A disk, do not take off the U disk.

Document Operation

Use the up and down buttons select the right document, then press U-Disk **Read**, **Save** and **Erase** soft keys to do corresponding operation.

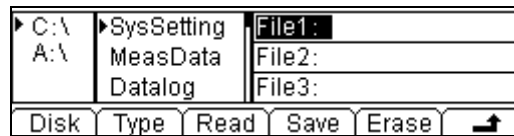

Figure 2-31

To save the document, you are allowed to name the document with letters and numeral.

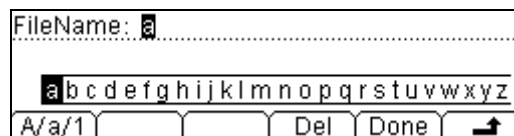

Figure 2-32

NOTE

- 1) Use the up/down key to choose the cursor position: for switching the area of filename and input method.
- 2) The cursor will wink at the position of the current operation area.
- 3) The delete function can only delete the letter on which the cursor taking place.

To Set Up the Utility

In utility function set up menu, the function of various parameters related system set up, include: system parameters, interface parameters, self-test, and calibration.

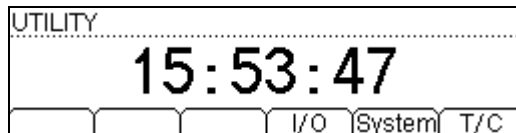

Figure 2-33

Table 2-22 Utility Function Menu Explanation

Function Menu	Explanation
I/O	To set up I/O parameters.
Sys	To set up system information configuration.
T/C	Test function.

System settings

Press **Utility** → **System**, enter the menu shown below:



Figure 2-34

The interface of setting the system function

Table 2-23 System Settings Function Menu Explanation

Function Menu	Explanation
Lang	Select the display interface languages.
Disp	Set up the display.
Sound	Switch beeper sound On/Off.
Clock	Set up the benchmark clock.
Format	Set up digit display format.
Cfg	Set up or resume the system values.

Select languages

DM3000 supports two kinds of languages for users.

Press **Utility** → **Sys** → **Lang**, enter the menu shown below:

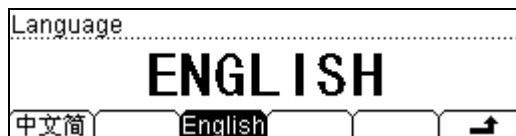

Figure 2-35

Table 2-24 System Settings Function Menu Explanation

Function Menu	Explanation
中文简	Select the Chinese Simplified.
English	Select the English.
↗	Save all changes, back to a higher level menu.

Set Up the Display

Press **Utility** → **Sys** → **Disp**, enter the menu shown below:

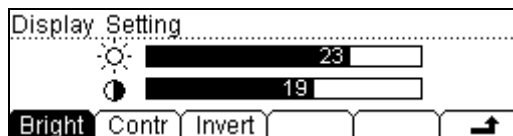

Figure 2-36

Table 2-25 Display Settings Function Menu Explanation

Function Menu	Explanation
Bright	Increase or decrease the display light with left and right keys.
Contr	Increase or decrease the display contrast with left and right keys.
Invert	Set to invert display mode.
↗	Save all changes, back to a higher level menu.

Switch Beeper Sound

Press **Utility** → **Sys** → **Sound**, enter the menu shown below:

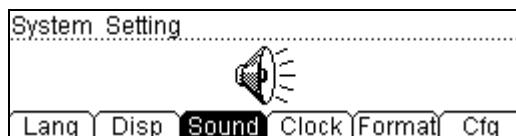

Figure 2-37
Sound On



Figure 2-38
Sound Off

Set Up the Benchmark Clock

Press **Utility** → **Sys** → **Clock**, enter the menu shown below:

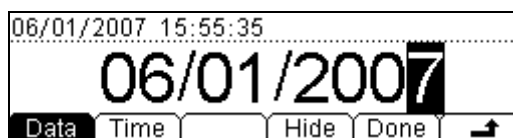

Figure 2-39
Data set interface

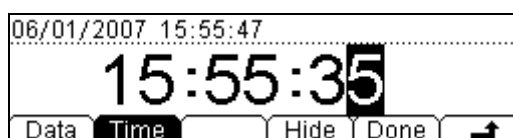

Figure 2-40
Time set interface

Table 2-26 Clock Settings Function Menu Explanation

Function Menu	Explanation
Data	Set up the data.
Time	Set up the time.
Hide	Hide data and time display.
Done	Save all changes, back to a higher level menu.
↩	Back to a higher level menu, without save.

Set Up Digit Format

Press **Utility** → **Sys** → **Format**, and enter the menu shown below:

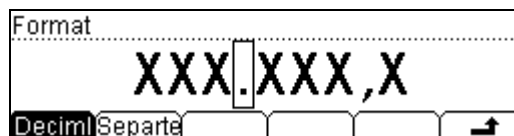

Figure 2-41

Table 2-27 Digit Format Function Menu Explanation

Function Menu	Explanation
Radix Point	Expresses radix point with • or , .
Separator	Expresses separator with , , space or none.
	Save all changes, back to a higher level menu.

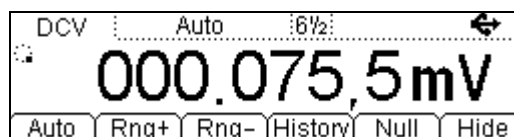

Figure 2-42

“•” express radix point, “,” express separator



Figure 2-43

“,” express radix point, “•” express separator



Figure 2-44

“•” express radix point, none express separator



Figure 2-45

“•” express radix point, “space” express separator

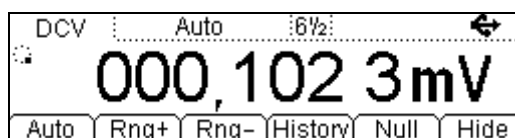

Figure 2-46

“,” express radix point, “space” express separator

Notice:

The decimal and the separator cannot be the same mode, if the decimal is “,”, then the separator can only be “•”, none of space; in contrarily, if the decimal is “•”, then the separator can only be “,”, none of space.

Set Up the I/O System

Press **Utility** → **I/O**, enter the menu shown below:

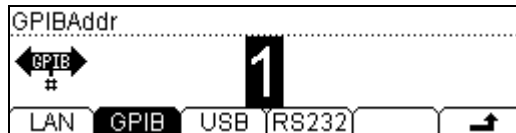

Figure 2-47

Table 2-28 I/O Setting Function Menu Explanation

Function Menu	Explanation
LAN	Set up LAN interface.
GPIB	Set up GPIB I/O interface.
USB	Check USB interface ID.
RS232	Set up RS-232 I/O interface.
↗	Save all changes, back to a higher level menu.

Set Up LAN I/O Parameter

LAN Parameters You may choose to manually set the following parameters, as described in the subsections that follow. Following these descriptions are procedures for setting up a LAN configuration from the front panel and the remote interface.

- IP Address
- Subnet Mask
- Default Gateway
- DNS Server
- Host Name

Press **Utility** → **I/O** → **LAN**, enter the menu shown below:

IP Address	:	168.254. 5.238
SubMask	:	255.255.255. 0
Default Gateway:		168.254. 5. 1
IP	DNS	Info
		↩

Figure 2-48

Table 2-29 LAN Parameter Function Menu Explanation

Function Menu	Setting	Explanation
IP		Set IP address and others information.
DNS	Host Name/ Domain Name/ DNS address	Set the host name. Set the domain name. Set DNS address.
Info		Examines the current LAN connection information.
↩		Save all changes, back to a higher level menu.

IP Settings

Press **Utility** → **I/O** → **LAN** → **IP**, enter the menu shown below:

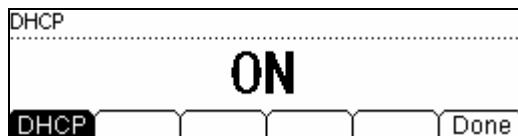

Figure 2-49
DHCP On



Figure 2-50
DHCP Off

Table 2-30 IP Setting Menu Explanation

Function Menu	Setting	Explanation
DHCP	ON/ OFF	Automatically assigns the IP address Manual assigns the IP address
Done		Save all changes, back to a higher level menu.

DNS Setting

Press **Utility** → **I/O** → **LAN** → **DNS**, enter the menu shown below:

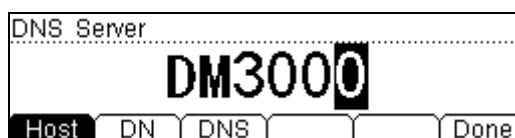

Figure 2-51

Table 2-31 DNS Setting Menu Explanation

Function Menu	Setting	Explanation
Host		Set the host name.
DN		Set the domain name.
DNS		Set the DNS address.
Done		Save all changes, back to a higher level menu.

Set Up GPIB I/O Parameter

Each device on the GPIB (IEEE-488) interface must have a unique address. You can set the address of multimeter to any integral value between 0 and 30. The default address is "1" when the instrument is shipped from the factory.

Press **Utility** → **I/O** → **GPIB**, enter the menu shown below:

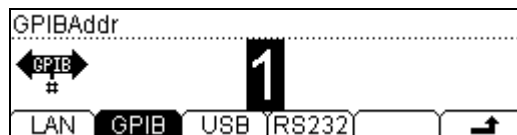

Figure 2-52

Table 2-32 GPIB I/O Setting Function Menu Explanation

Function Menu	Explanation
↗	Save all changes, back to a higher level menu.

Set Up RS-232 I/O Parameters

Press **Utility** → **I/O** → **RS232**, enter the menu shown below:

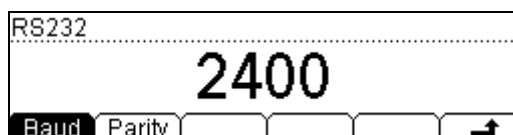



Figure 2-53

Table 2-33 RS-232 Parameter Function Menu Explanation

Function Menu	Display	Explanation
Baud	300 . . 38400	Set RS-232 baud rate as 300, 2400, 4800, 9600, 19200 or 38400.
Parity	None Odd Even	The parity check include: None, Odd check, and Even check.
↗		Save all changes, back to a higher level menu.

High-speed Data Logger

High-speed data logger displaying areas include: display mode settings, start acquire mode settings, and end acquire mode settings. When finish all settings, press  button to begin the high-speed data logger.

Setting high-speed data logger parameters

Press  button, enter the menu shown below:

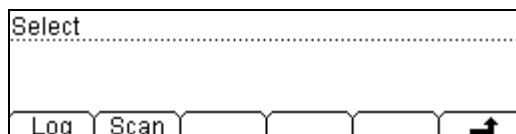



Figure 2-54
The main interface of DataLog

Table 2-34 Data Logger Parameter Setting Function Menu Explanation

Function Menu	Setting	Explanation
Log		Gather the data of DCV, DCI, 2WR or 4WR continuously.
Scan		Use the scanning mode to test the 16-roads signals continuously.
		Save all changes, back to a higher level menu.

Notice: Once in the DataLog mod, do not use the Auto range option function but choose the appropriate range option, thus the Log rates can be guaranteed.

Press , enter the data logger interface shown below.

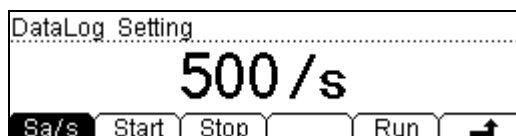

Figure 2-55
The DataLog setting interface

Table 2-35 Datalog menu Explanation

Function Menu	Setting	Explanation
Sa/s	1/10m 1/5m . . . 50k/s	To set the sample rate with 13 values from 1/10m to 50k/s.
Start	Trig Delay	To set the sample manner to be Trig or delay.
Stop	Timer REC#	To set the data measurement stop manner to be timer or counter.
Run		Start logger the data.
↵		Save all the changes, back to a higher level menu.

Press **Data Log** → **Log** → **Sa/s**, enter the interface shows below.

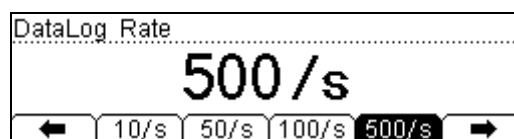

Figure 2-56

The DataLog rate setting interface

Press **Data Log** → **Log** → **Start**, enter the interface shows below.

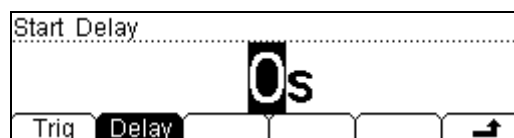

Figure 2-57

The DataLog start manner setting interface

Press **Data Log** → **Log** → **Stop**, enter the interface shows below.

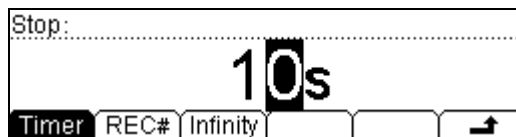

Figure 2-58
The DataLog Stop manner setting interface

1. DataLog rate

To set the DataLog sample rate.

Press **Data Log** → **Log** → **Sa/s**, enter the interface shows below.

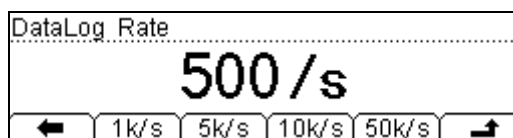

Figure 2-59

The Datalog rate setting interface

Table 2-36 The DataLog rate setting menu explanation

Function Menu	Setting	Explanation
1/10m 1/5m · · 50k/s		To set the sample rate with 13 values from 1/10m to 50k/s.
↗		Save all the changes, back to a higher level menu.

The system has set 13 DataLog rates; it is convenient for the user.

2. The start manner

To set a manner of the start condition and delay time of DataLog function.

Press **Data Log** → **Log** → **Start**, enter the interface shows below.

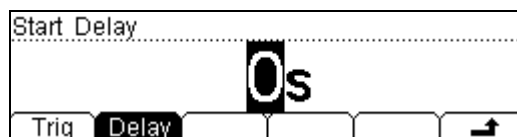

Figure 2-60

The start condition setting interface

Table 2-37 The start condition setting menu explanation

Function Menu	Setting	Explanation
Trig	Manu	To set the DataLog start manner to be manual trigger.
	Ext	To set the DataLog start manner to be external trigger.
Delay		The latency time from trigger start to beginning DataLog.
↵		Save all the changes, back to a higher level menu.

External trigger

The multimeter receives a trigger source from the rear external "Ext Trig" Under the External trigger mode.
Once under the External trigger mode the other trigger manner are prohibited automatically.

Manual trigger

Press **RUN** button, under the Manual trigger mode, to obtain continuous data.
The default trigger mode is Manual trigger which has been set before leaving the factory.

Start delay

The start delay time refers to the latency time from when the first sample finished to the second sample start.
Press **Data Log** → **Log** → **Start** → **Delay**, enter the interface shows below.

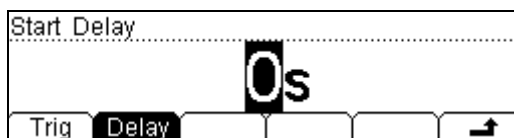

Figure 2-61
The menu of start manner interface

Table 2-38 The start delay menu explanation

Function Menu	Setting	Explanation
The set value	/	The default value of delay time is 0s, use the direction key to set the time you need.
↗	/	Save all the changes, back to a higher level menu.

3. The stop manner

To set the manner of stop DataLog.

Press  → Log → Stop, enter the interface shows below.

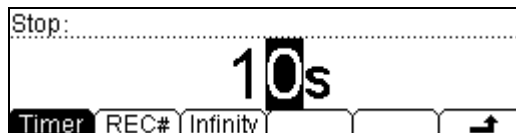



Figure 2-62
The stop condition menu interface

Table 2-39 The stop condition menu explanation

Function Menu	Setting	Explanation
Timer		To set the time of DataLog, stop the sample when the time is over.
REC#		To set the sample points of DataLog, stop the sample when reach the set number.
Infinity		To set the DataLog don't stop sampling.
		Save all the changes, back to a higher level menu.

Multi-route Scanning



Choose , in the menu of High-speed data sampling on the screen as figure 2-63 shows. Press **Scan** to set up the patrol inspecting function. The Scanning can accomplish the task of **New**, **Edit** and **Load**, Press  → **Scan**, enter the Scanning setting menu. The figure is as follows:



Figure 2-63

The main interface of Scanning

Table 2-40 the scanning menu explanation

Function Menu	Setting	Explanation
New		Create a new Scan task.
Edit		Amend a stored Scan task.
Load		Load a stored Scan task.
Run		Implement the current Scan task.
		Store the changing and return.

1. Create a new patrol inspecting task

Press  → Scan → New, enter the Scanning setting menu, the figure is shown below.

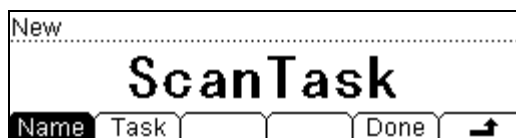



Figure 2-64

The main interface of setting Scanning

Table 2-41 the scanning task menu explanation

Function Menu	Setting	Explanation
Name		Create the name of the new Scanning Task.
Task		Add the Scanning task one by one.
Done	Save Apply	Affirm the setting of accomplishing the task and then stored or apply it straightly.
		Store the changing and return.

To set up the name of the scanning task

Press **Name**, and enter the input interface as the figure shown below.

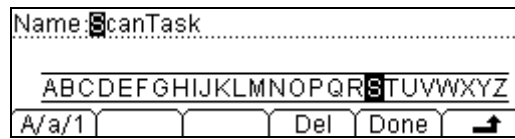

Figure 2-65

Where the cursor glittery is the item operating at the current time, use the up/down key to switch the operating item.

Press **Del**, delete the letter when it was pitched on.

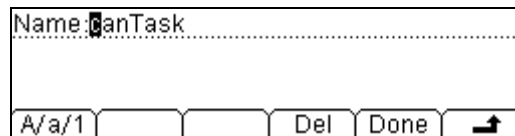

Figure 2-66

Press **Done** after the name was exported confirm using the name for this Scanning task.



Figure 2-67

To set up the scanning task

Press **Task**, enter the main interface to set up the scanning task.

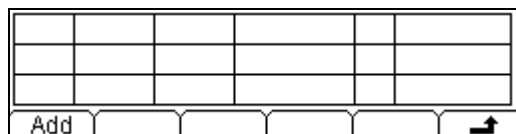

Figure 2-68

Press **Add**, setting one of the entry in the scanning task.

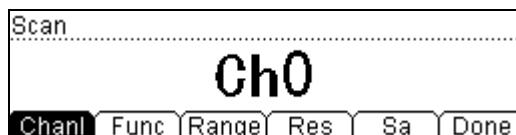

Figure 2-69

Table 2-42 the task menu explanation

Function Menu	Setting	Explanation
Chanl		Use the up/down key to select which channel the task will use
Func		Select the measure function
Range		Select the proper range options
Res		Select the digits reading precision
Sa		Set the number of the sampling for the task
Done		Store the changing and return

You can delete or edit the setting task if in need.

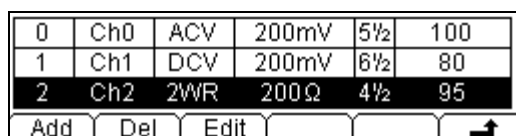

Figure 2-70

The appended task would be added at the end of the created scanning table orderly, when it comes to deleting or editing, it means to operating the current task.

Press **Done**, choose **Save** or **Apply** after accomplish to set the needed task.

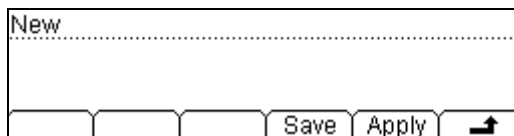

Figure 2-71

Press **Save**, enter the main interface of the scanning task, use the up/down key to choose the location for storing the file.



Figure 2-72

Press **Save**, enter the edit interface of the filename, Input a feat filename so it can be found out fleetly in the future.

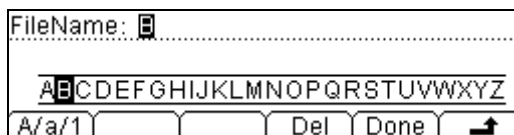

Figure 2-73

Press **Done**, then the scanning file will be stored in the appointed location. (the U disk operation is similar to the autochthonic, both of them should use the location to choose and store in the disk A:\)



Figure 2-74

If there is no need to store at the moment or store it later. Press **Apply** to scan and measure.



Figure 2-75

Press **Run**, start up the current scanning task and begin to measure.

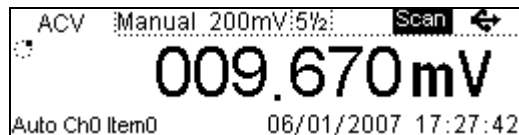

Figure 2-76

The instrument will measure the set of scanning tasks one by one after it is running.

Operation hint:

1. The system will exit the scanning function after the measure is over and return the function interface before.
2. Press **Single** while the scanning task is running for a few times, the current task will stop.

2. To edit the scanning task

Press **Edit**, enter the task editing interface.

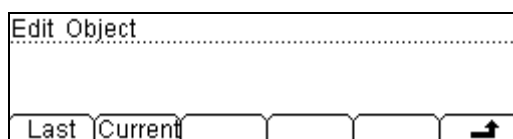

Figure 2-77

Table 2-43

Function Menu	Setting	Explanation
Last		Edit the scanning task which is created but non-apply.
Current		Edit the applied scanning task.
↗		Store the changing and return.

Option Explanation:

Last time: There is some error appear in the operation likely, thus the new-created scan task interface will be quit and can not return for another task. In this case you can enter the edit interface, choose editing **Last** and continue the operation before.
Current value: It is the last applied scanning task.

After choosing the object scanning task to edit, the later operation is the same as creating a new scanning task, thus not specify again here.

3. To load the scanning task

Press **Load**, enter the load interface of the scan task

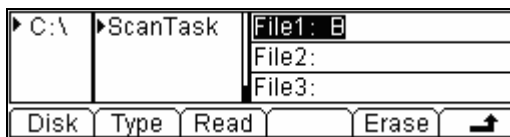

Figure 2-78

Use the direction key to choose the scanning task file needs to load, and then press **Read** to accomplish the task.

How to Use the Built-in Help System

To use the built-in help system you can get a particularly help for every button on the front panel.

Also you can press **Help** button to get more information, to press **Help** button, and enter the menu shown below:

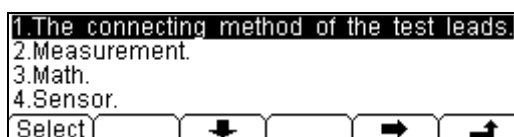

Figure 2-79

Table 2-44 Help Function Menu Explanation

Function Menu	Explanation
Select	To select the help information you want.
↑	Move up the cursor and select the help menu.
↓	Move down the cursor and select the help menu.
←	Enter the last page help menu.
→	Enter the next page help menu.
↶	Back to a higher level menu.

Notice: The arrowhead ↑ and ← are hidden before any operation is token.

The method of obtaining the help of the keyword:

Use the up/down key to choose the relevant keyword in the help file, press **Auto** you will get the help information.

1. Connect the test pen

Use to attain the method of how to connect the pen in different measurements.

2. Measure

Use to attain the help of getting how many functions can get when using Meas.

3. Math measure

Use to attain the help of how to operate the math measure function when using Meas.

4. Arbitrary sensor measure

5. Use to attain the help of how to operate the arbitrary sensor measure.

6. To set the DataLog

Use to attain the help of how to set the content when using Datalog.

7. Storage and read

Use to attain the method of how to store and read the data/parameter/arbitrary Sensors/scan task.

8. To set the Utility

Use to attain the method of setting the Utility.

9. I/O interface

Use to attain the method of setting the I/O interface.

10. Help on line

Press the key you need for help for 3 seconds at any operation interface, you will see the explanation about the key.

11. To change the electric power fuse

Use to attain the method of how to change the electric power fuse.

12. Technique support

Use to attain the manners of getting the technique support.

Chapter 3 Application & Examples

Example 1: Reading Statistic Functions

How to obtain the statistic of the maximum value read in the measurement.

When the total function is running, the first reading is taken the maximum value shown on the display. When continuously measures many readings, the multimeters renews the maximum value unceasingly.

Do these steps as follows:

1. Connect test leads as Chapter 1 introduced. Now we want to measure an AC Voltage. Connect test leads as shown:

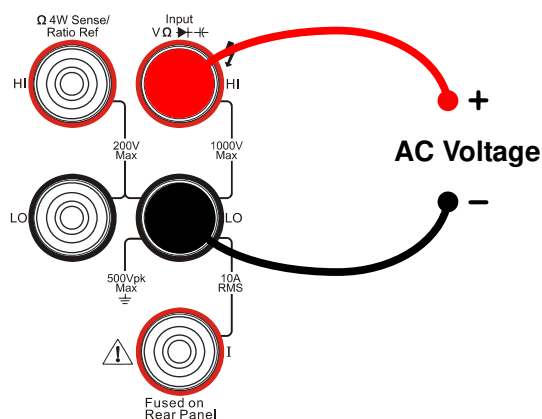

Figure 3-1

2. Press $\sim V$ button, select AC Voltage measurement function. Choose a correct range.
3. Set the Statistic measurement function parameters.
 - (1). Press Math → Stats → Max , choose maximum value measurement.
 - (2). Press \rightarrow , save all changes, back to a higher level menu.

4. Start Statistical measurement.
 - (1). Press **ON**, turn on the Statistic measurement function.
 - (2). Press **↵**, finish this setting.
5. Lead test leads into circuit, start to measure.

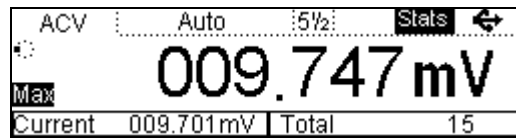

Figure 3-2

Example 2: Elimination Test Leads Resistance Error

When measuring smaller resistance the test leads resistance causes the measurement to have a great deviation. So we need to eliminate errors caused by resistance test leads.

Do these steps as follow:

1. Connect test leads as Chapter 1 introduced. Now we want to measure an AC Voltage. Connect test leads as shown:

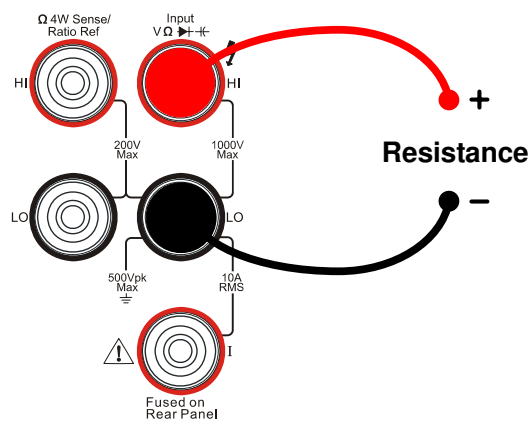

Figure 3-3

2. Press Ω button, select Resistance measurement function. And choose a correct range.
3. Set the Null measurement function parameters.
 - (1). Make the test leads shorted.
 - (2). Press Meas \rightarrow **Null**, set the Null setting value with current reading.
 - (3). Press \rightarrow save this setting.
 - (4). Press Meas button, finish the setting and back to a higher level menu.
4. In resistance measurement display interface, press **Null**, start Null function.
5. Lead test leads into circuit, start to measure.

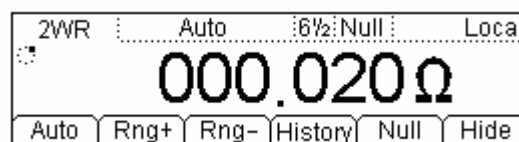

Figure 3-4

Example 3: dB Measurement

Do these steps as follows:

1. Connect test leads as Chapter 1 introduced. Now we want to measure an AC Voltage. Connect test leads as shown:

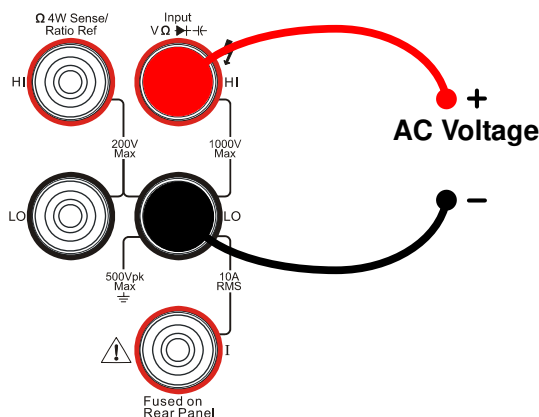

Figure 3-5

2. Press $\sim V$ button, select AC Voltage measurement function. Choose a correct range.
3. Set the Total measurement function parameters.
 - (1). Press Math \rightarrow dB , set the dB measurement setting value with the direction key.
 - (2). Press \rightarrow , save all changes, back to a higher level menu.
4. Start dB measurement.
 - (1). Press Math \rightarrow ON , turn on Total measurement function.
 - (2). Press \rightarrow , finish this setting.
5. Lead test leads into circuit, start to measure.

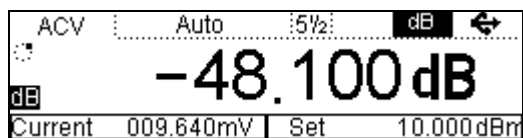

Figure 3-6

Example 4: dBm Measurement

Do these steps as follow:

1. Connect test leads as Chapter 1 introduced. Now we want to measure an AC Voltage. Connect test leads as shown:

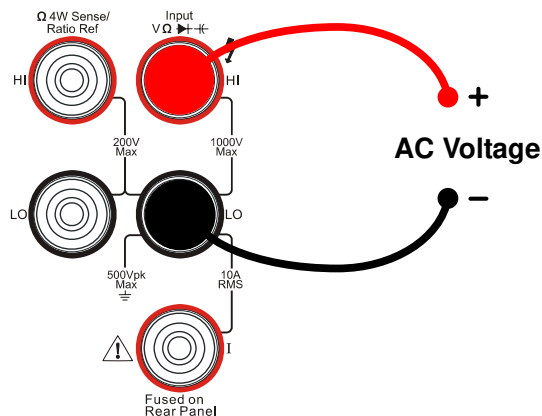

Figure 3-7

2. Press Ω button, select Resistance measurement function. And choose a correct range. Write down the reading count.
3. Press $\sim V$ button, select AC Voltage measurement function. And choose a correct range.
4. Set the Total measurement function parameters.
 - (1). Press Math \rightarrow **dBm**, set the Resistance measurement value with the direction key.
 - (2). Press \rightarrow , save all changes, back to a higher level menu.
5. Start dBm measurement.
 - (1). Press Math \rightarrow **ON**, turn on dBm measurement function.
 - (2). Press \rightarrow , and finish this setting.
6. Lead test leads into circuit, start to measure.

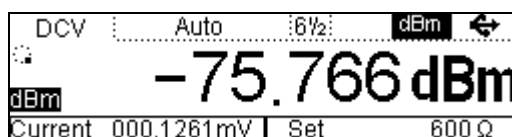

Figure 3-8

Example 5: Limit Test

Do these steps as follows:

1. Connect test leads as Chapter 1 introduced. Now we want to measure an AC Voltage. Connect test leads as shown:

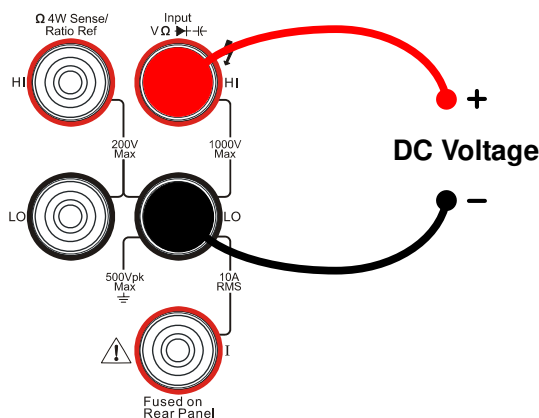

Figure 3-9

2. Press $\overline{\text{V}}$ button, select DC Voltage measurement function. Choose a correct range.
3. Set the Limit measurement function parameters.
 - (1). Press $\overline{\text{Math}}$ \rightarrow **Limit** \rightarrow **High**, Set up the upper value.
 - (2). Press $\overline{\text{Math}}$ \rightarrow **Limit** \rightarrow **Low**, Set up the lower value.
 - (3). Press $\overline{\text{Math}}$ \rightarrow **Limit** \rightarrow **OverR**, Set up the overload value.
 - (4). Press $\overline{\text{Enter}}$, save all changes, back to a higher level menu.
4. Start Total measurement.
 - (1). Press $\overline{\text{Math}}$ \rightarrow **ON**, turn on Limit measurement function.
 - (2). Press $\overline{\text{Enter}}$, finish this setting.
5. Lead test leads into circuit, start to measure.

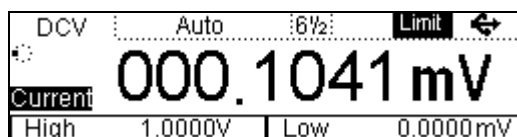

Figure 3-10

Example 6: Temperature Sensor

To set an arbitrary sensor is the same way to the temperature sensor. So, to set a temperature sensor, you will need to set the sensor name, sensor type, sensor physical unit, sensor reference data, and arithmetic.

Do these steps as following:

1. Press **Sensor** button, select the arbitrary sensor function.

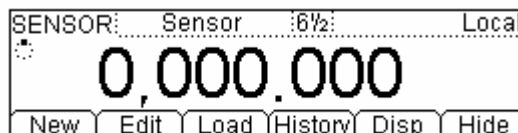

Figure 3-11

2. Press **New** → **Prpty**, select the proper function interface.

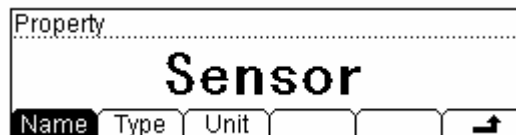

Figure 3-12

- (1). Press **Name**, input the name of this sensor: SensorT.

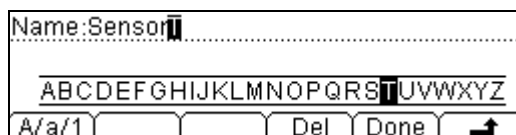

Figure 3-13

- (2). Press **Type**, select the type of the sensor: Resistance.



Figure 3-14

(3). Press **Unit** → °C, select the unit of the sensor: °C.

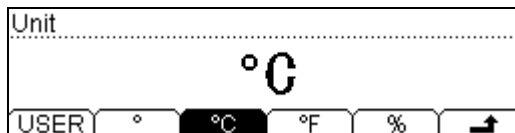

Figure 3-15

When you finish a proper input, press **↵**, save all the changes, back to a higher level menu.

3. Press **Define** button, button enter the interface shows below.

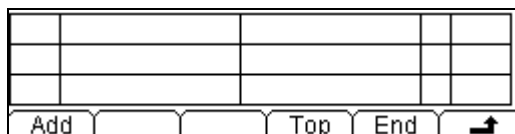

Figure 3-16

4. Press **Add** button, input the first group of reference value: 111.480Ω, 29.5°C.

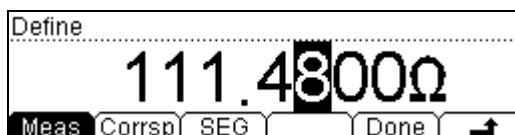

Figure 3-17

When finishing this group of reference value, press **Done** button, save all changes, and go on inputting other values.

1	111.4800Ω	29.5000°C	Line
2	112.5700Ω	32.5000°C	
3	113.8450Ω	35.5000°C	

Buttons: Add, Del, Edit, Top, End, ↵

Figure 3-18

In this interface you are allowed to delete and edit the reference values that you had inputted, select the group of reference value then press **Del** or **Edit** do the operations that you want to.

When you finish inputting all the data, press **↵** and save all the changes, back to a higher level menu.

5. In Define interface, Press **SEG** → **Arith** → **Line**, select the arithmetic: Line.

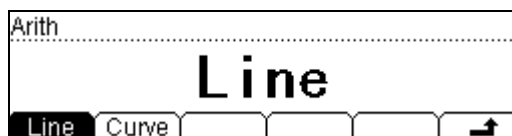

Figure 3-19

6. Press **↗** → **Done** → **Apply**, save all the data into the local storage, and applies it immediately.

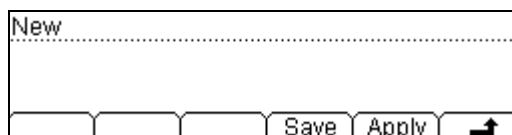

Figure 3-20

7. According to the sensor type, select an appropriate connection method.

(1). Voltage, resistance, frequency sensor:

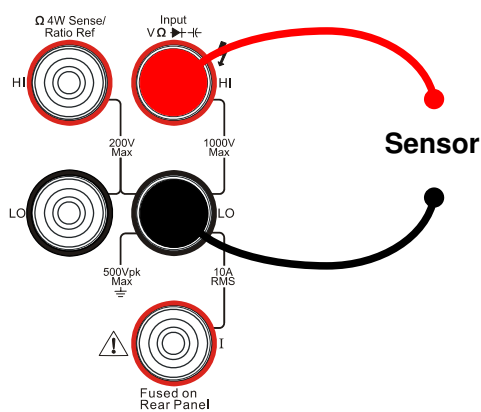

Figure 3-21

(2). Current sensor:

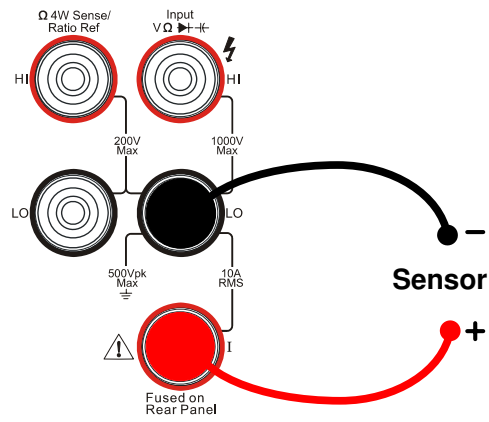

Figure 3-22

Example 7: Reading Hold

Do these steps as follows:

1. Connect test leads as Chapter 1 introduced. Now we want to measure an AC Voltage. Connect test leads as shown:

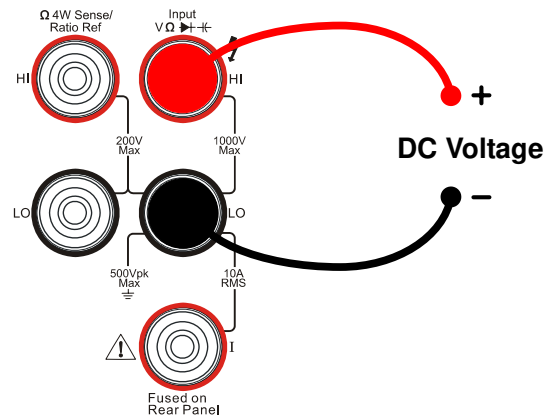

Figure 3-23

2. Press $\overline{\text{V}}$ button, select DC Voltage measurement function. Choose a correct range.
3. Set the Hold measurement function parameters.
 - (1). Press $\overline{\text{Trig}}$ → $\overline{\text{Auto}}$ → $\overline{\text{Hold}}$ → $\overline{0.1\%}$, Set up the hold scope to 0.1%.
 - (2). Press $\overline{\rightarrow}$, save all changes, back to a higher level menu.
 - (3). Press $\overline{\rightarrow}$, back to a higher level menu.
4. When the $\overline{\text{Run Hold}}$ was light, press this button once, the button will glitter, it means the trigger mode is now Hold mode. If current trigger mode is single, press $\overline{\text{Run Hold}}$ button twice.
5. Lead test leads into circuit, start to measure.

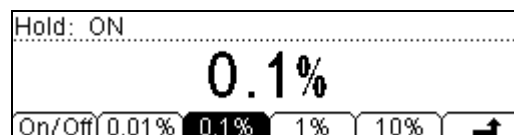

Figure 3-24

Chapter 4 Prompt messages& troubleshooting

Prompting Message

1. Delay time is 400 to 2000ms

In trigger setting, the setting value scope of auto trigger delay time is 400~2000ms.

2. No useful Math

Currently measurement function is not available for Math function.

3. Continue is 1Ω to 2000Ω

In continuity measurement, the short-current resistance setting value scope is 1Ω~2000Ω.

4. Sample is 1 to 50,000

Single trigger sampling number scope is 1~50,000.

5. Achieves the Maximum number

In arbitrary sensor setting, the reference value number gets the max value.

6. Number of reference value is **

The arbitrary sensor reference value number is: **.

7. Resistance is -120 to 120MΩ

In limit test and null value settings the resistance value scope: -120 MΩ~120MΩ.

8. Value must larger than 1μs

In limit test and null value settings the periods setting value should be bigger than 1μs.

9. Value is unable

Null value function setting value cannot surpass the measuring range scope.

10. Upper limit should larger than lower limit

In limit measurement the Upper limit should larger than lower limit.

11. GPIB address is 1 to 30

GPIB I/O interface address setting value scope: 1~30.

12. Frequency is 0 to 1MHz

In limit test and null value settings the frequency setting value scope is 0~1MHz.

13. DCV is -1200V to 1200V

In limit test and null value settings the DC voltage setting value scope is -1200V~1200V.

14. ACI is 0 to 12A

In limit test and null value settings the DC current setting value scope is 0~12A.

15. dB is -200dBm to 200dBm

In dB measurement function, the dB setting value scope is -200dBm ~200dBm.

16. dBm is 0 to 8000Ω

In dBm measurement function, the setting value scope is 0~8000Ω.

17. ACV is -900V to 900V

In limit test and null value settings the AC voltage setting value scope is -900V~900V.

18. DCI is 0 to 12A

In limit test and null value settings the AC current setting value scope is 0~12A.

19. Maximum value is **

Currently measurement function Max setting value: **.

20. Minimum value is **

Currently measurement function Min setting value: **.

21. Unused

The measurement for the forestall measuring function is unused for currently measuring function.

Troubleshooting

1. when press the power switch, the multimeter has blank screen with nothing displaying, please deal with the following steps:

- (1). Check if the power is correctly connected.
- (2). Check if the main power switch on the back panel has been open up.
- (3). Check if the safety tube has been melt, change another one if necessary.
- (4). Having done with the above steps, restart the instrument.
- (5). If it still can not work properly, please contract the local **RIGOL** Support center, let's serve for you.

2. when connecting a current signal, the reading has any change, please deal with the following steps:

- (1). Check if the meter pen is correctly connected with the current jack or the LO jack.
- (2). Check if the safety tube in the current location on the back panel has been melt.
- (3). Check if the measure location has switched to the DCI or ACI place correctly.
- (4). Check whether the input is ACI but the shelves location is DCI.

3. when connecting a DC power signal, the reading display is abnormality, please deal with the following steps:

- (1). Check if the meter pen is correctly connected with the current jack or the LO jack.
- (2). Check if the safety tube in the current location on the back panel has been melt.
- (3). Check if the measure location has switched to the DCI or DCV place correctly.
- (4). Check whether the input is DCI but the shelves location is ACI.

Chapter 5 *Support & Service*

Warranty (DM3000 Series Digital Multimeters)

RIGOL warrants that the products that it manufactures and sells will be free from defects in materials and workmanship for a period of three (3) years from the date of shipment from an authorized **RIGOL** distributor. If a product proves defective within the respective period, **RIGOL** will provide repair or replacement as described in the complete warranty statement.

To arrange for service or obtain a copy of the complete warranty statement, please contact your nearest **RIGOL** sales and service office.

RIGOL do not provide any other warranty items except the one being provided by this summary and the warranty statement. The warranty items include but not being subjected to the hint guarantee items related to tradable characteristic and any particular purpose.

RIGOL will not take any responsibility in cases regarding to indirect, particular and ensuing damage.

Contact RIGOL

If you meet any ambiguity during the use of our products, please contact **RIGOL** Technologies, Inc. or contact your local distributor.

Domestic: Please call

Tel: (8610)80706688

Fax: (8610)80720067

9:00 am –5: 00 pm from Monday to Friday

Or by e-mail:

support@rigol.com

Or mail to:

RIGOL Technologies, Inc.

156# CaiHe Village, ShaHe Town, ChangPing Districts, Beijing, China

Post Code: 102206

Overseas: Contact local **RIGOL** distributor or sales office.

For a list of worldwide service centers, visit our web site: www.rigol.com

To change the electric power fuse

The electric power fuse located in the rear of the Multimeter, the fuse is a kind of delay, no-burst, 250V/300mA, 5×20mm one.

Operation steps

1. Cut off the power. Use the tool to press down the block lingua (as the dashed line point out), and then pull out the seat of the fuse.
2. Choose the correct voltage shelves location in the voltage selected switches.
3. Enclose the seat of the fuse to the slot after placed the fuse.

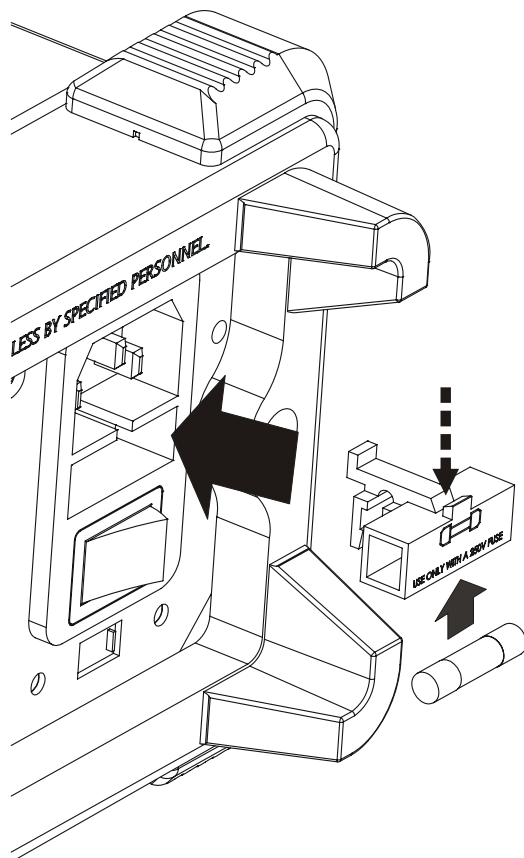

Figure 5-1

The sketch map of changing the electric power fuse

Chapter 6 Appendix

Appendix A: Specifications

DM3000 Series Digital Multimeters Performance Characteristics (6 1/2)			
Range Or Performance Parameters:	Resolution Or AC Voltage Frequency:	Accuracy: 1 Year \pm (% of reading + % of range)	Input Current, Or Current Source:
DC Voltage			
200.000,0 mV	100nV	0.0050 + 0.0017	10M Ω or >10G Ω
2.000,000 V	1 μ V	0.0040 + 0.0004	10M Ω or >10G Ω
20.000,00 V	10 μ V	0.0035 + 0.0003	10M Ω or >10G Ω
200.000,0 V	100 μ V	0.0045 + 0.0003	10M Ω
1000.000 V	1mV	0.0045 + 0.0005	10M Ω
DC Current			
2.000,000 mA	1nA	0.005 + 0.005	50 Ω
20.000,00 mA	10nA	0.005 + 0.004	50 Ω
200.000,0 mA	100nA	0.03 + 0.003	1 Ω
1.000,000 A	1 μ A	0.03 + 0.006	1 Ω
10.000,00 A	10 μ A	0.05 + 0.01	0.01 Ω
AC Voltage (RMS)			
Range from 200.000 mV to 750.000 V	3Hz-5Hz	1.00 + 0.01	1M Ω
	5Hz-10Hz	0.35 + 0.01	
	10Hz-20kHz	0.04 + 0.01	
	20kHz-50kHz	0.10 + 0.02	
	50kHz-100kHz	0.55 + 0.04	
	100kHz-300kHz	1.20 + 0.25	
AC Current (RMS)			
Range from 20.000,0 mA to 10.000,0 A	3Hz-10Hz	0.35 + 0.02	50 Ω /20.000,0 mA
	10Hz-5kHz	0.10 + 0.04	1 Ω /200.000 mA

DM3000 Series Digital Multimeters Performance Characteristics (6 1/2)			
Range Or Performance Parameters:	Resolution Or AC Voltage Frequency:	Accuracy: 1 Year±(% of reading + % of range)	Input Current, Or Current Source:
	5kHz-10kHz	0.20 + 0.04	1Ω/1.000,00 A 0.02Ω/10.000,0 A
Resistance (2-wire and 4-wire)			
200.000,0Ω	100μΩ	0.010 + 0.0020	1mA
2.000,000 kΩ	1mΩ	0.010 + 0.0005	1mA
20.000,00 kΩ	10mΩ	0.010 + 0.0005	100μA
200.000,0 kΩ	100mΩ	0.010 + 0.0005	10μA
2.000,000 MΩ	1Ω	0.010 + 0.0005	1μA
10.000,00 MΩ	10Ω	0.040 + 0.0005	200nA
100.000,0 MΩ	100Ω	0.080 + 0.0005	200nA
Capacitance			
2.000,0 nF	0.1pF	0.50 + 0.20	200nA
20.000 nF	1pF	0.40 + 0.05	1μA
200.00 nF	10pF	0.40 + 0.05	10μA
2.000,0 μF	100pF	0.40 + 0.05	100μA
20.000 μF	1nF	0.40 + 0.05	1mA
200.00 μF	10nF	0.10 + 0.05	1mA
Other Functions and Performance			
Continuity	2KΩ Range, Threshold Range 1Ω - 2KΩ		
Diodes test	2V Range, 1mA test current, 2.4V Max forward voltage drop		
Arbitrary Sensor	Support multiple ANSI standard thermocouple and the sensor with voltage, current, and resistance output.		
Frequency and Period	3Hz (0.333s) - 300kHz (3.33μs)		
Math	Null, Max/Min/Avg, dBm, dB, and Limit Test.		
Data Acquisition	Data Record, Inspection, Programmable Auto Measure.		
Other Functions	Auto Reading Hold, Ratio Test, Built-in 10 setup storage, 1M points of memory depth.		
High-speed Data Logger	50K/s (High-speed Data Logger)		
Measurement Precision	2,400,000 Count, >6 1/2		

DM3000 Series Digital Multimeters Performance Characteristics (6 1/2)			
Range Or Performance Parameters:	Resolution Or AC Voltage Frequency:	Accuracy: 1 Year \pm (% of reading + % of range)	Input Current, Or Current Source:
USB I/O Interface	USB Host to support USB disk and USB printer; USB Device		
Other I/O Interfaces	RS232, GPIB (Optional), LAN (Option), Inspection Module of 16 channels (Option)		
Display	256 \times 64 pixels LCD to support multi-display, menu, multi-language help and waveform display.		
Data Acquisition and Virtual	Support Microsoft [®] Windows 98/Me, Windows 2000/XP.		
Max Input	1,000V _{DC} , 750V _{RMS} AC, DC&AC max external current 10A, internal current 2A double fuses		
Shock and Vibration	MIL-T-28800, Type III, Class 5		
Power	115/230V, 45-65Hz, 20W Max		
Weight	2.5kg		
Size	107.0mmH \times 231.6mmW \times 290.5mmD		

DM3000 Series Digital Multimeters Performance Characteristics (5 3/4)			
Range Or Performance Parameters:	Resolution Or AC Voltage Frequency:	Accuracy: 1 Year±(% of reading + % of range)	Input Current, Or Current Source:
DC Voltage			
400.000 mV	1μV	0.025 + 0.002	10MΩ 或 >10GΩ
4.000,00 V	10μV	0.025 + 0.002	10MΩ 或 >10GΩ
40.000,0 V	100μV	0.025 + 0.002	10MΩ 或 >10GΩ
400.000 V	1mV	0.025 + 0.002	10MΩ
1000.00 V	10mV	0.025 + 0.002	10MΩ
DC Current			
4.000,00 mA	10nA	0.02 + 0.02	50Ω
40.000,0 mA	100nA	0.05 + 0.01	50Ω
400.000 mA	1μA	0.05 + 0.002	1Ω
4.000,00 A	10μA	0.20 + 0.002	1Ω
10.000,0 A	100μA	0.25 + 0.002	0.01Ω
AC Voltage (RMS)			
Range from 200.000 mV to 750.000 V	3Hz-5Hz	1.00 + 0.05	1MΩ
	5Hz-10Hz	0.50 + 0.05	
	10Hz-20kHz	0.40 + 0.05	
	20kHz-50kHz	1.00 + 0.05	
	50kHz-100kHz	3.00 + 0.10	
	100kHz-300kHz	1.20 + 0.20	
AC Current(RMS)			
Range from 20.000,0 mA to 10.000,0 A	3Hz-10Hz	1.50 + 0.04	50Ω/20.000 mA
	10Hz-5kHz	0.50 + 0.04	1Ω/200.00 mA
	5kHz-10kHz	2.00 + 0.10	1Ω/1.000,0 A
			0.02Ω/10.000 A
Resistance (2-wire and 4-wire)			
400.000Ω	1mΩ	0.05 + 0.002	1mA
4.000,00 kΩ	10mΩ	0.05 + 0.002	1mA
40.000,0 kΩ	100mΩ	0.05 + 0.002	100μA

DM3000 Series Digital Multimeters Performance Characteristics (5 3/4)			
Range Or Performance Parameters:	Resolution Or AC Voltage Frequency:	Accuracy: 1 Year \pm (% of reading + % of range)	Input Current, Or Current Source:
400.000 k Ω	1 Ω	0.05 + 0.002	10 μ A
4.000,00 M Ω	10 Ω	0.06 + 0.002	1 μ A
100.000 M Ω	1k Ω	2.00 + 0.002	200nA
Capacitance			
4.000 nF	0.1pF	2.0 + 0.2	200nA
40.00 nF	1pF	1.0 + 0.2	1 μ A
400.0 nF	10pF	1.0 + 0.2	10 μ A
4.000 μ F	100pF	1.0 + 0.2	100 μ A
40.00 μ F	1nF	1.0 + 0.2	1mA
200.0 μ F	10nF	1.0 + 0.2	1mA
Other Functions and Performance			
Continuity	2K Ω Range, Threshold Range 1 Ω - 2K Ω		
Diodes test	2V Range, 1mA test current, 2.4V Max forward voltage drop		
Arbitrary Sensor	Support multiple ANSI standard thermocouple and the sensor with voltage, current, and resistance output.		
Frequency and Period	3Hz (0.333s) - 300kHz (3.33 μ s)		
Math	Null, Max/Min/Avg, dBm, dB, and Limit Test.		
Data Acquisition	Data Record, Inspection, Programmable Auto Measure.		
Other Functions	Auto Reading Hold, Ratio Test, Built-in 10 setup storage, 1M points of memory depth.		
High-speed Data Logger	50K/s (High-speed Data Logger)		
Measurement Precision	2,400,000 Count, >6 1/2		
USB I/O Interface	USB Host to support USB disk and USB printer; USB Device		
Other I/O Interfaces	RS232, GPIB (Optional), LAN (Option), Inspection Module of 16 channels (Option)		
Display	256 \times 64 pixels LCD to support multi-display, menu, multi-language help and waveform display.		
Data Acquisition and Virtual	Support Microsoft $\text{\textcircled{R}}$ Windows 98/Me, Windows 2000/XP.		

RIGOL

DM3000 Series Digital Multimeters Performance Characteristics (5 3/4)			
Range Or Performance Parameters:	Resolution Or AC Voltage Frequency:	Accuracy: 1 Year \pm (% of reading + % of range)	Input Current, Or Current Source:
Max Input	1,000V _{DC} , 750V _{RMS} AC, DC&AC max external current 10A, internal current 2A double fuses		
Shock and Vibration	MIL-T-28800, Type III, Class 5		
Power	115/230V, 45-65Hz, 20W Max		
Weight	2.5kg		
Size	107.0mmH \times 231.6mmW \times 290.5mmD		

Appendix B: DM3000 Series Accessories

Standard Accessories:

- USB Data Wire
- Test Lead Kit
- A Power Cord that fits the standard of destination country.
- A User's Guide
- A User Registration Form
- Inspection Module (DM3063/64/53/54 only)
- Data Connection Cable (DM3063/64/53/54 only)
- UltraLogger Software CD-ROM (DM3063/64/53/54 only)

Optional Accessories:

- Ethernet cable
- RS-232 Cable
- GPIB cable (packing separated, not include in the main pack)

All the accessories (standard and optional) are available by contacting your local **RIGOL** office.

Appendix C: General Care and Cleaning

General Care

Do not store or leave the instrument in where the LCD display will be exposed to direct sunlight for long periods of time.



CAUTION: To avoid damage to the instrument or probes, do not expose them to sprays, liquids, or solvents.

Cleaning

If this instrument requires cleaning, disconnect it from all power sources and clean it with a mild detergent and water. Make sure the instrument is completely dry before reconnecting it to a power source.

To clean the exterior surface, perform the following steps:

1. Remove loose dust on the outside of the instrument and probes with a lint-free cloth. Take care to avoid scratching the clear plastic display filter.
2. Use a soft cloth dampened with water to clean the instrument.

NOTICE: To avoid damage to the surface of the instrument or probes, do not use any abrasive or chemical cleaning agent.