

Model 6752A

BNC (M), 75 Ohm, Crimp Type, RG 59, 59A, 59B, 62, 210

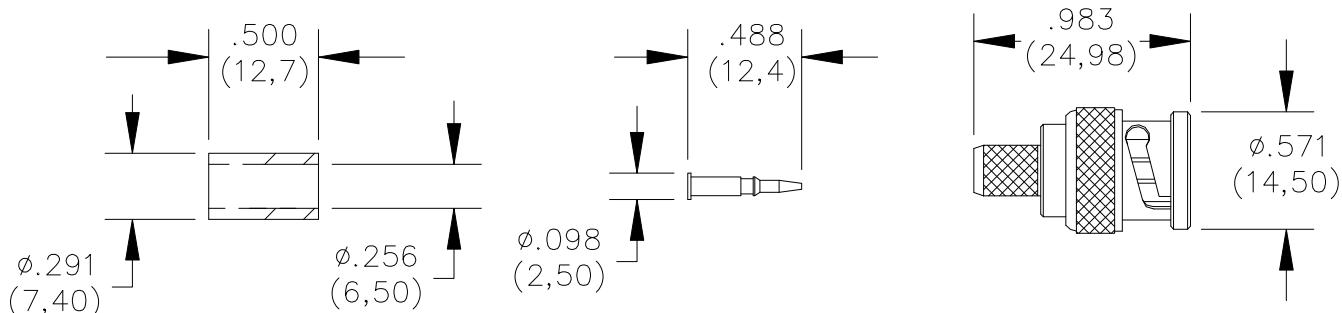

Model 6752A

BNC (M), 75 Ω, Crimp Type, RG 59, 59A, 59B, 62, 210

Features

- True 75 Ω. Designed for common cable types.
- Precision machined, gold plated contacts.
- Insulation material is PTFE (**not delrin**).
- Connector accepts cable types RG 59, 59A, 59B, 62, 210.

Materials

Center Conductor, Male: Brass, Gold Plated
 Connector Body: Brass, Tarnish Resistant Nickel Plated
 Crimp Ferrule: Brass, Nickel Plated
 Insulator: PTFE

Specifications

Impedance: 75 Ω
 Frequency Range: DC – 3GHz
 VSWR: 1.10 max., 0 – 1 GHz
 1.35 max., 1 – 3 GHz

Contact Resistance:
 Center Conductor: 1.5 mΩ
 Outer Conductor: 1.0 mΩ
 Dielectric Withstand Voltage: 1500 Vrms
 Voltage: 500 Vrms

For CE compliance, do not hold in hand when voltages exceed 33 Vrms / 70 Vdc.

Operating Temperature:
 -85°F to +329°F (-65°C to +165°C) Max.
 Number of Insertions: 500 cycles minimum

Ordering Information

Model: **6752A**

USA: Sales: 800-490-2361
 Technical Support: technicalsupport@pomonatest.com
 Fax: 425-446-5844

Europe: 31-(0) 40 2675 150 International: 425-446-5500

Where to Buy: www.pomonaelectronics.com

All dimensions are in inches. Tolerances (except noted): .xx = ±.02" (.51 mm), .xxx = ±.005" (.127 mm). All specifications are to the latest revisions. Specifications are subject to change without notice. Registered trademarks are the property of their respective companies.

Model 6752A
BNC (M), 75 Ohm, Crimp Type, RG 59, 59A, 59B, 62, 210

Cable Assembly Instructions

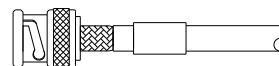

- A** CUT CABLE END EVENLY AND PERPENDICULAR.

- E** ASSEMBLE CONNECTOR BODY OVER THE CENTER CONTACT. FLARE THE BRAID BY ROTATING THE CONNECTOR AND PUSH THE BARREL UNDER THE BRAID. PRESS CONNECTOR ON CABLE UNTIL CENTER CONTACT CLICKS INTO PLACE.

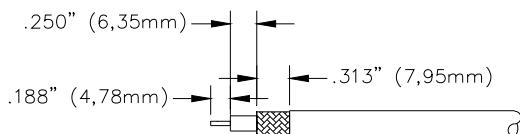

- B** STRIP CABLE JACKET, BRAID, AND DIELECTRIC TO SPECIFICATION LENGTHS. (NOTE: FOIL AND BRAID CABLES SHOULD LEAVE FOIL TO THE END OF DIELECTRIC).

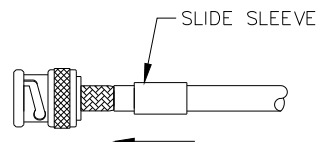

- F** SLIDE OUTER FERRULE OVER BRAID AND UP AGAINST BODY ASSEMBLY.

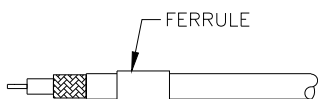

- C** SLIDE OUTER FERRULE OVER CABLE.

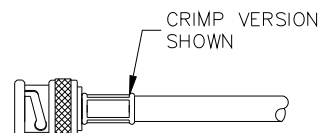

- G** CRIMP OUTER FERRULE WITH APPROPRIATE CRIMP TOOL.

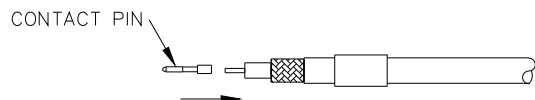

- D** INSERT CONTACT PIN ONTO CABLE'S CENTER CONDUCTOR SO THAT IT IS FLUSH TO DIELECTRIC, CRIMP OR SOLDER CONTACT FIRMLY.