

Model 6717

Dual Output, 50 Ohm BNC Circuit Board Mount, White Valox Case

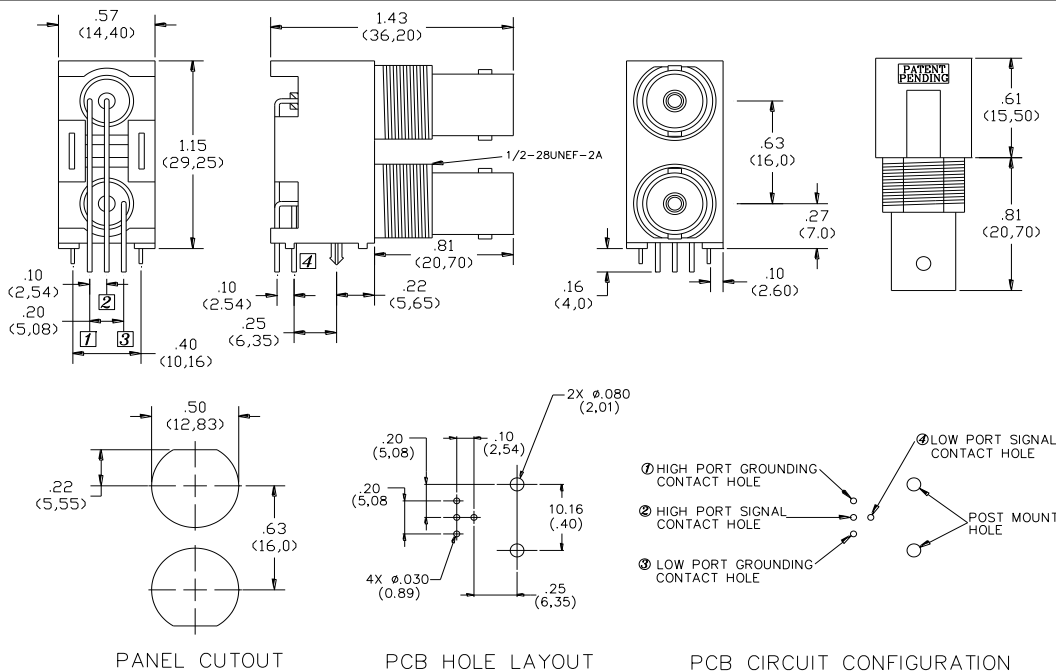

Materials

Case:	White Valox
BNC Body:	Nickel Plated Brass
Center Contact Pin:	Gold Plated Brass
Center Contact Socket:	Gold Plated Phosphor Bronze
Insulator:	Polybutylene Terephthalate

Ratings

Impedance:	50 Ohm
Frequency:	0 – 1 GHz
VSWR:	1.30 max
Contact Resistance:	3 Milliohms max.
Voltage:	* 500 V
Insulation Resistance:	5000 Megohms min.
Insertions:	500
Temperature:	-40°C to +85°C (-40°F to +185°F)
Shock:	50 G
Vibration:	20 G from 80 to 2000 Hz



* Maximum voltage for *hands free use* in controlled testing environments. For *CE compliance* and for personal safety, do not hold in hand when voltages exceed 30 Vrms / 42.4 Vpk / 60 Vdc, or current exceeds 8A maximum.

USA: Sales: 800-490-2361
Technical Support: technicalsupport@pomonatest.com
Fax: 425-446-5844

Europe: 31-(0) 40 2675 150 **International:** 425-446-5500
Where to Buy: www.pomonaelectronics.com

All dimensions are in inches. Tolerances (except noted): .xx = ±.02" (.51 mm), .xxx = ±.005" (.127 mm). All specifications are to the latest revisions. Specifications are subject to change without notice. Registered trademarks are the property of their respective companies.