

DA00016816-001



**WAVE FACTORY**

MULTIFUNCTION GENERATOR

**WF1973/WF1974**

---

Specifications

NF Corporation

[www.valuetronics.com](http://www.valuetronics.com)

---

## Contents

1. OVERVIEW .....	2
1.1 General.....	2
1.2 Features .....	2
2. CONFIGURATION.....	3
3. SPECIFICATIONS .....	3
3.1 Oscillation Modes .....	3
3.2 Waveforms.....	3
3.2.1 Standard waveforms.....	3
3.2.2 Arbitrary waveforms.....	3
3.3 Frequency, Phase .....	4
3.4 Output Characteristics.....	4
3.4.1 Amplitude.....	4
3.4.2 DC offset.....	5
3.4.3 Load impedance setting.....	5
3.4.4 Waveform output.....	5
3.4.5 Sync/sub output .....	5
3.5 Signal Characteristics .....	5
3.5.1 Sine wave .....	5
3.5.2 Square wave.....	6
3.5.3 Pulse wave .....	7
3.5.4 Ramp wave.....	7
3.5.5 Parameter-variable waveforms .....	7
3.6 Modulated Oscillation Mode.....	10
3.6.1 General.....	10
3.6.2 Modulation conditions .....	10
3.7 Sweep Oscillation Mode.....	11
3.7.1 General.....	11
3.7.2 Sweep conditions.....	12
3.8 Burst Oscillation Mode.....	13
3.9 Triggers .....	14
3.10 Sequence .....	14
3.11 Other I/Os .....	15
3.12 2-channel ganged operation (WF1974 only).....	16
3.13 Synchronous Operation of Multiple Units .....	17
3.14 User - Defined Units.....	18
3.15 Other Functions.....	18
3.16 Options.....	18
3.17 General Characteristics.....	19
■Block Diagram .....	20
■External Dimensions .....	21

---

## 1. OVERVIEW

### 1.1 General

The WF1973 and WF1974 are multifunctional generators based on direct digital synthesizers (DDS).

The WF1973 is a 1-channel generator, while the WF1974 is a two-channel generator.

### 1.2 Features

- Highest frequency: 30 MHz (sine wave), 15 MHz (square wave, pulse)
- Frequency accuracy:  $\pm(3 \text{ ppm} + 2 \text{ pHz})$ , high resolution of 0.01  $\mu\text{Hz}$ . 10 MHz external frequency reference can be used.
- Maximum output voltage: 20 Vp-p/open, 10 Vp-p/50  $\Omega$
- Large number of standard parameter-variable waveforms: Sine wave, square wave (variable duty), pulse (variable pulse width/duty, leading edge time, trailing edge time), ramp wave (variable symmetry), CF controlled sine wave (variable crest factor), staircase sine wave (variable number of steps), Gaussian pulse (variable  $\sigma$ ), Sin(x)/x (variable number of zero crossings), exponential rise/fall (variable time constant), damped oscillation (variable oscillation frequency, damping time constant), pulse surge (variable rising and duration times), trapezoid (variable rise, fall, and upper base width) , and so on.
- Large-capacity arbitrary waveform memory: 512 K words max., saving capacity: 128 waveforms/4 M words
- Phase and waveform remain continuous even when frequency is changed or during frequency sweep.
- Square wave, pulse with variable duty and high resolution of 0.0001%
- Pulse with variable leading edge time and trailing edge time
- Various oscillation modes
  - Continuous oscillation
  - Modulation: FM, FSK, PM, PSK, AM, DC offset modulation, PWM
  - Sweep: Frequency, phase, amplitude, DC offset, duty
  - Burst oscillation: Auto burst, trigger burst, gate oscillation, triggered gate oscillation
  - Sequence oscillation: Variable waveform/ frequency/ phase/ amplitude/ DC offset/ square wave duty, constant value/ linear interpolation, jump/ repeat/ hold/ branch
- Sequence function for easy test waveform creation and adjustment  
Flexible waveform creation possible through combination with standard parameter-variable waveforms  
Frequency, phase, amplitude, etc., can be rapidly changed and swept
- Intuitive user interface through use of high-resolution QVGA TFT color LCD
- Two-channel ganged function with 2 phases, constant frequency difference, constant frequency ratio, and differential output (only WF1974)
- Floated from housing for each channel to reduce effect of ground loop
- Multiple-phase oscillator can be configured by synchronizing multiple units
- USB and GPIB interfaces provided
- Thin and lightweight: Height of approx. 9 cm, weight of approx. 2.1 kg

---

## 2. CONFIGURATION

Main unit .....	1
Accessories	
Instruction Manual (Basics).....	1
CD(PDF instruction manuals, application software) .....	1
PDF instruction manuals :	
Basics, Application, Remote Control, Arbitrary Waveform Editing Software, Sequence Editing Software, LabVIEW Driver	
Application software :	
Arbitrary Waveform Editing Software, Sequence Editing Software, LabVIEW Driver	
Power cord set(2m, with 3-prong plug).....	1

( LabVIEW is registered trademark of National Instruments Corporation.  
All brand names and product names are trademarks or registered  
trademarks of their respective companies. )

## 3. SPECIFICATIONS

The values of items marked with \*1 are guaranteed values. All other values are either nominal values or typical (typ.) values, and are not guaranteed.

Conditions unless otherwise mentioned are as follows: Continuous oscillation, 50  $\Omega$  load, 10 V<sub>p-p</sub>/50  $\Omega$  amplitude setting, 0 V DC offset setting, auto-range,  $\pm$ FS waveform amplitude range, external addition off, AC voltage = RMS value measurement.

### 3.1 Oscillation Modes

Continuous, modulated, sweep, burst, sequence

### 3.2 Waveforms

#### 3.2.1 Standard waveforms

Types	Sine, square, pulse, ramp, parameter-variable waveform, noise (Gaussian distribution), DC
Polarity	Normal, inverted (selectable) (excluding DC)
Amplitude range	-FS/0, $\pm$ FS, 0/+FS (selectable) (excluding DC)

#### 3.2.2 Arbitrary waveforms

Waveform length	4 K to 512 K words ( $2^n$ , n = 12 to 19) or 2 to 10,000 control points (linear interpolation between control points)
Total waveform saving capacity	Up to 128 waveforms or 4 M words (combined total for channels 1 and 2) Saved to non-volatile memory
Waveform data amplitude resolution	16 bits
Sampling rate	120MS/s
Polarity	Normal, inverted (selectable)
Amplitude range	-FS/0, $\pm$ FS, 0/+FS (selectable)
Output bandwidth	25 MHz, -3 dB

### 3.3 Frequency, Phase

#### Frequency setting range

Oscillation Mode Waveform	Continuous, Modulated, Sweep (Continuous, Single-Shot)	Sweep (Gated Single-Shot), Burst	Sequence
Sine	0.01μHz to 30MHz	0.01μHz to 10MHz	0.01μHz to 10MHz
Square	0.01μHz to 15MHz	0.01μHz to 10MHz	0.01μHz to 10MHz
Pulse	0.01μHz to 15MHz	0.01μHz to 10MHz	Not usable
Ramp	0.01μHz to 5MHz		0.01μHz to 5MHz * <sup>2</sup>
Parameter- variable	0.01μHz to 5MHz		0.01μHz to 5MHz * <sup>2</sup>
Noise	Fixed to 26 MHz equivalent bandwidth		
DC	Frequency setting invalid		
Arbitrary	0.01μHz to 5MHz		

\*<sup>2</sup> : Used through conversion to arbitrary waveform

Frequency setting resolution	0.01μHz
Frequency setting by period	Setting equivalent to inverse number of the set period
Frequency accuracy at shipping * <sup>1</sup>	±(3 ppm of setting + 2 pHz )
Frequency aging rate * <sup>1</sup>	±1 ppm/year
Phase setting range	-1800.000° to +1800.000°(0.001° resolution)

### 3.4 Output Characteristics

#### 3.4.1 Amplitude

Setting range	0 Vp-p to 20 Vp-p/open, 0 Vp-p to 10 Vp-p/50 Ω Peak value combining waveform amplitude and DC offset is limited to ±10 V/open or lower
Setting resolution	999.9 mVp-p or lower 4 digits or 0.1 mVp-p 1 Vp-p or higher 5 digits or 1 mVp-p
Accuracy * <sup>1</sup>	±(1% of amplitude setting [Vp-p] + 2 mVp-p)/open Condition: 1 kHz sine, amplitude setting of 20 mVp-p/open or higher
Setting units	Vp-p, Vpk, Vrms, dBV, dBm
Range	Auto, hold (selectable) Maximum output voltage range: 20 Vp-p, 4 Vp-p Amplitude attenuator range: 0 dB, -10 dB, -20 dB, -30 dB
Waveform amplitude resolution	Approx. 14 bits Condition: Amplitude setting of 36 mVp-p/open or higher

---

### 3.4.2 DC offset

Setting range	$\pm 10$ V/open, $\pm 5$ V/50 $\Omega$
Setting resolution	$\pm 499.9$ mV or lower 4 digits or 0.1 mV $\pm 0.5$ V or higher 5 digits or 1 mV
Accuracy *1	$\pm ( 1\%$ of DC offset setting [V]  + 5 mV + 0.5% of amplitude setting [Vp-p])/open Condition: Sine wave output of 10 MHz or lower, 20°C to 30°C Outside 20°C to 30°C temperature range, 1 mV/°C typ. is added

### 3.4.3 Load impedance setting

Functions	Setting and display of the amplitude and DC offset for the output termination voltage under the specified load condition
Setting range	1 $\Omega$ to 10 k $\Omega$ (1 $\Omega$ resolution), 50 $\Omega$ , High-Z (load open)

### 3.4.4 Waveform output

Output on/off control	On, Off (selectable) (When Off, output pin open state)
Output impedance	50 $\Omega$ , unbalanced
Short-circuit protection	Protection against short circuit to signal GND
Output connector	Front panel, BNC receptacle

### 3.4.5 Sync/sub output

Output signal	Reference phase sync, internal modulation sync, burst sync, sweep sync, sequence step sync, internal modulation signal, sweep X drive (selectable)
Reference phase sync output waveform	Square waveform with 50% duty that rises at zero phase position of reference phase (DDS oscillation phase) of waveform output
Output voltage	Sync signals: TTL level (low level of 0.4 V/open or lower, high level of 2.7 V/open or higher) Internal modulation signal: -3 V to +3 V/open Sweep X drive: 0 V to +3 V/open
Output impedance	50 $\Omega$ , unbalanced
Load impedance	50 $\Omega$ or higher recommended
Output connector	Front panel, BNC receptacle

## 3.5 Signal Characteristics

### 3.5.1 Sine wave

Amplitude frequency characteristics *1	
100 kHz or lower	$\pm 0.1$ dB
100 kHz to 5 MHz	$\pm 0.15$ dB
5 MHz to 20 MHz	$\pm 0.3$ dB
20 MHz to 30 MHz	$\pm 0.5$ dB ( $\pm 0.8$ dB at amplitude setting of 2.8 Vp-p/50 $\Omega$ or higher)
	Condition: Amplitude setting 50 mVp-p to 10 Vp-p/50 $\Omega$ , reference frequency 1 kHz

---

Total harmonic distortion * <sup>1</sup>		
10 Hz to 20 kHz	0.2% or less	
	Condition:Amplitude setting of 0.5 Vp-p to 10 Vp-p/50 Ω	
Harmonic spurious * <sup>1</sup>		
Condition: Amplitude setting	0.5 Vp-p to 2 Vp-p/50 Ω	2 Vp-p to 10 Vp-p/50 Ω
1 MHz or lower	-60 dBc or lower	-60 dBc or lower
1 MHz to 10 MHz	-50 dBc or lower	-43 dBc or lower
10 MHz to 30 MHz	-40 dBc or lower	-30dBc or lower
Non-harmonic spurious * <sup>1</sup>		
1 MHz or lower	-60 dBc or lower	
1 MHz to 10 MHz	-50 dBc or lower	
10 MHz to 30 MHz	-45 dBc or lower	
	Condition:Amplitude setting of 0.5 Vp-p to 10 Vp-p/50 Ω	

### 3.5.2 Square wave

Duty		
Variable range selectable	Normal, extended (selectable)	
Normal range	Duty can be changed in range with little jitter and no pulse loss. The higher the frequency, the narrower the duty setting range.	
Extended range	With 2.5 ns rms or less typ. jitter, duty can be changed always in maximum range. In the case of a pulse width of 8.4 ns or less, loss may occur; on average, it is equal to the set duty.	
Setting range		
Normal range	0.0100% to 99.9900% (0.0001% resolution) Upper limit (%): 100 – frequency (Hz) / 300,000 Lower limit (%): frequency (Hz) / 300,000	
Extended range	0.0000% to 100.0000% (0.0001% resolution)	
Duty accuracy * <sup>1</sup>		
100 kHz or lower	±0.1% of period (duty setting 1% to 99%)	
100 kHz to 1 MHz	±1% of period (duty setting 5% to 95%)	
1 MHz to 3 MHz	±3% of period (duty setting 40% to 60%)	
Rising/falling time * <sup>1</sup>	17 ns or less	
	However, approx. 20 ns in the case of burst oscillation with stop level setting, gated single-shot sweep with stop level setting, and sequence oscillation	
Overshoot	5% or less typ.	
Jitter	Normal variable duty range : 300 ps rms or less typ. (100 Hz or higher)	
	Extended variable duty range : 2.5 ns rms or less typ.	

### 3.5.3 Pulse wave

#### Pulse width

Duty setting range	0.0170% to 99.9830% (0.0001% resolution)
Time setting range	25.50 ns to 99.9830 Ms (0.001% or less of period, or 0.01 ns resolution)

#### Leading edge time, trailing edge time

Setting range	15.0 ns to 58.8 Ms (3 digits or 0.1 ns resolution) Leading edge time and trailing edge time independently settable
---------------	---

Minimum setting value Largest of either 0.01% of period or 15 ns

#### Pulse width, leading edge time, trailing edge time limits

The pulse width time, leading edge time, trailing edge time, and period are mutually constrained by the following equations.

The duty is converted from pulse width time / period.

$$\begin{aligned} &(\text{leading edge time} + \text{trailing edge time}) \times 0.85 \leq \text{pulse width time} \\ &\text{pulse width time} \leq \text{period} - (\text{leading edge time} + \text{trailing edge time}) \times 0.85 \end{aligned}$$

Overshoot	5% or less typ.
Jitter	500 ps rms or less typ. (10 kHz or higher) 2.5 ns rms or less typ. (under 10 kHz)

### 3.5.4 Ramp wave

Symmetry setting range	0.00% to 100.00% (0.01% resolution)
------------------------	-------------------------------------

### 3.5.5 Parameter-variable waveforms

#### a) Steady sine group

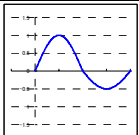
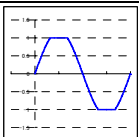
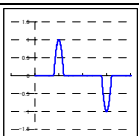
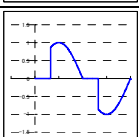
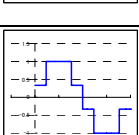
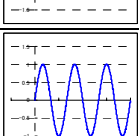
Waveform Name	Waveform Example	Description and Variable Parameters
Unbalanced sine		Waveform for which the amplitudes of the first half cycle and second half cycle of a sine wave can be changed independently
		First-half amplitude (-100.00% to 100.00%) Second-half amplitude (-100.00% to 100.00%)
Clipped sine		Waveform obtained by clipping the top and bottom of the amplitude of a sine wave
		Clip rate (0.00% to 99.99%)
CF controlled sine		Waveform obtained by extracting only the 90° and 270° neighborhood of a sine wave and expanding the amplitude
		Crest factor (1.41 to 10.00)
Conduction angle controlled sine		Waveform obtained by extracting only the front or back of each half cycle of a sine wave
		Conduction angle (-180.00° to 180.00°) Remark: In the case of a positive/negative conduction angle, back/front conduction angle
Staircase sine		Staircase shaped sine wave
		Number of steps (2 to 100)
Multi-cycle sine		Waveform obtained by continuing sine for several cycles
		Number of cycles (0.01 to 50.00) Start phase (-360.00° to 360.00°)

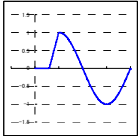
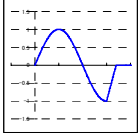
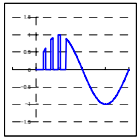
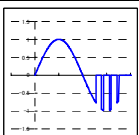

**b) Transient sine group**

Waveform Name	Waveform Example	Description and Variable Parameters
On-phase controlled sine		Sine wave with slope into on state
		Complete-on phase (0.00° to 360.00°) On-slope time (0.00% to 50.00% of basic period)
Off-phase controlled sine		Sine wave with slope into off state
		Off-phase (0.00° to 360.00°) Off-slope time (0.00% to 50.00% of basic period)
Chattering-on sine		Sine wave with chattering into on state
		On-phase (0.00° to 360.00°) Number of chatterings (0 to 3) On-state time (0.00% to 20.00% of basic period) Off-state time (0.00% to 20.00% of basic period)
Chattering-off sine		Sine wave with chattering into off state
		Off-phase (0.00° to 360.00°) Number of chattering (0 to 3) On-state time (0.00% to 20.00% of basic period) Off-state time (0.00% to 20.00% of basic period)

**c) Pulse group**

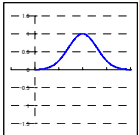
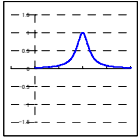
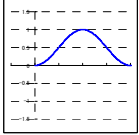
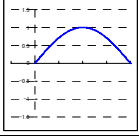
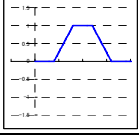
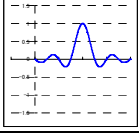
Waveform Name	Waveform Example	Description and Variable Parameters
Gaussian pulse		Gaussian distribution waveform
		Standard deviation (0.01% to 100.00% of basic period)
Lorentz pulse		Lorentz waveform
		Half value of width (0.01% to 100.00% of basic period)
Haversine		Sin <sup>2</sup> pulse
		Width (0.01% to 100.00% of basic period)
Half-sine pulse		Half-sine cycle pulse
		Width (0.01% to 100.00% of basic period)
Trapezoid pulse		Trapezoid pulse
		Slope width (0.00% to 50.00% of basic period) Upper base width (0.00% to 100.00% of basic period)
Sin(x)/x		Sin(x)/x waveform
		Number of zero crossings (1 to 50)

**d) Transient response group**

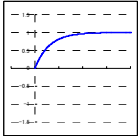
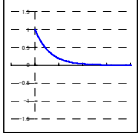
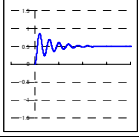
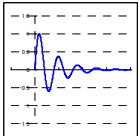
Waveform Name	Waveform Example	Description and Variable Parameters
Exponential rise		First order LPF step response waveform Time constant (0.01% to 100.00% of basic period)
Exponential fall		First order HPF step response waveform Time constant (0.01% to 100.00% of basic period)
Second order LPF step response		Second order LPF step response waveform LPF natural frequency (1.00 to 50.00 times basic frequency) LPF Q (0.50 to 50.00)
Damped oscillation		Oscillation waveform with an amplitude that decreases exponentially Oscillation frequency (0.01 to 50.00 times basic frequency) Damping time constant (-100.00% to 100.00% of basic period) Remark: In the case of a negative damping time constant, oscillation waveform with an amplitude that increases exponentially

**e) Surge group**

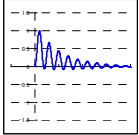
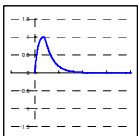
Waveform Name	Waveform Example	Description and Variable Parameters
Oscillation surge		Surge waveform with damped oscillation Oscillation frequency (0.01 to 50.00 times basic frequency) Damping time constant (0.01% to 100.00% of basic period) Trailing time constant (0.01% to 100.00% of basic period)
Pulse surge		Pulsed surge waveform Rising time (0.01% to 100.00% of basic period) Duration time (0.01% to 100.00% of basic period) Remark: The rising time represents the time from the 10% threshold to the 90% threshold of the rising edge. The duration time represents the time from 10% threshold of the rising edge to the 10% threshold of the next falling edge.

**f) Others group**

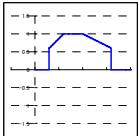
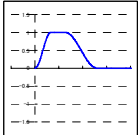
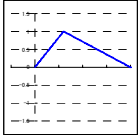
Waveform Name	Waveform Example	Description and Variable Parameters
Trapezoid with offset		Trapezoid waveform with offset in the amplitude direction Leading delay (0.00% to 100.00% of basic period) Rising-slope width (0.00% to 100.00% of basic period) Upper base width (0.00% to 100.00% of basic period) Falling-slope width (0.00% to 100.00% of basic period) Offset (0.00% to 100.00%)
Half-sine edge pulse		Pulse whose rise and fall are half-sine waveform Leading edge time (0.00% to 100.00% of basic period) Trailing edge time (0.00% to 100.00% of basic period) Duty (0.00% to 100.00%)
Bottom referenced ramp		Ramp waveform with bottom level as reference Symmetry(0.00% to 100.00%)

---

### 3.6 Modulated Oscillation Mode

#### 3.6.1 General

Modulation type	FM, FSK, PM, PSK, AM, DC offset modulation, PWM
Modulation source	Internal, external (selectable)
Internal modulation waveform	
Other than FSK, PSK	Sine wave, square wave (50% duty), triangular wave (50% symmetry), rising ramp wave, falling ramp wave, noise, arbitrary wave
FSK, PSK	Square wave (50% duty)
Internal modulation frequency	
Other than FSK, PSK	0.1 MHz to 100 kHz (5 digits or 0.1 MHz resolution)
FSK, PSK	0.1 MHz to 1 MHz (5 digits or 0.1 MHz resolution)
Internal modulation sync output	
Output waveform	Square wave with 50% duty that rises at zero phase position of internal modulation waveform
	Fixed to low level while internal modulation waveform is noise
Output connector	Shared with sync/sub-output connector
Internal modulation signal output	
Output voltage	-3 V to +3 V/open
Output connector	Shared with sync/sub-output connector
External modulation input (other than FSK, PSK)	
Input voltage range	$\pm 1$ V full scale
Maximum allowed input	$\pm 2$ V
Input impedance	10 k $\Omega$ , unbalanced
Input frequency	DC to 25 kHz
Input connector	Front panel (WF1973) / rear panel (WF1974)
	BNC receptacle
	Shared with external addition input, cannot be used simultaneously with adding operation
External modulation input (FSK, PSK)	
Polarity	Positive, negative (selectable)
Input frequency	DC to 1 MHz
Input connector	Use of external trigger input.
	Input voltage and input impedance follow the external trigger input specifications.

#### 3.6.2 Modulation conditions

##### ■ FM

Carrier waveform	Standard waveform other than noise, pulse wave and DC, and arbitrary waveform
Peak deviation setting range	0.00 $\mu$ Hz to less than 15 MHz (8 digits or 0.01 $\mu$ Hz resolution)

---

<b>■ FSK</b>	
Carrier waveform	Standard waveform other than noise, pulse wave and DC, and arbitrary waveform
Hop frequency setting range	Within settable carrier waveform frequency range (8 digits or 0.01 $\mu$ Hz resolution)
<b>■ PM</b>	
Carrier waveform	Standard waveform other than noise and DC, and arbitrary waveform
Peak deviation setting range	0.000° to 180.000° (0.001° resolution)
<b>■ PSK</b>	
Carrier waveform	Standard waveform other than noise and DC, and arbitrary waveform
Deviation setting range	-1800.00° to +1800.000°(0.001° resolution)
Remark	The sine wave amplitude frequency characteristics during PSK are limited to 25 MHz, -3 dB.
<b>■ AM(non-DSB-SC)</b>	
Carrier waveform	Standard waveform other than DC, and arbitrary waveform
Modulation depth setting range	0.0% to 100.0% (0.1% resolution)
Remark	When the modulation depth is 0%, the amplitude is 1/2 of the set value.
<b>■ AM(DSB-SC) (Double Side Band - Suppressed Carrier)</b>	
Carrier waveform	Standard waveform other than DC, and arbitrary waveform
Modulation depth setting range	0.0% to 100.0% (0.1% resolution)
Remark	When the modulation depth is 100%, the maximum amplitude is equal to the set value. During DSB-SC, the carrier frequency component is zero.
<b>■ DC offset modulation</b>	
Carrier waveform	Standard waveform and arbitrary waveform
Peak deviation setting range	0 V to 10 V/open
<b>■ PWM</b>	
Carrier waveform	Square wave, pulse wave
Peak deviation setting range	
Square wave	
Normal variable duty range	0.0000% to 49.9900% (0.0001% resolution)
Extended variable duty range	0.0000% to 50.0000% (0.0001% resolution)
Pulse wave	0.0000% to 49.9000% (0.0001% resolution)

### 3.7 Sweep Oscillation Mode

#### 3.7.1 General

Sweep types	Frequency, phase, amplitude, DC offset, duty
Sweep functions	One-way (ramp waveform shape), shuttle(triangular waveform shape) (selectable) Linear, log (frequency sweep only) (selectable)
Sweep range setting	Start value and stop value specification Center value and span value specification
Sweep time setting range	0.1 ms to 10,000s (4 digits or 0.1 ms resolution)

---

Sweep mode	Continuous, single-shot, gated single-shot (selectable) During gated single-shot, oscillation occurs only during sweep execution
Operation	Start, stop, hold/resume, start value output, stop value output
Trigger source (used for single-shot sweep and gated single-shot sweep)	Internal, external (selectable) Trigger delay setting is invalid. Manual trigger possible.
Internal trigger oscillator for sweep (used for single-shot sweep and gated single-shot sweep)	
Period setting range	100.0 $\mu$ s to 10,000 s (5 digits or 0.1 $\mu$ s resolution)
Stop level setting (used for gated single-shot sweep)	
Function	Specification of signal level while oscillation is stopped during gated single-shot sweep
Setting range	-100.00% to +100.00% of amplitude full scale (0.01% resolution) or off
Oscillation stop unit during gated single-shot	1 cycle, 0.5 cycles (selectable)
Sweep sync/marker output	
Marker off, one-way sweep	Low level from sweep start value to half of sweep time. High level at any other time.
Marker off, shuttle sweep	Low level from sweep start value to sweep stop value. High level at any other time.
Marker on	Low level from sweep start value until marker value. High level at any other time.
Output connector	Shared with sync/sub-output connector
Sweep X drive output	
Output voltage	0 V to +3 V/open 0 V $\rightarrow$ +3 V during sweep value rise +3 V $\rightarrow$ 0 V during sweep value fall
Output connector	Shared with sync/sub-output connector
Sweep external control input	
Input connector	Use of 3 bits of multi-I/O connector
Control items	Start, stop, hold/resume
Sweep external trigger input (used for single-shot sweep and gated single-shot sweep)	
Polarity	Positive, negative, off (selectable)
Input connector	Use of external trigger input. Input voltage and input impedance follow the external trigger input specifications.

### 3.7.2 Sweep conditions

#### ■ Frequency sweep

Waveform	Standard waveform other than noise, pulse wave, and DC, and arbitrary waveform
Start, stop frequency setting range	0.01 $\mu$ Hz to 30 MHz (0.01 $\mu$ Hz resolution)

#### ■ Phase sweep

Waveform	Standard waveform other than noise and DC, and arbitrary waveform
Start, stop phase setting range	-1800.000° to 1800.000° (0.001° resolution)

---

■ **Amplitude sweep**

Waveform Standard waveform other than DC, and arbitrary waveform  
Start, stop amplitude setting range 0 Vp-p to 20 Vp-p/open

■ **DC offset sweep**

Waveform Standard waveform and arbitrary waveform  
Start, stop DC offset setting range -10 V to +10 V/open

■ **Duty sweep**

Waveform Square wave, pulse wave  
Start, stop duty setting range  
Square wave  
Normal variable duty range 0.0100% to 99.9900% (0.0001% resolution)  
Extended variable duty range 0.0000% to 100.0000% (0.0001% resolution)  
Pulse wave 0.0170% to 99.9830% (0.0001% resolution)

### 3.8 Burst Oscillation Mode

Burst mode  
Auto burst Repeats oscillation of mark wave number and oscillation stop of space wave number.  
Trigger burst Trigger invalid.  
Performs oscillation of mark wave number in sync with trigger.  
Gate Performs oscillations in cycles of integers or integer multiples of half-cycles, in sync with the gate signal.  
However, if the waveform is noise, oscillation on/off operation is done through the gate signal.  
Triggered gate Gate oscillation switched on/off by gate upon trigger.  
Target waveforms  
Auto, trigger burst Standard waveform other than noise and DC, and arbitrary waveform  
Gate, triggered gate Standard waveform other than DC, and arbitrary waveform  
Setting range of mark wave number 0.5 cycles to 999,999.5 cycles, in 0.5-cycle units  
Setting range of space wave number 0.5 cycles to 999,999.5 cycles, in 0.5-cycle units  
Oscillation stop unit during gate 1 cycle, 0.5 cycles (selectable)  
Oscillation start/stop phase setting range  
-1800.000° to +1800.000° (0.001° resolution)  
Remark: Same setting value as phase setting in section 3.3  
Stop level setting range  
Function Specification of signal level when oscillation is stopped  
Setting range -100.00% to +100.00% of amplitude full-scale (0.01% resolution) or off  
When the stop level is set to off, stop occurs at the set oscillation start/stop phase  
Trigger source (used during other than auto burst)  
Internal, external (selectable). Manual trigger possible.  
Internal trigger oscillator for burst (used during other than auto burst)  
Period setting range 1.0 μs to 1,000 s (5 digits or 0.1 μs resolution)

---

Trigger delay setting range	0.00 $\mu$ s to 100.00 s (5 digits or 0.01 $\mu$ s resolution) Latent delay of 0.55 $\mu$ s Only valid for trigger burst (not valid for gate, triggered gate) Valid for both internal and external trigger sources Not valid for manual trigger
Trigger jitter	1 ns rms or less typ.
Burst sync output	
Polarity	Low level during oscillation. High level at all other times.
Output connector	Shared with sync/sub-output connector

### 3.9 Triggers

External trigger input	
Applications	Used for single-shot sweep, gated single-shot sweep, trigger burst, gate, triggered gate, and sequence
Input voltage	TTL level (low level of 0.8 V or lower, high level of 2.6 V or higher)
Maximum allowed input	-0.5 V to +5.5 V
Polarity	Positive, negative, off (selectable) FSK and PSK, sweep, sequence (independently settable)
Minimum pulse width	50 ns
Input impedance	10 k $\Omega$ (pulled up to +3.3 V), unbalanced
Input connector	Front panel (WF1973) / rear panel (WF1974) BNC receptacle
Manual trigger	Panel key operation
Applications	Used for single-shot sweep, gated single-shot sweep, trigger burst, gate, triggered gate
Internal trigger oscillator	Independent for sweep and burst Refer to internal trigger oscillator of each section

### 3.10 Sequence

Number of saved sequences	10 sequences (saved to non-volatile memory)
Maximum number of steps	Maximum of 255 steps per sequence (not including step of pre-start status)
Inter-channel operation	In sequence mode, the mode of both channels is the sequence mode. Step control is done in common for both channels.
Step control parameters	Step time, hold operation, jump destination, number of jumps, step stop phase, branch operation, step termination control, step sync code output
Intra-step channel parameters	Waveform, frequency, phase, amplitude, DC offset, square wave duty
In-step operations	Constant, keep, linear interpolation (except waveform switching)

---

Step time setting range	0.1 ms to 1,000 s (4 digits or 0.01 ms resolution)
Jump count setting range	1 to 999 or infinite
Step stop phase setting range	0.000° to 360.000° (CH1 reference phase. 0.001° resolution) or invalid
Branch operation	
State branch	Check of state branch input from multi-I/O connector at step end. Upon branch input detection, branching to specified destination step.
Event branch	Immediate branching to specified destination step through event branch manipulation or input
Control of step termination	Sequence end or transition to next step
Step sync code output	Output of 4-bit code specified for each step to multi-I/O connector
Usable waveforms	LSB outputtable to sync/sub-output connector Sine wave, square wave, noise, DC, and arbitrary wave Ramp wave and parameter-variable waveform can be used through saving as arbitrary waveforms
Maximum number of usable waveforms	128
Step start phase	Oscillation start from reference phase 0° of each channel at next step after DC or noise (excluding DC and noise)
Sequence manipulations	Start, stop, hold/resume, event branch
Sequence external control	
Input connector	Use of 4 bits of multi-I/O connector
Control items	Start or state branch, stop, hold/resume, event branch
Sequence external trigger input (start trigger)	
Polarity	Positive, negative, off (selectable)
Input connector	Use of external trigger input on CH1 side. Input voltage and input impedance follow the external trigger input specifications.

### 3.11 Other I/Os

External 10 MHz frequency reference input	
Frequency reference selection	External reference enable, disable (selectable)
Input voltage	0.5 Vp-p to 5 Vp-p
Maximum allowed input	10 Vp-p
Input impedance	1 kΩ, unbalanced, AC coupled
Input frequency	10 MHz (±0.5% (±50 kHz) )
Input waveform	Sine wave or square wave (50 ±5% duty)
Input connector	Rear panel, BNC receptacle



Frequency reference output (for synchronizing multiple WF1973, WF1974 units)	
Output voltage	1 Vp-p/50 Ω square wave
Output impedance	50 Ω, AC coupled
Output frequency	10 MHz
Output connector	Real panel, BNC receptacle
External addition input	
Addition gain	×2, ×10, off (selectable) During ×2, the maximum output voltage range is fixed to 4 Vp-p, and during ×10, 20 Vp-p. Off during sequence oscillation
Input voltage	-1 V to +1 V
Maximum allowed input	±2 V
Input frequency	DC to 10 MHz (-3 dB)
Input impedance	10 kΩ, unbalanced
Input connector	Front panel (WF1973) / rear panel (WF1974) BNC receptacle Shared with external modulation input, cannot be used during external modulation
Multi-I/O	
Applications	Sweep control, sequence control
Input voltage	TTL level (low level of 0.8 V or lower, high level of 2.6 V or higher. Pulled up to +5 V through 10 kΩ)
Maximum allowed input	-0.5V to +5.5 V
Output voltage	TTL level (low level of 0.4 V/open or lower, high level of 2.7 V/open or higher)
Connector	Rear panel, Mini-Dsub 15-pin multiconnector

### 3.12 2-channel ganged operation (WF1974 only)

#### Channel modes

Channel modes	Operation
Independent	Independent setting
2-phase	Holds same frequency. During frequency sweep, internal frequency modulation, and internal FSK, controls to hold the same frequency. External frequency modulation and external FSK are not possible. Phase independently set for each channel.
Constant frequency difference	Holds the frequency difference as a constant value. During frequency sweep, internal frequency modulation, and internal FSK, controls to hold the frequency difference. External frequency modulation and external FSK are not possible.
Constant frequency ratio	Holds the frequency ratio as a constant value. During frequency sweep, internal frequency modulation, and internal FSK, controls to hold the frequency ratio. External frequency modulation and external FSK are not possible.
Differential Output	Same frequency, amplitude, and DC offset. Reverse phase waveform. Controls to hold differential output during all types of sweep and internal modulation. External modulation and external addition are not possible.

Common limiting conditions during 2-phase, constant frequency difference, constant frequency ratio, and differential output

- Oscillation in same oscillation mode (also same modulation type during modulated oscillation, and same sweep type during sweep oscillation)
- Applicable to standard waveform other than noise and DC, and arbitrary waveform
- Burst, gated single-shot sweep not possible

Same value setting, same manipulation

	Yes
Frequency difference setting range	0.00 $\mu$ Hz to less than 30 MHz (0.01 $\mu$ Hz resolution) CH2 frequency – CH1 frequency
Frequency ratio N:M setting range	1 to 9,999,999 (for each of N and M) N:M = CH2 frequency:CH1 frequency
Phase synchronization	Automatically executed during channel mode switching
Time difference between channels during 2-phase <sup>*1</sup>	$\pm 20$ ns or less ( $\pm 10$ ns or less typ.) Condition: Same waveform (sine or square)

### 3.13 Synchronous Operation of Multiple Units

Connection

Connection method 1

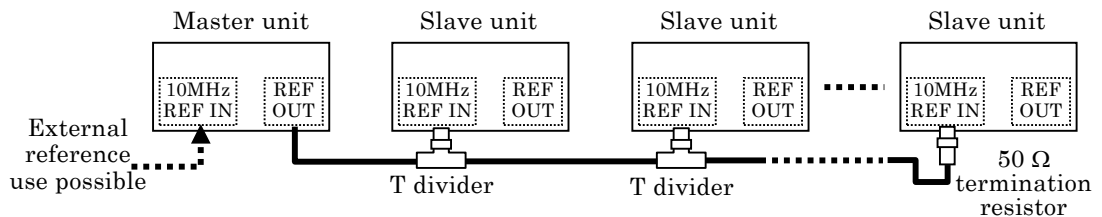

Connection method 2

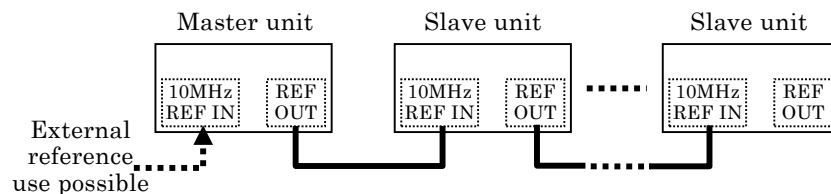

Connection cable

Cable type Coaxial cable of characteristic impedance 50  $\Omega$  with BNC connector (RG-58A/U, etc.)

Cable length limit 1 m or less between units, total length of 3 m or less

Maximum number of connectable units

Connection method 1: 6 units including master unit

Connection method 2: 4 units including master unit

Phase synchronization operation

Manual operation

---

Time difference between units

Delay of each channel of nth slave unit in relation to each channel of the master unit  
( $1 \leq N$ )

Connection method 1:

$$31 \text{ ns} + (N - 1) \times 6 \text{ ns} \quad \pm 25 \text{ ns or less typ.}$$

Connection method 2:

$$31 \text{ ns} + (N - 1) \times 31 \text{ ns} \quad \pm 25 \text{ ns or less typ.}$$

Condition: Same frequency, same phase, same waveform (sine or square), length of connection cable between frequency reference output and external frequency reference input = 1 m (RG-58A/U)

### 3.14 User - Defined Units

Function

Setting and display in arbitrary unit according to the specified conversion expression

Setting target

Frequency (Hz), period (sec), amplitude (Vp-p, Vpk), DC offset (V), phase (deg), duty (%)

Conversion expression

$[(\text{Setting target value}) + n] \times m$ , or  
 $[\log_{10}(\text{setting target value}) + n] \times m$

Specification of conversion expression and values of n and m

Unit character string

Up to 4 characters can be set

### 3.15 Other Functions

Setting saving capacity

10 settings(saved to non-volatile memory)

External control

GPIO, USBTMC (SCPI-1999, IEEE-488.2)

### 3.16 Options

PA-001-1318 multi-I/O cable

Cable with connector on one end, for connection to multi-I/O connector on rear panel. 2 m length. Cut off at one end

### 3.17 General Characteristics

Display unit 3.5 inch TFT color LCD

I/O ground

The signal grounds for waveform output (FCTN OUT), sync/sub-output (SYNC/SUB OUT), and external modulation/addition input (MOD/ADD IN) are insulated from the housing. These signal grounds are shared within the same channel.

The signal ground for the external 10 MHz reference input (10 MHz REF IN) is insulated from the housing.

Each of the signal grounds of CH1, CH2, and 10MHz REF IN are independent.

The withstand voltage between insulated signal grounds and between housings is 42 V<sub>pk</sub> max. (DC + AC peak)

The other signal grounds are connected to the housing.

Power supply

Power supply voltage range 100 V AC to 230 V AC ±10% (250 V or lower)

Power supply frequency range 50 Hz/60 Hz ±2 Hz

Power consumption WF1973: 50 VA or less

WF1974: 75 VA or less

Overvoltage category II

Ambient temperature and humidity ranges

Operation guarantee 0°C to +40°C, 5%RH to 85%RH

Absolute humidity of 1 g/m<sup>3</sup> to 25 g/m<sup>3</sup>,  
no condensation

Temperature range limitations apply for some specifications.

Storage conditions

-10°C to +50°C, 5%RH to 95%RH

Absolute humidity of 1 g/m<sup>3</sup> to 29 g/m<sup>3</sup>,  
no condensation

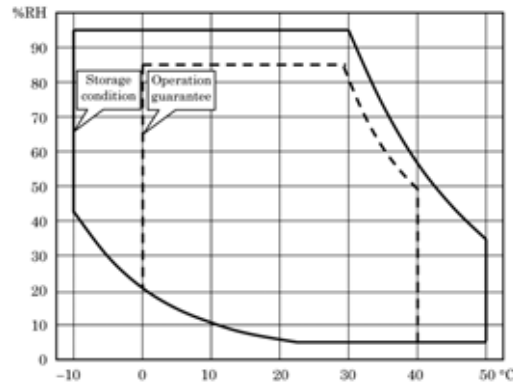

Warm-up time

30 minutes or more typ.

Pollution degree

2

External dimensions

216 (W) × 88 (H) × 332 (D) mm (excluding projections)

Weight

Approx. 2.1 kg (excluding accessories, weight of main unit only)

Safety and EMC

Applied only for models with CE marking on their rear panels

Safety EN61010-1:2001

EMC EN61326:1997 + A1:1998 + A2:2001 + A3:2003

■ Block diagram (WF1973)

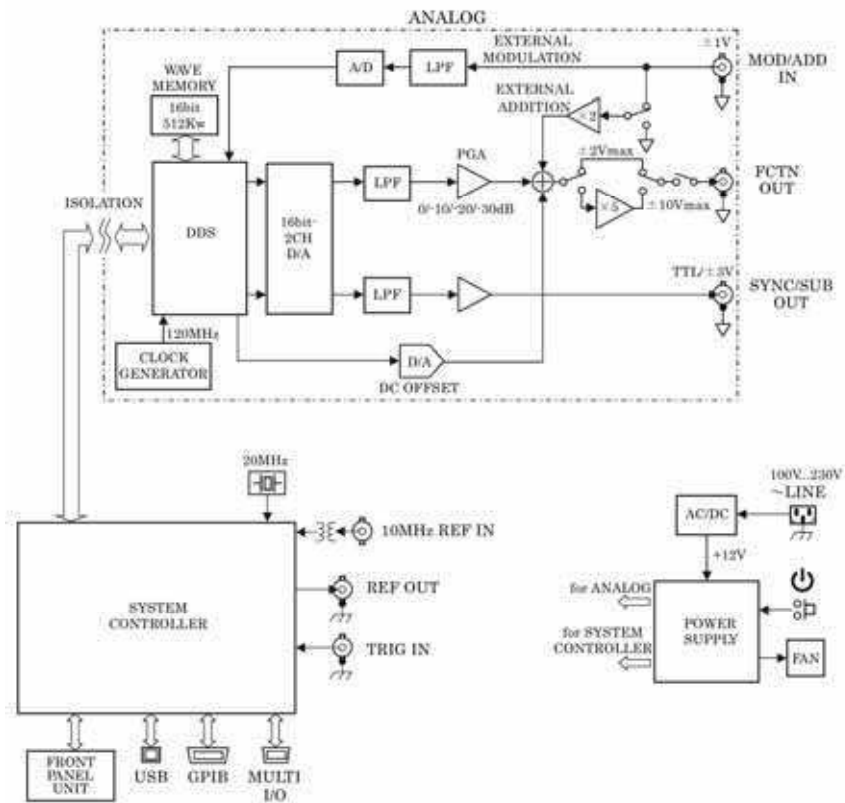

■ Block diagram (WF1974)

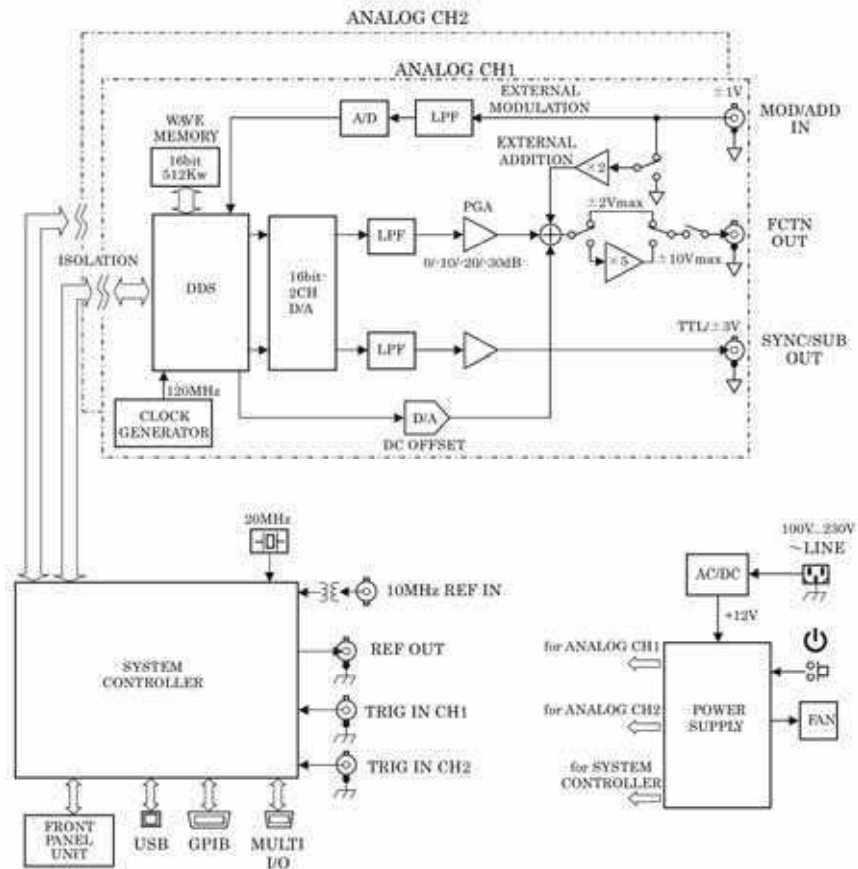

■ External dimensions (WF1973)

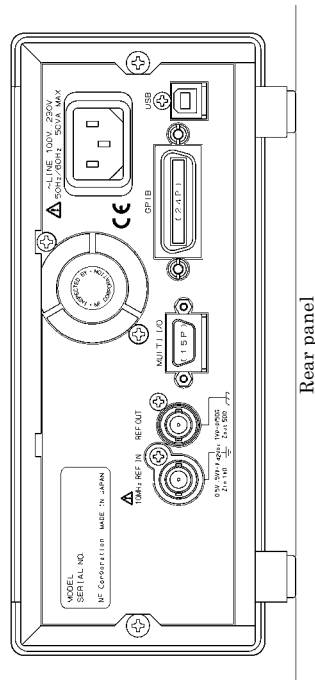
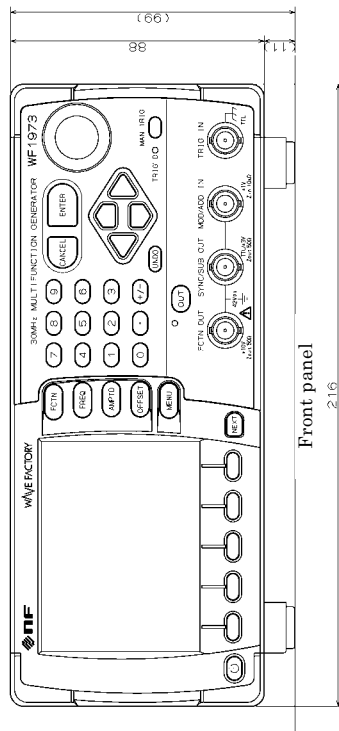
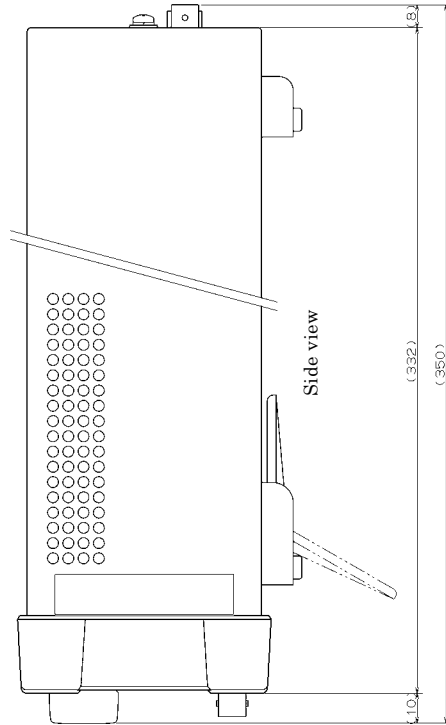

Surface treatment  
 Front panel: Plastic ultra-light gray (Munsell 6PB9.2/0.1)  
 Rear panel: Munsell 8.5PB2.6/0.2  
 Covers: Light gray leather tone (Munsell 6PB7.6/1.2 leather tone)

■ External dimensions (WF1974)

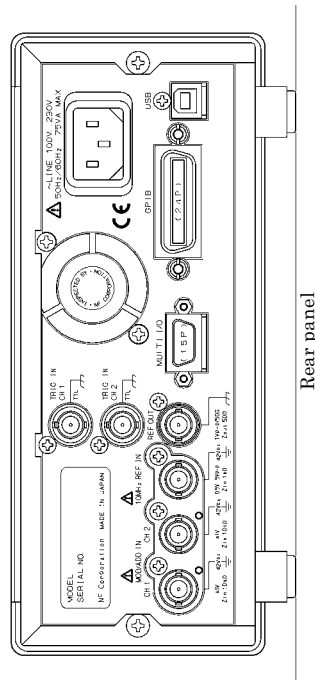
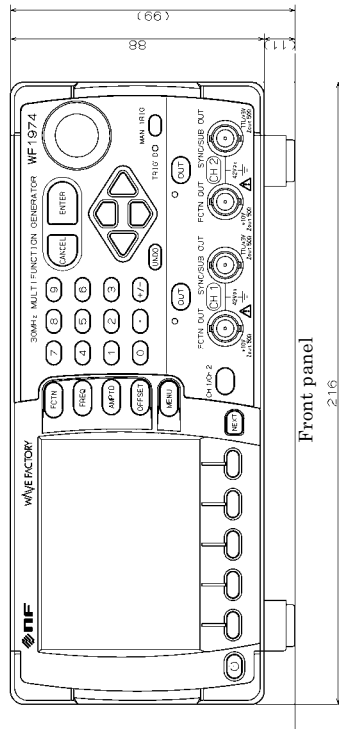
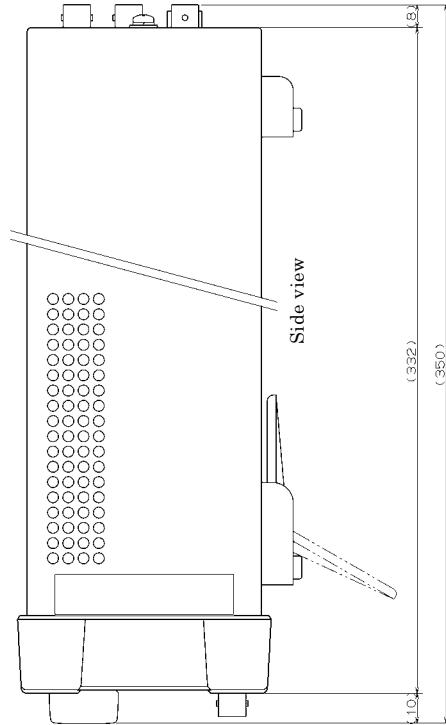

Surface treatment  
 Front panel: Plastic ultra-light gray (Munsell 6PB9.2/0.1)  
 Rear panel: Munsell 8.5PB2.6/0.2  
 Covers: Light gray leather tone (Munsell 6PB7.6/1.2 leather tone)

---

## WF1973 / WF1974 Specifications

NF Corporation

3-20 Tsunashima Higashi 6-chome, Kohoku-ku.

Yokohama-shi 223-8508, JAPAN

Phone: 81-45-545-8128 Fax: 81-45-545-8187

<http://www.nfcorp.co.jp/>

© Copyright 2007, **NF Corporation**