

Contains pages for

Operating Manual

for

RF and MICROWAVE TEST SETS 6200B SERIES

**Part number 46882-263L
Issue 6**

Creation date 29-Jul-96

Please open and fit to the supplied Ring Binder

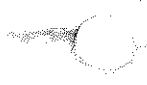
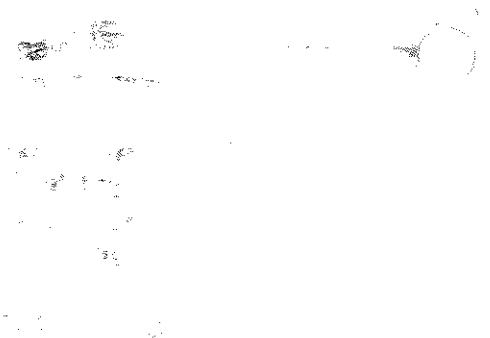

CUSTOMER QUESTIONNAIRE

Please spare a moment to detach, complete and return the Questionnaire on the next page. Your comments and suggestions will help us improve our products.

If you have had any problems with this product, please contact our Customer Support Help Desk on 01438-772008 at Stevenage if you are in the UK, or your Local Service Centre if outside the UK. The address and telephone number of your Local Service Centre is listed in this manual.

Please put the completed form in the addressed envelope provided and mail.

End User details

Name		
Company Name		
Company Address		
Country	Post Code	Fax no.
	Telephone No	Ext.

Equipment details

Part nos	Serial nos	Software Issues
Name & Address of Purchaser (if different from above)		
Delivery Date	Do you have a Maintenance Contract?	<input type="checkbox"/> Yes <input type="checkbox"/> No

Equipment Condition

Was the equipment in perfect working order when delivered?		<input type="checkbox"/> Yes <input type="checkbox"/> No
If the answer to the above question was 'no', was the problem to do with		
mechanical condition (damaged case etc.)	<input type="checkbox"/>	Severity Critical <input type="checkbox"/> Major <input type="checkbox"/> Minor <input type="checkbox"/>
suspected hardware fault	<input type="checkbox"/>	
suspected software fault	<input type="checkbox"/>	
did not meet its specification.	<input type="checkbox"/>	
Please tick the relevant item and describe below;		Repeatable? Yes <input type="checkbox"/> No <input type="checkbox"/> Occasionally <input type="checkbox"/>
<i>(continue in blank space on previous page if necessary)</i>		

Claim under Guarantee

If you have had problems,

have you already claimed under the Guarantee Yes No

or do you intend to claim under Guarantee? Yes No

Improvements

We should like to receive any suggestions for improvements or applications of this or other products that you may have. Please add them below or include them on an extra sheet.

(continue in blank space on previous page if necessary)

Marconi Instruments Action

	Initial/Date	Initial/Date	Initial/Date
Copy to Comm. Admin.	Distributor contacted	Problem established	
Service Dept response	Follow through needed	Cleared	

RF and MICROWAVE TEST SETS

6200B SERIES

Includes information on 6210 Reflection Analyzer

© Marconi Instruments Ltd. 1996

No part of this book may be reproduced or transmitted in any form or by any means, electronic or mechanical, including photocopying, or recorded by any information storage or retrieval system, without permission in writing by Marconi Instruments Ltd.

Printed in the UK

Manual Part No. 46882-263L
Issue 6

29-Jul-96

Contents

	Tab numbers	
Preface		
Precautions		
Chapter 1	GENERAL INFORMATION	1
Chapter 2	INSTALLATION	2
Chapter 3	OPERATION	3
Chapter 4	BRIEF TECHNICAL DESCRIPTION	4
Chapter 5	ACCEPTANCE TESTING	5
Appendices		6
Appendix A	INSTRUMENT DEFAULT SETTINGS	
Appendix B	ERROR MESSAGES	
Appendix C	FAULT LOCATION MEASUREMENT PRINCIPLES	
Appendix D	TIME DOMAIN MEASUREMENT PRINCIPLES	
Appendix E	CALIBRATION KIT HANDLING PRECAUTIONS	
Appendix F	FORMAT OF MEASUREMENT TRACE CSV FILES AND MACROTEXT FILES	
INDEX		7
ADDRESSES		8

Associated publications

GPIB Operating Manual for the 6200B Series Microwave Test Set
Getting Started Manual for the 6200B Series Microwave Test Set

PREFACE

CONVENTIONS

The following conventions apply throughout this manual:

- (1) Sequence of steps in a procedure.
- List of topics or items.
- CAPS Capitals are used to identify names of controls and panel markings, or system functions where no direct reference to an associated key is intended.
- [CAPS] Capitals in square brackets indicate hard key titles.
- [*Italics*] Italics in square brackets indicate soft key titles.

SOFTWARE STATUS

The operating software for this instrument is contained in EEPROMs fitted inside the unit. The software issue number can be determined by pressing [UTILITY][*Service*][*Status*][*Display Build State*].

TRADE MARKS

This manual contains various terms, descriptions and marks which may be the Trade Marks of other parties and where this is the case the rights of such parties are hereby acknowledged.

PATENT PROTECTION

The 6200B Series Microwave Test Sets are protected by the following Patents:

US4609881
US5237291
and others.

The 6210 Reflection Analyzer is protected by the following Patents:

US4808912
EP0234112
and others.

PRECAUTIONS

WARNINGS, CAUTIONS and NOTES

These terms have specific meanings in this manual:





WARNINGS contain information to prevent personal injury.

CAUTIONS contain information to prevent damage to the equipment.

Notes contain important general information.

HAZARD SYMBOLS

The meaning of hazard symbols appearing on the equipment is as follows:

Symbol	Nature of hazard
	General hazard
	Dangerous voltage
	Toxic hazards
	Static sensitive component
	This is a general warning which appears whenever care is necessary to prevent damage to the equipment, a typical example being the front panel precision connector.

GENERAL CONDITIONS OF USE

This product is designed and tested to comply with the requirements of EN61010-1/IEC1010-1 'Safety requirements for electrical equipment for measurement, control and laboratory use', for Class I portable equipment and is for use in a pollution degree 2 environment. The equipment is designed to operate from an installation category II supply.

Equipment should be protected from the ingress of liquids and precipitation such as rain, snow, etc. When moving the instrument from a cold to a hot environment, it is important to allow the temperature of the instrument to stabilise before it is connected to the supply to avoid condensation forming. The instrument must only be operated within the environmental conditions specified in Chapter 1 'Performance Data' in the Operating/Instruction manual.

This product is not approved for use in hazardous atmospheres. If the instrument is to be used in a safety-related application, the suitability of the product must be assessed and approved for use by a competent person.



WARNING - ELECTRICAL HAZARDS

AC supply voltage

This equipment conforms with IEC Safety Class 1, meaning that it is provided with a protective grounding lead. To maintain this protection the mains supply lead must always be connected to the source of supply via a socket with a grounding contact.

Be aware that the supply filter contains capacitors that may remain charged after the equipment is disconnected from the supply. Although the stored energy is within the approved safety requirements, a slight shock may be felt if the plug pins are touched immediately after removal.

Fuses

Note that there are supply fuses in both the live and neutral wires of the supply lead. If only one of these fuses should rupture, certain parts of the equipment could remain at supply potential.

Removal of covers

Disconnect the supply before removing the covers so as to avoid the risk of exposing high voltage parts. If any internal adjustment or servicing has to be carried out with the supply on, it must only be performed by a skilled person who is aware of the hazard involved.



WARNING - FIRE HAZARD

Make sure that only fuses of the correct rating and type are used for replacement.

If an integrally fused plug is used on the supply lead, ensure that the fuse rating is commensurate with the current requirements of this equipment. See under 'Performance Data' in Chapter 1 for power requirements.



WARNING - HEAVY INSTRUMENT

The 6200B Series MTS fitted with a 6210 exceeds the 18 kg (40 lb) guideline for manual handling by a single person. To avoid the risk of injury, an assessment should be carried out prior to handling which takes account of the load, workplace environment and individual capability, in accordance with European Directive 90/269/EEC and associated National Regulations.



WARNING - TOXIC HAZARDS

Some of the components used in this equipment include resins and other chemicals which give off toxic fumes if incinerated. appropriate precautions should therefore be taken in the disposal of these items.

Beryllia

Beryllia (beryllium oxide) is used in the construction of some of the components in this equipment. This material, if incorrectly handled, could cause a danger to health - refer to the Maintenance part of the Service Manual for safe handling precautions.

Lithium battery

A Lithium battery (or a Lithium battery contained within an IC) is used in this equipment.

As lithium is a toxic substance, the battery should in no circumstances be crushed, incinerated or disposed of in normal waste.

If the battery is rapidly charged or discharged, there is a risk of explosion. Take care therefore to avoid short-circuiting it.



WARNING - TILT FACILITY

When the instrument is in the tilt position, it is inadvisable, for stability reasons, to stack other instruments on top of it.

CAUTION - PRECISION CONNECTOR

The precision connectors fitted to this equipment may be damaged by mating with a non-precision type. Damage to the connectors may also occur if the connector interface parameters are not within specification. This should be checked with an appropriate gauging tool. Refer to Chapter 2 for further information on connector care.

CAUTION - CALIBRATION KIT HANDLING PRECAUTIONS

The calibration kit used for reflection analyzer measurements requires special handling precautions to be observed. Refer to Appendix E for full details.



CAUTION - STATIC SENSITIVE COMPONENTS

This equipment contains static sensitive components which may be damaged by handling - refer to the Maintenance manual for handling precautions.

CAUTION - CLEANING OF LCD WINDOW

The LCD window should be cleaned by wiping a slightly damp, soft, lint-free cloth gently over the surface. To remove grease or smears, use a clean cotton cloth moistened with Heptane. No other cleaning agents should be used. Clean the window using either horizontal or vertical strokes, NEVER a circular action.

Chapter 1

GENERAL INFORMATION

Chapter 1

GENERAL INFORMATION

CONTENTS

	Page
PURPOSE AND FEATURES OF EQUIPMENT	1-1
Introduction	1-1
Main Features	1-1
Operator Interface	1-2
Results Output	1-3
System Connections.....	1-3
Memory Card System	1-3
6210 Reflection Analyzer	1-3
SPECIAL TERMS USED IN THIS MANUAL	1-4
ASSOCIATED PUBLICATIONS	1-4
PERFORMANCE DATA - 6200B SERIES MTS.....	1-5
VERSIONS AND ACCESSORIES - 6200B SERIES MTS	1-22
ASSOCIATED EQUIPMENT.....	1-26
PERFORMANCE DATA - 6210 REFLECTION ANALYZER.....	1-27
OPTIONS AND ACCESSORIES - 6210 REFLECTION ANALYZER.....	1-32

PURPOSE AND FEATURES OF EQUIPMENT

Introduction

The 6200B Series RF and Microwave Test Sets are portable microwave measurement instruments, which integrate a synthesized sweep generator, a four input scalar analyzer, frequency counter and a power meter into a single compact case. Four versions are available: the 6201B covers 10 MHz to 8 GHz, the 6200B covers 10 MHz to 20 GHz, the 6203B covers 10 MHz to 26.5 GHz and the 6204B has coverage to 46 GHz. The 6202B covers 10 MHz to 2 GHz, and is especially suitable for users working exclusively in the RF band. Whereas the other instruments are called Microwave Test Sets, the 6202B is an RF Test Set. Throughout this and other manuals, however, the series of instruments will be referred to collectively as Microwave Test Sets (MTS).

A 70 dB step attenuator option is available for all versions of the MTS, which provides synthesizer outputs over a wide amplitude range. The 6210 Reflection Analyzer adapter can be fitted to the MTS, which enables the instrument to display the complex reflection coefficient at the input of a device, and also the time domain response.

The small size, integrated functions and ease of use of the MTS make the system ideal for development and production testing, installation and commissioning and field service applications. Integrating many functions into one unit not only provides convenience of operation, it also enables a number of specialized measurements to be made with ease. Typical applications for the MTS are:

- Measurement of insertion loss and return loss of passive components.
- Gain, gain compression and return loss of active components.
- Power and frequency measurements.
- Measurements on mixers and VCOs.
- Location of faults in waveguide and coaxial transmission lines is possible using the Fault Location facility. This utilises advanced processing techniques to improve distance and magnitude accuracy and reduce measurement uncertainty.

Main Features

The MTS uses a fully synthesized frequency source. The swept signal it provides combines the speed and convenience of an analogue sweep generator with the precision of a synthesized sweep. High frequency stability and a resolution of 1 Hz ensures that even narrow filters can be measured with accuracy and confidence.

Power level is settable over a 40 dB range with a maximum guaranteed levelled power of +7 dBm. With the step attenuator option, amplitudes down to -90 dBm may be set for the characterization of amplifiers and other active devices.

Self calibration of the synthesizer's power and frequency is possible using the integral power meter and frequency counter of the MTS. Two user calibration stores can be used to perform power calibrations over a limited frequency range.

The four input scalar analyzer has typically 85 dB dynamic range and a high resolution colour display. As well as the conventional 10x10 graticule two separate 10x10 graticules can be selected. Two display channels, each capable of displaying up to two swept measurements are provided. The channels may be coupled together for the simultaneous update of up to four traces, or they can be uncoupled so that each channel can display a different frequency range, allowing simultaneous display of pass-band and stop-band characteristics, for example.

The power meter has a high dynamic range (-70 dBm to +35 dBm) and wide frequency coverage (30 kHz to 40 GHz). One input of the scalar analyzer can be configured to be a power sensor input, and the measured power level is displayed as a digital readout when the readout mode is selected. A wide range of power sensors is available. Power sensors can be calibrated using the 50 MHz internal calibrator output provided on the front panel.

The frequency counter measures frequency from 10 MHz to 20 GHz (6200B and 6201B), 10 MHz to 26.5 GHz (6203B and 6204B) or 10 MHz to 2 GHz (6202B). A digital readout of the frequency can be displayed when the readout mode is selected. In the swept mode, the vertical axis can be set to record the frequency of a device under test as the voltage stimulus provided by the programmable voltage/current output is swept, a typical example being automatic VCO characterization.

The 6230A/L series scalar detectors with EEPROM correction, when used with the dynamic calibrator facility, give power meter accuracy even during swept frequency measurements. The dynamic calibrator characterises the detector linearity, enabling precision insertion loss measurements.

An external keyboard can be connected via a standard keyboard interface to simplify macro editing and generation of operator instructions. International support for keyboards is provided.

The optional 3.5 in. floppy disk drive enables data, such as measurement traces and instrument settings, to be stored on floppy disk.

Operator Interface

The MTS firmware controls the functions of the synthesized source, scalar analyzer, frequency counter and power meter. Operator interaction with the system is performed a colour liquid crystal display (LCD) and the front panel controls. Menus, instructions, error messages and help text are displayed on the LCD, and menu selection is accomplished via a set of eight soft keys adjacent to the display.

The measurement to be performed is defined using a simple menu system. Non-volatile storage is provided for ten measurement setups and four results traces for future use. Stores are also provided for calibration and linearity factor data for up to ten power sensors.

GPIB commands are provided enabling full control of the system via the GPIB interface. This interface also enables the MTS to control an HPGL plotter and an additional MTS synthesized source. The GPIB complies with IEEE 488.2 and follows the SCPI convention (Standard Commands for Programmable Instrumentation).

A Macro facility allows a sequence of key presses and control codes to be stored so that complex measurement sequences can be stored.

Results Output

Measurement results, either current or stored, may be output to any HPGL GPIB plotter, or to a suitable printer via the Centronics parallel interface. The operator has extensive control of hard copy formatting, with facilities for generating titles. The printer can also be used to obtain hard copy output of tabular data, such as current or stored instrument settings, and information relating to the displayed measurement.

System Connections

Because the MTS incorporates several instruments in one case, there are no interconnections to make, other than the connections to the device or system under test. This provides more reliable and repeatable results, and saves time in setting up and re-deploying equipment.

Similar advantages are obtained when a Fault Location Test Head or Transmission Line Test Head is used for fault location measurements; this integrates most of the necessary microwave components (such as detectors, dividers) into a small housing. The Test Head is supplied with a length of cable for connection to the MTS scalar inputs, and an optional length of ruggedised cable connects the Test Head to the MTS RF output. This allows the Test Head to gain access to difficult to reach test points.

Memory Card System

Memory cards containing battery-backed non-volatile RAM are available which can be used for additional storage of measurement setups and results data. If required, this information can then be transferred to other instruments, ensuring repeatability and time saving in setting up a number of identical test stations. The MTS enables the user to configure blank cards to set the number of stores of each type within the available memory capacity of the card.

6210 Reflection Analyzer

If the optional 6210 Reflection Analyzer is fitted to a 6200B series MTS, the system has the additional capability of making measurements of the complex reflection coefficient (i.e. magnitude and phase) at the input of a test device; this is the S_{11} S-parameter. The results can be presented in several formats, enabling, for example, measurements of magnitude, phase, VSWR and impedance. The frequency range over which the 6210 operates is from 250 MHz to 26.5 GHz, the upper limit depending on that of the MTS. Note that although the 6204B MTS operates up to 46 GHz, the upper limit of the 6210 is still 26.5 GHz.

The system can also transform frequency domain measurements into the time domain, enabling measurement of the performance of a device as a function of time. Both band pass and low pass transforms are available, and the MTS can display the response of the system under test to a simulated impulse or step function.

In addition, the 6210's gating facility allows the selective removal of time domain responses (due to connectors, for example), and the effect on the frequency response can be seen on returning to the frequency domain. See Appendix D for an overview of time domain measurements.

SPECIAL TERMS USED IN THIS MANUAL

Sweep is a series of consecutive measurements taken over a sequence of source stimulus values corresponding to each measurement point. The number of points per sweep can be set by the user.

Input. The instrument has four scalar detector inputs A, B, C and D; the D input can also be defined as a power meter sensor input. A counter input is also available for measuring frequency.

Display Channel (or Channel) is a signal path associated with the display, and should not be confused with the term 'Input', defined above. The instrument is capable of displaying one or two channels simultaneously. Each channel can be defined to be either a swept channel (e.g. scalar or fault location) which is capable of displaying either one or two measurement traces, or as a readout channel which can display either one or two digital readouts derived from the power meter or counter. Thus a total of four traces/readouts can be displayed simultaneously.

Domain. For swept measurements, the domain is the variable plotted on the X (horizontal) axis of the channel graticule (e.g. frequency, power, distance). A swept channel is capable of displaying one or two traces of the same domain, i.e. both traces share the same x-axis annotation.

Response. For swept measurements, response is the measurement (e.g. power, voltage, frequency) that is displayed on the Y (vertical) axis of the graticule.

Measurement point is a single piece of data representing a measurement at a single source stimulus value.

Power Sensor. Power sensors are connected to the instrument's power meter via Input D of the MTS, and provide a signal representing the RF power incident upon them. The power measurement is displayed as a digital reading on a readout channel.

Detector. A detector provides a DC voltage representing the RF power incident upon it, but has a wide dynamic range and fast response time, making it suitable for swept measurements. EEPROM detectors have linearity and flatness correction data stored on an EEPROM within the device, which can be read by the MTS, giving more accurate results.

The following terms are associated with fault location measurements:

Distance resolution is the minimum separation at which two peaks can be distinguished, and is inversely proportional to the measurement bandwidth.

Amplitude error occurs when a time domain peak falls between two adjacent points, leading to an underestimate of the amplitude of the peak. Amplitude error is a function of point spacing: the more measurement points there are the smaller the error.

Point spacing is the time interval between adjacent points on a swept display; the higher the number of measurement (domain) points, the smaller the point spacing. Point spacing is important for both amplitude accuracy and the accurate location of discontinuities in fault location measurements.

ASSOCIATED PUBLICATIONS

Two other manuals are supplied with the MTS, which provide the following information:

- The **GPIO Operating Manual** covers remote operations of the MTS. A full description is given of the GPIO command set and the conventions used in the implementation of the commands. The manual assumes familiarity with local operation of the instrument.
- The **Getting Started Manual** shows how the instrument is used by providing examples of some typical measurement situations.

POWER STABILITY WITH TEMPERATURE

6200B/6201B/6202B

0 °C to 20°C
 20 °C to 40°C
 40 °C to 50°C

Typical values following power calibration at operating temperature. Self-calibration with a power sensor removes temperature effects.

< 0.02 dB/°C.
 < 0.04 dB/°C.
 < 0.08 dB/°C.

6203B

0 °C to 20°C
 20 °C to 30°C
 30 °C to 50°C

< 0.1 dB/°C
 < 0.08 dB/°C
 < 0.06 dB/°C

6204B

0 °C to 20°C
 20 °C to 30°C
 30 °C to 50°C

10 MHz to 2 GHz	2 GHz to 40 GHz
< 0.12 dB/°C	< 0.05 dB/°C
< 0.15 dB/°C	< 0.05 dB/°C
< 0.08 dB/°C	< 0.06 dB/°C

SIGNAL PURITY

Harmonics

10 MHz to 2 GHz
 2 GHz to 8 GHz
 8 GHz to 26.5 GHz
 26.5 GHz to 40 GHz

< -27 dBc, -35 dBc typical.
 < -35 dBc, -40 dBc typical.
 < -40 dBc, -50 dBc typical.
 < -20 dBc typical

Sub-harmonics

2 GHz to 26.5 GHz
 26.5 GHz to 40 GHz

None
 < -40 dBc typical

Spurious signals (typical)

10 MHz to 2 GHz
 2 GHz to 8 GHz
 8 GHz to 26.5 GHz
 26.5 GHz to 40 GHz

25 kHz to 150 kHz	150 kHz to 1 MHz	>1 MHz
< -50 dBc	< -60 dBc	< -60 dBc
< -50 dBc	< -50 dBc	< -60 dBc
< -50 dBc	< -60 dBc	< -60 dBc
< -40 dBc	< -50 dBc	< -50 dBc

Phase noise

10 MHz to 2 GHz
 2 GHz to 8 GHz
 8 GHz to 12 GHz
 12 GHz to 20 GHz
 20 GHz to 26.5 GHz
 26.5 GHz to 40 GHz

Typical values measured in 1 Hz bandwidth at 20 kHz offset from the carrier in CW mode.

< -90 dBc/Hz
 < -78 dBc/Hz
 < -74 dBc/Hz
 < -70 dBc/Hz
 < -67 dBc/Hz
 < -57 dBc/Hz

Residual FM

10 MHz to 2 GHz
 2 GHz to 26.5 GHz
 26.5 GHz to 46 GHz

In 100 kHz bandwidth in CW mode

< 1 kHz peak
 < (500F) Hz peak where F is the frequency in GHz.
 < (1000F) Hz peak where F is the frequency in GHz.

OUTPUT CONNECTOR

Type	6200B/6201B/6202B 6203B 6204B Option 002	Precision N (female), 50 Ω . MPC (Marconi Precision Connector) 3.5 mm (female), 50 Ω . Precision 2.92 mm (female), 50 Ω . Field replaceable, 50 Ω precision 3.5 mm (female) and N-type (female).
Reverse input power		100 mW maximum.
Source match (internally levelled)	6200B/6201B/6202B/6203B	

	VSWR (minimum)	Return Loss (dB)	
		Typical	Minimum
10 MHz to 50 MHz	< 1.45 : 1	>17	>15
50 MHz to 2 GHz	< 1.11 : 1	>33	>26
2 GHz to 8 GHz	< 1.2 : 1	>30	>21
8 GHz to 12 GHz	< 1.35 : 1	>25	>16.5
12 GHz to 26.5 GHz	< 1.45 : 1	>20	>15
6204B			
10 MHz to 40 GHz	< 1.93 : 1	>12	>10
40 GHz to 46 GHz		>10	

With option 001 minimum return loss specification degrades by up to 5 dB.

With option 002 minimum return loss specification degrades by up to 3 dB.

VOLTS/GHz

Voltage proportional to frequency available from rear panel BNC Voltage/Current output.

Range	1 V or 0.5 V/GHz selectable (20 V maximum in 1 V/GHz mode).
Linearity	± 15 mV.

VOLTAGE RAMP OUTPUT

0 to +10 V ramp output corresponding to frequency start and stop, available from rear panel BNC Voltage/Current output.

Programmable Voltage/Current Source

VOLTAGE OUTPUT

Range	-15 V to +15 V
Resolution	1 mV
Accuracy	± 15 mV

Total power supplied not to exceed 2.5 W.

CURRENT OUTPUT

Range	-150 mA to +150 mA
Resolution	10 μ A
Accuracy	± 300 μ A
Stability with temperature	10 μ A/ $^{\circ}$ C

Total power supplied not to exceed 1.25 W.

OUTPUT CONNECTOR

Rear panel BNC.

Scalar Analyzer

NUMBER OF INPUTS	Four (A, B, C and D)
DETECTION MODES	AC and DC.
DYNAMIC RANGE	
AC detection	80 dB (-60 to +20 dBm, 623XA), (-54 to +26 dBm, 623XL)
	85 dB typical (-65 to +20 dBm, 623XA), (-59 to +26 dBm, 623XL)
DC detection	70 dB (-50 to +20 dBm, 623XA), (-44 to +26 dBm, 623XL)
NUMBER OF MEASUREMENT POINTS	User selectable from 2 to 1601.
NUMBER OF CHANNELS	Two. Two measurements may be made per channel allowing a total of four simultaneous measurements.
SWEEP TIME	
Settable range	40 ms to 500 s, automatically selected or manually entered.
Measurement times	
401 points	<200 ms.
1601 points	<800 ms.
DIRECT VOLTAGE INPUT RANGE	
Input A, B and C	0 to -4.5 V or 0 to +4.5 V, depending on accessory cable used
Input D	0 to -9 V or 0 to +9 V, depending on accessory cable used
NOISE REDUCTION	
Averaging	1 to 1000 (applied per measurement).
Smoothing	Aperture settable from 0.01 to 20% of span, resolution 0.01%
CALIBRATION	
Path calibration (normalization)types	Through, short/open, short, open.
INSTRUMENTATION ACCURACY	$\pm 0.05\%$
SYSTEM ACCURACY	Refer to individual specifications for detectors and Return Loss Bridges.

DYNAMIC CALIBRATION

When calibrating 6230A series steps between -30 dBm to +20 dBm

When calibrating 6230L series steps between -24 dBm to +26 dBm
(For frequency specification refer to Power Reference section)

Output connector

N(f), 50 Ω (adapter supplied with 6203B and 6204B for use with 3.5 mm and 2.92 mm detectors)

Fault Location

DISTANCE

Units

Metres or feet.

Accuracy

0.1% of range or 3 mm, whichever is the larger (for a single fault up to 1 km range).

Full scale

Up to 25 km depending on cable or waveguide loss.

Minimum resolution

For two equal amplitude discontinuities using maximum sweep width.

6200B
6201B
6202B
6203B
6204B

$1.82 \times V_r$ cm.
 $4.54 \times V_r$ cm
 $18.2 \times V_r$ cm
 $1.37 \times V_r$ cm
 $0.91 \times V_r$ cm
where V_r is relative volicity.

DYNAMIC RANGE

AC detection
DC detection

10 MHz to 26.5 GHz 26.5 to 40 GHz

80 dB >40 dB typical
70 dB >40 dB typical

MEASUREMENT TIME

(401 points)

Normal mode
Enhanced mode

< 250 ms
< 500 ms

NUMBER OF MEASUREMENT POINTS

User selectable from 51 to 1024.

Power Meter

Input D may be defined either as a power meter sensor input or as a scalar detector input.

FREQUENCY RANGE	30 kHz to 40 GHz, dependent upon sensor used.
POWER RANGE	-65 dBm (300 pW) to +35 dBm (3 W), dependent upon sensor used.
INSTRUMENTATION ACCURACY	±0.05%
CORRECTION	
Calibration Factor	
Range	0.01 to 200%
Resolution	0.01%
Linearity Factor	
Range	0.1 to 15
Resolution	0.1
Noise (after Auto-Zero)	
6910 Series	500 nW (-33 dBm)
6920	300 pW (-65 dBm)
6923/6924	100 nW (-50 dBm)
6930 Series	15 µW (-18 dBm)
POWER REFERENCE	Used for Power Sensor correction.
Output Connector	N (female) 50 Ω. Adapters are supplied with 75 Ω and MPC (Marconi Precision Connector) 3.5 mm Power Sensors.
Frequency	50 MHz ±0.01 MHz.
Level	1 mW.
Uncertainty	±0.7% traceable to National Standards.
Accuracy	±1.2% worst case for one year.
RESPONSE TIME	< 100 ms.
AVERAGING	1 to 1000 selected automatically or manually entered. Also selectable by resolution: 0.01, 0.1 or 1 dB
RESOLUTION	2 to 4 digits, user selectable

CHART RECORDER

Rear panel voltage/current BNC output gives a voltage proportional to measured power.

Sensitivity

0 to 5 V. 0 V level dependent upon type of detector or sensor used.

Log mode

1 V per decade.

Linear mode

Scaling dependent on detector or sensor.

Frequency Counter

FREQUENCY RANGE

6202B	10 MHz to 2 GHz
6200B/6201B/	10 MHz to 20 GHz.
6203B/6204B	10 MHz to 26.5 GHz.

RESOLUTION

Readout mode	Selectable from 1 Hz to 100 MHz in decade steps.
Swept mode	6 digits

ACCURACY

Readout mode	$< \pm 25 \text{ Hz} \pm \text{frequency standard error.}$
Swept mode	(6 significant figures or $\pm 100 \text{ Hz}$ whichever is greater) $\pm \text{frequency standard error.}$

SENSITIVITY

(Typical)

	6200B/6201B/6202B/6203B	6204B
25 MHz to 10 GHz	$< -20 \text{ dBm}$	$< -19 \text{ dBm}$
10 GHz to 20 GHz	$< -15 \text{ dBm}$	$< -14 \text{ dBm}$
20 GHz to 26.5 GHz	$< -10 \text{ dBm}$	$< -8 \text{ dBm}$

MAXIMUM INPUT LEVEL

+5 dBm typical.

DAMAGE LEVEL

+27 dBm peak.

INPUT CONNECTOR

Type

6200B/6201B/6202B	Precision N Type (female).
6203B/6204B	MPC (Marconi Precision Connector) 3.5 mm (female).
Option 002	Field replaceable, 50 Ω precision 3.5 mm (female) and N-type (female).

Input impedance

50 Ω nominal.

FM TOLERANCE

Readout mode	20 MHz peak to peak at 45 Hz to 10 MHz rate.
Swept mode	1.5 MHz peak to peak at 75 Hz to 10 MHz rate.

AM TOLERANCE

Up to 40% modulation depth for signals within the range of sensitivity and maximum input level.

ACQUISITION TIME

Readout mode
Typically 2s for frequencies greater than 300 MHz, at 1 Hz resolution.

Swept mode
Typically 50 ms per point.

SELECTIVITY

Typically 25 dB.

Display**TYPE**

Colour active matrix TFT liquid crystal display 16.5 cm (6.5 inch) visible diagonal. A choice of four colour palettes is available. External colour monitor (VGA) output available on rear panel.

NUMBER OF CHANNELS

Two. A channel may be configured either as a swept channel for displaying traces or a readout channel for displaying readouts of values such as power and frequency.

NUMBER OF TRACES/READOUTS

Four. Maximum of two per channel.

TITLES

Screen title plus individual measurement titles.
Individual title coded to each trace/readout.

Swept channel characteristics

The horizontal and vertical axes can be configured to display a variety of different measurements. The horizontal axes, referred to as 'Domain', may be defined to display the stimulus such as frequency, power, voltage, current and distance. The vertical axis, referred to as 'response', may display frequency, power and voltage.

DOMAIN

(Horizontal axis)

Frequency modes	CW, start/stop, centre/span, alternate sweep.
Frequency resolution	Settable to 1 Hz, displayed as 6 digits.
Frequency offset	Frequency offset between source and display can be entered to characterize frequency changing devices such as mixers.
Frequency scaling	Multiplication factor between source and display can be entered to characterize frequency multipliers and dividers.
Power sweep range	Range depends on Option - refer to Synthesized Sweep Generator section.
Power offset	Power offset between source and display can be entered for use when measuring amplifiers and attenuators.

RESPONSE

(Vertical axis)

Units	dBm, dB, pW to kW, nV to V, VSWR, Hz to GHz.
Scaling	Manual auto-scale (single shot), continuous auto-scale (every sweep) or user selectable.
Reference level position	Reference level may be set to any graticule line.
Reference level value	-199.99 to +199.99 all units except VSWR. 1 to 100 VSWR.

MEASUREMENT MANIPULATION

Scalar detector and counter inputs	Display live measurement. Display trace memory. Display live measurement relative to trace memory. Measurement hold may be applied for each trace.
Scalar detector inputs only	Any input or ratio of inputs may be assigned to any one or more than one of the traces. A trace may display absolute power, power relative to a path calibration or power minus a trace memory.
Complex limit lines	Four stores of 12 segments each. Each segment defines an upper and a lower limit line or point. Any store can be applied to any trace.
Input offsets	An offset in the range -99.99 to +99.99 dB in 0.01 dB steps may be applied per detector input.

MARKERS

Marker functions

Eight per channel plus a separate delta marker.

Marker, delta marker, minimum, maximum, search left, search right, N dB bandwidth (with centre frequency). Peak to peak response value and optional test against limit. dB/Octave and dB/Decade. Tracking for Max/Min, Peak to Peak and Bandwidth functions. Bandwidth function has ability to show centre frequency/delta frequency ratio.

MARKER RESOLUTION

Domain (Horizontal)

Frequency

Six digits with over-ride to give 1 Hz resolution.

Power

0.01 dB.

Voltage

1 mV.

Current

10 μ A.

Response (Vertical)

Power

0.01 dB.

Frequency

Six digits.

Voltage

1 nV.

Readout channel characteristics

RESOLUTION

Power	2 to 4 digits, user selectable.
Frequency	1 Hz. to 100 MHz, user selectable.
Voltage	Four digits.

UNITS

Power	dBm, dB, pW to kW.
Frequency	Hz to GHz.
Voltage	nV, uV, mV, V, kV.

MEASUREMENT MANIPULATION

Marker readout	Spot readings may be made at the domain value specified by the active marker.
Limit checking	Upper and lower test limits may be entered.
Relative measurement	To display the measured offset from a previously entered measured reading.
Max/min hold	To display maximum and minimum values over a period of time for drift measurements.
Duty cycle	To display peak power given by average power measured/duty cycle. Range: 0.001 to 100%
Peaking meter display	Analogue display to assist when adjusting power levels.
Input offsets	An offset in the range -99.99 to +99.99 dB in 0.01 dB steps may be applied per detector or sensor input.

Auxiliary Inputs and Outputs

GPIB INTERFACE

GPIB is IEEE 488.1 and 488.2 compatible. The interface has three applications:

- Instrument control with full talk and listen capability.
- Control of a plotter using HPGL. Plotter output is buffered to permit measurements to proceed whilst plotting.
- Control of a second MTS for mixer measurements. The instruments may be set to sweep with a fixed frequency offset between them.

MEMORY CARD INTERFACE

For external storage of data or installation of memory card applications.

PARALLEL PRINTER OUTPUT

Compatible with Epson FX, Hewlett Packard DeskJet/LaserJet4 or Canon BJ series printers. A mechanism is provided to select which type of printer is connected. Output is buffered to allow further measurements whilst printing.

FREQUENCY STANDARD IN/OUT BNC

1 or 10 MHz input or 10 MHz output (nominally 2 V pk-pk into 50 Ω) selectable from front panel.

EXTERNAL LEVELLING INPUT BNC

For connection of remote detector or power meter for source levelling.

VOLTAGE/CURRENT OUTPUT BNC

User definable to be:

Volts/GHz

Voltage proportional to frequency output from source.

Fixed

Fixed voltage or current output for bias measurements.

Swept V/I

Swept voltage or current for voltage/current domain measurements.

Chart recorder

Voltage proportional to power level of scalar detector or power meter sensor input.

Ramp output

0 to +10 V ramp output corresponding to frequency start and stop.

EXTERNAL MONITOR

Output to a VGA 640 x 480 standard colour monitor. Rear panel 15 way "high density" D-type female connector.

EXTERNAL KEYBOARD

To interface to compact keyboard (optional accessory). International support for keyboards is provided.

General

FREQUENCY STANDARD

Internal	For synthesized sweep generator and frequency counter.
Temperature stability	10 MHz oven controlled crystal oscillator.
Ageing	Better than ± 5 in 10^8 . 0 to 50°C.
External	Better than 2 in 10^7 per year.
Output	1 or 10 MHz standard rear panel BNC input socket.
	10 MHz, rear panel BNC socket.

MEMORIES

Trace memories	4
Settings stores	10
Power sensor cal stores	Stores for 10 sets of power sensor calibration and linearity factor data.
Memory card and 3.5 in disk drive	Extra stores available on memory card or 3.5 in disk (if option fitted).

REAL TIME CLOCK

Date and time	Used to date-stamp hard copies and to determine instrument operating hours.
---------------	---

ELECTRO-MAGNETIC COMPATIBILITY

Conforms with the protection requirements of EEC Council Directive 89/336/EEC.

Complies with the limits specified in the following standards:

EN55011 Class B	CISPR 11
EN50082-1	IEC 801-2,3,4
EN60555-2	IEC 555-2

SAFETY

Complies with IEC1010-1 BS EN61010-1 for Class 1 portable equipment and is for use in a pollution degree 2 environment. The instrument is designed to operate from an installation category 2 supply.

RATED RANGE OF USE (over which full specification is met)

Temperature	0 to 50°C. The dynamic calibrator is rated for use over the range 5°C to 50°C.
Humidity	93% RH at 40°C

CONDITIONS OF STORAGE AND TRANSPORT

Temperature	-40 to +70°C.
Humidity	93% RH at 40°C.

POWER REQUIREMENTS

Switchable voltage ranges	
115 V set	90 to 132 V
230 V set	188 to 265 V
AC Supply	45 to 440 Hz. 500 VA maximum.

DIMENSIONS AND WEIGHT

Height	197 mm (7.75 in)
Width	389 mm (15.3 in)
Depth	546 mm (21.5 in)
Weight	
6200B	16 kg (35 lb)
6201B	15 kg (33 lb)
6202B	14.5 kg (32 lb)
6203B	16.25 kg (36 lb)
6204B	17 kg (37.9 lb)

NOTES:

Guaranteed Power Range, Power Accuracy and VSWR are calibrated for the temperature range 0 to 50°C and are subject to the availability of National Standards.

Typical performance figures are non-warranted.

VERSIONS AND ACCESSORIES - 6200B SERIES MTS

Ordering numbers

6200B
6201B
6202B
6203B
6204B

Versions

10 MHz to 20 GHz Microwave Test Set
10 MHz to 8 GHz Microwave Test Set
10 MHz to 2 GHz RF Test Set
10 MHz to 26.5 GHz Microwave Test Set
10 MHz to 46 GHz Microwave Test Set

Options

Option 001
Option 002

Option 003
Option 004

70 dB step attenuator
Field replaceable RF output connector (3.5 mm and N-type) (Not available on 6204B.)
3.5 m floppy disk drive (standard on 6202B)
8.4 GHz frequency extension (6201B only)

SUPPLIED ACCESSORIES

43123-076Y
43138-663V
06950-069
46882-263L
46882-264J
46882-265F
54311-134R

AC supply lead
1.5 m DC cable
Input socket cap
Operating manual
GPIB Operating Manual
Getting Started Manual
N(m) to SMA(f) adapter supplied with 6203B and 6204B.

OPTIONAL ACCESSORIES

Scalar Detectors (with EEPROM correction)

6230A series
6230A
6233A
6234A
6230L series
6230L
6233L
6234L

(-65 dBm to +20 dBm) typical
10 MHz to 20 GHz, N type (m)
10 MHz to 26.5 GHz, 3.5 mm (m)
10 MHz to 46 GHz, 2.92 mm (m)
(-59 dBm to +26 dBm Low VSWR) typical
10 MHz to 20 GHz, N type (m)
10 MHz to 26.5 GHz, 3.5 mm (m)
10 MHz to 46 GHz, 2.92 mm (m)

Autotesters

59999-151W
59999-158R
59999-159B
59999-152D
59999-166H
59999-168V
59999-169Y

10 MHz to 18 GHz 7 mm
10 MHz to 18 GHz N (m)
10 MHz to 18 GHz N (f)
10 MHz to 26.5 GHz 3.5 mm WSMA (m)
10 MHz to 26.5 GHz 3.5 mm WSMA (f)
10 MHz to 40 GHz 2.92 mm (m)
10 MHz to 40 GHz 2.92 mm (f)

RF Bridge

59999-170E

5 MHz to 2 GHz N (f)

Fault Locators

6242F	10 MHz to 3 GHz, N (f)
6242M	10 MHz to 3 GHz, N (m)
6240F	10 MHz to 20 GHz, N (f)
6240M	10 MHz to 20 GHz, N (m)
6243F	10 MHz to 26.5 GHz, 3.5 mm (f)
6243M	10 MHz to 26.5 GHz, 3.5 mm (m)
6241	10 MHz to 20 GHz, 7 mm

Microwave Ruggedised Cables for Fault Locators

54311-197C	1.5 m, 20 GHz, N (m) to Right Angle N (m)
54311-198R	3.0 m, 20 GHz, N (m) to Right Angle N (m)
54311-201X	1.5 m, 26.5 GHz, 3.5 mm (m) to Right Angle 3.5 mm (m)
54311-202M	3.0 m, 26.5 GHz, 3.5 mm (m) to Right Angle 3.5 mm (m)

RF Ruggedised Cables for Fault Locators

54311-199B	1.5 m, 3 GHz, N (m) to Right Angle N (m)
54311-200P	3.0 m, 3 GHz, N (m) to Right Angle N (m)

Transmission Line Test Heads

56581-001T	10 MHz to 20 GHz Transmission Line Test Head, 6581
56583-001S	10 MHz to 26.5 GHz Transmission Line Test Head, 6583

Microwave Ruggedised Cables for Transmission Line Test Heads

54311-116J	1.5 m, 20 GHz, N (m) to N (m)
54311-109U	3.0 m, 20 GHz, N (m) to N (m)
54311-117F	1.5 m, 26.5 GHz, 3.5 mm (m) to 3.5 mm (m)
54311-110H	3.0 m, 26.5 GHz, 3.5 mm (m) to 3.5 mm (m)

Power Splitters/Dividers

54311-123S	Power Splitter DC to 18 GHz, Type N
54311-124W	Power Splitter DC to 26.5 GHz, 3.5 mm
54311-161T	Power Splitter DC to 40 GHz, 2.92 mm
54311-187S	Power Divider DC to 18 GHz
54311-188W	Power Divider DC to 26.5 GHz

RF Ruggedised Cables for Bridges and Dividers

54311-195X	1.5 m, 3 GHz, N (m) to N (m)
54311-196M	3.0 m, 3 GHz, N (m) to N (m)

Power Sensors

6910 Series Medium Power

56910-900L	10 MHz to 20 GHz, N type (m)
56911-900X	10 MHz to 20 GHz, Apc 7
56912-900U	30 kHz to 4.2 GHz, N type (m)
56913-900D	10 MHz to 26.5 GHz, MPC 3.5 mm (m)
56914-001R	10 MHz to 40 GHz, 2.92 mm (m)
56914-002B	10 MHz to 40 GHz, 2.92 mm (m) plus waveguide 22 transformer
56919-900Y	30 kHz to 3 GHz, N type 75 Ω

6920 Series Low Power

56920-900J	10 MHz to 20 GHz, N type (m)
56923-900T	10 MHz to 26.5 GHz, MPC 3.5 mm (m)
56924-001B	10 MHz to 40 GHz, 2.92 mm (m)
56924-002K transformer	10 MHz to 40 GHz, 2.92 mm (m) plus waveguide 22

6930 Series High Power

56930-900F	10 MHz to 18 GHz, N type (m)
56932-900N	30 kHz to 4.2 GHz, N type (m)
56934-001K	10 MHz to 40 GHz, 2.92 mm (m)
56934-002A transformer	10 MHz to 40 GHz, 2.92 mm (m) plus waveguide 22

Fault Locator, Scalar Detector, Power Sensor DC Cables

43138-663V	1.5 m, DC Cable
43138-664S	3.0 m, DC Cable
43138-665W	10 m, DC Cable
43138-666D	25 m, DC Cable
43138-667T	50 m, DC Cable

(For longer lengths contact your local Marconi Instruments sales office).

Pulse Modulator

6145	70 MHz to 20 GHz Pulse Modulator
54441-019A	AC Power Supply

Precision Adapters

54311-175E	N (m) to N (m)
54311-167B	N (m) to N (f)
54311-174H	N (f) to N (f)
54311-176U	N (f) to 3.5 mm (f)
54311-177Y	N (m) to 3.5 mm (f)
54311-178N	N (m) to 3.5 mm (m)
54311-185G	N (f) to 3.5 mm (m)
54311-137A	N (m) to TNC (f)
54311-138Z	N (m) to TNC (m)
54311-139H	N (f) to TNC (f)
54311-186V	N (f) to TNC (m)
54311-203C	7 mm to N (f)
54311-204R	7 mm to TNC (m)
54311-205B	7 mm to TNC (f)
54311-137A	N (m) to TNC (f)
54311-138Z	N (m) to TNC (m)
54311-139H	N (f) to TNC (f)
54311-136K	TNC (m) to TNC (m)
54311-107H	3.5 mm (f) to 3.5 mm (f)
54311-165C	3.5 mm (m) to 3.5 mm (f)
54311-164M	3.5 mm (m) to 3.5 mm (m)
54311-162P	2.92 mm (m) to 2.92 mm (m)
54311-206K	2.92 mm (m) to 2.92 mm (f)
54311-207A	2.92 mm (m) to 2.92 mm (m)

Standard Adapters

54311-133C
54311-134R
54311-135B

N (f) to SMA (f)
N (m) to SMA (f)
TNC (m) to SMA (m)

Miscellaneous Electrical Cables

54311-170B
54311-112U
43129-189U
43126-012S
46884-560M
03964-329R

Positive Voltage Measurement Cable
Negative Voltage Measurement Cable
GPIB Cable
50 Ω BNC (m) to BNC (m) 1.5 m
Parallel Printer Interface Cable
Autotester Adapter Cable

Standard Microwave Cables

54351-022X
54351-025R
54351-027K

0.5 m, 20 GHz, N (m) to N (m)
0.5 m, 26.5 GHz, 3.5 mm (m) to 3.5 mm (m)
0.5 m, 40 GHz, 2.92 mm (m) to 2.92 mm (m)

Fixed Load

23488-724L
23488-722Y
23488-721U
23488-725J
23488-723N

3.5 mm (f) Fixed Load
3.5 mm (m) Fixed Load
Type N (m) Fixed Load
Type N (f) Fixed Load
7 mm Fixed Load

Attenuators

56534-901K
56534-902A
56534-903Z
56534-904H

Precision Fixed Coaxial Attenuator 3 dB DC to 18 GHz 5 W
Precision Fixed Coaxial Attenuator 6 dB DC to 18 GHz 5 W
Precision Fixed Coaxial Attenuator 10 dB DC to 18 GHz 5 W
Precision Fixed Coaxial Attenuator 20 dB DC to 18 GHz 5 W

Applications and Memory Cards

59000-265B
59000-280L
59000-264R
59000-182V
59000-186T
59000-190P
54211-004X
54441-016R
54441-017B
54441-018K

Gain Compression Application
Guided Measurements Application
Transmission Line Database
128k Blank Memory Card
512k Blank Memory Card
MTS PC-Utilities Software
Memory Card Reader/Writer Unit
AC Adapter - UK style for Reader/Writer
AC Adapter - European style for Reader/Writer
AC Adapter - USA style for Reader/Writer

Miscellaneous

54127-309Z
54127-311A
54124-027S
54121-034F
46880-071C
54112-157G
54112-160G
54112-161V
54152-001B
54211-008B

Rack Mount Kit for 6200B
Rack Mount Kit for 6200B and 6210
Front Stowage Cover
Detector Input Socket Cap
Service Manual
Soft Carrying Case
Hard Flight Case for 6200B and 6210
Hard Flight Case for 6200B.
3.5 mm Torque Wrench for 6200B
Compact Keyboard

ASSOCIATED EQUIPMENT

The following items of equipment are recommended for use with the MTS, since they are known to operate satisfactorily with the instrument.

HPGL GPIB Plotters

HP 7440A
HP 7470A
HP 7475A

Epson FX Series Printers

Epson FX-105
Epson FX-800
Epson FX-850
Epson FX-1000

Hewlett Packard DeskJet/LaserJet Series Printers

HP DeskJet 500
HP DeskJet 500C
HP DeskJet 550C
HP LaserJet 4L
HP LaserJet 4P

Canon BJ Series Printers

Canon BJ10EX
Canon BJ10SX
Canon BJ330

Hewlett Packard Colour DeskJet Printers

HP DeskJet 500 (with colour cartridge)
HP DeskJet 550C
HP DeskJet 560C
HP DeskJet 600 (with colour cartridge)
HP DeskJet 660C
HP DeskJet 850C
HP DeskJet 1200C

VGA 640 x 480 standard colour monitors

Mitsubishi FA3415 ETKL
Taxan 770 Plus

The monitor cable must be specified for use with a VGA interface, and must have a 15-way D-type female connector, for connection to the EXT MONITOR input of the MTS.

PERFORMANCE DATA - 6210 REFLECTION ANALYZER

NUMBER OF TEST PORTS

One, for the measurement of S_{11} .

FREQUENCY RANGE

When used with:	6202B	250 MHz to 2 GHz
	6201B	250 MHz to 8 GHz
	6200B	250 MHz to 20 GHz
	6203B/6204B	250 MHz to 26.5 GHz

DYNAMIC RANGE (Noise Floor)

(Source set to +3 dBm)

250 MHz to 500 MHz	>50 dB, 60 dB typical
500 MHz to 18 GHz	>60 dB
18 GHz to 26.5 GHz	>50 dB, 60 dB typical

INSERTION LOSS FROM RF INPUT TO TEST PORT

Typically $5 + (8 \times f/26.5)$ dB
where f is the set frequency in GHz.

NUMBER OF MEASUREMENT POINTS

1 to 800, user selectable.

SWEEP TIME

Auto

Sweep time is as fast as possible for the attributes selected.

Manual

Sweep time will never be less than the sweep time entered and may be greater depending on constraints imposed by the system hardware, number of points and measurement software processing overhead.

Fastest time (401 points)

300 ms

Settable range

40 ms to 500 s

NOISE REDUCTION

Averaging

1 to 1000 (applied instrument wide).

Smoothing

0.01% to 20% of span, resolution 0.01%.

CALIBRATION

Calibration types

1 port

Coax

Short, Open, Fixed Load
Short, Open, Sliding Load

Waveguide

Short, Offset Short, Fixed Load
Short, 2 x Offset Shorts
Short, Offset Short, Sliding Load

In addition, the ability to specify sex and connector type of the test port.

Number of cal points Same as number of measurement points.

Calibration kits (optional)

Economy

Type N and 3.5 mm

Full

Type N, 3.5 mm and 7 mm

Calibration stores

Four

Additional storage is available via memory card (optional accessory).

REFLECTION ANALYZER SYSTEM PERFORMANCE

Dependent on calibration kit used. Specifications assume a 2 hour warm up period from power on, and an ambient temperature of 23°C ±3°C.

N type cal kit (economy)

Directivity

<2 GHz

>40 dB

2 GHz to 18 GHz

>30 dB

Source match

<2 GHz

>30 dB

2 GHz to 18 GHz

>24 dB

Frequency response

Within ±0.25 dB

N type cal kit (full)

Directivity

>40 dB

Source match

>30 dB

Frequency response

Within ±0.2 dB

7 mm type cal kit (full)

Directivity

>50 dB

Source match

>40 dB

Frequency response

Within ±0.1 dB

3.5 mm type cal kit (economy)

Directivity

<2 GHz

>40 dB

2 GHz to 26.5 GHz

>25 dB

Source match

<2 GHz

>30 dB

2 GHz to 26.5 GHz

>22 dB

Frequency response

Within ±0.4 dB

3.5 mm type cal kit (full)

Directivity	>40 dB
Source match	>30 dB
Frequency response	Within ± 0.2 dB

REFLECTION ANALYZER CHANNEL FEATURES

DOMAINS

Frequency

Modes CW, F1-F2, centre/span, frequency list sweep, harmonic frequency sweep, waveguide frequency sweep.

Ability to blank frequency information.

Resolution

1 Hz settable.
Six digits displayed on graticule

Power

Sweep range

25 dB
85 dB with MTS step attenuator option

Resolution

0.01 dB settable.

Offset

Ability to enter offset (per channel) between source and display.

Time

Time domain domain response for impedance discontinuity analysis.

Stimuli

Low-pass step
Low-pass impulse
Band-pass impulse

Resolution
(26.5 GHz sweep)

Reflection (in air transmission lines)
0.7 cm, low-pass.
1.4 cm, band-pass.

Point spacing

<0.01 cm

Windowing

Kaiser Bessel, user definable.

Gating

User definable start, stop and shape.

Fencing

User definable start, stop and shape.

Voltage/current	Ability to sweep MTS rear panel V/I output in the range -15 V to +15 V (± 15 mV, 2.5 W max) or -150 mA to +150 mA (± 300 μ A, 1.25 W max)
Voltage resolution	1 mV
Current resolution	10 μ A

RESPONSE

Format	
Cartesian	Logarithmic magnitude, linear magnitude, phase, VSWR, real, imaginary, impedance.
Polar	Logarithmic magnitude, linear magnitude, Smith, inverse Smith.
Scaling	
Magnitude	
Log format	0.01 dB/div to 20 dB/div in 1,2,5 sequence.
Lin format	10^{-12} units/div to 10^3 units/div.
Phase	
Cartesian	0.1°/div to 180°/div
Polar	45°/div
Reference level position	Any graticule line.
Reference level value	-99.99 to +99.99 all units except VSWR. 1 to 100 VSWR.

MEASUREMENT MANIPULATION

Display	Display live measurement. Display trace memory. Display user-defined expressions involving subtraction and division on a live measurement and a trace memory. Measurement hold applied per trace.
Complex limit lines	Four stores of 12 segments each. Each segment defines an upper and a lower limit line. Any store can be applied to any trace.
Markers	Eight per trace, any one of which can be enabled to become the active marker, plus a separate delta marker.

Marker domain resolution	
Frequency	Six digits with over-ride to give 1 Hz resolution.
Power	0.01 dB
Voltage	1 mV
Current	10 μ A
Marker response resolution	
Magnitude	0.01 dB, log format. Six digits, lin format.
Phase	0.01°
Marker functions	Active marker, delta marker, minimum, maximum, search left, search right, N-dB bandwidth, peak-to-peak response.
Reference plane extension	User definable
Electrical delay	± 1 s maximum or $\pm 300,000$ km
Phase offset	$\pm 360^\circ$ maximum
Non-dispersive media	Ability to enter delay as either physical length (m) or electrical delay (s). Relative velocity (V_r) and relative permittivity (ϵ_r) may be entered.
Characteristic impedance	User definable; default 50 Ω .
Waveguide cutoff frequency	User definable.

TEST PORT CONNECTOR

Type	Ruggedised precision 3.5 mm male.
Maximum input power	0.5 W

POWER CONSUMPTION

50 W maximum (in addition to MTS consumption).

DIMENSIONS AND WEIGHT

Height	46 mm (1.8 in)
Width	325 mm (12.8 in)
Depth	450 mm (17.7 in)
Weight	6.5 kg (14.3 lb)

OPTIONS AND ACCESSORIES - 6210 REFLECTION ANALYZER

Options

Option 011	Bias Tee
Option 012	Retrofit version

Note...

The 6210 can be supplied as part of a system with one of the 6200B Series Microwave Test Sets (MTS) or as a retrofit version for fitting to an existing MTS. The MTS must be fitted with software issue 2.0 or higher; software upgrades are available if required.

SUPPLIED ACCESSORIES

43138-328X	Auxiliary signal channel cable
43138-283G	Auxiliary data cable
43138-284V	Auxiliary power cable
43138-366R	RF interconnection cable, N type
43138-367B	RF interconnection cable, 3.5 mm

OPTIONAL ACCESSORIES

Cal Kit, Type N - economy version

54424-005X	Comprising: 2 x short circuit (male and female) 2 x open circuit (male and female) 2 x fixed load (male and female) Ruggedised 3.5 mm to N(m) adapter Ruggedised 3.5 mm to N(f) adapter Fixed load return loss: <2 GHz 40 dB 2 GHz to 18 GHz 30 dB Optional Accessories:
54425-004E	Gauge kit (N-type), comprising: 2 x gauges, (m) and (f) Adapter and gauge blocks
54311-166R	N-type male/male matched adapter
54311-167B	N-type male/female matched adapter
54311-168K	N-type female/female matched adapter

Cal Kit, Type N - full version

54424-003T	Comprising: As economy kit plus 2 x sliding load (male and female) Optional Accessory:
54425-002D	Precision 30 cm airline (N-type)

Cal Kit, 3.5 mm - economy version

54424-009

Comprising:

2 x short circuit (male and female)
2 x open circuit (male and female)
2 x fixed load (male and female)
Female/female precision adapter

Fixed load return loss:

<2 GHz	40 dB
2 GHz to 26.5 GHz	25 dB

Optional Accessories:

54425-005U

Gauge kit (3.5 mm), comprising:

2 x gauges (m) and (f)
Adapter and gauge blocks

54152-001B
54311-164M
54311-165C

3.5 mm torque wrench
3.5 mm male/male matched adapter
3.5 mm male/female matched adapter

Cal Kit, 3.5 mm - full version

54424-007C

Comprising:

As economy kit plus
2 x sliding load (male and female)

Optional Accessory:

54425-003H

Precision 15 cm airline (3.5 mm)

Cal Kit, 7 mm - full version

54424-001W

Comprising:

Short circuit
Open circuit
Fixed load
Sliding load
Gauge and gauge block
Ruggedised 3.5 mm (f) to 7 mm adapter
Collet extractor
Torque wrench

Fixed load return loss:

<2 GHz	50 dB
2 GHz to 18 GHz	30 dB

Optional Accessories:

54425-001A
54425-163C
54425-009J

Precision 30 cm airline (7 mm)
Ruggedised 3.5 mm (f) to 7 mm adapter
Fixed matched load (return loss as above)

Test Port Cables

54311-155S
54311-156W
54311-157D
54311-158T
54311-159P

Ruggedised 3.5 mm (f) to 7 mm
Ruggedised 3.5 mm (f) to N-type (m)
Ruggedised 3.5 mm (f) to N-type (f)
Ruggedised 3.5 mm (f) to ruggedised 3.5 mm (m)
Ruggedised 3.5 mm (f) to standard 3.5 mm (f)

50 Ω Fixed Loads

54421-009D
54421-010S
54421-011W
54421-012D
54421-013T

7 mm Fixed Load
3.5 mm (f) Fixed Load
3.5 mm (m) Fixed Load
N-type (f) Fixed Load
N-type (m) Fixed Load

Miscellaneous

54112-157G
54124-028W

Soft carrying case
Front stowage cover for assembled MTS and 6210

Note...

Calibration kits and accessories carry a one year warranty excluding wear and tear and mis-use.

Declaration of Conformity

We: Marconi Instruments Limited
Longacres House
Norton Green Road
Stevenage
Hertfordshire SG1 2BA
England

as the manufacturer of the apparatus listed, declare under our sole responsibility that the product(s):

Title: Microwave Test Set
6200B, 6201B, 6202B, 6203B & 6204B
(including
Options 1, 2, 3, 8, 96, 97, 98 and 99)

to which this declaration relates are in conformity with the following standards or other normative documents:

Safety: EN 61010-1:1993 (IEC 1010-1:1990)
EMC: EN55011:1991 Class B
EN50082-1:1992
EN60555-2:1987

and therefore conforms with the protection requirements of Council Directive 89/336/EEC relating to electromagnetic compatibility and Council Directive 73/23/EEC relating to safety requirements.

Issued on: 1st November 1995

Authorised by:

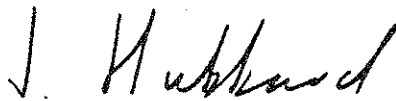

Julian Hubbard
Product Liability Manager



Chapter 2
INSTALLATION

Chapter 2 INSTALLATION

CONTENTS

	Page
INITIAL VISUAL INSPECTION	2-1
AC POWER SUPPLY	2-1
SAFETY TESTING	2-2
GOODS-IN CHECKS	2-2
MOUNTING ARRANGEMENTS	2-3
RACK MOUNTING	2-3
INSTALLATION OF THE 6210 REFLECTION ANALYZER	2-4
ROUTINE MAINTENANCE.....	2-7
Microwave Connectors	2-7
Cleaning the LCD Window.....	2-7
BATTERY REPLACEMENT.....	2-7
Instrument Battery	2-7
Memory Card Battery	2-8
ROUTINE SAFETY TESTING AND INSPECTION	2-8
PUTTING INTO STORAGE	2-10

LIST OF FIGURES

Fig. 2-1 Location of Supply Voltage Selector Switch	2-2
Fig. 2-2 Removal of Bail Arm Prior to Rack Mounting	2-3
Fig. 2-3 Side View of a 6210 Fitted to the MTS	2-5
Fig. 2-4 Front and Rear Views of 6200B/6210	2-6

INITIAL VISUAL INSPECTION

Immediately after unpacking, thoroughly inspect the instrument for signs of physical damage that may have occurred during shipping. If any damage is found, or if the instrument fails the Goods-In Checks (see below), the instrument must be returned to the following address:

Marconi Instruments Ltd.
The Airport
LUTON
Bedfordshire LU2 9NS

Attach a label indicating the service required, type or model number, serial number and your return address. Use the container and packing materials that were used to ship the instrument.

AC POWER SUPPLY

The instrument requires an AC supply of 90 to 132 V or 188 to 265 V, 45 to 440 Hz, 500 VA. The required supply fuses (time lag) are 4 A for 90 to 132 V operation or 2.5 A for 188 to 265 V operation. Before switching on, ensure that the rear panel voltage selector switch (located above the AC supply connector) is in the

correct position and that the correct fuses are fitted. The switch is operated by inserting a screwdriver blade into the recessed slot and pushing the switch to one side (see Fig. 2-1).

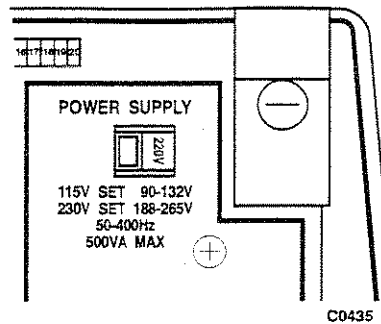

Fig. 2-1 Location of Supply Voltage Selector Switch

The AC supply cable is fitted at one end with a female plug which mates with the AC connector at the rear of the instrument. When fitting a supply plug ensure that the connections are as follows:

EARTH (ground) - Green/Yellow
 NEUTRAL - Blue
 LIVE (phase) - Brown

SAFETY TESTING

This product has been safety tested in accordance with BS4743 and IEC Publication 348.

GOODS-IN CHECKS

The following Goods-In Check verifies that the MTS is functioning correctly, but does not verify conformance to the listed specification. To verify that the instrument conforms to the specification given in Chapter 1, refer to Chapter 5, Acceptance Testing.

For the purpose of the Goods-in Check, the instrument's self test facility is used. Self tests are performed by the instrument at power on. If a failure occurs, an error report is written to a self test results store held in non-volatile memory (assuming that the failure does not prevent this). In addition, an error message (marked with the 'system failure' icon) is displayed, i.e.

Self-test failed. Examine power-on test results

To examine the record of the test results, use

[UTILITY]/[Service]/[Status]/[Display Test Results]

If the fault involves the data acquisition system, another, more specific message may be displayed, such as 'Data acquisition main amp failed'. In this case also, the test results should be examined.

In addition, certain hardware failures are reported at power on via the parallel printer port. This allows diagnostic information to be obtained from an instrument which otherwise may appear "dead", e.g. if the graphics system has failed.

Further details of the power-on self tests can be found in the Test Results Menu description in Chapter 3.

If the instrument appears to be completely dead, carry out the following:

- Check that the mains power supply line is providing power to the instrument.
- Check that the rear panel power supply status LEDs are all OFF.
- Check that the rear panel voltage selector switch matches the supply voltage.
- Check that the mains fuses have not blown (accessible from the rear panel).

MOUNTING ARRANGEMENTS

Ensure that the air vent and other ventilation holes are not obstructed, otherwise the maximum temperature specification is reduced, resulting in impaired operation. Avoid standing the instrument or associated sensors/detectors in the vicinity of large transformers or other possible magnetic fields.

RACK MOUNTING

The Microwave Test Set may be mounted in a standard 19 inch rack using the rack mounting kit 54127-309 available as an optional accessory. When a 6210 is fitted to the MTS, an additional mounting kit 54127-311 is needed to support the rear. It consists of a rack mounting tray, which is fitted to the rear of the rack, and a front blanking panel. In both cases the bail arm must first be removed.

Note...

A 6200B on its own can be mounted in a standard 19 inch rack which has a minimum depth of 550 mm. With a 6210 fitted, the rack depth must be between 550 mm and 800 mm.

- (1) Unclip both end caps and loosen the screws at both sides.
- (2) Remove one screw and pull the bail arm away from the indexing mechanism. Remove the remaining screw and remove the bail arm.
- (3) If a 6210 is fitted, secure the support tray from kit 54127-311 to the rear of the rack so that it will support the rear of the instrument when it is fitted to the rack.
- (4) Fit the rack mounting brackets to the side rails of the instrument using the supplied M5 screws and washers, then fit the instrument into the rack.
- (5) If a 6210 is present, and the front blanking plate is fitted, ensure that the painted surface of the plate is on the outside.

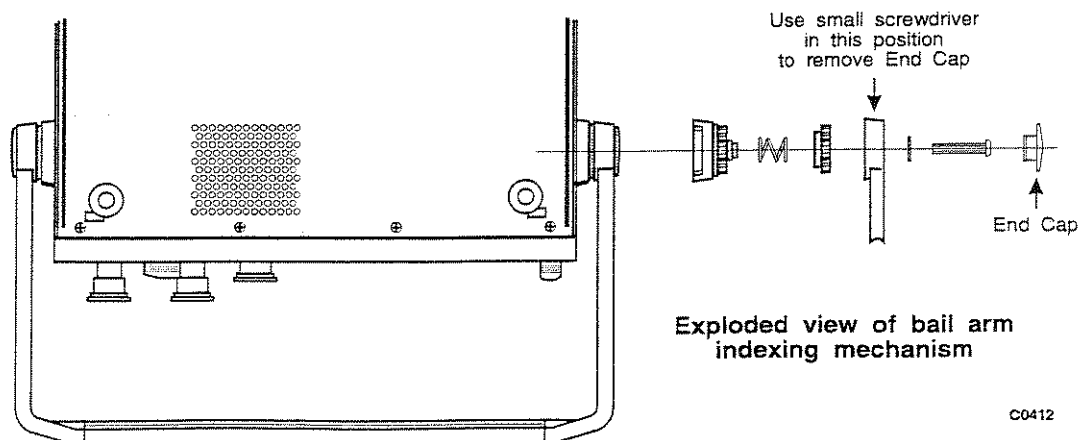

Fig. 2-2 Removal of Bail Arm Prior to Rack Mounting

INSTALLATION OF THE 6210 REFLECTION ANALYZER

The following procedure enables the user to fit a 6210 Reflection Analyzer to a 6200B Series MTS. This will be necessary, for example, if the 6210 was not purchased as part of a 6200B/6210 system, or if the units have had to be separated for servicing purposes.

The Installation Kit supplied with the 6210 comprises the following items:

<i>Description</i>	<i>Part No.</i>	<i>Qty.</i>
Pillar assembly	41700/616	4
Rear support bar	41700/772	2
Clip, R.H.	35905/447	2
Clip, L.H.	35905/448	2
Tie bar	35907/293	1
Bracket	35907/294	2
Washer, plain, M4	21171/110	2
Screw, pan head, M4 x 10	21833/003	2
Screw, pan head, M4 x 8	21833/008	4
Screw, pan head, M4 x 12	21833/009	2
Screw, pan head, M5 x 40	21837/575	4
Nut, hex, M4	21882/110	2
Warning label - heavy instrument	31739/891	1

Refer to Fig. 2-3.

- (1) Turn the MTS upside down. Pull off the studs covering the screws which hold the feet in place, and remove the four feet.
- (2) Place a clip over one of the holes where a foot was previously located, such that the lug of the clip is located in the slot adjacent to the hole. Note that there are two left hand clips and two right hand clips.
- (3) Screw a pillar assembly into the hole so that the clip is tightly secured between the pillar and the bottom cover of the instrument.
- (4) Repeat steps (2) and (3) at the other three locations.
- (5) Locate the 6210 over the pillar assemblies and screw the feet that were removed in step (1) into the pillar assemblies, thus securing the 6210. Refit the studs.
- (6) Remove the two rear supports on one side of the MTS. Discard the screws and plain washers but retain the lockwashers. Using the supplied M5x40 mm screws and the original lockwashers, re-attach the two rear supports together with one of the brackets.
- (7) Repeat step (6) at the other side of the instrument.
- (8) Attach a rear support bar to each of the brackets using M4x8 mm screws. The top end of the support bar is located in a slot in the upper rear support of the MTS.
- (9) Fix the tie bar to the lower end of the support bars using two M4x10 mm screws, nuts and plain washers, and to the rear of the 6210 using two M4x12 mm screws. Note that there is a strip of RF gasket material along one edge of the tie bar; this should be in contact with the bottom rear edge of the 6210.
- (10) Connect the four cable assemblies to the appropriate connectors as shown in Fig 2-4, which show the front and rear views of the 6200B/6210 combination.

- (11) Attach the warning label to the metal part of the carrying handle, adjacent to the black sleeving. This label is a warning to the user that the combined weight of the 6200/6210 combination exceeds the 18 kg guideline for safe handling by a single person.

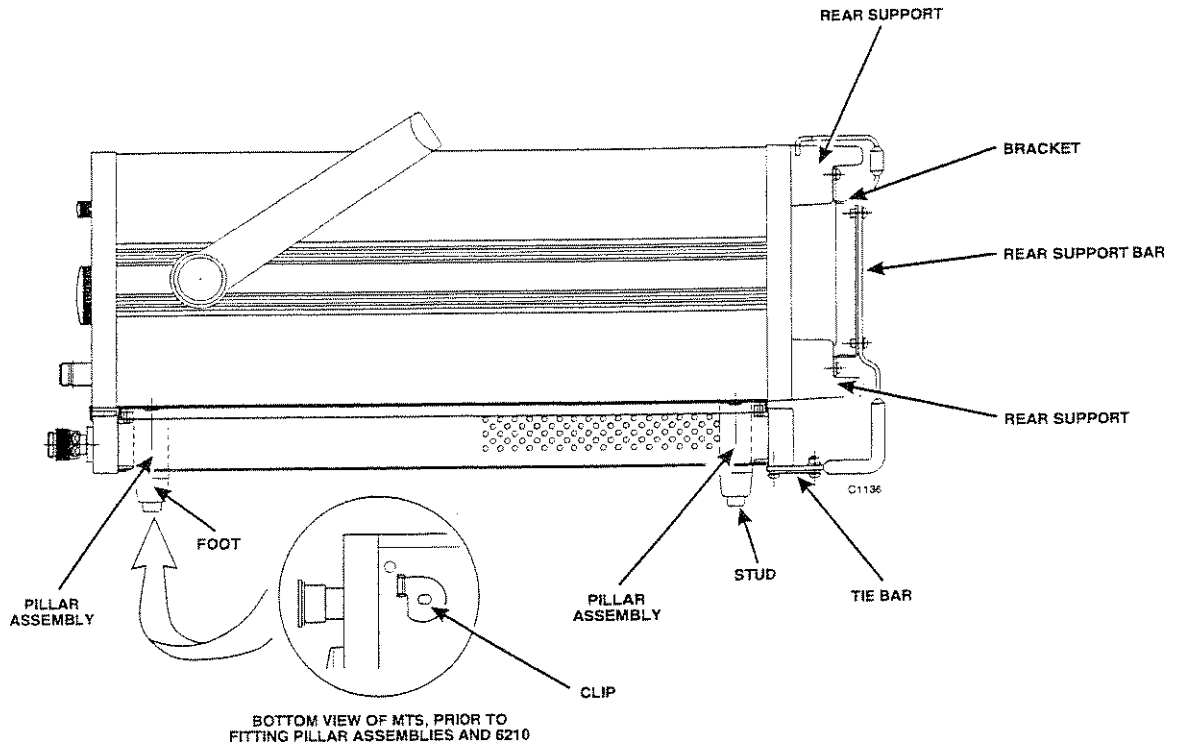
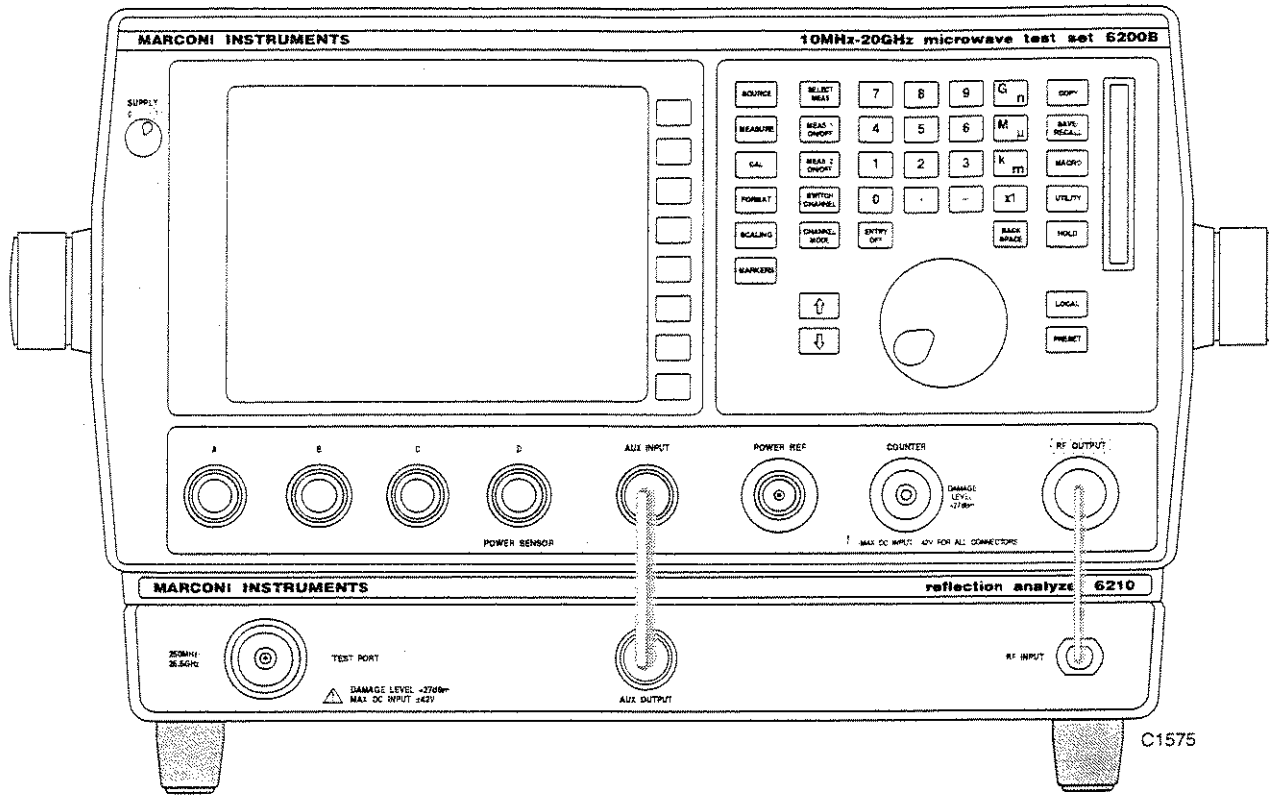
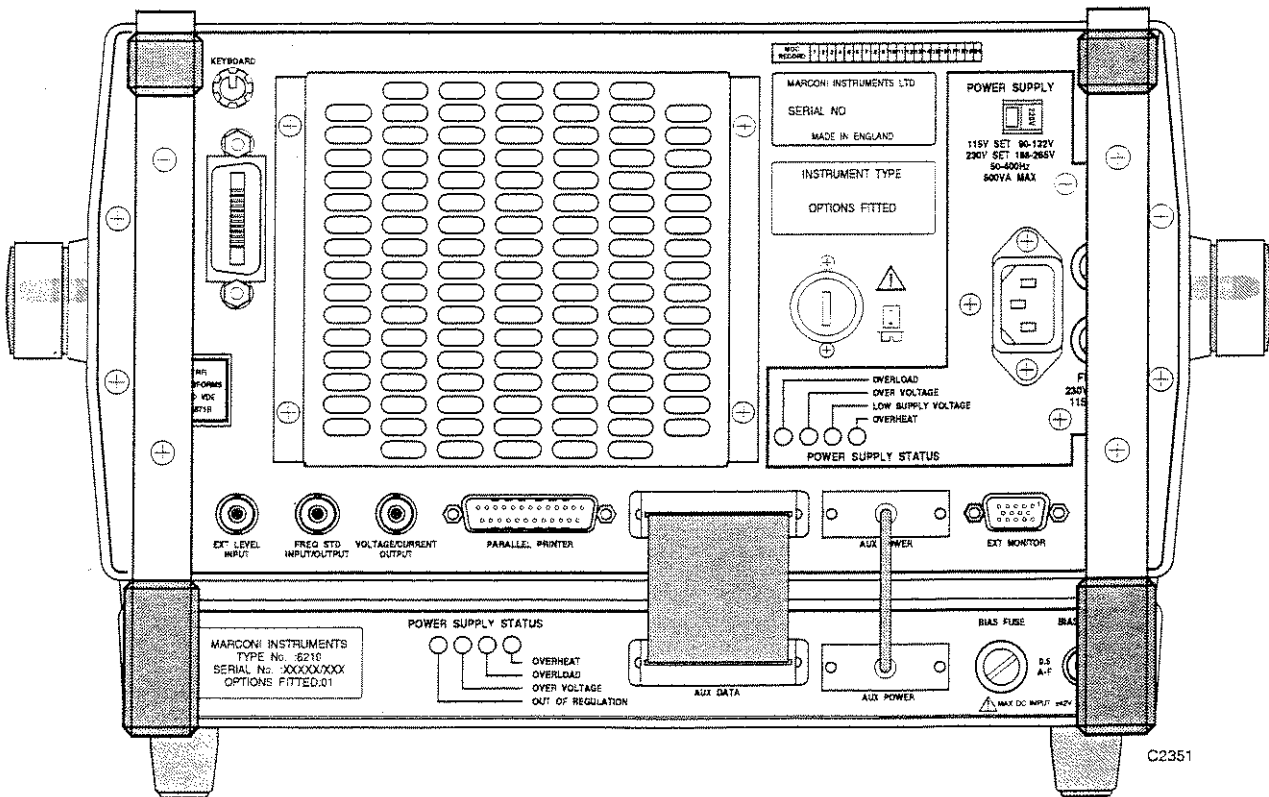

Fig. 2-3 Side View of a 6210 Fitted to the MTS



C1575



C2351

Fig. 2-4 Front and Rear Views of 6200B/6210

ROUTINE MAINTENANCE

Routine maintenance is limited to cleaning the display screen and taking proper care of microwave connectors.

Microwave Connectors

Care should be taken when using microwave connectors, both on the MTS and on any accessories that are used, such as cables, adapters, detectors, test heads, etc. Complying with the following precautionary notes will ensure longer component life and less equipment downtime due to connector or component failure.

- The precision connectors fitted to this equipment and its accessories may be damaged by mating with a non-precision type. Damage to the connectors may also occur if the connector interface parameters are not within specification. This should be checked with the appropriate gauging tool. It is strongly recommended that every connector be gauged prior to its first use and regularly thereafter, e.g. every 20 connections.
- The precise geometry of the connectors can be easily disturbed by dirt and other contamination adhering to connector interfaces. Alcohol is the recommended cleaning agent, and a clean, damp cotton swab is the recommended applicator. When not in use, keep the connectors covered with the protective caps provided.
- Always use the correct mating techniques. In particular, the two connectors to be mated should be pressed together such that the pin penetrates the collet prior to the nut being tightened. Never rotate one connector body relative to the other because this wears out the mating interfaces, thus reducing connector lifetime.
- Avoid over-torquing connectors during mating, because it may damage the connector centre pin or may cause the connector body to turn in its housing. Finger tight is usually sufficient.
- Avoid mechanical shock by dropping or otherwise roughly handling microwave components.

Cleaning the LCD Window

To prevent damage to the LCD window, care should be taken not to scratch the surface during use and also when cleaning. The LCD window should be cleaned by wiping a slightly damp, soft, lint-free cloth gently over the surface. To remove grease or smears, use a clean cotton cloth moistened with Heptane. No other cleaning agents should be used. Clean the window using either horizontal or vertical strokes, NEVER a circular action.

BATTERY REPLACEMENT

Instrument Battery

Both the MTS and the 6210 contain non-volatile memory which is powered by a lithium battery when the power is removed. Although battery life can extend to five years, this will depend on conditions of use, e.g. battery life is reduced as the temperature is increased. To avoid loss of data it is recommended that the battery is replaced every two years.

Replace the MTS battery as follows:

- (1) Ensure that the instrument is switched on; this will provide power for the non-volatile memory while the battery is replaced.
- (2) Using a coin or suitable tool, unscrew the battery compartment cover at the rear of the instrument.
- (3) Remove the battery and insert the replacement, then replace the battery compartment cover.

Replace the 6210 battery as follows:

- (1) Ensure that the 6210 is powered up, so that data is not lost while the battery is replaced.
- (2) Remove the four feet and the 6 screws that secure the 6210 bottom panel.
- (3) The battery is held in clips at the rear of the instrument. When replacing the battery, ensure that the outer plastic skin is not punctured by the clips as the battery is pushed in. Also ensure correct orientation, as indicated by the "+" sign on the board.

The replacement battery should be SAFT L56 or equivalent. This is a Lithium 3.5 V type, rated at 1800 mAH, size AA. A suitable replacement battery can be obtained from Marconi Instruments (Part Number 23711-106Z).

Memory Card Battery

The memory card circuits are powered from its own internal battery when not in use, but are powered from the MTS when the card is inserted into the memory card slot.

As for the instrument battery, the memory card battery should be replaced every two years to ensure data integrity. The battery is replaced as follows:

- (1) Insert the card into the memory card slot of a powered-up instrument. This ensures that the card receives power while the battery is replaced.
- (2) Remove the small screw at the edge of the card and slide out the battery holder (a suitable screwdriver is supplied with the card).
- (3) Remove the battery, insert the replacement and refit the battery holder.

The battery used is either a Lithium type 2016 or 2325, depending on the memory card

Note...

Refer to 'Precautions' at the front of this manual for hazards relating to Lithium batteries.

ROUTINE SAFETY TESTING AND INSPECTION

In the UK the 'Electricity at Work Regulations' (1989) section 4(2) places a requirement on the users of equipment to maintain it in a safe condition. The explanatory notes call for regular inspections and tests together with a need to keep records.

The following electrical tests and inspection information is provided for guidance purposes and involves the use of voltages and currents that can cause injury. It is important that these tests are only performed by competent personnel.

Prior to carrying out any inspection and tests the instruments must be disconnected from the mains supply and all external signal connections removed. All tests should include the instrument's own supply lead, all covers must be fitted and the supply switch must be in the 'ON' position.

The recommended inspection and tests fall into three categories and should be carried out in the following sequence:

1. Visual inspection
2. Earth Bonding Test (Class I equipment only)
3. Insulation Resistance test.

1. Visual Inspection

A visual inspection should be carried out on a periodic basis. This interval is dependant on the operating environment, maintenance and use, and should be assessed in accordance with guidelines issued by the Health and Safety Executive (HSE). As a guide, this instrument when used indoors in a relatively clean environment would be classified as 'low risk' equipment and hence should be subject to safety inspections on an annual basis. If the use of the equipment is contrary to the conditions specified, you should review the safety re-test interval.

As a guide, the visual inspection should include the following where appropriate:

Check that the equipment has been installed in accordance with the instructions provided (e.g. that ventilation is adequate, supply isolators are accessible, supply wiring is adequate and properly routed).

The condition of the mains supply lead and supply connector(s).

Check that the mains supply switch isolates the instrument from the supply.

The correct rating and type of supply fuses.

Security and condition of covers and handles.

Check the supply indicator functions (if fitted).

Check the presence and condition of all warning labels and markings and supplied safety information.

Check the wiring in re-wireable plugs and appliance connectors.

If any defect is noted this should be rectified before proceeding with the following electrical tests.

2. Earth Bonding Tests (Class I Equipment only)

Earth bonding tests should be carried out using a 25A (12V maximum open circuit voltage) DC source. Tests should be limited to a maximum duration of 5 seconds and have a pass limit of 0.1Ω after allowing for the resistance of the supply lead. Exceeding the test duration can cause damage to the equipment. The tests should be carried out between the supply earth and exposed case metalwork, no attempt should be made to perform the tests on functional earths (e.g. signal carrying connector shells or screen connections) as this will result in damage to the equipment.

3. Insulation Tests

A 500 VDC test should be applied between the protective earth connection and combined live and neutral supply connections with the equipment supply switch in the 'on' position. It is advisable to make the live/neutral link on the appliance tester or its connector to avoid the possibility of returning the instrument to the user with the live and neutral poles linked with an ad-hoc strap. The test voltage should be applied for 5 seconds before taking the measurement. Marconi Instruments products employ reinforced insulation in their construction and hence a minimum pass limit of $7 M\Omega$ should be achieved during this test.

Where a DC power adapter is provided with the instrument the adapter must pass the $7 M\Omega$ test limit.

We do not recommend dielectric flash testing during routine safety tests. Most portable appliance testers use AC for the dielectric strength test which can cause damage to the supply input filter capacitors.

It is recommended that the results from the above tests are recorded and checked during each repeat test. Significant differences between the previous readings and measured values should be investigated.

If any failure is detected during the above visual inspection or tests, the instrument should be disabled and the fault should be rectified by an experienced Service Engineer who is familiar with the hazards involved in carrying out such repairs.

INSTALLATION

Safety critical components should only be replaced with equivalent parts, using techniques and procedures recommended by Marconi Instruments Ltd.

The above information is provided for guidance only. Marconi Instruments products are designed and constructed in accordance with International Safety Standards such that in normal use they represent no hazard to the operator. Marconi Instruments Ltd reserve the right to amend the above information in the course of continuing its commitment to product safety.

PUTTING INTO STORAGE

IF the instrument is to be put into storage, ensure that the following conditions are maintained:

Temperature range	-40 to +70°C
Humidity	Less than 93% at 40°C

Chapter 3
OPERATION

Chapter 3 LOCAL OPERATION

CONTENTS

	Page
INTRODUCTION.....	3-8
FRONT PANEL FEATURES	3-8
FRONT PANEL KEYS AND SOFT KEY MENUS	3-10
Numeric Entry	3-12
Password Protection.....	3-13
Primary Password	3-13
User-defined Passwords	3-14
DISPLAY	3-14
Channels and Measurements	3-14
Swept Channel.....	3-14
Readout Channel.....	3-17
General Information Area	3-19
Error Messages	3-20
Display Set-up	3-20
Floppy Disk Drive Option.....	3-20
Using an External Keyboard	3-20
REAR PANEL FEATURES.....	3-21
6210 FRONT PANEL FEATURES.....	3-23
6210 REAR PANEL FEATURES	3-23
DISPLAY GROUP KEYS	3-25
[SELECT MEAS] KEY	3-25
[MEAS 1 ON/OFF] KEY	3-25
[MEAS 2 ON/OFF] KEY	3-25
[SWITCH CHANNEL] KEY	3-25
[CHANNEL MODE] KEY.....	3-26
Channel Mode	3-26
FUNCTION GROUP KEYS - SCALAR CHANNEL	3-27
[SOURCE] KEY	3-27
Channel Coupling	3-27
Source (Start/Stop Frequency Sweep Mode)	3-28
Source (Centre/Span Frequency Sweep Mode).....	3-29
Source (CW Mode).....	3-30
Source (Power Sweep).....	3-31
Source (Voltage Sweep).....	3-32
Source (Current Sweep).....	3-33
Sweep Time	3-34
Source Mode.....	3-35
Source Funcs	3-36
Lev & F Std	3-37
Int/Ext Source	3-38
V/I Output	3-39
CW & Loop BW.....	3-41
CW Set-up.....	3-42
[MEASURE] KEY	3-51
Measure	3-52
Single Input	3-53
Input Ratio.....	3-53
Averaging	3-54
Smoothing	3-55
Lim Checking	3-56

Edit Spec	3-58
Edit Segment	3-60
Add Segment	3-61
Gen Set-up.....	3-62
Input Config	3-63
Scale & Offset	3-64
Select Input	3-66
Input A (B, C or D).....	3-67
Sensor Corr.....	3-68
Cal & Lin Fact.....	3-69
Edit Specs.....	3-70
Edit Det Specs	3-70
Edit Spec	3-71
Edit Table.....	3-72
Edit Entry	3-73
Add Entry	3-74
[CAL] KEY	3-83
Cal.....	3-84
Through.....	3-85
Short & Open	3-86
Short OR Open	3-86
S/E Ins Loss.....	3-87
PC On/Off	3-87
Det/Sen Zero	3-88
Sensor Cal	3-89
[FORMAT] KEY	3-93
Format	3-93
[SCALING] KEY	3-95
Scaling	3-96
[MARKERS] KEY	3-97
Markers	3-98
Mkr Funcs	3-99
Max Min.....	3-100
dB/O dB/D	3-100
Peak to Peak	3-101
Search.....	3-102
Bandwidth	3-103
Set Up Mkrs	3-105
FUNCTION GROUP KEYS - READOUT CHANNEL.....	3-109
[SOURCE] KEY	3-109
[MEASURE] KEY	3-109
Measure.....	3-110
dB Rel	3-111
Freq Rel.....	3-111
Averaging.....	3-112
Input A (B, C or D).....	3-113
Meas Funcs.....	3-114
Single Input	3-115
Input Ratio.....	3-115
Input Diff.....	3-116
Duty Cycle	3-116
Lim Checking.....	3-117
Max Min Hold	3-117
Gen Set-up.....	3-118
Input Config	3-119
Select Input	3-120
Input A (B, C or D).....	3-120

Input A (B, C or D) Flat Corr.....	3-121
[CAL] KEY	3-131
Cal.....	3-132
[FORMAT] KEY	3-133
Format.....	3-133
FUNCTION GROUP KEYS - FAULT LOCATION CHANNEL	3-135
[SOURCE] KEY	3-135
Source.....	3-136
[MEASURE] KEY	3-139
Measure	3-141
Config F Loc	3-141
Meas Def	3-142
Single Input	3-142
Input Ratio.....	3-143
Set Up Meas	3-146
Access Dbase.....	3-147
Sel from Card	3-148
Select Subset.....	3-149
Menu	3-150
Cpy from Card.....	3-151
Edit Store.....	3-152
Edit Medium.....	3-153
Edit Attn Table	3-154
Set Params	3-155
F Loc Funcs	3-157
Enhance Mode	3-167
[CAL] KEY	3-168
Cal.....	3-171
[FORMAT] KEY	3-171
Format	3-172
[SCALING] KEY	3-173
Scaling.....	3-174
[MARKERS] KEY	3-175
Markers	3-176
Mkr Funcs.....	3-177
Max Min.....	3-177
Find Next Pk.....	3-177
Set Up Mkrs.....	3-178
FUNCTION GROUP KEYS - REFLECTION ANALYZER CHANNEL	3-181
[SOURCE] KEY	3-181
Source (Linear List Frequency Sweep).....	3-182
Source (Waveguide Sweep)	3-183
Source (Low Pass Sweep).....	3-184
Set Up List.....	3-185
Set Freqs.....	3-187
Source Mode (More).....	3-188
[MEASURE] KEY	3-195
Measure	3-196
Gate/Fence.....	3-197
Gating Mode.....	3-200
G / F Shape	3-200
Time Dom Funcs	3-201
DC Extrap.....	3-202
Windowing	3-203
Display Domain.....	3-205
Display Zoom.....	3-206

Measure (More).....	3-207
Elect Delay.....	3-208
Character Dev.....	3-209
[CAL] KEY.....	3-213
Cal.....	3-214
Reflect Cal.....	3-215
Set Up Cal.....	3-218
Edit Cal Kit.....	3-219
Connector.....	3-221
[FORMAT] KEY.....	3-225
Format.....	3-226
Format (Polar/Smith Formats).....	3-227
[SCALING] KEY.....	3-229
Scaling.....	3-230
[MARKERS] KEY.....	3-232
Markers.....	3-233
Mkr Funcs.....	3-234
Search.....	3-235
Find Next Pk.....	3-235
Set Up Mkrs.....	3-236
SYSTEM GROUP KEYS.....	3-241
[COPY] KEY.....	3-241
Copy.....	3-242
Graph Attrib.....	3-243
[SAVE/RECALL] KEY.....	3-245
Save/Recall.....	3-246
Save Memory.....	3-248
Save File.....	3-248
Memory Op (Scalar channel).....	3-252
Memory Op (Reflection analyzer channel).....	3-253
View Store.....	3-254
[MACRO] KEY.....	3-259
Macro.....	3-265
Save Macro.....	3-266
Copy Macro.....	3-267
Copy File.....	3-268
Delete Macro.....	3-269
Edit Macro.....	3-270
Add Code.....	3-271
Pause.....	3-272
Disp Message.....	3-272
Run Macro.....	3-273
Edit Macro.....	3-273
Edit Macro.....	3-274
Edit.....	3-275
Save Macro.....	3-276
Loop & Branch.....	3-277
Case.....	3-278
Conditions.....	3-278
[UTILITY] KEY.....	3-287
Utility.....	3-287
GPIB.....	3-288
Titles.....	3-289
Screen Title.....	3-290
Chan 1 Titles.....	3-291
Chan 2 Titles.....	3-291
Display Set-up.....	3-292

Colour Palette	3-292
Inc/Dec Steps	3-293
Inc/Dec Steps (More)	3-294
Store Ops	3-295
Inst Settings	3-296
Trace Memory	3-296
Sensor Cal	3-297
Src Pwr Cal	3-297
Reflect Cal	3-298
Cal Kit	3-298
Copy File	3-299
Service	3-300
Set-up	3-301
Date & Time	3-302
Set Passwords	3-303
Config Card	3-304
Adapt Stores	3-305
Options	3-306
International	3-306
Status	3-307
Test Results	3-308
Instrument Cals	3-310
Freq Std Cal	3-311
Pwr Ref Cal	3-311
Src Power Cal	3-312
Adapter Cals	3-312
Power Cal	3-313
Power Cal	3-314
Transfer to Pri	3-315
Select Pwr Cal	3-315
Tests	3-316
Edit Specs	3-317
Diagnostics	3-318
Src Diag	3-318
Band Select	3-319
RF Path	3-320
Src Control	3-321
Ctr Funcs	3-322
Src Diag More	3-322
DACq Diag	3-323
Set Up Input	3-324
Reflect DACq	3-325
Set DACs	3-326
Counter Diag	3-326
Dyn Cal Diag	3-327
Rep Ver Step	3-328
Disk Funcs	3-329
Applications	3-330
[HOLD] KEY	3-345
[LOCAL] KEY	3-345
[PRESET] KEY	3-346
Preset	3-346

LIST OF FIGURES

Fig. 3-1 MTS Front Panel	3-8
Fig. 3-2 Definition of Terms	3-10
Fig. 3-3 Display - Swept Measurements	3-15

Fig. 3-4 Trace Information Area	3-16
Fig. 3-5 Display - Readout Measurements	3-17
Fig. 3-6 Format of Readout	3-18
Fig. 3-7 General Information Area.....	3-19
Fig. 3-8 MTS Rear Panel.....	3-21
Fig. 3-9 6210 Front and Rear Panels.....	3-23
Fig. 3-10 Channel Mode Menu	3-26
Fig. 3-11 SOURCE Menus - Scalar and Readout Channels (Sheet 1).....	3-43
Fig. 3-12 SOURCE Menus - Scalar and Readout Channels (Sheet 2).....	3-45
Fig. 3-13 SOURCE Menus - Scalar and Readout Channels (Sheet 3).....	3-47
Fig. 3-14 SOURCE Menus - Scalar and Readout Channels (Sheet 4).....	3-49
Fig. 3-15 Effect of Averaging on a Trace	3-54
Fig. 3-16 Effect of Smoothing on a Trace.....	3-55
Fig. 3-17 Limit Lines for Bandpass Filter Testing	3-56
Fig. 3-18 Limit Checking Specification Form.....	3-58
Fig. 3-19 View Input Configuration Screen	3-63
Fig. 3-20 Detector Types Table	3-66
Fig. 3-21 User Detector Correction Specification Form.....	3-69
Fig. 3-22 Sensor Cal Data Table.....	3-70
Fig. 3-23 MEASURE Menus - Scalar Channel (Sheet 1)	3-75
Fig. 3-24 MEASURE Menus - Scalar Channel (Sheet 2)	3-77
Fig. 3-25 MEASURE Menus - Scalar Channel (Sheet 3)	3-79
Fig. 3-26 MEASURE Menus - Scalar Channel (Sheet 4)	3-81
Fig. 3-27 CAL Menu - Scalar Channel	3-91
Fig. 3-28 FORMAT Menu - Scalar Channel	3-93
Fig. 3-29 SCALING Menu - Scalar Channel.....	3-95
Fig. 3-30 Bandwidth Measurement of a Band-pass Filter.....	3-104
Fig. 3-31 MARKERS Menus - Scalar Channel	3-107
Fig. 3-32 Detector Types Table	3-120
Fig. 3-33 MEASURE Menus - Readout Channel (Sheet 1)	3-123
Fig. 3-34 MEASURE Menus - Readout Channel (Sheet 2)	3-125
Fig. 3-35 MEASURE Menus - Readout Channel (Sheet 3)	3-127
Fig. 3-36 MEASURE Menus - Readout Channel (Sheet 4)	3-129
Fig. 3-37 CAL Menu - Readout Channel	3-131
Fig. 3-38 FORMAT Menu - Readout Channel	3-133
Fig. 3-39 SOURCE Menus - Fault Location Channel.....	3-137
Fig. 3-40 Fault Location Parameters	3-143
Fig. 3-41 Effect of Data Windowing on a Fault Location Measurement.....	3-155
Fig. 3-42 Effect of Masking Correction on a Fault Location Measurement	3-156
Fig. 3-43 Effect of Enhanced Mode on a Fault Location Measurement.....	3-158
Fig. 3-44 MEASURE Menus - Fault Location Channel (Sheet 1)	3-159
Fig. 3-45 MEASURE Menus - Fault Location Channel (Sheet 2)	3-161
Fig. 3-46 MEASURE Fault Location Channel (Sheet 3)	3-163
Fig. 3-47 MEASURE Fault Location Channel (Sheet 4).....	3-165
Fig. 3-48 CAL Menu - Fault Location Channel	3-169
Fig. 3-49 FORMAT Menu - Fault Location Channel	3-171
Fig. 3-50 SCALING Menu - Fault Location Channel.....	3-172
Fig. 3-51 MARKERS Menus - Fault Location Channel	3-179
Fig. 3-52 Linear List Sweep Specification Form.....	3-185
Fig. 3-53 Source Menus - Reflection Analyzer Channel (Sheet 1)	3-189
Fig. 3-54 Source Menus - Reflection Analyzer Channel (Sheet 2)	3-191
Fig. 3-55 Source Menus - Reflection Analyzer Channel (Sheet 3)	3-193
Fig. 3-56 Effect of Fencing on a Measurement	3-199
Fig. 3-57 Effect of Windowing on the Time Domain Response	3-204
Fig. 3-58 MEASURE Menus - Reflection Analyzer Channel.....	3-211
Fig. 3-59 Reflection Analyzer Calibration Details Form.....	3-216
Fig. 3-60 CAL Menus - Reflection Analyzer Channel	3-223
Fig. 3-61 FORMAT Menu - Reflection Analyzer Channel.....	3-225

Fig. 3-62 Typical Polar and Smith Format Displays.....	3-228
Fig. 3-63 SCALING Menu - Reflection Analyzer Channel	3-229
Fig. 3-64 MARKER Menus - Reflection Analyzer Channel	3-239
Fig. 3-65 COPY Menus	3-241
Fig. 3-66 Typical Plotter Output	3-242
Fig. 3-67 Example of Displayed Instrument Settings Store	3-246
Fig. 3-68 SAVE/RECALL Menus (Sheet 1).....	3-255
Fig. 3-69 SAVE/RECALL Menus (Sheet 2).....	3-257
Fig. 3-70 MACRO Menu (Sheet 1)	3-279
Fig. 3-71 MACRO Menu (Sheet 2)	3-281
Fig. 3-72 MACRO Menu (Sheet 3)	3-283
Fig. 3-73 MACRO Menu (Sheet 4)	3-285
Fig. 3-74 Editing a Screen Title	3-290
Fig. 3-75 Setting Date and Time	3-302
Fig. 3-76 Configuring a Memory Card.....	3-305
Fig. 3-77 Band Select Word Form	3-319
Fig. 3-78 UTILITY Menus (Sheet 1)	3-331
Fig. 3-79 UTILITY Menus (Sheet 2)	3-333
Fig. 3-80 UTILITY Menus (Sheet 3)	3-335
Fig. 3-81 UTILITY Menus (Sheet 4)	3-337
Fig. 3-82 UTILITY Menus (Sheet 5)	3-339
Fig. 3-83 UTILITY Menus (Sheet 6)	3-341
Fig. 3-84 UTILITY Menus (Sheet 7)	3-343
Fig. 3-85 PRESET Menu	3-346

INTRODUCTION

This chapter explains how to operate the Microwave Test Set using the front panel controls and soft key menus. It provides illustrations and descriptions of the front panel features, the liquid crystal display and its labels, and the rear panel features and connectors. For a functional description and block diagram of the MTS refer to Chapter 4.

FRONT PANEL FEATURES

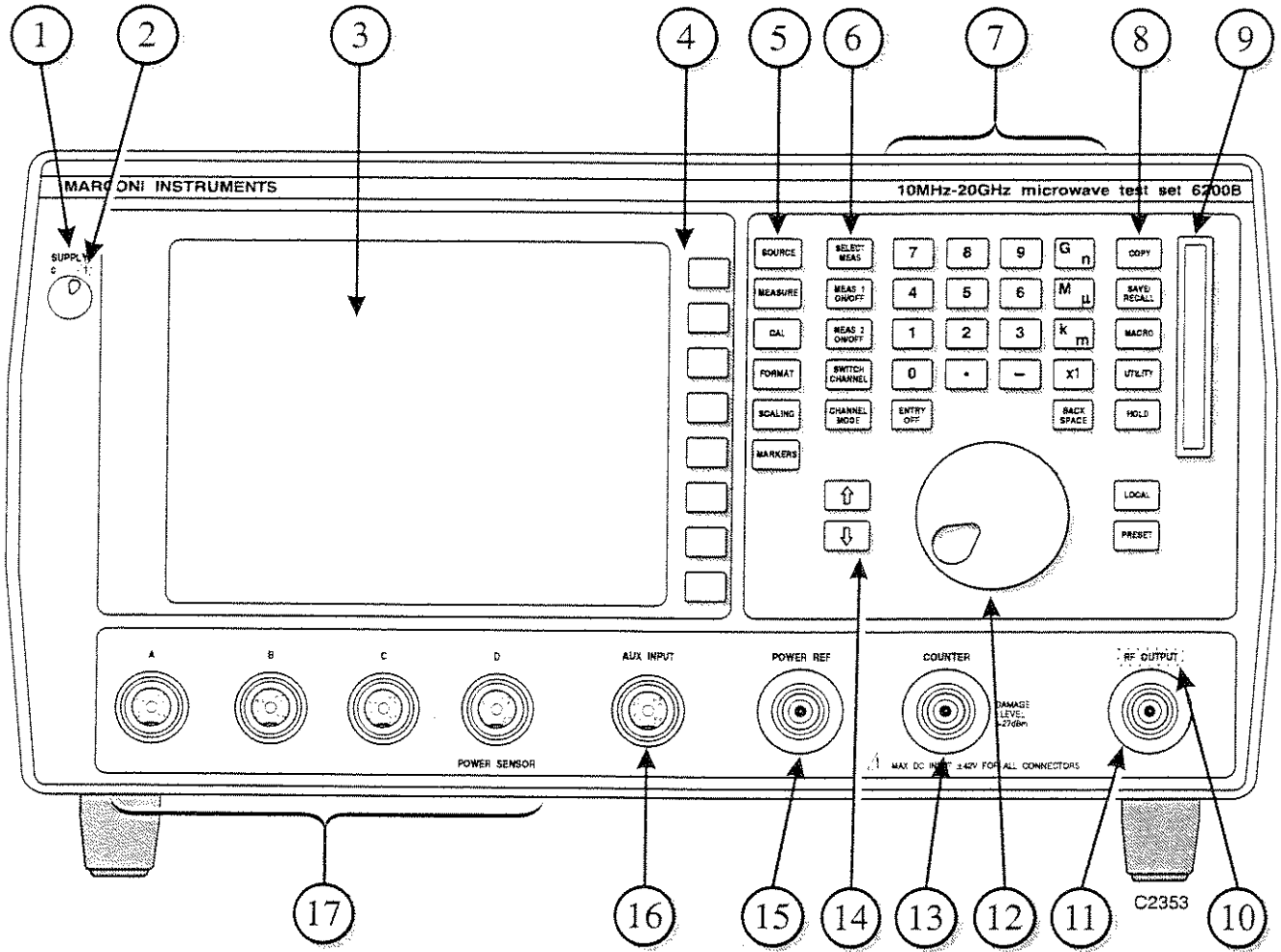

Fig. 3-1 MTS Front Panel

Fig. 3-1 illustrates the following features and function groups of the MTS front panel. These features are described in more detail later in this chapter.

- ① **SUPPLY On/Off Switch.** Controls the AC power to the MTS; clockwise = ON, anti-clockwise = OFF.
- ② **SUPPLY "ON" indicator.** This is an LED which is hidden until lit.

- ③ **Liquid Crystal Display.** This is used for display of measurement traces and annotations, soft key labels and other information. The display is divided into specific information areas, explained in detail later in this chapter.
- ④ **Soft Keys.** The eight soft keys are used to select the desired control and functional options presented by the various menus accessed through the function, display and system keys located on the front panel.
- ⑤ **Function Keys.** These keys are used to control the signal from the synthesized source, defining the measurement, calibrating the measurement system, formatting and scaling the display and setting up markers. The keys in this group are [SOURCE], [MEASURE], [CAL], [FORMAT], [SCALING] and [MARKERS].
- ⑥ **Display Keys.** These keys determine the number of channels and measurement that are displayed, the channel mode, and which channel or measurement is active. The keys in this group are [MEAS 1 ON/OFF], [MEAS 2 ON/OFF], [SELECT MEAS], [SWITCH CHANNEL] and [CHANNEL MODE].
- ⑦ **Numeric Entry and Terminator Keys.** These keys are used for entering values of numeric parameters and other numeric entries.
- ⑧ **System Keys.** The SYSTEM group keys control system functions including instrument preset, instrument settings save/recall functions, plotter and printer control, setting up the GPIB mode, and built-in diagnostic tests. The front panel keys in this group are [COPY], [SAVE/RECALL], [MACRO], [UTILITY], [HOLD], [LOCAL] and [PRESET].
- ⑨ **Memory Card Slot.** Accepts plug-in memory cards containing non-volatile RAM that can be used for extending the number of instrument stores and installing software options (e.g. Fault Location).
- ⑩ **RF OUTPUT "ON" indicator.** This is an LED which is hidden until lit.
- ⑪ **RF OUTPUT Connector.** This is a precision connector for the RF output signal.
- ⑫ **Rotary Control.** Adjustments may be made to a parameter value using the rotary control.
- ⑬ **COUNTER Connector.** This input is used when measuring the frequency of a signal.
- ⑭ **Step Keys.** The step keys (\uparrow and \downarrow) are used to step the current value of a parameter up or down.
- ⑮ **POWER REF Connector.** This connector provides a 50 MHz, 1 mW reference signal that is used to calibrate power sensors before taking any measurements.
- ⑯ **AUX INPUT Connector.** This is used to receive detector inputs from the 6210 Reflection Analyzer.
- ⑰ **Input Connectors.** Connectors A, B, C and D accept 12 pin connectors from the detector cable assemblies. Input D can also be configured to accept a power meter sensor when power meter accuracy is required.

FRONT PANEL KEYS AND SOFT KEY MENUS

The functions of the MTS are activated from the front panel by the operator using three groups of specific function keys (Function, Display and System groups), eight soft keys for accessing menu options, a numeric entry key group, a rotary control and step up/down keys.

Some of the more important terms relating to the operation of the instrument are defined below:

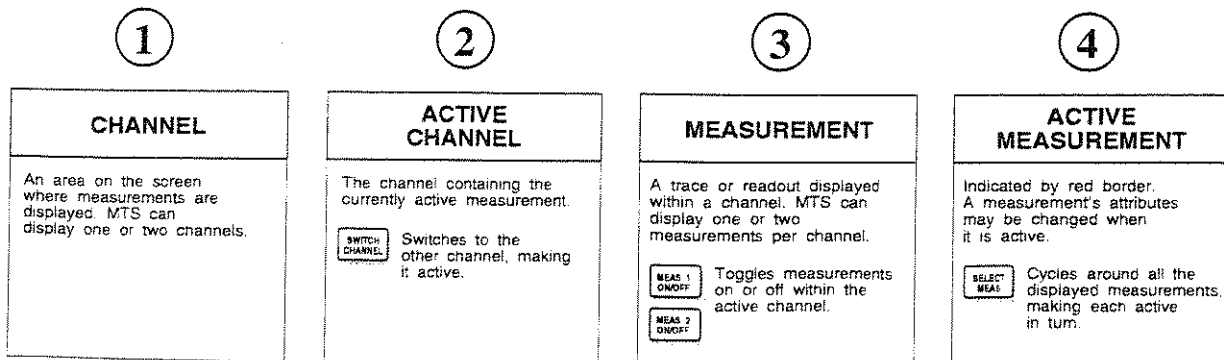
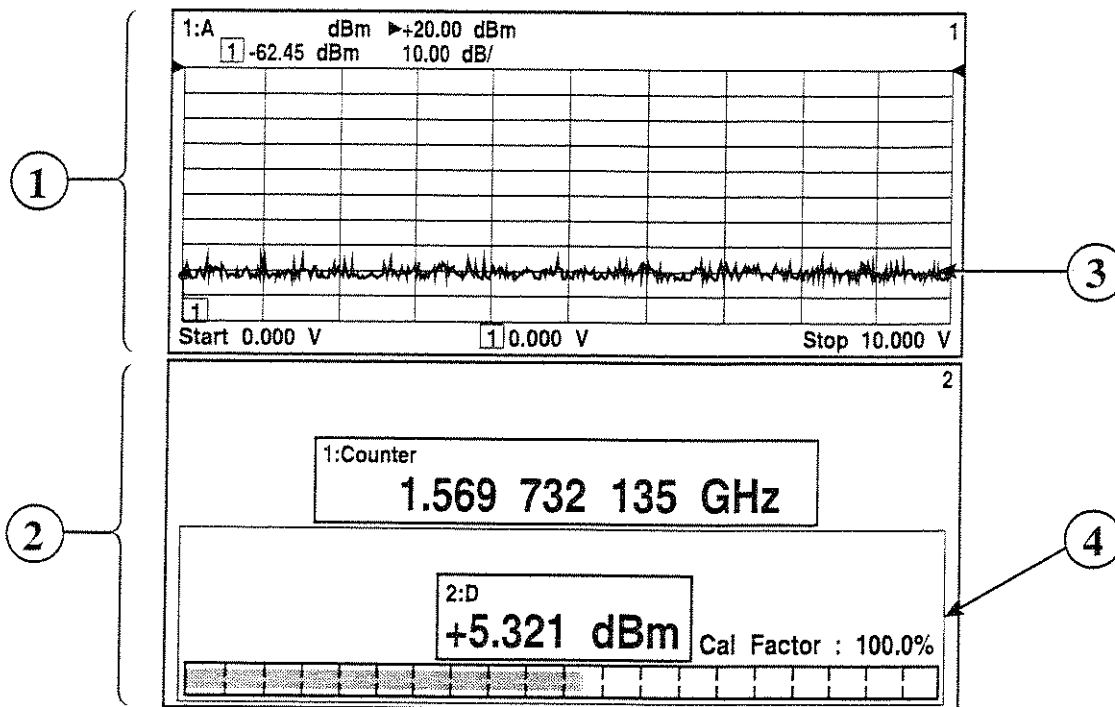
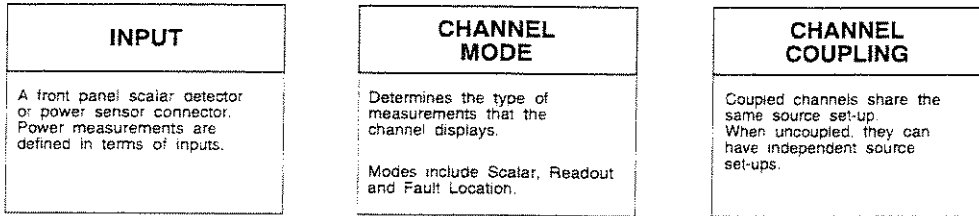

C1142

Fig. 3-2 Definition of Terms

Note...

In this manual all front panel keys are shown in brackets, e.g. [SOURCE]; soft key labels are shown in brackets in lower case italic type, e.g. [*Source Functions*].

The function currently activated is called the active function. As long as a function is active it can be modified with the numeric entry controls (explained later in this chapter). A function remains active until either another function is selected, [ENTRY OFF] is pressed, or the appropriate soft key is pressed that is provided for this purpose.

Front panel keys are used to change instrument functions directly or to provide access to additional functions available in soft key menus. These menus are displayed lists of related functions or choices for a particular function, with each choice corresponding to one of the eight soft keys located to the right of the LCD. Pressing one of the soft keys either executes the labelled function and makes it the active function, or changes the current status of a function, or presents another set of menu labels. The type of action is indicated by the shape of the box enclosing the soft key label, as shown below:



Indicates that selecting the soft key will immediately cause the instrument to perform the designated function, without any further interaction from the user.



CO267

Indicates that, after selecting this soft key, the user will be able to change a parameter. A dialogue box will be displayed on the screen containing a title indicating the parameter being changed, and an input field for entering the new value.



Indicates that selecting this soft key will toggle the indicated item on or off. The box contains a representation of an indicator lamp which 'lights up' to indicate that the item is on.



If the top and bottom edges are highlighted in green, this indicates that, out of two or more possible items, this one has been selected. Pressing it will have no effect, but selecting another of the same group will deselect it. The boxes representing soft keys in the same group are linked together by a vertical line.



Indicates that selecting this soft key will present the user with either a new menu or a dialogue box. The dialogue box is a window displayed on the screen to allow the user to change one or more parameters which make up the entries in the form. The soft keys are used to select, change, add or delete parameters, and various other operations according to the function involved.



This is always the bottom soft key of a menu, and is the 'return' key that returns the user to the previous level of the menu structure.



CO268

Unselectable items are indicated by a dotted outline.

Top level menus, i.e. the ones displayed when a hard key is pressed, are indicated by surrounding the menu title with a box outline.

Most menus allow access to other top level menu simply by pressing the appropriate hard key. The user does not need to return to the top level menu from which the current one is derived. The exceptions to this are the editor menus such as those used for editing detector correction specifications and sensor cal data tables. In these cases, the user must return back to the top level menu by pressing the appropriate return soft keys.

Detailed descriptions of all the MTS menus are given later in this chapter, grouped into three major sections, corresponding to the Display Group, Function Group and System Group keys.

The menu structure associated with the Function Group keys will depend upon the active channel type, e.g. scalar, readout or fault location etc. Since a particular measurement will be associated with one of these channel types, the menus for the keys in this group have been arranged accordingly, for ease of use.

At the start of each menu description is shown the path for that menu, i.e. the key presses the operator must make in order to access the menu. The menu title and soft key labels are listed on the left hand side of the page, exactly as they would be shown on the display. The right hand column contains the descriptions.

Numeric Entry

The numeric keypad, rotary control and step keys are used in conjunction with other front panel keys and soft keys to modify the active entry, to enter or change numeric data, and to change the domain value (i.e x-axis position) of the active marker. In many cases, the keypad, rotary control and step keys can be used interchangeably. Numeric data is entered via a small window displayed in the top left-hand corner of the channel display. In some cases a parameter can be set from the active and delta markers displayed on the active measurement.

Before a function can be modified it must be made the active function by pressing a front panel key or soft key. It can then be modified directly with the step keys or rotary control, or the new value can be entered on the numeric keypad and followed by a terminator as described below.

The Numeric Keypad is used to enter digits, decimal point and minus sign for numeric entries, followed by a units terminator.

The Units Terminator Keys are the four keys to the right of the numeric keypad. These are used to specify the units for numeric entries from the keypad, and at the same time terminate the entries. A numeric entry is incomplete until a terminator is supplied. Some functions, for example where only a single digit entry is required, do not require a terminator. The units are abbreviated on the terminator keys as follows:

G _n	=	Giga/Nano (10 ⁹ /10 ⁻⁹)
M _μ	=	Mega/Micro (10 ⁶ /10 ⁻⁶)
k _m	=	kilo/milli (10 ³ /10 ⁻³)
×1	=	basic units such as Hz, Volts etc; unitless entries, such as Averaging Number.

Functions can be terminated with any of the above terminator keys. The first three keys represent both positive and negative powers of ten, but the power represented by a particular terminator key at any given time is context dependent. That is, the parameter being changed determines whether positive or negative powers of ten apply (e.g. positive powers apply for frequency, and negative powers for voltage and current).

Some parameters which have a particularly wide range will default to either positive or negative powers of ten, but may be changed by pressing [-] before pressing a terminator key. For example, power in Watts defaults to negative powers of ten (n, μ, m), but positive powers (G,M,k) can be achieved by first pressing [-] before terminating the numeric entry.

Within the menu descriptions, each function requiring numeric entry will indicate the valid terminator by use of the following conventions:

10⁺ indicates positive powers of ten, including the [×1] key.

10⁻ indicates negative powers of ten, including the [×1] key.

Any indicates that any terminator key can be used.

A small checklist table will be used to indicate which terminators apply for numeric entry, and also whether the step keys or rotary control can be used. An example is shown below:

Rotary Control	√	Step Keys	√	Numeric Pad	√	Terminator	10+
----------------	---	-----------	---	-------------	---	------------	-----

The **Rotary Control** is used to make continuous adjustments to current values for various functions. The sensitivity and rate of parameter update depends on the parameter being controlled. If the active marker is turned on, and no other function is active, the control can be used to adjust the marker domain value (x-axis position). Values changed by the rotary control are effective immediately, and require no units terminator. The control can also be used to move horizontally between input fields on the displayed forms of certain menus.

The **Step Keys** (↑ and ↓) are used to step the current value of the active function up or down. The step size can be independently set for various parameter types, such as frequency, power and voltage, by accessing the Utility menus. The keys autorepeat when held down. The step keys can also be used to move vertically between input fields on the displayed forms of certain menus.

[ENTRY OFF]. When a numeric entry has been terminated with one of the units keys, the display is updated to reflect the new value. However, the numeric entry form remains to allow the parameter to be further modified, if required. Pressing [ENTRY OFF] removes the form, as well as any displayed prompts, error messages or warnings.

[BACK SPACE] deletes the last digit entered from the numeric keypad.

Parameter Entry Via Marker. Some parameters can be set from the position or response values of the active or active and delta markers displayed on the active measurement. This is done by pressing the soft key for the parameter, positioning the marker, then pressing [×1] on the numeric keypad. The following parameters can be set in this way:

Source start, stop, centre and span frequencies.

Display start, stop, centre and span frequencies.

(Enhance Menu - Fault Location Channel; Display Zoom Menu - Ref Analyzer Channel)

Reference level

Password Protection

Some of the functions accessed through the menus are password protected. A password protected function will prompt the user to enter a numeric authorisation code before the function is activated. There are three levels of password protection:

Primary

User-defined, Level 1

User-defined, Level 2

When entry of a password is required for a function, a form is displayed on the screen indicating the type of password protection. The numbers are not displayed on the screen as they are entered. The entry is terminated with any units key.

Primary Password

The Primary Password is a unique 6-digit authorisation code in the range 100000 to 999999, which is supplied with the instrument. The Primary Password is capable of enabling any password protected function, including the function that allows the user to change the user-defined passwords.

Each instrument leaves the factory with the Primary Password held in the screen title associated with instrument settings store 1. This can be viewed using [SAVE/RECALL] [Recall Settings][1][×1].

This information can be removed for security reasons as follows:

Recall instrument settings store 1 using [*Recall from Store*].

Erase or overwrite the screen title using [UTILITY]/[Titles]/[Set Screen Title].

Store the instrument settings back into store 1 using [SAVE/RECALL]/[Save Settings]/[1][×1].

User-defined Passwords

Two levels of user-defined password are provided:

The Level 1 Password is a 4-digit code in the range 1000 to 9999, and protects those functions which cannot affect the instrument's factory calibration. The factory set default password is 9999.

The Level 2 Password is a 6-digit code in the range 100000 to 999999, and protects the other functions. The factory set default password is 999999.

DISPLAY

Channels and Measurements

The MTS has two channels for independent measurement and display of data. Two different measurements can be displayed simultaneously on the same channel, for example insertion loss and return loss of a device.

A channel can be defined to be either:

- (a) A swept channel, e.g. a scalar channel, fault location channel or reflection analyzer channel. Up to two traces can be displayed on a swept channel.

or

- (b) A readout channel, which will be capable of displaying either one or two digital readouts, which may be either a power meter readout or a frequency counter readout.

The display of channels and measurements is controlled using the Display Group keys (see page 3-25).

The MTS provides a facility for channel coupling, which enables parameters for the source and voltage/current output to be set up identically for both channels. See the [SOURCE] key description on page 3-27

Swept Channel

Fig. 3-3 illustrates the screen information area for one swept channel. If only one swept channel is being displayed, it occupies the whole of the screen, but if two channels are displayed, Channel 1 will be displayed in the top half of the screen, and Channel 2 will be similarly displayed in the lower half.

Start Value is the start value of the sweep in units appropriate to the domain of that measurement, e.g. start frequency for a frequency sweep or start power for a power sweep. This value corresponds to the left hand edge of the display graticule. When the source is in centre/span frequency sweep mode, the centre frequency is shown in this location. This value corresponds to the centre frequency graticule line, and is made bolder than the other graticule lines. The frequency value (and also the Stop Value, described below) can be blanked from the display, as described in the Display Set-up Menu, accessed via the [UTILITY] key.

Stop Value is the stop value of the sweep, and corresponds to the right hand edge of the display graticule. When the source is in centre/span frequency sweep mode, the frequency span is shown in this location. For fault location measurements, the stop value will either be the entered range in the normal display mode, or the stop distance when a sub-range is being displayed.

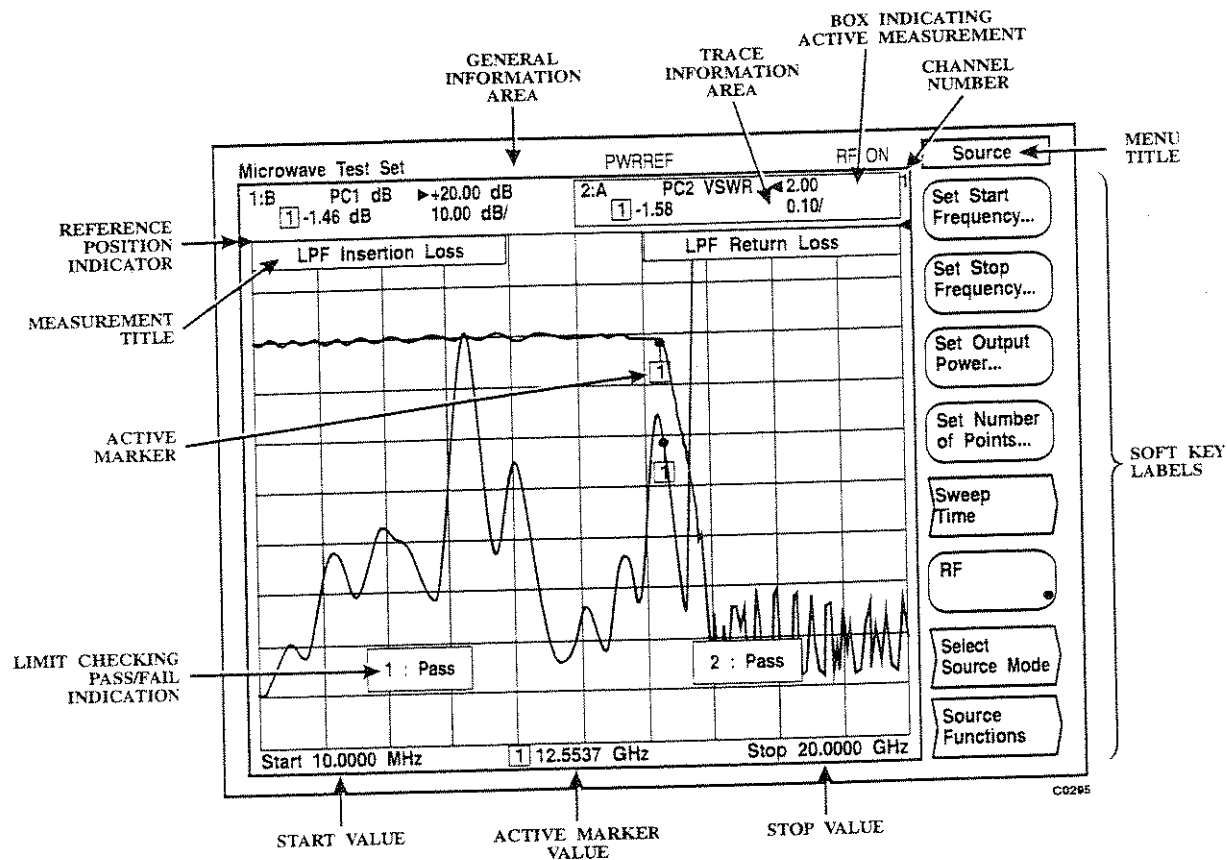

Fig. 3-3 Display - Swept Measurements

Active Marker shows the domain value (x-axis position) of the active marker, in units appropriate to the current measurement. In the delta marker mode, it is the domain value relative to the delta marker position. The measured response at the active marker position is displayed in the relevant Trace Information Area (see below).

Measurement Title is a descriptive alpha-numeric title which is entered by using the Titles Menu, accessed via the [UTILITY] key. If two traces are displayed, the title for measurement 1 appears on the left, and measurement 2 on the right.

Menu Title is the title of the currently displayed menu. If the instrument is set for GPIB (remote) operation, the title is removed and is replaced with the appropriate indicator (see 'General Information Area').

Soft Key Labels are menu labels displayed on the screen that re-define the functions of the soft keys immediately to the right of the screen. The title of the menu is displayed at the top of the menu area to indicate where the user is within the menu structure. See 'Front Panel Keys and Soft Key Menus' for a description of menu operation.

Pass/Fail displays the pass or fail status of a measurement compared to specified limits, as set up using the Lim Checking Menu, accessed via the [MEASURE] key. Each pass/fail window will only be displayed if limit checking is turned on for that trace.

Channel Number indicates which channel is being displayed.

Reference Position Indicator points to the position on the vertical scale which remains fixed during scaling. The indicator for trace 1 is shown to the left of the graticule, in the same colour as trace 1; the indicator for trace 2 is shown on the right. The reference values corresponding to the indicator positions are displayed in the relevant Trace Information Areas (see below). The position and value of the reference position indicator is set using the [SCALING] key.

Markers. Up to eight markers per trace can be set using the [MARKERS] key, to identify specific points of importance on the domain (x) axis of the display and to perform various measurement functions. Markers are denoted by small numbers on the trace, in a colour corresponding to that of the measurement trace. Any of the markers can be enabled to become the active marker (indicated by enclosing the marker number in a box). In addition, a delta marker (represented by Δ) can be set.

Trace Information Area comprises two lines of text indicating what the corresponding trace is displaying. If a trace is turned off, its information will not be present. The trace information area for the currently active measurements is surrounded by a red box outline. A typical example of a trace information area is shown below.

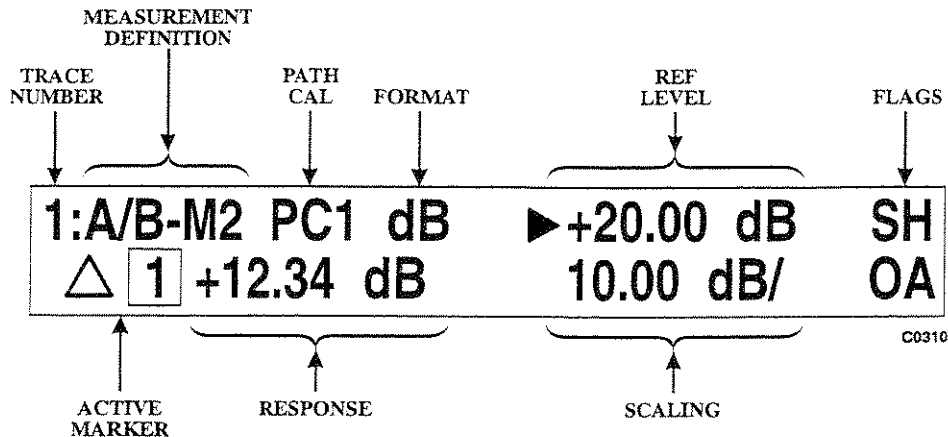

Fig. 3-4 Trace Information Area

Trace Number is the number of the trace (1 or 2) that the information refers to.

Measurement Definition indicates the type of measurement that is being displayed, e.g. single input, ratio, relative to memory, counter etc. "M" indicates that the measurement is relative to a memory; the following number is the store number of the memory. "Mdisk" indicates that the measurement is relative to a memory stored on floppy disk.

Path Cal indicates that the measurement is relative to the specified path calibration store (PC1 to PC4). For a reflection analyzer channel, the calibration store is indicated by Cal1 etc. A "?" after the calibration identity means that the calibration is not valid; this can occur if certain measurement parameters are changed subsequent to calibration. (See [CAL] key description.)

Format indicates the units of the measurement, e.g. dB, VSWR or Watts, as set up using the menus accessed via the [FORMAT] key. For counter measurements the word 'Freq' is displayed here.

Ref Level is the value corresponding to the position of the associated reference position indicator on the vertical scale. It is preceded by the reference indicator symbol as displayed at the side of the graticule. The Ref Level setting function is accessed via the [SCALING] key.

Flags provide the following information:

- S indicates smoothing is being applied to the measurement data.
- H indicates that the measurement is held (display frozen).
- O indicates that an offset is being applied to at least one input taking part in the measurement. For a reflection analyzer channel this is not relevant, so the 'G' and 'F' flags are shown here instead (see below).
- G indicates that gating is being applied to a reflection analyzer measurement. This is displayed in place of the 'O' flag.
- F indicates that fencing is being applied to a reflection analyzer measurement. This is displayed in place of the 'O' flag.
- A indicates averaging is being applied, and will be in lower case if the average number has not yet reached the target value set by the user through the Averaging Menu ([MEASURE] key).

Active Marker indicates the active marker type:

- [1] represents an active marker.
- Δ [1] represents active marker in delta mode.

The number within the box denotes the marker which has been designated the active marker.

Response is the value of the measured response at the active marker position, in units appropriate to the current measurement. In the delta marker mode, it is the measured response relative to the response at the delta marker position. For a reflection analyzer channel displaying results in polar or Smith formats, two response values are displayed (i.e. real and imaginary components, or magnitude and phase).

Scaling shows the vertical scaling factor that has been selected, via the [SCALING] key, in units appropriate to the current measurement.

Readout Channel

Fig. 3-5 illustrates the screen information area for one readout channel. The display for a readout channel is split in half horizontally, with Readout 1 in the top half and Readout 2 in the lower. If a readout is turned off, the relevant display area is blank. If two channels are displayed, Channel 1 information will be displayed in the top half of the screen, and Channel 2 will be similarly displayed in the lower half.

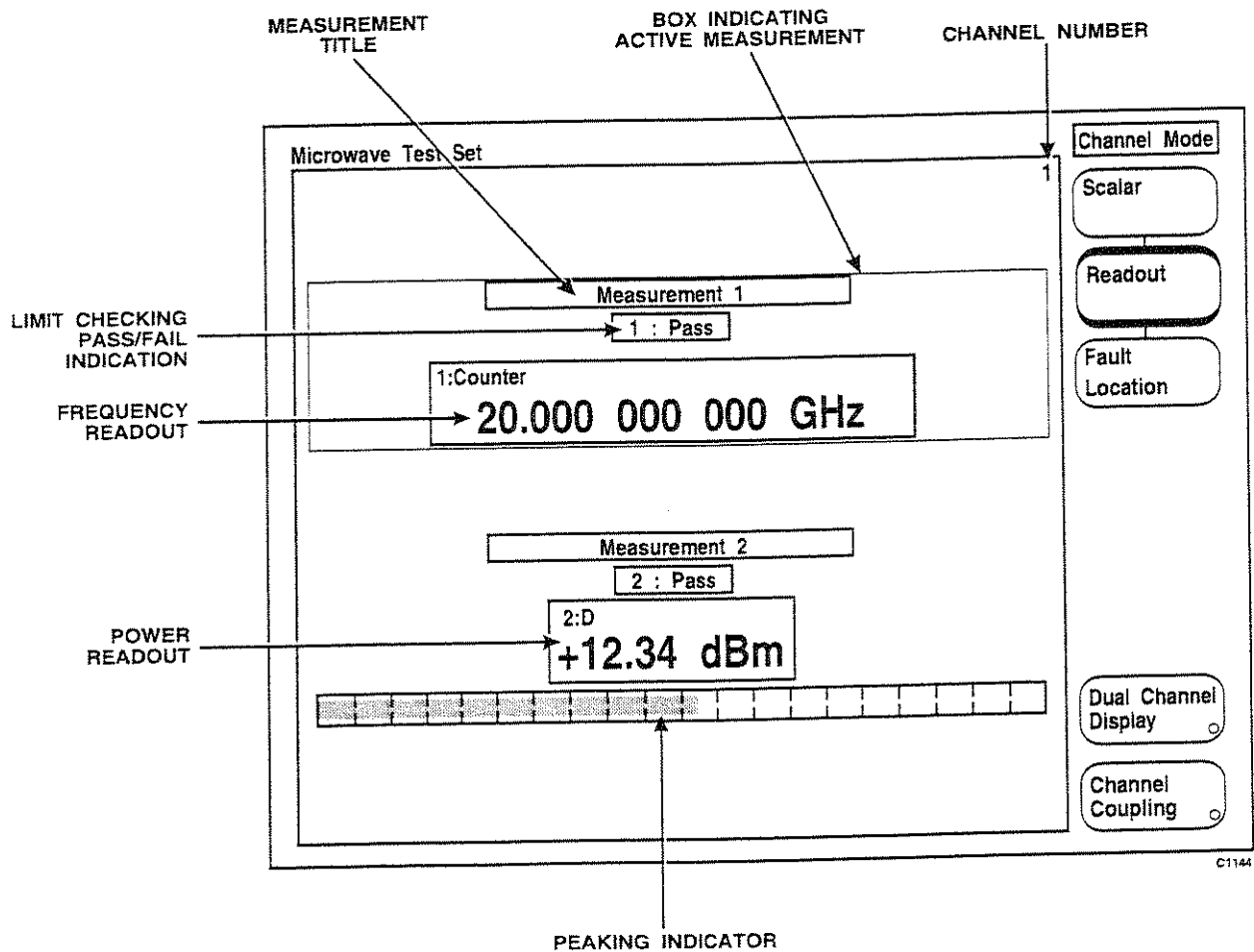

Fig. 3-5 Display - Readout Measurements

Channel Number indicates which channel is being displayed.

Measurement Title is a descriptive alpha-numeric title which is entered by using the Titles Menu, accessed via the [UTILITY] key.

Pass/Fail displays the pass or fail status of a measurement, in the same way as for a swept channel, described earlier.

Readout. The format of the readout depends on whether it is displaying a power meter or frequency measurement. In both cases the readout consists of a readout in large digits together with associated information. Power meter readings are displayed to a maximum of four significant figures with the display resolution selectable between 0.001 and 1 dB in decade steps. The display resolution of frequency readings is selectable between 1 Hz and 100 MHz in decade steps. The readout for the currently active measurement is surrounded by a red box outline. The two formats are shown in Fig. 3-6.

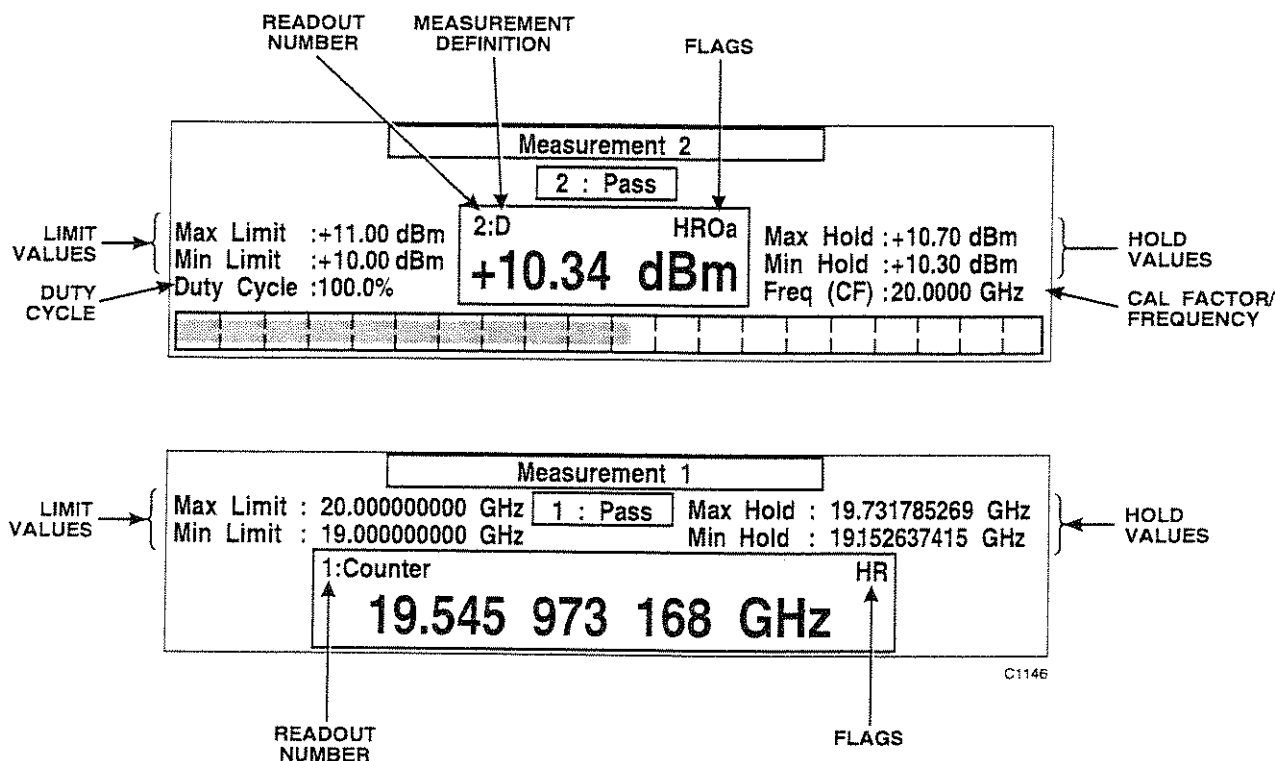

Fig. 3-6 Format of Readout

Limit Values. These are the maximum and minimum values used for limit checking, as set up using the Lim Checking Menu, accessed via the [MEASURE] key.

Hold Values. These are the maximum and minimum values the readout has reached whilst the max/min hold function has been turned on (via the [MEASURE] key).

Duty Cycle. This is the value that is being used in the duty cycle correction that is being applied to the power reading measurement, as set up using the Duty Cycle Menu, accessed via the [MEASURE] key.

Cal Factor/Frequency. This is only applicable if input D has been configured to take a power sensor. If the user has set a cal factor manually, the value is displayed here (labelled Cal Factor). If the cal factor has been chosen from a table using a manually entered frequency, or coupled to the active marker, the corresponding frequency is shown here (labelled Freq(CF)). If the device connected is a scalar detector, then the field is blank because these devices are not cal factor corrected.

Readout Number, Measurement Definition and Flags. The readout number (1 or 2) is followed by an indication of the measurement definition, e.g. single input, ratio or difference. Flags provide the following information:

- H indicates that the measurement is held (display frozen).
- R indicates a relative measurement.
- O indicates that an offset is being applied to at least one of the inputs (power measurements only).
- A indicates that averaging is being applied to at least one of the inputs. It is in lower case when the Average Number for at least one input has not yet reached the target value. This flag applies to power measurements only.

Peaking Indicator. This is a horizontal bar whose length varies depending upon the value of the power readout, and also on the value it was centred at (using the [Reset Peak Indicator] soft key of the Measure Menu). This analogue representation is not for measurement, but enables changes in the measurement to be seen more easily than with the digital display. The dynamic range of the indicator is approximately 10 dB.

General Information Area

This area is located at the top of the screen, and provides the user with general information concerning the measurement in progress. It is displayed in the format shown in Fig. 3-7.

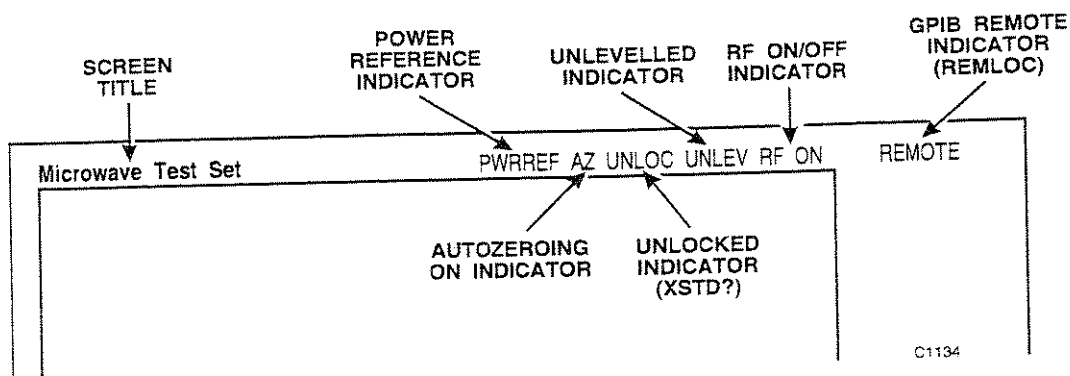

Fig. 3-7 General Information Area

Screen Title is the title of the screen which is entered by using the Titles Menu, accessed via the [UTILITY] key.

Power Reference On Indicator (PWRREF) will be present if the power reference is switched on.

RF On Indicator (RF ON/RF OFF) indicates whether the synthesized source RF is on or off. If it is on, RF ON is displayed in red; if it is off, RF OFF is displayed in blue.

Unlocked Indicator (UNLOC) and External Standard State Indicator (XSTD?) UNLOC indicates that the frequency of the source is unlocked. XSTD? is displayed in this position if the instrument is set up for an external standard, but there is either no standard detected or it is the wrong frequency.

Detector Autozeroing On Indicator (AZ) indicates that detector autozeroing has been enabled.

Unlevelled Indicator (UNLEV) indicates that the source power is unlevelled.

GPIB Remote Indicator (REMOTE) indicates that the instrument is in the GPIB remote state. REMLOC is displayed if this is also local lockout mode, i.e. the front panel controls are locked out. The indicator is displayed in the area that would otherwise be used for displaying the menu title. When the instrument is returned to local mode, the indicator is removed and the menu title is again displayed.

Error Messages

During operation of the MTS, one of several types of error message may be displayed on the screen. The message gives a description of the problem that has occurred and, where appropriate, the action that the operator can take to solve the problem. Appendix B lists all the possible error messages that the operator can receive.

Display Set-up

Facilities are provided to set the screen brightness and screen timeout for the LCD. The screen brightness can be set to either full or half brightness. The timeout facility enables the LCD backlight to be turned off automatically after a specified period of time. These functions are available from the Display Set-up Menu, accessed via the [UTILITY] key.

Floppy Disk Drive Option

The optional floppy disk drive enables MTS data to be stored on floppy disk as MSDOS files. Measurement traces can be saved directly to disk using the [SAVE/RECALL] key; they can later be retrieved for display or for use in relative measurements. The Macro menus provide functions for copying macros between memory and floppy disk. To copy instrument settings and the various types of cal data to and from disk [UTILITY] [Store Operations] is used to copy the relevant stores to files on the disk and vice versa.

Menus accessed via [UTILITY]/[Service] allow various disk operations to be performed, such as creating/deleting directories and formatting disks.

Using an External Keyboard

As an alternative to using the front panel to control the MTS functions, the instrument can be operated from an external IBM PC keyboard connected to the rear panel KEYBOARD connector. The keys are mapped to the MTS keys as follows:

MTS Key	Keyboard	MTS Key	Keyboard
Soft keys 1 to 8	F1 to F8	[G n]	<Ctrl> G
[SOURCE]	<Alt> SO	[M μ]	<Ctrl> M
[MEASURE]	<Alt> ME	[k m]	<Ctrl> K
[CAL]	<Alt> CA	[x1]	<ENTER>
[FORMAT]	<Alt> FO	[BACK SPACE]	<BACKSPACE>
[SCALING]	<Alt> SC	[COPY]	<Alt> CO
[MARKERS]	<Alt> MR	[SAVE/RECALL]	<Alt> SA
[SELECT MEAS]	<Alt> SE	[MACRO]	<Alt> MA
[MEAS 1 ON/OFF]	<Alt> M1	[UTILITY]	<Alt> UT
[MEAS 2 ON/OFF]	<Alt> M2	[HOLD]	<Alt> HO
[SWITCH CHANNEL]	<Alt> SW	[LOCAL]	<Alt> LO
[CHANNEL MODE]	<Alt> CM	[PRESET]	<Alt> PR or <Ctrl> C
[ENTRY OFF]	<Esc>		
Increment (\uparrow)	Up arrow key		
Decrement (\downarrow)	Down arrow key		
Rotary control	Left/right arrow keys		

The numeric keys, including `` and `` are directly mapped.

The MTS provides support for IBM keyboards from other countries in addition to the UK, such as France, Germany, Spain and the USA. The instrument can be set up for the required country using a menu accessed via the [UTILITY] key.

REAR PANEL FEATURES

Fig. 3-8 illustrates the following features and connectors of the rear panel.

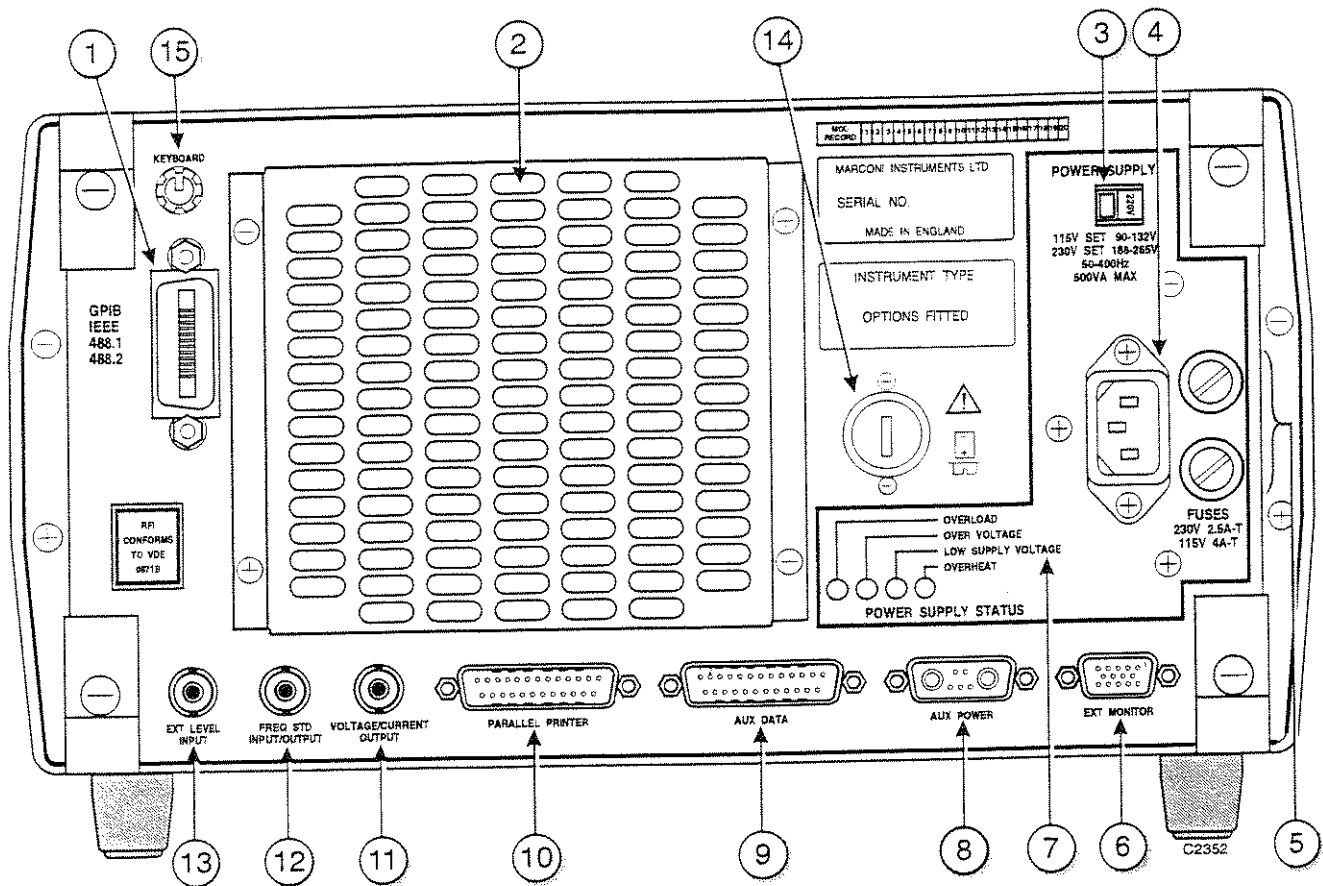

Fig. 3-8 MTS Rear Panel

- ① **GPIB Connector.** Connects the MTS to an external controller when the instrument is to be controlled through the GPIB. This connector is also used when the MTS is required to control a second MTS or an HPGL plotter. Refer to the GPIB Operating Manual for information on GPIB operation.
- ② **Cooling Fan.** The fan extracts the warm air generated by the instrument; it does not contain a filter as it is not necessary with this type of cooling.
- ③ **Supply Voltage Selector Switch.** This selects the AC supply voltage range. For more information refer to Chapter 2.
- ④ **Power Input Connector.** This is the connector for the AC mains power cable.
- ⑤ **Fuses.** For protection of the line and neutral lines of the supply input. The fuses are rated at 2.5A - T for 188 - 265 V operation, or 4A - T for 90 - 133 V operation.
- ⑥ **EXT MONITOR Connector.** This is used to connect a variable scan rate RGB colour monitor, if required.

⑦ **Power Supply Status.** Four LEDs indicate the following fault conditions within the instrument's power supply:

Overload
Over voltage
Low supply voltage
Overheat

If any of the LEDs illuminate, refer to the Maintenance Manual for remedial action.

⑧ **AUX POWER Connector.** This is used to provide a 25 V DC supply for the 6210 Reflection Analyzer

⑨ **AUX DATA Connector.** This is used to transfer digital data between the MTS and the AUX DATA port of the 6210 Reflection Analyzer.

⑩ **PARALLEL PRINTER Connector.** This is used to connect a suitable printer via the Centronics interface. Recommended printers are listed in Chapter 1, "Associated Equipment".

⑪ **VOLTAGE/CURRENT OUTPUT Connector.** This output can be defined by the user to be one of the following:

Voltage proportional to the synthesized source output frequency (i.e. Volts/GHz).
Voltage proportional to the power measured by the MTS, which is used to drive a chart recorder.
Swept voltage or current for voltage/current domain measurements.
Fixed voltage or current output for measurements with differing bias.

For details on how to configure this output refer to the V/I Output Menu (page 3-39).

⑫ **FREQ STD INPUT/OUTPUT Connector.** This BNC connector provides either a 10 MHz output derived from the internal frequency standard, or accepts either a 1 or 10 MHz input from an external standard, as selected from the front panel (refer to the Lev & F Std Menu, page 3-37).

⑬ **EXT LEVEL INPUT Connector.** Provides for the connection of a remote detector or power sensor for source levelling.

⑭ **Battery Compartment Cover.** Removal of this cover provides access to the Lithium battery that is used to power the instrument's non-volatile memory

⑮ **KEYBOARD Connector.** This is a standard PC keyboard connector which allows connection of a compact keyboard (optional accessory). Although a standard size keyboard may be connected it may not function correctly with the MTS and it is recommended that the keyboard which is available from Marconi Instruments as an optional accessory is used..

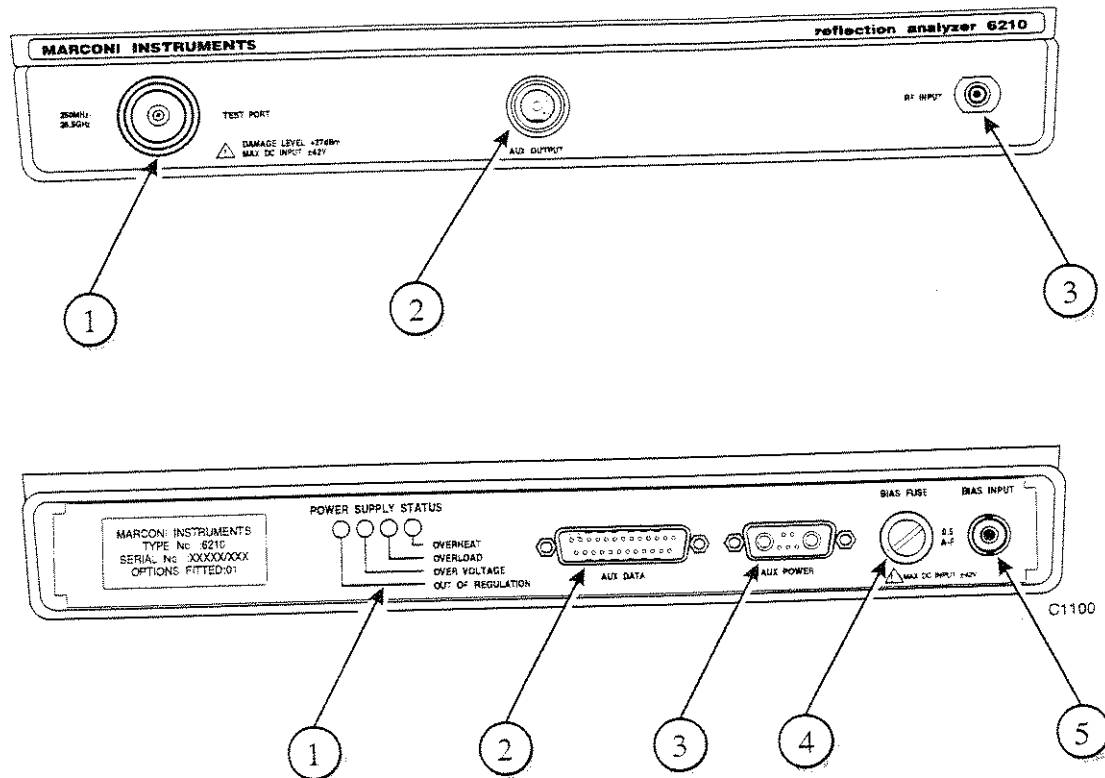

Fig. 3-9 6210 Front and Rear Panels

6210 FRONT PANEL FEATURES

- ① **TEST PORT Connector.** This is a ruggedised 3.5 mm connector for connection to the device under test.
- ② **AUX OUTPUT Connector.** This connector is used to route the four 6210 detector outputs to the AUX INPUT connector of the MTS.
- ③ **RF INPUT Connector.** This is a precision 3.5 mm connector for the RF output signal from the MTS.

6210 REAR PANEL FEATURES

- ① **Power Supply Status.** Four LEDs indicate the following fault conditions within the instrument's power supply:
 - Overload
 - Over voltage
 - Low supply voltage
 - Overheat

If any of the LEDs illuminate, refer to the Maintenance Manual for remedial action.
- ② **AUX DATA Connector.** This is used to transfer digital data between the 6210 and the AUX DATA port of the MTS.

- ③ **AUX POWER Connector.** This connects the AUX POWER output of the MTS which provides 25 V DC for the 6210 power supply.
- ④ **Bias Fuse.** For protection of the bias input. The fuse is rated at 0.5 A. (This is only present on instruments which have the Bias Tee Option fitted).
- ⑤ **BIAS INPUT Connector.** Provides for the input of a bias voltage, which the 6210 applies to the test port centre pin. The bias voltage can be obtained from the VOLTAGE/CURRENT OUTPUT connector at the rear of the MTS. **The voltage source must be removed from the BIAS INPUT connector whilst any calibration pieces are connected to the 6210, otherwise damage to the calibration pieces may occur. (The BIAS INPUT Connector is only present on instruments which have the Bias Tee Option fitted.**

DISPLAY GROUP KEYS

The keys in this group determine how many measurements will be displayed, and the type of measurement that is to be performed by the currently active channel. Only the [CHANNEL MODE] key has an associated menu structure.

[SELECT MEAS] KEY

The [SELECT MEAS] key is used to select one of the displayed measurements to be the active measurement within the active channel. This is the trace or readout currently controlled by the front panel keys, and all measurement specific functions apply to the active measurement. Pressing this key cycles through the displayed measurements, making each one in turn the active measurement, which is indicated by surrounding the trace information area or readout with a red box outline. The currently displayed menu will change to the equivalent menu for the type of the new active measurement.

[MEAS 1 ON/OFF] KEY

The [MEAS 1 ON/OFF] key has a toggle active which determines whether or not Measurement 1 of the selected channel will be displayed. Since at least one measurement must be displayed in a channel, turning off Measurement 1 with only this measurement displayed will automatically turn on Measurement 2.

[MEAS 2 ON/OFF] KEY

The [MEAS 2 ON/OFF] key has a toggle active which determines whether or not Measurement 2 of the selected channel will be displayed. Since at least one measurement must be displayed in a channel, turning off Measurement 2 with only this measurement displayed will automatically turn on Measurement 1.

[SWITCH CHANNEL] KEY

The [SWITCH CHANNEL] key selects either Channel 1 or Channel 2 to be the active channel. This is the channel currently controlled by the front panel keys. All channel-specific functions apply to the active channel. When the key is pressed, the box outline surrounding the selected channel momentarily brights up in green, to provide an indication to the user that the channel has changed. The currently displayed menu will change to the equivalent menu for the mode of the new active channel.

[CHANNEL MODE] KEY

The [CHANNEL MODE] key presents the Channel Mode Menu, which enables the channel mode to be selected for the currently active channel. It also allows selection of dual channel display and channel coupling.

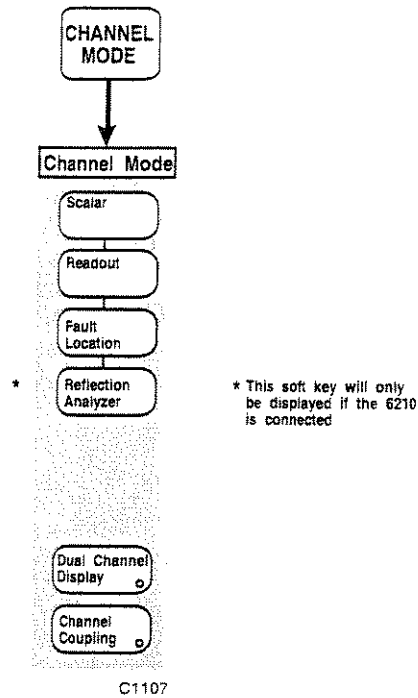

Fig. 3-10 Channel Mode Menu

CHANNEL MODE

Channel Mode

Scalar	Makes the currently active channel a scalar channel.
Readout	Makes the currently active channel a readout channel.
Fault Location	Makes the currently active channel a fault location channel.
Reflection Analyzer	Makes the currently active channel a reflection analyzer channel. This soft key will only be displayed if 6210 Reflection Analyzer is connected.
Dual Channel Display	Toggles between dual channel and single channel display.
Channel Coupling	Toggles the channel coupling facility on or off. <i>This soft key is unselectable if the channel types are different. See page 3-27 for an explanation of channel coupling.</i>

FUNCTION GROUP KEYS - SCALAR CHANNEL

[SOURCE] KEY

The [SOURCE] key provides access to the series of menus illustrated in Figs. 3-11 to 3-14, which are used to define and control all the source functions, e.g. the synthesized sweep generator and the programmable voltage/current output. When the [SOURCE] key is pressed, the Source Menu is displayed; this in turn provides access to the other soft key menus.

The [*Select Source Mode*] soft key is used to access the Source Mode Menu, and the required source mode is then selected by pressing the appropriate soft key. Pressing [*Return to Source*] will return the user to the source menu corresponding to the selected mode. There are therefore six source menus available for a scalar channel, one for each of the source modes that can be selected from the Source Mode Menu. The source modes available are:

Start & Stop Frequency Sweep Mode (linear frequency sweep between user-defined start and stop values).

Centre & Span Frequency Sweep Mode (linear frequency sweep defined by its centre frequency and span).

CW Mode (continuous wave output at a user-defined frequency and power).

Power Sweep Mode (power sweep between user-defined start and stop values).

Voltage Sweep Mode (voltage sweep between user-defined start and stop values).

Current Sweep Mode (current sweep between user-defined start and stop values).

The last three soft keys of the Source Menu are the same for each variant; the remaining five will vary to reflect the parameters required for the particular source mode.

Menus that occur more than once within the Source menu structure (e.g. Source Mode Menu and Source Funcs Menu) are described only once. For subsequent occurrences, a reference is made to the relevant part of the chapter.

The above applies to both the instrument's internal source and to an external source (e.g. a second MTS). If an external source is connected, it is set up by accessing the Int/Ext Source Menu ([Source] [Source Functions] [Int/Ext Source]) and selecting [*Ext Source Set-up*]. The same functions are then available as for the internal source set up, except that the menus make reference to the external source rather than the internal one.

Channel Coupling

In many applications, there may be a requirement that the RF source set-up and the rear panel voltage/current output be the same for both channels. This can be achieved by setting channel coupling on from the Channel Mode Menu. When channels are coupled, the instrument will ensure that the RF source and voltage/current output are set up identically for both channels.

When channel coupling is first switched on, the RF source and voltage/current settings defined for the active channel will be duplicated for the other channel. Afterwards, any changes made to the source or voltage/current output on the active channel will be reflected in the other channel.

Should it be necessary to have independent source set-ups for each channel, channel coupling can be switched off.

SOURCE

Source
(Start/Stop
Frequency
Sweep Mode)

See Fig. 3-11. This menu enables the operator to set up the source to provide a linear frequency sweep between the start frequency and stop frequency values. If channel coupling is on (see Channel Mode Menu), the settings defined for the active channel will be duplicated on the other channel. See page 3-27 for an explanation of channel coupling and how sweep modes are selected.

The start and stop frequencies can also be set to the frequency value corresponding to the position of the active marker on the active measurement. This is done by pressing the appropriate soft key, positioning the active marker on the trace, then pressing the [x1] key on the numeric keypad.

**Set Start
Frequency**

Used to change the start frequency of the source for the currently active channel to a value within the range permitted for the particular MTS.

Rotary Control ✓ Step Keys ✓ Numeric Pad ✓ Terminator 10+

**Set Stop
Frequency**

Similar to the above but applies to the stop frequency of the sweep.

**Set Output
Power**

Used to change the output power of the source for the active channel.

Rotary Control ✓ Step Keys ✓ Numeric Pad ✓ Terminator Any

**Set Number
of Points**

Used to change the number of measurement points generated by the sweep for the currently active channel, up to a maximum of 1601 points. Pressing the increment step key doubles the number of points; pressing the decrement key halves the number.

Rotary Control ✓ Step Keys ✓ Numeric Pad ✓ Terminator Any

**Sweep
Time**

Leads to the Sweep Time Menu, which enables the sweep time to be set up manually or automatically.
See page 3-34.

RF

Toggles the RF output on or off.

**Select
Source Mode**

Leads to the Source Mode Menu, which enables CW operation or one of several sweep modes to be selected.
See page 3-35.

**Source
Functions**

Leads to the Source Funcs Menu, which enables several options to be selected, allowing the source to be set up according to the requirements of a particular measurement.
See page 3-36.

SOURCE

Source
(Centre/Span
Frequency
Sweep Mode)

See Fig. 3-12. This menu enables the operator to set up the source to provide a linear frequency sweep by defining the centre and span of the sweep. If channel coupling is on (see Channel Mode Menu), the settings defined for the active channel will be duplicated on the other channel. See page 3-27 for an explanation of channel coupling and how sweep modes are selected.

The centre and span values of the frequency sweep can also be set from the positions of the active and delta markers displayed on the active measurement. To set the centre value, press [Set Cntr Frequency], position the active marker, then press the [x1] key on the numeric keypad. To set the span, press the [Set Span] soft key, position the delta marker to the appropriate point either side of the centre, then press the [x1] key. (If necessary, enable the delta marker from the Markers Menu.)

**Set Cntr
Frequency**

Used to change the centre frequency of the sweep for the currently active channel to a value within the range permitted for the particular MTS.

Rotary Control ✓ Step Keys ✓ Numeric Pad ✓ Terminator 10+

**Set
Span**

Similar to the above but applies to the span of the frequency sweep.

**Set Output
Power**

Used to change the output power of the source for the currently active channel.

Rotary Control ✓ Step Keys ✓ Numeric Pad ✓ Terminator Any

**Set Number
of Points**

Used to change the number of measurement points generated by the sweep for the currently active channel, up to a maximum of 1601 points. Pressing the increment step key doubles the number of points; pressing the decrement key halves the number.

Rotary Control ✓ Step Keys ✓ Numeric Pad ✓ Terminator Any

**Sweep
Time**

Leads to the Sweep Time Menu, which enables the sweep time to be set up manually or automatically.
See page 3-34.

RF

Toggles the RF output on or off.

**Select
Source Mode**

Leads to the Source Mode Menu, which enables CW operation or one of several sweep modes to be selected.
See page 3-35.

**Source
Functions**

Leads to the Source Funcs Menu, which enables several options to be selected, allowing the source to be set up according to the requirements of a particular measurement.
See page 3-36.

SOURCE

Source
(CW Mode)

See Fig. 3-12. This menu enables the operator to set up the source to provide a continuous wave (CW) frequency. If channel coupling is on (see Channel Mode Menu), the settings defined for the active channel will be duplicated on the other channel. See page 3-27 for an explanation of channel coupling and how sweep modes are selected.

Note that the CW Mode is not suitable for measurements when the MTS is to be used as an independent source. The Source Only Mode (see page 3-36) should be used in these cases. The [CW] soft key description on page 3-35 give a full explanation of the difference between these two modes.

Set Frequency

Used to change the CW frequency of the source for the currently active channel to a value within the range permitted for the particular MTS.

Rotary Control ✓ Step Keys ✓ Numeric Pad ✓ Terminator 10+

Set Output Power

Used to change the output power of the source for the currently active channel.

Rotary Control ✓ Step Keys ✓ Numeric Pad ✓ Terminator Any

Sweep Time

This soft key is unselectable in CW mode.

RF

Toggles the RF output on or off.

Select Source Mode

Leads to the Source Mode Menu, which enables CW operation or one of several sweep modes to be selected.
See page 3-35.

Source Functions

Leads to the Source Funcs Menu, which enables several options to be selected, allowing the source to be set up according to the requirements of a particular measurement.
See page 3-36.

SOURCE

Source
(Power Sweep)

See Fig. 3-13. This menu enables the operator to set up the source to provide a linear power sweep between the start power and stop power values. The settable power levels and power sweep range are given in the Performance Data section of Chapter 1.. If channel coupling is on (see Channel Mode Menu), the settings defined for the active channel will be duplicated on the other channel. See page 3-27 for an explanation of channel coupling and how sweep modes are selected.

Set Start Power

Used to change the start power level of the source for the currently active channel.

Rotary Control Step Keys Numeric Pad Terminator Any

Set Stop Power

Used to change the stop power level of the source for the currently active channel.

Rotary Control Step Keys Numeric Pad Terminator Any

Set Frequency

Used to change the CW frequency of the source for the currently active channel to a value within the range permitted for the particular MTS.

Rotary Control Step Keys Numeric Pad Terminator 10+

Set Number of Points

Used to change the number of measurement points generated by the sweep for the currently active channel, up to a maximum of 1601 points. Pressing the increment step key doubles the number of points; pressing the decrement key halves the number.

Rotary Control Step Keys Numeric Pad Terminator Any

Sweep Time

Leads to the Sweep Time Menu, which enables the sweep time to be set up manually or automatically.
See page 3-34.

RF

Toggles the RF output on or off.

Select Source Mode

Leads to the Source Mode Menu, which enables CW operation or one of several sweep modes to be selected.
See page 3-35.

Source Functions

Leads to the Source Funcs Menu, which enables several options to be selected, allowing the source to be set up according to the requirements of a particular measurement.
See page 3-36.

SOURCE

Source
(Voltage Sweep)

See Fig. 3-14. This menu enables the operator to set up the source to provide a linear voltage sweep between the start voltage and stop voltage values. The voltage sweep is available at the rear panel VOLTAGE/CURRENT OUTPUT connector. The voltage sweep range is given in the Performance Data section of Chapter 1. If channel coupling is on (see Channel Mode Menu), the settings defined for the active channel will be duplicated on the other channel. See page 3-27 for an explanation of channel coupling and how sweep modes are selected.

Set Start Voltage

Used to change the start voltage of the source for the currently active channel.

Rotary Control ✓ Step Keys ✓ Numeric Pad ✓ Terminator 10-

Set Stop Voltage

Used to change the stop voltage of the source for the currently active channel.

Rotary Control ✓ Step Keys ✓ Numeric Pad ✓ Terminator 10-

CW Set-up

Leads to the CW Set-up Menu, which enables the source frequency and output power to be set up.
See page 3-42.

Set Number of Points

Used to change the number of measurement points generated by the sweep for the currently active channel, up to a maximum of 1601 points. Pressing the increment step key doubles the number of points; pressing the decrement key halves the number.

Rotary Control ✓ Step Keys ✓ Numeric Pad ✓ Terminator Any

Sweep Time

Leads to the Sweep Time Menu, which enables the sweep time to be set up manually or automatically.
See page 3-34.

RF

Toggles the RF output on or off. It will not be possible to obtain RF output while a frequency counter measurement is being made, although the soft key is still selectable.

Select Source Mode

Leads to the Source Mode Menu, which enables CW operation or one of several sweep modes to be selected.
See page 3-35.

Source Functions

Leads to the Source Funcs Menu, which enables several options to be selected, allowing the source to be set up according to the requirements of a particular measurement.
See page 3-36.

SOURCE

Source
(Current Sweep)

See Fig. 3-14. This menu enables the operator to set up the source to provide a linear current sweep between the start current and stop current values. The current sweep is available at the rear panel VOLTAGE/CURRENT OUTPUT connector. The current sweep range is given in the Performance Data section of Chapter 1. If channel coupling is on (see Channel Mode Menu), the settings defined for the active channel will be duplicated on the other channel. See page 3-27 for an explanation of channel coupling and how sweep modes are selected.

Set Start Current

Used to change the start current of the source for the currently active channel.

Rotary Control ✓ Step Keys ✓ Numeric Pad ✓ Terminator 10-

Set Stop Current

Used to change the stop current of the source for the currently active channel.

Rotary Control ✓ Step Keys ✓ Numeric Pad ✓ Terminator 10-

CW Set-up

Leads to the CW Set-up Menu, which enables the source frequency and output power to be set up (see previous menu).
See page 3-42.

Set Number of Points

Used to change the number of measurement points generated by the sweep for the currently active channel, up to a maximum of 1601 points. Pressing the increment step key doubles the number of points; pressing the decrement key halves the number.

Rotary Control ✓ Step Keys ✓ Numeric Pad ✓ Terminator Any

Sweep Time

Leads to the Sweep Time Menu, which enables the sweep time to be set up manually or automatically.
See page 3-34.

RF

Toggles the RF output on or off. It will not be possible to obtain RF output while a frequency counter measurement is being made, although the soft key is still selectable.

Select Source Mode

Leads to the Source Mode Menu, which enables CW operation or one of several sweep modes to be selected.
See page 3-35.

Source Functions

Leads to the Source Funcs Menu, which enables several options to be selected, allowing the source to be set up according to the requirements of a particular measurement.
See page 3-36.

SOURCE

Sweep Time

Sweep Time

See Fig. 3-11. The sweep time is the time taken for the source to complete one sweep, excluding retrace time and the time required for internal processing of the data. The setting determined by this menu will apply instrument-wide, i.e. to all displayed traces.

Longer sweep times may be necessary when testing certain devices, and also have the effect of reducing noise.

Automatic Sweep Time

Sets the sweep time mode of the source to automatic. In this mode the sweep time automatically adjusts to the minimum sweep time available for the set frequency span and number of measurement points.

User Set Sweep Time

Sets the sweep time mode to manual; the following soft key can then be pressed to allow the sweep time to be changed by the operator.

Set Sweep Time

Allows the sweep time to be entered; the allowable range of values is given in the Performance Data section of Chapter 1. The MTS will generate an actual sweep time that will never be faster than the sweep time entered, but may be slower depending on constraints imposed by the number of measurement points, source frequency range and measurement definition.

This key will only be selectable if manual sweep time mode has been selected

Rotary Control ✓ Step Keys ✓ Numeric Pad ✓ Terminator 10-

Return to Source

Returns control to the Source Menu.

SOURCE**Select
Source Mode****Source Mode**

See Fig. 3-11. This menu enables the MTS source to be set up to provide either a CW (continuous wave) output or a swept output. For swept measurements, the variable that is swept (domain) is plotted on the x-axis of the channel graticule. The frequency, power, voltage and current domains are supported. If two traces are displayed on the same channel, or if the two channels are coupled, they will share the same x-axis annotation. Only one of the following options can be selected at a time; pressing one of the soft keys automatically de-selects the current mode and selects the new one. The parameters of the source for the selected mode can be set up after returning to the Source Menu.

CW

Sets the source to the CW mode of operation, in which the frequency and power level can be defined by returning to the Source Menu.

The CW mode assumes that the source is to be used as part of an integrated measurement system (the MTS) where the source and data acquisition system are synchronised. To use the MTS as an independent general purpose microwave source, use the Source Only Mode, accessed from the Source Funcs Menu (page 3-36). In this mode the data acquisition system is turned off, and the instrument acts solely as a microwave source.

**Start & Stop
Freq Sweep**

Sets the source to the swept frequency mode of operation, in which the start and stop values of the frequency sweep and its power level can be defined by returning to the Source Menu.

**Cntr & Span
Freq Sweep**

Similar to the above, but the sweep is defined by the centre frequency and its span.

**Power
Sweep**

Sets the source to the power sweep mode of operation, in which the start and stop values of the power sweep and its frequency can be defined by returning to the Source Menu.

**Voltage
Sweep**

Sets the source to the voltage sweep mode of operation, in which the start and stop values of the voltage sweep can be defined by returning to the Source Menu. The swept voltage is available at the rear panel VOLTAGE/CURRENT OUTPUT connector. A CW RF output is simultaneously available at the RF OUTPUT connector, which can be set up by returning to the Source Menu ([*CW Set-up*] soft key). The voltage sweep mode applies instrument-wide.

**Current
Sweep**

Sets the source to the current sweep mode of operation, in which the start and stop values of the current sweep can be defined by returning to the Source Menu. The swept current is available at the rear panel VOLTAGE/CURRENT OUTPUT connector. A CW RF output is simultaneously available at the RF OUTPUT connector, which can be set up by returning to the Source Menu ([*CW Set-up*] soft key). The current sweep mode applies instrument-wide.

More

This soft key will only be displayed if the 6210 Reflection Analyzer is connected, and will only be selectable if the active channel is a reflection analyzer channel. It leads to a sub-menu which provides additional sweep modes for a reflection analyzer channel (see page 3-188).

**Return to
Source**

Returns control to the Source Menu.

SOURCE**Source Functions**

Source Funcs	<p><i>See Fig. 3-11.</i> This menu enables various source functions to be set up according to the requirements of a particular measurement.</p>
Levelling & Freq Std	<p>Leads to the Lev & F Std Menu, which enables the levelling mode of the source to be selected, and the frequency standard to be set to internal or external. <i>See page 3-37.</i></p>
RF Blanking	<p>This soft key has a toggle action and is used to enable /disable RF blanking. With RF blanking enabled, spurious RF signals are reduced at the RF output by blanking out the signal during the frequency change switching points. This function should be turned on when measuring frequency selective devices below 2 GHz.</p>
Int/Ext Source	<p>Leads to the Int/Ext Source Menu, which allows either the internal source of the MTS or an external source to be set up. <i>This soft key is unselectable if the instrument is in source only mode (see below), or if the currently active channel is a fault location channel.</i> <i>See page 3-38.</i></p>
Voltage / Current O/P	<p>Leads to the V/I Output Menu, which enables the voltage/current output facility to be set up. <i>See page 3-39.</i></p>
CW Filter & Loop BW	<p>Leads to the CW & Loop BW Menu, which enables the CW filter to be switched on or off and the synthesizer loop bandwidth to be varied. <i>See page 3-41.</i></p>
Source Only Mode	<p>Toggles the Source Only Mode on or off. In this mode the data acquisition system is turned off and the MTS acts solely as a source, and can be used, for example, as an external source for a second MTS, if desired. When this mode is turned on, a screen is displayed which allows all the parameters of the source to be set up. The Save/Recall and Utility menus are still available but all other menus are locked out and cannot be accessed until source only mode is turned off. <i>This soft key is unselectable if an external source is being controlled, or if the sweep type is linear list, low pass or waveguide. It is not present if the currently active channel is a fault location channel.</i></p>
Return to Source	<p>Returns control to the Source Menu.</p>

SOURCE**Source
Functions****Levelling &
Freq Std****Lev & F Std**

See Fig. 3-11. This menu is used to select the levelling mode that is used to control the output power, and also allows the operator to select the frequency standard to be used by the synthesized source and frequency counter of the MTS.

Levelling Levelling is used for power level control, via a fast, closed-loop feedback system. The control (feedback) signal used to level the output can be derived from either the internal levelling detector of the MTS, or from an external detector or power meter, connected to the rear panel EXT LEVEL INPUT.

Internal levelling provides a constant signal at the MTS RF connector regardless of reflections by adjusting the level of the source, thus improving the source match. A further improvement in source match can be gained by using the external levelling mode, so that levelling is done at a point in the system closer to the test port. The emergent signal at the levelled point in the system is constant regardless of the signal travelling back towards the source; in this way the source appears matched.

Frequency Standard Under normal circumstances the internal crystal oscillator of the MTS would be used, but if necessary, an external frequency standard of higher accuracy and stability can be connected to the FREQ STANDARD INPUT/OUTPUT rear connector.

Int Levelling

Sets the levelling mode of the source to internal.

**Ext Levelling
+ve Det**

Sets the levelling mode of the source to external, and requires a detector of positive polarity.

**Ext Levelling
-ve Det**

Sets the levelling mode of the source to external, and requires a detector of negative polarity.

**Ext Levelling
Power Meter**

Sets the levelling mode of the source to external, and requires a power meter levelling output of positive polarity.

Int Std

Selects the internal crystal oscillator of the MTS as the frequency standard. In this mode, the MTS provides a 10 MHz reference output at the FREQ STANDARD INPUT/OUTPUT connector, derived from an internal oscillator.

**Ext Std
1 MHz**

Enables a 1 MHz external frequency to be used as the frequency standard.

**Ext Std
10 MHz**

Enables a 10 MHz external frequency to be used as the frequency standard.

**Return to
Source Func**

Returns control to the Source Funcs Menu.

SOURCE

Source Functions Int / Ext Source

Int/Ext Source

See Fig. 3-11. Measurements can be performed using either the internal synthesized source of the MTS, or an additional external source (a second MTS) connected to the instrument via the GPIB interface. Both internal and external sources can be controlled from either the front panel or using GPIB commands.

Int Source Set-up

Allows the parameters of the internal source to be set up, after exiting from this menu.

Ext Source Set-up

Allows the parameters of the external source to be set up, after exiting from this menu. The new parameters will not be transferred until external source control is turned on by using the [Ext Source Control] soft key.

Ext Source Control

Toggles external source control on or off. When it is turned off, the external source settings are held within the MTS, but are not sent to the external source. When it is turned on, all settings are transferred to the external source and the external source is kept up to date as changes are made by the user.

This soft key is unselectable if the external source is being set up.

Return to Source Func

Returns control to the Source Funcs Menu.

SOURCE**Source Functions Voltage / Current O/P****V/I Output**

See Fig. 3-11. The VOLTAGE/CURRENT OUTPUT connector at the rear panel of the instrument can be programmed to provide a Volts/GHz output when performing swept frequency measurements, a 0-10 V ramp voltage for swept frequency or power measurements, a swept voltage/current output for voltage/current domain measurements, a constant bias voltage/current output, or a chart recorder output. This menu enables the user to set up the scaling of the Volts/GHz output and the value of the constant bias voltage/current. The parameters for the swept voltage/current sweep are set up using the voltage sweep or current sweep menus, accessed via the [SOURCE] key.

1.0 V/GHz

Sets the voltage/current output to provide an output voltage proportional to the swept frequency, with a scale factor of 1 V/GHz. If the source mode is a power sweep or CW, the output will be set to the appropriate constant value. If the frequency exceeds 20 GHz, the output voltage will clip at 20 V. This parameter applies instrument-wide.

0.5 V/GHz

Sets the voltage/current output to provide an output voltage proportional to the swept frequency, with a scale factor of 0.5 V/GHz. If the source mode is a power sweep or CW, the output will be set to the appropriate constant value. This parameter applies instrument-wide.

Constant Voltage

Sets the voltage/current output to provide a constant voltage, as set by soft key 7; this will be labelled [Set Voltage] when constant voltage is selected. This mode applies instrument-wide.

Constant Current

Sets the voltage/current output to provide a constant current, as set by soft key 7; this will be labelled [Set Current] when constant current is selected. This mode applies instrument-wide.

10 V Ramp

Sets the voltage/current output to provide a 0-10 V ramp voltage proportional to swept frequency or power. The output will be set to 0 V for CW mode

Chart Recorder

This facility is only available for power readouts. It sets the voltage/current output to provide a voltage proportional to the power level measured by either a power meter sensor connected to Input D, or a scalar detector connected to any input. This output can be used to drive a chart recorder. This mode applies instrument-wide.

If there is more than one readout displayed, the MTS will select the readout that is to be sent to the chart recorder from the following priority list:

- Active Channel - Active Readout (highest)
- Active Channel - Other Readout
- Other Channel - Active Readout
- Other Channel - Other Readout (lowest)

The format of the chart recorder output depends on the display format, as set up using the Format Menu ([FORMAT] key).

For Log format (dB/dBm), the chart recorder output scaling is 1 V/decade, i.e.

-7.0 V	-70 dB(m)
-1.0 V	-10 dB(m)
0 V	-0 dB(m)
1 V	+10 dB(m)

For Linear format (Watts), the chart recorder output will be in the range 0 to 5 V, with offset and scaling dependent on the type of sensor:

Type	5 Volts
6910 Series	+20 dBm (100 mW)
6920 Series	-20 dBm (10 μ W)
6930 Series	+35 dBm (3.2 W)
6511/6230 Series detectors	+20 dBm (100 mW)

Set Voltage

or

Set Current

This soft key is labelled [*Set Voltage*] or [*Set Current*], depending on whether the voltage/current output mode is set to constant voltage or constant current. It is used to change the value of constant voltage or current available at the voltage/current output. The available range of values is given in the Performance Data section of Chapter 1. The value specified applies per channel.

This soft key will only be selectable for constant voltage and constant current modes.

Rotary Control	✓	Step Keys	✓	Numeric Pad	✓	Terminator	10-
----------------	---	-----------	---	-------------	---	------------	-----

Return to Source Func

Returns control to the Source Funcs Menu.

SOURCE**Source
Functions****CW Filter
& Loop BW****CW & Loop BW**

See Fig. 3-11. The CW filter is used to reduce the YIG oscillator tuning bandwidth and lower the residual FM to the values specified in the Performance Data section of Chapter 1. However, this also slows down the response due to the longer settling time. The Loop BW is the bandwidth of the frequency synthesizer phase-locked loop. Low bandwidth reduces the spurious signal content of the RF output but slows down the response; high bandwidth has the opposite effect. The soft keys have the following effect:

**CW Filter
Auto**

The CW filter is automatically turned ON for CW and power sweep modes, and turned OFF for frequency sweep modes. This is the default mode for the instrument.

**CW Filter
On**

The CW filter is always ON irrespective of the operating mode.

**CW Filter
Off**

The CW filter is always OFF irrespective of the operating mode.

**Loop BW
Auto**

The loop bandwidth is automatically set to LOW for CW and power sweep modes, and HIGH for frequency sweep modes. This is the default mode for the instrument.

**Loop BW
High**

The loop bandwidth is always HIGH irrespective of the operating mode.

**Loop BW
Low**

The loop bandwidth is always LOW irrespective of the operating mode.

**Return to
Source Func**

Returns control to the Source Funcs Menu.

SOURCE

**CW
Set-up**

CW Set-up

See Fig: 3-14 This menu enables the CW frequency and output power of the source to be set up for the voltage and current sweep modes

**Set Output
Power**

Used to change the output power of the source for the currently active channel. The power range available is given in the Performance Data section of Chapter 1.

Rotary Control Step Keys Numeric Pad Terminator Any

**Set
Frequency**

Used to change the CW frequency of the source for the currently active channel to a value within the range permitted for the particular MTS.

Rotary Control Step Keys Numeric Pad Terminator 10+

**Return to
Source**

Returns control to the Source Menu.

FUNCTION
(SCALAR CHANNEL)

SOURCE

**START & STOP
FREQUENCY
SWEEP MODE**

Fig. 3-11 SOURCE Menus - Scalar and Readout Channels (Sheet 1)

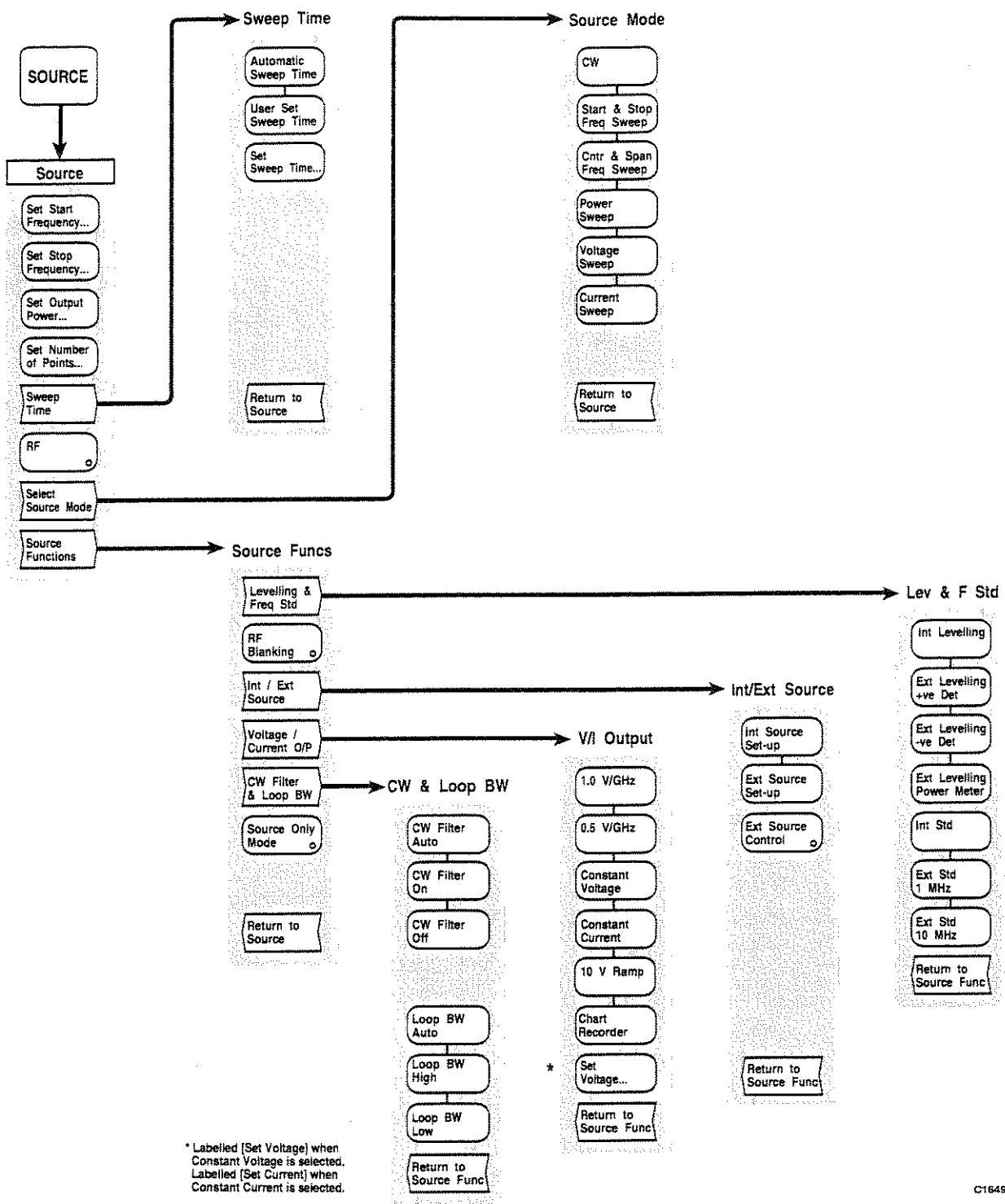

* Labelled [Set Voltage] when Constant Voltage is selected. Labelled [Set Current] when Constant Current is selected.

C1649

Start & Stop Frequency Sweep Mode

Fig. 3-11 SOURCE Menus - Scalar and Readout Channels (Sheet 1)

FUNCTION
(SCALAR CHANNEL)

SOURCE

CW MODE,
CENTRE & SPAN
FREQUENCY SWEEP MODE

Fig. 3-12 SOURCE Menus - Scalar and Readout Channels (Sheet 2)

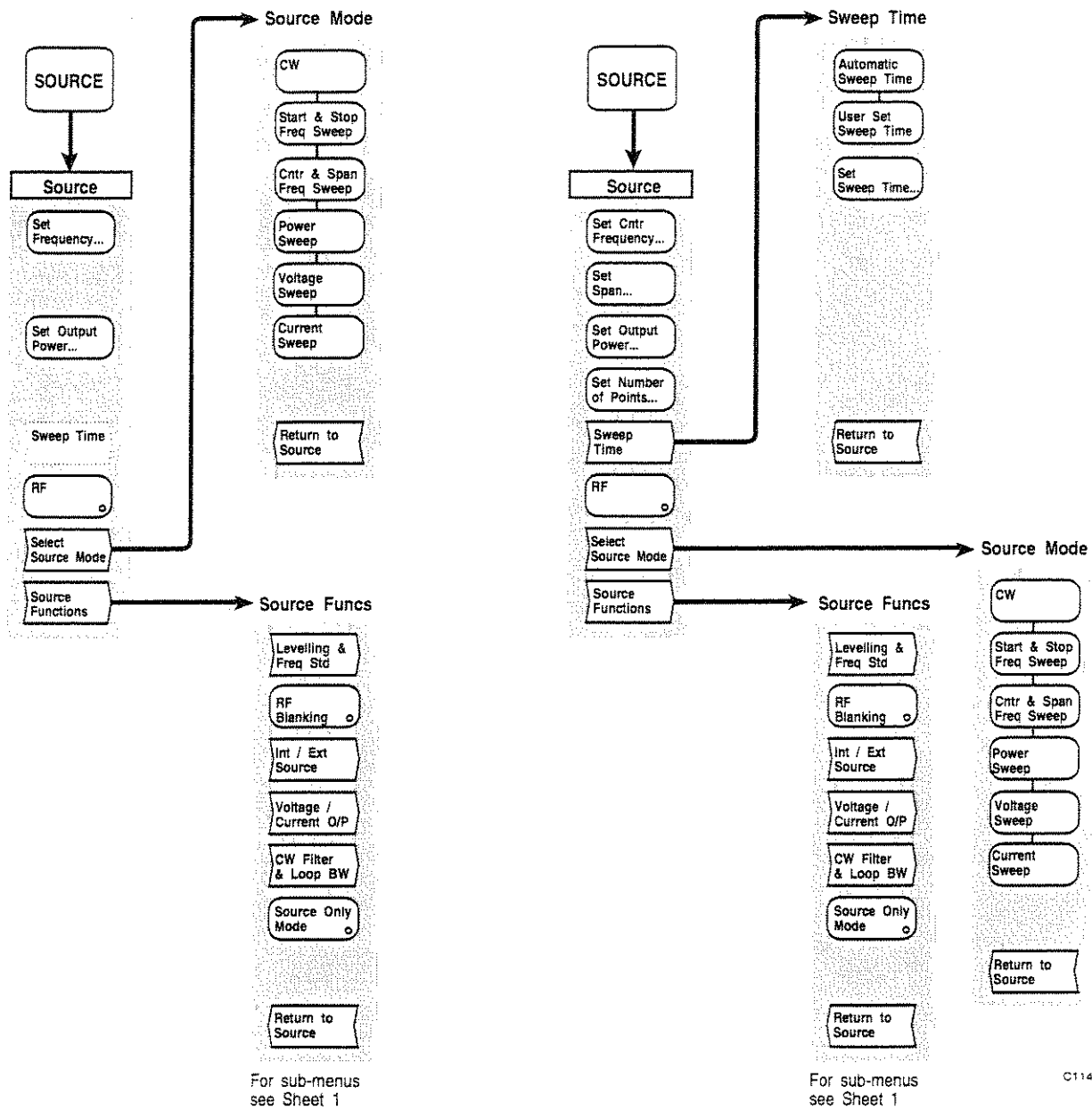

For sub-menus see Sheet 1

For sub-menus see Sheet 1

C1148

CW Mode

Centre & Span Frequency Sweep Mode

Fig. 3-12 SOURCE Menus - Scalar and Readout Channels (Sheet 2)

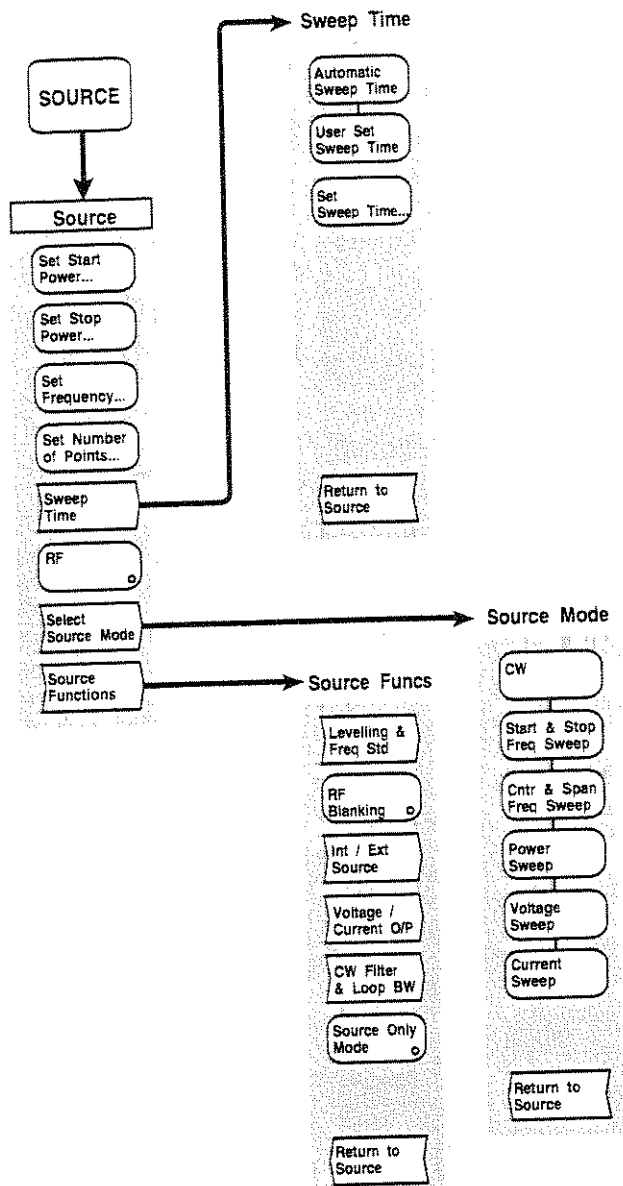

For sub-menus
see Sheet 1

C1149

Power Sweep Mode

Fig. 3-13 SOURCE Menus - Scalar and Readout Channels (Sheet 3)

SOURCE

POWER SWEEP MODE

Fig. 3-13 SOURCE Menus - Scalar and Readout Channels (Sheet 3)

FUNCTION
(SCALAR CHANNEL)

SOURCE

VOLTAGE SWEEP MODE,
CURRENT SWEEP MODE

Fig. 3-14 SOURCE Menus - Scalar and Readout Channels (Sheet 4)

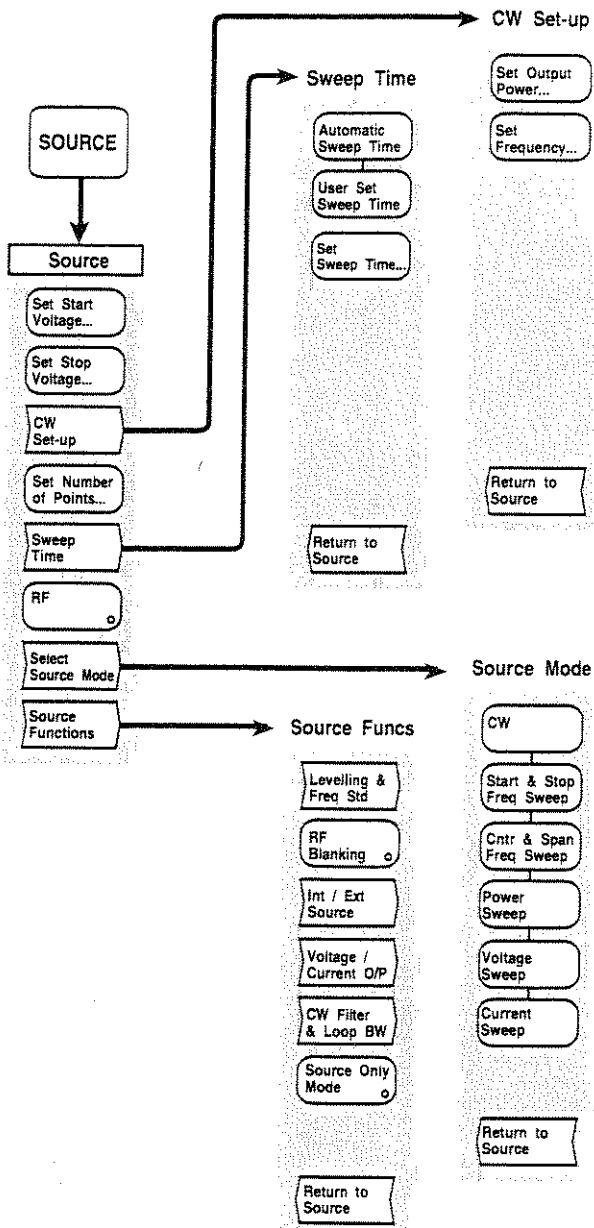

For sub-menus see Sheet 1

Voltage Sweep Mode

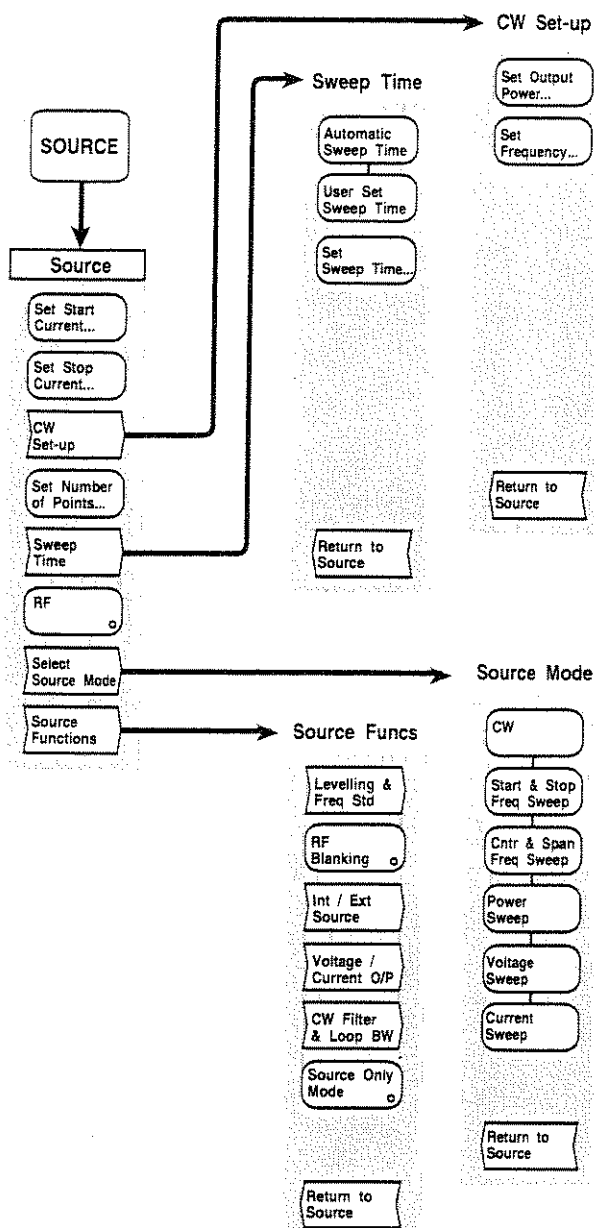

For sub-menus see Sheet 1

Current Sweep Mode

C1150

Fig. 3-14 SOURCE Menus - Scalar and Readout Channels (Sheet 4)

[MEASURE] KEY

The [MEASURE] key provides access to the series of menus illustrated in Figs. 3-23 to 3-26. These menus are used to define and set up the scalar measurement and apply various functions to aid examination of the results.

The current values or states for the major measurement functions of the active channel are displayed in specific locations on the screen (see 'Display' earlier in this chapter).

MEASURE

- Measure** *See Fig. 3-23* This menu is used to specify whether the system is to measure the absolute power level of a single input or the ratio of two input power levels, and whether path calibration is to be applied. If the source has been set up to provide a voltage or current sweep, the menu will also allow frequency to be measured, which will be displayed on the vertical axis. The user can also apply averaging, smoothing or limit checking to the measurement.
- Single Input
A, B, C or D** Leads to the Single Input Menu.
See page 3-53.
- Input
Ratio** Leads to the Input Ratio Menu.
See page 3-53.
- Counter** When this soft key is pressed, the quantity that will be measured and displayed on the vertical axis is the frequency of the signal present at the COUNTER input.
This soft key will only be selectable if the domain for the currently active channel is voltage or current (i.e. the source is set up for either a voltage sweep or a current sweep).
- Averaging** Leads to the Averaging Menu, which enables averaging to be applied to the trace data.
See page 3-54.
- Restart
Averaging** Restarts the averaging process. See also the Averaging Menu (page 3-54).
- Smoothing** Leads to the Smoothing Menu, which enables smoothing to be applied to the trace data.
See page 3-55.
- Limit
Checking** Leads to the Lim Checking Menu, which enables the displayed trace to be compared with user-defined limits.
See page 3-56.
- General
Set-up** Leads to the Gen Set-up Menu, which enables the user to set up the input configuration and to compensate for detector/sensor characteristics.
See page 3-62.

MEASURE

Single Input

Single Input

See Fig. 3-23. Enables the power level at a selected input to be measured by pressing the appropriate soft key. The power level can be displayed in dBm, Watts or Volts, as selected from the Format Menu ([FORMAT] key).

It will not be possible to select input D if it is configured to be a power meter sensor input.

- A Selects input A for power measurement.
- B Selects input B for power measurement.
- C Selects input C for power measurement.
- D Selects input D for power measurement.
- Return to Measure Returns control to the Measure Menu.

MEASURE

Input Ratio

Input Ratio

See Fig. 3-24. Enables the ratio of the power levels at two of the inputs to be measured by selecting the appropriate soft keys. The power ratio can be displayed in dB or VSWR, as selected from the Format Menu.

It will not be possible to select input D if it is configured to be a power meter sensor input.

- A / Selects input A as the numerator of the desired power ratio measurement. Selecting the numerator leads to a sub-menu where the denominator is chosen (B, C or D).
- B / Selects input B as the numerator of the desired power ratio measurement. Selecting the numerator leads to a sub-menu where the denominator is chosen (A, C or D).
- C / Selects input C as the numerator of the desired power ratio measurement. Selecting the numerator leads to a sub-menu where the denominator is chosen (A, B or D).
- D / Selects input D as the numerator of the desired power ratio measurement. Selecting the numerator leads to a sub-menu where the denominator is chosen (A, B or C).
- Return to Measure Returns control to the Measure Menu.

MEASURE

Averaging

Averaging

See Fig. 3-23. This menu enables averaging to be applied to the measurement data, the amount of averaging being set by the user. Averaging is used to reduce the amount of noise on a trace. The minimum amount of averaging should be selected to reduce noise to an acceptable level, in order to maintain a sufficiently fast response.

Each new sweep is averaged into the trace until the sweep count is equal to the user-entered average number, for a fully averaged trace. This condition is indicated by the 'A' flag in the relevant trace information area. The flag is in lower case until this condition is reached. It is absent if the averaging function is turned off.

The parameters in this menu apply per trace.

Fig. 3-15 illustrates the effect of averaging on a typical measurement trace.

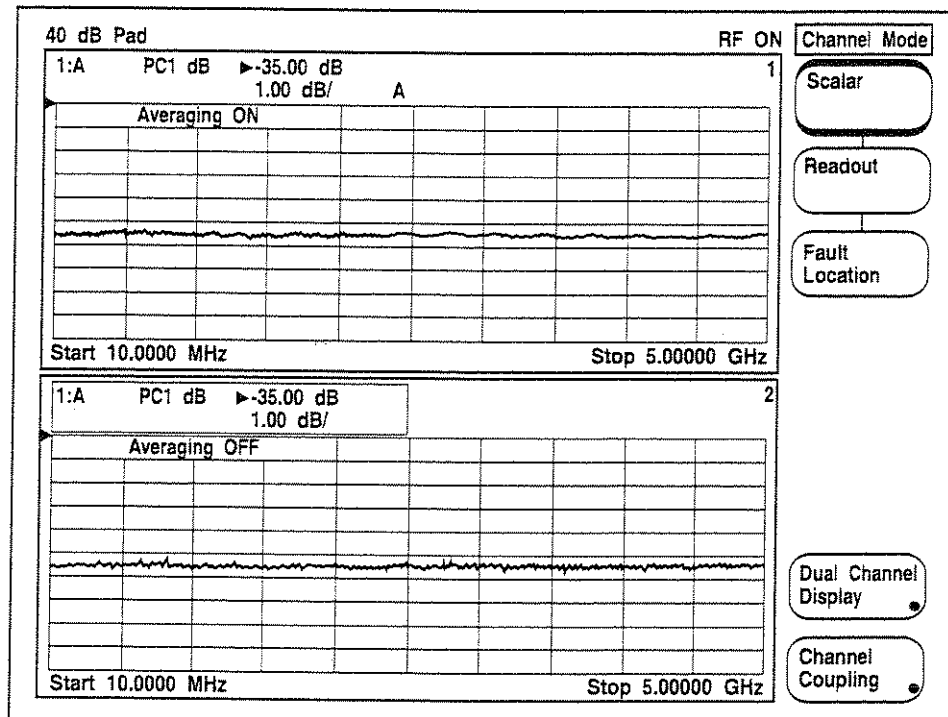

Fig. 3-15 Effect of Averaging on a Trace

Note...

The averaging process can be re-started by using the [Restart Averaging] soft key in the Measure Menu.

Averaging

Toggles averaging on or off for the currently active trace.

Set Average Number

Enables selection of the average number to be used in the averaging function. Values in the range 1 to 1000 can be entered. When using the rotary control and step keys the average number will be incremented in powers of 2.

Rotary Control	✓	Step Keys	✓	Numeric Pad	✓	Terminator	Any
----------------	---	-----------	---	-------------	---	------------	-----

Return to Measure

Returns control to the Measure Menu.

MEASURE

Smoothing

Smoothing

See Fig. 3-23. Smoothing is used to filter active trace data by performing a "moving average" on the data over a specified percentage of the sweep span. The parameter that specifies the percentage of the trace to be averaged for each data point is called the smoothing aperture.

Smoothing should be used to reduce ripple on a trace, e.g. to reduce relatively small peak-to-peak noise values on broadband measured data. Do not use smoothing for measurement of high resonance devices or other devices with wide variations in the trace, as it will introduce errors into the measurement.

Fig. 3-16 illustrates the effect of smoothing on a typical measurement trace.

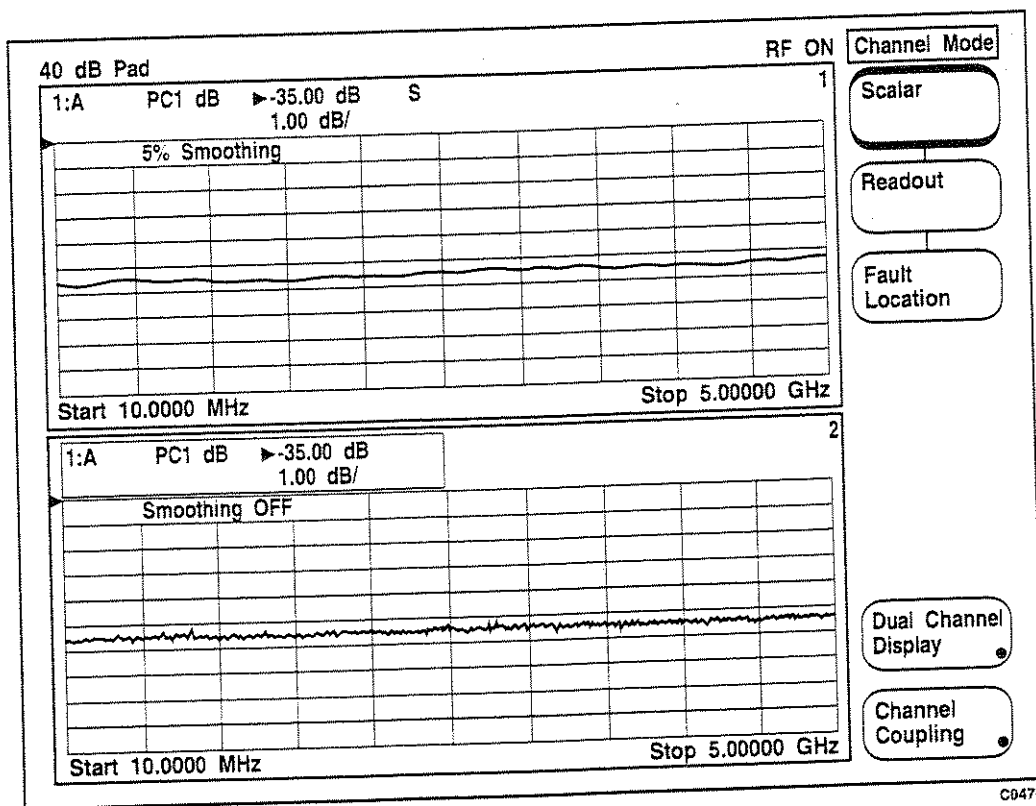

Fig. 3-16 Effect of Smoothing on a Trace

Smoothing

Toggles smoothing on or off for the currently active trace. If smoothing is applied to a trace, it is indicated in the relevant trace information area by an 'S' flag.

Set Aperture

Enables selection of the smoothing aperture for the currently active trace. The smoothing aperture is a percentage of the span swept, up to a maximum of 20%.

Rotary Control	√	Step Keys	√	Numeric Pad	√	Terminator	Any
----------------	---	-----------	---	-------------	---	------------	-----

Return to Measure

Returns control to the Measure Menu.

MEASURE

Limit
CheckingLim Checking

See Fig. 3-23. This menu enables a limit checking facility to be implemented, allowing any displayed trace to be compared against upper and lower complex limit lines, defined by the user. Limit lines are lines drawn on the screen to represent upper and lower limits or device specifications with which to compare the device under test. Limits are defined in segments, where each segment is a portion of the source span. Each limit segment can be defined with the following parameters: start domain value, start upper and lower limits, stop domain value, stop upper and lower limits.

Three types of segments are available: flat line, sloping line and single point. A flat line segment has limit values which are constant with frequency or other domain value. A sloping line segment has limit values which change linearly with the domain value. A single point segment sets the limits at a specified domain value. Fig. 3-17 illustrates limit lines defined for a bandpass filter.

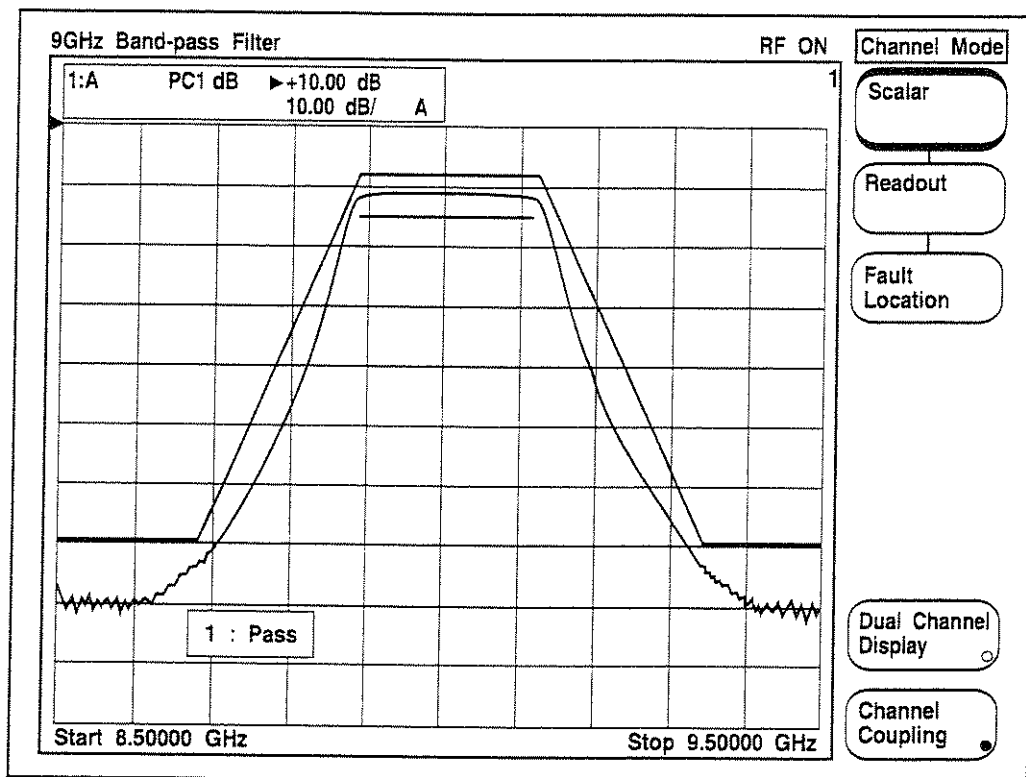

C0420

Fig. 3-17 Limit Lines for Bandpass Filter Testing

Limits can be defined independently for all displayed traces, with up to 12 segments for each trace. These can be in any combination of the three segment types.

Limit testing compares the measured data with the defined limits. If all measured data points for a trace are within limits, 1:Pass (for trace 1) or 2:Pass (for trace 2) is displayed on the screen, as appropriate. An out-of-limits test condition is indicated by 1:FAIL (2:FAIL). Limits are checked only at the actual measured data points. It is possible for a device to be out of specification without a limit test failure indication if the point density is insufficient, therefore ensure that a high enough number of measurement points is specified in the Source Menu.

The limit lines are superimposed on the graticule when limit checking is enabled and the corresponding trace is switched on. The limit lines are displayed in colours corresponding to the associated trace colours.

The MTS allows four different limit specifications to be defined by the user. By default, each specification will be associated with a particular trace, but the user can specify one of the other limit specifications to be applied to a trace. A limit specification may be shared by more than one trace.

**Limit
Checking**

Toggles the limit checking facility on or off for the currently active trace.

**Edit
Specification**

Leads to the Edit Spec Menu.
See page 3-58.

**Assign
Spec 1-4**

Used to assign one of the four limit checking specifications to the currently active trace, by entering the desired specification number (1 to 4) from the keyboard.

Rotary Control	×	Step Keys	×	Numeric Pad	√	Terminator	Any
----------------	---	-----------	---	-------------	---	------------	-----

**Return to
Measure**

Returns control to the Measure Menu.

MEASURE

Limit Checking Edit Specification

Edit Spec

See Fig. 3-23 This menu is used to set up or edit the current limit checking specification. In addition to soft key labels, a form is displayed on the screen showing the contents of the current limit checking specification, in segment order (Fig. 3-18). Each segment is defined by some or all of the following parameters, depending on the segment type:

Segment number, start domain value, start upper limit, start lower limit, stop domain value, stop upper limit and stop lower limit.

Limit Checking Specification 1						
	Start	Upper	Lower	Stop	Upper	Lower
1	8.500000000G	-60.00	-60.00	8.680000000G		
2	8.680000000G	-60.00	-60.00	8.890000000G	2.00	2.00
3	8.890000000G	2.00	-5.00	9.125000000G		
4	9.125000000G	2.00	2.00	9.340000000G	-60.00	-60.00
5	9.340000000G	-60.00	-80.00	9.500000000G		

C0421

Fig. 3-18 Limit Checking Specification Form

An existing segment is selected for editing using the [↑] and [↓] soft keys and then pressing the [Edit Segment] soft key. A new segment can be added by pressing the [Add Segment] soft key, or deleted by selecting it using the [↑] and [↓] soft keys and then pressing the [Delete Segment] soft key.

Select Spec

Used to select a new limit checking specification for examination or editing, by entering the desired specification number (1 to 4). If the current specification has changed since it was last stored in memory, the user will be given the opportunity to store it before the new specification is presented.

Rotary Control	×	Step Keys	×	Numeric Pad	√	Terminator	Any
----------------	---	-----------	---	-------------	---	------------	-----

↑ Makes the previous segment in the specification the active segment.

↓ Makes the next segment in the specification the active segment.

Edit Segment Leads to the Edit Segment Menu.
See page 3-60.

**Delete
Segment**

Deletes the active segment from the specification, after asking for confirmation. The segments below the active one will be moved upwards in the specification form and will be renumbered.

**Add
Segment**

Leads to the Add Segment Menu.
See page 3-61.

**Print
Spec**

Used to obtain a hard copy of the limit checking specification currently being edited.
Unselectable if there are no limit segments displayed.

**Return to
Lim Checking**

The editing function is terminated and control returned to the Lim Checking Menu.

MEASURE

Limit **Edit** **Edit**
Checking **Specification** **Segment**

Edit Segment

See Fig. 3-23. A form is displayed on the screen which enables the user to edit the currently active segment. The [⇐] and [⇒] soft keys are used to move between the fields of the segments. The currently selected field is changed by entering the required value as follows:

Start/stop values

Rotary Control	×	Step Keys	×	Numeric Pad	√	Terminator	10+
----------------	---	-----------	---	-------------	---	------------	-----

Upper/lower limit values

Rotary Control	×	Step Keys	×	Numeric Pad	√	Terminator	10-
----------------	---	-----------	---	-------------	---	------------	-----

After the value has been entered, the field to the right of the current one becomes the active field.

Note that a flat line segment does not use the stop upper/lower values, and a single point segment additionally does not use the stop domain value.

If no upper limit is required for a particular measurement, force the upper limit value out of range (for example +200 dB). If no lower limit is required, force the lower limit value out of range (for example -200 dB).

- Flat** Defines the selected limit segment as a flat line.
- Slope** Defines the selected limit segment as a sloping line.
- Point** Defines the selected limit segment as a single point.
- ⇒ Makes the next field in the segment the active field.
- ⇐ Makes the previous field in the segment the active field.
- ↑ Makes the previous segment in the specification the active segment.
- ↓ Makes the next segment in the specification the active segment.

Return to Edit Spec Causes the currently active segment to be checked to ensure that the start domain value is lower than the stop domain value, and that each lower limit value is less than its corresponding upper limit value. If the checks fail a message will be displayed; the error must be corrected before the new data will be accepted. If the segment is passed, the segment editing function is terminated and control returns to the Edit Spec Menu.

MEASURE

Limit
CheckingEdit
SpecificationAdd
SegmentAdd Segment

See Fig. 3-23. This menu is used to add a new segment to the end of the list, which initially will be of the same type as the previous segment, with all its limit fields set to zero, and its domain values set to the stop domain value of the previous segment. The soft keys are used in the same way as for the Edit Segment Menu (see previous page), but there is now an additional *[Add Segment]* soft key.

Flat

Defines the selected limit segment as a flat line.

Slope

Defines the selected limit segment as a sloping line.

Point

Defines the selected limit segment as a single point.

⇒

Makes the next field in the segment the active field.

⇐

Makes the previous field in the segment the active field.

Add
Segment

Pressing this soft key will cause the segment values to be checked for consistency, as in the Edit Segment Menu. If the checks fail, a message will be displayed and no new segment will be added. If the segment is passed, a new segment will be created at the end of the specification.

Return to
Edit Spec

Causes the values of the currently active segment to be checked for consistency, as in the Edit Segment Menu. If the checks fail a message will be displayed; the error must be corrected before the new data will be accepted. If the segment is passed, the segment editing function is terminated and control returns to the Edit Spec Menu.

MEASURE

**General
Set-up**

Gen Set-up

See Fig 3-25. This menu enables the user to set up the input configuration, apply domain offset/scaling and to compensate for non-ideal characteristics of detectors and sensors. Either AC or DC detection can be selected for scalar measurements.

**Input
Configuration**

Leads to the Input Config Menu, which is used to set up the input configuration for the measurement.
See page 3-63.

**Domain Scale
& Offset**

Leads to the Scale & Offset Menu, which is used to apply an offset and scale factor for translating between internal frequencies and displayed frequencies. An offset can also be applied to the swept power range.
See page 3-64.

**Detector
Correction**

Leads to the Select Input Menu, which is used to compensate for non-ideal detector characteristics.
See page 3-65.

**Sensor
Correction**

Leads to the Sensor Corr Menu, which is used to apply cal factor and linearity correction for the power sensor connected to the D input.
This soft key will only be selectable if Input D is configured for a power sensor.
See page 3-67

**Det / Sensor
Specs**

Leads to the Edit Specs Menu, which is used to modify detector correction specifications or sensor calibration data tables.
See page 3-69.

**AC
Detection**

Selects AC detection mode for scalar measurements. With AC detection, the RF output to the DUT is chopped, and the resulting pulsed RF output from the DUT is demodulated and processed in such a way that the effects of zero drift are effectively cancelled. The AC mode therefore gives more accurate results for low signal level swept measurements.

The AC detection mode applies instrument-wide.

**DC
Detection**

Selects DC detection mode for scalar measurements. In the DC detection mode, an unmodulated RF signal is used and the detector simply converts the incident RF to an equivalent DC output. This mode will have to be used, for example, when measuring amplifiers with automatic gain control which may behave differently in the presence of amplitude modulated signals. Power meter readings will always use the DC detection mode.

The DC detection mode applies instrument-wide.

**Return to
Measure**

Returns control to the Measure Menu.

MEASURE

**General
Set-up**

**Input
Configuration**

Input Config

See Fig 3-25. This menu provides functions for setting up the configuration of the four inputs.

An offset to be applied to a corrected detector or power sensor measurement. The offset is effectively a fixed dB value that is added or subtracted from the reading. They are useful for compensating for attenuators or amplifiers between the DUT and detector/power sensor. Use a positive offset value to compensate for attenuation and a negative offset to compensate for gain.

An 'O' flag will be displayed in the trace information area if an offset is being applied to any of the inputs taking part in the measurement.

**All Inputs
are Scalar**

Configures all four inputs A, B, C and D to accept scalar detectors.

**Input D is
Power Sensor**

Configures inputs A, B and C to accept scalar detectors and input D to accept a power meter sensor.

**Input A
Offset**

Enables the offset for Input A to be changed.

Rotary Control	✓	Step Keys	✓	Numeric Pad	✓	Terminator	Any
----------------	---	-----------	---	-------------	---	------------	-----

**Input B
Offset**

Enables the offset for Input B to be changed.

Rotary Control	✓	Step Keys	✓	Numeric Pad	✓	Terminator	Any
----------------	---	-----------	---	-------------	---	------------	-----

**Input C
Offset**

Enables the offset for Input C to be changed.

Rotary Control	✓	Step Keys	✓	Numeric Pad	✓	Terminator	Any
----------------	---	-----------	---	-------------	---	------------	-----

**Input D
Offset**

Enables the offset for Input D to be changed.

Rotary Control	✓	Step Keys	✓	Numeric Pad	✓	Terminator	Any
----------------	---	-----------	---	-------------	---	------------	-----

**View Current
Configuration**

Displays a form on the screen (Fig. 3-19) showing the detector or sensor type connected to each input, and whether manual or automatic correction will be applied (see Select Input Menu, page 3-65). If an EEPROM detector is connected, the form also indicates whether flatness or linearity correction is being applied. Pressing the [Return to Input Config] soft key returns control to the Input Config Menu.

**Return to
Gen Set-up**

Returns control to the Gen Set-up Menu.

Current Input Configuration	
Input A :	Automatic 6511 Series
Input B :	Automatic Autotester Adaptor Cable
Input C :	Automatic Voltage Measurement Cable
Input D :	Automatic 6910 Series

C0422

Fig. 3-19 View Input Configuration Screen

MEASURE

General Set-up

Domain Scale & Offset

Scale & Offset

See Fig 3-25. This menu enables an offset and scale factor to be entered for translating between displayed frequencies and the frequencies generated by the source at the RF OUTPUT connector. This may be required, for example, if the RF is applied to the DUT via a frequency conversion device. The display can then be set to display the actual frequency applied to the DUT, rather than the source output frequency.

When outputting frequencies to display, printer/plotter or GPIB:
 $f_{\text{displayed}} = (f_{\text{source}} \times \text{scale factor}) + f_{\text{offset}}$

When translating to source frequencies from keyboard or GPIB:
 $f_{\text{source}} = \frac{f_{\text{displayed}} - f_{\text{offset}}}{\text{scale factor}}$

The default values are scale factor = 1, $f_{\text{offset}} = 0$.

A power offset can also be applied for translation between the source swept power range and the displayed swept power range, as follows:

When outputting power domain values to display, printer/plotter or GPIB:
 $P_{\text{displayed}} = P_{\text{source}} + P_{\text{offset}}$

When translating to source power from keyboard or GPIB:
 $P_{\text{source}} = P_{\text{displayed}} - P_{\text{offset}}$

The default value is $P_{\text{offset}} = 0$ dB.

If a 6255 or 6256 Millimetre Wave Reflectometer is used with the MTS to extend its frequency range, preset frequency scaling is available of either 4 or 6 times, corresponding to the frequency multiplication of the 6255 and 6256.

Frequency Offset

Used to change the frequency offset value for the currently active trace. A form is displayed on the screen showing the current offset. This parameter applies per channel. *This soft key will only be selectable if the domain of the currently active channel is the frequency domain.*

Rotary Control X Step Keys X Numeric Pad ✓ Terminator 10+

Frequency Scaling

Used to change the frequency scaling factor for the currently active trace. A form is displayed on the screen showing the current scaling factor. This parameter applies per channel. *This soft key will only be selectable if the domain of the currently active channel is the frequency domain.*

Rotary Control X Step Keys X Numeric Pad ✓ Terminator Any

Power Offset

Used to change the power offset value for the currently active trace. A form is displayed on the screen showing the current offset. This parameter applies per channel. *This soft key will only be selectable if the domain of the currently active channel is the power domain.*

Rotary Control X Step Keys X Numeric Pad ✓ Terminator 10-

User Set	The frequency entry in the Source menu is done in terms of the frequency output by the MTS source, but the displayed frequency information can be offset and scaled using the [<i>Frequency Offset</i>] and [<i>Frequency Scaling</i>] keys. This is the default setting.
6255	The frequency entry in the Source menu is done in terms of the output from a 6255 (i.e. multiplied by 4) and the displayed frequency information corresponds to the scaled source frequencies. The [<i>Frequency Offset</i>] and [<i>Frequency Scaling</i>] keys are unavailable in this mode.
6256	As above, except that the scaling factor applied is 6.
Return to Gen Set-up	Returns control to the Gen Set-up Menu.

MEASURE

**General
Set-up**

**Detector
Correction**

Select Input

See Fig 3-25. This menu is used to compensate for non-ideal detector characteristics, such as temperature dependence and deviation from the ideal square-law response.

Below a certain power level, detectors are assumed to obey a square law response, where the detector output voltage is directly proportional to the input power. Above that level, deviation from the square law results in power readings lower than expected, which are corrected for by using a table of correction specifications. This table, held in non-volatile memory, contains an entry for all the detector types supported by the MTS. Other detectors are characterised by a sensitivity factor (in mV/mW) and a power factor, which modify the correction data to fit the detector's characteristics.

The instrument permits either manual or automatic selection of a correction specification. For manual selection, the user enters the required specification number. When automatic selection is enabled, the instrument determines the required specification from a self-identification mechanism built into the detector. For detectors without the self-identification facility, automatic selection defaults to the correction table for 6511 detectors, and a warning message is displayed. Correction can be turned off, if required, e.g. when measuring voltage.

Improved accuracy can be achieved if EEPROM detectors are used (6230A and 6230L series). These detectors are individually calibrated to provide linearity correction data (square-law response correction) and flatness correction data (frequency response). The data is held in the detectors's EEPROM and read by the MTS when the detector is connected to an input.

In order to achieve the improved accuracy, the Linearity Calibration function should be used prior to the measurement, so that the linearity correction data applies to the temperature at which the measurement is made. (The specified accuracy figures apply to a temperature of 23°C ±5°C; linearity calibration should be carried out if these figures are to be met outside this temperature range.)

The soft keys in this menu are used to select the detector input to which correction is to be applied, and leads to a sub-menu.

- Input A** Leads to the Input A Menu.
- Input B** Leads to the Input B Menu.
- Input C** Leads to the Input C Menu.
- Input D** Leads to the Input D Menu.
- Return to Gen Set-up** Returns control to the Gen Set-up Menu.

MEASURE

General Set-up

Detector Correction

Input A (B,C or D)

Input A (B, C or D)

See Fig 3-25. These four menus are identical, and are used to specify the correction mode (automatic or user set) and whether temperature correction is to be applied. If EEPROM detectors are used, flatness correction can be enabled/disabled and linearity calibration performed.

If detector correction for an input is set to 'Correction Auto Sense', and if an EEPROM detector is present, the linearity correction data stored in the EEPROM will be read by the MTS and used to apply linearity correction.

If an EEPROM detector is connected to an input and flatness correction is enabled for the input, the flatness correction data stored in its EEPROM will be read by the MTS and used to apply flatness correction. This can be enabled/disabled using the [Flatness Correction] soft key.

Correction Auto Sense

Sets the detector correction mode for the selected input to automatic.

Correction User Set

Enables manual entry of the detector type, by using the [Set Detector Type] soft key.

Correction Off

Turns off detector correction.

Set Detector Type

Selects the type of detector that is to be corrected. When this soft key is pressed, a table is displayed listing all the possible detector types and their identity numbers (Fig. 3-20).

Four entries in the table are reserved for user-specified values of sensitivity factor and power factor. These values can be set using the Edit Specs Menu (page 3-70). This soft key is only selectable if manual entry of the detector type has been selected ([Correction User Set] soft key).

Rotary Control X Step Keys X Numeric Pad ✓ Terminator Any

Set Detector Type	
1 :6511	9 :Reserved
2 :6512	10 :Reserved
3 :6513	11 :Reserved
4 :6514	12 :USER1
5 :6230	13 :USER2
6 :6233	14 :USER3
7 :6234	15 :USER4
8 :Reserved	
Detector Number :1	

C0775

Fig. 3-20 Detector Types Table

Linearity Calibration

When this soft key is pressed, the user is prompted to connect the detector to be calibrated to the POWER REF output and press the [Continue] soft key when ready. If the detector is not an EEPROM type the calibration will be aborted and an error message displayed. A detector zero is automatically performed, followed by the calibration of the detector. The user is informed when calibration data has been acquired. After verification, the cal data is written to the detector EEPROM and applied to the measurement immediately.

The [Abort Calibration] soft key is used to terminate the calibration process at any time; the original EEPROM data will not be affected.

Temperature Correction

This soft key has a toggle action and is used to enable/disable scalar detector temperature correction. When enabled, temperature correction will apply to detectors for which temperature correction is available (e.g. the 6230 series). This function applies per input.

Flatness Correction

This soft key has a toggle action and is used to enable/disable flatness correction. When enabled, flatness correction will apply to detectors for which flatness correction is available (e.g. 6230A and 6230L series). This function applies per input.

Return to Select Input

Returns control to the Select Input Menu.

MEASURE

General Set-up

Sensor Correction

Sensor Corr

See Fig. 3-25. Calibration data for all sensors used with the MTS are stored in non-volatile memory. The power sensors have a self-identification mechanism built in to enable the instrument to determine the sensor type. The calibration data comprises a 50 MHz cal factor, a linearity factor and a cal factor table. Each entry in the cal factor table consists of a frequency and a corresponding cal factor, stored in ascending order of frequency.

The cal factor can either be entered manually or derived from a cal factor table. In order that a cal factor can be applied using a cal factor table, it is necessary to know the frequency at which the power measurement is being made. The following options are provided:

- Manual entry of frequency
- Frequency read from the counter
- Frequency defined by the source

If a counter is used to define the frequency, at least one readout must be configured for frequency measurement. A counter reading will be taken and stored once per measurement update. If a reading cannot be obtained for any reason, the most recent counter reading or manually entered frequency will be used.

If the source is used to define the frequency, channel coupling must be on. The frequency used will depend on the source mode. If the source mode is CW or a power sweep, the CW frequency will be used. If the source mode is a swept frequency, the position of the active marker is used to define the frequency.

The frequency as defined above will be used to extract a value of cal factor from the table using linear interpolation. If the frequency lies outside the range for which data is available, the cal factor corresponding to the frequency nearest to the required frequency will be used, and the user will be informed via the display.

The cal factor will be applied as follows:

$$\text{Corrected Power} = \frac{\text{Measured Power} \times 100}{\text{Cal Factor (\%)}}$$

Cal Factor User Set

Enables manual entry of the cal factor by using the [Cal Factor & Lin Factor] soft key.

- Cal Factor User Freq** Enables manual entry of the cal factor frequency by using the [Set Frequency] soft key.
- Cal Factor Counter Freq** Applies a cal factor which corresponds to the frequency measured by the counter.
- Cal Factor Source Freq** Applies a cal factor which corresponds to the frequency of the source.
- Cal Factor & Lin Factor** Leads to the Cal & Lin Fact Menu, which allows cal factor and linearity factor for a sensor to be specified.
This soft key is only selectable if manual entry of the cal factor has been selected using the [Cal Factor User Set] soft key)
See below
- Set Frequency** Used to change the frequency value that is used to obtain the cal factor for input D.
This soft key is only selectable if manual entry of the cal factor frequency has been selected by using the [Cal Factor User Freq] soft key.

Rotary Control ✓ Step Keys ✓ Numeric Pad ✓ Terminator 10+

- Select Cal Fact Table** Used to select the cal factor table that the cal factor for input D will be selected from. A form is displayed listing the available cal factor tables, and the current cal factor table identity number.
This soft key is unselectable if manual entry of the cal factor has been selected.

Rotary Control ✗ Step Keys ✗ Numeric Pad ✓ Terminator Any

- Return to Gen Set-up** Returns control to the Gen Set-up Menu.

MEASURE

General Set-up Sensor Correction Cal Factor & Lin Factor

- Cal & Lin Fact** See Fig. 3-25. This menu enables manual entry of cal factor and linearity factor for a power sensor connected to input D.

- Set Cal Factor** Used to set the cal factor for the frequency of the signal to be measured.

Rotary Control ✓ Step Keys ✓ Numeric Pad ✓ Terminator Any

- Set Lin Factor** Used to set the linearity factor for the sensor.

Rotary Control ✓ Step Keys ✓ Numeric Pad ✓ Terminator Any

- Return to Sensor Corr** Returns control to the Sensor Corr Menu.

MEASURE

General Set-up

Det / Sensor Specs

Edit Specs

See Fig 3-25. This menu is used to edit the sensitivity and power factor values of the four user-defined detector correction specifications, and to edit the power sensor calibration data tables.

Edit Det Corr Spec

Leads to the Edit Det Specs Menu, which enables editing of correction data for the user-defined detectors.
See page 3-70

Edit Sensor Cal Data

Leads the Edit Spec Menu, which is used for editing the calibration data for the current sensor.
See page 3-71.

Return to Gen Set-up

Returns control to the Gen Set-up Menu.

MEASURE

General Set-up

Det / Sensor Specs

Edit Det Corr Spec

OR

UTILITY

Service

Det / Sensor Specs

Edit Det Corr Spec

Edit Det Specs

See Fig 3-25. This menu is used to edit the sensitivity and power factor values of the four user-defined detector correction specifications. A form is displayed on the screen showing the sensitivity and power factor values for the detectors. The soft keys enable selection of the value that is to be changed. The new value is entered as follows:

Rotary Control X Step Keys X Numeric Pad ✓ Terminator Any

- ← Selects the active field for numeric entry.
- ⇒ Selects the active field for numeric entry.
- ↑ Selects the previous user-defined detector.
- ↓ Selects the next user-defined detector.

Edit Identity

Leads to a sub-menu and displays a form which enables an identity of up to ten characters to be entered. The method of entry is the same as that described for the Screen Title Menu (page 3-290).

Return to Edit Specs

Terminates the editing function and writes the new data into the non-volatile memory which holds the correction specification. Control is then returned to the Edit Specs Menu.

Detector Correction Specifications		
Identity	Sensitivity	Power Factor
USER1	349.1200 mV/mW	800.0m
USER2	393.9600 mV/mW	1.00
USER3	0.00000 V/mW	1.00
USER4	0.00000 V/mW	1.00

C0424

Fig. 3-21 User Detector Correction Specification Form

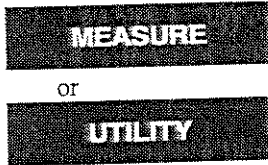

General Set-up	Det / Sensor Specs	Edit Sensor Cal Data
Service	Det / Sensor Specs	Edit Sensor Cal Data

Edit Spec

See Fig. 3-26. This menu and the associated sub-menus are used to edit the power sensor calibration data tables. A form is displayed on the screen (Fig. 3-22) showing the calibration data table contents for the current sensor.

See the Sensor Correction Menu description (page 3-68) for an explanation of how the calibration data is used for power sensor correction.

Power Sensor Cal Data 1	
Table Identity : 6910 Serial No. 138	
50 MHz Cal Factor : 100.00% Linearity Factor : 9.50	
Frequency	Cal Factor
10.00000 MHz	99.04%
30.00000 MHz	100.00%
50.00000 MHz	100.00%
100.00000 MHz	99.37%
300.00000 MHz	100.00%
500.00000 MHz	99.99%
1.00000 GHz	99.63%
2.00000 GHz	98.48%
3.00000 GHz	98.04%
4.00000 GHz	97.68%
5.00000 GHz	96.83%

C0425

Fig. 3-22 Sensor Cal Data Table

Select Table

Used to select a new cal factor table that the cal factor for input D will be selected from. A form is displayed listing the sensor identities. If the current table has changed since it was last saved, the user will be given the opportunity to save it before the new table is presented.

Rotary Control	×	Step Keys	×	Numeric Pad	√	Terminator	Any
----------------	---	-----------	---	-------------	---	------------	-----

Set Table Identity

Enables the entry of a text string as the identity of the table. The method of entry is the same as that described for the Screen Title Menu (page 3-290).

50 MHz Cal Factor

Used to change the 50 MHz cal factor for the sensor.

Rotary Control	×	Step Keys	×	Numeric Pad	√	Terminator	Any
----------------	---	-----------	---	-------------	---	------------	-----

Linearity Factor

Used to change the linearity factor for the sensor.

Rotary Control	×	Step Keys	×	Numeric Pad	√	Terminator	Any
----------------	---	-----------	---	-------------	---	------------	-----

- Edit Table** Leads to the Edit Table Menu, which provides facilities for editing the frequency and cal factor values in the table of entries.
See below:
- Save Table** Causes the current cal data table to be saved in non-volatile memory.
- Return to Edit Specs** Initially checks whether the current cal data table has changed since it was last saved. If it has, a prompt will be displayed asking if the table is to be saved. The editing function will then be terminated and control returned to the Edit Specs Menu.

MEASURE	General Set-up	Det / Sensor Specs	Edit Sensor Cal Data	Edit Table
	or			
UTILITY	Service	Det / Sensor Specs	Edit Sensor Cal Data	Edit Table

Edit Table *See Fig. 3-26.* This menu provides facilities for editing entries in the cal data table, and adding or deleting entries.

Edit Entry Leads to the Edit Entry Menu.

Add Entry Leads to the Add Entry Menu.

Delete Entry Deletes the active entry from the specification after prompting for confirmations. The entries below the active one will be moved upwards and renumbered.

↑ Makes the previous entry in the table the active entry.

↓ Makes the next entry in the table the active entry.

Page Up The previous page of entries in the table will be displayed.

Page Down The next page of entries in the table will be displayed.

Return to Edit Spec Returns control to the Edit Spec Menu.

MEASURE
OR
UTILITY

General
Set-up

Det / Sensor
Specs

Edit Sensor
Cal Data

Edit
Table

Edit
Entry

Service

Det / Sensor
Specs

Edit Sensor
Cal Data

Edit
Table

Edit
Entry

Edit Entry

See Fig. 3-26. This menu allows an entry in the cal data table to be edited. The new cal factor is changed as follows:

Rotary Control X Step Keys X Numeric Pad ✓ Terminator Any

Note that this menu only allows cal factor values to be edited. If a frequency is to be changed, the [Add Entry] soft key of the Edit Table Menu must be used to add a new entry with the required frequency, and the [Delete Entry] soft key used to remove the unwanted entry.

↑

Makes the previous entry in the table the active entry.

↓

Makes the next entry in the table the active entry.

Page
Up

The previous page of entries in the table will be displayed.

Page
Down

The next page of entries in the table will be displayed.

Return to
Edit Table

Returns the user to the Edit Table Menu.

MEASURE

General Set-up

Det / Sensor Specs

Edit Sensor Cal Data

Edit Table

Add Entry

OR

UTILITY

Service

Det / Sensor Specs

Edit Sensor Cal Data

Edit Table

Add Entry

Add Entry

See Fig. 3-26. Enables a new entry to be added to the cal factor table. Initially, the frequency and cal factor fields contain the default values of 50 MHz and 100% respectively. Entry of cal factor values is the same as for the Edit Entry screen. Frequency values are entered as follows:

Rotary Control X Step Keys X Numeric Pad ✓ Terminator 10+

⇒ Selects the active field for numeric entry.

⇐ Selects the active field for numeric entry.

Add Entry Inserts the entry into the appropriate place in the table (an existing entry that has the same frequency will be overwritten). The fields will then be set to their default values.

Return to Edit Table Terminates the add entry function and returns the user to the Edit Table Menu, after performing a check as above.

FUNCTION
(SCALAR CHANNEL)

MEASURE

Fig. 3-23 MEASURE Menus - Scalar and Readout Channels (Sheet 1)

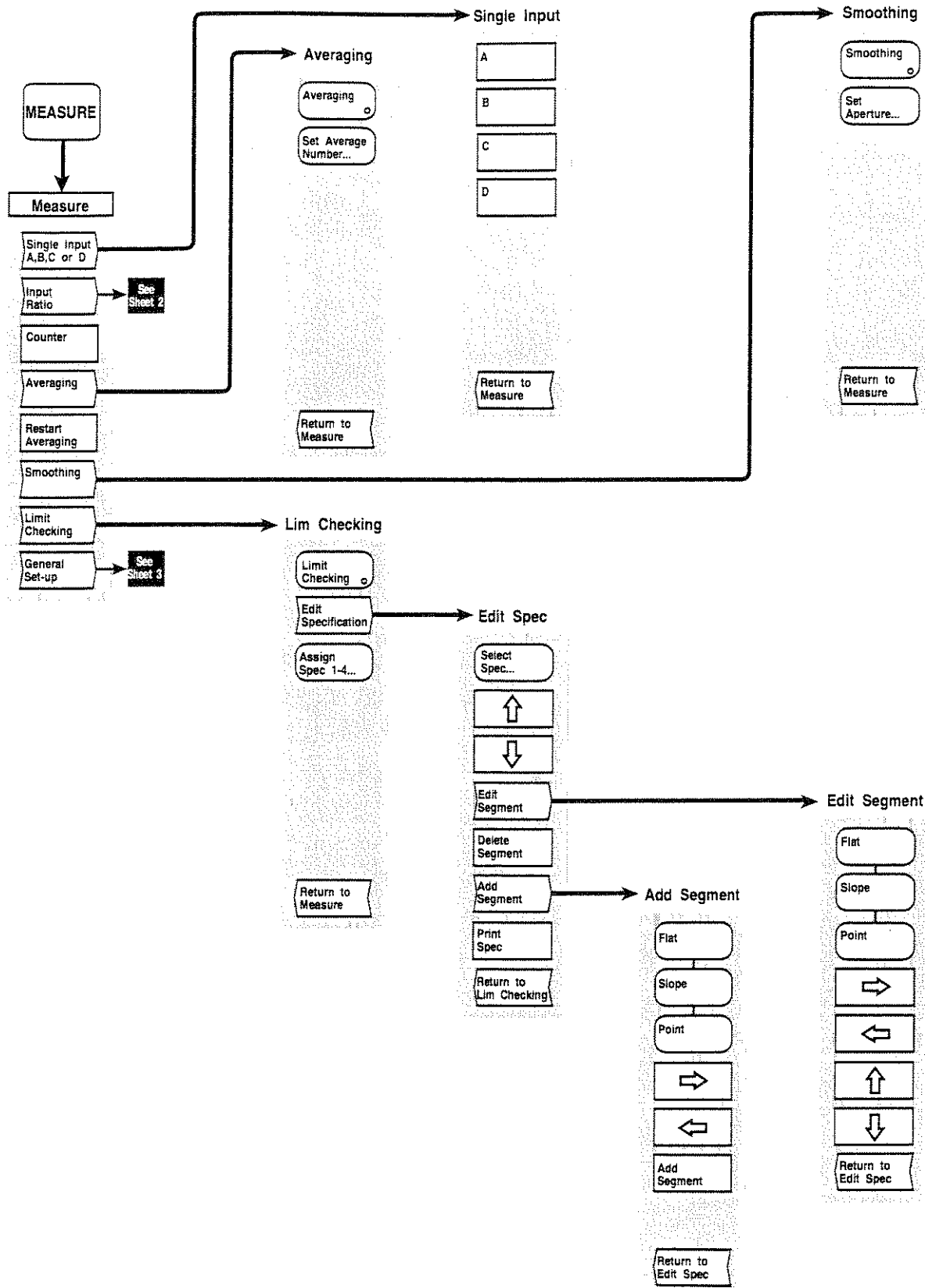

C1581

Fig. 3-23 MEASURE Menus - Scalar Channel (Sheet 1)

MEASURE

Input
Ratio

Fig. 3-24 MEASURE Menus - Scalar Channel (Sheet 2)

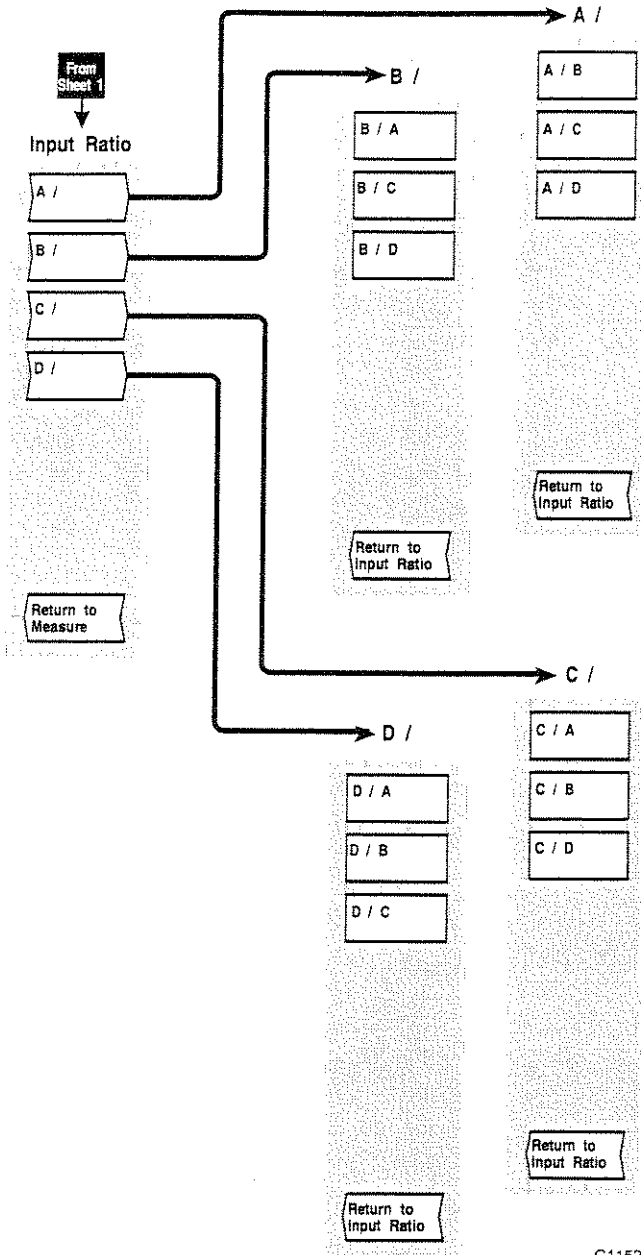

Fig. 3-24 MEASURE Menus - Scalar Channel (Sheet 2)

FUNCTION
(SCALAR CHANNEL)

MEASURE

General
Set-up

Fig. 3-25 MEASURE Menus - Scalar Channel (Sheet 3)

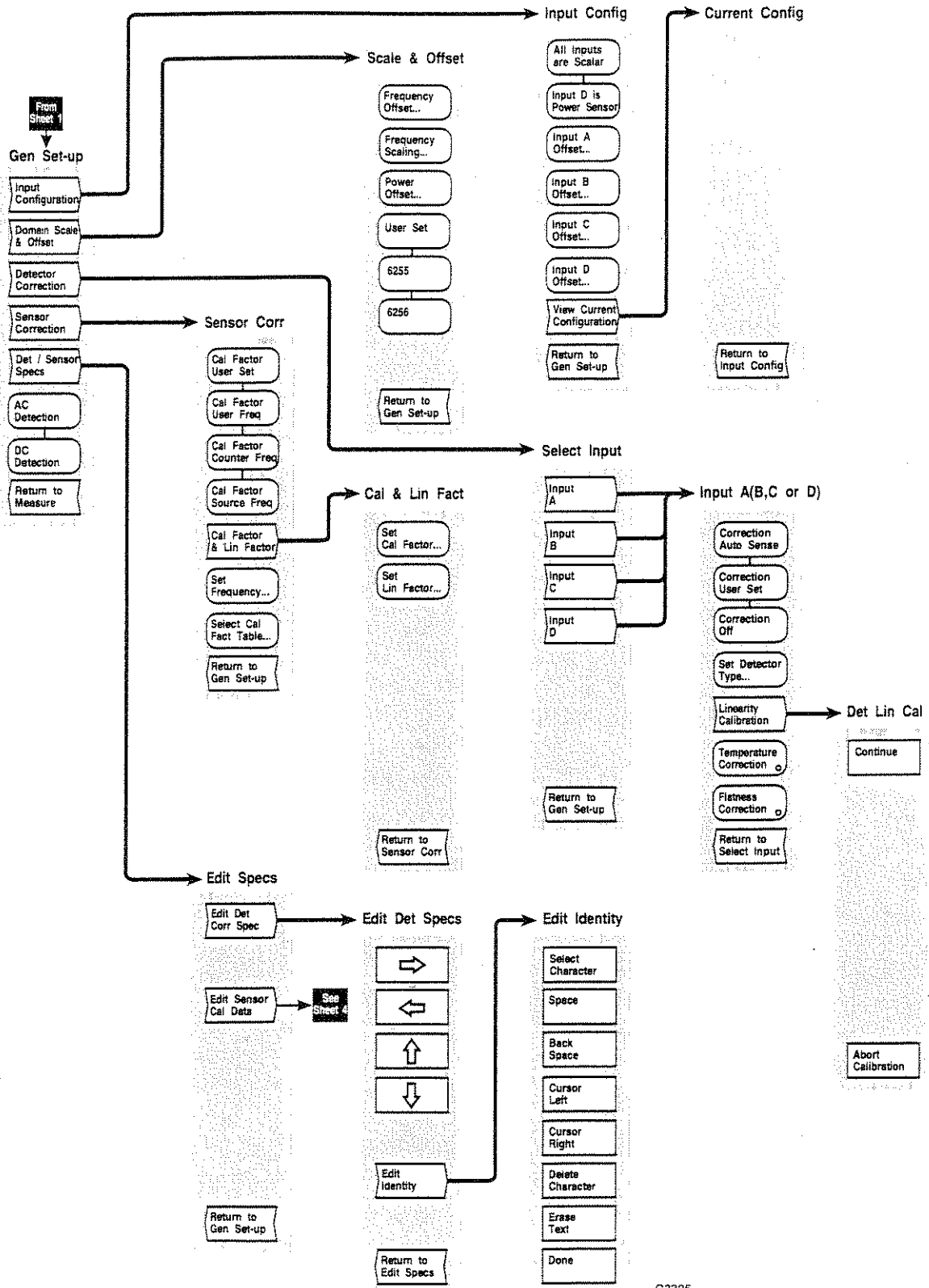

C3325

Fig. 3-25 MEASURE Menus - Scalar Channel (Sheet 3)

MEASURE

General
Set-up

Det / Sensor
Specs

Edit Sensor
Cal Data

OR

UTILITY

Service

Det / Sensor
Specs

Edit Sensor
Cal Data

Fig. 3-26 MEASURE Menus - Scalar Channel (Sheet 4)

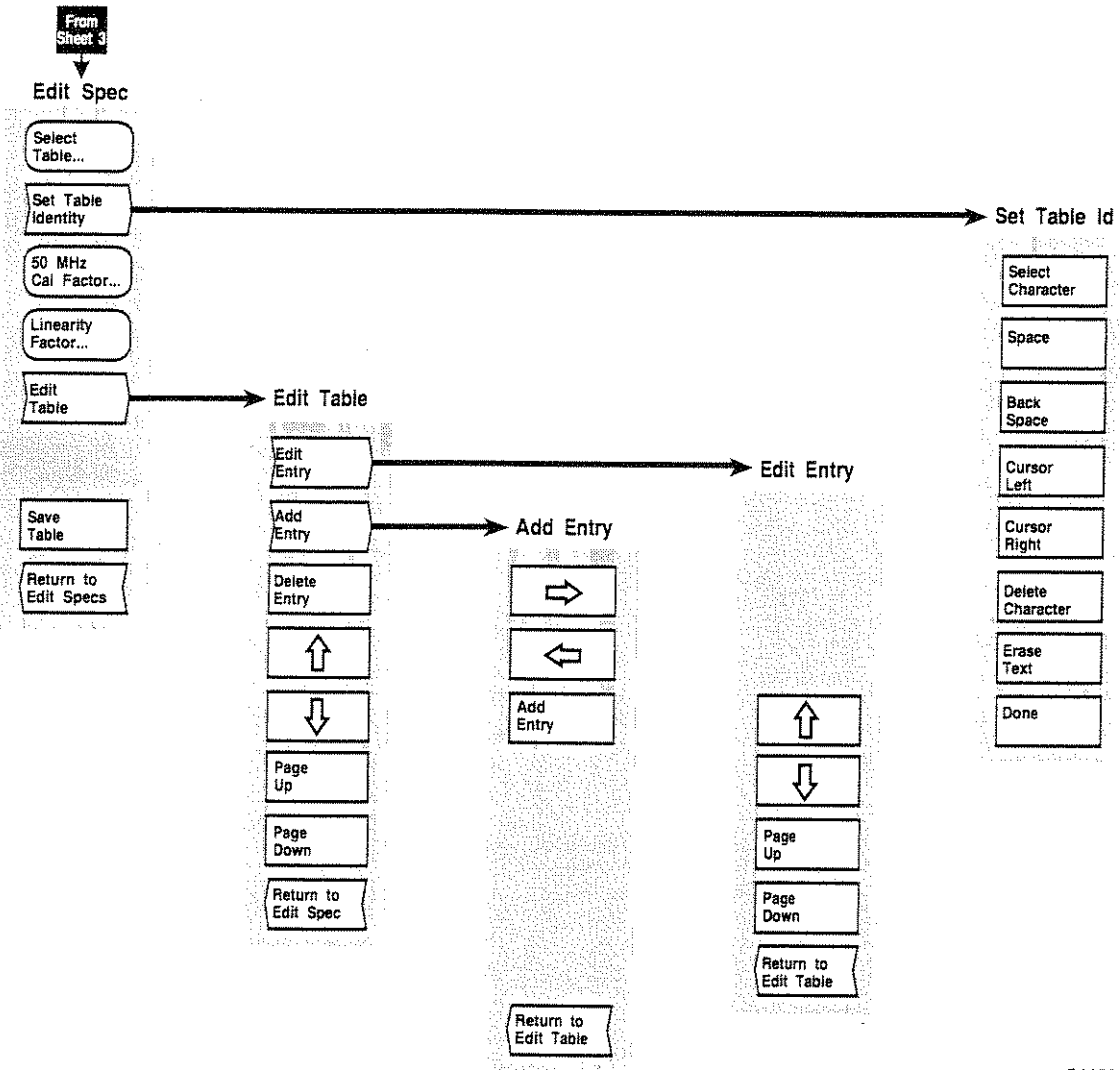

C1153

Fig. 3-26 MEASURE Menus - Scalar Channel (Sheet 4)

[CAL] KEY

The [CAL] key provides access to the calibration menu (Fig. 3-27). Calibration is used prior to a measurement in order to remove system errors that cause uncertainty in measuring a device under test.

Frequency variations in the components that comprise the measurement system (connectors, adapters, cables etc.) can be taken into account when making a component measurement. The MTS analyzes and stores the variations and automatically removes them from the measurement. This is known as path calibration since it calibrates out the frequency variations in each measurement path.

One of four stored path calibrations can be applied to the current measurement, which have previously been set up using the appropriate soft keys. The current measurement data is ratioed with the path calibration data before being formatted and displayed. The trace information area of the display indicates if path calibration is being applied to a trace, and the identity of the path calibration store. By default, each path calibration store is associated with a particular trace. However, it is possible for a trace to use one of the other path calibration stores, so that a single path cal can be shared by more than one trace.

If the calibration becomes invalid (e.g. due to subsequent changes in the source set-up) a warning message will be displayed and a "?" is displayed after the calibration identity.

Path calibration facilities are not available when making frequency measurements under swept conditions.

Power sensor calibration utilises the 50 MHz, 1 mW power reference output available from the front panel POWER REF connector. A sensor is calibrated by connecting it to the power reference output (via a 30 dB attenuator for 6920 series sensors) and pressing the [Sensor Cal] soft key. The system measures the difference between the sensor and reference outputs and uses this to correct subsequent measurements. The power reference will be switched on and off automatically as required by the calibration process.

CAL

- Cal** *See Fig. 3-27.* This menu provides facilities for calibrating the measurement system for a scalar channel, and applying any of four stored path calibrations to a measurement. It also provides access to menus for detector/sensor zeroing and sensor calibration.
- Through Cal** Leads to the Through Menu, which is used to carry out path calibration for insertion loss measurements on the currently active scalar measurement.
See page 3-85.
- Short AND
Open Cal** Leads to the Short & Open Menu, which is used to carry out a short/open path calibration on the currently active scalar measurement.
See page 3-86.
- Short OR
Open Cal** Leads to the Short OR Open Menu, which is used to carry out a path calibration on the currently active scalar measurement by using a short circuit or open circuit termination.
See page 3-86.
- Single Ended
Ins Loss** Leads to the S/E Ins Loss Menu.
See page 3-87.
- Path Cal
On/Off** Leads to the PC On/Off Menu.
See page 3-87.
- Det / Sensor
Zero** Leads to the Det/Sen Zero Menu, which is used for zeroing detectors/sensors.
See page 3-88.
- Sensor
Cal** Leads to the Sensor Cal Menu, which is used to zero the power sensor and to calibrate it against the reference.
This soft key will only be selectable if Input D is configured for a power sensor.
See page 3-89.
- Power
Ref** Toggles the power reference output on and off. When it is turned on, the front panel POWER REF connector provides a 50 MHz 0 dBm power reference output. The reference can be used, for example, to verify that the power sensor is functioning correctly. The Power Reference On indicator (PWRREF) will be present in the General Information Area at the top of the screen if a power reference signal is being output.

CAL

Through Cal

Through

See Fig. 3-27. This menu is used to carry out a through path calibration on the currently active scalar measurement. It compensates for residual levelling errors in the source and frequency variations in the components that form the measuring system.

The user is prompted to make the through connection. The [Select Path Cal Store] soft key is used to specify the path calibration store that is to be used for storing the calibration data. The [Continue] soft key starts the calibration process. The user is informed when calibration data has been acquired and path calibration has been applied. The function then terminates and the user is returned to the initial Cal Menu.

Continue

Starts the calibration process.

Select Path Cal Store

Used to specify the path calibration store that is to be used for storing the calibration data by entering a number in the range 1 to 4.

Rotary Control × Step Keys × Numeric Pad √ Terminator Any

Abort Calibration

Terminates the calibration process. The current path cal store will not be affected.

CAL

**Short AND
Open Cal**

Short & Open

See Fig. 3-27. This menu is used to carry out a short/open path calibration on the currently active scalar measurement. It calibrates the system against a known reference when measuring return loss. Open circuit and short circuit terminations are chosen as both of these devices theoretically reflect 100% of the power incident upon them and therefore have a return loss of 0 dB. If only an open or short circuit is used for calibration, however, there is an uncertainty added to the measurements due to test port impedance mismatch. This uncertainty is minimized by calibrating the system against both open and short circuits and calculating the average path cal.

The user is prompted to connect the short. The [Select Path Cal Store] soft key is used to specify the path calibration store that is to be used for storing the calibration data. The [Continue] soft key starts the calibration process. When the short calibration data has been acquired, the user is prompted to connect the open termination and press [Continue] when ready. The user is informed when the open calibration data has been acquired and path calibration has been applied. The calibration data is stored in the specified path cal store. The function then terminates and the user is returned to the initial Cal Menu.

Continue

Starts the calibration process.

**Select Path
Cal Store**

Used to specify the path calibration store that is to be used for storing the calibration data by entering a number in the range 1 to 4.

Rotary Control × Step Keys × Numeric Pad √ Terminator Any

**Abort
Calibration**

Used to terminate the calibration process at any time. The current path cal store will not be affected.

CAL

**Short OR
Open Cal**

Short OR Open

See Fig. 3-27. This menu functions in a similar way to the Short & Open Menu, except that a path cal is performed using either an open circuit or a short circuit termination. This method would be used, for example, in waveguide measurements, since a practical open circuit is not achievable for waveguide systems.

Continue

Starts the calibration process.

**Select Path
Cal Store**

Used to specify the path calibration store that is to be used for storing the calibration data by entering a number in the range 1 to 4.

Rotary Control × Step Keys × Numeric Pad √ Terminator Any

**Abort
Calibration**

Used to terminate the calibration process at any time. The current path cal store will not be affected.

CAL

**Single Ended
Ins Loss**

S/E Ins Loss

See Fig. 3-27. This menu is used to perform a single-ended insertion loss measurement.

This type of measurement can be used for example, when it is required to check the insertion loss of a long transmission line, where simultaneous access to both ends of the line would be impractical. In the single-ended insertion loss measurement, either a short, an open or both is connected to the end of the line so that theoretically 100% of the input power is reflected back to the source. A bridge or coupler at the input end of the line is used to measure the reflected signal. Since this signal is attenuated twice (once in each direction), the measurement of the total attenuation in dB is halved by the MTS to produce a value for the insertion loss.

Note that since the reflected signal undergoes two stages of attenuation, this method is not suitable for high loss cables.

Upon completion of the calibration the display will represent the insertion loss of the line.

**Short AND
Open Cal**

Leads to a sub-menu which is used to perform the short/open path calibration for the single-ended insertion loss measurement. This functions in the same way as the Short & Open Menu.

See page 3-86.

**Short OR
Open Cal**

Leads to a sub-menu which is used to perform either a short circuit or an open circuit path calibration for the single-ended insertion loss measurement. This functions in the same way as the Short OR Open Menu.

See page 3-86.

CAL

**Path Cal
On/Off**

PC On/Off

See Fig. 3-27. This menu is used to apply path calibration or to turn it off.

**Apply Path
Cal 1-4**

Enables one of four path calibrations to be used in the measurement by entering the required identity number. The relevant trace information area will indicate if path calibration is being applied to a trace, and also the path cal store that is being used (see page 3-16).

Rotary Control	×	Step Keys	×	Numeric Pad	√	Terminator	None
----------------	---	-----------	---	-------------	---	------------	------

**Path Cal
Off**

Turns off path calibration if it is not required.

**Return to
Cal**

Returns control to the Cal Menu.

CAL

**Det / Sensor
Zero**

Det/Sen Zero

This menu enables detector zeroing to be performed for all scalar detectors connected to the instrument. Zeroing is used to remove the effects of zero drift from the measurement. It is especially important for low level measurements (<-40 dBm). At very low levels (<-60 dBm), zeroing should be done every few minutes, but preferably using the autozeroing facility. The menu also enables power sensor zeroing to be performed.

**Detector
Autozeroing**

Toggles the autozeroing facility on or off. When enabled, the detectors will be zeroed automatically once every measurement update. The MTS momentarily turns off the RF in order to do this. The setting of this parameter applies instrument-wide. The AZ indicator is displayed in the General Information Area when autozeroing is on.

The autozero facility only operates if a manual zero has previously been performed (see [Zero Detectors]).

**Zero
Detectors**

Initiates zeroing of the detectors. A zero will be performed on all inputs, including any that do not have a detector connected. If a detector is then connected to one of these previously unused inputs, the zero is no longer valid and misleading results could occur. It is therefore necessary to perform a detector zero each time a detector is connected to an input.

The source power will be automatically turned off during a detector zero. If a source other than the MTS is providing the RF signal, it must be turned off before performing a zero.

**Zero
Sensor D**

Initiates zeroing of a power sensor connected to input D. The zero facility must only be used with no incident RF at the sensor. A horizontal bar indicator shows the percentage of the zeroing operation that has been completed.
This function is only selectable if input D has been configured to accept a power sensor.

**Return to
Cal**

Returns control to the Cal Menu.

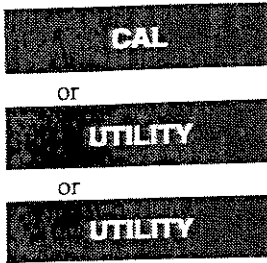

Sensor Cal					
Service	Instrument Calibrations	Source Power Cal	Broadband Power Cal	Sensor Cal	
Service	Instrument Calibrations	Source Power Cal	Narrowband Power Cal	Sensor Cal	

Sensor Cal

This menu is used to zero the power sensor and to calibrate it against the 50 MHz reference. The user is prompted to connect the power sensor to the reference output and press the [Continue] soft key when ready. The MTS turns off the power reference and a horizontal bar is displayed informing the user of the progress of the zeroing, as a percentage of the time to completion. The power reference is then turned on and the MTS performs sensor calibrations; a similar percentage indicator is displayed. When calibration has been completed the function terminates and the user is returned to the initial Cal menu.

Note...

If an external power reference is used to calibrate the sensor, ensure that no power is present during the zeroing phase. When zeroing has completed, the MTS allows a period of 5s for the user to turn on the power reference for the calibration phase.

Continue Starts sensor calibration.

Select Table Used to select the cal factor table appropriate to the power sensor being used, by entering the cal factor table identity number.
This soft key is unselectable if manual entry of the cal factor has been selected (see Sensor Correction Menu - [MEASURE][General Set-up][Sensor Correction]).

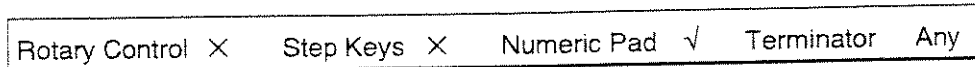

Set 50 MHz Cal Factor Used to change the 50 MHz cal factor for the sensor.
This soft key is only selectable if manual entry of the cal factor has been selected ([MEASURE][General Set-up][Sensor Correction][Cal Factor User Set]).

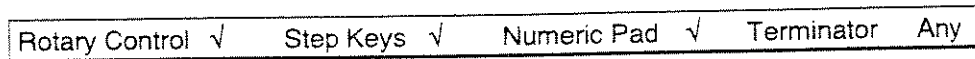

Set Lin Factor Used to change the linearity factor for the sensor.
This soft key is only selectable if manual entry of the cal factor has been selected ([MEASURE][General Set-up][Sensor Correction][Cal Factor User Set]).



Abort Calibration Terminates the calibration process.

LOCAL OPERATION

FUNCTION
(SCALAR CHANNEL)

CAL

Fig. 3-27 CAL Menu - Scalar Channel

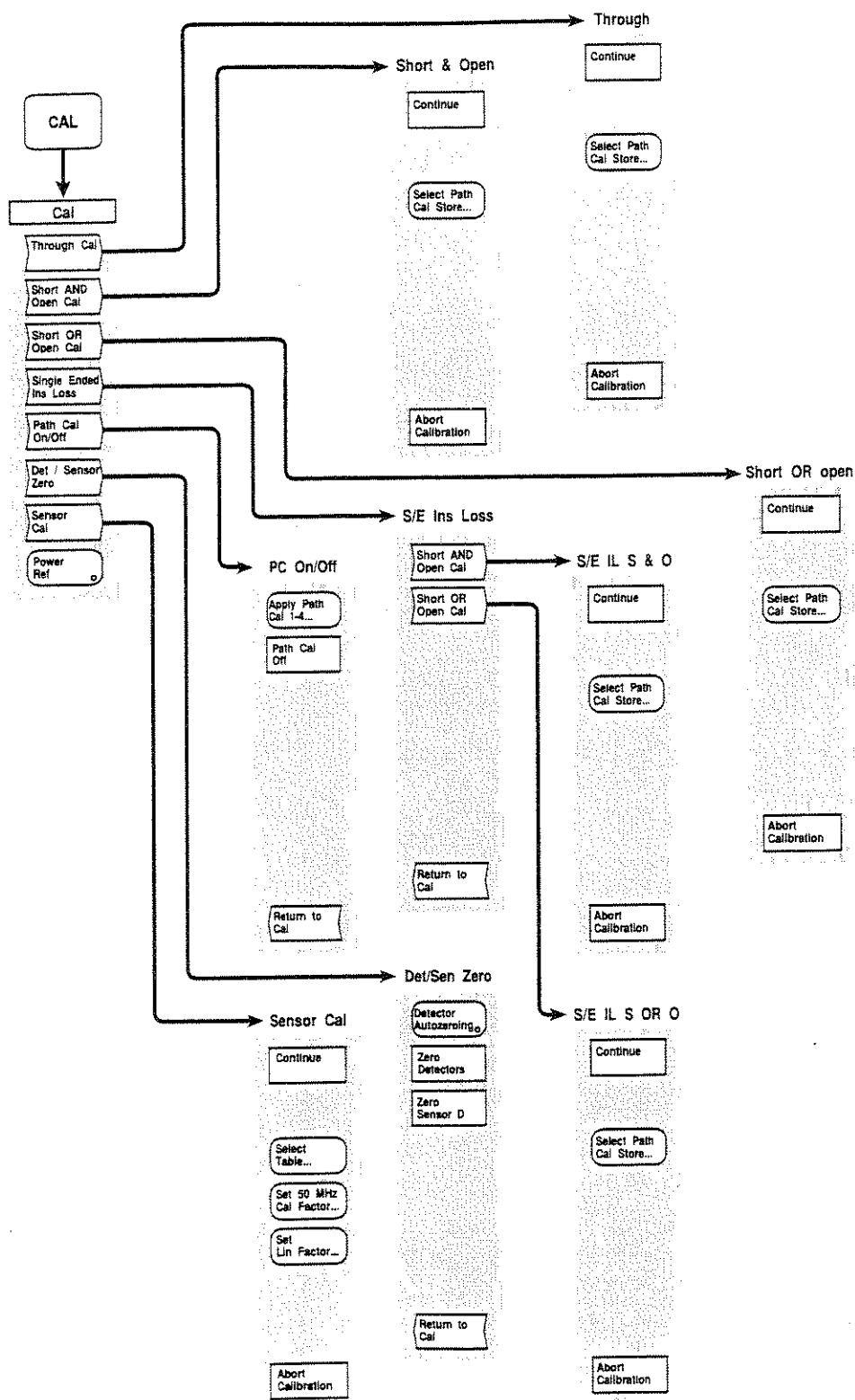

C3093

Fig. 3-27 CAL Menu - Scalar Channel

[FORMAT] KEY

The [FORMAT] key enables the active measurement in the active channel to be displayed in the required format; i.e. the units in which the response (vertical axis) is scaled. The options available depend upon the input configuration.

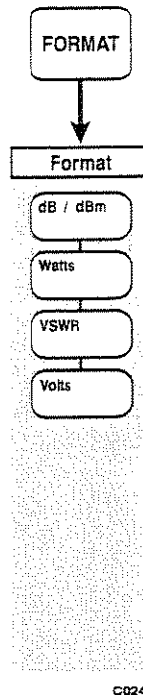

C0245

Fig. 3-28 FORMAT Menu - Scalar Channel

FORMAT**Format**

The soft keys in this menu enable the following display formats to be selected:

Linear: Watts, VSWR, Volts

Log: dB/dBm

The display format can be set up independently for each trace of the active channel. The formats permitted depends upon the measurement

dB / dBm

Selects dB/dBm format. The instrument will automatically select dB or dBm depending on whether the measurement is a ratio of inputs (i.e. relative power measurement) or a single input (i.e. absolute power measurement). The dB format is also selected if path calibration is applied or if the measurement is made relative to a memory.

This soft key will only be selectable for absolute or relative power measurements.

Watts

Selects Watts format.

This soft key will only be selectable for absolute power measurements.

FUNCTION
(SCALAR CHANNEL)

- VSWR** Selects VSWR format.
This soft key will only be selectable for relative power measurements (i.e. a ratio).
- Volts** Selects Volts format. The instrument displays the DC voltage output from the detector (or voltage adaptor cable).
This soft key will only be selectable for single input power measurements.

[SCALING] KEY

The [SCALING] key provides a menu which enables the user to adjust the positioning and scaling of the currently active trace in the currently active channel, or to allow the instrument to set the scaling automatically.

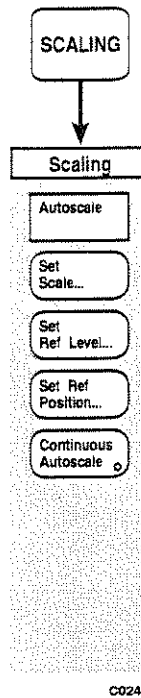

Fig. 3-29 SCALING Menu - Scalar Channel

SCALING

Scaling

This menu enables the user to set the reference level and scaling for a trace. The reference position is the position on the vertical axis that remains fixed during scaling. This is indicated on the screen by the Reference Position Indicator (see the 'Display' Section). The reference level is the value corresponding to the position of the Reference Position Indicator on the vertical scale, and is displayed in the relevant trace information area.

The default values for reference level and scaling factor for each type of format are listed below. Except for the VSWR format the default reference position in each case is the top graticule line.

Format	Reference Level	Scale Factor
dB and dBm	+20.0	10.0 dB(m)/div
VSWR*	1	0.1 /div
mW	100	10.0 mW/div
Volts	1	0.1 V/div
Linear Frequency	20.0 GHz	2.0 GHz/div

*Reference position is the bottom graticule line.

The parameters in this menu apply per trace.

Autoscale

Allows the instrument to determine optimum values of scale and reference level. The value chosen for the scale factor will be selected from a 1,2,5 sequence. The value chosen for the reference level will be a multiple of the scaling factor. The reference position will remain unchanged.

Set Scale

Used to set the scale factor for a trace.

dB/dBm Formats

Rotary Control	✓	Step Keys	✓	Numeric Pad	✓	Terminator	Any
----------------	---	-----------	---	-------------	---	------------	-----

VSWR, mV and Volts Formats

Rotary Control	✓	Step Keys	✓	Numeric Pad	✓	Terminator	10-
----------------	---	-----------	---	-------------	---	------------	-----

Linear Frequency Format

Rotary Control	✓	Step Keys	✓	Numeric Pad	✓	Terminator	10+
----------------	---	-----------	---	-------------	---	------------	-----

Set Ref Level

Used to set the reference level for a trace.

Numeric entry as above.

The reference level can also be set to the response measured at the active marker position, by pressing this soft key followed by the [x1] key on the numeric keypad.

Set Ref Position

Used to set the reference position for a trace. The reference position may be placed on any of the 11 horizontal lines on the graticule.

Rotary Control	✓	Step Keys	✓	Numeric Pad	×	Terminator	×
----------------	---	-----------	---	-------------	---	------------	---

Continuous Autoscale

Toggles continuous autoscale on or off, in which autoscaling will be performed automatically once per measurement update.

[MARKERS] KEY

The MTS can display up to eight markers per trace, with each marker identified by a number. Any one of these can be designated the active marker, indicated by a box around the number to distinguish it from the normal markers. The active marker can be moved along the x-axis using the step keys, rotary control or by keyboard entry. The step keys and keyboard entry are only available through the Position Active Mkr and Position Delta Mkr functions of the Markers Menu. The rotary control can be used to move the active marker at any time whilst it is displayed, provided that no other form of numeric entry is active. The domain value (x-axis position) of the active marker is displayed below the graticule, and the measured response at this position is displayed in the relevant trace information area.

The delta marker mode provides an additional marker, designated the delta marker, and is represented by Δ on the display. In this mode, the domain value of the active marker is relative to the delta marker position. The measured response is relative to the response at the delta marker position, i.e.

$$\begin{aligned}\text{Domain value} &= \text{Active Marker position} - \text{Delta Marker position} \\ \text{Response} &= \text{Active Marker response} - \text{Delta Marker response}\end{aligned}$$

The marker menus are shown in Fig. 3-31.

A tracking facility is available for the max/min, peak-to-peak and bandwidth functions. This enables the function to be automatically applied at each measurement update (i.e. at the end of each sweep).

MARKERS

Markers

This menu provides soft keys for setting up markers and using them to perform various types of measurement.

Active Mkr

Toggles the active marker on or off. Turning off the active marker also turns off the delta marker. Once the active marker is turned on it can be positioned anywhere along the graticule using the rotary control. To set the active marker to a specific domain value using the numeric keypad the [Position Active Mkr] soft key must be selected.

Place Mkr at Active

Used to place a marker at the active marker position by entering the required marker number.

Rotary Control Step Keys Numeric Pad Terminator None

This soft key will only be selectable if the active marker is turned on.

Position Active Mkr

Used to change the domain value (x-axis position) of the active marker, by entering the new value as follows:

Frequency

Rotary Control Step Keys Numeric Pad Terminator 10+

Power

Rotary Control Step Keys Numeric Pad Terminator Any

Voltage, Current

Rotary Control Step Keys Numeric Pad Terminator 10-

This soft key will only be selectable if the active marker is turned on.

Delta Mkr

Toggles the delta marker on or off. Turning on the delta marker also turns on the active marker.

Position Delta Mkr

Used to change the position of the delta marker, using the same method as for the active marker.

This soft key will only be selectable if the delta marker is turned on.

All Mkrs Off

Turns off all the markers for the currently active trace.

Mkr Functions

Leads to the Mkr Funcs Menu, which enables various measurement functions to be carried out by means of the active marker and delta marker.
See page 3-99.

Set Up Mkrs

Leads to the Set Up Mkrs Menu, which allows the user to activate and position selected markers.
See page 3-105

MARKERS

Mkr
FunctionsMkr Funcs

This menu leads to sub-menu for locating the maximum and minimum points on a trace, measuring the peak to peak ripple, searching for a specified response value and performing bandwidth measurements, and measuring the slope of a trace.

Marker to
Max Min

Leads to the Max Min Menu.
See page 3-100.

dB/Octave
dB/Decade

Leads to the dB/O dB/D Menu.
This soft key is only selectable if the domain is frequency, start frequency is < stop frequency, and format is dB/dBm.
See page 3-100.

Peak to
Peak

Leads to the Peak to Peak Menu, which enables measurement of peak to peak ripple.
This soft key is only selectable if the format is dB/dBm.
See page 3-101.

Search

Leads to the Search Menu, which is used to locate a response value on the trace.
See page 3-102.

Bandwidth

Leads to the Bandwidth Menu, which is used for bandwidth measurements.
This soft key is only selectable if format is dB/dBm, and the sweep type is frequency.
See page 3-103.

Find Next
Peak

Unselectable.

Return to
Markers

Returns control to the Markers Menu.

MARKERS

**Mkr Functions Marker to
Max Min**

Max Min

This menu is used to locate the maximum and minimum points on a trace.

When the tracking facility is turned on, the selected function is applied automatically at the end of each sweep, thus continually updating the maximum or minimum function.

**Active Mkr
to Maximum**

Moves the active marker to the maximum point on the displayed trace.

**Active Mkr
to Minimum**

Moves the active marker to the minimum point on the displayed trace.

**Tracking
Maximum**

Applies tracking to the maximum function.

**Tracking
Minimum**

Applies tracking to the minimum function.

**Tracking
Off**

Disables tracking.

**Return to
Markers**

Returns control to the Mkr Funcs Menu.

MARKERS

**Mkr Functions dB / Octave
dB / Decade**

dB/O dB/D

This menu enables the marker response to be set up to display the slope of the trace at the active marker position. This function applies per measurement.

dB/Octave

Enables the marker response to be displayed as dB per octave.

dB/Decade

Enables the marker response to be displayed as dB per decade.

Off

Restores normal marker response display.

**Return to
Mkr Funcs**

Returns control to the Mkr Funcs Menu.

MARKERS

Mkr Functions **Peak to Peak**

Peak to Peak

This menu enables measurement of the peak to peak ripple of a displayed trace. The system performs this function by enabling the delta mode and positioning the active marker and delta marker at the trace maximum and minimum respectively. A limit check can be performed on the peak to peak measurement by comparing it with a user-defined limit value.

When the tracking facility is turned on, the peak to peak function is applied automatically at the end of each sweep, thus continually updating the peak-to-peak measurement.

Find Pk - Pk

Initiates the peak to peak measurement and displays the result in a form overlaying the graticule. If limit checking is enabled, a pass/fail indication is also displayed in this form. The form is removed if there is any change in the trace or markers, or if the [ENTRY OFF] key is pressed.

Set Pk - Pk Limit Value

Used to set the limit value that the peak to peak measurement is to be checked against. A value in the range 0 to +99.99 dB can be entered.

Rotary Control	✓	Step Keys	✓	Numeric Pad	✓	Terminator	Any
----------------	---	-----------	---	-------------	---	------------	-----

Pk - Pk Limit Checking

Toggles limit checking on or off.

Tracking

Toggles the tracking function on and off.

Return to Mkr Funcs

Returns control to the Mkr Funcs Menu.

MARKERS

**Mkr
Functions Search**

Search

This menu is used for locating a response value on the trace that has previously been specified by the user. The search facility can also be used in delta marker mode.

**Search
Left**

Causes the system to search left from the current active marker position in order to find the response value specified with the [Set Search Value] soft key. The active marker will be placed at this position. If two adjacent measurement points encompass the search value, the active marker will be placed at the measurement point which is nearer to the search value. If the search value cannot be found, a message will be displayed indicating this, and the active marker will not be moved.

**Search
Right**

As above, but the search direction is right.

**Set Search
Value**

Sets the value that will be searched for.

dB/dBm formats

Rotary Control	✓	Step Keys	✓	Numeric Pad	✓	Terminator	Any
----------------	---	-----------	---	-------------	---	------------	-----

VSWR, mV and Volts formats

Rotary Control	✓	Step Keys	✓	Numeric Pad	✓	Terminator	10-
----------------	---	-----------	---	-------------	---	------------	-----

Linear Frequency format

Rotary Control	✓	Step Keys	✓	Numeric Pad	✓	Terminator	10+
----------------	---	-----------	---	-------------	---	------------	-----

**Return to
Mkr Funcs**

Returns control to the Mkr Funcs Menu.

MARKERS

**Mkr
Functions**

Bandwidth

Bandwidth

This menu enables the bandwidth to be determined corresponding to N dB points, where N can be a positive or negative value entered by the user.

If the search value is a negative dB value, pressing this soft key initiates both a right and left search simultaneously starting from the maximum point on the trace. If the search value is a positive dB value the searches are performed similarly, but starting from the minimum point on the trace. It is also possible to measure the bandwidth by starting the search from the active marker position.

If the bandwidth function is successful, marker number 7 will be placed at the lower frequency N dB point, and marker number 8 will be placed at the upper frequency N dB point. Fig. 3-30 shows the displayed results of a bandwidth measurement on a band-pass filter.

If the tracking facility is turned on, the bandwidth function is applied automatically at the end of each sweep, thus continually updating the bandwidth measurement.

**Bandwidth
Search**

Initiates the bandwidth search and displays the result in a form overlaying the graticule. The form is removed if there is any change in the measurement or markers, or if the [ENTRY OFF] key is pressed.

**Set n dB
Value**

Used to set the dB value for the bandwidth search.

Rotary Control	✓	Step Keys	✓	Numeric Pad	✓	Terminator	Any
----------------	---	-----------	---	-------------	---	------------	-----

**Display
CF/ΔF**

When this function is enabled, the ratio of centre frequency to bandwidth is displayed together with the bandwidth search result. This function applies instrument-wide.

**Search from
Max Min**

When this function is enabled, the bandwidth is measured by starting the search from a maximum or minimum point on the trace, depending on whether the search value is a negative or positive dB value.

**Search from
Active Mkr**

When this function is enabled, bandwidth is measured by starting the search from the active marker position.

Tracking

Toggles the tracking function on and off.

**Return to
Mkr Funcs**

Returns control to the Mkr Funcs Menu.

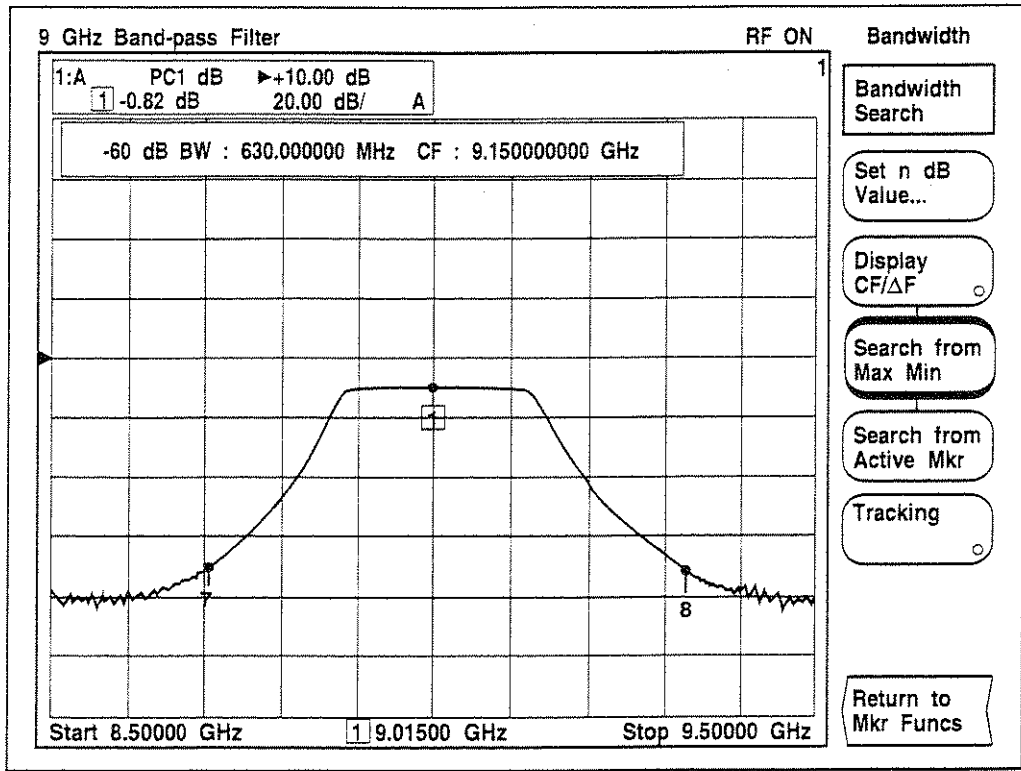

C1143

Fig. 3-30 Bandwidth Measurement of a Band-pass Filter

MARKERS**Set Up
Mkrs****Set Up Mkrs**

This menu enables selected markers to be turned on or off and positioned on the display, and allows one of the markers to be selected as the active marker. For frequency sweep measurements, the menu provides two alternative display resolutions for marker positions. A soft key is also provided to turn marker coupling between channels on or off.

**Assign Active
Mkr 1-8**

Used to select the marker which will act as the active marker.

Rotary Control	×	Step Keys	×	Numeric Pad	√	Terminator	None
----------------	---	-----------	---	-------------	---	------------	------

**Mkr 1-8
On**

Turns a selected marker on by entering the required marker number.

Rotary Control	×	Step Keys	×	Numeric Pad	√	Terminator	None
----------------	---	-----------	---	-------------	---	------------	------

**Mkr 1-8
Off**

Turns a selected marker off by entering the required marker number.

Rotary Control	×	Step Keys	×	Numeric Pad	√	Terminator	None
----------------	---	-----------	---	-------------	---	------------	------

**Position
Mkr 1-8**

Used to change the domain value (x-axis position) of a specified marker. A form is displayed on the screen containing numeric entry fields for the marker number and the marker position. The required marker is first selected, then its position is changed.

Marker Number

Rotary Control	×	Step Keys	×	Numeric Pad	√	Terminator	None
----------------	---	-----------	---	-------------	---	------------	------

Marker Position (Frequency Domain)

Rotary Control	√	Step Keys	√	Numeric Pad	√	Terminator	Any
----------------	---	-----------	---	-------------	---	------------	-----

Marker Position (Power Domain)

Rotary Control	√	Step Keys	√	Numeric Pad	√	Terminator	Any
----------------	---	-----------	---	-------------	---	------------	-----

Marker Position (Voltage or Current Domain)

Rotary Control	√	Step Keys	√	Numeric Pad	√	Terminator	10-
----------------	---	-----------	---	-------------	---	------------	-----

This soft key will only be selectable if at least one of the markers is turned on.

**6 Digits
Resolution**

Sets the displayed resolution for marker frequency information to six digits.
This soft key is only selectable when the domain is frequency.

**1 Hz
Resolution**

Sets the displayed resolution for marker frequency information to 1 Hz.
This soft key is only selectable when the domain is frequency.

**Mkr
Coupling**

Toggles marker coupling between channels on or off. When marker coupling is enabled, the positions (i.e. domain or x-axis values) of all markers on all traces will track the positions of the markers on the active trace of the active channel. When marker coupling is disabled, markers may be positioned independently on each channel. The default setting for marker coupling is on.
Marker coupling can only be disabled when channel coupling is switched off (Channel Mode Menu).

**Return to
Markers**

Returns control to the Markers Menu.



LOCAL OPERATION

FUNCTION
(SCALAR CHANNEL)

MARKERS

Fig. 3-31 MARKERS Menu - Scalar Channel

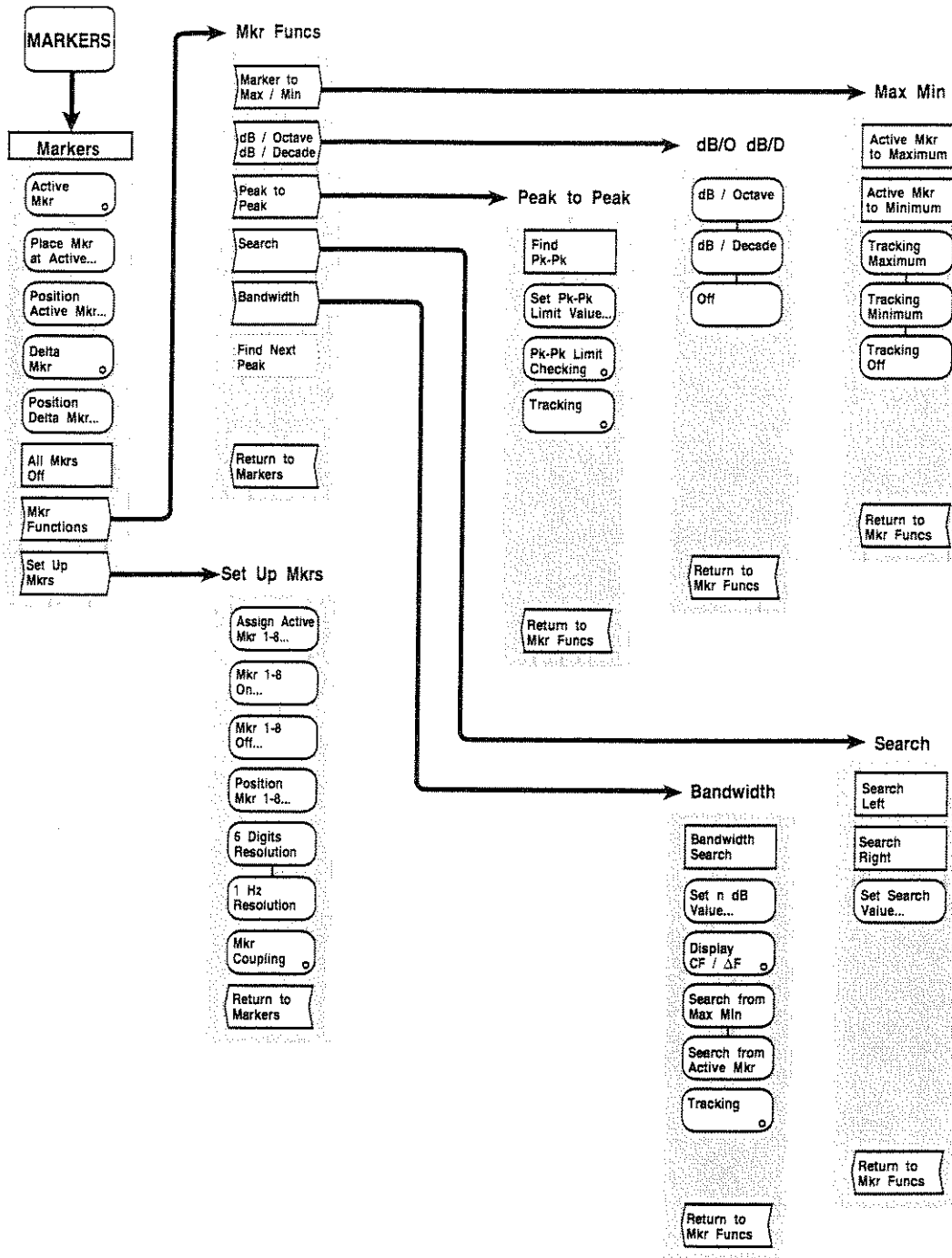

C1177

Fig. 3-31 MARKERS Menu - Scalar Channel

FUNCTION GROUP KEYS - READOUT CHANNEL

[SOURCE] KEY

The menus accessed by the [SOURCE] key are the same as for a scalar channel.

[MEASURE] KEY

The [MEASURE] key provides access to the series of menus illustrated in Figs. 3-33 to 3-36, which are used to define and set up the readout measurement and apply various functions to aid examination of the results.

The current values or states for the major measurement functions are displayed in specific locations on the screen (see 'Display' earlier in this chapter).

MEASURE

- Measure** See Fig. 3-33 This menu provides access to sub-menus for setting up the readout measurement and analyzing the results.
- Power Meter** When this soft key is pressed, the quantity that will be measured and displayed is the power level detected by a power sensor connected to Input D.
- Counter** When this soft key is pressed, the quantity that will be measured and displayed is the frequency of the signal present at the COUNTER input.
- dB Rel**
or
Frequency Rel This soft key is labelled [*dB Rel*] if the active measurement is a power meter reading, or [*Frequency Rel*] if it is a counter reading. When this soft key is pressed, the dB Rel Menu or Freq Rel Menu is presented which enables a measurement to be made relative to a value held in a relative measurement store.
See page 3-111.
- Averaging** Leads to the Averaging Menu, which enables averaging to be applied to power measurements.
This soft key will only be selectable for power meter readings.
See page 3-112.
- Restart Averaging** Restarts the averaging process. See also the Averaging Menu (Page 3-112).
- Reset Peak Indicator** Causes the peaking indicator to be reset such that the current power measurement will give half full scale reading.
This soft key is unselectable if the currently active readout is a frequency measurement or a difference measurement.
- Measurement Functions** Leads to the Meas Funcs Menu, which enables the basic measurement configuration to be set up.
See page 3-114.
- General Set-up** Leads to the Gen Set-up Menu, which enables the user to set up the input configuration and to compensate for detector/sensor characteristics.
See page 3-118.

MEASURE

dB
ReldB Rel

See Fig. 3-33. Enables a power measurement to be made relative to a value held in a relative measurement store (analogous to trace memory for swept measurements). This function applies per readout.

Store
Measurement

Causes the current readout measurement to be stored in the relative measurement store (this store is separate from the one used for relative frequency measurements). It will also turn on the relative measurement mode if it is off.

Relative
Meas

Toggles the relative measurement mode on or off, without affecting the contents of the relative measurement store. The relative measurement mode is indicated by an "R" flag above the displayed readout value, and is also indicated on hard copy output.

Return to
Measure

Returns control to the Measure menu.

MEASURE

Frequency
RelFreq Rel

See Fig. 3-33. Enables a frequency measurement to be made relative to a value held in a relative measurement store. This function applies per readout.

Store
Measurement

Causes the current readout measurement to be stored in the appropriate relative measurement store (this store is separate from the one used for relative power measurements). It will also turn on the relative measurement mode if it is off.

Relative
Meas

Toggles the relative measurement mode on or off, without affecting the contents of the relative measurement store. The relative measurement mode is indicated by an "R" flag above the displayed readout value, and is also indicated on hard copy output.

Return to
Measure

Returns control to the Measure menu.

MEASURE

Averaging

Averaging

See Fig. 3-33. Averaging is used to reduce the effects of noise on a power meter reading. The minimum amount of averaging should be selected to reduce noise to an acceptable level, in order to maintain a sufficiently fast response time.

Each new measurement is averaged into the previous average value until the measurement count is equal to the user-entered average number, for a fully averaged reading. This condition is indicated by the 'A' flag in the relevant readout information area. The flag is in lower case until this condition is reached. It is absent if the averaging function is turned off.

Note...

The averaging process can be re-started by using the [*Restart Averaging*] soft key in the MEASURE MENU.

**Input
A**

Leads to the Input A Menu, which enables averaging to be applied to input A.

**Input
B**

Leads to the Input B Menu, which enables averaging to be applied to input B.

**Input
C**

Leads to the Input C Menu, which enables averaging to be applied to input C.

**Input
D**

Leads to the Input D Menu, which enables averaging to be applied to input D.

**Return to
Measure**

Returns control to the Measure Menu.

MEASURE

Averaging **Input**
A (B, C or D)

Input A (B, C or D)

See Fig. 3-33. These menus are identical, and are used to apply averaging to the input, and to select the resolution to which the power meter reading is displayed.

The time taken for averaging to complete depends upon the resolution to which the readout is displayed. A choice of display resolutions is available, which provide a trade-off between resolution and averaging time (lower resolution gives faster averaging).

Automatic Averaging

Sets the averaging mode to automatic, in which the average number will be chosen automatically from a range of values depending on the power range being measured and the power sensor type. Averaging will restart automatically when the input power has deviated from the current average value by a certain amount. When automatic averaging is enabled, the MTS will, by default, display the highest resolution possible (0.001 dB).

0.01 dB Resolution

Selects 0.01 dB resolution for the readout.

0.1 dB Resolution

Selects 0.1 dB resolution for the readout.

1 dB Resolution

Selects 1 dB resolution for the readout.

User Set Averaging

Allows the user to enter the average number from the keyboard, using the *[Set Average Number]* soft key.

Averaging Off

Turns averaging off for the selected input.

Set Average Number

Enables selection of the average number to be used in the averaging function, by entering values in the range 1 to 1000.
This soft key will only be selectable if User Set Averaging has been selected.

Rotary Control	√	Step Keys	√	Numeric Pad	√	Terminator	Any
----------------	---	-----------	---	-------------	---	------------	-----

Return to Averaging

Returns control to the Averaging Menu.

MEASURE

**Measurement
Functions**

Meas Funcs

See Fig. 3-34. This menu is used to specify whether the system is to measure the absolute power level of a single input, the ratio of two input power levels or the difference between two input power levels.

**Single Input
A, B, C or D**

Leads to the Single Input Menu.
See page 3-115.

**Input
Ratio**

Leads to the Input Ratio Menu.
See page 3-115.

**Input
Difference**

Leads to the Input Diff Menu.
See page 3-116.

**Duty Cycle
Correction**

Leads to the Duty Cycle Menu, which enables duty cycle correction to be applied to power measurements when measuring the peak power of a pulsed signal.
This soft key will only be selectable for power meter readings.
See page 3-116.

**Limit
Checking**

Leads to the Lim Checking Menu, which enables measurements to be compared with user-defined maximum and minimum limits.
See page 3-117.

**Max Min
Hold**

Leads to the Max Min Hold Menu, which finds the maximum and minimum power or frequency readings over a period of time.
See page 3-117.

**Counter
Resolution**

Pressing this soft key leads to a sub-menu which is used to select the resolution to which the counter readout is displayed. The resolution can be set between 1 Hz and 100 MHz (in decades). The default setting is 100 kHz.

**Return to
Measure**

Returns control to the Measure Menu.

MEASURE

Measurement Functions	Single Input A, B, C or D
-----------------------	------------------------------

Single Input

See Fig. 3-34. Enables the power level at a selected input to be measured by pressing the appropriate soft key. The power level can be displayed in dBm or Watts, as selected from the Format Menu ([FORMAT] key).

- | | |
|-----------------------------|---|
| A | Selects input A for power measurement. |
| B | Selects input B for power measurement. |
| C | Selects input C for power measurement. |
| D | Selects input D for power measurement. |
| Return to Meas Funcs | Returns control to the Meas Funcs Menu. |

MEASURE

Measurement Functions	Input Ratio
-----------------------	-------------

Input Ratio

See Fig. 3-34. Enables the ratio of the power levels at two of the inputs to be measured by selecting the appropriate soft keys. The power ratio can be displayed in dB or as a percentage, as selected from the Format Menu

- | | |
|-----------------------------|---|
| A / | Selects input A as the numerator of the desired power ratio measurement. Selecting the numerator leads to a sub-menu where the denominator is chosen (B, C or D). |
| B / | Selects input B as the numerator of the desired power ratio measurement. Selecting the numerator leads to a sub-menu where the denominator is chosen (A, C or D). |
| C / | Selects input C as the numerator of the desired power ratio measurement. Selecting the numerator leads to a sub-menu where the denominator is chosen (A, B or D). |
| D / | Selects input D as the numerator of the desired power ratio measurement. Selecting the numerator leads to a sub-menu where the denominator is chosen (A, B or C). |
| Return to Meas Funcs | Returns control to the Meas Funcs Menu. |

MEASURE

Measurement Functions Input Difference

Input Diff

See Fig. 3-35. Enables the difference between the power levels at two of the inputs to be measured by selecting the appropriate soft keys. The power difference can be displayed in Watts only.

A – Selects input A as the minuend of the differential measurement. Selecting the minuend leads to a sub-menu where the subtrahend is chosen (B, C or D).

B – Selects input B as the minuend of the differential measurement. Selecting the minuend leads to a sub-menu where the subtrahend is chosen (A, C or D).

C – Selects input C as the minuend of the differential measurement. Selecting the minuend leads to a sub-menu where the subtrahend is chosen (A, B or D).

D – Selects input D as the minuend of the differential measurement. Selecting the minuend leads to a sub-menu where the subtrahend is chosen (A, B or C).

Return to Meas Funcs Returns control to the Meas Funcs Menu.

MEASURE

Measurement Functions Duty Cycle Correction

Duty Cycle

See Fig. 3-34. The power meter measures the average power of a signal. To measure the peak power of a pulsed signal, correction must be applied to compensate for the duty cycle of the waveform. The MTS calculates the peak power using:

$$\text{Peak Power} = \text{Average Power} \times 100 / \text{Duty Cycle}$$

If duty cycle correction is enabled, the current duty cycle value will be displayed.

Duty Cycle

Toggles duty cycle correction on or off for the currently active power meter measurement.

Set Duty Cycle Value

Used to set the duty cycle correction value for the currently active power meter measurement.

Rotary Control	✓	Step Keys	✓	Numeric Pad	✓	Terminator	Any
----------------	---	-----------	---	-------------	---	------------	-----

Return to Meas Funcs

Returns control to the Meas Funcs Menu.

MEASURE

Measurement Functions Limit Checking

Lim Checking

See Fig. 3-34. This menu is used to check the measurement against preset maximum and minimum limits held in store. When limit checking is enabled, each new measurement is compared with both limits. A window is displayed above the relevant readout value showing the pass/fail status of the current measurement. The maximum and minimum limit values are displayed to the left of the readout. The pass/fail window and limit values are not displayed if limit checking is turned off for that readout.

Limit Checking

Toggles limit checking on or off for the currently active readout.

Set Max Limit

Used to change the maximum limit value for the currently active readout. The new value is entered as follows:

Frequency

Rotary Control	✓	Step Keys	✓	Numeric Pad	✓	Terminator	10+
----------------	---	-----------	---	-------------	---	------------	-----

Watts

Rotary Control	✓	Step Keys	✓	Numeric Pad	✓	Terminator	10-
----------------	---	-----------	---	-------------	---	------------	-----

dB, dBm, Percentage

Rotary Control	✓	Step Keys	✓	Numeric Pad	✓	Terminator	Any
----------------	---	-----------	---	-------------	---	------------	-----

Set Min Limit

As above but applies to the minimum limit.

Return to Meas Funcs

Returns control to the Meas Funcs Menu.

MEASURE

Measurement Functions Max Min Hold

Max Min Hold

See Fig. 3-34. Provides a facility which finds and stores the maximum and minimum power or frequency readings over a period of time. When this function is enabled, each new measurement is compared with both stores. If the new measurement is less than that held in the min hold store or greater than that held in the max hold store, the store will be overwritten by the new measurement. This function applies per readout.

Hold

Toggles the max/min hold facility on or off.

Clear

Causes both the min hold and max hold stores to be set to the current measurement.

Return to Meas Funcs

Returns control to the Meas Funcs Menu.

MEASURE

**General
Set-up**

Gen Set-up

See Fig. 3-36. This menu enables the user to set up the input configuration and to compensate for non-ideal characteristics of detectors and sensors.

**Input
Configuration**

Leads to the Input Config Menu, which is used to set up the input configuration for the measurement.
See page 3-119.

**Domain Scale
& Offset**

This soft key is unselectable.

**Detector
Correction**

Leads to the Select Input Menu, which is used to compensate for non-ideal detector characteristics.
See page 3-120.

**Sensor
Correction**

Leads to the Sensor Corr Menu, which is used to apply cal factor and linearity correction for the power sensor connected to the D input.
*This soft key will only be selectable if Input D is configured for a power sensor.
See page 3-67.*

**Det / Sensor
Specs**

Leads to the Edit Specs Menu, which is used to modify detector correction specifications or sensor calibration data tables.
See page 3-69.

**AC
Detection**

Unselectable for a readout channel.

**DC
Detection**

Unselectable for a readout channel.

**Return to
Measure**

Returns control to the Measure Menu.

MEASURE

**General
Set-up**

**Input
Configuration**

Input Config

See Fig. 3-36. This menu provides the following functions for setting up the configuration of the four inputs.

**All Inputs
are Scalar**

Configures all four inputs A, B, C and D to accept scalar detectors.

**Input D is
Power Sensor**

Configures inputs A, B and C to accept scalar detectors and input D to accept power meter sensor.

**Input A
Offset**

Enables the offset for Input A to be changed.

Rotary Control	×	Step Keys	×	Numeric Pad	√	Terminator	Any
----------------	---	-----------	---	-------------	---	------------	-----

**Input B
Offset**

Enables the offset for Input B to be changed.

Rotary Control	×	Step Keys	×	Numeric Pad	√	Terminator	Any
----------------	---	-----------	---	-------------	---	------------	-----

**Input C
Offset**

Enables the offset for Input C to be changed.

Rotary Control	×	Step Keys	×	Numeric Pad	√	Terminator	Any
----------------	---	-----------	---	-------------	---	------------	-----

**Input D
Offset**

Enables the offset for Input D to be changed.

Rotary Control	×	Step Keys	×	Numeric Pad	√	Terminator	Any
----------------	---	-----------	---	-------------	---	------------	-----

**View Current
Configuration**

Displays a form on the screen showing the detector or sensor type connected to each input, and whether manual or automatic correction will be applied (see Select Input Menu, page 3-65). Pressing the [Return to Input Config] soft key returns control to the Input Config Menu.

**Return to
Gen Set-up**

Returns control to the Gen Set-up Menu.

MEASURE

General
Set-up

Detector
Correction

Select Input

See Fig 3-36. This menu is the same as the Select Input Menu for a scalar channel (see page 3-65).

MEASURE

General
Set-up

Detector
Correction

Input
A (B,C or D)

Input A (B, C or D)

See Fig 3-36. This menu is the same as the Input A (B, C or D) menu for a scalar channel (page 3-66) except that the [Flatness Correction] soft key leads to a further sub-menu.

Correction
Auto Sense

Sets the detector correction mode for the selected input to automatic.

Correction
User Set

Enables manual entry of the detector type, by using the [Set Detector Type] soft key.

Correction
Off

Turns off detector correction.

Set Detector
Type

Selects the type of detector that is to be corrected. When this soft key is pressed, a table is displayed listing all the possible detector types and their identity numbers (Fig. 3-20).

Four entries in the table are reserved for user-specified values of sensitivity factor and power factor. These values can be set using the Edit Specs Menu (page 3-69).

This soft key is only selectable if manual entry of the detector type has been selected ([Correction User Set] soft key).

Rotary Control × Step Keys × Numeric Pad √ Terminator Any

Set Detector Type	
1 :6511	9 :Reserved
2 :6512	10 :Reserved
3 :6513	11 :Reserved
4 :6514	12 :USER1
5 :6230	13 :USER2
6 :6233	14 :USER3
7 :6234	15 :USER4
8 :Reserved	
Detector Number :1	

C0775

Fig. 3-32 Detector Types Table

Linearity Calibration	When this soft key is pressed, the user is prompted to connect the detector to be calibrated to the POWER REF output and press the <i>[Continue]</i> soft key when ready. If the detector is not an EEPROM type the calibration will be aborted and an error message displayed. A detector zero is automatically performed, followed by the calibration of the detector. The user is informed when calibration data has been acquired. After verification, the cal data is written to the detector EEPROM and applied to the measurement immediately. The <i>[Abort Calibration]</i> soft key is used to terminate the calibration process at any time; the original EEPROM data will not be affected.
Temperature Correction	This soft key has a toggle action and is used to enable/disable scalar detector temperature correction. When enabled, temperature correction will apply to detectors for which temperature correction is available (e.g. the 6230 series). This function applies per input.
Flatness Correction	Leads to the Inp A (B, C or D) Flat Corr Menu below.
Return to Select Input	Returns control to the Select Input Menu.

MEASURE

General Set-up	Detector Correction	Input A (B,C or D)	Flatness Correction
-----------------------	----------------------------	---------------------------	----------------------------

Input A (B, C or D) Flat Corr

See Fig 3-36. Flatness correction (frequency response) data for individual 6230A/L Series detectors are stored in an EEPROM within the detector. This menu enables flatness correction to be applied for the frequency at which the power measurement is made.

In order that flatness correction can be applied using the EEPROM data, it is necessary to know the frequency at which the power measurement is being made. The following options are provided:

- Manual entry of frequency
- Frequency read from the counter
- Frequency defined by the source

If a counter is used to define the frequency, at least one readout must be configured for frequency measurement. A counter reading will be taken and stored once per measurement update. If a reading cannot be obtained for any reason, the most recent counter reading or manually entered frequency will be used.

If the source is used to define the frequency, channel coupling must be on. The frequency used will depend on the source mode. If the source mode is CW or a power sweep, the CW frequency will be used. If the source mode is a swept frequency, the position of the active marker is used to define the frequency.

Flatness Corr User Freq

Enables manual entry of the flatness correction frequency by using the *[Set frequency]* soft key.

Flatness Corr Counter Freq

Applies a flatness correction factor which corresponds the frequency measured by the counter.
This soft key is only selectable if at least one of the other measurements is a counter measurement.

**Flatness Corr
Source Freq**

Applies a flatness correction factor which corresponds to the frequency of the source.

**Set
Frequency**

Used to change the frequency value that is used to obtain the flatness correction factor.
This soft key is only selectable if manual entry of the flatness correction frequency has been selected by using the [Flatness Corr User Freq] soft key).

Rotary Control	√	Step Keys	√	Numeric Pad	√	Terminator	10 ⁺
----------------	---	-----------	---	-------------	---	------------	-----------------

**Flatness
Correction**

This soft key has a toggle action and is used to enable/disable flatness correction. When enabled, flatness correction will apply to detectors for which flatness correction is available (e.g. 6230A and 6230L Series).

**Return to
Input A (B, C or D)**

Returns control to the Input A (B, C or D) Menu.

FUNCTION
(READOUT CHANNEL)

MEASURE

Fig. 3-32 MEASURE Menus - Readout Channel (Sheet 1)

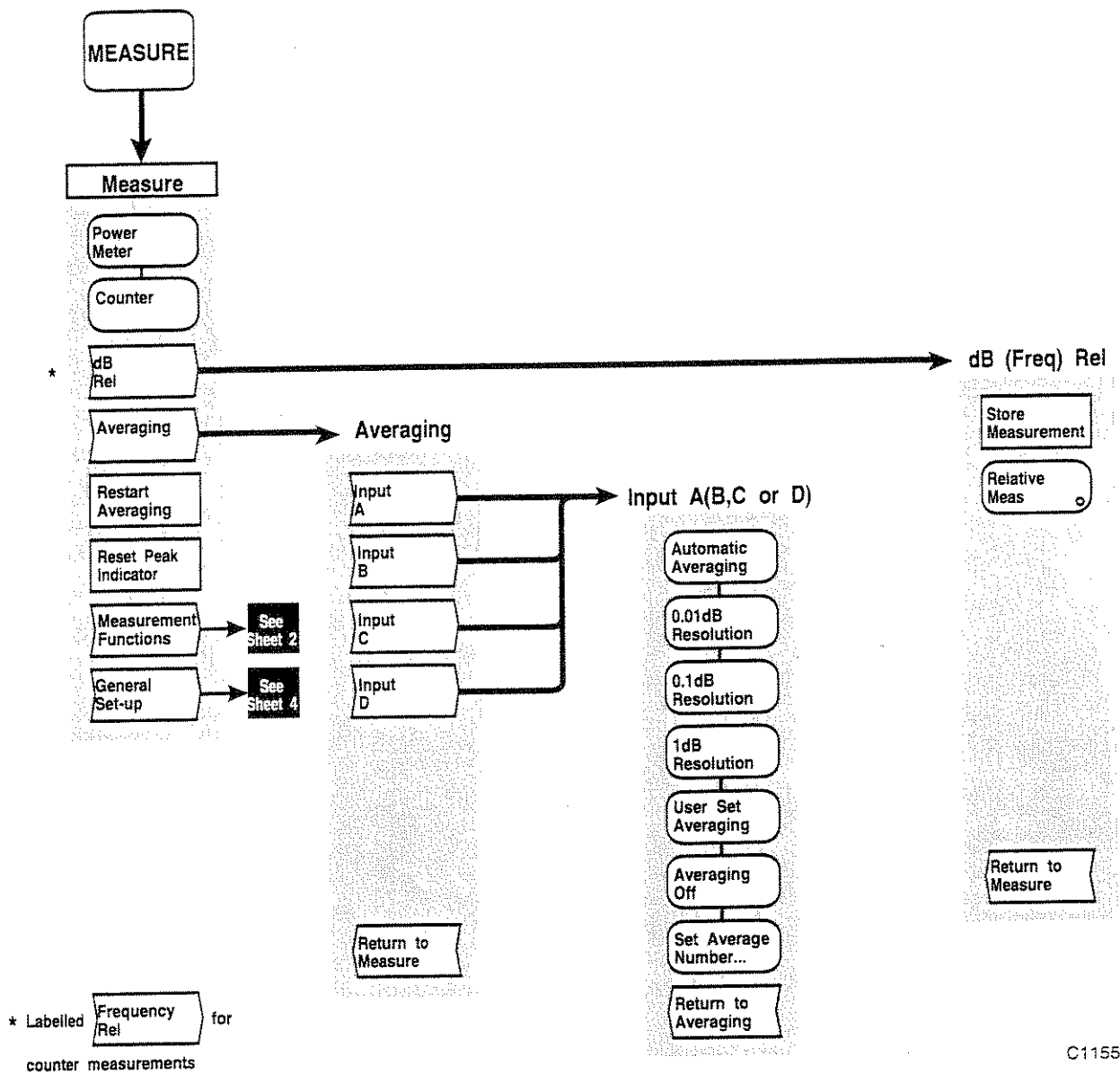

C1155

Fig. 3-32 MEASURE Menus - Readout Channel (Sheet 1)

LOCAL OPERATION

FUNCTION
(READOUT CHANNEL)

MEASURE

Fig. 3-33 MEASURE Menu - Readout Channel (Sheet 1)

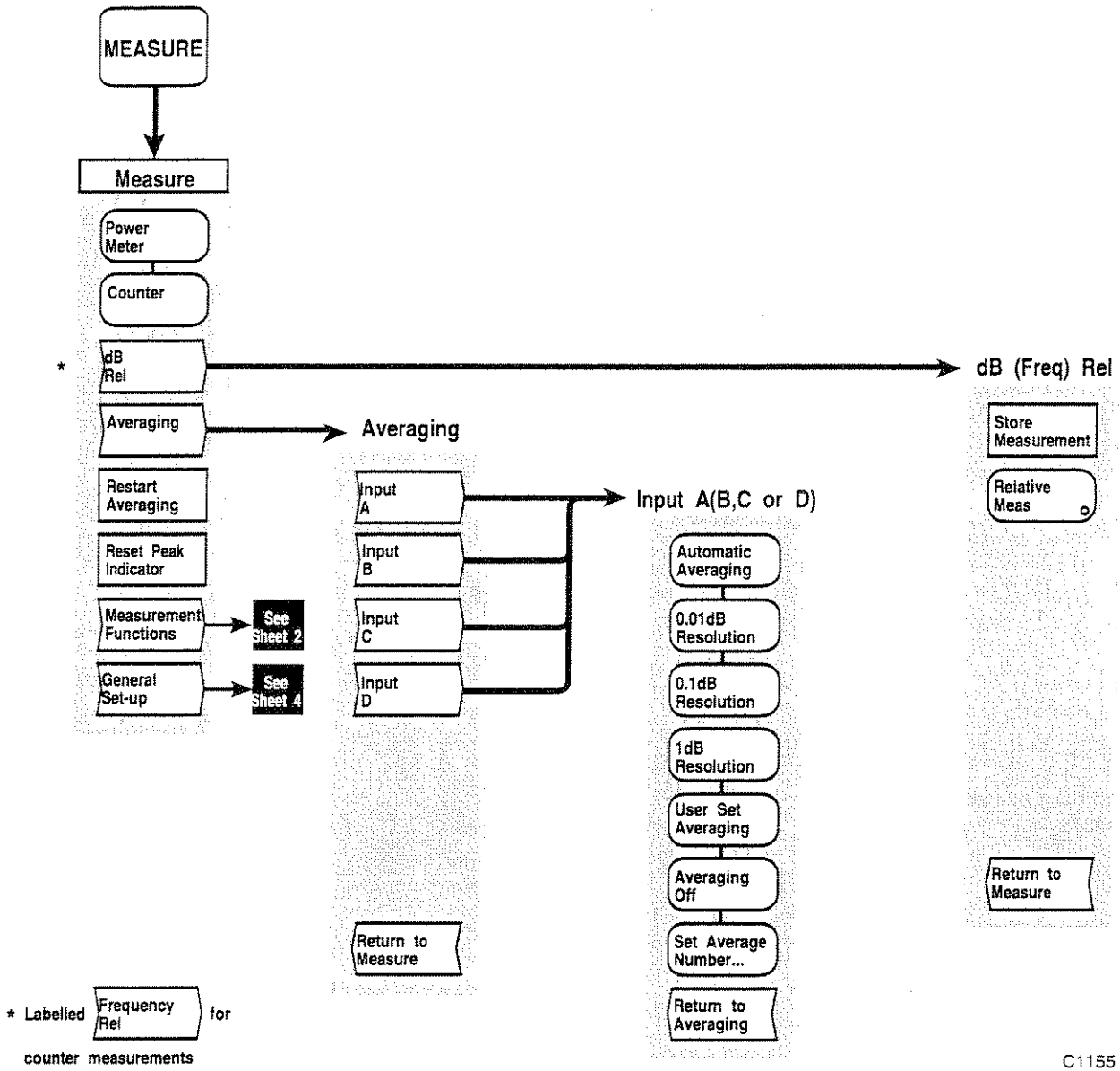

C1155

Fig. 3-33 MEASURE Menus - Readout Channel (Sheet 1)

LOCAL OPERATION

FUNCTION
(READOUT CHANNEL)

MEASURE

Measurement
Functions

Fig. 3-34 MEASURE Menus - Readout Channel (Sheet 2)

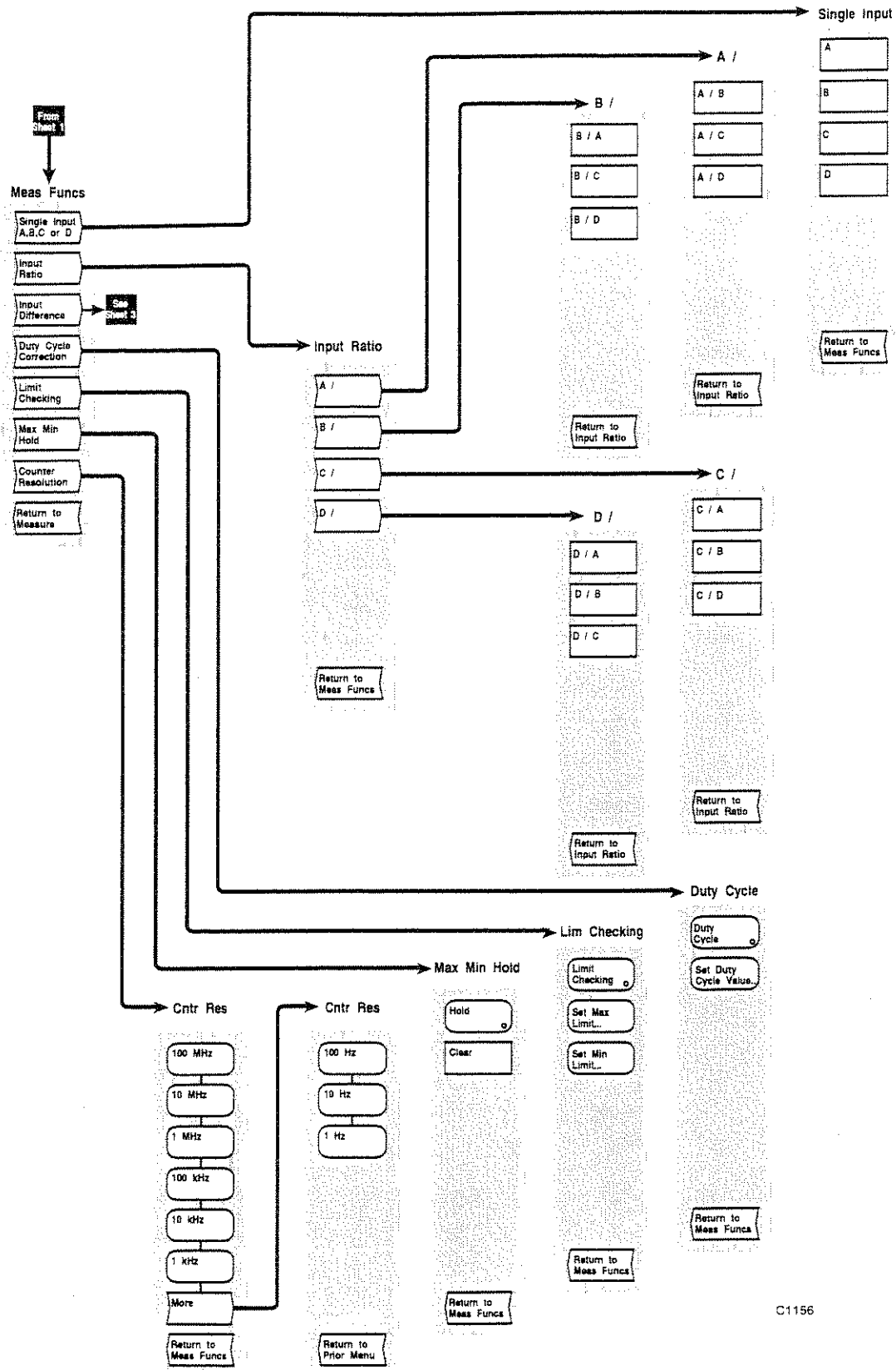

C1156

Fig. 3-34 MEASURE Menus - Readout Channel (Sheet 2)

MEASURE

**Measurement
Functions**

**Input
Difference**

Fig. 3-35 MEASURE Menus - Readout Channel (Sheet 3)

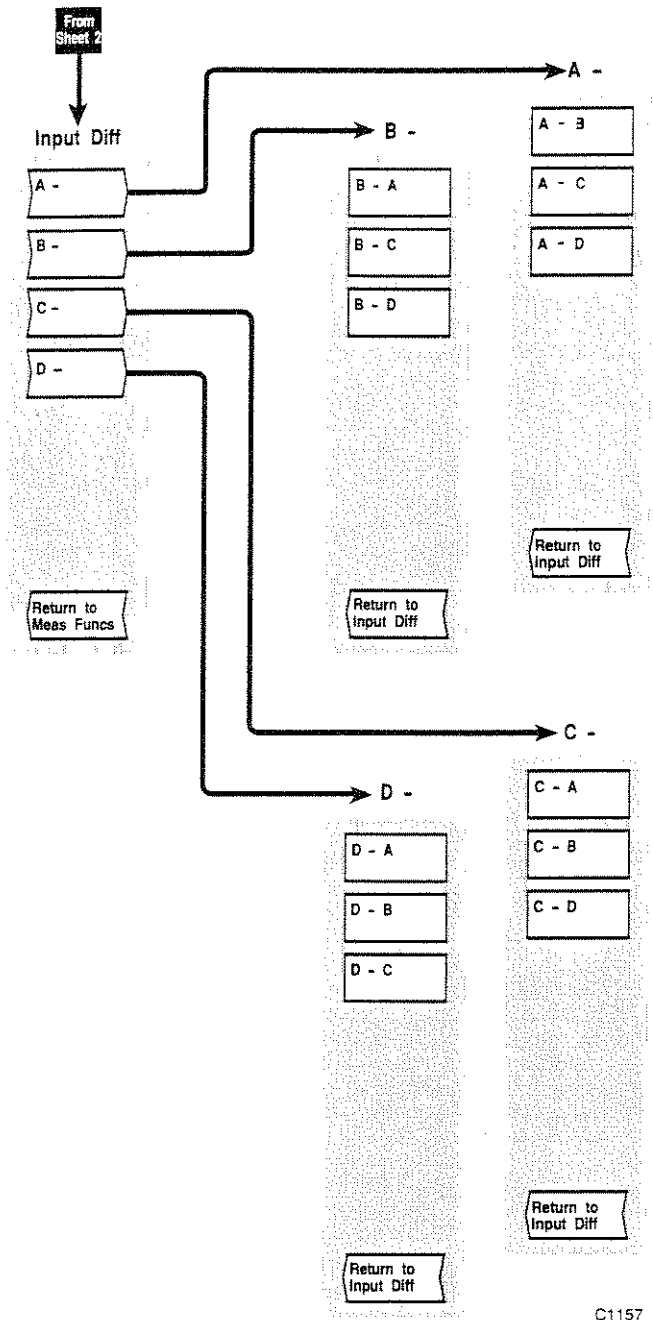

C1157

Fig. 3-35 MEASURE Menus - Readout Channel (Sheet 3)

MEASURE

**General
Set-up**

Fig. 3-36 MEASURE Menus - Readout Channel (Sheet 4)

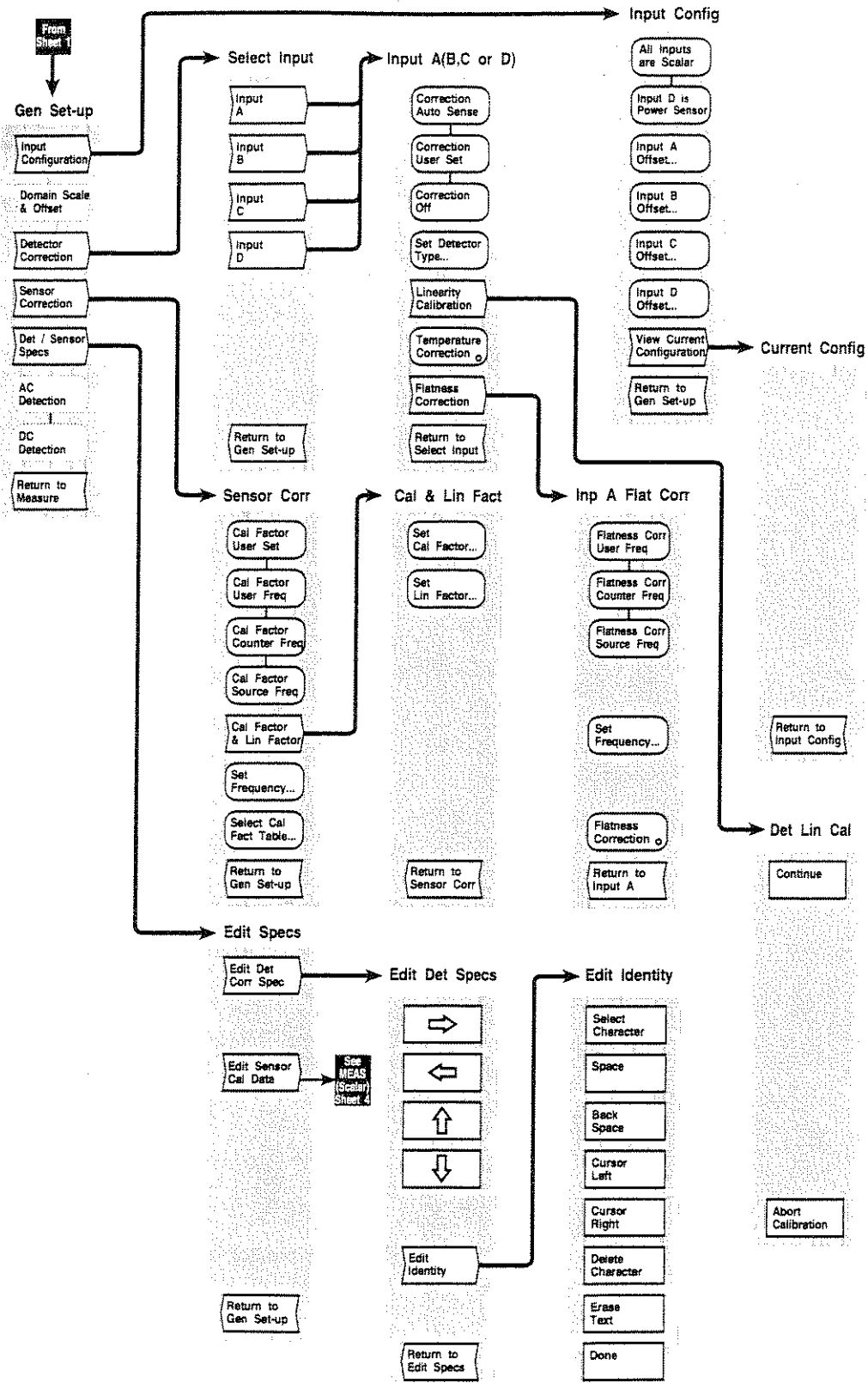
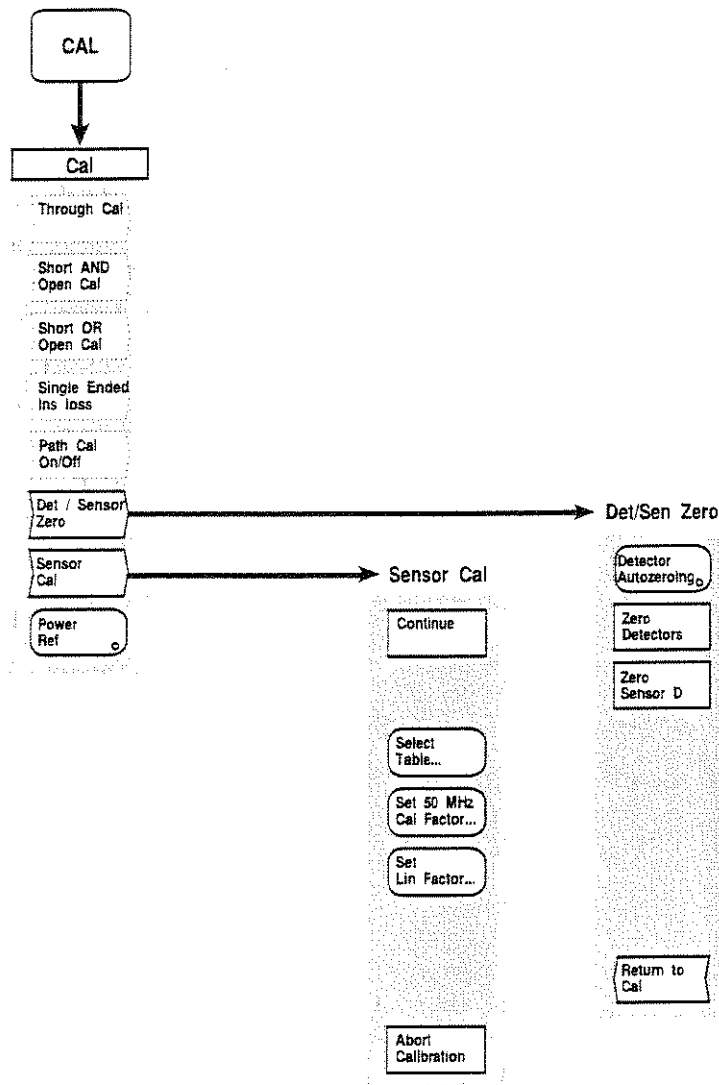

Fig. 3-36 MEASURE Menus - Readout Channel (Sheet 4)

[CAL] KEY

The [CAL] key is used to perform a power sensor calibration for a readout channel. Power sensor calibration utilises the 50 MHz, 1 mW power reference output available from the front panel POWER REF connector. A sensor is calibrated by connecting it to the power reference output (via a 30 dB attenuator for 6920 series sensors) and pressing the [Sensor Cal] soft key. The system measures the difference between the sensor and reference outputs and uses this to correct subsequent measurements. The power reference will be switched on and off automatically as required by the calibration process.



C3092

Fig. 3-37 CAL Menu - Readout Channel

CAL

Cal

This menu is used for detector/sensor zeroing and sensor calibration.

The first five soft keys in this menu are unselectable for a readout channel; only the three selectable soft keys are described here.

**Det / Sensor
Zero**

Leads to the Det/Sen Zero Menu, which is used for zeroing detectors/sensors.
See page 3-88.

**Sensor
Cal**

Leads to the Sensor Cal Menu, which is used to zero the power sensor and to calibrate it against the reference.
*This soft key will only be selectable if Input D is configured for a power sensor.
See page 3-89*

**Power
Ref**

Toggles the power reference output on and off. When it is turned on, the front panel POWER REF connector provides a 50 MHz 0 dBm power reference output. The reference can be used, for example, to verify that the power sensor is functioning correctly. The Power Reference On indicator (PWRREF) will be present in the General Information Area at the top of the screen if a power reference signal is being output.

[FORMAT] KEY

The [FORMAT] key enables the active measurement in the active channel to be displayed in the required format. The options available depend upon the input configuration.

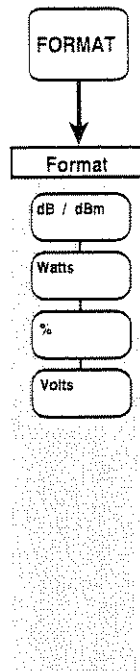

C1180

Fig. 3-38 FORMAT Menu - Readout Channel

FORMAT

Format

The soft keys in this menu enable linear (Watts or %) or log (dB/dBm) display formats to be selected.

dB / dBm

Selects dB/dBm format. The instrument will automatically select dB or dBm depending on whether the measurement is a ratio of inputs (i.e. relative power measurement) or a single input (i.e. absolute power measurement).

This soft key will only be selectable for absolute or relative power measurements.

Watts

Selects Watts format.

This soft key will only be selectable for absolute power or power difference measurements.

%

Selects percentage format.

This soft key will only be selectable for relative power measurements.

Volts

Selects Volts format. The instrument displays the DC voltage output from the detector (or voltage adaptor cable).

This soft key will only be selectable for single input power measurements.

FUNCTION
(READOUT CHANNEL)



FUNCTION GROUP KEYS - FAULT LOCATION CHANNEL

[SOURCE] KEY

The [SOURCE] key provides access to the series of menus illustrated in Fig. 3-39, which are used to define and control all the source functions for a fault location channel.

Due to the nature of the measurement the user does not have full control of the source for a fault location channel, other than setting the output power level, resulting in a simplified source menu, as described below. The parameters for setting the start and stop frequencies of the sweep and the number of measurement points are accessed via the fault location Measure menus.

SOURCE

Source This menu enables the operator to set up the source for fault location measurements on coaxial or waveguide transmission lines. Unlike the scalar and readout channels there is only one source menu for fault location measurements.

Set Output Power Used to change the output power of the source for the currently active channel.

Rotary Control	√	Step Keys	√	Numeric Pad	√	Terminator	Any
----------------	---	-----------	---	-------------	---	------------	-----

Sweep Time Leads to the Sweep Time Menu, which enables the sweep time to be set up manually or automatically.
See page 3-34.

RF Toggles the RF output on or off for the currently active channel.

Source Functions Leads to the Source Funcs Menu, which enables several options to be selected, allowing the source to be set up according to the requirements of a particular measurement. The Source Funcs Menu is the same as that for scalar and readout channels, except that the *[Int/Ext Source]* and *[Source Only Mode]* soft keys are not present.
See page 3-36.

LOCAL OPERATION

FUNCTION
(FAULT LOCATION CHANNEL)

SOURCE

Fig. 3-39 SOURCE Menus - Fault Location Channel

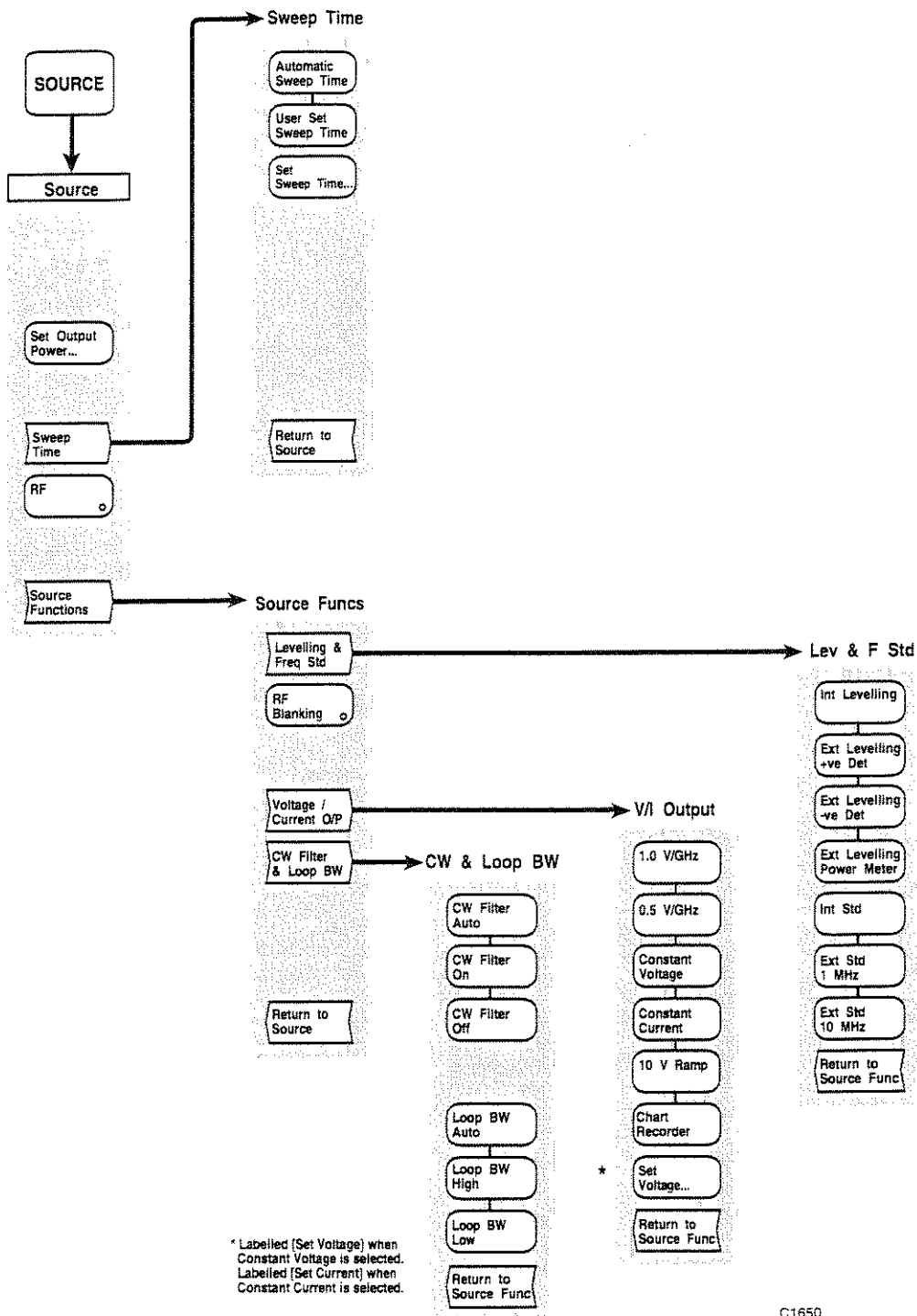

Fig. 3-39 SOURCE Menus - Fault Location Channel

C1650

[MEASURE] KEY

The [MEASURE] key provides access to the series of menus illustrated in Fig. 3-44 and Fig. 3-47 which are used to define and set up the fault location measurement, and apply various functions to aid examination of the results.

The current values or states for the major measurement functions are displayed in specific locations on the (see 'Display', page 3-14).

Values for cutoff frequency, relative velocity and attenuation can be set directly using the Set Parameters Menu, or the instrument can set up these parameters from data contained in a transmission line database (see the Access Dbase Menu, page 3-146).

MEASURE

Measure	See Fig. 3-44
Configure Fault Loc	Leads to the Config F Loc Menu. <i>This key is only selectable if Measurement 1 is active.</i> See page 3-141.
Set Up Measurement	Leads to the Set Up Meas Menu. <i>This key is only selectable if Measurement 1 is active.</i> See page 3-143.
Averaging	Leads to the Averaging Menu, which enables averaging to be applied to the measurement data. <i>This soft key is only selectable if Measurement 1 is active.</i> See page 3-54.
Restart Averaging	Restarts the averaging process. <i>This key is only selectable if Measurement 1 is active.</i> See also the Averaging Menu (page 3-54).
Recall Cal Conditions	Recalls the measurement conditions that were present when the fault location calibration was performed.
Fault Loc Functions	Leads to the F Loc Funcs Menu. <i>This key is only selectable if Measurement 1 is active.</i> See page 3-155.
General Set-up	Leads to the Gen Set-up Menu. This is the same as for a scalar channel, except that the [Domain Scale & Offset] soft key is unselectable. <i>This key is only selectable if Measurement 1 is active.</i> See page 3-62.

MEASURE

Configure Fault Loc

Config F Loc

See Fig. 3-44

Range
Entry

Sets the entry mode to 'range entry' (see page 3-143).

Frequency
Entry

Sets the entry mode to 'frequency entry' (see page 3-143).

Coax
MediumSets the medium to coax.
*This soft key will not be selectable if the transmission line database is on.*Waveguide
MediumSets the medium to waveguide.
*This soft key will not be selectable if the transmission line database is on.*Display Units
Metres

Sets the distance units to metres. This applies instrument-wide.

Display Units
Feet

Sets the distance units to feet. This applies instrument-wide.

Measurement
DefinitionLeads to the Meas Def Menu.
*See page 3-141.*Return to
Measure

Returns control to the Measure Menu.

MEASURE

Configure Fault Loc

Measurement Definition

Meas Def

See Fig. 3-45. Enables the ratio of the power levels at two of the inputs to be measured by selecting the appropriate soft keys.

A ration of B/C is required when making a fault location measurement using a Test Head.

The instrument defaults to a ratio of B/C.

It will not be possible to select input D if it is configured to be a power meter sensor input.

Single Input
A, B, C or DLeads to the Single Input Menu.
*See page 3-142*Input
RatioLeads to the Input Ratio Menu
*See page 3-142*Return to
Config F Loc

Return control to the Config. F Loc Menu.

MEASURE

Configure Fault Loc	Measurement Definition	Single Input A, B, C or D
--------------------------------	-----------------------------------	--------------------------------------

Single Input

See Fig. 3-45. Enables the power level of a selected input to be measured by pressing the appropriate soft key. A single input measurement needs to be specified when using a divider/detector instead of a Test Head.

It will not be possible to select input D if it is configured to be a power sensor input.

- A** Selects input A for the measurement.
- B** Selects input B for the measurement.
- C** Selects input C for the measurement.
- D** Selects input D for the measurement.
- Return to
Meas Def** Returns control to the Meas Def Menu.

MEASURE

Configure Fault Loc	Measurement Definition	Input Ratio
--------------------------------	-----------------------------------	------------------------

Input Ratio

See Fig. 3-45. Enables the ratio of the power levels at two of the inputs to be measured by selecting the appropriate soft keys.

A ratio of B/C is required when making a fault location measurement using a Test Head.

The instrument defaults to a ratio of B/C.

It will not be possible to select input D if it is configured to be a power meter sensor input.

- A /** Selects input A as the numerator of the desired power ratio measurement. Selecting the numerator leads to a sub-menu where the denominator is chosen (B, C or D).
- B /** Selects input B as the numerator of the desired power ratio measurement. Selecting the numerator leads to a sub-menu where the denominator is chosen (A, C or D).
- C /** Selects input C as the numerator of the desired power ratio measurement. Selecting the numerator leads to a sub-menu where the denominator is chosen (A, B or D).
- D /** Selects input D as the numerator of the desired power ratio measurement. Selecting the numerator leads to a sub-menu where the denominator is chosen (A, B or C).
- Return to
Meas Def** Returns control to the Meas Def Menu.

MEASURE

Set Up
MeasurementSet Up Meas

See Fig. 3-46 This menu enables the basic measurement configuration to be set up for fault location measurements.

A form is displayed on the screen (Fig. 3-40) showing the current values for the fault location measurement definition.

Set Up Measurement	
Range	: 100.000 m
Center Frequency	: 10.000000000 GHz
Start Frequency	: 9.850198145 GHz
Stop Frequency	: 10.149801854 GHz
Cutoff Frequency	: -
Relative Velocity	: 1.000
Number of Points	: 401

Fig. 3-40 Fault Location Parameters

The soft keys displayed in the first two positions depend upon whether the channel is in 'range entry' or 'frequency entry' mode, and whether the transmission medium is coax or waveguide, as selected in the Config F Loc Menu.

In the range entry mode (the default mode), the range is entered and this determines the frequency span over which the source is swept. The system adjust the centre frequency to the centre of the span previously set. A different band of frequencies may be chosen by adjusting the centre frequency, but the value of span (and hence range) will always be preserved. In the frequency entry mode, a frequency span can be entered by adjusting the start/stop values. The range will then be calculated from the entered span.

If waveguide medium has been selected from the Config F Loc Menu, the [*Set Cutoff Frequency*] soft key will be selectable (this is not required for coax medium).

If coax medium has been selected from the Config F Loc Menu, the [*Set Relative Velocity*] soft key will be selectable (this is not required for waveguide medium).

Note...

If any of the parameters defined by this menu or the Set Params Menu are changed subsequent to calibration, the calibration will become invalid and the path calibration must be repeated. An error message will be displayed to warn the user that this situation has occurred.

Range Entry Mode:

Set Range The range is the length of the transmission line to be measured. If the line consists of several sections, the range should be set to the sum of the lengths of the individual sections. The distance range determines the frequency span of the measurement. The maximum range depends on cable or waveguide loss. The minimum range that can be entered depends on the frequency range available from the source, the number of measurement points and the relative velocity of the transmission medium. If the resulting frequency span results in one of the limits being exceeded, then the centre frequency is changed so that the frequencies are within limits.

Rotary Control	√	Step Keys	√	Numeric Pad	√	Terminator	10+
----------------	---	-----------	---	-------------	---	------------	-----

Set Cntr Frequency Used to change the centre frequency of the measurement. The centre frequency should be set within the operating frequency bandwidth of the transmission line being tested. The centre frequency can only be set to a value which will not result in the source going beyond its frequency limits.

Rotary Control	√	Step Keys	√	Numeric Pad	√	Terminator	10+
----------------	---	-----------	---	-------------	---	------------	-----

Set Number of Points Used to change the number of measurement points generated by the sweep for each channel, up to a maximum of 1024 points. The number of measurement points determines the minimum range can be entered; decreasing the number of measurement points reduces the minimum range.

Rotary Control	√	Step Keys	√	Numeric Pad	√	Terminator	Any
----------------	---	-----------	---	-------------	---	------------	-----

Database Set Parameters Enables the transmission line database. While it is enabled, it will not be possible to alter any of the parameters that the database sets.

User Set Parameters Disables the transmission line database, allowing the parameters to be set directly.

Access Database Leads to the Access Dbase Menu, which is used to access all database functions.
See page 3-146.

Set Parameters Leads to the Set Params Menu, which enables the user to set parameters manually.
This soft key is unselectable if the transmission line database is enabled.
See page 3-154.

Return to Measure Returns control to the Measure Menu.

Frequency Entry Mode:

The menu is the same as for range entry except for the *[Set Start Frequency]* and *[Set Stop Frequency]* soft keys which replace the *[Set Range]* and *[Set Cntr Frequency]* soft keys.

**Set Start
Frequency**

This parameter is the start frequency of the measurement.

Rotary Control	√	Step Keys	√	Numeric Pad	√	Terminator	10+
----------------	---	-----------	---	-------------	---	------------	-----

**Set Stop
Frequency**

This parameter is the stop frequency of the measurement.

Rotary Control	√	Step Keys	√	Numeric Pad	√	Terminator	10+
----------------	---	-----------	---	-------------	---	------------	-----

MEASURE

**Set Up
Measurement**

**Access
Database**

Access Dbase

See Fig. 3-46. This menu provides access to the fault location transmission line database.

Transmission line data is provided on an optional memory card, and is organised by manufacturer, medium (coax or waveguide) and transmission line name. Parameters such as relative velocity, cutoff frequency and attenuation versus frequency are provided by the database. Data for a single transmission line can be stored into a non-volatile transmission line database store within the MTS; 10 of these stores are available.

To use the transmission line data from the database, it must be selected from either the card or one of these transmission line database stores. Once selected, it is stored in the 'currently selected transmission line store' (in non-volatile memory). This is the data that is used by the instrument, and remains valid until a new transmission line is selected.

If, at power-up, the transmission line database is on, the parameters will be set up from the 'currently selected transmission line store'. If this store is corrupted, invalid or empty, the transmission line database will be turned off.

A form is displayed giving all the data for the transmission line that is currently in use by the transmission line database (or would be used if the transmission line database was enabled). The form also displays the source of the transmission line data, i.e. memory card or MTS transmission line database store. In the latter case the store number is given. The form is for information only; the data displayed cannot be altered. Invalid data is indicated by the "-" symbol.

**Select
from Card**

Leads to the Sel from Card Menu.
See page 3-147.

**Select
from Store**

Used to select a transmission line database store, by entering the required store identity number. The selected data will be used until a new transmission line is selected from the card or a transmission line database store is selected

**Copy
from Card**

Leads to the Cpy from Card Menu.
See page 3-150.

**Edit
Store**

Leads to the Edit Store Menu.
See page 3-151.

**Return to
Set Up Meas**

Returns control to the Set Up Meas Menu.

MEASURE

Set Up Access Select
Measurement Database from Card

Set from Card

See Fig. 3-46. This menu allows selection of a transmission line from a memory card. The selected data will be used until a new transmission line is selected from the card or a transmission line database store is selected.

A form is displayed giving the data for transmission lines that match the subset selection criteria (Select Subset Menu). The subset selection criteria is also shown on the form. The [↑], [↓], [Page Up] and [Page Down] soft keys are used to highlight the required transmission line; on pressing [Select] the currently highlighted entry is loaded from the card and used by the instrument. Transmission line selection can be aborted by pressing [ENTRY OFF], in which case the transmission line that was last selected will continue to be used. Note that only the first 20 characters of the manufacturers' names will be displayed.

Select Subset

Leads to the Select Subset Menu.
See page 3-148.

View Data

Used to display all the data for the currently highlighted transmission line.
This soft key is unselectable if no transmission lines are listed.

↑

Highlights the previous entry in the list.

↓

Highlights the next entry in the list.

Page Up

Displays the previous page of entries in the list.

Page Down

Displays the next page of entries in the list.

Select

Selects the highlighted transmission line and returns to the Access Dbase Menu.
This soft key will be unselectable if no transmission lines are listed.

MEASURE

Set Up **Access** **Select** **Select**
Measurement **Database** **from Card** **Subset**

Select Subset *See Fig. 3-46. This menu allows a subset of all the transmission lines present on the card to be listed. It is possible to select a subset by manufacturer, medium (waveguide or coax) or by transmission line name, or any combination of the three.*

A form is displayed which lists the three subset selection criteria. One of these can be made the active parameter by using the [↑] and [↓] soft keys. The other soft keys provide various ways of altering the active subset selection criteria.

Any For a given subset selection criteria all values will be displayed.

Waveguide Sets the medium to Waveguide.
This soft key is only selectable if the currently selected subset selection criteria is Medium.

Coax Sets the medium to Coax.
This soft key is only selectable if the currently selected subset selection criteria is Medium.

Text Allows text entry for the currently selected subset selection criteria. The method of entry is the same as for the Screen Title Menu (page 3-290).

The text entry form can be used to enter either manufacturer or transmission line names. If the last character is a '*' then it is used as a wildcard, e.g. 'Abc*' will select all names beginning with 'abc'. Case is ignored when selecting.

The current manufacturer/transmission line name from the subset selection criteria is displayed on entry to this form; 'any' is shown as '*'.

This soft key is unselectable if the currently selected subset selection criteria is Medium.

Menu Leads to the Menu menu, which allows entry of subset selection criteria by selecting items from a menu.
This soft key is unselectable if the currently selected subset selection criteria is Medium. See page 3-149.

↑ Used to change the currently selected parameter for subset selection criteria.

↓ Used to change the currently selected parameter for subset selection criteria.

Search Applies the new subset selection criteria and returns to the Sel from Card Menu.

MEASURESet Up
MeasurementAccess
DatabaseSelect
from CardSelect
Subset

Menu

Menu

See Fig. 3-46. This menu allows manufacturer or transmission line names to be selected from an alphabetically arranged list.

The [↑], [↓], [Page Up] and [Page Down] soft keys are used to highlight the required name; on pressing [Select] the currently highlighted name is selected.

↑

Highlights the previous entry in the list

↓

Highlights the next entry in the list

Page
Up

Displays the previous page of entries in the list.

Page
Down

Displays the next page of entries in the list.

Select

Selects the highlighted entry and returns to Select Subset Menu.

MEASURE

Set Up **Access** **Copy**
Measurement **Database** **from Card**

Cpy from Card

See Fig. 3-46. This menu enables a transmission line to be selected from the card and copied to a transmission line database store.

A form is displayed similar to that of the Sel from Card Menu (page 3-147), but also includes information about the store that is to be written to.

Select Subset

Leads to the Select Subset Menu.
See page 3-148.

View Data

Used to display all the data for the currently highlighted transmission line.
This soft key is unselectable if no transmission lines are listed.

↑

Highlights the previous entry in the list.

↓

Highlights the next entry in the list.

Page Up

Displays the previous page of entries in the list.

Page Down

Displays the next page of entries in the list.

Select Store

Used to select the store to copy to by entering the required store identity number.

Copy

Copies the data for the highlighted transmission line to the specified transmission line database store, and returns to the Access Dbase Menu.
This soft key will be unselectable if no transmission lines are listed.

MEASURE

Set Up
MeasurementAccess
DatabaseEdit
Store**Edit Store**

See Fig. 3-Error! Bookmark not defined.. This menu allows data to be entered for transmission lines not provided on the memory card. A form is displayed giving the data contained in the selected transmission line database store.

Select Store

Used to select one of the five transmission line database stores to be edited, by entering the required store identity number.

Edit Manufacturer

A text entry form is provided to allow editing of the manufacturer name. The method of entry is the same as for the Screen Title Menu (page 3-290).

Edit Tx Line

A text entry form is provided to allow editing of the transmission line name. The method of entry is the same as for the Screen Title Menu (page 3-290).

Edit Medium

Leads to the Edit Medium Menu.
See page 3-152.

Edit Cutoff Frequency

Allows the value for waveguide cutoff frequency to be edited.
This soft key is unselectable if the medium is coax.

Edit Relative Velocity

Allows the value for relative velocity to be edited.
This soft key is unselectable if the medium is waveguide.

Edit Attn Table

Leads to the Edit Attn Table Menu.
See page 3-153.

Save Store

Writes the data back to the transmission line database store, and returns to the Access Dbase menu.
This soft key will be unselectable if any of the data is invalid.

FUNCTION
(FAULT LOCATION CHANNEL)

MEASURE

**Set Up
Measurement**

**Access
Database**

**Edit
Store**

**Edit
Medium**

Edit Medium

See Fig. 3-47. This menu allows the transmission line medium to be specified.

Waveguide

Sets the medium to waveguide.

Coax

Sets the medium to coax.

**Return to
Edit Store**

Returns control to the Edit Store Menu.

MEASURE

Set Up
MeasurementAccess
DatabaseEdit
StoreEdit
Atten TableEdit Attn Table

See Fig. 3-47. This menu allows the attenuation table for the transmission line to be edited. This table specifies the attenuation values for the transmission line at various frequencies; the table can contain a maximum of twenty entries.

Entries can be added to or deleted from the table, or existing entries changed. Frequencies cannot be edited, therefore if a new entry at a different frequency is to be added, the existing entry must be deleted and a new entry with the desired frequency added.

The [↑] and [↓] soft keys are used to highlight the entry to be edited or deleted.

Edit
Entry

Allows the attenuation value for the highlighted entry to be edited. The [↑] and [↓] soft keys are still available for selecting the required entry.
This soft key is unselectable if the table is empty.

Add
Entry

Allows additional entries to be added to the attenuation table. A form is displayed for the entry of the frequency and attenuation values. The [←] and [→] soft keys are used to select the parameter to be entered. The [Add Entry] soft key adds the entry into the table, and sorts the entries into frequency order.
This soft key is unselectable if the table is full.

Delete
Entry

Deletes the highlighted entry from the table.

↑

Highlights the previous entry in the table.

↓

Highlights the next entry in the table.

Return to
Edit Store

Returns control to the Edit Store Menu.

MEASURE

Set Up Measurement Set Parameters

Set Params

See Fig. 3-46. This menu is used to manually set the parameters for the transmission line, rather than using the transmission line database.

Set Cutoff Frequency

The cutoff frequency is the frequency below which propagation ceases in the waveguide. This parameter is required in order that the MTS can generate the non-linear frequency sweep that is required for waveguide measurements.
This soft key will only be selectable if the transmission line medium is waveguide (Config F Loc Menu, page 3-141)

Rotary Control √ Step Keys √ Numeric Pad √ Terminator 10+

Set Relative Velocity

The relative velocity represents the speed of propagation through the transmission medium as a fraction of the speed of light in free space range (0 to 1). If the line consists of more than one section, and the relative velocities are significantly different, an 'average' value can be calculated for the composite line. The individual figures for relative velocity should be weighted to take account of the relative lengths of the sections, i.e. the longer the section, the greater the effect it has on the composite figure. The relative velocity is 1 for most waveguides.
This soft key will only be selectable if the transmission line medium is coax (Config F Loc Menu, page 3-141).

Rotary Control √ Step Keys √ Numeric Pad √ Terminator Any

Set Attenuation

This parameter is the attenuation characteristic of the transmission medium in dB/m or dB/ft, depending on the distance units that have been selected. If the line consists of more than one section, and the attenuation figures are significantly different, an 'average' value can be calculated for the composite line. The individual figures for attenuation should be weighted to take account of the relative lengths of the sections, i.e. the longer the section, the greater the effect it has on the composite figure.

Rotary Control √ Step Keys √ Numeric Pad √ Terminator Any

Return to Set Up Meas

Returns control to the Set Up Meas Menu.

MEASURE

Fault Loc Functions

F Loc Funcs

See Fig. 3-44

Windowing Low

Sets the level of windowing to be applied to the acquired data in the fault location measurement to low. Data windowing reduces the amplitudes of the sidelobes associated with the main peak on the display, but gives reduced distance resolution. Variation of the windowing level provides a trade-off between distance resolution and the height of the sidelobes. A low windowing level gives greater distance resolution but higher sidelobes.

Fig. 3-41 shows the effect on the display of two data windowing levels.

Windowing Medium

Sets the level of windowing to be applied to the acquired data in the fault location measurement to medium. A medium windowing level gives an optimum trade-off between distance resolution and sidelobe height for most applications. This is the default setting for the instruments.

Windowing High

Sets the level of windowing to be applied to the acquired data in the fault location measurement to high. A high windowing level gives reduced sidelobe height but with some loss of distance resolution.

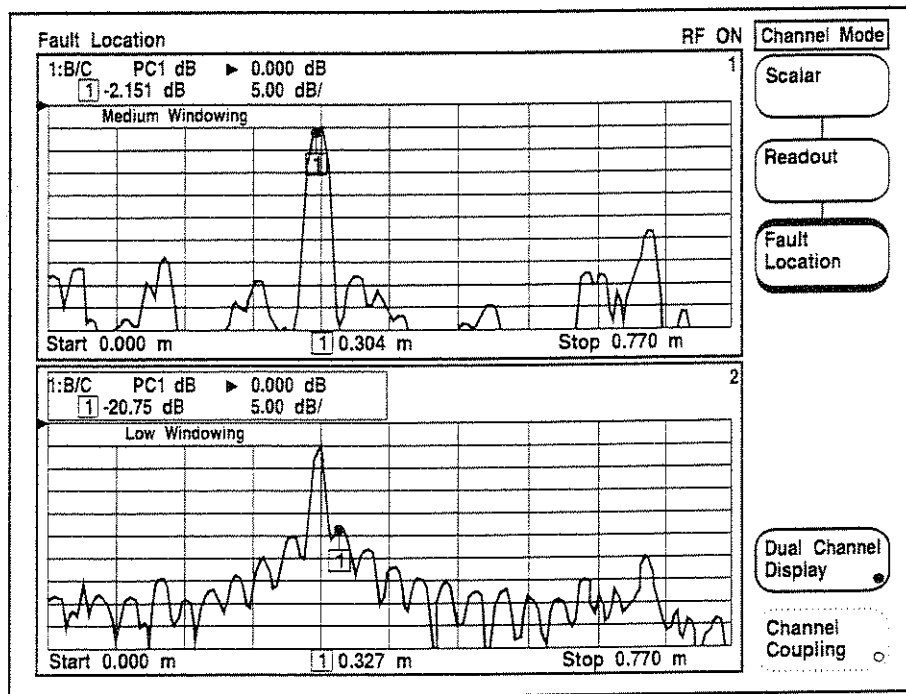

CD415

Fig. 3-41 Effect of Data Windowing on a Fault Location Measurement

Enhanced Mode

Leads to the Enhance Mode Menu, which enables a part of the display range to be magnified by changing the start and stop values. See page 3-157.

Masking Correction

Toggles masking correction on or off. This feature corrects for amplitude errors caused by preceding peaks in the fault location measurement. Refer to Fig. 3-42 for an example of the effect of masking correction.

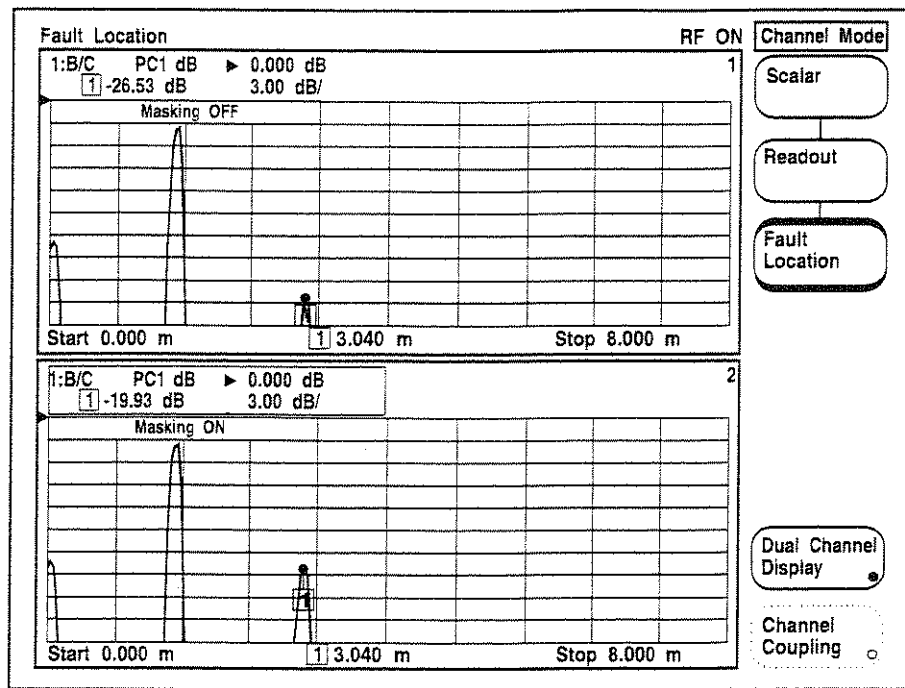

C2130

Fig. 3-42 Effect of Masking Correction on a Fault Location Measurement

**Limit
Checking**

Leads to the Lim Checking Menu, which enables the displayed trace to be compared with user-defined limits. This is the same as for a scalar channel, except that the bottom soft key returns control to the F Loc Funcs Menu, not the Measure Menu.
This soft key is only selectable if Measurement 1 is active.
See page 3-56.

**Return to
Measure**

Returns control to the Measure Menu.

MEASURE

Fault Loc Functions **Enhanced Mode**

Enhance Mode

See Fig. 3-44 Following calibration, the horizontal axis will display distance from zero to the range specified in the Set Up Meas Menu. This menu enables the user to specify a sub-range of displayed distance values by entering the required start and stop values, or by specifying centre and span values. This effectively provides a magnification facility for a selected part of the range. Note that the frequency sweep of the source remains constant; the magnification is accomplished by processing the measurement results.

The display start and stop values can also be set to the distances corresponding to the position of the active marker on the active measurement. This is done by pressing the appropriate soft key, positioning the active marker on the trace, then pressing the [x1] key on the numeric keypad.

If the centre & span mode has been selected, the centre value is set by pressing [Set Display Cntr], positioning the active marker, then pressing the [x1] key on the numeric keypad. The span is set by pressing [Set Display Span], positioning the delta marker to the appropriate point either side of the centre, then pressing the [x1] key. (If necessary, enable the delta marker from the Marker Menu.)

If the measurement range is subsequently altered while in this mode, then after recalibration the display will show the new measurement range, rather than the sub-range.

Set Display Start

If the start/stop mode has been selected, this soft key is used to change the start value of the displayed distance. In the centre/span mode this soft key is labelled [Set Display Cntr], and is used to change the centre value of the displayed range.

Rotary Control	✓	Step Keys	✓	Numeric Pad	✓	Terminator	10+
----------------	---	-----------	---	-------------	---	------------	-----

Set Display Stop

If the start/stop mode has been selected, this soft key is used to change the stop value of the displayed distance. In the centre/span mode this soft key is labelled [Set Display Span], and is used to change the span of the displayed range.

Rotary Control	✓	Step Keys	✓	Numeric Pad	✓	Terminator	10+
----------------	---	-----------	---	-------------	---	------------	-----

Display as Start & Stop

Displays distance as values between the start and stop values as defined above.

Display as Cntr & Span

Displays distance as a centre value and span.

Enhanced Mode

Toggles the Enhanced Mode on or off. Enhanced mode gives an optimally interpolated display trace resulting in improved distance and amplitude accuracy, particularly when displaying a sub-range of the distance scale. However, when the Enhanced Mode is turned on, the measurement time is significantly increased. Fig. 3-43 shows the effect of this mode when displaying a sub-range of a measurement.

Return to F Loc Funcs

Returns control to the F Loc Funcs Menu.

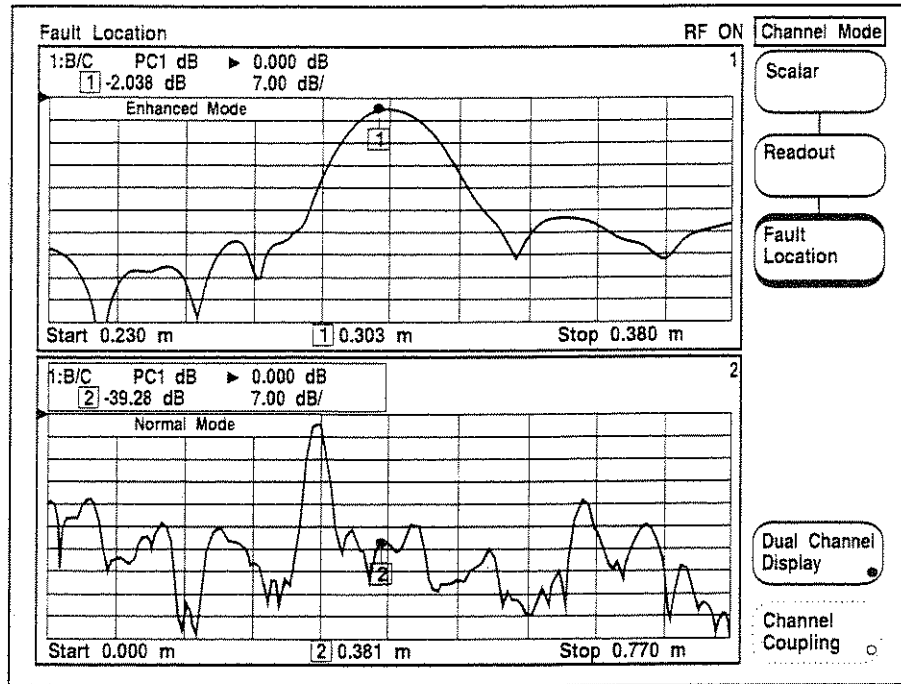

C0417

Fig. 3-43 Effect of Enhanced Mode on a Fault Location Measurement

LOCAL OPERATION

FUNCTION
(FAULT LOCATION CHANNEL)

MEASURE

Fig. 3-44 MEASURE Menus - Fault Location Channel (Sheet 1)

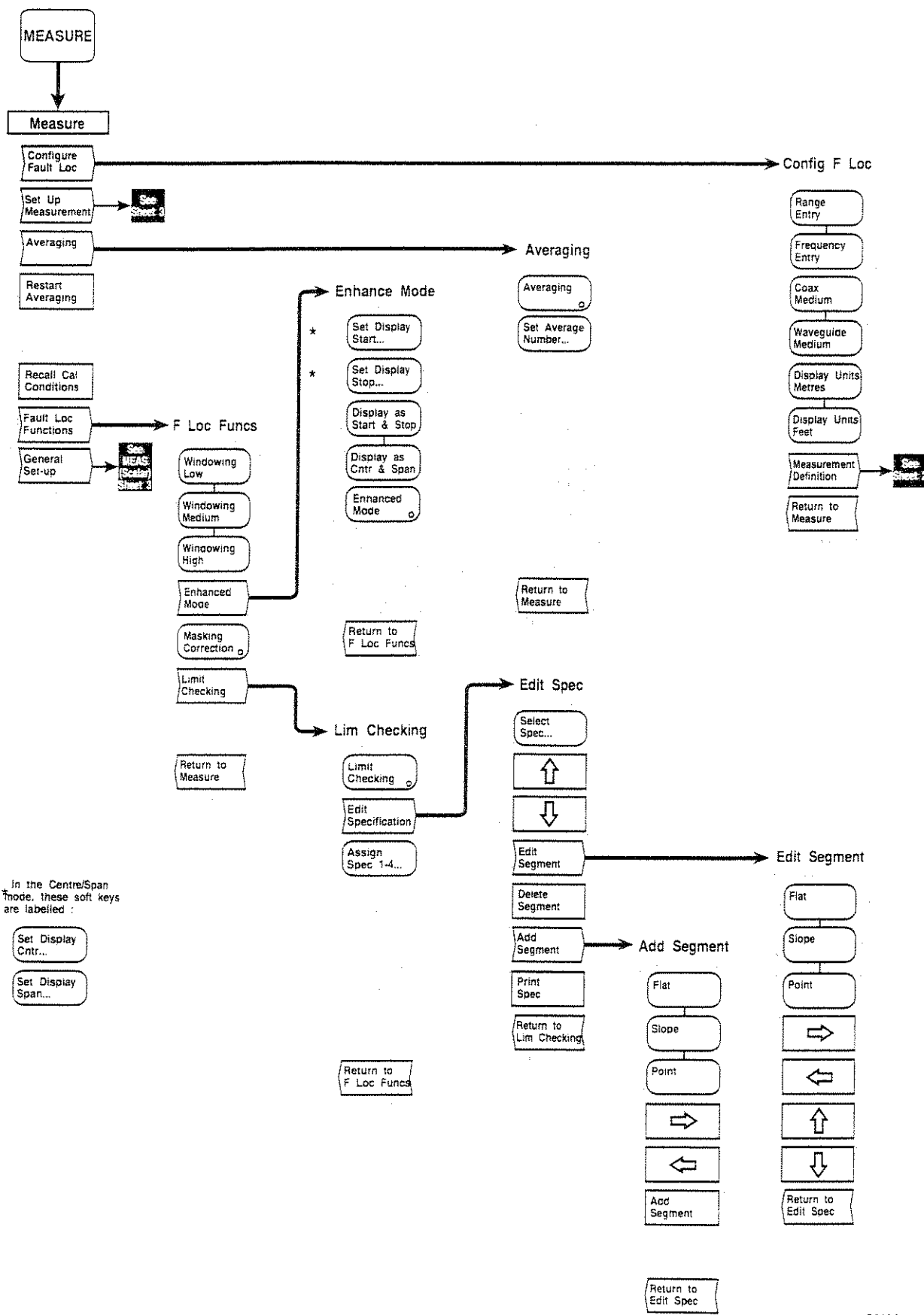

Fig. 3-44 MEASURE Menus - Fault Location Channel (Sheet 1)

MEASURE

**Configure
Fault Loc**

**Measurement
Definition**

Fig. 3-45 MEASURE Menus - Fault Location Channel (Sheet 2)

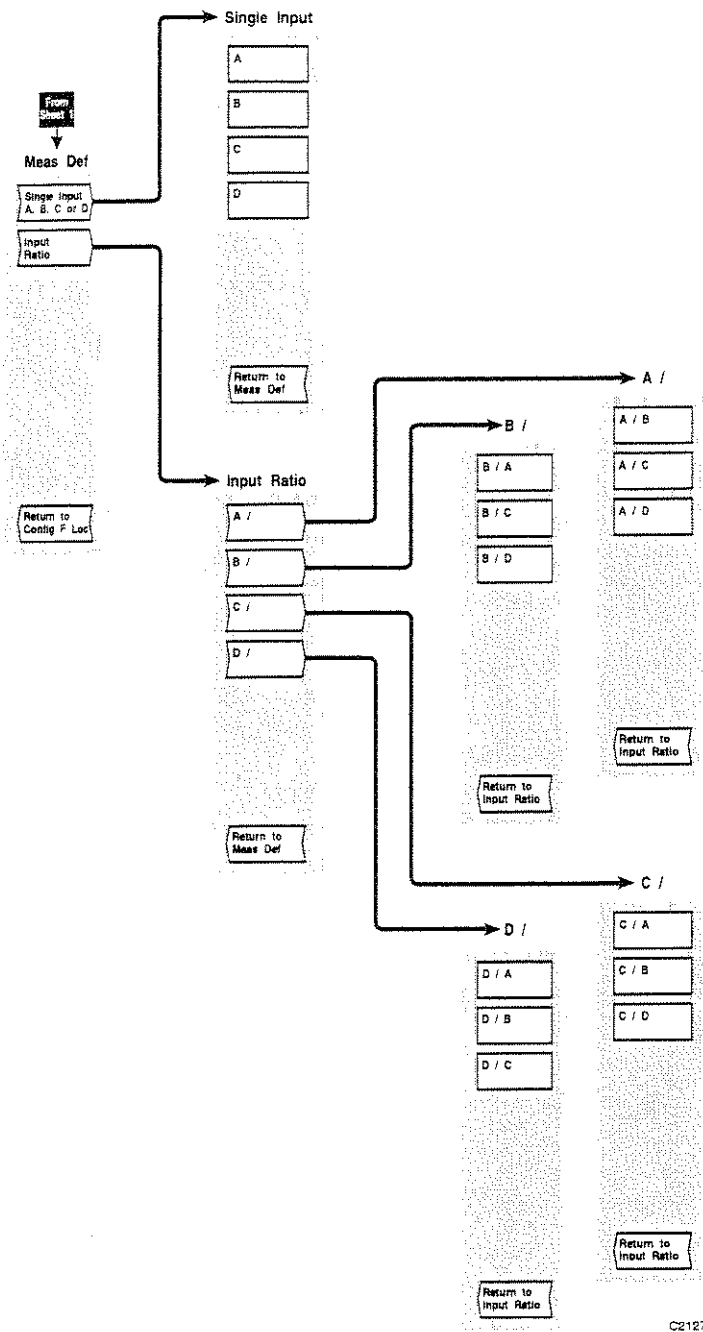

C2127

Fig. 3-45 MEASURE Menus - Fault Location Channel (Sheet 2)

MEASURE

Set Up
Measurement

Fig. 3-46 MEASURE Menus - Fault Location Channel (Sheet 3)

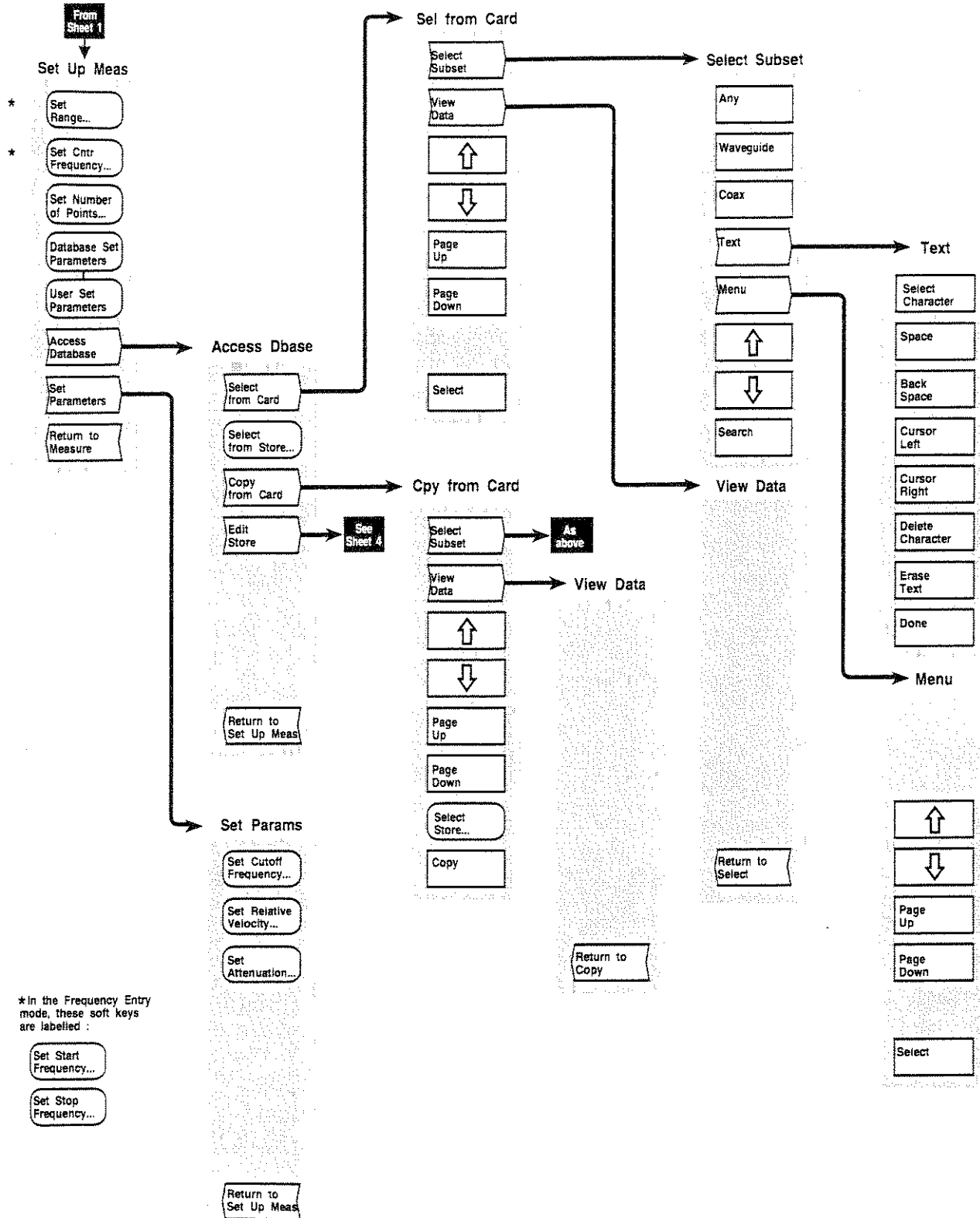

Fig. 3-46 MEASURE Menus - Fault Location Channel (Sheet 3)

MEASURE

Set Up
Measurement

Access
Database

Edit
Store

Fig. 3-47 MEASURE Menus - Fault Location Channel (Sheet 4)

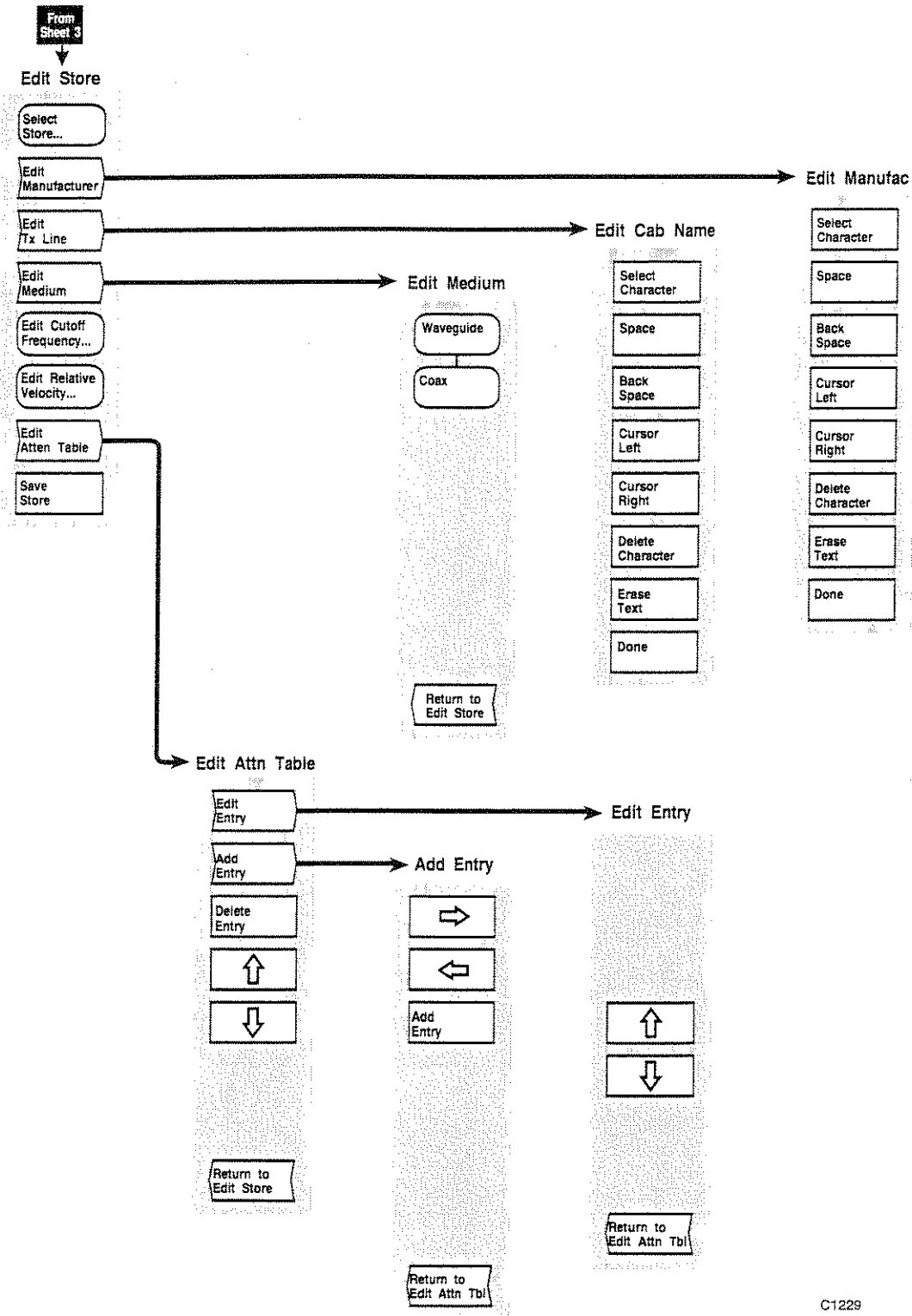

C1229

Fig. 3-47 MEASURE Menus - Fault Location Channel (Sheet 4)

[CAL] KEY

The [CAL] key provides access to the menu shown in Fig. 3-48, which is used for calibrating the measurement system prior to a measurement in order to remove system errors that cause uncertainty in measuring a device under test. Facilities are also provided for detector/sensor zeroing and sensor calibration.

CAL

Cal

**Fault
Location Cal**

When this soft key is pressed, the user is prompted to connect a matched load to the FAULT LOCATION test port of a Test Head and press the *[Continue]* soft key when ready. A detector zero is automatically performed, followed by calibration of the measurement system. The user is informed when calibration data has been acquired and path calibration has been applied. The calibration data is stored in the default path cal store associated with trace 1 of the fault location channel. The function then terminates and the user is returned to the initial Cal Menu.

The *[Abort Calibration]* soft key is used to terminate the calibration process at any time. The current path cal store will not be affected.

**Det/Sensor
Zero**

Leads to the Det/Sen Zero Menu, which is used for zeroing detectors/sensors.
See page 3-88.

**Sensor
Cal**

Leads to the Sensor Cal Menu, which is used to zero the power sensor and to calibrate it against the reference.
*This soft key will only be selectable if Input D is configured for a power sensor.
See page 3-89*

**Power
Ref**

Toggles the power reference output on and off. When it is turned on, the front panel POWER REF connector provides a 50 MHz 0 dBm power reference output. The reference can be used, for example, to verify that the power sensor is functioning correctly. The Power Reference On indicator (PWRREF) will be present in the General Information Area at the top of the screen if a power reference signal is being output.

CAL

Fig. 3-48 CAL Menu - Fault Location Channel

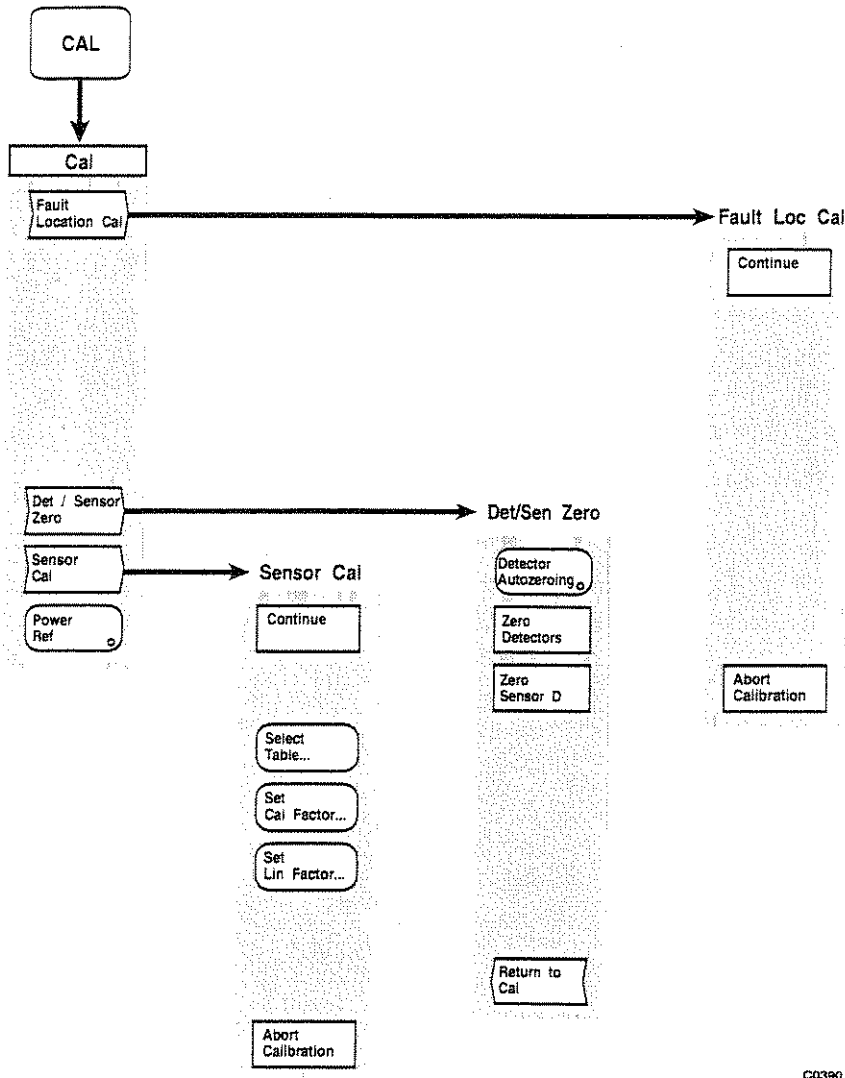

C0390

Fig. 3-48 CAL Menu - Fault Location Channel

[FORMAT] KEY

The [FORMAT] key enables the fault location measurement to be displayed in the required format.

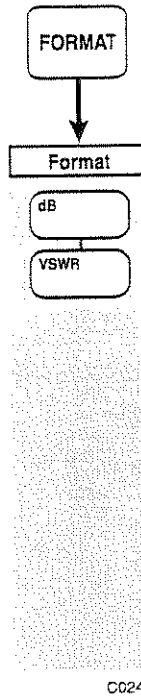

C6249

Fig. 3-49 FORMAT Menu - Fault Location Channel

FORMAT

- | | |
|---------------|--|
| Format | The two soft keys in this menu enable the measurement to displayed in dB or VSWR format. |
| dB | Selects dB format. |
| VSWR | Selects VSWR format. |

[SCALING] KEY

The [SCALING] key provides a menu which enables the user to adjust the positioning and scaling of the fault location trace, or to allow the instrument to set the scaling automatically.



C0248

Fig. 3-50 SCALING Menu - Fault Location Channel

SCALING

Scaling

This menu enables the user to set the reference level and scaling for a trace. The reference position is the position on the vertical axis that remains fixed during scaling. This is indicated on the screen by the Reference Position Indicator (see the 'Display' Section). The reference level is the value corresponding to the position of the Reference Position Indicator on the vertical scale, and is displayed in the relevant trace information area.

The default values for reference level and scaling factor for both types of format are given below. The default reference position for dB format is the top graticule line. For VSWR format the reference position is the bottom graticule line.

Format	Reference Level	Scale Factor
dB	+20.0	10.0 dB(m)/div
VSWR	1.0	0.1 /div

Autoscale

Allows the instrument to determine optimum values of scale and reference level. The value chosen for the scale factor will be selected from a 1,2,5 sequence. The value chosen for the reference level will be a multiple of the scaling factor. The reference position will remain unchanged.

For a Fault location channel, automatic baseline clipping is used to eliminate noise and emphasize peaks. The algorithm used selects the reference level such that the positive peaks of the measurement are not clipped by the top graticule line; the scale factor is selected such that 10% of the measurement points are visible above the bottom graticule line, the remaining 90% being clipped.

Set Scale

Used to set the scale factor for a trace.

dB/dBm Format

Rotary Control	✓	Step Keys	✓	Numeric Pad	✓	Terminator	Any
----------------	---	-----------	---	-------------	---	------------	-----

VSWR Format

Rotary Control	✓	Step Keys	✓	Numeric Pad	✓	Terminator	10-
----------------	---	-----------	---	-------------	---	------------	-----

Set Ref Level

Used to set the reference level for a trace.

Numeric entry as above.

The reference level can also be set to be response measured at the active marker position, by pressing this soft key followed by the [x1] key on the numeric keypad.

Set Ref Position

Used to set the reference position for a trace. The reference position may be placed on any of the 11 horizontal lines on the graticule.

Rotary Control	✓	Step Keys	✓	Numeric Pad	×	Terminator	×
----------------	---	-----------	---	-------------	---	------------	---

Continuous Autoscale

Toggles continuous autoscale on or off, in which autoscaling will be performed automatically once per measurement update.

[MARKERS] KEY

The MTS can display up to eight markers per trace, with each marker identified by a number. Any one of these can be designated the active marker, indicated by a box around the number to distinguish it from the normal markers. The active marker can be moved along the x-axis using the step keys, rotary control or by keyboard entry. The step keys and keyboard entry are only available through the Position Active Mkr and Position Delta Mkr functions of the Markers Menu. The rotary control can be used to move the active marker at any time whilst it is displayed, provided that no other form of numeric entry is active. The distance value (x-axis position) of the active marker is displayed below the graticule, and the measured response at this position is displayed in the relevant trace information area.

The delta marker mode provides an additional marker, designated the delta marker, and is represented by Δ on the display. In this mode, the distance value of the active marker is relative to the delta marker position. The measured response is relative to the response at the delta marker position, i.e.

$$\begin{aligned} \text{Distance value} &= \text{Active Marker position} - \text{Delta Marker position} \\ \text{Response} &= \text{Active Marker response} - \text{Delta Marker response} \end{aligned}$$

Note that the distance values indicated by the active marker represent the actual distance to a discontinuity, not the round trip distance.

The marker menus are shown in Fig. 3-51.

A tracking facility is available for the max/min function; this enables the function to be automatically applied at each measurement update (i.e. at the end of each sweep).

MARKERS

Markers This menu provides soft keys for setting up markers and using them to perform various types of measurement.

Active Mkr Toggles the active marker on or off. Turning off the active marker also turns off the delta marker.

Place Mkr at Active Used to place a marker at the active marker position by entering the required marker number from the keyboard.

This soft key will only be selectable if the active marker is turned on.

Position Active Mkr Used to change the distance value (x-axis position) of the active marker.
This soft key will only be selectable if the active marker is turned on.

Rotary Control	√	Step Keys	√	Numeric Pad	√	Terminator	10+
----------------	---	-----------	---	-------------	---	------------	-----

Delta Mkr Toggles the delta marker on or off. Turning on the delta marker also turns on the active marker.

Position Delta Mkr Used to change the position of the delta marker, using the same method as for the active marker.

This soft key will only be selectable if the delta marker is turned on.

All Mkrs Off Turns off all the markers for the currently active trace.

Mkr Functions Leads to the Mkr Funcs Menu, which enables various measurement functions to be carried out by means of the active marker and delta marker.
See page 3-176.

Set Up Mkrs Leads to the Set Up Mkrs Menu, which allows the user to activate and position selected markers.
See page 3-178.

MARKERS

**Mkr
Functions**

Mkr Funcs	This menu leads to sub-menus for locating the maximum point on a trace, searching for a specified response value and locating multiple peaks on a displayed trace.
Marker to Max Min	Leads to the Max Min Menu. <i>See page 3-177</i>
dB/Octave dB/Decade	<i>This soft key is unselectable for fault location measurements.</i>
Peak to Peak	<i>This soft key is unselectable for fault location measurements.</i>
Search	Leads to the Search Menu, which is used to locate a response value on the trace. <i>See page 3-102.</i>
Bandwidth	<i>This soft key is unselectable for fault location measurements.</i>
Find Next Peak	Leads to the Find Next Pk Menu. <i>See page 3-177.</i>
Return to Markers	Returns control to the Markers Menu.

MARKERS

Mkr Functions Marker to Max Min

Max Min

This menu is used to locate the maximum point on a trace.

When the tracking facility is turned on, the selected function is applied automatically at the end of each sweep, thus continually updating the maximum measurement.

Active Mkr to Maximum

Moves the active marker to the maximum point on the displayed trace.

Active Mkr to Minimum

Unselectable.

Tracking Maximum

Applies tracking to the maximum function.

Tracking Minimum

Unselectable.

Tracking Off

Disables tracking.

Return to Markers

Returns control to the Mkr Funcs Menu.

MARKERS

Mkr Functions Find Next Peak

Find Next Pk

This menu enables the active marker to be placed at peaks in the trace.

Find Next Peak Right

Positions the active marker at the next peak in the trace to the right of its current position. The peak that the active marker moves to is defined to be the next local maximum visible on the screen to the right of the current active marker position. If a peak cannot be found, the active marker will remain at its current position.

Find Next Peak Left

As above, but the next peak to the left of the current active marker position is located.

Returns to Mkr Funcs

Return control to the Mkr Funcs Menu.

MARKERS

**Set Up
Mkrs**

Set Up Mkrs

This menu enables selected markers to be turned on or off and positioned on the display, and allows one of the markers to be selected as the active marker. A soft key is also provided to turn marker coupling between channels on or off.

**Assign Active
Mkr 1-8**

Used to select the marker which will act as the active marker.

Rotary Control X Step Keys X Numeric Pad Terminator None

**Mkr 1-8
On**

Turns a selected marker on by entering the required marker number.

Rotary Control X Step Keys X Numeric Pad Terminator None

**Mkr 1-8
Off**

Turns a selected marker off by entering the required marker number.

Rotary Control X Step Keys X Numeric Pad Terminator None

**Position
Mkr 1-8**

Used to change the distance value (x-axis position) of a specified marker. A form is displayed on the screen containing numeric entry fields for the marker number and the marker position. The required marker is first selected, then its position is changed.

Marker Number

Rotary Control X Step Keys X Numeric Pad Terminator None

Marker Position

Rotary Control Step Keys Numeric Pad Terminator 10+

This soft key will only be selectable if at least one of the markers is turned on.

**6 Digits
Resolution**

This soft key is unselectable for a fault location channel.

**1 Hz
Resolution**

This soft key is unselectable for a fault location channel.

**Mkr
Coupling**

Toggles marker coupling between channels on or off. When marker coupling is enabled, the positions (i.e. domain or x-axis values) of all markers on all traces will track the positions of the markers on the active trace of the active channel. When marker coupling is disabled, markers may be positioned independently on each channel. The default setting for marker coupling is on.

Marker coupling can only be disabled when channel coupling is switched off (Channel Mode Menu).

**Return to
Makers**

Returns control to the Markers Menu.

MARKERS

Fig. 3-51 MARKERS Menu - Fault Location Channel

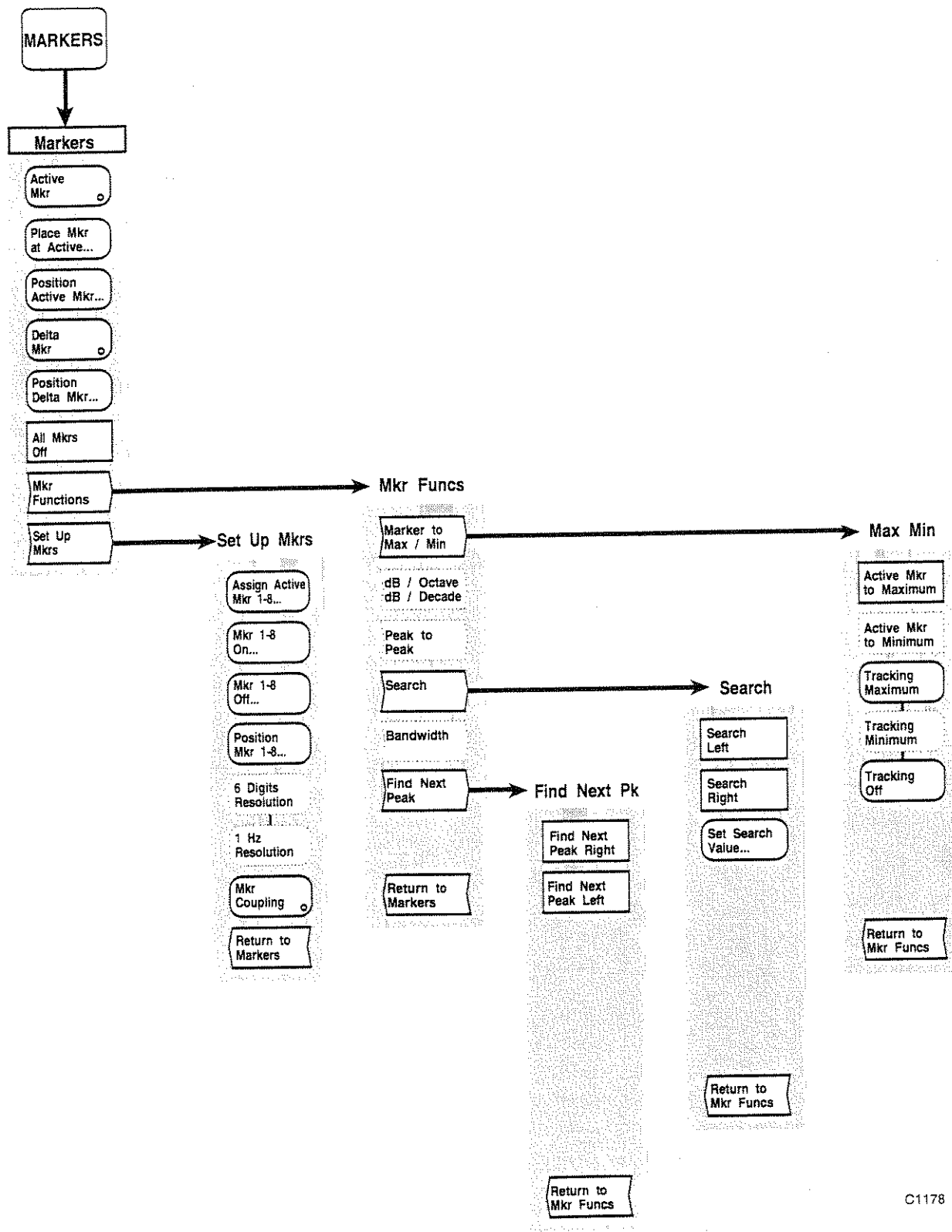

C1178

Fig. 3-51 MARKERS Menus - Fault Location Channel

FUNCTION GROUP KEYS - REFLECTION ANALYZER CHANNEL

[SOURCE] KEY

The [SOURCE] key provides access to the series of menus illustrated in Figs. 3-53 to 3-55, which are used to define and control all the source functions for a reflection analyzer channel.

The [*Select Source Mode*] soft key is used to access the Source Mode Menu, and the required mode is selected by pressing the appropriate soft key. Pressing [*Return to Source*] will return the user to the source menu corresponding to the selected mode. With the 6210 Reflection Analyzer connected, three additional source modes are available, accessed by pressing the [*More*] soft key in the Source Mode Menu. Pressing [*Return to Prior Menu*]/[*Return to Source*] returns the user to the appropriate source menu. There are therefore three extra source menus available for a reflection analyzer channel, one for each of the additional source modes. These are:

Linear List Frequency Sweep (sweep defined as a series of segments).

Waveguide Frequency Sweep (generates a non-linear sweep for waveguide measurements).

Low Pass Frequency Sweep (used when making low pass time domain measurements).

The last four soft keys of the Source Menu are the same for each of the source modes; the remaining four will vary to reflect the parameters required for the particular source mode.

Several of the source menus for a reflection analyzer channel are the same as for a scalar channel, and are fully described in the appropriate section. This section only covers new menus, or those that differ from the corresponding scalar channel menus.

SOURCE

Source (Linear List Frequency Sweep) *See Fig. 3-53.* This menu allows the operator to arbitrarily define the frequency sweep, by specifying up to 12 sweep segments, with each segment consisting of a start and stop frequency and a number of measurement points. This allows measurement points to be concentrated around points of interest during reflection analyzer measurements. The system will keep a running check on the total number of points required, and will not be permitted to exceed the limit for the system (800 points).

The menu will only be available if the 6210 Reflection Analyzer option is fitted, and if the currently active channel has been designated a reflection analyzer channel.

Set Up List Leads to the Set Up List Menu, which enables the sweep segments for the linear list sweep to be defined.
See page 3-185.

Set Output Power Used to change the output power of the source for the currently active channel.

Rotary Control	√	Step Keys	√	Numeric Pad	√	Terminator	Any
----------------	---	-----------	---	-------------	---	------------	-----

Sweep Time Leads to the Sweep Time Menu, which enables the sweep time to be set up manually or automatically.
See page 3-34.

RF Toggles the RF output on or off.

Select Source Mode Leads to the Source Mode Menu, which enables CW operation or one of several sweep modes to be selected
See page 3-35

Source Functions Leads to the Source Funcs Menu, which enables several options to be selected, allowing the source to be set up according to the requirements of a particular measurement.
See page 3-36.

SOURCE**Source**

(Waveguide Sweep)

See Fig. 3-54. This menu allows the operator to set up the source for making measurements on a waveguide system, by defining the start and stop frequency values and the waveguide cutoff frequency.

The menu will only be available if the 6210 Reflection Analyzer is fitted, and if the currently active channel has been designated a reflection analyzer channel.

Set Frequencies

Leads to the Set Freqs Menu.
See page 3-187.

Set Output Power

Used to change the output power of the source for the currently active channel.

Rotary Control ✓	Step Keys ✓	Numeric Pad ✓	Terminator	Any
------------------	-------------	---------------	------------	-----

Set Number of Points

Used to change the number of measurement points generated by the sweep for the currently active channel, up to a maximum of 800 points.

Sweep Time

Leads to the Sweep Time Menu, which enables the sweep time to be set up manually or automatically.
See page 3-34.

RF

Toggles the RF output on or off.

Select Source Mode

Leads to the Source Mode Menu, which enables CW operation or one of several sweep modes to be selected
See page 3-35.

Source Functions

Leads to the Source Funcs Menu, which enables several options to be selected, allowing the source to be set up according to the requirements of a particular measurement.
See page 3-36.

SOURCE**Source**

(Low Pass Sweep)

See Fig. 3-55. This menu allows the operator to set up the source for making measurements using the Low Pass Time Domain Transform. The menu will only be available if the 6210 Reflection Analyzer is fitted, and if the currently active channel has been designated a reflection analyzer channel..

In the low pass sweep mode, the frequency data points are harmonically related from DC to the stop frequency. That is, stop frequency = number of points × start frequency. The DC frequency response is extrapolated from the lower frequency data. The time domain functions are more fully described on page 3-201.

Set Stop Frequency

Used to set the stop frequency used in the low pass sweep. On entering a value, the stop frequency will be set to the nearest frequency that can be achieved within the constraints of a low pass sweep, and will always lie between the entered value and the maximum frequency of the instrument. In order to produce a valid low pass sweep with the selected stop frequency, the MTS may need to change the number of sweep points. This figure is indicated on the form that is displayed when this soft key is pressed, and is updated whenever the stop frequency is changed.

Rotary Control	√	Step Keys	√	Numeric Pad	√	Terminator	10+
----------------	---	-----------	---	-------------	---	------------	-----

Set Output Power

Used to change the output power of the source for the currently active channel.

Rotary Control	√	Step Keys	√	Numeric Pad	√	Terminator	Any
----------------	---	-----------	---	-------------	---	------------	-----

Set Number of points

Used to set the number of measurement points generated by the low pass sweep for the currently active channel. The number entered (up to a maximum of 800) will be set to the nearest lower value that satisfies the constraints of the low pass sweep with the existing stop frequency.

Sweep Time

Leads to the Sweep Time Menu, which enables the sweep time to be set up manually or automatically.

See page 3-34.

RF

Toggles the RF output on or off.

Select Source Mode

Leads to the Source Mode Menu, which enables CW operation or one of several sweep modes to be selected

See page 3-35.

Source Functions

Leads to the Source Funcs Menu, which enables several options to be selected, allowing the source to be set up according to the requirements of a particular measurement.

See page 3-36.

SOURCE

Set Up
List

Set Up List

See Fig. 3-53. This menu enables setting up of the sweep segments that define the linear list sweep. In addition to the soft key labels, a form is displayed on the screen showing the current sweep specification in segment order (Fig. 3-52).

Each segment is defined by the following parameters:

Segment number, start frequency, stop frequency and number of points in the segment

Set Up List			
	START FREQ	STOP FREQ	No POINTS
1	250.000000 MHz	20.00000000 GHz	400
2	1.00000000 GHz	2.00000000 GHz	100
3	5.00000000 GHz	8.00000000 GHz	100
4	10.00000000 GHz	12.00000000 GHz	100
5	15.00000000 GHz	17.00000000 GHz	100

Fig. 3-52 Linear List Sweep Specification Form

An existing segment can be selected for editing using the [\uparrow] and [\downarrow] soft keys. A new segment can be added to the end of the list by pressing the [Add Segment] soft key, or deleted by selecting it using the [\uparrow] and [\downarrow] soft keys and then pressing the [Delete Segment] soft key.

The [\Leftarrow] and [\Rightarrow] soft keys are used to move between the fields of the segments when editing. The currently selected field is changed by entering the required value as follows:

Start/stop frequencies

Rotary Control	×	Step Keys	×	Numeric Pad	√	Terminator	10+
----------------	---	-----------	---	-------------	---	------------	-----

Number of points

Rotary Control	×	Step Keys	×	Numeric Pad	√	Terminator	Any
----------------	---	-----------	---	-------------	---	------------	-----

After the value has been entered, the field to the right of the current one becomes the active field.

Add
Segment

Used to add a new segment to the end of the list. The start frequency defaults to the stop frequency of the previous segment, and the stop frequency defaults to the maximum available source frequency. The number of points defaults to the remaining number of available points. If all the points have been allocated or there are twelve segments in the list, the [Add Segment] soft key will be unselectable.

- ⇒ Makes the next field in the segment the active field.
- ⇐ Makes the previous field in the segment the active field.
- ⇑ Makes the previous segment in the specification the active segment.
- ⇓ Makes the next segment in the specification the active segment.
- Delete Segment** Used to delete a segment from the list, after asking for confirmation. The segments below the deleted one will be moved upwards in the list and renumbered. If there is only one segment in the list the *[Delete Segment]* soft key will be unselectable.
- Return to Source** Returns control to the Source Menu.

SOURCE**Set
Frequencies****Set Freqs**

See Fig. 3-54. This menu enables the operator to set up the source to provide a non-linear frequency sweep between the entered start and stop frequency values when making waveguide measurements. The MTS generates the required frequencies from a knowledge of the start and stop values and the waveguide cutoff frequency.

**Set Start
Frequency**

Used to change the start frequency of the source for the currently active channel to a value within the range permitted for the particular MTS.

Rotary Control	✓	Step Keys	✓	Numeric Pad	✓	Terminator	10+
----------------	---	-----------	---	-------------	---	------------	-----

**Set Stop
Frequency**

Similar to the above but applies to the stop frequency of the sweep.

**Set Cutoff
Frequency**

The cutoff frequency is the frequency below which propagation ceases in the waveguide. This parameter is required in order that the MTS can generate the non-linear frequency sweep that is required for waveguide measurements, and applies instrument wide.

Rotary Control	✓	Step Keys	✓	Numeric Pad	✓	Terminator	10+
----------------	---	-----------	---	-------------	---	------------	-----

**Return to
Source**

Returns control to the Source Menu.

SOURCE**Select**
Source Mode **More****Source Mode**
(More)

See Fig. 3-53. This menu extends the options available from the main Source Mode Menu (page 3-35), and enables the MTS source to be set up to provide one of three frequency sweeps when performing reflection analyzer measurements.

Only one of the following options can be selected at a time; pressing one of the soft keys automatically de-selects the current mode and selects the new one. The parameters of the source for the selected mode can be set up after returning to the Source Menu.

Linear List
Freq Sweep

Sets the source to the linear list frequency sweep mode of operation, where the sweep is defined in a series of segments.

Waveguide
Sweep

Sets the source to the waveguide sweep mode of operation, which is used to generate the non-linear frequency sweep required for waveguide measurements.

Low Pass
Sweep

Sets the source to the low pass sweep mode of operation; this sweep mode must be selected when the Low Pass Transform is to be used.

Return to
Prior Menu

Returns control to the Source Mode Menu.

SOURCE

**LINEAR LIST
FREQUENCY
SWEEP MODE**

Fig. 3-53 SOURCE Menus - Reflection Analyzer Channel (Sheet 1)

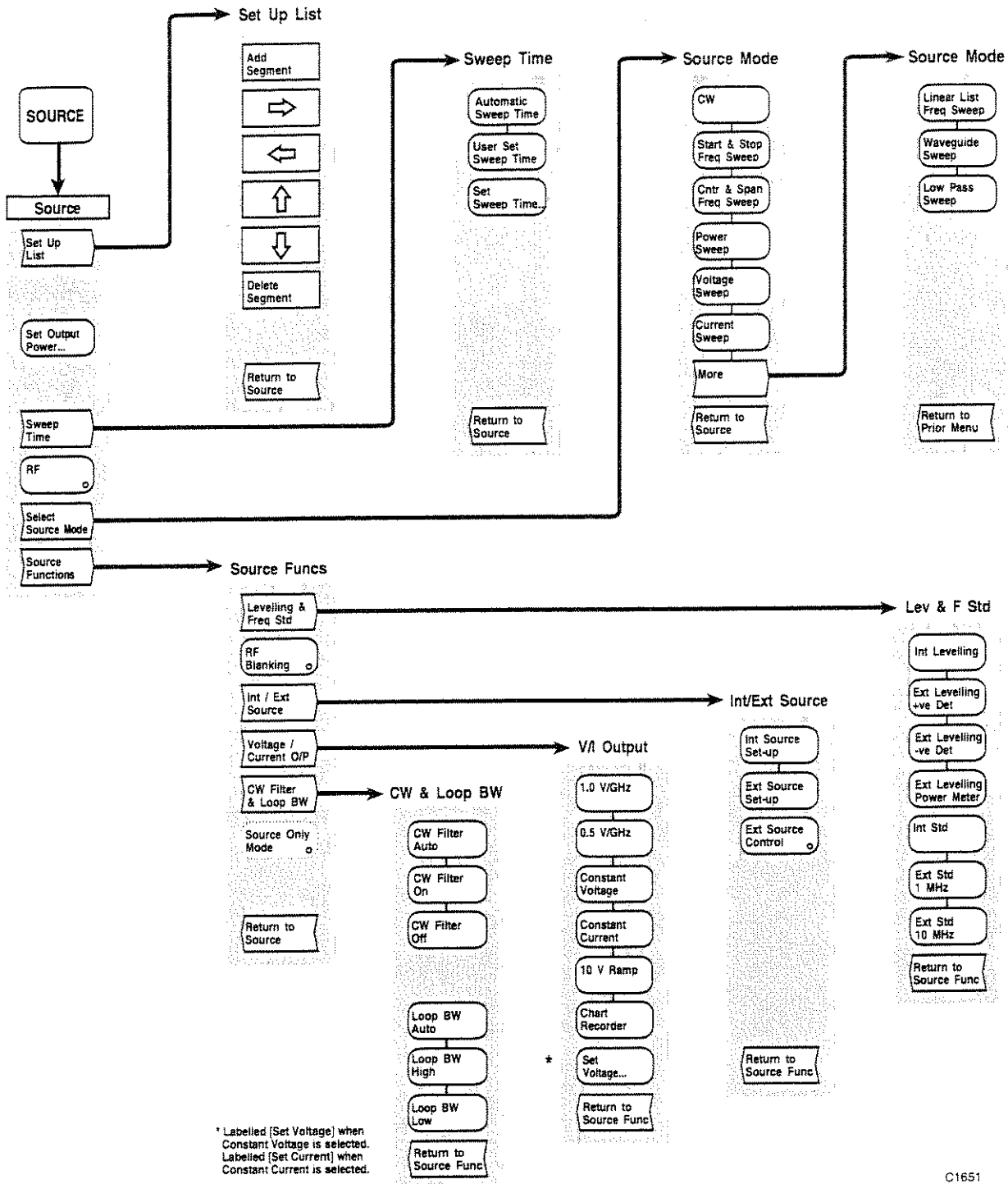

C1651

Linear List Frequency Sweep Mode

Fig. 3-53 SOURCE Menus - Reflection Analyzer Channel (Sheet 1)

FUNCTION
(REFLECTION ANALYZER CHANNEL

SOURCE

WAVEGUIDE SWEEP MODE

Fig. 3-54 SOURCE Menus - Reflection Analyzer Channel (Sheet 2)

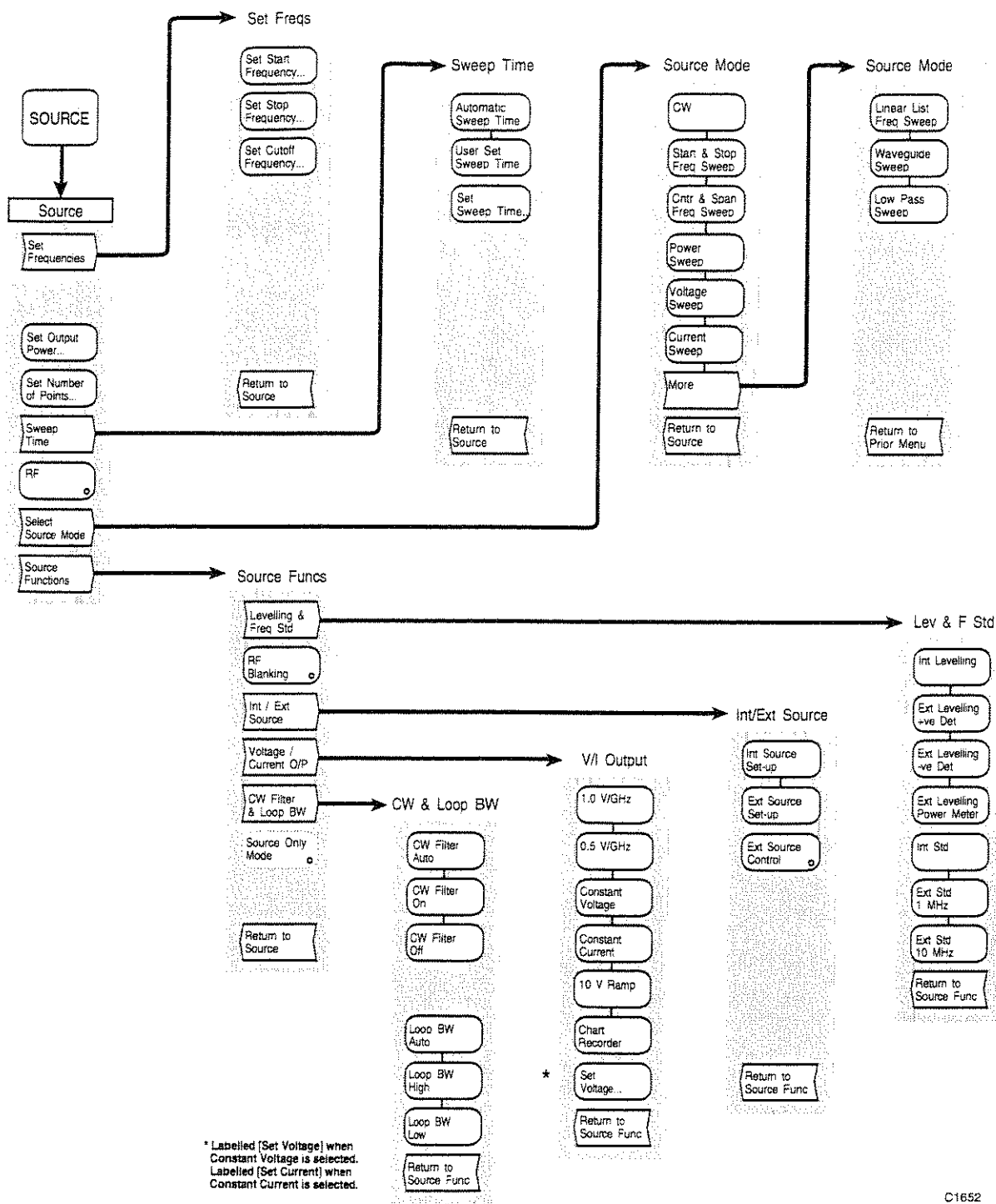

C1652

Waveguide Sweep Mode

Fig. 3-54 SOURCE Menus - Reflection Analyzer Channel (Sheet 2)

SOURCE

LOW PASS SWEEP MODE

Fig. 3-55 SOURCE Menus - Reflection Analyzer Channel (Sheet 3)

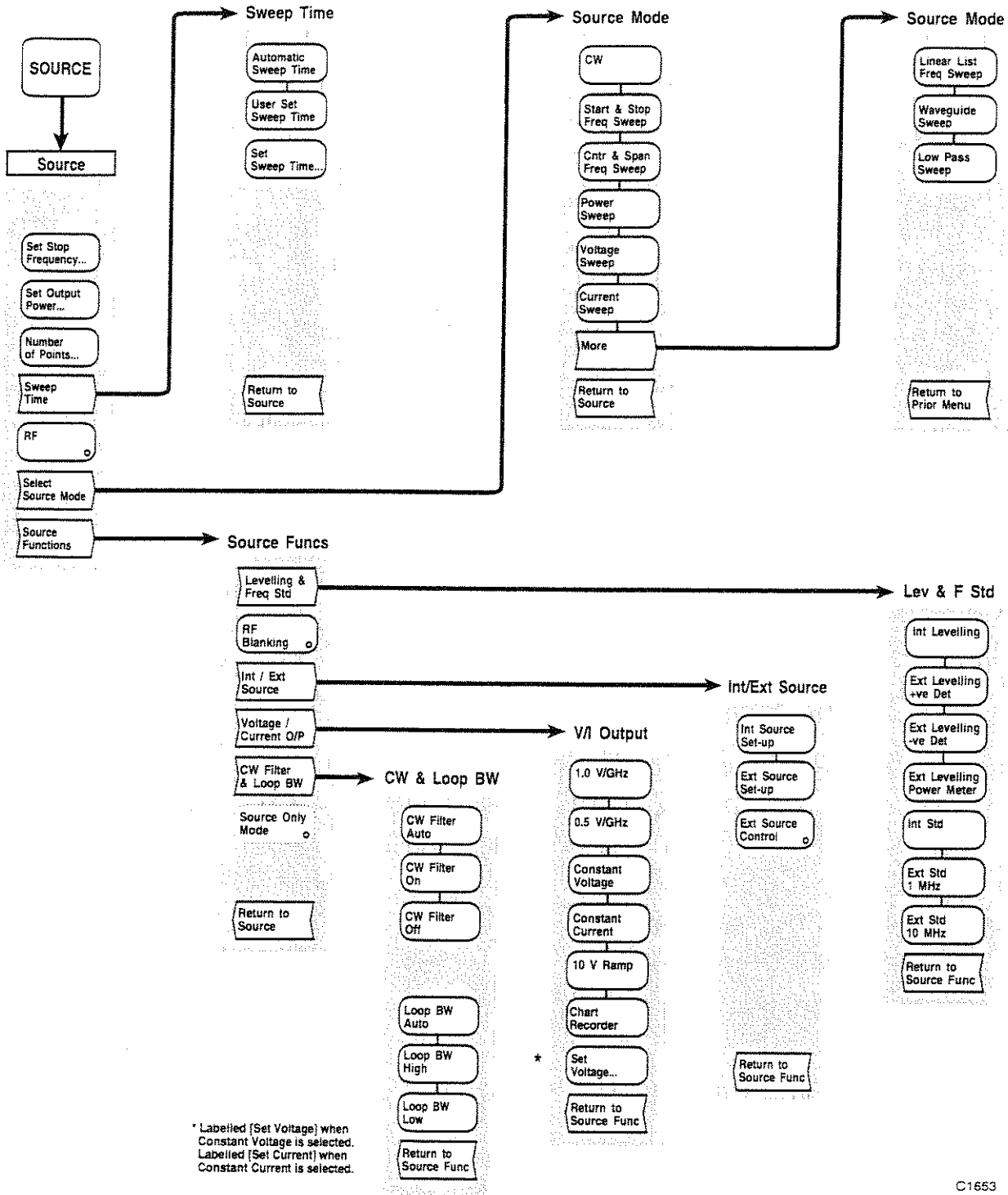

C1653

Low Pass Sweep Mode

Fig. 3-55 SOURCE Menus - Reflection Analyzer Channel (Sheet 3)

[MEASURE] KEY

The [MEASURE] key provides access to the series of menus illustrated in Fig. 3-58, which are used to define and set up the reflection analyzer measurement.

Many of the menus for a reflection analyzer channel are the same as for a scalar channel, and are fully described in the appropriate section. This section only covers new menus, or those that differ from the corresponding scalar channel menus.

Additional information on time domain measurements can be found in Appendix D.

MEASURE

Measure	This menu and its sub-menus are used for setting up the reflection analyzer channel to measure S_{11} and analyzing the results. S_{11} is the S-parameter representing the complex reflection coefficient (magnitude and phase) of the test device input.
S₁₁	If a stored measurement is being displayed, this soft key is used to restore the live measurement of S_{11} .
Time Domain	Used to toggle time domain measurements on or off. Using a mathematical technique (the inverse Fourier transform), frequency domain information is transformed into the time domain, with time as the horizontal display axis. Response values now appear separated in time or distance, as selected by the Display Domain Menu. <i>This soft key is unselectable if the sweep type is not linear list, low pass or waveguide, or the number of measurement points is less than 40.</i>
Averaging	This function is the same as for a scalar channel.
Restart Averaging	This function is the same as for a scalar channel.
Gating / Fencing	Leads to the Gate/Fence Menu, which provides the facility for selectively removing responses in either frequency or time/distance domains. <i>This soft key is unselectable if the sweep type is not linear list, low pass or waveguide, or the number of measurement points is less than 40.</i> <i>See page 3-197.</i>
Time Domain Functions	Leads to the Time Dom Funcs Menu, which provides facilities for displaying measurements in the time (or distance) domain. <i>This soft key is unselectable if the sweep type is not linear list, low pass or waveguide, or the number of measurement points is less than 40.</i> <i>See page 3-201.</i>
Display Zoom	Leads to the Display Zoom Menu, which provides a magnification facility. <i>See page 3-206.</i>
More	Leads to the Measure (More) Menu. <i>See page 3-207.</i>

MEASURE

Gating
/ FencingGate/Fence

Gating and fencing are methods by which responses in either the frequency or time/distance domain caused by features of the system under test in areas other than that of interest may be removed from the trace. Gating removes the effects of all features outside the specified range; fencing is the inverse of this and removes the effects of all features within the specified range. The gating/fencing functions applies per measurement.

This feature can be used, for example, to remove the effects of unwanted discontinuities in the time domain; the frequency response of the remaining discontinuities can then be viewed by switching back to the frequency domain. Two channels can be set up to display the time domain and frequency domain responses simultaneously. As adjustments are made in the time domain, the corresponding effect in the frequency domain can be observed in real time.

The start, stop and centre values can also be set to the domain value corresponding to the position of the active marker on the active measurement. This is done by pressing the appropriate soft key, positioning the active marker on the trace, then pressing the [×1] key on the numeric key pad. To set the span, press [Set Gate Span], position the delta marker to the appropriate point on either side of the centre, then press the [×1] key. (If necessary, enable the delta marker from the Markers Menu.)

If gating/fencing is enabled and the display domain is either time or distance for a trace, the gating parameters will be indicated on that trace by a set of three gating markers placed at the start, centre and stop values of the gate. The markers will also indicate whether gating or fencing is being applied. A 'G' flag or 'F' flag will be displayed in the trace information area if gating or fencing are being applied.

See Fig. 3-56 for an example of fencing on a measurement.

Gating
/ Fencing

This soft key has a toggle action and is used to enable/disable the time domain gating/fencing function for the currently active measurement, without affecting previously set parameters.

Set Gate
Start

Used to set the start value of the gating function. The value is entered as either time or distance, according to the domain that has been selected with the Display Domain Menu. If fencing has been selected this soft key is labelled [Set Fence Start], and is used to set the start value of the fencing function.

Time

Rotary Control	√	Step Keys	√	Numeric Pad	√	Terminator	10-
----------------	---	-----------	---	-------------	---	------------	-----

Distance

Rotary Control	√	Step Keys	√	Numeric Pad	√	Terminator	10+
----------------	---	-----------	---	-------------	---	------------	-----

**Set Gate
Stop**

Used to set the stop value of the gating function. The value is entered as either time or distance, according to the domain that has been selected with the Display Domain Menu. If fencing has been selected this soft key is labelled [*Set Fence Stop*], and is used to set the stop value of the fencing function.

Time

Rotary Control	✓	Step Keys	✓	Numeric Pad	✓	Terminator	10-
----------------	---	-----------	---	-------------	---	------------	-----

Distance

Rotary Control	✓	Step Keys	✓	Numeric Pad	✓	Terminator	10+
----------------	---	-----------	---	-------------	---	------------	-----

**Set Gate
Cntr**

Used to set the centre value of the gating function. The value is entered as either time or distance, according to the domain that has been selected with the Display Domain Menu. If fencing has been selected this soft key is labelled [*Set Fence Cntr*], and is used to set the centre value of the fencing function.

Time

Rotary Control	✓	Step Keys	✓	Numeric Pad	✓	Terminator	10-
----------------	---	-----------	---	-------------	---	------------	-----

Distance

Rotary Control	✓	Step Keys	✓	Numeric Pad	✓	Terminator	10+
----------------	---	-----------	---	-------------	---	------------	-----

**Set Gate
Span**

Used to set the span value of the gating function. The value is entered as either time or distance, according to the domain that has been selected with the Display Domain Menu. If fencing has been selected this soft key is labelled [*Set Fence Span*], and is used to set the span value of the fencing function.

Time

Rotary Control	✓	Step Keys	✓	Numeric Pad	✓	Terminator	10-
----------------	---	-----------	---	-------------	---	------------	-----

Distance

Rotary Control	✓	Step Keys	✓	Numeric Pad	✓	Terminator	10+
----------------	---	-----------	---	-------------	---	------------	-----

**Gating
Mode**

Leads to the Gating Mode Menu.
See page 3-200.

**Gate / Fence
Shape**

Leads to the G/F Shape Menu.
See page 3-200.

**Return to
Measure**

Returns control to the Measure Menu.

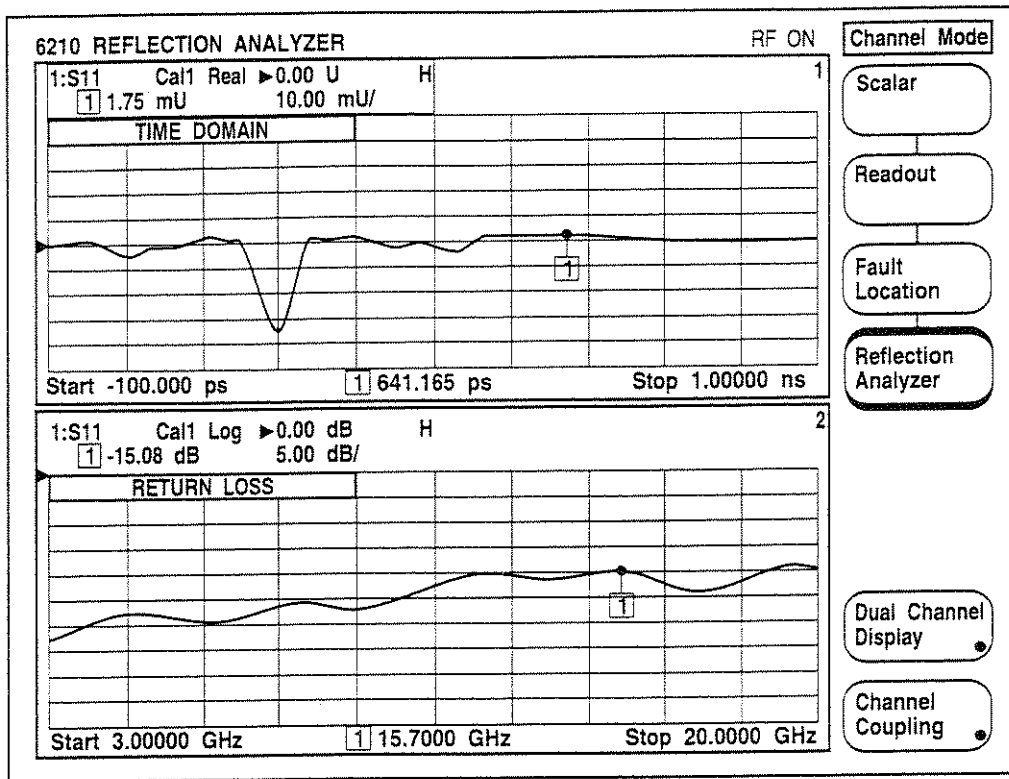

C2388

Normal Response

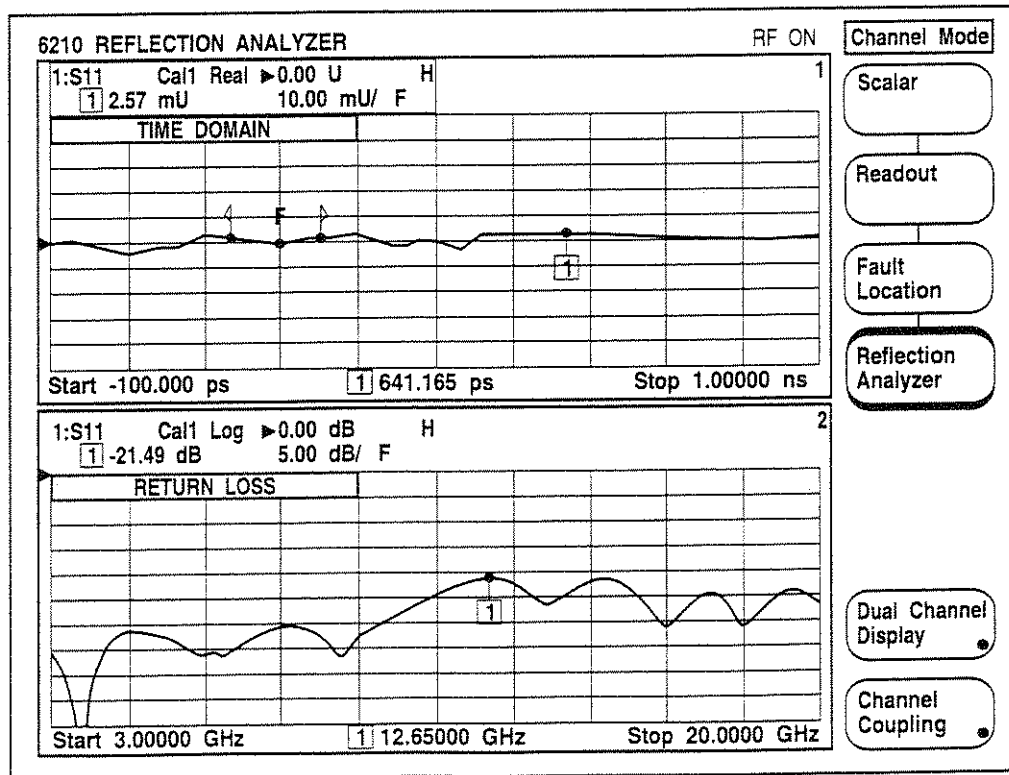

C2389

Response with Fencing Applied

Fig. 3-56 Effect of Fencing on a Measurement

MEASURE**Gating
/ Fencing****Gating Mode****Gating Mode**

This menu is used to select whether gating or fencing is to be applied to the active measurement, and provides a gate/fence coupling function.

Gating

Selects the gating function.

Fencing

Selects the fencing function

**Gate / Fence
Coupling**

Enables gating/fencing parameters to be coupled across measurements and channels. The parameters that can be coupled are start/stop (centre/span), gate type and gate shape. The enable/disable function, however, will remain independent for each measurement. When gate coupling is on, the gating parameters for the active measurement will be copied to all other measurement setups. If any of the parameters for any of the measurements are subsequently updated while coupling is on, the other measurement setups will also be updated.

**Return to
Gate / Fence**

Returns control to the Gate/Fence Menu.

MEASURE**Gating
/ Fencing****Gate / Fence
Shape****G / F Shape**

This menu allows the user to select the shape of the gate that will be applied to the measurement. The shape affects the degree to which information from one feature in the time (distance) domain can be filtered out without affecting the information obtained from a nearby feature.

The gate can be considered as a bandpass filter in the time (or distance) domain, with the start and stop times as the -6 dB cutoff points. The shape of the gate is determined by the cutoff time, which is the time between the -6 dB cutoff point and the peak of the first sidelobe. Four gate shapes are available, each having different cutoff times, sidelobe levels and passband ripple.

If the gate is set to minimum, this gives the minimum cutoff times but the highest sidelobe levels and passband ripple. The converse is true if it is set to maximum.

Minimum

Sets the gate shape to Minimum.

Normal

Sets the gate shape to Normal.

Wide

Sets the gate shape to Wide.

Maximum

Sets the gate shape to Maximum.

**Return to
Gate / Fence**

Returns control to the Gate/Fence Menu.

MEASURE

Time Domain
FunctionsTime Dom Funcs

This menu enables the user to select one of two transform types that are available, and to display the response to two different types of stimulus. A windowing facility is also provided to aid interpretation of the displayed measurements.

Two types of time domain transform are available.

The band pass mode is used to characterise band-limited devices, by simulating the time domain response to an impulse input. The horizontal axis represents the time taken for an impulse launched at the test port to reach a discontinuity. This can be expressed as either time or distance, as selected with the Display Domain menu.

The band pass transform simply uses the frequency domain data as it is measured. This gives rise to time domain data with an imaginary component and, in addition, it is not possible to calculate the step response to a system with this type of transform.

The low pass transform is used to simulate a traditional time domain reflectometry measurement. It can display the time domain response to either a step or impulse input, which provides information to determine the type of discontinuities (resistive, capacitive or inductive) that are present. As for the band pass mode, the horizontal axis represents the travel time to the discontinuity, expressed as either time or distance.

With the low pass transform, the frequency data passed into the transform is extrapolated down to DC and assumed to be symmetrical about 0 Hz. This has the advantage that the symmetry of the frequency domain data produces time domain data with no imaginary component. A sub-menu provides functions to control the way in which the extrapolation to DC is performed.

The low pass mode is not as easy to use as band pass, because of the constraints placed on the parameters of a low pass sweep (see the Source Menu for a low pass sweep).

The transform type and response type apply per channel. The default state is band pass transform/impulse response.

**Band Pass
Transform**

Used to transform band-limited frequency domain data into the time domain, with time (or distance) displayed on the horizontal axis. This mode will automatically be selected if the sweep type is Linear List or Waveguide when entering the time domain.

**Low Pass
Transform**

Used to transform low pass frequency domain data into the time domain, with time (or distance) displayed on the horizontal axis.

This soft key is only selectable if the sweep type is Low Pass.

**Impulse
Response**

Used to display the response of the system under test to a simulated impulse input.

**Step
Response**

Used to display the response of the system under test to a simulated step input.

This soft key is only selectable if the Low Pass time domain transform has been selected.

**DC
Extrapolation**

Leads to the DC Extrap Menu, which is used to select the DC extrapolation mode for the measurement.

This soft key is only selectable if the Low Pass time domain transform has been selected. See page 3-202.

Windowing

Leads to the Windowing Menu, which is used to apply windowing to the frequency domain data.

See page 3-203.

- Display Domain** Leads to the Display Domain Menu.
See page 3-205.
- Return to Measure** Returns control to the Meas Funcs Menu.

MEASURE

Time Domain Functions **DC Extrapolation**

- DC Extrap** This menu is used to control the way in which the extrapolation to DC is performed during a low pass transform. This function applies per measurement.
- Automatic** Sets the DC extrapolation mode to automatic, where the DC reflection coefficient is calculated by extrapolating the existing data.
- Matched** Used to set the DC reflection to zero.
- User Set** Sets the DC extrapolation mode to manual; the following soft key can then be pressed to enable the DC reflection coefficient to be set by the operator.
- Set DC Refl Coeff** Allows the DC reflection coefficient to be entered.
This soft key is only selectable if manual mode has been selected, using the [User Set] soft key.

Rotary Control √ Step Keys √ Numeric Pad √ Terminator Any

- Return to T Dom Funcs** Returns control to the Time Dom Funcs Menu.

MEASURE

Time Domain Windowing
FunctionsWindowing

This menu is used to determine the degree to which the frequency domain data is filtered prior to conversion to the time domain. The purpose of windowing is to reduce the side lobes created by the transformation process so that the time domain response is easier to interpret when attempting to isolate and identify individual responses.

Windowing is needed because of the abrupt transitions in a frequency domain measurement at the start and stop frequencies. This band limiting causes ringing and overshoot in the time domain response, resulting in sidelobes being displayed either side of an impulse response, which can hide lower level responses.

In order to reduce the sidelobes, the low frequency and high frequency data are attenuated before being passed into the time domain transformation. Thus features affecting the frequencies that are attenuated to a high degree are not seen in the transformed data. In order to compensate for this various window shapes are available, which provide a trade-off between the degree to which they eliminate sidelobes and the range and degree of attenuation that is applied to the extreme frequencies of the sweep. Fig. 3-57 shows the effect on the display of two different window shapes.

This function applies per measurement.

**Minimum
(Order 0)**

Provides essentially no window, and therefore results in the highest sidelobes.

**Normal
(Order 6)**

Gives an optimum trade-off between reduced sidelobes and the attenuation of the extreme frequencies of the sweep.

**Wide
(Order 13)**

Gives the minimum sidelobes, providing the greatest dynamic range, but with some attenuation at the extremes of the frequency range.

User Set

Enables the window to be set manually to any type between minimum and wide. The following soft key can then be pressed to enable the window order to be set by the operator.

**Set Window
Order**

Allows the window order to be to any value between 0 and 13.
This soft key is only selectable if manual mode has been selected, using the [User Set] soft key.

Rotary Control	×	Step Keys	×	Numeric Pad	√	Terminator	Any
----------------	---	-----------	---	-------------	---	------------	-----

**Return to
T Dom Funcs**

Returns control to the Time Dom Funcs Menu.

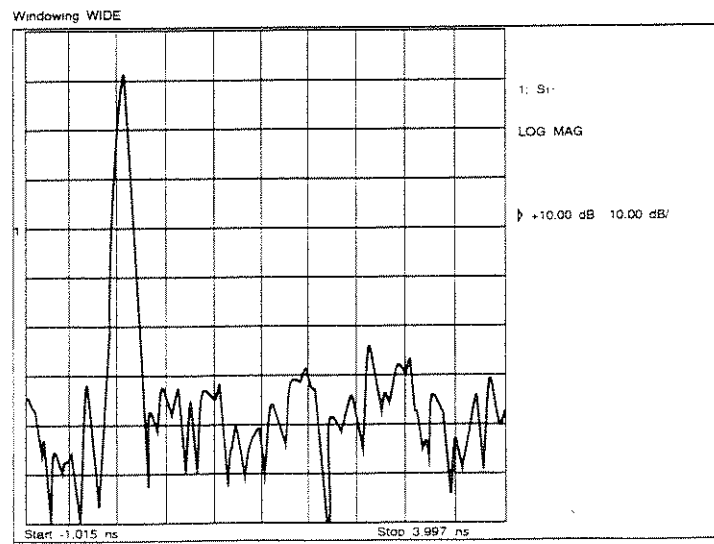
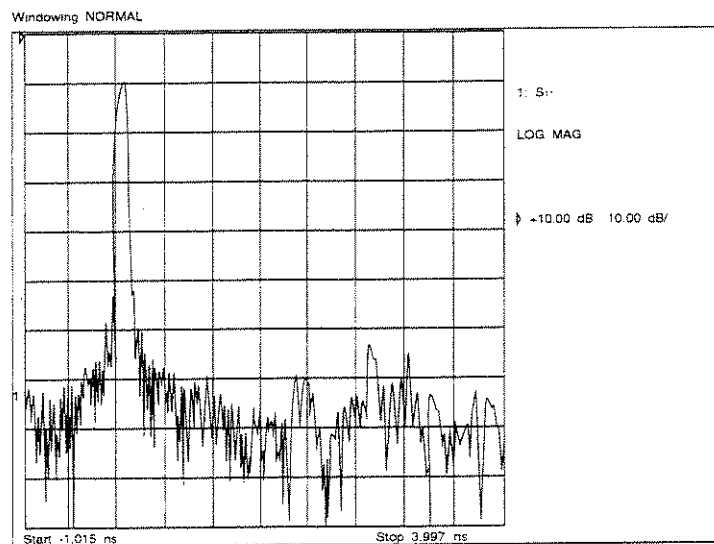
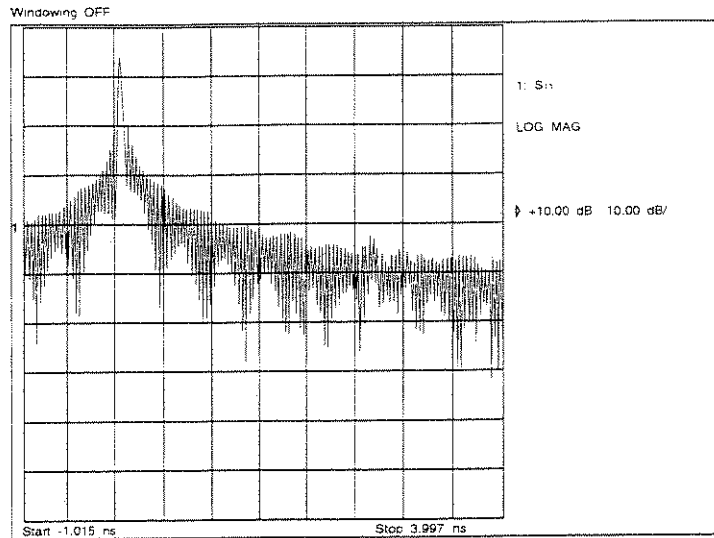

C1244

Fig. 3-57 Effect of Windowing on the Time Domain Response

MEASURE**Time Domain
Functions Display
 Domain****Display Domain**

This menu is used to select whether the time domain measurements are to be displayed in the time or distance domain. This setting also determines whether gate parameters (Gate / Fence Menu) are entered in units of time or distance.

For coax medium, distance units are converted from time units according to

$$\text{Distance} = \text{Time} \times c \times v_r$$

where c = speed of light in free space
 v_r = relative velocity factor of the medium

The relative velocity for coax is set using the Character Dev Menu.

Time

Measurements are displayed in the time domain, i.e. the horizontal axis represents time.

Distance

Measurements are displayed in the distance domain, i.e. the horizontal axis represents distance. The units are selected by the following two soft keys.
This soft key is unselectable if the medium is waveguide but the sweep type is not a waveguide sweep.

Metres

Displays distance in metres. This applies instrument-wide.
This soft key will only be selectable if the distance domain has been selected.

Feet

Displays distance in feet. This applies instrument-wide.
This soft key will only be selectable if the distance domain has been selected.

**Return to
T Dom Funcs**

Returns control to the Time Dom Funcs Menu.

MEASURE

Display
ZoomDisplay Zoom

This menu enables the user to specify a sub-range of displayed domain values by entering the required start and stop values, or by specifying centre and span values. This effectively provides a magnification facility for a selected part of the range. Note that the sweep of the source remains constant; the magnification is accomplished by processing the measurement results. The zoom function applies per channel.

The display start and stop frequencies can also be set to the frequency value corresponding to the position of the active marker on the active measurement. This is done by pressing the appropriate soft key, positioning the active marker on the trace, then pressing the [x1] key on the numeric keypad.

If the centre & span mode has been selected, the centre value is set by pressing [*Set Display Cntr*], positioning the active marker, then pressing the [x1] key on the numeric keypad. The span is set by pressing [*Set Display Span*], positioning the delta marker to the appropriate point either side of the centre, then pressing the [x1] key. (If necessary, enable the delta marker from the Marker Menu.)

Set Display
Start

If the start/stop mode has been selected, this soft key is used to change the start value of the displayed domain. In the centre/span mode this soft key is labelled [*Set Display Cntr*], and is used to display the centre value of the displayed domain.

Frequency, Distance

Rotary Control	✓	Step Keys	✓	Numeric Pad	✓	Terminator	10+
----------------	---	-----------	---	-------------	---	------------	-----

Voltage, Current, Time

Rotary Control	✓	Step Keys	✓	Numeric Pad	✓	Terminator	10-
----------------	---	-----------	---	-------------	---	------------	-----

Power

Rotary Control	✓	Step Keys	✓	Numeric Pad	✓	Terminator	Any
----------------	---	-----------	---	-------------	---	------------	-----

Set Display
Stop

If the start/stop mode has been selected, this soft key is used to change the stop value of the displayed domain. In the centre/span mode this soft key is labelled [*Set Display Span*], and is used to display the span of the displayed domain.

Values are entered as above.

Display as
Start & Stop

Displays the domain as values between the start and stop values as defined above.

Display as
Cntr & Span

Displays the domain as a centre value and span.

Return to
Meas Funcs

Returns control to the Meas Funcs Menu.

MEASURE**More**

Measure
(More)

This menu is a continuation of the Measure Menu.

**Electrical
Delay**

Leads to the Elect Delay Menu, which allows an electrical delay to be introduced into the measurement.
See page 3-208.

**Set Phase
Offset**

Used to apply a phase offset that is constant with frequency (rather than linear, as for electrical delay) to each measurement point of a live S_{11} measurement or a displayed memory. Values in the range $\pm 360^\circ$ can be entered, and applies to each measurement trace.

Rotary Control	√	Step Keys	√	Numeric Pad	√	Terminator	Any
----------------	---	-----------	---	-------------	---	------------	-----

**Characterise
Device**

Leads to the Character Dev Menu, which enables characterisation of the device to be measured.
See page 3-209.

Smoothing

This function is the same as for a scalar channel.
This soft key is unselectable for polar/Smith formats.

**Limit
Checking**

This function is the same as for a scalar channel.
This soft key is unselectable for polar/Smith formats.

**General
Set-up**

This function is the same as for a scalar channel.

**Return to
Prior Menu**

Returns control to the Measure Menu.

MEASURE

More

Electrical
DelayElect Delay

This menu enables an electrical delay to be introduced into the measurement, by adding or subtracting phase in proportion to frequency. The delay has the effect of shifting the zero degrees reference point away from the test port and this can be used to compensate for the electrical lengths of cables or adapters which have been added to the DUT. This parameter applies per measurement.

If the medium is coaxial, the delay can be entered either as a physical length (L) in metres or an electrical delay (D) in seconds. The relationship between L and D is given by:

$$D = L / cv_r$$

where v_r is the relative velocity of the medium, and $c = 3 \times 10^8$ m/s.

Alternatively, the medium can be characterised by its relative dielectric constant ϵ_r , from which v_r is calculated using:

$$v_r = 1 / \sqrt{\epsilon_r}$$

assuming a relative permeability of 1.

Values for v_r or ϵ_r are entered using the Character Dev Menu

For waveguides, the delay can only be entered in metres. The waveguide medium is characterised by its cutoff frequency (f_c), and is entered using the [Set Cutoff Frequency] soft key. Using this value, v_r is computed for each frequency above f_c , and the delay is calculated from the entered length using:

$$D = L / cv_r$$

The electrical delay in degrees at each frequency point f is $-360 Df$.

**Set
Length**

Used to set the electrical delay in metres. Values in the range ± 300 Mm can be entered.

Rotary Control	√	Step Keys	√	Numeric Pad	√	Terminator	10-
----------------	---	-----------	---	-------------	---	------------	-----

**Set
Time**

Used to set the electrical delay in seconds. Values in the range ± 1 s can be entered.
This soft key is unselectable if the medium is waveguide

Rotary Control	√	Step Keys	√	Numeric Pad	√	Terminator	10+
----------------	---	-----------	---	-------------	---	------------	-----

**Return to
Measure**

Returns control to the Measure Menu.

MEASURE

More Characterise Device

Character Dev

This menu is used to specify the characteristics of the system to be measured, and apply instrument-wide.

Set Char Impedance

Used to set the value of the system characteristic impedance, which is required for impedance and admittance calculations.

Rotary Control	✓	Step Keys	✓	Numeric Pad	✓	Terminator	Any
----------------	---	-----------	---	-------------	---	------------	-----

Coax Medium

Used to specify that the medium of the device to be measured is coax.

Waveguide Medium

Used to specify that the medium of the device to be measured is waveguide.

Set Rel Velocity

Used to set the value of relative velocity for coaxial transmission medium. If the line consists of more than one section, and the relative velocities are significantly different, an 'average' value can be calculated for the composite line. The individual figures for relative velocity should be weighted to take account of the relative lengths of the sections, i.e. the longer the section, the greater the effect it has on the composite figure. (The relative velocity is 1 for most waveguides.)

This soft key is unselectable if the medium is waveguide.

Rotary Control	✓	Step Keys	✓	Numeric Pad	✓	Terminator	Any
----------------	---	-----------	---	-------------	---	------------	-----

Set Dielec Constant

Used to set the value of the relative dielectric constant for coaxial transmission medium. For a multi-section line, a composite figure can be calculated as above.

This soft key is unselectable if the medium is waveguide.

Rotary Control	✓	Step Keys	✓	Numeric Pad	✓	Terminator	Any
----------------	---	-----------	---	-------------	---	------------	-----

Set Cutoff Frequency

Used to set the waveguide cutoff frequency, and applies instrument-wide.

This soft key is unselectable if the medium is coaxial.

Rotary Control	✓	Step Keys	✓	Numeric Pad	✓	Terminator	10+
----------------	---	-----------	---	-------------	---	------------	-----

Return to Measure

Returns control to the Measure Menu.



LOCAL OPERATION

FUNCTION
(REFLECTION ANALYZER CHANNEL)

MEASURE

Fig. 3-58 MEASURE Menu - Reflection Analyzer Channel

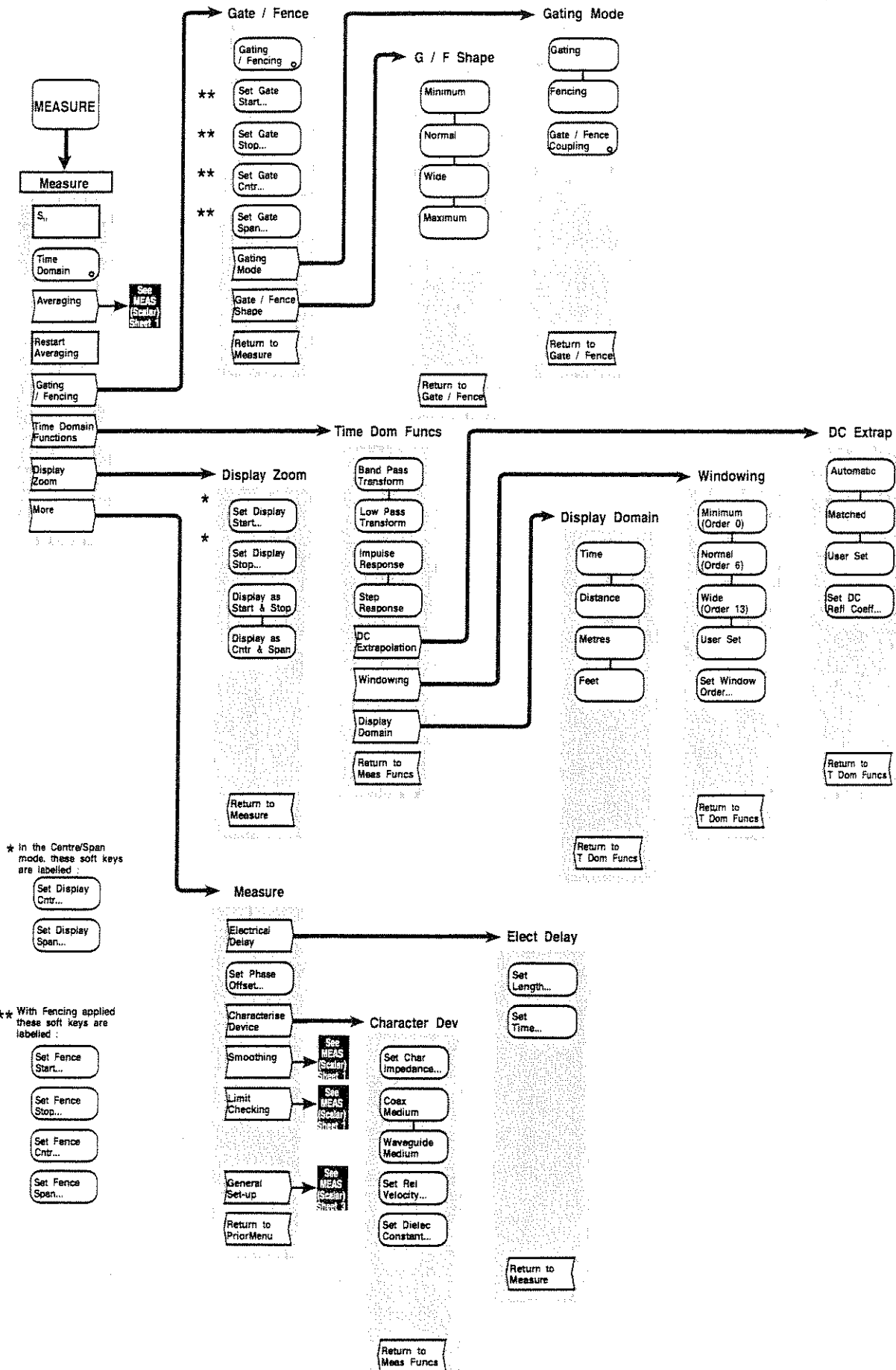

Fig. 3-58 MEASURE Menu - Reflection Analyzer Channel

C1106

[CAL] KEY

The [CAL] key provides access to the calibration menus (Fig. 3-60). Calibration is used in order to characterize the system and effectively remove system errors that cause uncertainty in measuring a device under test. For reflection measurements, errors are introduced which affect both magnitude and phase. Unlike a scalar channel, calibration does not just improve the accuracy of the measurement, it is a necessary part of the measurement procedure.

Calibration is performed by connecting known standard devices to the measurement port of the reflection analyzer and making measurements over the frequency range of interest. To accurately calibrate the measurement system three standards are required. The standards used are a short circuit, an open circuit and a matched load, since they cover the widest frequency range and are the most convenient to use. These standards are provided in the form of a calibration kit; one of several cal kits can be selected by the user. The true reflection coefficients of the standards can be found from data supplied with the cal kit. This is used together with the measured reflection coefficients in order to calculate the reflection coefficient of the device connected to the test port.

The standards used for calibration are as follows:

Coax	Waveguide
Short circuit	Short circuit
Open circuit	Offset short
Fixed load	Fixed load
Sliding load (8 positions)	Sliding load (5 positions)

For coax measurements, the fixed load is used for frequencies below 2 GHz, since it is impractical to use a sliding load at these frequencies. Above 2 GHz a sliding load can be used, and it also gives better accuracy. It is not possible to use an open circuit with waveguides because of the radiation from the open end, therefore offset shorts are used instead.

Since practical calibration standards are non-ideal, various parameters are used to characterize them. The characteristics of the devices in a cal kit are held in an associated cal kit store, and can be edited using the Edit Cal Kit Menu.

The following calibration types are available:

COAX	Short - Open - Load (fixed)
COAX	Short - Open - Load (fixed & sliding)
WAVEGUIDE	Short - Offset Short - Load (fixed sliding)
WAVEGUIDE	Short - Offset Short 1 - Offset Short 2

Any one of a number of stored calibrations can be applied to the current measurement. The trace information area of the display indicates if calibration is being applied, and the identity of the calibration store. Measurements will not be displayed unless a valid calibration is present. If the calibration becomes invalid (e.g. due to subsequent changes in the source set-up), a warning message will be displayed and a "?" is displayed after the calibration identity. The [Recall Cal Conditions] soft key in the Measure Menu can be used to restore the instrument state to that which existed when the current calibration was performed.

Facilities are also provided for calibrating sensors and zeroing detectors/sensors; these are the same as for a scalar channel.

For a discussion of calibration techniques, refer to the example reflection analyzer measurement in the Getting Started Manual for the MTS.

CAL

- Cal** This menu provides facilities for calibrating the measurement system for a reflection analyzer channel, saving the calibration for future use, and applying a previously stored calibration. It also provides access to menus for detector/sensor zeroing and sensor calibration.
- Reflection Analyzer Cal** Leads to the Reflect Cal Menu, which is used to perform a reflection analyzer calibration. *See page 3-215.*
- Select Cal** Enables a reflection analyzer calibration to be loaded from an instrument store or a memory card by entering the required identity number. A form is displayed on the screen containing the names and identity numbers of the available calibration stores. The [Page Up] and [Page Down] soft keys are used to select the previous and next page of entries in the list. The trace information area indicates which calibration store is being used.
- Rotary Control × Step Keys × Numeric Pad √ Terminator Any
- Recall Cal Conditions** Recalls the measurement conditions that were present when the reflection analyzer calibration was performed.
- Edit Cal Kit Data** Leads to the Edit Cal Kit Menu, which is used to edit a cal kit data store. The user is first of all requested to select the cal kit to be edited, by entering the required identity number. *See page 3-219.*
- Refl Analyzer Zero** This soft key is used to zero the detectors in the 6210 reflection analyzer.
- Det / Sensor Zero** Leads to the Det/Sen Zero Menu, which is used for zeroing detectors/sensors. *See page 3-88.*
- Sensor Cal** Leads to the Sensor Cal Menu, which is used to zero the power sensor and to calibrate it against the reference. *This soft key will only be selectable if Input D is configured for a power sensor. See page 3-89.*
- Power Ref** Toggles the power reference on and off. When it is turned on, the front panel POWER REF connector provides a 50 MHz 0 dBm power reference output. The reference can be used for example, to verify that the power sensor is functioning correctly. The Power Reference On indicator (PWRREF) will be present in the General Information Area at the top of the screen if a power reference signal is being output.

CAL

Reflection
Analyzer CalReflect Cal

This menu is used to carry out calibration on the currently active reflection analyzer channel, and to save the calibration if required.

A form is displayed on the screen (Fig. 3-59) containing the following calibration details:

- Cal kit identity
- Medium type
- The type and sex of the connectors used in the cal kit
- Calibration type.
- Calibration position (test port or end of cable)

The following source set-up details are displayed:

- Sweep type
- Sweep range
- Power level of sweep
- Sweep time
- Number of measurement points.

The instrument's detection mode and current averaging are also displayed.

Measurement calibrations are valid only for a specific source set-up, which must be defined before calibration is started.

Each standard in the selected cal kit is listed, together with its serial number and an indication of whether or not it has been measured. For waveguide calibration kits the lengths of the offset shorts will also be displayed. The calibration kit to be used is selected by using the *[Select Cal Kit]* soft key.

Initially, the calibration details displayed will be those of the last calibration performed. If a calibration has not yet been done then default data will be displayed. When a selection has been made using the following soft keys, the information in the form will be updated appropriately.

If either of the waveguide calibration types is chosen and the calibration kit cutoff frequency is different to the instrument-wide cutoff frequency ([MEASURE] key), then the user will be asked whether the instrument-wide cutoff frequency is to be set to the calibration kit cutoff frequency value.

MICROWAVE TEST SET		RF ON	
Reflection Analyzer Calibration			
Cal Kit	: Cal Kit Store 1	Sweep Mode	: Low Pass
Medium	: Coax	Start	: 282.378238 MHz
Cal Pieces	: 3.5mm (F)	Stop	: 26.500000000 GHz
Type	: S-O-L (Sliding)	Power	: +2.00 dBm
Calibrate at	: Test Port	Time	: AUTOMATIC
Detection Mode	: DC	No Points	: 401
Averaging	: OFF		
STANDARD		MEASURED	
Short	- 913123		Yes
Open	- 913174		Yes
Fixed Load	- 913201		Yes
Sliding Load	- 924067		
	Position 1		Yes
	Position 2		Yes
	Position 3		Yes
	Position 4		No
	Position 5		No
	Position 6		No
	Position 7		No
	Position 8		No
Start	282.378 MHz	Stop	26.5000 GHz

Fig. 3-59 Reflection Analyzer Calibration Details Form

Measure Standards

Used to perform a measurement of the selected standard. A sub-menu is displayed with the following soft keys:

- [Process Meas]
- [Measure Standard]
- [↑]
- [↓]
- [Abort Calibration]

The standard to be measured is indicated by a highlight box around the standard's name, which can be moved up and down the list using the [↑] and [↓] soft keys. Standards can be measured in any order, and the measurement may be repeated if desired. After the standard has been connected to the test port, the [Measure Standard] soft key is pressed to initiate the measurement

While calibration data is being acquired, a message is displayed informing the user which standard is being measured, together with a percentage complete indicator.

Once all the standards have been measured, the [Process Meas] soft key will become selectable. When this is pressed, the MTS completes the calibration process by performing the necessary calculations on the calibration data. A percentage complete indicator will be displayed during this process.

When calibration is complete, the following soft keys will become available:

- [Save Calibration]
- [Select Store]
- [Abort Calibration]

The [Select Store] soft key is used to select the store for saving the calibration, by entering the required store id number. The new calibration can then be saved to the specified store by pressing the [Save Calibration] soft key. Four internal stores are available in the MTS; alternatively, reflection analyzer calibrations can be stored on a memory card. At this point, the opportunity is given to change the id name of the store, if required.

Once the calibration has been performed and saved it will be used by the instrument.

**Select
Cal Kit**

Used to specify the cal kit that will be used for calibration, by entering the required identity number. A form is displayed listing the names and identity numbers of the available cal kits, stored internally or on a memory card. The [Page Up] and [Page Down] soft keys are used to select the previous and next page of entries in the list.

Rotary Control	×	Step Keys	×	Numeric Pad	√	Terminator	Any
----------------	---	-----------	---	-------------	---	------------	-----

**Short, Open
Fixed Load**

Used to select a coaxial calibration which measures the following standards:
Short - Open - Fixed Load

If a waveguide calibration kit has been selected, this soft key will be labelled [Short, Offset Short, Load], and is used to measure the following standards:
Short - Offset Short - Load

**Short, Open
Sliding Load**

Used to select a coaxial calibration which measures the following standards:
Short - Open - Sliding Load

If a waveguide calibration has been selected, this soft key will be labelled [Short, Offset Shorts], and is used to measure the following standards:
Short - Offset Short 1 - Offset Short 2

Male

Specifies male type cal pieces for coaxial calibration.
Unselectable if a 7 mm calibration kit has been selected.
Labelled [Short, Offset, Sliding Load] if a waveguide cal kit has been selected.

Female

Specifies female type cal pieces for coaxial calibration.
Unselectable if a 7 mm calibration kit has been selected.
Not displayed if a waveguide calibration kit has been selected.

**Set Up
Calibration**

Leads to the Set Up Cal Menu
See page 3-218.

**Abort
Calibration**

Terminates the calibration process. The current calibration store will not be affected.

CAL

**Reflection
Analyzer Cal Set Up
 Calibration**

Set Up Cal	This menu is used to set up the calibration.
Calibrate at Test Port	Enables calibration to be carried out at the Test Port of the Reflection Analyzer.
Calibrate at End of Cable	Enables calibration to be carried out at the end of a coaxial cable connected to the Test Port.
Set Up Source	Leads to the top level Source Menu for the Reflection Analyzer Channel. However, the <i>[RF]</i> soft key is not present and <i>[Source Functions]</i> is replaced by a 'Return' key.
Averaging	Leads to the Averaging Menu. <i>See page 3-54.</i>
AC Detection	This is the same as for the Measure Menu <i>See page 3-62.</i>
DC Detection	This is the same as for the Measure Menu. <i>See page 3-62.</i>
Return to Reflect Cal	Returns control to the Reflect Cal Menu.

CAL

**Edit Cal
Kit Data**Edit Cal Kit

This menu is used to edit a cal kit data store. Each store is associated with a cal kit, and contains the data which is used to characterize the standards comprising the cal kit.

The cal kit to be edited must first be selected. When the *[Select Cal Kit]* soft key is pressed, a form is displayed showing the names and identity numbers of the available cal kits. Once a cal kit has been selected, another form is displayed containing the following details:

Cal kit id number and name
Connector type (e.g. Coaxial, 3.5mm)
Cal data as follows:

Cal data for coaxial devices:
Short offset length
Open offset length
4 open fringing coefficients
Fixed load offset length
Fixed load break frequency
Sliding load break frequency

For sexed coaxial connectors, the data is displayed in two columns, one containing the male data and one the female data.

Cal data for waveguide devices:
Short offset length
Offset short 1 offset length
Offset short 1 minimum frequency
Offset short 1 maximum frequency
Offset short 2 offset length
Offset short 2 minimum frequency
Offset short 2 maximum frequency
Load offset length
Waveguide cutoff frequency

The *[Set Connector]* soft key is used to select the connector type to be edited, (e.g. 3.5 mm, N-type). The parameter to be edited is indicated by a highlight box around the parameter's name, which can be moved up and down the list using the *[↑]* and *[↓]* soft keys. If appropriate, the *[⇒]* soft key can be used to change between the male and female columns. The serial numbers of the calibration pieces can be changed by selecting the appropriate field using the *[↑]* and *[↓]* soft keys and then using the *[Set Serial No]* soft key. This displays a text entry form containing the serial number, which can then be edited. When editing has been completed, the cal kit data can be saved using the *[Save Cal Kit]* soft key; it can be saved under a different name by means of the *[Set Identity]* soft key. The *[Set Identity]* soft key is displayed in place of *[Set Serial No]* when the selected parameter is the calibration kit identity.

The cal kit parameters are entered as follows:

Offset Length

Rotary Control	×	Step Keys	×	Numeric Pad	√	Terminator	10-
----------------	---	-----------	---	-------------	---	------------	-----

Frequency

Rotary Control	×	Step Keys	×	Numeric Pad	√	Terminator	10+
----------------	---	-----------	---	-------------	---	------------	-----

Fringing Coefficient Mantissa

Rotary Control	×	Step Keys	×	Numeric Pad	√	Terminator	Any
----------------	---	-----------	---	-------------	---	------------	-----

Fringing Coefficient Exponent

Rotary Control	×	Step Keys	×	Numeric Pad	√	Terminator	Any
----------------	---	-----------	---	-------------	---	------------	-----

Select Cal Kit

Used to select the cal kit to be edited by entering the required identity number.

Rotary Control	×	Step Keys	×	Numeric Pad	√	Terminator	Any
----------------	---	-----------	---	-------------	---	------------	-----

Set Connector

Leads to the Connector Menu.
See page 3-221.

Set Serial No

Used to change the serial number of the selected calibration piece. A text entry form is displayed on the screen, which is the same as that described for the Screen Title Menu (page 3-290).

If the selected parameter is the calibration kit identity, this soft key is labelled [*Set Identity*]. A text entry form is displayed enabling the identity to be edited. *This soft key is only selectable if the selected parameter is a cal kit identity or serial number.*

⇒

Used to select between the male and female data columns (for sexed coaxial connectors). If the currently selected column is female, this soft key will be labelled [*⇐*]. *This soft key will only be selectable for sexed coaxial connectors.*

↑

Makes the previous entry in the table the active entry.

↓

Makes the next entry in the table the active entry.

Save Cal Kit

Causes the cal kit data to be saved in non-volatile memory.

Return to Cal

Returns control to the Cal Menu.

CAL**Edit Cal
Kit Data****Set
Connector****Connector**

This menu is used to specify the type of connectors used on the standard devices of the cal kit to be used for calibration.

3.5 mm

Specifies 3.5 mm coaxial connectors.

N

Specifies N-type coaxial connectors.

7 mm

Specifies 7 mm coaxial connectors.

Waveguide

Specifies waveguide connectors.

User

Specifies a connector type defined by the user. Parameters for user-defined connector types are entered using the Edit Cal Kit Menu (see page 3-219).

**Return to
Edit Cal Kit**

Returns control to the Edit Cal Kit Menu.

FUNCTION
REFLECTION ANALYZER CHANNEL

LOCAL OPERATION

FUNCTION
(REFLECTION ANALYZER CHANNEL)

CAL

Fig. 3-60 CAL Menu - Reflection Analyzer Channel

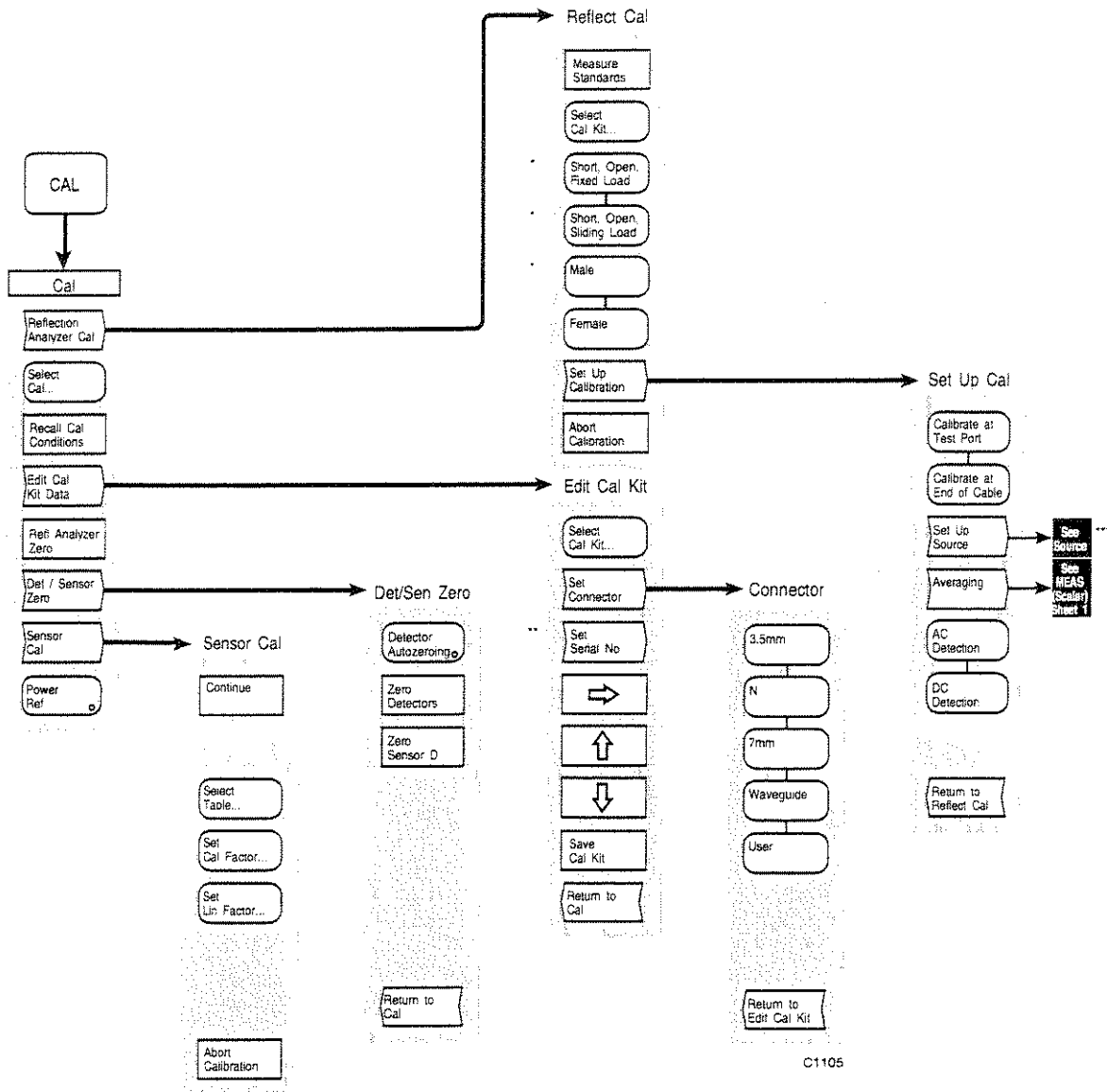

C1105

*With a waveguide calibration kit, these soft keys are labelled:

- Short, Offset
Short, Load
- Short, Offset
Shorts
- Short, Offset
Sliding Load

**When the cal kit identity field is selected this soft key is labelled:

- Set
Identity

***This is the same as the source menu structure for the reflection analyzer. However the 'RF' key and the 'Source Functions' keys have been removed with the latter being replaced by a 'Return' key.

Fig. 3-60 CAL Menu - Reflection Analyzer Channel

[FORMAT] KEY

The [FORMAT] key enables the reflection analyzer measurement to be displayed in the required format, i.e. the units in which the response (vertical axis) is scaled.

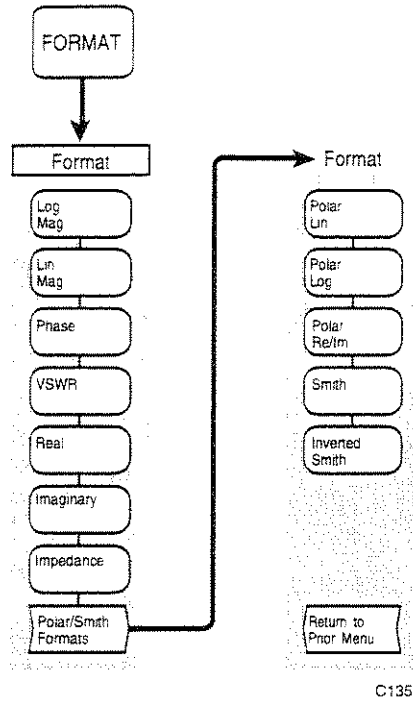

Fig. 3-61 *FORMAT Menu - Reflection Analyzer Channel*

FORMAT

Format

This menu enables one of several display formats to be selected.

In the following, the complex reflection coefficient at the test device input (S_{11}) is represented by Γ , where $\Gamma = \frac{\text{reflected voltage}}{\text{incident voltage}}$

The following display formats are available:

Cartesian formats

Linear magnitude of complex reflection coefficient, $|\Gamma|$

Log magnitude of Γ

Phase angle of Γ in degrees

Real part of Γ

Imaginary part of Γ

VSWR (= $(1 + |\Gamma|)/(1 - |\Gamma|)$).

Input impedance $\left(Z_0 \frac{1 + \Gamma}{1 - \Gamma} \right)$

Polar/Smith formats

Polar linear, i.e. $|\Gamma|$, phase angle

Polar log, i.e. $20 \log|\Gamma|$, phase angle

Polar Re/Im, i.e. $\text{Re}(\Gamma)$, $\text{Im}(\Gamma)$

Smith chart

Inverted Smith chart

If a low pass transform has been selected the phase and imaginary formats are not available. This is because these formats would present no information, since the imaginary part of the reflection coefficient would always be zero with a low pass transform.

If a low pass transform is selected while in the time (or distance) domain, and the current format is not permitted (i.e. Phase or Imaginary), a warning will be displayed and the format will be set to Real.

The format selected applies per measurement. It is not possible to display both a cartesian format and a polar/Smith format within the same channel.

Log Mag Displays log magnitude of $|\Gamma|$ in dB, i.e. $20 \log_{10} |\Gamma|$. Note that this is the same as return loss, but expressed as a negative quantity.

Lin Mag Displays linear magnitude of complex reflection coefficient, $|\Gamma|$.

Phase Displays phase angle of Γ in degrees, i.e. $\tan^{-1}(\text{Im}(\Gamma)/\text{Re}(\Gamma))$.
This soft key is unselectable if the low pass time domain option has been selected.

VSWR Displays VSWR, i.e. $(1 + |\Gamma|)/(1 - |\Gamma|)$.

Real Displays the real part of Γ .

Imaginary Displays the imaginary part of Γ .
This soft key is unselectable if the low pass time domain option has been selected.

- Impedance** Displays the input impedance, i.e. $Z_0 \frac{1+\Gamma}{1-\Gamma}$.
Unselectable unless the measurement is a low pass step response time domain one.
- Polar/Smith Formats** Leads to a sub-menu, which enables various types of polar/Smith formats to be selected.
This soft key is unselectable if time domain is turned on.
See page 3-227.

FORMAT

Polar/Smith Formats

Format
(Polar/Smith Formats)

This is a continuation of the previous menu, and allows polar or Smith formats to be selected.

Polar and Smith formats display the same measurement (i.e. reflection coefficient, Γ), but it is interpreted differently in each case by superimposing a different graticule and/or by processing the marker readout in a different way. Examples of these formats are shown in Fig. 3-62.

Polar Lin

Displays the reflection coefficient in polar format; each point corresponds to a particular value of both magnitude and phase. Quantities are read vectorally: the magnitude at any point is determined by its displacement from the centre, and the phase by the angle anti-clockwise from the positive x-axis.

The graticule comprises five equally spaced concentric circles. Magnitude is scaled linearly, from zero at the centre to the value represented by the outer circle. This value is equal to the reference level, which is set using the [SCALING] key. Markers can be used to obtain a readout of magnitude and phase corresponding to any point on the trace.

Polar Log

This provides a similar display to the polar lin format, except that the marker readout of magnitude is $20 \log_{10} |\Gamma|$.

Polar Re/Im

This provides a similar display to the polar lin format, except that the marker readout gives $\text{Re}(\Gamma)$ and $\text{Im}(\Gamma)$.

Smith

Provides impedance measurements in the form of a Smith chart. The Smith chart is essentially a polar diagram on which are superimposed loci of constant resistance and reactance, thus enabling the impedance at any point along a transmission line to be obtained. These values are normalized to the characteristic impedance of the system. As for the polar format, the radius corresponds to the magnitude of the reflection coefficient, and the angle corresponds to the phase of the reflection coefficient. The marker readout of impedance ($R+jX$) is given in units of resistance (R) and reactance (X) (i.e. the real and imaginary parts of the complex impedance).

If a reference level value of less than 0.1 is set (using the Scaling Menu) while in this mode, the display will revert to the polar format.

Inverted Smith

This format is similar to above, but is used for admittance measurements, where the loci now represent constant conductance (G) and susceptance (B). The marker readout of admittance ($G+jB$) is given in terms of these quantities.

Return to Prior Menu

Returns control to the Format Menu.

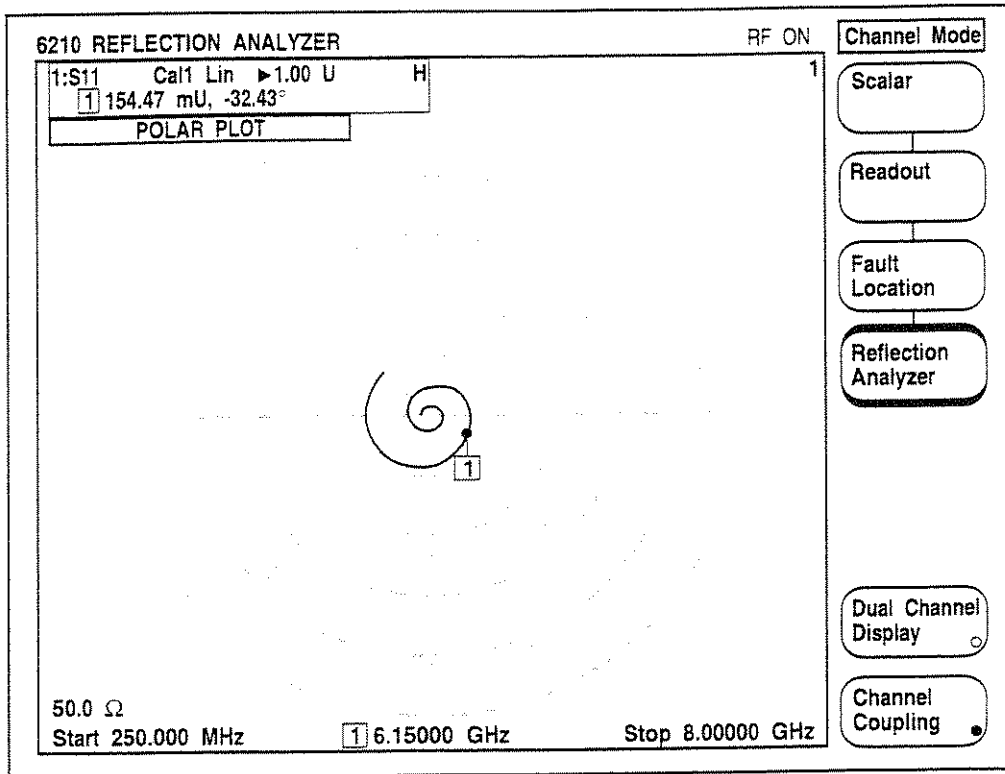

C2390

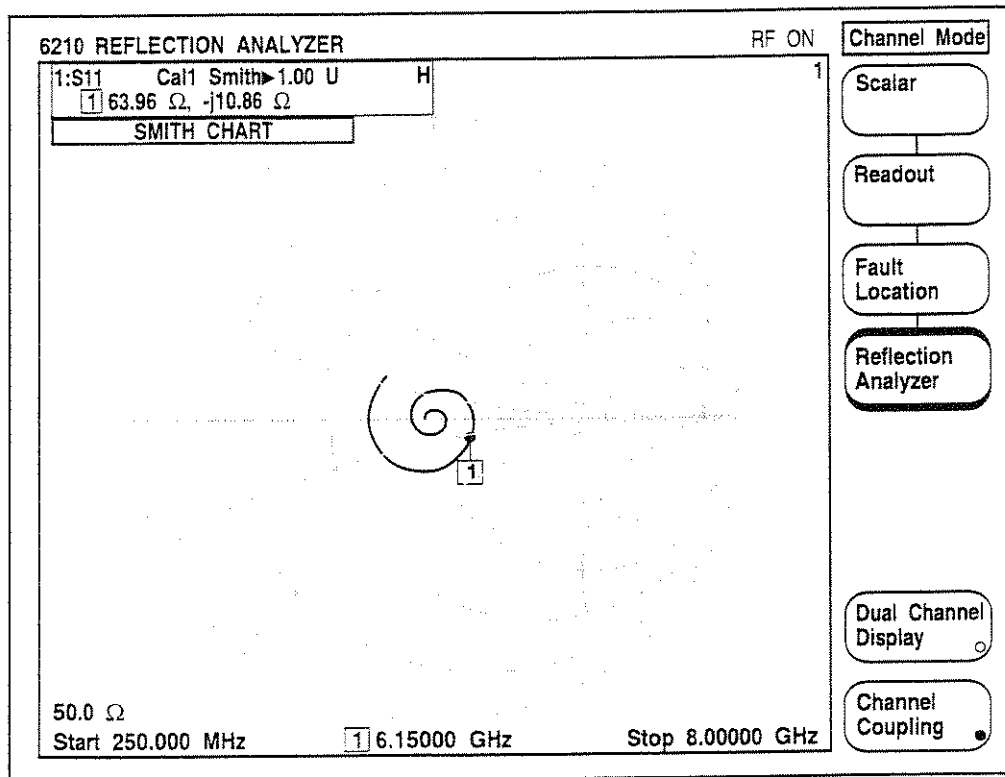

C2391

Fig. 3-62 Typical Polar and Smith Format Displays

[SCALING] KEY

The [SCALING] key provides a menu which enables the user to adjust the positioning and scaling of the currently active trace, or to allow the instrument to set the scaling automatically.

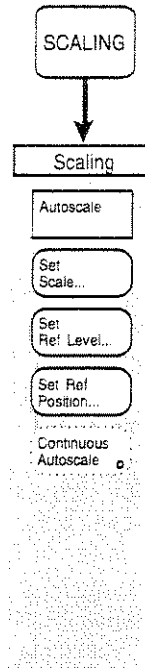

C0764

Fig. 3-63 SCALING Menu - Reflection Analyzer Channel

SCALING

Scaling

This menu enables the user to set the reference level and scaling for a trace.

Cartesian Formats

The reference position is the position on the vertical axis that remains fixed during scaling. This is indicated on the screen by the Reference Position Indicator (see the 'Display' section). The reference level is the value corresponding to the position of the Reference Position Indicator on the vertical scale, and is displayed in the relevant trace information area. The scaling value is the number of units per vertical division.

The default values for reference level and scaling factor for each type of format are listed below.

	Reference Level*	Scale Factor
Lin magnitude	1 (line 10)	0.1 /div
Log magnitude	0 dB (line 10)	5 dB/div
Phase	0° (line 5)	45°/div
Real	0 (line 5)	0.2 /div
Imaginary	0 (line 5)	0.2 /div
VSWR	1 (line 1)	1 /div
Impedance	50 Ω (line 5)	1.00 Ω /div

* Line 0 = bottom; line 10 = top.

Polar/Smith Format

The graticule for the polar format comprises five equally spaced concentric rings, with radial lines at 45° intervals. The reference level is the linear magnitude value corresponding to the outer circle. The scaling value is the linear magnitude value corresponding to the innermost circle. Since the graticule always consists of five circles, the scaling value is always one fifth of the reference level. Thus either the reference level or scaling value may be entered, and the instrument will calculate the other value.

For Smith formats, only the outer concentric ring is displayed, but the method of scaling is the same as for the polar display.

The default values for reference level and scaling factor for polar/Smith formats are listed below.

	Reference Level	Scale Factor
All formats	1 (magnitude of ref. coefficient)	0.2

The parameters in this menu apply per trace.

Autoscale

Cartesian formats

Allows the instrument to determine optimum values of scale and reference level, such that the trace occupies approximately 80% of the graticule height. The value chosen for the scale factor will be selected from a 1,2,5 sequence. The value chosen for the reference level will be a multiple of the chosen scaling factor. The reference position will remain unchanged.

Smith/polar formats

The smallest reference level value will be selected from a 1,2,5 sequence such that the whole of the measurement lies within the outer circle.

Set Scale

Used to set the scale factor for a trace.

Log Magnitude Format

Rotary Control	✓	Step Keys	✓	Numeric Pad	✓	Terminator	Any
----------------	---	-----------	---	-------------	---	------------	-----

Lin Magnitude, Real and Imaginary Formats

Rotary Control	✓	Step Keys	✓	Numeric Pad	✓	Terminator	10-
----------------	---	-----------	---	-------------	---	------------	-----

Phase Format

Rotary Control	✓	Step Keys	✓	Numeric Pad	✓	Terminator	Any
----------------	---	-----------	---	-------------	---	------------	-----

VSWR Format

Rotary Control	✓	Step Keys	✓	Numeric Pad	✓	Terminator	Any
----------------	---	-----------	---	-------------	---	------------	-----

Smith/Polar Formats

Rotary Control	✓	Step Keys	✓	Numeric Pad	✓	Terminator	10-
----------------	---	-----------	---	-------------	---	------------	-----

Set Ref Level

Used to set the reference level for a trace.

Numeric entry as above.

The reference level can also be set to the response measured at the active marker position, by pressing this soft key followed by the [x1] key on the numeric keypad.

Set Ref Position

Used to set the reference position for a trace. The reference position may be placed on any of the 11 horizontal lines of the graticule.

This soft key is unselectable for Smith/polar formats.

Rotary Control	✓	Step Keys	✓	Numeric Pad	×	Terminator	×
----------------	---	-----------	---	-------------	---	------------	---

Continuous Autoscale

This soft key is unselectable.

[MARKERS] KEY

The MTS can display up to eight markers per trace, with each marker identified by a number. Any one of these can be designated the active marker, indicated by a box around the number to distinguish it from the normal markers. The active marker can be moved along the x-axis using the step keys, rotary control or by keyboard entry. The step keys and keyboard entry are only available through the Position Active Mkr and Position Delta Mkr functions of the Markers Menu. The rotary control can be used to move the active marker at any time whilst it is displayed, provided that no other form of numeric entry is active. The domain value (x-axis position) of the active marker is displayed below the graticule, and the measured response at this position is displayed in the relevant trace information area. For Polar/Smith formats, a complex (2 part) number will be displayed.

The delta marker mode provides an additional marker, designated the delta marker, and is represented by Δ on the display. In this mode, the domain value of the active marker is relative to the delta marker position. The measured response is relative to the response at the delta marker position, i.e.

$$\begin{aligned}\text{Domain value} &= \text{Active Marker position} - \text{Delta Marker position} \\ \text{Response} &= \text{Active Marker response} - \text{Delta Marker response}\end{aligned}$$

Note that the distance (or time) values indicated by the active marker represent the actual distance (or time) to a discontinuity, not the round trip distance.

The marker menus are shown in Fig. 3-64.

A tracking facility is available for the max/min, peak-to-peak and bandwidth functions. This enables the function to be automatically applied at each measurement update (i.e. at the end of each sweep).

MARKERS

Markers This menu provides soft keys for setting up markers and using them to perform various types of measurement.

Active Mkr Toggles the active marker on or off. Turning off the active marker also turns off the delta Marker. Once the active marker is turned on it can be positioned any where along the graticule using the rotary control. To set the active marker to a specific domain value using the numeric keypad the [Position Active Mkr] soft key must be selected.

Place Mkr at Active Used to place a marker at the active marker position by entering the required number.

Rotary Control	×	Step Keys	×	Numeric Pad	✓	Terminator	None
----------------	---	-----------	---	-------------	---	------------	------

Position Active Mkr Used to change the domain value (x-axis position) of the active marker, by entering the new value as follows:

Frequency

Rotary Control	✓	Step Keys	✓	Numeric Pad	✓	Terminator	10+
----------------	---	-----------	---	-------------	---	------------	-----

Power

Rotary Control	✓	Step Keys	✓	Numeric Pad	✓	Terminator	Any
----------------	---	-----------	---	-------------	---	------------	-----

Voltage/current

Rotary Control	✓	Step Keys	✓	Numeric Pad	✓	Terminator	10-
----------------	---	-----------	---	-------------	---	------------	-----

Time

Rotary Control	✓	Step Keys	✓	Numeric Pad	✓	Terminator	10-
----------------	---	-----------	---	-------------	---	------------	-----

Distance

Rotary Control	✓	Step Keys	✓	Numeric Pad	✓	Terminator	10+
----------------	---	-----------	---	-------------	---	------------	-----

This soft key will only be selectable if the active marker is turned on.

Delta Mkr Toggles the delta marker on or off. Turning on the delta marker also turns on the active marker.

Position Delta Mkr Used to change the position of the delta marker, using the same method as for the active marker.

This soft key will only be selectable if the delta marker is turned on.

All Mkrs Off Turns off all markers for the currently active trace.

Mkr Functions Leads to the Mkr Funcs Menu, which enables various measurement functions to be carried out by means of the active marker and delta marker.

See page 3-234.

Set Up Mkrs Leads to the Set Up Mkrs Menu, which allows the user to activate and position selected markers.

See page 3-236.

MARKERS**Mkr
Functions****Mkr Funcs**

This menu leads to sub-menus for locating the maximum and minimum points on a trace, measuring the peak-to-peak ripple, searching for a specified response value, performing bandwidth measurements, measuring the slope of a trace, and locating multiple peaks in the time domain response.

**Marker to
Max/Min**

Leads to the Max Min Menu
See page 3-100.

**dB/Octave
dB/Decade**

Leads to the dB/O dB/D Menu.

This soft key is only selectable if the domain is frequency, start frequency is < stop frequency, source mode is not linear list sweep, format is log magnitude, and time domain is turned off.
See page 3-100.

**Peak to
Peak**

Leads to the Peak to Peak Menu, which enables measurement of peak-to-peak ripple.
*This soft key is only selectable if the format is log magnitude.
See page 3-101.*

Search

Leads to the Search Menu, which is used to locate a response value on the screen.
*This soft key is unselectable for polar and Smith format measurements.
See page 3-235.*

Bandwidth

Leads to the Bandwidth Menu, which is used for bandwidth measurements.
*This soft key is only selectable if the format is log magnitude, the source mode is a frequency sweep and time domain is turned off.
See page 3-103.*

**Find Next
Peak**

Leads to the Find Next Pk Menu.
*This soft key is only selectable if time domain is turned on.
See page 3-235.*

**Return to
Markers**

Returns control to the Markers Menu.

MARKERS

Mkr Functions Search

Search

This menu is used for locating a response value on the trace that has previously been specified by the user. The search facility can also be used in delta marker mode.

Search Left

Causes the system to search left from the current active marker position in order to find the response value specified with the *[Set Search Value]* soft key. The active marker will be placed at this position. If two adjacent measurement points encompass the search value, the active marker will be placed at the measurement point which is nearer to the search value. If the search value cannot be found, a message will be displayed indicating this, and the active marker will not be moved.

Search Right

As above, but the search direction is right.

Set Search Value

Sets the value that will be searched for.

Log Magnitude Format

Rotary Control	✓	Step Keys	✓	Numeric Pad	✓	Terminator	Any
----------------	---	-----------	---	-------------	---	------------	-----

Lin Magnitude, Real and Imaginary Format

Rotary Control	✓	Step Keys	✓	Numeric Pad	✓	Terminator	10-
----------------	---	-----------	---	-------------	---	------------	-----

Phase Format

Rotary Control	✓	Step Keys	✓	Numeric Pad	✓	Terminator	Any
----------------	---	-----------	---	-------------	---	------------	-----

VSWR Format

Rotary Control	✓	Step Keys	✓	Numeric Pad	✓	Terminator	Any
----------------	---	-----------	---	-------------	---	------------	-----

Return to Mkr Funcs

Returns control to the Mkr Funcs Menu.

MARKERS

Mkr Functions Find Next Peak

Find Next Pk

This menu enables the active marker to be placed at peaks in the time domain trace.

Find Next Peak Right

Positions the active marker at the next peak in the trace to the right of its current position. The peak that the active marker moves to is defined to be the next local maximum visible on the screen to the right of the current active marker position. If a peak cannot be found, the active marker will remain at its current position.

Find Next Peak Left

As above, but the next peak to the left of the current active marker position is located.

Returns to Mkr Funcs

Return control to the Mkr Funcs Menu.

MARKERS

Set Up
Mkrs

Set Up Mkrs

This menu enables selected markers to be turned on or off and positioned on the display, and allows one of the markers to be selected as the active marker. For frequency sweep measurements, the menu provides two alternative display resolutions for marker positions. A soft key is also provided to turn marker coupling between channels on or off.

Assign Active
Mkr 1-8

Used to select the marker which will act as the active marker.

Rotary Control	X	Step Keys	X	Numeric Pad	√	Terminator	None
----------------	---	-----------	---	-------------	---	------------	------

Mkr 1-8
On

Turns a selected marker on by entering the required marker number.

Rotary Control	X	Step Keys	X	Numeric Pad	√	Terminator	None
----------------	---	-----------	---	-------------	---	------------	------

Mkr 1-8
Off

Turns a selected marker off by entering the required marker number.

Rotary Control	X	Step Keys	X	Numeric Pad	√	Terminator	None
----------------	---	-----------	---	-------------	---	------------	------

Position
Mkr 1-8

Used to change the domain value (x-axis position) of a specified marker. A form is displayed on the screen containing numeric entry fields for the marker number and the marker position. The required marker is selected then its position is changed.

This soft key will only be selectable if the active marker is turned on.

Marker Number

Rotary Control	X	Step Keys	X	Numeric Pad	√	Terminator	None
----------------	---	-----------	---	-------------	---	------------	------

Marker Position (Frequency Domain)

Rotary Control	√	Step Keys	√	Numeric Pad	√	Terminator	Any
----------------	---	-----------	---	-------------	---	------------	-----

Marker Position (Power Domain)

Rotary Control	√	Step Keys	√	Numeric Pad	√	Terminator	Any
----------------	---	-----------	---	-------------	---	------------	-----

Marker Position (Voltage or Current Domain)

Rotary Control	√	Step Keys	√	Numeric Pad	√	Terminator	10-
----------------	---	-----------	---	-------------	---	------------	-----

Marker Position (Time Domain)

Rotary Control	√	Step Keys	√	Numeric Pad	√	Terminator	10-
----------------	---	-----------	---	-------------	---	------------	-----

Marker Position (Distance Domain)

Rotary Control	√	Step Keys	√	Numeric Pad	√	Terminator	10+
----------------	---	-----------	---	-------------	---	------------	-----

6 Digits
Resolution

Sets the displayed resolution for marker frequency information to six digits.
This soft key is only selectable when the domain is frequency.

**1 Hz
Resolution**

Sets the displayed resolution for marker frequency information to 1 Hz.
This soft key is only selectable when the domain is frequency.

**Mkr
Coupling**

Toggles marker coupling between channels on or off. When marker coupling is enabled, the positions (i.e. domain or x-axis values) of all markers on all traces will track the positions of the markers on the active trace of the active channel. When marker coupling is disabled, markers may be positioned independently on each channel. The default setting for marker coupling is on.

Marker coupling can only be disabled when channel coupling is switched off (Channel Mode Menu).

**Return to
Markers**

Returns control to the Markers Menu.





Fig. 3-64 MARKERS Menu - Reflection Analyzer Channel

SYSTEM GROUP KEYS

[COPY] KEY

The [COPY] key provides access to the menus shown in Fig. 3-65, which enables hard copy output to be obtained using a suitable parallel printer or a GPIB plotter with HPGL language (e.g. HP7470A/7475A). The system allows further measurements to be made while printing or plotting is in progress. Refer to Chapter 1 for information on recommended printers and plotters for the MTS.

Notes

- (1) If a Canon BJ10 printer is used, DIP switches 9, 7 and 11 must be set to OFF.
- (2) If an HP DeskJet printer is used, DIP switch Bank B number 1 must be set up (66 lines/page).
- (3) Pressing the [COPY] key on power up will result in the instrument's build state being printed out on the printer.

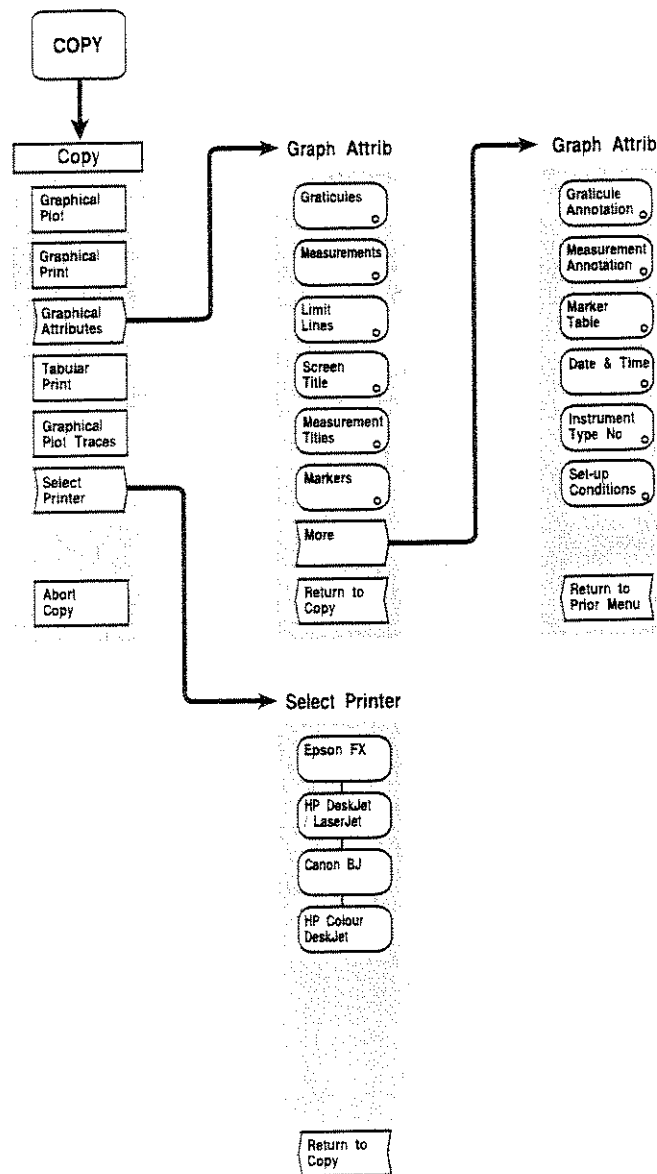

C3091

Fig. 3-65 COPY Menus

**Graphical
Attributes****Graph Attrib**

All of the soft keys in this menu (except for *[More]* and *[Return to Copy]*) perform an on/off action, and are used to specify which of the elements of the display are to be sent to the output device.

The graphical data available for plotting/printing depends on what is being displayed on the screen at the time the plot/print command is received. For example, if bandwidth or peak-to-peak measurements have been made, the displayed results will appear on the plot. The appearance of the plot/print will resemble that of the screen display with the addition of information to identify traces and their corresponding limit lines and measurement titles so that a monochrome plot/print (or photocopy) may be easily interpreted.

Graticules	Specifies printing/plotting of graticules.
Measurements	Specifies printing/plotting of measurements (traces or readings).
Limit Lines	Specifies printing/plotting of limit lines.
Screen Title	Specifies printing/plotting of the screen title. The screen title applies to the whole display, and appears at the top of the screen. Screen titles can be entered and switched on or off by using the Titles Menu (<i>[UTILITY]/Titles</i>).
Measurement Titles	Specifies printing/plotting of measurement titles. A channel may display up to two measurement titles, one for each trace or readout. Measurement titles can be entered and switched on or off by using the Titles Menu (<i>[UTILITY]/Titles</i>). A measurement title will be displayed only when both it and the corresponding trace or readout are switched on.
Markers	Specifies printing/plotting of markers.
More	Leads to the menu on the following page which is a continuation of this one.
Return to Copy	Returns control to the Copy Menu.

Graph Attrib

This menu is a continuation of the Graph Attrib Menu.

**Graticule
Annotation**

Specifies printing/plotting of the graticule annotation (the domain values at the bottom of the display).

**Measurement
Annotation**

Specifies printing/plotting of measurement annotation. For a scalar channel this comprises the data within the trace information area and the Pass/Fail indication. For a readout channel, the readout plus the associated information is output to the printer/plotter.

**Marker
Table**

Specifies printing/plotting of the marker summary table.

Date & Time

Specifies printing/plotting of the date and time.

**Instrument
Type No**

Specifies printing/plotting of the instrument type number.

**Set-up
Conditions**

Specifies printing/plotting of the following set-up conditions:

- Source output power (not applicable for power sweep)
- AC/DC detection (not applicable for readout channels)
- Sweep time (only applicable for swept source modes)
- Number of sweep points (only applicable for swept source modes)

**Return to
Prior Menu**

Returns control to the first Graph Attrib Menu.

[SAVE/RECALL] KEY

The [SAVE/RECALL] key provides access to the menus shown in Figs. 3-68 and 3-69, which enables the current instrument settings or measurement traces to be saved to or recalled from a memory location specified by the user. Measurement traces can also be saved to or recalled from a floppy disk as MS-DOS files if the floppy disk drive option is fitted. Instrument settings must first be saved to memory, then [UTILITY]/*Store Operations*]/*Copy Inst Settings*] used to copy the memory to floppy disk. Similarly, to recall instrument settings from floppy disk, they must first be copied to MTS memory, then recalled from memory using the Save/Recall Menu.

SAVE/RECALL

Save/Recall

The Save/Recall Menu enables instrument settings and measurement traces to be saved, and then recalled for use in subsequent measurements.

The current instrument settings can be stored in a specified memory location in the MTS internal non-volatile memory or on a memory card. Any of the stores can later be recalled in order to re-create the instrument state defined by the store contents. Facilities are available for viewing the stores without recalling them, and for obtaining a hard copy printout of the currently displayed store contents. Ten internal instrument settings stores are available.

A typical settings store screen is shown in Fig. 3-67.

Instrument Settings Store 1		
Screen Title	:Microwave Test Set	
Channel Coupling	:Off	
	CHANNEL 1	CHANNEL 2
Channel Type	:Fault Location	Scalar
Domain	:Distance	Voltage
Start	:9.850198145 GHz	-10.00 V
Stop	:10.149801854 GHz	10.00 V
Output	:0.00 dBm	0.00 dBm
	MEASUREMENT 1	
Meas Title	:Measurement 1	Measurement 3
Meas	:B/C	A
Format	:dB	dBm
Scale	:10.00 dB/	10.00 dB/
Ref Level	:0.00 dB	+20.00 dBm
	MEASUREMENT 2	
Meas Title	:Measurement 2	Measurement 4
Meas	:M1	A
Format	:dB	dBm
Scale	:10.00 dB/	10.00 dB/
Ref Level	:0.00 dB	+20.00 dBm

C0428

Fig. 3-67 Example of Displayed Instrument Settings Store

Measurement traces can be similarly stored, and subsequently recalled and/or used in relative measurements.

Save/recall operations on measurement traces can also be performed as MS-DOS files on a floppy disk, if the floppy disk drive option is fitted to the MTS.

Save Trace to Memory

Leads to the Save Memory Menu, which enables a measurement trace to be saved to an internal MTS store, a memory card or as a file on a floppy disk.

This soft key is unselectable for a readout channel. For a fault location channel it is only selectable if measurement 2 is active.

See page 3-248.

Display Memory

Leads to the Disp Memory Menu, which enables saved measurement traces to be displayed.

This soft key is unselectable for a readout channel. For a fault location channel it is only selectable if measurement 2 is active.

See page 3-250.

Memory Operation

Leads to the Memory Op Menu.
This soft key will only be selectable for a scalar channel, and if the currently defined trace is not a memory.
See page 3-252

Save Settings

Saves the current instrument settings to a specified store which can be either an internal MTS store or a memory card . When this soft key is pressed, a form is displayed on the screen indicating the range of available stores.

Rotary Control	×	Step Keys	×	Numeric Pad	√	Terminator	Any
----------------	---	-----------	---	-------------	---	------------	-----

View Settings Store

Leads to the View Store Menu, and enables the contents of instrument settings stores to be displayed.
See page 3-254.

View Current Settings

Displays the contents of the current instrument settings store. Pressing the [Print] soft key causes the information to be sent to printer; the printed format is the same as the displayed format.

View Preset Settings

As above but applies to the preset instrument settings.

Recall Settings

Recalls an instrument settings store by entering the required store identity number. This can refer to either an internal memory, or a store on a memory card. The instrument will be set up according to the stored parameters. Note that if a settings store stored on one instrument is recalled on another variant, the parameters being recalled will be clipped as necessary to match the hardware capability of that variant. If the instrument on which the settings are recalled does not have an appropriate adapter fitted (e.g. Reflection Analyzer), then a settings store containing a channel set-up that requires that adapter will not be recallable.

When a settings store is recalled, the associated trace memory will not be recalled if it is stored on floppy disk.

Rotary Control	×	Step Keys	×	Numeric Pad	√	Terminator	Any
----------------	---	-----------	---	-------------	---	------------	-----

SAVE/RECALL**Save Trace
to Memory****Save Memory**

This menu is used to save the currently active measurement to a memory location specified by the user, or onto a floppy disk.

A form is displayed listing the identities and store numbers of the available memories. To save the data to a specific memory location, the memory identity number is entered in the input field. The store can be either an internal MTS store or a memory card. A text editor is then presented which enables the measurement title to be edited, if required.

If the floppy disk drive option is fitted, the measurement can also be saved to a floppy disk as an MS-DOS file. Floppy disk functions are accessed by pressing the *[Floppy Disk]* soft key.

Some of the instrument settings are also saved with the measurement. These settings are required in order that the instrument can re-create the channel and measurement setup necessary to display the memory as it was originally stored.

**Page
Up**

Displays the previous page of the available memories list.

**Page
Down**

Displays the next page of the available memories list.

**Floppy
Disk**

Leads to the Save File Menu.
See page 3-248.

SAVE/RECALL**Save Trace
to Memory****Floppy
Disk****Save File**

This menu is used to save the currently active measurement to a file on a floppy disk.

A form is displayed listing the directories and files on the floppy disk, as described for the Disk Funcs Menu (page 3-329). The menu also allows a new directory to be created, if required.

**File
Selection
or**

This soft key is used to switch between the Directory section and the Files section of the form. When in the Directory section the soft key is labelled *[File Selection]*; when in the Files section it is labelled *[Directory Selection]*.

**Directory
Selection**

Selects the previous entry in the directory or file list. The list automatically scrolls, if necessary, when the highlight reaches the top of the list.



Selects the next entry in the directory or file list. The list automatically scrolls, if necessary, when the highlight reaches the bottom of the list.

File Information

Provides information on the currently highlighted file, as follows:

- File name
- File size
- Creation date/time
- File attributes (Read Only, Archive, Hidden, System)
- Type of file (trace memory, settings etc.)
- Memory title

Create Directory

Creates a sub-directory below the currently highlighted directory within the directory section. Text entry for the directory name is the same as that described for the Screen Title Menu (page 3-290).

Save to File

Leads to the Save to File Menu.
See page 3-249.

Return to Save/Recall

Returns control to the Save/Recall Menu.

SAVE/RECALL

Save Trace to Memory

Floppy Disk

Save to File

Save to File

This is a continuation of the previous menu. It enables the measurement to be saved in either MTS format or in CSV (spreadsheet) format. It also allows the read-only attribute of the file to be set.

Save File

When this soft key is pressed, a text entry form is presented which allows the filename to be edited. The input field contains the name of the currently highlighted file; if no file is highlighted the input field will be blank.

When the *[Done]* soft key is pressed, a check is made to determine if the chosen filename already exists in the current directory. If it does, then the user is given the choice of overwriting the file or selecting a different filename. A file can only be overwritten if it is the same type as the file to be saved, i.e. both internal MTS format or both CSV format.

The text entry form is again presented to enable the measurement title to be edited, if required. The filename extension is automatically set to .TRC or .CSV as appropriate. The measurement data is then saved to disk and control is returned to the top level Save/Recall Menu.

Read Only Status

Sets the read-only attribute of the file (it can only be cleared on a PC).

Spreadsheet Format

When spreadsheet format is enabled the trace data will be saved in spreadsheet (CSV) format and given the .CSV extension.

Return to Save File

Returns control to the previous menu.

Disp Memory

This menu enables a saved measurement trace to be displayed.

A form is displayed listing the identities and store numbers of the available memories, both in internal MTS memory and on memory card. To retrieve the data from a specific memory location, the memory identity number is entered in the input field.

If the floppy disk drive option is fitted, the measurement can also be retrieved from a floppy disk. Floppy disk functions are accessed by pressing the *[Floppy Disk]* soft key.

Various instrument settings are saved together with the trace memory. When the trace is recalled, these saved settings may affect other measurements that are being displayed. The user is therefore given the choice of using either the saved settings or current settings.

**Page
Up**

Displays the previous page of the available memories list.

**Page
Down**

Displays the next page of the available memories list.

**Floppy
Disk**

Leads to the Retrieve File Menu.
See page 3-251.



SAVE/RECALL

**Display
Memory**

**Floppy
Disk**

Retrieve File

This menu is used to retrieve a measurement trace that is stored as a file on a floppy disk.

A form is displayed listing the directories and files on the floppy disk, as described for the Save File Menu (page 3-248).

**File
Selection
or
Directory
Selection**

This soft key is used to switch between the Directory section and the Files section of the form. When in the Directory section the soft key is labelled [*File Selection*]; when in the Files section it is labelled [*Directory Selection*].

↑

Selects the previous entry in the directory or file list. The list automatically scrolls, if necessary, when the highlight reaches the top of the list.

↓

Selects the next entry in the directory or file list. The list automatically scrolls, if necessary, when the highlight reaches the bottom of the list.

**File
Information**

Provides information on the currently highlighted file, as follows:

- File name
- File size
- Creation date/time
- File attributes (Read Only, Archive, Hidden, System)
- Type of file (trace memory, settings etc.)
- Memory title (only present for trace memory files)

**Retrieve
File**

Retrieves the selected trace file, after asking for confirmation. An error message will be displayed if the file is not a trace file or CSV format file, or if the data has been corrupted.

**Return to
Save/Recall**

Returns control to the Save/Recall Menu.

**Memory
Operation****Memory Op**

(Scalar channel)

Enables the currently active measurement to be made relative to the measurement data in a specified trace memory which can be located in an MTS store or on a floppy disk. The measurement that is displayed is the ratio of the live trace to the stored trace for scalar measurements, and the difference between the live trace and the stored trace for frequency measurements.

For normal measurements, the domain range will be the same for both current and stored traces. Memory data will be interpolated to match a live measurement over a different start/stop range.

The memory operation applies per trace.

**Relative to
Memory**

Leads to the Rel to Memory Menu, which enables selection of the measurement trace that is to be used in the relative measurement. This menu provides the same functions as the Disp Memory Menu (page 3-250), except that the selected measurement trace will be used in the relative measurement, instead of being displayed.

**Memory
Operation Off**

Turns off the memory operation.

**Return to
Save/Recall**

Returns control to the Save/Recall Menu.

**Memory
Operation**

Memory Op
(Reflection analyzer
channel)

Enables the currently active measurement to be made relative to the measurement data in a specified trace memory which can be located in an MTS store or on a floppy disk.

The measurement that is displayed can be either the ratio of the live trace to the stored trace, or the difference between the live trace and the stored trace. Note that complex arithmetic is used since the quantities involved are complex.

The memory operation will not be permitted if the trace memory does not contain a reflection analyzer measurement, or if the settings displayed with the trace memory do not match those of the channel in which the live measurement is displayed.

/ Memory

Leads to the /Memory Menu, which is used to select a measurement to divide the live measurement by. This menu provides the same functions as the Disp Memory Menu (page 3-250), except that the selected measurement trace will be used in the relative measurement, instead of being displayed.

- Memory

Leads to the - Memory Menu, which is used to select a measurement to subtract from the live measurement. This menu provides the same functions as the Disp Memory Menu (page 3-250), except that the selected measurement trace will be used in the relative measurement, instead of being displayed.

**Memory
Operation Off**

Turns off the memory operation.

**Return to
Save/Recall**

Returns control to the Save/Recall Menu.

**View Settings
Store****View Store**

This menu is used for save, recall, erase and print operations on instrument settings stores.

Print

Causes the currently displayed information to be sent to the printer; the printed format is the same as the displayed format.

**Recall from
Store**

Applies the instrument settings from the store currently being viewed.

**Save to
Store**

Saves the current instrument settings to the store currently being viewed. If the store already contains data, this will be overwritten, after asking for confirmation.

**Erase
Store**

Erases the contents of the currently displayed store, after asking for confirmation.

**Select
Store**

Enables an instrument settings store to be selected for viewing, by entering the required store identity number.

Rotary Control	×	Step Keys	×	Numeric Pad	√	Terminator	Any
----------------	---	-----------	---	-------------	---	------------	-----

**Previous
Store**

Used to display the previous instrument settings store.

**Next
Store**

Used to display the next instrument settings store.

**Return to
Save/Recall**

Returns control to the Save/Recall Menu.



SAVE/RECALL

Fig. 3-68 SAVE/RECALL Menus (Sheet 1)



SAVE/RECALL

**Save Trace
to Memory**

OR

SAVE/RECALL

**Display
Memory**

Fig. 3-69 SAVE/RECALL Menus (Sheet 2)

[MACRO] KEY

The [MACRO] key provides access to the series of menus illustrated in Figs. 3-70 to 3-73. The MTS Macro facility, in its simplest form, allows a sequence of front panel keypresses to be recorded as the instrument is operated. The macro can then be saved in the instrument's internal non-volatile memory, or on a memory card. The amount of memory available for macros is that left over after the card has been configured to provide stores of various kinds - see Config Card Menu. A descriptive label can be assigned to the macro as an aid to remembering its function. When a macro is *run*, the saved keypresses are "replayed", and the MTS obeys them as though they came from the keyboard.

Control and Condition Codes

To be useful, the macro function needs to do more than simply replay keypresses. It must be able to emulate the actions of an experienced user. A human operator would not, for example, set up a swept measurement and then immediately initiate a marker peak search without having first waited until a complete trace had been captured. To simulate waiting for measurement update, and other operator actions, *control codes* may be embedded between the keypresses as the macro is recorded. Loop and branch control codes also have *condition codes* associated with them. The effects of the various types of control and condition codes are summarised in the following tables.

CONTROL CODE	FUNCTION
<Pause for Measurement Update>	Macro execution pauses until all displayed measurements have updated. This control code may be inserted after a sequence of keypresses that causes measurements to restart - for example, changing the number of displayed channels.
<Pause for Averaging>	Pauses execution until the active measurement averaging has completed.
<Pause for Terminator>	Pauses execution until one of the four numeric entry terminator keys is pressed. This is particularly useful in conjunction with the Display Message control code.
<Pause for Print/Plot>	Pauses execution until a print or plot has completed.
<Accept Numeric Input>	This control code can be inserted following a keypress that enables numeric input. It allows numeric values to be passed into a function while a macro is executing. The macro resumes running when one of the terminator keys is pressed.
<Display Message>	A message of up to 5 lines of text is displayed in an automatically sized window. Messages may be used to give instructions to an operator. If the message is not removed before the macro terminates, it is erased when the next keypress is received.
<Remove Message>	Erases the message displayed by the Display Message control code.
<Run Macro>	Runs a macro from within a macro. This is a powerful facility for simplifying the creation of a complex macro by chaining a series of shorter, simpler macros together.
<Macro Time Delay> n	Delays macro execution for a specified time. The delay (n) can be from 10 ms to 1 hr.
<If...Then> [CONDITION] <run macro> macro_1 {<Else> <run macro> macro_2}	On detecting the <If...Then> control code, the [CONDITION] is evaluated; if found to be true then macro_1 will be executed. If the condition is found to be false and there is no optional <Else> control code, then execution will continue with the next keypress or control code following the If...Then construct. If the condition evaluation is false and the <Else> control code is present, then macro_2 will be executed.
Items enclosed by { } are optional	
<Else>	The <Else> control code is optional to the <If...Then> and <Case> control codes

<pre> <Case> [CONDITION 1] <run macro> macro_1 [[CONDITION 2] <run macro> macro_2 : [CONDITION n] <run macro> macro_n <Else> <run macro> macro_m} Items enclosed by { } are optional </pre>	<p>On detecting the <Case> control code, [CONDITION 1] is evaluated; if found to be true then macro_1 will be executed. Execution of the main macro will then continue with the keypress or control code following the Case construct.</p> <p>If [CONDITION 1] is false then the next condition code is evaluated. This and subsequent condition codes are processed in a similar way. If found to be false, the macro proceeds to the next condition code; if true, the associated macro is executed and macro execution will then continue with the keypress or control code following the Case construct.</p> <p>If an <Else> is present and no conditions are true the macro_m will execute. Macro execution will then continue with the next keypress or control code following the case construct.</p>
<pre> <Repeat...Until> [CONDITION] <run macro> macro_1 </pre>	<p>On detecting the <Repeat...Until> control code, macro_1 will be executed. The [CONDITION] will be evaluated and if found to be false then macro_1 will again be executed. If true, then execution will continue with the next keypress or control code following the Repeat...Until construct.</p>
<pre> <While...Do> [CONDITION] <run macro> macro_1 </pre>	<p>On detecting the <While...Do> control code the [CONDITION] will be evaluated; if found to be true then macro_1 will be executed. If the condition is found to be false, then execution will continue with the next keypress or control code following the While...Do construct.</p>
<pre> <For> n <run macro> macro_1 </pre>	<p>On detecting the <For> control code, macro_1 will be executed n times, where n is in the range 1 to 10⁶.</p>

CONDITION CODE	FUNCTION
[TRUE]	Always TRUE, i.e. the condition code evaluated will always be returned with a true value. This can be used to implement While... Do loops. It can be aborted using the [LOCAL] key.
[AVERAGING COMPLETE]	The condition is true if averaging has completed for the active measurement.
[LIMIT PASS]	The condition is true if the active measurement has passed the limit check (a limit check which is not applied to the active measurement is assumed to be a pass condition).
[LIMIT FAIL]	The condition is true if the active measurement has failed the limit check.
[MTS TYPE = 6200] [MTS TYPE = 6201] [MTS TYPE = 6202] [MTS TYPE = 6203] [MTS TYPE = 6204]	The condition is true if the MTS on which the macro is running is that specified in the condition.
[70 dB STEP ATTENUATOR]	The condition is true if the 70 dB step attenuator is present in the instrument.
[90 dB STEP ATTENUATOR]	The condition is true if the 90 dB step attenuator is present in the instrument.
[110 dB STEP ATTENUATOR]	
[REFLECTION ANALYZER]	The condition is true if the Reflection Analyzer is fitted to the MTS.
[STORES EXTENSION CARD] [TRANSMISSION LINE CARD] [APPLICATION CARD]	The condition is true if a memory card of the type specified has been inserted into the MTS.
[ANY IDENTIFIABLE CARD]	The condition is true if any of the above types of memory card has been inserted.
[MACRO] macro_name	The condition is true if a macro with the specified name is present (either in internal memory or on a memory card).
KEY=[keypress]	<p>The condition is true if a particular front panel key has been pressed, as specified by [keypress]. This facility allows the user to interact with a running macro. All front panel keys are allowed except [LOCAL] and [PRESET]. For clarity, the condition code should be preceded by a display message stating which key to press.</p> <p>For the If...Then, Repeat...Until and While...Do conditions, the system will wait for a keypress. For the Case condition the system will wait for a keypress on the first occurrence of the condition code in the Case. Subsequent keypress condition codes will not wait but use the previously entered keypress.</p>

Macro Status Messages

While a macro is being recorded, run or stepped, status messages are displayed in the position normally occupied by the screen title.

MESSAGE	WHEN DISPLAYED
Macro: Record [LOCAL] to Edit	Recording Macro
Macro: Run [LOCAL] to Abort	Running Macro
Macro: Step [LOCAL] to Abort	Stepping Macro
Macro: Paused for Measurement	Executing Pause for Measurement control code.
Macro: Paused for Averaging	Executing Pause for Averaging control code.
Macro: Numeric Entry Expected	Executing Pause for Numeric Entry control code.
Macro: Terminator Key Expected	Executing Pause for Terminator control code
Macro: Paused for Print / Plot	Executing Pause for Printing or Plotting.
Macro: Suspended [LOCAL] Abort	Executing Macro Time Delay.

Creating a Macro

Recording starts after selecting [MACRO] [Start Recording]. Each keypress, with the exception of [LOCAL] or [PRESET] is recorded in the macro. [PRESET] has its usual function, and any macro recording in progress at the time is aborted. [LOCAL] gives access to the macro editor, which provides functions to correct errors, to suspend recording temporarily and to insert control codes. Recording is stopped by selecting [MACRO] [Stop Recording]. This function allows the macro to be given a descriptive name and then stored in the MTS memory or a memory card.

Running or Stepping a Macro

A macro is run by selecting [MACRO] [Run Macro] and choosing the required macro from the list displayed. Alternatively, a macro can be stepped by selecting [MACRO] [Step Macro]. In step mode, execution pauses after each keypress or control code until a keypress is received from the front panel. Stepping allows the operation of a macro to be observed in detail and can be useful for fault-finding. The [LOCAL] key may be used to abort a macro that is being run or stepped.

Macro Hints and Tips

Use Settings Stores

Although it is possible to use a macro to set up a particular instrument state - that is, a combination of settings, such as channel mode, measurement definitions, format and scaling parameters, this is better achieved using the save and recall settings functions - see Save/Recall Menu. The macro facility really comes into its own when it is used to automate *procedures*. For example, a macro could be written to measure the bandwidth of a bandpass filter at -3 dB and -60 dB, and automatically place markers at those points of interest. To do this, the set-up required to display the filter response can be saved in a settings store. A macro can then be written to recall the settings store, calibrate the measurement (using display message control codes to prompt the operator to make the necessary connections), and finally to position the markers.

Preset Settings Within a Macro

For technical reasons the [PRESET] key cannot be recorded as part of a macro. However, to set up the instrument to the preset state, press [PRESET], then save the default settings in a settings store. These may be recalled within the macro.

Minimise Text Entry

Text entered for display with the Display Message control code is not lost after the message is added to the macro. The next time the Display Message control code function is selected, the most recent message text is made available for editing. Since messages within a macro are often very similar, time can be saved by simply editing the previous message text rather than starting from scratch.

Correcting Errors While Recording - Use of Suspend & Resume Functions

Keypresses or control codes entered by mistake can be removed from the macro by entering the macro editor and using the *[Delete Last Entry]* function. Sometimes, however, this is not enough to correct the error. Suppose the [SWITCH CHANNEL] key is inadvertently pressed while recording a macro. The erroneous keypress can be removed by the editor *[Delete Last Entry]* function easily enough, but the effect that the keypress has had on the operation of the instrument has, of course, not been corrected; the wrong channel has been made active.

Problems like this can be corrected by using the *[Suspend Recording]* function available within the editor. With recording suspended, changes to the instrument settings caused by pressing the wrong key can be reversed. When this has been done, the *[Resume Recording]* function allows macro recording to continue.

Using the Main Macro Editor

Corrections can be made to a macro that has already been recorded and saved, using the macro editor accessed from the top level macro menu. This editor enables items to be added or deleted anywhere within the macro; it can also be used to create a new macro, but this is easier to achieve by recording keypresses.

Create a Library of Short Macros

It is good practice to break down complex procedures into a series of simpler tasks, and create a short macro for each one. The complex macro need only consist of a series of Run Macro control codes that run a selection of short macros from the "library".

Limitations

The maximum number of macros is 999 and the maximum length of a macro is 2048 bytes. Each key press, control code or character in a displayed message requires 1 byte. The maximum depth to which Run Macro control codes can be nested (i.e. macro calls a macro which calls another macro...etc) is 50.

MACRO

Macro

See Fig. 3-70

Run Macro

Used to run a macro contained in a specified macro store by entering the required store identity number. While a macro is running, the screen title is replaced by 'Macro: Run [LOCAL] to Abort'.

If a control code is encountered (see Add Code Menu, page 3-271) the screen title area will change to one of the following, as appropriate.

Macro: Paused for Measurement
 Macro: Paused for Averaging
 Macro: Numeric Entry Expected
 Macro: Terminator Key Expected
 Macro: Paused for Print / Plot
 Macro: Suspended [LOCAL] Abort

A running macro can be aborted at any time by pressing the [LOCAL] key.

Rotary Control	×	Step Keys	×	Numeric Pad	√	Terminator	Any
----------------	---	-----------	---	-------------	---	------------	-----

Step Macro

Pressing this soft key enable the user to step through a macro by pressing any front panel key. To load the required macro, its identity number is entered from the keyboard. While a macro is stepping, the screen title is replaced by 'Macro: Step [LOCAL] to Abort'.

If a control code is encountered, a message will be displayed, as above.

A stepping macro can be aborted at any time by pressing the [LOCAL] key.

Start Recording

Places the instrument into the macro recording mode in which subsequent keypresses (except [LOCAL] and [PRESET]) will be recorded until the recording mode is exited. The maximum size of a macro is 2048 bytes. Each keypress or message character is one byte, but control codes can be more than one byte long. During macro recording, the screen title is replaced by 'Macro: Record [LOCAL] to Edit'.

Whilst in the recording mode, pressing [LOCAL] invokes the macro editor function (See Edit Macro Menu, page 3-270).

Once this soft key has been pressed, it is replaced by [*Stop Recording*].

Stop Recording

Stops recording keypresses and presents the Save Macro Menu. The [*Stop Recording*] soft key appears in place of [*Start Recording*] once this soft key has been pressed. See page 3-266.

Log Errors

Provides a method of logging the first three errors that occur during the execution of a macro. The log is cleared when a macro is run or single stepped; it is not cleared by the execution of a control code that causes another macro to run. When error logging is enabled and an error is logged, a message will be displayed at the end of macro execution informing the user that errors have occurred and to examine the error log.

View Error Log

Enables the contents of the error log to be examined. The [*Previous Error*] and [*Next Error*] soft keys are used to select the error that is displayed.

Copy Macro	Leads to the Copy Macro Menu <i>See page 3-267</i>
Edit Macro	Leads to the Edit Macro Menu. <i>See page 3-273</i>
Delete Macro	Leads to the Delete Macro Menu. <i>See page 3-269.</i>

MACRO

Stop Recording

Save Macro *See Fig. 3-70.* This menu is used to save a macro following completion of macro recording.

Save to MTS Memory Saves the macro that has just been recorded into MTS non-volatile memory. A form is displayed showing the available memory and the size of the macro to be saved. Any number of macros up to 999 can be stored subject to available memory. This function automatically brings up the Macro Id Menu which allows a title to be entered. The method of entry is the same as that described for the Screen Title Menu. Pressing *[Done]* saves the macro to memory.
This soft key will be unselectable if there is insufficient memory to save the macro.

Save to Card Saves the macro that has just been recorded onto a memory card. A form is displayed showing the available memory and the size of the macro to be saved. Any number of macros up to 999 can be stored subject to available memory. This function automatically brings up the Macro Id Menu which allows a title to be entered. Pressing *[Done]* saves the macro to memory.
This soft key will be unselectable if there is insufficient memory available or if no memory card is present.

Delete Macro Leads to the Delete Macro Menu, which can be used to create more space, if required.
See page 3-269.

Abort Terminates the function without performing a save, after prompting for confirmation.

MACRO**Copy
Macro****Copy Macro**

See Fig. 3-70. This menu is used to copy a macro stored in the MTS to a memory card, or vice versa. Macros can also be copied to and from floppy disk.

**Copy Macro
to Card**

Enables copying of a macro stored in the MTS to a memory card. A form is displayed listing the macros present in memory and the amount of memory available on the card for macro storage. The macro will be copied when the required identity number is entered from the keyboard. The macro will not be copied if there is not enough storage capacity on the card. The [Delete Macro] soft key (Macro Menu) can be used to create more space on the card, if required.

Rotary Control	×	Step Keys	×	Numeric Pad	√	Terminator	Any
----------------	---	-----------	---	-------------	---	------------	-----

**Copy Macro
from Card**

As above, but copies a macro from a memory card to non-volatile RAM in the MTS.

**Floppy
Disk**

Leads to the Copy File Menu, which is used for copying macros to and from floppy disk. See page 3-268.

**Return to
Macro**

Returns control to the Macro Menu.

Copy File

See Fig. 70. This menu is used to copy macros between floppy disk and MTS memory or between floppy disk and a memory card.

A form is displayed listing the directories and files on the floppy disk, as described for the Disk Funcs Menu (page 3-329).

**File
Selection
or
Directory
Selection**

This soft key is used to switch between the Directory section and the Files section of the form. When in the Directory section the soft key is labelled [*File Selection*]; when in the Files section it is labelled [*Directory Selection*].

↑

Selects the previous entry in the directory or file list. The list automatically scrolls, if necessary, when the highlight reaches the top of the list.

↓

Selects the next entry in the directory or file list. The list automatically scrolls, if necessary, when the highlight reaches the bottom of the list.

**File
Information**

Provides information on the currently highlighted file, as follows:

- File name
- File size
- Creation date/time
- File attributes (Read Only, Archive, Hidden, System)
- Type of file (trace memory, settings etc.)
- Memory title (only present for trace memory files)

**Copy Macro
to MTS**

Copies the currently highlighted macro file from the floppy disk into MTS memory as a new macro.

**Copy Macro
to Card**

Copies the currently highlighted macro file from the floppy disk onto a memory card as a new macro.

**Copy to
Disk**

Copies a macro stored in the MTS or on a memory card to the floppy disk as an MS-DOS format file. When this soft key is pressed a sub-menu is presented:

The [*Text Format*] soft key is used to save the macro in text (ASCII) format. When the [*Copy*] soft key is pressed a form is displayed listing the available macros. The identity number of the macro to be copied is entered into the input field. A text entry form is then presented in which to enter an 8-character filename. The macro will then be copied to disk. The filename extension will be .MAC for macros copied in MTS format, or .TXT for text format.

**Return to
Copy Macro**

Returns control to the Copy Macro Menu.

MACRO**Delete
Macro****Delete Macro**

See Fig. 3-70. This menu enables the deletion of a range of macros from either the MTS or a memory card.

A form is displayed listing the macros present in the MTS and on the card, and their sizes in bytes. A range of macros can be deleted by entering a 'from' and a 'to' macro identity number. The macros are deleted when the *[Delete]* soft key is pressed. Only the 'from' macro identity needs to be entered if a single macro is to be deleted. The delete function is confirmation protected.

**From
Macro**

Used to enter the identity of the first macro of a range of macros to be deleted.

**To
Macro**

Used to enter the identity of the last macro of a range of macros to be deleted.

**Page
Up**

Displays the next page of the macro list.

**Page
Down**

Displays the previous page of the macro list.

Delete

Deletes the macros in the specified range and returns control to the Macro Menu.

MACRO

**Start
Recording**

LOCAL

Edit Macro

See Fig. 3-71. This menu is used to correct errors made during keystroke recording and allows special control codes to be inserted in the macro.

This menu is accessed by pressing the [LOCAL] key whilst in the recording mode.

(To edit existing macros, i.e. stored in memory, the macro editor accessed from the top level menu is used.)

**Delete
Last Entry**

Deletes the last keystroke or control code (i.e. the last entry in the macro buffer).
This soft key is unselectable if there are no entries in the macro buffer.

**Add
Control Codes**

Leads to the Add Code Menu.
*This soft key is unselectable if the macro buffer is full.
See page 3-271*

**Suspend
Recording**

Suspends recording of the macro and allows the user to return to normal menu operation by pressing the [Exit Macro Editor] soft key. This allows the user to return to the required point within the menu structure and to continue recording using the [Resume Recording] soft key.
This soft key is unselectable if recording has already been suspended.

**Resume
Recording**

Allows the user to continue recording keystrokes after suspending recording with the above soft key.
This soft key becomes unselectable when recording has been resumed.

**Exit
Macro Editor**

Exits the Edit Macro Menu and allows macro recording to resume.

MACRO

Start Recording

LOCAL

Add Control Codes

Add Code

See Fig. 3-71. This menu enables control codes to be inserted in the macro. They are used to pause execution until certain actions have occurred, add loop and branch conditions, specify further macros that are to be run, or to display messages specified by the user.

When entering control codes, certain soft keys may become unselectable to prevent the introduction of syntax errors. For example, only Condition codes, Run Macro codes and Else codes are allowed within a Case construct; all other soft keys are unselectable. A description of the control codes and their usage is given at the start of the Macro Key description.

All soft key except [Return to Macro Editor] are unselectable if the macro buffer is full

Pause Leads to the Pause Menu.
See page 3-272.

Loop & Branch Leads to the Loop & Branch Menu.
See page 3-277

Accept Numeric Input Pauses execution until a terminator key is pressed

Accept Numeric Input Accepts numeric entry (either keyboard, rotary control or step keys) until a terminator is received.

Display Message Leads to the Disp Message Menu.
See page 3-272.

Remove Message Removes the message that is currently being displayed.

Run Macro Leads to the Run Macro Menu.
See page 3-273.

Set Time Delay Used to suspend macro execution for a specified period of time, by entering the required time delay. Delays between 10 ms and 1 hr can be entered. If the time delay is greater than 1 s, an appropriate message is displayed while the macro is suspended.

Rotary Control × Step Keys × Numeric Pad √ Terminator 10⁺

Return to Macro Editor Returns control to the Edit Macro Menu.

MACRO

Start Recording . . .

LOCAL

Add Control Codes

Pause

Pause

See Fig. 3-71. This menu is used to insert control codes in a macro which are used to pause execution until certain actions have occurred.

Pause for Meas Update

Pauses execution until measurement update has completed.

Pause for Averaging

Pauses execution until the averaging target value has been reached for the active trace.

Pause for Terminator

Pauses execution until a terminator key is pressed.

Pause for Print / Plot

Pauses execution until printing or plotting has completed.

Return to Add Code

Returns control to the Add Code Menu.

MACRO

Start Recording

LOCAL

Add Control Codes

Display Message

Disp Message

See Fig. 3-71. This menu allows a message of up to five lines to be displayed on the screen. Each line can be up to 50 characters in length.

Set Line 1

Enables the entry of a text string as line 1 of the displayed message. The method of entry is the same as that described for the Screen Title Menu (page 3-290).

Set Line 2

As above, but for line 2 of the message.

Set Line 3

As above, but for line 3 of the message.

Set Line 4

As above, but for line 4 of the message..

Set Line 5

As above, but for line 5 of the message.

Return to Add Code

Returns control to the Add Code Menu.

MACRO

Start
Recording . . .

LOCAL

Add
Control CodesRun
MacroRun Macro

See Fig. 3-71. This menu is used to insert a Run Macro control code. When this control code is encountered another macro begins running at this point; when it terminates, the calling macro resumes operation. The macro that is to be run can be selected from a list of stored macros that is displayed, or its name can be entered directly.

Enter Macro
By Number

When this soft key is pressed, a form is displayed listing the available macros. A sub-menu is presented with two soft keys, *[Page Up]* and *[Page Down]*; these are used to select pages if there is more than one. The macro to be run is selected by entering the appropriate store number.

Enter Macro
By Name

When this soft key is pressed, a form is displayed allowing the name of the required macro to be entered. The method of entry is the same as that described for the Screen Title Menu (page 3-290).

Return to
Add Code

Returns control to the Add Code Menu.

MACRO

Edit
MacroEdit Macro

See Fig. 3-72. This menu provides access to the macro editor, which is used to edit existing macros or to create a new one.

Edit Macro
By Number

When this soft key is pressed, a form is displayed listing the available macros. To select a macro for editing, the macro store number is entered from the keyboard. Control is then passed to the next level of the Edit Macro function (page 3-274).

Edit Macro
By Name

When this soft key is pressed, a form is displayed allowing the name of a macro to be entered. The method of entry is the same as that described for the Screen Title Menu (page 3-290). Control is then passed to the next level of the Edit Macro function (page 3-274).

Edit New
Macro

Leads directly to the next level of the Edit Macro function, without requesting for the identity of a macro.
See page 3-274.

Exit
Edit

Exits the macro editor and returns control to the Macro Menu.

MACRO**Edit
Macro****Edit Macro
By Number****Edit Macro
By Name****Edit New
Macro****Edit Macro**

See Fig. 3-72. This menu follows on from the previous Edit Macro Menu, and provides functions for editing, printing and saving macros.

Edit

Leads to the Edit Menu.
See page 3-275.

**Print
Macro**

Enables the macro currently being edited to be printed
This soft key will be unselectable if the contents of a macro have been deleted, and will initially be unselectable if a new macro is being created.

**Save
Macro**

Leads to the Save Macro Menu. When this soft key is pressed, a syntax check is performed on the macro. If there are any errors an explanatory warning message will be displayed; any errors must be rectified using the Edit Menu before the save will be permitted.
This soft key will be unselectable if the contents of a macro have been deleted, and will initially be unselectable if a new macro is being created.
See page 3-276.

**Save as
New Macro**

Leads to the Save Macro Menu. When this soft key is pressed, a syntax check is performed on the macro. If there are any errors an explanatory warning message will be displayed; any errors must be rectified using the Edit Menu before the save will be permitted.
This soft key will be unselectable if the contents of a macro have been deleted, and will initially be unselectable if a new macro is being created.
See page 3-276.

Exit

Returns control to the previous Edit Macro Menu. Before doing so, a syntax check is performed on the macro. If there are any errors an explanatory warning message will be displayed; any errors must be rectified using the Edit Menu before the exit will be permitted.

MACRO

Edit
MacroEdit Macro
By Number

Edit

Edit Macro
By NameEdit New
Macro**Edit**

See Fig. 3-72. This menu enables front panel keys and control codes to be added to a macro, and macro items to be deleted.

The current edit position is indicated by a box surrounding the macro item. This can be moved around the macro by using the [↑], [↓], [Page Up] and [Page Down] soft keys. If a new macro is being created, the cursor box will not appear until an item has been added.

**Add
Keys**

Allows front panel keys to be added to a macro. All front panel keys are allowed except [LOCAL] and [PRESET]. Hard keys are added by pressing the appropriate key. If a soft key is added, its function depends on the menu that would result from the keypresses previously entered into the macro. Pressing the [LOCAL] key exits from this function. *This soft key will be unselectable if the current edit position lies within a Case construct.*

**Add
Code**

Leads to the Add Code Menu.
See page 3-271.

**Delete
Entry**

Used to delete the macro item at the current edit position, as identified by the cursor box surrounding the item. If the cursor box is on the 'Case' macro item, the whole Case construct will be deleted.
This soft key becomes unselectable when there are no more items in the macro.

↑

Selects the previous item in the macro.

↓

Selects the next item in the macro.

**Page
Up**

The previous page of the macro will be displayed.

**Page
Down**

The next page of the macro will be displayed.

**Return to
Edit Macro**

Returns control to the Edit Macro Menu.

MACRO**Edit
Macro****Edit Macro
By Number****Save
Macro****Edit Macro
By Name****Edit New
Macro****Save Macro***See page 3-72.* This menu is used to save the macro currently being edited.**Save**Saves the edited macro to its previous location and with the same identity. If the identity is to be changed, this can be done with the *[Change Identity]* soft key.
*This soft key will be unselectable if there is insufficient memory to save the macro, or if a memory card needs to be inserted.***Change
Identity**This soft key brings up the Macro ID Menu, which allows the macro identity to be edited. Pressing *[Done]* returns to this menu; *[Save]* then saves the macro to memory under the new identity.**Delete
Macro**Leads to the Delete Macro Menu, which can be used to create more space, if required.
*See page 3-269.***Return to
Edit Macro**

Returns control to the Edit Macro Menu.

MACRO**Edit
Macro****Edit Macro
By Number****Save as
New Macro****Edit Macro
By Name****Edit New
Macro****Save Macro***See page 3-72.* This menu is used to save a macro that has just been created, or to save an edited macro as a new macro.**Save to
MTS Memory**Saves the macro that has just been created or edited into MTS non-volatile memory. A form is displayed showing the available memory and the size of the macro to be saved. Any number of macros up to 999 can be stored subject to available memory. This function automatically brings up the Macro Id Menu which allows a title to be entered. Pressing *[Done]* saves the macro to memory.
*This soft key will be unselectable if there is insufficient memory to save the macro.***Save to
Card**Saves the macro that has just been created or edited onto a memory card. A form is displayed showing the available memory and the size of the macro to be saved. Any number of macros up to 999 can be stored subject to available memory. This function automatically brings up the Macro Id Menu which allows a title to be entered. Pressing *[Done]* saves the macro to memory.
*This soft key will be unselectable if there is insufficient memory available or if no memory card is present.***Delete
Macro**Leads to the Delete Macro Menu, which can be used to create more space, if required.
*See page 3-269.***Return to
Edit Macro**

Returns control to the Edit Macro Menu.

MACRO

Start
Recording

LOCAL

Add
Control CodesLoop &
BranchLoop & Branch

See Fig. 3-73. This menu allows a macro to be run using the programming constructs of a high-level language.

The available constructs for looping/branching are:

If...Then
Repeat...Until
While...Do
Case
For

The loop/branch control code is followed by a Condition code and then a Run Macro control code. The Condition code is the item that enables looping or branching, according to whether the condition is evaluated as true or false. A full description of the condition code soft keys and their usage is given in 'Control and Condition Codes' at the start of the Macro key description.

After a [*For*], [*Else*] or a condition code soft key has been pressed, the Run Macro menu will be presented, which enables selection of the macro that is to be run at this point. When a macro has been selected, control returns to the Add Code Menu.

If...Then

Enters the <If...Then> control code into the macro, then presents the Conditions Menu (page 3-278).

Else

Enters an <Else> control code, which is associated with the <If...Then> control code. *During macro recording this soft key is only selectable after [If...Then] has been pressed; once [Else] has been pressed it becomes unselectable again.*

Repeat...Until

Enters the <Repeat...Until> control code into the macro, then presents the Conditions Menu (page 3-278).

While...Do

Enters the <While...Do> control code into the macro, then presents the Conditions Menu (page 3-278).

For

Enters the <For> control code into the macro. The user then enters the number of times that a macro is to be run. The user is then presented with the Run Macro menu.

Case

Leads to the Case Menu.
See page 3-278.

**Return to
Add Code**

Returns control to the Add Code Menu.



Case *See Fig. 3-73 . This menu is used to enter control and condition codes for the Case construct.*

Case Conditions Leads to the Conditions Menu.
See below.

Else Enters an <Else> control code, which is associated with the <Case> control code.
During macro recording this soft key is only selectable after [Case] has been pressed; once [Else] has been pressed it becomes unselectable again.

Return to Loop Branch Returns control to the Loop & Branch Menu.

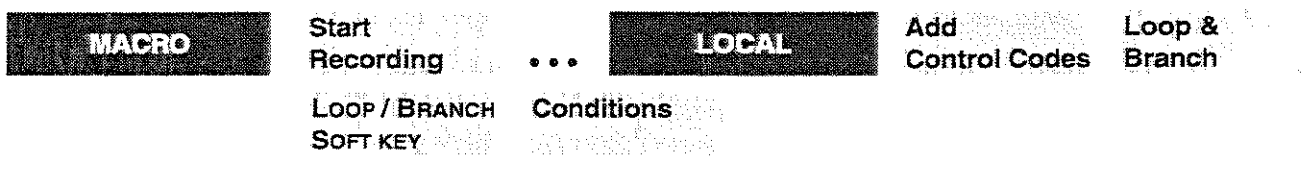

Conditions *See Fig. 3-73. This menu is used to specify the conditions that determine looping or branching in the If...Then, Repeat...Until, While...Do and Case constructs.*

The conditions are selected using this menu and the subsequent sub-menus. The soft keys are not described here, since a full description of the condition codes and their usage has been given in 'Control and Condition Codes' at the start of the Macro key description.

After a [For], [Else] or a condition code soft key has been pressed, the Run Macro menu will be presented, which enables selection of the macro that is to be run at this point. When a macro has been selected, control returns to the Add Code Menu.

LOCAL OPERATION

SYSTEM

MACRO

Fig. 3-71 MACRO Menu (Sheet 2)

*Edit Macro

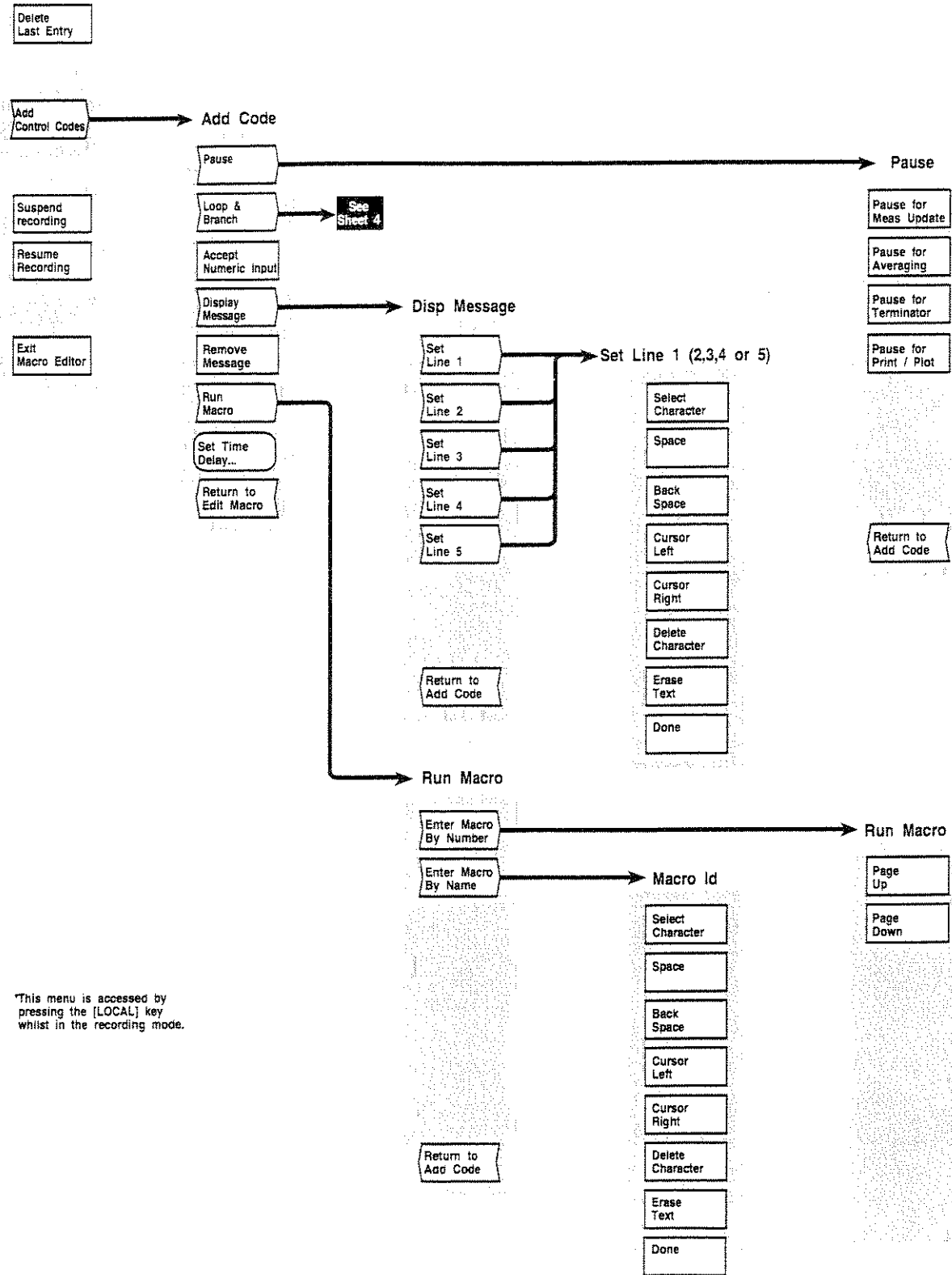

C1184

Fig. 3-71 MACRO Menu (Sheet 2)

SYSTEM

MACRO

Fig. 3-70 MACRO Menu (Sheet 1)

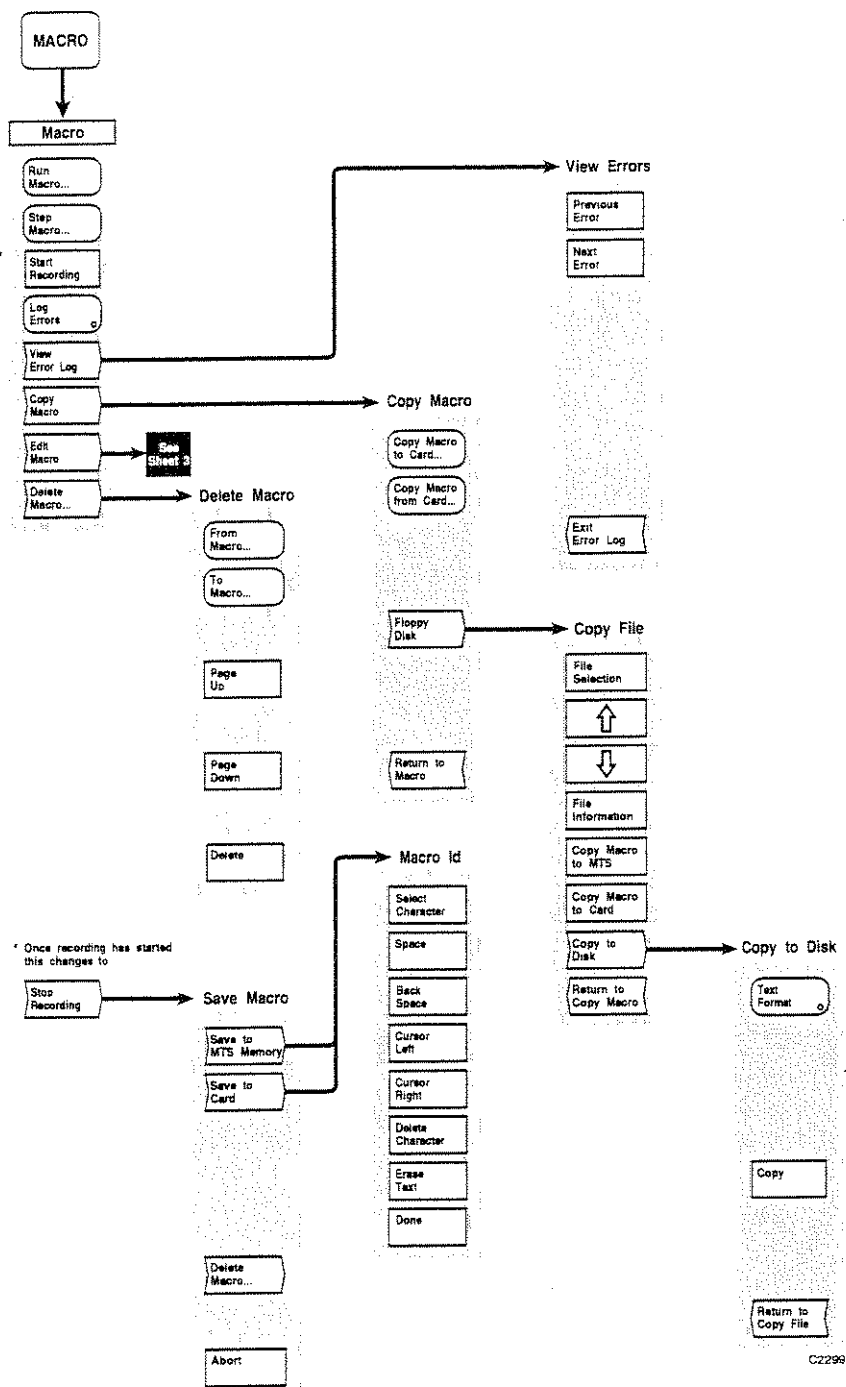

C2299

Fig. 3-70 MACRO Menu (Sheet 1)



MACRO

Fig. 3-72 MACRO Menu (Sheet 3)

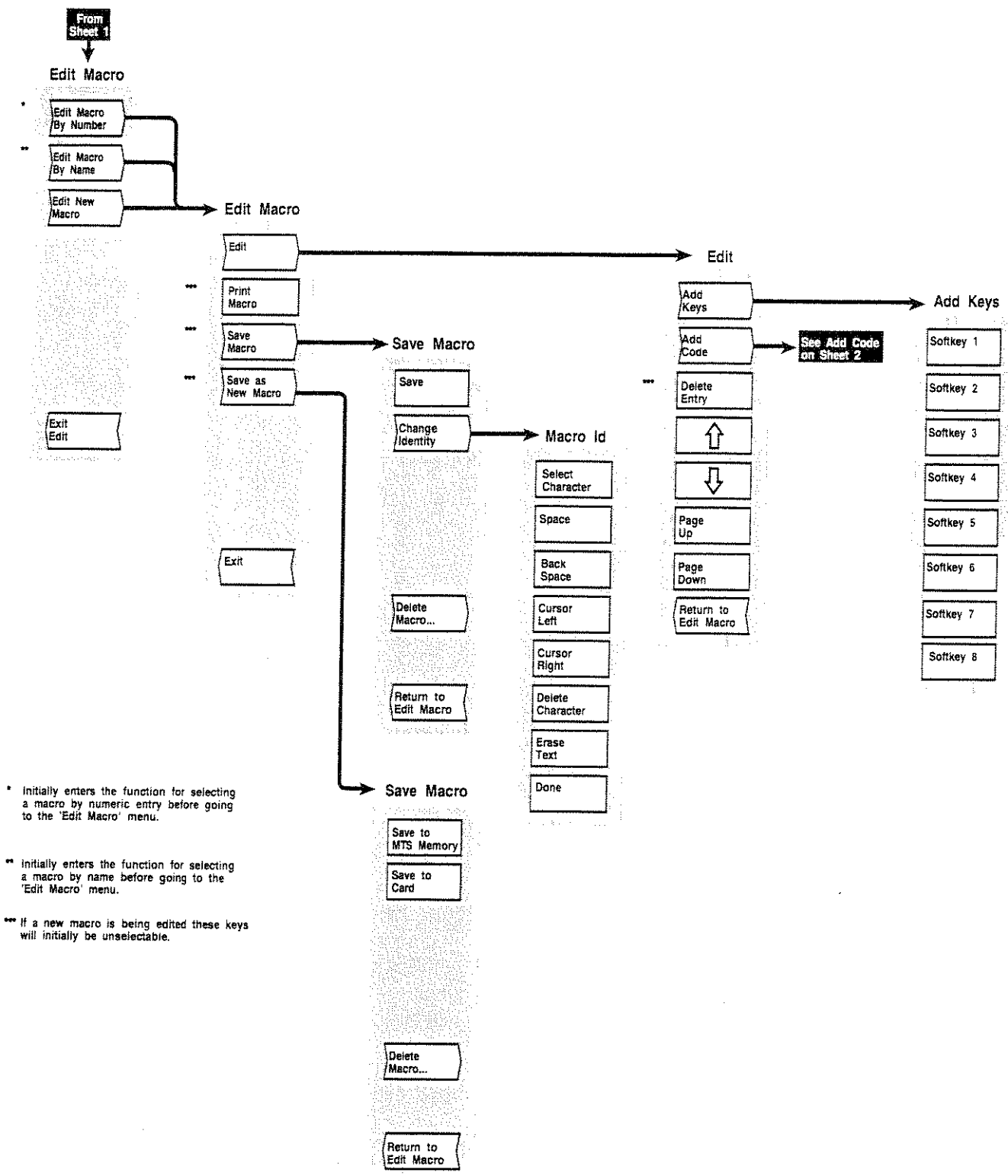

C1185

Fig. 3-72 MACRO Menu (Sheet 3)

SYSTEM

MACRO

Fig. 3-73 MACRO Menu (Sheet 4)

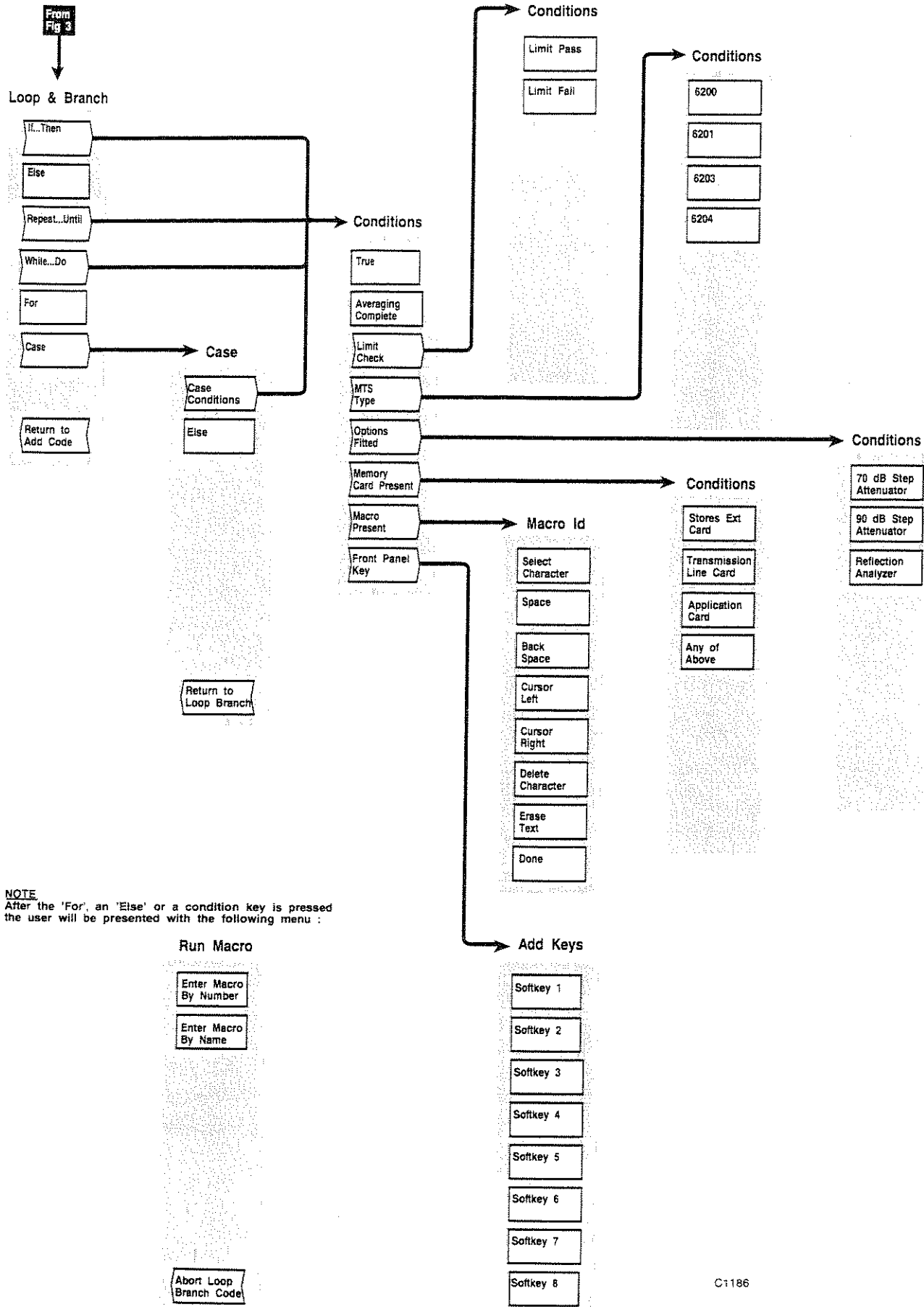

C1186

Fig. 3-73 MACRO Menu (Sheet 4)

[UTILITY] KEY

The [UTILITY] key provides access to the series of menus illustrated in Figs. 3-78 to 3-83. The menus provide utility functions, such as setting up GPIB addresses, generating titles, setting up the display, and performing various system functions.

UTILITY

- Utility** *See Fig. 3-78. All the soft keys in this menu lead to further menus which provide utility functions not directly concerned with the measurement.*

- GPIB** *Leads to the GPIB Menu, which enables the instrument to be set up for GPIB operation. See page 3-288.*

- Titles** *Leads to the Titles Menu, which enables the main screen title and measurement titles to be entered and displayed. See page 3-289.*

- Display Set-up** *Leads to the Display Set-up Menu, which enables the display brightness to be set, and also provides a screen blanking facility. This menu also provides access to the "Secret Freq Display" function. See page 3-292.*

- Set Inc / Dec Steps** *Leads to the Inc/Dec Steps Menu, which enables the user to define the step size that is used when changing numeric parameters with the step keys and rotary control. See page 3-292.*

- Store Operations** *Leads to the Store Ops Menu, which enables the contents of a selected store to be copied to another and also enables copying of data between stores and floppy disk.. See page 3-295.*

- Service** *Leads to the Service Menu, which enables various system functions to be carried out, such as instrument tests, diagnostics and calibration, and setting up the instrument according to the user's requirements. See page 3-300.*

- Applications** *Leads to the Applications Menu, which enables the user to run an application program stored on a memory card. See page 3-330.*

GPIB

See Fig. 3-78. This menu enables the GPIB mode to be selected, and the GPIB addresses for the MTS, external source and plotter to be set up. GPIB operation is covered in detail in the GPIB Operating Manual.

Instrument Address

Enables the GPIB address for the MTS to be set up by entering a number between 0 and 30.

Rotary Control Step Keys Numeric Pad Terminator Any

Ext Source Address

Enables the GPIB address for the external source to be set up by entering a number between 0 and 30.

Rotary Control Step Keys Numeric Pad Terminator Any

Plotter Address

Enables the GPIB address for the plotter to be set up by entering a number between 0 and 30.

Rotary Control Step Keys Numeric Pad Terminator Any

Controller Mode

Puts the MTS in the Controller mode, in which the instrument acts as controller of the GPIB system. In this mode, the instrument can control a second MTS or an HPGL plotter.

Talk / Listen Mode

Puts the MTS in the Talk/Listen mode, in which the instrument behaves like a device conforming to IEEE 488.2, under the control of an external controller (which can be another MTS).

Restore Autotrigger

Returns the instrument to auto-trigger mode if a GPIB program leaves it in remote trigger mode.

Return to Utility

Returns control to the Utility Menu.

UTILITY

Titles

Titles

See Fig. 3-78. This menu allows the user to generate the main screen title and also titles for both measurements on Channels 1 and 2.

Set Screen Title

Leads to the Screen Title Menu.
See page 3-290.

Screen Title

Toggles the screen title on or off.

Channel 1 Meas Titles

Leads to the Chan 1 Titles Menu.
See page 3-291.

Channel 2 Meas Titles

Leads to the Chan 2 Titles Menu.
See page 3-291.

Return to Utility

Returns control to the Utility Menu.

Screen Title

See Fig. 3-78. Enables a title to be entered which will be displayed at the top left of the screen. A form is displayed on the screen containing the current screen title in an input field and three rows of characters arranged as follows:

Screen Title	
Microwave Test Set	
A	BCDEFGHIJKLMNOPQRSTUVWXYZ
	abcdefghijklmnopqrstuvwxy z
	0 1 2 3 4 5 6 7 8 9 . , ; + - / * = < > () [] # ' " ! ? & % ° μ Ω

C0429

Fig. 3-74 Editing a Screen Title

The character that is to be selected is enclosed by a box which can be moved along the rows of characters using the rotary control. The step keys are used to select the row of characters (upper case, lower case or digits/symbols). Note that the front panel keys 0 to 9, "." and "-" can be used directly.

Select Character	Causes the selected character to be added to the title at the cursor position.
Space	Causes a space character to be added to the title at the cursor position.
Back Space	Causes the character before the cursor to be deleted from the title.
Cursor Left	Moves the cursor left one character.
Cursor Right	Moves the cursor right one character.
Delete Character	Deletes the character at the cursor position.
Erase Text	Causes the entire text to be deleted from the input field.
Done	Terminates screen title entry.

UTILITY

Titles

Channel 1
Meas TitlesChan 1 Titles

See Fig. 3-78. This menu is used to enter titles for measurement 1 and measurement 2 of channel 1, using the same procedure as for the screen title (see above).

Set Meas 1
Title

Leads to a sub-menu which is used to enter a title for measurement 1. The procedure and soft keys are the same as for the Screen Title Menu.
See page 3-290.

Meas 1
Title

Toggles measurement 1 title on or off.

Set Meas 2
Title

Leads to a sub-menu which is used to enter a title for measurement 2. The procedure and soft keys are the same as for the Screen Title Menu.
See page 3-290.

Meas 2
Title

Toggles measurement 2 title on or off.

Return to
Titles

Returns control to the Titles Menu.

UTILITY

Titles

Channel 2
Meas TitlesChan 2 Titles

See Fig. 3-78. This menu is the same as the Channel 1 Titles Menu, but applies to channel 2.

UTILITY**Display Set-up****Display Set-up**

See Fig. 3-78. This menu provides soft keys for the following display functions:

Secret Freq Display

Used to remove all frequency annotation from the display. The soft key has an on/off toggle action.

Screen Timeout

Sets the screen timeout value for the LCD. The LCD backlight will be automatically turned off after the timeout period has expired. Values in the range 1 to 999 minutes can be set; the default is 20 minutes. The display will be restored and the timeout counter reset when any key is pressed or the rotary control moved.

Rotary Control	√	Step Keys	√	Numeric Pad	√	Terminator	Any
----------------	---	-----------	---	-------------	---	------------	-----

Screen Brightness

Enables the LCD backlight to be switched between full and half brightness (the default is full brightness). When this soft key is pressed, a sub-menu is displayed; the LCD brightness is selected by pressing either the *[Full Brightness]* or *[Half Brightness]* soft key.

Lock Instrument

Used to blank the display and disable the front panel keys and GPIB. When this soft key is pressed, a 9 digit security password must be entered and then verified. The instrument remains locked until the security password is entered again, even if the instrument is switched off then on again.

Colour Palette

Leads to the Colour Palette Menu.
See menu below.

Return to Utility

Returns control to the Utility Menu.

UTILITY**Display Set-up****Colour Palette****Colour Palette**

See Fig. 3-78. This menu enables selection of the colour palette used by the display. The palettes are provided to enable easier viewing in bright light conditions, especially outdoors.

Colour

Selects the standard palette.

White on Black

Provides a high contrast display for brightly lit viewing conditions.

Black on White

Provides an alternative high contrast display for brightly lit viewing conditions.

Green on Black

Displays shades of green for green optimised photographic film in scope cameras.

Return to Disp Set-up

Returns control to the Display Set-up Menu.

UTILITY

Set Inc
/ Dec StepsInc/Dec Steps

See Fig. 3-78. This menu enables the user to define the step size that is used when changing numeric parameters with the step keys and rotary control. Pressing one of the soft keys in this menu allows the step size for the indicated parameter to be changed by entering the new value.

Set dB
Step

Enables the dB step size to be changed.

Rotary Control	×	Step Keys	×	Numeric Pad	√	Terminator	Any
----------------	---	-----------	---	-------------	---	------------	-----

Set Freq
Step

Enables the Frequency step size to be changed.

Rotary Control	×	Step Keys	×	Numeric Pad	√	Terminator	10+
----------------	---	-----------	---	-------------	---	------------	-----

Set Watts
Step

Enables the Watts step size to be changed

Rotary Control	×	Step Keys	×	Numeric Pad	√	Terminator	10-
----------------	---	-----------	---	-------------	---	------------	-----

Set Voltage
Step

Enables the Voltage step size to be changed.

Rotary Control	×	Step Keys	×	Numeric Pad	√	Terminator	10-
----------------	---	-----------	---	-------------	---	------------	-----

Set Current
Step

Enables the Current step size to be changed.

Rotary Control	×	Step Keys	×	Numeric Pad	√	Terminator	10-
----------------	---	-----------	---	-------------	---	------------	-----

Set Units
Step

Enables the Units step size to be changed.

Rotary Control	×	Step Keys	×	Numeric Pad	√	Terminator	10-
----------------	---	-----------	---	-------------	---	------------	-----

More

Leads to the Inc/Dec Steps (More) Menu.

Return to
Utility

Returns control to the Utility Menu.

UTILITY

Set Inc / Dec Steps **More**

Inc/Dec Steps
(More)

See Fig. 3-78. This menu is a continuation of the Set Inc/Dec Steps Menu.

Set % Step

Enables the Percentage step size to be changed.

Rotary Control × Step Keys × Numeric Pad ✓ Terminator Any

Set Distance Step

Enables the Distance step size to be changed.

Rotary Control × Step Keys × Numeric Pad ✓ Terminator 10+

Set Time Step

Enables the Time step size to be changed.

Rotary Control × Step Keys × Numeric Pad ✓ Terminator 10-

Return to Prior Menu

Returns control to the Inc/Dec Steps Menu.

UTILITY

Store
OperationsStore Ops

See Fig. 3-79. This menu enables copying of data held in a store to another store of the same type. The stores can be located either in internal MTS memory or on a memory card. If the floppy disk drive option is fitted, stores can also be copied to floppy disk as MS-DOS files and vice versa.

If the memory card has been configured to provide stores extensions, the MTS will automatically recognise that additional stores are present, and are referenced by store numbers that follow on from those used to select the built-in stores of the basic instrument. Stores located on the memory card are manipulated identically to the internal resident stores. When the MTS prompts for a store number, the current range of available store numbers will be displayed, distinguishing between the internal stores and those on the card.

For information on configuring memory cards, refer to the menu accessed using [UTILITY][Service][Set-Up].

The soft keys provide a copy facility for the various types of store that can be located on a memory card.

**Copy Inst
Settings**

Leads to the Inst Settings Menu.
See page 3-296.

**Copy Trace
Memory**

Leads to the Trace Memory Menu.
See page 3-296.

**Copy Sensor
Cal**

Leads to the Sensor Cal Menu.
See page 3-297.

**Copy Source
Power Cal**

Leads to the Src Pwr Cal Menu.
See page 3-297.

**Copy Reflect
Analyzer Cal**

Leads to the Reflect Cal Menu.
*This soft key will only be displayed if the 6210 Reflection Analyzer is connected.
See page 3-298.*

**Copy Reflect
Cal Kit**

Leads to the Cal Kit Menu.
*This soft key will only be displayed if the 6210 Reflection Analyzer is connected.
See page 3-298.*

**Erase All
Stores**

Erases the contents of all the above stores. This function is Level 1 Password protected.

**Return to
Utility**

Returns control to the Utility Menu.

UTILITY**Store
Operations****Copy Inst
Settings****Inst Settings**

See Fig. 3-79. This menu is used to copy the contents of one Instrument Settings store to another.

**From Inst
Settings**

Used to select the settings store to copy from by entering the store identity number.

Rotary Control X Step Keys X Numeric Pad √ Terminator Any

**To Inst
Settings**

Used to select the settings store that is to be copied to by entering the store identity number.

Rotary Control X Step Keys X Numeric Pad √ Terminator Any

**Floppy
Disk**

Leads to the Copy File menu, which enables instrument settings to be copied between stores and floppy disk.
See page 3-299.

Copy

Copies the store contents and terminates the function.

UTILITY**Store
Operations****Copy Trace
Memory****Trace Memory**

See Fig. 3-79. This menu is used to copy the contents of one trace memory to another.

**From Trace
Memory**

Used to select the trace memory to copy from by entering the memory identity number.

Rotary Control X Step Keys X Numeric Pad √ Terminator Any

**To Trace
Memory**

Used to select the trace memory that is to be copied to by entering the memory identity number.

Rotary Control X Step Keys X Numeric Pad √ Terminator Any

**Floppy
Disk**

Leads to the Copy File menu, which enables trace memories to be copied between stores and floppy disk.
See page 3-299.

Copy

Copies the trace memory and terminates the function.

UTILITY

Store
OperationsCopy Sensor
CalSensor Cal

See Fig. 3-79. This menu is used to copy the contents of one sensor calibration store to another.

From Sensor
Cal

Used to select the sensor cal store to copy from store by entering the store identity number.

Rotary Control	X	Step Keys	X	Numeric Pad	√	Terminator	Any
----------------	---	-----------	---	-------------	---	------------	-----

To Sensor
Cal

Used to select the sensor cal store that is to be copied to by entering the store identity number.

Rotary Control	X	Step Keys	X	Numeric Pad	√	Terminator	Any
----------------	---	-----------	---	-------------	---	------------	-----

Floppy
Disk

Leads to the Copy File menu, which enables sensor cal data to be copied between stores and floppy disk.
See page 3-299.

Copy

Copies the store contents and terminates the function.

UTILITY

Store
OperationsCopy Source
Power CalSrc Pwr Cal

See Fig. 3-79. This menu is used to copy the contents of one source power calibration store to another.

From Source
Power Cal

Used to select the source power cal store to be copied from by entering the store identity number.

Rotary Control	X	Step Keys	X	Numeric Pad	√	Terminator	Any
----------------	---	-----------	---	-------------	---	------------	-----

To Source
Power Cal

Used to select the source power cal store that is to be copied to by entering the store identity number.

Rotary Control	X	Step Keys	X	Numeric Pad	√	Terminator	Any
----------------	---	-----------	---	-------------	---	------------	-----

Floppy
Disk

Leads to the Copy File menu, which enables source power cal data to be copied between stores and floppy disk.
See page 3-299.

Copy

Copies the store contents and terminates the function.

UTILITY

Store Operations Copy Reflect
Analyzer CalReflect Cal

See Fig. 3-79. This menu is used to copy the contents of one reflection analyzer calibration store to another.

From
Reflect Cal

Used to select the reflection analyzer cal store to be copied from by entering the store identity number.

Rotary Control × Step Keys × Numeric Pad √ Terminator Any

To
Reflect Cal

Used to select the reflection analyzer cal store to be copied to by entering the store identity number.

Rotary Control × Step Keys × Numeric Pad √ Terminator Any

Floppy
Disk

Leads to the Copy File menu, which enables reflection analyzer cal data to be copied between stores and floppy disk.
See page 3-299.

Copy

Copies the store contents and terminates the function.

UTILITY

Store Operations Copy Reflect
Cal KitCal Kit

See Fig. 3-79. This menu is used to copy the contents of one cal kit store to another.

From
Cal Kit

Used to select the cal kit store to be copied from by entering the store identity number.

Rotary Control × Step Keys × Numeric Pad √ Terminator Any

To
Cal Kit

Used to select the cal kit store that is to be copied to by entering the store identity number.

Rotary Control × Step Keys × Numeric Pad √ Terminator Any

Floppy
Disk

Leads to the Copy File menu, which enables cal kit data to be copied between stores and floppy disk.
See page 3-299.

Copy

Copies the store contents and terminates the function.

UTILITY

Store
OperationsCopy Inst
SettingsFloppy
DiskCopy File

See Fig. 3-79. This menu is used to copy data between floppy disk and internal MTS stores or between floppy disk and a memory card.

A form is displayed listing the directories and files on the floppy disk, as described for the Disk Funcs Menu (page 3-329).

File
Selection
or
Directory
Selection

This soft key is used to switch between the Directory section and the Files section of the form. When in the Directory section the soft key is labelled [*File Selection*]; when in the Files section it is labelled [*Directory Selection*].

↑

Selects the previous entry in the directory or file list. The list automatically scrolls, if necessary, when the highlight reaches the top of the list.

↓

Selects the next entry in the directory or file list. The list automatically scrolls, if necessary, when the highlight reaches the bottom of the list.

File
Information

Provides information on the currently highlighted file, as follows:

File name
File size
Creation date/time
File attributes (Read Only, Archive, Hidden, System)
Type of file (trace memory, settings etc.)
Memory title (only present for trace memory files)

Copy from
Disk

Copies the currently highlighted file from the floppy disk into MTS memory or a memory card in internal store format. A form is displayed indicating the range of available stores for the file type (including those on a memory card), as indicated by the filename extension. The store number to copy to is specified by entering its identity number:

Rotary Control	×	Step Keys	×	Numeric Pad	√	Terminator	Any
----------------	---	-----------	---	-------------	---	------------	-----

An error message is displayed if the wrong file type is selected from the disk.

Copy to
Disk

Copies an internal MTS store to the floppy disk as an MS-DOS format file. A form is displayed indicating the range of available stores for the store type (including those on a memory card). The store to be copied is specified by entering its identity number. A text entry form is then presented which enables an 8 character filename to be entered. The MTS adds a three character extension to the filename, depending on the store type.

Return to
Store Ops

Returns control to the Store Ops Menu.

Service

- Service** *See Fig. 3-80.* This menu provides various service functions.
- Set-up** Leads to the Set-up Menu, which provides various configuration and set-up functions.
See page 3-301.
- Status** Leads to the Status Menu, which allows the user to examine the power on test results and the build state of the instrument.
See page 3-307.
- Instrument Calibrations** Leads to the Instrument Cals Menu, which provides calibration facilities for the instrument.
See page 3-310.
- Tests** Leads to the Tests Menu, which enables the display and keyboard to be checked for correct operation.
See page 3-316.
- Det / Sensor Specs** Leads to the Edit Specs Menu, which is used to modify detector correction specifications or sensor calibration data tables.
See page 3-317.
- Diagnostics** Leads to the Diagnostics Menu.
See page 3-318.
- Floppy Disk Functions** Leads to the Disk Funcs Menu, which provides various floppy disk functions, such as examining the contents, creating directories and deleting files.
This soft key is only present if the floppy disk drive option is fitted.
See page 3-329.
- Return to Utility** Returns control to the Utility Menu.

UTILITY

Service

Set-up

Set-up

See Fig. 3-81. This menu provides facilities for setting the instrument's real-time clock, setting user-defined passwords, configuring memory cards and installing software options.

**Set Date
& Time**

Leads to the Date & Time Menu, which is used for setting the instrument's real time clock.
See page 3-302.

**Reset Op
Hours Clock**

This is a Marconi Password protected function and is not available to the user.

**Set
Passwords**

Leads to the Set Passwords Menu, which is used to set the two user-defined passwords. This facility is Primary Password protected.
See page 3-303.

**Configure
Memory Card**

Leads to the Config Card Menu, which is used to configure memory cards before use. This function is Level 1 Password protected.
See page 3-304.

**Format
Disk**

Used to format a floppy disk to accept MS-DOS files (1.44 MB storage capacity). A text entry form will be presented in which to enter the name of the volume; up to 11 characters can be entered for the volume label. A horizontal bar progress indicator is displayed during the formatting operation, which can be aborted at any time by pressing the *[Abort Format]* soft key.
This soft key is only present if the floppy disk drive option is fitted.

**Set Serial
Number**

This is a Marconi Password protected function and is not available to the user.

Options

Leads to the Options Menu which allows the instrument's hardware options to be specified.
See page 3-306.

**Return to
Service**

Returns control to the Service Menu.

Date & Time

See Fig. 3-81. This menu is used to set the instrument's real-time clock and calendar.

A form is displayed on the screen (Fig. 3-75) showing the current time and date, together with soft keys for parameter selection. Pressing a soft key enables the corresponding value to be changed, as follows:

Rotary Control	√	Step Keys	√	Numeric Pad	√	Terminator	Any
----------------	---	-----------	---	-------------	---	------------	-----

The displayed time and date will be regularly updated to reflect any changes that are made.

Set Hours

Enables the Hours to be set.

Set Minutes

Enables the Minutes to be set.

Set Seconds

Enables the Seconds to be set.

Set Day

Enables the Day to be set.

Set Month

Enables the Month to be set.

Set Year

Enables the Year to be set.

Return to Set-up

Returns control to the Set-up Menu.

Set Date & Time
17 : 37 : 18
30 Oct 1991

Co430

Fig. 3-75 Setting Date and Time

UTILITY

Service

Set-up

Set
Passwords**Set Passwords**

See Fig. 3-81. A form is displayed on the screen containing the Level 1 and Level 2 user-defined passwords. The soft keys are used to select the password to be changed.

The Set Password function requires entry of the instrument's Primary Password before the user-defined passwords can be changed (see page 3-13).

**Set Level 1
Password**

Enables the Level 1 Password to be set by entering a 4-digit number in the range 1000 to 9999.

Rotary Control	×	Step Keys	×	Numeric Pad	√	Terminator	Any
----------------	---	-----------	---	-------------	---	------------	-----

**Set Level 2
Password**

Enables the Level 2 Password to be set by entering a 6-digit number in the range 100000 to 999999.

Rotary Control	×	Step Keys	×	Numeric Pad	√	Terminator	Any
----------------	---	-----------	---	-------------	---	------------	-----

**Return to
Set-up**

Returns control to the Set-up Menu.

Config Card

See Fig. 3-81. This menu is used to initialise a blank memory card and configure it to hold a number of stores. These stores are extensions of the instrument's resident stores, and can be used in the same way as the resident ones. The following store types can be located on the card:

User Source Power Calibration
Power Sensor Calibration Data
Reflection Analyzer Calibration Data
Reflection Analyzer Cal Kit
Trace Memory
Instrument Settings

Since any data present on the memory card will be destroyed by the configuration process, this function is Level 1 Password protected.

A form is displayed showing identity of the card, the store types and their sizes (in bytes), and the number of stores allocated for each type. The current amount of memory remaining on the card is also shown (see Fig. 3-76).

Soft keys are displayed for each of the above store types. Pressing a soft key enables the user to change the number of stores allocated for the selected store type. If the number of stores entered would cause the memory capacity of the card to be exceeded, the number of stores will be limited to the maximum number possible.

The memory card can also be used to store macros (see [MACRO] key description). Any space not allocated for the above fixed length stores can be used for macros.

**Source
Power Cal**

Enables a specified number of stores to be allocated for user source power calibration.

Rotary Control	✓	Step Keys	✓	Numeric Pad	✓	Terminator	Any
----------------	---	-----------	---	-------------	---	------------	-----

**Sensor
Cal Data**

Enables a specified number of stores to be allocated for power sensor calibration data.

Rotary Control	✓	Step Keys	✓	Numeric Pad	✓	Terminator	Any
----------------	---	-----------	---	-------------	---	------------	-----

**Trace
Memory**

Enables a specified number of stores to be allocated for trace memories.

Rotary Control	✓	Step Keys	✓	Numeric Pad	✓	Terminator	Any
----------------	---	-----------	---	-------------	---	------------	-----

**Instrument
Settings**

Enables a specified number of stores to be allocated for instrument settings.

Rotary Control	✓	Step Keys	✓	Numeric Pad	✓	Terminator	Any
----------------	---	-----------	---	-------------	---	------------	-----

**Adapter
Stores**

Leads to the Adapt Stores Menu.

This soft key will only be displayed if the 6210 Reflection Analyzer is connected.

See page 3-305.

- Edit Title** Leads to a sub-menu and displays a form which enables a text string of up to twenty characters to be entered as the identity of the card. The method of entry is the same as that described for the Screen Title Menu (page 3-290).
- Configure Card** Initiates the configuration process.
- Return to Set-up** Terminates the configure memory card function. The function prompts for confirmation if the store allocation for any of the store types has been changed.

Configure Memory Card		
Title : PRODUCTION TEST 1-9		
Store Type	Size	Number
Source Power Calibration	2512	1
Sensor Calibration Data	520	2
Trace Memory	7092	2
Instrument Settings	6380	5
Reflection Analyzer Calibration	38760	1
Reflection Analyzer Cal Kit	284	20
Macro Memory: 36896		

Fig. 3-76 Configuring a Memory Card

UTILITY

Service

Set-up

Configure Memory Card

Adapter Stores

Adapt Stores See Fig 3-81. This menu is used to specify the number of reflection analyzer stores.

Reflection Analyzer Cal Enables a specified number of stores to be allocated for reflection analyzer calibration data.

Rotary Control	✓	Step Keys	✓	Numeric Pad	✓	Terminator	Any
----------------	---	-----------	---	-------------	---	------------	-----

Refl Analyzer Cal Kit Enables a specified number of stores to be allocated for reflection analyzer calibration kits.

Rotary Control	✓	Step Keys	✓	Numeric Pad	✓	Terminator	Any
----------------	---	-----------	---	-------------	---	------------	-----

Return to Config Card Returns control to the Config Card Menu.

UTILITY

Service

Set-up

Options

Options

See Fig 3-81. This menu is used to provide international support for the MTS, and also enables the instrument's hardware options to be specified.

International

Leads to the International Menu.
See menu below.

Set MTS
Options

Leads to the Set MTS Options function. This function allows the instrument's hardware options to be specified. This facility is Primary Password protected.

Return to
Set-up

Returns control to the Set-up Menu.

UTILITY

Service

Set-up

Options

International

International

See Fig 3-81. This menu enables external keyboards other than the UK version to be used with the MTS. It also enables the use of spreadsheet format files that employ a semi-colon field separator.

Keyboard
Layout

This soft key leads to a sub-menu which enables one of the following types of external keyboard to be used by pressing the appropriate soft key:

France, Germany, Spain, United Kingdom or USA

Spreadsheet
Format

This soft key leads to a sub-menu which enables either of two CSV formats to be used when generating spreadsheet format files which are to be exported to a spreadsheet application on a PC. Soft keys are provided for the following formats:

1. A comma is used as a field separator and a dot as the decimal point.
2. A semi-colon is used as field separator and a comma as a decimal point.

Return to
Options

Returns control to the Options Menu.

UTILITY

Service

Status

Status

See Fig. 3-80. This menu allows the user to examine the power on test results and the build state of the instrument.

Display Test Results

Leads to the Test Results Menu, which enables power on test results to be displayed and printed.

See page 3-308.

Erase Test Results

Clears the power on test results, i.e. sets all the tests to 'pass'. This function is confirmation protected.

Display Build State

Displays the build state of the instrument, including the total number of hours that the instrument has been operating, and the time and data of the most recent frequency standard cal and power reference cal. The [Print] soft key sends this data to the printer. The instrument's build state can also be printed out by pressing the [COPY] key on power up.

Return to Service

Returns control to the Service Menu.

Test Results

See Fig. 3-80. This menu is used to display and print the results of the tests carried out by the instrument at power on.

The test results occupy several pages which can be accessed using the [Page Up] and [Page Down] soft keys. The overall pass/fail indication is shown at the top of the first page. The MTS maintains records in non-volatile memory of the time and date of the most recent failure for each test. The menu also gives information about failures during source calibration.

The following self-tests are carried out at power-on.

Bootstrap Loader Tests. These are carried out by the program that loads programs into the Digital Board RAM and the Analogue Board RAM (for the Graphics System) for execution by the associated transputers. The bootstrap loader also loads code into two additional processors in the reflection analyzer, if it is present.

ROM Test. At power on, the bootstrap loader generates and stores a ROM checksum, and this is compared with the stored checksum generated at the previous power on. If the checksums differ, a failure message is displayed together with the previous and current checksums.

Digital Board Transputer. If this device is unserviceable it is very unlikely that any software will run, therefore no attempt is made to test or report failures.

Analogue Board Transputer Test (Graphics System). The internal memory in the Graphics System transputer chip is tested via the link from the Digital Board transputer. If a failure is detected, the message *Analogue board processor failure* is sent to the printer port. Without the graphics transputer, no further testing is possible.

Reflection Analyzer Transputer Tests. If the reflection analyzer is present, its two processors are tested via a link from the Digital Board transputer. If either processor fails the test, the message *Adapter processor failure* is sent to the printer port. The instrument will then power up as an MTS with no reflection analyzer fitted, and all reflection analyzer functions will be disabled.

Memory Tests. These are carried out on both the Digital Board transputer (T1) and the Analogue Board transputer (T2). The first occurrence of a failure is logged and the message *Digital board memory failure* or *Analogue board memory failure* is output to the printer port. The transputer number (T1 or T2), address and test pattern are recorded in the Test Results.

Memory tests are also carried out on the two processors within the reflection analyzer, if it is present. If either of these have failed, the message *Adapter processor memory failure* is printed. The transputer number (T3 or T4), address and test pattern are recorded in the Test Results as they are for T1 and T2. In the event of a reflection analyzer memory failure, the instrument will power up as an MTS with no reflection analyzer fitted, and all reflection analyzer functions will be disabled.

Device Tests. Tests are carried out on the GPIB chip, the keyboard and the real-time clock. Failures are reported in the Test Results, and the following messages are sent to the printer port:

Keyboard failure
GPIB chip failure
Real time clock failure

If the clock fails, an attempt is made to set it to the default date and time: Midnight, 1st January, 1990.

Subsystem Tests. These tests are carried out as the main software components of the system initialise the hardware for which they are responsible.

Graphics. Reports "pass" if the graphics system appears to have initialised satisfactorily.

Source. Reports "pass" if the source system has initialised satisfactorily and locking is achieved.

Data Acquisition. Tests are carried out on the following data acquisition components and the pass/fail status is reported:

- ADC
- Calibration DAC
- Main amplifier
- Sequencer

Non-Volatile Memory. Each store within the instrument's non-volatile memory is protected by a checksum. When data is accessed from a store, the checksum is recalculated. If the data within a store is found to be corrupt, a "Store Corrupted" error message is displayed, and an entry made in the Test Results. Corrupted stores are automatically reset to empty, or overwritten with default data from ROM, depending on the store type.

Power Supply Temperature Monitoring. The power supply temperature is checked every few minutes. If operational limits are exceeded, a "Power supply overheating" message is displayed, and an entry made in the Test Results. (If the temperature continues to rise, the power supply will eventually shut down automatically.)

Source Calibration. If a source frequency cal or power cal fails, detailed information concerning the failure is recorded. This is described fully in the 6200B Maintenance Manual.

Page Up	Displays the previous page of test results.
Page Down	Displays the next page of test results.
Print	Enables a hard copy printout of the test results to be obtained.
Return to Status	Returns control to the Status Menu.

Instrument Cals

See Fig. 3-82. This menu provides facilities calibrating the internal frequency standard and power reference, and calibrating the instrument to match non-standard test conditions (e.g. high ambient temperature), or calibration at the output of an amplifier, filter, cable or autotester.

The calibration process is controlled automatically by the MTS. For operations taking more than a few seconds to complete in the following sub-menus, a percentage complete indicator will be displayed after the function has been initiated.

Frequency Standard Cal

Leads to the Freq Std Cal Menu, which is used to calibrate the instrument's internal frequency standard. This facility is Level 2 Password protected.
See page 3-311.

Power Ref Cal

Leads to the Pwr Ref Cal Menu, which is used to calibrate the power reference output.
See page 3-311.

Perform Freq Cal

Calibrates the YIG oscillators of the instrument's source using the internal counter. When this soft key is pressed, frequency calibration commences. When calibration is complete, the user is informed and is returned to the Instrument Cals Menu.
This soft key is not displayed on the 6202B, since it does not contain any YIG oscillators.

Source Power Cal

Leads to the Src Power Cal Menu, which provides power calibration facilities for the instrument's source.
See page 3-312.

Transfer to Primary

Leads to the Transfer to Pri Menu, which is used to transfer a user power calibration into the Primary calibration store. This function is Level 2 Password protected.
See page 3-315.

Select Power Cal

Leads to the Select Pwr Cal menu, which is used to select which power calibration is to be used in the instrument.
See page 3-315.

Adapter Cals

Leads to the Adapter Cals Menu, which provides calibration functions for the Reflection Analyzer detector diodes.
(See page 3-312)
This soft key is only displayed if the 6210 Reflection Analyzer is connected.

Return to Service

Returns control to the Service Menu.

UTILITY

Service	Instrument	Frequency
	Calibrations	Standard Cal

Freq Std Cal

See Fig. 3-82. This menu is used to calibrate the instrument's internal frequency standard against an external frequency standard. This facility is Level 2 Password protected

A form is displayed containing the date and time of the last frequency calibration. A message is displayed prompting the user to connect the frequency standard to the FREQ STD INPUT/OUTPUT connector on the rear panel, and to press the [Continue] soft key when ready. When calibration is complete, the user is informed and is returned to the Instrument Cals Menu.

Continue

Initiates calibration of the internal frequency standard.

Abort
Calibration

Terminates the function without performing a frequency calibration.

UTILITY

Service	Instrument	Power Ref
	Calibrations	Cal

Pwr Ref Cal

See Fig. 3-82. This menu is used to calibrate the power reference output of the instrument. This facility is Level 2 Password protected. A function is also provided to characterise the dynamic calibrator.

0 dBm Power
Ref Cal

When this soft key is pressed, a message is displayed prompting the user to disconnect the sensor from any RF source and to press the [Continue] soft key when ready. When the sensor has been zeroed, the user is prompted to connect the sensor to an external power reference standard and press [Continue] when ready. Readings are then taken from the standard. When this has been done, the user is asked to connect the sensor to the instrument's POWER REF connector and press [Continue] when ready. The instrument's power reference is then calibrated. When complete, the user is informed and is returned to the Instrument Cals Menu.

Characterise
Dynamic Cal

Initiates a function to determine the settings of the dynamic calibrator that best approximate to the 20 and 26 dBm power levels that are required for linearity calibrations on EEPROM detectors. The characterisation requires a 693X sensor, which will be calibrated as the first part of the characterisation process.

Return to
Inst Cals

Return control to the Instrument Cals Menu.

UTILITY

Service

Instrument
CalibrationsSource
Power CalSrc Power Cal

See Fig. 3-82. This menu provides broadband and narrowband power calibration facilities for the instrument's source.

In broadband calibration, the MTS is calibrated for frequency and power over its full operating range. The narrowband calibration facility enables a power calibration to be performed over a limited frequency range. This makes it possible to calibrate the instrument at the output of frequency selective devices such as filters and amplifiers. The calibration data can be stored in the instruments non-volatile memory or on a memory card, while still retaining the primary calibration, created during factory calibration.

**Broadband
Power Cal**

Leads to the Power Cal Menu (Broadband), which is used to carry out a full frequency range power calibration of the instrument's source. This facility is Level 1 Password protected.

See page 3-313.

**Narrowband
Power Cal**

Leads to the Power Cal Menu (Narrowband), which is used to carry out a narrowband frequency range power calibration of the instrument's source. This facility is Level 1 Password protected.

See page 3-314.

**Return to
Inst Cals**

Returns control to the Instrument Cals Menu.

UTILITY

Service

Instrument
CalibrationsAdapter
CalsAdapter Cals

See Fig. 3-82. This menu is used to carry out a calibration of the detector diodes in the 6210 and generate new linearity polynomials for them. If required, the 6210 detector diode polynomials can be reset to their default (factory set) values.

**Refl Analyzer
Lin Cal**

This soft key initiates calibration of the 6210 detector diodes and generates new linearity polynomials for them. A message is displayed prompting the user to connect the MTS RF output to the 6210 RF input, and to ensure that nothing is connected to the 6210 test port. A sub-menu is also displayed containing [Continue] and [Abort Calibration] soft keys.

On pressing [Continue], this instrument will make its initial set of measurements and a percentage complete indicator will be displayed. When the data has been acquired, the user is prompted to connect the MTS RF output to the 6210 test port, and to connect a matched load to the 6210 RF input. After pressing [Continue], a percentage complete indicator will again be displayed while a second set of measurements are made. When completed, the new linearity polynomials are generated, the calibration will exit, and the user is informed that the new polynomials are in use.

**Default
Lin Cal Data**

Resets the 6210 detector diode polynomials to their default (factory set) values.

**Return to
Inst Cals**

Returns control to the Instrument Cals Menu.

UTILITY

Service

Instrument
CalibrationsSource
Power CalBroadband
Power CalPower Cal

Fig. 3-82. This menu is used to carry out a full frequency range power calibration of the instrument's source. This facility is Level 1 Password protected.

A window is displayed prompting the user to connect the sensor to input D and to the RF OUTPUT connector, and to press the [Continue] soft key when ready. After pressing [Continue], percentage complete indicators are displayed while linearity and flatness data are being collected.

When the data has been acquired, the user can save the calibration by specifying a store then pressing the [Save] soft key. The MTS provides two internal stores for this; a suitably configured memory card can be used for additional storage. Before saving, the user is asked if he wishes to change the identity of the calibration, using the same method as in the Screen Title Menu (see page 3-290).

Note...

Instead of calibrating at the RF output connector, calibration may be carried out at the output of any cables, adapters, etc. that are connected to the RF output.

Continue	Initiates broadband source power calibration.
Set Start Frequency	<i>This soft key is unselectable.</i>
Set Stop Frequency	<i>This soft key is unselectable.</i>
Select Cal Fact Table	Used to select the cal factor table that the cal factor for input D will be selected from, by entering the identity number of the table from the keyboard.
Edit Sensor Cal Data	Leads to the Edit Spec Menu, which is used for editing the calibration data for the current sensor. This menu is the same as for the measurement setup for a scalar channel. <i>See page 3-70.</i>
Sensor Cal	Leads to the Sensor Cal Menu, which is used to zero the power sensor and to calibrate it against the reference. <i>See page 3-89</i>
Abort Calibration	Terminates calibration.

Power Cal

See Fig. 3-82. This menu is used to carry out a narrowband frequency range power calibration of the instrument's source. This facility is Level 1 Password protected.

A window is displayed showing the frequency range the calibration will cover (initially the entire range of the source), and a message is displayed prompting the user to connect the sensor to input D and to the RF OUTPUT connector. The frequency range that the calibration will cover is specified using the [Set Start frequency] and [Set Stop Frequency] soft keys. After pressing [Continue], percentage complete indicators are displayed while linearity and flatness data are being collected.

When the data has been acquired, the user can save the calibration by specifying a store then pressing the [Save] soft key. The MTS provides two internal stores for this; a suitably configured memory card can be used for additional storage. Before saving, the user is asked if he wishes to change the identity of the calibration, using the same method as in the Screen Title Menu (see page 3-290)

Note...

Instead of calibrating at the RF output connector, calibration may be carried out at the output of any cables, adapters, etc. that are connected to the RF output.

Continue

Initially checks that the start and stop values are within the frequency range of the source, and then initiates the narrowband calibration.

**Set Start
Frequency**

Enables the start frequency of the calibration to be specified.

Rotary Control	✓	Step Keys	✓	Numeric Pad	✓	Terminator	10+
----------------	---	-----------	---	-------------	---	------------	-----

**Set Stop
Frequency**

Enables the stop frequency of the calibration to be specified.

Rotary Control	✓	Step Keys	✓	Numeric Pad	✓	Terminator	10+
----------------	---	-----------	---	-------------	---	------------	-----

**Select Cal
Fact Table**

Used to select the cal factor table that the cal factor for input D will be selected from, by entering the identity number of the table from the keyboard.

**Edit Sensor
Cal Data**

Leads to the Edit Spec Menu, which is used for editing the calibration data for the current sensor. This menu is the same as for the measurement setup for a scalar channel.
See page 3-70.

**Sensor
Cal**

Leads to the Sensor Cal Menu, which is used to zero the power sensor and to calibrate it against the reference.
See page 3-89

**Abort
Calibration**

Terminates calibration.

UTILITY

Service Instrument Transfer
Calibrations to PrimaryTransfer to Pri

See Fig. 3-82. This menu is used to replace the current primary power calibration with a user power calibration created using the Src Power Cal Menu.

This function overwrites the primary calibration, which is stored in EEPROM, and is Level 2 Password protected. The primary calibration store of a new instrument contains the factory generated power calibration data. Only broadband power calibration data can be transferred to the primary store. A window is displayed containing a summary of the current primary calibration and a summary of user calibration store 1.

Transfer

Overwrites the Primary calibration store with the user calibration data contained in a selected store.

This soft key is unselectable if the displayed store is narrowband.

Select
Store

Used to select a user store by entering the store identity number from the keyboard.

Rotary Control	×	Step Keys	×	Numeric Pad	√	Terminator	Any
----------------	---	-----------	---	-------------	---	------------	-----

Previous
Store

Selects the previous user calibration store.

Next
Store

Selects the next user calibration store.

Return to
Inst Cals

Returns control to the Instrument Cals Menu.

UTILITY

Service Instrument Select Power
Calibrations CalSelect Pwr Cal

See Fig. 3-82. This menu allows the user to select which power calibration is to be used in the instrument. A window is displayed containing a summary of the current calibration and indicates whether it is a primary or user calibration.

Primary
Calibration

Selects primary calibration

User
Calibration

Allows a user calibration to be selected by entering the identity number of the required store.

Rotary Control	×	Step Keys	×	Numeric Pad	√	Terminator	Any
----------------	---	-----------	---	-------------	---	------------	-----

Return to
Inst Cals

Returns control to the Instrument Cals Menu.

Tests

See Fig. 3-80. This menu enables the operator to verify that the display and keyboard are functioning correctly.

**Test
Keyboard**

Allows each key on the front panel to be tested individually, and allows the rotary control to be tested for clockwise and anti-clockwise rotation.

A form is displayed on the screen containing a representation of the front panel key layout. For each keypress or rotary control movement detected, the corresponding symbol on the front panel representation will be highlighted, and remains highlighted for the duration of the test. The *[Exit]* soft key terminates the test.

Note that this test should only be performed with the standard colour palette selected, since it relies on pressed keys changing colour on the display.

**Test
Display**

This function is Marconi password protected and is not available to the user.

**Return to
Service**

Returns control to the Service Menu.

UTILITY

Service

Det / Sensor
SpecsEdit Specs

See Fig. 3-80. This menu is used to edit the sensitivity and power factor values of the detector correction specifications for Marconi and user-defined detectors, and to edit the power sensor calibration data tables.

Edit Det
Corr Spec

Leads to the Edit Det Specs Menu, which enables editing of correction data for the user-defined detectors.
See page 3-69.

Edit MI Det
Corr Spec

This is a Marconi Password protected function and is not available to the user.

Edit Sensor
Cal Data

Leads to the Edit Spec Menu, which is used for editing the calibration data for the current sensor. This menu is the same as for the measurement setup for a scalar channel.
See page 3-70.

Return to
Service

Returns control to the Service Menu.

Diagnostics	<i>See Fig. 3-83.</i> The Diagnostics Menu provides diagnostics functions for the instrument's source, data acquisition system and frequency counter.
Source Diagnostics	Leads to the Src Diag Menu. <i>See below.</i>
Data Acq Diagnostics	Leads to the DAcq Diag Menu. <i>See page 3-323.</i>
Counter Diagnostics	Leads to the Counter Diag Menu. <i>See page 3-326.</i>
Save Cal Variance	Used to store the variance data of the reflection analyzer calibration currently being used by the instrument into a trace memory. The variance can then be viewed by displaying the memory. To save the data to a specific memory location, the memory identity number is entered in the input field. <i>This soft key will only be displayed if the 6210 Reflection Analyzer is connected.</i>
Dynamic Cal Diagnostics	Leads to the Dyn Cal Diag Menu, which provides diagnostic facilities for the Dynamic Calibrator. <i>See page 3-327.</i>
Detector Diagnostics	Leads to sub-menus which provide diagnostic functions for the EEPROM detectors. These are Marconi Password protected and are not described in the manual.
Return to Service	Returns control to the Service Menu.

Src Diag	<i>See Fig. 3-83.</i> This menu is used to perform diagnostics functions on the instrument's source, by permitting low level monitoring and control of various source parameters.
Band Select Word	Leads to the Band Select Menu. <i>See page 3-319.</i>
RF Path Switch	Leads to the RF Path Menu. <i>See page 3-320.</i>
Source Control	Leads to the Src Control Menu. <i>See page 3-321.</i>
Counter Functions	Leads to the Ctr Funcs Menu. <i>See page 3-322.</i>
Counter	Selects the 'Counter' setting of the SP2T switch on the microwave chassis; the switch then routes the COUNTER input signal to the sampling gate.

- YIG Lock** Selects the 'YIG lock' setting of the SP2T switch on the microwave chassis; the switch then routes the YIG signal to the sampling gate.
- More** Leads to the Src Diag More Menu.
See page 3-322.
- Exit Src Diagnostics** Returns control to the Diagnostics Menu, after prompting for confirmation.

UTILITY

Service Diagnostics Source Diagnostics Band Select Word

Band Select

See Fig. 3-83. This menu enables individual bits of the band select word to be set on or off.

The band select word comprises 14 digital lines which are used to control the MTS source. The meaning of each bit is shown on the form that is displayed (Fig. 3-77). An individual bit is selected using the [↑] and [↓] soft keys, and is toggled on or off using the [On / Off] soft key. (On instruments other than 6204B the 26.5 - 40 GHz bit is replaced with the word 'Reserved'.)

Band Select Word	
10 - 250 MHz	On
250 - 500 MHz	Off
0.5 - 1 GHz	On
1 - 2 GHz	Off
Sampler drive enable	On
2 - 8 GHz	Off
8 - 12.4 GHz	On
12.4 - 20 GHz	Off
20 - 26.5 GHz	On
26.5 - 40 GHz	Off
Lower 1/2 octave	On
Upper 1/2 octave	Off
Direct count	On
Count(on) YIG lock (off)	Off

Fig. 3-77 Band Select Word Form

- On / Off** Used to toggle the selected bit on or off.
- ↑** Selects the previous bit of the band select word.
- ↓** Selects the next bit of the band select word.
- Return to Src Diag** Returns control to the Src Diag Menu.

UTILITY

Service

Diagnostics

Source
DiagnosticsRF Path
Switch**RF Path**

See Fig. 3-83. This menu is used to control the setting of the SP4T (or SP5T) PIN switch on the microwave chassis and, for 6204B instruments, to switch the frequency doubler circuit in or out.

**Synth
Band**

Sets the PIN switch to the 'Synth Band' position.

2-8 GHz

Sets the PIN switch to the '2 - 8 GHz' position.
This soft key is not selectable on 6202B instruments.

8-12 GHz

Sets the PIN switch to the '8 - 12 GHz' position.
This soft key is not selectable on 6201B and 6202B instruments.

12-20 GHz

Sets the PIN switch to the '12 - 20 GHz' position.
This soft key is not selectable on 6201B and 6202B instruments.

20-26.5 GHz

Sets the PIN switch to the '20 - 26.5 GHz' position.
This soft key is not selectable on 6200B, 6201B and 6202B instruments.

Off

Sets the PIN switch to the 'Off' position.

Doubler

Toggles the frequency doubler on or off.
This soft key is only displayed on 6204B instruments.

**Return to
Src Diag**

Returns control to the Src Diag Menu.

UTILITY

Service Diagnostics Source Diagnostics Source Control

Src Control

See Fig. 3-83. This menu provides the following functions for controlling the source.

Changing the values of the level DAC, YIG tuning DAC and YIG FM gain.

Selection of the synthesizer loop bandwidth, which is the frequency of the synthesizer phase-locked loop. Low bandwidth reduces the spurious signal content of the RF output but slows down the response; high bandwidth has the opposite effect.

Enabling/disabling of the CW filter. The CW filter is used to reduce the YIG oscillator tuning bandwidth and lower the residual FM to the values specified in the Performance Data section of Chapter 1. However, this also slows down the response due to the longer settling time.

Level DAC

Enables the value of the Level DAC to be changed.

Rotary Control	✓	Step Keys	✓	Numeric Pad	✓	Terminator	Any
----------------	---	-----------	---	-------------	---	------------	-----

YIG Tuning DAC

Enables the value of the YIG tuning DAC to be changed.

Rotary Control	✓	Step Keys	✓	Numeric Pad	✓	Terminator	Any
----------------	---	-----------	---	-------------	---	------------	-----

YIG FM Gain

Enables the value of the YIG FM gain to be changed.

Rotary Control	✓	Step Keys	✓	Numeric Pad	✓	Terminator	Any
----------------	---	-----------	---	-------------	---	------------	-----

FM Zero

Temporarily sets the YIG FM gain to zero in order to centralise the currently selected YIG oscillator.

Synth Loop BW High

The loop bandwidth is always HIGH irrespective of the operating mode.

Synth Loop BW Low

The loop bandwidth is always LOW irrespective of the operating mode.

CW Filter

Toggles the CW filter on or off irrespective of the operating mode.

Return to Src Diag

Returns control to the Src Diag Menu.

UTILITY

Service **Diagnostics** **Source** **Counter**
Diagnostics **Diagnostics** **Functions**

Ctr Funcs *See Fig. 3-83.* This menu is used to perform diagnostic functions on the instrument's counter.

Set UHF Freq Used to set the counter UHF frequency within the range 1 - 2 GHz.

Rotary Control ✓ Step Keys ✓ Numeric Pad ✓ Terminator 10+

Set Gate Time Enables the counter gate time to be changed.

Rotary Control ✓ Step Keys ✓ Numeric Pad ✓ Terminator 10-

Measure Initiates a measurement of the counter IF for the specified gate time.

Direct Count Sets the counter mode to 'direct count'.

Harmonic Count Sets the counter mode to 'harmonic count'

Return to Src Diag Returns control to the Src Diag Menu.

UTILITY

Service **Diagnostics** **Source** **More**
Diagnostics **Diagnostics** **Diagnosics**

Src Diag More *See Fig. 3-83.* This menu is used to toggle individual pads of the step attenuator on or off, if this option is fitted, and to change the values of the standard tuning DACs.

Pad 1 (20 dB) Used to toggle Pad 1 of the step attenuator on or off.

Pad 2 (10 dB) Used to toggle Pad 2 of the step attenuator on or off.

Pad 3 (20 dB) Used to toggle Pad 3 of the step attenuator on or off.

Pad 4 (20 dB) Used to toggle Pad 4 of the step attenuator on or off.

Std Tuning (Coarse) Enables the value of the standard tuning DAC (coarse) to be changed.

Rotary Control ✓ Step Keys ✓ Numeric Pad ✓ Terminator Any

Std Tuning (Fine) Enables the value of the standard tuning DAC (fine) to be changed.

Rotary Control ✓ Step Keys ✓ Numeric Pad ✓ Terminator Any

UTILITY

Service

Diagnostics

**Data Acq
Diagnostics**

**Set Up
Input**

Set Up Input

See Fig. 3-83. This menu is used to define the input that will be used during data acquisition system diagnostics.

**Select ADC
Input**

Used to select any ADC multiplexer channel, i.e. the input to the ADC. A form is displayed containing the input types together with their identity numbers, and the currently selected input identity in an input field.

Rotary Control X Step Keys X Numeric Pad Terminator Any

**All
Detectors**

Configures all four inputs A, B, C and D to accept scalar detectors.

**ABC Detector
D Pwr Sensor**

Configures inputs A, B and C to accept scalar detectors and input D to accept a power meter sensor.

**Auxiliary
Input**

Enables the signal present at the front panel AUX INPUT connector to be used by the data acquisition diagnostics.

**1st Stage
Amp Cal DAC**

Enables the signal present at the 1st Stage Amp Cal DAC to be used by the data acquisition diagnostics.
This soft key will only be selectable if the currently selected input is in the range 1 to 4 or 6.

**2nd Stage
Amp Cal DAC**

Enables the signal present at the 2nd Stage Amp Cal DAC to be used by the data acquisition diagnostics.
This soft key will only be selectable if the currently selected input is in the range 1 to 4 or 6.

**Reflect DACq
Diagnostics**

Leads to the Reflect DACq Menu.
This soft key will only be displayed if the 6210 Reflection Analyzer is connected, and will only be selectable if the [Auxiliary Input] soft key has been selected.

**Return to
DACq Diag**

Returns control to the DACq Diag Menu.

[PRESET] KEY

The [PRESET] key provides a menu which enables the instrument to be set to a known condition.

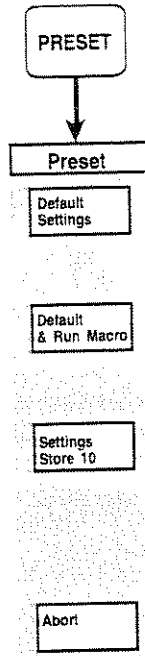

C1138

Fig. 3-85 PRESET Menu

PRESET

Preset

Default Settings

Returns the instrument to its default set-up conditions. A complete listing of the default conditions is provided in Appendix A.

Default & Run Macro

Presets the instrument to its default state (as above), but additionally it will then run a macro named "preset" (the name can be either upper or lower case).
This soft key will be unselectable if the macro is not present, either internally or on a memory card.

Settings Store 10

Sets the instrument to the conditions defined by the contents of settings store 10.
This soft key will be unselectable if setting stores 10 does not contain valid data.

Abort

Aborts the preset operation.

[HOLD] KEY

The [HOLD] key does not have an associated menu structure. It is used to hold (freeze) the display of the active measurement. This is useful, for example, if the display is to be photographed. If HOLD is enabled for a swept measurement, changes to trace parameters (such as format, scaling, etc.) will cause the displayed trace to be refreshed from stored data.

Pressing the [HOLD] key again restores normal operation. Hold will also be disabled under the following circumstances:

Swept measurements: channel mode or channel domain changed.
Readout: channel mode or measurement definition changed.

A held measurement is indicated on the display by setting the 'H' flag in the readout or trace information area.

[LOCAL] KEY

The [LOCAL] key does not have an associated menu structure. It is used to return the instrument to local (front panel) operation after being put into the remote (GPIB controlled) state by a GPIB controller. This is the only front panel key that is not disabled when the instrument is remotely controlled over the GPIB. The exception to this is when local lockout is in effect; this is a remote command that disables the [LOCAL] key making it difficult to interfere with the MTS while it is under remote control.

This key is also used to access the Edit Macro Menu when in the macro recording mode (see page 3-265).

SYSTEM

UTILITY

Service

Diagnostics

**Dynamic Cal
Diagnostics**

Fig. 3-84 UTILITY Menus (Sheet 7)

SYSTEM

UTILITY

Service

Diagnostics

Fig. 3-83 UTILITY Menus (Sheet 6)

SYSTEM

UTILITY

**Instrument
Calibrations**

Fig. 3-82 UTILITY Menus (Sheet 5)

SYSTEM

UTILITY

Service

Set-up

Fig. 3-81 UTILITY Menus (Sheet 4)

SYSTEM

UTILITY

Service

Fig. 3-80 UTILITY Menus (Sheet 3)

SYSTEM

UTILITY

Store
Operations

Fig. 3-79 UTILITY Menus (Sheet 2)

SYSTEM

UTILITY

Fig. 3-78 UTILITY Menu (Sheet 1)



Selects the previous entry in the directory or file list. The list automatically scrolls, if necessary, when the highlight reaches the top of the list.



Selects the next entry in the directory or file list. The list automatically scrolls, if necessary, when the highlight reaches the bottom of the list.

File Information

Provides information on the currently highlighted file, as follows:

File name
File size
Creation date/time
File attributes (Read Only, Archive, Hidden, System)
Type of file (trace memory, settings etc.)
Memory title (only present for trace memory files)

Create Directory

Creates a sub-directory below the currently highlighted directory within the directory section. Text entry for the directory name is the same as that described for the Screen Title Menu (page 3-290). The MS-DOS filename convention is used for directory names.

Delete Directory or Delete File

This soft key is labelled [*Delete Directory*] when in the directory section, and is used to delete the currently highlighted directory, after asking for confirmation. Only empty directories can be deleted. This soft key changes to [*Delete File*] when in the file section, and is used to delete the currently highlighted file, after asking for confirmation.

Return to Service

Returns control to the Service Menu.

UTILITY

Applications

Applications

See Fig. 3-78. This menu enables the user to load and run an applications program which is stored on a memory card. The applications software adds new features to the MTS to fulfil a particular requirement (unlike a macro which only controls the existing features of the instrument). When the menu is first entered, a form is displayed showing the applications available on the card, and the current application if one has already been loaded.

Run Application

When this soft key is pressed, the user is given the choice of running the current application (if any), or running another one by entering the application number from the keyboard.

Install Application

Copies the application on the memory card into MTS non-volatile memory.

Remove Application

Removes an application from MTS memory. The identity number of the required application is entered from the keyboard.

Auto Run

Toggles the auto run feature on and off. When the instrument powers up, and auto run was previously enabled, any application on the card which has been designated as auto run will be automatically run.

Marks as Auto Run

Designates an application in memory as auto run, by entering the application number from the keyboard.

Clear Data Store

Clears applications specific non-volatile settings data stores. This function is confirmation protected.

Return to Utility

Returns control to the Utility Menu.

UTILITY

Service Floppy Disk
FunctionsDisk Funcs

See Fig. 3-80. This menu enables the directory structure of floppy disks to be examined, creation/deletion of directories, file deletion and display of file information. The MTS utilises 1.44 MB double-sided high density floppy disks. (To format a disk it is necessary to press [UTILITY] [Service] [Set-up] [Format Disk].)

A form is displayed on the screen in which the directory structure of the floppy disk is presented. Directory information is placed on the left hand side starting from the root directory; sub-directories are indented according to their level within the directory structure. Files contained within a selected directory are listed on the right hand side of the form together with their sizes. Directories and files are not listed alphabetically, but appear in the order in which they are read from the disk.

A directory is selected by highlighting it using the [↑] and [↓] soft keys or the front panel increment/decrement keys. As the highlight is moved within the directory section the file section displays the files contained within that directory. When the correct directory is found, the [File Selection] soft key is pressed which moves the highlight into the file section of the form. The required file is selected by highlighting it, using the same method as for directory selection.

Store Type Identification

The MS-DOS filenames convention is used, which allows up to 8 characters for the filename with an optional filename extension of up to 3 characters. Only MS-DOS legal characters are allowed. (The same naming convention also applies to directory names.)

For file or directory names the following characters are allowed:

A-Z a-z 0-9 - # ' ! % ` \$ _ ~ { } @ () & = ^

For volume names the following characters are allowed:

A-Z a-z 0-9 - # ' ! % ` \$ _ ~ { } @

Store types are identified by the filename extension as follows:

Store type	Filename extension
Instrument settings	.SET
Trace memory	.TRC or .CSV
User source power calibration	.USP
Power meter sensor calibration	.PMS
Reflection analyzer calibration	.RCS
Reflection analyzer cal kit	.RCK
Macros	.MAC or .TXT

The .CSV extension is used when a trace memory is saved in Comma Separated Values Format so that the trace memory can be imported into a spreadsheet program.

The .TXT extension is used when a macro is saved in ASCII format

File
Selection
or
Directory
Selection

This soft key is used to switch between the Directory section and the Files section of the form. When in the Directory section the soft key is labelled [File Selection]; when in the Files section it is labelled [Directory Selection].

UTILITY

Service

Diagnostics

Dynamic Cal
Diagnostics

Rep Ver Step

Rep Ver Step

See Fig. 3-84. This menu sets the state of the second attenuation stage of the dynamic calibrator.

Through

Sets the second stage attenuation to a through line.

**Repeatable
Step**

Switches in the 3 dB repeatable step.

**Verification
Step**

Switches in the 10 dB verification step.

**Return to
Dyn Cal Diag**

Returns control to the Dyn Cal Diag Menu.

UTILITY

Service

Diagnostics

Dynamic Cal
Diagnostics**Dyn Cal Diag**

See Fig. 3-84. This menu provides facilities for testing the dynamic calibrator.

When the menu is exited the dynamic calibrator will return to its normal operating state (0 dBm output power).

Service Mode

This soft key toggles the dynamic calibrator service mode on and off. Except during detector linearity calibration, the dynamic calibrator output is set at 0 dBm; when service mode is enabled, power levels up to 28 dBm can be output. The following soft keys are unselectable until service mode is turned on,

Rep Ver Step

Leads to the Rep Ver Step Menu.
See page 3-328.

6 dB Pad

Toggles the 6 dB attenuation of the dynamic calibrator between two states: through line and 6 dB pad switched in.

Set DAC

Enables the value of the dynamic calibrator output level control DAC to be changed, by entering a decimal number.

Set to 0 dBm

Sets the output power level of the calibrator to 0 dBm.

Set to 20 dBm

Sets the output power level of the calibrator to 20 dBm (the maximum permissible input power of the 6230A).

Set to 26 dBm

Sets the output power level of the calibrator to 26 dBm (the maximum permissible input power of the 6230L).

Return to Diagnostics

Returns control to the Diagnostics Menu.

UTILITY

Service

Diagnostics

**Data Acq
Diagnostics**

**Set
DACs**

Set DACs

See Fig. 3-83. This menu is used to change the values of the offset DAC and Cal DAC.

**Set
Offset DAC**

Enables the 12-bit offset DAC value to be changed, by entering a decimal number. *This soft key will only be selectable if the currently selected input is in the range 1 to 4. It will be unselectable if the [Auxiliary Input] soft key of the Set Up Input Menu has been selected.*

Rotary Control	√	Step Keys	√	Numeric Pad	√	Terminator	Any
----------------	---	-----------	---	-------------	---	------------	-----

**Set
Cal DAC**

Enables the 16-bit Cal DAC value to be changed, by entering a decimal number. *This soft key will only be selectable if the currently selected input is in the range 1 to 4 and the calibration mode has been selected, or the currently selected input is input 6 (calibration).*

Rotary Control	√	Step Keys	√	Numeric Pad	√	Terminator	Any
----------------	---	-----------	---	-------------	---	------------	-----

**Return to
DAcq Diag**

Returns control to the DAcq Diag Menu.

UTILITY

Service

Diagnostics

**Counter
Diagnostics**

Counter Diag

See Fig. 3-83. This menu is used to perform diagnostics functions on the instrument's counter, by allowing the user to set the counter gate time and to trigger a counter measurement.

Measure

Initiates a counter measurement. The measurement will be displayed in a window together with the intermediate values used to compute it, i.e. IF frequency, LO frequency and harmonic number.

**Set
Gate Time**

Enables the counter gate time to be changed.

Rotary Control	√	Step Keys	√	Numeric Pad	√	Terminator	10-
----------------	---	-----------	---	-------------	---	------------	-----

**Return to
Diagnostics**

Returns control to the Diagnostics Menu.

UTILITY

Service

Diagnostics

Data Acq
Diagnostics

Set Up
Input

Reflect DACq
Diagnostics

Reflect DACq

See Fig. 3-83. This menu provides several diagnostic functions for the reflection analyzer data acquisition system.

View Reflect ADC Inputs

When this soft key is pressed, a form is displayed containing a list of the reflection analyzer ADC inputs together with their current values, as shown below.

View Reflection Analyzer ADC Inputs	
Ambient Temperature	:1.000 V (28.56C)°C
Integrated Coupler Temperature	:1.000 V (28.56C)°C
Single Coupler Temperature	:1.000 V (28.56C)°C
Internal Air Temperature	:1.000 V (28.56C)°C
Temp Control DAC	:1.000 V
PSU Thermistor	:1.000 V
+5V Ref	:1.000 V
0V Ref	:1.000 V

Set ATG State

In order to calibrate the measurement system for a reflection analyzer measurement, the MTS automatically applies 10 different terminations generated by an arbitrary termination generator (ATG). This soft key can be used to set the ATG state by numeric entry as follows:

Rotary Control × Step Keys × Numeric Pad √ Terminator Any

Temperature Control

Used to toggle the reflection analyzer's temperature control on or off.

Set Temp Control DAC

Enables the reflection analyzer temperature control DAC value to be changed by entering a decimal number.

Rotary Control × Step Keys × Numeric Pad √ Terminator Any

Set Refl Offset DAC

Enables the reflection analyzer offset DAC value to be changed by entering a decimal number.
This soft key will only be selectable if the currently selected input is in the range 1 to 4.

Rotary Control √ Step Keys √ Numeric Pad √ Terminator Any

High Resolution

Used to toggle the under-range threshold level between its low resolution value (0.5 V) and its high resolution value (0.9 V).

Linearity Correction

Toggles linearity correction for the currently selected ADC Input on and off.
This soft key will only be selectable if the currently selected input is in the range 1 to 4.

Return to Set Up Input

Returns control to the Set Up Input Menu.