

2022

**10kHz-1000MHz
AM/FM SIGNAL GENERATOR**

Operating Manual



10 kHz - 1000 MHz

AM/FM SIGNAL GENERATOR

2022

Code No. 52022-900C

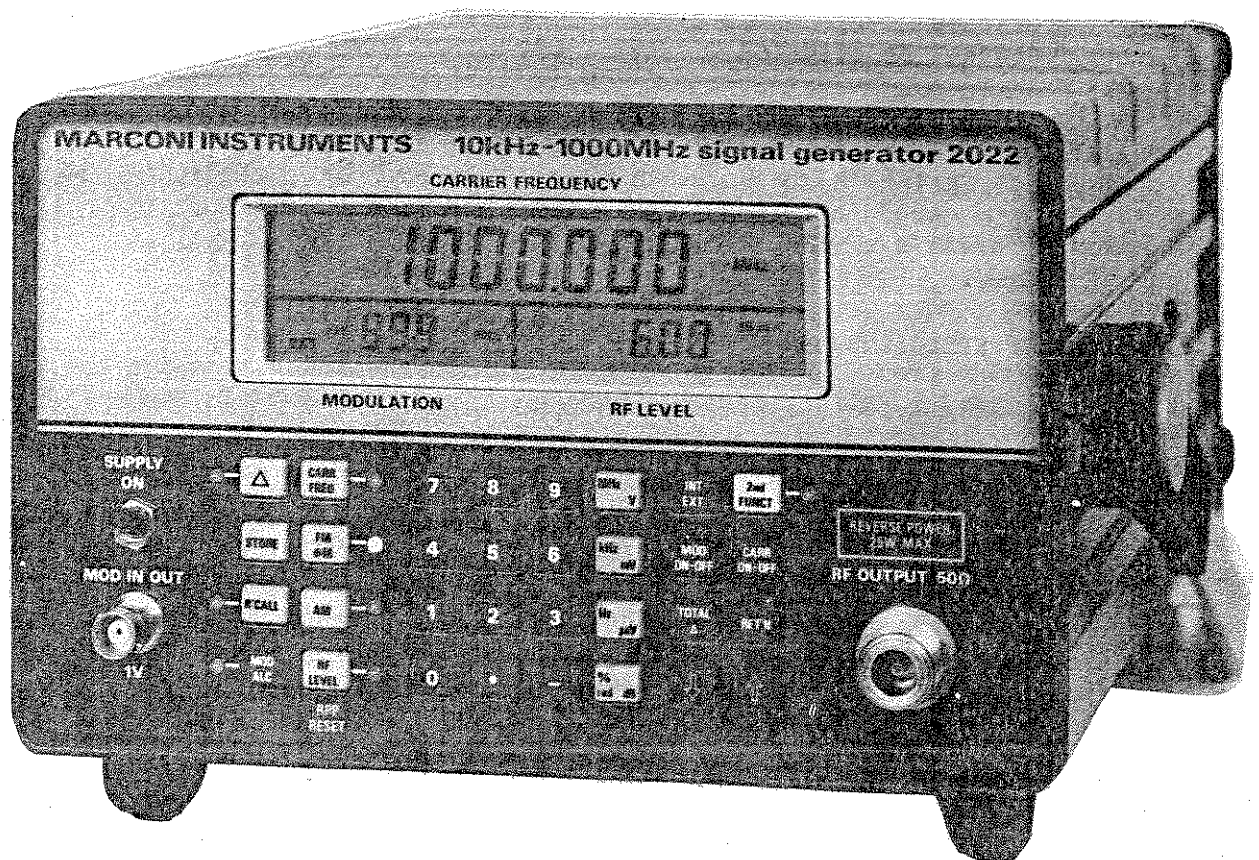

© Marconi Instruments Ltd. 1984
Printed in the UK

Part No. 46881-514E
Print code: D-7/85,MI10c



CONTENTS

PRELIMINARIES

Title page
Contents
Notes and Cautions

CHAPTERS

1 General information
2 Installation
3 Operation
4 Technical description
5 Maintenance
6 Replaceable parts
7 Servicing diagrams
8 Modifications and supplements

} These chapters are contained in a separate volume available as an optional extra.

HAZARD WARNING SYMBOLS

The following symbols appear on the equipment.

Symbol	Type of hazard	Reference in manual
△	Static sensitive device	Page (iv)

Note ...

Each page bears the date of the original issue or the code number and date of the latest amendment (Am. 1, Am. 2 etc.). New or amended material of technical importance introduced by the latest amendment is indicated by triangles positioned thus ▶.....◀ to show the extent of the change. When a chapter is reissued the triangles do not appear.

Any changes subsequent to the latest amendment state of the manual are included on inserted sheets coded C1, C2 etc.

NOTES AND CAUTIONS

ELECTRICAL SAFETY PRECAUTIONS

This equipment is protected in accordance with IEC Safety Class 1. It has been designed and tested according to IEC Publication 348, 'Safety Requirements for Electronic Measuring Apparatus', and has been supplied in a safe condition. The following precautions must be observed by the user to ensure safe operation and to retain the equipment in a safe condition.

Defects and abnormal stresses

Whenever it is likely that protection has been impaired, for example as a result of damage caused by severe conditions of transport or storage, the equipment shall be made inoperative and be secured against any unintended operation.

Removal of covers

Removal of the covers is likely to expose live parts although reasonable precautions have been taken in the design of the equipment to shield such parts. The equipment shall be disconnected from the supply before carrying out any adjustment, replacement, or maintenance and repair during which the equipment shall be opened. If any adjustment, maintenance or repair under voltage is inevitable it shall only be carried out by a skilled person who is aware of the hazard involved.

Note that capacitors inside the equipment may still be charged when the equipment has been disconnected from the supply. Before carrying out any work inside the equipment, capacitors connected to high voltage points should be discharged; to discharge mains filter capacitors, if fitted, short together the L (live) and N (neutral) pins of the mains plug.

Mains plug

The mains plug shall only be inserted in a socket outlet provided with a protective earth contact. The protective action shall not be negated by the use of an extension lead without protective conductor. Any interruption of the protective conductor inside or outside the equipment is likely to make the equipment dangerous.

Fuses

Note that there is a supply fuse in both the live and neutral wires of the supply lead. If only one of these fuses should rupture, certain parts of the equipment could remain at supply potential.

To provide protection against breakdown of the supply lead, its connectors, and filter where fitted, an external supply fuse (e.g. fitted in the connecting plug) should be used in the live lead. The fuse should have a continuous rating not exceeding 6 A.

Make sure that only fuses with the required rated current and of the specified type are used for replacement. The use of mended fuses and the short-circuiting of fuse holders shall be avoided.

RADIO FREQUENCY INTERFERENCE

This equipment conforms with the requirements of IEC Directive 76/889 as to limits of r.f. interference.

CAUTION : STATIC SENSITIVE COMPONENTS

Components identified with the symbol \triangle on the circuit diagrams and/or parts lists are static sensitive devices. The presence of such devices is also indicated in the equipment by orange discs, flags or labels bearing the same symbol. Certain handling precautions must be observed to prevent these components being permanently damaged by static charges or fast surges.

- (1) If a printed board containing static sensitive components (as indicated by a warning disc or flag) is removed, it must be temporarily stored in a conductive plastic bag.
- (2) If a static sensitive component is to be removed or replaced the following anti-static equipment must be used.

A work bench with an earthed conductive surface.

Metallic tools earthed either permanently or by repeated discharges.

A low-voltage earthed soldering iron.

An earthed wrist strap and a conductive earthed seat cover for the operator, whose outer clothing must not be of man-made fibre.

- (3) As a general precaution, avoid touching the leads of a static sensitive component. When handling a new one, leave it in its conducting mount until it is required for use.
- (4) If using a freezer aerosol in fault finding, take care not to spray programmable ICs as this may affect their contents.

CAUTION : LCD HANDLING

When operating or servicing this equipment take care not to depress the front or rear faces of the display module otherwise damage to the display elements may occur.

WARNING : HANDLING HAZARDS

This equipment is formed from metal pressings and although every endeavour has been made to remove sharp points and edges care should be taken, particularly when servicing the equipment, to avoid minor cuts.

WARNING : TOXIC HAZARD

Many of the electronic components used in this equipment employ resins and other chemicals which give off toxic fumes on incineration. Appropriate precautions should therefore be taken in the disposal of these items.

Chapter 1

GENERAL INFORMATION

CONTENTS

Para.	
1	Features
3	Output
4	Modulation
5	Front panel
6	Second function mode of operation
7	Performance data
7	Carrier frequency
8	RF output
9	Spurious signals
10	Frequency modulation
11	Phase modulation
12	Amplitude modulation
13	Modulation oscillator
14	Frequency standard
15	Auxiliary inputs and outputs
16	Keyboard and displays
17	GPIB interface
18	Environmental
19	Safety
20	Radio frequency interference
21	Power requirements
22	Weight and dimensions
23	Accessories
23	Supplied accessories
24	Optional accessories

FEATURES

1. 2022 is a light-weight easily portable synthesized signal generator. It has a frequency range of 10 kHz to 1000 MHz and provides comprehensive amplitude, frequency and phase modulation facilities. The instrument is designed to cover a wide range of applications in both production and repair of radio equipments. Output frequency is phase locked to an internal or external frequency standard and frequencies up to 100 MHz can be set to a resolution of 10 Hz, and above that to a resolution of 100 Hz.

2. Front panel operation is carried out by direct entry of required settings via the keyboard. Microprocessor control ensures flexibility, simplicity of use and allows programming by the General Purpose Interface Bus (GPIB).*

GPIB - Marconi Instruments General Purpose Interface Bus in accordance with IEEE Standard 488 - 1978 and IEC Publication 625-1.

This facility is offered as an optional accessory enabling the instrument to be used both as a manually operated bench mounted instrument or as part of a fully automated test system.

Output

3. Calibrated output levels from -127 dBm to +6 dBm are provided. A choice of ten output level unit combinations can be obtained on the front panel. The r.f. output level can be set to a resolution of 0.1 dB over the entire output voltage range and features a total cumulative accuracy of better than ± 2 dB. Protection against the accidental application of up to 25 W of reverse power is provided by a fast responding relay trip.

Modulation

4. Amplitude, frequency and phase modulation can be provided internally or externally. AM depth can be set in 0.5% steps up to 99.5% at carrier frequencies up to 400 MHz. FM is available at all carrier frequencies and provides deviations up to 99.9 kHz. Phase modulation is also available with a range of up to 9.99 radians.

Front panel

5. All data and units selected are visible on a single liquid crystal display. Data is entered on a keyboard that has been designed to be simple and logical to use. Carrier frequency, modulation and r.f. level functions may be incremented or decremented using the \uparrow (UP) and \downarrow (DOWN) keys. Non-volatile store and recall facilities are also provided using an electrically alterable read only memory that does not require a battery back-up system. Available accessories include a front panel cover for protecting the instrument in transit.

Second function mode of operation

6. This includes the means of setting the GPIB address, selection of alternative r.f. level calibration units, access to various calibration routines and a facility to aid diagnostic fault finding via the internal instrument bus.

PERFORMANCE DATA

Carrier frequency

Characteristic	Performance
7. Range:	10 kHz to 1000 MHz.
Displayed resolution:	10 Hz up to 100 MHz. 100 Hz above 100 MHz.

Characteristic

Performance

Selection:	By keyboard entry.
Accuracy:	Equal to the frequency standard accuracy - see under Frequency standard.
Display:	7 digit l.c.d. - see under Keyboard and displays.

RF output

8. Output level range:	-127 dBm to +6 dBm. (0.2 μ V to 892 mV e.m.f.) except when a.m. is selected. (When a.m. is selected the maximum output power reduces linearly with a.m. depth to 0 dBm (447 mV e.m.f.) at maximum depth).
Selection:	By keyboard entry - units may be μ V, mV, V e.m.f. or p.d. Or dB relative to 1 μ V, 1 mV, e.m.f. or p.d. Or dBm. Conversion between dB and voltage units may be achieved by pressing the appropriate unit key (dB or V, mV, μ V).
Output impedance:	50 Ω , Type N female socket to MIL 39012/3D.
VSWR:	<1.5:1 for output levels below -10 dBm
Reverse power protection:	An electronic trip protects the generator output against reverse power of up to 25 watts from d.c. to 1 GHz. For safety the output socket is automatically disconnected from the attenuator when the a.c. power is off. The trip may be reset from the front panel (or via the GPIB).
Output level accuracy:	± 1 dB from 10 kHz to 1000 MHz and levels above -10 dBm. ± 2 dB from 10 kHz to 1000 MHz and levels below -10 dBm.
Displayed resolution:	0.1 dB or better.
Display:	4 digit l.c.d. - see under Keyboard and displays.

Spurious signals

9. Harmonically related signals for output levels below 0 dBm:	Better than -25 dBc for any carrier frequency.
--	--

Characteristic	Performance
Sub-harmonics for output levels below 0 dBm.	None for carrier frequencies below 500 MHz. -20 dBc for carrier frequencies above 500 MHz.
Non-harmonically related signals for output levels below 0 dBm:	<-70 dBc for carrier frequencies of 62.5 MHz and above. For carrier frequencies below 62.5 MHz the spurious signals in the band up to 150 MHz, are better than -55 dBc while the spurious signals in the band above 150 MHz are better than -40 dBc.
Residual f.m.: (f.m. off)	<20 Hz equivalent peak deviation in a 300 Hz-3 kHz bandwidth at 499 MHz and improving by approximately 6 dB/octave with reducing carrier frequency down to 62.5 MHz. <10 Hz below 62.5MHz.
RF leakage:	<0.5 μ V p.d. generated in a 50 Ω load by a 2 turn 25 mm loop, 25 mm or more from the case of the generator with the output level set to less than -10 dBm and the output terminated in a 50 Ω sealed load.

Frequency modulation

10. Range:	Peak deviation from 0 Hz to 99.9 kHz at all carrier frequencies.
Displayed resolution:	10 Hz for deviations up to 9.99 kHz 100 Hz for deviations from 10 kHz to 99.9 kHz.
Selection:	By keyboard entry. Internal 1 kHz modulation or external modulation input may be selected.
Deviation accuracy:	\pm 5% of deviation at 1 kHz modulating frequency excluding residual f.m.
Frequency response:	\pm 1 dB from 50 Hz to 25 kHz relative to 1 kHz, using external modulation. With a.l.c. off the low frequency response is extended to 10Hz with a peak deviation value limited to the lower of 99.9kHz or $[0.047 \times \text{Modulation Freq. (in Hz)} \times \{\text{Carrier Freq. (in MHz)} + 160 \text{ (if Carrier Freq. is below 62.5MHz)}\}]$ kHz. With a.l.c. off, can also be used for 10Hz square wave switching with a peak deviation value limited to the lower of 99.9kHz or 0.6 times the value obtained by the formula above.

Characteristic

Performance

Distortion:

<5% total harmonic distortion at 1 kHz modulating frequency and maximum deviation for any carrier frequency above 250 kHz.

External modulation accuracy:

With modulation a.l.c. on the deviation is calibrated for input levels between 0.9 V and 1.1 V r.m.s. A HI or LO message is indicated in the modulation display if the level is outside the range of the a.l.c. With modulation a.l.c. off the deviation is calibrated for an input level of 1 V p.d.

Input impedance is 100 k Ω nominal.

Display:

3 digit l.c.d. - see under Keyboard and display.

Phase modulation

11. Range:

Peak deviation from 0 to 9.99 radians.

Displayed resolution:

0.01 radians.

Selection:

By keyboard entry. Internal 1 kHz modulation or external modulation may be selected.

Deviation accuracy:

\pm 5% of deviation at 1 kHz modulating frequency excluding residual phase modulation.

Frequency response:

\pm 1 dB from 10 Hz to 10 kHz relative to 1 kHz using external modulation input and a.l.c. off.

\pm 1 dB from 50 Hz to 10 kHz relative to 1 kHz using external modulation input and a.l.c. on.

Distortion:

<5% total harmonic distortion at 1 kHz modulating frequency and maximum deviation at any carrier frequency above 250 kHz.

External modulation accuracy:

With modulation a.l.c. on the deviation is calibrated for input levels between 0.9 and 1.1 V r.m.s. A HI or LO message is indicated in the modulation display if the level is outside the range of the a.l.c. With modulation a.l.c. off the deviation is calibrated for an input level of 1 V p.d.

Input impedance is 100 k Ω nominal.

Characteristic

Performance

Amplitude modulation

12. Range:	0 to 99.5%.
Resolution:	0.5%.
Selection:	By keyboard entry. Internal 1 kHz modulation or external modulation may be selected.
Accuracy:	Better than $\pm(4\%$ of depth setting +1%) for 1 kHz modulating frequency and depths up to 95% for carrier frequencies up to 62.5 MHz. Better than $\pm(4\%$ of depth setting +1%) for 1 kHz modulating frequency and depths up to 80% for carrier frequencies up to 400 MHz.
Frequency response:	± 1 dB from 50 Hz to 15 kHz relative to 1 kHz at 80% depth using external modulation input and a.l.c. on. DC coupled with a.l.c. off.
Envelope distortion:	<5% total harmonic distortion at 1 kHz modulating frequency for depths of: 0-95% for carrier frequencies up to 62.5 MHz. 0-80% for carrier frequencies up to 400 MHz.
External modulation:	With the modulation a.l.c. on the modulation depth is calibrated for input levels between 0.9 and 1.1 V r.m.s. A HI or LO message is indicated in the modulation display if the level is outside the range of the a.l.c. With the modulation a.l.c. off the modulation depth is calibrated for an input level of 1.0 V. Input impedance is nominally 100 k Ω d.c. coupled.
Display:	3 digit l.c.d. - see under Keyboard and display.

Modulation oscillator

13. Frequency:	1 kHz, accuracy as frequency standard.
Distortion:	<1% total harmonic distortion.

Characteristic

Performance

Frequency standard

14. Internal standard:	High stability, oven controlled 10 MHz crystal oscillator.
Selection:	By internal link setting.
Temperature stability:	Better than ± 2 in 10^7 over the temperature range 0 to 40°C.
Age rate:	<0.1 p.p.m. per month of continuous use after one month's continuous use at constant ambient temperature.
Warm up time:	Within 0.5 p.p.m. of final frequency after 5 minutes from switch on at ambient 20°C.

Auxiliary inputs and outputs

15. Modulation input/output:	A front panel BNC socket provides an output from the modulation oscillator when internal modulation is selected and becomes the external modulation input when external modulation is selected.
Internal modulation oscillator output:	1 V $\pm 10\%$ e.m.f. from a nominal 600 Ω source impedance.
Internal modulation oscillator frequency:	1 kHz. Accuracy as internal frequency standard.
Internal modulation oscillator distortion:	Less than 1% total harmonic distortion.
External modulation input:	Input level nominally 1 V into 100 k Ω see under Frequency modulation and Amplitude modulation.
External frequency standard input:	A rear panel BNC socket accepts a 10 MHz signal of at least 1 V r.m.s. into a 100 Ω nominal impedance. A 5 MHz or 1 MHz signal can be accepted by changing an internal link.
Alternative outputs:	Blanked holes are provided so that the user can fit the r.f. output and modulation input/output socket to the rear panel for system use etc.

Characteristic

Performance

Keyboard and displays

16. Main and secondary keyboard functions:

These are described in Chap. 3, Operation. All instrument settings are controlled by the front panel keyboard.

Display:

Liquid crystal display provides simultaneous readout of carrier frequency, modulation and r.f. level.

- (i) Carrier frequency display - 7 digit with annunciators to show frequency units, external frequency standard, GPIB service requests, remote operation selection and instrument addressed.
- (ii) Modulation display - 3 digit with annunciators to show modulation units, a.m., f.m., ϕ .m., modulation off and external modulation selected.
- (iii) RF level display - 4 digit with annunciators to show r.f. level units, r.f. output off, reverse power trip operated.

GPIB interface

17.

A GPIB interface is available as an optional accessory and can be easily fitted by the user. All functions except the SUPPLY ON switch are remotely programmable.

Capabilities:

Complies with the following subsets as defined in IEEE 488 - 1978 and IEC Publication 625-1: SH1, AH1, T6, TE0, L4, LEO, SR1, RL1, PPO, DC1, DTO, CO, EI.

Environmental

18. Conditions of storage and transport

Temperature:

-40⁰C to +70⁰C.

Humidity:

Up to 90% relative humidity.

Altitude:

Up to 2500 m (pressurized freight at 27 kPa differential i.e. 3.9 lbf/in²).

Characteristic

Performance

Rated range of use
Temperature:
(Over which the full specification is met).

0 to 55°C.

Safety

19. Complies with Publication IEC 348.

Radio frequency interference

20. Conforms to the requirements of EEC Directive 76/889 as to limits of r.f. interference.

Power requirements

21. Voltage: AC supply. Voltage ranges (switchable)
 105 V - 120 V } ±10%
 210 V - 240 V }
 Frequency: 45 Hz - 440 Hz.
 Consumption: 50 VA max.

Weight and dimensions (Not including handle forward projection)

22. Height: 152 mm (6 in)
 Width: 256 mm (10 in)
 Depth: 367 mm (14.5 in)
 Weight: 7.5 kg (16.5 lb)

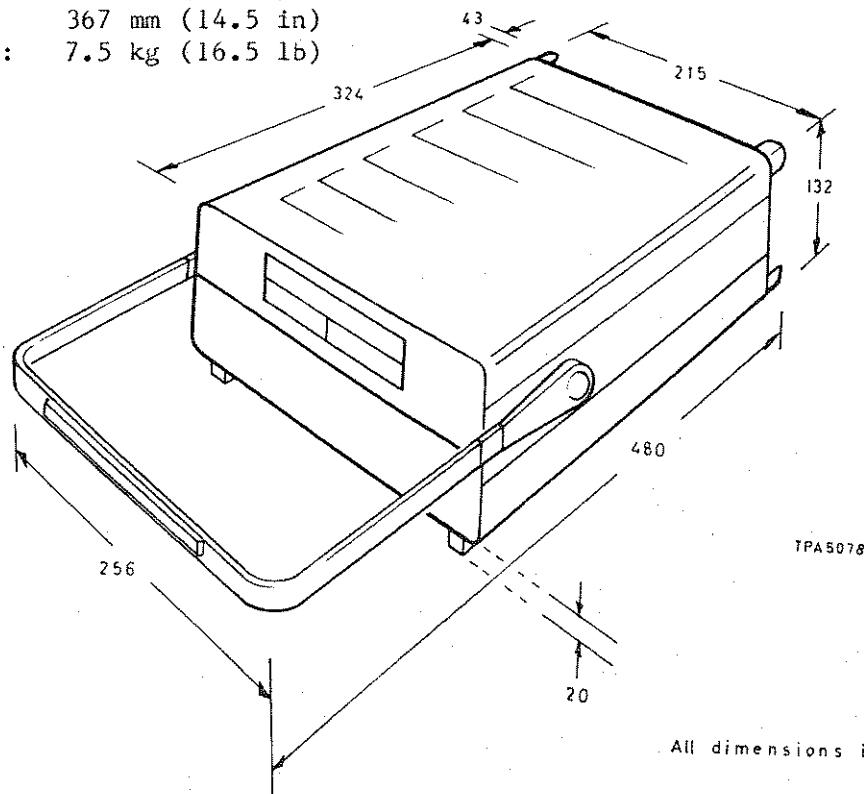

ACCESSORIESSupplied accessories

23. AC supply lead
 Operating Manual H 52022-900C (Vol. 1)
 Front panel blanking kit

Code no.
 43129-003W
 46881-514E
 46883-654E

Optional accessories

24. Service Manual H 52022-900C (Vol. 2)
 GPIB module
 Front panel protective cover
 Rack mounting kit single
 Rack mounting kit double
 GPIB Manual H 54811-010P (Contains details of general
 GPIB protocols)
 GPIB lead assembly
 GPIB IEEE/IEC connector adapter
 RF coaxial cable (N to N type)
 Impedance adapter 50/75 Ω

46881-515U
 54433-003N
 54124-023J
 46883-717K
 46883-716B

 46881-365R
 43129-189U
 46883-408K
 54311-095C
 54411-051X

Chapter 2

INSTALLATION

CONTENTS

Para.

- 1 Unpacking and repacking
- 3 Mounting arrangements
- 4 Connecting to supply
- 6 Safety testing
- 7 GPIB interface
- 8 Rack mounting

Fig.

									Page
1	Voltage ranges	3
2	Single unit rack mounting	4
3	Twinned unit rack mounting	4

UNPACKING AND REPACKING

1. Retain the container, packing material and the packing instruction note (if included) in case it is necessary to reship the instrument.

2. If the instrument is to be returned for servicing attach a label indicating the service required, type or model number (on rear label), serial number and your return address. Pack the instrument in accordance with the general instructions below or with the more detailed information in the packing instruction note.

(1) Place supply lead in a suitable plastic bag and tape it to the instrument's rear panel, between the rear feet casting.

(2) Spread the inner "wrap-round" padded fitting flat and place the instrument into this with the carrying handle folded underneath and the four feet positioned into the four holes provided.

(3) Wrap the instrument with the packing all around and seal the two ends together with adhesive tape.

(4) Position the two end cushion protecting pieces at either end of the outer packing carton then slide the instrument within its inner wrap round protection into the outer packing carton. Close and seal the outer carton.

(5) Wrap the container in water proof paper and secure with adhesive tape.

(6) Mark the package FRAGILE to encourage careful handling.

Note ...

If the original container or materials are not available, use a strong double-wall carton packed with a 7 to 10 cm layer of shock absorbing material around all sides of the instrument to hold it firmly. Protect the front panel controls with a plywood or cardboard load spreader with holes drilled to avoid the projecting r.f. output, mod in-out sockets and the supply on-off switch; if the rear panel has guard plates or other projections a rear load spreader is also advisable.

MOUNTING ARRANGEMENTS

3. Excessive temperatures may affect the instrument's performance; therefore, completely remove the plastic cover, if one is supplied over the case, and avoid standing the instrument on or close to other equipment that is hot.

CONNECTING TO SUPPLY

4. Before connecting the instrument to the a.c. supply check the position of the two voltage selector switches on the rear panel. A locking plate fixes both switches into one of four possible combinations and only the selected voltage range is displayed when the locking plate is fixed to the back panel. The instrument is normally despatched with the switches selected to 230/240 V. To select a different voltage range remove the locking plate and re-position the switches to the required range as shown in Fig. 1 below and refit the locking plate into its alternative position.

Note ...

The a.c. supply fuse may also have to be changed. An indication of the correct fuse rating is given with each displayed voltage range:-

i.e.	0.5 A-TT (0.5 amp time lag)	105 V - 120 V \pm 10%
	0.25 A-TT (0.25 amp time lag)	210 V - 240 V \pm 10%

The fuses are 20 mm x 5 mm cartridge type.

5. The free a.c. supply cable is fitted at one end with a female plug which mates with the a.c. connector at the rear of the instrument. When fitting a supply plug ensure that conductors are connected as follows:-

Earth	-	Green/yellow
Neutral	-	Blue
Live	-	Brown

When attaching the supply lead to a non-soldered plug it is recommended that the tinned ends of the lead are first cut off owing to the danger of cold flow resulting in intermittent connections.

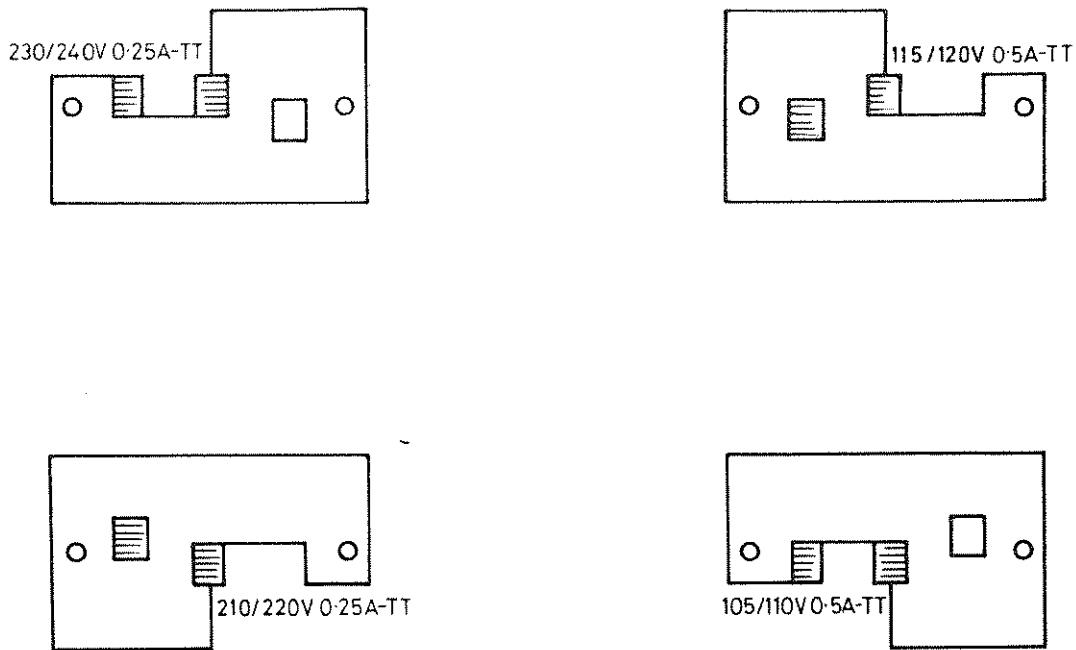

TPB 5073

Fig. 1 Voltage ranges (alternative switch and locking plate positions)

SAFETY TESTING

6. Where safety tests on the a.c. supply input circuit are required, the following procedures can be applied. These comply with BS 4743 and IEC Publication 348. Tests are to be carried out as follows and in the order given, under ambient conditions, to ensure that a.c. supply input circuit components and wiring (including earthing) are safe.

(1) Earth lead continuity test from any part of the metal frame to the bared end of the flexible lead for the earth pin of the user's a.c. supply plug. Preferably a heavy current (about 25 A) should be applied for not more than 5 seconds.

Test limit : not greater than 0.5 Ω .

(2) 500 V d.c. insulation test from the a.c. supply circuit to earth.

Test limit : not less than 2 M Ω .

GPIB INTERFACE

7. The GPIB interface is an optional accessory and can easily be fitted as follows:-

(1) Remove the rectangular cover plate from the left-hand side of the rear panel, withdraw the interconnecting lead and discard the cover plate but retain the fixing screws.

(2) Connect the GPIB interface assembly ADO taking care that the ribbon cable connector SKP is correctly aligned with the connector PLP.

(3) Slide the GPIB assembly into the instrument engaging top and bottom card guides and switch the instrument on temporarily. Check that the 2022 front panel displays data correctly. If this is satisfactory switch off 2022 and continue step (4); if however display data is corrupted switch off and re-check the alignment of SKP and PLP.

(4) Secure the GPIB assembly into the instrument engaging top and bottom card guides fastening the assembly to the rear panel using the two screws removed in step (1). The interface is now ready for GPIB operation.

RACK MOUNTING

8. The instrument may be mounted in a standard 19 inch rack as a single unit using the kit 46883-716B. This contains a pair of side angle plates wide enough to allow the instrument to sit centrally within the rack frame as shown in Fig. 2 below.

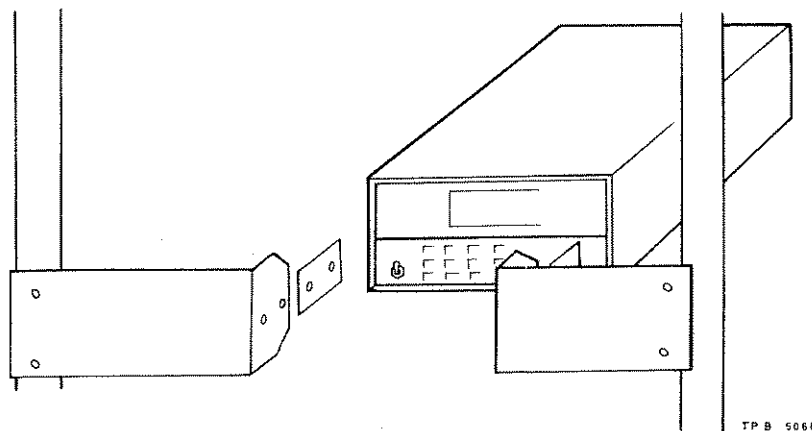

Fig. 2 Single unit rack mounting

9. For rack mounting the 2022 side by side with another instrument of similar modular construction, a double unit rack mounting kit 46883-717K is available. Fixings for joining the two instruments together and attaching both to the rack are shown in Fig. 3. For detailed information on kit parts, assembly etc., refer to the fitting instructions supplied with each rack mounting kit.

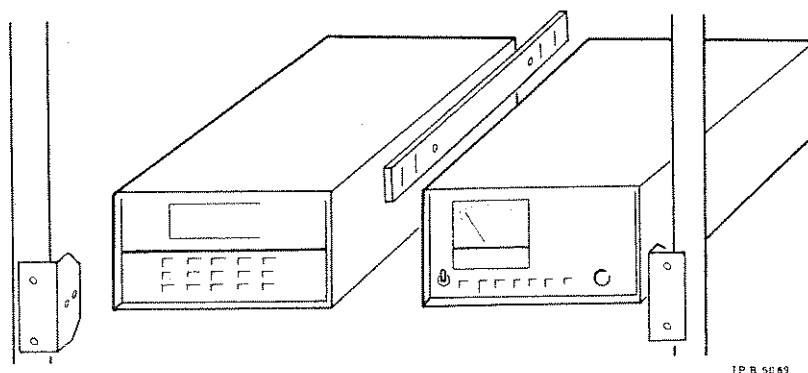

Fig. 3 Twinned unit rack mounting

10. If it is required to mount the r.f. output and modulation in/out sockets on the rear panel these can be disconnected from the front and transferred to the rear using the same connections. Detailed fitting instructions for this are contained in Chap. 5 of the Service Manual.

Chapter 3

OPERATION

CONTENTS

Para.

- 1 Principles of control
- 2 Front panel control
- 3 Rear panel layout
- 4 Preparation for use
- 4 Switching on
- 5 Operating procedures
- 6 Setting a carrier frequency
- 7 Carrier on/off
- 8 Internal/External frequency standard
- 9 Incrementing and decrementing
- 10 Internal modulation source
- 11 External modulation
- 12 Setting frequency or phase modulation
- 15 Setting a.m.
- 16 Setting r.f. level
- 18 Reverse power protection
- 19 Store and recall
- 20 Second function operations
- 22 Second function 0 "Unlock"
- 24 Second function 1 "Status"
- 25 Second function 2 "GPIB address setting"
- 26 Second function 3 "Manual latch setting"
- 27 Second function 4 "SRQ mask setting"
- 29 Second function 5 "Read identity string"
- 30 Second function 6 "Test display"
- 31 Second function 9 "Read elapsed time"
- 32 Second function 10 "Record external frequency standard choice"
- 33 Second function 11 "Read identity string"
- 34 Second function 12 "Write user definable string"
- 35 Second function 13 "Read user definable string"
- 36 Second function 14 "RF level units setting"
- 37 Second function 15 "RF level offsets"
- 40 Second function 16 "Recall STORE 10 at switch on"
- 41 Second functions 190-199 (Second level operation)
- 42 Operation with 75 Ω loads
- 43 General purpose interface bus (GPIB) functions
- 53 Setting the GPIB address
- 54 GPIB programming codes
- 55 Listening function
- 58 Talking function
- 62 SF1, QU Status string
- 63 SF11, QU Identity string (read only)
- 64 SF12, User string write facility

CONTENTS (continued)

Para.	
65	SF13, QU User string read facility
66	Service requests (SRQ)
67	Error numbers
68	SRQ mask
70	Reverse power protection
71	Clear, switch on, and return to local
72	GPIB connector contact assignments

Table		Page
1	Modulation string	23
2	Frequency string	23
3	RF level string	23

Fig.		
1	Front panel controls	3
2	Rear panel layout	4
3	2022 Initial Operating Mode	5
4	2022 Second function '1' Status mode	13
5	SRQ mask setting display	14
6	GPIB connector contact assignments	26
7	2022 Simplified Block Diagram	27

PRINCIPLES OF CONTROL

1. All operations of the generator are carried out from the front panel keyboard which is divided into five distinct areas. Remote operation via a GPIB controller is possible if the optional GPIB interface is fitted.

Front panel control

2. (1) SUPPLY switch. Applies the a.c. supply voltage.
- (2) MOD IN/OUT socket. Provides a 600 Ω , nominal 1 V e.m.f. output from the internal modulation oscillator or accepts an input from an external source.
- (3) Major function keys. Six of the seven orange keys have an associated l.e.d. to indicate the function currently selected.
- (4) Numerical keypad. Enters the required value for the function currently selected, includes a minus sign and a decimal point.

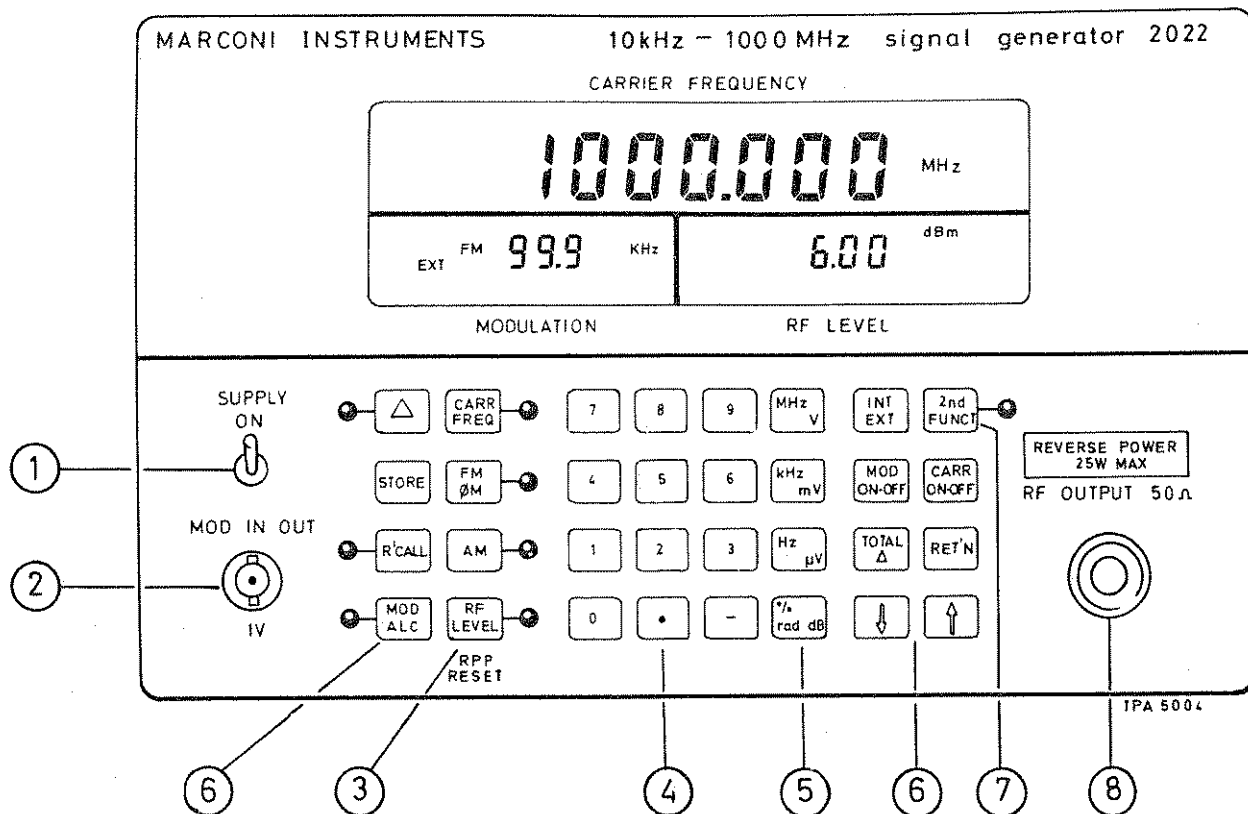

Fig. 1 Front panel controls

(5) Units. The four grey keys are used to terminate the numerical entry.

(6) Miscellaneous functions. The right-hand group of seven brown keys is concerned with such operations as switching the carrier and modulation on or off, incrementing/decrementing and displaying the total shift. One further miscellaneous key selecting modulation a.l.c. is positioned on the left of the keyboard.

(7) 2ND FUNCT. This blue key with its associated l.e.d. is used to provide further less commonly used facilities.

(8) RF OUTPUT : 50 Ω N type output socket.

Rear panel layout

3. (1) REMOTE CONTROL GPIB INTERFACE. This optional accessory allows remote control of the instrument. Accepts the 24-way IEEE GPIB connector.

(2) MOD IN-OUT/RF OUT, these blanked holes provide alternative fittings when the instrument is rack mounted. Fitting instructions are included in Chap. 5 of the Service Manual Vol. 2.

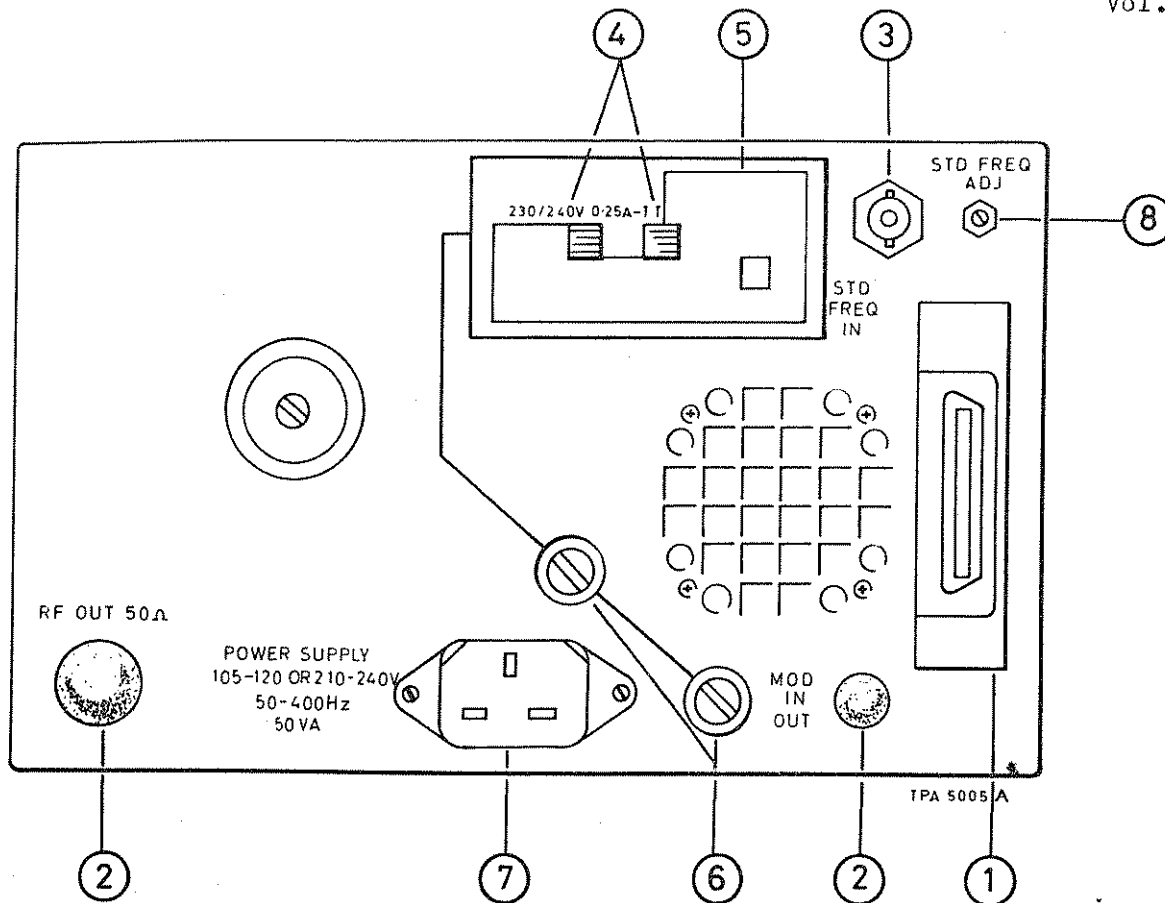

Fig. 2 Rear panel layout with optional GPIB interface

(3) STD FREQ IN, a BNC socket allows an input from an external 1 MHz, 5 MHz or 10 MHz reference depending on a link selected internally.

(4) VOLTAGE SELECTOR switches, selects in a combination of four positions 105-110 V/115-120 V, or 210-220 V/230-240 V, each has a 10% tolerance to afford a complete cover over the voltage ranges 95 V-132 V and 190 V-264 V respectively.

(5) Selector switch plate. Secures the VOLTAGE SELECTOR switches into one of four pre-selected positions by either turning and/or reversing the plate before re-affixing to the rear panel.

(6) AC fuses. Supply input fuses are rated at 0.25 amp time lag for 190 V - 264 V range or 0.5 amp time lag for the 95 V - 132 V range.

(7) AC supply input. The a.c. supply is connected through this plug which mates with the connector fitted to the supply lead.

(8) STD FREQ ADJ. This adjustment allows the internal standard to be set against a primary external standard.

CAUTION ...

Incorrect adjustment of this preset will impair the frequency accuracy of the generator and should therefore only be adjusted by an authorized re-calibration unit.

PREPARATION FOR USE

Switching on

4. With the instrument connected to a suitable a.c. supply proceed as follows:-

(1) Switch SUPPLY ON and check that the instrument has taken up the correct initial operating mode, that is CARRIER FREQ 1000 MHz internal MOD, no MODULATION and minimum RF LEVEL (-127 dBm or equivalent). The instrument may be set to recall the contents of store 10 if second function 16 is in use. For details see the paragraph, Second function 16 'Switch on state'. If store 10 contents are recalled when display blanking (Second function 197) is in operation none of the settings will be visible. To obtain a working display select recall 00.

(2) Check that the carrier frequency window does not indicate EXT STD, unless an external frequency standard is being used. If this has been inadvertently selected press CARR FREQ and INT/EXT keys to reselect internal frequency standard.

(3) During normal operation the instrument's internal reference standard will give an accuracy within the rated performance after a warm-up period of 5 minutes at normal ambient temperatures.

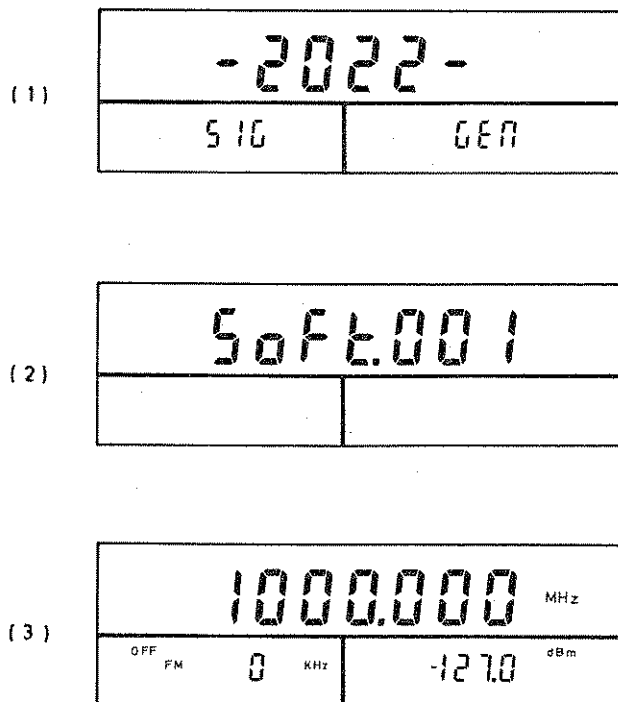

Fig. 3 2022 Initial Operating Mode

(4) The sequence of three display patterns shown above are used at switch on to give an indication of serviceability. Display (2) gives a brief indication of the software programme issue number e.g. 001,002,003 followed by (3), the initial operating mode. If however the instrument has developed a fault condition an error number will be continually displayed. Details of these error numbers are given in the GPIB functions, paragraph 67.

OPERATING PROCEDURES

5. Selection of data is carried out by first pressing the required function key and this is then indicated by an adjacent l.e.d. Follow this with the numerals including a decimal point or negative sign if required, a positive sign is otherwise implied. If an error is made in the entry re-selection of the function key will clear the previous entry. Complete the entry by pressing the appropriate UNITS terminator key. If a request outside the operating range of the instrument is made the generator will tune to either the minimum or the maximum value nearest to the initial request.

Setting a carrier frequency



6. If the l.e.d. associated with the orange CARR FREQ key is off press the CARR FREQ key. If the l.e.d. is on this will not be necessary. Enter the required value via the numerical key pad including the decimal point if required, the data entered will appear in the carrier frequency display. Terminate the instruction by pressing the appropriate UNITS terminator key. If a request lower than the minimum specified frequency 10 kHz is made the instrument will tune to the minimum specified frequency 10 kHz. Similarly if a request greater than 1000 MHz is requested the instrument will tune to the maximum specified frequency.

Carrier on/off



7. The carrier may be switched on or off at any time by pressing the CARR ON-OFF key.

Internal/External Frequency standard



8. The selection of either internal or an external frequency standard at the initial power on is determined by the previous selection of the INT/EXT key. Re-selection of this key whilst the l.e.d. adjacent to the CARR FREQ key is lit will change from INT to EXT or vice versa. The internal frequency standard employs an extremely stable crystal controlled 10 MHz oscillator. If EXT standard is selected a 10 MHz signal whose input level should be at least 1 V r.m.s. can be applied to the rear panel STD FREQ IN socket. The instrument will lock automatically to a suitable external standard and will, when EXT is selected, display EXT STD in the frequency window. Two alternative frequencies, 1 or 5 MHz, may also be used. Either can be facilitated by the re-positioning of a link within the instrument, for details see the Service Manual Vol.2. If the input is of the incorrect level (or not connected) error number 11 is displayed in the frequency window. If the frequency of the input is such that it cannot 'lock' the internal standard then error number 12 is shown. Error number 12 is also displayed when the instrument is initially switched on until such time as the internal frequency

standard synchronizing circuits have locked to the external frequency standard input. This will take approximately one minute. Subsequent reselections made when the instrument is at or near to its operating temperature will not incur this delay and therefore the error message will not then be displayed.

Incrementing and decrementing



9. To display current increment values press the orange key identified by a Δ (delta sign). Initially the instrument will automatically select and display an increment for each of the main functions as follows:- Carrier frequency 1 kHz, Modulation, either FM 1 kHz, ϕ M 0.1 Rad or AM 1%, and RF level 1 dB. To return the instrument to normal operation without affecting any current increment values that may have been selected press any function key twice. To enter a new value of increment such as a carrier frequency step of 10 kHz, press the keys shown in the example above. FM, ϕ M, AM or RF LEVEL may be similarly incremented, note that if incrementing the RF LEVEL the only valid terminator is the dB key.



(1) Each press of the \uparrow (UP) key will then increment the carrier frequency by 10 kHz, likewise pressing the \downarrow (DOWN) key will decrement the carrier frequency by a similar amount.

(2) Holding the UP or DOWN key pressed will result in continuous incrementing or decrementing after a delay of one second.

(3) Changing from the incrementing mode to the decrementing mode without the one second delay can be achieved by keeping the UP key continuously pressed allowing the instrument to increment, then following this selection press the DOWN key also. When the UP key is released the instrument will immediately decrement. A reversal from down to up without delay can then be achieved by pressing the UP key before releasing the DOWN key, and when the DOWN key is released the instrument will then immediately increment.



(4) To find the total shift from the original setting press the TOTAL Δ key. While this key is pressed all the displays will show the total shift of each function from their starting values.



(5) To return to the initial value of the selected function press the RET'N (RETURN) key.

Internal modulation source

10. The internal 1 kHz modulation source is derived from the Frequency standard and Reference divider circuit. The signal is also used as an a.f. output and is available at the MOD IN/OUT socket. The modulation a.l.c is always on in the internal mode.



Control of the modulation signal in both Internal and External modes is carried out by the MOD ON-OFF key.

External modulation



11. Press the FM, ϕ M or AM function key as appropriate followed by the INT/EXT key to select external, this is indicated on the modulation display by an EXT annunciator. Further pressing the INT/EXT key will return the instrument to the internal mode.



(1) If external modulation has been selected the signal from the externally applied modulation source can be set internally to the correct level (provided the applied voltage is between 0.9 V and 1.1 V) by pressing the MOD ALC key. If the input is outside the range of the a.l.c. system either a HI or LO message will indicate this in the modulation display. Selection is indicated by the adjacent l.e.d. The instrument will normally power up with MOD ALC off when in the external modulation mode. The modulation a.l.c is always on in the Internal modulation mode.

Setting frequency or phase modulation



12. Select the FM/ ϕ M function key if the adjacent l.e.d. is not lit. Enter the required data i.e. 20 or (.2 if a ϕ .m. selection of say 0.2 radians is required), followed by the required terminator key (MHz, kHz, Hz or rad). When the first digit of a new setting is entered both FM and ϕ M annunciators are set, when the terminator key is pressed either FM or ϕ M will be selected and the unwanted annunciator will turn off. To change from FM or ϕ M or vice versa again press FM/ ϕ M key, re-enter data and re-select the required terminator key.



13. The instrument normally switches on in the Internal mode. To select External mode first press the FM/ ϕ M key if its l.e.d. is not lit, then press the INT/EXT key. The f.m. will then be selected to External mode, and the EXT annunciator will be set in the modulation display. Pressing the INT/EXT key again will return the FM/ ϕ M to the Internal mode.

The instrument will normally power up with the MOD ALC off in the external modulation mode.



14. To turn FM/ ϕ M off whilst still retaining the current value of entered deviation, (for example in signal-to-noise ratio measurements) press the MOD ON/OFF key. The off condition is indicated by the setting of an OFF annunciator in the modulation display. Entering a new value of f.m. deviation will automatically select the FM/ ϕ M on again.

Setting a.m.

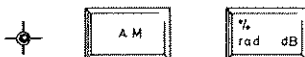

15. The procedure for selecting a value of a.m. depth is similar to that described for setting f.m., the only differences being that the AM function key is pressed and the instruction data is ended by the % terminating key. If the requested value of AM exceeds that allowed by the current output level setting then the level is reset to the maximum available for the AM depth selected and a warning to the user is given in the form of a flashing colon symbol to the left of the r.f. level display.

Setting r.f. level

16. Press the RF LEVEL key and enter the required data including any decimal point or minus sign as required. The terminator keys give a choice of volts, millivolts, microvolts or decibels. Linear voltage scales can be calibrated in either e.m.f. or p.d. and are set up by a second function control. Further references for the logarithmic dB scales are also set up by the second function control, for details see Second function operations.

17. The scale in use will be shown on the r.f. level display. If the level requested is too high at the currently set a.m. depth then level is set to the maximum available and a warning is given in the form of a flashing colon symbol to the left of the r.f. level display.

Note ...

Units conversion may be effected when the r.f. level is selected (r.f. annunciator lit), simply by pressing the relevant unit's key. For example to convert an indication in mV to dBm press the dB key.

Reverse power protection

18. The instrument is protected from accidental application of reverse power and if the reverse power protection (RPP) unit is tripped the REV PWR annunciator will flash on the RF LEVEL display. During this time the keyboard will not respond except to reset commands. After the source of power has been disconnected the RPP is reset by pressing the RF LEVEL function key. Attempting to reset the RPP with power still applied will result in the RPP tripping again. When the instrument is switched OFF, the output socket is automatically disconnected from the output attenuator - a further safety feature.

Store and recall

19. The instrument has 100 non-volatile stores available. Stores numbered 00 - 19 store complete instrument settings (including increment values). Stores 20 - 99 store settings of carrier frequency only.

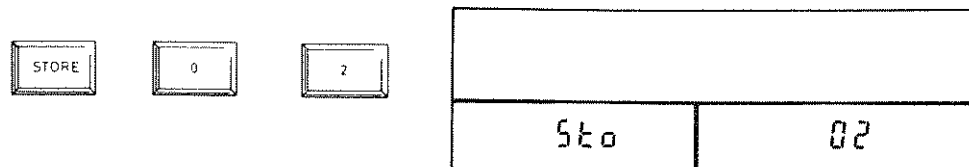

- (1) To store press STORE followed by a two-digit numeral entry. Holding the last entered digit key pressed will keep the 'Sto 02' information on the display. The command will be executed only when the key is released.

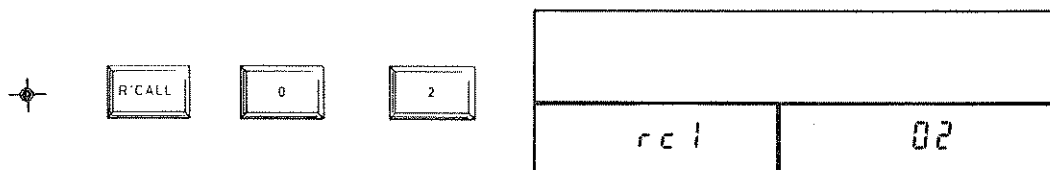

- (2) To recall, press R'CALL followed by the appropriate two digit numeric entry. Increment or decrement keys can be used to sequence the recall of stores if required. Pressing the RET'N key will recall the first store selected before incrementing or decrementing took place.

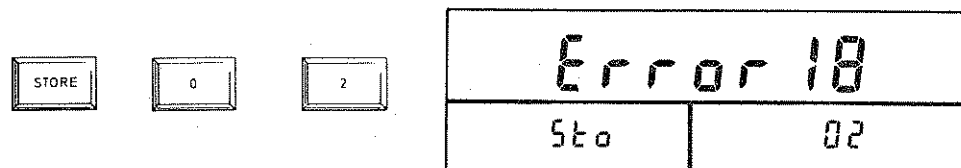

- (3) If an attempt is made to store values when Second function 196 (protection of store settings) is in operation this will not be possible and error message 18 will be displayed as shown above. A list of Error numbers can be seen in the GPIB functions paragraphs. Also if Second function 197 (display blanking) is operating only the numerals of the stored or recalled store will be displayed in the r.f. level window. Further details of Second functions 196 and 197 (both of which are second degree protected) are contained in the Service Manual.

SECOND FUNCTION OPERATIONS

20. Second function operations provide a means of controlling various secondary features and calibrations within the instrument. Access to many of these operations is generally not required during routine use of the instrument and some should only be accessed by skilled personnel during the

course of realignment, fault finding, or repair. There are three levels of operation as follows:

(1) Normal operation. Second functions accessed by a single key entry (0-9) are unprotected.

(2) First level operation. Second functions accessed by a two key entry (10-18) have first degree protection. Access to this level can be gained after operating an unlocking procedure described in para. 22.

(3) Second level operation. Second functions accessed by a three key entry (190-199) have second degree protection and can only be accessed by the operation of a special key code. Details of the code are given in the Service Manual.



21. In general the Second function mode is entered by pressing the blue 2ND FUNCT key followed by a number corresponding to the Second function required. Pressing the Second function key inhibits the action of some keys, however the instrument can always be restored to its normal operating mode by pressing any of the orange function keys. This means of exit from second function operation is always safe, i.e. it will not corrupt any data, or alter any status bits and the displays will revert to their normal functions.



No data will be permanently altered unless the STORE key is pressed. The operation of each of the secondary functions is as follows:-

Second function 0 'Unlock'



22. Switching on the instrument, automatically locks all Second functions that have a First or Second degree of protection. Access to first level operation is obtained by the UNLOCK procedure. Press 2nd FUNCT and '0' keys, this will result in the following display.

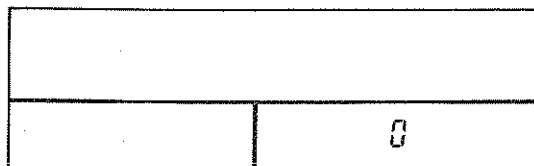

The instrument will remain in this condition until two further keys + and MOD ALC are pressed, both of which should be pressed together until '1' is displayed in the frequency window.

23. The instrument will then be unlocked to enable selection of the required Second function within the First level group. If the sequence is in error, or aborted part way through, the instrument will remain locked. Once unlocked the instrument remains so until either the 2nd FUNCT and '0' keys are once more pressed or until the instrument power is switched off.

Notes ...

- (1) Access to all Second functions is always available over the GPIB (where fitted). Care must therefore be taken when selection of either First or Second level operations are required. Access to Second functions via GPIB selection should be restricted to personnel who have a full knowledge of these operations and require access to them in the course of realignment, fault finding or repair only. If inadvertent selections are made it is possible to invalidate the instrument's calibration
- (2) The instrument always reverts to the locked state after using the bus.

Second function 1 'Status'



24. Entering 2nd FUNCT followed by the numeral 1 key will result in the instrument displaying status information as shown below in Fig. 4.

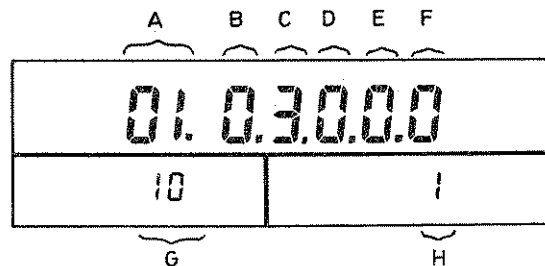

Fig. 4 2022 Second function 1 'Status mode'

- Where
- A = GPIB address (display shows '-' if GPIB is not fitted)
 - B = RF Level offsets 0 - off 1 - on
 - C = RF level units 0 - 9 (see second function 14 for details)
 - D = Store locking 0 - normal 1 - write protected (second function 196, see Service Manual for details)
 - E = Display blanking of recalled stores (second function 197, see Service Manual for details)
 - F = Protection level 0 - Unprotected, 1 - First level, 2 - Second level
 - G = External standard frequency 1,5 or 10 MHz (see second function 10 for details)
 - H = Indicates second function number currently selected.

GPIB data output in response to QU command when the 2022 is addressed to talk gives the following string with ' ' indicating a space.

AA B C D E F GG

Second function 2 'GPIB address setting'

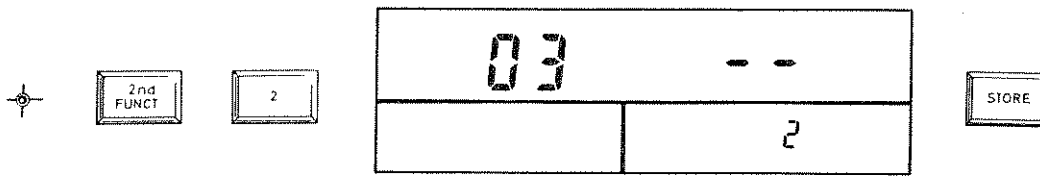

25. If the GPIB option is not fitted the sign "--" is displayed in the carrier frequency display; otherwise the current GPIB address is displayed. If a new address is required, this may be entered via the keyboard. Numbers rotate in from the right. When the required address is displayed pressing STORE key will, if the address is acceptable (00 - 30), replace the previous one. If the address is invalid it will be ignored and the current address re-displayed. The GPIB address is stored in the non-volatile memory.

Second function 3 'Manual latch setting'

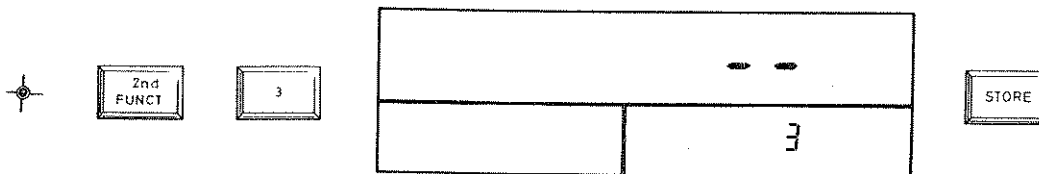

26. This function allows a 6 or 8 bit binary instruction to be directed to any of the instrument's internal latches for testing and fault finding. This facility is fully described in the Service Manual and is an invaluable aid when diagnosing internal instrument bus or latch faults. On exiting from second function 3 all latch data which may have been over-written is restored.

Second function 4 'SRQ mask setting'

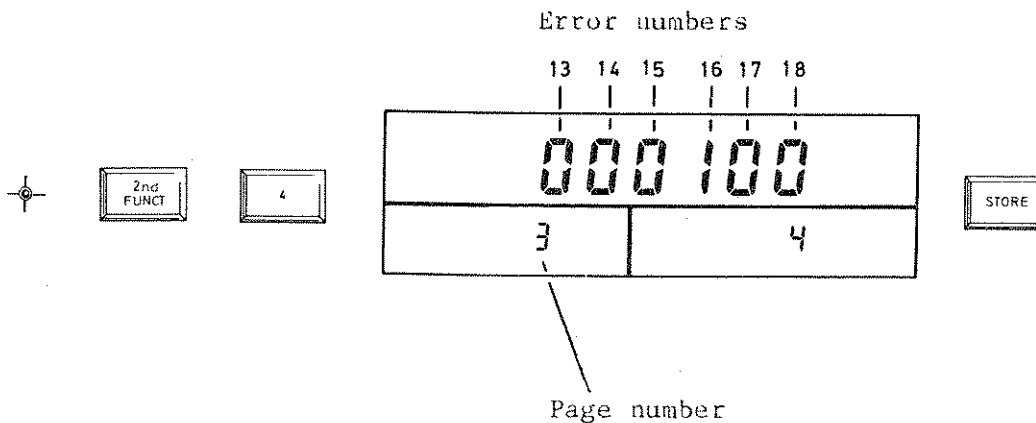
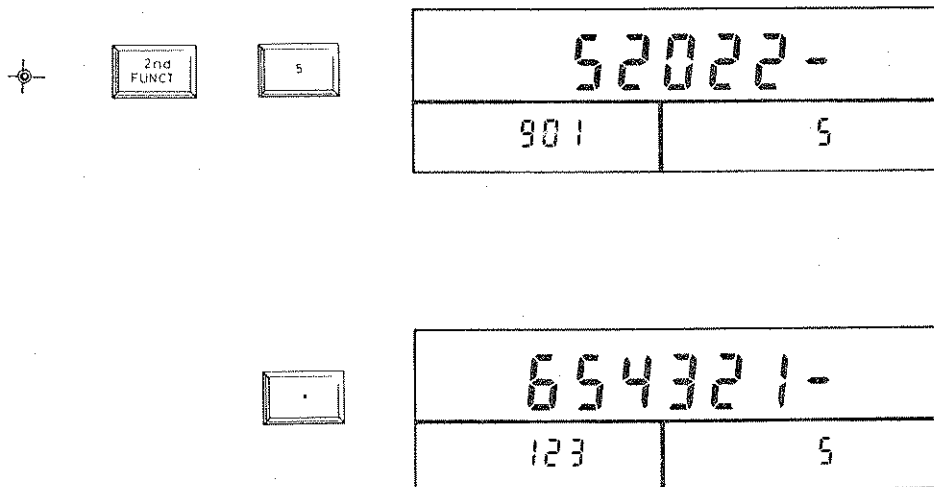

Fig. 5 SRQ mask setting display

27. Select 2nd FUNCT mode and the numeral 4. The SRQ mask allows an instruction to be made for the 2022 not to request service over the GPIB for particular conditions. Error numbers are listed from 1 to 18 inclusive. At switch on all error numbers are unmasked '0'. Selection of second function 4 gives a six bit binary number in the frequency display. To access all 18 error numbers three 'pages' are required. At switch on (default mode) page 1 is selected and the page number indicated in the modulation display. Error numbers 1 - 6 are represented in the frequency display, the lowest error is on the left of the display. To move to page 2 press the '.' (decimal point) key, modulation display now indicates page 2 and error numbers 7 - 12 are represented from left to right. Again press the decimal point to give access to page 3 representing error numbers 13 - 18. Pressing the decimal point a further time will return the user to page 1.

28. Ones and zeros are entered via the keyboard and rotate in from the right. Enter a bit '1' to mask the desired error and when in position press the STORE key. For more information on the significance of each digit see the paragraph - Error numbers. Fig. 5 shows the mask set to ignore a GPIB bus error (Error No. 16).

Second function 5 'Read identity string'



29. Selection of this facility enables the user to confirm Instrument type number, then after pressing the decimal point, its serial number e.g. 52022-900, Ser. No. 654321/123. If QU command is sent via the optional GPIB interface the following string is put into the output buffer 52022-900_001_654321-123. Software issue number (001), although not displayed is inserted between type and serial number in the string.

Second function 6 'Test display'

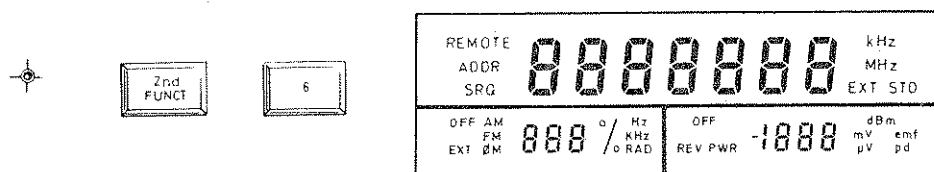

30. Select 2nd FUNCT mode followed by the numeral 6. All display components are then set to give confirmation of the back-plane drive and l.e.d. operation, and also the c.m.o.s. logic and l.c.d. segments on the Carrier frequency, Modulation and RF level displays.

Second function 9 'Read elapsed time'

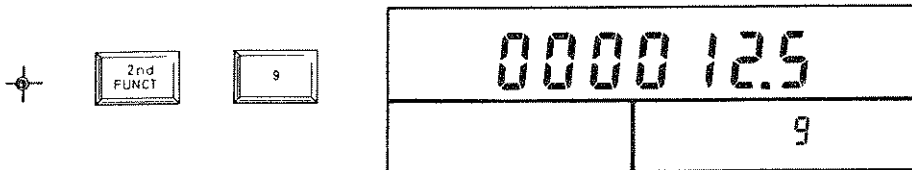

31. This facility enables the user to observe the total number of instrument running hours from the last reset. It may be used to indicate for instance, calibration intervals. The elapsed time is as shown above and has a resolution of 0.5 hrs. Display characters are not updated while being viewed. The display can be reset, see Service Manual Vol. 2 for details.

Second function 10 'Record external frequency standard choice'

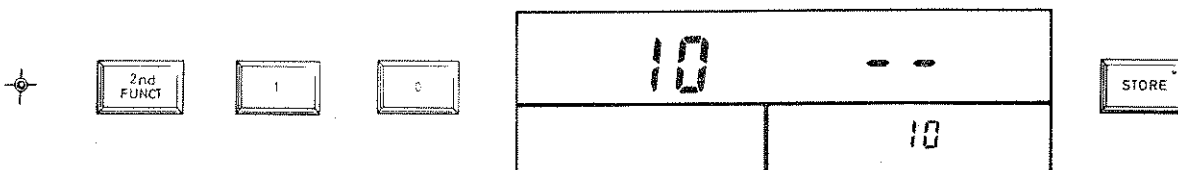

32. Unlock the instrument to the first level of operation completing the unlocking procedure given in para. 22, then select 2ND FUNCT key followed by the numeral(s) (1, 5 or 10) then press the STORE key. This facility enables the choice of external frequency standard (set by the position of the internal link) to be recorded and displayed in the status display mode second function 1. Choice of three frequencies can be made 1, 5 or 10 MHz.

Note ...

This function does not actually change the frequency accepted.

Second function 11 'Read identity string'

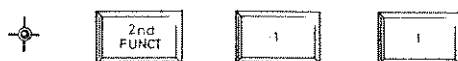

33. This facility is the same as Second function 5 and provides identical display features but is first degree protected. Unlock the instrument to the first level operation by completing the unlocking procedure given in para. 22 then select 2ND FUNCT key and the numerals 11. The purpose of Second function 11 is to provide compatibility with 2018A where an identical Second function 11 facility allows commonality with GPIB controller instructions. As described in Second function 5, if QU is sent via the GPIB the following string is placed in the output buffer e.g. 52022-900, 001, 654321-123 to confirm the instrument type, software issue and serial number.

Second function 12 'Write user definable string'

34. This is a GPIB only facility where a string of up to 32 ASCII characters can be stored in a non-volatile memory by the user. The second function number is displayed in the r.f. level display. Up to 31 ASCII characters can be accepted then terminated by <lf>. Follow this with ST command to store,

e.g. SF12 - This is a user-defined string <cr> <lf> ST
would store 'This is a user-defined string'

If an attempt is made to store too many characters then <lf> is automatically inserted as the 32nd.

Second function 13 'Read user definable string'

35. This facility provides a means of reading back data set by means of SF12 write facility and is again a bus only facility. The second function number is displayed in the r.f. level display and in response to QU command places the user defined string into the GPIB output buffer.

Second function 14 'RF level units setting'

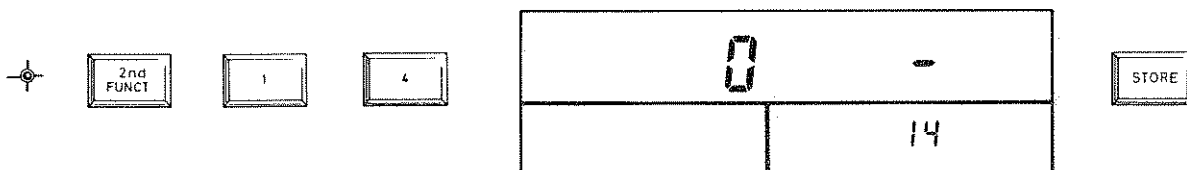

36. Unlock the instrument to the first level of operation completing the unlocking procedure given in para. 22, then select 2nd FUNCT key followed by the numerals 1 and 4. On entering Second function 14 a digit is displayed in the frequency window as shown above. This represents the r.f. level units which are currently selected. Select unit code required from 0 - 9 by reference to the list given below then press the STORE key to terminate the entry.

<u>Unit code</u>	<u>Log unit</u>	<u>Lin unit</u>
0	dBmV e.m.f.	e.m.f.
1	dB μ V e.m.f.	e.m.f.
2	dBmV p.d.	e.m.f.
3	dB μ V p.d.	e.m.f.
4	dBm	e.m.f.
5	dBmV e.m.f.	p.d.
6	dB μ V e.m.f.	p.d.
7	dBmV p.d.	p.d.
8	dB μ V p.d.	p.d.
9	dBm	p.d.

Second function 15 'RF level offsets'

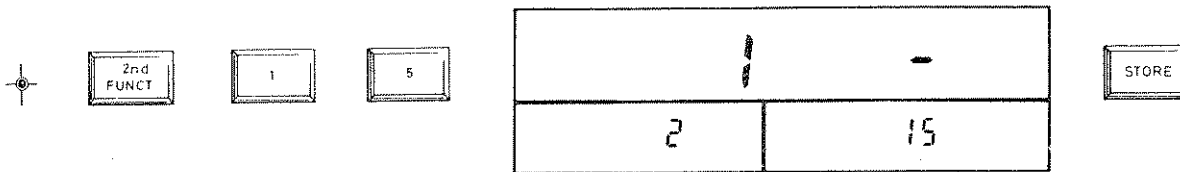

37. In addition to the standard calibration for r.f. output level, the instrument has a capability for overall level adjustment to facilitate matching with other equipment. The output level can be raised or lowered by approximately 2 dB in the offset mode. First select a carrier frequency within the chosen band followed by a suitable r.f. level. Complete the unlocking procedure given in para. 22, then select 2nd FUNCT and the numerals 15. There are three carrier frequency bands <250 MHz, 250-500 MHz and 500-1000 MHz, these are identified in the modulation display as 1,2 or 3 respectively. One offset value may be set for each frequency band.



38. Selection of offsets 'on' is made with the numeral 1 key, or 'off' with the 0 key. Indication of the selected state is shown with either 1 or 0 in the carrier frequency display. Either terminate the selection by pressing the STORE key, or before doing so set a value of offset in the following manner; ensure offset on '1' is selected then press the ↑ (UP) key or the ↓ (DOWN) key to increment or decrement the r.f. level by 0.1 dB. Each successive operation of the key will increment/decrement the r.f. by a further 0.1 dB. When sufficient offset has been determined press the STORE key to terminate the selection which will, together with the offsets 'on' selection, remain valid until further adjustment is made.

39. If an offset value of +0.1 dB is selected when the instrument is set to the limit of its operating range i.e. +6 dBm or equivalent a maximum r.f. level of 5.9 dBm will be displayed (a further +0.1 dB offset increment will decrease this to +5.8 dBm).

Note ...

When an offset value has been selected and stored it will remain valid for all subsequent power on sequences. RF level accuracy of the instrument is therefore impaired and care should be taken to account for this.

Second function 16 'Recall STORE 10 at switch on'

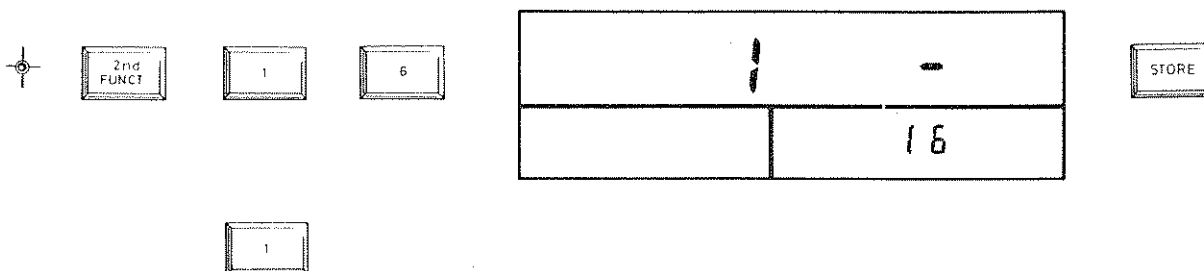

40. This facility allows the instrument to be operated in a remote or unattended location with a pre-selected set of conditions which will remain unchanged in the event of inadvertent switching off and on of the input supply voltage. In the normal operating mode if this happens, the instrument would resume the initial operating mode, that is CARRIER FREQ 1000 MHz, INT MOD, no MODULATION and minimum RF LEVEL (-127 dBm or equivalent). These conditions can be superseded by storing the required operating conditions into STORE 10 and carrying out an automatic recall of the STORE 10 settings using the second function 16 mode.

- (1) First select by means of the front panel keyboard, the required CARRIER FREQ, MODULATION and RF LEVEL settings.
- (2) Press the STORE key followed by the numerals 10.
- (3) Complete the first level unlocking procedure given in para. 22 and select 2nd FUNCT, and the numerals 16, follow this by selecting offsets on (numeral 1). Finally press the STORE key to terminate the entry.

If the supply voltage is interrupted, then restored, the instrument will automatically carry out a RECALL 10 instruction and reset to the STORE 10 conditions previously set. To disable the facility first unlock the instrument to First level operation, select 2nd FUNCT 16 followed by the numeral 0, and finally the STORE key. If second function 197 is in use all information normally shown on the front panel will be blanked. Details of this facility are given in the Service Manual Vol. 2

Second functions 190 - 199 (Second level operation)

41. The following facilities all have second degree protection, further information on these and details of the special key code used to unlock to this level are contained in the Service Manual.

- Second function 190 : Identity string setting
- Second function 191 : FM tracking calibration
- Second function 192 : RF level calibration
- Second function 193 : Voltage tuned filter (VTF) calibration
- Second function 194 : AM calibration
- Second function 195 : Set checksum
- Second function 196 : Protection of store settings
- Second function 197 : Display blanking of recalled stores
- Second function 198 : Read total instrument operating time
- Second function 199 : Reset elapsed time

OPERATION WITH 75 Ω LOADS

42. The performance specification for the instrument assumes operation into 50 Ω loads, but often it is desirable to work into mismatched loads. This is in general possible although an uncertainty of performance may be introduced. When external loads of 75 Ω are employed these can be accurately matched for carrier frequencies up to 500 MHz by using a 50/75 Ω Impedance Adapter Code No. 54411-051X offered as an optional accessory. This 25 Ω series load maintains the correct (open circuit) voltage calibration and allows the reverse power protection circuit to function correctly.

GENERAL PURPOSE INTERFACE BUS (GPIB) FUNCTIONS

43. The GPIB interface, offered as an optional accessory allows the instrument to be coupled to a controller. The essential purpose of the GPIB functions are described below. Further information on the general features and applications of the GPIB system can be obtained from the separate GPIB manual offered as an optional accessory.

44. The 2022 has both talker and listener capabilities. One address is used for both talking and listening and is set via the front panel or via the GPIB using Second function 2. The instrument can request service (assert SRQ) on certain error conditions under the control of an SRQ mask which is set using Second function 4.

45. SH1 : Source handshake (complete capability)

The source handshake sequences the transmission of each data byte from the instrument over the bus data lines. The sequence is initiated when the function becomes active, and the purpose of the function is to synchronize the rate at which bytes become available to the rate at which accepting devices on the bus can receive the data.

46. AH1 : Acceptor handshake (complete capability)

The acceptor handshake sequences the reading of the data byte from the bus data lines.

47. T6 : Talker function (no talk only function)

The talker function provides the 2022 with the ability to send device dependent messages over the bus to other devices. The ability of any device to talk exists only when it has been addressed as a talker.

48. L4 : Listener function (no listen only function)

The listener function provides a device with the ability to receive device dependent messages over the bus. The capability only exists where the device is addressed to listen via the bus by the controller.

49. SR1 : Service request function (complete capability)

The service request function gives the 2022 the capability to inform the controller when it requires attention.

50. RL1 : Remote/local function (complete capability)

The remote/local function allows the 2022 to be controlled either by the local front panel keys or by device dependent messages over the bus.

51. DCL : Device clear function (complete capability)

Device clear is a general reset and may be given to all devices in the system simultaneously (DCL) or only to addressed devices (SDC). 2022 resets to the default power-up mode, that is

Maximum carrier frequency 1000 MHz
 No a.m., f.m., or phase modulation
 Minimum r.f. level - 127 dBm or equivalent
 Internal modulation selected
 Increment settings ... Carrier frequency 1 kHz
 Modulation FM 1 kHz, Φ M 0.1 Rad or AM 1%
 RF level 1 dB

Before these conditions are set, a checksum is calculated for the calibration data (FM tracking and RF level) and referred to a number held in the non-volatile memory. If this test of calibration validity fails, the instrument responds by asserting SRQ. The status byte will contain the error number 7 to signal a calibration data fault in addition to the "SRQ asserted" bit. In order to continue with the device clear (and normal operation thereafter) the instrument must be restarted by sending any valid instruction code (e.g. "CF"). This serves only as a reset and will not be interpreted in the normal way.

52. E1 : Open collector drivers

The GPIB drivers fitted to 2022 have open collector, rather than tristate, outputs.

Setting the GPIB address

53. The instruments talk/listen address is selected by means of the second function 2. Acceptable addresses (00 to 30) can be set by this means and the instruments internal address register will be updated by reading the address at power-on and on receipt of a device clear message. The current GPIB address is shown in the frequency display window when the interface is correctly installed.

GPIB programming codes

54.	<u>Functions</u>	<u>Miscellaneous functions</u>
	CF Carrier frequency	ST Store } followed by
	FM Frequency modulation	RC Recall } a number 00-99
	AM Amplitude modulation	IS Internal freq. standard
	PM Phase modulation	XS External freq. standard
	LV RF level	IM Internal modulation
	DE Delta (Increment/Decrement)	XM External modulation

SF	Second function (see Chap. 3) page 11, para. 23 Notes)	CO	Carrier off
RS	Reset RPP	CI	Carrier on
QU	Query - send current function setting to GPIB buffer	UP	Increment up
		DN	Increment down
		RT	Return

<u>Units</u>		<u>MOD OSC/ALC</u>	
MZ	Megahertz	VL	Volts
KZ	Kilohertz	MV	Millivolts
HZ	Hertz	UV	Microvolt
PC	Percentage	DB	Decibel
RD	Radians	LO	Mod ALC off
		LI	Mod ALC on
		MO	Mod off
		MI	Mod on

Listening function

55. The 2022 is remotely controlled over the GPIB by strings or two-character codes and digits sent in upper case ASCII format. Where possible these codes correspond directly to the front panel keys : however where the normal front panel control requires a knowledge of the previous state of the instrument (e.g. toggling controls such as on/off), special codes are provided to simplify programming.

56. In order to improve the readability of control strings, the codes may be separated by commas or spaces after each code pair or data group. These are ignored by the instrument. When data is entered, the syntax is the same over the GPIB as that used in control from the front panel. For example to enter a complex string of instructions such as a carrier frequency of 123.45 MHz with an increment of 25 kHz and an r.f. level of 1.2 μ V the string can be sent as follows, "CF 123.45 MZ, DE CF 25 KZ, LV 1.2 UV". Or similarly, if it is required to change the r.f. level units setting to dBm (Second function mode 14, level unit code 4), the string "SF 14,4, ST" should be sent. Selection of a second function via the GPIB will result in a display of the SF number being shown in the instrument's r.f. level display.

57. The MOD ON/OFF, CARR ON/OFF and INT/EXT controls operate on the function currently active for data entry. This may be specified, e.g. "FM MI"; "AM XM" or implied, e.g. "FM 1.5 KZ, IM" but it is recommended that the function is specified within the string to ensure that the string will always have the same result.

Talking function

58. On receipt of the QU command the current function setting (e.g. CF,FM) is transferred to the GPIB output buffer in a format corresponding to the GPIB commands needed to set the instrument to the current state. RF level will be displayed in log. or linear units but without a specific reference since this information cannot be re-entered directly. Increment settings are also available if QU is sent whilst in DELTA mode with a current function i.e.d. lit. The following tables give the format for each type of string.

TABLE 1 MODULATION STRING (16 characters)

NUMBER OF CHARACTERS IN FIELD						
2	2	4	2	2	2	2
DE **	FM PM AM	3 digits or leading spaces plus decimal point or space	MZ KZ HZ PC RD	MO MI	IM XM	LO LI **

* Represents a space which is used when the field has no relevance such as the levelling field when internal modulation is selected.

e.g. DE FM 1.00 KZ MI IM **

TABLE 2 FREQUENCY STRING (17 characters)

NUMBER OF CHARACTERS IN FIELD				
2	2	9	2	2
DE **	CF	7 digits or leading spaces plus decimal point or space	MZ KZ	IS XS

e.g. ** CF 123.4567 MZ IS

TABLE 3 RF LEVEL STRING (14 characters)

NUMBER OF CHARACTERS IN FIELD						
2	2	1	1	4	2	2
DE **	LV	- *	1 0 *	3 digits or leading spaces plus decimal point or space	DB VL MV UV	CO CI

e.g. ** LV * 100.0 MV CI

59. Provision for talking second function values can also be made by a similar use of QU when the function is engaged, the format being numeric strings only for calibration data etc., e.g. FM tracking, and a numeric string representing hours for the elapsed time indicator. Three further data strings are available, Status string, Identity string and a User string, these are accessed by means of second function controls and the QU function.

60. The external modulation input level status indicated by the modulation window HI and LO is also accessed. The current status, if outside the specified limit, is transferred to the GPIB output by means of an error message:

Error No. 9 input too low
Error No. 10 input too high

61. Requesting a string to be output will overwrite any string data waiting to be sent. Addressing the instrument to talk without specifying a string to be sent or re-addressing to talk after a string has been completed will result in an error (and SRQ if not masked).

SF1, QU Status string

62. When accessed by SF1, QU the status of the instrument is sent to the controller, each data field being delimited by one space in the following format:-

XX	┌	X	┌	X	┌	X	┌	X	┌	X
GPIB		OFFSETS		LEVEL		STORE		DISPLAY		PROTECTION
ADDRESS		ON/OFF		UNITS		LOCKING		BLANKING		LEVEL
				CODE						FREQ STD
										1, 5 or 10 MHz

GPIB Address 00-30.

Offsets on '1', off '0'.

Level units code 0-9 (see Second function 14, Operating Manual Vol. 1).

Store locking '0' - normal, '1' - write protected (see Second function 196, Service Manual Vol. 2).

Display blanking of recalled stores (see Second function 197, Service Manual Vol. 2).

Protection level '0' Unprotected, '1' First level, '2' Second level.

External standard frequency 1,5 or 10 MHz (see Second function 10, Operating Manual Vol. 1).

SF11, QU Identity string (read only)

63. The identity string accessed by SF11, QU allows instrument type number, software issue number and serial number to be read by the controller. The information is stored in non-volatile memory. The string is displayed as described in Second function 11 paragraph. Each data field is delimited by one space.

SF12, User string write facility

64. Up to 32 ASCII characters can be stored in non-volatile memory by the user. This bus only facility is useful for recording such information as the date the next calibration is due, test gear numbers etc. The string is terminated by the LINEFEED character <lf>, (ASCII code 10) which is included as the last character stored. If an attempt is made to store too many characters then <lf> is automatically inserted as the 32nd.

SF13, QU User string read facility

65. This facility provides a means of reading back data set by means of SF12 write facility and is again a bus only facility.

Service requests (SRQ)

66. The 2022 can request service to warn the controller of certain error conditions. In response to a serial poll after asserting the SRQ line, the 2022 will provide a status word (8 bits) in which bit 6 is set to indicate an SRQ request and the first five bits 0 to 4 indicate an error number. The error number is also displayed briefly in the carrier frequency window. Errors 06 and 08 will result in the instrument not functioning. Error 07 can be overridden with a restart command (any function code or digit).

Error numbers

<u>67. No.</u>	<u>Error condition</u>	<u>Action taken</u>
00	NO ERROR	
01	REQUEST OUTSIDE LIMITS	
02	INCORRECT KEY CODE SEQUENCE	
03	TOO MANY DIGITS	
04	INCORRECT UNIT	
05	RPP TRIP	Wait for reset instruction (RS)
06	RAM CHECK FAILURE (IC9)	
07	EAROM CHECKSUM FAILURE (IC10)	Wait for restart instruction (any function code or digit)
08	EPROM CHECKSUM FAILURE (IC5-IC8)	
09	EXTERNAL MODULATION OUTSIDE ALC RANGE (LOW)	
10	EXTERNAL MODULATION OUTSIDE ALC RANGE (HIGH)	
11	EXT STD SELECTED BUT NOT APPLIED	None
12	EXT STD FREQ NOT LOCKING	None
13	LATCH WRITE ERROR	
14	EAROM WRITE ERROR	
15	EAROM RECALL ERROR	
16	GPIB BUS ERROR	
17	UNRECOGNIZED GPIB MNEMONIC/CHARACTER	Ignore both characters: e.g. if the string "P,CF,MO" was received, the Q,C would result in error 17 being displayed and the rest of the string would be interpreted as "FM,0".
18	ATTEMPT TO WRITE TO PROTECTED STORE	

SRQ mask

68. The SRQ response to the errors listed above can be suppressed by setting a 3 page 6-bit mask, via second function 4. The bits of the mask refer directly to the errors, i.e. the left most bit set indicates no response to error 1, the second from left no response to error 2, etc.

69. The mask is displayed by selection of second function 4, and may be changed by entering 1's and 0's via the keyboard. The STORE key is pressed to finalize a change. The SRQ mask is not stored in the non-volatile memory when power is removed. When the instrument is initially switched on the mask is set to all 0's.

Reverse power protection

70. When tripped by an overload applied to the RF OUTPUT socket, the GPIB SRQ line is asserted, and the status byte (obtainable by the controller conducting

a serial poll) will contain the value 69 (decimal). The RFP can be reset via the bus by sending the RS command.

Note ..

If error 05 has been masked using second function 4 the service request action will not be initiated.

Clear, switch on, and return to local

71. SDC and DCL clear 2022 to the following state:-

Max. carrier freq 1000 MHz
 Min. output level, -127 dBm or the equivalent
 Carrier on
 FM, a.m., phase modulation, off
 Internal modulation selected.
 Increments ... Carrier frequency 1 kHz
 Modulation FM 1 kHz, FM 0.1 Rad, or AM 1%
 RF level 1 dB

To revert from GPIB to front panel control, press the RET_N key.

If a Local lock out command has been given the return key operation will be ignored.

Notes ...

- (1) Int/Ext frequency standard selection, the GPIB address and instrument stores are unaffected by the SDC and DCL commands.
- (2) Switching on clears the 2022 to the same state as SDC or DCL unless 'Recall STORE 10 at switch on', conditions apply.

GPIB connector contact assignments

72. The contact assignment of the GPIB cable connector and the device connector is as shown in Fig. 6 below.

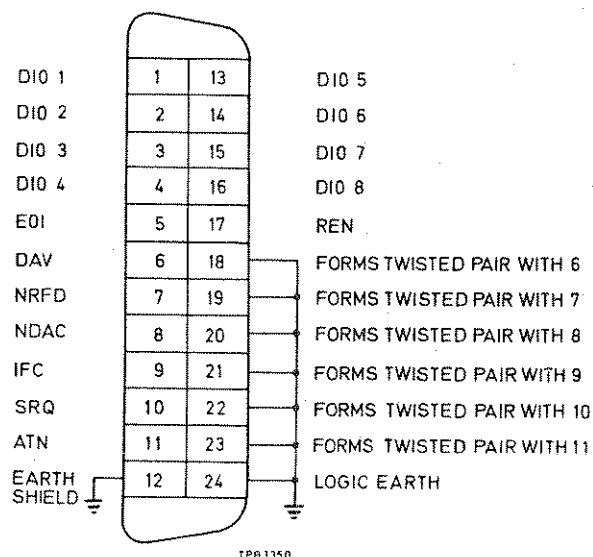

Fig. 6 GPIB connector contact assignments

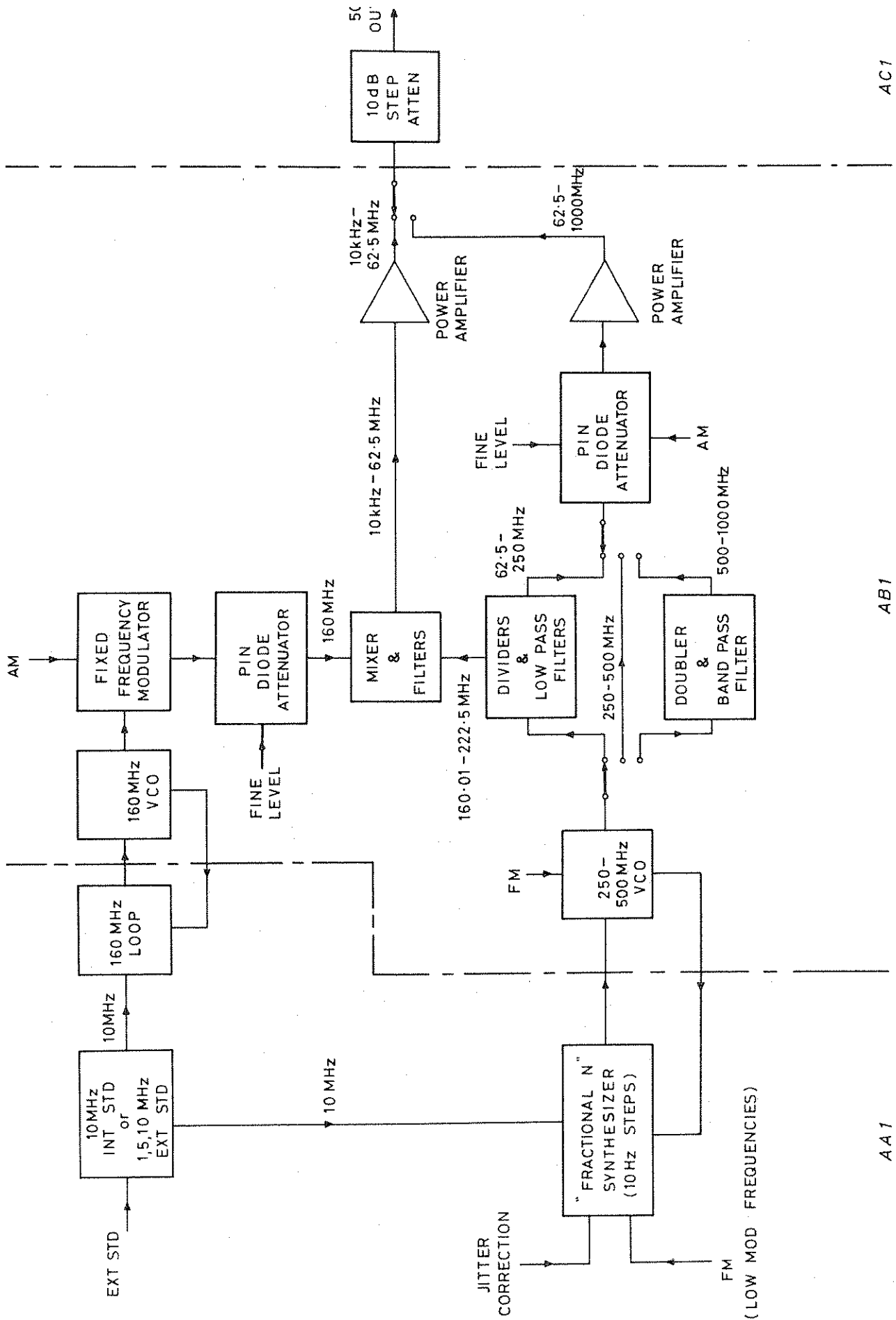

Fig. 7 2022 Simplified Block Diagram

AC1

AB1

AA1

TPC 5081

