

INSTRUCTION MANUAL

ELECTRONIC LOAD

MODEL PLZ-700W

KIKUSUI ELECTRONICS CORPORATION

Kanagawa, Japan

82.10.14

824489

# Power Requirements of this Product

Power requirements of this product have been changed and the relevant sections of the Operation Manual should be revised accordingly.

(Revision should be applied to items indicated by a check mark )

Input voltage

The input voltage of this product is \_\_\_\_\_ VAC,  
and the voltage range is \_\_\_\_\_ to \_\_\_\_\_ VAC. Use the product within this range only.

Input fuse

The rating of this product's input fuse is \_\_\_\_\_ A, \_\_\_\_\_ VAC, and \_\_\_\_\_.

### WARNING

- To avoid electrical shock, always disconnect the AC power cable or turn off the switch on the switchboard before attempting to check or replace the fuse.
- Use a fuse element having a shape, rating, and characteristics suitable for this product. The use of a fuse with a different rating or one that short circuits the fuse holder may result in fire, electric shock, or irreparable damage.

AC power cable

The product is provided with AC power cables described below. If the cable has no power plug, attach a power plug or crimp-style terminals to the cable in accordance with the wire colors specified in the drawing.

### WARNING

- The attachment of a power plug or crimp-style terminals must be carried out by qualified personnel.

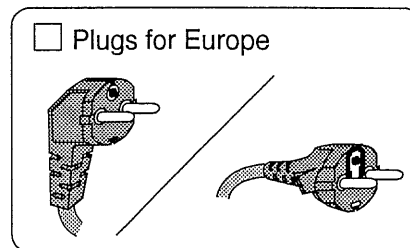
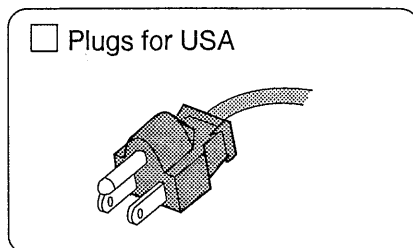
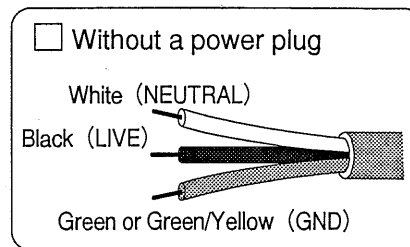
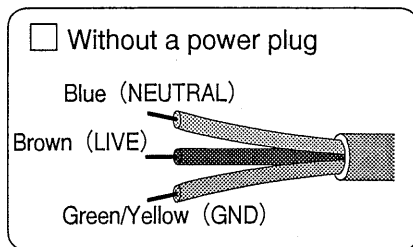

Provided by Kikusui agents  
Kikusui agents can provide you with suitable AC power cable.  
For further information, contact your Kikusui agent.

Another Cable \_\_\_\_\_

## Corrigenda (Additional)

For further corrections of the contents of this manual, add the following items:

### 1. Conditions for Illuminating the Alarm Lamp

The alarm lamp illuminates when any of the following conditions has occurred.

- (1) Overheating of internal components
- (2) Wrong-polarity connection of load

### 2. Remote Control of PLZ-700W in Constant Voltage Mode

To remote-control the PLZ-700W which is operating in the constant voltage mode, proceed as follows:

- (1) To gain access to the INT/EXT selector switch which is located inside the casing, remove the top cover of the casing referring to the Figure 2-11-1 on Page 28.
- (2) Throw the INT/EXT selector switch to the EXT state.  
(The switch is located on a PCB as shown in Figure 1.)

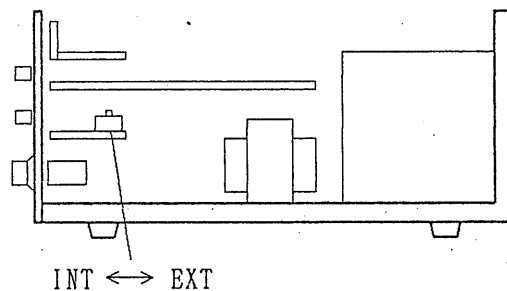

Figure 1

- (3) Turn the C.V MODE control to the full clockwise position.  
Note that the control is kept enabled even when the PZL-700W is operated in the remote control mode.
- (4) Put back the top cover to the original position.
- (5) Apply a remote control voltage signal to between terminals ① and ② of the rear terminal block (⑭ as shown in Figure 2-2-1 on Page 10).

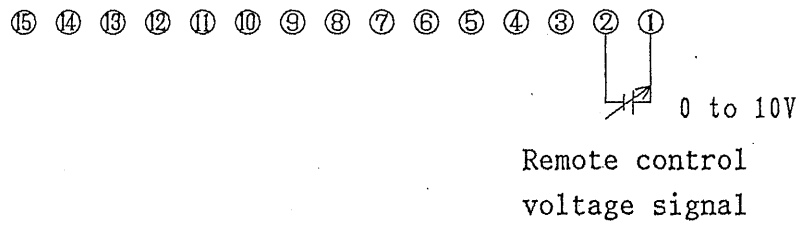

Figure 2...

88.9.26

884735

## CONTENTS

	<u>Page</u>
SECTION 1. GENERAL .....	1
1-1. Introduction .....	1
1-2. Specifications .....	2
SECTION 2. OPERATION .....	5
2-1. Notes Before Operation .....	5
2-2. Front and Rear Panel Descriptions .....	10
2-3. Initial Setting .....	13
2-4. Operation in the Constant Resistance Mode .....	14
2-5. Graph of Resistance Range and Power Limit Relation .....	17
2-6. Operation in the Constant Current Mode .....	19
2-7. Operation in the Switching Mode .....	21
2-8. Operation in the Constant Voltage Mode .....	23
2-9. Indication of Loading Power .....	26
2-10. Presetting the Power Limit .....	27
2-11. Remote Control with an External Resistance (Constant Resistance or Constant Current) .....	28
2-12. Remote Control with an External Voltage (Constant Current only) .....	29
2-13. Remote Control of Load Switch by an External Terminal .....	30
2-14. One-control Parallel Operation .....	30
2-15. Installing the Terminal Cover .....	32
SECTION 3. OPERATING PRINCIPLES .....	33
3-1. Constant Current Operation .....	33
3-2. Constant Resistance Operation .....	33
3-3. Block Diagram .....	35

	<u>Page</u>
SECTION 4. MAINTENANCE .....	36
4-1. How to Open the Chassis Case .....	36
4-2. Inspections and Cleaning .....	36
4-3. Calibration .....	37

PL2700W

86.11.8

8244914

## SECTION 1. GENERAL

### 1-1. Introduction

Series PLZ-W Electronic Loads can be operated in constant resistance mode, constant current mode and switching action electronically, replacing the conventional sliding resistors (rheostats). Major features of the PLZ-W series are as follows:

1. Digital Meters.

A digital voltmeter and an ammeter with an autorange of 3 1/2 digits.

2. A 10-Turn Multi-Dial.

Current values and resistance values may be set very precisely with the 10 turn multi-dial having a lock mechanism.

3. Function of Presetting.

Current and resistance values may be preset.

4. Built-in Oscillator for Switching Action.

To be used in the constant current mode. Switching action occurs within the frequency range of 10 Hz - 1 kHz.

5. Display of Loading Power.

Supplied power value is displayed in a digital figure and in the form of luminescent bar graph.

6. Remote Control Functions.

When operated in the constant current mode the instrument may be remotely controlled by either an external voltage or an external resistance. The instrument may also be remotely controlled by an external resistance when operated in the constant resistance mode.

7. One-controlled Parallel Operation.

It is possible to increase current capabilities by operating a number of units connected in parallel simultaneously under the control of a master unit.

8. Protection Circuits Include:

Overvoltage, overcurrent, overpower, overheating, and input terminal connection in reverse polarity.

The PLZ series is offered as a portable desk-top unit and may be integrated into a 19 inch or 500 mm Kikusui standard rack, with the use of the option brackets.

1-2. Specifications

Power Requirements.

Line voltage: 120 V AC  $\pm$  10% 50/60 Hz single phase

Power consumption: Approx. 65 VA (at 120 V AC)

Input.

Loading voltage: 4 - 60 V DC

Loading current: 0 - 140 A

Maximum loading power: 700 W

Operating ambient temperature range: 0 - 40°C (32 - 104°F)

Operating ambient humidity range: 10% - 90% RH

Cooling method: Forced air cooling by means of fan

Isolation from ground:  $\pm$ 250 V DC

Modes.

Constant current mode: 0 - 140 A (1st range)

0 - 14 A (2nd range)

Constant resistance mode: 10 - 100 m $\Omega$  (1st range) (minimum 0.025  $\Omega$ )

0.1 - 1  $\Omega$  (2nd range)

1 - 10  $\Omega$  (3rd range)

10 - 100  $\Omega$  (4th range)

700 W  
84.4.16  
S244P3A



Constant voltage mode: 5 - 60 V DC

Constant Current Characteristics.

Stability: 0.1% + 10 mA for loading voltage variation from 4 to 60 V

0.1% + 10 mA for line voltage variation by  $\pm 10\%$

Ripple and noise: 15 mA RMS

Temperature coefficient: 0.02%/°C (standard value)

Rise/fall time: 200  $\mu$ sec or less (when an internally installed oscillator is used).

Constant Resistance Characteristics.

Stability:  $\pm 10\%$  loading voltage variation:

(Stability)	(Input Voltage Variation)	(Setting resistance)
-------------	---------------------------	----------------------

	4 - 10 V	1 $\Omega$
--	----------	------------

	4 - 40 V	10 $\Omega$
--	----------	-------------

Stability  $\pm 10\%$  variation of line voltage: 0.1% + 10 mA

Temperature coefficient: 0.03%/°C standard value (at the minimum resistance value of a range).

Remote Control.

Constant current: External resistance 0 - 1000  $\Omega$

External voltage 0 - 10 V DC

Constant resistance: External resistance 0 - 1000  $\Omega$

Constant voltage: External voltage 0 - 10 V DC

Protecting Functions.

Overvoltage protection: Approx. 65 V DC

Overcurrent protection: Approx. 145 A DC

Overpower protection: Approx. 730 W

Wrong polarity input protection: By use of a diode

Overheating protection: 100°C  $\pm 5^\circ$ C at cooling package

Line input fuse rating: 1 A

700W  
24.4.16  
4767708

## Meters.

Maximum significant number for display: 1999

Ammeter accuracy:  $\pm(0.5\%$  of reading + 0.1% of F.S + 1 digit)  
at 20°C  $\pm 10^\circ\text{C}$

Voltmeter accuracy:  $\pm(0.1\%$  of reading + 0.1% of F.S + 1 digit)  
at 20°C  $\pm 10^\circ\text{C}$

Power meter accuracy:  $\pm(3\%$  of F.S + 1 digit) at 5 V or more and  
5 A or more

Constant voltage mode display: Yellow LED

Parallel operation: Control by one unit (master unit) is  
possible

## Oscillator.

Frequency: 10 - 100 Hz (1st range)  
0.1 - 1 kHz (2nd range)

Duty ratio: 20 - 80% or more (continuously variable)

## Insulation resistances

Between chassis and line: 500 V DC, min. 30 M $\Omega$

Between chassis and input terminals: 500 V DC, min. 20 M $\Omega$

Dimensions: 448W  $\times$  178H  $\times$  464D (mm) (largest parts)

Weight: Approx. 17 kg

## Accessories (in carton)

Instruction manual	1
Terminal Cover	1
Nuts M8N $\times$ 1.25	2
Screws M3 $\times$ 0.5 $\times$ 5 (polycarbonate)	2

## SECTION 2. OPERATION

The Model PLZ-700W is equipped with the complete derating function and protection features for consideration of various uses. However, in order to make the best use of the performance of this model while protecting the unit from unanticipated damages, the following items (points) on usage must be understood.

### 2-1. Notes Before Operation.

#### 1. AC Power Requirements.

Connect the power supply cable to a single phase 108 - 132 V, 48 - 62 Hz power source.

#### 2. Input Condition.

- o The loading voltage applied to the electronic load must be DC voltage. Never apply AC voltage.
- o The range of loading voltage to be applied is between 4 V and 60 V. (See Fig. 2-1-1).

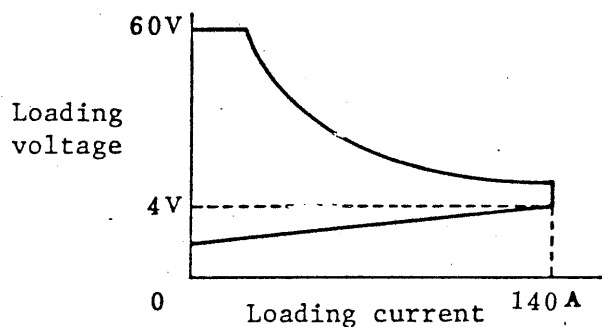

Figure 2-1-1

- o The polarity of the input terminal connection must be correct. If the input lines are connected in such a way that the polarity is reversed, the current will flow through a diode that is installed in parallel for main circuit protection. However, the wrong connection should be corrected immediately.
- o Note that if high level ripples and/or pulse-natured voltage in superposition exist instantaneous voltage may exceed the limit of loading voltage such that normal operation may be impaired.

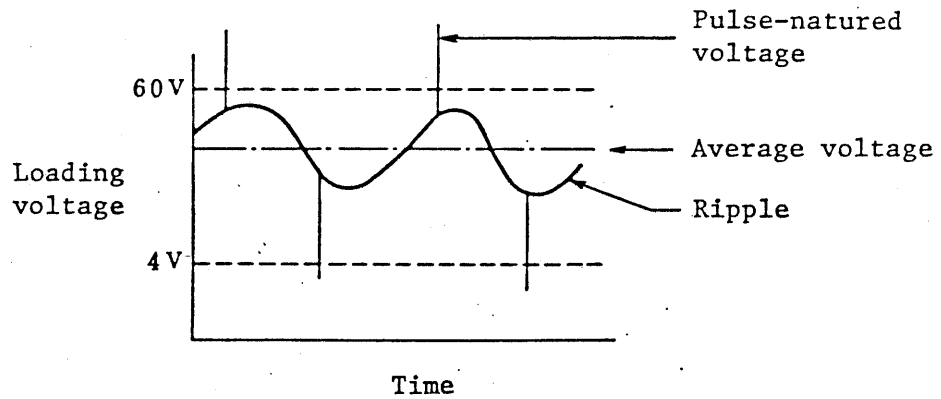

Figure 2-1-2

### 3. Loading Wire.

In the switching mode, distortion in current wave forms may occur due to a voltage drop below the minimum loading voltage caused by the inductance of parts of the cable line where the value of current changes suddenly. (See Fig. 2-1-3). Use cables as large in diameter and as short as possible to make the wiring connection to a load. Also, the positive and negative lines should be interlaced together to cancel inductance.

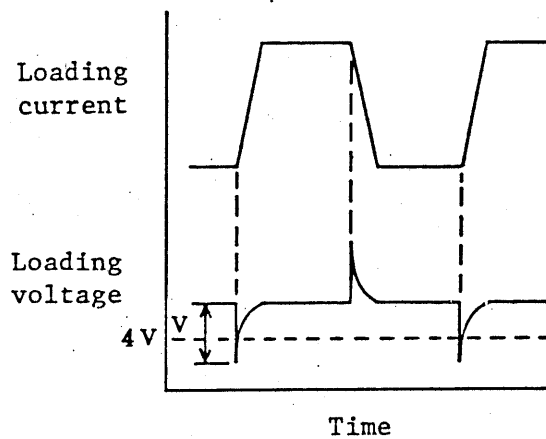

Figure 2-1-3

824497

$$V = L \frac{di}{dt}$$

where, L: inductance of wiring (H)

$\frac{di}{dt}$ : current change per time change (A/sec.)

Note: Current wave forms will be impaired when loading voltage drops to a value lower than 4 V due to a voltage drop (V) caused by inductance L.

For example, if a 4 m, 38 mm<sup>2</sup> cable is used for connecting a load, the output voltage value of a tested power supply source has to be 4 - 10 V, depending on the current to meet the voltage drop across the load.

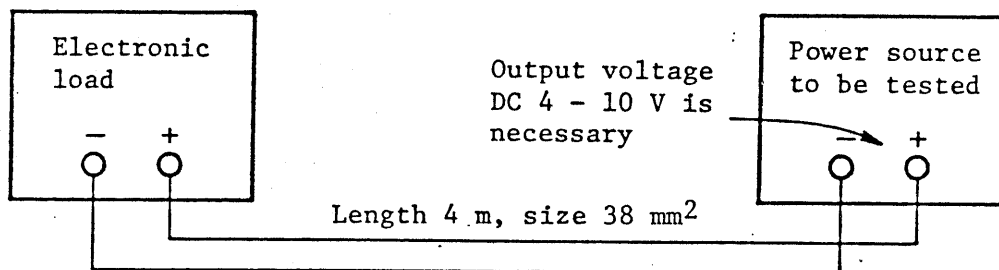

Figure 2-1-4

An insufficient output voltage of a tested power source causes an insufficient loading voltage to the electronic load due to the combined effect of the inductance and the ohm resistance of the wirings as explained previously, such that overshoot will occur on the current wave form as shown in Fig. 2-1-5. In such a case, increase the output voltage level of the tested power source, but use caution so that maximum power value does not exceed 700 W.

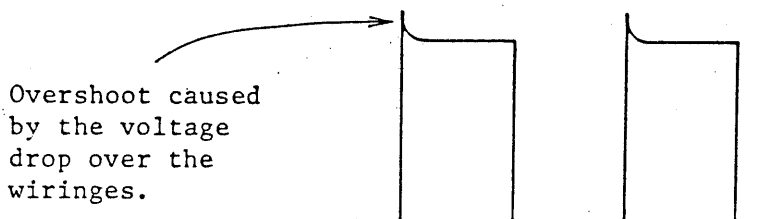

Figure 2-1-5

824498

Incidentally, if the maximum power capacity of an electronic load is exceeded under the switching mode, the electronic load unit will be protected by the automatic power supply limiting function. However, do not continue operation under such conditions. A current wave form in such a state is shown in Fig. 2-1-6.

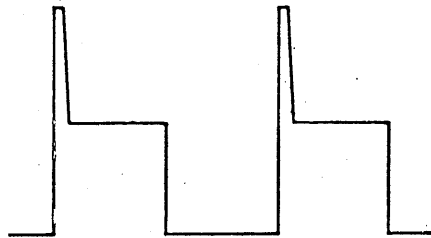

Figure 2-1-6

4. Ambient Temperature Range.

Operation of the instrument should be within a temperature range of 0 - 40°C. If operating temperature is abnormally high or if the fan blowout channel and/or the ventilation channel is blocked by objects, the current will be automatically cutoff by an installed temperature sensor. If this occurs, cool down the surrounding temperature and/or improve ventilating conditions, to correct the condition.

5. Selection of Installation Site.

Select a place where the ventilating channels and the blowout channel of the fan will not be blocked, and where there is as little vibration as possible.

6. Rear Terminal Board.

On the back panel, the load input terminals and the control terminals board are installed. The use of each control terminal is shown in Fig. 2-1-7.

824499

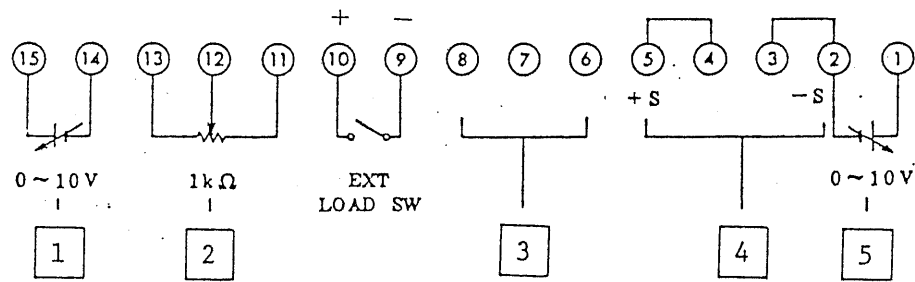

Figure 2-1-7

- 1 Constant current external voltage control input.
- 2 Constant current external resistance control.
- 3 One-controlled parallel operation input/output.
- 4 Constant voltage mode, sensor terminal.
- 5 Constant voltage mode, external voltage control.

PLZ 700W

89.5.15

824500A

2-2. Front and Rear Panel Descriptions:

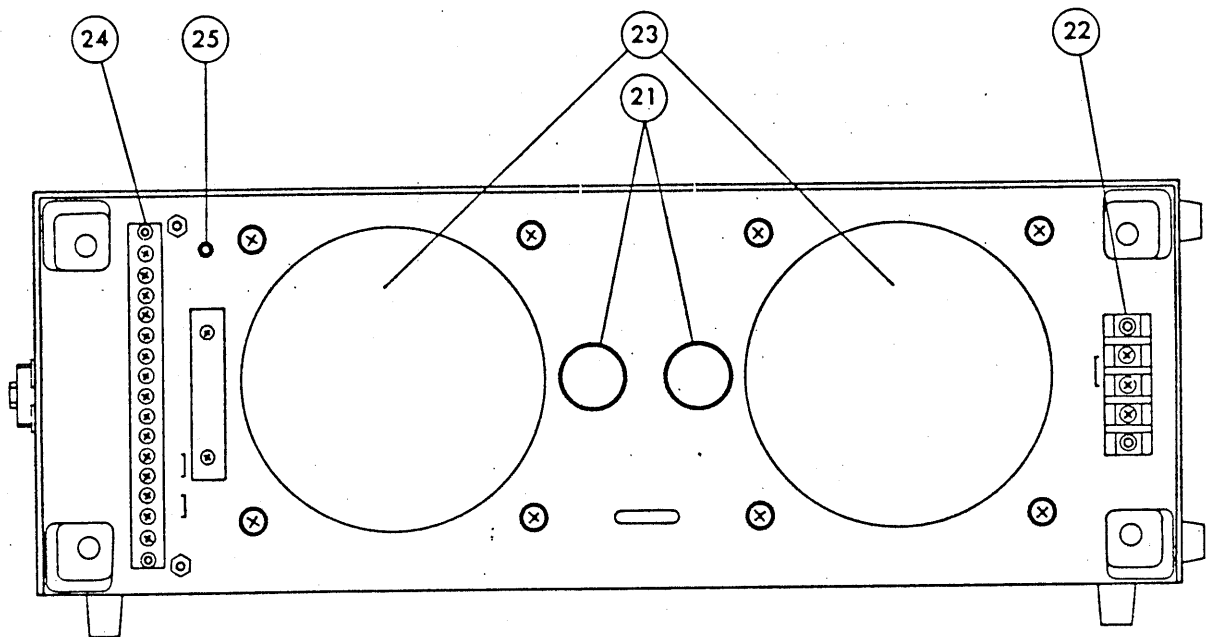
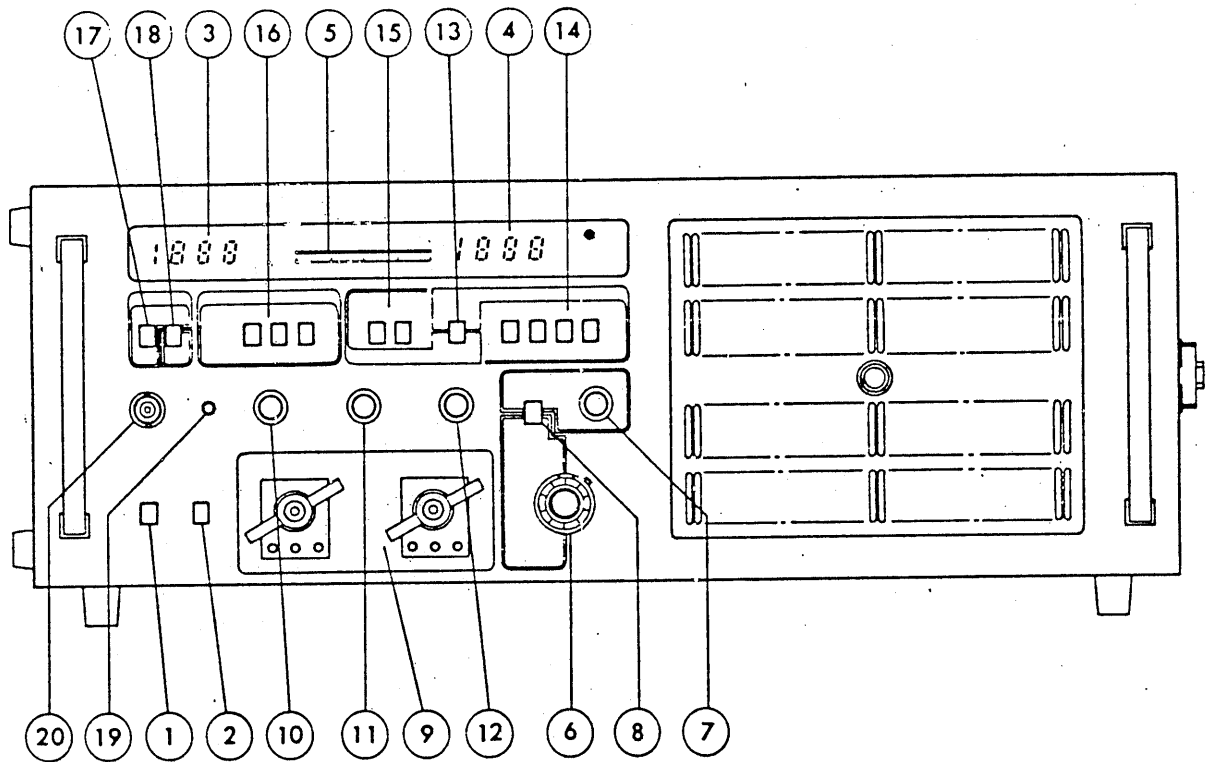

Figure 2-2-1

824501



Description of Panel Items

- ① POWER. Power supply switch.
- ② LOAD. DC input switch. Will be automatically turned off when the overvoltage and/or overheat protection circuit operates.
- ③ AMMETER. A 3-1/2 digit digital ammeter with an auto range. Input current value and preset value of current and resistance are indicated.
- ④ VOLTMETER. A 3-1/2 digit digital voltmeter. Loading voltage and loading power are indicated.
- ⑤ POWER INDICATOR. Normally indicates loading power. However, by depressing PRESET W button, power limit value will be indicated.
- ⑥ CURRENT I/RESISTOR. A 10-turn multi-dial to vary loading current value and load resistance value. Turning clockwise increases current value and decreases resistance value.
- ⑦ CURRENT II. A 5-turn dial to vary loading current II. Turning clockwise gives an increased current value. Used for setting bias current for switching mode.
- ⑧ MANUAL SW. Switch to select CURRENT I or CURRENT II. Selection of load CURRENTS I or II is made manually.
- ⑨ DC INPUT. Input terminals of the load.
- ⑩ FREQUENCY. Dial to adjust switching frequency. Frequency is increased as the dial is turned clockwise.
- ⑪ DUTY. Duty control dial of switching wave form.

824502

- 824503
- ⑫ CV MODE. A shunt regulator-type constant voltage power source. It is available by connecting to a constant current power source. Turning the dial clockwise starting from OFF position will increase loading voltage in the range from 5 V to 60 V. A yellow LED will be turned on at CV mode. (See details in 2-9.)
  - ⑬ MODE. Switch to select the constant current (C.C) mode or the constant resistance (C.R) mode.
  - ⑭ C.R RANGE. Switch to change resistance range in at the constant resistance mode.
  - ⑮ C.C RANGE. Switch to change the range for constant current mode.
  - ⑯ FUNCTION. Either of the following four constant current modes may be selected: EXT (External Voltage Control), INT (Manual Control), SW (Switching Operation), and DC (DC Operation).
  - ⑰ PRESET. By depressing this switch, current value or resistance value will be indicated on the digital ammeter depending on the state of the mode switch. At the constant current mode, current value may be preset by either CURRENT I or CURRENT II dial which is selected by the manual switch. At the constant resistance mode, resistance value may be preset by the CURRENT/RESISTOR dial.
  - ⑱ PRESET W INPUT POWER. Loading power (watt) is indicated on the voltmeter while power limit value is indicated on the power indicator.
  - ⑲ POWER LIMIT. Semi-fixed adjuster to change power limit value. The value may be set by use of the power indicator while depressing PRESET W switch.

- ⑳ CURRENT MONITOR. Current monitor terminals (5 mV/A). At the switching mode, current wave form and switching frequency and duty may be adjusted through an oscilloscope.
- ㉑ DC INPUT. Rear panel input terminals installed in parallel connection to DC INPUT terminals on the front panel.
- ㉒ 120 V AC 50/60 Hz. Power supply cable.
- ㉓ Fan Blowout Opening. Air blowout opening of clean package. Do not place anything sensitive to heat around the unit, since hot air is expelled. Also, be certain to place the unit at a distance of 30 cm or more from the wall.
- ㉔ Terminal Base. The terminal base is installed for external controls. (See Fig. 2-1-4). Terminals for the following operations are installed: External voltage control and resistance control under the constant current mode; external voltage control, sensing and one-controlled parallel operation; sensing under the constant voltage mode; and external control of the LOAD switch.
- ㉕ Option Unit Installation Holes. Screwed holes for installing the DPO series (Digital Programmable Options).

### 2-3. Initial Setting.

Each dial and switch should initially be set according to the following steps:

- |          |   |                      |   |
|----------|---|----------------------|---|
| Step 1.  | ① | POWER Switch         | OFF   |
| Step 2.  | ② | LOAD Switch          | OFF   |
| Step 3.  | ⑥ | CURRENT I/RESISTOR   | Counterclockwise extreme position                     |
| Step 4.  | ⑧ | MANUAL SW Switch     | Up position, CURRENT I                                |
| Step 5.  | ⑦ | CURRENT II Dial      | Counterclockwise extreme position                     |
| Step 6.  | ⑫ | CV MODE Dial         | OFF position at the counterclockwise extreme position |
| Step 7.  | ⑬ | MODE Switch          | Down position, C.R. RANGE                             |
| Step 8.  | ⑭ | C.R. RANGE Switch    | 0.1 - 1 $\Omega$                                      |
| Step 9.  | ⑮ | C.C RANGE Switch     | 140 A   |
| Step 10. | ⑯ | FUNCTION INT EXT     | Up position, INT                                      |
| Step 11. | ⑯ | FUNCTION DC SW       | Up position, DC                                       |
| Step 12. | ⑯ | FUNCTION 10 - 100 Hz | .1 - 1 kHz (Up position)                              |

After the above settings have been completed, proceed to the steps described in the following section (2-4).

#### 2-4. Operation in the Constant Resistance Mode,

The instrument has characteristics similar to an ohmic resistance,

1. Connect the power supply plug to the AC line (120 V 10%, 50/60 Hz).
2. Turn on the POWER switch. But keep the LOAD switch in the off position.
3. Connect the DC INPUT terminals to the voltage source to be tested according to Fig. 2-4-1.

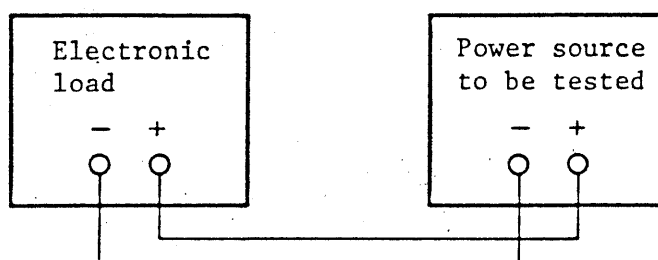

824505

4. Set the MODE switch to the C.R RANGE and the range switch at a desired value of resistance.

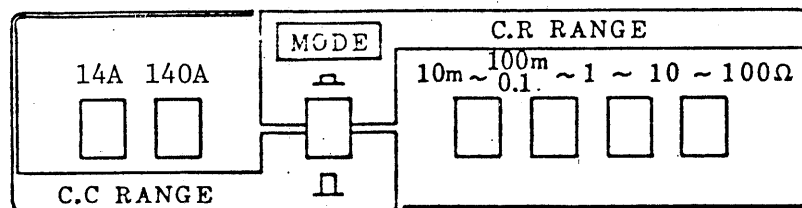

"DOWN" Position: Resistance mode

"UP" position: Constant current mode

Figure 2-4-2

A locking-type push button. DOWN Position: Resistance mode;  
UP Position: Constant current mode.

5. Turn on the LOAD switch for current flow. The current value may be adjusted by the CURRENT I/RESISTOR 10-turn multidial. Turning it clockwise will decrease the resistance value and increase the current value. A resistance value may be preset beforehand. The method is discussed in 6.

6. Method of Presetting a Resistance Value.

- 1) Select a value to be preset in the CR range. Depress the A/Ω switch and the resistance value will be indicated on the digital ammeter A/Ω.

Note: A resistance value to be preset is an approximate value. There is a 3% error at the minimum resistance of a range, and a 30% error at the maximum resistance of a range.

- 2) While depressing PRESET A/Ω switch, preset a resistance value with the CURRENT/RESISTOR dial.

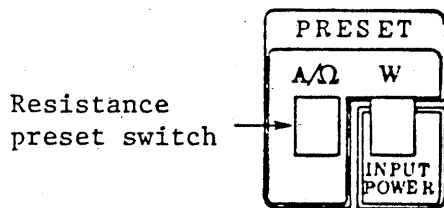

Figure 2-4-3

7. Characteristics of Input Impedance in the Resistance Mode.

The value of resistance is kept constant with DC, while it may vary with AC. The typical input impedances available under the resistance mode of this PLZ-700W unit are shown in Fig. 2-4-4. The nature of these impedances are similar to the impedance characteristics of a common sliding resistor (Slidak) except that more capacitance will appear at higher resistance.

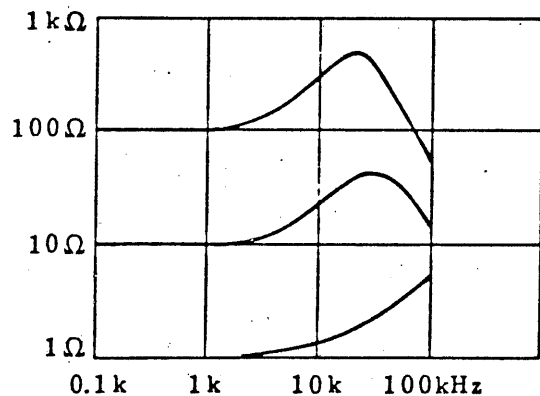

Figure 2-4-4 Impedance Characteristics of PLZ-700W

824507

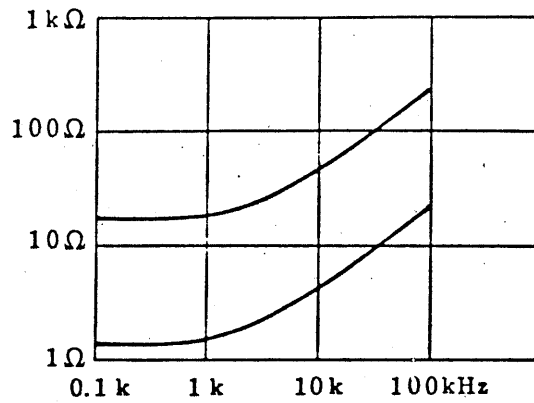

Figure 2-4-5 Impedance Characteristics of a Common Sliding Resistor

2-5. Graph of Resistance Range and Power Limit Relation.

This unit may be used within the limits shown by Fig. 2-5-1. If the limit is exceeded, the protecting circuit will function automatically. (See the following detailed illustrations.)

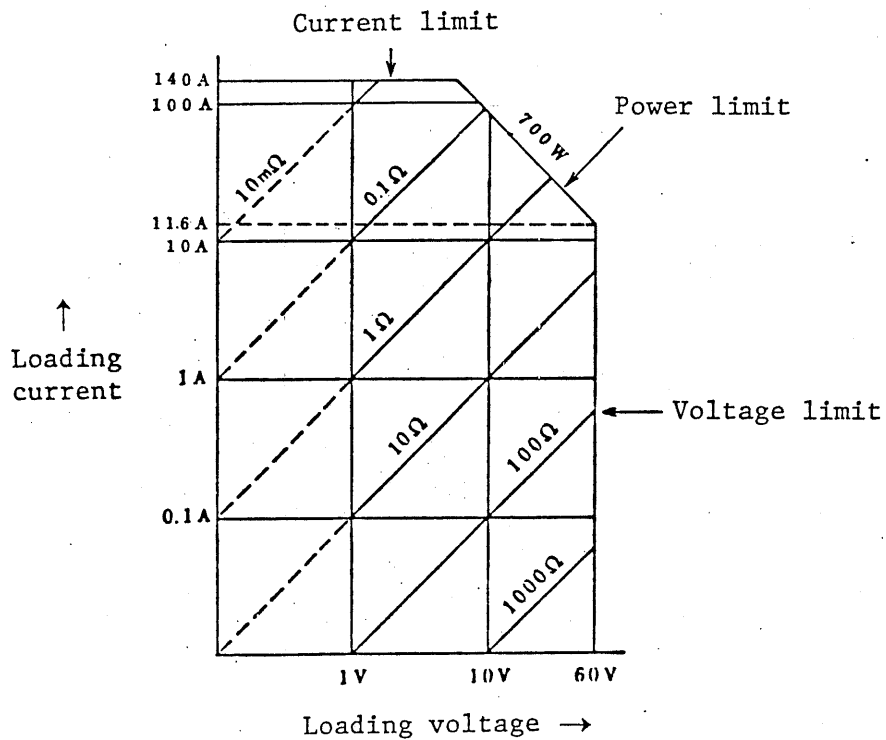

Figure 2-5-1

824508

Relation between resistance range and power limiter.

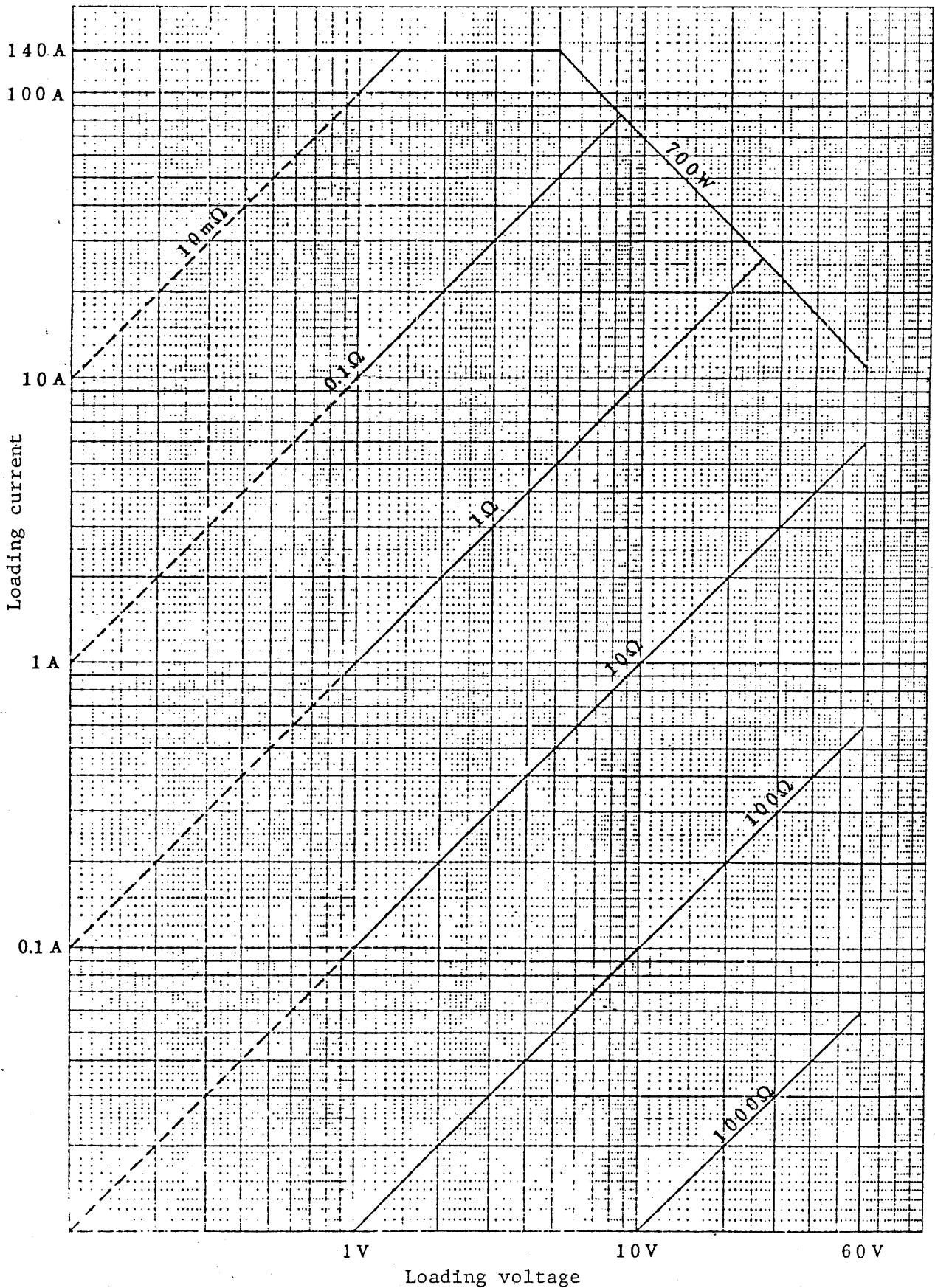

Figure 2-5-2 Magnified illustration of Fig. 2-5-1

602779



2-6. Operation in the Constant Current Mode.

- o Constant current characteristics are provided. A constant value of current will be supplied to the loading voltage in the range of 4 V - 60 V DC.
- o Control by external voltage and switching action may be performed.

Step 1. Connect the power cord to an AC line voltage of 120 V  $\pm$ 10%, 50/60Hz.

Step 2. Turn on the POWER switch. But keep the LOAD switch in the off position.

Step 3. Connect the DC INPUT terminals of this unit to the power source to be tested, see Fig. 2-6-1.

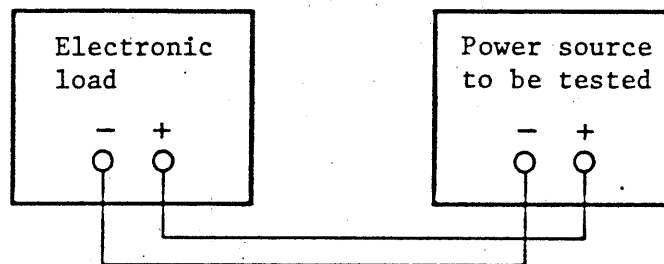
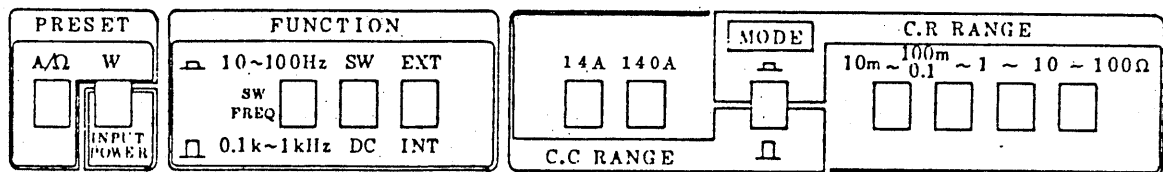

Figure 2-6-1

Step 4. After setting the MODE switch to C.C RANGE, set the range switch at a desired value.

Step 5. Set EXT/INT switch of FUNCTION to INT, and set SW.DC switch to DC.



"DOWN" Position: Resistance mode;

"UP" Position: Constant current mode.

Figure 2-6-2

Step 6. Set the MANUAL SW switch to "CURRENT I."

Step 7. Turn on the LOAD switch to initiate current flow.

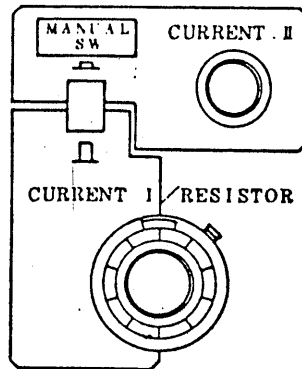

Figure 2-6-3

Step 8. The current value may be varied with the CURRENT I/RESISTOR multi-dial.

Step 9. With the MANUAL SW switch set at "CURRENT II," the current value may be varied with the CURRENT II dial. When the MANUAL SW switch is turned, either CURRENT I or CURRENT II may be used accordingly.

#### How to Preset a Current Value.

A current value may be preset according to the following steps:

- Step 1. Turn off the LOAD switch. Or leave the unit under test disconnected.
- Step 2. Depress the PRESET A/ $\Omega$  switch, and the current value will be indicated on the digital ammeter.
- Step 3. Set a desired current value with the CURRENT I multi-dial or with the CURRENT II dial.
- Step 4. After a unit is connected, turn on the LOAD switch and the preset value of current will be supplied.

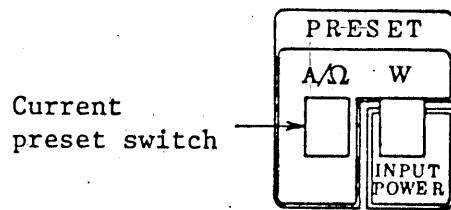

Figure 2-6-4

Characteristics of Impedance in Constant Current Mode.

This unit has an ideal constant current characteristic in the DC range. However, the impedance will be lowered in the AC range as the frequency increases. Fig. 2-6-5 shows the typical input impedance characteristics, in which the impedance starts to fall at 10 kHz.

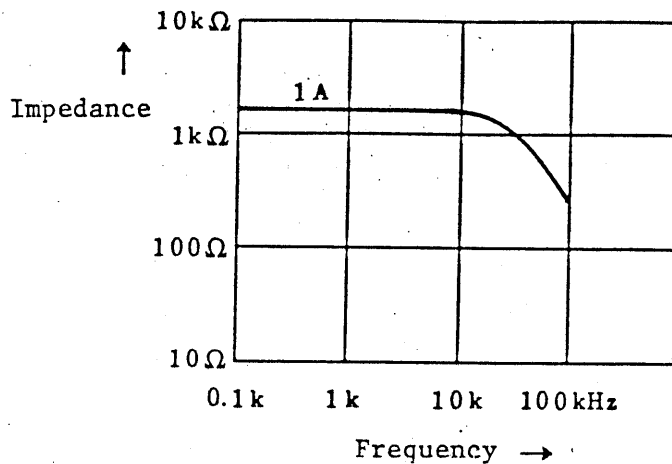

Figure 2-6-5

2-7. Operation in the Switching Mode.

Switching of the constant current mode is possible.

- Step 1. Set the SW/DC portion of the FUNCTION switch to the "SW" (DOWN) position.
- Step 2. After pressing the preset (A/Ω) button, set a desired current value with the CURRENT I and II dials.

824512

- Step 3. Set the **FREQ** portion of the **FUNCTION** switch to a desired frequency range.
- Step 4. Turn on the **LOAD** switch.
- Step 5. The switching frequency may be varied with the **FREQUENCY** dial, switching duty cycles may also be varied with the **DUTY** dial.

Through an oscilloscope connected to the **CURRENT MONITOR** terminals, frequency and duty (values) may be observed (only during operation).

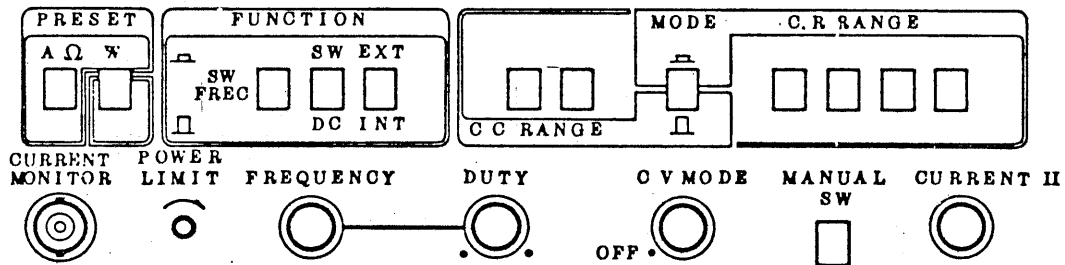

Figure 2-7-1

In the switching mode the two respective current values set by **CURRENTS I** and **II** will be taken alternately. The action of the **MANUAL SW** switch, which is mentioned in the preceding 2-6., Step 8., is performed electronically with the use of an oscillator.

**Note:** If the preset button (A/Ω) is depressed during switching operation, the switching action will be interrupted and the preset value of current will be indicated.

824513

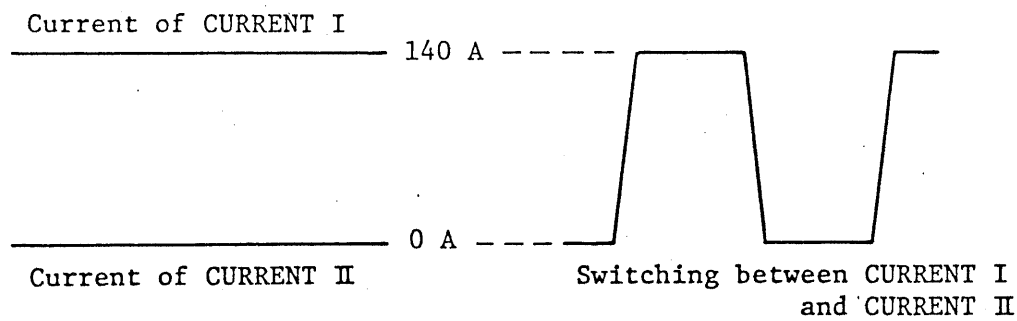
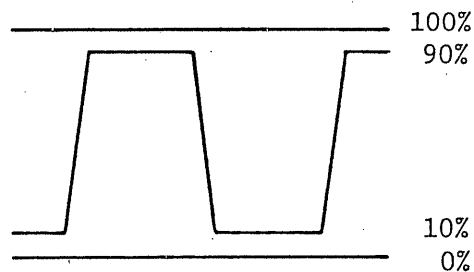

Figure 2-7-2



As shown in the illustration at the bottom right corner of Fig. 2-7-2, a test for setting at the 90% value of CURRENT I and the 10% value of CURRENT II may be easily performed, for example. The interval period of CURRENTS I and II may be adjusted as shown in Fig. 2-7-3, using the duty control dial.

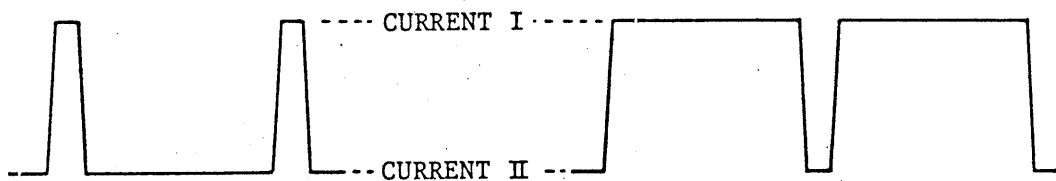

Figure 2-7-3

2-8. Operation in the Constant Voltage Mode.

1. This mode is available by applying a constant current power source to the DC INPUT terminals with the shunt regulator method. This mode is used mainly for tests and adjustments of the current limit characteristics of a DC constant voltage stabilizing power source having power capacity of 700 W or less. Fig. 2-8-1 shows the basic circuit diagram.

824514

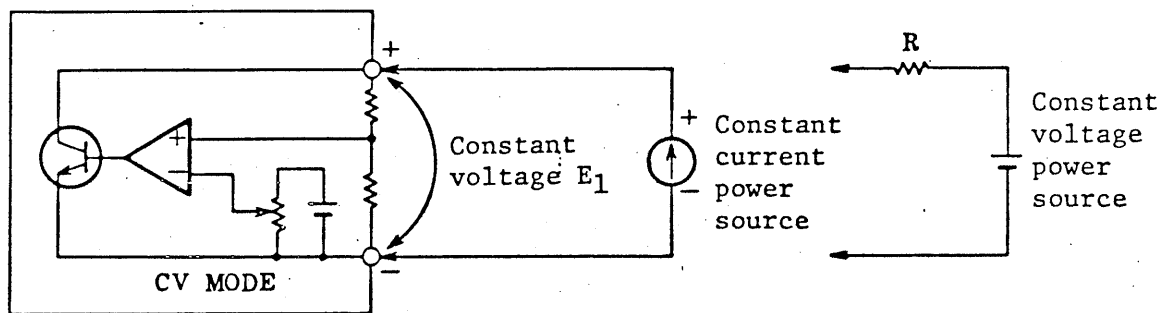

Figure 2-8-1

As shown by the Fig. 2-8-1, connecting a constant voltage power source, to which a constant current power source or an impedance is connected in series, a shunt regulator is constituted. The value of the constant voltage  $E_1$  may be varied within the range of 5 V - 60 V DC with use of the CV dial. A yellow LED will be lit during the CV mode. The operating method for the constant voltage mode is explained below:

Step 1. Set dials and switches as follows:

MODE	CC/140 A
FUNCTION	DC, INT
MANUAL SW	CURRENT I
CURRENT I	Turn clockwise to the extreme position.
Power Limiter	700 W

Step 2. Turn the CV mode dial clockwise from the "OFF" position to disconnect the switch.

Step 3. Connect the power supply source to the unit. Observe correct terminal polarity.

Step 4. Turn the POWER switch and the LOAD switch on.

Step 5. Set a desired voltage value with the CV mode dial. (See Fig. 2-8-3). A yellow LED will be lit during the constant voltage mode. If the LED is not lit one of the following may be the cause:

- a. The unit is not in the constant voltage mode.
  - b. The power source, which is connected to this unit for test, has a current limit of 140 A or more.
  - c. Output power capacity of the power source to be tested exceeds 700 W.
2. Remote Sensing for Setting an Loading Voltage Value Precisely.

Remove the jumpers connecting terminals 2 and 3, and terminals 4 and 5, which are on the terminal board on the rear panel. Connect terminal 5 to the positive stabilizing point, and terminal 2 to the negative stabilizing point, use shielded cables. (The shield shell should be connected to terminal 2. See Fig. 2-8-2.)

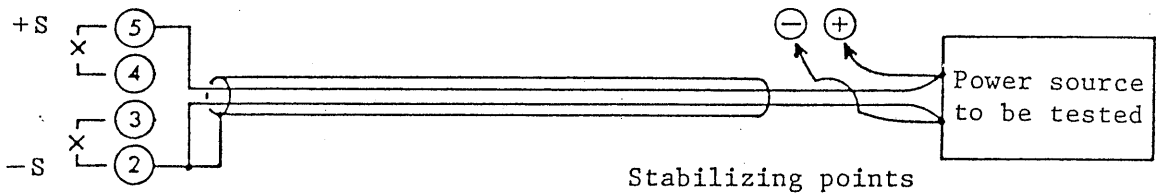

Figure 2-8-2

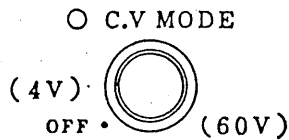

Figure 2-8-3

The loading voltage will be increased as the CV dial is turned clockwise. For example, if there is a power source to be tested with the output capacity of 10 V/10 A and it is desired to alter the output to 9 V/11 A, proceed as follows:

824516A

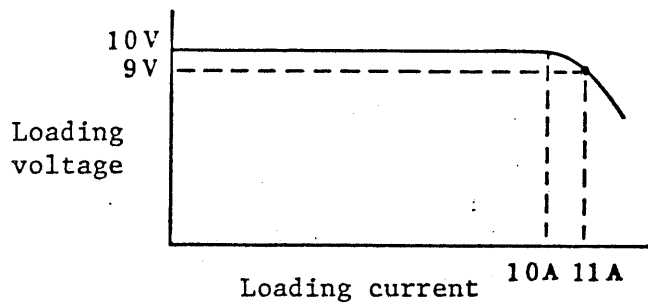

Figure 2-8-4

- a. Set the output voltage value of the power source to be tested to 9 V, by adjusting the CV mode dial. This voltage is indicated on the digital voltmeter of the electronic load.
- b. Adjust the current limit value of the power source under test, to 11 A.

The above method may be applied to any current control method, including the example cases shown in Fig. 2-8-5.

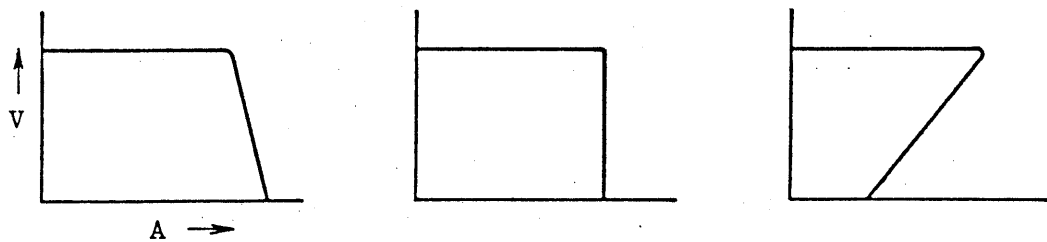

Figure 2-8-5

## 2-9. Indication of Loading Power.

1. Loading power to the electronic load is indicated on the power indicator. But the value also may be indicated in digital figures with the precision of  $\pm 3\%$  F.S +.1 digit. The loading power indicator/switch in Fig. 2-9-1 is commonly used for presetting the power limit.

824517



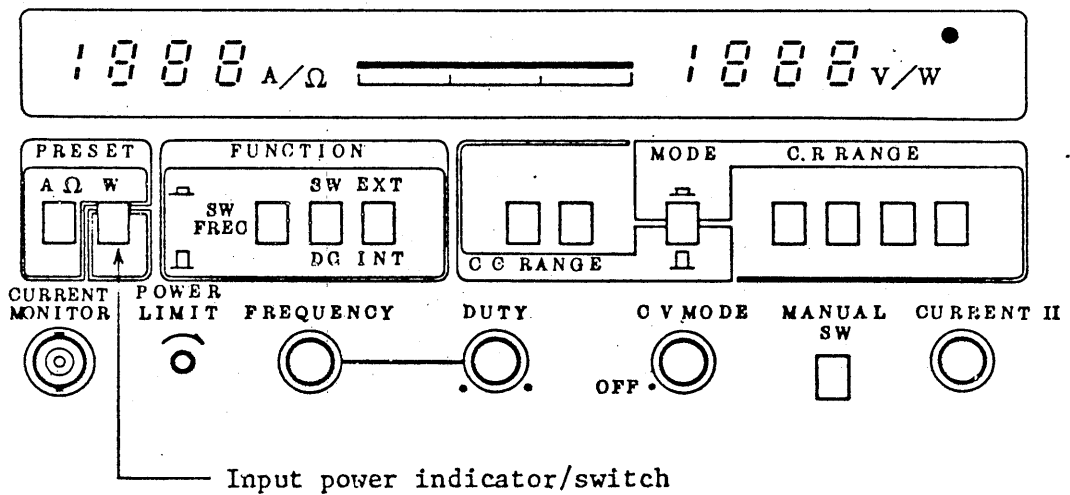

Figure 2-9-1

2-10. Presetting the Power Limit.

The power limit of the electronic load has been set at 700 W, However, any desired value lower than that may be set with the half fixed POWER LIMIT adjuster on the panel. Power limit adjustments can be done as follows:

- Step 1. Turn the load switch to the off position.
- Step 2. Press the PRESET W switch, and the power indicator will light up to the 700 W range.
- Step 3. While pressing the PRESET W switch, turn the POWER LIMIT dial counterclockwise using a small screw driver. The value on the indicator will be decreased, and set at a desired value. However, setting a power limit by the above method cannot be performed with high precision because of the low resolution of the bar graph. For a precise setting, after loading, adjust the power limit while referring to the digital indication of loading power on the voltmeter.

824518

2-11. Remote Control with an External Resistance (Constant Resistance or Constant Current)

The CURRENT I/RESISTOR part of the panel may be controlled externally by a remote control system employing a variable resistor.

1. To have access to the internal operation/external operation switch which is installed inside the unit case remove the top cover. (See Fig. 2-11-1.)

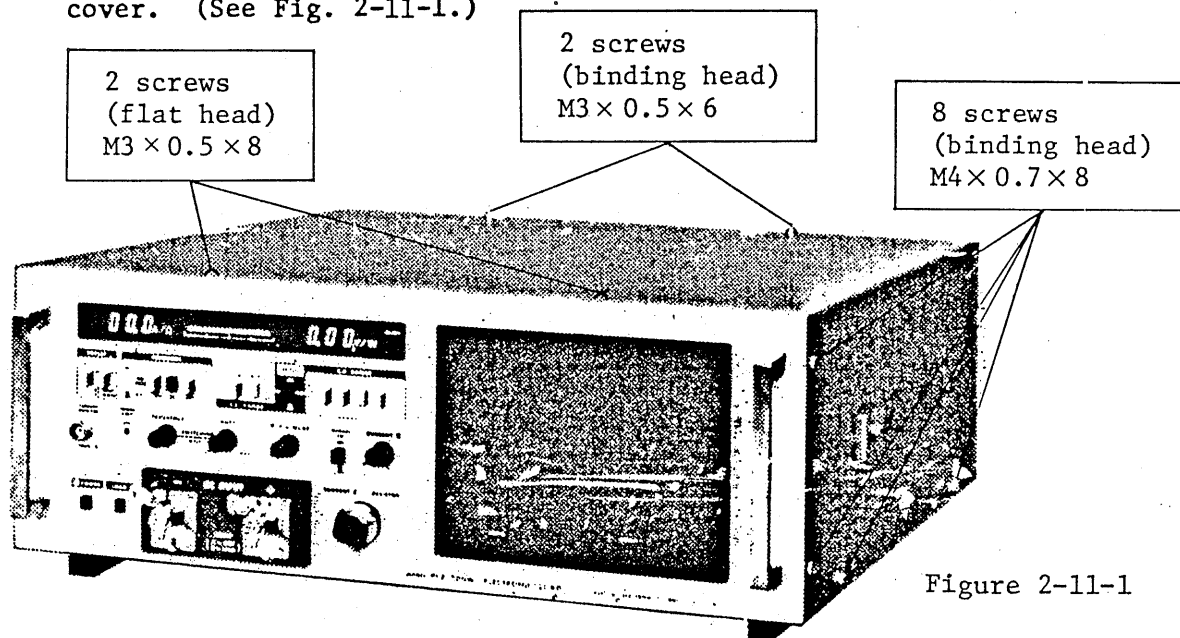

Figure 2-11-1

2. Set the slide switch on the printed circuit board to "EXT". See Fig. 2-12-2.

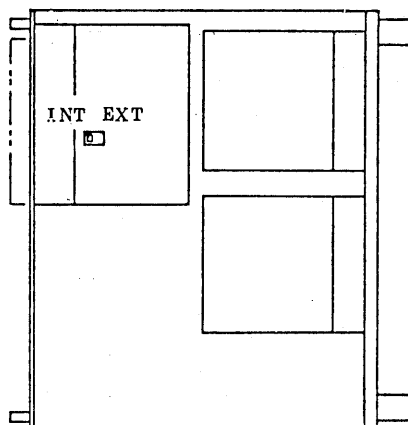

Figure 2-11-2

824519

3. Connect a 1 k $\Omega$  variable resistor to the terminal board on the rear panel, as shown in Fig. 2-11-3. The variable resistor should be a 10-turn potentiometer.

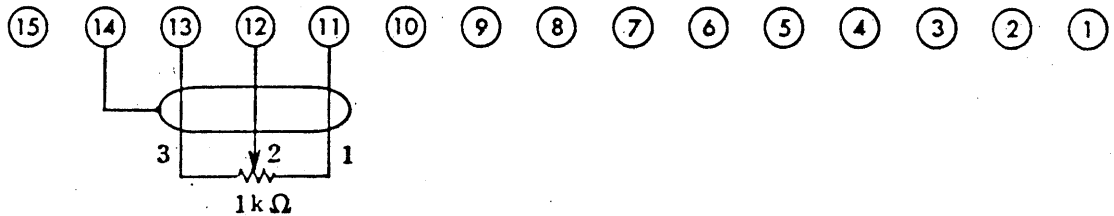

Figure 2-11-3

2-12. Remote Control with an External Voltage (Constant Current only).

1. Set the panel switches as follows:

FUNCTION	DC, EXT
MANUAL SW	CURRENT I
MODE	C.C (140 A range)

2. Turn the CURRENT I dial clockwise to the extreme position.
3. Apply the controlling voltage between terminals 14 and 15 on the rear panel, as shown in Fig. 2-12-1.
4. The relation between control signal voltage and loading current is adjusted such that the corresponding current to an input of 10 V, will be 140 A, as indicated in Fig. 2-12-2. The current value may be decreased with the CURRENT I dial. The control signal voltage should not exceed 10 V.

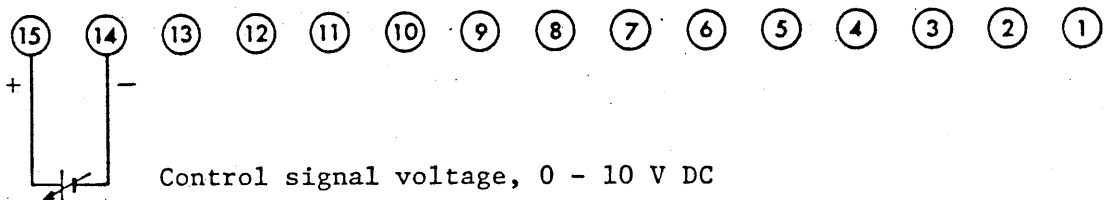
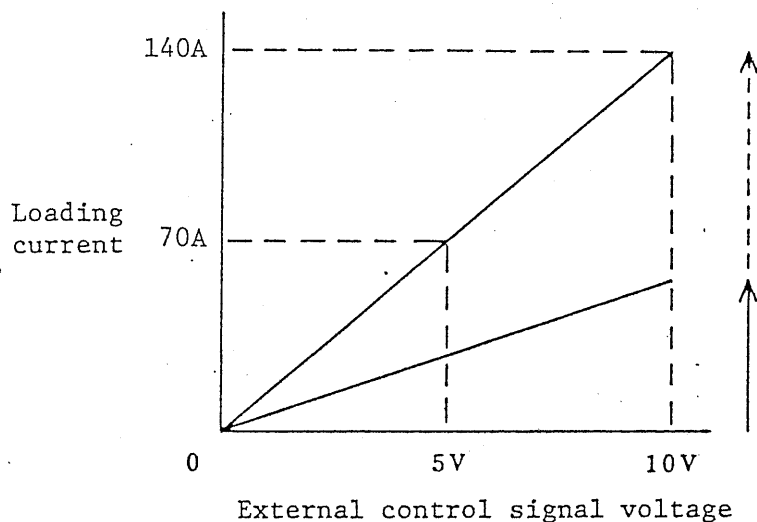

Figure 2-12-1

824320



May be varied with the CURRENT I dial.

Figure 2-12-2

2-13. Remote Control of Load Switch by an External Terminal.

- As shown in Fig. 2-13-1, connect the external load switch between terminals 9 and 10 on the terminal board. The switch capacity should be around 125 V AC at 1 A.

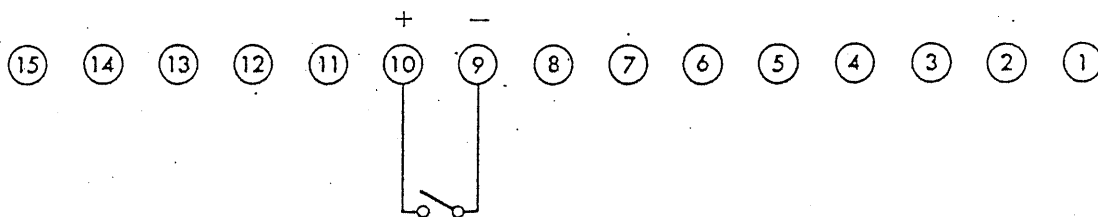

Figure 2-13-1

- Turn off the LOAD switch on the panel. Now it is ready for switching load with the external load switch. (The LOAD switch on the panel and the switch connected between terminals 9 and 10 are in a parallel connection.)

2-14. One-control Parallel Operation.

This is a method to increase current capacity by connecting a number of units in parallel. These units operate under the control of one unit called a master unit.

PLZ 700W

89.5.15

824521A

1. Turn off the power supply switch. Connect the terminals of each of the units as shown in Fig. 2-14-1. The length of the loading wire cables to each of the units should be approximately the same. Also, note if electrical potential of the negative input terminal of a unit is different from the others, the current generated by the unit will be imbalanced.

Rear Panel Control Terminal Board

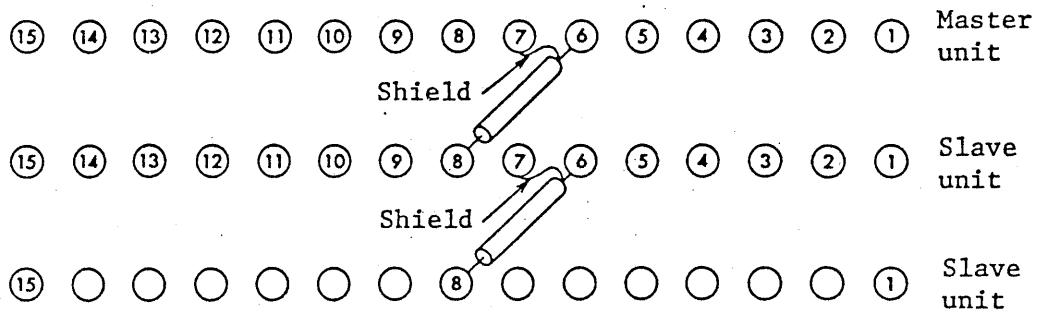

Rear Panel Input Terminal Board

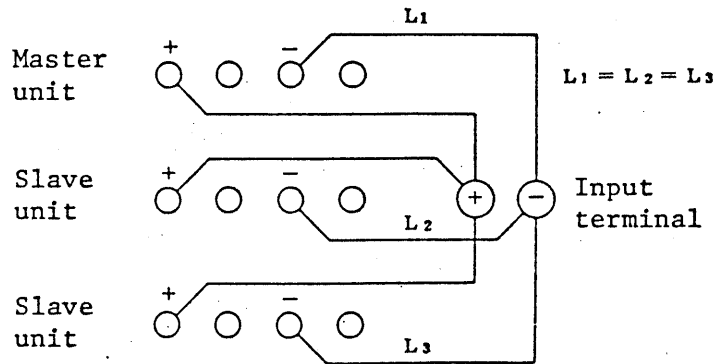

Figure 2-14-1

2. Set both the C.C RANGE push buttons for each of the slave units, 140 A and 14 A, at "UP" position, as shown in Fig. 2-14-2.

8245222

Slave unit

Master unit

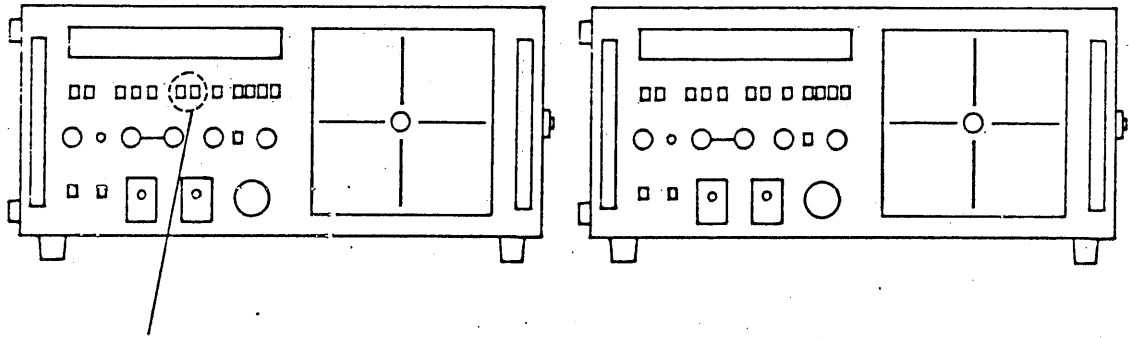

Set at "UP" positions.

Figure 2-14-2

3. Before turning on the power supply switch, the POWER switch and the LOAD switch of each unit must be turned off. Switches other than the C.C RANGE switch, the POWER switch and the LOAD switch, of each slave unit, may be in any position.
4. When starting to operate, turn on the power supply switch of the master unit first, then, of the slave units. When the operation is finished, the power supply switch of the master unit must be turned off last, following those of the slave units. There may be a 10% difference among the currents generated from each unit, due to the error on the internally installed current detecting resistor unit and because of the resistance imbalance on the loading cable wirings.

### 2-15. Installing the Terminal Cover

The terminal cover which is supplied as an accessory item can be installed on the input terminal board of the front panel. To install the terminal cover, remove the wing nuts and fix the cover with the M6×1 nuts (supplied as accessory items) as shown in Figure 2-15-1.

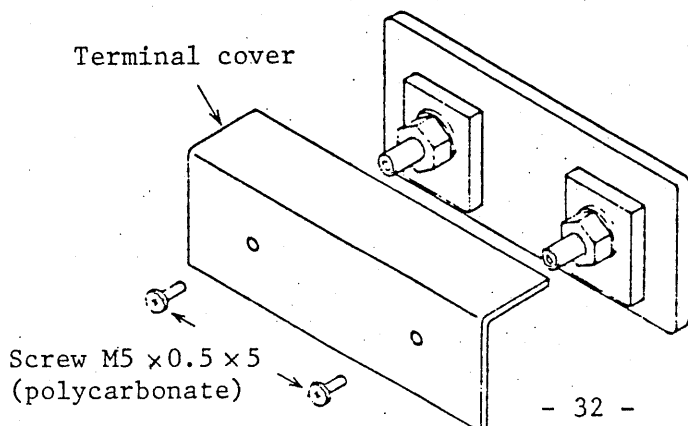

Figure 2-15-1

824523

### SECTION 3. OPERATING PRINCIPLES

#### 3-1. Constant Current Operation.

A negative feedback circuit using an error comparative amplifier is installed such that reference voltage  $E_{ref}$  and the voltage drop over the current detecting resistance have the same value, as shown in Fig. 3-1-1.

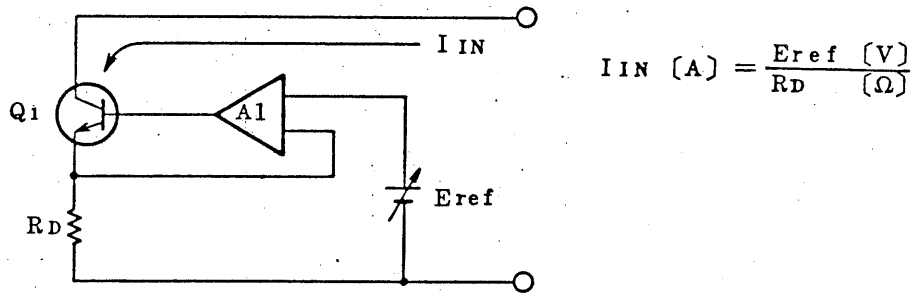

Figure 3-1-1

Consequently, the loading current  $I_{in}$  is determined only by the reference voltage  $E_{ref}$  and the detecting resistance  $R_D$ ; and the circuit works as a constant current load which is independent of the loading voltage. The typical frequency characteristic of the output impedance is shown in Fig. 2-7-5. A decrease in the gains of the error amplifier ( $A_1$ ) and the power transistor  $Q_1$  causes a decrease in the output impedance at higher frequencies. A resistance value which is within the range of  $10\Omega$  or larger will decrease as frequency increases, due to the  $C_{ob}$  and the distributed capacity.

#### 3-2. Constant Resistance Operation.

Negative feedback is applied by an error amplifier as shown in Fig. 3-1-2, to create current flow proportional to the input voltage.

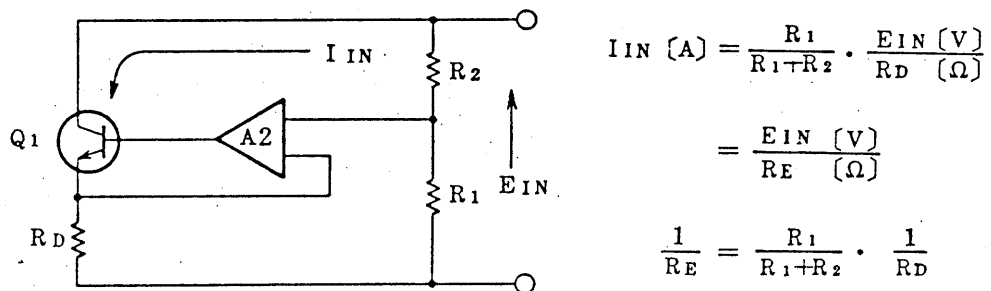

Figure 3-1-2

Consequently, the apparent equivalent resistance value seen from the input side  $R_E$  will be determined only by the partial ratio  $R_1/(R_1 + R_2)$  of the loading voltage and the current detecting resistor  $R_D$ . The frequency characteristics of the resistance are similar to that shown in Fig. 2-3-4. The resistance value, which is within the range of  $1 \Omega$  or less, will increase as frequency increases because the gains of  $A_2$  and  $Q_1$  will decrease and the inductance due to the internal wiring will increase at a higher frequency range.

824525



3-3. Block Diagram.

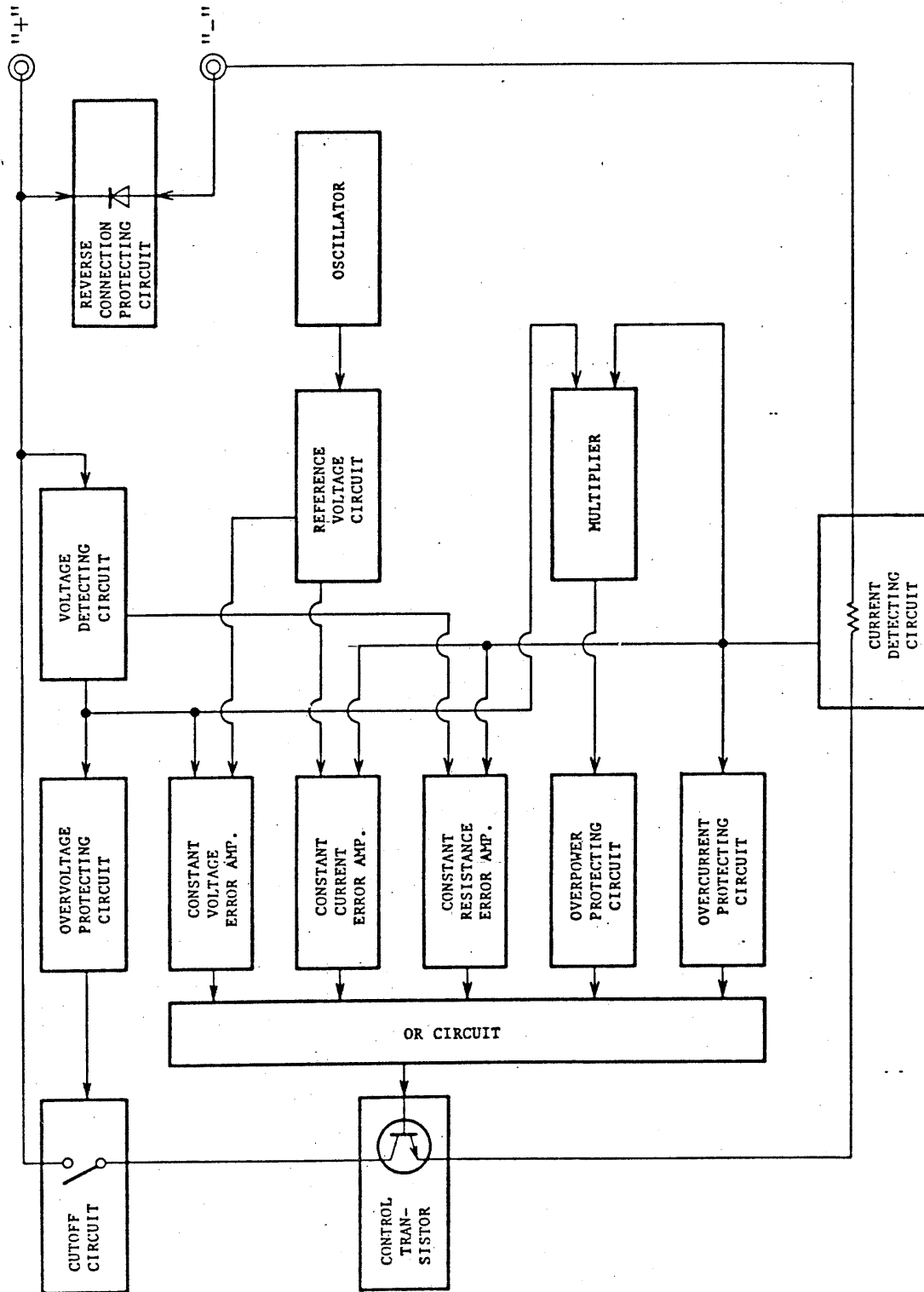

Figure 3-3-1 Block Diagram of PLZ "W" Series.

824526

## SECTION 4. MAINTENANCE

### 4-1. How to Open the Chassis Case.

Detach the screws and the bolts shown in Fig. 4-1-1.

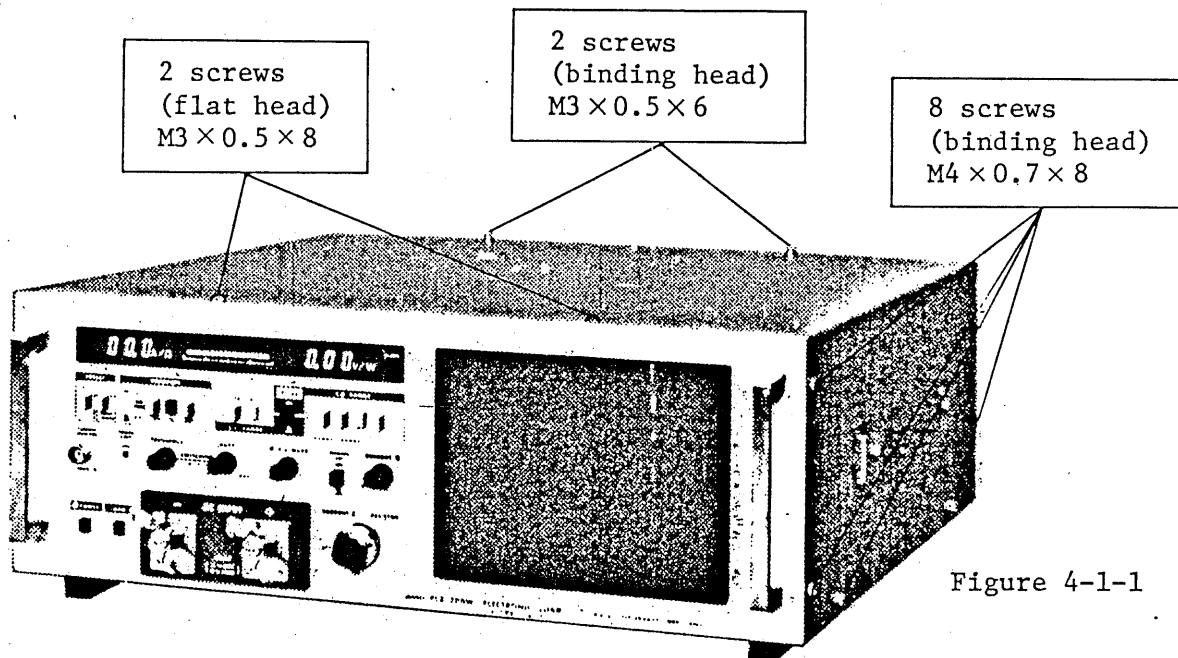

Figure 4-1-1

### 4-2. Inspections and Cleaning.

Routine inspections and cleaning are recommended for maintaining the optimal level of performance.

#### 1. Cleaning.

Softly wipe the surface with a dampened cloth using a diluted neutral detergent or alcohol, and then wipe the surface again with a dry cloth. Do not use benzene or any kind of thinner. Use a compressor or vacuum cleaner to blow off dust accumulated in the ventilating channel of the case and inside the case.

#### 2. Inspection of Power Supply Cable.

Check for breakage in the vinyl cover layer and for loose or cracked plugs.

#### 4-3. Calibration.

##### 1. Calibration of voltmeter and ammeter.

Fig. 4-3-1 shows the location of the adjustments for calibration of the voltmeters and ammeters.

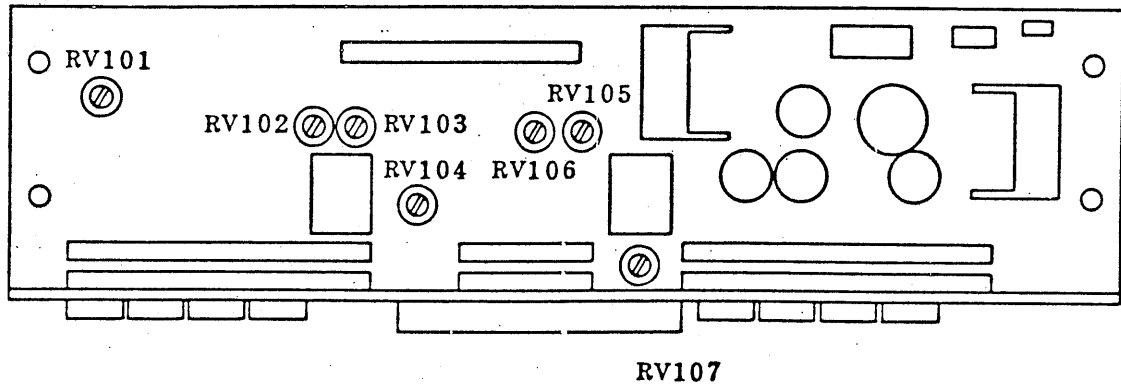

Figure 4-3-1

RV101	Ammeter Auto Range Adj
RV102	Ammeter Low Range Adj
RV103	Ammeter High Range Adj
RV104	Voltmeter Auto Range Adj
RV105	Voltmeter Low Range Adj
RV106	Voltmeter High Range Adj
RV107	Bar Graph Adj

Calibration work on voltmeters and ammeters should be performed after 30 minutes of warming up with loading voltage across the PLZ.

#### Instruments to be Used for Calibration.

1 digital multimeter (Kikusui Model 1504 or equivalent).

1 variable resistor for calibrating current (200 A, 100 mV, 0.2% or less).

1 DC constant voltage stabilizing power supply unit (output: 60 V or more, 140 A or more).

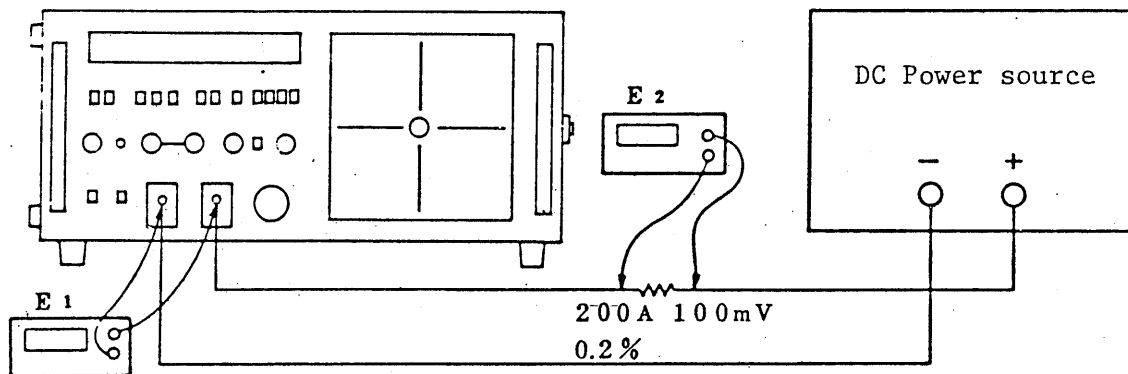

Figure 4-3-2

Connection to the electronic load should be made as shown in Fig. 4-3-2. Calibration of a voltmeters is made based on  $E_1$ , and calibration of an ammeter is made based on  $E_2$  which may be converted to a current value.

Calibration Procedures:

1) Calibration of Voltmeter

- Step 1. Apply a voltage such that  $E_1$  indicates 60.000 V. And then adjust RV106 so that the indication of the voltmeter becomes 60.0 V.
- Step 2. Apply a voltage is such that  $E_1$  indicates 19.000 V, and then adjust RV105 so that the indication becomes 19.00 V.
- Step 3. Adjust RV104 so that the auto range function works in the current range from 19.90 V to 19.95 V,

2) Calibration of Ammeter:

- Step 1. Adjust the current to make  $E_2$  indicate 70.00 mV, and then adjust RV103 so that the indication is 140.0 A.
- Step 2. Adjust the current to make  $E_2$  indicate 7.00 mV and then adjust RV102 so that the indication is 14.00 A.

824529

Step 3. Adjust RV101 so that the auto range function may work in the current range from 19.9 A to 19.95 A.

824530