

Part No. Z1-001-542, IB000606

Nov. 2007

## Operation Manual

---

AC POWR SUPPLY  
PCR-W SERIES

**PCR 2000W**  
**PCR 4000W**  
**PCR 8000W**  
**PCR12000W**

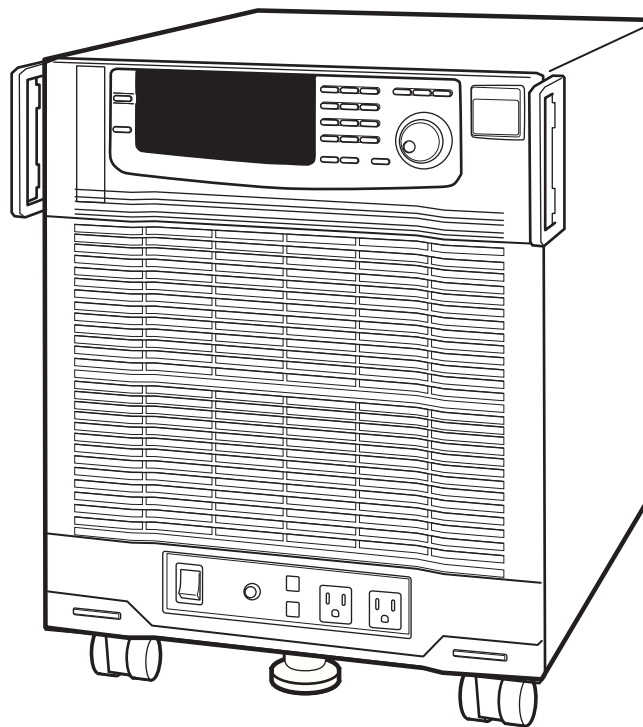

## About this manual

We recommend that you read this manual thoroughly beforehand to ensure correct operation of the product. Be sure to store the manual in safe place so that you can use it whenever necessary. When the product is relocated, be sure to the operation manual be included.

All or any parts of this manual may not be reproduced in any forms, without express written permission of Kikusui Electronics Corporation.

The contents of this manual, including the specifications of the instrument, are subject to change without notice.

Copyright© 1996-2007 Kikusui Electronics Corporation

# ⚠ SAFETY PRECAUTIONS

The following safety precautions must be observed to avoid fire hazard, electrical shock, accidents, and other failures. Keep them in mind and make sure that all of them are observed properly. Kikusui assumes no liability against any damages or problems resulting from negligence of the precautions.

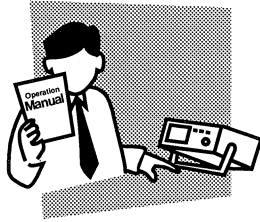

## **Users**

This product is for qualified personnel.

- The product must be used only by qualified personnel who understand the contents of this operation manual.
- If it is handled by disqualified personnel, personal injury may result. Be sure to handle it under supervision of qualified personnel (those who have electrical knowledge.)

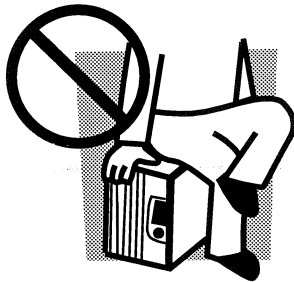

## **Purposes of use**

Do not use the product for special purposes.

- If the product is to be used for purposes not described in this manual, contact your Kikusui agent in advance.

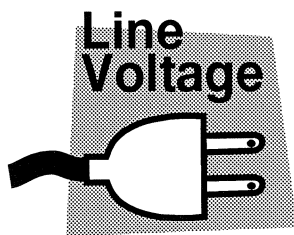

## **Input power**

- Use the product with the rated input power voltage.
- For applying power, use the AC power cable provided.

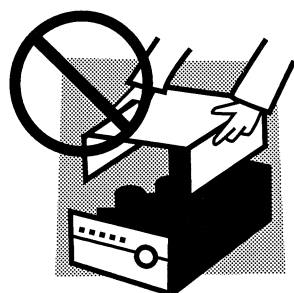

## **Cover**

Do not remove the external cover.

- There are parts inside the product which may cause physical hazards.

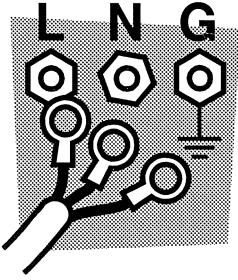

## Grounding and Connecting

Ground the product.

- To avoid electrical shock, connect the protective ground terminal to electrical ground (safety ground).
- When applying power to the products from a power distribution board, be sure work is performed by a qualified and licensed electrician or is conducted under the direction of such a person.
- Be sure to use the AC power cable provided. Consult your Kikusui agent if other cable than included is to be used for some reason.

## Installation

- When installing the product be sure to observe "Installation and Location" described in this manual.
- When installing the product, be sure to lock the casters.

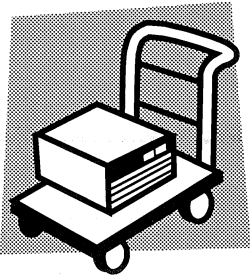

## Relocation

The product is heavy.

- Turn off the power switch and then disconnect all cables when relocating the product.
- The product weights more than 20 kg. Use two or more persons when relocating the product. The weight of the products can be found on the rear panel of the product and/or in this operation manual.
- Use extra precautions such as using more people when relocating into or out of present locations including inclines or steps. Also handle carefully when relocating tall products as they can fall over easily.
- Be sure the operation manual be included when the product is relocated.



## Operations

Stop using the product with any abnormality or failure.

- Check that the AC input voltage setting is satisfied and that there is no abnormality on the surface of the AC power cable. Be sure to stop applying power before checking.
- If any abnormality or failure is detected in the products, stop using it immediately. Disconnect the AC power cable from the power distribution board. Be careful not to allow the product to be used before it is completely repaired.
- For output wiring, use connection cables with larger current capacity.
- Do not disassemble or modify the product. If it must be modified, contact your Kikusui agent.



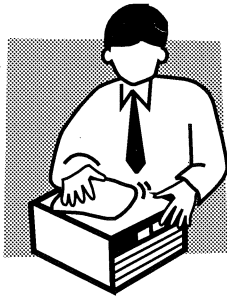

### **Maintenance and checking**

Perform periodic maintenance and checking.

- To avoid electrical shock, be absolutely sure to stop applying power before performing maintenance or checking.
- Do not remove the cover when performing maintenance or checking.
- To maintain performance and safe operation of the product, it is recommended that periodic maintenance, checking, cleaning, and calibration be performed.



### **Service**

Internal service is to be done by Kikusui service engineers.

- If the product must be adjusted or repaired, contact your Kikusui agent.

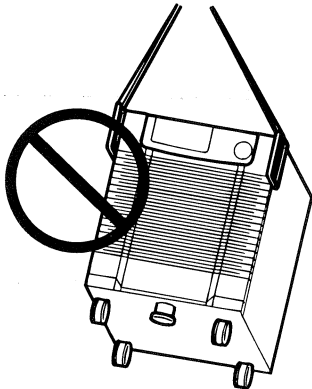







### **Handgrips**

Do not use the handgrips to lift equipment.

- The grips are provided only for moving the equipment across a flat surface and will not support the equipment's weight.

# SAFETY SYMBOLS

The following symbols are indicated where caution is especially required in handling the equipment.

| Equipment   | Operation manual   | Description  |
|---|--|--|
| WARNING   |   | <p>Indicates the existence of a personnel hazard.</p> <ul style="list-style-type: none"> <li>• Never fail to follow the operating procedure. Incorrect operating procedures may result in personal injury.</li> <li>• Do not proceed beyond a WARNING sign until the indicated conditions are fully understood and met.</li> </ul> |
| CAUTION   |   | <p>Indicates the existence of a hazard.</p> <ul style="list-style-type: none"> <li>• Always follow the operating procedure. Incorrect operating procedures may damage the equipment or other devices.</li> <li>• Do not proceed beyond a Caution sign until the indicated conditions are fully understood and met.</li> </ul>      |
|   |  | Indicates action prohibited.   |
|  |  | <p>Operation manual reference symbol</p> <ul style="list-style-type: none"> <li>• When this mark is indicated on the equipment, see the relevant section of the Operation Manual.</li> </ul>   |
|  |  | Grounding terminal   |
|  |  | Chassis grounding  |
|   | [Description]  | Description and supplement   |

# CONFIGURATION OF THE OPERATION MANUAL

This operation manual is configured as follows:

|            |  |  |
|------------|--|--|
| Chapter 1  | GENERAL                                      | Describe the basics of the equipment use. Always read them.                            |
| Chapter 2  | INSTALLATION                                 |  |
| Chapter 3  | CONNECTING THE INPUT POWER                   |  |
| Chapter 4  | OPERATION CHECK                              |  |
| Chapter 5  | CONNECTING A LOAD                            | Describe the basic operating procedures.   |
| Chapter 6  | OPERATION METHOD                             |  |
| Chapter 7  | OPTIONAL EQUIPMENT                           | Describe the part names and their functions in detail. The options are also explained. |
| Chapter 8  | PART NAMES AND OPERATIONS                    |  |
| Chapter 9  | PROTECTIVE FUNCTIONS AND THEIR OPERATIONS    | Describes the protective functions and solutions in the event of a problem.            |
| Chapter 10 | MAINTENANCE                                  | Describes daily maintenance. Always read this chapter before requesting a repair.      |
| Chapter 11 | SPECIFICATIONS AND OPERATING CHARACTERISTICS | Sets out the electrical specifications and overall dimensions.                         |
| APPENDIX   |  | Shows the hierarchy of the control panel key operation menu.                           |

# CONTENTS

|               |  |      |
|---------------|--|------|
| Chapter 1     | GENERAL .....  | 1-1  |
| 1.1           | Outline .....  | 1-2  |
| 1.2           | Features.....  | 1-2  |
| 1.3           | About This Operation Manual and ROM version .....    | 1-3  |
| Chapter 2     | INSTALLATION .....                                   | 2-1  |
| 2.1           | Check at Unpacking .....                             | 2-2  |
| 2.2           | Installation and Location .....                      | 2-3  |
| 2.3           | Checking the Input Power .....                       | 2-4  |
| 2.4           | Grounding.....                                       | 2-5  |
| 2.5           | Moving Precautions .....                             | 2-6  |
| Chapter 3     | CONNECTING THE INPUT POWER .....                     | 3-1  |
| Chapter 4     | OPERATION CHECK .....                                | 4-1  |
| 4.1           | Power ON .....                                       | 4-2  |
| 4.2           | Version Check .....                                  | 4-5  |
| 4.3           | Initial Setup Status.....                            | 4-5  |
| [Description] | Control Panel Angle Adjustment.....                  | 4-7  |
| 4.4           | Basic Operation Check .....                          | 4-8  |
| Chapter 5     | CONNECTING A LOAD .....                              | 5-1  |
| 5.1           | Connection to the OUTPUT Terminal Board .....        | 5-2  |
| [Description] | Polarity of the OUTPUT terminal board .....          | 5-2  |
| 5.2           | Connection to an OUTPUT Outlet .....                 | 5-3  |
| [Description] | Output and Load of this Equipment .....              | 5-5  |
| 1.            | DC Mode .....  | 5-5  |
| 2.            | AC Mode .....  | 5-6  |
| Chapter 6     | OPERATION METHOD .....                               | 6-1  |
| [Description] | Home Position .....                                  | 6-2  |
| [Description] | Shift Key .....                                      | 6-2  |
| [Description] | ENT Wait.....  | 6-2  |
| 6.1           | Setting the Output Voltage Mode (AC/DC) .....        | 6-2  |
| [Description] | AC+DC mode (with optional equipment) .....           | 6-2  |
| 6.2           | Setting the Output Voltage Range (100 V/200 V) ..... | 6-4  |
| 6.3           | Output Voltage Setting .....                         | 6-5  |
| 6.4           | Frequency Setting .....                              | 6-6  |
| 6.5           | Limit Value Setting .....                            | 6-7  |
| 6.5.1         | Setting the Voltage Limit Values.....                | 6-8  |
| 6.5.2         | Setting the Frequency Limit Values .....             | 6-10 |
| 6.5.3         | Setting the Current Limit Value.....                 | 6-12 |
| 6.6           | Output ON/OFF.....                                   | 6-14 |
| [Description] | Output ON/OFF Switching.....                         | 6-15 |

|           |   |      |
|-----------|---|------|
| 6.7       | How to Use JOG and SHUTTLE .....  | 6-16 |
| 6.7.1     | Numeric Setting Using JOG/SHUTTLE .....   | 6-16 |
| 6.7.2     | How to Use the Digit Function .....   | 6-17 |
| 6.8       | Setting the Voltage Display Mode .....  | 6-18 |
| 6.8.1     | Switching the Voltage Display Mode .....  | 6-18 |
|           | [Description] Voltage Display Mode .....  | 6-19 |
| 6.9       | Setting the Current/Power Display Mode .....  | 6-20 |
| 6.9.1     | Switching the Current/Power Display Mode .....  | 6-20 |
|           | [Description] Current/Power Display Mode .....  | 6-21 |
|           | [Description] Offset display with no load .....   | 6-21 |
| 6.9.2     | How to Use the LOAD Level Meter .....   | 6-22 |
|           | [Description] The LOAD level meter .....  | 6-22 |
| 6.10      | Memory Function .....   | 6-23 |
|           | [Description] Memory Function .....   | 6-23 |
| 6.11      | Key-Lock Function .....   | 6-26 |
|           | [Description] Key lock function by using the Remote Controller<br>(with optional equipment) ..... | 6-26 |
| 6.12      | How to Use the Sensing Function .....   | 6-27 |
|           | [Description] Sensing Function .....  | 6-27 |
| Chapter 7 | OPTIONAL EQUIPMENT .....  | 7-1  |
| 7.1       | Introducing Optional Products .....   | 7-2  |
| 7.2       | Functions Available through Optional Equipment .....  | 7-2  |
| 7.2.1     | Measurements of Power-Factor, VA, and Peak Holding Current ..                                     | 7-2  |
| 7.2.2     | Output ON/OFF Phase Setting .....   | 7-2  |
| 7.2.3     | AC + DC Mode .....  | 7-3  |
| 7.2.4     | Expansion of the Memory Function .....  | 7-3  |
| 7.2.5     | Regulation Adjustment .....   | 7-3  |
| 7.2.6     | Rack Mounting .....   | 7-4  |
| Chapter 8 | PART NAMES AND OPERATIONS .....   | 8-1  |
| 8.1       | Front Panel .....   | 8-2  |
| 8.1.1     | Control Panel Operating Section .....   | 8-2  |
| 8.1.2     | Control Panel Display Unit .....  | 8-5  |
| 8.1.3     | Front Panel Upper Part .....  | 8-7  |
| 8.1.4     | Front Panel Lower Part .....  | 8-8  |
| 8.1.5     | Air-Intake, Casters, and Others .....   | 8-10 |
| 8.2       | Rear Panel .....  | 8-12 |
| 8.2.1     | Rear Panel Lower Part .....   | 8-12 |
| 8.2.3     | Exhaust Port(s) .....   | 8-14 |
| Chapter 9 | PROTECTIVE FUNCTIONS AND THEIR OPERATIONS .....   | 9-1  |
| 9.1       | Types of Protective Functions .....   | 9-2  |
| 9.2       | Measures to be Taken in the Event of an Alarm .....   | 9-2  |
| 9.3       | Overload Protective Function .....  | 9-5  |



|            |  |              |
|------------|--|--------------|
| Chapter 10 | MAINTENANCE .....  | 10-1         |
| 10.1       | Before Requesting a Repair .....   | 10-2         |
| 10.2       | Cleaning the Air-Intake Filters .....  | 10-4         |
| 10.3       | Limitation on the Number of Update Operations for Home Position Status<br>[Description] About the number of EEPROM updates ..... | 10-6<br>10-6 |
| Chapter 11 | SPECIFICATIONS AND OPERATING CHARACTERISTICS....   | 11-1         |
| 11.1       | Specifications .....   | 11-2         |
| 11.2       | Operating Characteristics .....  | 11-5         |
| 11.3       | Dimensions .....   | 11-6         |
| APPENDIX   | .....  | A-1          |
| Appendix 1 | Control Panel Key Operating Menu Hierarchy .....   | A-2          |
| Appendix 2 | Glossary .....   | A-6          |
| 1.         | Rated Output (Power) Capacity or Power Capacity .....  | A-6          |
| 2.         | Maximum Rated Output Current .....   | A-6          |
| 3.         | Rated Output Current .....   | A-6          |
| 4.         | Maximum Output Peak Current (Maximum Peak Current) .....   | A-7          |
| 5.         | Output Current Percentage .....  | A-7          |
| 6.         | Output Voltage Percentage .....  | A-7          |
| 7.         | Output Voltage Waveform Distortion Factor .....  | A-7          |
| 8.         | Output Voltage Response Time .....   | A-8          |
| 9.         | High Power Factor Converter (Active Filter) .....  | A-8          |
| 10.        | Capacitor-Input-Type Rectifying (Circuit) Load .....   | A-9          |
| 11.        | Derating .....   | A-9          |
| INDEX      | .....  | I-1          |

# Chapter 1

## GENERAL

Describes the AC power supply overview and features.

### Contents

|   |     |
|---|-----|
| 1.1 Outline .....                               | 1-2 |
| 1.2 Features .....                              | 1-2 |
| 1.3 About This Operation Manual and ROM version | 1-3 |

## 1.1 Outline

---

The PCR-W series are highly reliable AC power supplies manufactured by the application of Kikusui Electronics advanced measuring instrument technology and long-term power supply manufacturing experience.

The combination of a high frequency PWM inverter and a high power factor converter offers a high efficiency and a low input current, a compact and lightweight body, and a high quality output.

The PCR-W series offers the following models.

| Single-phase output |                       |
|---------------------|-----------------------|
| Model name          | Rated output capacity |
| PCR2000W            | 2kVA                  |
| PCR4000W            | 4kVA                  |
| PCR8000W            | 8kVA                  |
| PCR12000W           | 12kVA                 |

- In addition to these models, large capacity models that are able to switch single phase and three phase output (PCR-W<sup>2</sup> series), are also available.

## 1.2 Features

---

The PCR-W series has the following features.

### ■ Compact and lightweight

The PCR-W series offers two times output capacity as compared with our AC power supply of equal dimensions and/or weight which is employed a liner amplifier.

### ■ High efficiency and low input current

As compared with our product with liner amplifier method, the efficiency is approx. 1.5 times and the input current is approx. 1/1.5 times.

### ■ Applying to low power factor load

The PCR-W series is able to supply maximum output current to a load whose power factor is from 0 to 1.

### ■ Various measuring functions

Allows output voltage rms and current rms, peak voltage and current, power, and power factor\* to measure.

### ■ AC/DC output function

The PCR-W series offers DC output and AC + DC output\*, as well as AC output, which allows the equipment to also be used in additional fields such as chemistry and physics.



## ■ Sensing and regulation adjustment functions\*

Allow constant voltage (rms) to be obtained at a loaded end even if load equipment is installed away from the AC power supply.

To use a function marked \* requires the purchase of an option. For the optional equipment, refer to Chapter 7.

## 1.3 About This Operation Manual and ROM version

This manual applies to the products with any of the 1.00 to 1.09 version ROMs. To inquire about the product, you should provide us with the:

- Model number
  - ROM version
  - Serial number and the revision number
- (These are indicated at the lower rear part of the equipment.)

If you are using a PCR-W Series AC power supply for the first time or after reinstalling it, always read:

- Chapter 2 "INSTALLATION"
- Chapter 3 "CONNECTING THE INPUT POWER"
- Chapter 4 "OPERATION CHECK"

These chapters describe the basics of using the AC power supply. Perform the operations described in these chapters, then check the ROM version in accordance with 4.2 "Version Check" in Chapter 4.



# Chapter 2

## INSTALLATION

Describes the precautions to be followed in installing the AC power supply and the preparation procedures, such as power cable connection and operation checks.

### Contents

|                                     |     |
|-------------------------------------|-----|
| 2.1 Check at Unpacking .....        | 2-2 |
| 2.2 Installation and Location ..... | 2-3 |
| 2.3 Checking the Input Power .....  | 2-4 |
| 2.4 Grounding .....                 | 2-5 |
| 2.5 Moving Precautions .....        | 2-6 |

## 2.1 Check at Unpacking

This equipment was carefully tested and inspected both mechanically and electrically before shipment to ensure its normal operation.

The equipment should be checked upon receipt for damage that might have occurred during transportation. Also check if all accessories have been provided (see the following table). Should the equipment be damaged or any accessory missing, notify your Kikusui agent.

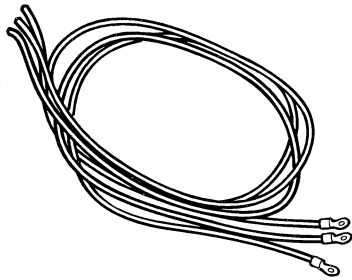

Input power cable

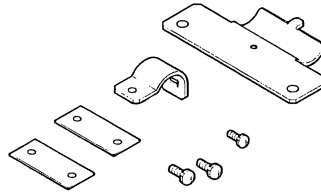

Cable clamber for PCR2000W

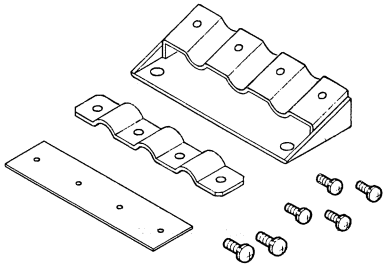

Cable clamber for PCR4000W

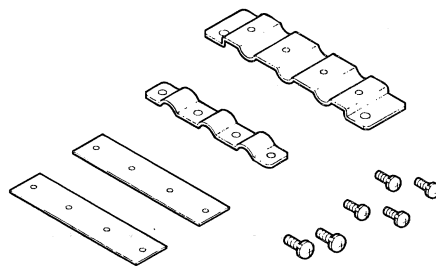

Cable clamber for PCR8000W

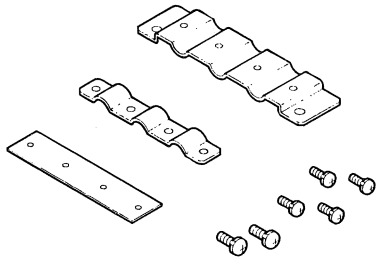

Cable clamber for PCR12000W

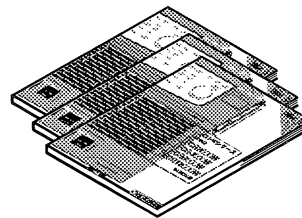

Operation manual

| Accessories/model name |   | PCR2000W                  | PCR4000W          | PCR8000W          | PCR12000W         | Check |
|------------------------|---|---------------------------|-------------------|-------------------|-------------------|-------|
| Input power cable (3m) | Type  | Single-core cables, three |                   |                   |                   |       |
|                        | Wire size   | 5.5mm <sup>2</sup>        | 14mm <sup>2</sup> | 14mm <sup>2</sup> | 22mm <sup>2</sup> |       |
| Cable clamber          | One set<br>(together with fixing-screws, in a bag)  |                           |                   |                   |                   |       |
|                        | M3 (1 pc)<br>M4 (2 pcs)   | M3 (4 pcs)<br>M4 (2 pcs)  |                   |                   |                   |       |
| Operation manual       | PCR-W series (this equipment): One<br>Remote controller (PCR-W series edition): One*<br>GPIB/RS-232C interface (PCR-W series edition): One* |                           |                   |                   |                   |       |

\*: The operation manual is attached only. Its hardware is option.

## 2.2 Installation and Location

---

Do not install this equipment in the following locations.

### ■ Tilted or unsteady surfaces

- Even if the equipment is installed on a flat floor, lock the casters and use the stopper to fix the equipment to the floor surface. For further information on how to use the casters and stopper, see 2.5 "Moving Precautions."
- Do not place the equipment upside-down or with its side facing up.
- Consult your Kikusui agent if the PCR8000W or PCR12000W is fixed for vibration-proof.

### ■ High- or low-temperature areas or areas exposed to direct sunlight

- Operating temperature range is 0 to 50°C
- Outdoor use is not allowed.
- Do not use the equipment outside of the above conditions. Otherwise, performance cannot be guaranteed and problems may arise.

### ■ Humid areas

- Operating humidity range is 10 to 90% R.H.
- Outdoor use is not allowed.
- Do not use the equipment outside of the above conditions. Otherwise, performance cannot be guaranteed and problems may arise.

### ■ Areas exposed to dust, corrosive gases, or inflammable materials

- Do not use the equipment in dusty areas (such as dust containing conductive materials.)

### ■ Areas exposed to strong magnetic or electric fields or to distortion or noise from an input power line

- Installing the equipment in such an area may result in malfunctions.

### ■ Areas where highly sensitive measuring instruments or receivers are installed

- Such instruments may be affected by the noise that this equipment generates if the equipment is installed nearby.

### ■ Places in which the equipment's air intake or exhaust port will be blocked

- Always provide 20 cm or more space between the air intake and exhaust port and the wall (or interference).
- Hot air (about 30°C higher than ambient temperature) comes out of the exhaust ports; do not place heat-sensitive articles near the exhaust ports.

## 2.3 Checking the Input Power

■ Always use input power at the rated input voltage and rated input frequency ranges.

- Rated input voltage range:
  - 85 to 132 V at 100 V input voltage range
  - 170 to 250 V at 200 V input voltage range
  - (PCR8000W and PCR12000W are a model dedicated to the 200 V input voltage range.)
- Rated input frequency range: 50/60 Hz (47 to 63 Hz)
- There are two input voltage ranges: 100 V and 200 V. Use the INPUT VOLTAGE SELECTOR switch to select any range.
 

To select the range, see step 4 in Chapter 3, CONNECTING THE INPUT POWER (page 3-4.)

The INPUT VOLTAGE SELECTOR switch is installed in the rear terminal box.

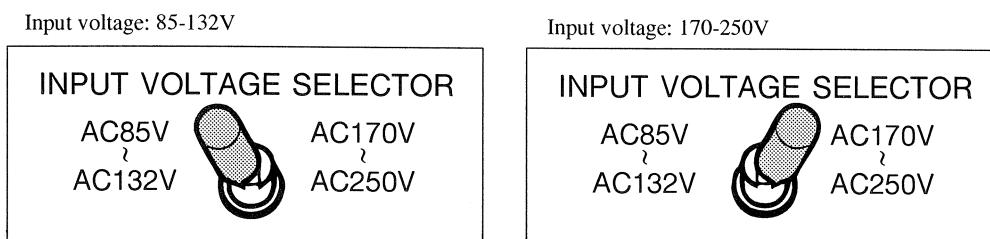

### CAUTION

- Use of the equipment outside of the above ranges may cause a problem.
- The PCR-W must be supplied power from a commercial AC power line.
 

If the PCR-W is supplied power from the other power source as an independent power generator, Input voltage may exceed transiently the rated input voltage range when the load connected to the PCR-W changes.
- If the input power source that the output impedance is extremely high is connected to PCR-W, and the input voltage is in the rated input voltage range at no load, the input voltage becomes less than the rated voltage range when PCR-W supplies power to the load. And PCR-W does not work normally or the protection function may operate.

Or as PCR-W does not start normally at power on, the protection function may operate also.

There is not a problem usually if PCR-W is connected to the distribution board which can supply the rating input current of PCR-W (see Chapter 11 "11.1 Specification") by using the provided input cable. However, if PCR-W is connected to an wall outlet or a distribution board using a long cable, a trouble mentioned above may happen.

## 2.4 Grounding

Always ground the equipment securely.

- Always connect terminal  $\oplus$  on the equipment's INPUT terminal board to a dedicated grounding terminal (GND) by using the provided cable.

To ground the equipment, see steps 2 and 3 in Chapter 3, CONNECTING THE INPUT POWER (pages 3-2 and 3-3.)

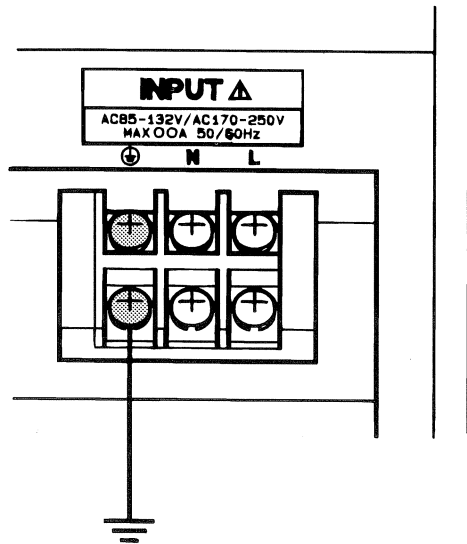

### WARNING

- If no grounding is provided, personal injury due to an electrical shock may be caused.
- Connect a grounding wire to an electrical ground (safety ground), or in compliance to the grounding requirements called for by the Electrical Codes and Regulations applicable in your area.

### CAUTION

- If no grounding is provided, a malfunction may result from external noise and/or the equipment may generate greater noise.

## 2.5 Moving Precautions

When moving this equipment, exercise care as follows:

- Disconnect all the connected cables from the equipment.

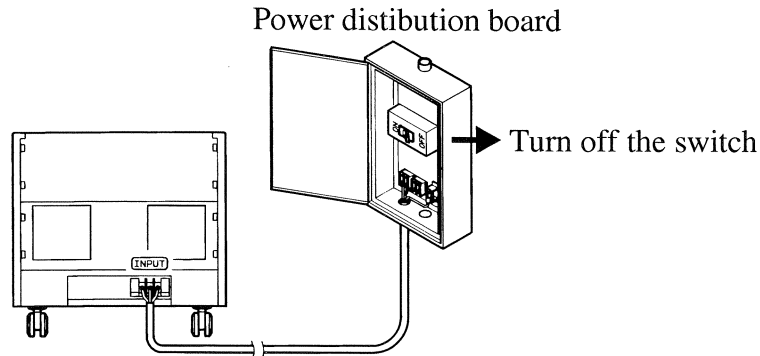

### WARNING

- Before disconnecting a wire, always cut off the power feed from a power distribution board. Otherwise, personal injury due to an electrical shock may be caused. Even if the equipment's POWER switch is turned OFF, voltage is still live at the input terminals.

- Raise the bottom stopper to the upper limit to release the casters.

- The stopper is raised by turning it counterclockwise as viewed from above or lowered by turning clockwise.
- The stopper can be turned using a slight force since it is not locked to the ground.
- If the casters are unlocked, shake the equipment slightly so that pressure against the casters are dispersed. You can unlock them using a slight force.
- After the equipment is moved, lock all the casters and turn the stopper clockwise until the equipment is fixed.

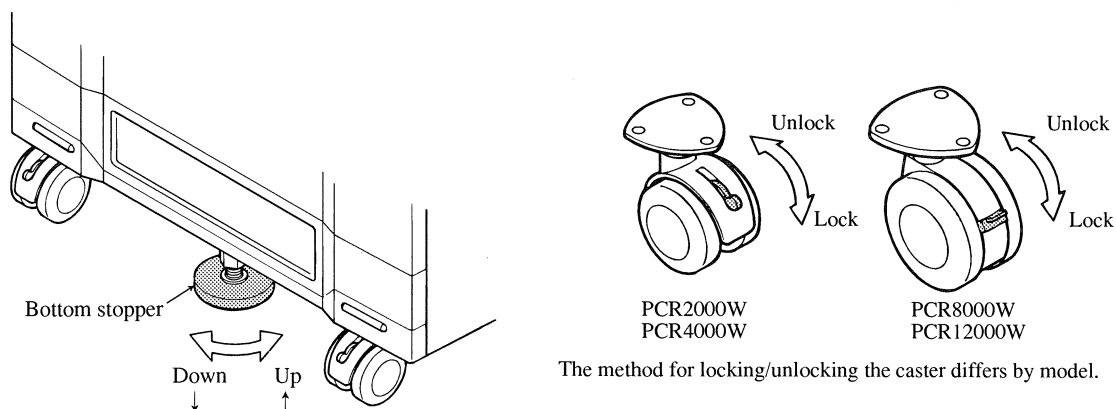

The method for locking/unlocking the caster differs by model.

### WARNING

- Before moving the equipment, always raise the bottom stopper.
- Before moving the equipment, always unlock the casters. Otherwise, the equipment will not move smoothly because of friction in the wheels.
- If you move the equipment by force without observing this WARNING, personal injury may be caused by falling down the equipment.



■ Move the equipment across a flat surface whenever possible, and exercise great care in moving the equipment across a slope or step.

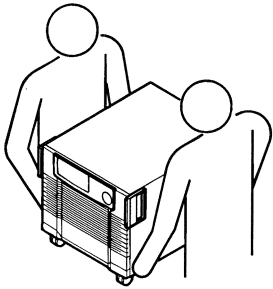

- Check the equipment weight beforehand.
- The equipment weight is indicated at the lower rear of the equipment.
- Moving work with a forklift or a crane must be performed by qualified personnel.
- When using a forklift to move the equipment, place the fork underneath the equipment and confirm all safety conditions before lifting.
- When lifting the equipment with a crane using lifting bands, always apply the bands at the equipment bottom and confirm all safety conditions before lifting.
- During movement, do not lay the equipment with its side up or place the equipment upside-down.

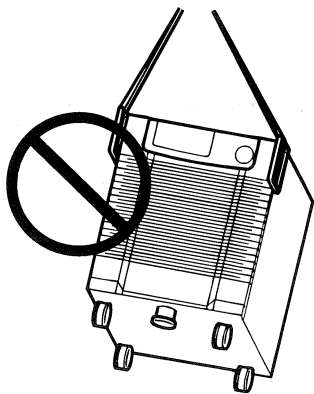
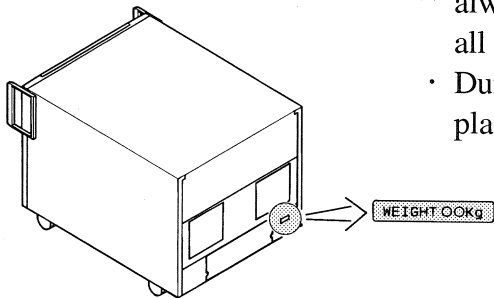

**WARNING**

- Do not use the handgrips to lift equipment. The grips are provided only for moving the equipment across a flat surface and will not support the equipment's weight.

How to Handle the Grips

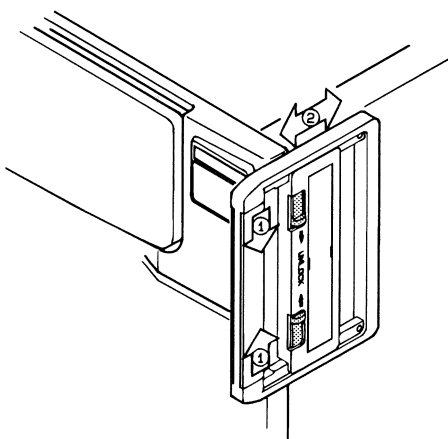

- ① To shift a grip, simultaneously slide two locks to the UNLOCK direction.
- ② Pull a grip toward you or push it forward until you hear a clicking sound.



# Chapter 3

## CONNECTING THE INPUT POWER

Faulty use of this equipment may result in electrical shock or fire since it handles high voltage and power. Always prepare the equipment in accordance with this chapter.

**CAUTION**

Before proceeding to preparation work, carefully read Chapter 2, INSTALLATION and perform the following:

- Check the input power
- Provide grounding

**WARNING**

- Do not turn on the power distribution board switch until the connection has been completed.
- Before connecting the input power cable to the power distribution board, always connect the input power cable to the equipment first. If the input power cable to the power distribution board is connected first, personal injury due to an electrical shock or fire hazard due to short circuit may result.

**Input Power Connecting Procedure**

---

- Step 1 Remove the rear terminal box cover.

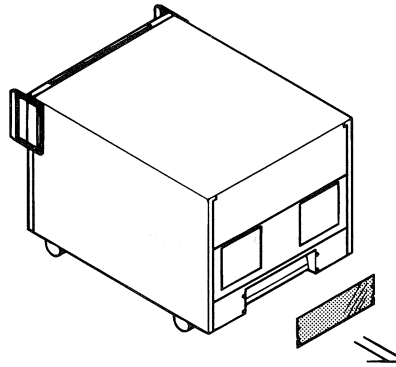

- Step 2 Securely connect the crimp-style terminals of the provided input power cable to the INPUT terminal board in accordance with the table and figure below.

| INPUT terminal board indication | Color of terminal cap* |
|---------------------------------|------------------------|
| L                               | Black                  |
| N                               | White                  |
| ⊕                               | Green                  |

\*Color of crimp-style terminal caps on three black cables

[INPUT terminal board side]

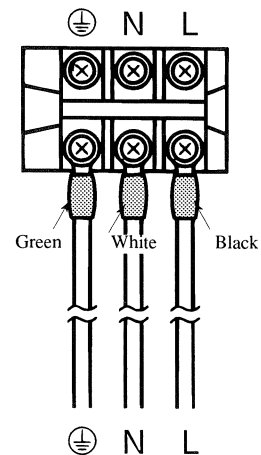

[Power distribution board side]

**CAUTION**

- Tighten terminal screws securely. Improper tightening of terminal screws may result in cable disconnection or overheating at the connection, which is dangerous.
- Do not connect the input power cable to the OUTPUT terminal board.

## ► Step 3

Connect the other side of the input power cable connected to the equipment in step 2 to a power distribution board.

- Securely connect the cables by matching the cable or cap colors specified in the table in step 2 to L, N, and  $\oplus$  (GND) on the power distribution board.

**CAUTION**

- The power distribution board side of the input power cable is not provided with terminals.
- Attach crimp-style terminals, that match the terminal screws of the power distribution board to be connected to the input power cable and securely connect the cables (this work must be performed by qualified personnel).
- If the polarity (L, N, and  $\oplus$ ) of the power distribution board is unknown, always have it inspected by a power distribution board installer or qualified personnel.
- If the input power cable provided cannot be used due to installation site, consult a qualified personnel and select wire size with reference to the table below.
- Always use appropriate crimp-style terminals on this equipment side.

The following table shows the correspondence between the wire size (nominal conductor cross-section) and the allowable current.

| Wire size<br>[mm <sup>2</sup> ] | Allowable current [A]                      |          |
|---------------------------------|--|----------|
|                                 | Maximum allowable temperature of insulator |          |
|                                 | 60°C use                                   | 75°C use |
| 0.75                            | 8  | 13       |
| 1.25                            | 11   | 17       |
| 2                               | 15   | 23       |
| 3.5                             | 21   | 34       |
| 5.5                             | 28   | 45       |
| 8                               | 36   | 56       |
| 14                              | 51   | 80       |
| 22                              | 67   | 105      |
| 38                              | 96   | 150      |

The value in the table were obtained at 50°C.

- The values in the above table are those of a single-core cable; they differ depending on the cable covering (insulator) and material (allowable temperature) used or multi-core cable. For cables other than those given in the above table, consult a qualified personnel.
- For a grounding  $\oplus$  cable, use a cable whose size is equal to or greater than that of cables for the L and N terminals. A thin grounding cable may not be effective for preventing trouble.
- Check the current capacity of the power distribution board. Insufficient current capacity may cause abnormally high temperatures at the input power source or may open a circuit breaker.

- Step 4 Select the INPUT VOLTAGE SELECTOR switch in accordance with the input voltage range.
- This step is not required for the PCR8000W and PCR12000W since it has no INPUT VOLTAGE SELECTOR switch.
  - The INPUT VOLTAGE SELECTOR is located at the center of the terminal box.

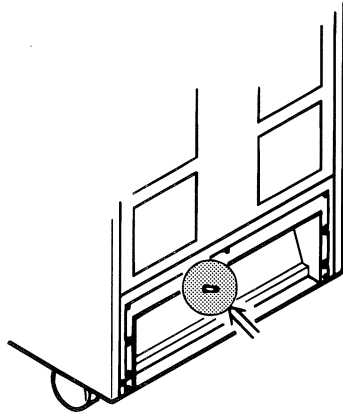

- The INPUT VOLTAGE SELECTOR is a lock-type toggle switch. Pull the knob to select the input voltage.

**CAUTION**

- To select the voltage, be sure to pull the knob. If you select the voltage without pulling the knob thoroughly, the switch may be damaged.

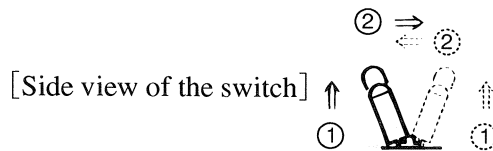

For 85 to 132V input voltage

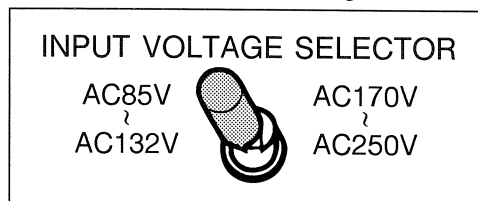

For 170 to 250V input voltage

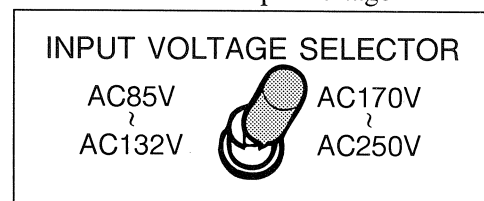

- Step 5 Attach the provided cable clamber to securely fix the input power cables.
- If a cable other than the provided input power cable is used, the cable clamber may not fit such cable.
  - Cable clamber parts and screws are also provided (in a PVC bag).
  - Mount part (A) onto the equipment by using the provided M4 screw.
  - Lay the input power cables on the recessed sections of part (A).
  - Securely connect the cables to the input terminals, in the procedure of Step 2.
  - Using the provided M3 screws, fasten parts (B) and (C) onto part (A).

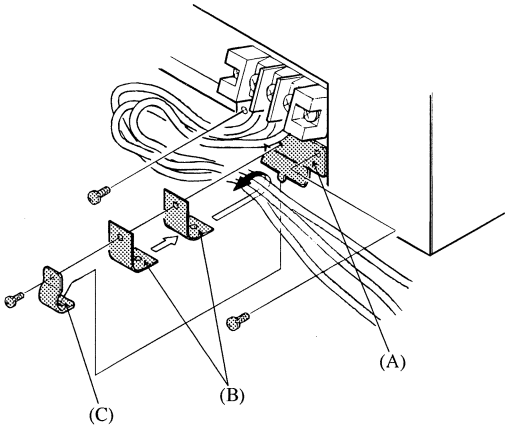

For PCR2000W

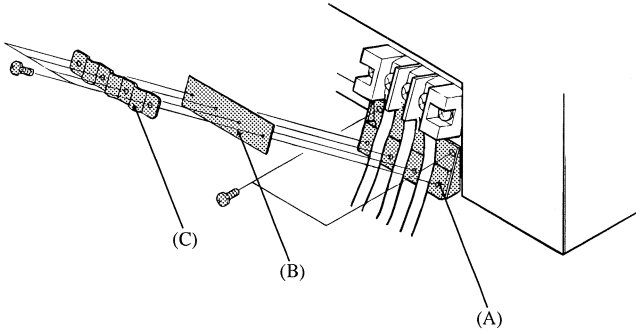

For PCR4000W

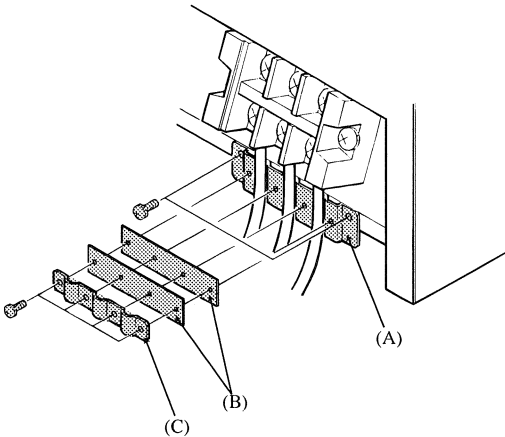

For PCR8000W

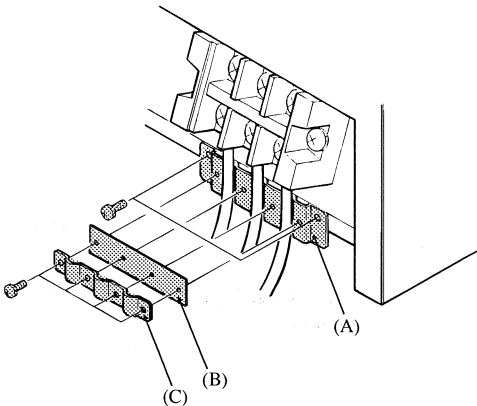

For PCR12000W

**WARNING**

• If the cable clammer is not used to securely fix the input power cables to the equipment, application of excessive force to the INPUT terminal board may damage the terminal board or disconnect a cable wire, resulting in fire hazard due to an electrical short or personal injury due to electrical shock.

► Step 6 Install the cover removed in step 1 to the terminal box.

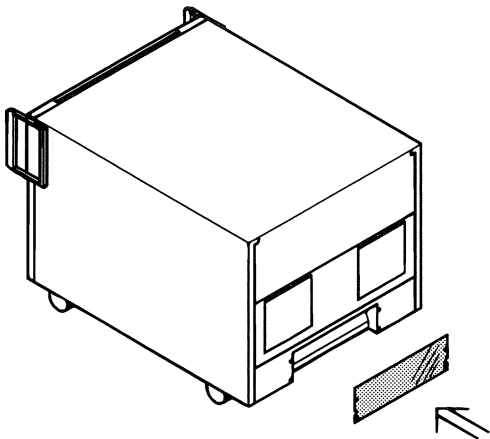





# Chapter 4

## OPERATION CHECK

After connecting the input power cable by following the steps described through Chapter 3, conduct operation check as described in this chapter.

### Contents

|  |     |
|--|-----|
| 4.1 Power ON .....                           | 4-2 |
| 4.2 Version Check .....                      | 4-5 |
| 4.3 Initial Setup Status .....               | 4-5 |
| [Description] Control Panel Angle Adjustment | 4-7 |
| 4.4 Basic Operation Check .....              | 4-8 |

Operation check must be performed in any of the following.

- Purchasing the equipment
- Moving the equipment to a new location
- Using the equipment after it has not been used for a long period

## 4.1 Power ON

---

After connecting the input power cable, check the following a) to e), then follow these steps, starting with step 1.

- Check that the input power cable is correctly connected.
- Check that no output cable is connected to the equipment OUTPUT terminal board.
- Check that no load is connected to the OUTPUT outlets at the lower front part of the equipment.

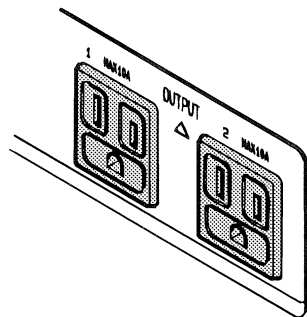

- Ensure that the terminal box cover is installed.

**CAUTION**

- Conduct an operation check with nothing connected to the OUTPUT terminals and OUTPUT outlets of the equipment. Disconnect any load that is connected to an output.

- Ensure that the equipment POWER switch is OFF.

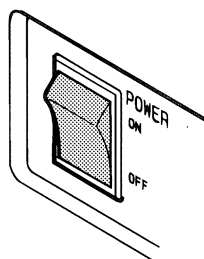

PCR2000W  
PCR4000W

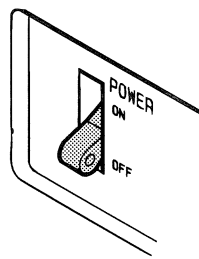

PCR8000W  
PCR12000W

## Power ON Operation Checking Procedure

- Step 1 Turn on the switch of the power distribution board to which the input power cable is connected to feed power to the equipment.

**CAUTION**

- If there is noise, a bad odor, fire, or smoke coming from the equipment when the power is fed, immediately turn off the power distribution board switch.

- Step 2 Check that the LINE lamp at the lower front part of the equipment is lit.

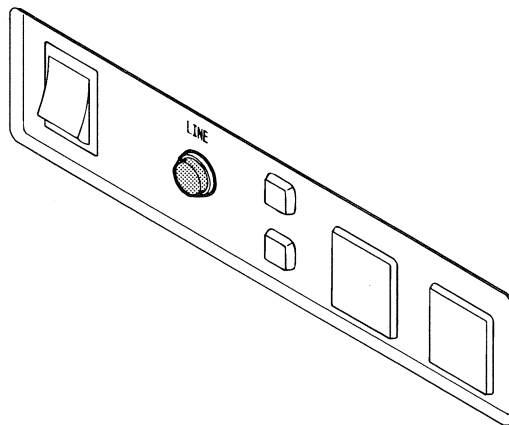

**CAUTION**

- If the LINE lamp does not light, turn off the power distribution board switch and recheck the input power cable connection. Then restart the procedure from step 1.

Should the LINE lamp still not light, the equipment may be defective. Then turn the power distribution switch off and contact your Kikusui agent.

- Step 3 Turn the equipment POWER switch ON.

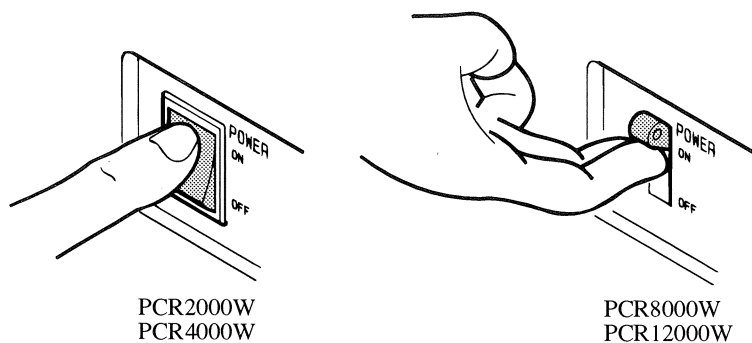

**CAUTION**

- If there is noise, a bad odor, fire, or smoke coming from the equipment when the power is fed, immediately turn off the power distribution board switch.

► Step 4 Check that the control panel displays appear. All display examples hereafter refer to those of the PCR2000W. (The display differs slightly by model.)

- ① The version is displayed for approx. one minute. At this time, SELF TEST blinks. (The equipment is conducting an internal check.) The version is displayed as "V1.XX" (XX: numerics) in the current display area.

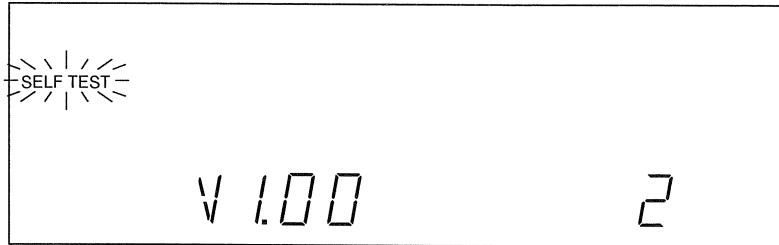

For more details, refer to 4.2, Version Check.

- ② If no error is detected by internal check, the display status proceeds to the Home Position.

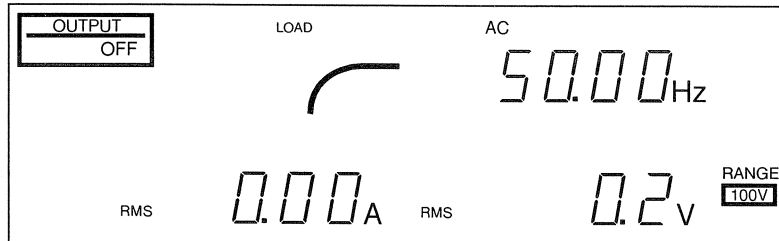

**CAUTION**

- If ALARM lights after the self-test, an alarm has been triggered. See Chapter 9, PROTECTIVE FUNCTIONS AND THEIR OPERATIONS.
- If Err X (X: numeric) appears, see Chapter 9, PROTECTIVE FUNCTIONS AND THEIR OPERATIONS.
- Turning the POWER switch OFF and then ON again in rapid succession may cause problems. After turning the POWER switch OFF, wait for more than five seconds before turning it ON again.
- After the POWER switch is turned ON, all control panel indications may appear. If this status (all indications lit) continues for more than one minute, turn the POWER switch OFF. Wait for more than five seconds, then turn the switch ON.
- When the POWER switch is turned OFF, always conduct the following procedure to discharge the internal capacitors connected to the OUTPUT terminals.  
Turn the OUTPUT switch OFF first, wait for more than one second, and then turn the POWER switch OFF.

**[Description] Home Position**

The status obtained immediately after turning the POWER switch ON is called the Home Position. To return to the Home Position from another status, press ESC once or twice (regardless of OUTPUT ON/OFF status).

If no error occurs after completing the above steps, the power ON operation check is complete.

## 4.2 Version Check

The equipment version is displayed on the control panel immediately after the POWER switch is turned ON. The version is indicated using "V" and numerics on the current display area. Other numerics are not related to the version. The following shows an example of the PCR2000W version 1.00 display.

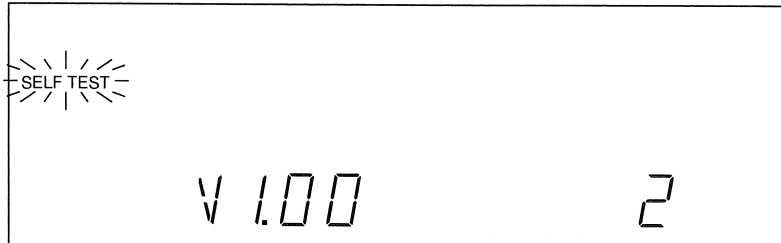

[Description] SHIFT + 3 (SELF TEST)

If the SHIFT + 3 (SELF TEST) is pressed when the POWER switch has been turned ON, the equipment version is always displayed on the frequency display area.

### CAUTION

- Turning the POWER switch OFF and then ON again in rapid succession may cause problems. After turning the POWER switch OFF, wait for more than five seconds before turning it ON again.

## 4.3 Initial Setup Status

The status obtained when power is first fed to the equipment after purchase (factory shipment status) is called the Initial Setup Status. The figure below shows the control panel display in the Initial Setup Status.

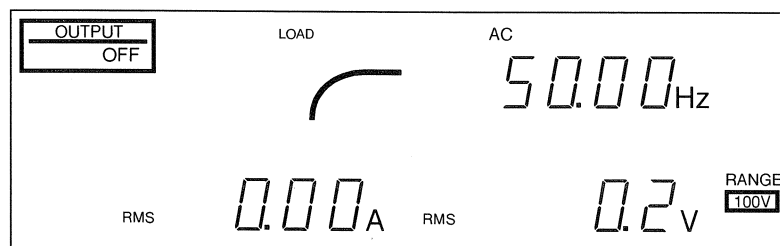

The main settings in the Initial Setup Status are as follows:

- OUTPUT OFF
- RANGE 100 V
- AC/DC AC
- Frequency 50.00 Hz
- Voltage 0.0 V
- Voltage display mode RMS
- Current display mode RMS

To call up the Initial Setup Status from another status, follow the reset procedure described next page. A reset returns all settings to the Initial Setup Status.

## Reset Procedure

- Step 1 Turn the POWER switch ON to start from the Home Position.

[Description] Home Position

The status obtained immediately after turning the POWER switch ON is called the Home Position. To return to the Home Position from another status, press ESC once or twice (regardless of OUTPUT ON/OFF status).

- Step 2 Press SHIFT + 6 (RESET)

[Description] Shift key operation

In this manual, key operations accompanied by pressing the SHIFT key are denoted as follows:

Example: SHIFT + 6 (RESET)

Denotes that you should press SHIFT, which lights the SHIFT indication on the control panel, and then 6. (This selects the reset function.)

- Step 3 The RESET and ENT indications on the control panel blink, waiting for ENT to be entered. Waiting for ENT, see "Description ENT Wait" in Chapter 6.

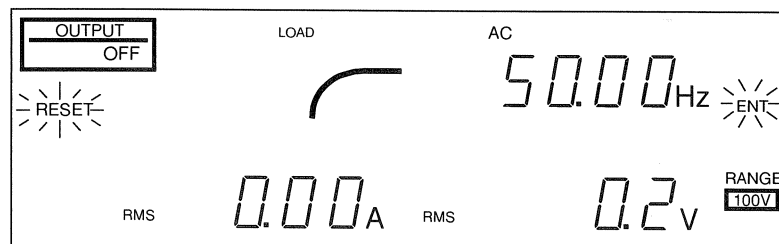

Pressing ESC in the above condition cancels a reset, returning the display status to the Home Position.

- Step 4 Press SHIFT + ENT

This causes the reset function to work, returning all settings to the Initial Setup Status.

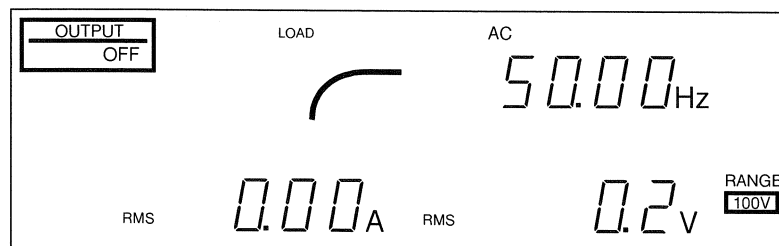

**[Description] SHIFT + ENT**

SHIFT + ENT is a special key operation used only for the reset function. A reset returns all set values and memory data to the Initial Setup Status; a reset operation should not be easy to perform. Accordingly, a reset operation cannot be confirmed by simply pressing ENT, but requires SHIFT + ENT instead.

**[Description] Control Panel Angle Adjustment**

The control panel can be pulled out as shown below (in two steps).

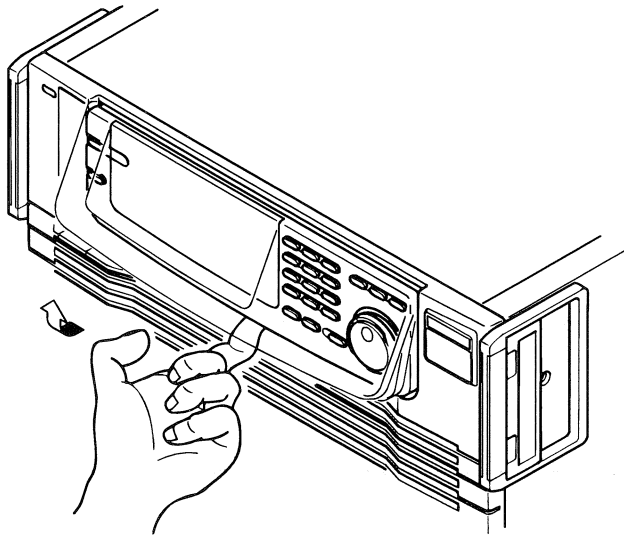

To house the control panel, press the PUSH button.

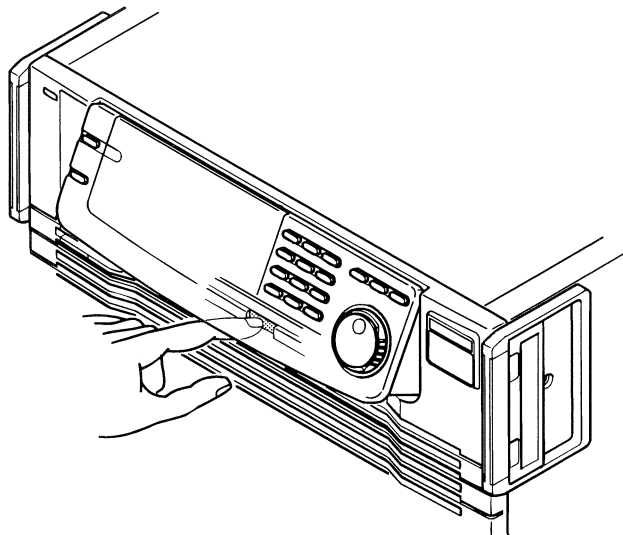

## 4.4 Basic Operation Check

**CAUTION**

- Carry out the basic operation check described in this section with nothing connected to the equipment outputs. If any load is connected to the equipment, always disconnect such load first. Also, read 4.1, Power ON, beforehand.
- If ALARM lights during the basic operation check, it indicates that an alarm has been triggered. See Chapter 9, PROTECTIVE FUNCTIONS AND THEIR OPERATIONS.

### Basic Operation Check Procedure

- ▶ Step 1 Follow the reset procedure in 4.3, Initial Setup Status, to enter the equipment in the Initial Setup Status.
- ▶ Step 2 Press "V" to call up the voltage setting mode.

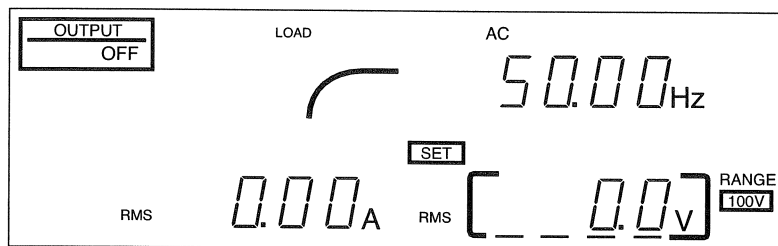

- This encloses the voltage display area with a frame and lights SET.

- ▶ Step 3 Turn JOG clockwise to set the voltage value to 30.0 V (you don't need to press the ENT).

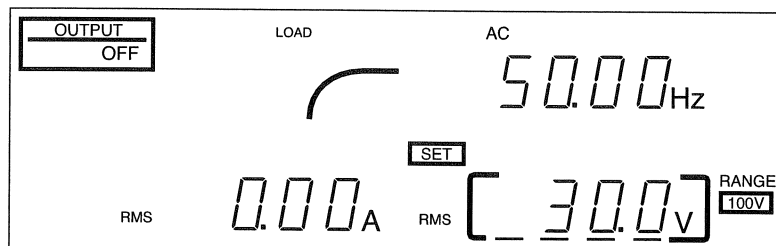

- If the voltage value is increased by too much, turn JOG counterclockwise to reduce the voltage.



- Step 4 Press ESC to exit the voltage setting mode.

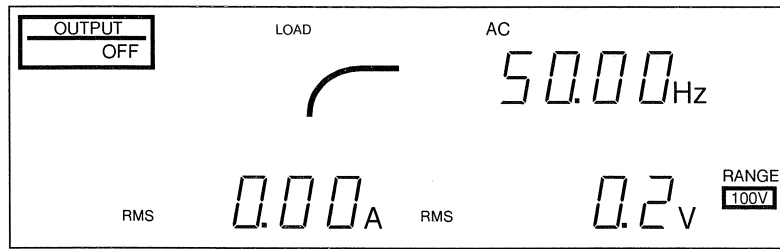

- SET goes off and only RMS is lit.
- The "30.0 V" voltage indication change to approximately 0 V.
- This status displays the output voltage rms.

- Step 5 Press OUTPUT once.

This causes "OUTPUT ON" to appear, and the voltage indication changes to 29.7 - 30.3 V.

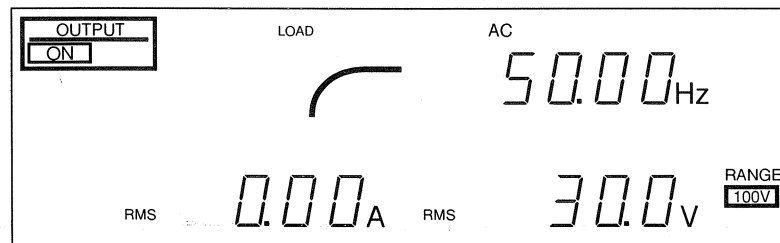

- In this status, 30 V is applied to the equipment OUTPUT terminal board.

**CAUTION**

- If there is noise generation, a bad odor, fire, or smoke coming from the equipment, immediately turn OFF the equipment POWER switch.
- If the voltage indication is abnormal in any steps, contact your Kikusui agent.

- Step 6 Press OUTPUT once.

This causes "OUTPUT OFF" to appear, and the voltage indication changes to approximately 0 V.

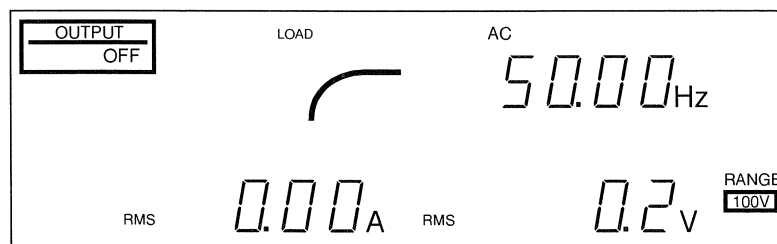

► Step 7 Press SHIFT + 7 (RANGE).

This causes "ENT" and "200 V" below RANGE to blink.

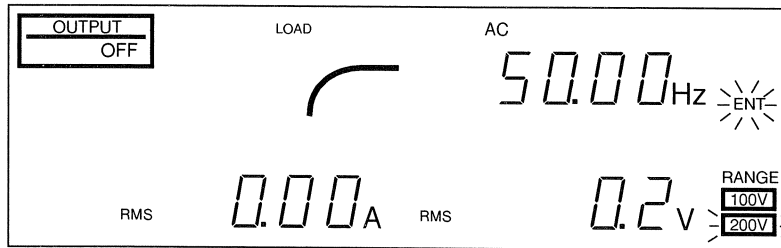

► Step 8 Press ENT.

This causes "100 V" below RANGE to go off and "200 V" to light.

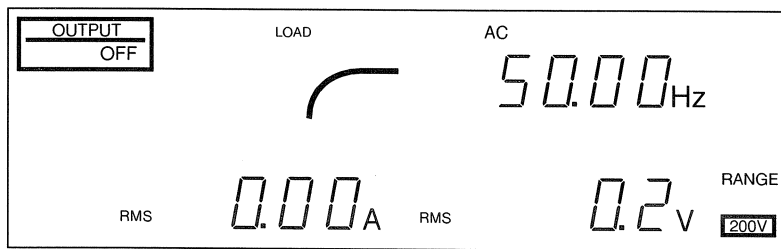

► Step 9 Press OUTPUT once.

This causes "OUTPUT ON" to appear, and the voltage indication changes to 29.7 - 30.3 V.

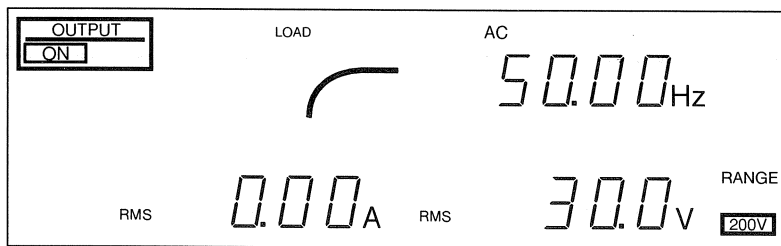

- In this condition, 30 V is applied to the equipment's OUTPUT terminal board.

**CAUTION**

- If there is noise generation, a bad odor, fire, or smoke coming from the equipment, immediately turn OFF the equipment POWER switch.
- If the voltage indication is abnormal in any steps, contact your Kikusui agent.

► Step 10 Press OUTPUT once.

This causes "OUTPUT OFF" to appear, and the voltage indication changes to approximately 0 V.

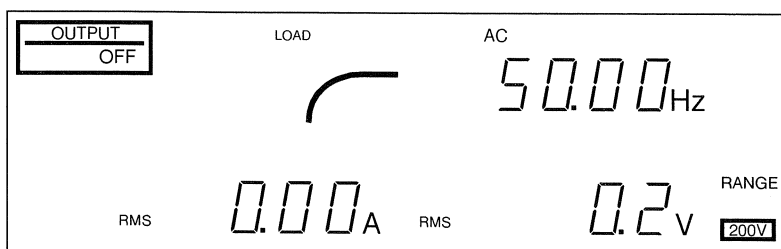

- Step 11 Press "V" to enter the voltage setting mode.

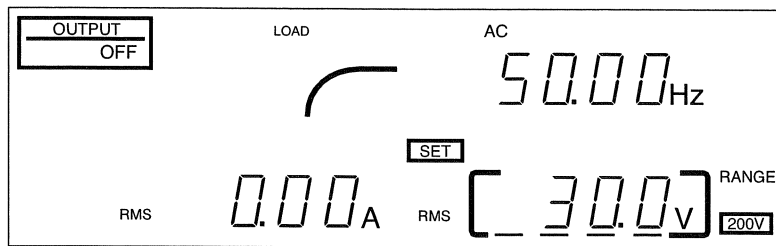

- Step 12 Press "0" and "ENT" in that order.

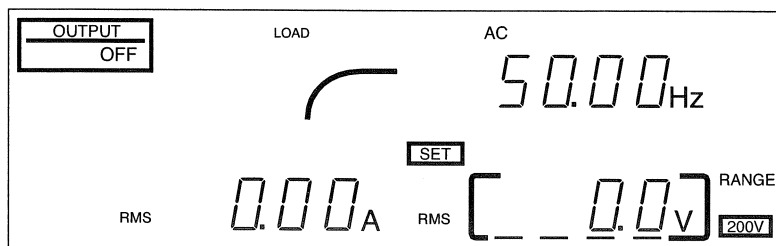

- Step 13 Press OUTPUT once.

This causes "OUTPUT ON" to appear, and the voltage indication changes to approx. 0 V.

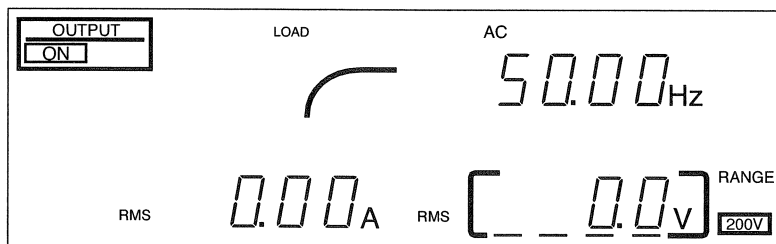

- Step 14 Press OUTPUT once. This cause "OUTPUT OFF" to appear.

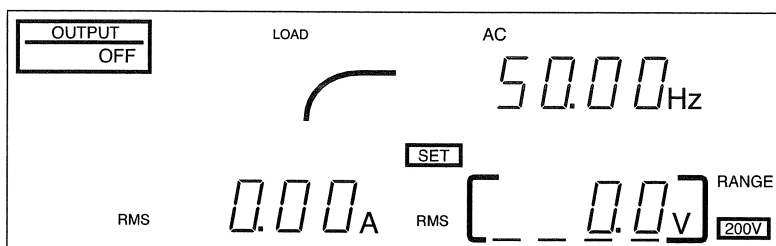

- Step 15 Press ESC to exit the voltage setting mode.  
This extinguishes "SET" and the frame.

- ▶ Step 16 Press SHIFT + 7 (RANGE).  
This causes "ENT" and "100V" below RANGE to blink.

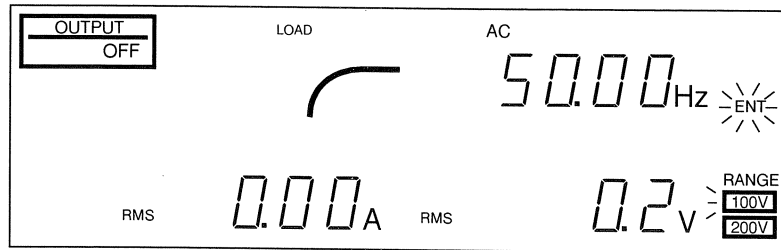

- ▶ Step 17 Press ENT.  
This causes "200V" below RANGE to go off and "100V" to light.

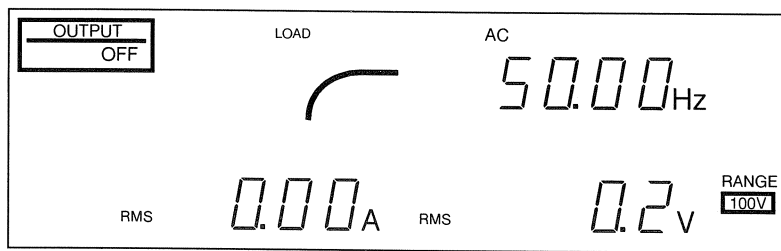

- ▶ Step 18 Press OUTPUT once.  
This causes "OUTPUT ON" to appear, and the voltage indication changes to approx. 0 V.

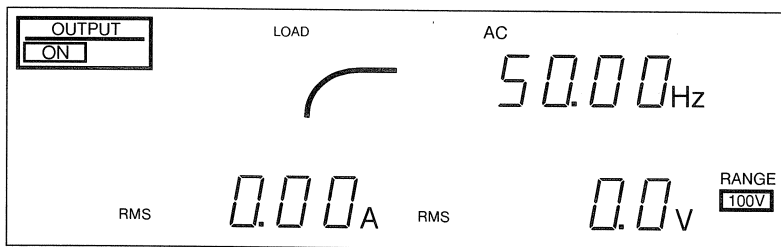

- ▶ Step 19 Press OUTPUT once. This causes "OUTPUT OFF" to appear.

This completes the basic operation check. The next page shows a list of the basic operation check steps. This basic operation check enables you to confirm whether the equipment's main functions are operating normally.

**CAUTION**

- Before proceeding to the next operation, always turn OFF the POWER switch.

## A List of Basic Operation Check Steps

| Step | Operation                               | Checking content  | Check |
|------|---|---|-------|
| 1    | Call up the Initial Setup Status.       | See 4.3 Initial Setup Status.                               |       |
| 2    | Press "V."                              | The voltage display area is enclosed within a yellow frame. |       |
| 3    | Turn JOG to set 30.0 V.                 | —   |       |
| 4    | Press ESC.                              | —   |       |
| 5    | Press OUTPUT (to activate OUTPUT ON).   | Voltage indication: 29.7 to 30.3 V                          |       |
| 6    | Press OUTPUT (to activate OUTPUT OFF).  | Voltage indication: Approx. 0 V                             |       |
| 7    | Press SHIFT + 7 (RANGE).                | ENT and "200V" blink.                                       |       |
| 8    | Press ENT.                              | "100V" goes off and "200V" lights.                          |       |
| 9    | Press OUTPUT (to activate OUTPUT ON).   | Voltage indication: 29.7 to 30.3 V                          |       |
| 1 0  | Press OUTPUT (to activate OUTPUT OFF).  | Voltage indication: Approx. 0 V                             |       |
| 1 1  | Press "V."                              | SET lights. Voltage indication: 30.0 V                      |       |
| 1 2  | Press "0" and "ENT" in that order.      | Voltage indication: 0.0 V                                   |       |
| 1 3  | Press OUTPUT (to activate OUTPUT ON).   | Voltage indication: Approx. 0 V                             |       |
| 1 4  | Press OUTPUT ( to activate OUTPUT OFF). | Voltage indication: Approx. 0 V                             |       |
| 1 5  | Press ESC.                              | —   |       |
| 1 6  | Press SHIFT + 7 (RANGE).                | ENT and "100V" blink.                                       |       |
| 1 7  | Press ENT.                              | "200V" goes off and "100V" lights.                          |       |
| 1 8  | Press OUTPUT (to activate OUTPUT ON).   | Voltage indication: Approx. 0 V                             |       |
| 1 9  | Press OUTPUT (to activate OUTPUT OFF).  | Operation check is complete.                                |       |



# Chapter 5

## CONNECTING A LOAD

After completing the operation check in Chapter 4, connect a load in accordance with this chapter.

### Contents

|     |  |     |
|-----|--|-----|
| 5.1 | Connection to the OUTPUT Terminal Board .... | 5-2 |
|     | [Description] Polarity of the OUTPUT         |     |
|     | terminal board .....                         | 5-2 |
| 5.2 | Connection to an OUTPUT Outlet .....         | 5-3 |
|     | [Description] Output and Load of this        |     |
|     | Equipment .....                              | 5-5 |

**WARNING**

- Before connecting a load, turn the POWER switch OFF and cut off the power feed from the power distribution board. Otherwise, personal injury due to an electrical shock may be caused.

## 5.1 Connection to the OUTPUT Terminal Board

---

Securely connect the output cables from a load to the OUTPUT terminal board.

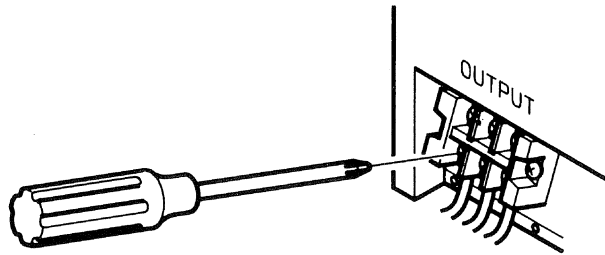

**[Description]**      Polarity of the OUTPUT terminal board

Terminals L and N of the OUTPUT terminal board are isolated from the input power; their polarity will not cause any safety problems. However, since polarity is relevant when in the DC mode, check the load polarity before connection. Grounding can be provided at either L or N.

**CAUTION**

- Select the conductor size of output cables based on Wire size and Allowable Current table shown in step 3 of Chapter 3.
- If a load has a grounding terminal (GND), always connect a grounding wire to terminal G of the equipment OUTPUT terminal board. In this case, the grounding cable should have a diameter greater than or equal to that of the output cables.
- For DC mode, use terminal N as a reference and L as + for positive output or - for negative output.



## 5.2 Connection to an OUTPUT Outlet

Connect the output cable from a load to one of the OUTPUT outlets at the front.

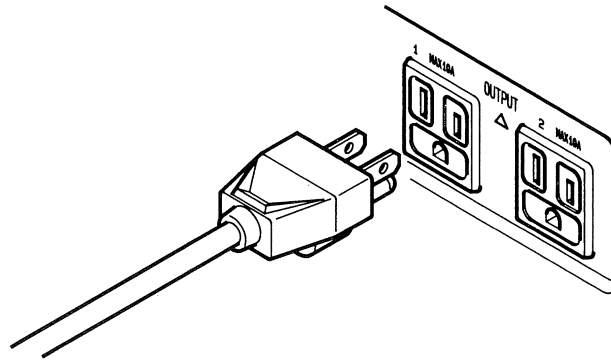

This equipment's output is available from both the OUTPUT terminal board at the rear of the equipment and the OUTPUT outlets at the front. Note the following items when using an OUTPUT outlet:

■ The OUTPUT outlets are dedicated to the power plugs shown in the figure below.

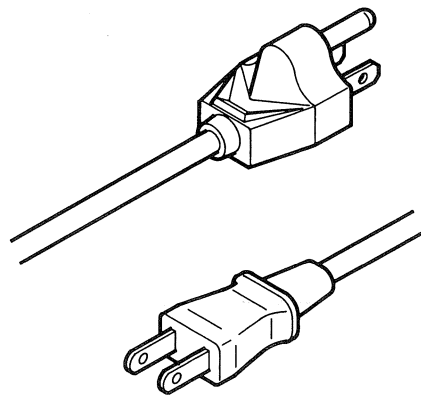

- The maximum rated voltage of the OUTPUT outlets and the power plug is 125 V AC.

| Maximum output voltage | Maximum output current |
|------------------------|------------------------|
| 125 V (rms) AC         | 10 A (rms) AC          |

### CAUTION

- Do not connect a load when the equipment outputs voltage exceeding the above limit or is in DC mode. Otherwise a problem may arise.

■ The maximum output current obtained from one OUTPUT outlet is 10 A (rms) AC per one outlet.

- Maximum output current may be less than these values depending on output voltage and frequency.

Example: For PCR2000W, the maximum output current for a total of two OUTPUT outlets becomes 17.4 A when output voltage is 115 V, and output frequency 50 Hz. Under this condition, if an output current of 10 A flows from one outlet, only 7.4 A is obtained from the other outlet.

**CAUTION**

- If more than 10 A (rms) of output current flows from one OUTPUT outlet, the CIRCUIT BREAKER at the left of the OUTPUT outlets may open. This causes the red button to project from the CIRCUIT BREAKER. In this case, take the following steps:

- ▶ Step 1 Turn the POWER switch OFF.
- ▶ Step 2 Push the red CIRCUIT BREAKER button.

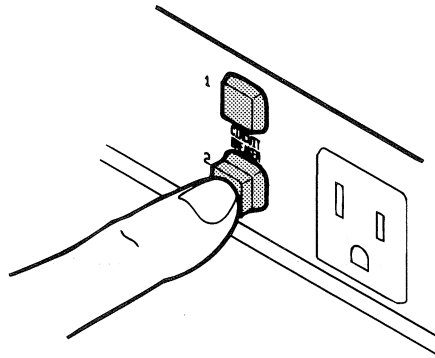

CIRCUIT BREAKER 1 corresponds to OUTPUT outlet 1, and CIRCUIT BREAKER 2 to OUTPUT outlet 2.

- ▶ Step 3 Adjust the load so that the output current is 10 A (rms) or less.
- ▶ Step 4 Turn the POWER switch ON and set OUTPUT to ON.

■ The total value of the output current obtained from the two OUTPUT outlets and OUTPUT terminal board cannot exceed the rated output current.

- If the output current exceeds the rated value, the overload protective function is activated.  
Example: For PCR4000W, if an output current of 10 A flows through each of the two OUTPUT outlets when output voltage is 100 V (100 V range), and output frequency 50 Hz, the maximum output current of the OUTPUT terminal board becomes 20 A (= 40 - 10 - 10 A).

■ An OUTPUT outlet may decrease performance.

The standard values given in 11.1, Specifications, in Chapter 11 are those obtained when the OUTPUT terminal board is used. If an OUTPUT outlet is used, the output voltage load variation and distortion factor may exceed the standard values.

## [Description] Output and Load of this Equipment

### 1. DC Mode

The rated DC output current obtained from this equipment is limited by the equipment output voltage as shown in the graph below.

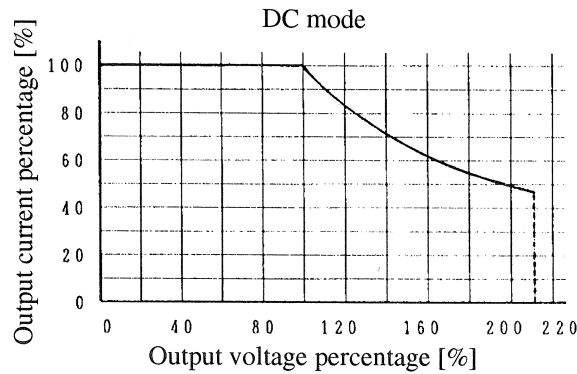

Use of the equipment at an output current exceeding the rated DC output current activates the equipment protective function, which may cause the output voltage to drop off or to be cut off altogether. For the detailed protective functions, see Chapter 9, PROTECTIVE FUNCTIONS AND THEIR OPERATIONS.

Output current percentage shows the rate obtained when the maximum rated current is regarded as 100%. Output voltage percentage shows the rate obtained when 100 V/200 V output voltage is regarded as 100% for the 100 V/200 V output range.

## 2. AC Mode

For linear Loads

The rated AC output current obtained from the equipment is limited by the conditions of the equipment output voltage, and output frequency, as shown in the graphs below.

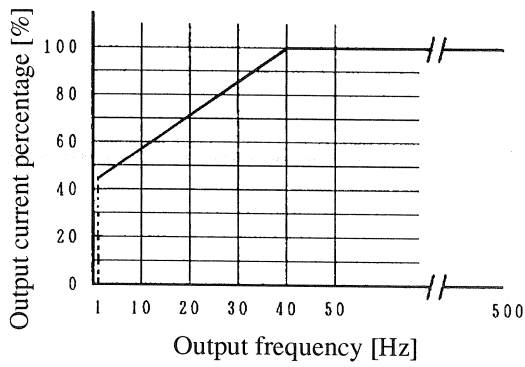
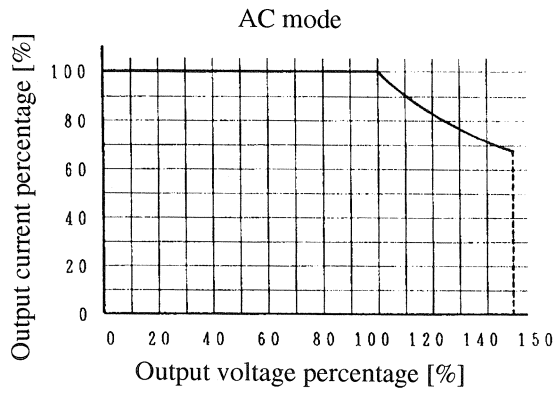

The following describes two examples of how to obtain the rated output current for the PCR2000W.

Example 1: Where output voltage is 115 V (100 V range), and output frequency 50 Hz.

- Output current percentage at 115 V output voltage: 87% .... (a)
- Output current percentage at 50 Hz output frequency: 100% ... (b)

When (a) is compared with (b), (a) is lower than (b); the rated output current is limited by the value obtained by (a). Therefore, the maximum output current percentage is 87%. For the PCR2000W, since the output current available for 100% output current percentage in the 100 V output range is 20 A, the rated output current under the above conditions is  $20 \times 0.87 = 17.4$  [A]

|                         | Output current percentage [%] |                         | Rated output current [A]  |
|-------------------------|-------------------------------|-------------------------|---------------------------|
| Output voltage : 115V   | (a) 87                        | (a) < (b)<br>Select (a) | $20 \times 0.87$<br>=17.4 |
| Output frequency : 50Hz | (b) 100                       |                         |                           |

Example 2: Where output voltage is 240 V (200 V range), and output frequency 15 Hz.

- Output current percentage at 240 V output voltage : 83% .. (a)
- Output current percentage at 15 Hz output frequency : 64% .. (b)

When (a) is compared with (b), (b) is lower than (a); the rated output current is limited by the value of (b). Therefore, the maximum output current percentage is 64%. For the PCR2000W, since the output current available for 100% output current percentage in the 200 V output range is 10 A, the rated output current under the above conditions is  $10 \times 0.64 = 6.4$  [A]

|                         | Output current percentage [%] |                         | Rated output current [A] |
|-------------------------|-------------------------------|-------------------------|--------------------------|
| Output voltage : 240V   | (a) 83                        | (a) > (b)<br>Select (b) | $10 \times 0.64$<br>=6.4 |
| Output frequency : 15Hz | (b) 64                        |                         |                          |

In this case, the control panel LOAD level meter indicates the limited output current as full scale.

If the equipment is used exceeding the condition of the rated output current noted above, the equipment protective function is activated, which may cause output voltage to droop or to be cut off altogether. For further information on the protective functions, see Chapter 9, PROTECTIVE FUNCTIONS AND THEIR OPERATIONS.

### For loads having a capacitor-input-type rectifying load

When electronic devices having a capacitor-input-type rectifying circuit are used as loads for this equipment, a peak current a few times greater than the output current rms flows near the peak output voltage as the output current.

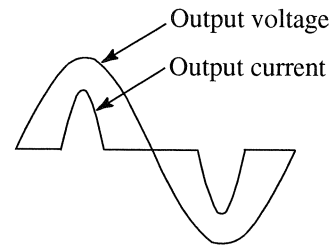

### For loads which draw a rush current

For loads noted below, a rush current (several to several tens of times greater than the normal current) may flow during several to several tens of cycles of output frequency when voltage is applied to such a load or when voltage changes suddenly.

- Transformers and slide transformers loads

When voltage is applied to a transformer or slide transformer, a rush current of the maximum several tens to hundreds of times greater than the normal current may flow during several cycles depending on voltage application timing or the state of residual magnetism.

- Motors and lamps loads

When voltage is applied to a motor or lamp loads, a rush current several to several tens of times greater than the normal current may flow during several tens to hundreds of cycles.

- Capacitor-input-type rectifying loads

For electronic devices with a capacitor-input-type rectifying circuit in an power input block, if a protective (limiting) circuit against rush current is not provided, a rush current several tens to hundreds of times greater than the normal current may flow during several cycles.

In above case, the maximum output peak current must not exceed four times of the maximum rated current (rated output capacity [VA]/100 [V] (for 100 V range) or rated output capacity [VA]/200 [V] (for 200 V range)).

Also, the output current rms should not exceed the rated output current value calculated in the case of the linear load noted above.

If the equipment is used at a current exceeding the rated output current (peak or rms) noted above, the equipment's protective function is activated, which may distort the output voltage waveform or cut off the output. For further information on the protective functions, see Chapter 9, PROTECTIVE FUNCTIONS AND THEIR OPERATIONS.

### For loads where surge occurs

Loads (such as a fluorescent lamp) subject to surges when voltage is applied to a load or when voltage changes suddenly may cause the equipment to malfunction. In such a case, install a noise filter in the output circuit.

### For output waveform with the low output voltage

When the equipment is used with the low output voltage (less than 10 V), ripple noise may appear on the waveform of the output voltage and/or output current. It is reason why PWM inverter has a specific chractor. The equipment is not defective.

For loads which have small saturation magnetic flux density

To implement a power supply simulation or other functions, DC amplifier is used in this equipment.

Therefore, DC offset voltage (about 100mV) may be superimposed on AC output.

If the load such as a transformer which has small saturation magnetic flux density is connected to the output, an excessive current may flow.





# Chapter 6

## OPERATION METHOD

Describes how to operate various functions of the equipment.

### Contents

|               |   |      |
|---------------|---|------|
| [Description] | Home Position .....   | 6-2  |
| [Description] | Shift Key .....   | 6-2  |
| [Description] | ENT Wait .....  | 6-2  |
| 6.1           | Setting the Output Voltage Mode (AC/DC) .....                                 | 6-2  |
| [Description] | AC+DC mode<br>(with optional equipment) .....                                 | 6-2  |
| 6.2           | Setting the Output Voltage Range (100 V/200 V)                                | 6-4  |
| 6.3           | Output Voltage Setting .....  | 6-5  |
| 6.4           | Frequency Setting .....   | 6-6  |
| 6.5           | Limit Value Setting .....   | 6-7  |
| 6.5.1         | Setting the Voltage Limit Values .....  | 6-8  |
| 6.5.2         | Setting the Frequency Limit Values .....                                      | 6-10 |
| 6.5.3         | Setting the Current Limit Value .....   | 6-12 |
| 6.6           | Output ON/OFF .....   | 6-14 |
| [Description] | Output ON/OFF Switching .....   | 6-15 |
| 6.7           | How to Use JOG and SHUTTLE .....  | 6-16 |
| 6.7.1         | Numeric Setting Using JOG/SHUTTLE ....  | 6-16 |
| 6.7.2         | How to Use the Digit Function .....   | 6-17 |
| 6.8           | Setting the Voltage Display Mode .....  | 6-18 |
| 6.8.1         | Switching the Voltage Display Mode .....                                      | 6-18 |
| [Description] | Voltage Display Mode .....  | 6-19 |
| 6.9           | Setting the Current/Power Display Mode .....                                  | 6-20 |
| 6.9.1         | Switching the Current/Power Display Mode                                      | 6-20 |
| [Description] | Current/Power Display Mode .....  | 6-21 |
| [Description] | Offset display with no load .....   | 6-21 |
| 6.9.2         | How to Use the LOAD Level Meter .....   | 6-22 |
| [Description] | The LOAD level meter .....  | 6-22 |
| 6.10          | Memory Function .....   | 6-23 |
| [Description] | Memory Function .....   | 6-23 |
| 6.11          | Key-Lock Function .....   | 6-26 |
| [Description] | Key lock function by using the Remote<br>Controller (with optional equipment) | 6-26 |
| 6.12          | How to Use the Sensing Function .....   | 6-27 |
| [Description] | Sensing Function .....  | 6-27 |

[Description] Home Position

The status obtained immediately after turning the POWER switch ON is called the Home Position. To return to the Home Position from another status, press ESC once or twice (regardless of OUTPUT ON/OFF status).

[Description] Shift Key

When the SHIFT key is pressed, "SHIFT" on the control panel lights, and when the key is pressed again, "SHIFT" goes off.

Pressing a key when "SHIFT" is lit activates the function written in blue letters below the corresponding key.

Example: SHIFT + 4 (KEYLOCK)

This indicates that SHIFT should be pressed, which lights "SHIFT" on the control panel, then "4" pressed. (This selects the key lock function.)

[Description] ENT Wait

The condition whereby ENT has not yet been pressed to initiate operations made thus far is called ENT wait. In this case, "ENT" on the control panel blinks. To cancel the operation before pressing ENT, press ESC.

## 6.1 Setting the Output Voltage Mode (AC/DC)

---

This equipment has two output voltage modes: an AC voltage output mode (AC mode) and a DC voltage output mode (DC mode). They are selected in accordance with the type of voltage you wish to output.

The equipment stores the output voltage mode. When the POWER switch is turned ON, the equipment starts up in the output voltage mode applied immediately before the POWER switch was turned OFF.

The output voltage mode is displayed on the control panel as follows:

AC voltage output mode: Lights "AC" and displays frequency.

DC voltage output mode: Displays "dc" in the frequency display area.

[Description] AC+DC mode (with optional equipment)

Use of a Remote Controller (RC02-PCR-L), GPIB Interface (IB11), or RS-232C Interface (RS11) allows the use of the AC+DC mode. This causes "AC+DC" to appear on the control panel. See Chapter 7 OPTIONAL EQUIPMENT or, for details, the operation manual of each option.

## Procedure for Switching the Output Voltage Mode

The output voltage mode can be switched from the AC to the DC mode or vice versa.

- ▶ Step 1 When "OUTPUT ON" is lit, press OUTPUT to turn the output OFF.
- ▶ Step 2 Press ESC to select the Home Position.
- ▶ Step 3 Press SHIFT + 8 (AC/DC).
  - The control panel display changes as shown below depending on the existing output voltage mode.

In AC mode: AC lights continuously and +DC blinks.

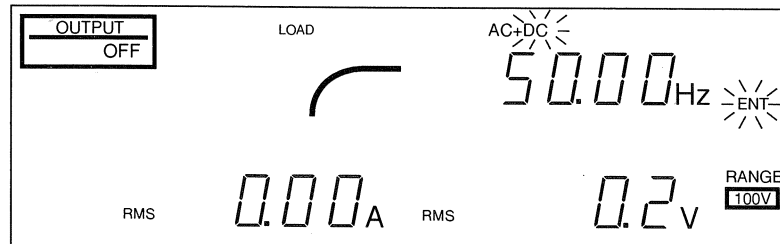

In DC mode: +DC lights continuously and AC blinks.

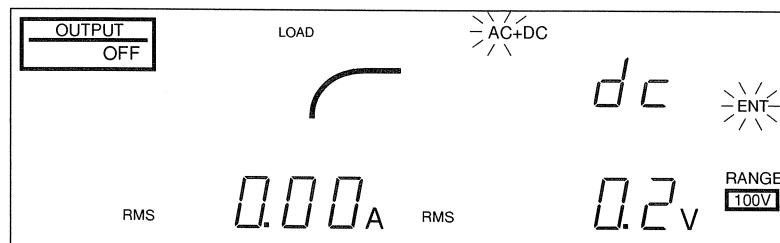

- ▶ Step 4 Press ENT to establish the output voltage mode.

This changes the output voltage mode to the mode which was blinking.

- To cancel operation and return to the Home Position, press ESC during ENT wait (the status in which ENT blinks).
- The output voltage mode can be changed only when OUTPUT is OFF in the Home Position.
- In the Initial Setup Status, the equipment is in the AC voltage output mode (AC mode).

Examples of AC and DC modes

AC mode

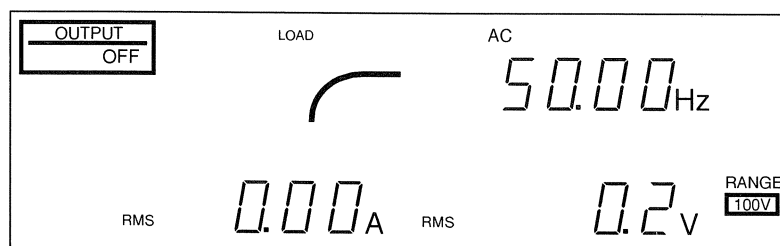

DC mode

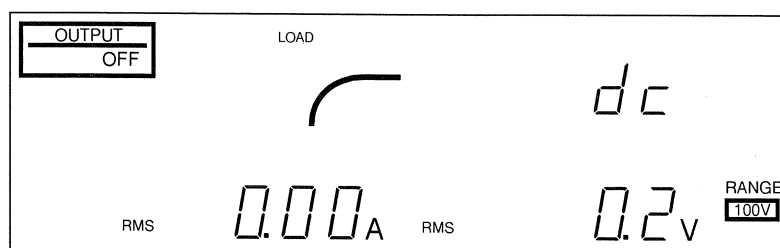

## 6.2 Setting the Output Voltage Range (100 V/200 V)

The equipment has two output voltage ranges, a 100 V range and a 200 V range. This range can be selected as necessary. The equipment stores the output voltage range data. When the POWER switch is turned ON, the equipment starts up in the output voltage range applied immediately before the POWER switch was turned OFF.

The output voltage range is displayed on the control panel as follows:

100 V range: "100V" below RANGE lights.

200 V range: "200V" below RANGE lights.

### Procedure for Switching the Output Voltage Range

The output voltage range can be switched from the 100 V range to the 200 V range or vice versa.

- ▶ Step 1 When "OUTPUT ON" is lit, press OUTPUT to turn the output OFF.
- ▶ Step 2 Press ESC to select the home position.
- ▶ Step 3 Press SHIFT + 7 (RANGE)
  - The control panel display changes as shown below depending on the existing output voltage range.

In the 100 V range: "100V" lights continuously and "200V" blinks.

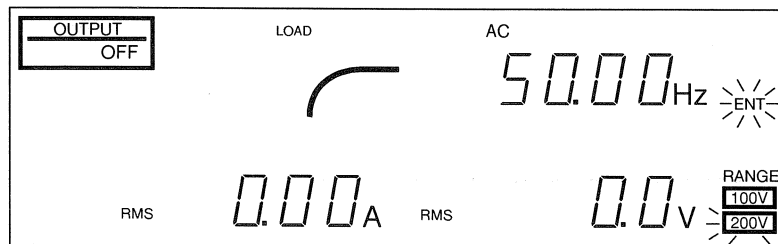

In the 200 V range: "200V" lights continuously and "100V" blinks.

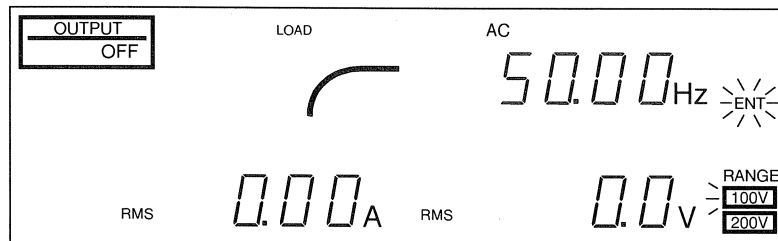

- ▶ Step 4 Press ENT to establish the output voltage range.
  - When the equipment was in the 100 V range, the 200 V range is selected, and when in the 200 V range, the 100 V range is selected.
  - To cancel operation and return to the Home Position, press ESC during ENT wait (the status in which ENT blinks).
  - The output voltage range can be changed only when OUTPUT is OFF in the Home Position.
  - In the Initial Setup Status, the equipment is in the 100 V range.

[Description] Maximum output current value

The maximum output current value changes depending on the output voltage range. The maximum output current value for the 200 V range is half that of the 100 V range. Select the range after carefully checking the equipment specifications.

## 6.3 Output Voltage Setting

The equipment stores an output voltage value. When the POWER switch is turned ON, the equipment sets the output voltage value applied immediately before the POWER switch was turned OFF.

### Procedure for Setting the Output Voltage

- ▶ Step 1 Press ESC to select the Home Position.
- ▶ Step 2 Press "V" to enter the voltage setting mode.

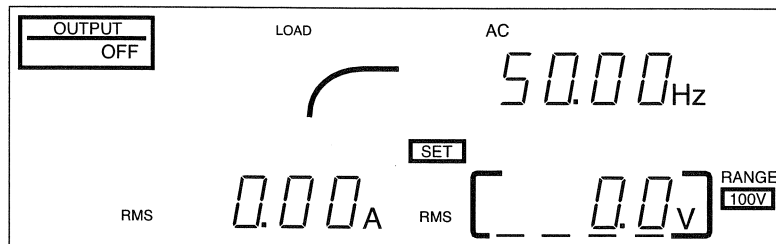

- This causes the frame that encircles the voltage display area to light, indicating that setting is possible.
- ▶ Step 3 Set the output voltage.
  - Using the numeric keys (0 to 9), enter a voltage value and press ENT to set it.

#### [Description] Entering a voltage value

Entry using the numeric keys is possible when the output is OFF.

When the output is ON, entry using the numeric keys is possible only when the "SET" is lit. In the voltage setting mode, voltage setting using JOG/SHUTTLE is always possible. For details, refer to Section 6.7, "How to Use JOG and SHUTTLE."

- The voltage display area indicates polarity (+/-) on the left only in the DC mode. To reverse polarity, press SHIFT + 0 (+/-).
- To cancel operation during entry using the numeric keys and to return to step 2, press ESC or CLR during ENT wait.
- If an attempt is made to set a voltage that exceeds the specified range, the setting is ignored.
- To exit the voltage setting mode, press ESC or F.
- The equipment can enter the voltage setting mode only in the Home Position or the frequency setting mode.
- In the Initial Setup Status, the output voltage set value shows 0.0 V for both the AC and DC modes.

#### CAUTION

- In the AC mode, output voltage can be set from 0.0 V. However, the actual output voltage does not go 0 V. (Approx. 0.1 V may be supplied.)
- Since the equipment's output impedance is very low, current may flow even when output voltage is set to 0.0 V, depending on the load. When you do not wish to allow current to flow or when connecting a load, always set OUTPUT OFF or turn OFF the POWER switch.

## 6.4 Frequency Setting

---

The AC mode allows frequency setting. The equipment stores the frequency, and when the POWER switch is turned ON, it sets the frequency applied immediately before the POWER switch was turned OFF.

### Procedure for Setting the Frequency

---

- ▶Step 1 Press ESC to select the Home Position.
- ▶Step 2 Press "F" to enter the frequency setting mode.

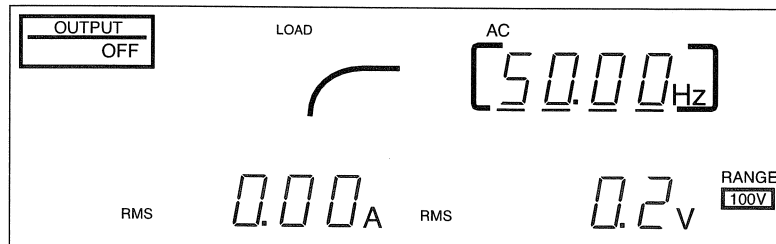

- This causes the frame that encircles the frequency display area to light, indicating that setting is possible.

- ▶Step 3 Set the Frequency.
  - Using the numeric keys (0 to 9), enter the frequency and press ENT to set it.
  - Frequency setting is also possible using JOG and SHUTTLE. For details, see section 6.7, "How to Use JOG and SHUTTLE."
  - If an attempt is made to set a frequency that exceeds the specified range, the setting is ignored.
  - To exit the frequency setting mode, press ESC or V.
  - The equipment can enter the frequency setting mode only in the Home Position or the voltage setting mode.
  - In the Initial Setup Status, the frequency is at 50.00 Hz.

## 6.5 Limit Value Setting

The equipment allows the voltage and frequency setting ranges to be specified. Moreover, when the output current rms high limit is set, the equipment turns the output OFF if the actual output current value exceeds the high limit.

The high and low voltage and frequency limits and output current rms high limit are all called limit values. They are called voltage limit values, frequency limit values, and current limit value for the voltage, frequency, and output current rms, respectively.

Mode for limit value setting are as follows:

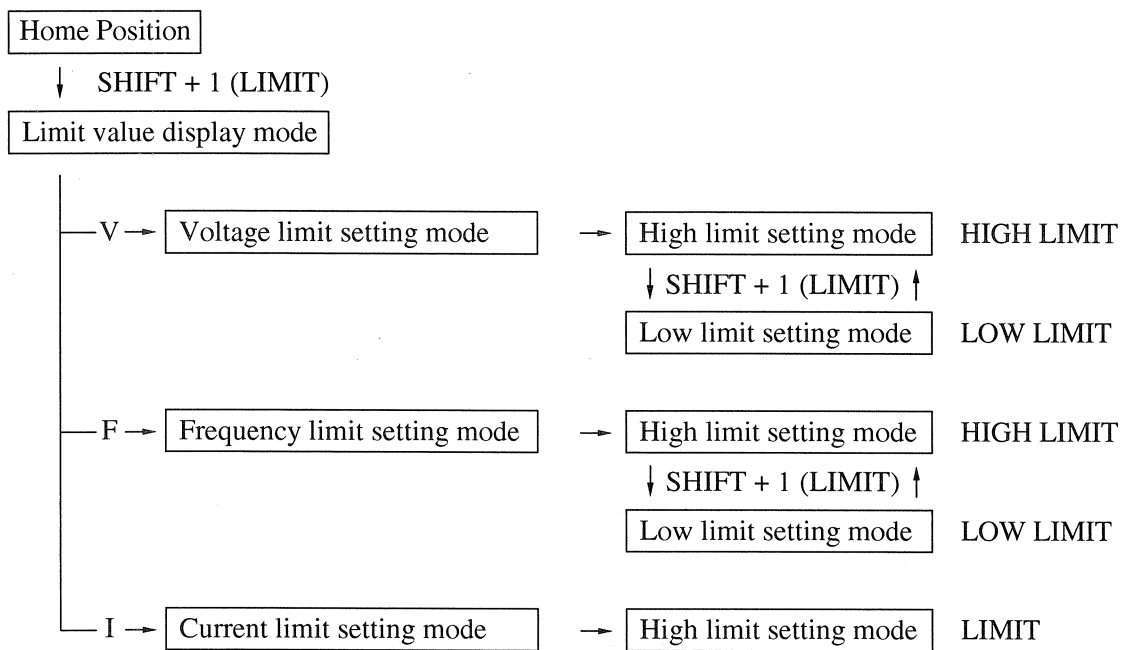



### 6.5.1 Setting the Voltage Limit Values

A high voltage limit value is called a high limit and a low voltage limit value a low limit. The equipment stores voltage limits values, and when the POWER switch is turned ON, it sets the voltage limit values applied immediately before the POWER switch was turned OFF.

- In the Initial Setup Status, the voltage limit values are set to the values of the maximum variable range of the equipment.
- Any output voltage that exceeds the voltage limits cannot be set, except 0 V; 0 V can be set even if it is not within the voltage limit range.
- High and low voltage limits can be set for both AC and DC voltages, that is, four limit values can be set.
- Setting a limit value in the AC mode establishes an AC limit value; setting a limit value in the DC mode establishes a DC limit value.

**WARNING**

- Output of an unreasonably high voltage due to an erroneous setting may damage the load connected to the equipment or expose the operator to danger. Therefore, always set the voltage limit values beforehand.

#### Procedure for Setting the Voltage Limit Value

- ▶ Step 1 Press ESC to select the Home Position.
- ▶ Step 2 Press SHIFT + 1 (LIMIT) to select the limit value display mode.

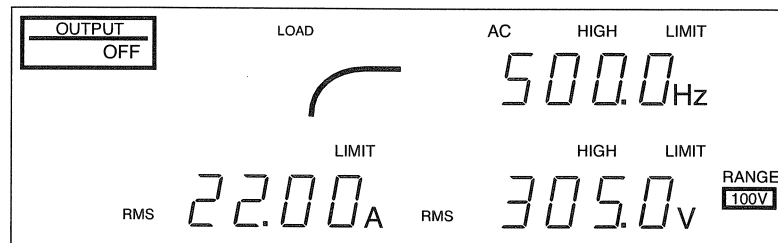

- "HIGH" and "LIMIT" light, and the values of the voltage, frequency, and current high limit appear.

- ▶ Step 3 Press "V" to select the voltage limit value setting mode. In this case, the high limit setting mode is activated.

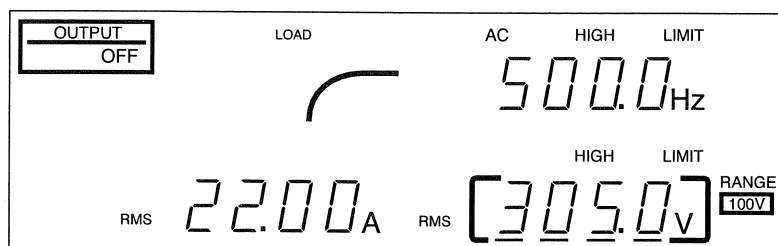

- The frame that encircles the voltage display area lights to indicate that setting is possible.



- ▶ Step 4 Set a high limit value.
  - Use the numeric keys or JOG/SHUTTLE to set a high limit value. Setting is accomplished in the same way as voltage setting (See Section 6.3, step 3).
- ▶ Step 5 Press SHIFT + 1 to select the low limit setting mode.

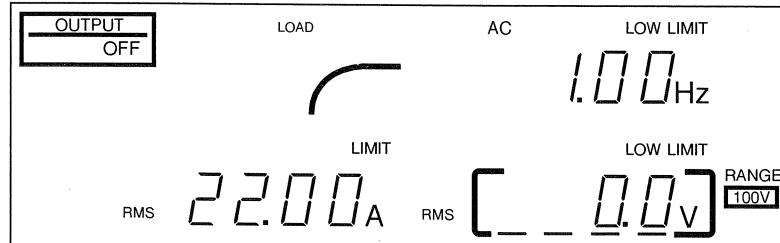

This causes "LOW LIMIT" to light.

- ▶ Step 6 Set a low limit value.
- ▶ Step 7 Press ESC to exit the voltage limit setting mode.

In the voltage limit setting mode, the following occurs.

- Pressing SHIFT + 1 (LIMIT) allows you to switch between the high and low limit setting modes.

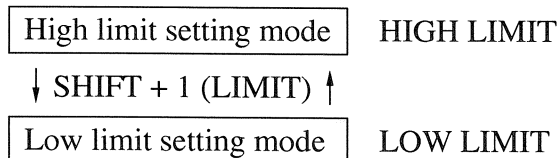

- Pressing "F" transfers the status to the frequency limit setting mode and pressing "I" to the current limit setting mode. However, the low limit setting mode does not allow transfer to the current limit setting mode even when "I" is pressed.
- Pressing ESC returns the status to the limit value display mode and pressing ESC once again selects the Home Position.

## 6.5.2 Setting the Frequency Limit Values

A high frequency limit value is called a high limit and a low frequency limit value a low limit. The equipment stores the frequency limit values, and when the POWER switch is turned ON, it sets the frequency limit values applied immediately before the POWER switch was turned OFF.

- In the Initial Setup Status, frequency limit values are set to the values of the maximum variable range of the equipment.
- Any frequency that exceeds the frequency limits cannot be set.

### WARNING

- Outputting frequency that exceeds the specified range due to an erroneous setting may damage the load connected to the equipment or expose the operator to danger. Therefore, always set the frequency limit values beforehand.

### Procedure for Setting the Frequency Limit Value

- ▶Step 1 Press ESC to select the Home Position.
- ▶Step 2 Press SHIFT + 1 (LIMIT) to select the limit value display mode.

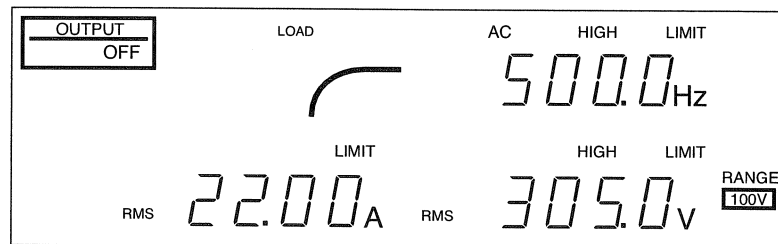

- "HIGH" and "LIMIT" light, and the values of the voltage, frequency, and current high limit appear.

- ▶Step 3 Press "F" to select the frequency limit setting mode. In this case, the high limit setting mode is activated.

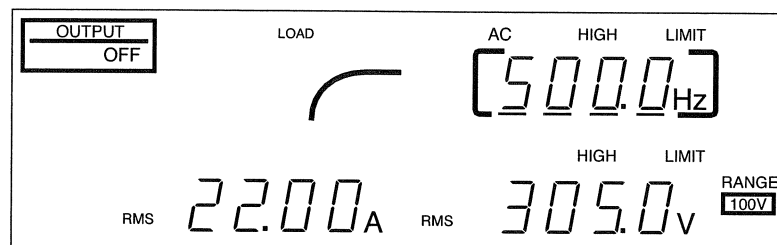

- The frame that encircles the frequency display area lights to indicate that setting is possible.

- ▶ Step 4 Set the high limit value.
  - Use the numeric keys or JOG/SHUTTLE to set the high limit value. Setting is accomplished in the same way as frequency setting (See Section 6.4, step 3).
- ▶ Step 5 Press SHIFT + 1 to select the low limit setting mode.

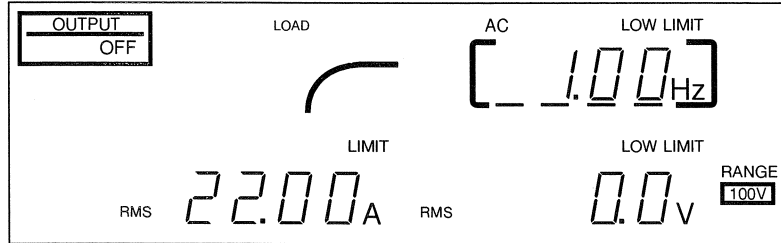

This causes "LOW LIMIT" to light.

- ▶ Step 6 Set the low limit value.
- ▶ Step 7 Press ESC to exit the frequency limit setting mode.

In the frequency limit setting mode, the following occurs.

- Pressing SHIFT + 1 (LIMIT) allows you to switch between the high and low limit setting modes.

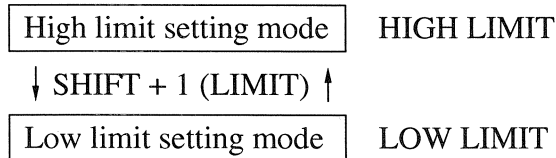

- Pressing "V" transfers the status to the voltage limit setting mode and pressing "I" to the current limit setting mode. However, the low limit setting mode does not allow transfer to the current limit setting mode even when "I" is pressed.
- Pressing ESC returns the status to the limit value display mode and pressing ESC once again selects the Home Position.

### 6.5.3 Setting the Current Limit Value

The equipment allows a current limit value to be set for both AC and DC. The equipment stores the current limit values, and when the POWER switch is turned ON, it sets the current limit values applied immediately before the POWER switch was turned OFF.

- Setting a limit value in the AC mode establishes the AC limit value; setting a limit value in the DC mode establishes the DC limit value.

When the current limit value is set, the control panel LOAD level meter displays the full-scale value of the current limit. However, if the rated current value is lower than the current limit, it displays the full-scale value of the rated current.

- If a current that exceeds the current limit value flows, the control panel warning "OVERLOAD" lights and the output voltage drops. If this condition continues for about 10 s in the AC mode or about 1 s in the DC mode, the output is automatically turned OFF.
- The function that controls the current limit works in current rms. Therefore, it does not directly respond to the peak current drawn by a capacitor-input rectifying load.
- In the Initial Setup Status, the current limit value is set to a value 1.1 times greater than the maximum rated current of the 100 V range.

#### CAUTION

- If this equipment's output current becomes greater than that for normal use due to an error in the load connected to the output of the equipment, the load may be damaged. (If the wire that connects the equipment to the load is not sufficiently thick, the wire may burn.) To prevent such a problem, use wires with sufficient current capacity and also set the current limit values. To select the proper wire, see the table of the wire size and the allowable current in Chapter 3, Step 3.

#### Procedure for Setting the Current Limit Value

The current limit value requires only the high limit value setting.

- ▶ Step 1 Press ESC to select the home position.
- ▶ Step 2 Press SHIFT + 1 (LIMIT) to select the limit value display mode.

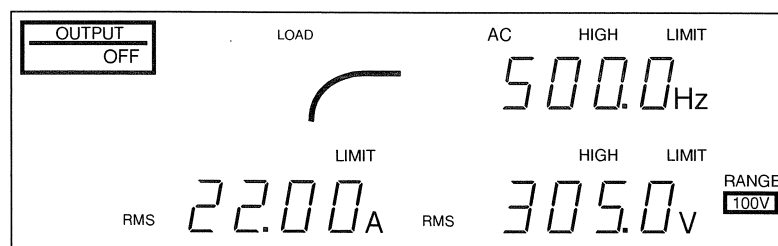

- "HIGH" and "LIMIT" light, and the values of the voltage, frequency, and current high limit appear.

- ▶Step 3 Press "I" to select the current limit value setting mode.

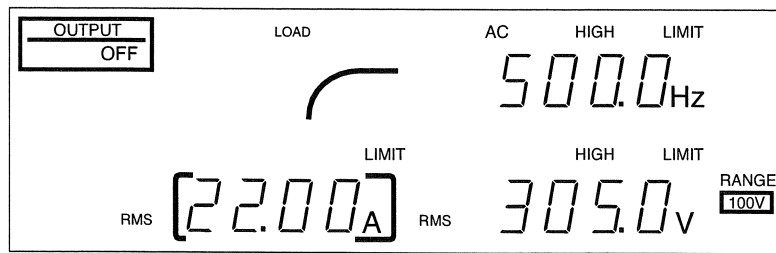

- The frame that encircles the current display area lights to indicate that setting is possible.

- ▶Step 4 Set the limit value.

- Use the numeric keys or JOG/SHUTTLE to set the high limit value. Setting is accomplished in the same way as frequency setting (See Section 6.4, step 3).

- ▶Step 5 Press ESC to exit the current limit setting mode.

In the current limit setting mode, the following occurs:

- Pressing "F" always transfers the status to the frequency limit setting mode and pressing "V" to the voltage limit setting mode.
- Pressing ESC returns the status to the limit value display mode and pressing ESC once again selects the Home Position.

## 6.6 Output ON/OFF

Using OUTPUT, switching between the output ON condition (in which power is fed to the load) and the output OFF condition (in which no power is fed to the load) is possible. Output ON/OFF is displayed as follows on the control panel.

- Output ON status: OUTPUT ON lights.
- Output OFF status: OUTPUT OFF lights.

Immediately after the POWER switch has been turned ON, output is set to OFF (OUTPUT OFF) . Whenever OUTPUT is pressed, output ON/OFF changes alternately.

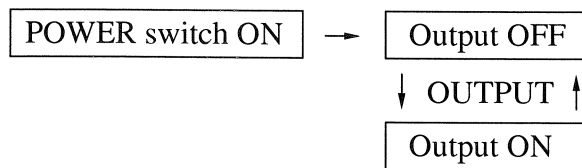

OUTPUT OFF

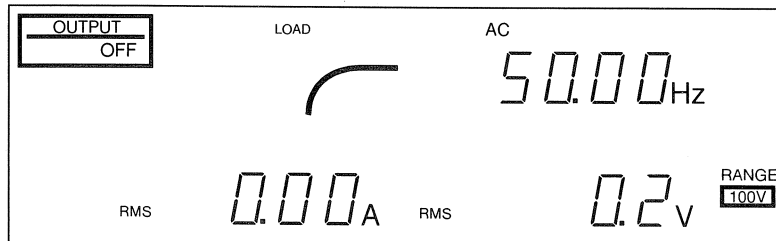

OUTPUT ON

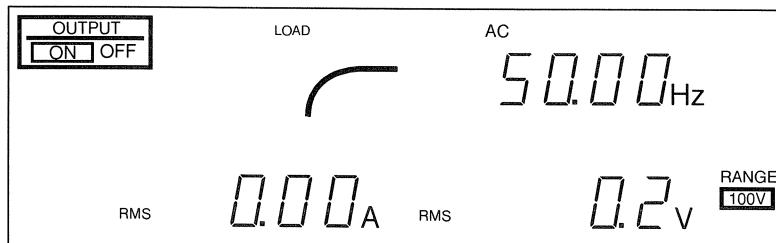

### [Description] Output ON/OFF Switching

This equipment does not cut off output from the internal circuits mechanically using switches and relays, but rather increases output impedance electrically to turn the output off. This allows output to be turned ON/OFF in a smooth waveform without producing any contact chatter. When output is OFF, the output is in the high impedance condition\*.

The Output ON phase angle is changed by timing when the OUTPUT switch is pressed. The Output OFF phase angle is always turned off at zero cross phase so that the internal output capacitor can discharge with no load output. However, by using the optional equipment, you can set the output ON/OFF phase angle.

#### CAUTION

- The output voltage does not go 0 V until the internal output capacitor has been discharged (100 ms max.) with no load output.
- When the POWER switch is turned OFF, always conduct the following procedure to discharge the internal capacitors connected to the OUTPUT terminals.  
Turn the OUTPUT switch OFF first, wait for more than one second, and then turn the POWER switch OFF.
- When a load such as capacitor or battery is connected to the output with DC modes, the output voltage remains until electric charge that is charged to the load has been discharged.

\* In the high impedance condition, the impedance (resistance) value is approximately as follows:

- For the 100 V output range  
 $R_{\text{OFF}} = \text{Approx. } 20 / N \text{ [ k } \Omega \text{ ]}$
- For the 200 V output range  
 $R_{\text{OFF}} = \text{Approx. } 80 / N \text{ [ k } \Omega \text{ ]}$

N indicates the value equivalent to the PCR-W series rated output capacity [kVA].

Example: Impedance in PCR4000W's 200 V output range

$$R_{\text{OFF}} = \text{Approx. } 80 / 4 \text{ [ k } \Omega \text{ ]} = \text{Approx. } 20 \text{ [ k } \Omega \text{ ]}$$

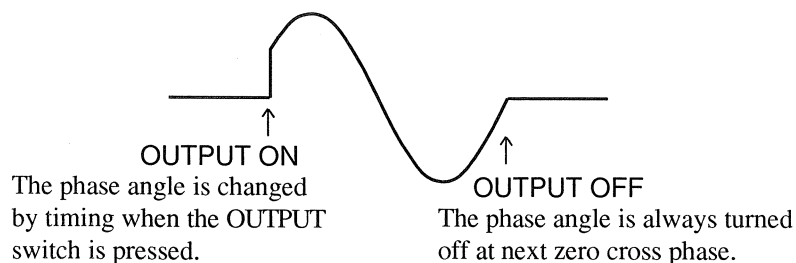

## 6.7 How to Use JOG and SHUTTLE

### 6.7.1 Numeric Setting Using JOG/SHUTTLE

#### Numeric setting using JOG

Turn JOG clockwise to increase the displayed value or counterclockwise to decrease it. The displayed value is established as a set value whenever changed. (Pressing ENT is not required.)

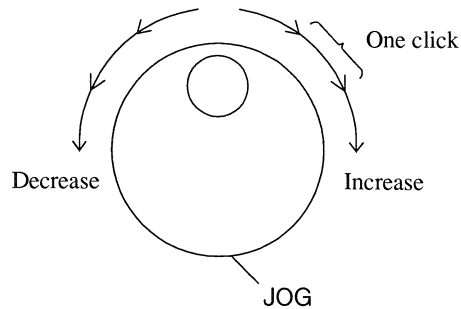

- JOG is useful in making fine set-value adjustments.
- Any value that exceeds the allowable range is ignored.

#### Numeric setting using SHUTTLE

Turn SHUTTLE clockwise and hold it to increase the displayed value continuously or turn it counterclockwise and hold it to decrease the value continuously. Return SHUTTLE to the neutral position to stop the set value change. The displayed value is established as a set value whenever changed. (Pressing ENT is not required.)

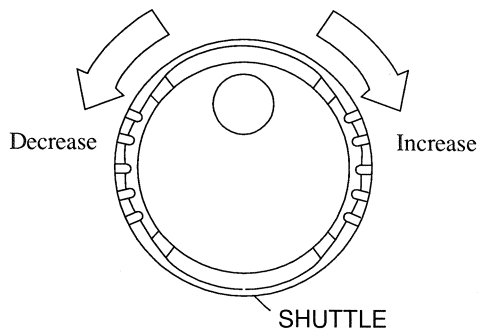

- Turning SHUTTLE to a greater degree of angle increases the speed at which the numeric change is made.
- The numeric change speed can be changed in four steps.
- SHUTTLE is useful for changing the set value to an approximate desired value.
- Any value that exceeds the allowable range is ignored.
- When SHUTTLE is used, the set value may be increased or decreased too much because of the rapid speed at which the set value changes.

#### **WARNING**

- Output voltage or frequency that exceeds the specified range may damage the load connected to the equipment or expose the operator to danger. Therefore, always set the voltage and frequency limit values beforehand. For details, see section 6.5, "Limit Value Setting."



## 6.7.2 How to Use the Digit Function

The digit function allows you to change the higher digits than the specified one using JOG or SHUTTLE when the voltage or frequency is set. This function is useful for making step changes in the voltage or frequency setting.

### Procedure for Using the Digit Function

Take the following steps in the voltage or frequency setting mode. (The setting mode is the status in which the frame encircling the voltage or frequency display area is lit, which is obtained by pressing V or F.)

►Step 1 Press SHIFT + . (DIGIT).

This causes the cursor (part of the frame) to blink at the specified variable digit, and to select the digit mode. This mode allows the digit where the cursor blinks and a higher digit to be changed.

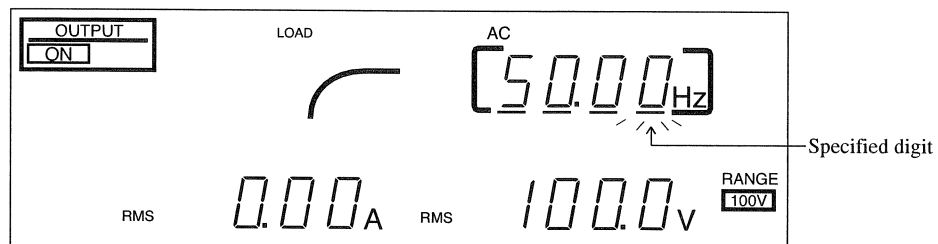

- The digit where the cursor blinks is called the specified digit.
- Pressing SHIFT + . (DIGIT) once makes the specified digit move one digit to the left.

►Step 2 Press SHIFT + . (DIGIT) the required number of times to move the cursor to the desired digit.

- Pressing SHIFT + . (DIGIT) when the cursor is at the most significant digit causes the cursor to return to the least significant digit.
- The value at the specified digit can also be set using the numeric keys and ENT key, but the digit function is cancelled after the specified digit is set.
- To exit the digit function, press ESC, ENT, or CLR.
- For voltage, the digit function can be used only when SET is lit.

## 6.8 Setting the Voltage Display Mode

### 6.8.1 Switching the Voltage Display Mode

The voltage display modes are provided in the table below.

| Voltage display mode              | Control panel indication (lit) |
|-----------------------------------|--------------------------------|
| Rms value display mode (RMS)      | RMS V                          |
| Peak value display mode (PEAK)    | PEAK V                         |
| Set voltage display mode (SET)    | SET RMS V                      |
| Average value display mode* (AVE) | V                              |

\* This mode is available only in the DC mode.

- In the Initial Setup Status, the rms value display mode (RMS) is activated.
- The equipment stores the voltage display mode, and when POWER switch is turned ON, it sets the voltage display mode applied immediately before the POWER switch was turned OFF.

#### Procedure for Switching the Voltage Display Mode

- Step 1 Press SHIFT + V (V MODE).

Whenever SHIFT + V (V MODE) are pressed the voltage display mode changes as follows:

A C mode



D C mode

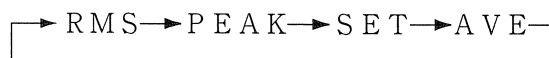

**[Description] Voltage Display Mode**

The voltage display mode can be classified into a set-voltage display and a measured voltage display as follows:

- Set-voltage display: Displays the currently set voltage.  
 Measured voltage display: Displays the actual output voltage measured in three measuring methods.

The output voltage measuring method includes rms value measurement, peak value measurement, and average value measurement. One of these measuring methods should be set for voltage measurement. The features of these measuring methods are as follows:

**rms value measurement (RMS)**

Divides a single voltage cycle into 256 portions to measure an instantaneous voltage value at each portion and calculates the voltage rms value based on the data obtained.

- This measurement method is available for both the AC and DC modes.

**Peak value measurement (PEAK)**

Divides a single voltage cycle into 256 portions to measure an instantaneous voltage value at each portion and obtains the maximum absolute value from among the data obtained.

- The peak voltage display provides an absolute value with no polarity sign.
- The peak value is cleared after every measurement cycle.
- Since measurement is made by dividing a voltage cycle into 256 portions, if a narrow pulse having peak voltage is generated between the measurement points, the peak voltage cannot be measured.
- This measurement method is available for both the AC and DC modes.

**Average value measurement (AVE)**

Divides a single voltage cycle into 256 portions to measure an instantaneous voltage value at each portion and calculates an average value based on the data obtained.

- This measurement method is available only in the DC mode.

The voltage measurement interval of this equipment is approximately 0.3 s to 2 s. (This value changes depending on output frequency. The Value is approx. 0.3 s when the output frequency is near 40 Hz or 40 Hz more.)

Because the internal auto range attenuator is switched when a measured voltage changes frequently, however, a time when measured value is stabilized is max. 4 times of above measurement interval.

## 6.9 Setting the Current/Power Display Mode

### 6.9.1 Switching the Current/Power Display Mode

The current/power display modes are provided in the table below.

| Current/power display mode           | Control panel indication (lit) |
|--------------------------------------|--------------------------------|
| Current rms value display mode (RMS) | RMS A                          |
| Peak current display mode (PEAK)     | PEAK A                         |
| Power display mode (W)               | W (E3)*1                       |
| Average current display mode (AVE)*2 | A                              |

\*1 In the PCR12000W, "E3" is displayed when the output power is 10 kW or more.  
 Example) The control panel display with the output power of 12000 W

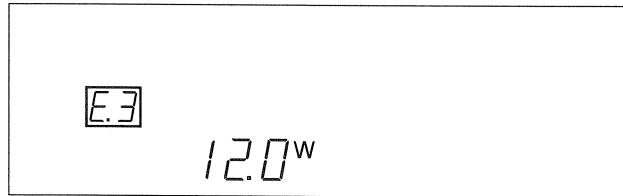

\*2 This mode is available only in the DC mode.

- In the Initial Setup Status, the rms value display mode (RMS) is activated.
- The equipment stores the current/power display mode, and when the POWER switch is turned ON, it sets the current/power display mode applied immediately before the POWER switch was turned OFF.

### Procedure for Switching the Current/Power Display Mode

► Step 1 Press SHIFT + I (I MODE).

When SHIFT + I (I MODE) are pressed, the current/power display mode changes as follows:

A C mode



D C mode



### [Description] Current/Power Display Mode

The methods by which the output current can be measured include rms value measurement, peak value measurement, and average value measurement. One of these methods should be set for current/power measurement. The features of these measuring methods are as follows:

#### Current rms value measurement (RMS)

Divides a single current cycle into 256 portions to measure an instantaneous current value at each portion and calculates a current rms value based on the data obtained.

- This measurement method is available for both the AC and DC modes.

#### Peak current measurement (PEAK)

Measures peak current values using an analog peak holding circuit to obtain the maximum absolute value from among the data obtained.

- The peak current display indicates an absolute value with no polarity sign.
- The peak value is cleared after every measurement cycle.
- This measurement method is available for both the AC and DC modes.

#### Average current measurement (AVE)

Divides a single current cycle into 256 portions to measure an instantaneous current value at each portion and calculates an average value based on the data obtained.

- This measurement method is available for only DC mode.

#### Power measurement (W)

Divides one voltage cycle and one current cycle into 256 portions each to measure instantaneous voltage and current values at each portion respectively and calculates power (W) based on the current and voltage data obtained.

- This measurement method is available for both the AC and DC modes.

The current/power measurement interval of this equipment is approximately 0.3 s to 2 s. (This value changes depending on the output frequency. The Value is approx. 0.3 s when the output frequency is near 40 Hz or 40 Hz more.)

Because the internal auto range attenuator is switched when a measured current/power changes frequently, however, a time when measured value is stabilized is max. 4 times of above measurement interval.

### [Description] Offset display with no load

When the voltage and output frequency are set higher with no load, the dozen of mA (max.) is displayed on the current display area.

It is reason why reactive current flows the capacitor that is connected to the internal (output terminal.) The equipment is not defective.

## 6.9.2 How to Use the LOAD Level Meter

The equipment LOAD level meter detects the current flowing in a load and displays (for reference) the ratio of the load current value to the rated current value.

### [Description] The LOAD level meter

The current flowing in a load varies depending on the load connected. The output current should be derated depending on the output voltage, and frequency in the AC mode, or depending on the output voltage in the DC mode; the rated current value changes with the load condition. Therefore, obtaining an accurate ratio of the load current value to the rated current value is difficult. The LOAD level meter applies a momentary rated current value or current limit value, whichever is smaller, as a full scale and displays the ratio of a load current value to the relevant value. The level meter should be used as a reference to know the available load current.

### Examples of LOAD level meter displays

Below are some display examples of the PCR2000W LOAD level meter.

- To display derating in the rated output current according to the output voltage setting
  - Example: For 100 V output voltage (in the 100 V range)  
The rated current 20 A is displayed as a full scale.
  - For 150 V output voltage (in the 100 V range)  
The rated current 13.3 A is displayed as a full scale.
- To display the change in the rated output current caused by the output voltage range
  - Example: For the 100 V range  
The rated current 20 A is displayed as a full scale.
  - For the 200 V range  
The rated current 10 A is displayed as a full scale
- To display derating in the rated output current caused by output frequency
  - Example: For 50 Hz  
The rated current 20 A is displayed as a full scale.
  - For 5 Hz  
The rated current 10 A is displayed as a full scale.
- To display the change in the rated output current caused by the output voltage mode (AC/DC)
  - Example: For the AC mode  
The rated current 20 A is displayed as a full scale.
  - For the DC mode  
The rated current 10 A is displayed as a full scale.
- To display a current limit set value as the rated output current
  - Example: For current limit 10 A  
The rated current 10 A is displayed as a full scale.

## 6.10 Memory Function

The function allows the voltage and frequency set values to be stored in the memory beforehand for subsequent reading out and setting. This feature is convenient for writing frequently used voltage and frequency set-values in the memory.

### [Description] Memory Function

The memory function allows the output voltage and output frequency set-values to be written as a set in the memory for later reading out and setting. In the DC mode, the function allows only voltage to be read and written. The memory allows nine sets of voltage and frequency to be set for the AC mode and nine voltages to be set for the DC mode. Read-write memory addresses are 1 to 9.

The following table shows the data set in the memory in the Initial Setup Status.

| Memory address | AC voltage | Frequency | DC voltage |
|----------------|------------|-----------|------------|
| 0              | 0.0 V      | 50 Hz     | 0.0 V      |
| 1              | 0.0 V      | 50 Hz     | 0.0 V      |
| 2              | 0.0 V      | 50 Hz     | 0.0 V      |
| 3              | 0.0 V      | 50 Hz     | 0.0 V      |
| 4              | 0.0 V      | 60 Hz     | 0.0 V      |
| 5              | 0.0 V      | 60 Hz     | 0.0 V      |
| 6              | 0.0 V      | 60 Hz     | 0.0 V      |
| 7              | 0.0 V      | 400 Hz    | 0.0 V      |
| 8              | 0.0 V      | 400 Hz    | 0.0 V      |
| 9              | 0.0 V      | 400 Hz    | 0.0 V      |

- Since the equipment stores the data in its memory, the stored values can be retrieved as desired.
- Memory address 0 is for readout only.



## Procedure for Storing Data in the Memory

- ▶ Step 1 Set the desired output voltage mode (AC or DC).
- ▶ Step 2 Set the voltage (and frequency) you wish to store.
  - Set only the voltage for the DC mode.
  - Set both voltage and frequency for the AC mode.
- ▶ Step 3 Press ESC to select the Home Position.
- ▶ Step 4 Press SHIFT + MEM (STORE).

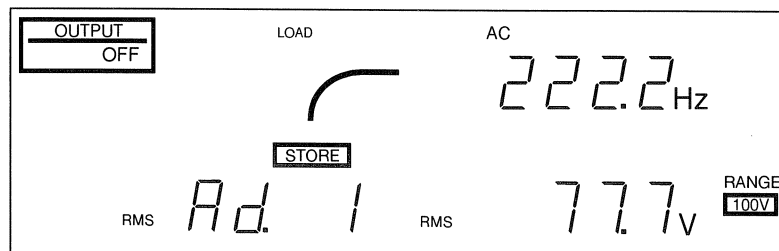

- ▶ Step 5 Press any of the keys from 1 to 9 to select the write destination memory address. This will cause "Ad. X" (X: number) to appear in the current display area and "STORE" to blink.

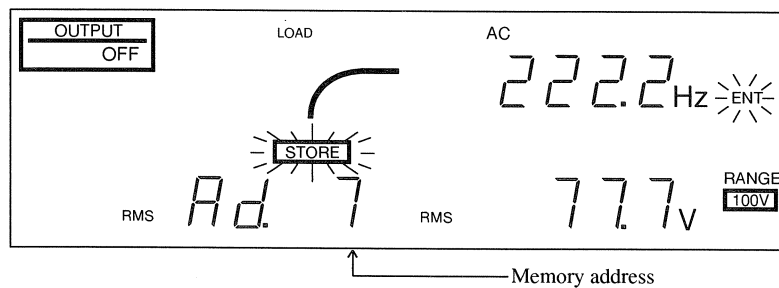

- ▶ Step 6 To establish the memory address, press ENT.
  - To cancel the selection, press ESC.
- ▶ Step 7 The voltage (and frequency) are written (as a pair) in the memory.
  - Only the voltage is written for the DC mode.
  - Both voltage and frequency are written for the AC mode.



## Memory Read Procedure

- ▶ Step 1 Set the desired output voltage mode (AC or DC).
- ▶ Step 2 Press ESC to select the Home Position.
- ▶ Step 3 Press MEM.

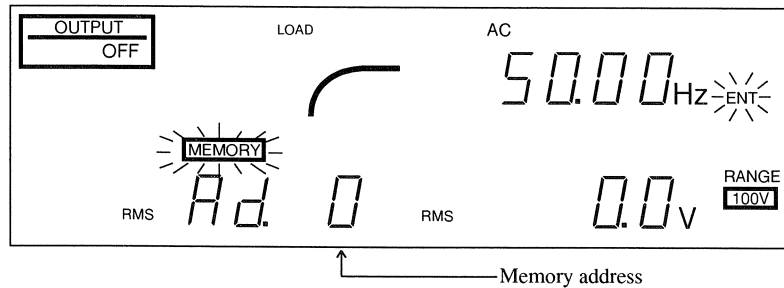

- ▶ Step 4 Press any of the keys from 1 to 9 to select the read destination memory address. This will cause "Ad. X" (X: number) to appear in the current display area. The voltage and frequency stored in the relevant memory address are retrieved and displayed in the respective voltage and frequency display areas.
  - Only the voltage is retrieved in the DC mode.
  - Both voltage and frequency are retrieved in the AC mode.
- ▶ Step 5 To establish the retrieved value(s) as the set value(s), press ENT.
  - To cancel the value(s), press ESC.
  - In the DC mode, only the voltage is set.
  - In the AC mode, both voltage and frequency are set.

[Description] A maximum of 99 sets of memory-stored data to be set (with optional equipment)

Use of the Remote Controller (RC02-PCR-L), GPIB Interface (IB11), or RS-232C Interface (RS11) allows a maximum of 99 sets of memory-stored data to be set. In this case, memory addresses 1 to 9 can be accessed from both the control panel and the optional equipment. See Chapter 7 OPTIONAL EQUIPMENT or, for details, see the operation manual of each unit.

## 6.11 Key-Lock Function

The key lock function prevents key operation through the control panel.

This function is used to prevent the set values from being changed by accident in order to retain the desired output voltage and frequency.

- The key-lock function is not applied in the initial setup status.

[Description] Key lock function by using the Remote Controller (with optional equipment)

Operation via the control panel can also be locked using the key-lock function when the Remote Controller (RC02-PCR-L) is used. For details, see the operation manual of the Remote Controller.

### Key-Lock Procedure

- ▶ Step 1 Press ESC to select the Home Position.
- ▶ Step 2 Press SHIFT + 4 (KEYLOCK).  
This activates the key-lock mode, causing KEYLOCK to light.

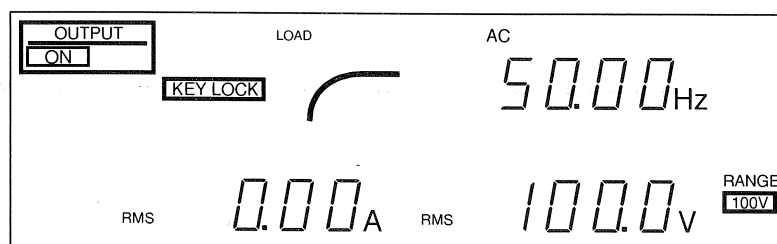

- OUTPUT ON/OFF is available even in the key-lock mode.
- The key-lock mode is retained until cancelled. If the key-lock mode was on when the POWER switch was turned OFF, the key-lock mode is also activated when the POWER switch is turned ON again (however OUTPUT is turned OFF).
- To cancel the key-lock mode, press SHIFT + 4 (KEYLOCK) again.

## 6.12 How to Use the Sensing Function

### [Description] Sensing Function

This equipment's sensing function is significantly different from the remote sensing of conventional DC power supplies (the function that instantaneously corrects voltage in real-time).

The equipment can output both AC and DC; however, AC output is given priority. Since an AC power supply outputs AC voltage, no large-capacity capacitor can be connected to the output end. Therefore, performing remote sensing in the same way as do ordinary DC power supplies results in an unstable power supply. To connect a load at a distant place and stabilize voltage at that point (the sensing point), the equipment uses its output voltage measuring function to measure the voltage at the sensing point and automatically corrects any insufficiencies in voltage. Therefore, voltage stability, output voltage response in the event of a sudden change in load current, and waveform quality (distortion rate) are inferior. The equipment sensing method is also the same in the DC mode; output voltage response is also inferior for the sensing function in the DC mode.

The output voltage cannot be changed when the sensing function is being used. The above should be kept in mind when using the sensing function.

If there is a difference of about 10% or more between the voltage at the equipment's output terminal and that at the sensing point during use of the sensing function, the equipment will not function normally and an alarm will be issued a few seconds later in the form of an intermittent buzzer sound and the word "SENSING" blinking.

To clear this condition, turn the POWER switch OFF or press SHIFT + CLR (ALM CLR). If the above condition occurs, take the appropriate measures, such as using thicker, shorter output wire that connects the equipment to the load, to minimize the wire voltage drop as much as possible.

## Procedure for Using the Sensing Function

► Step 1 Make the connection shown below.

**WARNING**

- Before connecting the load and sensing cables, turn the POWER switch OFF and cut off power feed from the power distribution board.

PCR-W series terminal box (the configuration differs slightly depending on the model.)

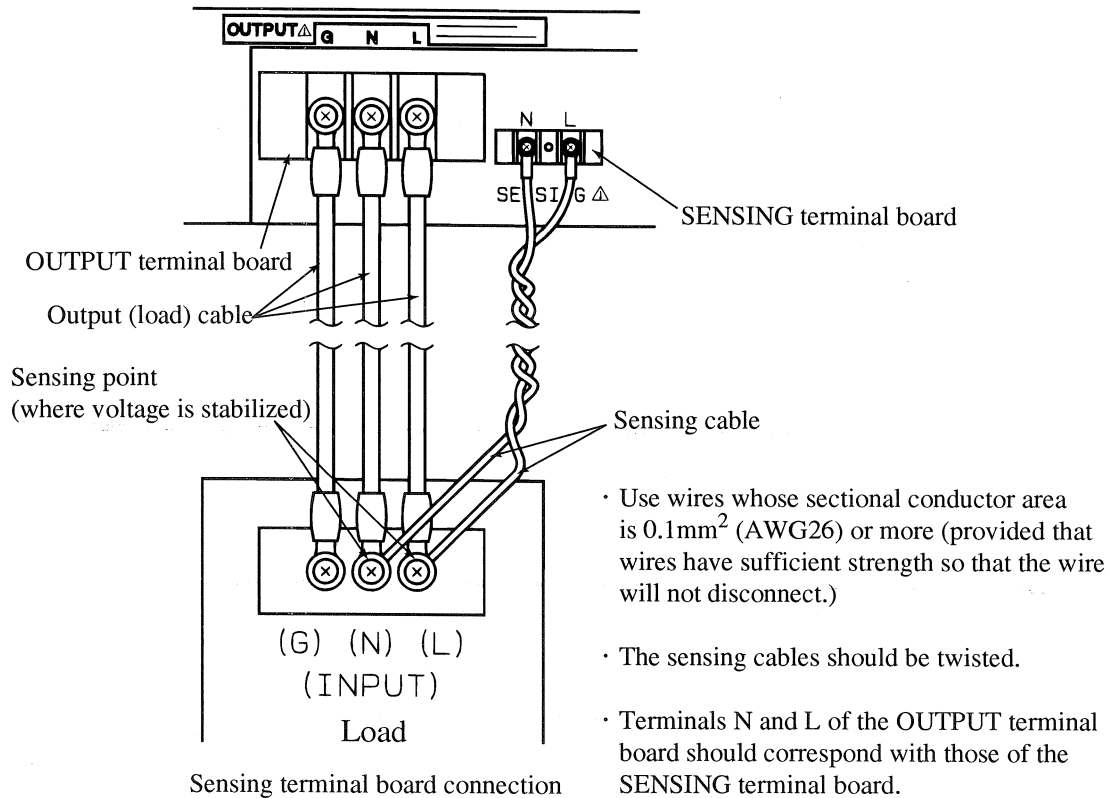

► Step 2 Set the voltage and frequency to be stabilized at the sensing point.

- Set only the voltage in the DC mode.

► Step 3 Press ESC to select the Home Position.

► Step 4 Press SHIFT + 5 (SENSING).

This causes the sensing function to activate and the word "SENSING" to light.

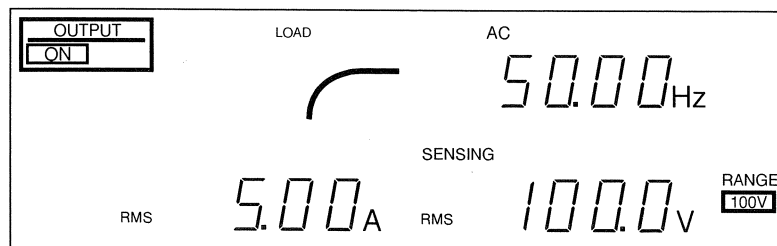

- To cancel the sensing function, press SHIFT + 5 (SENSING).

# Chapter 7

## OPTIONAL EQUIPMENT

Describes options available for this equipment.

### Contents

|       |   |     |
|-------|---|-----|
| 7.1   | Introducing Optional Products .....                                 | 7-2 |
| 7.2   | Functions Available through Optional Equipment                      | 7-2 |
| 7.2.1 | Measurements of Power-Factor, VA,<br>and Peak Holding Current ..... | 7-2 |
| 7.2.2 | Output ON/OFF Phase Setting .....                                   | 7-2 |
| 7.2.3 | AC + DC Mode .....  | 7-3 |
| 7.2.4 | Expansion of the Memory Function .....                              | 7-3 |
| 7.2.5 | Regulation Adjustment .....   | 7-3 |
| 7.2.6 | Rack Mounting .....   | 7-4 |

## 7.1 Introducing Optional Products

---

The following optional products are available for the PCR-W series AC power supplies. An option is inserted into a slot in the equipment for use.

| Product           | Model      | Applicable slot number |
|-------------------|------------|------------------------|
| Remote Controller | RC02-PCR-L | 1                      |
| GPIB Interface    | IB11       | 1                      |
| RS-232C Interface | RS11       | 1                      |

- IB11 requires a computer with a GPIB interface and a GPIB cable.
- RS11 requires a computer with an RS-232C interface and a RS-232C cable (reverse cable).

### CAUTION

- For operation of the optional products, see the operation manual of each optional products.

## 7.2 Functions Available through Optional Equipment

---

### 7.2.1 Measurements of Power-Factor, VA, and Peak Holding Current

The equipment has diverse measuring functions which can be extended using an optional product. These additional functions include the measurement of power-factor, VA, and the peak holding current. With peak holding current measurement, the peak current is measured until the equipment receives a peak clear operation or command. This function is useful in measuring a rush current and can be used to test various devices and equipment.

The function requires one of the following optional devices.

- RC02-PCR-L
- IB11
- RS11

### 7.2.2 Output ON/OFF Phase Setting

Output ON/OFF phase setting is available separately. This function is used when output ON/OFF phase setting is required. This function is backed up inside the equipment. Therefore, once setting is accomplished using an optional device, the equipment can operate in the same condition continuously with the option removed, as long as the setting conditions remain the same.

The function requires one of the following optional devices.

- RC02-PCR-L
- IB11
- RS11

### 7.2.3 AC + DC Mode

This function allows the equipment to output voltage waveforms in which AC voltage is superimposed on DC voltage.

The function can be used not only for various electronics devices but also in chemical experiments and for production equipment.

The function requires one of the following optional devices.

- RC02-PCR-L
- IB11
- RS11

### 7.2.4 Expansion of the Memory Function

This equipment allows nine sets of voltage and frequency settings to be stored as standards in the memory (memory addresses 1 to 9), enabling the data to be read for output as necessary. When an optional product is attached, the equipment can accommodate a maximum of 99 sets of voltage and frequency set values for storage.

In the AC + DC mode, both AC and DC memory values can be output, allowing all the memory operations in the AC + DC mode.

The function requires one of the following optional devices.

- RC02-PCR-L
- IB11
- RS11

### 7.2.5 Regulation Adjustment

With regulation adjustment, the output voltage is adjusted automatically to compensate the voltage drop caused by the output current.

This function is used for the same purpose as the sensing function. The sensing function measures the sensing-point voltage in order to maintain a constant sensing-point voltage; with regulation adjustment, the voltage drop caused by the output current is calculated in order to raise the output voltage in an amount equivalent to the drop.

This function is used for stabilizing voltage at the load end if there is a considerable distance between the load and the equipment.

When regulation adjustment is performed, voltage stability accuracy, distortion factor, and response speed decrease. Therefore, this function may not be suitable depending on application. Check the condition required for load before use.

The function requires one of the following optional devices.

- RC02-PCR-L

## 7.2.6 Rack Mounting

Using a rack mounting bracket below allows the equipment to be installed in the Kikusui standard rack KRO1600, KRO1250, KRO900, or RC322.

For details on the racks, see the product catalogs.

Rack mounting is available using any of the following:

| PCR-W series<br>model name<br>for rack mounting | Option model name required       |                             |
|---|----------------------------------|-----------------------------|
|   | JIS standard<br>(in millimeters) | EIA standard<br>(in inches) |
| PCR 2000W                                       | KRB400                           | KRB8                        |
| PCR 4000W                                       | KRB500                           | KRB11                       |
| PCR 8000W                                       | KRB850                           | KRB19                       |



# Chapter 8

## PART NAMES AND OPERATIONS

Denotes the part names of the PCR-W series AC power supplies and describes the functions of the parts.

### Contents

|   |      |
|---|------|
| 8.1 Front Panel .....                       | 8-2  |
| 8.1.1 Control Panel Operating Section ..... | 8-2  |
| 8.1.2 Control Panel Display Unit.....       | 8-5  |
| 8.1.3 Front Panel Upper Part .....          | 8-7  |
| 8.1.4 Front Panel Lower Part .....          | 8-8  |
| 8.1.5 Air-Intake, Casters, and Others ..... | 8-10 |
| 8.2 Rear Panel .....                        | 8-12 |
| 8.2.1 Rear Panel Lower Part .....           | 8-12 |
| 8.2.3 Exhaust Port(s) .....                 | 8-14 |

## 8.1 Front Panel

### 8.1.1 Control Panel Operating Section

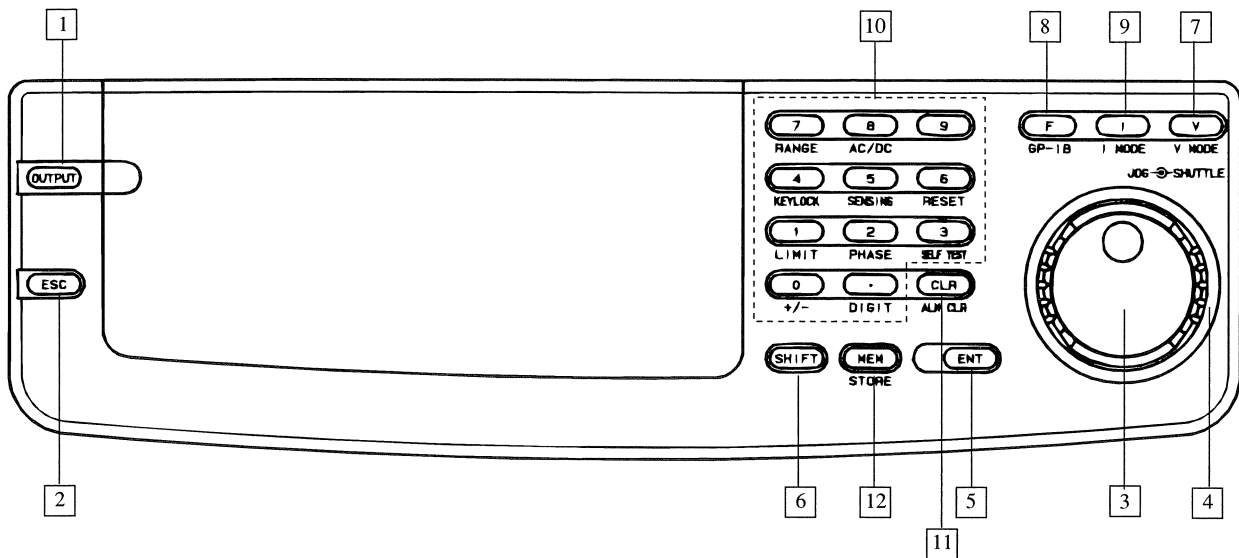

- 1** **OUTPUT** Selects output ON/OFF. (Whenever this switch is pressed, output ON/OFF is switched alternately.) The output status is indicated by the ON/OFF indication at the upper-left side of the control panel. Immediately after the POWER switch is ON, output is OFF.
- 2** **ESC** Used to end or cancel each operation.
- 3** **JOG** Used to set numbers for voltage, frequency, etc. This is a rotary encoder with 10 clicks per rotation. The encoder increases the set value when it is turned clockwise or decreases the set value when it is turned counterclockwise.
- 4** **SHUTTLE** Used to set numbers for voltage, frequency, etc. You can choose four levels by setting the change speed, which varies with the angle to which the SHUTTLE is turned. The set value increases when the SHUTTLE is turned clockwise and decreases when it is turned counterclockwise.
- 5** **ENT** Establishes the key operation.  
ENT blinks during ENT wait.
- 6** **SHIFT** Enables the function set out in blue letters below each key.  
To use such a function, press SHIFT, and then press the relevant key. If SHIFT is pressed, SHIFT in the display panel lights up.
- 7** **V** Selects the voltage setting mode or the voltage limit setting mode. When any of these modes is selected, the frame encircling the voltage display area lights up.

#### SHIFT + V (V MODE)

Switches the voltage display mode. The voltage display mode includes the set voltage (SET), rms value (RMS), peak value (PEAK), and average value (AVE). (The average value display mode is available only in the DC mode.)

- 8 F Selects the frequency setting mode or the frequency limit setting mode. If one of these modes is selected, the frame encircling the frequency display area lights up.

**SHIFT + F (GP-IB)**

Used to change the option setting when an option is used. For further details, see the operation manual for each option.

- 9 I Selects the current limit setting mode. When the mode is selected, the frame encircling the current display area lights up.

**SHIFT + I (I MODE)**

Switches the current display mode. The current display mode includes the rms value (RMS), peak value (PEAK), power (W), and average value (AVE). (The average value display mode is available only in the DC mode.)

- 10 0, 1, 2, .... 9 (numeric keys), and .

Used to directly enter the voltage, current, and frequency values. ( . : Decimal point)

A value entered is established when ENT is pressed or is canceled when ESC is pressed.

**SHIFT + 0 (+/-)**

Switches the DC mode voltage polarity (+/-).

**SHIFT + 1 (LIMIT)**

Selects the limit value display mode for voltage, frequency, and current. When this mode is selected, the LIMIT above the current display area and the HIGH LIMIT or LOW LIMIT above the voltage display and frequency display areas lights up. The frame encircling one of these display areas also lights up.

**SHIFT + 2 (PHASE)**

Currently not used.

**SHIFT + 3 (SELF TEST)**

Used to select the self-test mode in the event of an alarm or overload. If this mode is selected, SELF TEST in the control panel lights up. At the same time, the current display area indicates "No." and a number, while the voltage display area indicates "Ad." and a number. Also the frequency display area indicates the equipment version.

**SHIFT + 4 (KEYLOCK)**

Selects the key lock mode. The key lock mode is also available when the Remote Controller (RC02-PCR-L) is used. In the key lock mode, KEY LOCK lights up and all keys except OUTPUT and SHIFT + 4 (KEYLOCK) keys are disabled.

**SHIFT + 5 (SENSING)**

Selects the sensing mode. To use the sensing mode, connect the sense wires to the sensing terminals and set the voltage and then press these keys. The sensing mode will allow no voltage change and will cause SENSING in the control panel to light up.

**SHIFT + 6 (RESET)**

Resets the equipment.

When a reset is made, all set values return to their Initial Setup Status (factory shipment status).

- A reset can be established by pressing SHIFT + ENT.

**SHIFT + 7 (RANGE)**

Selects the output voltage range. "100V" below the RANGE indication lights up in the 100 V range and "200V" lights up in the 200 V range.

- When SHIFT + 7 is pressed, the range indication to be selected blinks. Pressing ENT will determine the mode selection.

**SHIFT + 8 (AC/DC)**

Switches the AC mode to the DC mode or vice versa. In the AC mode, "AC" above the frequency display area lights up. In the DC mode, "dc" above the frequency display area appears.

- When SHIFT + 8 is pressed, the mode to be selected blinks.

Pressing ENT will determine the mode selection.

In the AC + DC mode, "AC + DC" in the control panel lights up.

- To use the AC + DC mode, an option is required. For further details, see Chapter 7 OPTIONAL EQUIPMENT and the operation manual for each option.

**SHIFT + 9** Currently not used.

**SHIFT + . (DIGIT)**

Selects the digit mode that enables arbitrary and higher digits to change in the voltage setting or frequency setting mode.

In the digit mode, part (cursor) of the frame encircling the voltage display or frequency display area blinks, thereby allowing the relevant and higher (left of the relevant digit) digits to change.

- Whenever SHIFT + . (DIGIT) is pressed, the cursor moves to the left.

**11 CLR**

Cancels the set value and calls the previous value.

**SHIFT + CLR (ALM CLR)**

Clears the alarm status in the event of an alarm.

**12 MEM**

Calls voltage (and frequency) values from the memory.

Pressing MEM and then any of 1 to 9 keys to select a memory address will cause "Ad. X" (X: memory address) to appear in the current display area and will call the voltage (and frequency) stored in the relevant memory address to the voltage display (and frequency display) area (or areas).

- Pressing ENT establishes the voltage (and frequency) called.

**SHIFT + MEM (STORE)**

Writes the voltage (and frequency) value (or values) in the memory.

Set the voltage (and frequency) you wish to store and press SHIFT + MEM (STORE). Then press any of keys 1 to 9 to select the memory address. After that press ENT. This will store the value or values in the memory.

## 8.1.2 Control Panel Display Unit

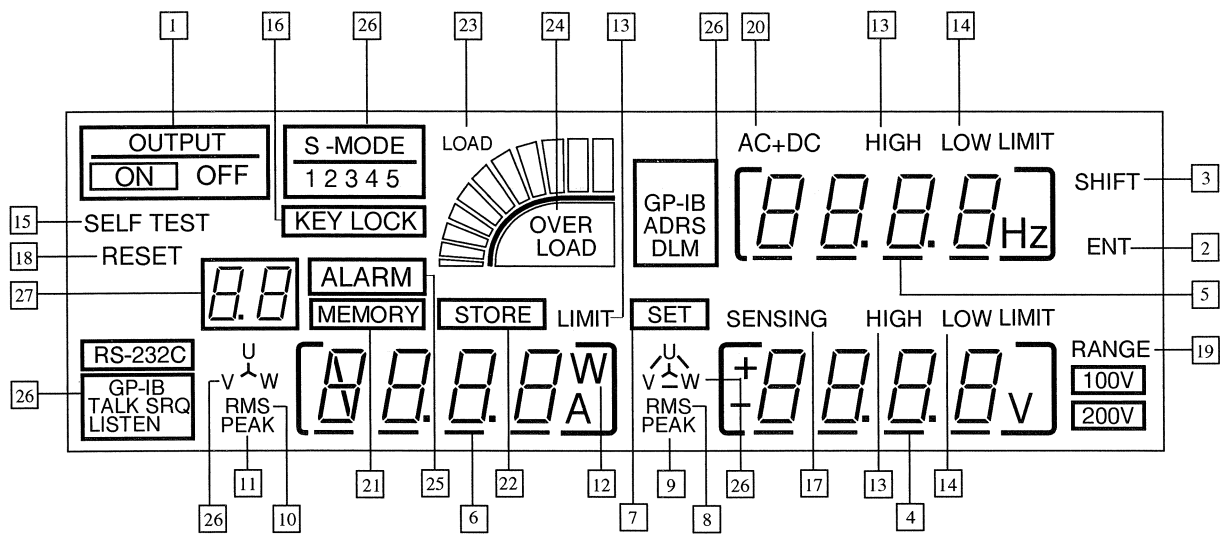

- 1 OUTPUT ON/OFF  
ON lights up when the output is set to ON, and OFF lights up when it is set to OFF. Immediately after the POWER switch is turned ON, output is OFF. When OUTPUT is pressed, output ON/OFF changes alternately.
- 2 ENT  
Blinks before operation or before a set value is established. The status in which ENT is blinking is called ENT wait.
- 3 SHIFT  
Lights up when the SHIFT key is pressed. (Shift mode)
- 4 Voltage display area  
Displays the voltage value, etc.
- 5 Frequency display area  
Displays the frequency value, etc.
- 6 Current display area  
Displays the current value, etc.
- 7 SET  
Lights up when the set voltage is displayed in the voltage display area.
- 8 RMS  
Lights up when the value displayed in the voltage display area is rms.
- 9 PEAK  
Lights up when the value displayed in the voltage display area is the peak value.
- 10 RMS  
Lights up when the value displayed in the current display area is rms.
- 11 PEAK  
Lights up when the value displayed in the current display area is the peak value.
- 12 W  
Lights up when the value displayed in the current display area is a value of power.

- 13 HIGH LIMIT/LIMIT**  
Lights up when the high limit setting mode is selected.
- 14 LOW LIMIT**  
Lights up when the low limit setting mode is selected.
- 15 SELF TEST**  
Blinks in the self-test mode.  
In the self-test mode, the current display area displays "No." and a number, the voltage display area displays "Ad." and a number, and the frequency display area displays the equipment version.
- 16 KEYLOCK**  
Lights up in the key lock mode.  
In the key lock mode, no keys other than the OUTPUT and SHIFT + 4 (KEYLOCK) keys can be used.
- 17 SENSING**  
Lights up in the sensing mode.  
The sensing mode disables voltage changes.
- 18 RESET**  
Blinks together with ENT when the SHIFT + RESET keys are pressed.  
Pressing the SHIFT + ENT keys in this status will reset the equipment, returning all the set values to their initial setup status (factory shipment status).
- 19 RANGE**  
Displays the output voltage range.  
"100V" below the RANGE indication lights up when the 100 V range is selected, and "200V" lights up when the 200 V range is selected.
- 20 AC+DC**  
Displays the output voltage mode. "AC" lights up in the AC mode and "AC+DC" lights up in the AC + DC mode.  
• The AC + DC mode requires an option. See Chapter 7 OPTIONAL EQUIPMENT and, for further details, the operation manual of each option.
- 21 MEMORY** Lights up during memory write/read execution.
- 22 STORE** Lights up when data is written into the memory.
- 23 LOAD** Displays the ratio of a load current value to the rated current value as guidance.
- 24 OVERLOAD**  
Lights up if overload (over current) occurs. If this condition continues for a few seconds, the output is set to OFF and alarm is generated, sounding an intermittent buzzer tone.
- 25 ALARM** Lights up when the intermittent buzzer tone is generated in the event of alarm.

26 S-MODE

Lights when an option is used.

RS-232C  
GP-IB  
TALK SRQ  
LISTEN  
GP-IB  
ADRS  
DLM

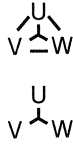

However, once an option is used, this indication may be lit even when such option is disconnected. For further details about this, see the operation manual of the relevant option.

27 E3

Is displayed on the current display area with the output power of 10 kW or more.

### 8.1.3 Front Panel Upper Part

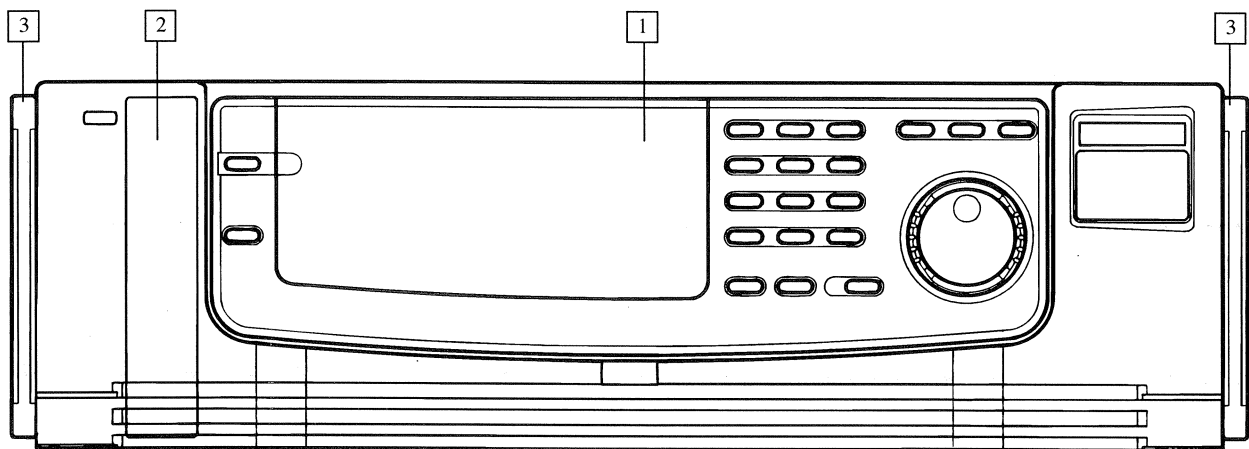

1 Control panel

2 SLOT1 Allows optional board connection.

3 Grips Use the grips to move the equipment along a flat place only.

**WARNING**

- Do not use the handgrips to lift equipment. The grips are provided only for moving the equipment across a flat surface and will not support the equipment's weight.



### 8.1.4 Front Panel Lower Part

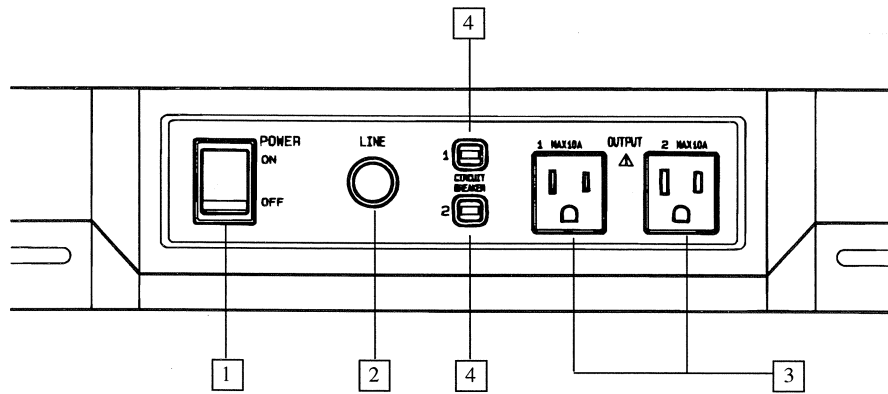

PCR2000W, PCR4000W

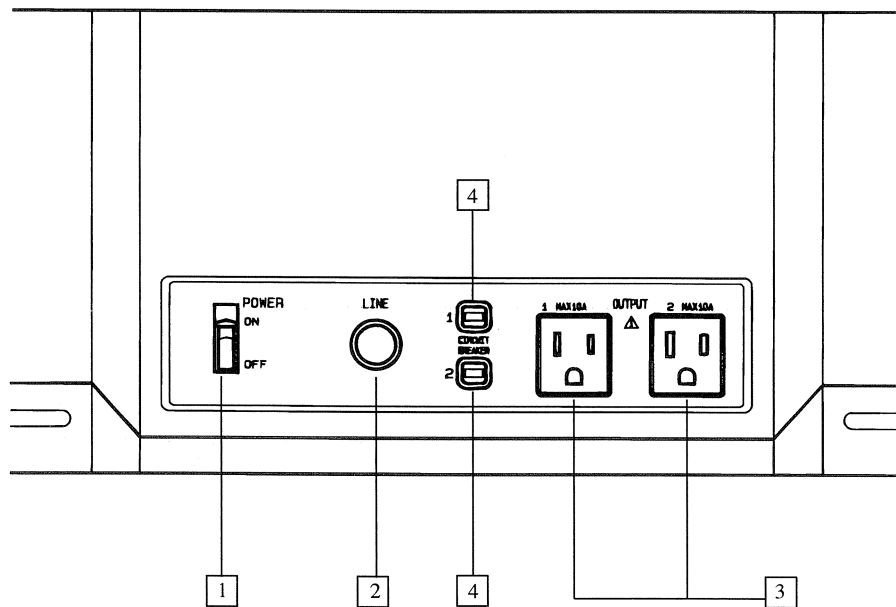

PCR8000W, PCR12000W



- 1 **POWER** The equipment's power switch.  
 For the PCR2000W and PCR4000W, pressing the upper button turns the POWER switch ON, while pressing the lower button turns the switch OFF.  
 For the PCR8000W and PCR12000W, inclining the lever up turns the POWER switch ON, while inclining the lever down turns the switch OFF.  
 The equipment stores the following value. When the POWER switch is turned ON, the equipment starts up with the set values applied immediately before the POWER switch was turned OFF.
- Output voltage and frequency set values
  - Output voltage range (100 V/200 V)
  - Output voltage, frequency, and current limit values
  - Output voltage mode (AC/DC)
  - Voltage, current, and power display modes
  - Key lock

- 2 **LINE lamp** This lamp lights up when input power is fed into the INPUT terminal board.

**WARNING**

- This lamp lights up regardless of the POWER switch ON/OFF. When this lamp is lit, voltage is being applied to the INPUT terminal board. Therefore, do not touch the INPUT terminal board.

- 3 **OUTPUT outlets**

Used to obtain the output from the front panel.

**CAUTION**

- The maximum current available is 10 A (rms) AC and the maximum voltage is 125 V (rms) AC. See Section 5.2 Connection to an OUTPUT Outlet.

- 4 **CIRCUIT BREAKER**

Flowing an output current of 10 A (rms) or more through one OUTPUT outlet may interrupt the CIRCUIT BREAKER to the left of the OUTPUT outlets. This will cause the red button to project from the CIRCUIT BREAKER, thereby, interrupting the circuit. In this case, see the procedure set forth in the latter half of 5.2 Connection to an OUTPUT Outlet.

### 8.1.5 Air-Intake, Casters, and Others

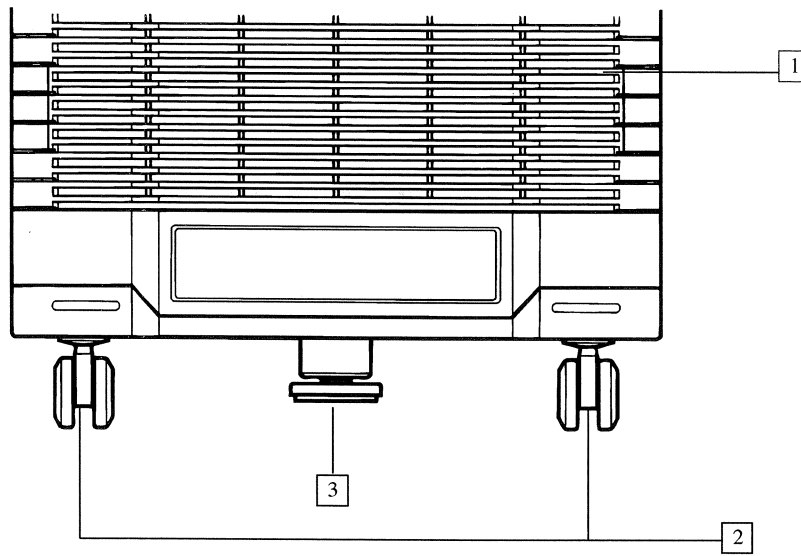

PCR2000W, PCR4000W

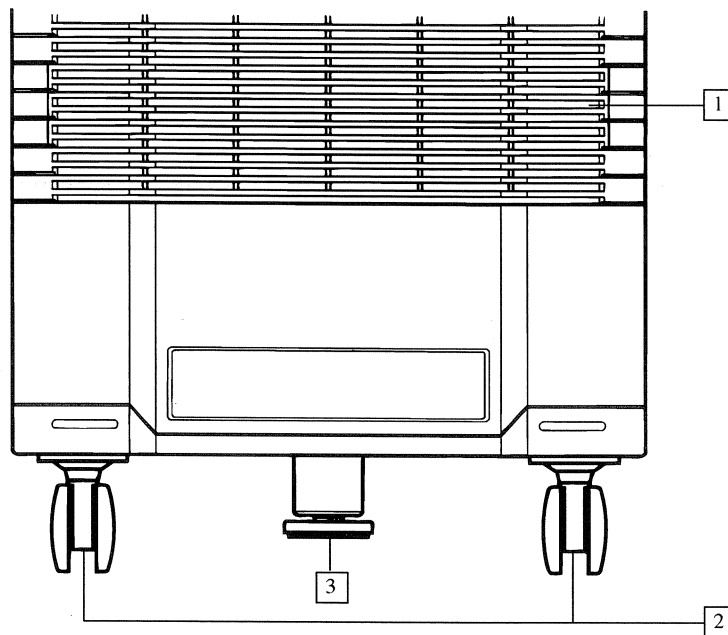

PCR8000W, PCR12000W

1 Air-intake

For cooling the inside of the equipment. The built-in air filters require periodic cleaning.

2 Casters

Allow the equipment to be moved in any direction. The casters have a lock which temporarily fixes the equipment onto the floor.

**CAUTION**

- To fix the equipment, always use the stopper described below, together with the caster locks.

3 Stopper

Used to fix the equipment on the flat floor.

**CAUTION**

- When installing the equipment, always apply the stopper.

## 8.2 Rear Panel

### 8.2.1 Rear Panel Lower Part

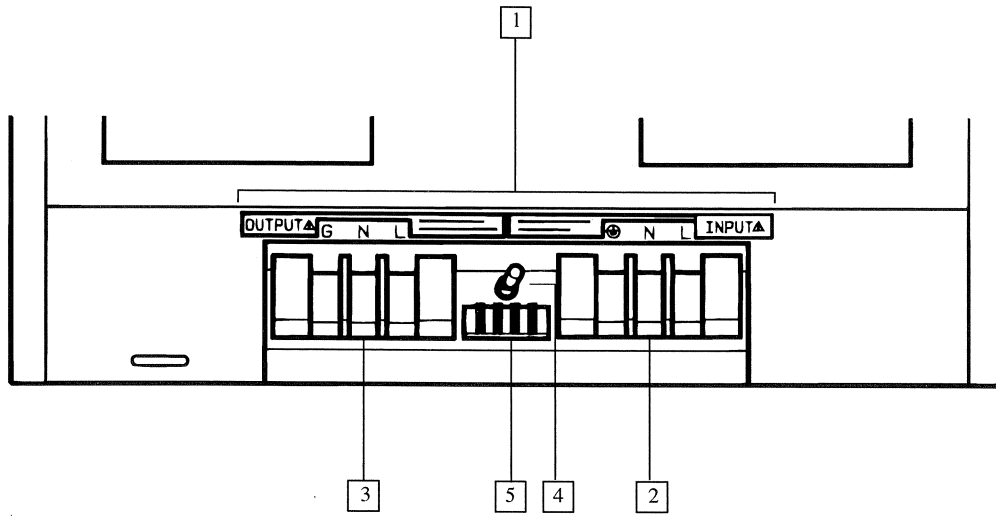

PCR2000W, PCR4000W



PCR8000W, PCR12000W

**1** Terminal box

Incorporates the INPUT, OUTPUT, SENSING terminal boards and INPUT VOLTAGE SELECTOR switch.

**2** INPUT terminal board

Used to connect input power.

**WARNING**

- Before connecting the input power cable, always cut off the power feed from the power distribution board.

**3** OUTPUT terminal board

Used to connect a load.

**WARNING**

- Before connecting an output cable, always cut off the power feed from the power distribution board.

**4** INPUT VOLTAGE SELECTOR

The PCR8000W and 12000W have no INPUT VOLTAGE SELECTOR.

This selector switch should be manipulated in accordance with the input voltage range.

The selector is a lock-type toggle switch. When selecting the input voltage range, pull and then set the switch.

**CAUTION**

- Use of the equipment outside the rated input voltage range may cause problem.

**5** SENSING terminal board

Used to connect sensing cables to carry out the sensing function.

### 8.2.3 Exhaust Port(s)

The exhaust port or ports are provided to cool the inside of the equipment with air.

- CAUTION**
- Set up the equipment at least 20 cm distance from the wall, and do not place anything within 20 cm of the exhaust port.

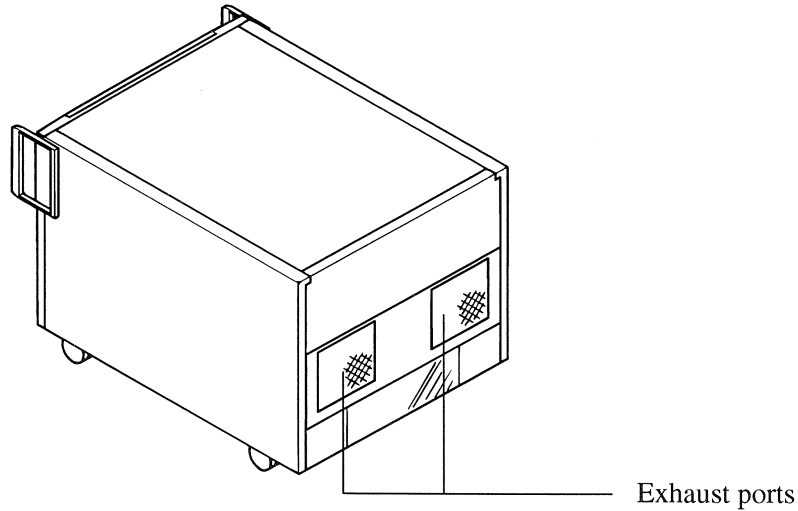

PCR2000W

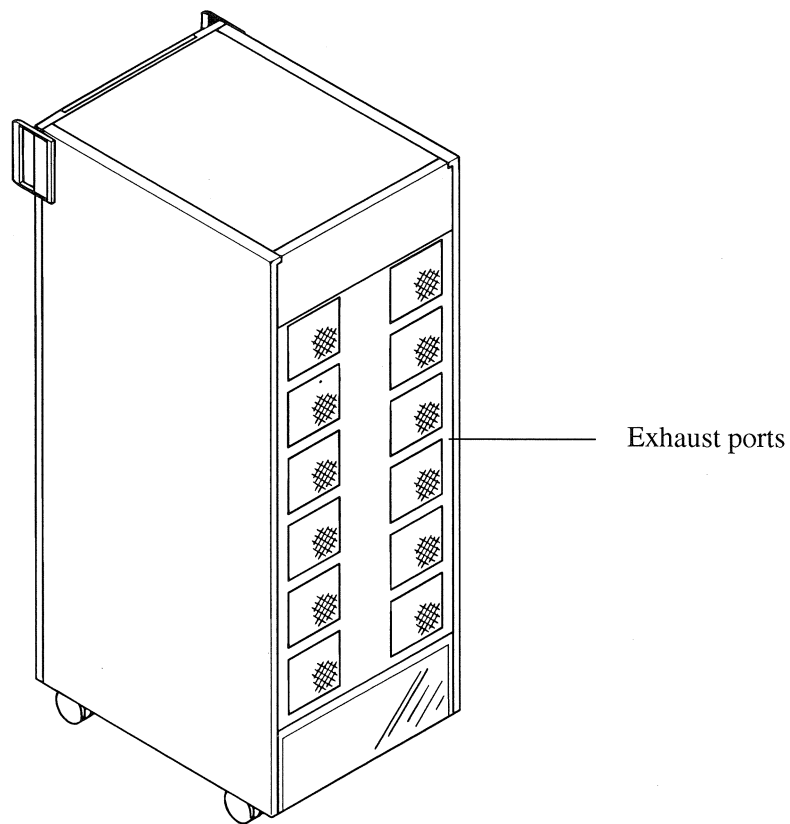

PCR4000W, PCR8000W, PCR12000W

The geometry of the exhaust ports is different in the PCR4000W and the PCR8000W.

## Chapter 9

# PROTECTIVE FUNCTIONS AND THEIR OPERATIONS

Describes the protective functions and their operations.

### Contents

|   |     |
|---|-----|
| 9.1 Types of Protective Functions .....           | 9-2 |
| 9.2 Measures to be Taken in the Event of an Alarm | 9-2 |
| 9.3 Overload Protective Function .....            | 9-5 |

## 9.1 Types of Protective Functions

---

This equipment has the following protective functions.

|   | Protective function name                                | Display/Symptom                                |
|---|---|--|
| For internal circuit protection                     | Input voltage range protection                          | Error (5) is generated.                        |
|   | Overheat protection                                     | Alarm (2) is generated.                        |
|   | Internal circuit protection                             | Alarm is generated.                            |
| For load protection and internal circuit protection | Overload protection (current limiting)                  | OVERLOAD lights up.<br>Alarm (6) is generated. |
|   | Overload protection (internal semiconductor protection) | OVERLOAD lights up.<br>Alarm (3) is generated. |

## 9.2 Measures to be Taken in the Event of an Alarm

---

This section describes the possible causes of an alarm and measures to be taken.

If the equipment is operating in an unsuitable environment or if an error occurs inside the equipment, an intermittent buzzer tone will sound and "ALARM" will light up or "Err X" (X: number) will appear. (For an Err X display, no buzzer tone sounds.) In such a case, the protective function relevant to the cause of error will operate to prevent an escalation of the problem and to protect a connected load from breakage.

If an alarm sounds, the equipment always sets the output OFF. These may not be a problem in the equipment, depending on alarm type. In such a case, release the alarm, and use the equipment as usual.

### Steps to be Taken if ALARM Lights Up

---

- Step 1 Turn the POWER switch OFF and wait for more than 5 seconds, then turn the switch ON again.
- When the ALARM lamp is lit, be sure to turn the POWER switch OFF. If you take other procedure, the ALARM indication may be cleared.
  - If no alarm occurs in this case, the equipment can continue to be used.
  - If an alarm occurs again, check the type of alarm in accordance with the SELF TEST described below and take the appropriate steps to deal with such an alarm.



## Alarm-type Checking Procedure (SELF TEST)

- Step 1 If ALARM lights up, press SHIFT + 3 (SELF TEST).  
This will cause "No. X" to appear in the current display area and "Ad. X" to appear in the voltage display area.
- Step 2 Turn JOG. This will cause the contents in the current and voltage display areas to change. Then read a number in the "No." area when "Ad. 0" appears.
- Step 3 Apply the measure corresponding to the displayed "No." in accordance with the table below. The numbers in the "Ad." and "No." areas displayed in SELF TEST have the following meaning.

Ad.: Indicates the internal location of the equipment. "0" indicates the entire section of the equipment. The number or numbers to be displayed other than 0 will differ as follows, depending on the model.

PCR2000W: 1  
 PCR4000W: 1 to 2  
 PCR8000W: 1 to 4  
 PCR12000W: 1 to 6

These numbers indicate the positions of the internal power units. The power units are numbered sequentially from top to down.

No.: Indicates the cause of the alarm (see the table below). When requesting a repair, inform us of this number.

| No. | Description/Solution  |
|-----|---|
| 0   | No alarm  |
| 1   | The internal circuit protective function has activated.<br>The output impedance of the input power source may be extremely.<br>Read 2.3 Checking the Input Power again. If nothing is wrong, contact your Kikusui agent.  |
| 2   | The internal circuit protective function has activated.<br>The internal temperature is expected to be abnormally high.<br>Wait for about 10 minutes with the power ON.<br>If the alarm goes off, the equipment may be installed inappropriately.<br>Read 2.2 Installation and Location again to make corrections.<br>If the alarm continues, read 2.3 Checking the Input Power again. If nothing is wrong, contact your Kikusui agent.<br>The alarm may be generated with extreme overload such as output shorting.<br>Get rid of the cause and then clear the alarm. |
| 3   | The internal semiconductor protective function has activated.<br>See 9.3 Overload Protective Function.  |
| 6   | The current limiting function has activated.<br>See 9.3 Overload Protective Function.   |
| 7   | The sensing function has not been correctly used.<br>See 6.13 How to Use the Sensing Function.  |
| 8   | An internal power unit has possibly been removed for repair, etc. Clear the alarm.  |

## Alarm Clear Procedure

---

When an alarm (8) has occurred, clear it in the following procedure.

- ▶ Step 1 Press SHIFT + CLR (ALM CLR).
- ▶ Step 2 When the intermittent buzzer sound stops and the alarm indication goes off, press SHIFT + 3 (SELF TEST) again to check the alarm type.
- ▶ Step 3 Check for the presence of alarm as to "Ad. 1" to the last number (the last Ad. number will differ depending on the model).  
If there is no alarm, the equipment can continue to be used.

If the check results in an alarm for all numbers, the equipment can no longer be used. Contact your Kikusui agent.

### Before clearing the alarm

If an "Ad." number when the alarm occurs is present together with an "Ad." number when no alarm occurs, calculate the output power and current based on the number of Ad.s, Na, when no alarm occurs and the number of Ad.s, Nb, for the model in question by using the following equation. Then clear the alarm, and begin to use the equipment again. However, always request a repair.

$$\text{Applicable power} = \text{Rated power} \times \text{Na} \div \text{Nb}$$

$$\text{Applicable current} = \text{Rated current} \times \text{Na} \div \text{Nb}$$

Example: For PCR12000W, Nb = 6.

If the number of Ad.s when no alarm occurs is 2, Na = 2. Then

$$\text{Applicable power} = 12000 \times 2 \div 6 = 4000 \text{ [W]}$$

$$\text{Applicable current} = 120 \times \text{Na} \div \text{Nb} \text{ (100Vrange)} = 40 \text{ [A]}$$

### **CAUTION**

- Clearing an alarm will cause the output voltage set value to become 0 V.

## Check to be Made if "Err X" appears

---

If there is an error as described in the table below, the control panel will continue displaying "Err X (X: number)."

| No.           | Measures   |
|---------------|--|
| 1             | All internal power units are defective.<br>Contact your Kikusui agent.   |
| 4             | Turn the POWER switch OFF and wait for more than 5 seconds.<br>Then turn the POWER switch ON, keeping MEM pressed to reset.<br>This will call up the initial setup status. |
| 5             | Input voltage is outside the rated range.<br>See Section 2.3 Checking the Input Power.   |
| Other numbers | Contact you Kikusui agent.   |

## 9.3 Overload Protective Function

---

This equipment has two types of overload protective functions.

One is the current limiting function that applies if the equipment's output current exceeds the current limit value (maximum setting: 1.1 times the rated output current). If a current exceeding the current limit flows in a load, OVERLOAD will light up. If this status continues for either 10 s (in the AC mode) or 1 s (in the DC mode), the current limiting function will automatically turn the output OFF. For further details, see 6.5.3 Setting the Current Limit Value.

The other is the function that is activated if the equipment's internal semiconductor protective circuit is activated. As long as the using method of the equipment agrees with the specifications, the internal semiconductor protective function will not usually operate. However, in the event of an instantaneous overcurrent such as a rush current, the internal semiconductor protective function will operate and if such a status continues about 1 s, an overload will occur.

The internal circuit protective function (alarm No. 1) may be activated with extreme overload such as output shorting.

### CAUTION

- Even if the internal semiconductor protective function is activated, an overload will not occur for about 1 s. However, the output voltage waveform may be distorted to protect the semiconductor during the operation of this protective function (depending on the load condition.)
- Even if no overload occurs, frequent operation of the internal semiconductor protective function may cause a problem in the equipment.
- Always use the equipment in such a way that the internal semiconductor protective function is activated at more than one-minute intervals.
- For particular example; when the current limit function is activated and then another alarm is generated, the current limit function is not activated (OVERLOAD goes off and the output is turned OFF) and the alarm sound stops. In this case, the equipment is not defective. Also, you can check the alarm type by pressing SELF TEST.

Whether an overload has been caused by the current limiting function or by the internal semiconductor protective function can be checked as follows:

### Overload Cause Checking Procedure

---

- ▶ Step 1 While the output is OFF and OVERLOAD is lit, press SHIFT + 3 (SELF TEST). This will cause "No. X" (X: number) to appear in the current display area and "Ad. X" (X: number) to appear in the voltage display area.
- ▶ Step 2 Turn JOG. This will cause the content of the current display area, and the content of the voltage display area to change. Then, when "Ad. 0" appears, read a number indicated by "No."

Examples:

No. 3: Internal semiconductor protective function is activated.

No. 6: Current limiting function is activated.

### Measures to be Taken if the Overload Function is Activated

If an overload occurs and continues for a specified time, the output will be turned OFF, generating an intermittent buzzer sound and causing OVERLOAD to light up.

In such a case, eliminate the cause of the overload and press OUTPUT again. This will cancel the overload display status and set the output ON. If the cause of the overload has not been eliminated, the overload will recur after a specified time.

- CAUTION** · If an overload occurs, always eliminate its cause, then press OUTPUT. Frequent recurrence of overload may cause a problem.

### Specific Examples of Overload Causes and Solutions

① For a linear load

| Overload actuating condition   | Solution  |
|--|---|
| If the output current (rms value) exceeds the current limit value when the output current is increased gradually, the current limiting function is activated.                              | <ul style="list-style-type: none"> <li>· If the current limit value is set low, change the set value.</li> <li>· If the rated current has been exceeded, reduce the load capacity.</li> </ul> |
| If the output voltage waveform is distorted as shown in Fig. A when the output current is increased rapidly, this means that the internal semiconductor protective function has activated. |   |

② For capacitor-input-type rectifying load

| Overload actuating condition  | Solution  |
|---|---|
| If the output current (rms value) exceeds the current limit value when the output current is increased gradually, the current limiting function is activated.                                 | <ul style="list-style-type: none"> <li>· If the current limit value is set low, change the set value.</li> <li>· If the rated current has been exceeded, reduce the load capacity.</li> </ul> |
| If the output voltage waveform is distorted as shown in Figs. A and B when output current is increased, the output peak current has activated the internal semiconductor protective function. | <ul style="list-style-type: none"> <li>· Reduce the peak current.</li> </ul>  |

③ For a load which draws a rush current

| Overload actuating condition  | Solution   |
|---|--|
| If the voltage waveform is distorted as shown in Fig. B when voltage is applied to a load or when the voltage is changed suddenly, a rush current has activated the internal semiconductor protective function. | <ul style="list-style-type: none"> <li>• Reduce the rush current.</li> </ul> |

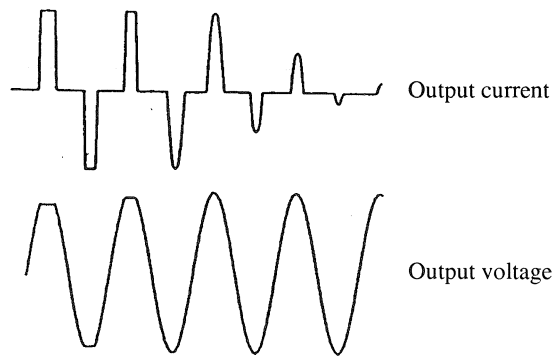
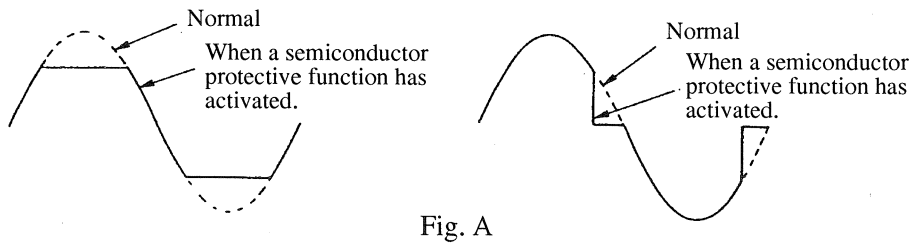



# Chapter 10

## MAINTENANCE

Describes how to maintain and control the equipment and cleaning methods.

### Contents

|  |      |
|--|------|
| 10.1 Before Requesting a Repair .....  | 10-2 |
| 10.2 Cleaning the Air-Intake Filters .....   | 10-4 |
| 10.3 Limitation on the Number of Update<br>Operations for Home Position Status ..... | 10-6 |
| [Description] About the number of EEPROM<br>updates .....                            | 10-6 |

## 10.1 Before Requesting a Repair

If a problem occurs in the equipment, check that problem in accordance with the following table. If it is not possible to recover a normal status, contact your Kikusui agent to request repairs.

| Problem   | Check items  | Results   | Possible causes  |
|---|--|---|--|
| LINE lamp does not light up.  | Check if the rated voltage is being applied to the INPUT terminal board.                 | NO  | <ul style="list-style-type: none"> <li>Input power cable has been improperly connected.</li> <li>Input power cable has been disconnected.</li> </ul> |
|   | Ditto  | YES   | <ul style="list-style-type: none"> <li>The equipment is defective.</li> </ul>  |
| The control panel display unit does not light up even when the POWER switch is turned ON. | Check if the rated voltage is being applied to the INPUT terminal board.                 | NO  | <ul style="list-style-type: none"> <li>Input power cable has been improperly connected.</li> <li>Input power cable has been disconnected.</li> </ul> |
|   | Ditto  | YES   | <ul style="list-style-type: none"> <li>The equipment is defective.</li> </ul>  |
| Part of or all the sections of the control panel do not operate.                          | Check if the key lock mode has been activated.   | YES   | <ul style="list-style-type: none"> <li>The key lock function has been inadvertently activated.</li> </ul>  |
|   | Check if the input voltage is within the rated range.                                    | NO  | <ul style="list-style-type: none"> <li>The input voltage is improper.</li> </ul>   |
|   | Check if the ALARM is lit.   | YES   | <ul style="list-style-type: none"> <li>See the next page.</li> </ul>   |
|   | Check for the existence of a device generating a great deal of noise near the equipment. | YES   | <ul style="list-style-type: none"> <li>Malfunction has occurred due to noise.</li> </ul>   |
|   | Check if the GPIB (IB11) or RS-232C (RS11) interface has been connected.                 | YES   | <ul style="list-style-type: none"> <li>The control panel is under control by GPIB/RS-232C interface.</li> </ul>                                      |
|   | Check if the voltage and frequency are within the limit ranges.                          | NO  | <ul style="list-style-type: none"> <li>The limit value setting is inappropriate.</li> </ul>  |
|   | Has the cause of the problem been revealed by checking the above six items?              | NO  | <ul style="list-style-type: none"> <li>The equipment is defective.</li> </ul>  |
| Check if the AC+DC mode has been activated.   | YES  | <ul style="list-style-type: none"> <li>The AC+DC mode is set by GPIB/RS-232C interface or remote controller.</li> </ul> |  |



| Problem  | Check items   | Results | Possible causes  |
|--|---|---------|--|
| ALARM lights up.<br>See Chapter 9<br>PROTECTIVE<br>FUNCTIONS<br>AND THEIR<br>OPERATIONS. | Check if fan has stopped.   | YES     | • The overheat protective function has activated due to a defective fan.                                   |
|  | Check if an exhaust port or air-intake port is blocked.   | YES     | • The overheat protective function has activated.<br>• The filter is clogged.                              |
|  | Check if the ambient temperature is more than 50°C.   | YES     | • The overheat protective function has activated.  |
|  | Check if the input voltage is within the rated range.   | NO      | • The INPUT VOLTAGE SELECTOR setting is inappropriate.   |
|  | Check if there is a problem at no load or when PCR-W is connected to a distribution board directly. | YES     | • The output impedance of the input power source is extremely.   |
|  | Has the cause of the problem been revealed by checking the above five items?                        | NO      | • The equipment is defective.  |
| The control panel display is not normal.   | Check if the input voltage is within the rated range.   | NO      | • The input voltage is abnormal.   |
|  | Check for the existence of a device generating a great deal of noise near the equipment.            | YES     | • Malfunction has been caused due to noise.  |
|  | Check if the S-MODE is lit.   | YES     | • The setting established for use of an option has been held.  |
|  | Has the cause of the problem been revealed by checking the above three items?                       | NO      | • The equipment is defective.  |
| The output voltage waveform is distorted.  | Check if OVERLOAD is lit.   | YES     | • The overload protective function has activated.  |
|  | Ditto   | NO      | • The equipment is defective.  |
| The output current cannot be obtained. (OVER LOAD lights up.)                            | Check if the output voltage range is correct.   | NO      | • The output voltage range setting is inappropriate.   |
|  | Check if maximum peak current is within the range determined by the specifications.                 | NO      | • The protective circuit has been activated by a capacitor-input-type rectifying load or a nonlinear load. |
|  | Check if current limit has been set to a low level.   | YES     | • The current limit value setting is inappropriate.  |
|  | Check if the equipment is in DC mode.   | YES     | • The output mode setting is inappropriate.  |
|  | Has the cause of the problem been revealed by checking the above four items?                        | NO      | • The equipment is defective.  |

## 10.2 Cleaning the Air-Intake Filters

---

**CAUTION**

- Clean the air-intake filters periodically to assure proper operation of the equipment. The dirty air-intake filter cause ability of the filter to go down and internal temperature of the equipment to go up. It damages the equipment. Do not use the equipment in dirty areas (such as dust containing conductive materials.)

### Removing the Louver

---

- Step 1 Press the latches at both ends of the louver and pull the entire louver to remove it from the equipment.

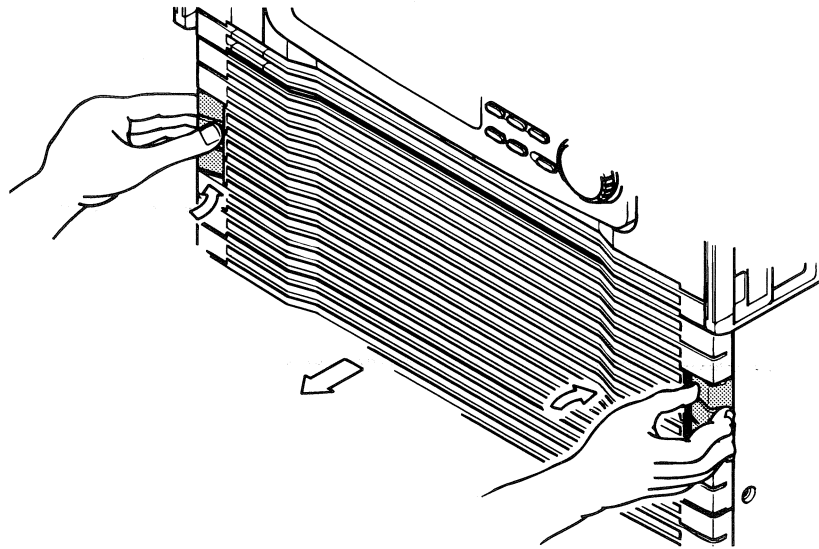

### Cleaning the Air-Intake Filter

---

- Step 1 Remove two air-intake filters from the clicks of the louver.

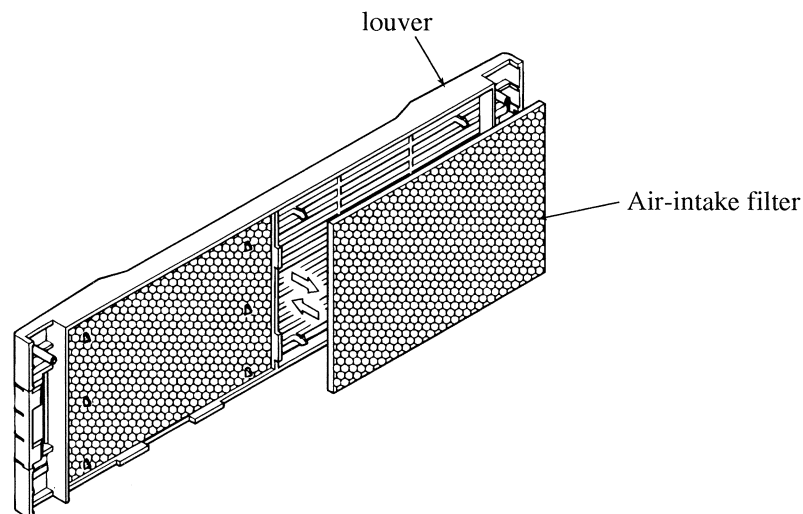

- Step 2 Using a cleaner, remove any dust or dirt from the air-intake filters.
- If a filter is extremely dirty, clean it by using a neutral detergent, and then dry it thoroughly.

**CAUTION**

- While it is operating, the equipment sucks air through the air-intake filters to cool the inside. Therefore, if an air-intake filter is wet, the humidity inside the equipment will rise, which may cause a problem.

- Step 3 Place the air-intake filters within the louver frame and push the filters so that louver clicks are engaged.

### Installing the Louver

---

- Step 1 Check the top and bottom of the louver (the top part has guide pins). Hold both ends of the louver, then align the guide pins to the equipment guide holes.

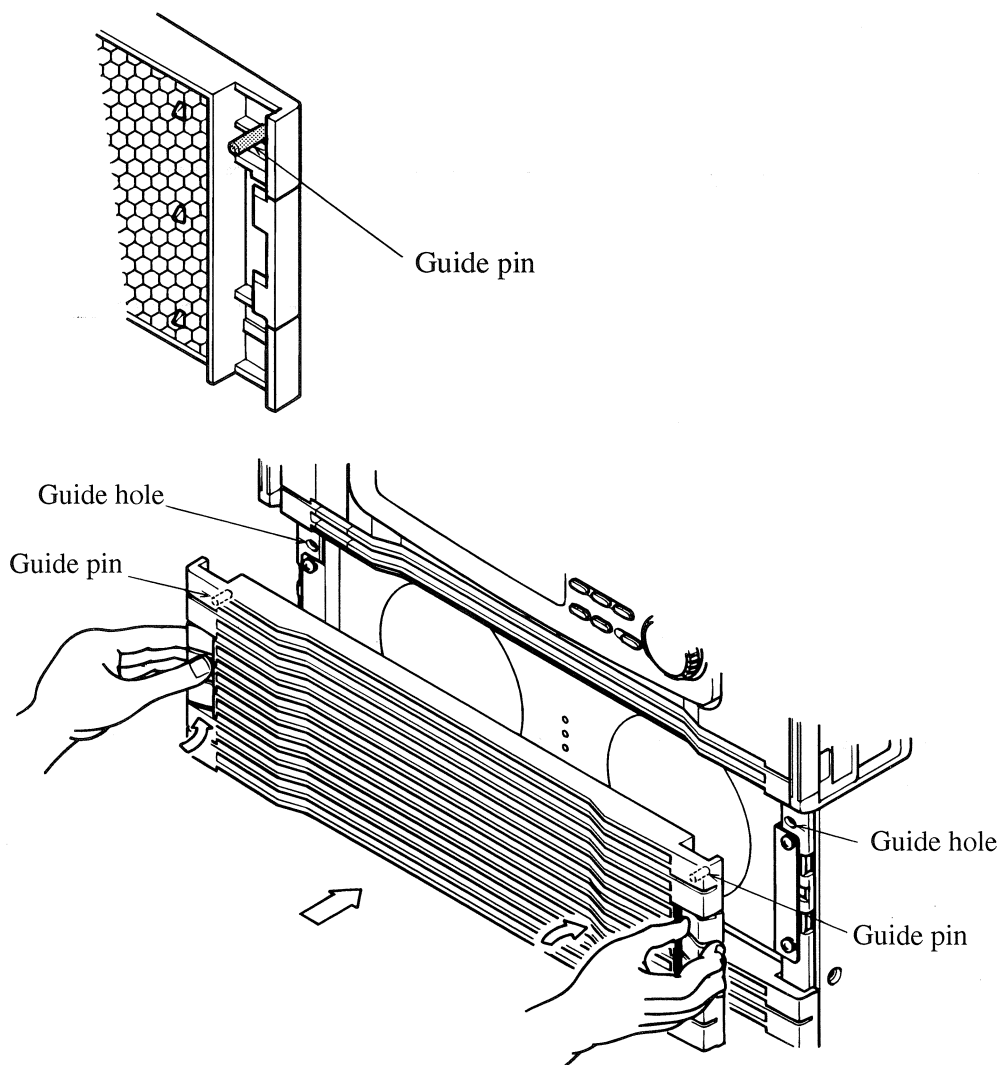

- Step 2 By pushing the latches of the louver, attach the louver to the equipment.

## 10.3 Limitation on the Number of Update Operations for Home Position Status

---

The home position status of the power supply (see page 6-2) is backed up by the internal EEPROM and remains intact even if the power switch is turned off. However, there is a limitation on the number of EEPROM update operations.

With normal operating conditions, the life expectancy of the EEPROM is much longer than that of the power supply itself. However, if voltage or frequency setting has been changed frequently, the internal settings may be initialized instead of being backed up when the power switch is turned off, because of the limitation on the number of EEPROM update operations. (For initial setup status, see page 4-5.) If the power supply incurs such a trouble, contact your KIKUSUI agent representative for exchanging the EEPROM.

[Description] About the number of EEPROM updates

The EEPROM manufacturer guarantees that the EEPROM in the power supply has an error rate of 1% or less after 100,000 times of updates. The power supply updates or backs up the internal settings approximately once every second. However, if there is no difference between the setting data and backup data, no update operation results.

The following are examples of time period until the number of EEPROM updates reaches 100,000 (times) in actual operating conditions.

Example 1: With 20 update operations a day  
 $10^5 / 20 = 5000$  days (Approx. 14 years)

Example 2: With 200 update operations a day  
 $10^5 / 200 = 500$  days (Approx. 1.4 years)

# Chapter 11

## SPECIFICATIONS AND OPERATING CHARACTERISTICS

Shows the specifications and operating characteristics of the equipment.

### Contents

|                                      |      |
|--------------------------------------|------|
| 11.1 Specifications .....            | 11-2 |
| 11.2 Operating Characteristics ..... | 11-5 |
| 11.3 Dimensions .....                | 11-6 |

## 11.1 Specifications

| Model name                                      |  | PCR2000W  | PCR4000W   | PCR8000W                  | PCR12000W                 |      |
|---|--|---|--|---------------------------|---------------------------|------|
| Input rating (AC rms value)                     |  |   |  |                           |                           |      |
| Voltage   |  | 85 to 132 V/170 to 250 V<br>(100 V/200 V input range) (*1)                      |  | 170 to 250 V              |                           |      |
| Number of phases, Frequency                     |  | 1 $\phi$ , 47 to 63Hz   |  |                           |                           |      |
| Apparent power                                  |  | Approx. 2.8kVA  | Approx. 5.5kVA   | Approx. 11kVA             | Approx. 16.5kVA           |      |
| Power factor                                    |  | 0.95 (typical value) (*2)   |  |                           |                           |      |
| Current (100 V/200 V input range)               |  | 33A or less<br>16A or less  | 66A or less<br>32A or less   | 64A or less               | 96A or less               |      |
| Output rating in the AC mode (AC rms value)     |  |   |  |                           |                           |      |
| Voltage   |  | 1 to 150 V / 2 to 300 V (100 V/200 V output range) (*3)                         |  |                           |                           |      |
| Maximum current                                 | (*4)                                     | 20A / 10A   | 40A / 20A  | 80A / 40A                 | 120A / 60A                |      |
| Number of phases                                |  | 1 $\phi$  |  |                           |                           |      |
| Power capacity                                  |  | 2kVA  | 4kVA   | 8kVA                      | 12kVA                     |      |
| Maximum peak current                            | (*5)                                     | Four times the maximum current (rms value)                                      |  |                           |                           |      |
| Load power factor                               |  | 0 to 1 (lead or lagged phase)   |  |                           |                           |      |
| Frequency                                       |  | 1 to 500.0Hz (*4, 6)  |  |                           |                           |      |
| Output rating in the DC mode                    |  |   |  |                           |                           |      |
| Voltage   |  | 1.4 to 212V / 2.8 to 424V (100 V/200 V output range) (*3)                       |  |                           |                           |      |
| Maximum current                                 | (*4)                                     | 10A / 5A  | 20A / 10A  | 40A / 20A                 | 60A / 30A                 |      |
| Power capacity                                  |  | 1kVA  | 2kVA   | 4kVA                      | 6kVA                      |      |
| Output voltage stability                        |  |   |  |                           |                           |      |
| Source effect                                   | Changes in the rated range               | Within $\pm 0.15\%$   |  |                           |                           |      |
| Load effect                                     | Changes in the 0 to 100%<br>rating range | Within $\pm 0.15V / \pm 0.3V$ (*7)<br>(100 V/200 V output range)                |  | Within $\pm 0.3V$<br>(*7) | Within $\pm 0.5V$<br>(*7) |      |
| Output frequency variation                      | Changes in the rated range               | Within $\pm 0.5\%$ (*8)   |  |                           |                           |      |
| Ambient temperature variations                  | Changes in the rated range               | 100 ppm/°C (typical value) (*9)   |  |                           |                           |      |
| Output frequency stability                      | Changes in all the rated ranges          | Within $\pm 5 \times 10^{-5}$ , Setting accuracy: Within $\pm 1 \times 10^{-4}$ |  |                           |                           |      |
| Output voltage waveform distortion factor       | (*10)                                    | 0.5% or less  |  |                           |                           |      |
| Output voltage response time                    | (*11)                                    | 60 $\mu s$ (typical value)  |  |                           |                           |      |
| Efficiency                                      | (*2)                                     | 75% or more   |  |                           |                           |      |
| Indicator (fluorescent display tube indication) |  |   |  |                           |                           |      |
| Voltmeter<br>(*12)                              | Resolution                               | RMS display mode  | 0.1V   |                           |                           |      |
|   |  | PEAK and AVE display modes  | 0.2V (0 to $\pm 212V$ ) / 0.3V ( $\pm 212$ to $\pm 424V$ )   |                           |                           |      |
|   | Accuracy                                 | RMS and AVE display modes   | Within $\pm (1\% \text{ of r.d.g} + 2d)$ (from 10 to 424 V and at room temperature)  |                           |                           |      |
|   |  | PEAK display mode   | Within $\pm (2\% \text{ of r.d.g} + 2d)$ (from 10 to 424 V and at room temperature)  |                           |                           |      |
| Ammeter<br>(*12)                                | Resolution                               | RMS display mode  | 0.01A  | 0.1A                      | 0.1A                      | 0.1A |
|   |  | PEAK and AVE display modes  | 0.02A  | 0.2A                      | 0.2A                      | 0.2A |
|   | Accuracy                                 | RMS and AVE display modes   | Within $\pm (1\% \text{ of r.d.g} + 2d)$ (from 5% of the maximum rated current to the maximum rated current, and at room temperature) (*13)      |                           |                           |      |
|   |  | PEAK display mode   | Within $\pm (2\% \text{ of r.d.g} + 4d)$ (from 5% of the maximum rated current to the maximum rated peak current, and at room temperature) (*13) |                           |                           |      |

(\*1) The 100 V/200 V input range can be selected by using the switch.

(\*2) For 100 V/200 V input voltage, 100 V/200 V output voltage, rated output current, load power factor of 1, and an output frequency of 40 to 500 Hz



| Model name   |  | PCR2000W   | PCR4000W                 | PCR8000W              | PCR12000W             |
|--|--|--|--------------------------|-----------------------|-----------------------|
| Indicator (fluorescent display tube indication)              |  |  |                          |                       |                       |
| Wattmeter (*14)  | Resolution   | 0.1W/1W  |                          |                       | 0.1W/1W/100W          |
|  | Accuracy   | Within $\pm(1\%$ of r.d.g.+3d)(from 10% of the rated power capacity to the rated power capacity, at a load-power factor of 1, and at room temperature) (*13) |                          |                       |                       |
| Frequency indicator  | Resolution   | 0.01Hz/0.1Hz   |                          |                       |                       |
| Insulation resistance  | Input-to-cubicle, output-to-cubicle, and input-to-output | 10M $\Omega$ or more at 500VDC   |                          |                       |                       |
| Withstanding voltage   | Input-to-cubicle, output-to-cubicle, and input-to-output | 1.5 kV AC for one minute   |                          |                       |                       |
| Power circuit  |  | PWM inverter   |                          |                       |                       |
| Service ambient temperature humidity                         |  | 0 to 50°C/10 to 90% R.H. (no dew condensation allowed)   |                          |                       |                       |
| Storage temperature  |  | -10 to 60°C  |                          |                       |                       |
| Dimensions   |  | See 11.3 Dimensiones.  |                          |                       |                       |
| Weight   |  | Approx. 49kg   | Approx. 69kg             | Approx. 120kg         | Approx. 160kg         |
| I/O terminal board connection screws                         |  |  |                          |                       |                       |
| Input terminal board   |  | M 6  | M 6                      | M 6                   | M 8                   |
| Output terminal board  |  | M 6  | M 6                      | M 6                   | M 8                   |
| Accessories  |  |  |                          |                       |                       |
| Input power cable<br>(cross-sectional conductor area/length) | Configuration  | Single-core cables, three  |                          |                       |                       |
|  | Wire size  | 5.5mm <sup>2</sup> /3m   | 14mm <sup>2</sup> /3m    | 14mm <sup>2</sup> /3m | 22mm <sup>2</sup> /3m |
| Cable clamper  |  | One set<br>(together with fixing-screws, in a bag)   |                          |                       |                       |
|  |  | M3 : 1 pc<br>M4 : 2 pcs  | M3 : 4 pcs<br>M4 : 2 pcs |                       |                       |
| Operation Manual   |  | PCR-W series (this equipment): One<br>Remote controller (PCR-W series edition): One (*16)<br>GPIB/RS-232C interface (PCR-W series edition): One (*16)        |                          |                       |                       |

- (\*3) The 100 V/200 V range can be selected using the switch on the front panel. Resolution: 0.1 V
- (\*4) For an output voltage of 1 to 100 V/2 to 200 V (in AC mode)  
When output voltage is 100 to 150 V/200 to 300 V (in AC mode) or 100 to 212 V/200 to 424 V (in DC mode), the output current is reduced by the output voltage. Figs. 1 and 2  
When the output frequency is 1 to 40 Hz, the output current is reduced by output frequency (in AC mode). Fig. 3
- (\*5) For a capacitor input rectifying load (However, it is limited by a rated output current rms value.)
- (\*6) Resolution: 1) 0.01 Hz (1.00 to 100.0 Hz) 2) 0.1 Hz (100.0 to 500 Hz)
- (\*7) For an output voltage of 80 to 150 V/160 to 300 V, and a load-power factor of 1. The value specified is obtained at the output terminal board.
- (\*8) For an output voltage of 80 to 150 V/160 to 300 V and a load-power factor of 1. The value specified is the output voltage variation obtained with 200 Hz as a reference.
- (\*9) For 100 V/200 V output voltage and 0 A output current
- (\*10) For an output voltage of 80 to 150 V/160 to 300 V and a load-power factor of 1
- (\*11) To change from the 0 A output current to the rated value and vice versa when output voltage is 100 V/200 V, and the load-power factor is 1.
- (\*12) For true rms value display or waveform with a crest factor of 3 or less and 40 to 500Hz
- (\*13) Typical room temperature 23  $\pm$  5°C
- (\*14) With a frequency from 45 to 65 Hz
- (\*15) The output frequency set value (internal reference frequency) is indicated.
- (\*16) The operation manual is attached only. Its hardware is option.

■ Output voltage percentage - rated output current characteristics

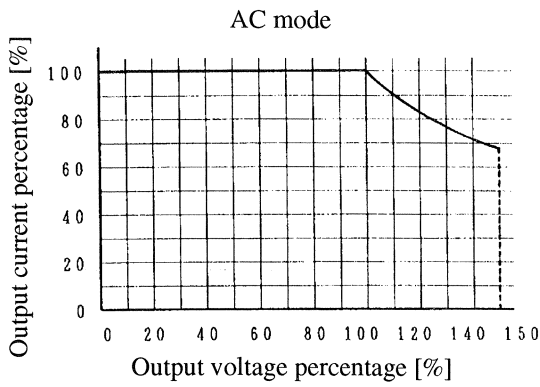

Fig. 1

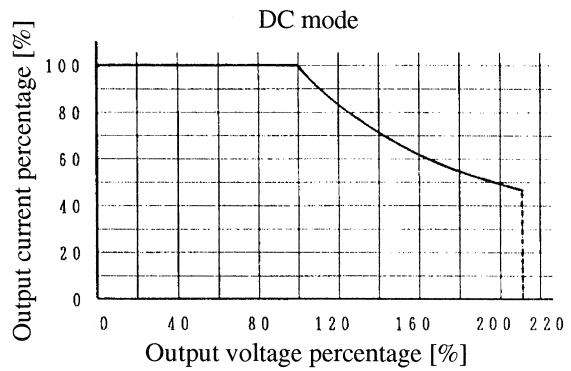

Fig. 2

■ Output frequency - rated output current characteristics

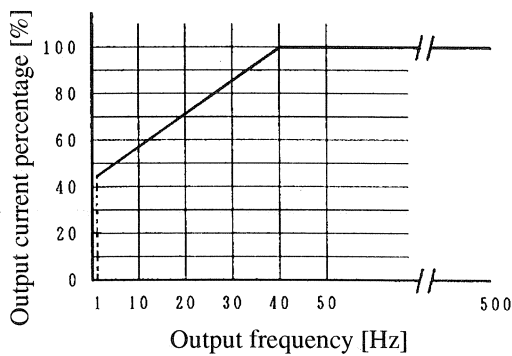

Fig. 3

- The output voltage percentage is obtained when 100 V/200 V output voltage (in the 100 V/200 V output range) is treated as 100%.
- The output current percentage is obtained when the maximum rated output current is treated as 100%.
- The output current percentage in Fig. 1 and Fig. 3 takes priority the smaller of the two Figs. (This applies only in the AC mode.)



## 11.2 Operating Characteristics

- The output voltage percentage is obtained when 100 V/200 V output voltage (in 100 V/200 V output range) is treated as 100%.
- The output current percentage is obtained when the maximum rated output current is treated as 100%.

### ■ Output current vs input current or efficiency characteristics

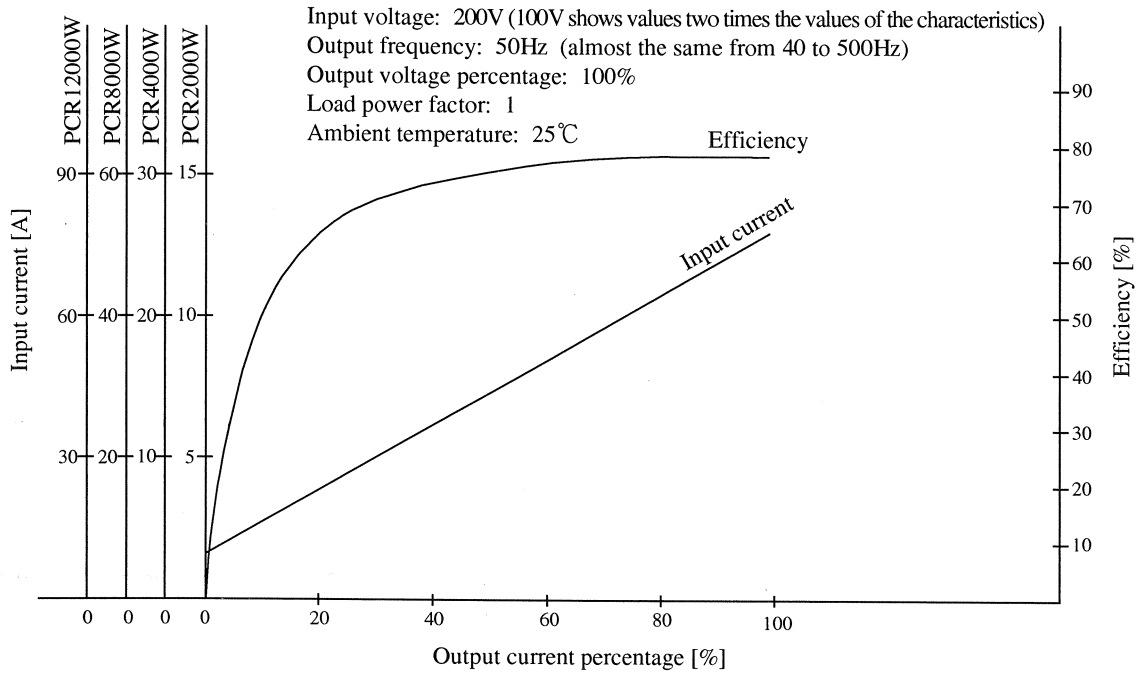

### ■ Output voltage vs input current or efficiency characteristics

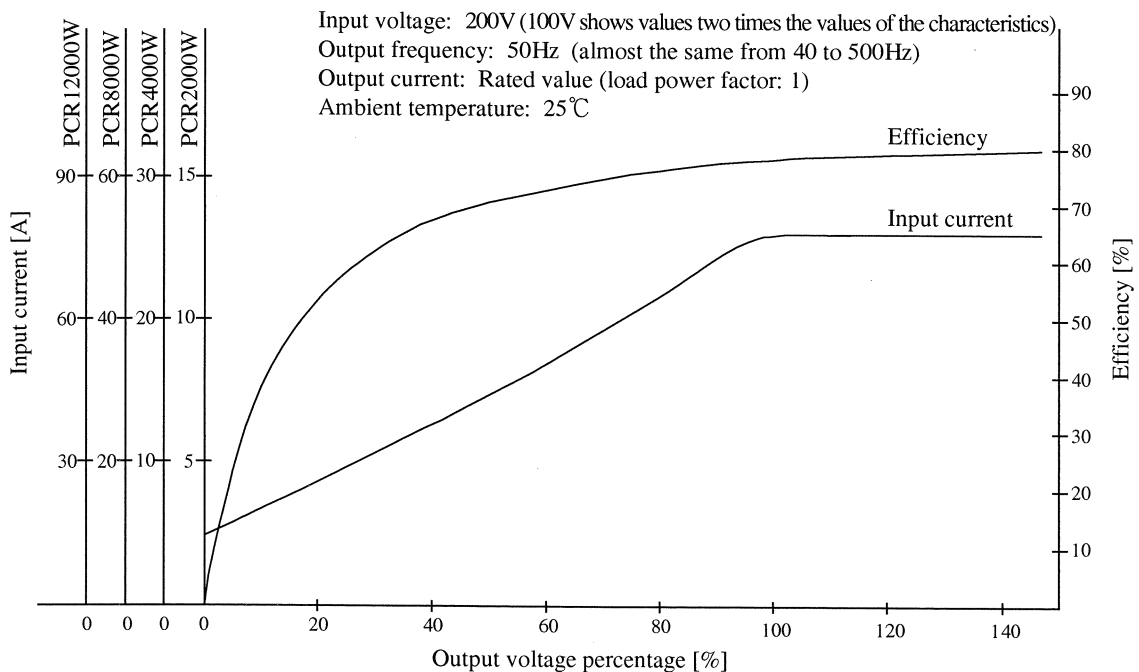

# 11.3 Dimensions

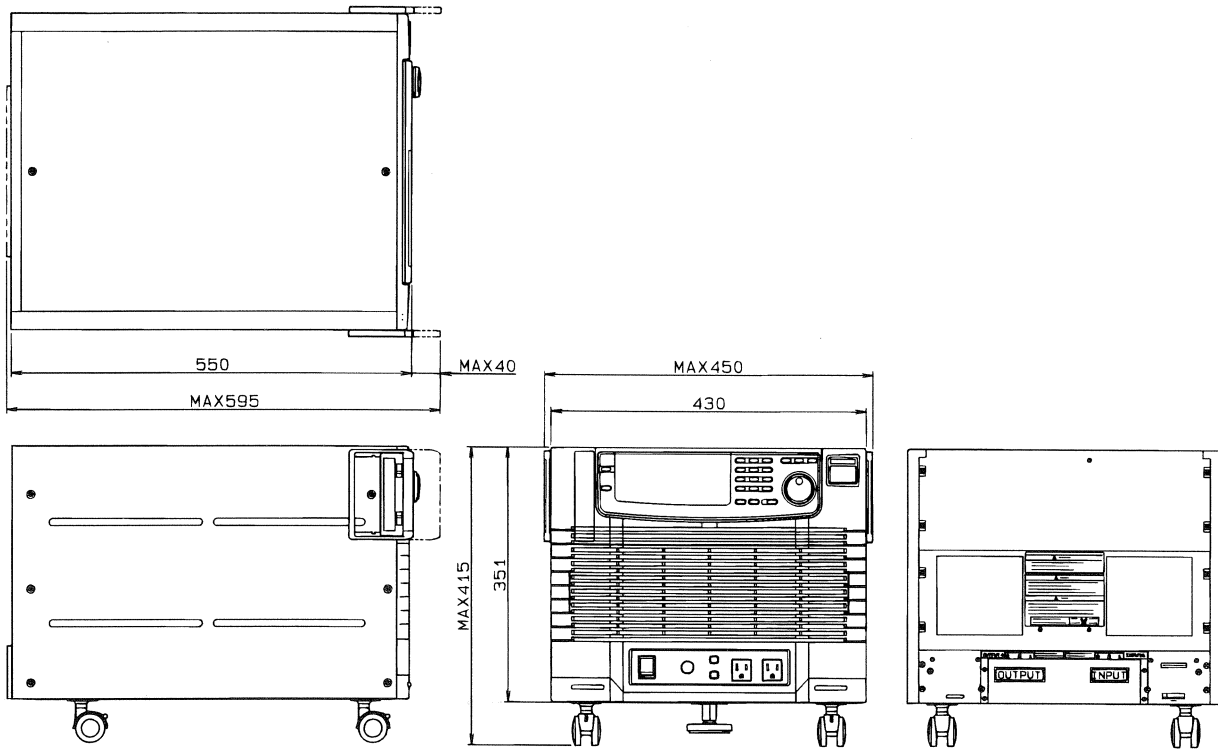

PCR2000W

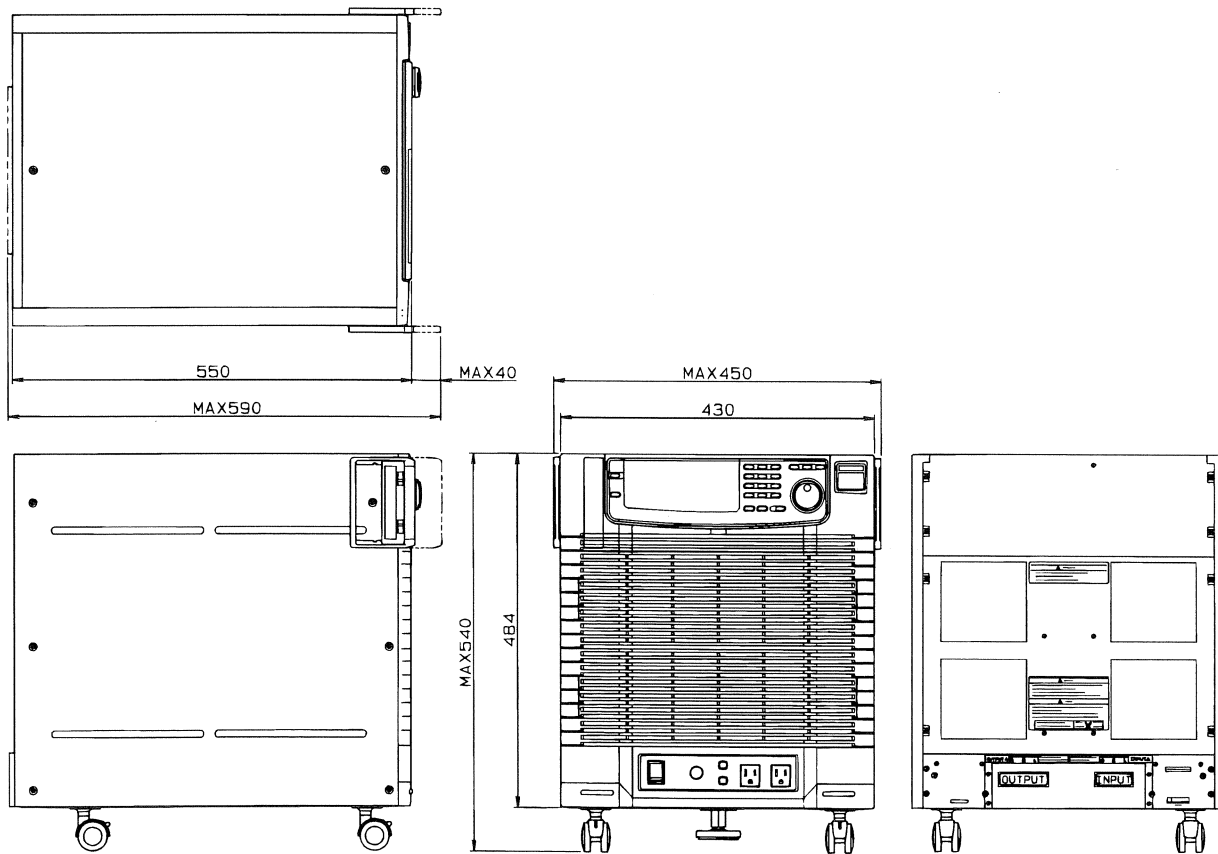

PCR4000W

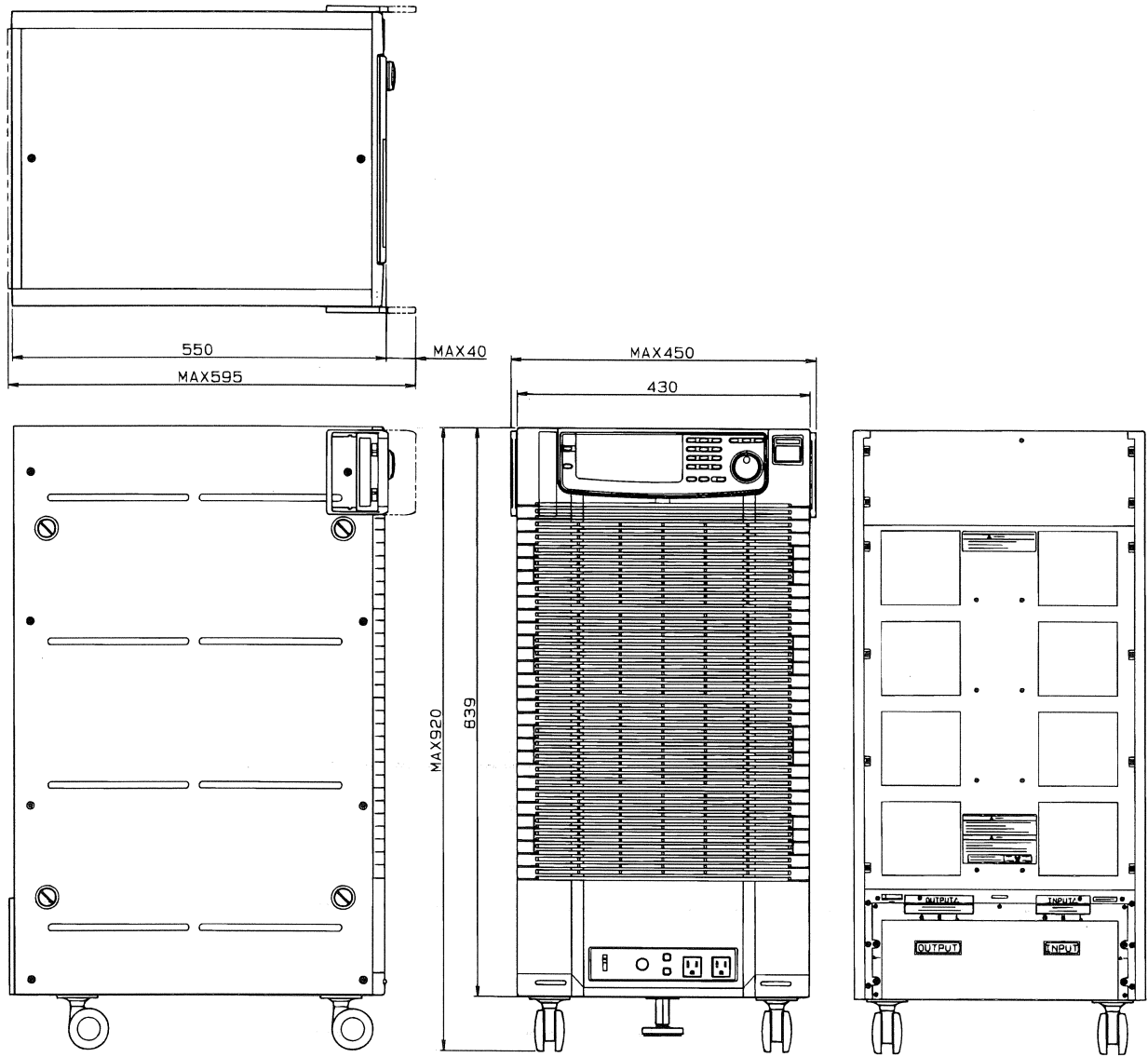

PCR8000W

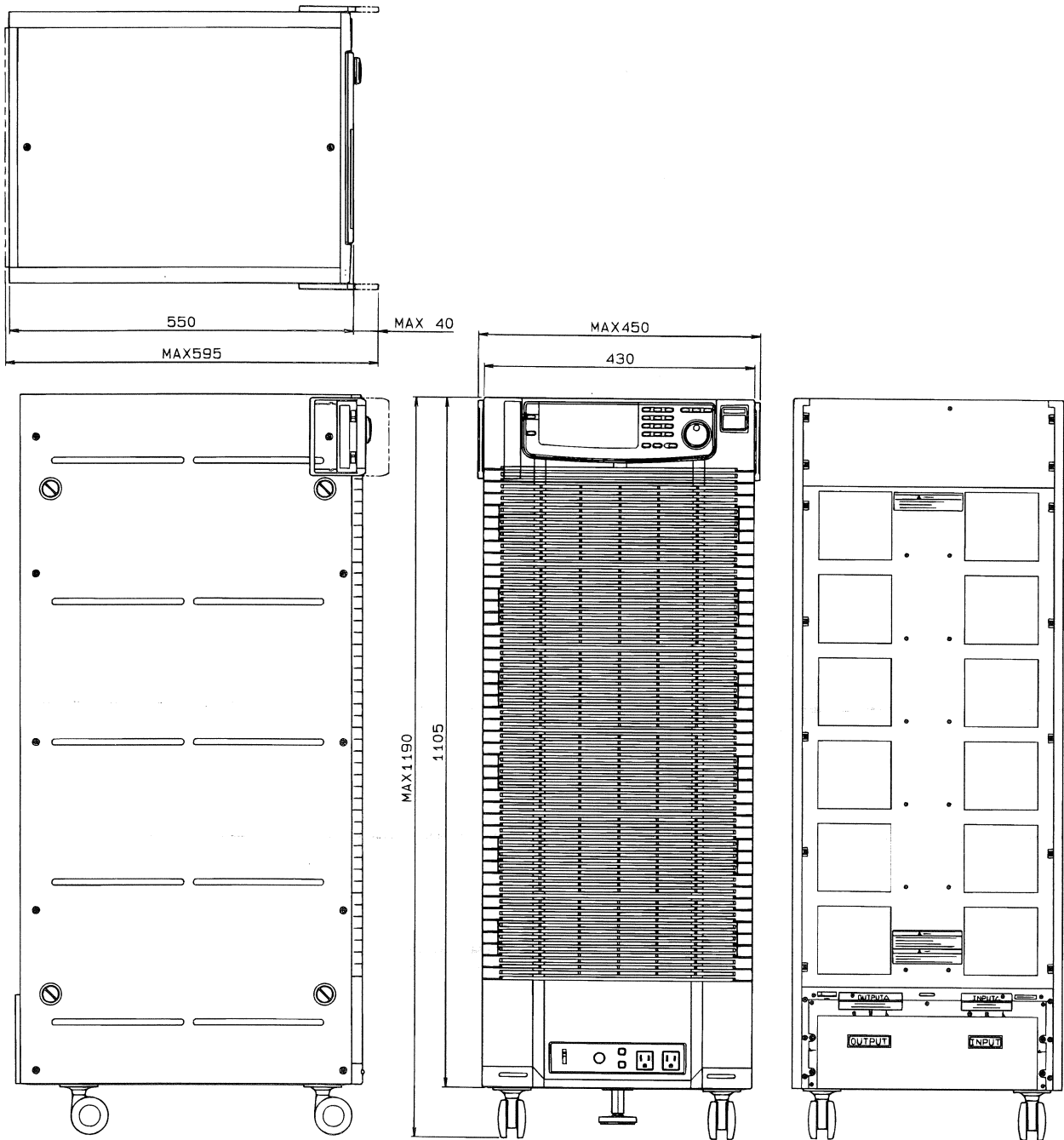

PCR12000W

# APPENDIX

## Contents

|  |     |
|--|-----|
| Appendix 1 Control Panel Key Operating Menu Hierarchy .....    | A-2 |
| Appendix 2 Glossary .....                                      | A-6 |
| 1. Rated Output (Power) Capacity or Power Capacity             | A-6 |
| 2. Maximum Rated Output Current .....                          | A-6 |
| 3. Rated Output Current.....                                   | A-6 |
| 4. Maximum Output Peak Current<br>(Maximum Peak Current) ..... | A-7 |
| 5. Output Current Percentage .....                             | A-7 |
| 6. Output Voltage Percentage .....                             | A-7 |
| 7. Output Voltage Waveform Distortion Factor ..                | A-7 |
| 8. Output Voltage Response Time.....                           | A-8 |
| 9. High Power Factor Converter (Active Filter)..               | A-8 |
| 10. Capacitor-Input-Type Rectifying (Circuit) Load             | A-9 |
| 11. Derating .....   | A-9 |

# Appendix 1 Control Panel Key Operating Menu Hierarchy

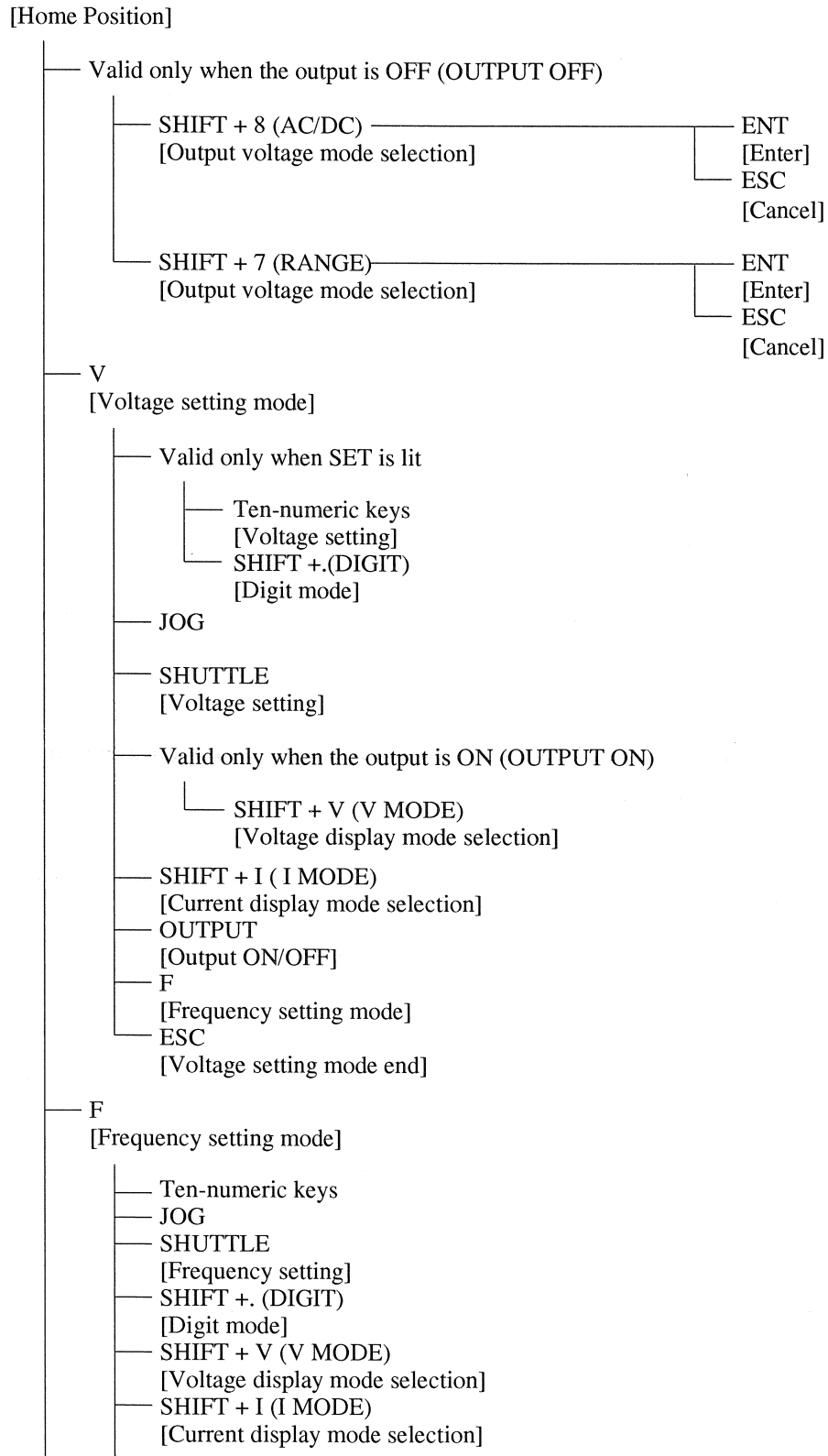

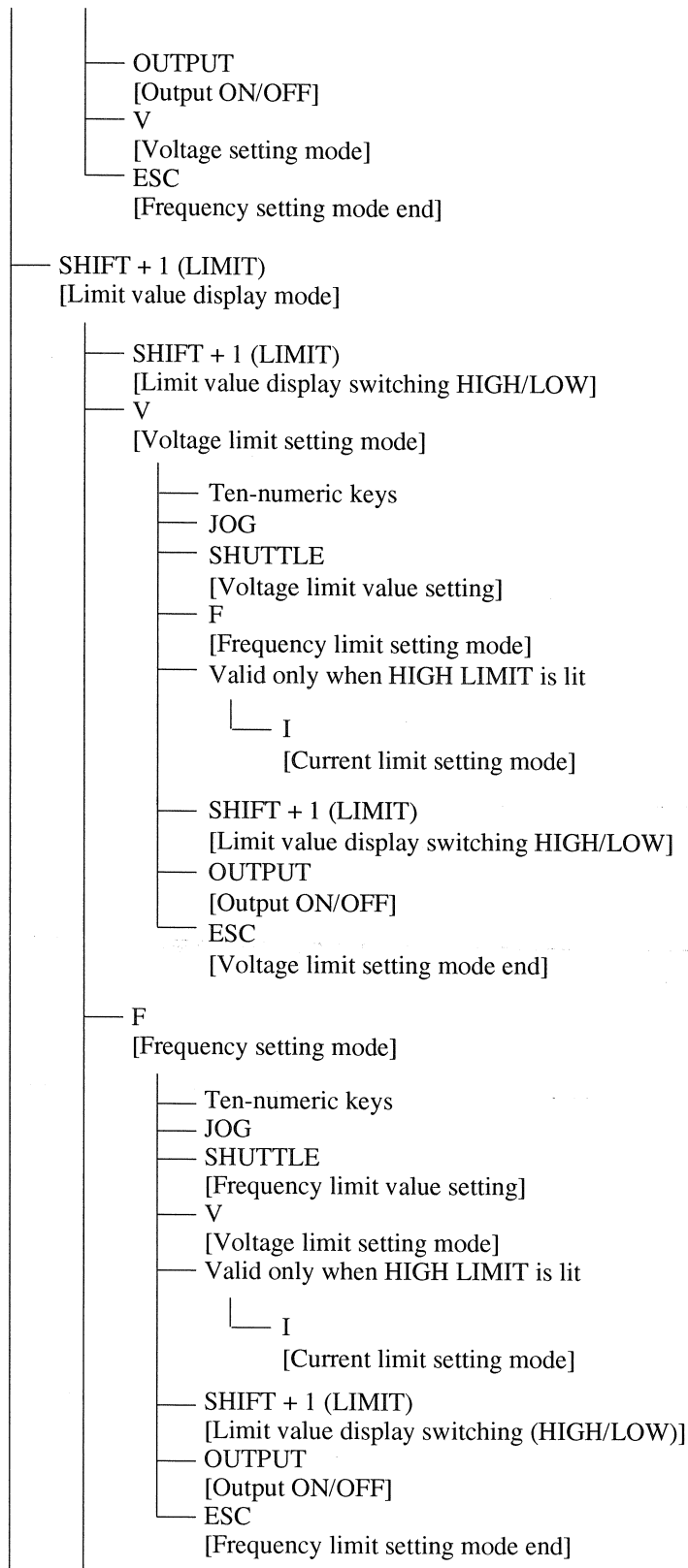

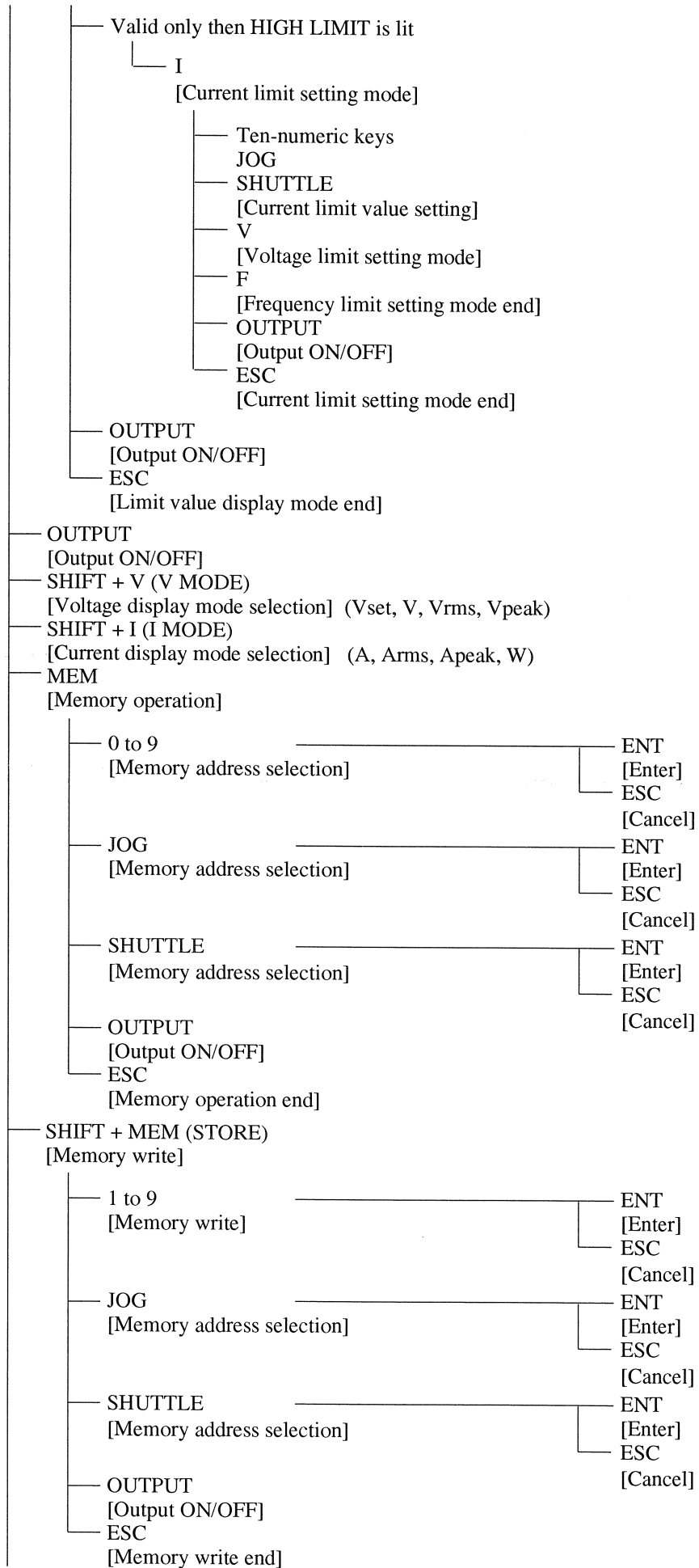



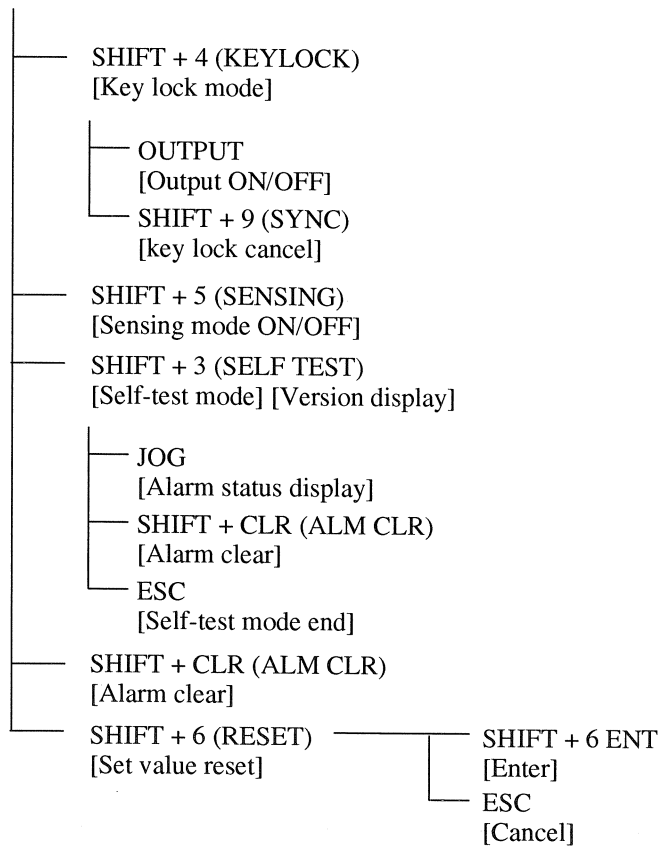

## Appendix 2 Glossary

### 1. Rated Output (Power) Capacity or Power Capacity

Maximum Value (unit:VA) of output power capacity that can be continuously supplied in the following range.

|                  |                            | AC mode         | DC mode      |
|------------------|----------------------------|-----------------|--------------|
| Output voltage   | For the 100 V output range | 100V to 150V    | 100V to 212V |
|                  | For the 200 V output range | 200V to 300V    | 200V to 424V |
| Output frequency |                            | 40Hz to 500.0Hz | —            |

- For example, PCR2000W has a rated output capacity of 2 [kVA].
- In the DC mode the value becomes half that of the AC mode.

### 2. Maximum Rated Output Current

Maximum value (unit: A) of the output current (rms value) that can be continuously supplied in the following range.

|  |                            | AC mode         | DC mode |
|--|----------------------------|-----------------|---------|
| Voltage in which the output voltage percentage is 100% | For the 100 V output range | 100V            | 100V    |
|  | For the 200 V output range | 200V            | 200V    |
| Output frequency                                       |                            | 40Hz to 500.0Hz | —       |

- In the DC mode the value becomes half that of the AC mode.

$$\text{Maximum rated output current} = \frac{\text{Rated output (power) capacity [VA]}}{\text{Voltage at which the output voltage percentage is 100% [V]**}}$$

\*\*100V or 200V

### 3. Rated Output Current

AC mode: Maximum continuous value of the output current (rms value) reduced by a combination of the output voltage and output frequency.

DC mode: Maximum continuous value (unit: A) of the output current reduced by the output voltage.

- For further details, see the description of "Output and Load of this Equipment" in Chapter 5.

#### 4. Maximum Output Peak Current (Maximum Peak Current)

Maximum continuous value (unit: A peak) of the output current (peak value) that the equipment can supply to a load.

Maximum output peak current = Maximum rated output current (rms value)  $\times$  4

Only when the crest factor =  $\frac{\text{peak value}}{\text{rms value}} \leq 4$

|                  |   |
|------------------|---|
| Output voltage   | 100 to 150 V (for the 100 V output range) |
|                  | 200 to 300 V (for the 200 V output range) |
| Output frequency | 40 Hz to 500.0 Hz                         |

[Sample output current waveform]

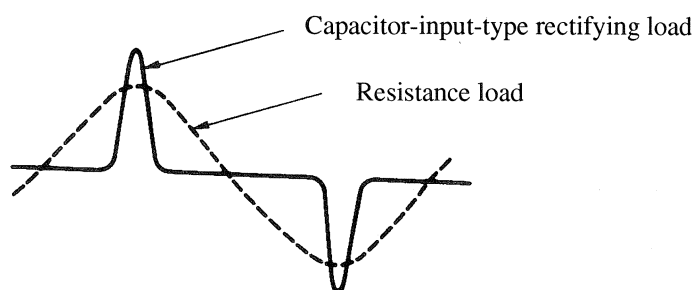

#### 5. Output Current Percentage

Percentage (%) of the output current when the maximum rated output current is regarded as 100%.

#### 6. Output Voltage Percentage

Percentage (%) of the output voltage when an output voltage of 100 V/200 V is regarded as 100% in the 100 V/200 V output range.

#### 7. Output Voltage Waveform Distortion Factor

Total harmonic distortion Factor (%) of the output voltage waveform when the output voltage is 80 to 150 V (for the 100 V output range) or 160 to 300 V (for the 200 V output range), and the load power factor is 1.

## 8. Output Voltage Response Time

Time (unit: ms) from the instant the output voltage change exceeds 10% of the overall change to the instant the output voltage change returns to within 10% of the overall change, while the output current percentage changes from 0% to 100% when the output voltage is 100 V (for 100 V output range) or 200 V (for the 200 V output range) and the load power factor is 1 (in the AC mode).

[Output voltage waveform]

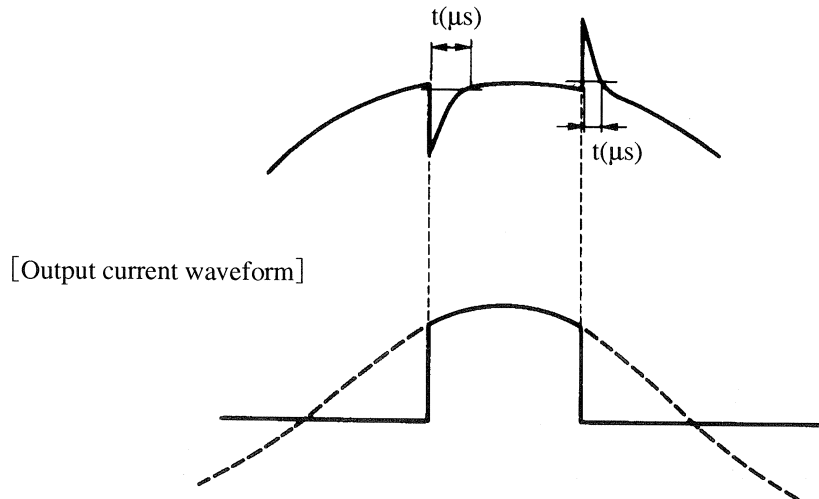

## 9. High Power Factor Converter (Active Filter)

A circuit used to reduce the input current distortion factor (harmonic current). This filter is used in the input power supply block of the equipment. It is a switching-control active filter. Using an active filter improves the power factor (0.95 or more, and the current waveform is virtually sinusoidal), and the input voltage is less distorted.

## 10. Capacitor-Input-Type Rectifying (Circuit) Load

The "capacitor-input-type rectifying load" has a filter capacitor connected directly across the rectifier output, as shown in Fig. A. This type of load draws a current as shown in Fig. B. The input current peak value is generally about two to four times the rms value, and the conduction angle (current flowing period) is 20 deg. to 90 deg., centering on the output voltage peak (phase angle: 90 deg. or 270 deg.)

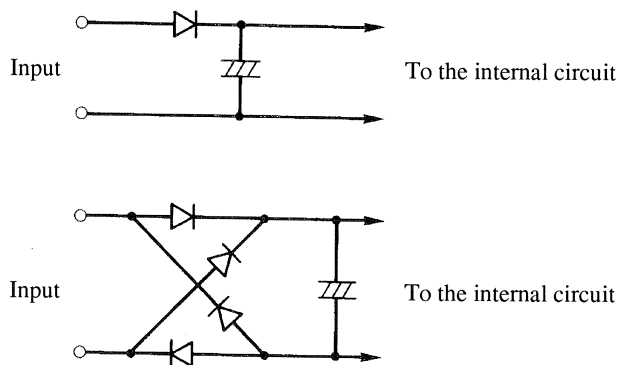

Fig. A

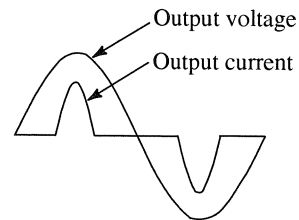

Fig. B

- Typical examples of capacitor-input-type rectifying loads
  - Consumer electronics appliances: TV sets, video equipment such as VCR, audio equipment, microwave ovens, and inverter lighting fixtures
  - Office automation equipment: Personal computers, office computers, word processors, facsimiles, and CAD systems
  - Others: Mainframe computers, factory automation equipment, communication equipment, and other switching power supply equipped devices and equipment.

## 11. Derating

This generally means reducing the claimed maximum performance ratings (such as voltage and current) of the relevant equipment or devices with respect to ambient conditions (such as temperature and load).



# INDEX

---

## Alphabetical order

+/- ..... 6-5, 8-3

## A

AC mode ..... 5-6, 6-2  
AC voltage output mode ..... 6-2  
AC/DC ..... 6-2, 8-4  
AC+DC ..... 6-2, 8-6  
AC+DC Mode ..... 7-3  
accessory ..... 2-2  
Active Filter ..... A-8  
Air-intake ..... 8-11  
ALARM ..... 8-6, 9-2  
Alarm Clear Procedure ..... 9-4  
allowable current ..... 3-3  
ALM CLR ..... 8-4  
Average current measurement (AVE) ..... 6-21  
Average value measurement (AVE) ..... 6-19

## B

Basic Operation Check ..... 4-8  
bottom stopper ..... 2-6

## C

Capacitor-Input-Type Rectifying (Circuit) Load A-9  
capacitor-input-type rectifying load ..... 5-8, 9-6  
casters ..... 2-6, 8-11  
Checking the Input Power ..... 2-4  
CIRCUIT BREAKER ..... 5-4, 8-9  
Cleaning the Air-Intake Filter ..... 10-4  
CLR ..... 8-4  
Control Panel Angle Adjustment ..... 4-7  
Control Panel Display Unit ..... 8-5  
Control Panel Key Operating Menu Hierarchy ... A-2  
Control Panel Operating Section ..... 8-2  
Current display area ..... 8-5  
current limit value ..... 6-7  
Current rms value measurement (RMS) ..... 6-21  
Current/Power Display Mode ..... 6-21

## D

DC mode ..... 5-5, 6-2  
DC voltage output mode ..... 6-2  
Derating ..... A-9  
DIGIT ..... 8-4  
digit mode ..... 6-17, 8-4

## E

ENT ..... 8-2, 8-5  
ENT wait ..... 6-2, 8-5

ESC ..... 8-2  
Exhaust Port(s) ..... 8-14  
Expansion of the Memory Function ..... 7-3

## F

Frequency display area ..... 8-5  
frequency limit values ..... 6-7  
Frequency Setting ..... 6-6

## G

GPIO interface ..... 7-2  
Grips ..... 2-7, 8-7  
Grounding ..... 2-5

## H

high limit setting mode ..... 6-7, 6-8, 6-9, 6-10, 8-6  
high power factor converter ..... 1-2, A-8  
Home Position ..... 6-2  
how to obtain the rated output current ..... 5-7

## I

I MODE ..... 8-3  
Initial Setup Status ..... 4-5  
Input power cable ..... 2-2  
Input Power Connecting Procedure ..... 3-2  
INPUT terminal board ..... 2-5, 3-2, 8-13  
INPUT VOLTAGE SELECTOR ..... 3-4, 8-13  
Installation and Location ..... 2-3

## J

JOG ..... 8-2

## K

Key-Lock Function ..... 6-26  
KEYLOCK ..... 8-3, 8-6

## L

LIMIT ..... 8-3  
Limit value display mode ..... 6-7, 8-3  
Limit Value Setting ..... 6-7  
LINE lamp ..... 4-3, 8-9  
linear load ..... 5-8, 9-6  
List of Basic Operation Check Steps ..... 4-13  
LOAD ..... 8-6  
Load ..... 5-5  
LOAD level meter ..... 6-12  
loads where surge occurs ..... 5-8  
locks ..... 2-7  
low limit setting mode ..... 6-7, 6-9, 6-11, 8-6

## M

maximum output current ..... 5-4

|   |          |
|---|----------|
| maximum output peak current .....                                   | 5-8, A-7 |
| Maximum Peak Current .....  | A-7      |
| Maximum Rated Output Current .....                                  | A-6      |
| measurement of peak holding current .....                           | 7-2      |
| measurement of power-factor .....                                   | 7-2      |
| Measures to be Taken if the Overload Function<br>is Activated ..... | 9-6      |
| Measures to be Taken in the Event of an Alarm ..                    | 9-2      |
| MEM .....   | 8-4      |
| MEMORY .....  | 8-6      |
| Memory Function .....   | 6-23     |
| Memory Read Procedure .....   | 6-25     |
| Motors and lamps loads .....  | 5-8      |
| Moving Precautions .....  | 2-6      |

## N

|   |      |
|---|------|
| nominal conductor cross-section .....   | 3-3  |
| number of EEPROM updates .....          | 10-6 |
| Number of Update Operations .....       | 10-6 |
| numeric keys .....                      | 8-3  |
| Numeric Setting Using JOG/SHUTTLE ..... | 6-16 |

## O

|   |               |
|---|---------------|
| Operating humidity range .....                  | 2-3           |
| Operating temperature range .....               | 2-3           |
| OUTPUT .....                                    | 8-2           |
| Output Current Percentage .....                 | A-7           |
| OUTPUT ON/OFF .....                             | 8-5           |
| Output ON/OFF .....                             | 6-14          |
| Output ON/OFF phase setting .....               | 7-2           |
| OUTPUT outlets .....                            | 4-2, 5-3, 8-9 |
| OUTPUT terminal board .....                     | 5-2, 8-13     |
| Output Voltage Percentage .....                 | A-7           |
| Output Voltage Response Time .....              | A-8           |
| Output Voltage Setting .....                    | 6-5           |
| Output Voltage Waveform Distortion Factor ..... | A-7           |
| OVERLOAD .....                                  | 8-6           |
| Overload Protective Function .....              | 9-5           |

## P

|   |      |
|---|------|
| PEAK .....  | 8-5  |
| Peak current measurement (PEAK) .....                     | 6-21 |
| Peak value measurement (PEAK) .....                       | 6-19 |
| PHASE .....   | 8-3  |
| polarity of the power distribution board .....            | 3-3  |
| POWER .....   | 8-9  |
| Power Capacity .....                                      | A-6  |
| Power measurement (W) .....                               | 6-21 |
| Power ON .....  | 4-2  |
| POWER switch .....  | 4-2  |
| Procedure for Storing Data in the Memory .....            | 6-24 |
| Procedure for Switching the Output Voltage<br>Range ..... | 6-4  |
| Procedure for Using the Digit Function .....              | 6-17 |
| Procedure for Using the Sensing Function .....            | 6-28 |
| Protective Functions .....                                | 9-2  |

## R

|                                     |          |
|-------------------------------------|----------|
| Rack Mounting .....                 | 7-4      |
| RANGE .....                         | 8-4, 8-6 |
| Rated input frequency range .....   | 2-4      |
| Rated input voltage range .....     | 2-4      |
| Rated Output (Power) Capacity ..... | A-6      |
| Rated Output Current .....          | A-6      |
| regulation adjustment .....         | 1-3, 7-3 |
| Removing the Louver .....           | 10-4     |
| RESET .....                         | 8-4, 8-6 |
| Reset Procedure .....               | 4-6      |
| RMS .....                           | 8-5      |
| rms value measurement (RMS) .....   | 6-19     |
| RS-232C interface .....             | 7-2      |
| rush current .....                  | 5-8      |

## S

|  |               |
|--|---------------|
| S-MODE .....                                   | 8-7           |
| SELF TEST .....                                | 8-3, 8-6, 9-3 |
| SENSING .....                                  | 8-3, 8-6      |
| sensing function .....                         | 6-27, 8-13    |
| SENSING terminal board .....                   | 6-28, 8-13    |
| SET .....                                      | 8-5           |
| Setting the Current/Power Display Mode .....   | 6-20          |
| Setting the Output Voltage Mode (AC/DC) .....  | 6-2           |
| SHIFT .....                                    | 8-2, 8-5      |
| Shift key .....                                | 4-6, 6-2      |
| SHUTTLE .....                                  | 8-2           |
| SLOT1 .....                                    | 8-7           |
| Stopper .....                                  | 8-11          |
| STORE .....                                    | 8-4, 8-6      |
| Switching the Current/Power Display Mode ..... | 6-20          |

## T

|   |           |
|---|-----------|
| terminal box .....                              | 3-4, 8-13 |
| Transformers and slide transformers loads ..... | 5-8       |

## V

|                            |      |
|----------------------------|------|
| V MODE .....               | 8-2  |
| Version Check .....        | 4-5  |
| Voltage display area ..... | 8-5  |
| Voltage Display Mode ..... | 6-19 |
| voltage limit values ..... | 6-7  |

## W

|                 |     |
|-----------------|-----|
| wire size ..... | 3-3 |
|-----------------|-----|