

PCR - M S E R I E S



Small
Slim Simple

Compact AC Power Supply PCR-M Series

Compact AC power supply using the PWM inverter method
Output capacity: 500 VA, 1,000 VA and 2,000VA (single phase) and 4,000VA
AC output: 1 V to 135 V/2 V to 270 V at 40 Hz to 500 Hz
DC output: ± 1.4 V to 190 V/ ± 2.8 V to 380 V
The maximum peak current triples the rated current (RMS value).
Equipped with measurement functions and various communication interface options.

Small Slim Simple

The compact AC power supply makes you change of work style.

The PCR-M is a small-size AC power supply with the ease of a variable auto transformer or an automatic voltage regulator (AVR) and the usefulness of a multifunctional AC power supply. As the PWM inverter method is adopted for the power unit, the PCR-M is much smaller and lighter than the predecessors while enabling high-quality and highly-efficient (about 70 %) operation. For its size like never before enables you to use on your desktop or on the side of your desk. (Photo on right: PCR500M Actual size) This power supply comes with measurement features, memory feature, protection functions and various communication interface options, and it is even possible to provide DC power. This small and versatile unit can provide you with more work styles than you can imagine. You can't do without it once you use it!

Selectable the Output Mode

In addition to the "AC mode" and "DC mode", it is possible to control the output by external analog signals. AD + DC mode, EXT-AC mode and EXT-DC mode by using an optional analog interface board. (EX04-PCR-M)

Output Mode	Description
AC mode	AC output
DC mode	DC output
AC+DC mode	Superimpose DC voltage on the AC voltage and output *1
EXT-AC mode	Output sine waves using external DC signals *2
EXT-DC mode	Simply amplify and output the waveform applied externally*2

*1 When any of the optional communication interface (US21/IB21/EX04-PCR-M) is equipped with the unit.

*2 When the analog interface board is installed.

[AC mode]

Since it is possible to comply with the nominal voltage (single phase) of each country, the output voltage range can be set in two ranges for 1 V to 135 V or 2 V to 270 V, and the frequency range can be set from 40 Hz to 500 Hz. It can be also applied to the testing of the power supply system such as equipped on the aircraft, boat, and actuator.

Output Voltage Varies		Frequency Varies
135 V range	270 V range	
0.0 V to 137.5 V	0.0 V to 275.0 V	40 Hz to 500 Hz

[DC mode]

The output voltage can be varied from ± 1.4 V to 190 V or ± 2.8 V to 380 V (Selectable range:135V or 270V or Auto)

Output Voltage Setting	
135 V range	270 V range
-194.0 V to +194.0 V	-388.0 V to +388.0 V

[AC + DC mode]

The output voltage can be varied from ± 1.4 V to 190 V or ± 2.8 V to 380 V (Selectable range:135V or 270V)

Output Voltage Setting	
135 V range	270 V range
-194.0 V to +194.0 V	-388.0 V to +388.0 V

AC + DC mode is a function used to superimpose DC voltage on AC voltage or AC voltage on DC voltage. It can be used via the RS232C, or GPIB, or USB interface when an optional interface board is installed.

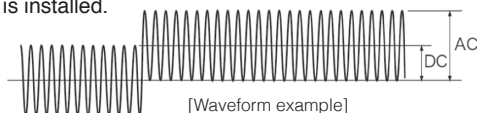

Maximum peak current (AC mode only)

The maximum peak current can be output up to three times of the maximum rated current compared to a capacitor input-type rectifying load.

[Maximum peak current = Rated maximum current (rms value) \times 3]

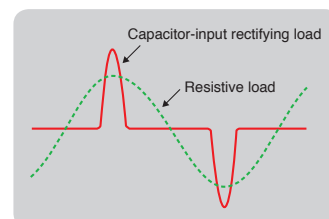

**Compact/
Light weight
6 kg!
(PCR500M)**



Abundant measurement functions

The PCR-M is capable of measuring the voltage, current, and power of AC and DC output. It can display the true RMS and the average (DC) values for the output voltage, and the true RMS, peak and the average (DC) values for the output current. When a communication interface is used, the PCR-M can measure the apparent power (VA), the reactive power (VAR), the power factor (PF), the crest factor (CF), and the peak hold current.

Protection

The following protection features are available:

- Protection against non-rated input voltage
- Protection against overheat (OHP)
- Protection against overload:
 - Current limit (OCP)/monitoring for exceeded power (OPP)/ monitoring for exceeded peak current
- Detection of voltage abnormalities:
 - Increased voltage (OVP)/decreased voltage (LVP)

Output on phase angle

The output on phase angle can be set at AC mode. The output off phase angle is turned off at a zero cross phase.

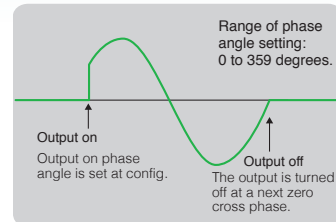

Memory function

The PCR-M can store three sets of setting value for output voltage and frequency, and limit value. By manually changing the preset memory during output, the test for sudden changes of voltage and frequency is also possible. When an optional interface board (IB21, US21 or EX04-PCR-M) is installed, the memory can store up to 10 settings.

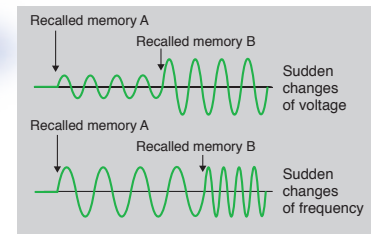

Actual size



On the design and development of the DC-DC converter, on-board power supply.

COMPACT AC POWER SUPPLY PCR-M Series 4 Models

■ Lineup

Model	Voltage	Max current	Power capacity
PCR500M	1 V to 135 V 2V to 270 V (2 range)	5 A / 2.5 A	500 VA
PCR1000M		10 A / 5 A	1 kVA
PCR2000M		20 A / 10 A	2 kVA
PCR4000M		40 A / 20 A	4 kVA

Control using a PC

The PCR-M comes with the control software "Easy Controller For PCR-M" as a standard accessory. This software enables you to set each parameter and logging the measurement value of output (data acquisition).

Operating environment for Easy Controller for PCR-M

- OS: Windows XP(x86 SP2 or later), Vista(x86/x64), or 7(x86/x64)
- CPU: Pentium 233 MHz or greater
- Memory: At least 128 MB
- Driver: VISA library supporting VISA COM
- Interface: RS-232C*, GPIB, or USB

* Note: Not available in the "AC+DC mode". The "AC+DC mode" is functioned if the "EX04-PCR-M" is equipped with the unit.

* Instrument drivers for Microsoft Visual Basic, Microsoft Office VBA, Microsoft Visual C++, LabVIEW, or LabWindows/CVI are also included in the disc.

The screenshot shows the 'Easy Controller For PCR-M' software interface. Callouts point to the following features:

- Output mode selection:** AC, DC, ACDC, Ext AC, Ext DC.
- Switching the range:** Voltage Range (135V, 270V, AUTO).
- Setting the peak hold function:** Enable Measurement Average, Current Peak Hold Time (Short, Long).
- Output on phase angle:** Enable On-Phase Synchro, Phase [deg] (0, set).
- Setting the limit value:** Unit Settings (AC Current [A], DC Current [A]), Current Limit Behaviour (Limit, Trip).
- Output setting Voltage, Current, Frequency:** AC Voltage [V], DC Voltage [V], Frequency [Hz].
- Status monitor:** Measurement Monitor table.

Time	Volt AC	Volt DC	Curr AC	Curr DC	Curr Ph	CF	Watt	Watt DC	VA	VAR	PF	
12:56:25	104.492	21.642	1.980	0.453	3.210	16.674	1.621	206.869	9.799	206.894	3.216	1.000
12:56:26	104.498	21.672	1.981	0.453	3.221	16.674	1.626	206.898	9.828	207.010	6.809	0.999
12:56:27	104.480	21.695	1.980	0.454	3.219	16.674	1.626	206.805	9.854	206.870	5.185	1.000
12:56:29	104.475	21.710	1.980	0.454	3.219	16.674	1.626	206.768	9.861	206.860	6.169	1.000
12:56:30	104.490	21.687	1.981	0.454	3.221	16.674	1.626	206.871	9.850	206.994	7.135	0.999
12:56:31	104.499	21.657	1.981	0.453	3.216	16.674	1.623	206.913	9.821	207.012	6.401	1.000
12:56:33	104.479	21.620	1.980	0.452	3.216	16.674	1.624	206.805	9.773	206.868	5.105	1.000
12:56:34	104.454	21.605	1.980	0.452	3.213	16.674	1.623	206.670	9.766	206.818	7.823	0.999
12:56:35	104.458	21.605	1.980	0.452	3.221	16.674	1.627	206.692	9.766	206.826	7.444	0.999

Options

"Wavy" sequence creation software

Wavy series



Wavy for the PCR-M series

- *Note: The "Wavy" for the "PCR4000M" will be available soon.
- [Operating environment] Windows 2000/Windows XP/Windows Vista/Windows 7
- *For details, please refer to our web site.

The software extends the feature of waveform generation and sequence functions. Easy sequence control without programming knowledge.

Graph viewer/Configuration

Time	Volt AC	Volt DC	Curr AC	Curr DC	Curr Ph	CF	Watt	Watt DC	VA	VAR	PF	
12:56:25	104.492	21.642	1.980	0.453	3.210	16.674	1.621	206.869	9.799	206.894	3.216	1.000

Command control

Direct control

Got a sense of remote control for easy operation!
Capable of monitoring, logging of the output!

Wavy is an application software that supports sequence creation and the operation for Kikusui power supplies and electronic loads. Wavy allows you to create and edit sequences visually with a mouse without programming knowledge. Real-time monitor function is added to the Ver. 4.0 or later, that enables monitoring and logging values of voltage and current. The Ver.5.0 equips Remote Control Panel function that enables you to control power supplies as if you were using a remote controller.

- It makes easier for creation or editing the test condition file required for the sequence operation.
- By using the storage function of test condition data file, it enables you to manage the test condition of the standard routine test.
- The progress of execution sequence will be displayed on the "execution graph" with the setting value and the cursor.
- It is possible to observe the intuitionistic output through by the "monitor graph" that plots the ongoing monitor value.
- You can save the acquired monitor data as a test result.
- Added the "waveform image" window. You can easily kept track of the AC signal.
- Allows you to edit and create the new arbitrary waveform easily. You can instantly write then output the created arbitrary waveform.
- Supports the status of description of sequence step for "selected" or "not selected". It enables you to select depends on the requirement such as the "pausing function", "trigger function", or "AC waveform".

Download! Trial version available on our web !! <http://www.kikusui.co.jp/en/download/index.html>

Application example

● The AC power supply used for the measurement of standby power.

Combining with the Digital Power Meter, Model KPM1000, you can conduct a measurement complied to the First Edition of IEC63201. It is possible to measure the "standby and off mode power" of the household and office electrical and electronic equipment products required by the standard such as ErP Directive Lot 6.

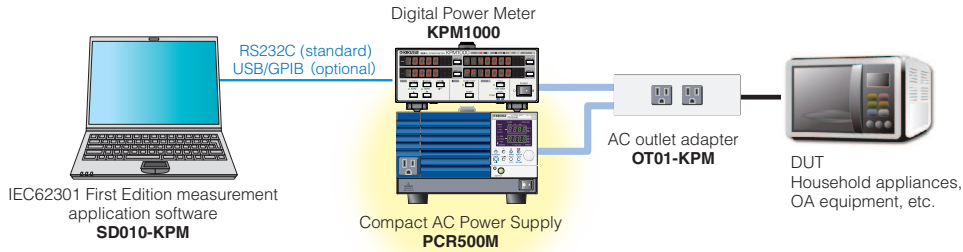

● The AC power supply used for the measurement of harmonic current.

Combining with the Harmonic/Flicker Analyzer, Model KHA1000, you can conduct a harmonic measurement of power supply complied to IEC61000-3-2.

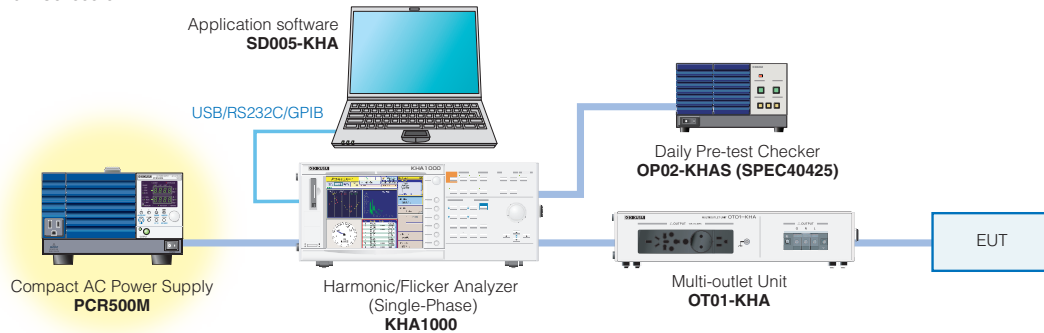

● The AC power supply used for the contact check.

Combining with the Contact Checker, it allows you to detect the current flowing through the capacitor, and verify that the capacitor has been whether connected or not.

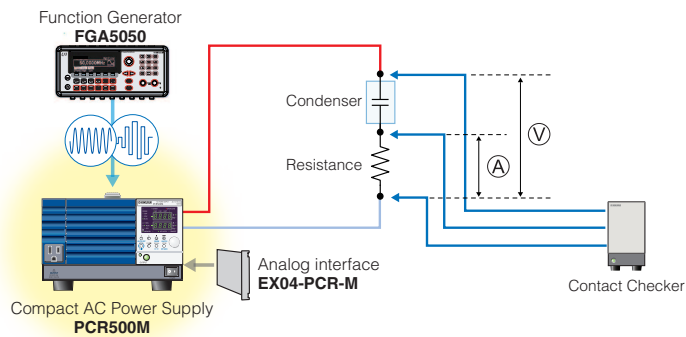

● The DC power supply used for the simplified power source variation test.

Combining with the Bi-polar power supply, Model PBZ40-10 and a High-voltage electronic load, Model PLZ164WH, it allows you to conduct the simplified power variation test for the DC high-voltage of automotive equipment.

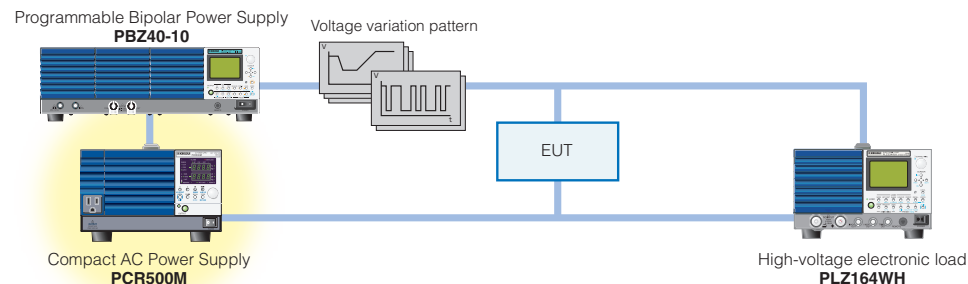

Specifications

		PCR500M	PCR1000M	PCR2000M	PCR4000M
Output rating for AC mode					
Voltage range (135 V/270 V range)	Rated voltage range	1 V to 135 V / 2 V to 270 V			
	Input voltage range	0 V to 137.5 V / 0 V to 275 V			
Voltage setting resolution		0.1 V			
Voltage setting accuracy *1		± (1 % of set + 0.6 V/1.2 V)			
Output phase		Single phase			
Maximum current *2		5 A / 2.5 A	10 A / 5 A	20 A / 10 A	40 A / 20 A
Maximum peak current *3		15 A / 7.5 A	30 A / 15 A	60 A / 30 A	120 A / 60 A
Load power factor		0 to 1 (leading phase or lagging phase)			
Power capacity		500 VA	1000 VA	2000 VA	4000 VA
Frequency setting range		40 Hz to 500 Hz			
Frequency setting resolution		0.1 Hz			
Frequency accuracy		Within ± 2×10 ⁻⁴			
Output rating for DC mode					
Voltage range (135 V/270 V range)	Rated voltage range	1.4 V to 190 V / 2.8 V to 380 V			
	Preset voltage range	-194 V to 194 V / -388 V to 388 V			
Voltage setting resolution		0.1 V			
Voltage setting accuracy *4		± (1 % of set + 0.6 V/1.2 V)			
Maximum current *5		4 A / 2 A	8 A / 4 A	16 A / 8 A	32 A / 16 A
Maximum instantaneous current *6		12 A / 6 A	24 A / 12 A	48 A / 24 A	96 A / 48 A
Power capacity		400 W	800 W	1600 W	3200 W
Output voltage stability					
Power variation *7		Within ± 0.15 %			
Load variation*8 (135 V/270 V range)		For 40 Hz to 100 Hz: Within ± 0.15 V/± 0.3 V For other frequencies: Within ± 0.5 V/± 1 V			
Output frequency variation *9		Within ± 1 %			
Ripple noise *10		0.7 Vrms / 1.4 Vrms (TYP value)			
Ambient temperature variation *11		100 ppm / °C (TYP value)			
Output voltage waveform distortion ratio *12		0.5 % or less			
Output voltage response time *13		150 μs (TYP value)			
Efficiency *14		70 % or greater			
Measured value display *15					
Voltage measurement	Resolution	0.1 V			
	Accuracy (135 V/270 V range)	RMS, AVG *16	For 45 Hz to 65 Hz and DC: ±(0.5 % of rdng + 0.3 V / 0.6 V) For all other frequencies: ±(0.7 % of rdng + 0.9 V / 1.8 V)		
Current measurement	Resolution	0.01 A			0 A~99.99 A:0.01 A 100 A or greater:0.1 A
	Accuracy (135 V/270 V range)	RMS, AVG *17	For 45 Hz to 65 Hz and DC: ±(0.5 % of rdng + 0.02 A / 0.01 A) For all other frequencies: ±(0.7 % of rdng + 0.04 A / 0.02 A)	For 45 Hz to 65 Hz and DC: ±(0.5 % of rdng + 0.04 A / 0.02 A) For all other frequencies: ±(0.7 % of rdng + 0.08 A / 0.04 A)	For 45 Hz to 65 Hz and DC: ±(0.5 % of rdng + 0.08 A / 0.04 A) For all other frequencies: ±(0.7 % of rdng + 0.16 A / 0.08 A)
	Accuracy (135 V/270 V range)	Peak *18	±(2 % of rdng + 0.1 A / 0.05 A) (TYP value)	±(2 % of rdng + 0.2 A / 0.1 A) (TYP value)	±(2 % of rdng + 0.4 A / 0.2 A) (TYP value)
Power measurement	Resolution	0.1 W, 1 W (For 1000 W or more)			
	Accuracy *19	±(2 % of rdng + 0.5 W)	±(2 % of rdng + 1 W)	±(2 % of rdng + 2 W)	±(2 % of rdng + 4 W)
Input rating					
AC input	Nominal input rating	100 V to 120 V / 200 V to 240 V, 50 Hz / 60 Hz, single phase			
	Input voltage range	90 V to 132 V / 180 V to 250 V (auto detected when the power is turned on)			
Input frequency range		47 Hz to 63 Hz			
Apparent power		800 VA or less	1600 VA or less	3200 VA or less	6400 VA or less
Power factor *20		0.9 (TYP value)			
Current (Input AC voltage 90 V to 132 V/180 V to 250 V)		9 A / 4.5 A or less	18 A / 9 A or less	36 A / 18 A or less	74 A / 36 A or less

*1. For an output voltage of 13.5 V to 135 V/27 V to 270 V, an output frequency of 45 Hz to 65 Hz, no load, and 23 °C ± 5 °C.
 *2. For an output voltage of 1 V to 100 V/2 V to 270 V. Limited by the power capacity when the output voltage is 100 V to 135 V/200 V to 270 V.
 *3. With respect to the capacitor-input rectifying load. Limited by the maximum current.
 *4. For an output voltage of 19 V to 190 V/38 V to 380 V, no load, and 23 °C ± 5 °C.
 *5. For an output voltage of 1.4 V to 100 V/2.8 V to 200 V. Limited by the power capacity when the output voltage is 100 V to 190 V/200 V to 380 V.
 *6. Limited by the maximum current.
 *7. For changes in the rated range.
 *8. For an output voltage of 80 V to 135 V/160 V to 270 V, a load power factor of 1, stepwise change from an output current of 0 A to maximum current (or its reverse), using the output terminal on the rear panel.
 *9. For an output voltage of 100 V/200 V and a load power factor of 1. Output voltage variation with 55 Hz as reference.
 *10. For 5 Hz to 1 MHz components in DC mode using the output terminal on the rear panel.
 *11. For an output voltage of 100 V/200 V, an output current of 0 A, and within the operating temperature range.
 *12. At an output voltage of 50 V to 135 V/100 V to 270 V, a load power factor of 1, and in AC mode.
 *13. For an output voltage of 100 V/200 V, a load power factor of 1, with respect to stepwise change from an output current of 0 A to the maximum current (of its reverse).
 *14. For AC mode, at an output voltage of 100 V/200 V, maximum current, load power factor of 1, and an output frequency of 40 Hz to 500 Hz.
 *15. RMS, average (AVG), and power (W) are derived using the following equations.

$$RMS \text{ (true rms computation)} = \sqrt{\sum (\text{instantaneous voltage or instantaneous current})^2 / \text{the number of samples}}$$

$$AVG = (\text{instantaneous voltage or instantaneous current}) / \text{the number of samples}$$

WAC = \sum (instantaneous voltage × instantaneous current) / the number of samples
 WDC = VAVG × IAVG
 ● Sample period: 100 ms to 125 ms for AC output (an integer multiple of the output waveform period. 125 ms for DC output)
 ● Update interval: Approx. 3 times/s, averaging over 3 s when averaging is turned on
 ● Peak current value holds the maximum value of the absolute value of the peak current for 0.3 s or approximately 5 s.
 ● The voltage display is set to RMS in AC mode and AVG in DC mode.
 *16. AC mode: For an output voltage of 13.5 V to 135 V/27 V to 270 V and 23 °C ± 5 °C.
 DC mode: For an output voltage of 19 V to 190 V/38 V to 380 V and 23 °C ± 5 °C.
 *17. For a waveform of crest factor 3 or less, an output current in the range of 5 % to 100 % of the maximum current, and 23 °C ± 5 °C.
 *18. For a waveform of crest factor 3 or less, an output current in the range of 5 % to 100 % of the maximum peak current in AC mode, an output current in the range of 5 % to 100 % of the maximum instantaneous current in DC mode, and 23 °C ± 5 °C.
 *19. For an output voltage of 50 V or greater, an output current in the range of 10 % to 100 % of the maximum current, DC or an output frequency of 45 Hz to 65 Hz, a load power factor of 1, and 23 °C ± 5 °C.
 *20. For an output voltage of 100 V/200 V (v135 V/270 V range), maximum current, and a load power factor of 1.

Specifications

		PCR500M	PCR1000M	PCR2000M	PCR4000M
Insulation resistance	Between input and chassis, output and chassis, input and output	500 Vdc, 30 MΩ or more			
Withstand voltage	Between input and chassis, output and chassis, input and output	1.5 kVac for 1 minute			
Earth continuity		25 Aac, 0.1Ω or less			
Electromagnetic Compatibility (EMC) *1 *2		Complies with the requirements of the following directive and standards EMC Directive 2004/108/EC EN 61326-1 EN 61000-3-2 EN 61000-3-3		Complies with the requirements of the following directive and standards EMC Directive 2004/108/EC EN 61326-1	
		Under following conditions The maximum length of all connecting cables and wires to the PCR-M series are less than 3 m.			
Safety *1		Complies with the requirements of the following directive and standard LOW Voltage Directive 2006/95/EC EN 61010-1 Class I Pollution Degree II			
Circuit system		PWM inverter system			
Environment	Operating environment	Indoor use, Overvoltage Category II			
	Operating temperature and humidity range	0 °C to 40 °C (32 °F to 104 °F), 20 % rh to 80 % rh (no condensation)			
	Storage temperature and humidity range	-10 °C to 60 °C (14 °F to 140 °F), 90 % rh or less (no condensation)			
	Altitude	Up to 2000 m			
External dimensions	214 (8.43") Wx124 (4.88") Hx350 (13.78") D mm	429 (16.89") Wx128 (5.04") Hx350 (13.78") D mm	429 (16.89") Wx128 (5.03") Hx450 (17.72") D mm	429 (16.89") Wx262 (10.31") Hx520 (20.47") D mm	
Weight	Approx. 6 kg (13.23 lb)	Approx. 11 kg (24.25 lb)	Approx. 15 kg (33.07 lb)	Approx. 32 kg (70.55 lb)	
Input terminal		Inlet	M4 terminal block	M6 terminal block	M6 terminal block
Output terminal		M4 terminal block			M6 terminal block
Accessories	Power cord	1 pc. with plug Length: Approx. 2.5 m	1 pc. without plug 3-core flexible cable Nominal cross-sectional area : 3.5 mm ² Length: Approx. 3 m	1 set with ferrite core without plug, 1-core cable : 3pcs. Nominal cross-sectional area : 5.5 mm ² Length: Approx. 3 m	1 set without plug, 1-core cable : 3pcs. Nominal cross-sectional area : 14 mm ² Length: Approx. 3 m
	Ferrite core	-	-	1 pc.	-
	Cable tie	-	-	1 pc.	-
	CD-ROM *3	1 pc. Setup Guide, Quick Reference (1 each for English and Japanese), Safety information			

*1. Not applicable to custom order models.

*2. Only on models that have CE marking on the panel. Not be applied with the EMC limits when the OUTPUT outlet on the front panel is used. PCR2000M will not be in compliance with EMC limits unless the ferrite core is attached on the load wires.

*3. Contains the User's Manual, Communication Interface Manual, software application, instrument driver, and VISA library (KI-VISA)

Other

■ The communication interface

*Note: Only one interface board can be installed.

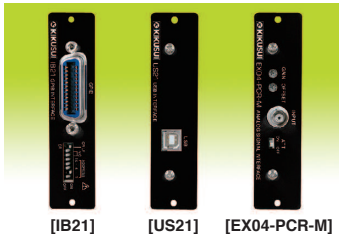

GPIB interface board: IB21

USB interface board: US21

Analog interface board: EX04-PCR-M

■ Rack mount adapters

For the PCR500M

- KRA150 (for millimeter specifications)
- KRA3 (for inch specifications)

For the PCR1000M and PCR2000M

- KRB150-TOS (for millimeter specifications)
- KRB3-TOS (for inch specifications)

For the PCR4000M

- KRB300 (for millimeter specifications)
- KRB6 (for inch specifications)

■ Analog interface specifications (EX04-PCR-M: optional)

Input terminal	Maximum allowable input voltage	± 15 V	
	Type	BNC	
	Input impedance	10 kΩ ± 5 % (not unbalanced)	
	Isolation voltage	±100 Vmax	
EXT-AC mode *1	Input voltage range	0 V to ±10 V (DC)	
	Voltage amplification rate (135 V / 270 V range)	13.5 times or 27 times	
	Frequency setting range	40 Hz to 500 Hz	
EXT-DC mode	Input voltage range	ATT off	0 V to ±1.90 Vpeak (0 to 1.35 Vrms sine wave)
		ATT on	0 V to ±10 V (DC)
	Input frequency range	ATT off *2	40 Hz to 500 Hz (sine wave) / 40 Hz to 100 Hz (square wave) / DC
	Frequency characteristics	ATT off	- 0.3 dB at 500 Hz with respect to 55 Hz (typical value)
Voltage amplification rate (135 V/270 V range)	ATT off	100 times or 200 times	
	ATT on	19 times or 38 times	
Output voltage distortion ratio *3	Main unit specifications + 0.5 % or less		

*1 ATT is always set to on.

*2 Measurable range for voltage, current and power is DC and from 40 Hz to 500 Hz. The frequency is set based on the input waveform cycle.

*3 In the EXT-AC mode, when direct current is input. In the EXT-DC mode, when a sine wave with 0.1 % or less distortion rate is input.

■ Specifications of the communication interface

RS-232C	Conforms to EIA232D specifications. D-SUB9 pin connector. Baud rate: 1200, 2400, 4800, 9600, 19200 bps Data length: 8 bits, stop bit: 1 bit, no parity bit, X-Flow control
GPIB (IB21: optional)	Conforms to IEEE STD.488.1-1978 specifications. SH1, AH1, T6, L4, SR1, RL1, PP0, DC1, DT1, C0, E1
USB (US21: optional)	Conforms to USB 2.0 specifications. Conforms to USBTMC-USB488 device class specifications. Communication speed: 12 Mbps (full speed)
Common	Software protocol: IEEE 488.2 STD 1992 Command language: SCPI Specification 1999.0

■ Rear panel / Dimensions (units: mm)

PCR500M

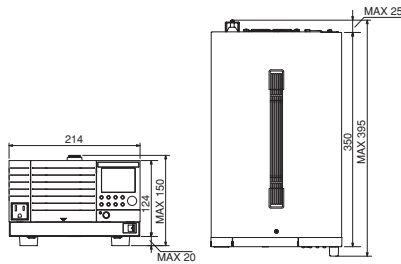

PCR1000M

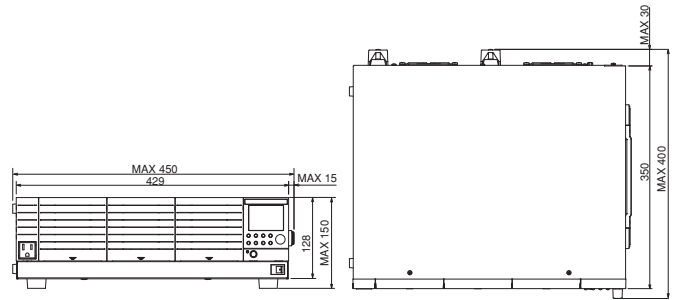

PCR2000M

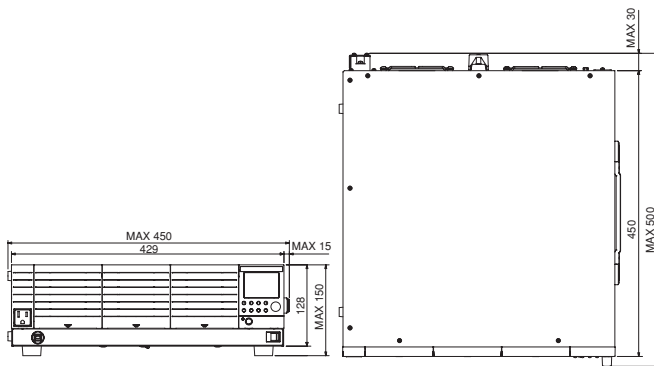

PCR4000M

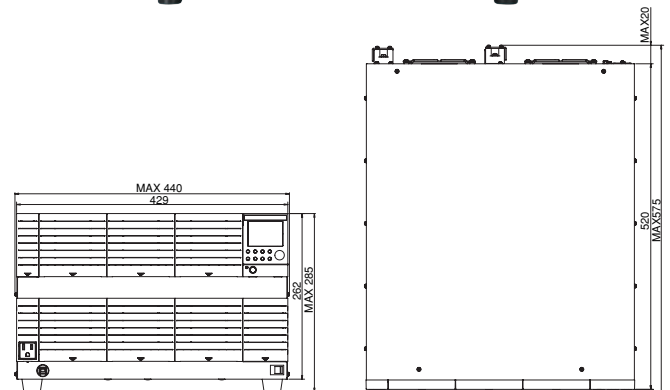

KIKUSUI ELECTRONICS CORPORATION

1-1-3, Higashiyamata, Tsuzuki-ku, Yokohama, 224-0023, Japan
 Phone: (+81) 45-593-7570, Facsimile: (+81) 45-593-7571, www.kikusui.co.jp

KIKUSUI AMERICA, INC. 1-877-876-2807 www.kikusuiamerica.com



2975 Bowers Avenue, Suite 307, Santa Clara, CA 95051
 Phone : 408-980-9433 Facsimile : 408-980-9409

KIKUSUI TRADING (SHANGHAI) Co., Ltd. www.kikusui.cn



Room 216, Building 4, No.641, Tianshan Road, Shanghai City, China
 Phone : 021-5887-9067 Facsimile : 021-5887-9069

For our local sales distributors and representatives, please refer to "sales network" of our website.

■ Distributor:

■ All products contained in this catalogue are equipment and devices that are premised on use under the supervision of qualified personnel, and are not designed or produced for home-use or use by general consumers. ■ Specifications, design and so forth are subject to change without prior notice to improve the quality. ■ Product names and prices are subject to change and production may be discontinued when necessary. ■ Product names, company names and brand names contained in this catalogue represent the respective registered trade name or trade mark. ■ Colors, textures and so forth of photographs shown in this catalogue may differ from actual products due to a limited fidelity in printing. ■ Although every effort has been made to provide the information as accurate as possible for this catalogue, certain details have unavoidably been omitted due to limitations in space. ■ If you find any misprints or errors in this catalogue, it would be appreciated if you would inform us. ■ Please contact our distributors to confirm specifications, price, accessories or anything that may be unclear when placing an order or concluding a purchasing agreement.