



Multifunctional AC Power Supply PCR-LA Series

High-quality, high-stability output with high-speed linear amplifier

Features a full range of measuring functions and supports both AC and DC outputs

Single-phase 500 VA to 6 kVA

Options enable implementation of many system configurations - parallel, single-phase, three-wire, three-phase, single-phase/single-phase, three-wire switchable, and single-phase/three-phase switchable
Single-phase system is expandable up to 30 kVA, and three-phase system up to 54 kVA



JQA-EM1176
JQA-1100
Oscilloscopes
Withstanding Voltage Testers
Power Supply Equipment

Multifunctional AC Power Supply

PCR-LA SERIES

PCR-LA SERIES

High-stability, high-quality output with high-speed linear amplifier

Features a full range of measuring functions and supports both AC and DC outputs

Diverse power line abnormality simulation functions

RS-232C and remote control interface are standard equipment

Expandable to single-phase/single-phase, three-wire or single-phase/
three-phase switchable system



Multifunctional AC power supply capable of power supply environment testing

The PCR-LA Series is a line of advanced multifunctional AC power supplies that have been developed from our best-selling PCR-L Series of AC power supplies. By incorporating new functions and adding options while inheriting the well-proven performance of its predecessor, the PCR-LA Series provides a new line of safe and highly reliable models that are much easier to use. The PCR-LA Series models are equipped with an RS-232C interface and a dedicated remote control external interface as standard (GPIB is optional), allowing you to access all of the system's functions from a PC. An optional remote controller (RC03-PCR-LA) has been specifically designed for power line abnormality simulations, which constitute a major part of power supply environment

testing. This controller lets you perform these simulations both easily and at low cost. Also, by adding an output extension kit (OT01-PCR-LA/2, OT01-PCR-LA/3, etc.) to the system, you can easily create a single-phase/single-phase, three-wire or single-phase/three-phase switchable system configuration.

With its advanced basic performance and flexible and expandable configuration, the PCR-LA Series system can be applied to most fields, including electrical apparatus, machinery, and chemicals, and supports a host of capabilities including power supply environment testing, immunity testing, and the power amplification of output waveforms from arbitrary signal generators.



Wide-Ranging Specs

Output voltage rating (2 ranges) 1.0 - 150.0 V/2.0 - 300.0 V

Output frequency rating 1.00 - 999.9 Hz *¹

Input power is as stated in the universal specs.

85 - 132 V/170 - 250 V, 50/60 Hz *²

In addition to the output pins on the back panel, the system also has three-pin outlets on its front panel, making it easy to use.

Peak Current Four Times Greater Than Rating

A peak current of up to four times the maximum current rating (RMS value) can be handled with a capacitor input-type rectifier load. *³

DC Output Also Supported

The system supports a DC output mode as standard, enabling a DC output of ± 1.4 to 424 V.

Excellent I/O Characteristics

The system offers excellent I/O characteristics with a voltage waveform distortion rate of 0.3% or less. An active filter (power factor = 0.95) reduces the occurrence of a harmonics current.

Range of Measuring Functions

In addition to the RMS and peak voltage and current values, power factor, and apparent and effective power values, the FFT function built into the system's main unit enables the simple measurement of the harmonics current (1st to 39th). *⁴

Arbitrary Waveform Creation

The built-in arbitrary waveform synthesizer can be used for power line abnormality simulations. *⁴

Diverse Options

A wide range of options are available, including a remote controller, several types of interfaces, drivers, and output extension kits.





*¹ Resolution is 0.01 Hz for 1.00 to 99.99 Hz and 0.1 Hz for 100.0 to 999.9 Hz.

*² For PCR500LA, PCR1000LA, PCR2000LA, and PCR4000LA

*³ For a capacitor input-type rectifier load, such as that of a switching power supply

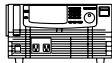
*⁴ Some simulations assume the use of the relevant options.

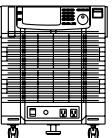
Lineup

Model Name	PCR500LA	PCR1000LA	PCR2000LA	PCR4000LA	PCR6000LA
Output capacity	Single-phase 500 VA	Single-phase 1 kVA	Single-phase 2 kVA	Single-phase 4 kVA	Single-phase 6 kVA
Maximum output current (100 V/200 V)	5 A/2.5 A	10 A/5 A	20 A/10 A	40 A/20 A	60 A/30 A
Apparent input power	Approx. 1 kVA	Approx. 2 kVA	Approx. 4 kVA	Approx. 8 kVA	Approx. 12 kVA
Input current (100 V/200 V)	12 A/6 A or less	24 A/12 A or less	48 A/24 A or less	96 A/48 A or less	72 A or less
Dimensions (mm)	430 (455) W 217 (245) H 550 (595) D	430 (455) W 351 (415) H 550 (595) D	430 (455) W 484 (550) H 550 (595) D	430 (455) W 839 (920) H 550 (605) D	430 (455) W 1105 (1190) H 550 (605) D
* Figures in parentheses are maximum values.					
Weight	Approx. 25 kg	Approx. 49 kg	Approx. 69 kg	Approx. 120 kg	Approx. 160 kg
Appearance					

R&D

Research & Development

✎ For determining proof values for power line abnormalities

✎ Support of DC output

✎ Power can be measured easily

✎ For use in radio wave darkrooms and shielded rooms

The main unit of the PCR-LA Series system has built-in measuring functions that let you easily measure not only voltage and current values but also other values including apparent and effective power values, power factor, and harmonics current. Furthermore, functions such as power line abnormality simulation, sequence, and arbitrary waveform creation give better-than-ever reproducibility and reliability of the data needed for proof evaluations for instantaneous power failure, voltage fluctuation, waveform distortion, missing phase, and other power line abnormalities. In addition, the system supports a DC output of up to 424 V. This feature very convenient when a temporary DC output is needed, such as when driving a DD converter. The system can also be used as an AC power supply in all kinds of EMC testing site (radio wave darkrooms, shielded rooms, etc.).

* The relevant options are required to enable the apparent power, peak current, and harmonics current measuring functions, simulation functions, sequence function, arbitrary waveform creation function, and so on.

Production

Production Lines

✎ Can be used as a CVCF power supply

✎ For stabilizing the line power supply

A single PCR-LA Series system can be used as a CVCF power supply that satisfies all global commercial power supply specs (100 to 240 V), as well as those for ships and aircraft (400 Hz). The system also supports a maximum output peak current of four times the current rating for a capacitor input-type load, such as that of a switching power supply (continuous supply is possible), or about twice the current rating for a larger rush (peak) current such as that of a motor (about 10 seconds* for a power factor of 1). The PCR-LA Series system is also recommended for stabilizing the power supplies of precision processing machines, measuring equipment, or other apparatus that could be adversely affected by unstable line voltages. It offers extremely high-speed, high-quality output, with an output voltage response speed of 30 μ s (typical value) and a waveform distortion rate of 0.3% or less. This makes the system particularly suitable for use with equipment whose quality and accuracy can be affected by minor fluctuations in the power or load, such as welding machines or semiconductor production systems.

* The Output will be shut off when period of time exceeds 10 seconds. The distortion of wave will be appeared when the current value exceeds rated value during the period until 10 seconds.

Inspection

Adjustment and Inspection Lines

✎ For checking power supply voltage margins

✎ For automated inspection systems

The PCR-LA Series system can be used for operation checking within the power supply voltage range, and also as a power supply for aging. Multiple PCR-LA Series systems can be connected in parallel to increase the overall system capacity or to provide a three-phase connection. This flexibility lets you respond to the changing needs of your line configuration, or to increase or decrease the number of power supplies needed for aging. In addition, the system supports PC-based remote control and monitoring through either the GPIB (option) or RS-232C interface. You can use the system to manage quality control data such as inspection records.



QA

Quality Assurance

✎ Can be used as a standard room power supply

✎ For IEC standard tests

The PCR-LA Series system can be used as a power supply in a standard room or measuring equipment control room.

Service

✎ Can be used as a power supply for repair and calibration

✎ For reproducing power line abnormalities

The PCR-LA Series system also performs extremely well in applications involving repair, inspection, calibration, and so forth. For example, the PCR500LA (with an output capacity of 500 VA) can deliver power that satisfies all global commercial power supply specs (100 to 240 V), even from a residential power outlet (100 V/15 A). This makes the system ideal for use in service situations where large-scale equipment cannot be installed, as well as for use on business trips. Also, the system can provide a stable supply of power that is free of fluctuation and distortion during the inspection and calibration work, thereby contributing to maintaining or improving the level of service quality.

Performance and Functions

High-quality output characteristics provided by a high-speed linear amplifier system

* Some of the functions described below assume the use of the relevant options. For details, see pages 16 and 17.

Output Voltage

The output voltage can be varied over a wide range so as to satisfy any global commercial power supply specs (100 to 240 VAC). The output voltage can be set directly in steps of 0.1 V by using the numerical keypad, or changed in small consecutive steps by using the jog/shuttle wheel. Also, for a three-phase output (extended configuration featuring a three-phase output driver), the phase voltage or inter-wire voltage can be set.

100 V range
1.0 to 150.0 VAC/Resolution: 0.1 V
200 V range
2.0 to 300.0 VAC/Resolution: 0.1 V

Output Frequency

An output frequency of 1.00 to 999.9 Hz can be set directly by using the numerical keypad, or changed in small consecutive steps by using the jog/shuttle wheel without the need to switch ranges.

1.00 Hz to 99.99 Hz
Resolution: 0.01 Hz
100.0 Hz to 999.9 Hz
Resolution: 0.1 Hz

DC Mode

Switching to DC mode in single-phase operation causes the system to output a DC voltage between ± 1.4 and 424 V.

100 V range
1.4 to 212 VDC/Resolution: 0.1 V
200 V range
2.8 to 424 VDC/Resolution: 0.1 V

Input Voltage

The system supports a wide range of input voltages and thus can be used around the world without modification.

PCR500LA+1000LA+2000LA+4000LA
Single phase 85 to 132 VAC/170 to 250 VAC
PCR6000LA
Single phase 170 to 250 VAC

Memory Function/Limit Value Setting Function

Memory function

Nine sets of output voltage and frequency settings can be stored as address data in memory. Installing the relevant option increases the storage capacity to 99 addresses.

Limit value setting function

This function allows you to set the upper and lower limits of the output voltage and frequency, as well as the upper limit of the current. This helps prevent load damage caused by operational errors.

Note: For a system with a three-phase output driver, you cannot use this function to set an upper limit on the current.

Input Current

An active smoothing filter is used so that the waveform of the input current approximates to a sine wave with a power factor is 0.95 (typical value), thereby reducing the waveform distortion of the input current and the harmonics current.

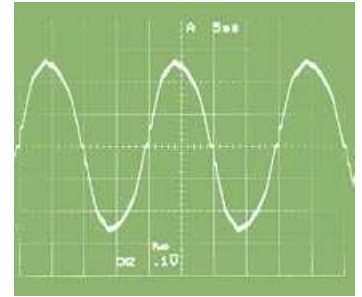

Output Impedance

While the output impedance (output resistance) of this system is nearly 0 Ω , you can change the output impedance value (resistance) from a PC (connected via the RS-232C interface) or an optional remote controller (RC04-PCR-LA). Thus, the output impedance can be closely matched to the actual commercial power supply environment. Also, once an impedance value has been set using this function, the system saves the setting and retains it even after the option is uninstalled from the main unit.

* GPIB control requires the installation of an interface card (IB03-PCR-LA).

100 V range			
Model Name	Setting Range	Resolution	Setting Accuracy
PCR500LA	0 Ω to 4.0 Ω	40 m Ω	$\pm(20\% + 80 \text{ m}\Omega)$
PCR1000LA	0 Ω to 2.0 Ω	20 m Ω	$\pm(20\% + 40 \text{ m}\Omega)$
PCR2000LA	0 Ω to 1.0 Ω	10 m Ω	$\pm(20\% + 20 \text{ m}\Omega)$
PCR4000LA	0 Ω to 0.5 Ω	5 m Ω	$\pm(20\% + 10 \text{ m}\Omega)$
PCR6000LA	0 Ω to 0.333 Ω	3.33 m Ω	$\pm(20\% + 6.67 \text{ m}\Omega)$
200 V range			
Model Name	Setting Range	Resolution	Setting Accuracy
PCR500LA	0 Ω to 16.0 Ω	160 m Ω	$\pm(20\% + 320 \text{ m}\Omega)$
PCR1000LA	0 Ω to 8.0 Ω	80 m Ω	$\pm(20\% + 160 \text{ m}\Omega)$
PCR2000LA	0 Ω to 4.0 Ω	40 m Ω	$\pm(20\% + 80 \text{ m}\Omega)$
PCR4000LA	0 Ω to 2.0 Ω	20 m Ω	$\pm(20\% + 40 \text{ m}\Omega)$
PCR6000LA	0 Ω to 1.333 Ω	13.33 m Ω	$\pm(20\% + 26.67 \text{ m}\Omega)$

* Some of the functions described below assume the use of the relevant options. For details, see pages 16 and 17.

Output Voltage Stability

High-speed linear amplifier system with high-quality output characteristics.

Line voltage variation	Within $\pm 0.1\%$
Output current variation	Within ± 0.1 V/ ± 0.2 V (100 V/200 V range)
Output frequency variation	Within $\pm 0.3\%$
Ambient temperature variation	100 ppm/ $^{\circ}$ C (typical value)
Output frequency stability	Within $\pm 5 \times 10^{-5}$
Output voltage waveform distortion ratio	0.3% or less
Output voltage response time	30 μ s (typical value)

On/Off switching without Chattering

The use of an electronic switch allows you to switch the output on or off while maintaining a pure waveform free of chattering. Also, the phase can be set arbitrarily (using the relevant option) when switching the output on or off (see the "Output On/Off Phase Setting" section on page 9).

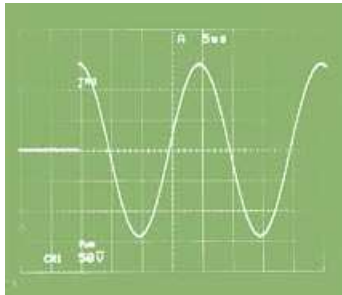

Safety, Maintainability, Protection, etc.

■ **Modular configuration**

If any of the power units fails, the modular configuration (available for systems supporting 1 kVA or higher) allows you to remove that faulty power unit from the system, thus minimizing system downtime. This significantly improves the system's maintainability.

■ **Self-test function**

If the system experiences any abnormality (such as when the overload protection function is activated), this function executes self-diagnosis to identify its cause and displays the result on the display panel.

■ **Protection functions**

- Input range protection function
- Overheat protection function
- Internal circuit protection function
- Overload protection function

■ **Key lock function**

This function prevents the system from being operated from the operation panel.

Sensing

This function is useful when the load is in a remote location and you want to improve the stability of the RMS voltage at that location (sensing point).

Note: When the sensing function is being used, the output stability, response characteristics to sudden changes in the load current, waveform distortion rate, and other parameters degrade relative to the system's standard specifications.

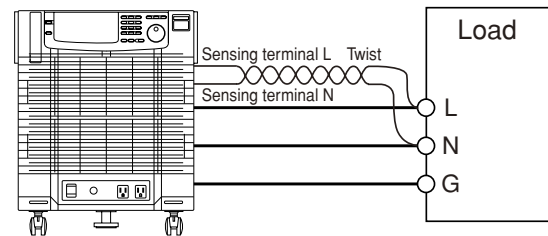

Regulation Adjustment

The output voltage can be adjusted automatically according to the output current. While this function is similar to the sensing function, it differs in that the former detects and calculates a drop in the output voltage caused by the output current through the output terminal on the system's main unit, and raises the output voltage by that amount. The regulation adjustment function also has the advantage of not requiring a separate cable for the detection signals, which is needed to use the sensing function.

- * The use of this function requires that a PC (controlled via the RS-232C interface) and a remote controller (RC04-PCR-LA) be connected. An interface card (IB03-PCR-LA) is also needed to apply GPIB control.
- * When using the regulation adjustment function, you must make sure that the output current is at least one-tenth of the current rating. The voltage can be adjusted by up to 10% of the output voltage of the PCR-LA system.
- * When the regulation adjustment function is being used, the voltage stabilization accuracy, distortion rate, and response speed degrade relative to the system's standard specs. This function should be used with caution depending on the application.
- * This function cannot be used with a system featuring a three-phase output driver.

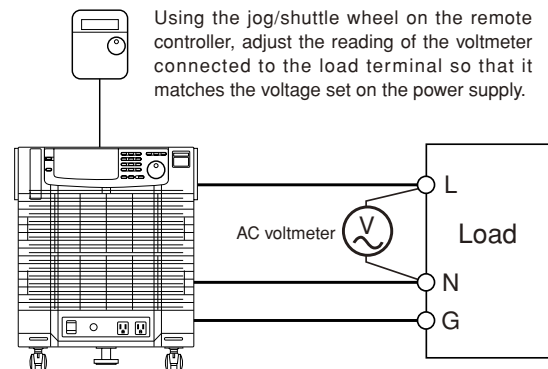

Maximum Output Peak Current Four Times the Rating

A maximum peak current of up to four times the maximum current rating (RMS value) can flow with respect to a capacitor input-type rectifier load.

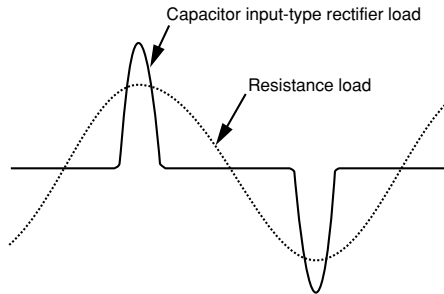

Maximum output peak current
 = Rated maximum output current (RMS value) × 4
 (Only when the RMS value of the current is equal to or smaller than the rated current)

In addition, a momentary peak current can be supplied for several seconds with other types of load. (This varies depending on the current waveform, output voltage, output frequency, and other factors.)

The table on the right lists the momentary peak currents that can be supplied for an output voltage of 100 VAC and an output frequency of 50 Hz. The momentary peak current ratio is the output current ratio (reference) assumed when that of the maximum output current is 100%.

Load Power Factor	Momentary Peak Current Ratio
1	200%
0.9	160%
0.8	150%
0.6	140%
0.4	120%
0.2	110%

Synchronization Function

This function allows the output voltage frequency and phase to be synchronized with the frequency of the input power (50 Hz/60 Hz).

Power Amplifier Function

The system can amplify the power of analog signals received from an external source and thus can be used as a power amplifier. Note that the signal input terminal is electrically isolated from the output of the PCR-LA main unit. The isolated amplifier offers a voltage amplification factor of either 100 or 200. The voltage amplification factor can be fine-tuned. The system can be used with electrical apparatus, machinery, chemicals, and almost all other fields of technology, and supports a host of capabilities including power supply environment testing that involves reproduction of the power line status, immunity testing, and power amplification of waveforms output from arbitrary signal generators.

* To use this function, an analog interface card (EX03-PCR-LA) is needed.

Measuring Functions

The system displays the root mean square (RMS) and peak (PEAK) values of the output voltage or current, effective power value (W), and the average voltage or current value in DC mode. Also, the load meter lets you know the reference load factor with respect to the rated value. Furthermore, the use of the optional remote controller (RC04-PCR-LA) or interface card (IB03-PCR-LA) makes it possible to measure the power factor (PF), apparent voltage (VA), and peak hold current. Once activated, the peak hold current measurement function continues the peak current measurement until the system receives the peak clear signal or command. This function, when used in combination with the output on/off phase setting function, lets you perform rush current measurements and other tests with the voltage phase set to any value.

[System display panel] Displays the load level as well as the voltage, current, and frequency.

* The photo below shows the display panel with all its elements lit. It may appear different in actual operation.



Item		Single-Phase	Three-Phase
Voltage	RMS value	○	Phase voltage/ Inter-wire voltage
	Peak value	○	Phase voltage/ Inter-wire voltage
	Average DC value	○	×
Current	RMS value	○	○
	Peak value	○	○
	Average DC value	○	×
	Peak hold value	●	●
Harmonics current		●	●
Power	Effective power	○	○
	Apparent power	●	●
	Power factor	●	●

* Those measurements marked ● require that a PC (controlled via the RS-232C interface) and a remote controller (RC04-PCR-LA) be used. An interface card (IB03-PCR-LA) is needed to apply GPIB control.

* All the functions described below assume the use of relevant options. For details, see pages 16 to 20.

Power Line Abnormality Simulation

This function lets you set the parameters listed below to perform power failure, voltage drop (dip), and voltage surge (pop) simulations.

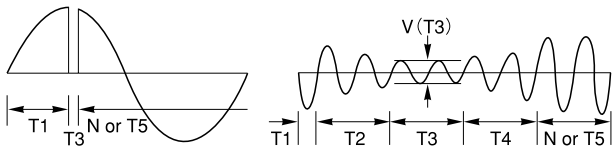
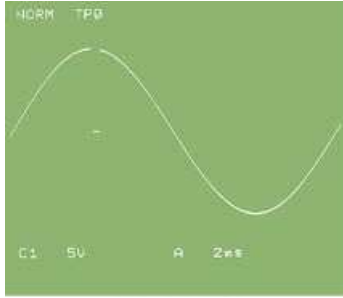

* This function requires that a PC (controlled via the RS-232C interface) or a remote controller (RC04-PCR-LA or RC03-PCR-LA) be used. An interface card (IB03-PCR-LA) is necessary to apply GPIB control.

- A setup is possible at RC04-PCR-LA
- A setup is possible at RC03-PCR-LA

Parameter Setting Range			
[Magnifying Power]	Single-Phase	Three-Phase*	
Voltage fluctuation start time and phase			
[x1ms]	0.0 to 999.9 ms	0 to 999 ms	● ●
	0 to 360 deg	←	●
Slope time (T2, T4)			
[x1]	0 to 9999 ms	←	● ●
[x10]	0.00 to 99.99 s	×	●
Voltage fluctuation time (T3)			
[x1]	0.0 to 999.9 ms	×	● ●
[x10]	0 to 9999 ms	←	●
Power restoration time (T5)			
[x1]	0 to 9999 ms	←	●
[x10]	0.00 to 99.99 s	←	●
Power restoration cycles (N)			
[x1]	0 to 9999 cycles	←	● ●
[x10]	0 to 99990 cycles	←	●
[x100]	0 to 999900 cycles	←	●
Pop/dip voltage (V(T3))			
	Within the rated output voltage	Within the rated output voltage (same setting for three-phase)	● ●
Repeat (RPT)			
	0 to 9998 times or infinity	←	●

* System featuring a three-phase output driver

Sequence Operation

This function creates a fluctuation in the voltage, frequency, and other characteristics by outputting a series of settings in sequence for up to 100 addresses (10 items are set per address, including the voltage, frequency, and execution time). This function can be used for brown-out and automated tests. It also allows the status and trigger signals to be set (the signals are output at the TTL level through the BNC connector on the back panel) and thus can be used for the likes of establishing synchronization with other equipment.

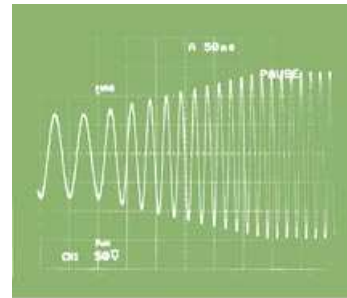

* This function requires that a PC (controlled via the RS-232C interface) and a remote controller (RC04-PCR-LA) be used. An interface card (IB03-PCR-LA) is necessary to apply GPIB control.

* In the case of a single-phase, three-wire system (one featuring a single-phase, three-wire output driver) or a three-phase system (one featuring a three-phase output driver), the same voltage is set for all the phases.

Parameter Setting Range		
Address	: ADRS	0 to 99
Time	: HOUR	0 to 999 h 59 min
	: MIN	0 to 999 min 59 s
	: SEC	0 to 999.999 s
Waveform	: WAVE	Sine, peak clip (14 waveforms can be input.)
Voltage (AC)	: Vac	1.0 V to 300.0 V
Frequency	: FRQ	1.00 Hz to 999.9 Hz
Impedance	: IMP	Varies with the model.
Frequency change characteristic	: R	Ramp/step
Voltage (DC)	: Vdc	-424.0 V to + 424.0 V
Status signal	: STAT	ON/OFF
Trigger signal	: TRG	ON/OFF
Output	: OUT	ON/OFF
AC voltage change characteristic	: R	Ramp/step

Effective Mode for Each Parameter					
		AC	DC	AC + DC	
Address	: ADRS	○	○	○	
	Time	: HOUR	○	○	○
		: MIN	○	○	○
	: SEC	○	○	○	
Waveform	: WAVE	○	×	○	
Voltage (AC)	: Vac	○	×	○	
Frequency	: FRQ	○	×	○	
Impedance	: IMP	○	×	×	
Frequency change characteristic	: R	○	×	○	
Voltage (DC)	: Vdc	×	○	○	
Status signal	: STAT	○	○	○	
Trigger signal	: TRG	○	○	○	
Output	: OUT	○	○	○	
AC voltage change characteristic	: R	○	×	○	

Special Waveform Output

This function allows the power supply to output waveforms for which the peak of the sine wave is suppressed. A crest factor value (= peak value/RMS value) of between 1.10 and 1.40 can be set (with a resolution of 0.01). Also, operational load savings can be achieved by storing a waveform having a value you want to use repeatedly in the waveform bank (up to 14 waveforms can be stored).

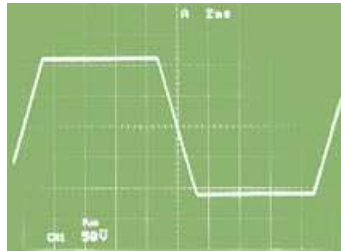

- * This function requires that a PC (controlled via the RS-232C interface) or a remote controller (RC04-PCR-LA) be used. An interface card (IB03-PCR-LA) is necessary to apply GPIB control.
- * In the case of a single-phase, three-wire system (one with a single-phase, three-wire output driver) or a three-phase system (one with a three-phase output driver), the same voltage is set for all the phases. Also, the voltage waveform differs from that for a single-phase system.

User-Defined Waveform Output

This function outputs a waveform by converting numerical data input from a PC. Using the function, you can output arbitrary waveforms from the system, such as distorted waveforms that include harmonic components. In the case of a three-phase connection, a command is available that lets you write data separately for each of the three phases (U, V, and W).

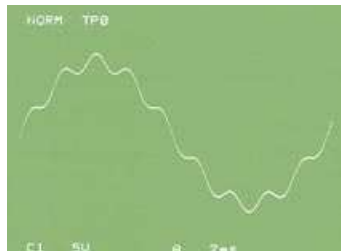

- * This function requires that a PC (controlled via the RS-232C interface) be used. Also, an interface card (IB03-PCR-LA) is necessary to apply GPIB control.

Output On/Off Phase Setting (Phase Difference Setting)

A separate output on/off phase can be set individually for each phase in the range of 0 to 360 degrees, with a setting resolution of 1°. Once values have been set using this function, the system saves the settings and retains them even if the option is uninstalled from the main unit. In the case of a three-phase system (one with a three-phase output driver), phase differences can be set between Phases U and V and between Phases U and W, respectively.

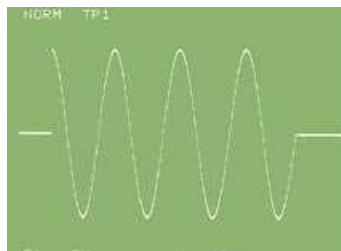

- * This function requires that a PC (controlled via the RS-232C interface) or a remote controller (RC04-PCR-LA) be connected. An interface card (IB03-PCR-LA) is necessary to apply GPIB control.

AC + DC Superimposition

This function allows the output of a voltage waveform in which an AC voltage is superimposed over a DC voltage.

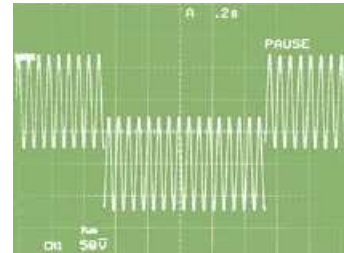

- * This function requires that a PC (controlled via the RS-232C interface) and a remote controller (RC04-PCR-LA) be used. Also, an interface card (IB03-PCR-LA) is necessary to apply GPIB control.
- * This function cannot be used for a single-phase, three-wire system (one featuring a single-phase, three-wire output driver) or a three-phase system (one featuring a three-phase output driver).

Software

The "Quick Wave Sequencer [model name: SD04-PCR-L(E)]" arbitrary waveform creation software is available as an option. This is a parameter setting and data editing support tool for special waveform output, user-defined waveform output, and sequence operation functions.

In addition, the optional software SD003-PCR-LA "Quick Immunity Sequencer" is also available for Power Line Disturbance Immunity testing.

It can be applied for the latest standards testing as well as for part of preliminary testing.

- * For details of the software, see pages 18 to 20.

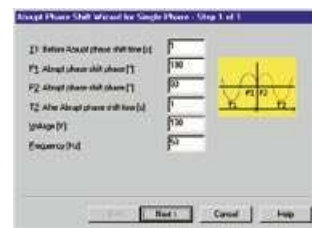

Quick Wave Sequencer [SD04-PCR-L(E)]

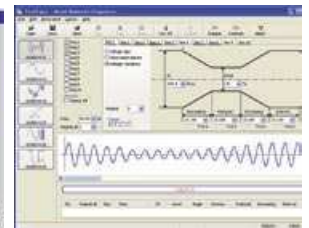

Quick Immunity Sequencer [SD003-PCR-LA]

Simplified Measurement of Harmonics Current

Japanese electrical and electronic equipment manufacturers lead the world in terms of anti-harmonics measures. With a variety of EMI-proof products already on the domestic market, there is an increasing trend to simplify the measurement of harmonics currents and identify where anti-harmonics measures should be applied.

The PCR-LA Series system supports the simplified measurement of the 1st to 39th harmonic currents with the optional remote controller (RC04-PCR-LA). This is extremely convenient for performing preliminary tests.

Example of a Single-Phase, Three-Wire System

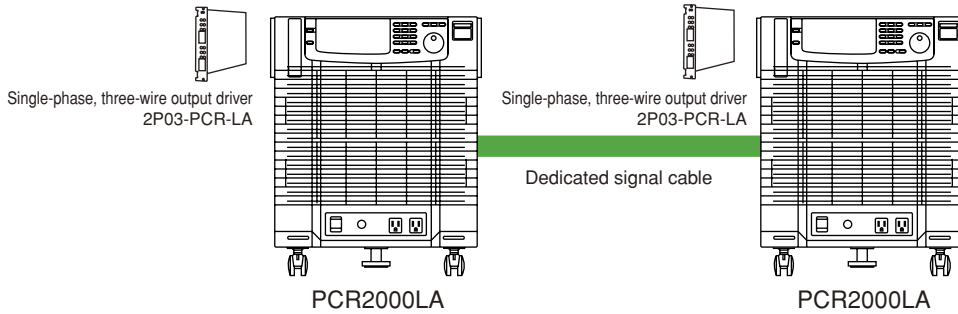

* Single-phase, three-wire output drivers (option) are provided in pairs, with a dedicated signal cable included.

Example of a Single-Phase/Single-Phase, Three-Wire Switchable System

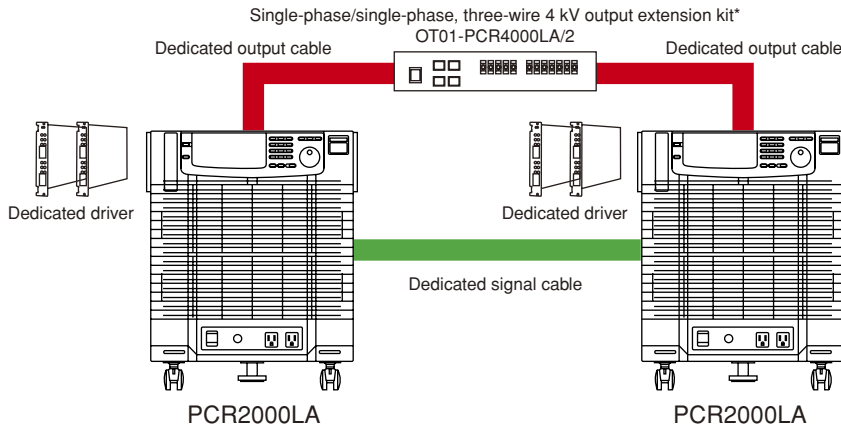

* The output extension kit (option) includes all the components necessary to implement this system configuration, including dedicated drivers, output cables, and signal cables.

Example of a Single-Phase/Three-Phase Switchable System

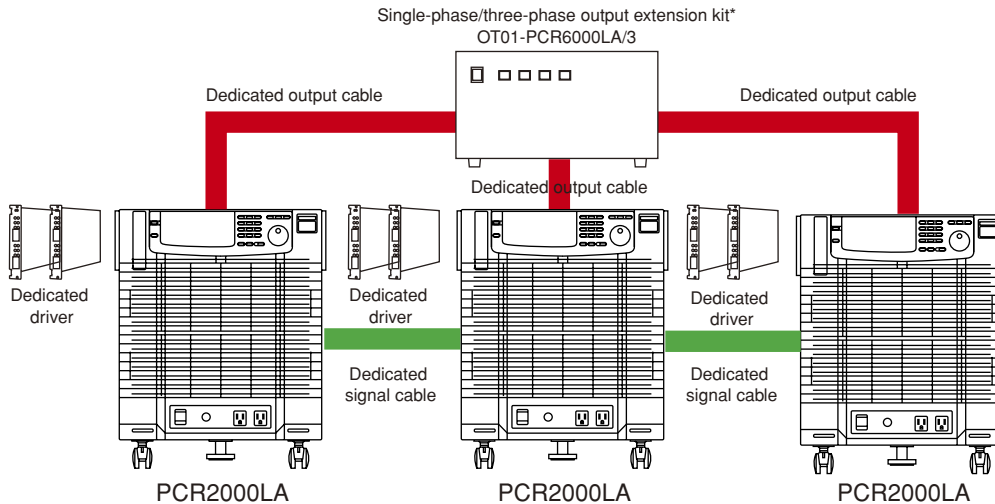

* The output extension kit (option) includes all the components necessary to implement this system configuration, including dedicated drivers, output cables, and signal cables.

The PCR-LA Series system can be upgraded and applied to wide range of system implementations by using the available options (see pages 16 and 17). In addition to the system examples described below, even more system configurations can be implemented by combining the options differently. For details, contact our sales department.

● Example of a single-phase, three-wire system configuration

Capacity	Main Unit	Qty	Option	Qty
1kVA	PCR500LA	2	2P03-PCR-LA	1
2kVA	PCR1000LA	2	2P03-PCR-LA	1
4VA	PCR2000LA	2	2P03-PCR-LA	1
8kVA	PCR4000LA	2	2P03-PCR-LA	1
12kVA	PCR6000LA	2	2P03-PCR-LA	1

● Example of system configuration with the single-phase/single-phase, three-wire output extension kit

Capacity	Main Unit	Qty	Option	Qty
4kVA	PCR2000LA	2	OT01-PCR4000LA/2	1
8kVA	PCR4000LA	2	OT01-PCR8000LA/2	1
12kVA	PCR6000LA	2	OT01-PCR12000LA/2	1

● Example of system configuration with the single-phase/three-phase output extension kit

Capacity	Main Unit	Qty	Option	Qty
6kVA	PCR2000LA	3	OT01-PCR6000LA/3	1
12kVA	PCR4000LA	3	OT01-PCR12000LA/3	1
18kVA	PCR6000LA	3	OT01-PCR18000LA/3	1

● Parallel extended operation system using PCR2000LA

Capacity	Main Unit	Qty	Parallel Operation Driver (Master)	Qty	Parallel Operation Driver (Slave)	Qty
Single-phase 4 kVA	PCR2000LA	2	PD03M-PCR-LA	1	PD03S-PCR-LA	1
Single-phase 6 kVA	PCR2000LA	3	PD03M-PCR-LA	1	PD03S-PCR-LA	2
Single-phase 8 kVA	PCR2000LA	4	PD03M-PCR-LA	1	PD03S-PCR-LA	3
Single-phase 10 kVA	PCR2000LA	5	PD03M-PCR-LA	1	PD03S-PCR-LA	4

● Parallel extended operation system using PCR4000LA

Capacity	Main Unit	Qty	Parallel Operation Driver (Master)	Qty	Parallel Operation Driver (Slave)	Qty
Single-phase 8 kVA	PCR4000LA	2	PD03M-PCR-LA	1	PD03S-PCR-LA	1
Single-phase 12 kVA	PCR4000LA	3	PD03M-PCR-LA	1	PD03S-PCR-LA	2
Single-phase 16 kVA	PCR4000LA	4	PD03M-PCR-LA	1	PD03S-PCR-LA	3
Single-phase 20 kVA	PCR4000LA	5	PD03M-PCR-LA	1	PD03S-PCR-LA	4

● Parallel extended operation system using PCR6000LA

Capacity	Main Unit	Qty	Parallel Operation Driver (Master)	Qty	Parallel Operation Driver (Slave)	Qty
Single-phase 12 kVA	PCR6000LA	2	PD03M-PCR-LA	1	PD03S-PCR-LA	1
Single-phase 18 kVA	PCR6000LA	3	PD03M-PCR-LA	1	PD03S-PCR-LA	2
Single-phase 24 kVA	PCR6000LA	4	PD03M-PCR-LA	1	PD03S-PCR-LA	3
Single-phase 30 kVA	PCR6000LA	5	PD03M-PCR-LA	1	PD03S-PCR-LA	4

● Three-phase extended operation system

Capacity	Main Unit	Qty	Three-Phase Output Driver	Qty
Three-phase 1.5 kVA	PCR500LA	3	3P03-PCR-LA	1
Three-phase 3 kVA	PCR1000LA	3	3P03-PCR-LA	1
Three-phase 6 kVA	PCR2000LA	3	3P03-PCR-LA	1
Three-phase 12 kVA	PCR4000LA	3	3P03-PCR-LA	1
Three-phase 18 kVA	PCR6000LA	3	3P03-PCR-LA	1

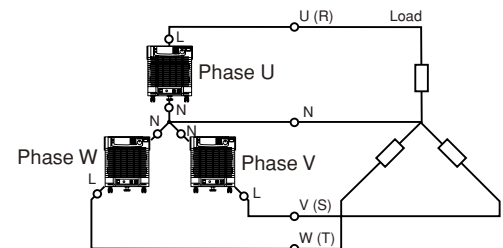

● Parallel extended operation system using three phases * Three-phase operation is possible with each phase operating in parallel.

Capacity	Main Unit	Qty	Three-Phase Output Driver	Qty	Parallel Operation Driver (Master)	Qty	Parallel Operation Driver (Slave)	Qty
Three-phase 24 kVA	PCR4000LA	6	3P03-PCR-LA	1	PD03M-PCR-LA	3	PD03S-PCR-LA	3
Three-phase 36 kVA	PCR6000LA	6	3P03-PCR-LA	1	PD03M-PCR-LA	3	PD03S-PCR-LA	3
Three-phase 54 kVA	PCR6000LA	9	3P03-PCR-LA	1	PD03M-PCR-LA	3	PD03S-PCR-LA	6

Panel Description

PCR500LA (500VA)

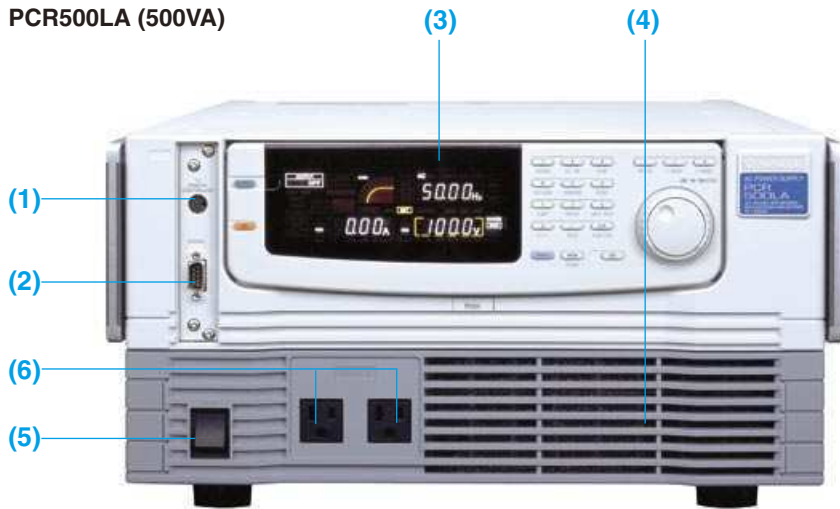

- (1) **Remote controller interface:**
Connector for the optional remote controller (RC03-PCR-LA or RC04-PCR-LA) cable
- (2) **RS-232C**
Terminal for connecting the RS-232C cable (9-pin cross cable)
- (3) **Display & operation panel**
The large-size color vacuum fluorescent display (VFD) screen provides a clear, easy-to-read display. Operations are performed by using the function keys, numerical keypad, or jog/shuttle wheel. Panel angle is adjustable.
- (4) **Air intake**
Air intake for forced air cooling of the equipment. Air filters are built-in.
- (5) **POWER**
Power switch of the power supply (Those models rated at 4 kVA or more use a breaker-type switch.)
- (6) **OUTPUT**
Output connector (Maximum permissible voltage is 125 V, and maximum permissible current is 10A.)
- (7) **OUTPUT**
Output terminal board
- (8) **INPUT**
Input connector (PCR500LA only). All models other than the PCR500LA use an input terminal board. Input power supply voltage of 85 to 250 V. (170 to 250 V for those models rated at 6 kVA or more.)
- (9) **INPUT VOLTAGE SELECTOR**
Used to select the voltage range of the input power supply voltage (PCR500LA, PCR1000LA, PCR2000LA, and PCR4000LA).
- (10) **Exhaust port**
Exhaust port for forced air cooling
- (11) **BNC connectors**
Used for trigger signal output, status signal output, and peak clear signal input for peak hold current measurement.
* Available only when the relevant options are installed.
- (12) **Slots**
These slots are provided to accommodate the optional interfaces and drivers.

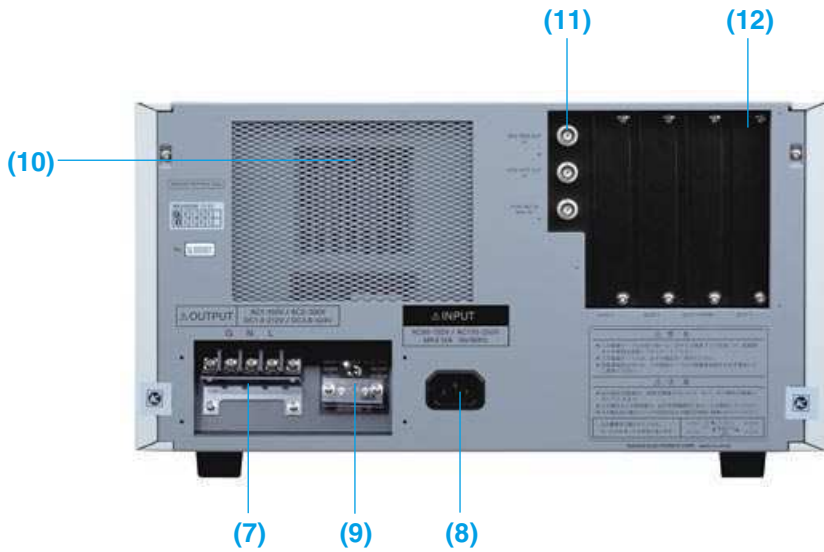

* The PCR2000LA, PCR4000LA, and PCR6000LA have additional connectors on their back panel for centrally controlled parallel operation.



Specifications

Five models

Item/Model	PCR500LA	PCR1000LA	PCR2000LA	PCR4000LA	PCR6000LA		
Input ratings (AC RMS values)							
Voltage (input voltage range 100 V/200 V) (*1)	85 V to 132 V/170 V to 250 V				170 V to 250 V		
Number of phases, single-phase frequency	47 Hz to 63 Hz						
Apparent power	Approx. 1 kVA	Approx. 2 kVA	Approx. 4 kVA	Approx. 8 kVA	Approx. 12 kVA		
Power factor (*2)	0.95 (typical value)						
Current (input voltage range 100 V/200 V)	12 A/6 A or less	24 A/12 A or less	48 A/24 A or less	96 A/48 A or less	72 A or less		
Output ratings - AC mode (AC RMS values)							
Voltage (output voltage range 100 V/200 V) (*3)	1 V to 150 V/2 V to 300 V						
Voltage setting accuracy (output voltage range 100 V/200 V) (*16)	±(0.3% of the set value + 0.6 V)						
Maximum current (*4)	5 A/2.5 A	10 A/5 A	20 A/10 A	40 A/20 A	60 A/30 A		
Number of phases	Single phase						
Power capacity	500 VA	1 kVA	2 kVA	4 kVA	6 kVA		
Maximum peak current (*5)	Four times the maximum current (RMS value)						
Load power factor	0 to 1 (advanced or delayed phase) (*4)						
Frequency	1 Hz to 999.9 Hz (*4,6)						
Output ratings - DC mode							
Voltage (output voltage range 100 V/200 V) (*3)	1.4V to 212V/2.8V to 424V						
Voltage setting accuracy (output voltage range 100 V/200 V) (*17)	±(0.05% of the set value + 0.05 V/0.1 V)						
Maximum current (*4)	2.5 A/1.25 A	5 A/2.5 A	10 A/5 A	20 A/10 A	30 A/15 A		
Maximum momentary current (*18)	Four times the maximum current (RMS value)						
Power capacity	250 W	500 W	1 kW	2 kW	3 kW		
Output voltage stability							
Input voltage variation (with respect to changes in the rated range)	Within ±0.1%						
Output current variation (with respect to 0% to 100% changes in the rating)	Within ±0.1 V/±0.2 V (output voltage range 100 V/200 V) (*7)						
Output frequency variation	AC mode (40 to 999.9 Hz)	Within ±0.3% (*8)					
	AC-S mode (40 to 999.9 Hz)	Within ±1% (*8)					
Ripple noise: DC mode (5 Hz to 1 MHz components)	0.1 Vrms or less	0.15 Vrms or less	0.2 Vrms or less	0.3 Vrms or less	0.4 Vrms or less		
Ambient temperature variation (with respect to changes in the rated range)	100 ppm/°C (typical value) (*9)						
Output frequency stability, waveform distortion, response speed, and efficiency							
Output frequency stability (with respect to changes in all rated ranges)	Within ±5 × 10 ⁻⁵ ; Setting accuracy: Within ±5 × 10 ⁻⁴						
Output voltage waveform distortion (*10)	0.3% or less						
Output voltage response speed (*11)	30 μs (typical value)						
Efficiency (*2)	50% or more						
Indicators [vacuum fluorescent display (VFD) indications]							
Voltmeter (*12, 14)	Resolution	RMS display mode	±0.1V				
		PEAK and AVE display mode	0.2 V (0 V to ±212 V)/0.3V (±212 V to ±424 V)				
	Accuracy	RMS and AVE display mode	Within ±(1% of rdg + 2 digits) (10 V to 424 V at room temperature)				
		PEAK display mode	Within ±(2% of rdg + 2 digits) (10 V to 424 V at room temperature)				
Ammeter (*12, 14)	Resolution	RMS display mode	0.01 A	0.01 A	0.01 A	0.1 A	0.1 A
		PEAK and AVE display mode	0.02 A	0.02 A	0.02 A	0.2 A	0.2 A
	Accuracy	RMS and AVE display mode	Within ±(1% of rdg + 2 digits) (5% of the rated maximum current to the rated maximum current at room temperature)				
		PEAK display mode	Within ±(2% of rdg + 4 digits) (5% of the rated maximum current to the rated maximum current at room temperature)				
Power meter (*15)	Resolution	0.1 W/1 W					
	Accuracy	Within ±(1% of rdg + 3 digits) (10% of the rated power capacity to the rated power capacity, load power factor of 1, at room temperature)					
Frequency meter (*13)	Resolution	0.01 Hz/0.1 Hz					
Insulation resistance, withstand voltage, circuit method, operating ambient temperature and humidity							
Insulation resistance (input to cabinet, output to cabinet, and input to output)	30 MΩ or more at 500 VDC or 10 MΩ or more at 500 VDC						
Withstand voltage (input to cabinet, output to cabinet, and input to output)	1.5 kV AC for 1 minute						
Circuit method	Linear amplifier system						
Operating ambient temperature and humidity	0 °C to +50 °C/20% to 80%RH (no condensation)						
I/O terminal board connection screws and accessories							
Input terminal board connection screws	(Inlet)		M6				
Output terminal board connection screws	M4		M6				
Accessories	Input power cable - Type	Dedicated cable	3-core cable	3 single-core cables			
	(Conductor sectional area/length) Wire diameter	2 mm ² /3 m with a 3-pin plug	5.5 mm ² /3 m	8 mm ² /3 m	22 mm ² /3 m	22 mm ² /3 m	
	Cable clamber	—	1 set				
	Cable clamber fixing screws	—	M3 1 pc./M4 2 pcs.	M3 2 pcs./M4 2 pcs.	M3 4 pcs./M4 2 pcs.		
	Operation manual	1 copy					
	Weight seal	1 sheet					

*1 The input voltage range - 100 V or 200 V - is switch-selectable.
 *2 When the output voltage range is 100 V or 200 V, the output current is the rated value, the load power factor is 1, and the output frequency is 40 to 999.9 Hz.
 *3 The output voltage range - 100 or 200 V - can be selected using a switch on the front panel. The resolution is 0.1 V.
 *4 When the output voltage is 1 to 100 V/2 to 200 V and the load power factor is 0.8 to 1 (AC/AC-S mode) When the output voltage is 100 to 150 V/200 to 300 V (AC/AC-S mode) or 100 to 212 V/200 to 424 V (DC mode), the output current is reduced based on the output voltage. When the load power factor is 0 to 0.8, the output current is reduced based on the load power factor (AC/AC-S mode). When the output frequency is 1 to 40 Hz, the output current is reduced based on the output frequency (AC/AC-S mode).
 *5 With respect to a capacitor input-type rectifier load. (Note that the peak current is limited based on the RMS value of the rated output current.)
 *6 Resolution: 1) 0.01 Hz (1.00 to 100.0 Hz); 2) 0.1 Hz (100.0 to 999.9 Hz)
 *7 When the output voltage is 80 to 150 V/160 to 300 V and the load power factor is 1. The value is obtained from the output terminal board.
 *8 When the output voltage is 80 to 150 V/160 to 300 V and the load power factor is 1. This output voltage variation is measured with 200 Hz as the reference.
 *9 When the output voltage range is 100 V or 200 V and the output current is 0 A
 *10 When the output voltage is 80 to 150 V/160 to 300 V and the load power factor is 1
 *11 With respect to changes from an output current of 0 A to the rating and vice versa when the output voltage range is 100 V or 200 V and the load power factor is 1
 *12 RMS values are displayed for waveforms having a crest factor of 3 or less.
 *13 The set output frequency value (frequency of the internal reference voltage) is displayed.
 *14 When the output frequency is 40 to 999.9 Hz
 *15 When the output frequency is 45 to 65 Hz
 *16 When the output frequency is 45 to 65 Hz with no load at room temperature
 *17 With no load at room temperature
 *18 Limited based on the RMS value of the rated output current.

Item/Model	PCR500LA	PCR1000LA	PCR2000LA	PCR4000LA	PCR6000LA
Compliant standards					
Electromagnetic compatibility (EMC) *	Conforms to the requirements of the following directive and standard. EMC Directive 89/336/EEC EN61326:1997/A2:2001 Emissions: Class A Immunity: Minimum immunity test requirements			-	-
Safety *	Conforms to the requirements of the following directive and standard. Low Voltage Directive 73/23/EEC EN61010-1:2001 Class I Pollution degree 2			-	-

* Applicable only to those models with the CE marking. Contact us for more detailed information.

■ Output voltage rate - rated output current characteristics

Figure 1

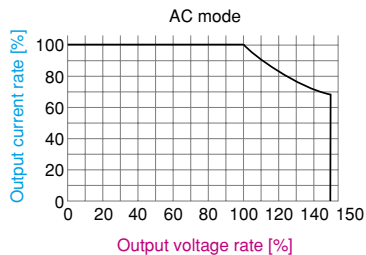

■ Load power factor - rated output current characteristics

Figure 3

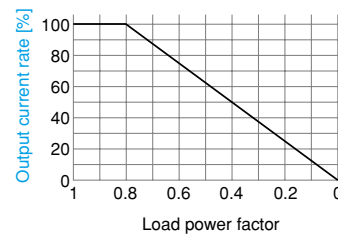
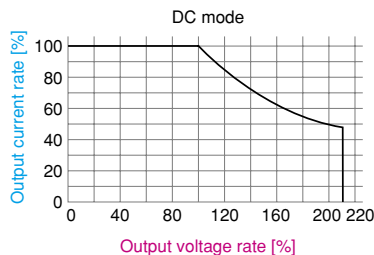
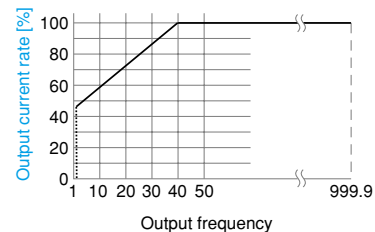

Figure 2



■ Output frequency - rated output current characteristics

Figure 4



* The output voltage rate represents the percentage of the voltage when the output voltage of 100 V/200 V is assumed to be 100% (when the output voltage range is 100 V or 200 V).

* The output current rate represents the percentage of the current when the maximum rated output current is assumed to be 100%.

From Figures 1 and 3, the rated output current is the product of the two output current rates. The output current rate shown in Figure 4 takes precedence when it is smaller than the product of the two output current rates (AC mode only).

■ Specifications for analog interface EX03-PCR-LA

The following specifications pertain to the overall performance of the analog interface attached to the PCR-LA Series system's main unit. Other specifications are the same as those for the PCR-LA Series system.

Input	
External signal input voltage range	Nominal value: 0 to ±2.12 Vpeak (0 to 1.5 Vrms sine wave) when the voltage amplification rate is set to 100/200 (100 V/200 V range) Maximum permissible error: ±5 Vpeak
External signal input frequency range	DC/1 Hz to 1 kHz sine wave (distortion rate of 10% or less)/1 Hz to 100 Hz square wave (within the external signal input voltage range)
External signal input impedance	10 kΩ ±10% (unbalanced)
Output (PCR-LA Series system's output)	
Maximum rated output frequency	999.9 Hz (basic frequency for which all harmonic distortion rates are 10% or less)
Voltage amplification rate	100 V range: 100 ±10% 200 V range: 200 ±10% Permissible range: ±20% (or more) of 100 or 200
Frequency response	DC: Up to 5 kHz (-3 dB) with 200 Hz as the reference (when a sine wave of 0.5 Vrms or less is input)
Output voltage distortion rate	Main unit's specification + 0.5% or less (when a sine wave of 0.1% or less is input)
Output voltage rise/fall time	Main unit's specification + 50 μs (typical value) (when the input voltage changes from 0 V to 2 V or vice versa)
Output voltage temperature coefficient	Main unit's specification + 200 ppm/°C (typical value)
General specifications	
Insulation resistance	30 MΩ or more at 500 VDC (external signal terminal to cabinet, external signal terminal to input, and external signal terminal to output)
Withstand voltage	500 VAC for 1 minute (external signal terminal to cabinet, external signal terminal to input, and external signal terminal to output)
Voltmeter	3-digit display, main unit's specification + 3% (typical value), with only peak values displayed
Ammeter	3-digit display, main unit's specification + 5% (typical value), with only peak values displayed
Frequency meter	3-digit display without the measurement function (only set values are displayed)

External Dimensions

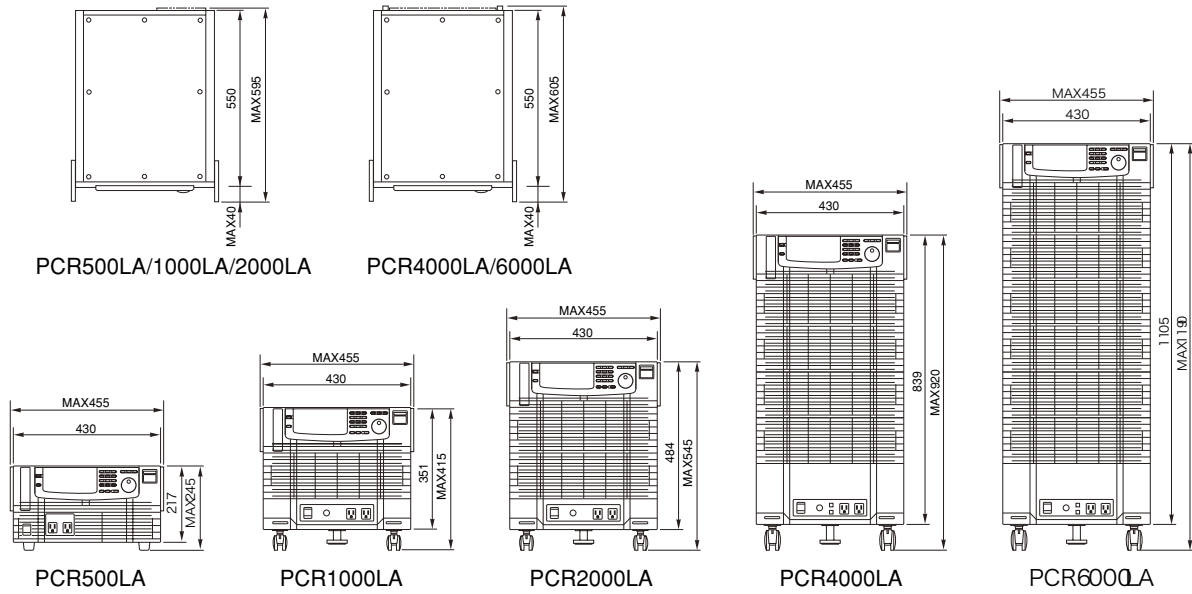

Rack Mount Brackets

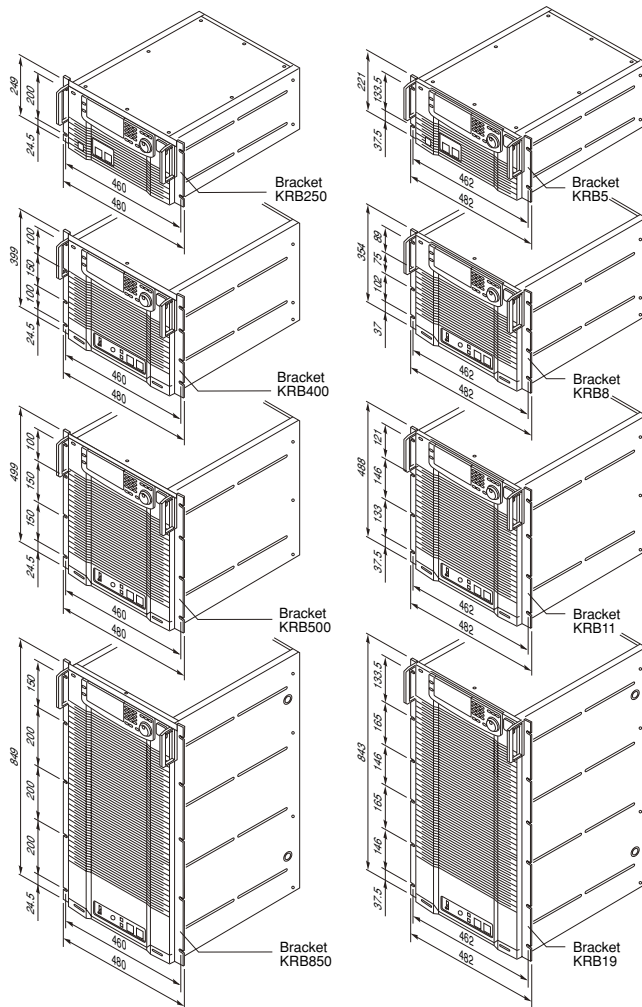

For metric-type racks (JIS)

- KRB250** (for PCR500LA)
- KRB400** (for PCR1000LA)
- KRB500** (for PCR2000LA)
- KRB850** (for PCR4000LA)

For inch-type racks (EIA)

- KRB5** (for PCR500LA)
- KRB8** (for PCR1000LA)
- KRB11** (for PCR2000LA)
- KRB19** (for PCR4000LA)

Remote Controller

RC03-PCR-LA (simple type)



This remote controller enables power line abnormality simulations in addition to voltage setting, frequency setting, and voltage/frequency display functions. Cable length: Approx. 2 m

* The setting range of parameters and items have restriction in part Please refer to page 8 "Power Line Abnormality Simulation" for details.

RC04-PCR-LA (multifunctional type)



This remote controller lets you perform the same operations as are possible from the operation panel of the PCR-LA Series system, and greatly expands the PCR-LA Series system's functionality. Cable length: Approx. 2 m

Functions enabled by this option
Power line simulation
Sequence operation
Harmonics current analysis
Special waveform output
Output impedance setting
Power factor, VA, and peak hold current measurement
Output on/off phase setting
AC + DC mode
Memory function expansion
Regulation adjustment

Interface

IB03-PCR-LA (for GPIB)

EX03-PCR-LA (for external signal input)



IB03-PCR-LA

EX03-PCR-LA

EX03-PCR-LA amplifies the power of analog signals input from an external source and can be used as the power amplifier for the PCR-LA Series system.

Parallel Operation Driver

PD03M-PCR-LA (parallel operation for master)

PD03S-PCR-LA (parallel operation for slave)



Up to five systems of the same model can be operated in parallel and under centralized control through the use of PCR2000LA, PCR4000LA, or PCR6000LA.

[Main accessories of PD03S-PCR-LA]
 Power signal cable for PCR2000LA (0.3 m)
 Power signal cable for PCR4000LA and PCR6000LA (0.3 m)
 Drive signal cable (0.6 m)

Three-Phase Output Driver

3P03-PCR-LA



Three PCR-LA Series systems of the same model can be connected in a star topology to implement three-phase output operation.

[Main accessories]
 Drive signal cable × 2 (0.6 m)

Single-phase, three-wire Output Driver

2P03-PCR-LA



This option allows the PCR-LA Series system to be used as a single-phase, three-wire power supply.

[Main accessories]
 Drive signal cable (0.6 m)

Parallel Terminal

PT01-PCR-LA (for PCR2000LA)



▲When two PT01-PCR-LA terminals are connected

PT02-PCR-LA (for PCR4000LA and PCR6000LA)



The parallel terminal is connected to the back panel of the master unit. Up to three PCR-LA Series systems can be connected in parallel to retrieve the output. The terminal combines multiple wires into a single bundle. Note that the parallel operation driver is not included.

Download !!



Device drivers

The following device drivers (freeware) can be downloaded from our website (www.kikusui.co.jp).

- Device driver for VisualBasic (ActiveX)
- Device driver for LabVIEW
- Device driver for LabWindows/CVI

NOTICE Users of PCR-L Series systems

The PCR-LA Series is not compatible with previous PCR-L Series products. It is therefore impossible to operate a PCR-LA Series system in parallel with a PCR-L Series system, or to include any PCR-L Series products when upgrading your system configuration as described on page 10. The options cannot be used with PCR-L Series systems, with a few exceptions. For more information, please contact local distributor.

Single-phase/single-phase, three-wire output extension kit

The kit includes all the accessories needed to implement the system configuration.

OT01-PCR4000LA/2 (4 kVA)



OT01-PCR8000LA/2 (8 kVA)
OT01-PCR12000LA/2 (12 kVA)



Accessories

Product Name	Qty	Length	Remark
Power cable*1	6	2.5 m	Size: 5.5 mm ² or 14 mm ² *1
Power cable 1	1	2 m	For master J1 (4 poles to 6 poles)
Power cable 2	2	2 m	For J4 (6 poles to 6 poles)
Power cable 3*3	1	0.3 m	For J3 and J1 (4 poles to 4 poles)
Power cable 4	1	2 m	For sensing (10 poles to 2 crimp terminals)
Power cable 5	1	2.3 m	With connector for parallel operation master (26 poles)
Dedicated parallel operation driver	2	—	One driver for master and one driver for slave (with fixing screws)
Drive signal cable	1	0.7 m	26 poles
Dedicated single-phase, three-wire output driver	2	—	One phase-U card and one phase-V card (with fixing screws)
Drive signal cable	1	0.7 m	34 poles 0.7 m

*1 The size of the OT01-PCR4000LA/2 is 5.5 mm².
The size of OT01-PCR8000LA/2 and OT01-PCR12000LA/2 is 14 mm².
*2 The cable for the OT01-PCR8000LA/2 and OT01-PCR12000LA/2 is of 6-pole-to-6-pole type.
Other accessories include signal cable bands and the operation manual.

Single-phase/three-phase output extension kit

The kit includes all the accessories needed to implement the system configuration.

OT01-PCR6000LA/3 (6kVA)



OT01-PCR12000LA/3 (12kVA)
OT01-PCR18000LA/3 (18kVA)



Accessories

Product Name	Qty	Length	Remark
Power cable*1	9	2.5 m	Size: 5.5 mm ² or 14 mm ² *1
Power cable 1	1	2 m	For master J1 (4 poles to 6 poles)
Power cable 2	3	2 m	For J4 (6 poles to 6 poles)
Power cable 3*3	2	0.3 m	For J3 and J1 (4 poles to 4 poles)
Power cable 4	1	2 m	For sensing (10 poles to 2 crimp terminals)
Power cable 5	1	2.3 m	With connector for parallel operation master (26 poles)
Dedicated parallel operation driver	3	—	One driver for master and two drivers for slaves (with fixing screws)
Drive signal cable	2	0.7 m	26 poles
Dedicated single-phase, three-wire output driver	3	—	One phase-U card, one phase-V card, and one phase-W card (with fixing screws)
Drive signal cable	2	0.7 m	34 poles



*1 The size of the OT01-PCR6000LA/3 is 5.5 mm².
The size of OT01-PCR12000LA/3 and OT01-PCR18000LA/3 is 14 mm².
*2 The cable for the OT01-PCR12000LA/3 and OT01-PCR18000LA/3 is of 6-pole-to-6-pole type.
Other accessories include signal cable bands and the operation manual.

Software Quick Wave Sequencer SD04-PCR-L(E)

Implements highly flexible simulation test environments through the use of a waveform bank and the sequence operation functions of the PCR-LA Series.

Arbitrary waveform creation software Quick Wave Sequencer [model name: SD04-PCR-L(E)] allows you to perform AC power line simulations by exploiting the functions of the PCR-LA Series system. This lets you create any desired power conditions, including abnormal power feed statuses that rarely occur with general commercial power lines, and ideal power feed statuses.

Features

Power line abnormality simulations

The system supports the following AC power line abnormality simulations:

Instantaneous power failure test/voltage fluctuation test/abrupt phase shift test^{*1}/output of harmonic composite waveforms/output of oscilloscope-captured waveforms from the PCR-LA Series system^{*2}

*1 Intended exclusively for single-phase PCR-LA Series systems.

*2 Not supported for single-phase, three-wire system (featuring a single-phase, three-wire output driver) or a three-phase system (featuring a three-phase output driver).

Supports the setting of individual inter-wire phase differences for a three-phase system

With a three-phase system, differences can be set between individual phases, and sequence control (for changing the voltage and frequency, etc.) can be exerted over either all the phases or one of the three phases (U, V, or W).

Easy reproduction of simulation tests

The created test data can be saved as a configuration file, making it easy to perform the same test again at a later date. It is also possible to transfer the configuration file via e-mail or a commercial BBS and reproduce the same test on a PCR-LA Series system at a remote location.

Test summary print-out

A summary of the created test data can be printed out for checking.

Software Operation Concept

Quick Wave Sequencer [model name: SD04-PCR-L(E)] consists of two applications - Sequence Builder and Wave Bank Server - which run in conjunction with each other.

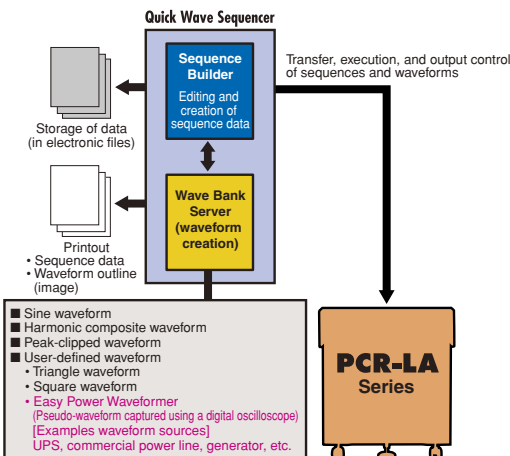

Sequence Builder

A sequence is a function that performs a specific action, such as changing the AC output voltage, frequency, or waveform, or outputting a trigger signal, at a predetermined point in time (step). The PCR-LA Series system is provided with a sequence function. To enable the PCR-LA Series system to use a sequence, however, change points (steps) must be specified/edited and then transferred to the system to be controlled. Sequence Builder does this for you. This application has several useful functions including sequence wizards that automatically generate test data based on entered parameters and a function for printing out sequence data.

Basically, the sequence wizard performs simulations based on specified sequence steps. For simulations involving an instantaneous power failure, voltage fluctuation, or abrupt phase shift in the single-phase output, however, all you need to do is enter the relevant parameters, after which the sequence wizard automatically creates the ideal sequence for the test.

Any or all of the following items can be set for each step. Up to 100 steps can be specified.

Step items to be edited

- Time..... Set the duration of the step.
 - Setting range 0.001 seconds to 999 hours 59 seconds 59.999 seconds
 - Minimum increment 0.001 seconds (resolution: 1 ms)
- Voltage..... Set the voltage (Vrms) to be output in the step. This voltage setting is held until the next step begins.
 - Setting range 0.0 to 305.0 Vrms
 - Minimum increment 0.1 Vrms
 - * For a three-phase output, set a phase voltage. The voltage is changed simultaneously with respect to the time axis.
- Voltage ramp Set this item when you want the [Voltage] specified in the previous step to gradually change to the [Voltage] specified in this step, over the specified [Time].
- Frequency..... Set the frequency (Hz) to be output in this step. This frequency setting is held until the next step begins.
 - Setting range 1.00 to 999.9 Hz
 - Minimum increment 1.00 to 99.99 Hz (setting resolution: 0.01)
 - 100.0 to 999.0 Hz (setting resolution: 0.1)
 - * For a three-phase output, the frequency is changed simultaneously with respect to the time axis.
- Frequency ramp..... Set this item when you want the [Frequency] specified in the previous step to gradually change to the [Frequency] specified in this step, over the specified [Time].
- Wave bank..... From the Wave Bank Server, select the waveform to be used in this step.
 - Setting range No. 0 to No. 13
 - No. 0 is dedicated to a sine waveform, while Nos. 1 to 13 are the Wave Bank Server's current waveforms.
- Output..... Indicates whether to supply power.
- Trigger Set this item when you want to output a trigger signal from the BNC connector on the back panel of the PCR-LA Series system when this step is executed. This signal can be used as a trigger for an oscilloscope or the like.
- Waveform synchronization Set this item when you want this step to be executed after the next zero crossing of the output voltage.

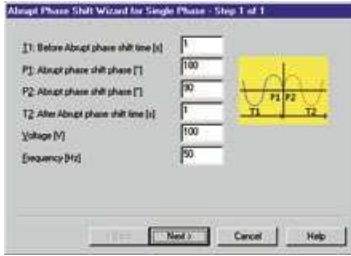

(Left) Wizard for abrupt phase shift simulation in single-phase output
(Middle) Wizard for instantaneous power failure simulation
(Right) Wizard for voltage fluctuation simulation

Wave Bank Server

The PCR-LA Series system stores the shapes of the waveforms used as output references in an internal memory called the “wave bank.” There are 15 wave banks, from No. 0 to No. 14. Bank No. 0 is dedicated to a sine waveform, while bank Nos. 1 to 13 can be edited by the user. The Wave Bank Server is used to edit these stored waveforms. The waveforms generated by the Wave Bank Server (wave bank Nos. 0 to 13) can be printed as simplified waveform images. Bank No. 14 is used as a data area by this application.



Types of waveforms

- Sine waveform This is an ordinary AC, or sine, waveform.
- Harmonic composite waveform The generated waveform contains harmonic components. The output level and phase, from the 1st to 50th orders, can be set for each harmonic component.
 - The output level and phase can be set for each order.
 - Output level: 1% to 100% (in steps of 1%)
(Assuming the output level of the set voltage of the basic waveform to be 100%)
 - Phase: 0° to 359° (in steps of 1°)
- Peak-clipped waveform..... Specifying the degree of waveform distortion causes the Wave Bank Server to generate a sine waveform with a clipped peak. If you enter a numerical value (in steps of 0.01), a peak-clipped waveform is created according to the specified value.
 - Peak-clipped value in single-phase output: 1.10 to 1.40
 - Peak-clipped value in single-phase, three-wire output: 1.25 to 1.40
 - Peak-clipped value in three-phase output: 1.25 to 1.40
- User-defined waveform..... The sampling waveforms can be input to a PCR-LA Series system (for single-phase output) or PCR-LT Series system from an external source via the GPIB interface. Using this function, the Wave Bank Server can support several types of waveforms. It can generate triangle waveforms, square waveforms, and oscilloscope-captured waveforms based on minor categories called “applets.”

Types of applets

- Triangle This applet creates triangle waveforms and lets you specify the duty ratio of the waveform (position of the peak).^{*1}
- Square This applet creates square waveforms and lets you specify the duty ratio of the positive and negative portions.^{*2}
- Easy Power Waveformer Waveformer This function captures waveforms using a digital oscilloscope and lets you reproduce them as user-defined waveforms. It allows you to acquire the actual waveform of a commercial power line, signal generator, power generator, UPS, or other equipment and then have the PCR-LA Series system output that waveform. Captured waveforms can also be saved to a file.^{*3}

^{*1} The waveform resolution is calculated by multiplying 4096 points on the voltage axis by 1024 points on the time axis, regardless of the frequency. The actual output depends on the performance of the PCR-LA Series system being used, however. It cannot be used with PCR-LA Series systems or three-phase systems (those using a three-phase output driver).
^{*2} If the duty ratio is disturbed, a DC component is superimposed on the plus or minus side, in proportion to the degree of imbalance between the positive and negative portions. If the output contains a DC component, only half of the PCR-LA Series system's power can be guaranteed.
^{*3} When an oscilloscope is to be used to capture waveforms from a commercial power line or other power source, the oscilloscope must be isolated from the commercial power line or other power source.

Recommended Operation Environment for SD04-PCR-L(E)

Computer, OS, and printer

IBM PC/AT-compatible machine/i486DX/66 MHz or better/16 MB of more of RAM/20 MB or more of free hard disk space/SVGA or better display adapter and monitor/Microsoft mouse or compatible pointing device/CD-ROM drive/Microsoft Windows 95, 98, NT 4.0, 2000, or XP/printer compatible with Microsoft Windows

GPIB card

GPIB card made by National Instruments Corp. or Agilent Technologies, Inc.

GPIB driver

GPIB driver compatible with the GPIB card being used (NI: NI488-2M software; Agilent: Agilent I/O Library)

VISA library

NI-VISA 2.6 or later or Agilent VISA 2.0 or later

GPIB cable

Cable with 24-pin connectors compliant with ANIS/IEEE std 488.1-1987

Power supply (AC power supply) and other equipment

- Single-phase system: PCR-LA Series
- Single-phase, three-wire system: PCR-LA Series + single-phase, three-wire output driver
- Three-phase system: PCR-LA Series + three-phase output driver
(This application requires that the ROM version of the PCR-LA Series system be 2.04 or later.)
- IB03-PCR-LA (GPIB interface card for PCR-LA)
- Device under test (Must be compatible with the PCR-LA Series system.)

Note: Check that the National Instruments GPIB card is compatible with the OS being used. Also, if your PC is running Windows NT 4.0, the system will fail to operate correctly unless Windows NT ServicePack3 or later, or equivalent, is installed.

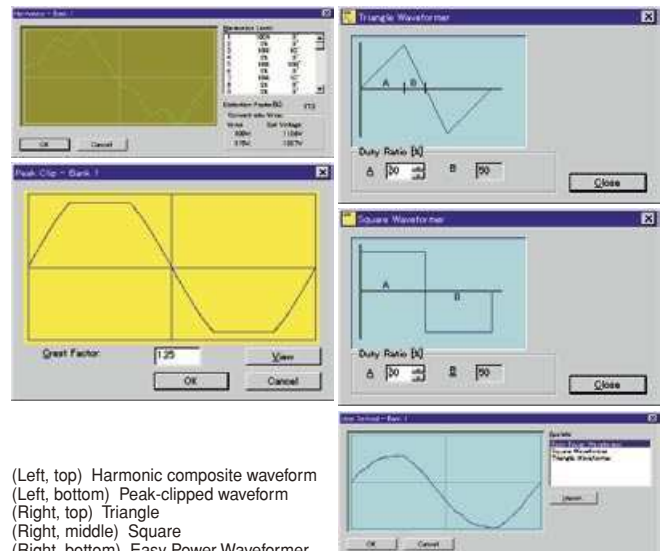

(Left, top) Harmonic composite waveform
(Left, bottom) Peak-clipped waveform
(Right, top) Triangle
(Right, middle) Square
(Right, bottom) Easy Power Waveformer

Power Line Disturbance Immunity Testing Software SD003-PCR-LA

Supporting the latest IEC61000-4* standards!

*Supports standard compliance testing for IEC61000-4-11, 4-13, 4-14, 4-27, 4-28, and 4-29, as well as preliminary testing.

Power line disturbance immunity testing software "Quick Immunity Sequencer" (model name: SD003-PCR-LA) is an application software for Immunity testing standard (IEC61000-4 Series) of EMC standard which complies to Power Line Disturbance Immunity testing, a suite of international specifications concerning power line disturbances. Not only can it be used for compliance testing based on the latest standards and for some types of preliminary testing, but the software can also be employed for advance checking in development phases and for immunity margin tests, because it allows extended testing conditions to be set as needed.

• Please refer to the brochure for details.

Features

- Supports standard compliance testing for IEC61000-4-11, 4-13, 4-14, 4-27, 4-28, and 4-29, as well as preliminary testing.
- Allows parameters to be set to out-of-spec values (for margin tests).
- Supports single- and three-phase operations as well as DC operations.
- Graphics-based screen design that makes the software easy to operate.
- Preview function permits output waveforms to be checked in advance.
- Sequence chain function streamlines the testing process (10 sequences max.).
- Export function exports test conditions and results (in text format).
- This trigger function is to stable for the observation of output waveform.
- Pause function can be used when checking or replacing the supplied device.
- It can be set either Japanese/English automatically depend upon OS of PC.

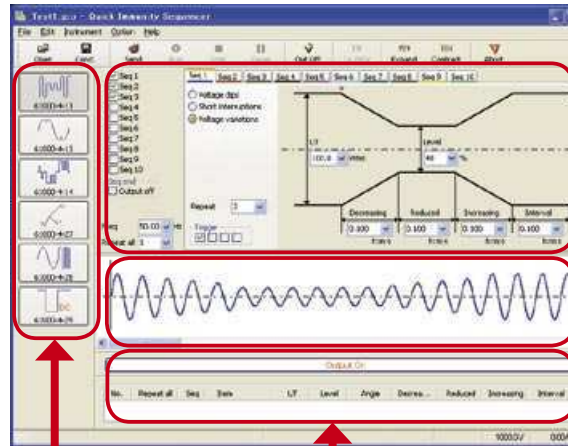

Set the testing conditions.

Waveform preview

Choose a standard.

Test result

[Operation environment] Windows XP / 2000 / Me / 98SE



KIKUSUI ELECTRONICS CORP.

1-1-3, HIGASHIYAMATA, TSUZUKI-KU, YOKOHAMA, 224-0023, JAPAN

TEL: (045)593-7570, Fax: (045)593-7571

Internet: <http://www.kikusui.co.jp/>

● Distributor:

■ All products contained in this catalogue are equipment and devices that are premised on use under the supervision of qualified personnel, and are not designed or produced for home-use or use by general consumers. ■ Specifications, design and so forth are subject to change without prior notice to improve the quality. ■ Product names and prices are subject to change and production may be discontinued when necessary. ■ Product names, company names and brand names contained in this catalogue represent the respective registered trade name or trade mark. ■ Colors, textures and so forth of photographs shown in this catalogue may differ from actual products due to a limited fidelity in printing. ■ Although every effort has been made to provide the information as accurate as possible for this catalogue, certain details have unavoidably been omitted due to limitations in space. ■ If you find any misprints or errors in this catalogue, it would be appreciated if you would inform us. ■ Please contact our distributors to confirm specifications, price, accessories or anything that may be unclear when placing an order or concluding a purchasing agreement.

Printed in Japan

Issue: Sep. 2004

2004093KELEC11

Recycled Paper