

# InfiniiMax RCRC Probing System

The world's highest-performing probe system keeps getting better

## Introduction

The new InfiniiMax 4 series probing system is a groundbreaking solution designed to deliver unparalleled signal fidelity and accuracy with bandwidth capabilities reaching up to 52 GHz, all while maintaining exceptionally low loading. With the InfiniiMax III/III+ probe amplifiers, this advanced InfiniiMax RCRC probe system ensures swift and reliable measurements ranging from 8 GHz to 52 GHz, setting a new standard in probing technology.



# Unmatched Performance

- Full 52 GHz brick-wall bandwidth to the probe tip
- InfiniiMode probing for making differential, single-ended and common mode measurements with a single probe (available with InfiniiMax III+ probing system)
- Industry's highest fidelity and accuracy due to bandwidth and extremely low loading
- Probe amplifiers loaded with measured s-parameters for more accurate response correction
- Bandwidth upgradable (available with InfiniiMax III only)
- Variety of probe heads for different use models with maximum usability

## Industry-leading probe performance

Get the highest performance available for measuring differential and single-ended signals on high-density ICs and PCBs. As devices get smaller and faster, accurately probing signals becomes more challenging. Keysight's InfiniiMax Probing System has the most accurate probe amplifiers, the widest variety of probe heads, and all the accessories you need to get the job done.

## Challenges

Upon completing your ASIC tape-out, packaging process, or designing a new PCB, the initial step is to confirm the system's functionality aligns with the design intentions. Modern probing solutions, such as the InfiniiMax 4, facilitate this verification process, significantly reducing the time required and eliminating the need for designing additional verification boards or fixtures.

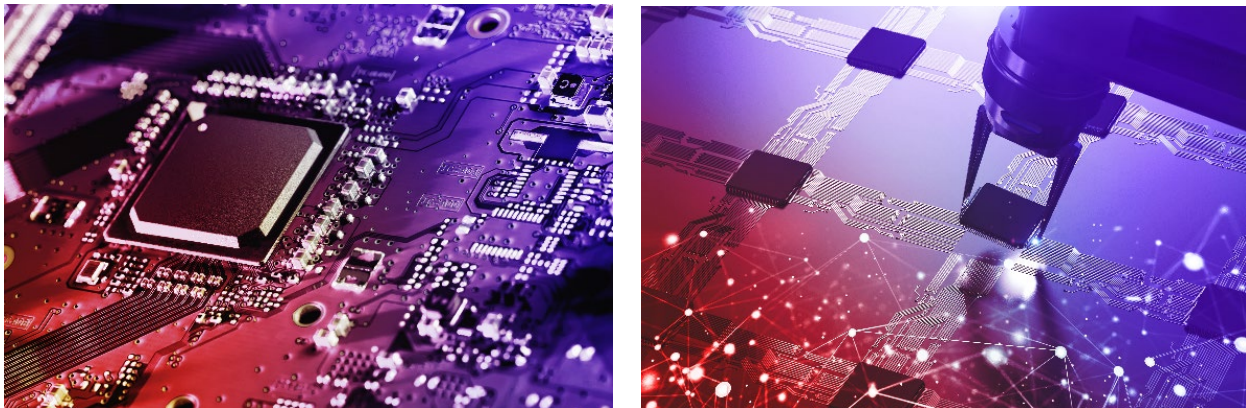

In today's increasingly complex digital designs, employing an oscilloscope for transmitter testing and a bit error rate tester for receiver analysis is imperative to verify system performance. Nonetheless, testing the link between the transmitter and receiver presents a unique set of challenges in modern digital systems.

The InfiniiMax probing solution addresses these challenges, allowing for swift and non-disruptive debugging of the system. It enables you to quickly identify and rectify real system link errors, ensuring smooth and efficient system operation.

## InfiniiMax 4

The InfiniiMax 4 series probes, a recent innovation from Keysight, stand out as the market's premier high-bandwidth probing solution, offering capabilities of up to 52GHz. This probe incorporates Keysight's cutting-edge designs and leverages Keysight-proprietary InP IC process technology. It is meticulously engineered to tackle the complexities of assessing next-generation high-speed signals, delivering unparalleled performance and precision. The InfiniiMax 4 offers comprehensive support, featuring up to 52 GHz Brickwall response and 40 GHz Bessel Thompson response, ensuring it meets the demands of next-generation testing requirements. This includes support for faster DDR, PCIe, and 400G/800G technologies.



## InfiniiMax III

The InfiniiMax III probing system offers you the highest performance available for measuring differential and single-ended signals, with flexible connectivity solutions for today's high-density ICs and circuit boards. Four different InfiniiMax III probe amplifiers ranging from 16 to 30 GHz are available for matching your probing solution to your performance and budget requirements. A proprietary 200 GHz fT InP (indium phosphide) IC process with backside ground vias and novel thick film technology is utilized to accommodate your highest performance needs and is unmatched by any product in the market.



## InfiniiMax III+

The InfiniiMax III+ probing system, N2830A/N7000A Series, significantly enhances both the measurement capabilities and user-friendliness of probes designed for comprehensive analysis of all components in a differential signal. Thanks to the integrated InfiniiMode technology, users can effortlessly transition between differential, single-ended, and common mode measurements without the need to alter the connections at the probe tip. The InfiniiMax III+ probe, through its InfiniiMode feature, supports various operational modes to accommodate diverse measurement requirements.

- A - B (differential)
- A - ground (single-ended A)
- B - ground (single-ended B)
- (A+B)/2 - ground (common mode)



## Highest fidelity and accuracy

The InfiniiMax RCRC probe system provides the highest bandwidth and incredibly low loading to allow for a new level of signal fidelity and accuracy. Continuing the probe head topology pioneered by Keysight Technologies, Inc. in the InfiniiMax RC probe systems, ten probe heads are provided to accommodate multiple-use models: a 52 GHz solder-in shows the unparalleled performance, a 30 GHz browser that is extremely usable, a 25/28 GHz ZIF probe head with economical replaceable/removable ZIF tips, a 30 GHz 2.92 mm probe head which allows cabled measurements using 2.92 mm, 3.5 mm, or SMA coax cables, an economical 26 GHz solder-in probe head for demanding measurements, and a 16 GHz QuickTip for a quick and secure connection.



8.8ps edge is measured with InfiniiMax 4 probing solution



## More accurate probe correction

Each individual InfiniiMax RCRC probe amp contains its unique S-parameters, and this frequency response data is used with the S-parameters of the various probe heads to further flatten the probe's magnitude and phase response for accuracy. Traditionally, probe correction uses a nominal model based on a typical probe amplifier instead of the specific amplifier's data, collected during the final steps of production. Generally, the biggest variation between probing systems is a result of the probe amplifier. The ability to correct a specific probe amplifier's response results in a more accurate probe correction, which yields a more accurate measurement.

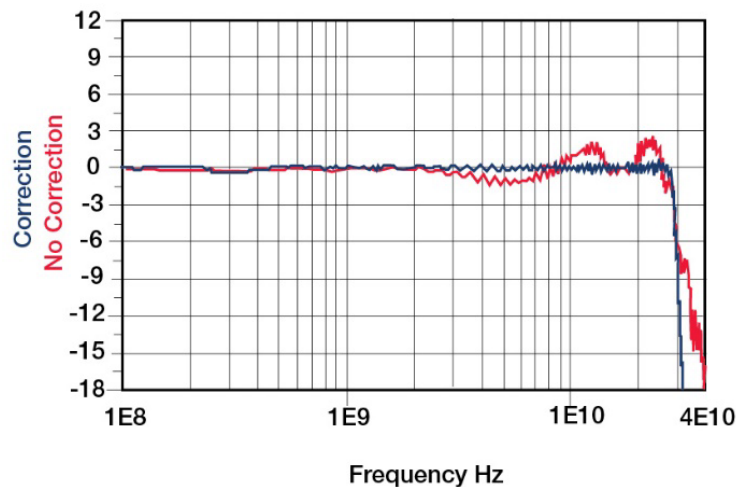

## Uncompromised Usability

### Extensive line-up of probe heads and accessories

Keysight's InfiniiMax RCRC probes are designed to accommodate a broad spectrum of high-speed applications, offering a comprehensive range of probe heads and accessories. This system ensures exceptional signal fidelity and accuracy, thanks to its impressive bandwidth capabilities and extremely low loading. Building on the innovative probe head topology initiated by Keysight Technologies, Inc., the InfiniiMax RCRC probes set a new standard in precision measurement.

The InfiniiMax 4, Keysight's latest probe system, offers an impressive bandwidth capacity of up to 52 GHz. Achieving this level of performance required the development of an innovative modular probe head system, featuring a flexible printed circuit (FPC) probe head.

This unique system comprises the MX0040A probe head connector and two FPC probe heads of varying lengths (MX0041A and MX0042A), catering to diverse testing needs. The design facilitates rapid attachment of the amplifier to different probe head connectors, and the 3 different position cradles (MX0046A) aid in precisely aligning the probe and DUT. The newly developed FPC not only enhances signal stability but also adds flexibility to the probing process, making it more user-friendly and efficient.

The MX0045A adapters seamlessly bridge the InfiniiMax 4 with previous generations of InfiniiMax III/III+ probe systems, substantially broadening the selection of compatible probe heads. This compatibility extends to earlier generation probe heads such as the N5445A Browser, N5444A SMA head, N5439A ZIF head, among others, providing users with a wide range of probing options.

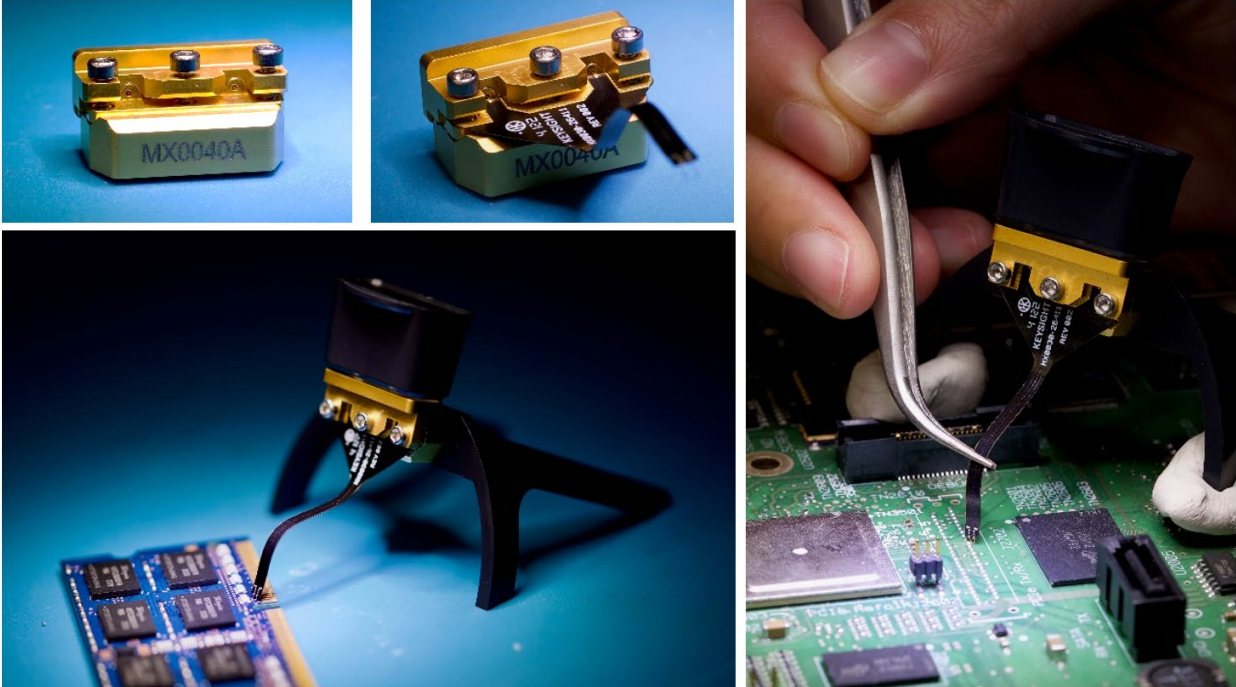

The N5445A browser head (30 GHz) is the best choice for quick general-purpose troubleshooting of differential signals with its z-axis compliance and variable spacing from 20 mil to 125 mil (or 0.5 mm to 3.1 mm). The span between the signal tips is easily adjusted with a thumb wheel on the browser. Integrated LED lighting at the tip illuminates the probing area for better visibility. Order N5476A for replacement browser tips (set of 4).

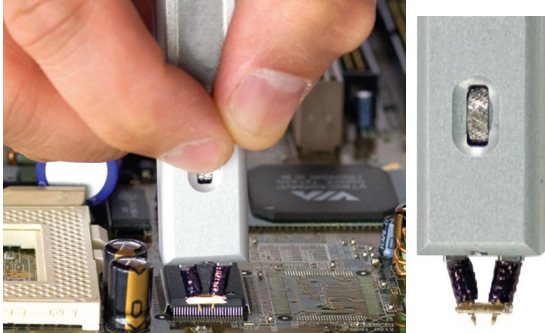

The N2848A/49A QuickTip offers the industry's first magnetically-engaged probe head and tip for a quick and secure connection, pushing the usability to the next level. The N2848A QuickTip probe head quickly snaps to the N2849A probe tip, utilizing magnets to connect to the two sides of the differential signal and ground. Multiple N2849A probe tips can be installed on a DUT, allowing quick and reliable measurement of many probe points. The QuickTip supports the InfiniiMode probing when used with the InfiniiMax III+ probe amp and supports differential probing with the InfiniiMax III probe amp. The N2849A QuickTip tips can also be used with the InfiniiMax I/II probe amps when used in conjunction with the N2851A QuickTip probe head for InfiniiMax I/II RC probes.

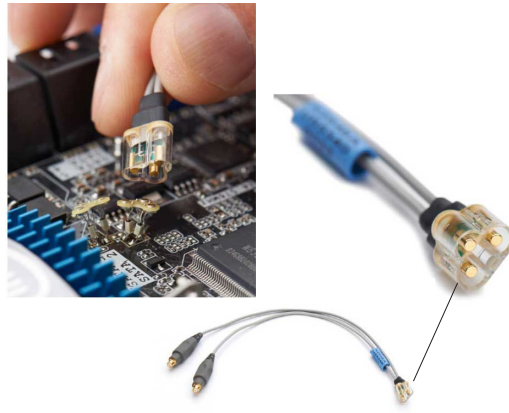

The N5439A ZIF probe head provides 28 GHz bandwidth in an economical replaceable tip form factor. For differential measurement, the N5439A ZIF probe head with the N5440A or N5447A ceramic ZIF tip provides the industry's lowest signal loading. The ZIF tips can be left on the DUT as the probe head is moved from one probing site to the next. Order N5440A (450  $\Omega$  ceramic), N5447A (200  $\Omega$  ceramic) or the new N2838A (450  $\Omega$  PC board) for a set of 5 ZIF tips with plastic sporks to aid in soldering the tips to your DUT. The N2838A PC board ZIF tip increased the robustness of the ZIF tip significantly while maintaining the bandwidth performance up to 25 GHz when used in conjunction with the N2803A and N5439A. Variable spacing from 5 mil to 80 mil (or 0.127 mm to 2 mm). (The N5447A 200  $\Omega$  ZIF tip is not compatible with InfiniiMax III+ and InfiniiMax 4 probes.





The N5444A 2.92 mm/3.5 mm/SMA probe head (30 GHz) allows you to connect two 2.92 mm, 3.5 mm or SMA cables to make a differential measurement on a single oscilloscope channel. Order N5448B 2.92 mm head flex cables (10" or 25 cm) or N2823A 2.92 mm cables with 1 m to extend the cable length and add convenience. You can control the termination voltage of the N5444A probe head using either the Infiniium scope software or by using a N5444-61601 cable included in the N5444A kit connected to your own DC power supply.

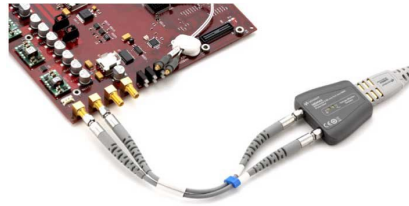

For extended temperature testing with extreme temperature range measurements, the MX0109A 26 GHz solder-in head supports extreme operating temperature of  $-55$  to  $+150$  °C per JEDEC JESD22-A104 revision E. Variable span of leads ranges from 5 to 250 mil. Damping resistor tips are user replaceable when damaged. This probe head is form, fit, function compatible with N2836A. This probe head supports InfiniiMode probing when used with the InfiniiMax III+ probe amp.



The N2836A solder-in head provides up to 26 GHz bandwidth when used in conjunction with the N2803A probe amplifier. This probe head supports InfiniiMode probing when used with the InfiniiMax III+ probe amp.

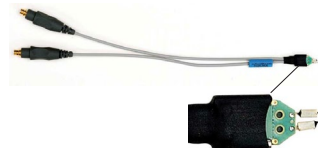

The N5442A Precision BNC 50  $\Omega$  adapter allows you to use your existing InfiniiMax I (1130B-1134B), InfiniiMax II (1168B/69B), N2750A-52A, N2795A-97A active probes or a general purpose 50  $\Omega$  BNC cable with the V, 90000 X- or 90000 Q-Series oscilloscope.



The N5449A high impedance adapter allows connection for probes that require a high impedance scope input such as a high impedance passive probe, 1147B/N2893A current probe, or N2790A differential probe to the Infiniium V, 90000-X/Q Series oscilloscopes. The N5449A provides switchable AC/DC coupling as well as 10:1 and 1:1 attenuation settings. The adapter comes with a N2873A 500 MHz 10:1 passive probe.



The N5477A sampling oscilloscope adapter makes the InfiniiMax III probing system fully compatible with the Infiniium 86100C DCA-J sampling oscilloscope. Previously the DCA-J was limited to 13 GHz of probing, but with the N5477A, the DCA-J now has 30 GHz of probing, increasing its performance and flexibility.



The MX0104A performance verification and deskew fixture is required to calibrate and verify the performance of the InfiniiMax III probe. The MX0104A is a replacement of the N5443A. The MX0104A comes with the 50 ohm through fixture only. You have an option to choose the option 001 plastic stand or the option N2787A 3D probe positioner which will help you properly position the probe amplifier. Order E2655C to calibrate and verify the performance of the InfiniiMax probe with < 13 GHz of bandwidth.



## Bandwidth upgradability (for InfiniiMax III)

As frequencies have continued to increase, so have the cost of probes. The InfiniiMax III system (N280xA) offers the world's first fully upgradable probe amplifier. Purchase a 16 GHz probe amplifier today, knowing that in the future, you can upgrade the amplifier to higher bandwidths (20/25/30 GHz) at a fraction of the cost of a new probe amplifier.

## InfiniiMax RCRC Probing System family diagram

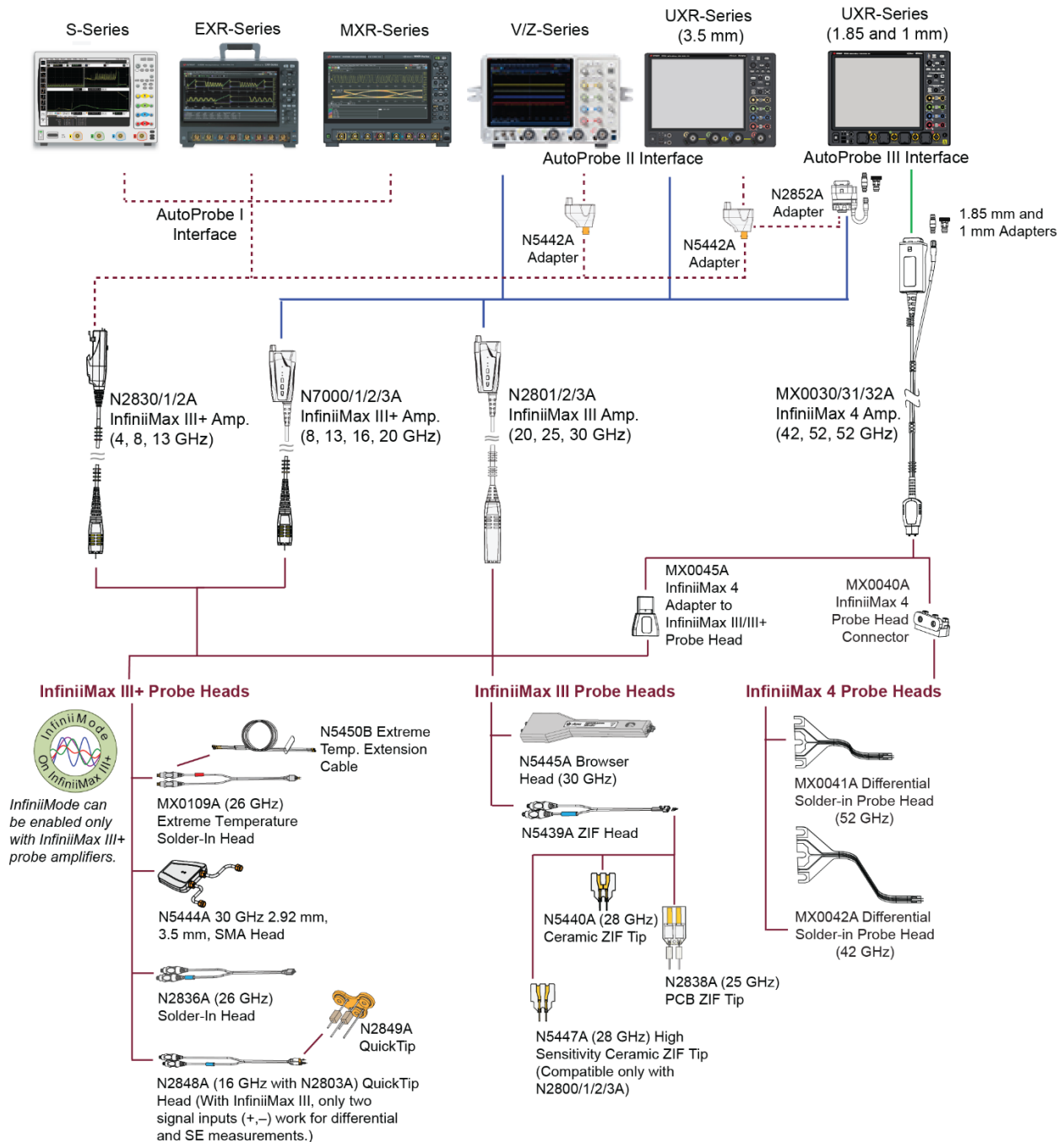

# Performance Specification and Characteristics

## Warranted specifications

Probe head	Probe Amp	Bandwidth	DC input
MX0041A	MX0032A MX0031A MX0030A	52 GHz (Brickwall), 40 GHz (Bessel-Thomson) 52 GHz 42 GHz	Rdiff=100 kΩ ± 2%, Rse=50 kΩ ± 2%
N5440A with N5439A	N2803A N2802A N2801A N2832A N2831A N2830A N7003A N7002A N7001A N7000A	26 GHz 25 GHz 20 GHz 13 GHz 8 GHz 4 GHz 20 GHz 16 GHz 13 GHz 8 GHz	Rdiff=100 kΩ ± 2%, Rse=50 kΩ ± 2%
N5445A browser	N2803A N2802A N2801A N2832A N2831A N2830A N7003A N7002A N7001A N7000A	28 GHz 25 GHz 20 GHz 13 GHz 8 GHz 4 GHz 20 GHz 16 GHz 13 GHz 8 GHz	Rdiff=100 kΩ ± 2%, Rse=50 kΩ ± 2%
MX0109A/N2836A	N2803A N2802A N2801A N2832A N2831A N2830A N7003A N7002A N7001A N7000A	26 GHz 25 GHz 20 GHz 13 GHz 8 GHz 4 GHz 20 GHz 16 GHz 13 GHz 8 GHz	Rdiff=100 kΩ ± 2%, Rse=50 kΩ ± 2%

## Probe head characteristics

	Input Capacitance	With N280xA Differential Mode	With N700xA Differential Mode	With MX0032A Differential Mode
MX0041A differential solder-in probe head - 52 GHz	Cdiff=30 fF; Cse=40 fF	Not compatible	Not compatible	52 GHz, 10 pS, 7 pS
MX0042A differential solder-in probe head - 42 GHz	Cdiff=30 fF; Cse=40 fF	Not compatible	Not compatible	42 GHz, 12.7 pS, 8.8 pS
N5440A_N5439A ceramic 450 Ω ZIF tip and ZIF probe head	Cdiff=32 fF; Cse=44 fF	28 GHz, 15.5 pS, 11.0 pS	20 GHz, 21.7 pS, 15.4 pS	28 GHz, 15.5 pS, 11.0 pS
N5447A_N5439A ceramic 200 Ω ZIF tip and ZIF probe head	Cdiff=32 fF; Cse=44 fF	28 GHz, 15.5 pS, 11.0 pS	Not compatible	28 GHz, 15.5 pS, 11.0 pS
N5445A 450 Ω browser	Cdiff=35 fF; Cse=50 fF	30 GHz, 14.5 pS, 10.3 pS	20 GHz, 21.7 pS, 15.4 pS	30 GHz, 14.5 pS, 10.3 pS
N2838A_N5439A PC board 450 Ω ZIF tip and ZIF probe head	Cdiff=95 fF; Cse=130 fF	25 GHz, 17.4 pS, 12.3 pS	20 GHz, 21.7 pS, 15.4 pS	25 GHz, 17.4 pS, 12.3 pS
MX0109A/N2836A 450 Ω solder-in probe head vertical orientation with no ground wires	Cdiff=108 fF; Cse=140 fF	27 GHz, 16.1 pS, 11.4 pS	20 GHz, 21.7 pS, 15.4 pS	27 GHz, 16.1 pS, 11.4 pS
MX0109A/N2836A 450 Ω solder-in probe head flat orientation with minimum length ground wires	Cdiff=108 fF; Cse=140 fF	27 GHz, 16.1 pS, 11.4 pS	20 GHz, 21.7 pS, 15.4 pS	27 GHz, 16.1 pS, 11.4 pS
N2849A_N2848A 450 Ω QuickTip and QuickTip probe head with ground wires connected	Cdiff=340 fF; Cse=200 fF	16 GHz, 27.1 pS, 19.3 pS	20 GHz, 21.7 pS, 15.4 pS	16 GHz, 27.1 pS, 19.3 pS
N5444A 2.92 mm, SMA, 3.5 mm probe head	N/A	30 GHz, 15.5 pS, 11.0 pS	20 GHz, 21.7 pS, 15.4 pS	30 GHz, 15.5 pS, 11.0 pS

# Probe amp characteristics

N280XA InfiniiMax III

N283XA InfiniiMax III+

MX003XA InfiniiMax 4

	N280XA InfiniiMax III	N283XA InfiniiMax III+	N5444A 2.92 mm	N283XA InfiniiMax III+	N5444A 2.92 mm	MX003XA InfiniiMax 4	N5444A 2.92 mm
DC input resistance	450 Ω probe heads Rse=50 kΩ ± 2% each input to ground, Rdiff=100 kΩ ± 2% and Rcm=25 kΩ ± 2%	200 Ω probe heads Rse=50 kΩ ± 2% each input to ground, Rdiff=100 kΩ ± 2% and Rcm=25 kΩ ± 2%	55 Ω to Vterm	450 Ω probe heads Rse=50 kΩ ± 2% each input to ground, Rdiff=100 kΩ ± 2% and Rcm=25 kΩ ± 2%	55 Ω to Vterm	450 Ω probe heads Rse=50 kΩ ± 2% each input to ground, Rdiff=100 kΩ ± 2% and Rcm=25 kΩ ± 2% 55 Ω to Vterm	55 Ω to Vterm
Input resistance > 10 kHz	Rse=500 Ω each input to ground, Rdiff=1 kΩ and Rcm=250 Ω	Rse=500 Ω each input to ground, Rdiff=1 kΩ and Rcm=250 Ω	50 Ω to .901*Vterm	Rse=500 Ω each input to ground, Rdiff=1 kΩ and Rcm=250 Ω	50 Ω to .901*Vterm	Rse=500 Ω each input to ground, Rdiff=1 kΩ and Rcm=250 Ω	50 Ω to .901*Vterm
Input voltage range (differential or single-ended), mains isolated	1.6 Vpp, ± 0.8 V (HD2&3 < -38 dbc), 2.5 Vpp, ± 1.25 V (HD2&3 < -34 dbc)	0.8 Vpp, ± 0.4 V (HD2&3 < -38 dbc), 1.6 Vpp, ± 0.8 V (HD2&3 < -34 dbc)	1.6 Vpp, ± 0.8 V (HD2&3 < -38 dbc), 2.5 Vpp, ± 1.25 V (HD2&3 < -34 dbc)	2.5 Vpp or ± 1.25 Vat 5:1 attenuation, 5.0 Vpp or ± 2.50 V at 10:1 attenuation	2.5 Vpp or ± 1.25 Vat 5:1 attenuation, 5.0 Vpp or ± 2.50 V at 10:1 attenuation without violating max input power	1.6 Vpp, ± 0.8 V (HD2&3 < -38 dbc), 2.5 Vpp, ± 1.25 V (HD2&3 < -34 dbc)	1.6 Vpp, ± 0.8 V (HD2&3 < -38 dbc), 2.5 Vpp, ± 1.25 V (HD2&3 < -34 dbc)
Max input power	N/A	N/A	125 mW calculated by $\{[rms(vin-vterm)]^2/55\}$ for each input	N/A	125 mW calculated by $\{[rms(vin-vterm)]^2/55\}$ for each input	N/A	125 mW calculated by $\{[rms(vin-vterm)]^2/55\}$ for each input
Input common mode range	± 2 VDC to 250 Hz, ± 1.25 V > 250 Hz	± 6 VDC to 250 Hz, ± 0.65 V > 250 Hz	± 6 VDC to 250 Hz, ± 1.25 V > 250 Hz without violating max input power	± 7 VDC to 100 Hz, ± 1.25 V > 100 Hz at 5:1 attenuation, ± 2.5 V > 100 Hz at 10:1 attenuation	± 6 VDC to 100 Hz, ± 1.25 V > 100 Hz at 5:1 attenuation, ± 2.5 V > 100 Hz at 10:1 attenuation without violating max input power	± 2 VDC to 250 Hz, ± 1.25 V > 250 Hz	± 6 VDC to 250 Hz, ± 1.25 V > 250 Hz without violating max input power
DC attenuation ratio	6:1	3:1	6:1	5:1 or 10:1 Automatically selected based on volts/division (all modes)	5:1 or 10:1 Automatically selected based on volts/division (all modes)	6:1	6:1
Offset range (for probing a single-ended signal)	± 16 V	± 8 V	± 6 V without violating max input power	± 16 V	± 6 V without violating max input power	± 16 V	± 6 V without violating max input power
Input referred noise spectral density	23.9 nV/rt (Hz)	12.0 nV/rt (Hz)	23.9 nV/rt (Hz)	Diff 5:1 atten 33.5 nV/rt (Hz) Diff 10:1 atten 53.9 nV/rt (Hz) SE A or B 5:1 atten 27.8 nV/rt (Hz) SE A or B 10:1 atten 47.7 nV/rt (Hz) CM 5:1 atten 21.8 nV/rt (Hz) CM 10:1 atten 38.4 nV/rt (Hz)	23.9 nV/rt (Hz)	23.9 nV/rt (Hz)	23.9 nV/rt (Hz)
Input referred noise example	4 mVrms with 28 GHz probe head and 30 GHz probe amp	2 mVrms with 28 GHz probe head and 30 GHz probe amp	4 mVrms	4.5 mVrms in diff mode 5:1 atten with >= 18 GHz probe head and 13 GHz probe amp	4.5 mVrms in diff mode 5:1 atten with 30 GHz N5444A probe head and 13 GHz	4 mVrms with 28 GHz probe head and 30 GHz probe amp	4 mVrms
Maximum input voltage	18 Vpeak mains isolated	18 Vpeak mains isolated	8 Vpeak without violating max input power	18 Vpeak mains isolated	8 Vpeak without violating max input power	18 Vpeak mains isolated	8 Vpeak without violating max input power

## What is InfiniiMode?

InfiniiMode allows convenient measurement of differential, single-ended and common mode signals with a single probe tip - without reconnecting the probe from its connection point. (Available in InfiniiMax III+)

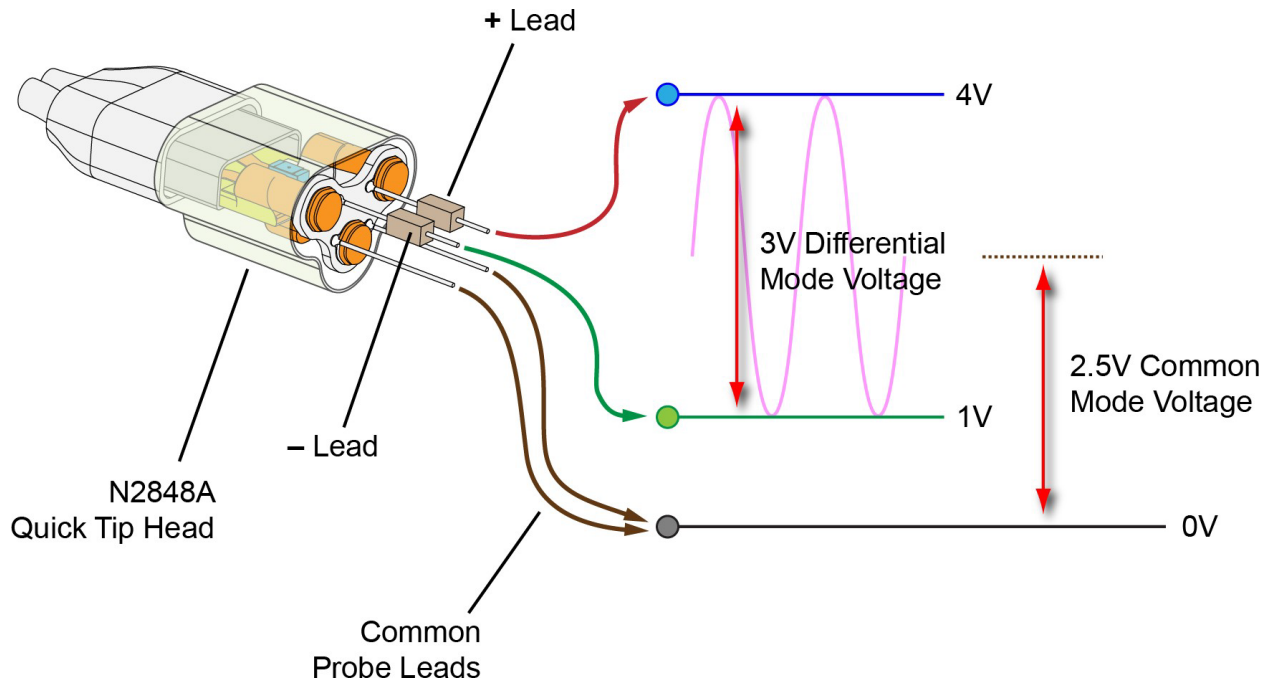

## Ordering information

### InfiniiMax RCRC probe amplifier models

Model	Description	Recommended oscilloscope
MX0032A	52 GHz InfiniiMax 4 probe amplifier (with 40 GHz B-T filter)	Infiniium UXR 1.85 / 1 mm Series models with AP3 interface
MX0031A	52 GHz InfiniiMax 4 probe amplifier	Infiniium UXR 1.85 / 1 mm Series models with AP3 interface
MX0030A	52 GHz InfiniiMax 4 probe amplifier	Infiniium UXR 1.85 / 1 mm Series models with AP3 interface
N2803A	30 GHz InfiniiMax III probe amplifier	Infiniium V/Z/UXR 3.5mm Series models with AP2 interface
N2802A	25 GHz InfiniiMax III probe amplifier	Infiniium V/Z/UXR 3.5mm Series models with AP2 interface
N7003A	20 GHz InfiniiMax III+ probe amplifier	Infiniium V/Z/UXR 3.5mm Series models with AP2 interface
N2801A	20 GHz InfiniiMax III probe amplifier	Infiniium V/Z/UXR 3.5mm Series models with AP2 interface
N7002A	16 GHz InfiniiMax III+ probe amplifier	Infiniium V/Z/UXR 3.5mm Series models with AP2 interface
N2800A	16 GHz InfiniiMax III probe amplifier	Infiniium V/Z/UXR 3.5mm Series models with AP2 interface
N7001A	13 GHz InfiniiMax III+ probe amplifier	Infiniium V/Z/UXR 3.5mm Series models with AP2 interface
N2832A	13 GHz InfiniiMax III+ probe amplifier	Infiniium 9000A/S/EXR/MXR Series models with AP1 interface
N7000A	8 GHz InfiniiMax III+ probe amplifier	Infiniium V/Z/UXR 3.5mm Series models with AP2 interface
N2831A	8 GHz InfiniiMax III+ probe amplifier	Infiniium S/EXR/MXR Series models with AP1 interface
N2830A	4 GHz InfiniiMax III+ probe amplifier	Infiniium S/EXR/MXR Series models with AP1 interface

## InfiniiMax RCRC probe heads

Model	Description	Notes
MX0040A	InfiniiMax 4 probe head connector	Required for connecting MX0041A and MX0042A
MX0041A	InfiniiMax 4 differential solder-in probe head - 52 GHz 5 pack (option 001) 25 pack (option 002)	Compatible with InfiniiMax 4 amp only (MX0040A is required)
MX0042A	InfiniiMax 4 differential solder-in probe head - 42 GHz 5 pack (option 001) 25 pack (option 002)	Compatible with InfiniiMax 4 amp only with longer tip length (MX0040A is required)
N2848A	InfiniiMax III QuickTip probe head	Compatible with InfiniiMax III/III+ amp Supports InfiniiMode with InfiniiMax III+ amp
N2849A	InfiniiMax III QuickTip tips	Set of 4 tips
N5445A	InfiniiMax III browser head	Order N5476A for replacement probe tips (set of 4)
N5439A	InfiniiMax III ZIF probe head	Order N2838A PC board ZIF (450 Ω), N5440A Ceramic ZIF (450 Ω) or N5447A Ceramic ZIF (200 Ω) for a set of 5 ZIF tips with plastic sporks
N5444A	InfiniiMax III 2.92 mm/3.5 mm/SMA probe head	Order N5448B (25 cm) or N2823A (1 m) 2.92 mm (m)-to-2.92 mm (m) head flex cables to extend the cable length. Supports InfiniiMode with InfiniiMax III+ amp
N5441A	InfiniiMax III 16 GHz solder-in probe head	Discontinued and replaced by N2836A and MX0109A
N2836A	InfiniiMax III 26 GHz solder-in probe head	Supports InfiniiMode with InfiniiMax III+ amp. Order N2836-68701 for damping resistor replacement tips
N2835A	InfiniiMax III differential connectivity kit	Contains 1x N5445A, 2x N2836A, 2x N5439A, 2x N2838A, 2x N2848A, 2x N2849A
MX0109A	InfiniiMax III 26 GHz Extreme temperature solder-in probe head	Supports -55 to +150 °C of operating temperature range and InfiniiMode with InfiniiMax III+ amp. Order N2836-68701 for damping resistor replacement tips

## InfiniiMax III probe adapters

Model	Description	Notes
MX0045A	InfiniiMax 4 adapter to InfiniiMax III probe head	InfiniiMax 4 to InfiniiMax III/III+ probe head adapters
N5442A	Precision BNC adapter (50 Ω)	For use with InfiniiMax I/II/III+ probes, N2750A-52A, N2795A/96A/97A, 1156A-58A etc.
N5449A	High impedance probe adapter	Includes one N2873A 500 MHz 10:1 passive probe
N5477A	Sampling scope adapter	For InfiniiMax III amp to use with Keysight 86100C DCA-J sampling scope
N1022B	Probe adapter	For InfiniiMax III+ amp to use with 86100C DCA-J sampling scope
MX0104A	Performance verification and deskew fixture	For InfiniiMax III and InfiniiMax III+ > 13 GHz. Order option 001 plastic stand or theoption N2787A 3D probe positioner.
E2655C	Performance verification and deskew fixture	For InfiniiMax III+ <=13 GHz and InfiniiMax I/II
N2852A	AutoProbe II to AutoProbe III interface adapter for Infinium UXR Series	



## Probe bandwidth upgrade options (for InfiniiMax III only)

Model	Description	Notes
N5446A-001	16 to 20 GHz bandwidth upgrade	
N5446A-002	20 to 25 GHz bandwidth upgrade	
N5446A-003	25 to 30 GHz bandwidth upgrade	
N5446A-004	16 to 25 GHz bandwidth upgrade	
N5446A-005	16 to 30 GHz bandwidth upgrade	
N5446A-006	20 to 30 GHz bandwidth upgrade	

## Other recommended accessories for InfiniiMax III/III+ probing system

Model	Description	Notes
MX0046A	InfiniiMax 4 mounting cradles	For positioning InfiniiMax 4 connectors
N2787A	3D probe positioner	For hands-free probing
N5450B	Extreme temperature extension cable	1 m long, check out Keysight literature 5990-3504EN for other available probe accessories for extreme temperature testing
N2812B	High performance input cable, 2.92 mm connectors, 1 m length	For use with Infinium V, 90000-X/Q Series oscilloscope
N5448B	Phase matched cable pair, 25 cm, 2.92 mm (m) to 2.92 mm (m)	> 40 GHz bandwidth. Skew error matched to < 5 psec
N2823A	Phase matched cable pair, 1 m, 2.92 mm (m) to 2.92 mm (m)	> 40 GHz bandwidth. Skew error matched to < 5 psec
MV-23	Carson Optical MagniVisor	<a href="http://www.carsonoptical.com/Magnifiers">www.carsonoptical.com/Magnifiers</a>



Keysight enables innovators to push the boundaries of engineering by quickly solving design, emulation, and test challenges to create the best product experiences. Start your innovation journey at [www.keysight.com](http://www.keysight.com).



This information is subject to change without notice. © Keysight Technologies, 2015 – 2024, Published in USA, February 5, 2024, 5990-5653EN