

INSTRUCTION MANUAL

BHK SERIES

POWER SUPPLY

REGULATED DC SUPPLY

KEPCO INC.
An ISO 9001 Company.



NOTE This on-line version of the Technical Manual includes only installation and operating instructions. For the complete manual, please contact Kepco.

©2000, KEPCO, INC.



KEPCO, INC. 1 131-38 SANFORD AVENUE 1 FLUSHING, NY. 11352 U.S.A. 1 TEL (718) 461-7000 1 FAX (718) 767-1102
email: hq@kepcopower.com 1 World Wide Web: <http://www.kepcopower.com>

TABLE OF CONTENTS

PARAGRAPH	PAGE
SECTION I—INTRODUCTION	
1-1 Scope of Manual.....	1-1
1-3 General Description.....	1-1
1-10 Specifications, General.....	1-1
1-11 Specifications, Performance.....	1-1
1-12 Specifications, Fast Slewing Mode.....	1-2
1-13 Specifications, Physical	1-3
SECTION II—INSTALLATION	
2-1 Unpacking and Inspection	2-1
2-3 Terminals and Controls.....	2-1
2-5 A-C Input Requirements	2-1
2-7 Grounding	2-1
2-8 Load Connection.....	2-1
2-10 Cooling	2-1
2-13 Operational Check	2-2
SECTION III—OPERATION	
3-1 General	3-1
3-3 Theory of Operation	3-1
3-6 D-C Specifications for Operational Power Supplies	3-2
3-11 Standard Power Supply Operation, Local Control.....	3-6
3-19 Introduction to Remote Programming.....	3-7
3-21 Output Voltage Programming with External Resistance.....	3-8
3-24 Output Current Programming with External Resistance.....	3-9
3-28 Initial Adjustments for Precision Programming	3-9
3-30 Programming Ratio Adjustment, Voltage Mode	3-10
3-31 Programming Ratio Adjustment, Current Mode	3-11
3-32 High Speed Programming.....	3-12
3-35 Lag Network Adjustments	3-13
3-38 Output Voltage Programming with External Control Voltage.....	3-13
3-41 Output Current Programming with External Voltage	3-15
3-44 Capacitive Loading	3-16
3-47 Series Operation	3-17
3-52 Parallel Operation.....	3-18
SECTION IV—THEORY OF OPERATION	
4-1 General	4-1
4-4 Circuit Description.....	4-1
SECTION V—MAINTENANCE	
5-1 General	5-1
5-3 Precautions.....	5-1
5-5 Test Equipment Required.....	5-1
5-7 Disassembly	5-1
5-9 Internal Adjustments.....	5-2
5-15 Trouble Shooting.....	5-3
5-20 Power Supply Measurements.....	5-3
SECTION VI—ELECTRICAL PARTS LIST AND DIAGRAMS	
6-1 General.....	6-1/6-2
6-3 Ordering Information.....	6-1/6-2

LIST OF ILLUSTRATIONS

FIGURE	PAGE
1-1 BHK Power Supply, Front View	iii/iv
1-2 BHK Power Supply, Rear View	iii/iv
1-3 Mechanical Outline Drawing	1-4
2-1 Transformer Connections for 115V A-C and 230V A-C Operation	2-2
2-2 Terminations, Front	2-3/2-4
2-3 Terminations, Rear	2-3/2-4
3-1 Voltage Control Circuit, Operation Notation	3-2
3-2 Operational Amplifier, Inverting Configuration	3-2
3-3 Simplified Power Supply Diagram	3-3/3-4
3-4 Load Connection with and without Error Sensing	3-6
3-5 Automatic Voltage/Current Crossover	3-7
3-6 Setup for Resistance Programming (Voltage Mode)	3-8
3-7 Output Current Programming with External Resistance	3-9
3-8 Establishing Programming Linearity (Voltage Mode)	3-10
3-9 Setup for Precision Programming Ratio Adjustment, Voltage Mode	3-10
3-10 Establishing Programming Linearity (Current Mode)	3-11
3-11 Setup for Precision Programming Ratio Adjustment, Current Mode	3-11
3-12 Conversion to High Speed Operation	3-12
3-13 Setup for Lag Network Adjustments	3-13
3-14 BHK Power Supply Sine Wave Programmed	3-14
3-15 Setup for Voltage Programming with a Bipolar Sine Wave	3-15
3-16 Setup for Voltage Programming with a Positive Sawtooth Wave	3-15
3-17 Output Current Programming with External Voltage	3-16
3-18 Series Resistor External to Feedback Loop	3-16
3-19 Series Resistor, Part of Feedback Loop	3-17
3-20 "Automatic" Series Connection	3-19
3-21 "Master-Slave" Series Connection	3-19
3-22 "Automatic" Parallel Connection	3-20
3-23 Parallel Operation	3-20
3-24 "Master-Slave" Parallel Connection	3-20
4-1 BHK Connecting Diagram	4-2
4-2 Simplified Diagram	4-3/4-4
5-1 Measuring Output Effects (Voltage Mode) without Error Sensing	5-4
5-2 Measuring Output Effects (Voltage Mode) Directly at the Load	5-4
5-3 Measuring Output Effects in the Current Mode	5-4
5-4 Location of Internal Adjustments	5-5/5-6
6-1 Component Location, Main Chassis	6-17/6-18
6-2 Component Location, Assembly A1	6-19
6-3 Component Location, Assembly A3	6-19
6-4 Component Location, Assembly A4	6-20
6-5 Component Location, Assembly A5	6-20
6-6 Main Schematic	6-21/6-22

LIST OF TABLES

TABLE	PAGE
1-1 Output Specifications and A-C Input Characteristics, BHK Series	1-1
1-2 Output Effects, Offsets and Reference Specifications	1-2
2-1 Terminations, Front	2-3/2-4
2-2 Terminations, Rear	2-3/2-4
5-1 Internal Adjustments	5-2

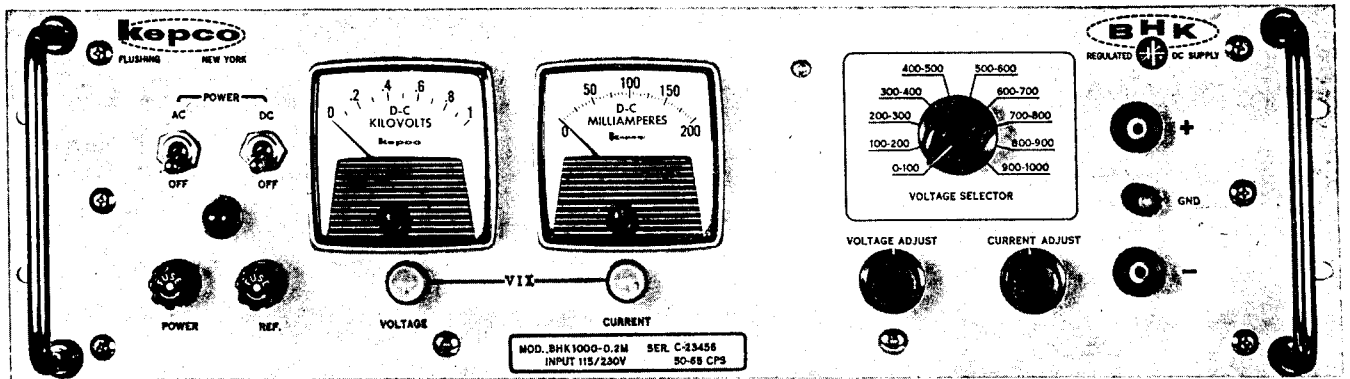

FIG. 1-1 BHK POWER SUPPLY, FRONT VIEW.

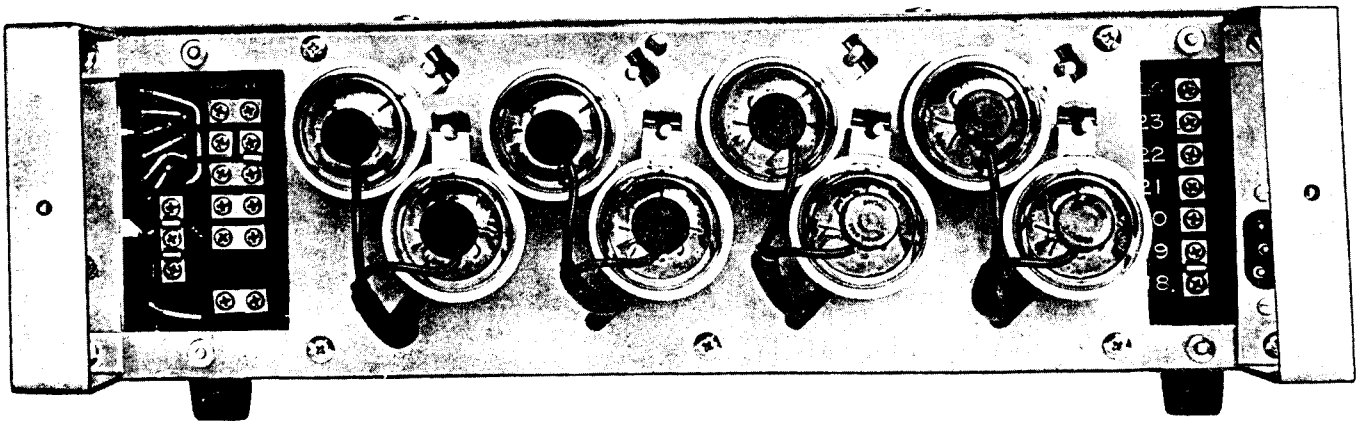

FIG. 1-2 BHK POWER SUPPLY, REAR VIEW.

SECTION I—INTRODUCTION

1-1 SCOPE OF MANUAL

1-2 This instruction manual contains information for the installation, operation, and maintenance of the Kepco Series BHK High Voltage Operational Power Supplies.

1-3 GENERAL DESCRIPTION

1-4 The Kepco BHK Design Group consists of high voltage, precision regulated power supplies with automatic crossover between their voltage and current regulation modes. The BHK power supplies are equipped with high resolution, 10-turn voltage and current controls, mode indicator lamps, and output voltage and current meters, located on the front panel. A-C power line and d-c on/off switching, monitored by indicator lamps, a-c and d-c fusing, as well as safety output binding posts, complete the front panel equipment.

1-5 Rear barrier-strips provide the necessary terminals for programming in the voltage or current mode of operation as well as output and error-sensing terminals.

1-6 Internal jumper connections are provided to convert the BHK power supply from standard to high speed operation.

1-7 The BHK power supply is of hybrid design, making use of vacuum tubes as the series control element thus forming, with the solid-state reference and amplifiers, an exceptionally reliable high voltage power supply.

1-8 The power supply chassis and cover are constructed of etched aluminum. The front panel is heavy gauge aluminum finished in light gray (if not otherwise specified) and equipped with chrome-plated carrying handles.

1-9 The major part of the circuitry is located on printed circuit boards of the plug-in type to simplify disassembly.

1-10 SPECIFICATIONS, GENERAL

- a) INPUT REQUIREMENTS: 105V a-c to 125V a-c or 210V a-c to 250V a-c (selectable), 50 to 65 Hz, single phase. Input current, see TABLE 1-1.
- b) AMBIENT OPERATING TEMPERATURE RANGE: -20°C to $+55^{\circ}\text{C}$.
- c) STORAGE TEMPERATURE RANGE: -40°C to $+85^{\circ}\text{C}$.
- d) ISOLATION VOLTAGE: 1000V d-c (or p-p) plus maximum rated output voltage between chassis and either output terminal.

1-11 SPECIFICATIONS, PERFORMANCE

MODEL	D-C OUTPUT RANGE		OUTPUT IMPEDANCE OHMS + MICROHENRIES			A-C INPUT CURRENT at 125V A-C
	VOLTS	AMPS	D-C 100 Hz	0.1—1 kHz	1—100 kHz	
BHK 500-0.4M	0-500	0-0.4	0.13	0.1	0.2 + 0.5	4.0A
BHK 1000-0.2M	0-1000	0-0.2	0.5	0.1	0.2 + 0.5	3.6A
BHK 2000-0.1M	0-2000	0-0.1	2.0	0.2	0.5 + 2.0	3.7A

TABLE 1-1 OUTPUT SPECIFICATIONS AND A-C INPUT CURRENTS, BHK SERIES.

NOTE: With the introduction of the 1970 Catalog (B-703), Kepco has adopted new technical terms recommended by the International Electrotechnical Commission (IEC). These terms replace or supplement previously used expressions, mainly to avoid difficulties in translation and prevent erroneous interpretations at home and abroad.

As a beginning, Kepco will discontinue the use of the specifications entitled "Line Regulation" and "Load Regulation" because of the long standing (and misleading) connotation that a power supply regulates the line or the load. Instead, Kepco will follow the recommendation of the IEC and speak of the "Output Effects, caused by changes in the Influence Quantities". The "Output Effects" are specified as before, either as a percentage change referred to the maximum specified output voltage (E_o) or current (I_o) or as an absolute change (ΔE_o , ΔI_o) directly in millivolts or milliamperes or both. The "Influence Quantities" are the "Source Variations" (formerly a-c line variations), the changes in load, temperature or time as previously specified. The illustration below will clarify the use of the new terminology.

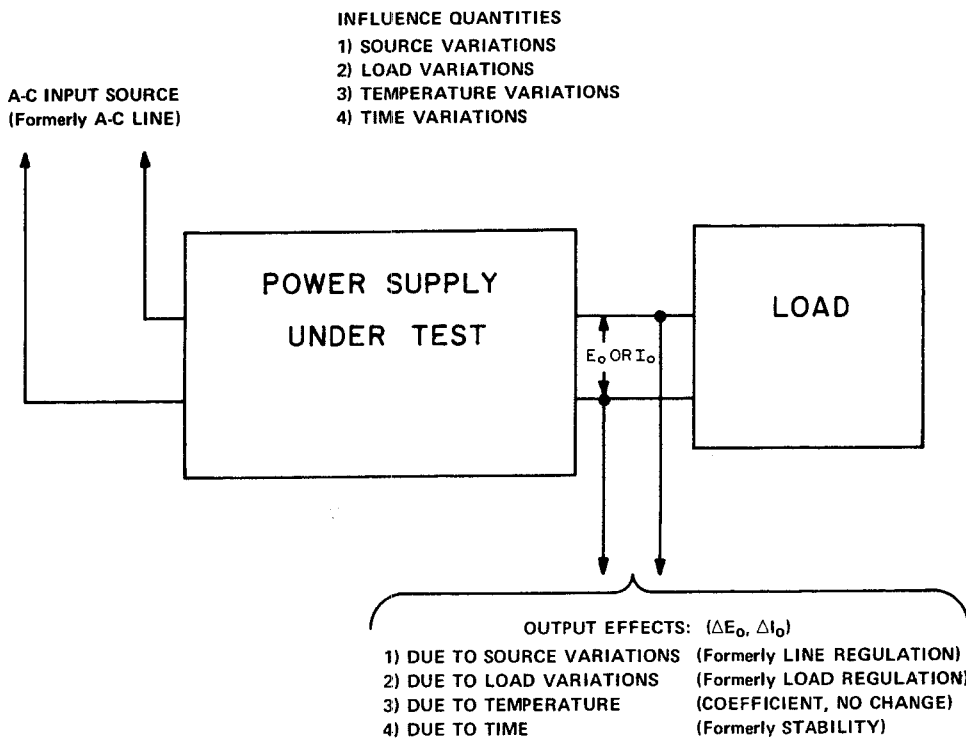

SPECIFICATIONS	OUTPUT EFFECTS VOLTAGE MODE	OUTPUT EFFECT CURRENT MODE (Internal Sensing)	VOLTAGE AMPLIFIERS OFFSET**		VOLTAGE REFERENCE (Internal)***
			ΔE_{i_o}	ΔI_o	
OUTPUT RANGE:	0-100% E_o max.	0.2%-100% I_o max.	—————	—————	Fixed 6.2V \pm 5%
SOURCE: 105-125/210-250V a-c	< 0.005% or 1 mV*	< 100 μ A	< 1 mV	< 10 nA	0.0001%
LOAD: No load-full load	< 0.01% or 1 mV*	< 100 μ A	< 1 mV	< 10 nA	—————
TIME: 8-hour (drift)	< 0.01% or 2.0 mV*	< 0.01% or 20 μ A*	< 50 μ V	< 50 nA	0.005%
TEMPERATURE: Per $^{\circ}$ C	< 0.01%	< 0.05% of I_o max.	< 100 μ V	< 50 nA	0.005%
RIPPLE: (rms)	< 1 mV	< 100 μ A	—————	—————	—————

*Whichever is greater

**Refer to Section III for definitions and evaluations of the offset specifications.

***Specifications valid for 1 mA \pm 10% control current.

TABLE 1-2 OUTPUT EFFECTS, OFFSETS AND REFERENCE SPECIFICATIONS.

1-12 SPECIFICATIONS, FAST SLEWING MODE

- a) GENERAL. The Kepco BHK Power Supply can be converted from the standard speed d-c power source to a high speed operational device by means of provided internal jumper connections. The conversion procedure is described elsewhere in this manual. (Refer to Section III, paragraph 3-32). To accurately described the high speed performance of the BHK power supply, additional specifications are presented below. Performance data given in paragraph 1-11 is still valid if not superseded by these complimentary specifications.
- b) SLEWING RATE: $>0.5/\mu\text{sec.}$ measured as the chord to the first time constant on the exponential response to a square-wave program.
- c) OPEN-LOOP GAIN (at d-c): $>0.5 \times 10^6$ volts per volt.
- d) RIPPLE: Ungrounded: $<0.001\% E_o \text{ max.}$
One side of output grounded: $<0.001\% E_o \text{ max.}$
- e) TRANSIENT RESPONSE:
 - 1) Voltage Mode: For a load current step, recovery is an exponential with a $50\mu\text{sec.}$ time constant.
 - 2) Current Mode: For a load voltage step, recovery is at the rate of $0.5\text{V per } \mu\text{sec.}$
- f) IMPEDANCE: Above 1000 Hz the reactive impedance of $500\mu\text{Hz}$ must be added to the values presented in TABLE 1-1.
- g) SINUSOIDAL FULL POWER FREQUENCY RESPONSE:

$$f_{\text{max.}} = \frac{500,000}{\pi E_{\text{pp}}} \quad (E_{\text{pp}} \text{ is the peak-to-peak output voltage excursion.})$$

1-13 SPECIFICATIONS, PHYSICAL

- a) FRONT PANEL METERS (MODELS WITH SUFFIX "M" ONLY): $2\frac{1}{2}$ inch rectangular volt and ampere meter, 2% full scale accuracy.
- b) TERMINALS AND CONTROLS: Refer to "Mechanical Outline Drawing" (FIG. 1-3) and Section II (paragraph 2-3).
- c) DIMENSIONS AND FINISH: Refer to "Mechanical Outline Drawing" (FIG. 1-3).

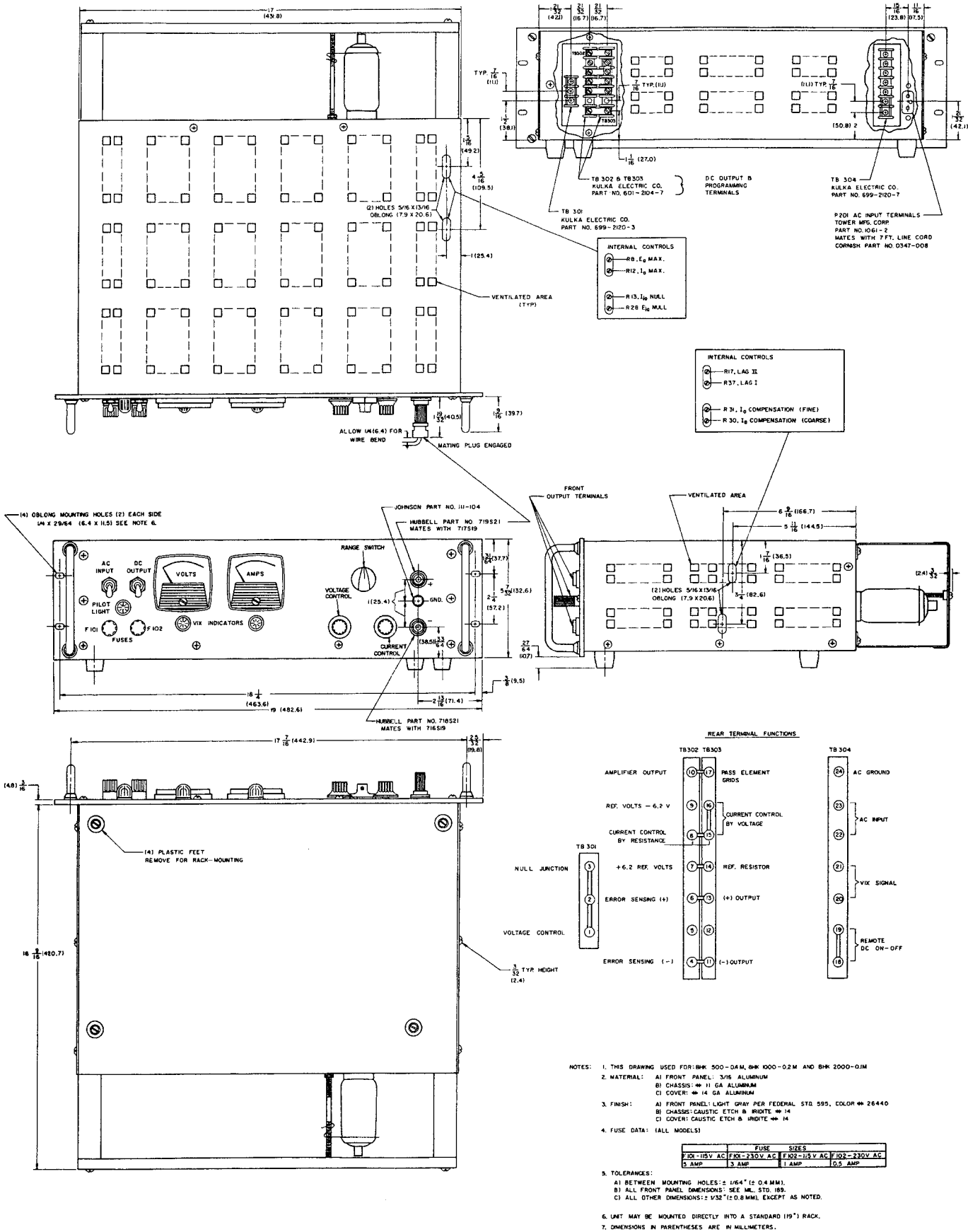

FIG. 1-3 MECHANICAL OUTLINE DRAWING, BHK SERIES

SECTION II—INSTALLATION

2-1 UNPACKING AND INSPECTION

2-2 This power supply has been completely tested and inspected at the factory prior to packing and is ready for installation and operation. No special precautions are necessary for unpacking of the unit. Inspect the instrument for obvious shipping damage before attempting to operate it. Perform an operational check as described in paragraph 2-13. If there is any indication of damage, file a claim immediately with the responsible transport service.

2-3 TERMINALS AND CONTROLS

2-4 For the location of all terminations and controls, refer to FIG's. 2-2 and 2-3 as well as TABLES 2-1 and 2-2. The nomenclature used will be followed throughout this manual.

2-5 A-C INPUT REQUIREMENTS

2-6 This power supply is normally supplied for operation on a single phase, nominal 115V a-c line. For conversion to 230V a-c line operation, refer to FIG. 2-1. For a-c input current requirements, see TABLE 1-1.

2-7 GROUNDING

- a) **SAFETY GROUND.** The power supply is equipped with a 3-wire safety line cord and polarized plug. The third (green) wire in the line cord is connected to the chassis and the case of the unit. If a 2-terminal receptacle in combination with an adapter is used, it is imperative that the chassis of the power supply be returned to a-c ground with a separate lead.
- b) **SIGNAL GROUND.** The d-c output is isolated from the a-c power line and from any direct connection to chassis or ground. The negative side of the output is connected to chassis through a capacitor in series with a resistor⁽¹⁾. The maximum voltage that can be supported between either output terminal and ground or chassis is 1000V d-c plus the maximum output voltage of the power supply. Either side of the output may be grounded. Convenient grounding terminals are provided at the front panel binding post or at the rear barrier-strip. (Refer to FIG. 1-3).

⁽¹⁾ This connection is opened during high speed programming (see paragraph 3-32) and grounding of the (+) positive output terminal is recommended.

2-8 LOAD CONNECTION

2-9 The load may be connected to the front panel binding posts or at the rear terminals. The output effect specifications as given in Section I are valid for rear terminal connections only. If optimum regulation directly at the load is essential, remote error sensing as described in paragraph 3-13 must be applied.

2-10 COOLING

2-11 This equipment is convection cooled. Side-panel openings and the top of the case must be kept clear from obstruction to insure proper circulation.

2-12 If the supply must be rack-mounted or installed into confined space, care must be taken that the ambient temperature does not rise above the limit specified in Section I of this manual.

2-13 OPERATIONAL CHECK

2-14 A simple operational check after unpacking and before permanently installing the power supply is advisable. The purpose of the test is to check the power supply for any damage resulting from shipment.

NOTE: Refer to FIG. 2-2 and FIG. 2-3 for location of front and rear terminations.

- a) Connect power supply to 115V a-c line. Refer to FIG. 2-1 for 230V line operation.
- b) Turn "current control" fully clockwise. Rotate "voltage control" fully counterclockwise and then clockwise for one turn. For units without metering, connect a d-c voltmeter across the rear output terminals. The range of the voltmeter must be sufficient to cover the maximum output voltage of the power supply.
- c) Turn a-c line switch "on". After 30 seconds, turn d-c high voltage switch "on". Slowly rotate the "voltage control" clockwise and observe the gradual increase of the output voltage. The "voltage" VIX[®] light should be on and the "current" VIX[®] light should be out. Turn power "OFF."
- d) Connect a short circuit across the output terminals, consisting of a length of heavy copper wire. For unmetered models an ammeter with sufficient range to cover the maximum output current of the power supply may be connected in series with the short circuit.
- e) Turn power "on". Rotate the "current control" slowly clockwise. A smooth increase in output current should be observed on the output current meter. The "current" VIX[®] light should be "on" and the "voltage" VIX[®] light should be out. Turn power "off". This completes the operational check of the power supply.

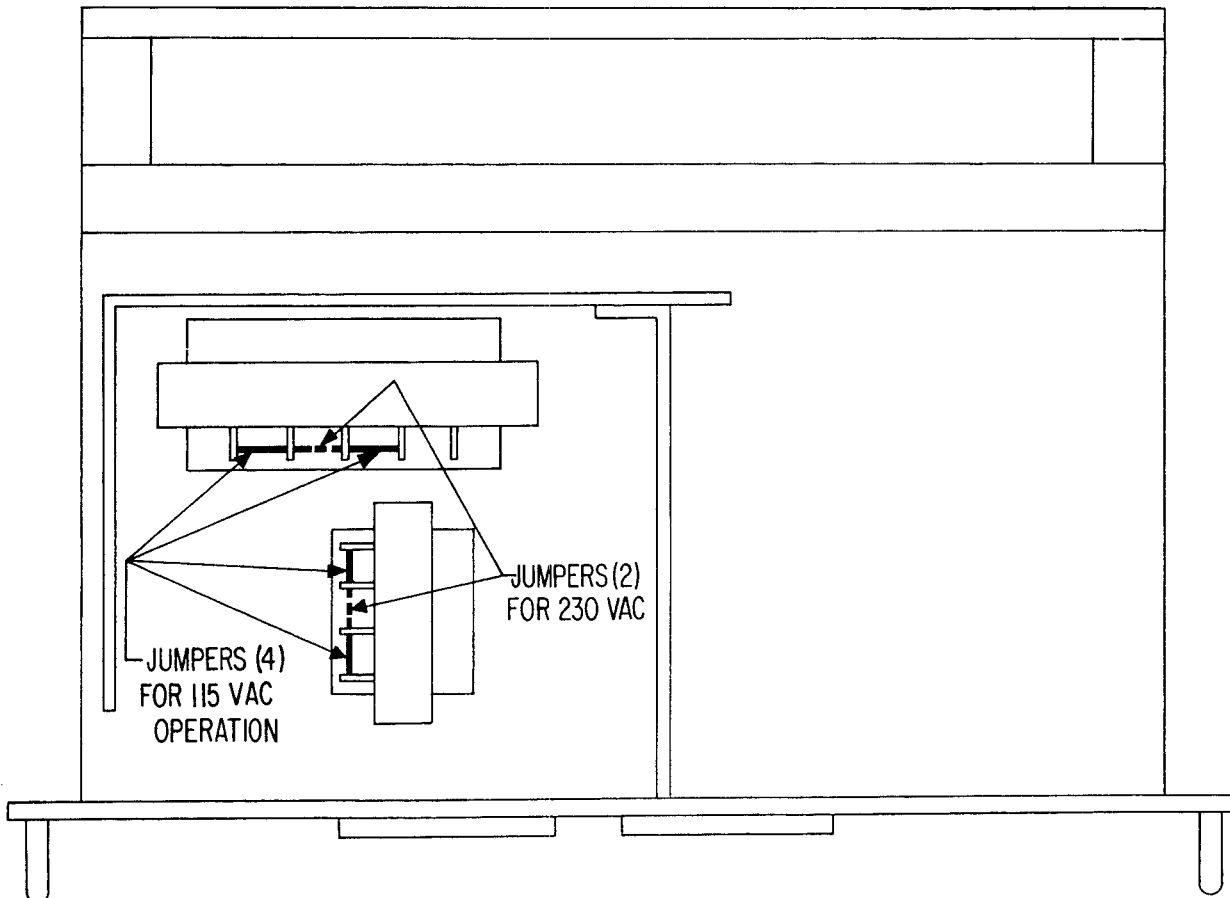

FIG. 2-1 TRANSFORMER CONNECTION FOR 115V A-C AND 230V A-C
POWER LINE OPERATION, (MODEL BHK 1000-0.2).

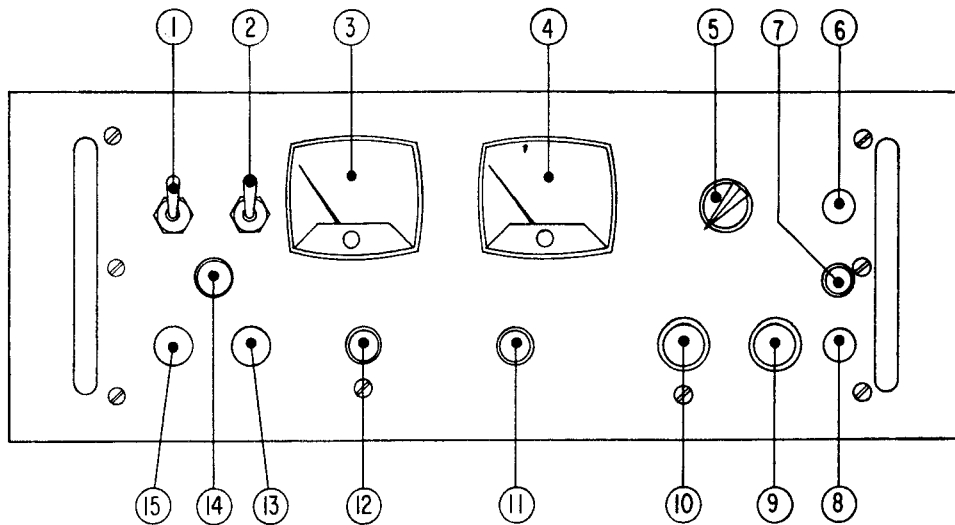

FIG. 2-2 TERMINATIONS, FRONT.

NO.	TERMINATION OR CONTROL	FUNCTION
1	LINE SWITCH	CONNECTS UNIT TO AND FROM A-C POWER LINE
2	D-C SWITCH	SWITCHES HV D-C VOLTAGE ON/OFF
3	VOLTMETER	INDICATES OUTPUT VOLTAGE
4	AMPERE METER	INDICATES OUTPUT CURRENT
5	RANGE SWITCH	COARSE OUTPUT VOLTAGE SWITCHING, 10 POS.
6	OUTPUT TERMINAL (+)	PLUS TERMINAL, D-C OUTPUT, FRONT
7	OUTPUT TERMINAL (GND)	CHASSIS CONNECTION MUST RETURN TO A-C GROUND
8	OUTPUT TERMINAL (-)	MINUS TERMINAL, D-C OUTPUT, FRONT
9	CURRENT CONTROL	10-TURN CONTROL, SETS OUTPUT CURRENT
10	VOLTAGE CONTROL	10-TURN CONTROL, SETS OUTPUT VOLTAGE
11	VIX INDICATOR	DISPLAYS CURRENT OPERATING MODE
12	VIX INDICATOR	DISPLAYS VOLTAGE OPERATING MODE
13	FUSE	PROTECTS REFERENCE TRANSFORMER
14	PILOT LIGHT	INDICATES A-C LINE POWER "ON"
15	FUSE	PROTECTS MAIN TRANSFORMER

TABLE 2-1 TERMINATIONS, FRONT

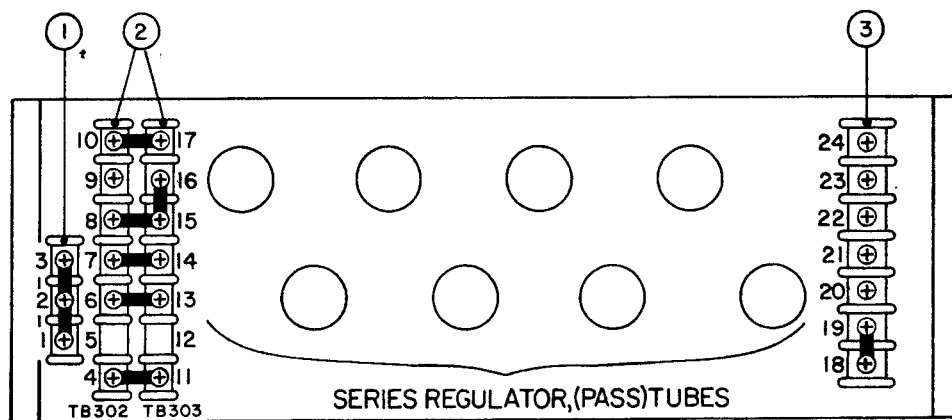

FIG. 2-3 TERMINATION, REAR.⁽¹⁾

⁽¹⁾ Refer to Main Schematic for Individual Terminal Identification.

NO.	TERMINATION OR CONTROL	FUNCTION
1	TB301	PROGRAMMING TERMINALS
2	TB302,303	OUTPUT AND PROGRAMMING TERMINALS
3	TB304	VIX CONNECTIONS, A-C INPUT

SECTION III—OPERATION

3-1 GENERAL

- 3-2 This section contains directions for the operation of BHK Series Power Supplies. The output control modes possible with the BHK power supply range from local voltage or current control at the front panel over simple remote resistance control of the output to sophisticated high speed amplifier duty. With the versatility of these power supplies, only a few of the many possible circuit configurations can be shown. For a more extensive view on power supply applications, please consult the "Kepco Power Supply Handbook," available from your Kepco sales engineer or write directly to: Kepco, Inc. 131-38 Sanford Avenue, Flushing, New York 11352.

3-3 THEORY OF OPERATION

- 3-4 In order to familiarize the user of this equipment with the terminology used in this manual and with the various modes of operations described in this section, the Kepco comparison circuits will be described, the operating equations derived, and the analogy between power supplies and operational amplifiers will be shown.
- 3-5 In the BHK power supply, separate comparison or control circuits and amplifiers with automatic crossover from voltage to current mode of operation (or vice versa) are provided. (Refer to FIG. 3-3). The connections to the control circuitry and the amplifiers are accessible at the rear barrier-strip. (See FIG. 4-2). The internal control circuits will be discussed below.
- a) **CURRENT MODE CONTROL CIRCUIT.** (Refer to FIG. 3-3). In the current mode of operation, the voltage drop across the current sensing resistor (R_s) is compared with the voltage drop across the current control resistor (R_{cc} , front panel "current control"). At balance, $V_s = V_{CC}$ and $E_{BB}' = 0$, and equations (1), (2) and (3) are found to be valid. Any unbalance caused by either a change in the setting of the front panel control (R_{cc}), a variation in a-c line voltage or a change in load resistance will produce a signal at the differential input (B,B') of the current mode comparison amplifier. This amplifier in combination with the driver circuit will bias the series regulator in such a way as to restore the previous balanced conditions. For example, for an increase in R_L (meaning a decrease in I_o), the voltage across R_s drops and results in a negative input signal at the input to the amplifier and a positive signal at the grid of the series regulator producing in turn a reduction of the plate-cathode impedance and effecting an increase in compliance voltage E_o , thus keeping I_o constant.
- b) **VOLTAGE MODE CONTROL CIRCUIT.** (Refer to FIG. 3-3). The comparison circuit in the voltage mode of operation consists of a bridge circuit normally connected directly to the output terminals (via the error-sensing links). When remote error sensing is used, the comparison circuit is removed from the output terminals and connected directly to the remote load.
- At balance:
 $E_{AA}' = 0$ and equations (4), (5) and (6) are found to be valid. Any unbalance, due to either a variation in a-c line, output load or change in setting of the front panel control (R_{VC}), will produce an input signal at the voltage comparison amplifier. The amplifier, in combination with the driver stage and the series regulator, will tend to restore the previous balanced position. A rise in output voltage (E_o) or a change in the value of R_{VC} will cause a change in input voltage at the null junction of the amplifier (A). The resulting grid signal at the series regulator will vary the voltage drop E_p in such a way as to correct E_o until the previous balance is restored.
- c) **POWER SUPPLY/AMPLIFIER ANALOGY**
- 1) Without changing the physical layout of any component in FIG. 3-3, the voltage comparison amplifier and control circuitry can be redrawn to illustrate a useful analogy between a power supply and a d-c feedback "operational" amplifier. (See FIG. 3-1).

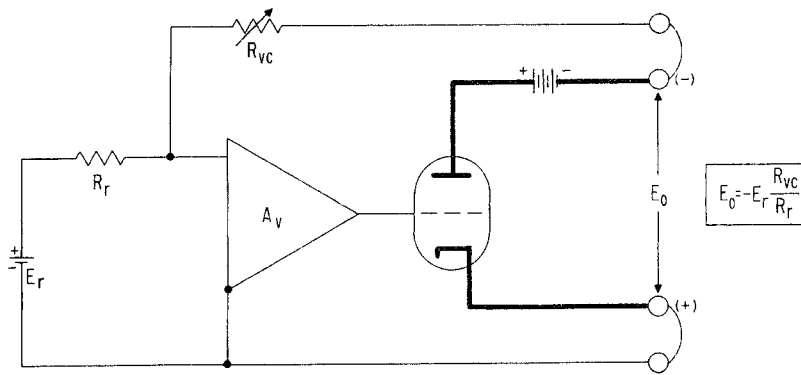

FIG. 3-1 VOLTAGE CONTROL CIRCUIT, OPERATIONAL NOTATION.

Substituting the familiar operational amplifier terminology for the elements around the power supply, a model of an inverting, unipolar amplifier results. Its output voltage, E_o is derived from relationship: $E_o = - E_i R_f/R_i$ (7), (from Eq. 4) where R_f/R_i is defined as the closed-loop or operational gain. (See FIG. 3-2).

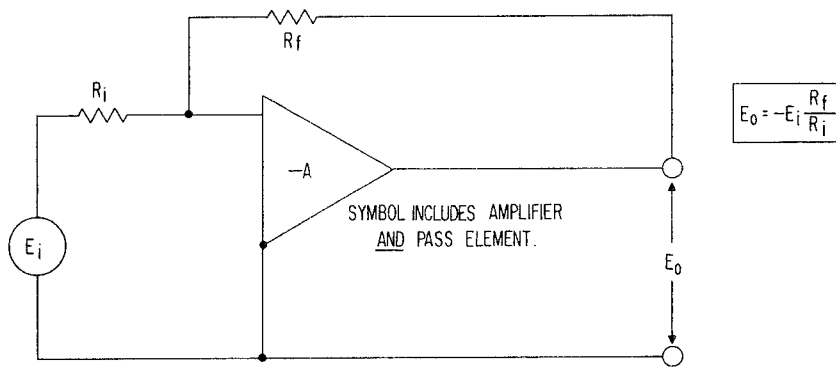
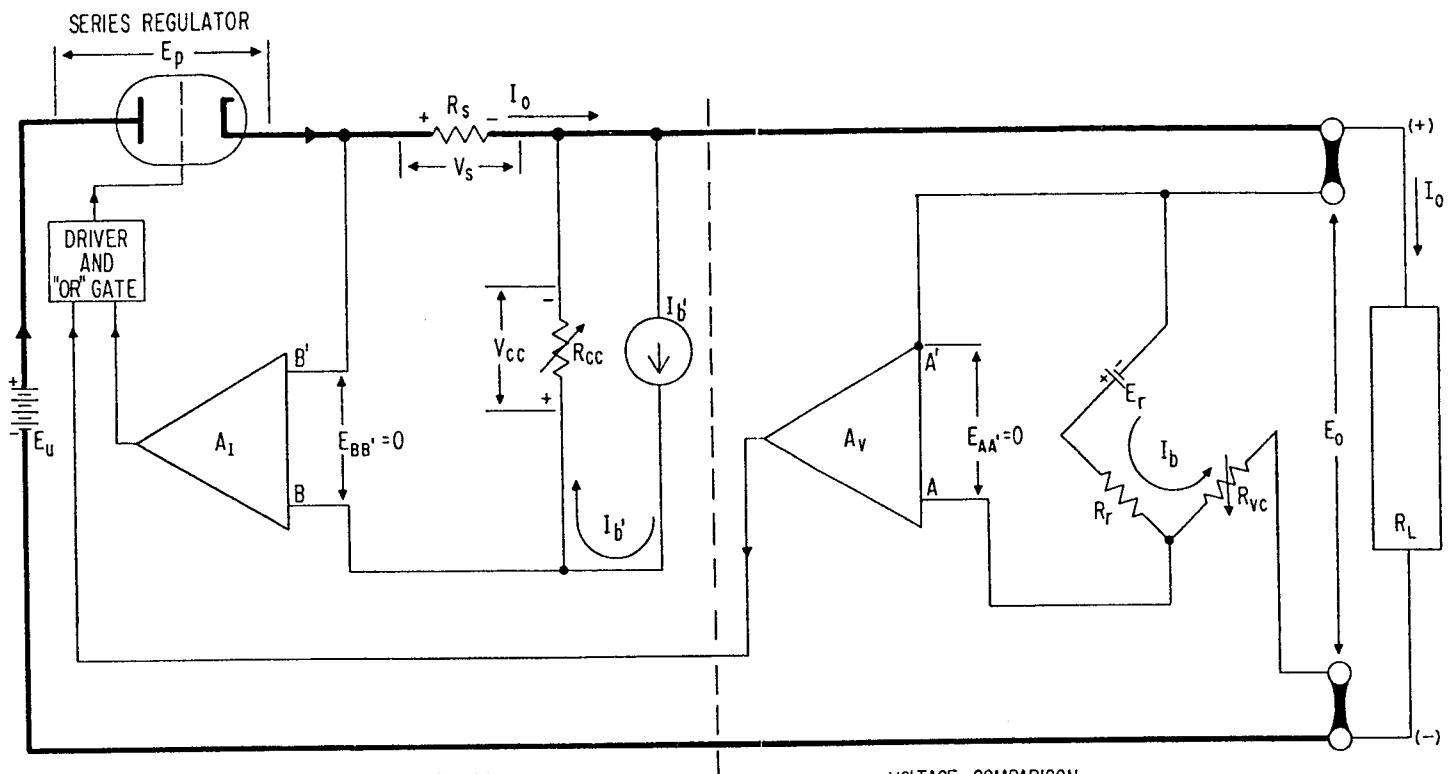

FIG. 3-2 OPERATIONAL AMPLIFIER, INVERTING CONFIGURATION

- 2) A power supply contains, in addition to its high gain d-c amplifier, an inverting high power “booster” (the pass elements), main and auxiliary d-c supplies, and shunt regulated reference sources. By comparison with low power operational amplifiers, the frequency response of the power supply is limited due mainly to its large output capacitor needed for high current delivery at low output impedance. For high speed operation, however, the filter capacitors in the BHK Power Supplies may be disconnected, resulting in excellent performance at high frequencies.

3-6 D-C SPECIFICATIONS FOR OPERATIONAL POWER SUPPLIES

- 3-7 If the power supply is used as an amplifier, its output effects which were formerly specified in terms of the output variations (ΔE_o) must now be respecified for the amplifier input. The reason for this is that the variations with a-c source, output load, temperature and time become a function of the selected feedback components and closed-loop gain. Their effect on the output will therefore vary with the value of these components and may be calculated for each case.
- 3-8 In developing the amplifier model, we tacitly assumed the null junction voltage and current to be zero, causing the “ideal” equation (7) to be valid. In reality, however, nonidealities do exist at the null junction or input of the amplifier and must be considered if d-c performance is to be evaluated. These nonidealities take the form of an offset voltage (E_{i0}) and an offset current (I_{i0}). Although their **initial** values may be cancelled or zeroed, either by external means or by provisions made internally (as in the case of the BHK power supplies), their **variations** with a-c input source, load, temperature and time appear at the input and are specified as ΔE_{i0} and ΔI_{i0} .



CURRENT COMPARISON
CIRCUIT AND AMPLIFIER
AT BALANCE ($E_{BB'}=0$)

$$I_b' R_{cc} = I_o R_s \quad (\text{eq. 1})$$

$$V_{cc} = I_b' R_{cc} \quad (\text{eq. 2})$$

$$I_o = \frac{V_{cc}}{R_s} \quad (\text{eq. 3})$$

VOLTAGE COMPARISON
CIRCUIT AND AMPLIFIER
AT BALANCE ($E_{AA'}=0$)

$$\frac{E_r}{R_r} = \frac{E_o}{R_{vc}} \quad (\text{eq. 4})$$

$$\frac{E_r}{R_r} = I_b \quad (\text{eq. 5})$$

$$E_o = I_b R_{vc} \quad (\text{eq. 6})$$

A_1 = CURRENT COMPARISON AMPLIFIER.

A_v = VOLTAGE COMPARISON AMPLIFIER.

E_o = OUTPUT VOLTAGE.

E_r = REFERENCE VOLTAGE.

E_u = UNREGULATED, RAW D.C.

I_b = CONTROL (BRIDGE) CURRENT, VOLTAGE

COMPARISON CIRCUIT.

I_b' = CONTROL CURRENT SOURCE, CURRENT

COMPARISON CIRCUIT.

I_o = OUTPUT CURRENT.

R_L = LOAD RESISTANCE.

R_s = CURRENT SENSING RESISTOR.

R_r = REFERENCE RESISTOR.

R_{vc} = VOLTAGE CONTROL RESISTOR.

FIG. 3-3 SIMPLIFIED POWER SUPPLY DIAGRAM.

BHK GROUP, VOLTAGE AMPLIFIER OFFSETS		
SPECIFICATION:	ΔE_{i_o}	ΔI_{i_o}
A-C INPUT SOURCE: (105-125V a-c)	< 1 mV	< 10 nA
LOAD: (No load/Full load)	< 1 mV	< 10 nA
TIME: (8 hours)	< 50 μ V	< 50 nA
TEMPERATURE: Per $^{\circ}$ C	< 100 μ V	< 50 nA

3-9 Considering both offset variations, the modified expression for the output voltage (with the initial or fixed parts of E_{i_o} and I_{i_o} nulled) becomes:

$$E_o = \underbrace{E_i \frac{R_f}{R_i}}_{\text{Ideal Part}^{(1)}} + \underbrace{\Delta E_{i_o} \left[\frac{R_f}{R_i} + 1 \right] + \Delta I_{i_o} R_f}_{\text{Output Effects}} \quad (\text{Eq. 8})$$

As seen from equation (8), the offset voltage variations (ΔE_{i_o}) are multiplied by unity plus the gain ratio R_f/R_i to obtain their contribution to the output voltage change while the offset current variations are multiplied by the value of the feedback resistor (R_f). The separation of the specifications for ΔE_{i_o} and ΔI_{i_o} not only allows an analysis of the contributions from each offset variation but also permits component selection such as to minimize the effects of either offset or find an acceptable compromise.

3-10 A practical example will illustrate the usefulness of the concept.

- a) For an application requiring a gain of 10, an operational programming circuit is to be set up with a model BHK power supply.

From the Table of Specifications, the output effect due to a-c input source variations is found to be:

$$\Delta E_{i_o} = 1 \text{ mV}, \Delta I_{i_o} = 10 \text{ nA}$$

⁽¹⁾NOTE: A second order effect, neglected in this analysis, is contributed by the variations in the input or reference source. If this effect is known and its magnitude is comparable to the output effects due to the offsets, the term " $\pm \Delta E_i (R_f/R_i)$ " must be added to equation (8).

If we let $R_i = 100\text{K}$ ohms, then for $R_f/R_i = 10$, we need $R_f = 1$ megohm. The expected output effects due to a-c input source variations are (from Eq. 8):

$$\begin{aligned} \Delta E_o &= \Delta E_{i_o} \left(\frac{R_f}{R_i} + 1 \right) + \Delta I_{i_o} R_f \\ &= 1 \text{ mV} (10 + 1) + 10 \text{ nA} (10^6 \text{ ohms}) \\ &= 11 \text{ mV} + 10 \text{ mV} \\ \Delta E_o \text{ due to } \Delta E_{i_o} & \quad \Delta E_o \text{ due to } \Delta I_{i_o} \end{aligned}$$

The contribution of ΔI_{i_o} is seen to be almost as much as that of ΔE_{i_o} , due of course, to the choice of a relatively large feedback resistor. Generally, in low gain applications, it is wise to select lower values for the feedback and input resistors if the loading on the input source will permit it. If, for example: $R_i = 10\text{K}$ and $R_f = 100\text{K}$ (retaining the previous gain ratio of $R_f/R_i = 10$), the total change in output voltage ΔE_o would only be $11 \text{ mV} + 1 \text{ mV} = 12 \text{ mV}$, showing clearly the advantage of selecting lower values of feedback resistors, thereby reducing the contribution due to ΔI_{i_o} .

- b) Using the same amplifier in an application with a required operational gain of 100, we select R_i to be 1K ohm and $R_f = 100K$, thus establishing the desired gain ratio ($R_f/R_i = 100$). For this choice of input and feedback elements, we find the output effects due to a-c input source variations to be:

$$\begin{aligned} \Delta E_o &= 1 \text{ mV} (100 + 1) & + 10 \text{ nA} (1 \times 10^5 \text{ ohms}) \\ &= 101 \text{ mV} & + 1 \text{ mV} \\ \Delta E_o \text{ due to } \Delta E_{i_o} & & \Delta E_o \text{ due to } \Delta I_{i_o} \end{aligned}$$

In these cases of large gain ratios, the contribution from ΔE_{i_o} is dominant. Its effect can only be reduced by externally limiting wide variations of the a-c input source. Similar calculations to the above examples may be made to predict the effects of load changes, temperature variations or stability (changes in output voltage with time). It must be realized, of course, that the examples shown represent "worst case" analysis. As a rule, total output effects are much smaller, due to cancelling effects and "better than specified" performance of the BHK.

3-11 STANDARD POWER SUPPLY OPERATION, LOCAL CONTROL

- 3-12 GENERAL. The BHK power supply is shipped from the factory with 8 removable jumper-links in place at the rear barrier-strips TB301, TB302 and TB303. All links must be in place and secured tightly for standard local operation.

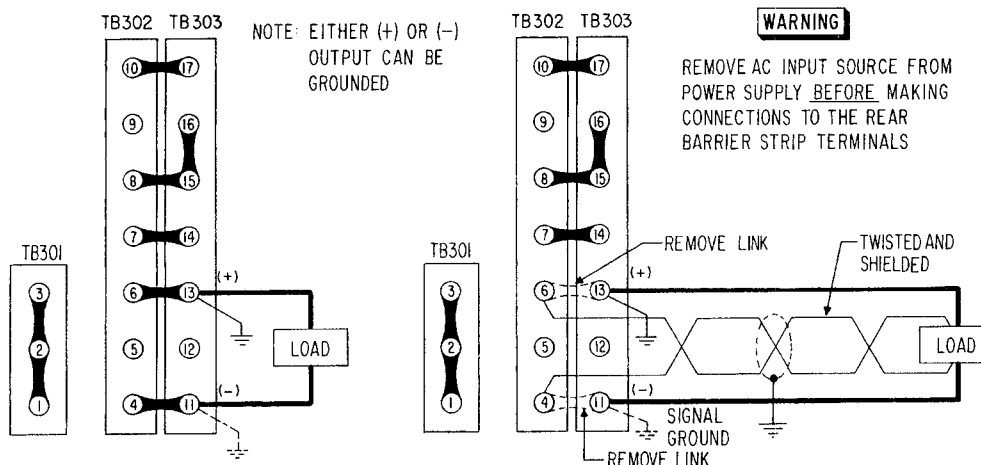

FIG. 3-4 LOAD CONNECTION WITH AND WITHOUT ERROR SENSING.

- 3-13 LOAD CONNECTION. The load may be connected to the front or the rear output terminals as shown. Specified d-c performance is measured at the error-sensing terminal (4)—(6). Front terminal connection and remote load operation requires, therefore, the use of error sensing as shown in FIG. 3-4. A twisted, shielded pair of sensing wires is connected to the rear sensing terminals and terminated directly at the load. The shielded error-sensing leads must be insulated to the shield for (at least) the maximum output voltage of the power supply. Specified d-c performance is now available directly at the load.
- 3-14 TURN-ON. A-C power line turn-on is indicated by illumination of the red signal lamp at the front panel. The BHK power supply is now in standby condition. **A waiting period of approximately 30 seconds should be allowed to let the filaments of the series regulator tubes reach their operating temperature.** After the d-c switch is turned on, output is available at the output terminals. The "d-c-on" condition is indicated by the illumination of one of the white VIX® lights on the front panel. D-C output may also be switched on remotely by removing the jumper-links between rear terminals (18)—(19) on TB304 and inserting a single pole switch between those terminals. The BHK power supply may be switched "on" or "off" with its front panel controls in any position.
- 3-15 SETTING OUTPUT VOLTAGE AND CURRENT. The output voltage of the BHK power supply is adjustable from zero to the maximum output voltage by a "coarse" and "fine" voltage control located at the front panel. The "coarse" control consists of a step switch dividing the output range into 10 equal voltage ranges. The "fine" control is a 10-turn precision rheostat which adjusts the output to any point within the individual range so that continuous control with exceptional resolution is provided throughout the full output voltage range. The output current of the BHK power supply is adjustable from zero to the maximum output current by a 10-turn precision rheostat on the front panel.

- 3-16 **AUTOMATIC CROSSOVER.** The operating mode of the BHK power supply will be determined by the setting of the front panel voltage and current controls and the load resistance. For any given setting of the output controls, a sharp crossover point exists where the load resistance (R_L) is equal to the output voltage (E_o) set by the front panel control, divided by the output current (I_o). Front panel signal lights (VIX[®] indicator) indicate whether the power supply is operating in the voltage or current mode of operation. (Refer to FIG. 3-5).

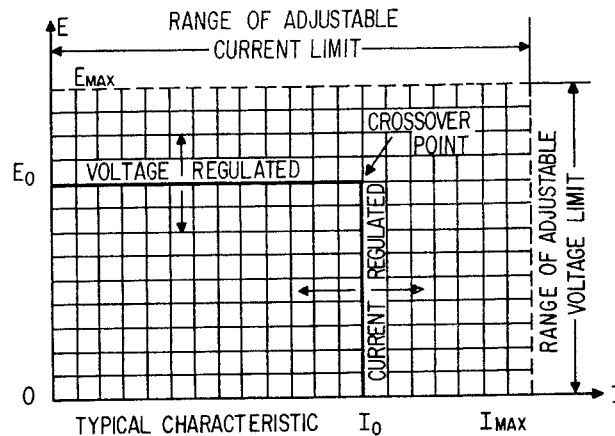

FIG. 3-5 AUTOMATIC VOLTAGE/CURRENT CROSSOVER.

- 3-17 **VOLTAGE MODE OPERATION.** If constant voltage operation is desired, the CURRENT ADJUST control may be set to its maximum clockwise position. The supply will then operate as a voltage regulator and deliver any desired current up to its maximum output rating. Overload protection is provided at this setting at the maximum output current of the power supply. Any other setting of the CURRENT ADJUST control will provide overload cutoff at the adjusted output current level. The BHK power supply will deliver constant voltage and the output current will vary with the load changes. If the output current reaches the preadjusted level, it will automatically switch into the current mode.
- 3-18 **CURRENT MODE OF OPERATION.** If the constant current operation is desired, the CURRENT ADJUST control at the front panel is set to the desired output current level, and the VOLTAGE SELECTOR and VOLTAGE ADJUST controls to the desired "compliance voltage." (At constant current output, the power supply changes its output voltage in "compliance" to the demand of the load while holding the current constant. This changing output voltage under constant current operation is termed the "compliance voltage range").
- 3-19 **INTRODUCTION TO REMOTE PROGRAMMING**
- 3-20 **GENERAL.** As with all high voltage equipment, basic safety rules must be observed at all times.

WARNING

- Use **extreme caution** when connecting or disconnecting the load or other external components to the power supply. This is a high voltage device with very low impedance and must be operated carefully. Remove the line cord completely before touching the rear barrier-strips or components inside the case.
- If shielded cable is required, connect the shield to the case of the unit. A grounding screw is provided near the rear barrier-strip for that purpose. The cable must be insulated for the maximum output voltage of the supply.
- If possible, return one side of the output to ground. (Either side may be grounded.) If this is not possible, use extra care and ground at least the case to a good a-c ground. (Since the power supply is "floating", all external programming sources must be insulated for the maximum output voltage to be programmed.)
- All external connections must be tight, especially the screw connections to the rear barrier-strips.
- External programming or reference sources must have specifications equal or better than the BHK power supply to be programmed.

- f) Programming resistors should be high quality wirewound units with temperature coefficients of 20 parts per million or better. Their wattage rating must be at least 10 times the actual power dissipated. Although the control current through these resistors is only 1 mA, an error current exists when programming large voltage excursions. The magnitude of this error current equals the change in output voltage divided by the final resistance of the programming resistor. (If, for example, the voltage step is from 500 Volts to zero, $\Delta E_o = 500V$ and the final resistance of the programming resistor is $\Delta R_{VC} = 2$ ohms, $I_{peak} = 250A$). The duration of the peak error current depends upon the size of the output capacitor. I_{peak} decays exponentially as the output voltage assumes the final value. (In the "high speed" mode of operation, the output capacitor is disconnected, and the duration of the error current is sharply reduced.)

If step switch devices are used in resistance programming, they must be of the "make before break" variety to avoid programming infinity. Programming resistors must have a **voltage rating** at least equal to the maximum output voltage of the power supply.

3-21 OUTPUT VOLTAGE PROGRAMMING WITH EXTERNAL RESISTANCE

3-22 The output voltage of the BHK power supply may be controlled remotely by an external resistance, replacing the built-in voltage control resistance which is disconnected at the rear barrier-strip. If the standard programming ratio is retained, 1000 ohms of external control resistance is needed for every volt of output desired. The external control resistance can take the form of another rheostat or it can be a fixed resistor or a group of resistors which are step-switch or relay controlled. (Refer to paragraph 3-20f for selection of suitable programming resistors).

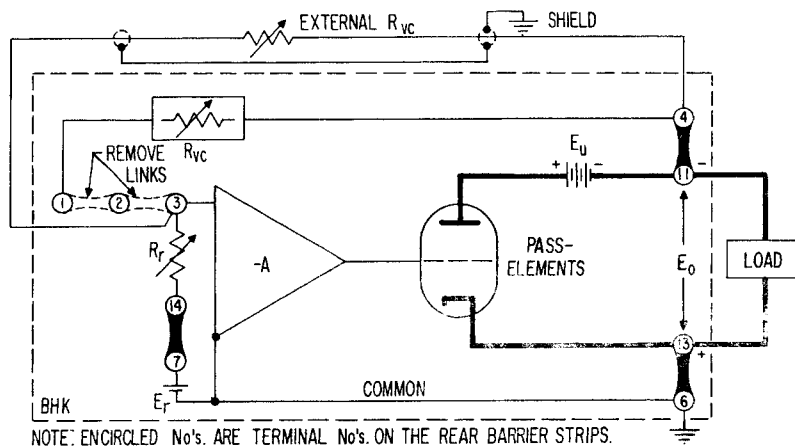

FIG. 3-6 SETUP FOR RESISTANCE PROGRAMMING (VOLTAGE MODE).

3-23 PROCEDURE (Refer to FIG. 3-6).

- Remove links between terminals (1)—(2)—(3) at the rear barrier-strip TB301. (The double link is used for insulation since the full output voltage may appear across terminals (1) and (3).
- Using a shielded, twisted-wire pair (the voltage rating of the cable must be at least equal to the maximum output voltage of the BHK power supply), connect the external resistance to the rear barrier-strip as shown. Programming may commence after turn-on and warm-up period.
- If high accuracy and linearity are required, the programming ratio of 1000 ohms per volt may be precision calibrated as directed in paragraph 3-28.
- Voltage mode resistance programming may be performed at standard speed or the power supply may be converted to the high speed operating mode as described in paragraph 3-32.

3-24 OUTPUT CURRENT PROGRAMMING WITH EXTERNAL RESISTANCE

3-25 The output current of the BHK power supply may be controlled remotely by disconnecting the internal CURRENT ADJUST potentiometer and substituting an external control resistor. All necessary connections can be made at the barrier-strips. If the standard programming ratio is retained, 1000 ohms of control resistance will produce the full output current. The ratio of ohm/milliampere is therefore: 1000 ohms/ $I_{o\ max.}$. The programming resistors may take the form of another rheostat or it can be a fixed resistor or a group of resistors which are step-switch or relay controlled. Criteria for the selection of programming resistors have been established in paragraph 3-19. If extreme linearity is required, the programming ratio may be precision calibrated as described in paragraph 3-28. Current mode resistance programming may be performed at standard speed, or the power supply can be converted to the high speed operating mode as described in paragraph 3-32.

3-26 In the high speed mode, full advantage can be taken of the fast slewing speed of the BHK group. The BHK power supply comes very close to the properties of an ideal current source. Its output impedance is very high because of high-loop gain and the absence of an output capacitor. Due to its high bandwidth, its amplifier will respond quickly to changes in load resistance and load current transients will be short. (Refer also to paragraph 3-28).

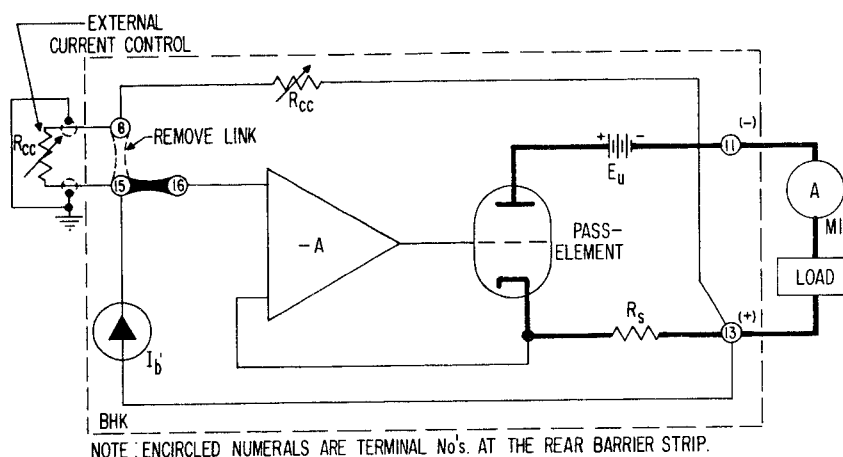

FIG. 3-7 OUTPUT CURRENT PROGRAMMING WITH EXTERNAL RESISTANCE.

3-27 PROCEDURE (Refer to FIG. 3-7).

- Remove link between terminals (8) and (15) at the rear barrier-strip.
- Using a shielded, twisted-wire pair, connect the external resistor (1000 ohms, wirewound, single or multiturn) to the rear barrier-strip as shown. The external control resistor is now in series with the internal R_{cc} which is turned to zero (completely counterclockwise). M1 is a d-c ammeter with a range including the maximum output current of the BHK power supply.
- After turn-on, turn the external current control clockwise to its maximum position. Locate R12 (see FIG. 5-1) and adjust to exactly maximum rated output current. Programming can commence after turn-on and warm-up.
- If the linearity or accuracy is not sufficient for the application at hand, a precision programming ratio may be established as shown in paragraph 3-28.

3-28 INITIAL ADJUSTMENTS FOR PRECISION PROGRAMMING

3-29 In the BHK Power Supply Series, the control currents for the voltage and current comparison circuits (I_b and I_b') are adjusted to a nominal 1 milliampere value to provide maximum rated output in the respective operating modes. The 1 mA control current establishes control ratio of 1000 ohms per volt in the voltage mode of operation and 1000 ohms per volt of sensing in the current mode. Since one volt of sensing is used at maximum output current, the ohm/milliampere ratio for the BHK Series is:

- 10 ohms per milliampere (BHK 2000-0.1M)
- 5 ohms per milliampere (BHK 1000-0.2M)
- 2.5 ohms per milliampere (BHK 500-0.4M)

Internal trim resistors are provided for the adjustment of the control currents (and with it, the programming ratios) $\pm 5\%$ around their nominal values. Adjustment is not required if the power supply is used in the local control mode, except perhaps after replacement of components directly associated with the control circuit. Precision calibration may, however, be readily performed for external programming with precision decades or other highly accurate components. The procedures are described below.

3-30 PROGRAMMING RATIO ADJUSTMENT, VOLTAGE MODE (Refer to FIG's. 3-8 and 3-9.)

- a) Equipment required:
 - 1) Precision digital or differential voltmeter (M1).
 - 2) Precision resistor, accuracy equal to or better than M1. The value is not important but must be known. For every 1000 ohms, 1 volt will appear across M1. The resistor will be externally connected and functions as the voltage control resistance, R_{VC} .
 - 3) SPST switch (S1).
- b) **With the line power removed** from the power supply, disconnect links on the rear barrier-strip TB301 between terminals (1)—(2)—(3). (The double link is used for insulating purposes since the voltage across (1) and (3) may equal the maximum output voltage.)
- c) Connect external components as shown in FIG. 3-9. Turn line power "on". With S1 open and R_{VC} , for example, 100K ohms, approximately 100 volts output voltage will be read on M1.
- d) Locate R8 (E_o MAX) and R28 (E_{io} NULL) by referring to location drawing FIG. 5-4. Close S1 and adjust R28 to precisely zero volts on M1. Open S1 and adjust R8 for exact 100V on M1. This concludes the programming ratio adjustment in the voltage mode. Careful adjustment will yield excellent linearity.

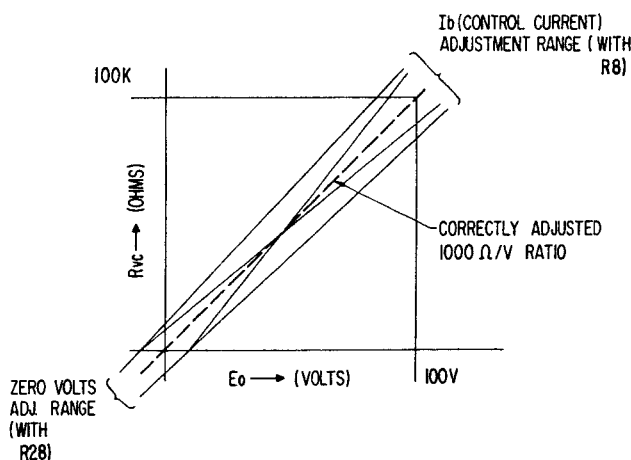

FIG. 3-8 ESTABLISHING PROGRAMMING LINEARITY.

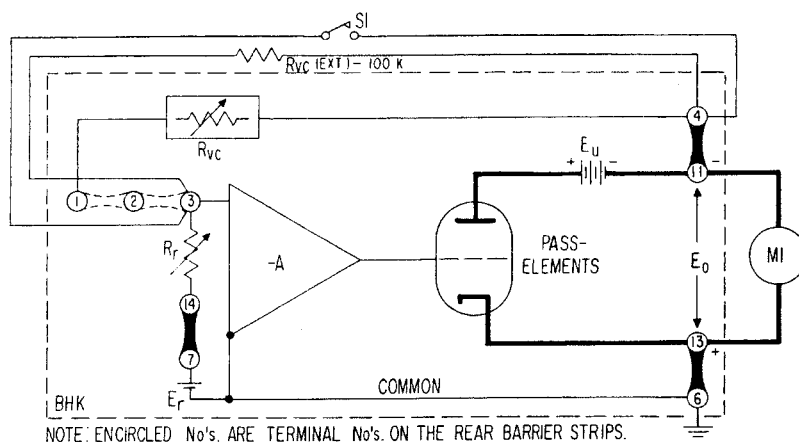

FIG. 3-9 SETUP FOR PRECISION PROGRAMMING RATIO ADJUSTMENT, VOLTAGE MODE.

3-31 PROGRAMMING RATIO ADJUSTMENT, CURRENT MODE (Refer to FIG'S. 3-10, 3-11).

- a) Equipment required:
- 1) Precision differential or digital voltmeter.
 - 2) Precision d-c ammeter, range according to maximum output current.
 - 3) Trim resistor, 100 ohms, 10-turn.
 - 4) External current control resistor. An adjustable resistor in the range from 0-1000 ohms will control the full output current range.
- b) With line power removed from the power supply, connect the d-c ammeter directly across the output terminals. Turn front panel CURRENT ADJUST completely counterclockwise.
- c) Turn line power "on" and turn CURRENT ADJUST slowly clockwise to its end stop. Read the maximum output current on the precision ammeter and adjust (by turning $I_{o\ max}$ control R12) until the rated value is reached.
- d) No internal zero adjustment is provided in the current mode amplifier; a negative offset in the millivolt range is present. For precision external programming in the current mode of operation, this offset may be zeroed by the insertion of a small trimming resistor in series with the CURRENT ADJUST control. The internal CURRENT ADJUST on the front panel now functions (with the additional external trim resistor) as a zero control. A setup is illustrated with this additional resistor (100Ω) in place (see FIG. 3-11) and an external current control connected. While the internal R_{CC} and the trim rheostat R_T set the zero point of I_o , the external R_{CC} sets the maximum point of I_o . This concludes the programming ratio adjustment in the current mode. Careful adjustment will yield excellent linearity.

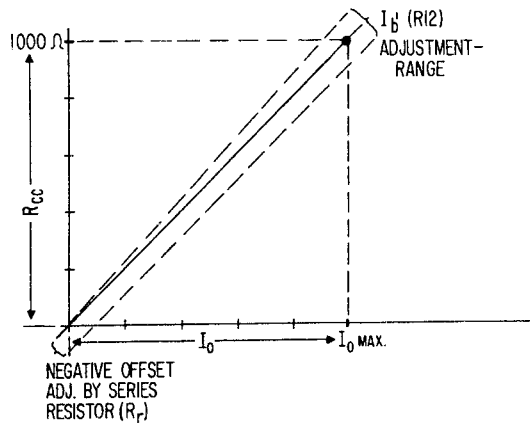

FIG. 3-10 ESTABLISHING PROGRAMMING LINEARITY (CURRENT MODE).

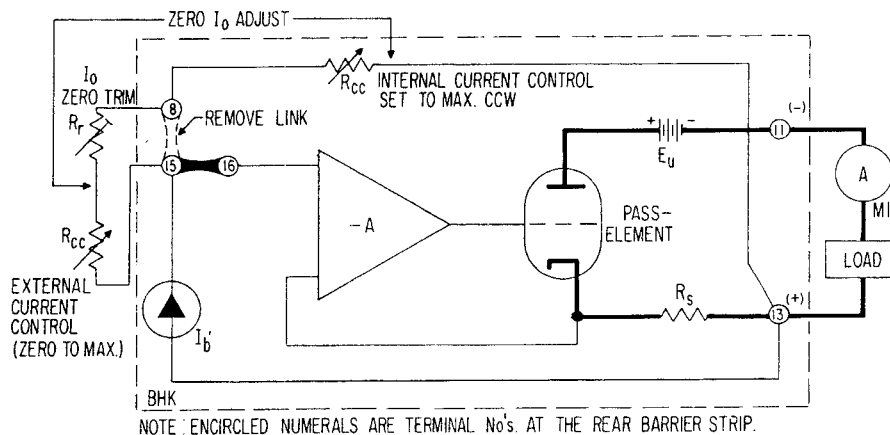

FIG. 3-11 SETUP FOR PRECISION PROGRAMMING RATIO ADJUSTMENT, CURRENT MODE.

3-32 HIGH SPEED PROGRAMMING

3-33 Modern voltage and current regulated power supplies represent a compromise between the opposing characteristics of an ideal voltage source and an ideal current source.

A good **voltage** regulator should have such properties as low output ripple, low output impedance, and good stability in the presence of loads with capacitive or inductive content. For this reason a voltage regulator relies heavily upon the qualities of a large output capacitor with its low terminal impedance (which decreases with increasing frequency), its good energy storage capability, its resistance to instantaneous voltage changes, and its large phase lag.

On the other hand, a good current regulator should have a very high output impedance and its terminal voltage should be capable of rapidly assuming any value (within the rated output range) as may be needed to keep the output current constant while the load is changing.

The BHK power supply is designed to perform a dual function as a voltage regulator and as a current regulator source (as well as being an "operational" amplifier using the voltage mode amplifier). For voltage regulator duty, heavy output and feedback capacitors are used, and excellent stability with low ripple is achieved. For current regulator duty or for **high speed programming** in the voltage mode, the BHK power supply may be converted to **high speed** operation by disconnecting the output and feedback capacitors from the circuit. Removable jumper-links are provided on a printed circuit board (PCB-5,A5), accessible from the top after the cover has been removed. (Refer to FIG. 3-12).

WARNING

REMOVE LINE POWER FIRST!

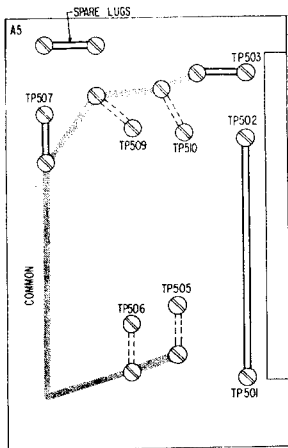

FOR HIGH SPEED CONVERSION

Remove jumpers between terminals:

Common + TP503

Common + TP507

TP501 + TP502

FOR ADDITIONAL FEEDBACK CAPACITANCE

Connect jumpers between terminals:

Common + TP505 = 680 pF

Common + TP506 = 400 pF

Common + TP509 = 1000 pF

Common + TP510 = 3900 pF

or a combination thereof

FIG. 3-12 CONVERSION TO HIGH SPEED OPERATION.

3-34 The output capacitor, and to a lesser extent the feedback capacitor of a power supply, control the programming speed and the current mode recovery time. The removal of these capacitors results in greatly improved performance of the power supply in these areas. The power supply's a-c stability, however, is greatly reduced, making it sensitive to the load phase angle. For this reason the load should be as nearly a pure resistance as possible. The programming speed of the BHK power supply with the capacitors disconnected is in excess of 5×10^5 volts per second, and the current recovery time, a direct function of the programming speed, is therefore better than 0.5 volts per microsecond. When these capacitors are removed, there will be a small increase in the ripple and noise (mainly high frequencies and pick-up), therefore shielding and good grounding practices are especially important in the high speed mode. Built-in, adjustable lag networks and a group of selectable feedback capacitors in the BHK power supply serve to stabilize the amplifier for a small range of load phase angles when operating in the high speed mode. With the large output and feedback capacitors removed and the circuitry stabilized by means of the lag networks, the power supply assumes the characteristics of a wide-band amplifier. The output impedance will be high, especially at high frequencies, and the response to step voltage programs is greatly improved. For example, the conventional speed BHK will respond to a 50 volt step in 0.1 seconds (connected as a normal power supply). In the high speed operating mode, it will respond to the same step in 0.1 milliseconds; an improvement of 1000:1!

3-35 LAG NETWORK ADJUSTMENTS

3-36 The built-in lag networks in the BHK power supply have been adjusted with the instrument in the high speed operating mode working into a resistor load while voltage programmed with a square wave. The factory alignment procedure is readily duplicated and described below. The lag networks must be **readjusted by the user to stabilize the power supply when operating into other than purely resistive loads**. In addition to the lag networks, small feedback capacitors are provided which may be selected across the voltage control resistor. (Refer to FIG. 3-12). As all high gain feedback amplifiers, the BHK power supply may become unstable for capacitive loads. Paragraph 3-44 describes a possible solution to this problem.

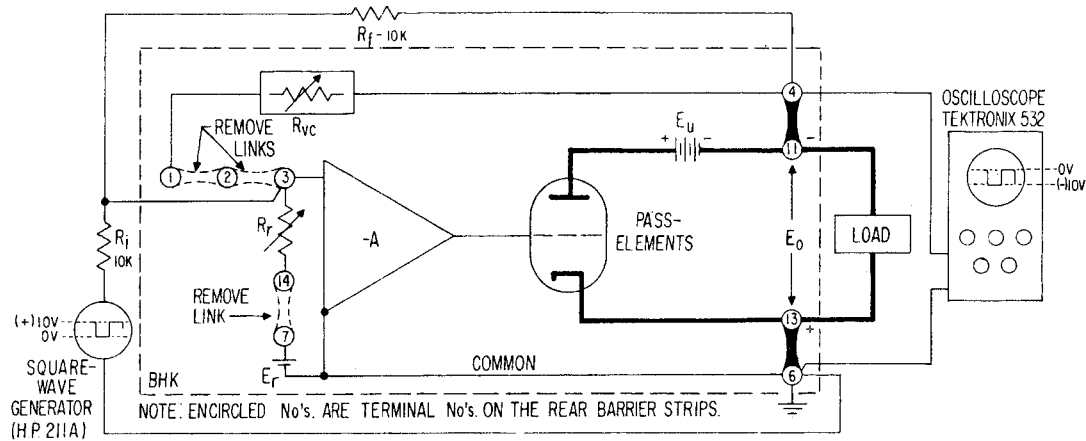

FIG. 3-13 SETUP FOR LAG NETWORK ADJUSTMENTS.

3-37 PROCEDURE

- a) Equipment required:
 - 1) Oscilloscope, Tektronix Model 545 or equivalent.
 - 2) Square-wave generator, HP Model 211A or equivalent.
- b) Connect test setup as shown in FIG. 3-13.
- c) Select a unity gain ratio by adjusting the feedback resistor \$R_f\$ to the same value as the input resistor \$R_i\$ (ratio 1:1). Locate the lag networks by referring to FIG. 5-4.
- d) Turn instruments on and observe input and output waveforms. Adjust the lag networks to provide the desired amount of damping.

3-38 OUTPUT VOLTAGE PROGRAMMING WITH EXTERNAL CONTROL VOLTAGE

3-39 The control of the output voltage source by means of another external voltage source is termed "voltage programming". In this mode of operation, the internal reference source is disconnected, and the control current is supplied by the external programming source. Voltage programming can be mathematically expressed by referring to the balancing equation of the voltage comparison circuit:

$$\frac{E_r}{R_r} = \frac{E_o}{R_{vc}} \text{ (Eq. 4),}$$

solving for \$E_o\$:

$$E_o = -E_r \frac{R_{vc}}{R_r} \text{ or } E_o = -E_i \frac{R_f}{R_i},$$

using the operational terminology, where \$E_i\$ is now the input voltage, \$R_f\$ and \$R_i\$ the feedback and input resistors respectively. The last expression is the equation for an inverting operational amplifier. The power supply becomes in effect a unipolar amplifier with very high power gain (and considerable bandwidth if first converted for high speed operation; refer to paragraph 3-32 for conversion procedure.) If the closed-loop gain \$R_f/R_i\$ is held constant, \$E_o\$ becomes a linear function of \$E_i\$.

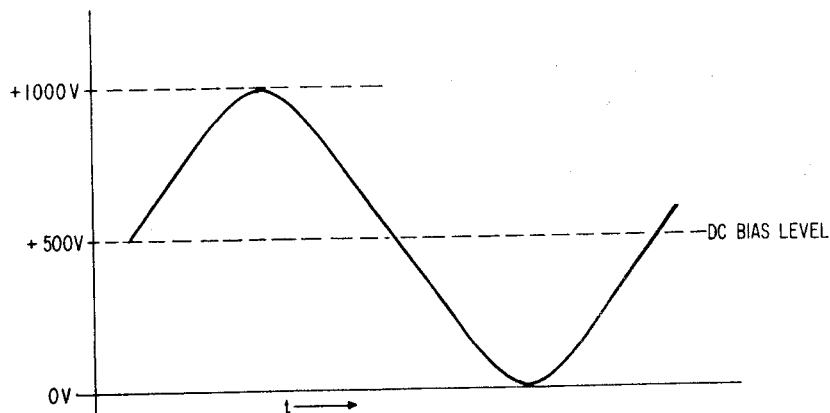

FIG. 3-14 BHK POWER SUPPLY SINE WAVE PROGRAMMED.

3-40 Before programming, the amplifier offsets should be nulled by following the procedures described in paragraph 3-28. It must be remembered that the BHK power supply is a **unipolar** device. Since its output can vary in **one** direction only, the input source must also be unipolar (positive going only) or the output level must be set by d-c biasing the input in such a way that it can accommodate the amplified signal if the input is bipolar. Two examples illustrating component selection and d-c biasing will be given below:

Example I: A BHK 1000-0.2M is to be sine wave programmed from a source having a bipolar output of 20V peak-to-peak into 600 ohms. The maximum output swing possible for the BHK power supply is equal to its maximum output voltage or 1000 volts peak-to-peak. In order to achieve this output from a bipolar input, the d-c output level must be preset to 500V d-c (midpoint) so that our amplified sine wave signal can swing around the 500V bias axis. (Refer to FIG. 3-14). Applying the operational equations to both required a-c and d-c conditions, we can calculate the necessary circuit components as follows:

- a) D-C. The 500V d-c bias may be achieved two ways. We can either retain the standard 1 mA control current and change the feedback resistor to 500K ohm, or we can retain the internal voltage control as the feedback resistor (1M ohm at the fully clockwise position) and alter the control current to 0.5 mA. If we choose to do the latter, the links between rear barrier-strip terminals (7) and (14) must be opened and an additional trim resistor inserted to reduced I_b . Its value is calculated by the known d-c condition and equation (6).

$$E_o = I_b R_{vc}, E_o = 500V$$

$$R_{vc} = 1 \text{ M ohm.}$$

$$I_b = \frac{500V}{1 \times 10^6 \text{ ohm}} = 0.5 \text{ mA}$$

Since $I_b = E_r/R_r$ and E_r is known to be 6.2V (nominal)

$$R_r = \frac{6.2V}{0.5 \text{ mA}} = 12.4 \text{ K ohms.}$$

Since approximately 6.2K are already in the circuit, an additional 6.2K ohm resistor is needed. Choosing a 10K ohm wirewound trim rheostat will allow us to precision adjust the control current to 0.5 mA.

- b) A-C. E_o required = 1000V p-p.

$$E_i = 20V \text{ p-p (available drive signal).}$$

The gain required therefore equals $G = E_o/E_i = R_r/R_i = 50$ and $R_i = \frac{1 \text{ meg}}{50} = 20K \text{ ohms.}$

The complete programming setup is now connected to the rear barrier-strips as shown in FIG. 3-15 below, and operation can commence. From the frequency response chart (FIG. 3-14), it is seen that the BHK in the high speed configuration (specified slewing rate = $5 \times 10^5 V/sec.$) has a sine wave frequency response of approximately 200 Hz under full load before slope distortion sets in.

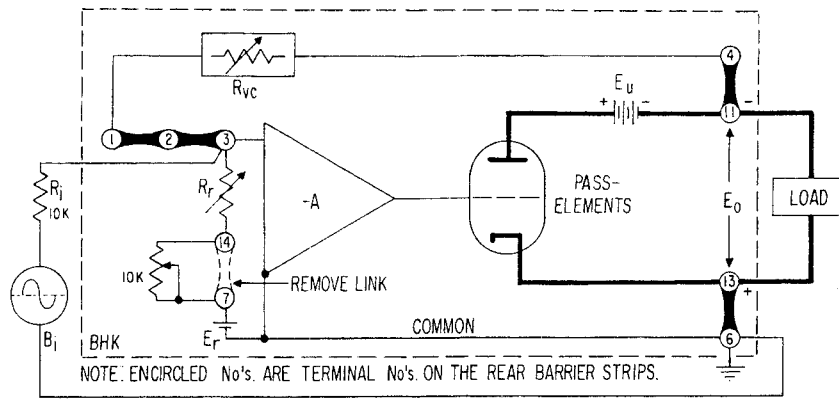

FIG. 3-15 SETUP FOR VOLTAGE PROGRAMMING WITH A BIPOLAR SINE WAVE.

Example II: The output of a Model BHK 500-0.4M is to be programmed with a triangular wave from zero to the maximum output voltage. The programming source is a triangular-wave generator with a maximum positive output of 20 volts and can deliver 1 mA of control current. R_i is thereby given:

$$R_i = E_i / I_b = 20K \text{ ohms.}$$

The internal voltage control resistance will be retained and used as R_f by turning both front panel controls (VOLTAGE SELECTOR and VOLTAGE ADJUST) to their maximum clockwise position. (In this position $R_f = 500K$ ohms.) The internal reference source will be disconnected since our input source is unipolar (positive) and will deliver the control current. (No d-c bias is needed).

The programming setup is now connected to the rear barrier-strips as shown in FIG. 3-16, and operation can commence. FIG. 3-16 also shows the resulting waveform.

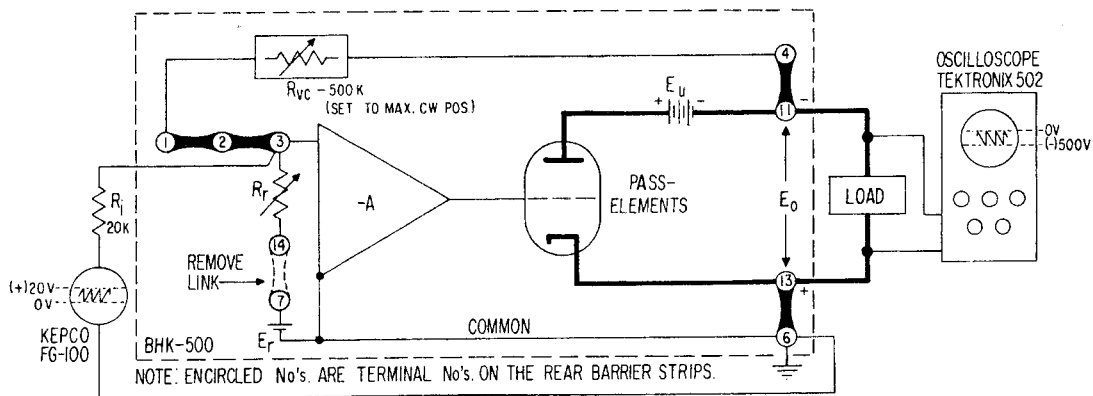

FIG. 3-16 SETUP FOR VOLTAGE PROGRAMMING WITH A POSITIVE SAWTOOTH WAVE.

3-41 OUTPUT CURRENT PROGRAMMING WITH EXTERNAL VOLTAGE.

3-42 The output current of the BHK power supply may be controlled by an external programming voltage (E_i). The internal current generator is disconnected from the current mode amplifier and replaced by a variable (0-1 volt) source. The output current will be controlled in accordance with the equation $I_o = E_i / R_s$, where R_s is the internal current sensing resistor. Since the product I_o (max.) R_s equals always 1 volt in all BHK Power Supplies, varying E_i from 0 to 1 volt will vary the output current from zero to its maximum value. E_i must be extremely stable and free of noise and ripple since any change in E_i (ΔE_i) will be reproduced as part of the output current in the ratio: $\Delta I_o = \Delta E_i / R_s$.

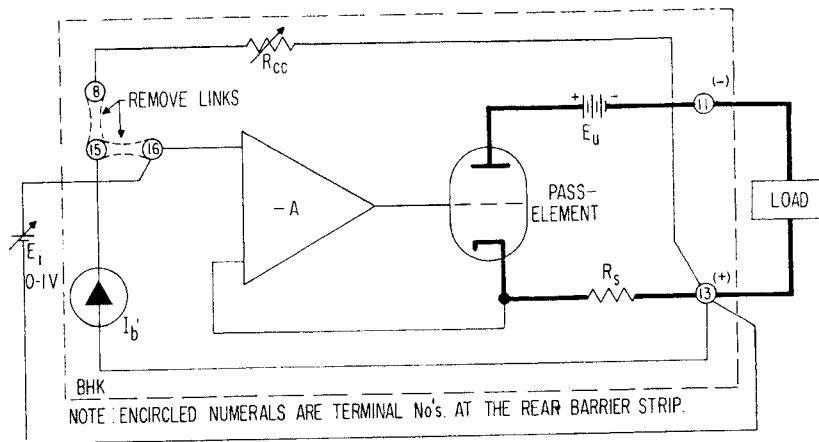

FIG. 3-17 OUTPUT CURRENT PROGRAMMING WITH EXTERNAL VOLTAGE.

3-43 PROCEDURE (Refer to FIG. 3-17).

- a) Remove link between terminals (8), (15) and (16). This disconnects the internal current generator I_b and the internal CURRENT ADJUST control.
- b) Connect external programming source E_i as shown. Varying E_i from zero to 1 volt will vary the output current from zero to its maximum rated value.

3-44 CAPACITIVE LOADING

3-45 The Kepco BHK Group of power supplies can drive reactive loads at reduced slewing rates with appropriate adjustments of the lag networks. (See paragraph 3-35, "Lag Network Adjustment".)

If loads with a larger capacitive content must be driven, several techniques can be used, including the use of additional capacitance across the feedback terminals (see FIG. 3-12), alteration of the fixed internal lag networks or use of isolation resistance in series with the load. The latter method may be used in two variations.

- a) **SERIES RESISTOR EXTERNAL TO FEEDBACK LOOP.** The advantage of this method is that the network equations are not affected. The disadvantage of this method is the rise in output impedance, evidenced by degraded load regulation. (Refer to FIG. 3-18).

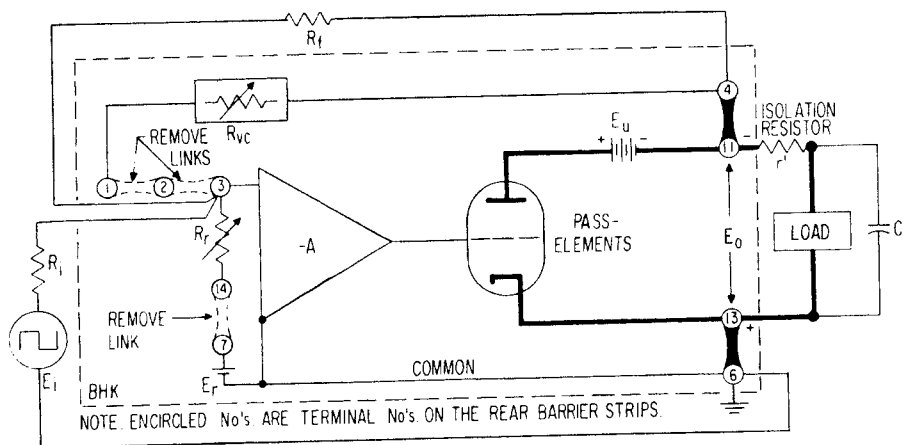

FIG. 3-18 SERIES RESISTOR EXTERNAL FEEDBACK LOOP.

- b) **SERIES RESISTOR INSIDE THE FEEDBACK LOOP.** The advantage of this method is that the isolation resistance (r') will not affect the output impedance (load regulation). The disadvantage of this method is that r' must be considered part of the feedback resistance R_f and will enter the operational amplifier equation:

$$E_o = -E_i \frac{R_f + r'}{R_i}$$

Also, the voltage drop across is, of course, lost and must be subtracted from the maximum output voltage of the model BHK power supply. When using this method, C302 and CR302 must be disconnected from the printed circuit board assembly A3. (See FIG. 5-3 for location).

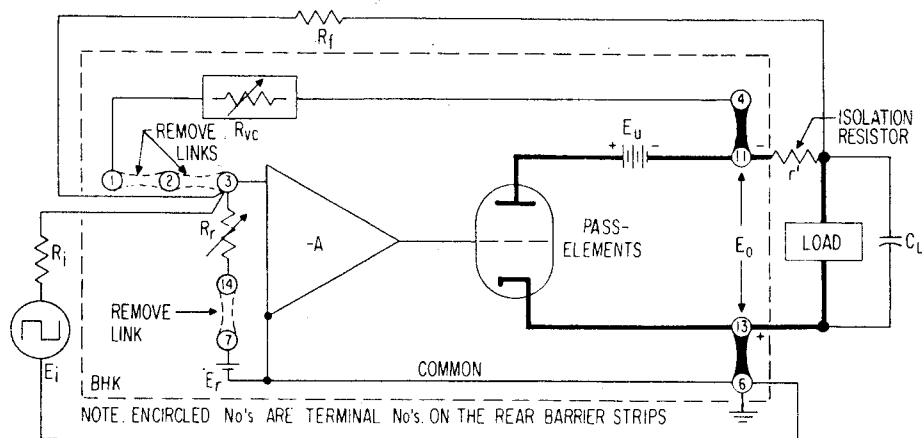

FIG. 3-19 SERIES RESISTOR PART OF FEEDBACK LOOP.

3-46 The method best suited for a particular load must, of course, be chosen in view of the desired advantages, as described above. The best technique for the assurance of maximum stability consists of minimizing load capacitance as much as possible since any compensating measure has the disadvantage of narrowing the amplifier's bandwidth and slowing down the slewing rate of the device.

3-47 SERIES OPERATION

3-48 General. Kepco BHK power supplies can be series-connected for increased voltage output, provided the necessary precautions are taken.

- DO NOT EXCEED THE SPECIFIED ISOLATION VOLTAGE LIMIT OF 1000 VOLTS. Up to 1000 volts may be connected in series with any BHK model. If two Models BHK 2000-0.1M are to be series-connected, the output of one must be restricted to 1000 volts.
- WHEN SERIES CONNECTED, EACH SUPPLY SHOULD BE PROTECTED BY MEANS OF A SEMICONDUCTOR DIODE ACROSS ITS OUTPUT TERMINALS as shown in FIG. 3-20. The peak inverse voltage of these diodes must be greater than the output voltage of the supply to which they are connected. The continuous current rating of the diodes should be greater than the largest short circuit current of the series-connected supplies.
- THE USER IS AGAIN REMINDED OF THE DANGER INVOLVED WHEN HANDLING HIGH VOLTAGE, LOW IMPEDANCE EQUIPMENT. Please review the precautionary notes presented earlier in this section. (Refer to paragraph 3-19)
- USE THE RECOMMENDED GROUND CONNECTION if at all possible. Instead of grounding the positive output as shown (see FIG. 3-20), the negative output of the series combination may alternately be grounded if necessary, but special precautions are required when using external programming sources and a negative ground. Since the "common" lead is now "floating" with a high voltage above ground, the **programming source must be isolated** for the sum of the voltages of the series connected power supplies. Since this is ordinarily not the case with signal generators or other input sources, isolation transformers may have to be used in such applications.
- (Refer to FIG. 3-20). If error sensing is not required, the jumper-links (shown removed in FIG. 3-20) may be reconnected, and the error-sensing leads may be deleted. All external leads connected to the supply (as well as the load itself) must be insulated for the maximum output voltage produced by the series combination.

3-49 Two basic series connection methods are generally used, the "automatic series connection" as described before and as shown in FIG. 3-20 and the "master-slave" connection shown in FIG. 3-21 and discussed below. The basic difference between the two alternate connections is that in the "automatic" connection the outputs of both supplies may be controlled or programmed individually, while in the "master-slave" connection only the "master" supply is controlled, while the "slave" follows the command of the master in a ratio which may be predetermined by the user. This method of series connection is therefore often termed "automatic tracking."

3-50 ALL PRECAUTIONARY NOTES AND GENERAL INFORMATION AS GIVEN IN PARAGRAPH 3-48 ARE EQUALLY VALID FOR THIS METHOD. Please refer to these previous paragraphs. The principle of operation of the series connection is as follows. As seen from FIG. 3-21, the reference voltage of the "slave" supply is disconnected and its input is connected to the output of the "master" supply thus making the "slave" supply completely dependent upon the output voltage of the "master".

$$E_{os} = E_{om} \frac{R_{vcs}}{R_t}, \text{ where } \begin{array}{l} E_{om} = \text{Output voltage "master"} \\ E_{os} = \text{Output voltage "slave"} \\ R_t = \text{Tracking resistor} \\ R_{vcs} = \text{Voltage control resistor, "slave"} \end{array}$$

As seen from the above, if the tracking resistor value is made equal to the value of the "slave" voltage control, a "tracking" ratio of 1:1 is achieved, and the output of the "slave" will equal that of the "master." If a single load is connected to the series combination, twice the master output is applied to it; if separate loads are connected (shown in dashes lines in FIG. 3-21), identical voltages are applied to the individual loads.

3-51 The ratio E_{os}/E_{om} can be readily changed, if the application so requires, by simply altering either R_{vcs} or R_t . If required, error sensing may be used, the connection method being equivalent to that shown in FIG. 3-20.

3-52 PARALLEL OPERATION

3-53 GENERAL. Kepco BHK Power Supplies can be parallel connected for increased load current output. As in the previously described series connections, an "automatic" or a "master-slave" connection method can be chosen. For applications requiring up to 3 units in parallel, the "master-slave" method is recommended since it overcomes some of the disadvantages of the "automatic" parallel connection. For more than 3 units, the "automatic" method should be used. Details on each method are presented in the following paragraphs. For either method, some general rules apply which should be observed in paralleling power supplies.

- a) Error sensing (from either supply) may be used as shown in the diagram. Close links if this is not desired.
- b) Load wires should be as short as practicable. Select the wire gauge as heavy as possible and twist tightly. Approximately equal lengths of wire should be used.

3-54 AUTOMATIC PARALLEL OPERATION. BHK power supplies may be connected in parallel as indicated in FIG. 3-22. Although only two supplies are shown, the method may readily be expanded to include more than two units. Once the outputs are paralleled as shown, each supply is adjusted to approximately the same output voltage. After turn-on, one of the supplies (#1 in FIG. 3-22) will be at a slightly higher voltage than all others. Consequently, this supply will deliver all the load current up to the setting of its current control and will then transfer into the current mode (indicated at the front panel). As the load current increases, supply #2 (or the supply with the next higher output voltage) will take over and deliver the additional current up to its current control setting and so on. The current control setting of the supply which is NOT in the "current mode" should now be reduced until all supplies share the load current equally as indicated on their front panel meter. FIG. 3-23 shows in form of a diagram how two supplies operate in parallel with their respective current controls set so that both operate in the "voltage mode." It will be obvious from the diagram that the areas of load regulation are within the output current bands of the individual supplies only. Therefore, load regulation cannot be measured from zero to twice the load current, for example, but only within the individual load current bands.

NOTE: When paralleling power supplies, care should be exercised to avoid turning the voltage control of **only one** supply close to zero. This precaution is necessary to prevent possibly damaging currents in the voltage control resistor as its limiting resistance is lowered.

3-55 MASTER-SLAVE PARALLEL CONNECTION. Two BHK power supplies are shown in this configuration in FIG. 3-24 although up to 3 units can be connected this way: two "slaves" and one "master" unit. The amplifier of the "slave" unit is disconnected from its own pass elements which are now driven from the "master" amplifier. A shielded lead, connected from the "master" amplifier to the pass elements of the "slave" unit is connected as shown. Error sensing from the "master" unit may be used.

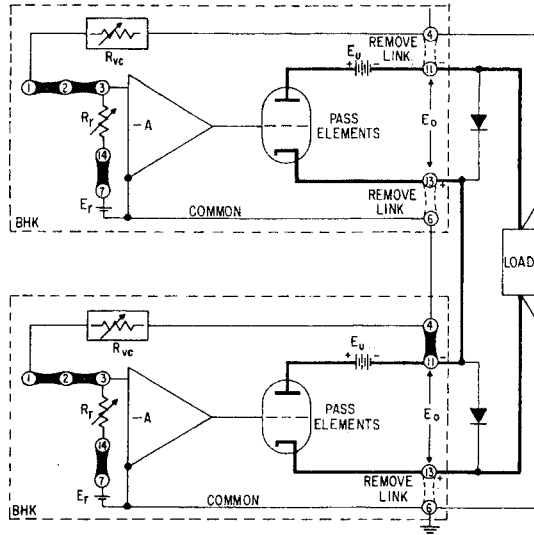

NOTE: ENCIRCLED NO'S ARE TERMINAL NO'S ON THE REAR BARRIER STRIP

FIG. 3-20 "AUTOMATIC" SERIES CONNECTION
(INDIVIDUAL OUTPUT CONTROL).

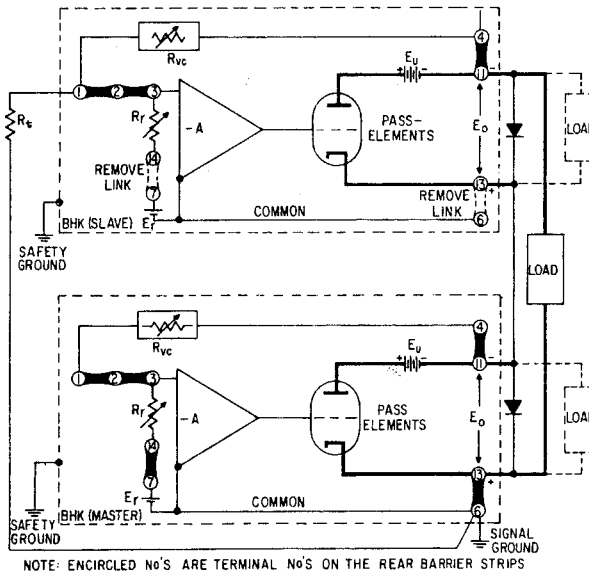

NOTE: ENCIRCLED NO'S ARE TERMINAL NO'S ON THE REAR BARRIER STRIPS

FIG. 3-21 "MASTER-SLAVE" SERIES CONNECTION
(MASTER UNIT CONTROL OF OUTPUT).

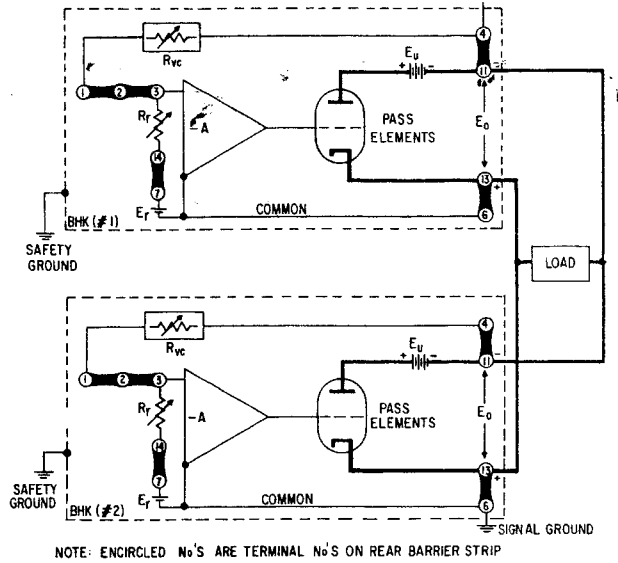

FIG. 3-22 "AUTOMATIC" PARALLEL CONNECTION.

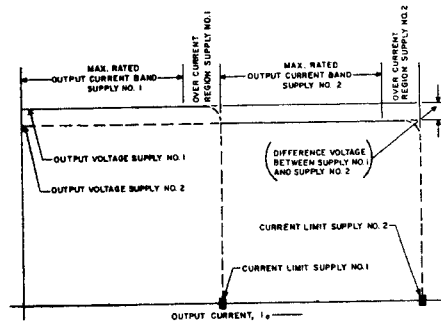

FIG. 3-23 AUTOMATIC PARALLEL OPERATION OF BHK POWER SUPPLIES.

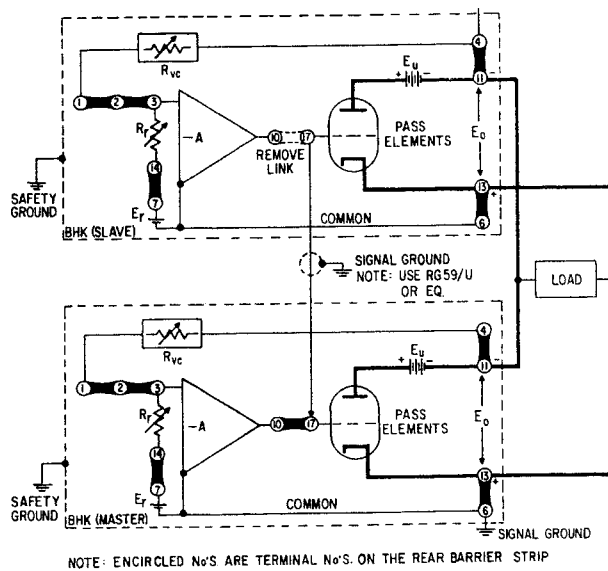

FIG. 3-24 "MASTER-SLAVE" PARALLEL CONNECTION.