

**Instruction Manual
Model 179A
TRMS Multimeter**

**©1982, Keithley Instruments, Inc.
Cleveland, Ohio, U.S.A.
Document Number 32430**

SPECIFICATIONS

DC VOLTS

RANGE	RESOLUTION	ACCURACY (1 YEAR) 18°-28°C		MAXIMUM ALLOWABLE INPUT
		± (%rdg + digits)		
200mV	10 µV	0.04% + 3d		1200V†
2 V	100 µV	0.04% + 1d		1200V†
20 V	1mV	0.04% + 1d		1200V†
200 V	10mV	0.04% + 1d		1200V†
1200 V	100mV	0.04% + 1d		1200V†

†For 10 seconds. ‡Continuous.

TEMPERATURE COEFFICIENT (0°-18°C & 28°-55°C): ± (0.006% + 0.2d) /°C except ± (0.006% + 0.4d) /°C on 200mV range.

INPUT RESISTANCE: 10MΩ ± 0.1%.

NORMAL MODE REJECTION RATIO: Greater than 60dB at 50Hz and 60Hz.

COMMON MODE REJECTION RATIO (1kΩ unbalance): Greater than 120dB at DC, 50Hz and 60Hz.

SETTLING TIME: 1 second to within 1 digit of final reading.

AC VOLTS

RANGE	RESOLUTION	ACCURACY (1 YEAR) (above 2000 counts) 18°-28°C; 100Hz-10kHz		TEMPERATURE COEFFICIENT 0°-18°C & 28°-55°C	
		± (%rdg + digits)		45Hz-10kHz	10kHz-20kHz
200mV	10 µV	0.7% + 15d		0.07% + 2d	0.15% + 3d
2 V	100 µV	0.6% + 15d		0.07% + 2d	0.15% + 3d
20 V	1mV	0.5% + 15d		0.05% + 2d	0.05% + 2d
200 V	10mV	0.5% + 15d		0.05% + 2d	0.05% + 2d
1000 V	100mV	0.5% + 15d		0.05% + 2d	0.05% + 2d

EXTENDED FREQUENCY ACCURACY:

(45Hz-100Hz): ± (0.7% + 15d).

(10kHz-20kHz): ± (0.8% + 15d) on 20V and higher ranges;

± (1.5% + 15d) on 2V range;

± (2% + 15d) on 200mV range.

RESPONSE: True root mean square.

CREST FACTOR (ratio of peak value to rms value): 3:1.

INPUT IMPEDANCE: 1MΩ shunted by less than 75pF.

MAXIMUM ALLOWABLE INPUT VOLTAGE: 1000V rms, 1400V peak, 10⁷V•Hz maximum.

COMMON MODE REJECTION RATIO (1kΩ unbalance): 60dB at DC, 50Hz and 60Hz.

SETTLING TIME: 2 seconds to within 15 digits of final reading.

DC AND TRMS AC AMPS

RANGE	RESOLUTION	ACCURACY (1 YEAR) 18°-28°C		MAXIMUM VOLTAGE BURDEN	SHUNT RESISTANCE
		± (%rdg + digits)			
200 µA	10 nA	0.2% + 2d	1% + 15d	0.2 V	1 kΩ
2mA	100 nA	0.2% + 2d	1% + 15d	0.2 V	100 Ω
20mA	1 µA	0.2% + 2d	1% + 15d	0.2 V	10 Ω
200mA	10 µA	0.2% + 2d	1% + 15d	0.25V	1 Ω
2000mA	100 µA	0.2% + 2d	1% + 15d	0.6 V	100mΩ
20 A	1mA	0.5% + 2d*	1% + 15d†*	0.5 V	10mΩ

*Add 0.1%rdg above 15A for self-testing.

†1kHz max.

MAXIMUM INPUT: 2A, 250V DC or rms (fuse protected) except for 20A range: 15A continuous, 20A for 1 minute (unfused).

TEMPERATURE COEFFICIENT (0°-18°C & 28°-55°C):

DC ± (0.01% + 0.2d) /°C.

AC ± (0.07% + 2d) /°C.

CREST FACTOR (ratio of peak value to rms value): 3:1.

SETTLING TIME: DC: 1 second to within 1 digit of final reading. AC: 2 seconds to within 15 digits of final reading.

OHMS

RANGE	RESOLUTION	ACCURACY (1 YEAR) 18°-28°C		MAXIMUM VOLTAGE ACROSS UNKNOWN ON RANGE		TEMPERATURE COEFFICIENT 0°-18°C & 28°-55°C		NOMINAL APPLIED CURRENT	
		± (%rdg + digits)		HI Ω	LO Ω	± (%rdg + digits) /°C		HI Ω	LO Ω
		HI Ω	LO Ω	HI Ω	LO Ω	HI Ω	LO Ω	HI Ω	LO Ω
2 kΩ	100mΩ	0.15% + 15d		0.2V		0.02% + 2d		100 µA	
20 kΩ	1 Ω	0.04% + 1d		2V		0.003% + 0.2d		10 µA	
200 kΩ	10 Ω	0.04% + 1d		2V		0.003% + 0.2d		10 µA	
2000 kΩ	100 Ω	0.04% + 1d		2V		0.003% + 0.2d		1 µA	
20MΩ	1 kΩ	0.10% + 1d		2V		0.02 % + 0.2d		0.1µA	

MAXIMUM ALLOWABLE INPUT: 1kV DC or peak AC for 10 seconds, 450V rms continuous.

MAXIMUM OPEN CIRCUIT VOLTAGE: 5V.

SETTLING TIME: 1 second to within 1 digit of final reading except 2 seconds on 20MΩ range. Ohms settling time is specified for on-scale readings. 20MΩ is 5s for overrange to on-scale readings.

GENERAL

DISPLAY: Five 0.5" LED digits, appropriate decimal position and polarity indication.

CONVERSION PERIOD: 400ms.

OVERRANGE INDICATION: Display blinks all zeroes above 19999 counts.

MAXIMUM COMMON MODE VOLTAGE: 1400V peak.

ENVIRONMENT: Operating: 0°-55°C, 0% to 80% relative humidity up to 35°C. **Storage:** -25°C to +65°C.

POWER: 105-125V or 210-250V (switch selected), 90-110V available. 50-60 Hz, 5.5W. Optional 6-hour battery pack, Model 1788.

DIMENSIONS, WEIGHT: 85mm high × 235mm wide × 275mm deep (3 1/2" × 9 1/4" × 10 3/4"). Net weight 1.8kg (4 lbs.).

ACCESSORIES SUPPLIED: Instruction Manual and Model 1691 Test Leads.

ACCESSORIES AVAILABLE:

Model 1010: Single Rack Mounting Kit

Model 1017: Dual Rack Mounting Kit

Model 1301: Temperature Probe

Model 1600A: High Voltage Probe (40kV)

Model 1651: 50-Ampere Current Shunt

Model 1681: Clip-On Test Lead Set

Model 1682A: RF Probe

Model 1683: Universal Test Lead Kit

Model 1684: Hard Shell Carrying Case

Model 1685: Clamp-On AC Probe

Model 1691: General Purpose Test Lead Set

Model 1788: Rechargeable Battery Pack

Model 1792: Isolated BCD Output

Model 1793: Isolated IEEE-488 Output

Model 7008-3: IEEE-488 Cable (3 ft.)

Model 7008-6: IEEE-488 Cable (6 ft.)

TABLE OF CONTENTS

PARAGRAPH	TITLE	PAGE			
SECTION 1 GENERAL INFORMATION					
1.1	Introduction	1-1	4.4	AC Conversion	4-2
1.2	Features	1-1	4.5	Ohms Conversion	4-2
1.3	Warranty Information	1-1	4.5.1	Range Selection	4-2
1.4	Manual Addenda	1-1	4.5.2	Ω Circuit	4-2
1.5	Safety Symbols and Terms	1-1	4.6	A/D Converter	4-3
1.6	Unpacking and Inspection	1-1	4.6.1	Auto-Zero	4-3
1.7	Optional Accessories	1-1	4.6.2	Signal-Integrate	4-3
1.8	Specifications	1-2	4.6.3	Reference-Integrate	4-3
			4.6.4	Reference Voltages	4-3
			4.7	Display	4-4
			4.8	Current Measurements	4-4
			4.9	AC Power Supply	4-4
			4.10	Model 1788 Battery Pack	4-4
			4.10.1	Battery Charging Circuit	4-5
			4.10.2	Battery Operation and Shutdown Circuit	4-5
SECTION 2 OPERATION					
2.1	Preparation for Use	2-1			
2.1.1	Line Power	2-1			
2.1.2	Battery Pack Power	2-1			
2.1.3	Battery Charging	2-1			
2.2	Operating Instructions	2-1			
2.2.1	Environmental Conditions	2-1			
2.2.2	Front Panel Familiarization	2-1			
2.3	DMM Measurements	2-3			
2.3.1	DC Voltage Measurement	2-3			
2.3.2	TRMS AC Voltage Measurement	2-4			
2.3.3	Resistance (Ω) Measurement	2-4			
2.3.4	Current Measurement (DC or TRMS AC)	2-4			
2.3.5	AC and DC Measurement	2-5			
SECTION 3 PERFORMANCE VERIFICATION					
3.1	Introduction	3-1			
3.2	Environmental Conditions	3-1			
3.3	Recommended Test Equipment	3-1			
3.4	Performance Verification Procedure	3-1			
3.5	Initial Conditions	3-1			
3.6	DC Volts Verification	3-1			
3.7	AC Volts Verification	3-2			
3.8	Resistance Verification	3-2			
3.9	DC Current Verification	3-2			
3.10	AC Current Verification	3-2			
SECTION 4 THEORY OF OPERATION					
4.1	Introduction	4-1			
4.2	Overall Operation	4-1			
4.2.1	Signal Conditioning	4-1			
4.2.2	Ohms Conversion	4-1			
4.2.3	A/D Converter	4-1			
4.3	Attenuation	4-2			
4.3.1	DC Volts	4-2			
4.3.2	AC Volts	4-2			
			5.1	Introduction	5-1
			5.2	Calibration Procedure	5-1
			5.2.1	Recommended Test Equipment	5-1
			5.2.2	Environmental Conditions	5-1
			5.2.3	Calibration Shield Installation	5-1
			5.2.4	Calibration Adjustments	5-1
			5.3	Battery Pack (Model 1788) Installation	5-2
			5.4	Troubleshooting	5-2
			5.4.1	Troubleshooting Procedure	5-3
			5.5	Special Handling of Static Sensitive Devices	5-3
			5.6	Battery Charge Voltage Adjustments	5-3
			5.7	Fuse Replacement	5-4
			SECTION 5 MAINTENANCE		
			SECTION 6 REPLACEABLE PARTS		
			6.1	Introduction	6-1
			6.2	Replaceable Parts	6-1
			6.3	Ordering Information	6-1
			6.4	Factory Service	6-1
			6.5	Component Location Drawings	6-1
			6.6	Schematic Diagram	6-1

LIST OF TABLES

TABLE	TITLE	PAGE
2-1	 Model 179A Maximum Allowable Inputs	2-4
3-1	Recommended Test Equipment for Performance Verification	3-1
3-2	DC Voltage Performance Check	3-2
3-3	AC Voltage Performance Check	3-2
3-4	Resistance Performance Check	3-2
3-5	DC Current Performance Check	3-2
4-1	Full Scale A/D Inputs	4-2
4-2	DC Attenuation and Gain Setting Components	4-2
4-3	AC Attenuation Gain Setting Components	4-3
4-4	Resistance Range Setting Components	4-3
5-1	Recommended Test Equipment for Calibration	5-1
5-2	Calibration Adjustments	5-2
5-3	Voltage Levels	5-3
5-4	Signal Tracing Levels	5-4
5-5	Model 179A Static Sensitive Devices	5-4
5-6	Fuse Replacement	5-5
6-1	Model 179A Mother Board PC-492, Parts List	6-2
6-2	Model 179A Display Board PC-485, Parts List	6-4
6-3	Model 1788 Battery Pack PC-451, Parts List	6-5
6-4	Recommended Spare Parts	6-5

LIST OF FIGURES

FIGURE	TITLE	PAGE
2-1	Rear View Showing Line Switch	2-2
2-2	Front Panel Familiarization	2-2
2-3	DC Voltage Measurement	2-3
2-4	AC Voltage Measurement	2-4
2-5	Resistance (Ω) Measurement	2-4
2-6	Current Measurement Up to 2000mA	2-5
2-7	Current Measurement Between 2000mA and 20A	2-5
4-1	Simplified Signal Flow Block Diagram, Model 179A DMM	4-1
4-2	Attenuation and Ohms Conversion	4-1
4-3	A/D Converter Function	4-4
6-1	Miscellaneous Parts	6-1
6-2	Model 179A Display Board PC-485, Component Location Drawing 29663	6-6
6-3	Model 1788 Battery Pack PC-451, Component Location Drawing 29007	6-6
6-4	Model 179A Display Board PC-492, Component Location Drawing 32045	6-7
6-5	Model 179A and 1788, Schematic Diagram 32046	6-9

SECTION 1

GENERAL INFORMATION

1.1 INTRODUCTION

The Model 179A is a precision 4½ digit TRMS multimeter useful for measurement of AC and DC voltage, AC and DC current and resistance. Ranges and accuracies are listed in the detailed specifications which precede this section. Ranges and functions are selected with front panel push buttons (see Figure 2-2). The decimal point is also positioned by the selected range push button. Polarity of the measured signal is automatically displayed.

1.2 FEATURES

The Model 179A includes the following features:

- TRMS AC measurement capability gives waveform-insensitive measurement accuracy to applications such as solid-state regulator design, measurement of power transformer input currents and capacitor ripple currents.
- AC and DC CURRENT ranges allow continuous measurements of up to 15A or periodic measurement up to 20A.
- 10µV AC and DC sensitivity
- HI-LO Ohms. In the HI mode, enough voltage can be applied to semiconductors to turn them on for a test. LO can be used for in-circuit measurements without turning on semiconductor junctions. Full-scale compliance voltage is 2V on HI, 200mV on LO.
- 1kV protection on Ω. 1000V overload protection on ohms eliminates accidental damage due to improper function selection.
- Optional BCD output. The Model 1792 Isolated BCD Output may be ordered and is field installable.
- Optional IEEE-488 data output. The Model 1793 IEEE-488 Interface can be ordered with the unit, or can be easily field-installed with a screwdriver. It is powered internally from the instrument. With the interface and any of the low cost controllers now on the market, it is possible to set up an economical, automated test system that saves the time of manually recording, transcribing and entering large amounts of measurement data.

1.3 WARRANTY INFORMATION

Warranty information is provided on the inside front cover of this manual. If there is a need to exercise the warranty, contact the Keithley representative in your area to determine the proper action to be taken. Keithley maintains complete repair and calibration facilities in the United States, West Germany, Great Britain, France, the Netherlands, Switzerland and Austria. Information concerning the application, operation or service of your instrument may be

directed to the applications engineer at any of the previously mentioned locations. Check the inside front cover of this manual for addresses

1.4 MANUAL ADDENDA

Improvements or changes to this manual will be explained on an addendum included with this manual.

1.5 SAFETY SYMBOLS AND TERMS

Safety symbols used in this manual are as follows:

The symbol  on the instrument denotes that the user should refer to the operating instructions.

The symbol  on the instrument denotes that 1000V or more may be present on the terminal(s)

The **WARNING** used in the manual explains dangers that could result in personal injury or death.

The **CAUTION** used in this manual explains hazards that could damage the instrument.

1.6 UNPACKING AND INSPECTION

The Model 179A is inspected both mechanically and electrically before shipment. Upon receiving the Model 179A unpack all items from the shipping container and check for any obvious damage that may have occurred during transit. Report any damage to the shipping agent. Retain and use the original packaging materials if reshipment is necessary. The following items are shipped with all Model 179A orders:

- A Model 179A TRMS Multimeter
- A Model 179A Instruction Manual
- A Model 1691 General Purpose Test Lead Set
- Optional accessories per request

1.7 OPTIONAL ACCESSORIES

A wide range of accessories are available to facilitate the use of the Model 179A DMM, extend its range, and adapt it for additional uses.

1. Model 1010 Single Rack Mounting Kit - To mount one bench DMM in a standard 5¼" × 19" rack mounting.
2. Model 1017 Dual Rack Mounting Kit - To mount two bench DMMs in a standard 5¼" × 19" rack mounting.
3. Model 1301 Temperature Probe - A rugged low cost temperature probe designed to allow precision temperature measurements from -55°C to 150°C.

Range: -55°C to 150°C

Output: 1mV/°C; compatible with any DMM with at least 10MΩ input impedance

Accuracy: ±2°C from 0° to 100°C; ±3°C from -55° to 0°C and 100° to 150°C

Power: 9V alkaline or C-Zn (NEDA 1604) battery.

4. Model 1600A High Voltage Probe extends the DMM to 40kV.
Maximum Input: 40kV DC or peak AC to 300Hz
Input Resistance: 1000MΩ
Division Ratio: 1000:1 (into 10MΩ)
Ratio Accuracy (into 10MΩ DMM): ±2.5% from 1kV to 40kV DC; -3dB at 300Hz AC
Operating Temperature: 0° to 50°C
5. Model 1651 50-Ampere Current Shunt—The external 0.001Ω ±1%, 4-terminal shunt permits current measurements from 0-50A DC and 20-50A AC.
6. Model 1681 Clip-On Test Lead Set contains two leads, 1.2m (48 inches) long terminated with banana plugs and spring action clip-on probes.
7. Model 1682A RF Probe permits voltage measurements from 100kHz to 250MHz.
AC to DC transfer accuracy: ±1dB from 100kHz to 250MHz at 1V, peak responding, calibrated in rms of a sine wave, compatible with instruments with 10MΩ input resistance
Voltage Range: 0.25V to 15V rms
Maximum Allowable Input: 42V AC peak, 200V (DC + AC peak)
8. Model 1683 Universal Test Lead Kit consists of two test leads. 1.2m (48 inches) long with 12 screw-in tips, 2 banana plugs, 2 spade lugs, 2 alligator clips with boots, 2 needle tips with chucks and 4 heavy duty tip plugs.
9. Model 1684 Hard Shell Carrying Case—Hard vinyl case, 100mm × 300mm × 350mm (4" × 13" × 14") has a fitted

foam insert with room for the Model 179A, instruction manual and small accessories.

10. Model 1685 Clamp-On AC Probe measures AC current by clamping onto a single conductor. Interruption of the current path is unnecessary. The Model 1685 detects current by sensing the magnetic field produced by the current flow.
Range: 2, 20 and 200A rms
Accuracy: ±4% of range at 60Hz; ±6% of range at 50Hz
Temperature Coefficient: ±0.05%/°C on 20A and 200A range; ±0.3%/°C on 2A range
Maximum Allowable Current: 300A rms
Maximum Conductor Voltage: 600V rms
Conversion Ratio: 0.1V/A rms
11. Model 1691 General Purpose Test Lead Set consists of two 0.91mm (36 inches) test leads with probe tips terminated in banana plugs.
12. Model 1788 Rechargeable Battery Pack provides six hours minimum operation from full charge, recharges within 14 hours and is field installable.
13. Model 1792 Isolated BCD Output provides parallel BCD data output including sign, overrange and busy. Field installable.
14. Model 1793 Isolated IEEE-488 Interface—Field installable option provides isolated data output. Switch-selectable TALK ONLY or ADDRESSABLE modes. Mounts within and powered by the Model 179A. Model 7008 IEEE-488 cable is available.

1.8 SPECIFICATIONS

For Model 179A detailed specifications, refer to the specifications that precede this section.

SECTION 2 OPERATION

2.1 PREPARATION FOR USE

The Model 179A is shipped ready to use. The instrument may be powered from line voltage or from rechargeable batteries (when the optional Model 1788 Rechargeable Battery Pack is installed).

2.1.1 Line Power

The Model 179A is provided with a three-wire line cord which mates with third-wire grounded receptacles. Connect the instrument to AC line power as follows:

1. Set the LINE VOLTAGE switch on the back of the instrument to correspond to line voltage available. Ranges are 105 to 125 volts and 210 to 250 volts AC as shown in Figure 2-1.

CAUTION

Connect only to the line voltage selected. Application of incorrect voltage can damage the instrument.

2. Plug the power cord into a properly grounded outlet.

WARNING

Ground the instrument through a properly grounded receptacle before operation. Failure to ground the instrument can result in severe injury or death in the event of short circuit or malfunction.

2.1.2 Battery Pack Power

The Model 179A may also be operated from rechargeable sealed lead-acid batteries contained in the optional Model 1788 Battery Pack. The battery pack will operate the 179A for up to six hours. Circuits within the battery pack will automatically shut down the instrument when the battery charge is insufficient to maintain accurate readings. Refer to Section 5, paragraph 5.3 for installation procedures.

2.1.3 Battery Charging

After the Model 1788 Battery Pack is installed in the Model 179A it can be charged and recharged as follows:

1. Connect the instrument to line power as described in paragraph 2.1.1.
2. With the power switch off, the battery charge circuitry is automatically energized to charge the battery at the maximum rate. When the battery pack is first installed, or if it is completely discharged, allow it to charge for at least 14 hours.

NOTE

For maximum battery life, do not allow the battery pack to remain completely discharged. Constant charging will not harm either the battery pack or the instrument. Allowing the battery pack to discharge below 7.2V and remain discharged will ruin the battery pack.

3. When the 179A is in use on line power, the battery charger maintains a trickle charge on the battery pack.

2.2 OPERATING INSTRUCTIONS

2.2.1 Environmental Conditions

All measurements should be made at an ambient temperature within the range of 0°C to 55°C, and with a relative humidity of 0% to 80% up to 35°C. For instruments above 35°C derate humidity 3% per °C up to 55°C. If the instrument has been subjected to extremes of temperature, allow sufficient time for internal temperatures to reach environmental conditions. Typically, it takes one hour to stabilize a unit that is 10°C (18°F) out of specified temperature range.

2.2.2 Front Panel Familiarization

The following text and Figure 2-2 provide a brief description of the front panel controls, input terminals and display.

1. ON/OFF - Depressing (in) this push button turns the instrument on for either battery power (if the Model 1788 is installed) or line power. Releasing (out) this push button turns the instrument off.

NOTE

In the OFF position, the Model 1788 (if installed) will be charging if the instrument is connected to line power.

2. AC/DC - This switch is used along with the volts (V) and current (A) functions. Depressing (in) this push button selects AC and releasing (out) this push button selects DC.
3. LO/HI - This feature is used along with the Ω function. The front panel push button selects the LO or HI mode for the 20k Ω , 200k Ω and 2000k Ω ranges. Depressing the push button (in) selects LO and releasing the push button selects HI. On the 2k Ω range the Model 179A is in the LO mode, regardless of the push button position. On the 20M Ω range the Model 179A is in the HI mode, regardless of the push button position.

These adjustments are used only for calibration. They are not intended for adjustment during operation.

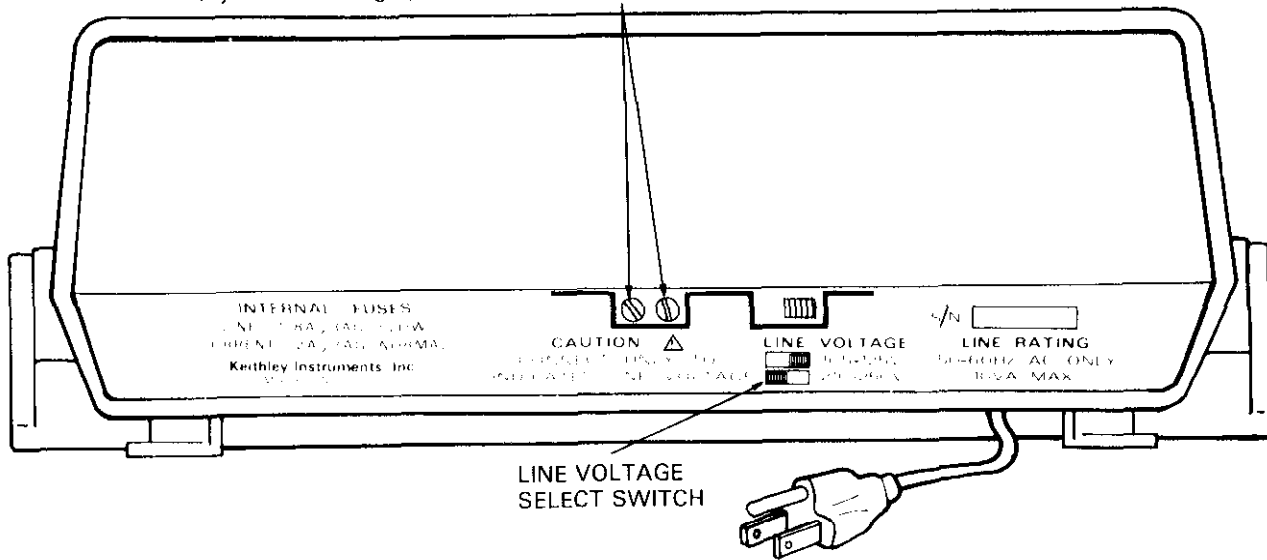

Figure 2-1. Rear View Showing Line Switch

MINUS SIGN DISPLAYED
PLUS SIGN IMPLIED

OVERRANGE IS INDICATED BY A FLASHING "0000" EXCEPT
ON THE 1000 VOLT RANGE

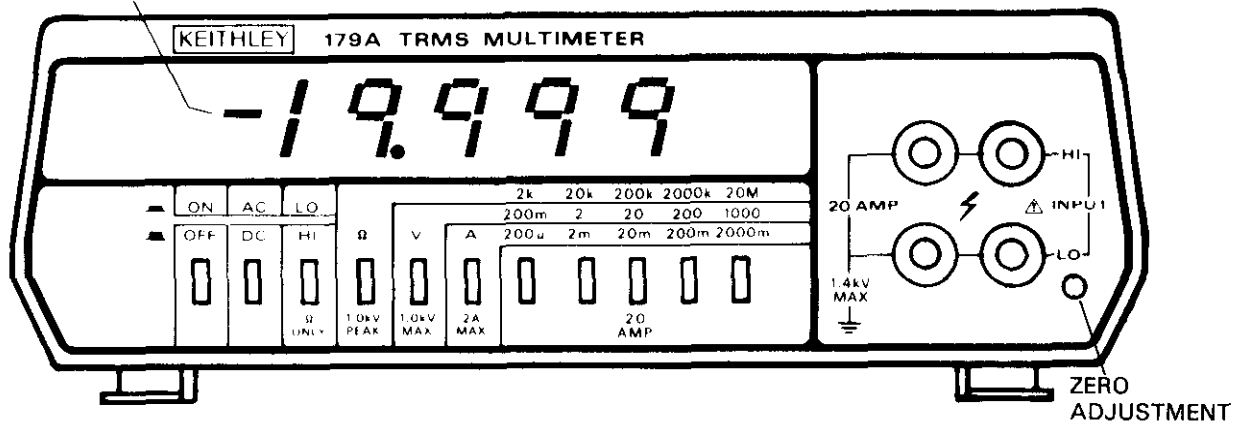

Figure 2-2. Model 179A Front Panel View

- A. Use the HI mode for measurements in the 20k, 200k, 2000k and 20M ranges. Full range voltage drop is 2 volts and is sufficient to cause forward conduction of semiconductor junctions. The HI terminal is positive.
 - B. Use the LO mode for measurements in the 2k, 20k, 200k and 2000k ohm ranges. Full range voltage drop is 200mV. Maximum open circuit voltage is 5V on all ranges.
4. Function Selection
- A. Ω - Depressing this push button selects the ohms function.
 - B. V - Depressing this push button selects the volts function.
 - C. A - Depressing this push button selects the current function.
5. Range Selection - Select the desired range by depressing the appropriate push button.
6. Input
- A. 20 AMP jacks (grey and black) - Use this pair exclusively for measuring current up to 20A.
 - B. INPUT jacks (red and black) - Use this pair for current measurements up to 2000mA and all other measurements.
7. Zero Adjustment - The front panel zero adjustment nulls input offset on the 20, 200 and 1200 DC voltage ranges and on all resistance ranges. Typically, this adjustment need not be performed more often than once a week unless the instrument is operated at ambient temperatures outside the range of 18°C to 28°C. Zero the instrument as follows:
- A. Turn on the power and select LO Ω and the 200k range.
 - B. Plug in test leads and short them. Adjust the zero adjustment pot on front panel to obtain a reading of 0000 \pm 3 digits.

NOTE

The zero adjustment may also be used for lead compensation on a particular Ω range.

2.3 DMM MEASUREMENTS

1. Turn on and zero the instrument as described in paragraph 2.2.2 step 7. Zero the instrument before the first use or whenever the instrument is used outside the temperature range of 18°C to 28°C, and weekly during normal use.
2. TRMS - The Model 179A measures the true root mean square of a signal within the frequency range of 45 to 20kHz. The maximum crest factor for rated accuracy to three.

NOTE

Accuracy is specified for 2000 counts and above. The method of calibrating the converter may yield an offset up to 50 digits with the input shorted. This does not affect the instrument's accuracy.

3. Crest Factor (CF) is the ratio of the peak voltage to the rms voltage. $CF = \frac{V_{PEAK}}{V_{RMS}}$

Some typical crest factors:

Sine wave: $CF = \sqrt{2}$

Square wave: $CF = 1$

Triangular wave: $CF = \sqrt{3}$

Positive pulse train: $CF = 1/\sqrt{\text{duty cycle}}$ (duty cycle for $CF = 3$ is 0.11)

NOTE

There will be some additional measurement error for signals with a crest factor greater than 3 ($CF > 3$).

CAUTION

Do not exceed the maximum allowable inputs of the 179A or instrument damage that is not covered by the warranty, may occur. See Table 2-1 for maximum inputs.

WARNING

Exercise extreme caution when measuring voltage that present a shock hazard to the user. The American National Standard Institute (ANSI) states that a shock hazard exists when voltage levels greater than 30 volts rms or 42.4V peak are present. A good safety practice is to expect that hazardous voltages are present in any unknown circuit to be measured, until actual conditions are verified.

2.3.1 DC Voltage Measurement

1. Select DC V function.
2. Select desired range.
3. Connect the unknown DC voltage to the INPUT jacks of the Model 179A as shown in Figure 2-3.
4. Note reading on display.

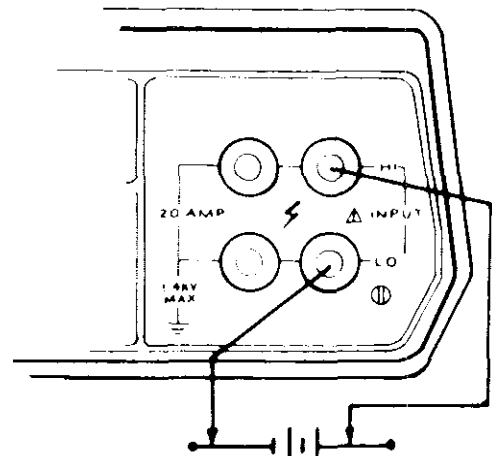

Figure 2-3. DC Voltage Measurement

Table 2-1.  Model 179A Maximum Allowable Inputs

Function	Ranges	Maximum Inputs
DCV	200mV, 2V	450V rms continuous; 1200V peak, for 10 seconds per minute.
ACV	20-1200V	1200V peak.
DCA, ACA	All	1000V rms; 1400V peak; $10^7 V \cdot Hz$.
	200 μ A-2000mA	2A, 250V DC or rms (fuse protected)
	20A	15A continuous, 20A for 1 minute (50% duty cycle)
Ω	All	450V rms sine wave; 1000V peak, for 10 seconds per minute.

2.3.2 TRMS AC Voltage Measurement

1. Select AC V function.
2. Select desired range.
3. Connect the unknown AC voltage to the INPUT jacks of the Model 179A as shown in Figure 2-4.
4. Note the reading on display.

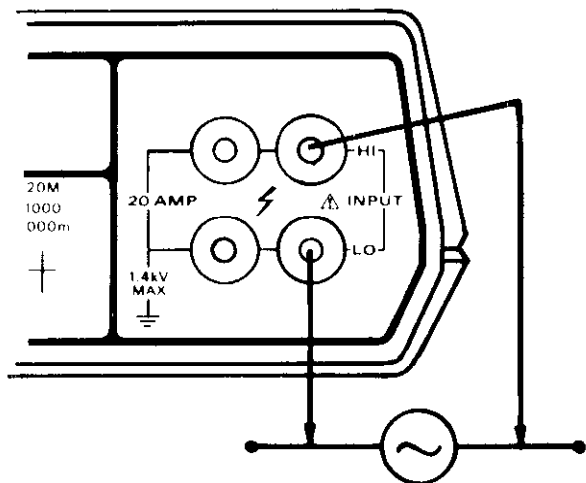

Figure 2-4. AC Voltage Measurement

2.3.3 Resistance (Ω) Measurement

1. Select the Ω function.
2. Select the HI mode or the LO mode (see paragraph 2.2.2 step 3).
3. Connect the unknown resistance (R) to the INPUT jacks of the 179A as shown in Figure 2-5.
4. Note reading on display.

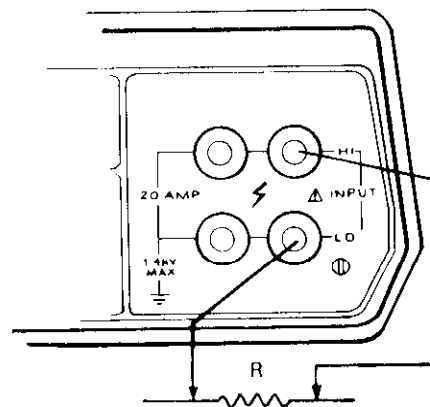

Figure 2-5. Resistance (Ω) Measurement

2.3.4 Current Measurement (DC or TRMS AC)

NOTE

To prevent measurement errors, connect the current test leads to either the 20A jacks or the normal INPUT jacks. Disconnect all circuits from the unused jacks.

WARNING

To prevent electrical shock, remove power from the circuit to be measured before connecting the Model 179A.

1. For current measurements up to 2000mA:
 - A. Select the ACA or DCA function.
 - B. Select the desired range (up to 2000mA).
 - C. Connect the unknown current to the INPUT jacks of the Model 179A as shown in Figure 2-6.
 - D. Note reading on display.
2. For current measurements between 2000mA and 20A:
 - A. Select the ACA or DCA function.
 - B. Depress the 20A range switch.
 - C. Connect the unknown current to the 20 AMP jacks of the Model 179A as shown in Figure 2-7.
 - D. Note the reading on display.

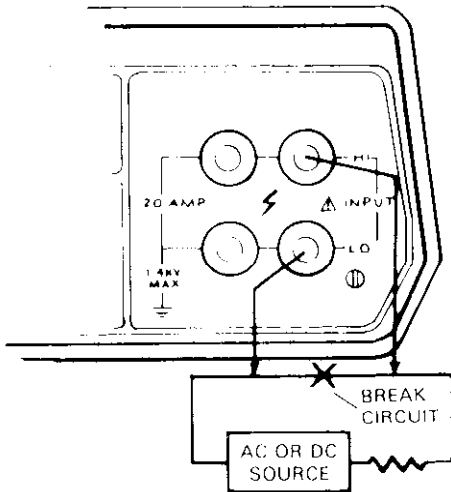

Figure 2-6. Current Measurements Up to 2000mA

NOTE

Up to 15A may be applied continuously without degradation of the measurement due to self-heating effects. For currents between 15A and 20A, specified accuracy can only be obtained when measurements are limited to a 50% duty cycle (i.e., apply the current for a maximum of one minute and then allow at least one minute for cooling before the next measurement).

NOTE

The test leads used must be capable of handling 20A and it is recommended that they be twisted (see Figure 2-7) to minimize external fields which could affect the Model 179A or other equipment. Also, keep the test leads as short as possible to minimize voltage drop.

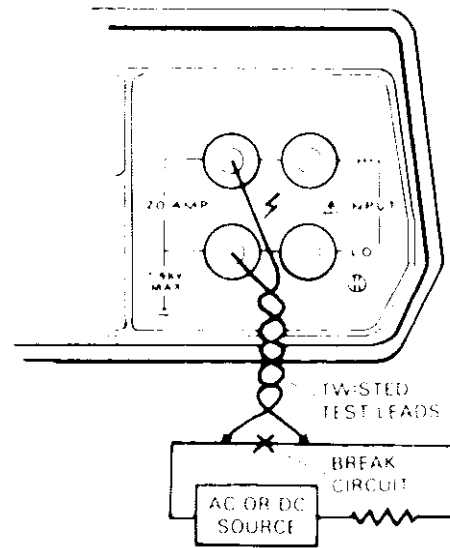

Figure 2-7. Current Measurements Between 2000mA and 20A

2.3.5 AC + DC Measurement

Use the Model 179A to measure TRMS on a signal which has both AC and DC components as follows:

1. Measure and record the TRMS AC component as described in paragraph 2.3.2.
2. Measure and record the DC component as described in paragraph 2.3.1.
3. Compute the rms value from the following equation.

$$E_{RMS} = \sqrt{E_{DC}^2 + E_{AC}^2}$$

SECTION 3 PERFORMANCE VERIFICATION

3.1 INTRODUCTION

Performance verification may be done upon receipt of the instrument to ensure that no damage or misadjustment has occurred during transit. Verification may also be performed whenever there is question of the instrument's accuracy and following calibration if desired.

NOTE

For instruments that are still under warranty (less than 12 months since date of shipment), whose performance falls outside specifications at any point, contact your Keithley representative or the factory immediately.

3.2 ENVIRONMENTAL CONDITIONS

Measurements should be made at 18-28°C and at less than 80% relative humidity.

3.3 RECOMMENDED TEST EQUIPMENT

Table 3-1 lists all the test equipment required for verification. If alternate equipment is used, the alternate test equipment's specifications must be at least as good as the equipment specifications listed in Table 3-1.

3.4 PERFORMANCE VERIFICATION PROCEDURE

Use this procedure to verify the Model 179A's accuracy. If the Model 179A is out of spec, proceed to maintenance (calibration) Section 5, unless the Model 179A is under warranty.

NOTE

Verification should be performed by qualified personnel using accurate and reliable test equipment.

WARNING

Some procedures require the use of high voltage. Take care to prevent contact with live circuits which could cause electrical shock resulting in injury or death.

3.5 INITIAL CONDITIONS

Before beginning the verification procedure, the instrument must meet the following conditions:

1. If the instrument has been subjected to extremes of temperature, allow internal temperatures to stabilize for one hour minimum at the environmental conditions specified in paragraph 3.2.
2. Turn on the 179A DMM and allow it to warm up for ten minutes. The instrument may be operated from either line power or battery pack power, as long as the battery pack has been fully charged as described in paragraph 2.1.3.
3. Zero the instrument as described in paragraph 2.2.2 step 7.

3.6 DC VOLTS VERIFICATION

1. Select the DC V function.
2. Connect the DC Calibrator (Item A, Table 3-1) to the instrument.
3. Select the 200mV range, and apply positive 100mVDC to the DMM. The reading must be within the limits specified in Table 3-2.
4. Select each remaining range and apply the required voltage as specified in Table 3-2, verify that the reading is within specifications.
5. Repeat all checks with negative voltage.

Table 3-1. Recommended Test Equipment for Performance Verification

ITEM	DESCRIPTION	SPECIFICATION	MFR	MODEL
A	DC Calibrator	0.1V, 1V, 10V, 100V, 1000V ±0.002% or 20µV	Fluke	343A
B	AC Calibrator	.1V, 1V, 10V, 100V ±.022%	Fluke	5200A
C	AC Calibrator/Amplifier	1000V @ ±.044%	Fluke	5215A
D	Decade Resistor	1.9kΩ, 19kΩ, 190kΩ 1.9MΩ, 10MΩ, ±0.01%	ESI	RS725
E	Current Calibrator	100µA, 1mA, 10mA, 100mA, 1A, 10A, ±0.03%	Valhalla	2500E

Table 3-2. DC Voltage Performance Check

Range	Applied Voltage	Allowable Readings at 18° to 28°C
200mV	100.00mV	99.93 to 100.07
2V	1.0000V	0.9995 to 1.0005
20V	10.000V	9.995 to 10.005
200V	100.00V	99.95 to 100.05
1200V	1000.0V	999.5 to 1000.5

3.7 AC VOLTS VERIFICATION

1. Select the AC V function.
2. Connect the AC Calibrator (Item B, Table 3-1) to the DMM. Set the calibrator frequency to 1kHz.
3. Set the DMM to the 200mV range and apply 100mV AC to the DMM. The reading must be within the limits specified in Table 3-3.
4. Select the 2, 20 and 200 volt ranges and apply the required voltages as specified in Table 3-3. Verify that the readings are within specifications.
5. To check the 1000V range, connect the AC Calibrator Amplifier (Item C, Table 3-1) to the output of the AC Calibrator per the manufacturer's instructions. Set it for an output of 1000V AC rms and verify that the DMM reading is within the specified limits.

Table 3-3. AC Voltage Performance Check

Range	Applied Voltage	Allowable Readings at 18° to 28°C
200mV	100.00mV	99.15 to 100.85
2V	1.0000V	0.9925 to 1.0075
20V	10.000V	9.935 to 10.065
200V	100.00V	99.35 to 100.65
1000V	1000.0V	993.5 to 1006.5

3.8 RESISTANCE VERIFICATION

1. Select the Ω function.
2. Set the HI/LO push button to HI and select the 20kΩ range.
3. Connect the decade resistor (Item D, Table 3-1) to the DMM.
4. Set the decade resistor to zero and measure the resistance of the test leads. Subtract this reading from the displayed reading in all of the following steps.
5. Set the decade resistor to 19.000kΩ. Verify that the reading is within the limits specified in Table 3-4.
6. Select the next range and measure the next resistance as specified in Table 3-4. Verify that each reading is within specifications. Test the remaining ranges in the table, switching the HI/LO push button as indicated.

Table 3-4. Resistance Performance Check

HI/LO	Range	Resistance	Allowable Readings at 18° to 28°C
HI	20kΩ	19.000kΩ	18.991 to 19.009kΩ
HI	200kΩ	190.00kΩ	189.91 to 190.09kΩ
HI	2000kΩ	1.9000kΩ	1899.1 to 1900.9kΩ
HI	20MΩ	19.000MΩ	18.980 to 19.020MΩ
LO	2kΩ	1.9000kΩ	1.8957 to 1.9043kΩ
LO	20kΩ	19.000kΩ	18.957 to 19.043kΩ
LO	200kΩ	190.00kΩ	189.57 to 190.43kΩ
LO	2000kΩ	1900.0kΩ	1895.7 to 1904.3kΩ

3.9 DC CURRENT VERIFICATION

1. Select the DC A function.
2. Connect the DC current source (Item E, Table 3-1) to the DMM.
3. Select the 200μA range and apply a current of 100.00μA to the DMM. The reading must be within the limits in Table 3-5.
4. Select each range and apply the required current as specified in Table 3-5. Verify that the reading is within specifications.

Table 3-5. DC Current Performance Check

Range	Applied Voltage	Allowable Readings at 18° to 28°C
200μA	100.00μA	99.78 to 100.22μA
2mA	1.0000mA	0.9978 to 1.0022mA
20mA	10.000mA	9.978 to 10.022mA
200mA	100.00mA	99.78 to 100.22mA
2000mA	1000.0mA	997.8 to 1002.2mA
20A	10.000A	9.948 to 10.052A

3.10 AC CURRENT VERIFICATION

Since AC Current uses the same circuitry as AC Volts and DC Current already checked in paragraphs 3.6 and 3.9, no additional accuracy checks are necessary.

SECTION 4 THEORY OF OPERATION

4.1 INTRODUCTION

This section contains circuit descriptions for the Model 179A DMM and Model 1788 Battery Pack. An overall signal flow block diagram is provided in Figure 4-1. An overall schematic diagram, drawing 32046, is contained at the end of this manual.

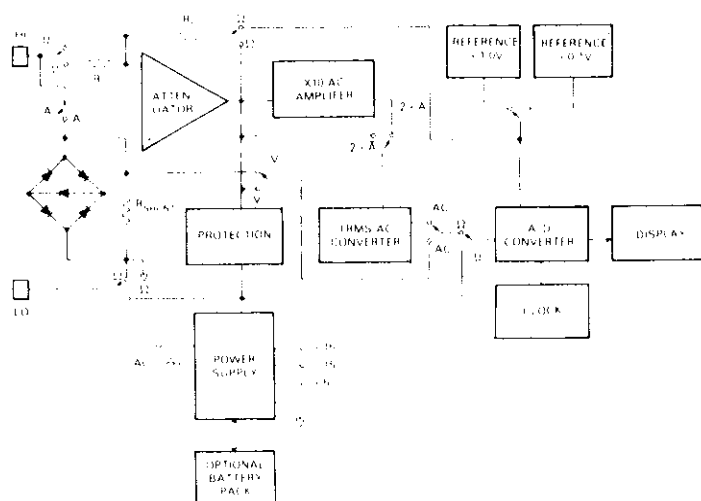

Figure 4-1. Simplified Signal Flow Block Diagram, Model 179A DMM

4.2 OVERALL OPERATION

The Model 179A DMM uses a 2V or 200mV full scale analog to digital (A/D) converter with a 4½ digit multiplexed display. Signal conditioning permits the A/D converter to handle full scale AC and DC voltage and current measurements over five decades, and to measure resistance over five ranges.

4.2.1 Signal Conditioning

Signal conditioning includes DC attenuation (except on the 2V and 200mV ranges), AC attenuation, X10 amplification, AC to DC conversion, ohms conversion and current shunts as shown in Figure 4-2.

1. In the DCV mode, signal conditioning to the A/D converter is an active attenuator, except on the two lowest ranges. The A/D input is $-V_{HI-LO} \cdot R_f / R_i$ (R_f = feedback resistance, R_i = input resistance), except on the lowest ranges or under overload conditions. In the DCA mode, the voltage across the shunt resistor is applied to the A/D converter with 200mV giving a full scale reading.

2. In the ACV mode, AC inputs pass through the attenuator on all ranges. The input is scaled to 2V rms full scale, including X10 amplification for the 200mV range. The TRMS converter outputs a positive DC signal proportional to the true root mean square AC signal. This DC signal is the A/D input. In the ACA mode, shunt voltage is treated as a 200mV signal.

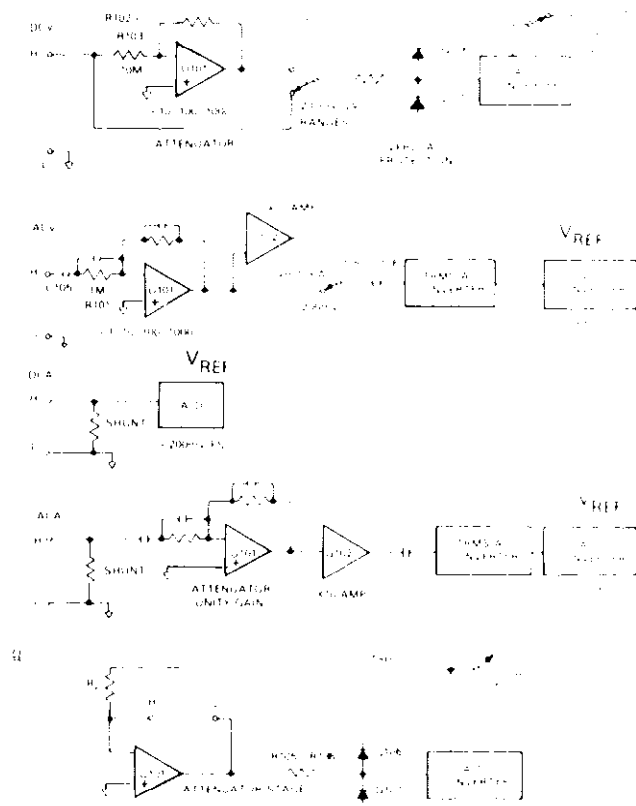

Figure 4-2. Attenuation and Ohms Conversion

4.2.2 Ohms Conversion

Resistance measurements are made by configuring the attenuator as a resistance to voltage converter. Attenuator stage voltage feedback resistors R_f function as amplifier input resistance connected to either 0.1V reference (LO) or the 1.0V reference (HI). The unknown resistance is connected as a feedback resistor around the attenuation amplifier. The resulting voltage applied to the A/D converter is proportional to the unknown resistance.

4.2.3 A/D Converter

The A/D converter is a large scale integration (LSI) ratiometric device. Converter output is a multiplexed five digit binary coded decimal (BCD) number which is equal to

the ratio of input voltage to reference voltage. A separate clock circuit supplies a 100kHz timing input to the integrated circuit, which also multiplexes the BCD output. Full scale A/D inputs for various ranges and functions are listed in Table 4-1.

Table 4-1. Full Scale A/D Inputs

Function	Range	Full Scale A/D Input	Reference Voltage
DCV	200mV	200mV	0.1V
DCV	2, 20, 200 1200V	2V	1.0V
ACV	All	2V	1.0V
DCA	All	200mV	0.1V
ACA	All	2V	1.0V
Ω	HI	2V	1.0V
	LO	200mV	0.1V

4.3 ATTENUATION

When measuring AC and DC voltages, input signal conditioning is provided by inverting amplifier U101 and additional components as described below.

4.3.1 DC Volts

Input resistance is set by R102 and R103. During calibration, R103 is adjusted to obtain a total input resistance of 10MΩ. Zero adjustments are provided for U101 since an amplifier output resolution of 10μV is required for LO resistance measurements.

1. On the 2V and 200mV ranges, input HI is connected to the A/D converter through protection resistors R106, R135G and R136. Diode-connected FETs Q106 and Q107 clamp the A/D input during overload.
2. On the 20, 200 and 1200 volt ranges, the amount of attenuation is selected by switching feedback resistors into the attenuator with relays K101, K102 and K103. Gain setting components and attenuation values are listed in Table 4-2.

Table 4-2. DC Attenuation and Gain Setting Components

Range	Gain Set Components	Relay/ Switch	Attenuation
200mV			Signal Bypasses attenuator
2V			
20V	R118, R126	K101	0.1
200V	R119, R127	K102	0.01
1200V	R120, R128	K103	0.001

4.3.2 AC Volts

Input resistance is 1MΩ (R101). Shunt capacitance is typically less than 75pF. Additional conditioning is as follows:

1. For all ranges except the 200mV range, the amount of attenuation is selected by switching feedback resistors into the attenuator with relays K101 through K104. For the 200mV range, non-inverting X10 amplifier U102 boosts the signal to a 2V full scale. Gain setting components and attenuation values are listed in Table 4-3.
2. On the 200mV and 2V ranges, high frequency compensation is adjusted with capacitor C111, as shown in Table 4-3. On the 20V range, adjustment is performed with C112. On the 200 and 1000 volt ranges, adjustment is performed with C106. Some low frequency rolloff is introduced by input blocking capacitor C105, and AC converter input capacitors C115 and C116.

4.4 AC CONVERSION

The AC converter is a monolithic TRMS module. Output $V_{DC} = \sqrt{\text{Avg}(V_{in})^2}$. Potentiometer R143 provides gain adjustment, and R142 establishes output zero. Settling time and ripple are determined by C110 and C120. Low frequency rolloff is a function of C120.

4.5 OHMS CONVERSION

During calibration, the 10MΩ input resistance (R102 and R103) and all attenuator feedback resistors are adjusted for both ratio and absolute value. Therefore, these resistors can also serve as reference for resistance measurements. In the Ω mode, the attenuation (feedback) resistors are disconnected from the output of the attenuation amplifier (U101) and are connected instead to the A/D converter reference voltage. Since two reference voltages and two A/D converter gains are available, the Model 179A DMM provides the option of measuring resistance with the sense current reduced by a factor of ten.

4.5.1 Range Selection

Operation of the range push buttons selects range resistors to provide the reference current listed in Table 4-4. Operation of the HI/LO push button selects the 1V or 0.1V reference respectively on the 20kΩ, 200kΩ and 2000kΩ ranges. Relay K105 is always energized in the Ω mode.

4.5.2 Ω Circuit

For resistance measurements, relay K105 and terminals 4, 5 and 6 of the Ω push button connect the input HI terminal directly to the amplifier summing node. Input LO is disconnected from ground and is connected to the A/D converter input through the protection components described below. The unknown resistance (R_x) then becomes the amplifier feedback resistance.

1. Current flow in the unknown resistance is from input HI to input LO. At full scale, the voltage across R_x is either 2V (HI) or 200mV (LO). Reference source loading does not affect accuracy since the A/D converter is ratiometric.

Table 4-3. AC Attenuation Gain Setting Components

Range	Gain Set Components	Relay Energized	Attenuation	Freq. Comp. Capacitors
200mV	R118, R126	K101	1(X10*)	C106, C111
2V	R118, R126	K101	1	C106, C111
20V	R119, R127	K102	0.1	C106, C112
200V	R120, R128	K103	0.01	C106, C113
1000V	R121, R122, R129	K104	0.001	C106, C114

*Signal applied to X10 AC amplifier U102.

Table 4-4. Resistance Range Setting Components

Range	Range Resistors	Relay/Switch	Nom. I_{REF} in HI Ω	Nom. I_{REF} in LO Ω
2k Ω	R121, R122, R129	K104	--	100 μ A
20k Ω	R120, R128	K103	100 μ A	10 μ A
200k Ω	R119, R127	K102	10 μ A	1 μ A
2000k Ω	R118, R126	K101	1 μ A	0.1 μ A
20M Ω	R102, R103	1000 switch, pins 17, and Ω 8, 9	0.1 μ A	--

2. The HI terminal is clamped to analog common by Q101 and Q102. The instrument protection network at the amplifier output consists of a pulldown resistance (R104 and CR103, CR104 and CR105). R104 sinks approximately 150 μ A. During in-range measurements, this current is supplied by the reference voltage through CR105 and voltage through the amplifier (U101) and CR104. Overloads with input HI positive are sustained by CR105; diodes CR103 and CR104 sustain negative overloads. Open circuit voltage is set to less than 5V by R150 and R151 through CR103 and CR105. A/D protection in Ω is the same as in V except R105 is substituted for R106.

4.6 A/D CONVERTER

The A/D converter operates on the dual slope principle. The timing is divided into three periods as described below. Operation with high and low reference voltages is described separately in paragraph 4.6.4.

4.6.1 Auto-Zero

The auto-zero period (A, Figure 4-3) is 100ms in length, which corresponds to 10,000 clock pulses. During this period, reference voltage V_{REF} (see paragraph 4.6.4) is stored on capacitor C124. Capacitor C117 stores $V_{REF} + V_{OS1} - V_{OS2}$.

4.6.2 Signal-Integrate

The signal-integrate period (B, Figure 4-3) is 100ms in length. The A/D input is buffered by U104 (see paragraph 4.6.4) and integrated by U103. Positive signals generate a

negative-going ramp at the integrator output (pin 14), while negative signals produce a positive-going ramp. The level of the integrated signal at the end of the signal-integrate period is proportional to the average of the applied signal during this period. Since signal integration continues for 100ms, the A/D converter exhibits high normal mode rejection for AC signals in multiples of 10Hz, particularly the 50 and 60Hz line frequencies.

4.6.3 Reference-Integrate

The reference-integrate period (C or D, Figure 4-3) is 200ms or 20,000 counts in length. During this period, the integrator is returned to baseline level by applying a reference voltage of a polarity opposite to that of the signal. A positive-going ramp is obtained by grounding the buffer input, while negative going ramp is produced by the integration of $2XV_{REF}$ (that is, $V_{REF} +$ the voltage stored on C124). The time, or number of clock pulses required for discharge is proportional to the signal input. Digital output is from latches within U106 which store the number of clock pulses required for the integrator to return to baseline level. The maximum count during this period is 20,000 which corresponds to a discharge period of 200ms or full scale input.

4.6.4 Reference Voltages

Reference voltage V_{REF} may be either 1V or 0.1V. The voltages are provided by a divider across a temperature compensated zener diode. An operational amplifier on U103 provides the zener with a self-regulating bias. Use of the 0.1V reference increases converter sensitivity to 200mV full scale, permitting accurate LO ohms operation, 10 μ V resolution on DC voltage measurements, and DC amperage

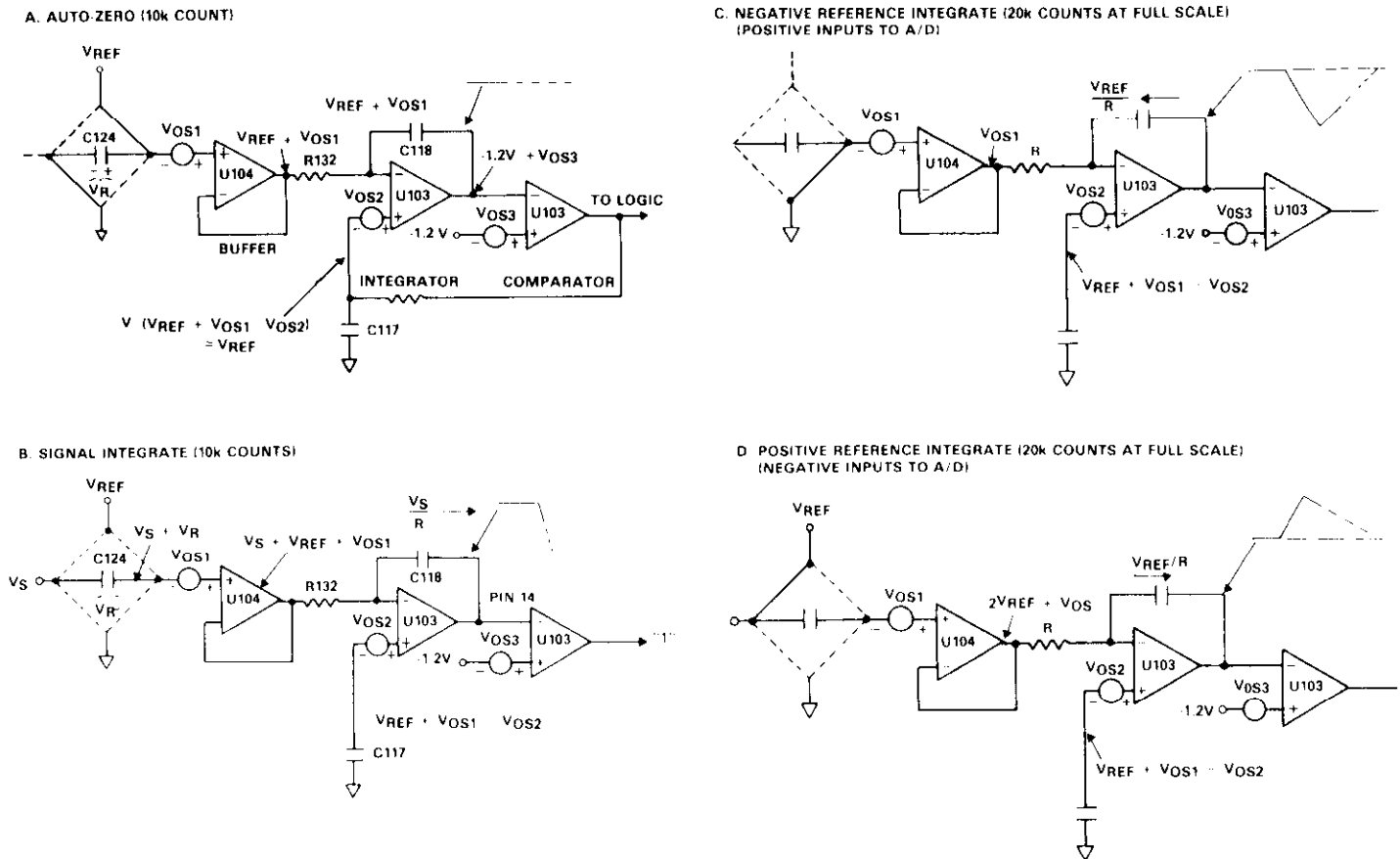

Figure 4-3. A/D Converter Function

measurements with a full scale burden of 200mV. Increased sensitivity is accomplished by switching input buffer U104 into a gain of 10 configuration by turning on Q105. Auto-zero charging on C124 is to a 100mV reference instead of a 1V reference. Integrator and comparator voltage levels are unaffected by buffer gain. Buffer offset voltage is zeroed.

4.7 DISPLAY

Five LED indicators are driven by U201, which is a CMOS BCD to seven segment decoder/driver with bipolar current-sourcing outputs. Segment currents are limited to approximately 20mA peak by resistor network R202. The LED readout is a multiplexed, common-cathode configuration with Darlington array U202 sequentially sinking current from each digit. Blanking of the overrange digit is accomplished by gates U107A and U107B. Emitter-follower Q108 ensures that CMOS-compatible levels are maintained on U107A, pin 1, regardless of the loading of U202. The minus polarity readout is blanked on AC voltage and resistance ranges by contacts on the push button switch. Proper decimal point position is determined by the combination of function and range selected.

4.8 CURRENT MEASUREMENTS

In the A mode, the signal is switched into one of six current shunts ahead of the attenuator section. For DC current measurements, the shunt voltage drop is applied directly to the A/D converter input at 200mV full scale. For AC current measurements, the shunt voltage drop is treated as a 200mV AC signal and passes through the AC attenuator and the X10 AC amplifier. Overload clamping occurs at three diode voltage drops which is a level high enough to permit high crest factor current waveforms.

4.9 AC POWER SUPPLY

When the DMM is operated from AC line power, the power supply furnishes +5, +15 and -15 volts from regulators VR104, VR102 and VR101, respectively. Full-wave rectified AC from bridge rectifiers CR101 and CR102 is filtered by reservoir capacitors C108, C104 and C103 and is applied to the linear voltage regulators.

4.10 MODEL 1788 BATTERY PACK

When the Model 1788 Battery Pack is installed in the DMM, S102 must be set to the BAT position to provide additional secondary voltage for battery charging. S102 also switches

the input to VR104 from bridge rectifier CR101 to batteries BT301. Four 2V, 2.5 ampere-hour lead-acid cells supply approximately 9.8V at full charge. After six hours of use on battery power, the battery pack should be recharged to ensure long battery life.

4.10.1 Battery Charging Circuit

While the DMM is plugged into line power and the battery pack is installed, battery charging proceeds as follows:

1. Full wave rectified voltage from CR101 is applied to the anode of Q301, which is an SCR which regulates charging voltage. When Q301 is triggered on by a sufficient gate-cathode voltage differential, the batteries receive charge. Charging continues as long as the bridge output voltage exceeds battery voltage by 1V or more. Resistor R304 limits charging current when recharging a set of completely discharged cells. A filtered positive output from CR102 (or T301) provides the necessary gate turn-on bias through R306 and diode CR301. Resistor R303 ensures proper high temperature operation on Q301.
2. When the battery voltage reaches the preset float voltage of 9.8V, zener VR301 conducts sufficient current to turn on Q302 and thus remove the gate trigger voltage from Q301. Float voltage is adjusted with R301. This is a factory adjustment which normally does not need field re-adjustment.

4.10.2 Battery Operation and Shutdown Circuit

The DMM operates as follows on battery power:

1. When the power is turned on, the batteries are connected to the input of VR104 to supply +5V for the logic, display and the clock circuit. The clock output is applied to the A/D converter as described in paragraph 4-6 and also to U301, which is a divide-by-four binary counter. The outputs of U301 drive a DC to DC inverter which is synchronized to the A/D converter to filter out inverter noise. The 25kHz operating frequency is optimal for the small transformer size, and results in low switching losses. Blocking capacitors C301 and C302 protect Q307 and Q308 from damage if the drive is lost. Two half-wave rectifiers (CR304 and CR305) on the secondary of T301 provide rectified AC to filter capacitors C304 and C305 which provide power to +15V and -15V regulators VR102 and VR101.
2. To prevent permanent loss of battery capacity caused by deep discharge, a shutdown circuit stops operation on battery power when the battery voltage drops below approximately 7.2V. Shutdown is performed by micropower voltage detector U302. The open-collector output U302, pin4 saturates low and turns off pass transistor Q309 when the input voltage (at U302, pin 3) drops below 1.15V (typical). Resistor R314 provides sufficient hysteresis to prevent discharge from resuming when the battery voltages rises following disconnection of the load.

SECTION 5 MAINTENANCE

5.1 INTRODUCTION

This section contains calibration, installation and service information for the Models 179A DMM and 1788 Battery Pack.

5.2 CALIBRATION PROCEDURE

Calibration should be performed yearly (every 12 months) or whenever performance verification (see Section 3) indicates that the Model 179A is out of specifications. If any step in the calibration procedure cannot be performed properly, refer to paragraph 5.4 for troubleshooting information or contact your Keithley representative or the factory.

5.2.1 Recommended Test Equipment

Recommended test equipment for calibration is listed in Table 5-1. Alternate test equipment may be used. However, the accuracy of the alternate test equipment must be at least 10 times better than the instrument specification, or equal to Table 5-1 specifications.

5.2.2 Environmental Conditions

Calibration should be performed under laboratory conditions having an ambient temperature of 20° to 26°C (68° to 78°F), and a relative humidity of less than 80%.

5.2.3 Calibration Shield Installation

If the Model 1788 Battery Pack is installed in the instrument it must be removed and the calibration shield reinstalled before calibration.

WARNING

Disconnect the line cord before removing the case cover.

1. Turn off the power and disconnect the line cord. Remove the four screws from the bottom of the case and separate the top cover from the bottom cover.

2. Push back the ground clip (shown in Figure 6-1) from the upper side of the battery pack and remove the battery pack from the spacers.
3. Calibration may be performed on battery power as long as the battery pack is sufficiently charged. Leave the battery pack plugged into the instrument, but set the battery pack behind the DMM on the bench or table.
4. Set the calibration shield in place on the spacers. The shield should read correctly when viewed from the front of the instrument.
5. Slide the ground clip over the top of the calibration shield so that it contacts the upper surface of the shield.
6. If battery power is not to be used, plug in the line cord (make sure the BAT/LINE switch is in the line position if the battery pack is not installed).

5.2.4 Calibration Adjustments

WARNING

Some procedures require the use of high voltage. Take care to prevent contact with live circuits which could cause electrical shock resulting in injury or death.

1. Refer to Table 5-2 and perform the listed adjustments in the sequence indicated. Note that the step sequence is indicated on the calibration shield by boxed numerals. The sequence must be followed exactly because the adjustments are interrelated and dependent on the preceding steps.

NOTE

Perform step 5 only if R112 is installed. If not, proceed to step 6.

2. If the indicated adjustment cannot be made to obtain the specified reading, refer to paragraph 5.4 for troubleshooting information.

Table 5-1. Recommended Test Equipment for Calibration

Item	Description	Specification	Mfr.	Model
A	DC Calibrator	0.1V, 1V, 10V, 100V, 1000V ±0.002% or 20µV	Fluke	343A
B	AC Calibrator	.1V, 1V, 10V, 100V ±.022%	Fluke	5200A
C	Decade Resistor	1.9kΩ, 190kΩ, ±0.01%	ESI	RS725

5.3 BATTERY PACK (MODEL 1788) INSTALLATION

WARNING

Disconnect the line cord before removing the case cover.

1. Turn off the power and disconnect the line cord. Remove four screws from the bottom of the case and separate the top cover from the bottom cover.
2. Lift off the calibration shield, and save it for later use. The four plastic spacers must remain in place on the upright studs projecting through the main circuit board.

NOTE

Do not discard the calibration shield. This shield must be reinstalled during calibration, as described in paragraph 5.2.3.

3. Set the BAT/LINE switch to the BAT position shown in Figure 6-1. Note that the battery pack will not operate properly if this switch is not in the BAT position.
4. Remove fuse F301 on the battery pack.
5. Install the battery pack in the instrument so that it rests on the plastic spacers. The ground clip must make contact with the upper side of the battery pack plate.
6. Carefully align the battery pack plug with connector P1004 on the circuit board. Push the plug firmly onto the connector until the lip on the plug engages the lip on the connector to lock the plug in place.

CAUTION

Make sure the connector is aligned so that all pins mate properly, otherwise damage to the DMM will result.

7. Install fuse F301. Reinstall top cover and secure with four screws.
8. Charge the battery pack as described in paragraph 2.1.3.

5.4 TROUBLESHOOTING

The troubleshooting information in this section is intended for use by qualified personnel who have a basic understanding of analog and digital electronic principles and components used in a precision electronic test instrument.

NOTE

For instruments that are still under warranty (less than 12 months since date of shipment), whose performance falls outside specifications at any point, contact your Keithley representative or the factory immediately.

The troubleshooting information provided includes checking the power supplies, clock, voltage references and signal tracing 1 volt rms up to the processor (U106). It is strongly recommended that the Theory of Operation (Section 4) be utilized along with schematic diagram 32046.

Table 5-2. Calibration Adjustments

Step	Function	Range	Input	Adjustment Point	Desired Reading	Test Equipment (see Table 5-1)
1	DCV	2V	+ 1.9V	R107	1.9000	DC Calibrator (A)
2	DCV	200mV	+ 190mV	R108	190.00	DC Calibrator
3	DCV	2V	+ 1.9V	R107	1.9000	DC Calibrator
4	ΩLO	200kΩ	Short	R149	Set Front Panel Zero to Mechanical Center	None
5*	ΩLO	200kΩ	Short	R112	00.0 ± 10 digits	None
6	ΩLO	200kΩ	Short	R149	00.00 ± 2 digits	None
7	ΩHI	200kΩ	190kΩ	R127	190.00	Decade Resistor (C)
8	ΩLO	2kΩ	1.9kΩ	R129	1.9000	Decade Resistor
9	DCV	200V	+ 190V	R103	190.00	DC Calibrator
10	DCV	20V	+ 19V	R126	19.000	DC Calibrator
11	DCV	1000V	+ 1000V	R128	1000.0	DC Calibrator
12	ACV	20V	1V at 1kHz	R142	1.000	AC Calibrator (B)
13	ACV	20V	10V at 1kHz	R143	10.000	AC Calibrator
14	ACV	20V	1V at 1kHz	R142	1.000	AC Calibrator
15	ACV	20V	10V at 1kHz	R143	10.000	AC Calibrator
16	ACV	200V	100V at 10kHz	C106	100.00	AC Calibrator
17	ACV	20V	10V at 10kHz	C112	10.000	AC Calibrator
18	ACV	2V	1V at 10kHz	C111	1.0000	AC Calibrator

*Perform Step 5 only if R112 is installed. If it is not, proceed to Step 6.

5.4.1 Troubleshooting Procedure

1. Remove the top cover per instructions in paragraph 5.2.3 step 1.

WARNING

High voltage is present with the top cover removed. Take care to prevent contact with line circuits which could cause electrical shock resulting in injury or death.

2. To gain access to the test points:
 - A. Remove the Calibration Shield, if installed.
 - B. If the Model 1788 Battery Pack is installed, leave it plugged into the instrument but set it behind the Model 179A on the bench or table.
3. Turn the Model 179A ON and check the power supplies, clock and reference voltages per Table 5-3.
4. Select the ACV function and 2 volt range of the Model 179A. Input a 1 volt rms sine wave (1kHz) into the Model 179A and check signals per Table 5-4.

NOTE

Test points 1 through 10 and the power supply and clock pads are called out on the Model Board (PC-492). Test points 11 through 14 are not called out on the Model 1788 Battery Pack board (PC-541). Use the schematic diagram and component layout drawing to located these test points.

5.5 SPECIAL HANDLING OF STATIC SENSITIVE DEVICES

CMOS devices are designed to function at high impedance levels. Normal static charge can destroy these devices. Table 5-5 lists all static sensitive devices for the Model 179A. Steps 1 through 7 provide instructions on how to avoid damaging these devices.



1. Devices should be handled and transported in protective containers, antistatic tubes or conductive foam.
2. Use a properly grounded work bench and a grounding wriststrap.
3. Handle device by the body only.
4. PCBs must be grounded to bench while inserting devices.
5. Use antistatic solder suckers.
6. Use grounded tip soldering irons.
7. After devices are soldered or inserted into sockets they are protected and normal handling can resume.

5.6 BATTERY CHARGE VOLTAGE ADJUSTMENT

Perform the following steps if it is determined that the Model 1788 battery charge voltage needs adjusting.

1. Remove the top cover.
2. Connect the Model 179A to line power and turn the instrument OFF.

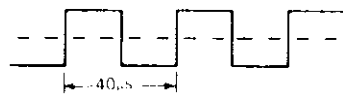
Table 5-3. Power Supplies, Clock and Reference Voltages

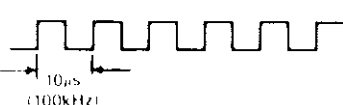
Checks	Test Point	Sch Loc	Signal
Line Power:			
VR102 Input	TP 1	C8	• 17.5V minimum
VR101 Input	TP 2	C8	• 17.5V minimum
VR102 Output	• 15V pad	D8	• 15V • 10%
VR101 Output	• 15V pad	D8	• 15V • 10%
VR104 Output	• 5V pad	D7	• 5V • 10%
Battery Power	TP 11	E7	Approx. • 10V
	TP 12	F8	23 to 28V 0V 23 to 28V 
	TP 13	F7	17 to 20V 0V 
	TP 14	F8	17 to 20V 0V 
	CLK pad	G5	5V 0V 
0.1 & 1.0V Reference			
0.1V Reference	TP 3	H2	• 100mV
1.0V Reference	TP 8	H2	• 1.00V
Reference Diode	TP 4	J1	• 6.3V • 0.25V

- Turn R301 (see Figure 6-1) fully counter-clockwise (maximum charge rate) and monitor battery voltage (BT301) for > 9.8V. Fully charged cells require several minutes to reach this level. Discharged cells require several hours.

CAUTION

Charging to greater than 10 volts for longer than 30 minutes will reduce battery life.

- When cells reach 9.8V, turn the Model 179A ON and adjust R301 to maintain 9.8V across BT301.
- Turn the Model 179A OFF, disconnect line power and reinstall the top cover.

5.7 FUSE REPLACEMENT

The line fuse and current fuse are located internally in the Model 179A. The battery fuse is located on the battery pack PC-board. Turn off, unplug and remove the top cover of the instrument. Referring to Figure 6-1 for exact fuse location, replace blown fuses with those indicated in Table 5-6.

CAUTION

Installing a higher rated fuse than the one specified could result in damage to the instrument.

Table 5-4. Signal Tracing Levels

Checks	Test Point	Sch. Loc.	Signal
Attenuator (U101) Output	TP-5	E3	
TRMS Converter Input	TP-9	F2	
A/D Converter: A/D Converter Input	TP-10	G4	+ 1.0000V
U104 (buffer) Input and Output	U104 pins 3 and 6	H2	
Integrator	TP-7	J2	
Auto-Zero Cap	TP-6	J3	+ 1.00V ± 0.1V

Table 5-5. Model 179A Static Sensitive Devices

Reference Designation	Keithley Part Number
U101	IC-165
U103	LSI-12
U104	IC-175
U106	LSI-11
U107	IC-102
U201	IC-168
U301	IC-103

Table 5-6. Fuse Replacement

Fuse	Circuit Designation	Rating	Keithley Part Number
Line	F101	1/8A, 250V, 3AG, Slo-Blo	FU-20
Current	F102	2A, 250V, 3AG	FU-13
Battery	F301	2A, 250V, 3AG	FU-13

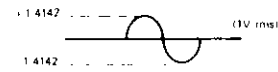
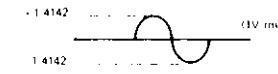
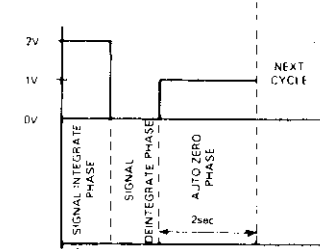
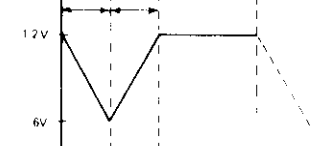
SECTION 6 REPLACEABLE PARTS

6.1 INTRODUCTION

This section contains replacement parts information, a schematic diagram and component layouts for the Model 179A.

6.2 REPLACEABLE PARTS

Parts are listed alpha-numerically in order of their circuit designation. Table 6-1 contains parts list information for the Model 179A Mother Board PC-492. Table 6-2 contains a parts list for the Model 179A Display Board PC-485. Table 6-3 contains a parts list for the Model 1788 Battery Pack PC-451. Miscellaneous replaceable parts not listed in a table can be identified in Figure 6-1. Table 6-4 contains a complement of spare parts that can be ordered to maintain up to 10 Model 179A DMMS for approximately one year.

6.3 ORDERING INFORMATION

To place an order, or to obtain information concerning replacement parts, contact your Keithley representative or the factory. See the inside front cover for addresses. When ordering include the following information:

1. Instrument Model Number
2. Instrument Serial Number
3. Part Description
4. Circuit Description (if applicable)
5. Keithley Part Number

6.4 FACTORY SERVICE

If the instrument is to be returned to the factory for service, please complete the service form which follows this section and return it with the instrument.

6.5 COMPONENT LAYOUTS

Figure 6-2—Model 179A Display Board PC-485, Drawing No. 29663.

Figure 6-3—Model 1788 Battery Pack PC-451, Drawing No. 29007.

Figure 6-4—Model 179A Mother Board PC-492, Drawing No. 32045.

6.6 SCHEMATIC DIAGRAM

Figure 6-5—Model 179A and 1788—Drawing No. 32046.

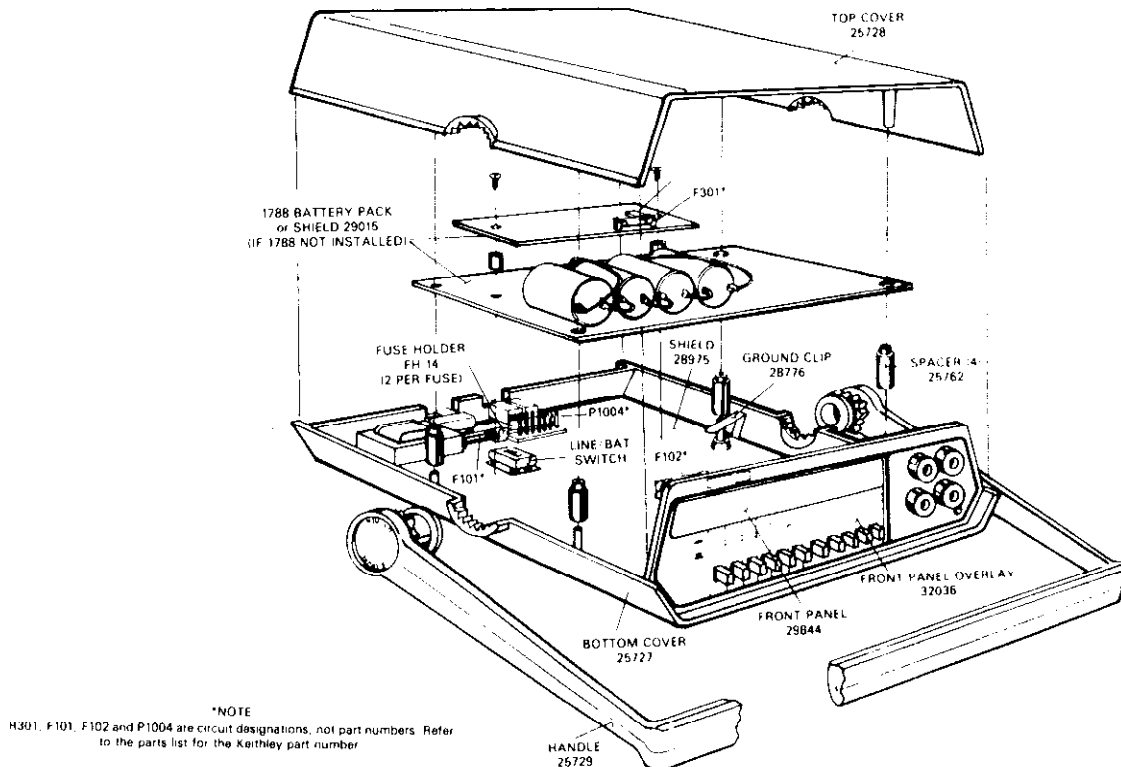

Figure 6-1. Miscellaneous Parts

Table 6-1. Model 179A Mother Board PD-492, Parts List

Circuit Desig.	Description	Location		Keithley Part No.
		Sch.	Pcb.	
C101	4.7 μ F, 25VDC, -20%, +100%, Aluminum Electrolytic	D-7	D-4	C-314-4.7
C102	4.7 μ F, 25VDC, -20%, +100%, Aluminum Electrolytic	D-7	E-4	C-314-4.7
C103	470 μ F, 35V, Aluminum Electrolytic	C-8	E-5	C-289-470
C104	470 μ F, 35V, Aluminum Electrolytic	C-8	E-5	C-289-470
C105	0.1 μ F, 1000V, MPF	C-3	F-5	C-285-.1
C106	.25-1.5pF, 2000V, Teflon Trimmer	D-2	F-4	C184
C107	1000pF, 500V, 5%, Polystyrene	D-3	F-4	C-306-.001
C108	2200 μ F, 15V, Aluminum Electrolytic	C-7	D-3	C-290-2200
C109	3.3pF, \pm 0.5pF, 50VDC, Ceramic Disc	E-2	E-3	C-291-3.3p
C110	1 μ F, 100V, 10%, MPF	G-2	E-3	C-294-1
C111	.25-1.5pF, 2000V, Teflon Trimmer	D-2	E-3	C-184
C112	1.9-15.8pF, 250V, Trimmer	D-2	E-3	C-339
C113	110pF, 500VDC, 1%, Silver Mica	D-2	F-3	C-278-110p
C114	1100pF, 500VDC, 5%, Dipped Mica	D-1	F-3	C-236-1100p
C115	33 μ F, 16VDC, 10%, Aluminum Electrolytic	F-2	E-3	C-321-33
C116	33 μ F, 16VDC, 10%, Aluminum Electrolytic	F-2	E-3	C-321-33
C117	1 μ F, 100V, 10%, MPF	J-3	D-2	C-294-1
C118	.22 μ F, 200VDC, 10%, MPF	J-2	D-2	C-269-.22
C119	NOT USED			
C120	1 μ F, 100V, 10%, MPF	F-3	F-1	C-294-1
C121	4.7 μ F, 25VDC, -20%, +100%, Aluminum Electrolytic	D-8	D-2	C-314-4.7
C122	4.7 μ F, 25VDC, -20%, +100%, Aluminum Electrolytic	D-8	D-2	C-314-4.7
C123	.1 μ F, 200V, 20%, MPF	G-4	E-2	C-306-.1
C124	4 μ F, 100V, 10%, MPF	H-2	E-1	C-294-4
C125	100pF, 1000V, Ceramic Disc	F-5	F-2	C-64-100p
CR101	Bridge Rectifier, 100V, 2A	C-6	D-5	RF-36
CR102	Bridge Rectifier, 1A, 400V	C-7	D-5	RF-52
CR103	Silicon Rectifier, 1A, 1000V	E-3	F-5	RF-50
CR104	Silicon Rectifier, 1A, 1000V	E-3	F-5	RF-50
CR105	Silicon Rectifier, 1A, 1000V	E-3	G-5	RF-50
CR106	Rectifier, 75mA, 75V	D-8	D-4	RF-28
CR107	Rectifier, 75mA, 75V	J-2	D-2	RF-28
CR108	Rectifier, 75mA, 75V	J-2	D-2	RF-28
CR109	Rectifier, 75mA, 75V	K-3	F-2	RF-28
CR110	Rectifier, 75mA, 75V	J-3	F-2	RF-28
CR111	Bridge Rectifier, 5A, 50V	A-3	G-3	RF-36
CR112	Rectifier, 3A, 50V	A-4	G-2	RF-34
CR113	Rectifier, 75mA, 75V	H-1	C-2	RF-28
F101	Fuse, S10-B10, 1/8A, 250V, 3AG	B-7	D-4	FU-20
F102	Fuse, 2A, 250V, 3AG	A-3	F-3	FU-13
J1001	8 Pin Female Connector	H-7	H-5	CS-356-4
J1002	10 Pin Female Connector	H-6	H-2	CS-356-5
J1003	3Pin Connector Housing	B-8	—	CS-287-3
J1004*	8 Pin Connector Housing	D-8	D-5	CS-287-8
J1005	Banana Jack, Black	A-4	—	BJ-11-0
J1006	Banana Jack, Red	A-3	—	BJ-11-2
J1007	NOT USED			
J1008	14 Pin Socket	K-5	G-2	S0-70
J1009	Banana Jack, Black	A-5	—	BJ-11-0
J1010	Banana Jack, Gray	A-5	—	BJ-11-8
K101	5V, Reed Type, Relay	B-8	E-4	RL-56
K102	5V, Reed Type, Relay	B-8	F-4	RL-56
K103	5V, Reed Type, Relay	A-8	F-4	RL-59
K104	5V, Reed Type, Relay	A-8	F-4	RL-59
K105	5V, Reed Type, Relay	A-8	F-4	RL-59
P1001*	8 Pin Male Connector	H-7	G-5	CS-355-4
P1002*	10 Pin Male Connector	H-6	G-2	CS-355-5
P1003	3 Pin Male Connector	B-8	D-5	CS-288-3
P1004	8 Pin Male Connector	D-5	D-3	CS-288-8
P1005	NOT USED			
P1006	NOT USED			
P1007	Line Cord	B-8	—	CO-9

Table 6-1. Model 179A Mother Board PC-492, Parts List (Cont.)

Circuit Desig.	Description	Location		Keithley Part No.
		Sch.	Pcb.	
Q101	N-Chan, JFET	D-3	E-4	TG-139
Q102	N-Chan, JFET	D-3	E-4	TG-139
Q103	N-Chan, JFET, 2N4392	H-2	D-2	TG-77
Q104	N-Chan, JFET, 2N4392	H-2	C-2	TG-77
Q105	N-Chan, JFET, 2N4392	J-3	D-2	TG-77
Q106	N-Chan, JFET	G-3	E-2	TG-139
Q107	N-Chan, JFET	G-4	F-2	TG-139
Q108	NPN, Switch, 2N3904	H-6	G-2	TG-47
R101	1M Ω , 0.5%, 2W, Metal Film	D-3	E-5	R-267-1M
R102	9.88M, 0.5%, .5W, 1200V, Metal Film	D-2	F-5	R-265-9.88M
R103	200k Ω , 10%, Cermet Trimmer	C-2	F-5	RP-89-200k
R104	100k Ω , 10%, 2W, Composition	E-4	F-5	R-3-100k
R105	47k Ω , 10%, 2W, Composition	G-4	F-5	R-3-47k
R106	47k Ω , 10%, 2W, Composition	D-4	G-5	R-3-47k
R107	100 Ω , 10%, Cermet Trimmer	J-1	D-3	RP-64-100
R108	200 Ω , 10%, Cermet Trimmer	J-1	D-3	R-64-200
R109	8.98k Ω , 0.1%, 0.1W, Metal Film	J-1	D-3	R-263-8.98k
R110	4.59k Ω , 0.1%, 0.1W, Metal Film	J-1	D-3	R-263-4.59k
R111	931 Ω , 1%, 1/8W, Metal Film	J-1	D-3	R-88-931
R112*	50k Ω , 10%, Cermet Trimmer	E-3	E-3	RP-97-50k
R113	NOT USED			
R114	750k Ω , 5%, 1/4W, Composition	D-3	E-3	R-76-750k
R115	100 Ω , 1%, 1/8W, Metal Film	D-3	E-3	R-88-100
R116	4.99k Ω , .1%, 1/10W, Metal Film	E-2	E-3	R-263-4.99k
R117	44.9k Ω , .1%, 1/10W, Metal Film	E-2	E-3	R-263-44.9k
R118	998k Ω , .1%, 1/4W, Metal Film	D-2	E-3	R-264-998k
R119	99.8k Ω , .1%, 1/4W, Metal Film	D-2	E-3	R-263-99.8k
R120	9.98k Ω , .1%, 1/10W, Metal Film	D-2	F-3	R-263-9.98k
R121	1.002k Ω , 10%, 1/10W, Metal Film	D-1	F-3	R-263-1.002k
R122	270k Ω , 5%, 1/4W, Composition	D-1	F-3	R-76-270k
R123	.898 Ω , .1%, 5W, WW	B-4	F-3	R-310-.898
R124	.1 Ω , .1%, 7.5W, Composition	B-4	F-2	R-262-.1000
R125	120 Ω , 5%, 1/4W, Composition	G-7	G-3	R-76-120
R126	5k Ω , 10%, Cermet Trimmer	D-2	E-3	RP-97-5k
R127	500 Ω , 10%, Cermet Trimmer	D-2	E-3	RP-97-500
R128	50 Ω , 10%, Cermet Trimmer	D-2	F-3	RP-97-50
R129	50k Ω , 10%, Cermet Trimmer	E-1	F-3	RP-97-50k
R130	143 Ω , .1%, 1/10W, Metal Film	J-2	D-2	R-263-143
R131	856 Ω , .1%, 1/10W, Metal Film	J-2	D-2	R-263-856
R132	100k Ω , 1%, 1/10W, Metal Film	J-2	D-2	R-88-100k
R133	26.7k Ω , 1%, 1/8W, Metal Film	J-2	D-2	R-88-26.7k
R134	3.01k Ω , 1%, 1/8W, Metal Film	J-3	E-2	R-88-3.01k
R135	Thick Film Network	Several	E-2	TF-65
R136	47k Ω , 10%, WW, Composition	F-4	F-2	R-3-47k
R137	9 Ω , 0.5W, 0.1%, WW	B-4	F-3	R-252-9
R138	900 Ω , 0.1%, 1/2W, Metal Film	C-4	F-3	R-168-900
R139	90 Ω , 1/2W, .1%, Metal Film	B-4	F-3	R-169-90
R140	11k Ω , 1%, 1/8W, Metal Film	J-1	D-2	R-88-11k
R141	19.6k Ω , 1%, 1/8W, Metal Film	J-2	D-2	R-88-19.6k
R142	50k Ω , 10%, Cermet Trimmer	G-3	E-2	RP-97-50k
R143	500 Ω , 10%, Cermet Trimmer	G-2	E-2	RP-97-500
R144	NOT USED			
R145	NOT USED			
R147	47k Ω , 5%, 1/4W, Composition	F-5	G-2	R-76-47k
R148	22M Ω , 10%, 1/4W, Composition	F-5	G-2	R-76-22M
R149	200k Ω , 10%, Cermet Trimmer	D-3	G-1	RP-89-200k
R150	3.3k Ω , 5%, 1/4W, Composition	E-3	F-5	R-76-3.3k
R151	12k Ω , 5%, 1/4W, Composition	F-3	F-5	R-76-12k
R152	R152, R153 and UR105 are part of a selected set	J-1	D-3	R-88-SEL 28798
R153	R152, R153 and UR105 are part of a selected set	J-1	D-3	R-88-SEL 28798

Table 6-1. Model 179A Mother Board PC-492, Parts List (Cont.)

Circuit Desig.	Description	Location		Keithley Part No.
		Sch.	Pcb.	
R154	0.01Ω, 0.25%, 7.5W, WW, 4-Terminal	K-1	G-2	R-274-.01
R155	Thick Film Network	A-8	F-4	TF-103-1
R156	10kΩ 5%, 1/4W, Composition	G-4	E-2	R-76-10k
S101	Line Voltage Selector	B-7	D-4	SW-318
S102	Line/Battery	C-6	D-4	SW-397
S103	11 Station Pushbutton	A-5	G-4	27696 SW 702
T101	Transformer Power (STD.)	C-6	D-5	TR-168
T101	Transformer Power (Japanese Version 100/200V)	C-6	D-5	TR-169
U101	B1-FET Operational Amplifier 8 Pin TO-99	D-3	E-4	IC-165
U102	Operational Amplifier, 8 Pin, Dip	E-2	E-3	IC-167
U103	4 ½ Digit Analog-Processor	K-2	D-2	LSI-12
U104	Operational Amplifier, 8 Pin, TO-5	H-2	E-2	IC-175
U105	TRMS Converter	F-2	D-2	IC-172-1
U106	4 ½ Digit Logic Processor <i>ECO 12908 7-88</i>	J-4	E-2	LSI-11 791-600
U107	4011 CMOS Unbuffered	Several	G-2	IC-102
VR101	-15V, 3-Term	C-8	E-5	IC-253
VR102	+15V, 3-Term, LO-Power	C-8	E-5	IC-170
VR103	NOT USED			
VR104	+5V, 3-Term, TO-220	D-7	D-4	IC-93
VR105	Reference Zener, (VR105, R152 and R153 are part of a selected set)	J-2	D-2	<i>28798</i> DZ-58
Y101	Quartz, ±0.1%, 100kHz	F-5	F-1	CR-8

*J1004 is located on PC-451 (1788 Battery Pack)

*P1001 and P1002 are located on PC-485 (Display Board)

*R112 may or may not be installed

Table 6-2. Model 179A Display Board PC-485, Parts List

Circuit Desig.	Description	Location		Keithley Part No.
		Sch.	Pcb.	
C201	4.7μF, 25VDC, -20%, +100%, Aluminum Electrolytic	K-7	B-2	C-314-4.7
DS201	±1 LED Digit	H-7	C-2	DD-31
DS202	7 Segment LED Digit	H-7	C-2	DD-30
DS203	7 Segment LED Digit	H-7	D-2	DD-30
DS204	7 Segment LED Digit	J-7	D-2	DD-30
DS205	7 Segment LED Digit	J-7	E-2	DD-30
R201	120Ω, 1/4W, 5%, Composition	H-7	C-2	R-76-120
R202	47Ω, Thick Film Network	J-7	E-2	TF-102-3
U201	Segment Drive	K-7	E-2	IC-168
U202	Digit Driver	H-6	B-2	IC-169
P1001	8 Pin Male Connector	H-7	G-5	CS-355-4
P1002	10 Pin Male Connector	H-6	G-2	CS-335-5

Table 6-3. Model 1788 Battery Pack PC-451, Parts List

Circuit Desig.	Description	Location		Keithley Part No.
		Sch.	Pcb.	
BT301	Lead Acid "D" cell, 2V, 2.5AH (Set of four)	F-6	-	BA-33
C301	4.7 μ F, 20VDC, 20%, Tantalum Electrolytic	F-7	E-3	C-179-4.7
C302	4.7 μ F, 20VDC, 20%, Tantalum Electrolytic	F-7	E-3	C-179-4.7
C303	1 μ F, 250VDC, 10%, Metalized Polyester	F-7	E-3	C-256-1
C304	100 μ F, 35VDC, -10, +100%, Aluminum Electrolytic	F-8	F-4	C-295-100
C305	100 μ F, 35VDC, -10, +100%, Aluminum Electrolytic	F-8	F-3	C-295-100
CR301	Rectifier, 75mA, 75V	E-6	D-4	RF-28
CR302	Rectifier, 75mA, 75V	E-7	E-3	RF-28
CR303	Rectifier, 75mA, 75V	E-7	E-3	RF-28
CR304	Rectifier, 75mA, 75V	E-8	F-4	RF-28
CR305	Rectifier, 75mA, 75V	E-8	F-4	RF-28
F301	2A, 250V, 3AG	F-6	C-3	FU-13
J1004	8 Pin Connector Housing	D-8	D-5	CS-287-8
Q301	Thyristor, SCR, 106F1	D-6	C-4	TG-132
Q302	NPN, Switch, 2N3904	E-7	C-3	TG-47
Q303	PNP, Silicon, 2N3905	E-7	D-4	TG-53
Q304	NPN, Switch, 2N3904	E-7	E-4	TG-47
Q305	NPN, Switch, 2N3904	E-8	E-4	TG-47
Q306	PNP, Silicon, T0-92 Case, 2N3905	E-7	E-4	TG-53
Q307	NPN, Switch, 2N3725	F-7	E-3	TG-131
Q308	NPN, Switch, 2N3725	F-7	E-3	TG-131
Q309	PNP, Silicon, MPS-WA5	E-6	D-3	TG-133
Q310	PNP, Silicon, T0-92 Case, 2N3905	E-6	D-3	TG-53
R301	20k Ω , 0.5W, POT	E-7	C-3	RP-97-20k
R302	330 Ω , 5%, 1/4W, Composition	E-7	C-3	R-76-330
R303	1k Ω , 5%, 1/4W, Composition	E-6	D-4	R-76-1k
R304	3.9 Ω , 20%, 3W, WW	D-6	D-4	R-268-3.9
R305	4.7k Ω , 5%, 1/4W, Composition	E-7	D-3	R-76-4.7k
R306	33k Ω , 5%, 1/4W, Composition	D-8	C-3	R-76-3.3k
R307	82k Ω , 5%, 1/4W, Composition	F-7	E-3	R-76-82
R308	82k Ω , 5%, 1/4W, Composition	F-7	E-3	R-76-82
R309	10 Ω , 5%, 1/4W, Composition	D-8	F-4	R-76-10
R310	10 Ω , 5%, 1/4W, Composition	D-8	F-4	R-76-10
R311	100k Ω , 5%, 1/4W, Composition	E-6	E-3	R-76-100k
R312	100k Ω , 5%, 1/4W, Composition	E-6	E-3	R-76-100k
R313	100k Ω , 5%, 1/4W, Composition	F-6	E-3	R-76-100k
R314	6.8M Ω , 10%, 1.4W, Composition	F-6	E-3	R-76-6.8M
R315	576k Ω , 1%, 1/8W, Composition	F-6	E-3	R-88-576k
R316	100k Ω , 1%, 1/8W, Composition	F-6	E-3	R-88-100k
T301	Transformer, Power	F-7	F-3	TR-170
U301	Dual D-Type Flip-Flop, 14-Pin, Dip	E-7	D-3	IC-103
U302	1.1V Micro-Power Detector	F-6	E-3	IC-177
VR301	8.2 Volt Zener	E-6	C-3	DZ-61

Table 6-4. Recommended Spare Parts

Qty	Keithley Part No.	Sch. Designation
1	C-294-4	C124
2	DD-20	DS202 through DS205
1	DD-21	DS201
5	FU-13	F102
2	FU-20	F101
1	IC-93	VR104
1	IC-102	U107
2	IC-165	U101
1	IC-168	U201
1	IC-169	U202
1	IC-170	VR102
1	IC-253	VR101
1	LSI-11	U106
1	LSI-12	U103
1	RL-56	K101 and 102
2	RL-59	K103 through K105
2	TG-128	Q106 and 107

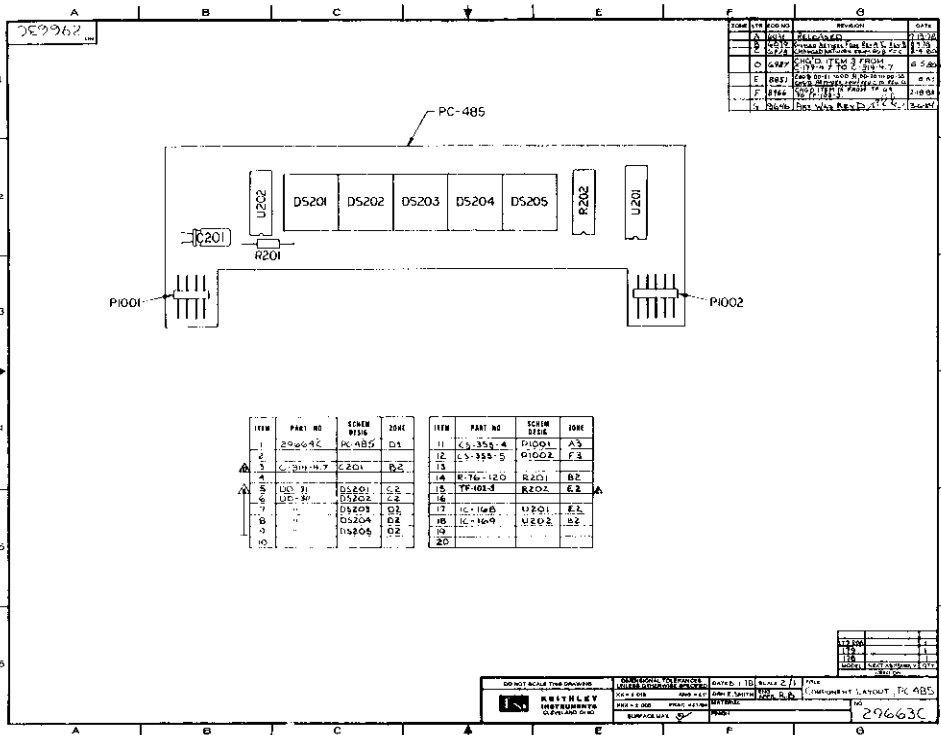

Figure 6-2. Model 179A Display Board PC-485, Component Location Drawing, Dwg. No. 29663

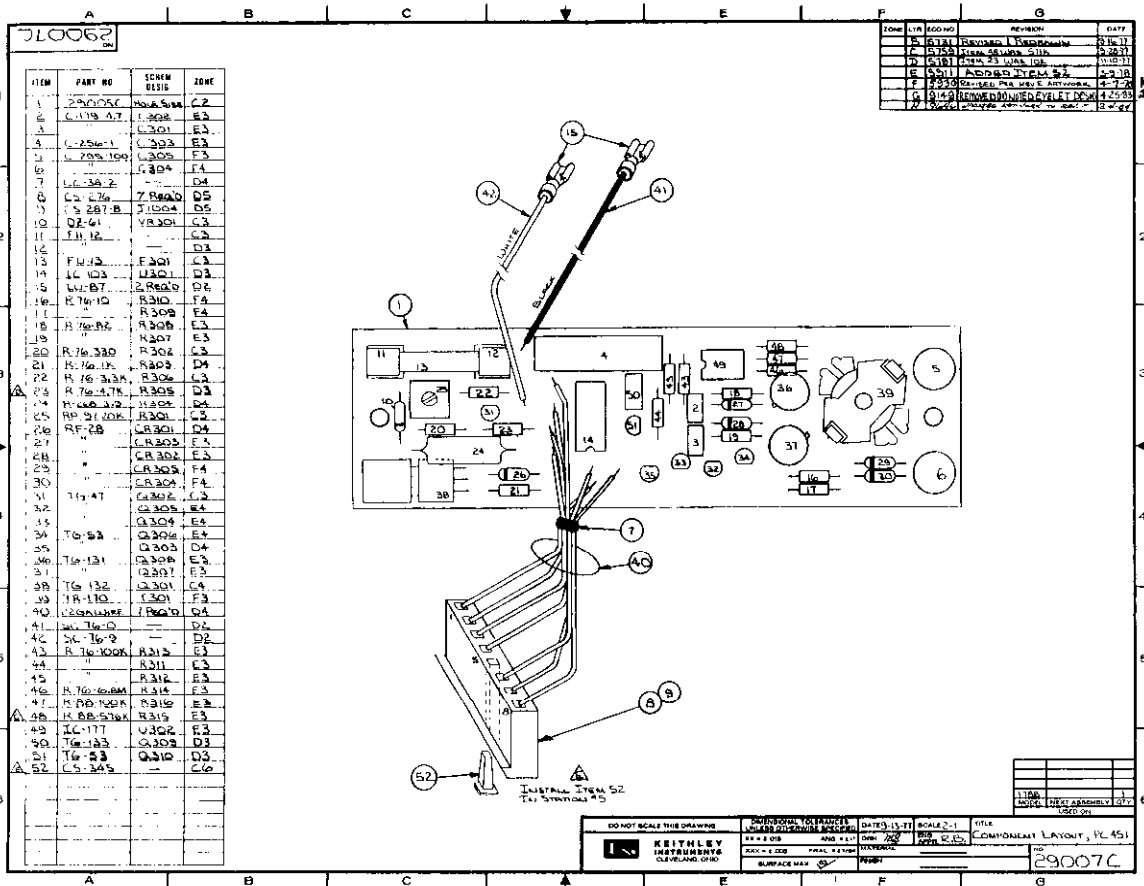

Figure 6-3. Model 1788 Battery Pack PC-451, Component Location Drawing, Dwg. No. 29007

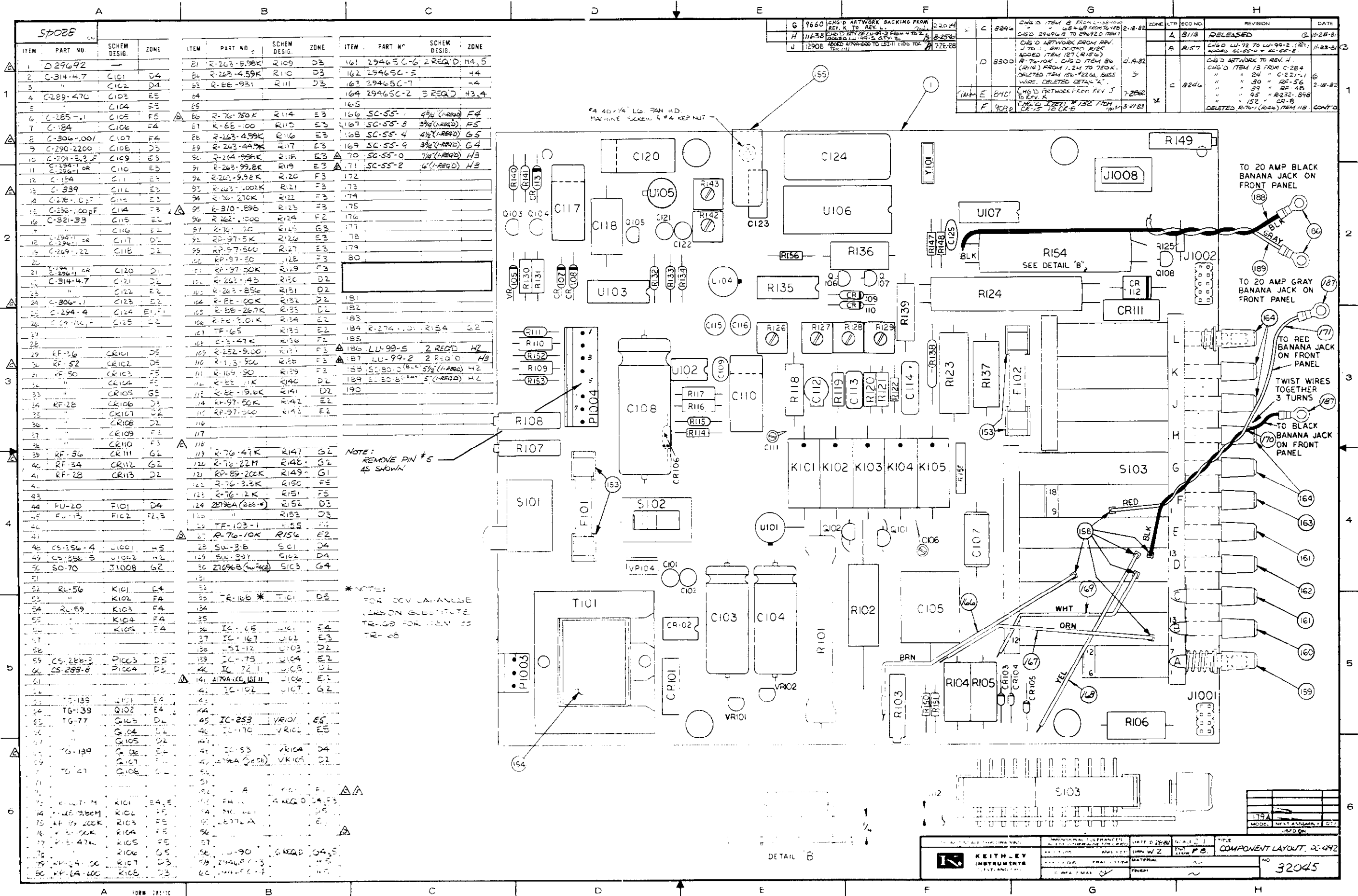

Figure 6-4. Model 179A Mother Board PC-492 Component Location Drawing, Dwg. No. 32045

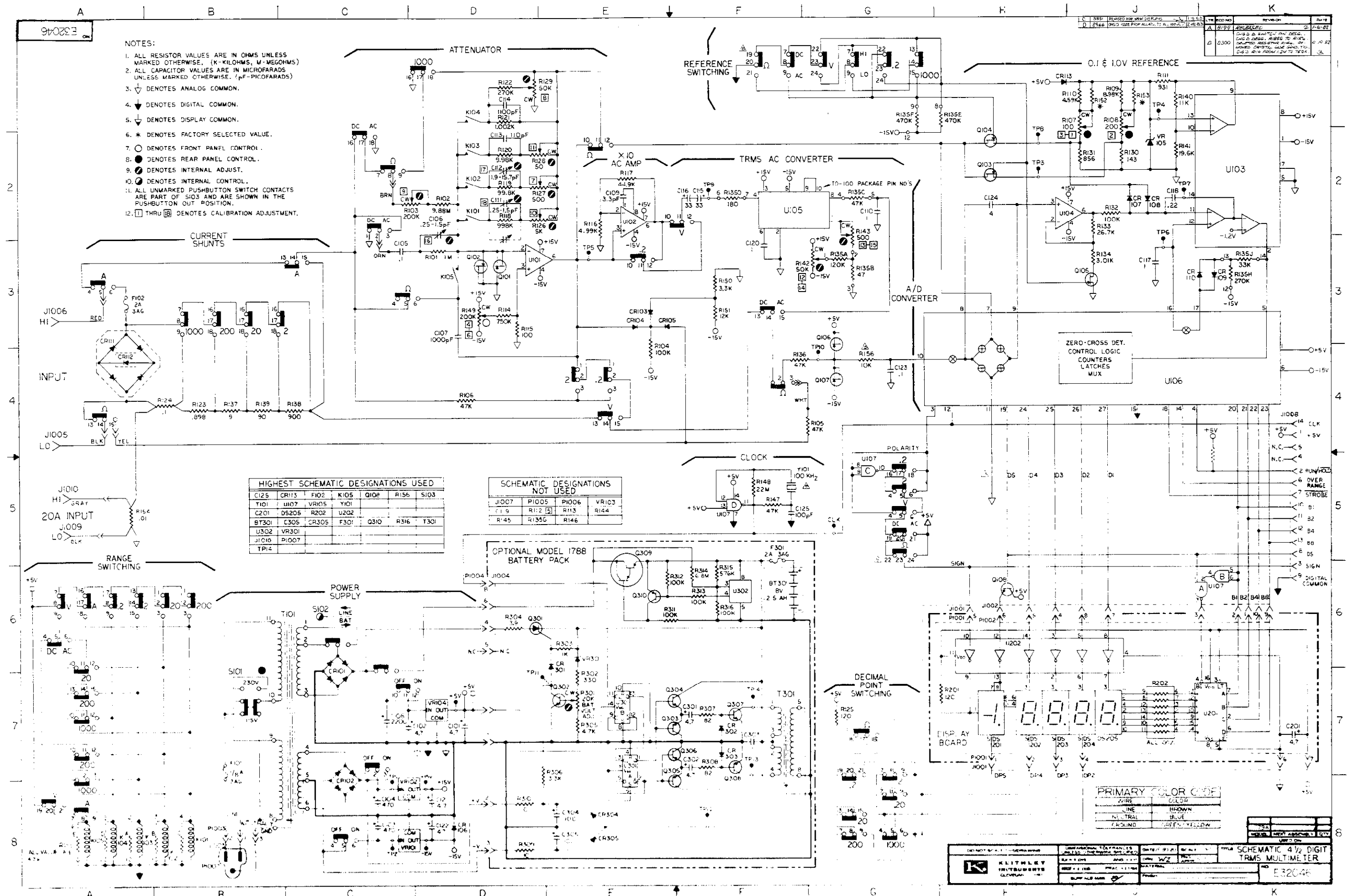

Figure 65 Model 179A and 1788. Schematic Diagram, Dwg No 32046 6-9/6-10



SERVICE FORM

Model No. _____ Serial No. _____ Date _____

Name and Telephone No. _____

Company _____

List all control settings, describe problem and check boxes that apply to problem. _____

- Intermittent Analog output follows display Particular range or function bad; specify _____
- IEEE failure Obvious problem on power-up Batteries and fuses are OK
- Front panel operational All ranges or functions are bad Checked all cables

Display or output (circle one)

- Drifts Unable to zero
- Unstable Will not read applied input
- Overload

- Calibration only C of C required
- Data required

(attach any additional sheets as necessary.)

Show a block diagram of your measurement system including all instruments connected (whether power is turned on or not). Also, describe signal source.

Where is the measurement being performed? (factory, controlled laboratory, out-of-doors, etc.)

What power line voltage is used? _____ Ambient Temperature? _____ °F

Relative humidity? _____ Other? _____

Any additional information. (If special modifications have been made by the user, please describe.) _____

Be sure to include your name and phone number on this service form.