

The Specification of LCR Accessories

LCR-05



Description:

Test fixture for measurement of both axial and vertical lead components

Frequency: DC ~ 1MHz

Max. Voltage: +/- 35V

Applicable Instruments:

LCR-8110G/8105G/8101G
LCR-6300/6200/6100/6020/6002

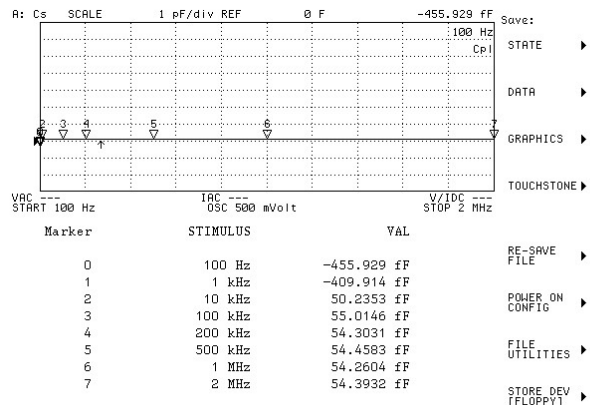
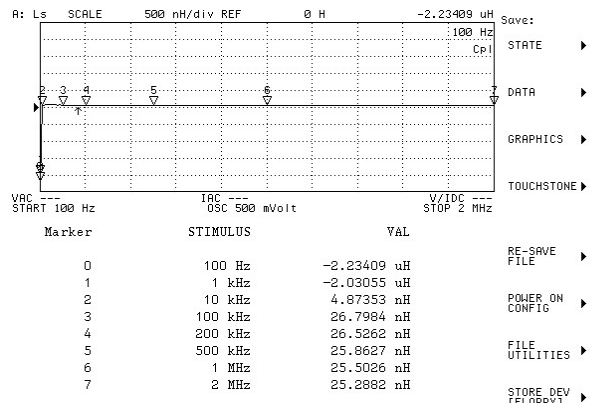
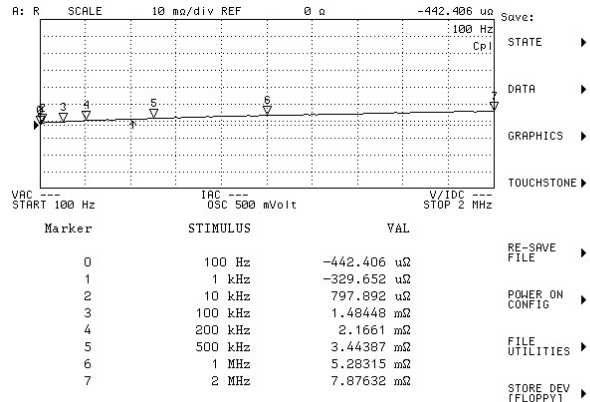

The Specification of LCR Accessories

LCR-06A (Phase-out)*



Description:

Kelvin clip test leads.

Frequency: DC ~ 1MHz

Max. Voltage: +/- 35V

Applicable Instruments:

LCR-8110G/8105G/8101G
LCR-6300/6200/6100/6020/6002

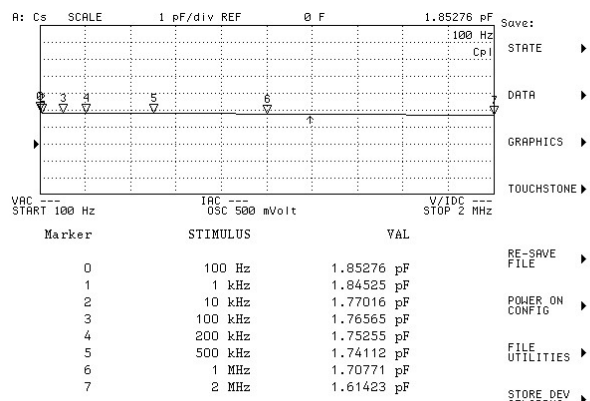
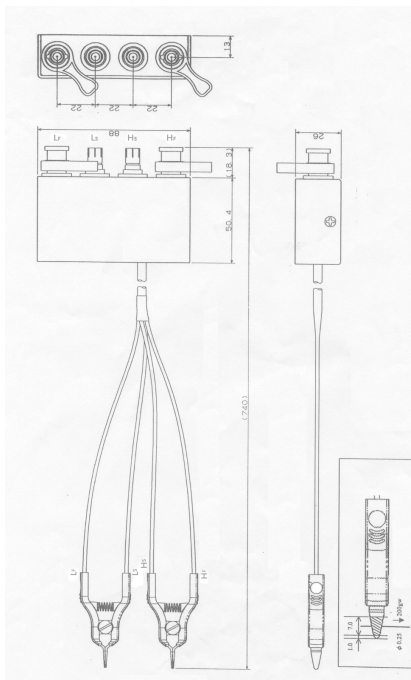
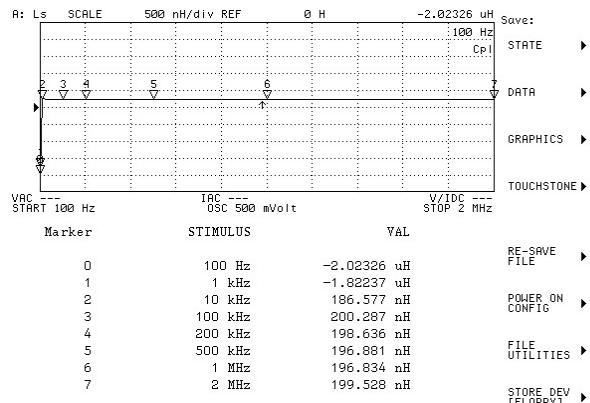
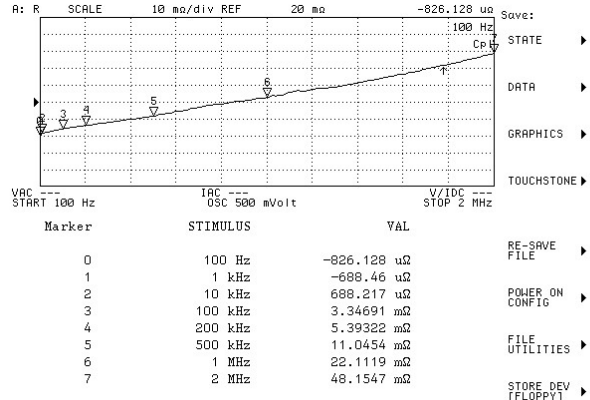

*** Recommend Equivalent fixture : LCR-06B**

The Specification of LCR Accessories

LCR-06B (NEW)

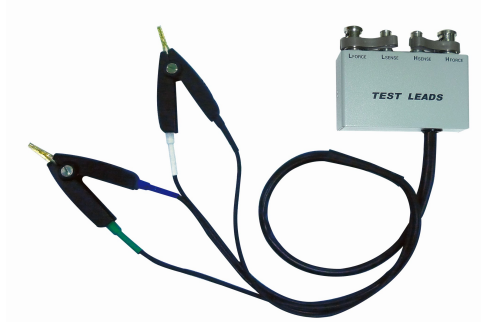

Description:

Kelvin clip test leads

Frequency: DC ~ 1MHz

Max. Voltage: +/- 45V

Applicable Instruments:

LCR-8110G/8105G/8101G
LCR-6300/6200/6100/6020/6002

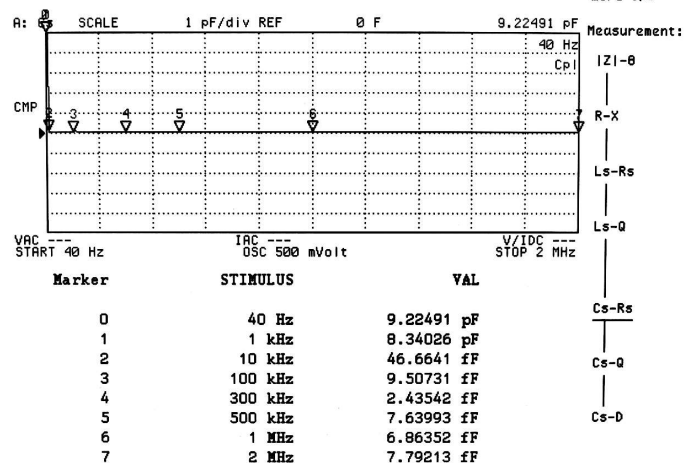
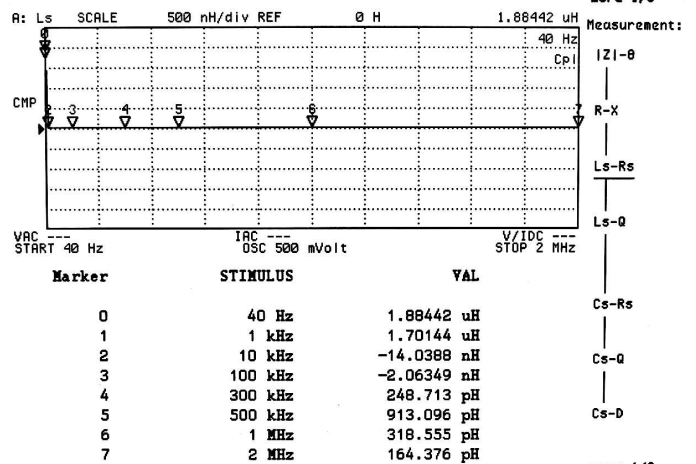
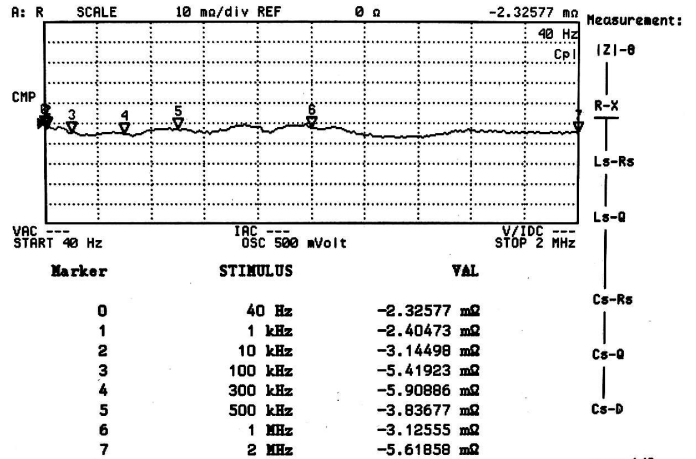
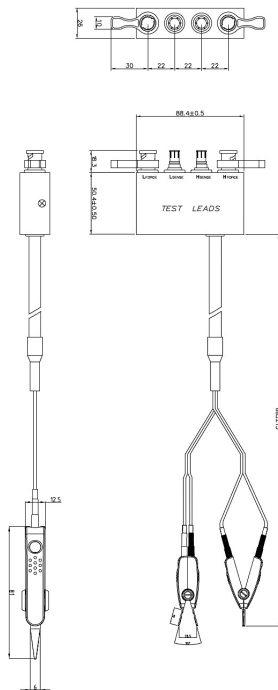

The Specification of LCR Accessories

LCR-07



Description:

Test leads for conventional component measurement. It is especially useful for high impedance measurement. (With alligator clips)
Two-wire measurement; apply to low C or high R

Frequency: DC ~ 1MHz

Max. Voltage: +/- 35V

Applicable Instruments:

LCR-8110G/8105G/8101G
LCR-6300/6200/6100/6020/6002

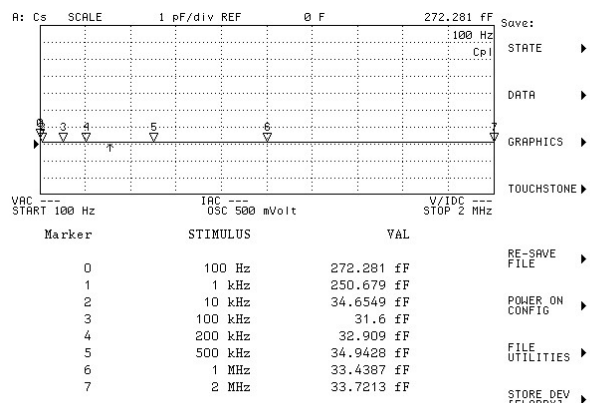
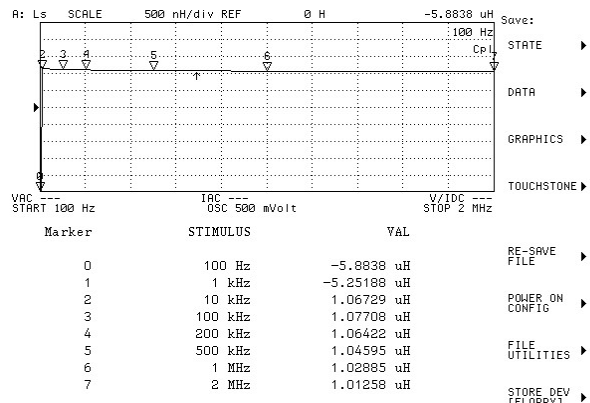
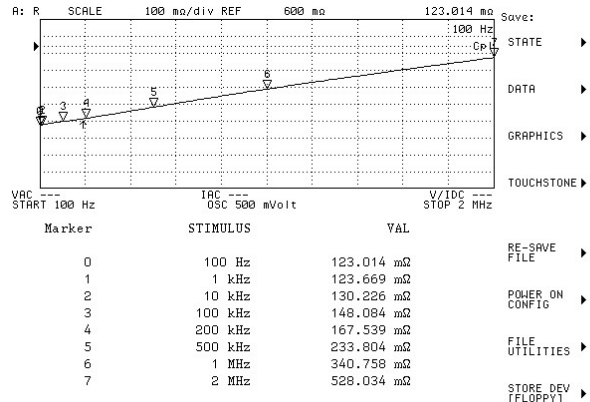
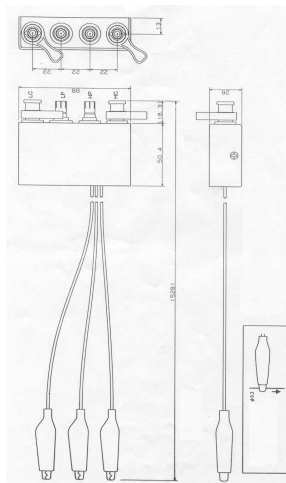

The Specification of LCR Accessories

LCR-08

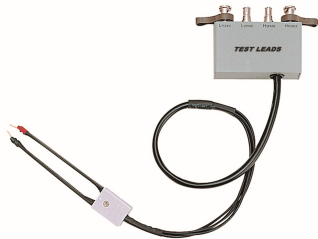

Description:

SMD / chip tweezers

Frequency: DC ~ 1MHz

Max. Voltage: +/- 35V

Applicable Instruments:

LCR-8110G/8105G/8101G

LCR-6300/6200/6100/6020/6002

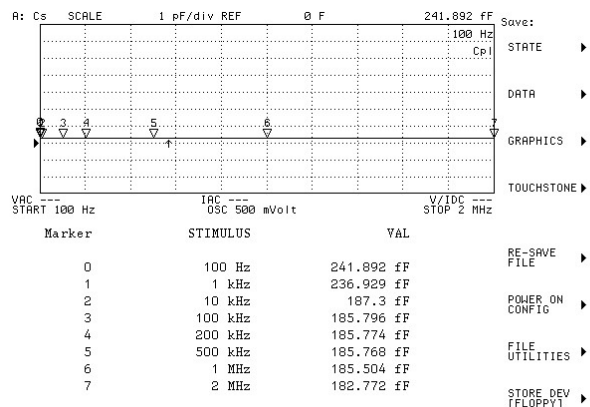
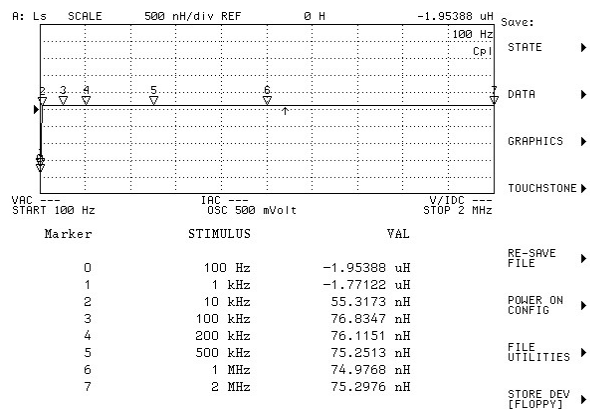
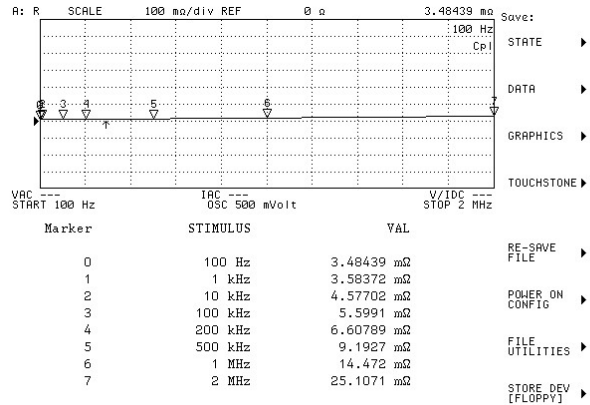
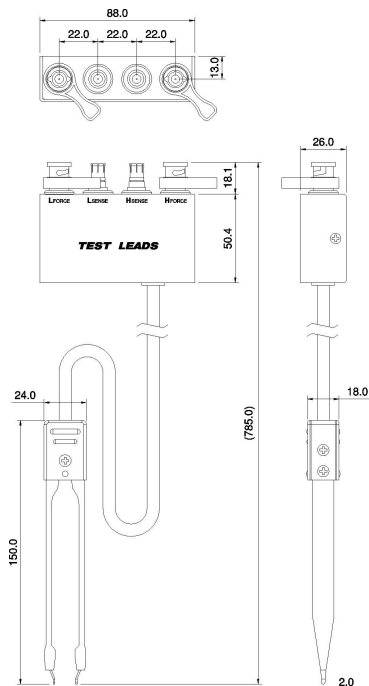

The Specification of LCR Accessories

LCR-09 (Phase-out)*

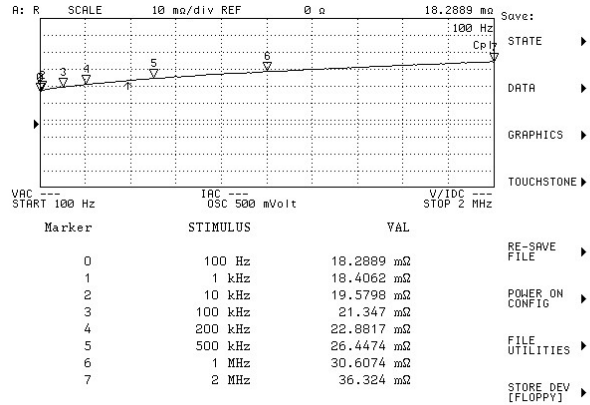
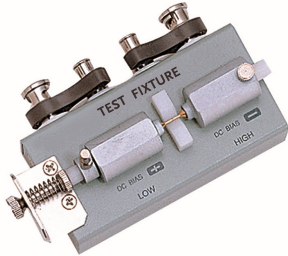

Description:

SMD / chip test fixture

Frequency: DC ~ 10MHz

Max. Voltage: +/- 35V

SMD Size Range:

0603 to 1812 (in inch)

Applicable Instruments:

LCR-8110G/8105G/8101G

LCR-821/819/817/816

LCR-829/827/826

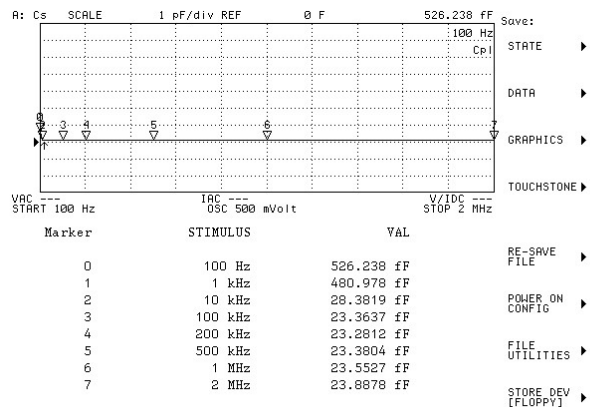
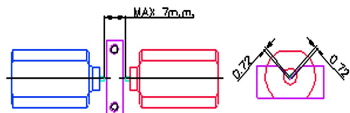
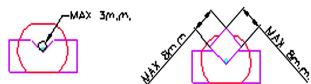
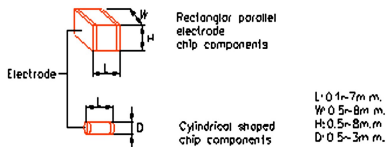
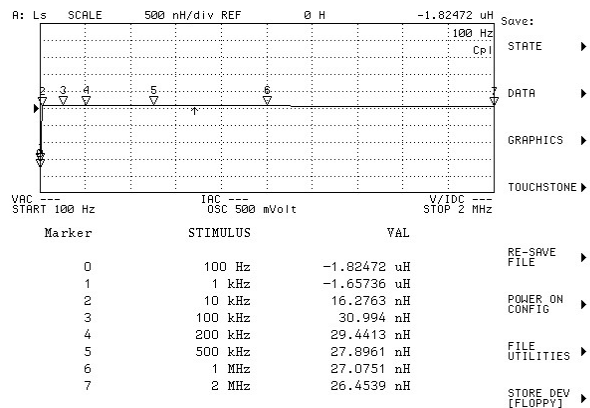

* Recommend Equivalent fixture : LCR-15

The Specification of LCR Accessories

LCR-12

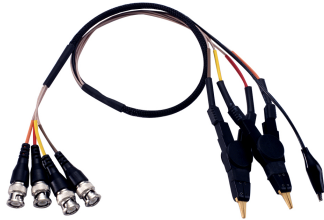

Description:

Kelvin clip test leads with GND line.

Frequency: DC ~ 10MHz

Max. Voltage: +/- 35V

Applicable Instruments:

LCR-8110G/8105G/8101G

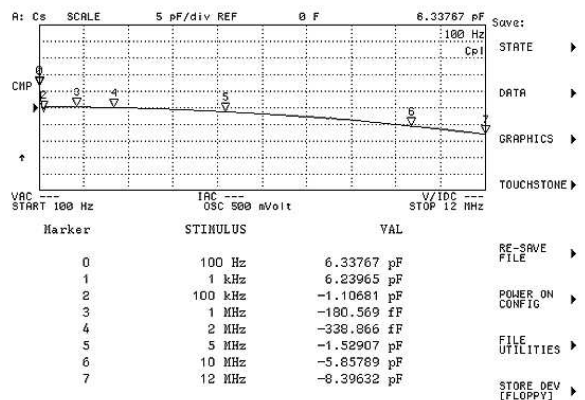
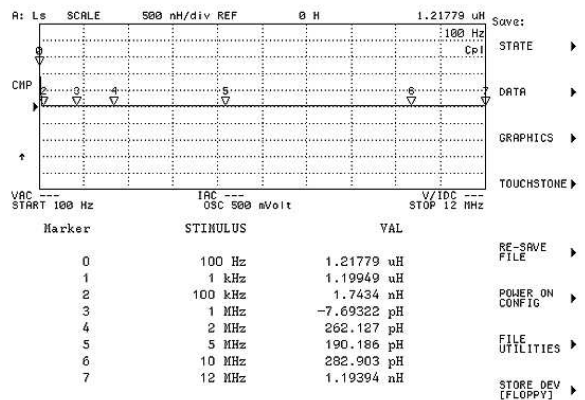
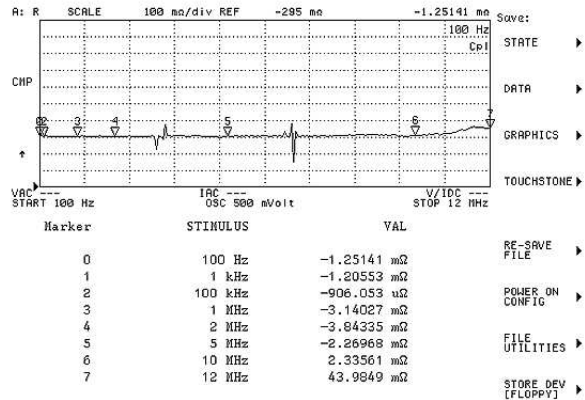

The Specification of LCR Accessories

LCR-13 (Phase-out)*

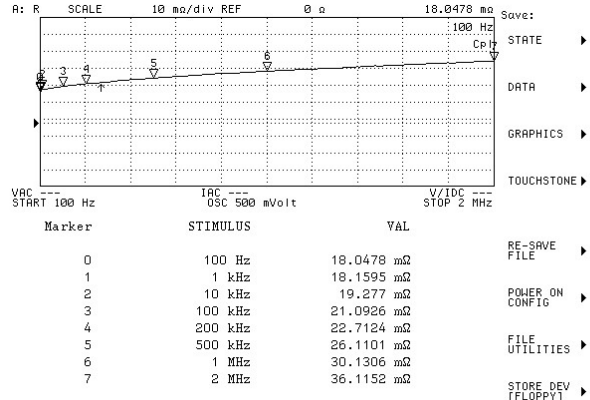
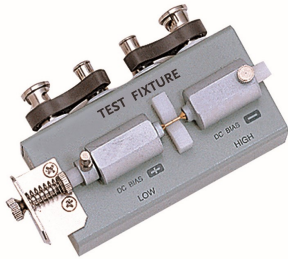

Description:

SMD / chip test fixture

Frequency: DC ~ 10MHz

Max. Voltage: +/- 35V

SMD Size Range:

0201 to 0805 (in inch)

Applicable Instruments:

LCR-8110G/8105G/8101G

LCR-821/819/817/816

LCR-829/827/826

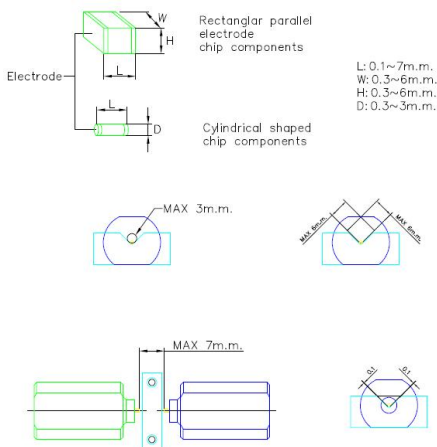
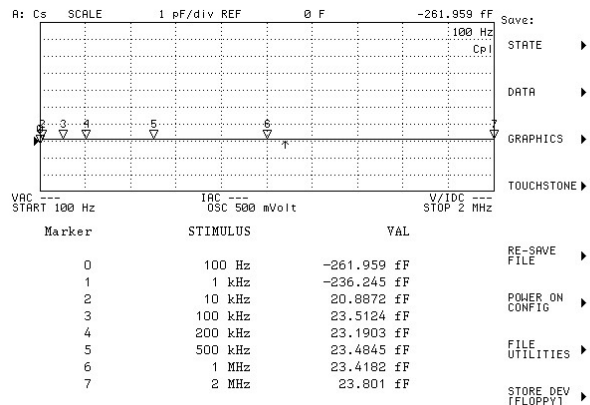
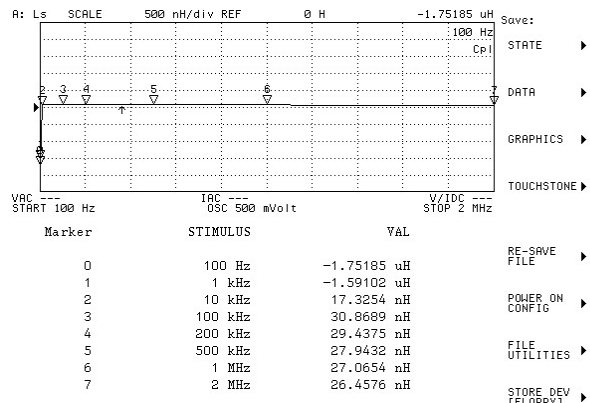

* Recommend Equivalent fixture : LCR-15

The Specification of LCR Accessories

LCR-15 (NEW)

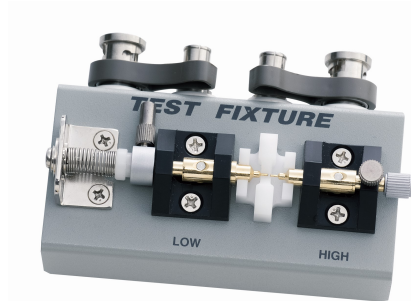

Description:

SMD / chip test fixture

Frequency: DC ~ 10MHz

Max. Voltage: +/- 45V

SMD Size Range:

0201 to 1812 (in inch)

Applicable Instruments:

LCR-8110G/8105G/8101G

LCR-6300/6200/6100/6020/6002

