



GPM-8320/8330

Digital Power Meter

FEATURES

- 5" TFT LCD
- Voltage/Current Meter Test Freq. Bandwidth: DC, 0.1Hz ~ 100kHz
- Waveform Display : V (Voltage), I (Current), P (Wattage)
- Distorted wave Current/Voltage Measurement: Full Range for CF=3, and Half Range for CF=6 (or 6A)
- Meeting IEC 61000-4-7 Harmonic Measurement (50/60Hz)
- Wiring Selecting Button (1P3W, 3P3W, 3P4W, 3V3A)
- Harmonic Measurement & Analysis up to 50 Orders
- Auto Ranging Function for Integration Mode
- Screen Capture Through USB Host
- Provide External Current Sensor Input (EXT1/EXT2)
- Standard Interface: RS-232C, USB Device/Host, LAN
- Optional Interface: GPM-DA12 - GPIB + Digital I/O (Factory Installed Only)

GW INSTEK
Simply Reliable

GW Instek GPM-8320/8330 are digital power meters designed specifically for measuring power in three-phase AC power sources, making it suitable for most electrical and electronic product testing applications (GPM-8320 provides 2 modules, and GPM-8330 provides 3 modules). These models have a testing bandwidth of DC, 0.1Hz~100 kHz and feature 16-bit A/D converters and a sampling rate of 300 kHz. A 5-inch TFT LCD display, 5 digits of measurement readings, 25 different power measurement parameters, and high precision measurement capabilities are also provided. GPM-8320/8330 also feature waveform display capabilities (voltage/current/power), the integration measurement function, harmonics measurement and analysis of multiple orders (50/60Hz measurement complies with IEC61000-4-7 requirements), external sensor input terminals, and a variety of communications interfaces. These features help users achieve clear, convenient, and accurate power measurements, making them the most fully-featured and cost-effective power meters in the same category.

GPM-8320/8330 provide multiple input voltage configuration wiring modes (1P3W/3P3W/3P4W/3V3A). Users can choose the wiring mode according to their specific requirements to measure parameters for specific wiring methods, and even calculate efficiency. In addition, for a rated input voltage of 1000V and an input current of 20A, they support a minimum current range of 0.5A (resolution of 0.1mA), power measurement resolution of 0.1mW, crest factor of 3 (for half range, the CF can reach up to 6 or 6A), and voltage/current/power measurement accuracy of $\pm 0.1\%$ reading $\pm 0.05\%$ range. Users can select different measurement modes (AC+DC/AC/DC/ V-MEAN) to provide up to 25 related parameters for power measurement. These parameters include voltage (Vrms/ Vac/ Vdc/ Vmn/ V+pk / V-pk), current (Irms/ Iac/ Idc/ I+pk/ I-pk), frequency (VHz/ IHz), power (P/ P+pk/ P-pk), crest factor (CFV/ CFI), apparent power (VA), reactive power (VAR), power factor (PF), phase angle (DEG), total harmonic distortion (THDV/ THDI), maximum current ratio (MCR), and MATH calculation function. Therefore, they provide the best range and accuracy support for measuring the power consumption of electrical and electronic products.

GPM-8320/8330 also effectively utilize the advantages of TFT LCD display, providing results of parameter measurements in both numerical and graphical formats. In terms of numerical display, it offers a general mode and a multiple mode. The general mode includes 4 tabs (page1~page4), and each tab can display 10 measurement parameters (2 main measurements + 8 monitoring measurements). Users can freely combine these parameters to display the results of measurements from various modules. The multiple mode can simultaneously display the measurement results of three modules, which is particularly suitable for comparing differences in measurements between modules, such as unbalanced three-phase. This mode also offers 4 tabs, and each tab can display 8 measurement parameters. In terms of graphical display, they offer a simple oscilloscope mode to display voltage, current, and power parameters in waveform format. Additionally, the display provides numerical or bar chart display for the measurement and analysis of harmonics signals at various orders that not only satisfies the need for accuracy and clear readability in process testing, but also meets the diverse measurement application requirements for research and development, design and quality verification.

GPM-8320/8330 have comprehensive mechanisms and functions for auxiliary measurements. For applications that require measuring high voltage, they provide VT rate settings that can be used with external potential transformers. For measuring large current, it depends on the type of current transformer, whether it is a voltage output type or a current output type. If it is a current output type, it can be directly locked onto the meter's rear panel and used with CT rate settings for measurement. If it is a voltage output type, it can be measured through the external current sensor input terminals (EXT1/EXT2) provided by GPM-8320/8330. Automatic range switching can be customized to the required range to save unnecessary time spent on range switching. The internal memory of 10,000 data logs can store measurement data at the update rate set by GPM-8320/8330 or at a user-defined time interval for future analysis.

In terms of data acquisition and storage, GPM-8320/8330 offer a variety of communications interfaces, including RS-232C/USB device (virtual COM)/LAN, or optional GPIB. Users can choose to write programs to read measurement results according to their habits or in collocation with existing system interfaces. The USB host can support screen capture, internal data logging, and firmware updates for GPM-8320/8330. For those with the needs of using external signal control or data recorder for data recording, GPM-8320/8330 also offer an optional Digital I/O (DA12) interface (must be installed at the factory), which can be connected to external controllers such as PLC or data recorders to meet the needs of automated measurements or long recording applications.

A. WIRING SELECTION



GPM-8320/8330 provide multiple input voltage configuration wiring modes (1P3W/3P3W/3P4W/3V3A). Users can choose the wiring mode according to their specific requirements to measure parameters for specific wiring methods, and even calculate efficiency.

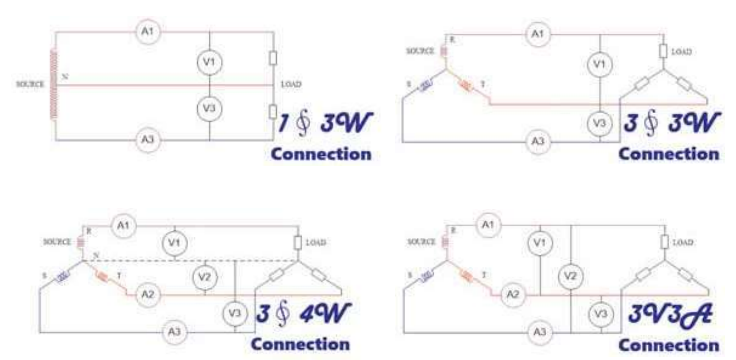

B. VARIOUS DISPLAY MODES



Numerical (Single) Mode

Numerical (Multiple) Mode

Numerical (Simple) Mode

Waveform Mode

Harmonics (Bar Graph) Measurement

Harmonics (List) Measurement

GPM-8320/8330 provide two display modes, numerical and graph, which help users maximize the benefits of their measurements. In numerical mode, there are two options: single and multiple. In single mode, there are four tabs that can be customized with the module's measurement settings, and each tab can display up to 10 measurement parameters (2 main and 8 secondary measurements). In multiple mode, there are also four tabs, and users can simultaneously observe the same 8 measurement parameters from three different modules. Parameters in both modes can be arranged and customized as needed, and a simple mode that displays only the first four parameters is also available regardless of which tab is selected. In graph mode, there is a simple oscilloscope function that

displays the waveforms of three parameters: voltage, current, and power. The horizontal scale can be adjusted (from 50 μ s/div to 10ms/div depending on the set data update rate), and three waveform observation magnification ratios are available. When measuring harmonics, the harmonics measurement results of each order can be displayed in a bar chart, and a specific observation order can be specified. Additionally, all relevant values for harmonics of each order (voltage/current/power voltage distortion percentage/current distortion percentage/power distortion percentage/voltage phase angle/current phase angle) can be fully recorded and presented.

C. RICH MEASUREMENT PARAMETERS

Measurement Items	Symbols
Voltage	Vrms, V-pk, V-pk, Vac [*] , V _{dc} [*] , V _{rm} [*]
Current	Irms, I-pk, I-pk, Iac [*] , Idc [*]
Power	P, P+pk, P-pk, VA, VAR
Power Factor	PF
Crest Factor	CF, CFI
Phase Angle	DEG
Frequency	VHz, IHz
Total Harmonic Distortion	THDV, THDI
Mathematical Computation	MATH
Maximum Current Ratio	MCR
Integration	WP, WP+, WP-, q, q+, q-, Vac, Iac

*: Only applicable to specific measurement modes and available for selection

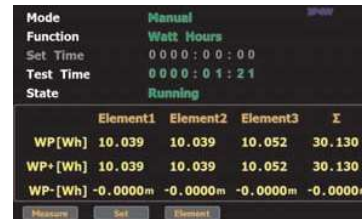

GPM-8320/8330 provide a variety of measurement items, including voltage, current, frequency, active power, apparent power, reactive power, power factor, crest factor, total harmonic distortion, and even the ability to measure maximum current ratio. Additionally, GPM-8320/8330 are equipped with measurement functions for power or current time integration specific to the DUT. Users set a period of time to perform

instantaneous power integration during this time, and then divide by the time to obtain the average power of the DUT. Moreover, during integration measurements, GPM-8320/8330 support automatic range switching function to obtain the most complete integration results in response to the power changes of the DUT in different time periods.

D. SUPERB MEASUREMENT ASSISTANCE

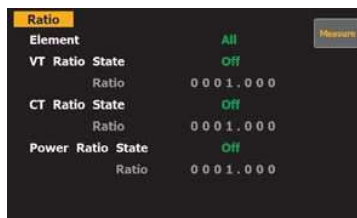

Ratio Configuration

In terms of measurement support, GPM-8320/8330 perform exceptionally well. Firstly, in the measurement of high voltage/power, they provide voltage/power ratio settings to restore the attenuation rate to the true value. In addition, for large current measurement, other than the current ratio setting, there are also terminals (EXT1/EXT2) for external current sensors that can be connected to voltage output type current transformers, making large current measurement more convenient.

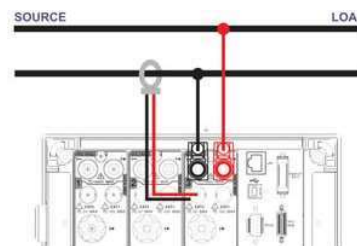

External Current Sensor Input

Furthermore, GPM-8320/8330 provide 4 sets of panel settings for storage/recall and a memory that can store up to 10,000 measurements. The measurement storage can record the measurement results according to the update rate or a user-defined time interval for later analysis. The USB host on the front panel supports screen capture, measurement value storage, and firmware updates.

E. FLEXIBLE LEVEL-CHANGING MECHANISM

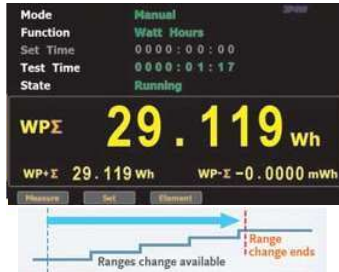

Automatic level-changing under the integration function

GPM-8320/8330 offer automatic range switching mode for integral measurement, allowing users to calculate the total value of the DUT's power variation from the start to the end of the integration period. In



Self-defined automatic level-changing mechanism

addition, GPM-8320/8330 also support a customizable range switching mechanism. Users can select the desired range, which not only saves time wasted during range switching but also speeds up the testing process.

F. CONVENIENT AND PRACTICAL INTERFACE



Practical Interface

GPM-8320/8330 offer a comprehensive and diverse set of communications interfaces, including RS-232/USB/LAN/GPIB (optional), suitable for users to remotely control and collect measurement results through command sets to program computer software. The optional Digital I/O (DA12) interface provides three different modes according to users' settings: including external control, DA12 output, and self-defined output. When the setting is external control mode, users can activate, stop, trigger, or reset the integration measurement function through

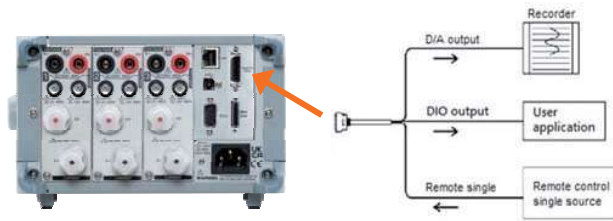

DA12 Interface Mechanism

external signals. When it is set to DA12 output mode, users can define 12 measurement parameter values from the provided 17 measurement parameters (even the result of integration measurement) to output in a fixed range (full scale +5V) or manual range (full scale $\pm 5V$) and receive the results in collocation with a data recorder. When it is set to custom output mode, it needs to be used with a communications interface, and the action of each defined pin is controlled through commands.

PANEL INTRODUCTION

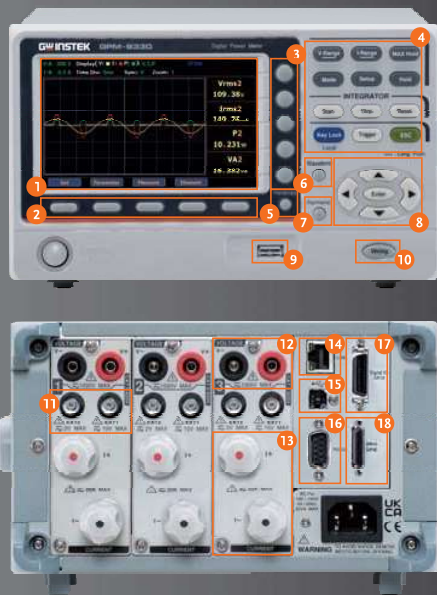

1. LCD
2. Function Keys (F1~F5)
3. Soft Keys
4. Function Keys
5. Hardcopy Key
6. Waveform Key
7. Harmonic Key
8. Arrow Keys
9. USB Host Port
10. Wiring Key
11. External Input 1/2
12. Voltage Input Terminal
13. Current Input Terminal
14. LAN Port
15. USB Device Port
16. RS-232 Connector
17. Digital IO / DA12 (Opt.)*
18. Mini GPIB Connector (Opt.)*

* GPIB and Digital IO are 2-in-1 interfaces called GPM-DA12; they must be installed in the factory.

SPECIFICATIONS

INPUT		
Item	Specifications	
Input Type	Voltage / Current Floating input through resistive voltage divider; Floating input through shunt	
Measure Range	Voltage	15V, 30V, 60V, 150V, 300V, 600V, 1000V
	Current	Direct input 0.5A, 1A, 2A, 5A, 10A, 20A Sensor input EXT 1: 2.5 V, 5 V, 10 V; EXT 2: 50 mV, 100 mV, 200 mV, 500 mV, 1 V, 2 V
Input Impedance	Voltage	Input resistance: approach 2 MΩ
	Current	Input resistance: approach 5 mΩ
	Sensor	Input resistance: approach 100 kΩ Input range 50mV ~ 2V (EXT2) Input resistance: approach 20 kΩ
Continuous Maximum Allowable Input	Voltage	peak value of 1.5kV or RMS value of 1kV, whichever is less peak value of 100A or RMS value of 30A, whichever is less peak value less than or equal to 5 times of the rated range
	Current	
Input Bandwidth	DC, 0.1 Hz ~ 100kHz	
Continuous Maximum Common-mode Voltage	600 Vrms, CAT II	
Line Filter	select OFF or ON (cut off frequency of 500 Hz)	
Frequency Filter	select OFF or ON (cut off frequency of 500 Hz)	
A/D Converter	Simultaneous conversion voltage and current inputs; Resolution 16bits; Maximum conversion rate Approx. 300kHz	
Display Update Interval	When the data update interval is 100 ms the numeric display 10 items display update interval is 200 ms. When the data update interval is 100 ms or 250ms and the numeric value display is set to Matrix or ALL Items display update interval is 500 ms. The waveform display update intervals are approximately 1s.	
VOLTAGE AND CURRENT ACCURACY		
Item	Specifications	
Requirements	Temperature	23 ± 5°C
	Humidity	30~75% RH
	Input waveform	Sine wave crest factor = 3
	common-mode voltage	0 V
	Number of displayed digits	5 digits
	Frequency filter	Turn on to measure voltage or current of 200 Hz or less
	After 30 minutes after warm-up time has passed; After measurement range is changed (zero-level compensation); Update interval is 250 ms	
Accuracy	DC	± (0.1% of reading + 0.2% of range)
	0.1 Hz ≤ f < 45 Hz	± (0.1 % of reading + 0.2 % of range)
	45 Hz ≤ f ≤ 66 Hz	± (0.1 % of reading + 0.05 % of range)
	66 Hz < f ≤ 1 kHz	± (0.1 % of reading + 0.2 % of range)
	1 kHz < f ≤ 10 kHz	± (0.07 *f) % of reading + 0.3% of range)
	10 kHz < f ≤ 100 kHz	± (0.5 % of reading + 0.5 % of range) ± [{0.04x(f-10)}% of reading]
	Values for voltage in excess of 750V for which 30kHz < f < 100kHz are reference only.	
Temperature Coefficient	Add	±0.03% of reading/°C within the range 5 to 18°C or 28 to 40°C.
When the Line Filter is Turned ON	45 ~ 66 Hz	Add 0.3% of reading
	< 45 Hz	Add 0.1% of reading
Accuracy When the Crest Factor is Sset to 6 or 6A	accuracy obtained by doubling the measurement range error for the accuracy when the crest factor is set to 3	
Accuracy Changes Caused by Data Update Interval	When the data update interval is 100 ms, and Auto, add 0.05% of reading to the 0.1 Hz to 1 kHz accuracy.	
Influence of Temperature Changes After Zero-level Compensation or Range Change	Add 0.02% of range/°C to the DC voltage accuracy. Add the following value to the DC current accuracies.	
	5 mA/10 mA/20 mA/50 mA/100 mA/200 mA ranges	5 μA/°C
	0.5 A/1 A/2 A/5 A/10 A/20 A ranges	500 μA/°C
	External current sensor input (/EXT1)	1 mV/°C
	External current sensor input (/EXT2)	50 μV/°C
Accuracy When the Crest Factor is Set to 6 or 6A	accuracy obtained by doubling the measurement range error for the accuracy when the crest factor is set to 3	
Accuracy Changes Caused by Data Update Interval	When the data update interval is 100 ms, and Auto, add 0.05% of reading to the 0.1 Hz to 1 kHz accuracy.	
ACTIVE POWER ACCURACY		
Item	Specifications	
Requirements	same as the conditions for voltage and current. Power factor 1	
Accuracy	DC	(0.1 % of reading + 0.2 % of range)
	0.1Hz ≤ f < 45 Hz	± (0.3 % of reading + 0.2 % of range)
	45 Hz ≤ f ≤ 66 Hz	± (0.1 % of reading + 0.05 % of range)
	66 Hz < f ≤ 1kHz	± (0.2 % of reading + 0.2 % of range)
	1 kHz < f ≤ 10 kHz	± (0.1 % of reading + 0.3 % of range) ± [{0.067x(f-1)}% of reading]
	10 kHz < f ≤ 100 kHz	± (0.5 % of reading + 0.5 % of range) ± [{0.09x(f-10)}% of reading]
Influence of Power Factor	when power factor (λ) = 0 (S: apparent power) ± 0.1 % of S for 45 Hz ≤ f ≤ 66 Hz ± {(0.1 + 0.15 × f) % of S} for up to 100 kHz as reference data •f is frequency of input signal in kHz when 0 < λ < 1 (Φ: phase angle of the Voltage and current) (power reading) × [(power reading error%) + (power range %) × (power range / indicated apparent power value) + {tanΦ × (influence when λ=0)%}]	

SPECIFICATIONS																																	
When The Line Filter is Turned ON	45 – 66 Hz Add 0.3 % of reading < 45 Hz Add 1 % of reading																																
Temperature Coefficient	same as the temperature coefficient for voltage and current																																
Accuracy When The Crest Factor is Set to 6 or 6A	accuracy obtained by doubling the measurement range error for the accuracy when the crest factor is set to 3																																
Accuracy of Apparent Power S	voltage accuracy + current accuracy																																
Accuracy of Reactive Power Q	accuracy of apparent power + $(\sqrt{1.0004 - \lambda^2} - (\sqrt{1 - \lambda^2})) \times 100 \%$																																
Accuracy of Power Factor Δ	$\pm [(\lambda - \lambda/1.0002) + \lambda \cos \theta - \cos\{\theta + \sin^{-1}(\text{influence from the power factor when } \lambda = 0\%/100)\}] \pm 1$ digit when voltage and current are at the measurement range rated input																																
Accuracy of Phase Difference Φ	$\pm [\theta - \cos^{-1}(\lambda/1.0002) + \sin^{-1}(\text{influence from the power factor when } \lambda = 0\% / 100)] \pm 1$ digit when voltage and current are at the measurement range rated input																																
Accuracy When The Crest Factor is Set to 6 or 6A	accuracy obtained by doubling the measurement range error for the accuracy when the crest factor is set to 3																																
Accuracy Changes Caused by Data Update Interval	When the data update interval is 100 ms, and Auto, add 0.05% of reading to the 0.1 Hz to 1 kHz accuracy.																																
VOLTAGE, CURRENT AND ACTIVE POWER MEASUREMENTS																																	
Item	Specifications																																
Measurement Method	Digital sampling method																																
Crest Factor	3 or 6 (6A)																																
Wiring System	Single-phase, two-wire (1 P2 W)																																
Range Select	Select manual or auto ranging																																
Auto Range	Auto-range increase: The range is upped when any of the following conditions is met. Crest factor 3 Vrms or Irms exceeds 130% of the currently set measurement range. Vpk, Ipk value of the input signal exceeds 300% of the currently set measurement range. Crest factor 6 Vrms or Irms exceeds 130% of the currently set measurement range. Vpk, Ipk value of the input signal exceeds 600% of the currently set measurement range. Crest factor 6A Vrms or Irms exceeds 260% of the currently set measurement range. Vpk, Ipk value of the input signal exceeds 600% of the currently set measurement range. Auto-range decline: The range is downed when all of the following conditions are met. Crest factor 3 Vrms or Irms is less than or equal to 30% of the measurement range. Vrms or Irms is less than or equal to 125% of the next lower measurement range. Vpk, Ipk value of the input signal exceeds 300% of the currently set measurement range. Crest factor 6 or 6A Vrms or Irms is less than or equal to 30% of the measurement range. Vrms or Irms is less than or equal to 125% of the next lower measurement range. Vpk, Ipk value of the input signal exceeds 600% of the currently set measurement range.																																
Display Mode Switching	Vrms (the true RMS value of voltage and current) VOLTAGE MEAN (the rectified mean value calibrated to the RMS value of the voltage and the true RMS value of the current) AC DC																																
Measurement Synchronization Source	Select voltage, current, or off In the case of Auto Update Rate, select the voltage or current from the equipped element.																																
Line Filter	Select OFF or ON (cutoff frequency at 500 Hz).																																
Peak Measurement	Measures the peak (max, min) value of voltage, current or power from the instantaneous voltage, instantaneous current or instantaneous power that is sampled.																																
Zero-level Compensation	Removes the internal offset of the measure unit (After measurement range is changed)																																
Measurement Parameters	<table border="0"> <tr> <td>Voltage</td> <td>Vrms , Vmn, Vdc , Vac</td> <td>Frequency</td> <td>IHz and VHz</td> </tr> <tr> <td>Current</td> <td>Irms , Idc , Iac</td> <td>Voltage Peak</td> <td>V+pk and V-pk</td> </tr> <tr> <td>Active Power</td> <td>P</td> <td>Current Peak</td> <td>I+pk and I-pk</td> </tr> <tr> <td>Apparent Power</td> <td>VA</td> <td>Active Power Peak</td> <td>P+pk and P-pk</td> </tr> <tr> <td>Reactive power</td> <td>VAR</td> <td>Total Harmonic Distortion</td> <td>THDI and THDV</td> </tr> <tr> <td>Power Factor</td> <td>PF</td> <td>Mathematical Computation</td> <td>MATH</td> </tr> <tr> <td>Crest Factor</td> <td>CFI, CFV</td> <td>Maximum Current Ratio</td> <td>MCR</td> </tr> <tr> <td>Phase Angle</td> <td>DEG</td> <td></td> <td></td> </tr> </table>	Voltage	Vrms , Vmn, Vdc , Vac	Frequency	IHz and VHz	Current	Irms , Idc , Iac	Voltage Peak	V+pk and V-pk	Active Power	P	Current Peak	I+pk and I-pk	Apparent Power	VA	Active Power Peak	P+pk and P-pk	Reactive power	VAR	Total Harmonic Distortion	THDI and THDV	Power Factor	PF	Mathematical Computation	MATH	Crest Factor	CFI, CFV	Maximum Current Ratio	MCR	Phase Angle	DEG		
Voltage	Vrms , Vmn, Vdc , Vac	Frequency	IHz and VHz																														
Current	Irms , Idc , Iac	Voltage Peak	V+pk and V-pk																														
Active Power	P	Current Peak	I+pk and I-pk																														
Apparent Power	VA	Active Power Peak	P+pk and P-pk																														
Reactive power	VAR	Total Harmonic Distortion	THDI and THDV																														
Power Factor	PF	Mathematical Computation	MATH																														
Crest Factor	CFI, CFV	Maximum Current Ratio	MCR																														
Phase Angle	DEG																																
FREQUENCY MEASUREMENT																																	
Item	Specifications																																
Measurement Item	Voltage and current																																
Measurement Frequency Range	<table border="0"> <tr> <td>Data update interval</td> <td>Measurement Frequency Range</td> </tr> <tr> <td>0.1 s</td> <td>20 Hz ≤ f ≤ 100 kHz</td> </tr> <tr> <td>0.25 s</td> <td>10 Hz ≤ f ≤ 100 kHz</td> </tr> <tr> <td>0.5 s</td> <td>5 Hz ≤ f ≤ 100 kHz</td> </tr> <tr> <td>1 s</td> <td>2.0 Hz ≤ f ≤ 100 kHz</td> </tr> <tr> <td>2 s</td> <td>1.0 Hz ≤ f ≤ 100 kHz</td> </tr> <tr> <td>5 s</td> <td>0.5 Hz ≤ f ≤ 100 kHz</td> </tr> <tr> <td>10 s</td> <td>0.2 Hz ≤ f ≤ 100 kHz</td> </tr> <tr> <td>20 s</td> <td>0.1 Hz ≤ f ≤ 100 kHz</td> </tr> <tr> <td>Auto (*)</td> <td>0.1 Hz ≤ f ≤ 100 kHz</td> </tr> <tr> <td>(*)</td> <td>Limit of the measurement lower limit frequency by the Timeout setting</td> </tr> <tr> <td>Timeout</td> <td>lower limit frequency</td> </tr> <tr> <td>1 s</td> <td>2.0 Hz</td> </tr> <tr> <td>5 s</td> <td>0.5 Hz</td> </tr> <tr> <td>10 s</td> <td>0.2 Hz</td> </tr> <tr> <td>20 s</td> <td>0.1 Hz</td> </tr> </table>	Data update interval	Measurement Frequency Range	0.1 s	20 Hz ≤ f ≤ 100 kHz	0.25 s	10 Hz ≤ f ≤ 100 kHz	0.5 s	5 Hz ≤ f ≤ 100 kHz	1 s	2.0 Hz ≤ f ≤ 100 kHz	2 s	1.0 Hz ≤ f ≤ 100 kHz	5 s	0.5 Hz ≤ f ≤ 100 kHz	10 s	0.2 Hz ≤ f ≤ 100 kHz	20 s	0.1 Hz ≤ f ≤ 100 kHz	Auto (*)	0.1 Hz ≤ f ≤ 100 kHz	(*)	Limit of the measurement lower limit frequency by the Timeout setting	Timeout	lower limit frequency	1 s	2.0 Hz	5 s	0.5 Hz	10 s	0.2 Hz	20 s	0.1 Hz
Data update interval	Measurement Frequency Range																																
0.1 s	20 Hz ≤ f ≤ 100 kHz																																
0.25 s	10 Hz ≤ f ≤ 100 kHz																																
0.5 s	5 Hz ≤ f ≤ 100 kHz																																
1 s	2.0 Hz ≤ f ≤ 100 kHz																																
2 s	1.0 Hz ≤ f ≤ 100 kHz																																
5 s	0.5 Hz ≤ f ≤ 100 kHz																																
10 s	0.2 Hz ≤ f ≤ 100 kHz																																
20 s	0.1 Hz ≤ f ≤ 100 kHz																																
Auto (*)	0.1 Hz ≤ f ≤ 100 kHz																																
(*)	Limit of the measurement lower limit frequency by the Timeout setting																																
Timeout	lower limit frequency																																
1 s	2.0 Hz																																
5 s	0.5 Hz																																
10 s	0.2 Hz																																
20 s	0.1 Hz																																

SPECIFICATIONS	
Measurement Range	Auto switching among six types: 100mHz, 1 Hz, 10 Hz, 100 Hz, 1 kHz, 10 kHz, and 100 kHz.
Frequency Filter	Select OFF or ON (cut off frequency of 500 Hz)
Accuracy	Requirements When the input signal level is 30% or more of the measurement range If the crest factor is set to 3. (60% or more if the crest factor is set to 6 or 6A) • Frequency filter is ON when measuring voltage or current of 200 Hz or less. ± (0.06% of reading)
INTEGRATION	
Item	Specifications
Mode	Select manual integration mode, standard integration mode, or repetitive integration mode.
Timer	Automatically stop integration by setting a timer. Selectable range: 0 hours 00 minutes 00 seconds to 9999 hours 59 minutes 59 seconds
Accuracy	±(Power accuracy (or current accuracy) + 0.1% of reading) (fixed range)
Range Setting	Auto range or fixed range is available for Integration
Timer Accuracy	±0.02%
Remote Control	Start, stop and reset operations are available using an external remote signal. (option)
HARMONIC MEASUREMENT	
Item	Specifications
Measured Item	Voltage, Current, Power
Measured Method	Zero-cross simultaneous calculation method
Frequency Range	10 Hz to 1.2 kHz.
FFT Data Length	4096 (Auto switch when both 50Hz/60Hz and update rate must be greater than or equal to 0.5s)
Sample rate, window width, and upper limit of Analysis orders*	Fundamental Frequency Sample rate Window Width upper limit of Analysis orders 45 Hz to 55 Hz f × 512 10 50 54 Hz to 66 Hz f × 512 12 50
FFT Data Length	1024
Sample rate, window width, and upper limit of Analysis orders*	Fundamental Frequency Sample rate Window Width upper limit of Analysis orders 10 Hz to 67 Hz f × 1024 1 50 67 Hz to 150 Hz f × 512 2 32 150 Hz to 300 Hz f × 256 4 16 300 Hz to 600 Hz f × 128 8 8 600 Hz to 1200 Hz f × 64 16 4
Accuracy	Frequency Voltage Current Power 10 Hz ≤ f < 45 Hz 0.15% of reading + 0.35% of range 0.15% of reading + 0.35% of range 0.35% of reading + 0.50% of range 45 Hz ≤ f < 440 Hz 0.15% of reading + 0.35% of range 0.15% of reading + 0.35% of range 0.25% of reading + 0.50% of range 440 Hz ≤ f < 1.2kHz 0.20% of reading + 0.35% of range 0.20% of reading + 0.35% of range 0.40% of reading + 0.50% of range
* 50Hz/60Hz Compliant IEC61000-4-7 (update rate must be > 0.5s)	
* Harmonic calculation: FFT method in which FFT data length is divided into 2 types: 1024 and 4096.	
* FFT data length automatically switches in accord with the Frequency and Update Rate of measured signal.	
D/A OUTPUT (OPTIONS)	
Item	Specifications
Output Voltage	±5 V FS (approach ±7.5 V maximum) against each rated value.
Number Of Output Channels	12
Output Items	Set for each channel: V, I, P, VA, VAR, PF, DEG, VHZ, IHZ, Vpk, Ipk, WP, WP±, q, q±, Off
Accuracy	±(accuracy of each measurement item + 0.2% of FS) (FS = 5 V)
D/A Conversion Resolution	16 bits
Minimum Load	100 kΩ
Update Interval	Same as the data update interval. In the case of Auto Update Rate, update interval is equal to signal interval. More than 100ms.
Temperature Coefficient	±0.05%/°C of FS
REMOTE CONTROL INPUT/OUTPUT SIGNAL (OPTIONS)	
Item	Specifications
Remote Control Input Signal	EXT HOLD, EXT TRIG, EXT START, EXT STOP, EXT RESET
Remote Control Output Signal	INTEG BUSY
I/O Level	TTL
I/O Logic Format	Negative logic, Falling edge
* Q (VAR), S (VA), λ (PF) and Φ (DEG) are originated from the measured values including voltage, current and active power which go through computation process. In respect to distorted signal input, accordingly, the value acquired from other instruments, which employ different methods, may differ from that acquired from GPM-8320/8330 unit.	
* "Zero" will be shown for S or Q and "--" will be displayed for λ and Φ when either current or voltage is less than 0.5% of the rated range (less than or equivalent to 1% when crest factor is set 6)	
GENERAL	
 Note	The below are the basic conditions required to operate the GPM-8320/8330 within specifications: <ul style="list-style-type: none"> • 1-year Calibration: Yearly • Operating Environment: 18–28 °C (64.4–82.4 °F) • Humidity: <80%RH, • Accuracy: ± (% of reading + % of range) • The specifications apply when it warmed up for at least 30 minutes and operates in the slow rate. • The power supply cable must be grounded to ensure accuracy. • Input voltage and current must be standard sine wave. • The power factor must be 1. • The crest factor must be 3. • The common-mode voltage must be zero.

SPECIFICATIONS

Specification Condition	Temperature: 23°C±5°C; Humidity: <80%RH (non-condensing)
Operation Condition	Temperature 0°C ~ 40°C, <ul style="list-style-type: none"> • 30 ~ 40°C, Relative Humidity < 70%RH (non-condensing) • >40°C, Relative Humidity < 50%RH (non-condensing) Indoor use only Altitude: < 2000 meters Pollution degree 2
Storage Condition	Temperature -40°C ~ 70°C; Humidity: < 90%RH (non-condensing)
Power Source	AC 100-240V, 50-60Hz; Consumption Max. 35VA
Dimensions	220(W) x 132(H) x 402.5(D)mm (w/t bumpers)
Weight	Approx. 3.85kg

Specifications subject to change without notice. PM-83208330CD1BH

ORDERING INFORMATION

- GPM-8320** Digital Power Meter (RS-232C/USB device & Host/LAN)
GPM-8320 Digital Power Meter (RS-232C/USB device & Host/LAN and opt. GPIB+DA12)
 (with GPM-DA12)
GPM-8330 Digital Power Meter (RS-232C/USB device & Host/LAN)
GPM-8330 Digital Power Meter (RS-232C/USB device & Host/LAN and opt. GPIB+DA12)
 (with GPM-DA12)

ACCESSORIES

Safety Instruction Sheet x 1, Power cord x 1, Test lead GTL-209 x 2, Test lead GTL-212A x 2 (for GPM-8320), Test lead GTL-209 x 3, Test lead GTL-212A x 3 (for GPM-8330), CD x 1 (including complete user manual and USB driver), DA12 cable GTL-214 (available for GPM-8320/8330 with GPM-DA12 only), GPM-002 Terminal Cover



GPM-002



GTL-209



GTL-212A



GTL-214

OPTION

GPM-DA12 GPIB+DA12 Interface (including cable, GTL-214)

Note: The option is 2-in-1 interface and must be installed in factory.

OPTION ACCESSORIES

- GTL-209** Test Lead, Banana to Bare-wire, Approx. 1000mm
GTL-212A Test Lead, O-Type to Bare-wire, Approx. 1000mm
GTL-214 DA4 Cable, Approx. 1000mm
GTL-232 RS-232C cable, 9-pin Female to 9-pin, null modem for computer, Approx. 2000mm
GTL-246 USB Cable, A-B type, Approx. 1200mm
GTL-258 GPIB Cable, 25-pin Micro-D Connector, Approx. 1900mm
GRA-452 Rack Mount Kit, 19" 3U size

Global Headquarters

GOOD WILL INSTRUMENT CO., LTD.

No.7-1, Jhongsing Road, Tucheng Dist., New Taipei City 236, Taiwan
 T +886-2-2268-0389 F +886-2-2268-0639
 E-mail: marketing@goodwill.com.tw

China Subsidiary

GOOD WILL INSTRUMENT (SUZHOU) CO., LTD.

No. 521, Zhujiang Road, Snd, Suzhou Jiangsu 215011 China
 T +86-512-6661-7177 F +86-512-6661-7277

Malaysia Subsidiary

GOOD WILL INSTRUMENT (SEA) SDN. BHD.

No. 1-3-18, Elit Avenue, Jalan Mayang Pasir 3,
 11950 Bayan Baru, Penang, Malaysia
 T +604-6111122 F +604-6115225

Europe Subsidiary

GOOD WILL INSTRUMENT EURO B.V.

De Run 5427A, 5504DG Veldhoven, THE NETHERLANDS
 T +31 (0)40-2557790 F +31 (0)40-2541194

U.S.A. Subsidiary

INSTEK AMERICA CORP.

5198 Brooks Street Montclair, CA 91763, U.S.A.
 T +1-909-399-3535 F +1-909-399-0819

Japan Subsidiary

TEXIO TECHNOLOGY CORPORATION.

7F Towa Fudosan Shin Yokohama Bldg., 2-18-13 Shin
 Yokohama, Kohoku-ku, Yokohama, Kanagawa,
 222-0033 Japan
 T +81-45-620-2305 F +81-45-534-7181

Korea Subsidiary

GOOD WILL INSTRUMENT KOREA CO., LTD.

Room No.503, Gyeonginro 775 (Mullae-Dong 3Ga,
 Ace Hightech-City B/D 1Dong), Yeongduengpo-Gu,
 Seoul 150093, Korea.
 T +82-2-3439-2205 F +82-2-3439-2207

India Subsidiary

GW INSTEK INDIA LLP.

No.2707/B&C, 1st Floor UNNATHI Building,
 E-Block, Sahakara Nagar, Bengaluru-560 092, India
 T +91-80-6811-0600 F +91-80-6811-0626

GW INSTEK

Simply Reliable



Website



Facebook



LinkedIn