

<u>Table of Contents</u>	Pages
1. USAGE PRECAUTIONS AND RECOMMENDATIONS.....	2
2. GENERAL DESCRIPTION AND FEATURES.....	7
3. FIRST TIME OPERATION	9
4. PANEL DESCRIPTION	12
5. OPERATION	17
6. BLOCK DIAGRAM.....	68
7. RS-232 CONFIGURATION	69
8. SPECIFICATIONS.....	72
9. EC DECLARATION OF CONFORMITY.....	82

Due to continuous improvements in the GDS-800 series Digital Storage Oscilloscope, information contained in this manual is subject to change without notice. Contact GW, for revisions and corrections.

This document supports firmware version v1.0 for GDS-806S/C and GDS-810S/C; firmware version v2.03 for GDS-820S/C, GDS-840S/C and previous version

1. Usage Precautions and Recommendations

The following precautions are recommended to insure your safety and to provide the best condition of this instrument. If this equipment is used in a manner not specified by the manufacture, the protection provided by the equipment may be impaired.

Safety Terms and Symbols

These terms may appear in this manual or on the product:



WARNING: Warning statements identify condition or practices that could result in injury or loss of life.



CAUTION: Caution statements identify conditions or practices that could result in damage to this product or other property.

The following symbols may appear in this manual or on the product:



DANGER
High Voltage



ATTENTION
refer to
Manual



**Protective
Conductor
Terminal**



**Frame
or Chassis
Terminal**

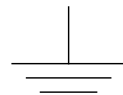

**Earth (ground)
Terminal**

FOR UNITED KINGDOM ONLY

NOTE: This lead / appliance must only be wired by competent persons



WARNING: THIS APPLIANCE MUST BE EARTHED

IMPORTANT: The wires in this lead are coloured in accordance with the following code:

Green/ Yellow:	Earth
Blue:	Neutral
Brown:	Live (Phase)

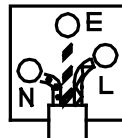

As the colours of the wires in main leads may not correspond with the colours marking identified in your plug/appliance, proceed as follows:

The wire which is coloured Green & Yellow must be connected to the Earth terminal marked with the letter E or by the earth symbol  or coloured Green or Green & Yellow.

The wire which is coloured Blue must be connected to the terminal which is marked with the letter N or coloured Blue or Black.

The wire which is coloured Brown must be connected to the terminal marked with the letter L or P or coloured Brown or Red.

If in doubt, consult the instructions provided with the equipment or contact the supplier.

This cable/appliance should be protected by a suitably rated and approved HBC mains fuse: refer to the rating information on the equipment and/or user instructions for details. As a guide, cable of 0.75mm² should be protected by a 3A or 5A fuse. Larger conductors would normally require 13A types, depending on the connection method used.

Any moulded mains connector that requires removal /replacement must be destroyed by removal of any fuse & fuse carrier and disposed of immediately, as a plug with bared wires is hazardous if engaged in live socket. Any re-wiring must be carried out in accordance with the information detailed on this label.

Use and Wear



CAUTION

- Do not exceed $300V_{\text{peak}}$ into the channel BNC **INPUTS**.
- To avoid risk of fire hazard and electrical shock, a hazardous live voltage must never be connected to the negative side (reference side) of the BNC measuring terminals.
- Do not place any heavy object on the instrument.
- Avoid severe impacts or rough handling that could damage the oscilloscope.
- Use electrostatic discharge precautions while handling and making connections to the oscilloscope.
- Do not place wires into the connectors of the oscilloscope, only mating connectors and adapters.
- Do not block or obstruct cooling fan vent opening on side panels or on the rear panel of unit.

1) Disassembly of the Instrument

- Do not disassemble the instrument; refer the instrument to a factory approved service facility only.

2) AC Power Input

CAUTION



- AC input should be within the range of selected line voltage $\pm 10\%$.
- Insure the correct fuse is installed prior to applying voltage for the first time -

100 V ~ 240 VAC input : T 2A / 250V

3) Grounding



WARNING

- To avoid electrical shock, the power cord protective grounding conductor must be connected to earth ground.

4) Fuse Replacement



WARNING

- For continued fire protection, replace the fuse with the specified type and rating only.
- Disconnect power cord before replacing fuse.
- Open cover of AC socket with flat blade screwdriver.
- If the fuse is blown, there is something wrong with the instrument. Repair the cause of fault before replacing fuse.
- Replace the fuse.

5) Cleaning

- Disconnect AC Power Cord from the instrument before cleaning.
- Use a soft cloth dampened in a solution of mild detergent and water. Do not spray any liquid into the unit.
- Do not use chemicals or cleaners containing benzene, toluene, xylene, acetone or other harsh chemicals.

6) Operating Environment

- The following conditions are recommended for optimum use of the instrument -

Indoor Use Altitude < 2000 m Temperature 0° to 50° C
Relative Humidity < 80% No direct sunlight No strong magnetic fields
Dust Free

- Installation Category: II*
- Pollution degree: 2

7) Storage Environment

- The following conditions are recommended for optimum storage of the instrument

-
Indoor Temperature -20° to 70° C Relative Humidity < 80%



WARNING

This is a Class A product. In a domestic environment this product may cause radio interference in which case the user may be required to take adequate measures.

**: Measurement category IV is for measurement performed at the source of low-voltage installation
Measurement category III is for measurement performed in the building installation
Measurement category II is for measurement performed on the circuits directly connected to the low voltage installation*

2. General Description and Features

The GDS-806/810/820/840 is a useful, 2 channel digital storage oscilloscope with following features:

- Up to 250MHz (60MHz for GDS-806S/C, 100MHz for GDS-810S/C, 150MHz for GDS-820S/C and 250MHz for GDS-840S/C series) repetitive bandwidth and 100MSa/s sample rate per channel (25GSa/s E.T. sample rate per channel).
- Up to 10ns peak detection for glitch capture.
- A large 5.7" mono or color LCD display (monochrome display for GDS-806S, GDS-810S, GDS-820S and GDS-840S, color display for GDS-806C, GDS-810C, GDS-820C and GDS-840C).
- Two input channels, each with a record length of 125k points and 8 bits vertical resolution. Both channels acquire waveforms simultaneously.
- Time base: 1ns/div~10s/div.
- 6-digit trigger frequency counter.
- Auto-setting for quick setup and hands-free operation.
- Three Acquisition modes: Sample, peak detect, and average mode.
- Cursors and 15 continuously update, automatic measurements: V_{hi} , V_{lo} , V_{max} , V_{min} , V_{pp} , $V_{average}$, V_{rms} , V_{amp} , rise time, fall time, duty cycle, frequency, period, positive width, negative width.
- 15 sets memory for front panel setting save & recall.
- 2 sets memory for waveform trace save & recall.
- 100 sets arbitrary waveforms can be input as templates for Go/NoGo function.
- FFT spectrum analysis.
- Two valuable "Program mode" and "Go-No Go" function are included.
- Advanced video and pulse width trigger.
- A large 8 ×12 divisions (menu off) waveform display graticule.
- RS-232, Centronics port, USB output and GPIB interface module are supported.
- Multi-language operating environment are supported, there are English, tradition Chinese, simplified Chinese, French, German, Italian, Korean, Russian, Finnish, Spanish and Polish are supported for this moment.

The advance 32-bit microprocessor controlled GDS-800 series Digital Storage Oscilloscope has been designed for a wide multitude of applications in service and industry. For ease of operation the “Autoset” function allows for signal related automatic setup of measuring parameters. On-screen readout and cursor functions for voltage, frequency and frequency measurement provide extraordinary operational convenience. Fifteen different user defined instrument settings can be saved and recalled without restriction. The built-in RS-232 serial interface allows for remote controlled operation by a PC. A six digits frequency counter provides extra value for users. The USB port is able to dump entire scope’s LCD screen to computer via specific software. The valuable “Program” mode is able to help users to record all the necessary measuring steps and replay all steps again. The special “Go-No Go” function is very useful for the people who need to distinguish the pass or failure for particular conditions.

The instrument offer the right combination of triggering control, frequency response, and time base versatility to facilitate measurements in a wide range of applications in laboratory as well as in field service use. It is another example of our dedication to engineering excellence.

3. First Time Operation

The following text assumes that the “SAFETY” section of this manual has been read carefully and understood.

Each time before the instrument is put into operation check that the oscilloscope is connected to protective earth. For that reason the power cable must be connected to the oscilloscope and the power outlet. Then the test lead(s) must be connected to the oscilloscope input(s). Check that the device under test is switched off and connect the test lead(s) to the test point(s). Then switch on the instrument and afterward the device under test.

The oscilloscope is switched on by depress the **ON/STBY** pushbutton (**Before depress the **ON/STBY** pushbutton of front panel, the main power switch of rear panel have to be switched on**). After a few second the system initiated, the instrument will revert to its last used operating mode.

Tilt stand this oscilloscope: For desktop use, lock the tilt stand in place as following figures.

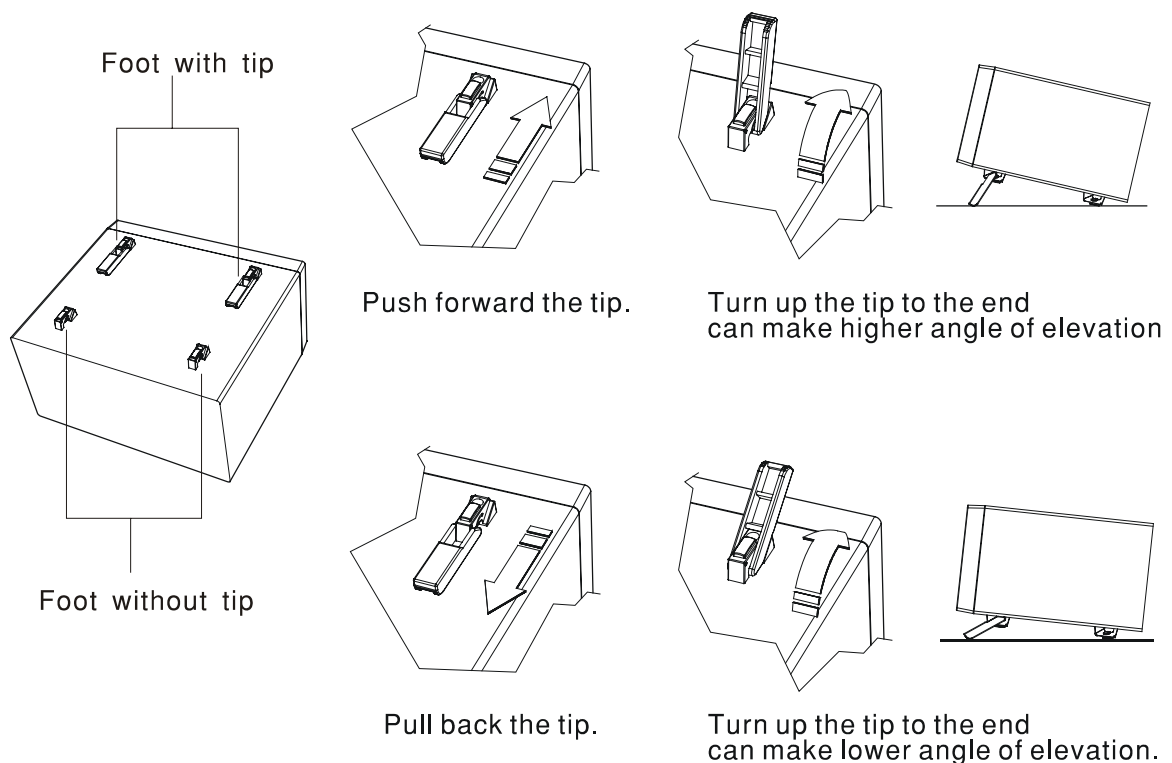

Figure 3-1: Tilts stand this oscilloscope

Probe compensation

To display an undistorted waveform on an oscilloscope, the probe must be matched to the individual input impedance of each vertical amplifier.

For this purpose a square wave signal with a very fast rise time and minimum overshoot should be used, as the sinusoidal contents cover a wide frequency range. The build-in compensation signal generator provides a square wave signal with a very fast rise time, and frequency of approx. 1kHz from the output socket below the LCD screen. As the square wave signals are used for probe compensation adjustment, neither the frequency accuracy nor the pulse duty factor are of importance and therefore not specified.

The output provides $2V_{pp} \pm 3\%$ for 10:1 probe. When the Y deflection coefficient is set to 50mV/div, the calibration voltage corresponds to a vertical display of 4 divisions (10:1 probe).

User checks the waveform indicated correct compensation (see Figure 3-2). If the waveform indicates over or under compensation, use the alignment tool to adjust the compensation.

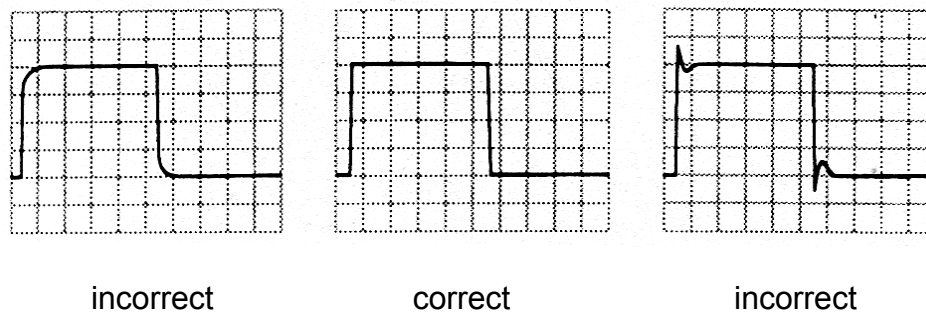

Figure 3-2: Probe compensations

For GDS-806S/C and GDS-810S/C only

GDS-806 and GDS-810 series provides a valuable “adjustable probe compensation signal function”. The range for adjustable probe compensation signal is adjusted from 1kHz to 100kHz, 1kHz per step; and duty cycle is adjusted from 5% to 95%, 5% per step. This function can satisfy user with the probe compensation easily and accurate.

AUTOSET

The “Autoset” function provides a stable, triggered display of any input signal (almost). User can connect a signal to either the channel 1 or channel 2 input BNC connectors and press **AUTOSET** button. Table 3-1 shows the defaults of “Autoset” function

Table 3-1: Defaults of “Autoset” function

Control	Modified by Autoset
Acquire	Sample
Acquire stop after	RUN/STOP button only
Display style	Vectors
Display format	YT
Horizontal position	Centered within the graticule windows
Horizontal Scale	As determined by the signal frequency
Trigger coupling	DC
Trigger level	Midpoint of data for the trigger source
Trigger position	Center
Trigger slope	Positive
Trigger source	Highest frequency if both channel available
Trigger type	Edge
Vertical bandwidth	Full
Vertical coupling	DC or AC (depend on the signal)
Vertical offset	0 V
Vertical scale	As determined by the signal level

4. Panel Description

Front Panel

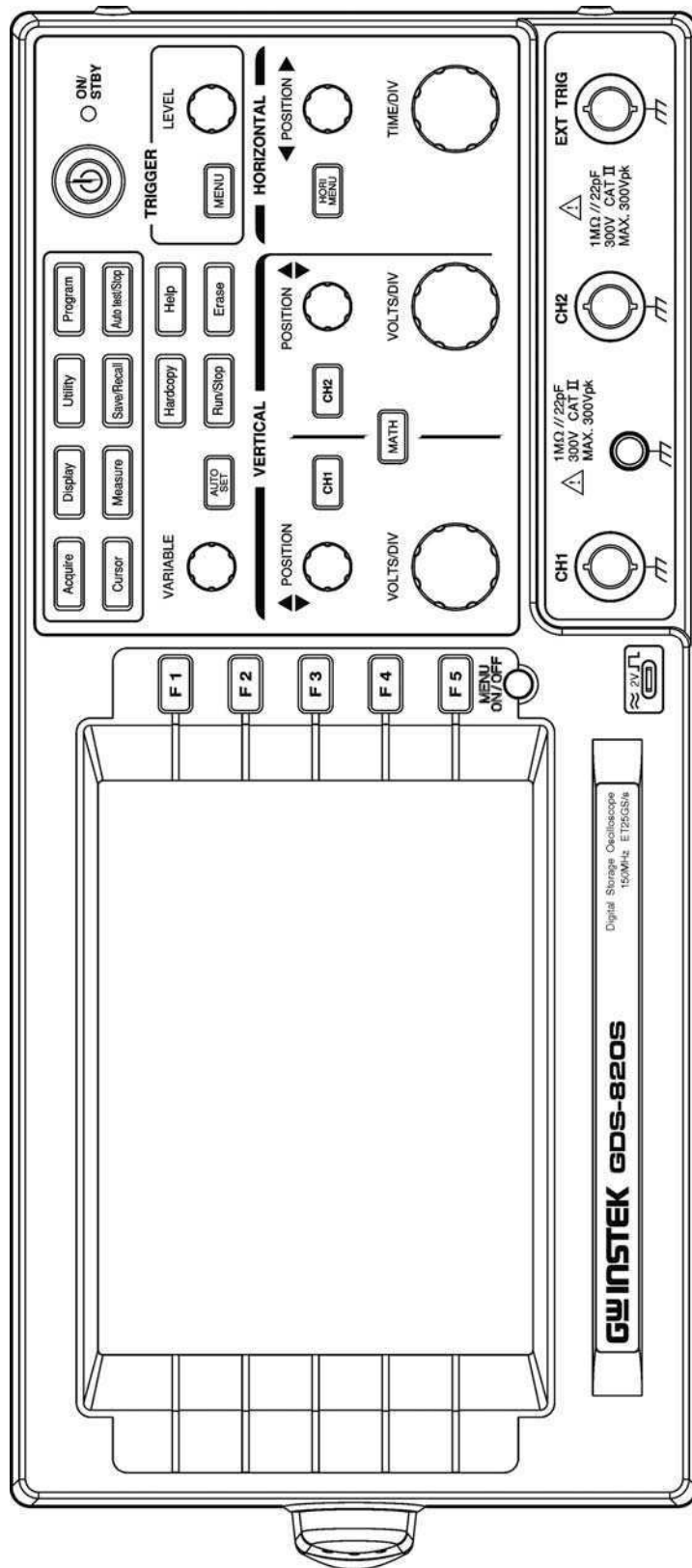

Display Area

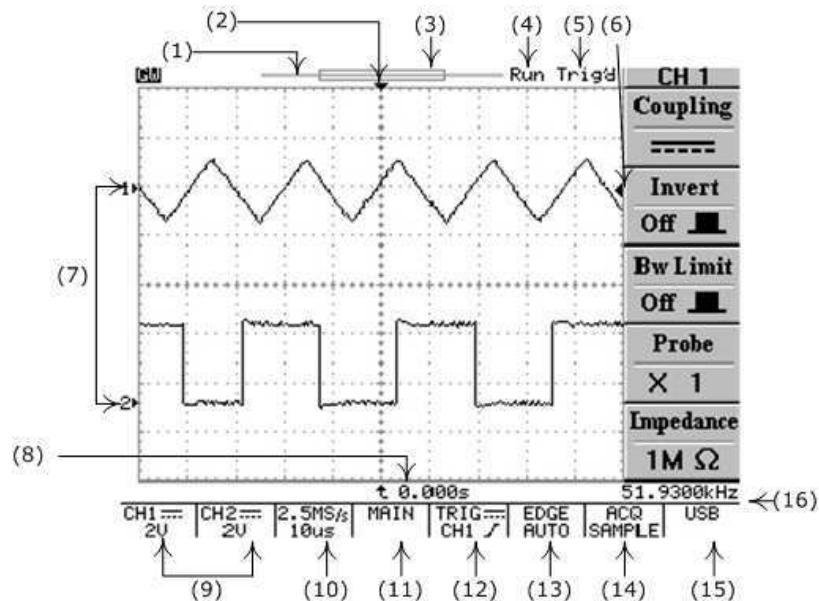

- (1): The memory bar (500 point processed by oscilloscope)*.
- (2): Trigger position (T) indicator
- (3): Viewable area shows segment of memory bar which been displayed*. Please refer page 40 for details.
- (4): Run/Stop mode indicator
- (5): Trigger status
- (6): Trigger level indicator
- (7): Channel position indicator
- (8): Delay trigger indicator
- (9): Status display for channel 1 & 2
- (10): Sample rate status readout
- (11): Horizontal status readout
- (12): Trigger source and status readout
- (13): Trigger type and mode readout
- (14): Acquisition status
- (15): Interface type indicator
- (16): Trigger Frequency counter

***: The memory bar is always 500 points under RUN mode even the memory length is selected over 500 points, the oscilloscope is still displaying 250points or 300points (menu off) on LCD screen waveform area.**

Vertical controls

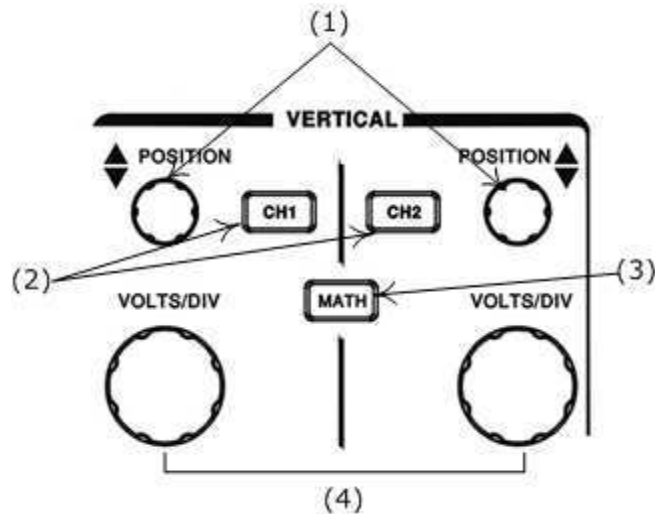

- (1): Channel 1, 2 **POSITION** knobs. The position control knobs adjust the vertical position of the channel 1 and channel 2 waveforms
- (2): **CH1**, **CH2** Menu pushbutton. Shows the vertical waveform function and waveform display on/off
- (3): **MATH** function pushbutton. Selects the different math function
- (4): **VOLTS/DIV** knobs. Adjusts the vertical scale of the waveforms.

Horizontal controls

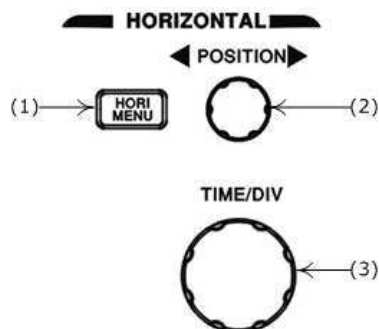

- (1): **HORI MENU**. Select the horizontal functions
- (2): Horizontal **POSITION** knob. Adjust waveforms horizontal position
- (3): **TIME/DIV** knob. Adjusts the horizontal scale of selected waveform

Trigger controls

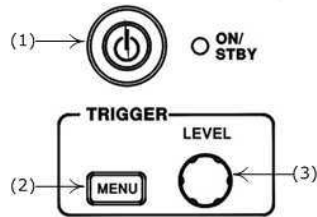

- (1): The power ON/STANDBY pushbutton
- (2): Selects the trigger type, source and mode
- (3): Adjust the trigger level

Miscellaneous controls

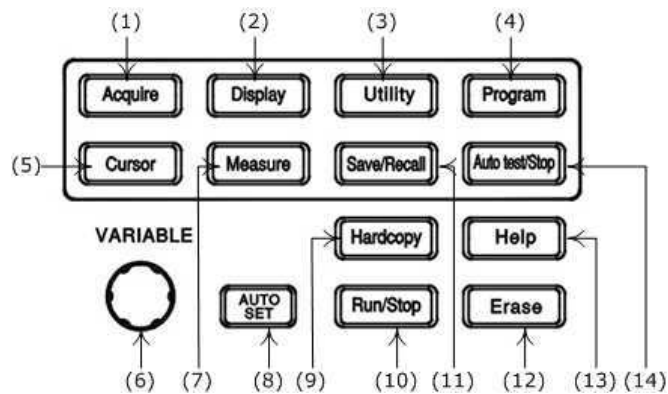

- (1): Select the acquire modes
- (2): Control the display modes
- (3): Select the utility functions
- (4): Sets the Program mode
- (5): Select the cursor types
- (6): **VARIABLE** knob. Multi-function knob which controls many menu functions
- (7): Access the 15 automatic measurements.
- (8): **AUTOSET** pushbutton automatically adjusts setup values to track a signal
- (9): Printout a hardcopy of the LCD display.
- (10): Start and stop oscilloscope acquisition.
- (11): Save and recall the setups and waveforms
- (12): Erases the stationary waveforms display
- (13): Display build-in help files on the LCD screen
- (14): Stop the replay for Program mode

BNC inputs

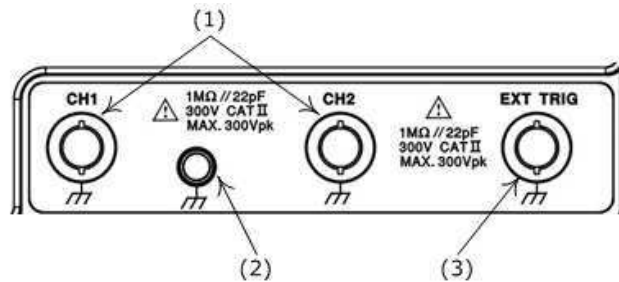

- (1): The channel 1 & 2 BNC inputs receive electrical signals for display
- (2): Ground
- (3): Connects with a external trigger signal to oscilloscope

Rear Panel

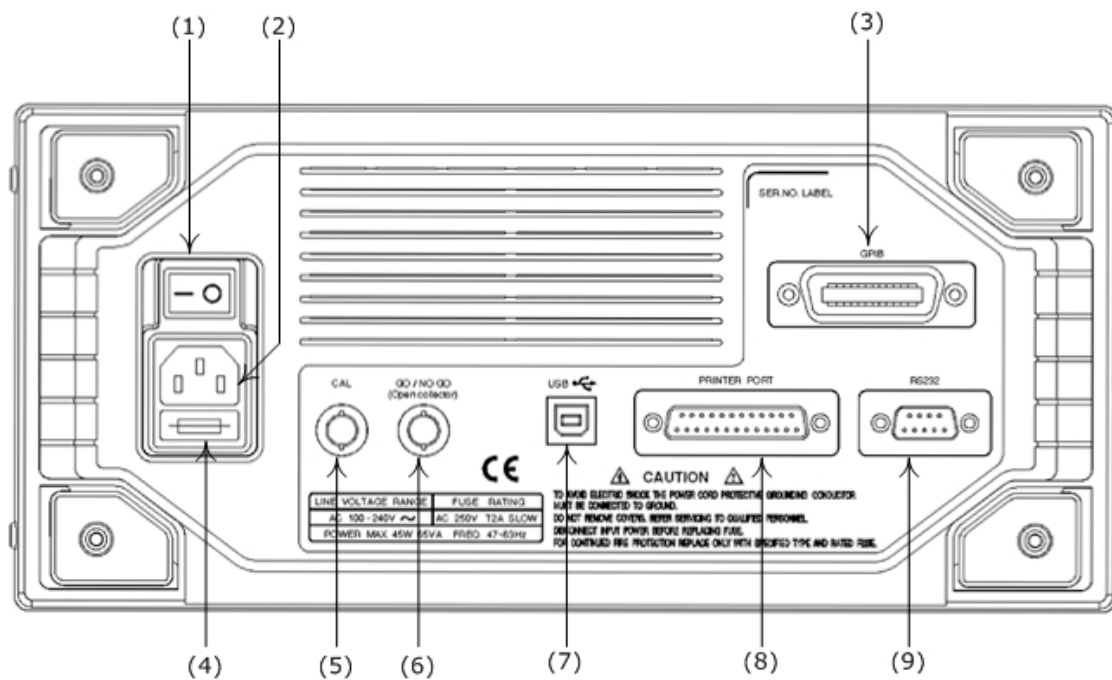

- (1): Main power switch
- (2): AC power socket
- (3): GPIB port (option)
- (4): Fuse drawer
- (5): "SELF CAL" output BNC ((DC output :0~±2V).
- (6): "GO/NO GO" output BNC (A 10us pulse will generated, 5V Maximum/10mA TTL output. Please refer to page 46 for details)
- (7): USB connector
- (8): Printer port
- (9): RS-232 port

5. Operation

This chapter contains useful information about the operation of this oscilloscope.

Vertical Control

All vertical operations affect the selected waveform. Press the **CH1**, **CH2**, or **MATH** pushbutton to adjust and select the waveform scale and position.

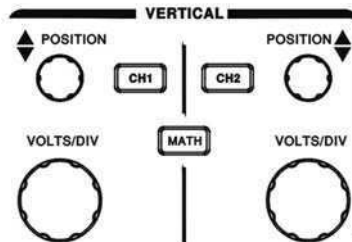
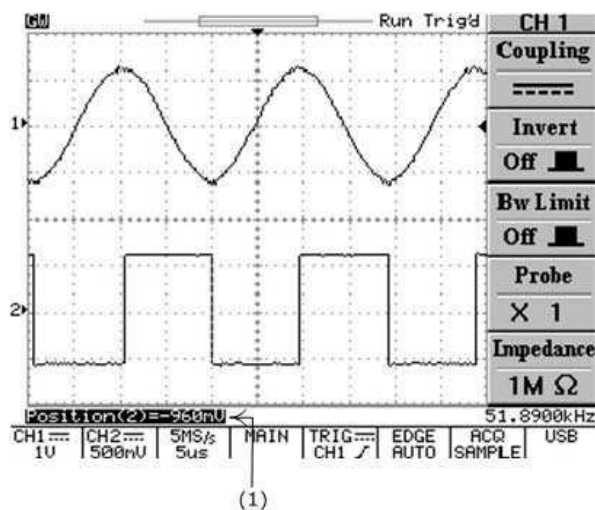

Figure 5-1: The vertical controls panel

VOLTS/DIV: The VOLTS/DIV knobs adjust the vertical scale (in a 1-2-5 sequence) of the selected waveforms (channel 1 and channel 2).







POSITION: The position control knobs adjust the vertical position of the channel 1 & 2 waveforms. When the vertical position is adjusted, the channel position indicator 1 \uparrow or 2 \uparrow (located on the left side of the LCD graticule) will change the position simultaneously. Besides, the vertical position reached to the vertical border of LCD graticule, the channel position indicator will change the shape to the “ \uparrow_1, \uparrow_2 ” or “ $\downarrow_1, \downarrow_2$ ”. The information of vertical scale will also display on the LCD screen.



(1): If position of channel1 (or channel2) changed, the vertical position readout will be displayed on here

Figure 5-2: Operating the position knob

CH1, CH2: The vertical menu contains the following items when channel 1 or channel 2 is the selected. These two pushbuttons are also switching the waveform display of channel 1/channel 2 on or off. If channel one (or channel 2) turned off, the light of **CH1** (or **CH2**) LED button will be off, and vice versa.

- **Coupling**  /  / : Press **F1** softkey to select **AC** (), **DC** () coupling, or ground ().
- **Invert On/Off**: Press **F2** softkey to select to turn (waveform) invert on or off
- **Bw Limit On/Off**: Press **F3** softkey to switch between 20MHz or full bandwidth.
- **Probe 1/10/100**: Press **F4** softkey to select the probe's $\times 1$, $\times 10$, or $\times 100$ attenuation.
- **Impedance 1M Ω** : Input impedance display. Always 1M Ω input impedance for GDS-800 series digital storage oscilloscope.

MATH: Select a formula from the math menu: **CH1+CH2**, **CH1-CH2** or **FFT** (Fast Fourier Transform). You can convert a time-domain signal into its frequency components by our advanced FFT math function. The Math menu contains the following items by pressing **F1** softkey after math function is selected. The display of mathematical waveform can be disabled by pressing **MATH** pushbutton again.

- **CH1+CH2**: Waveform of channel 1 plus waveform of channel 2.

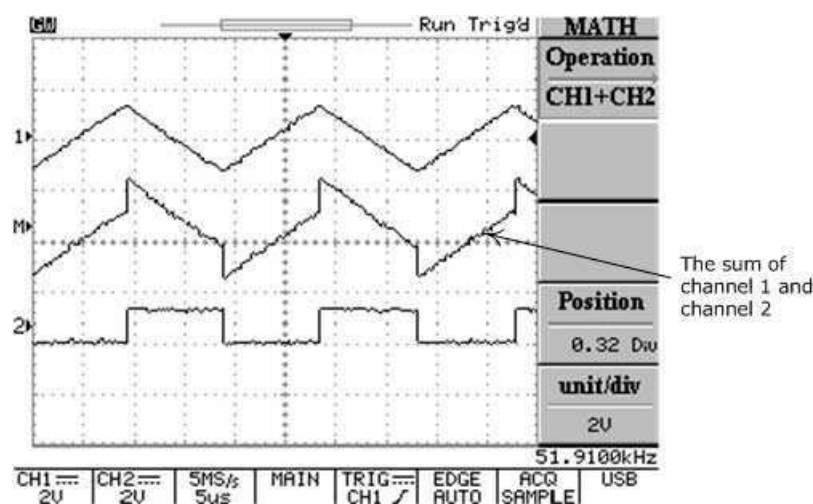



Figure 5-3: Operating the math function (Channel + channel 2)

- **CH1-CH2**: Waveform of channel 1 minus waveform of channel 2.

The position of CH1+CH2/CH1-CH2 mathematical waveform can be adjusted by rotating the **VARIABLE** knob. The math position indicator  (located on the left side of the LCD graticule) will change the position simultaneously. The information of mathematical division and unit will also display on the math menu bar.

- **FFT**: The details of FFT operations are following:

FFT

Operation: Push the **MATH** button to select the FFT function. The **Source** Channel and **Window** algorithm can be selected. Press **MATH** pushbutton again to disable FFT spectrum display.

- **Source CH1/CH2**: Selects the channel which assigned as the FFT spectrum.
- **Window Rectangular/Blackman/Hanning/Flattop**:
 - **Window Rectangular**: Transform to rectangular windowing mode. This windowing mode is suitable for transient analysis.
 - **Window Blackman**: Transform to Blackman windowing mode. The peak resolution of Blackman windowing is not as fine as Hanning windowing, however, the response shape flares out less at low levels and rejection of sidelobes is better.
 - **Window Hanning**: Transform to Hanning windowing mode. User can acquire higher frequency resolution by using this windowing mode.
 - **Window Flattop**: Transform to flattop windowing mode. This mode can obtain higher magnitude accuracy.

- **Position**: Adjusts the FFT position on the display area by rotating the **VARIABLE** knob. The “f1” math position indicator which located on the left side of LCD screen is always pointed to 0 dB approximately, where 0dB is defined as 1Vrms.
- **Unit/div 20/10/5/2/1 dB**: Press **F5** softkey to expand the FFT spectrum vertically. Expand factors are 20dB/Div, 10dB/Div, 5dB/Div, 2dB/Div and 1dB/Div.

FFT spectrum measurement by using cursors: FFT spectrum’s magnitude (dB) and frequency (Hz) can be measured by using cursors. Press **CURSOR** pushbutton and select **Source MATH** by pressing **F1** softkey.

- **Source MATH**: Selects FFT spectrum cursors measuring function.
- **Horizontal** : Adjust vertical cursors by rotating the **VARIABLE** knob. The reference values are also shown on the LCD screen:

f1: first cursor frequency indication

f2: second cursor frequency indication

Δ : The difference value of f1 and f2

Div: frequency per division at present

For more detail operations, please refer to page 59.

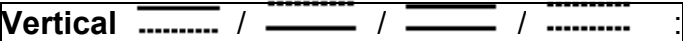
- **Vertical** : Adjust horizontal cursors by rotating the **VARIABLE** knob. The reference values are also shown on the LCD screen: The color of two horizontal cursors will be changed to red for the color oscilloscope.

M1: magnitude indication of first cursor

M2: magnitude indication of second cursor

Δ : The difference value of M1 and M2

For more detail operations, please refer to page 60.

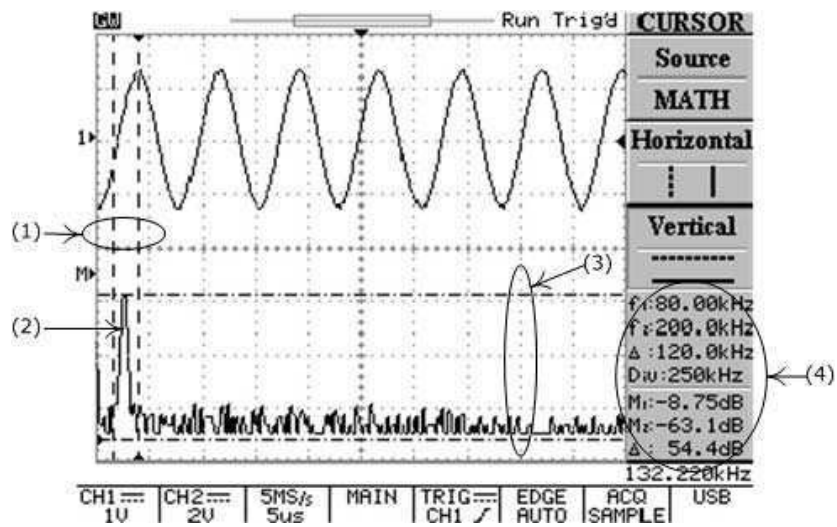

- (1): Cursors measure frequency of input waveform.
- (2): The spectrum of channel one input waveform.
- (3): Cursors measure magnitude of input waveform.
- (4): the readouts for both horizontal and vertical cursors.

Figure 5-4: Operating the math function (FFT) with cursors measurement

Horizontal Control

To select the horizontal controls, press the **MENU** pushbutton to select the features.

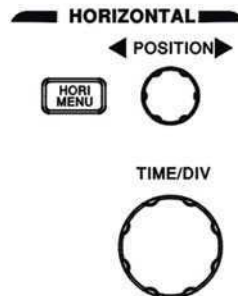

Figure 5-5: The horizontal controls panel

TIME/DIV: The **TIME/DIV** knob adjusts the horizontal scale (in a 1-2-5 sequence) of the selected waveforms (channel 1 and channel 2).

POSITION: The position control knobs adjust the horizontal position of the channel 1 & 2 waveforms. When the horizontal position is adjusted, the trigger position (T) indicator “▼” (located on the upper side of the LCD graticule) will change the position simultaneously. Besides, the horizontal position reached to the horizontal border of the LCD graticule, the trigger position (T) indicator “▼” will change the shape to the “τ” or “υ”.

MENU: Select a control to modify the timebase, horizontal position, and horizontal magnification of selected waveform.

- **Main**: Display the main timebase only.
- **Window**: To switch between the normal and zoomed display, Press **F2** softkey to display the timebase of windows zoom, in the meantime, the waveform display area will change to gray color except the zoomed area (see figure 6-6). Use the **TIME/DIV** knob to change the length (windows frame time range: from 2ns to one more step faster than the desired timebase. For example, if the 1ms timebase is selected, the maximum window frame timebase will be 500μs) of the zone and rotates the horizontal’s **POSITION** knob to change the position.

- **Window Zoom**: Press **F3** softkey to display the zoomed waveform.

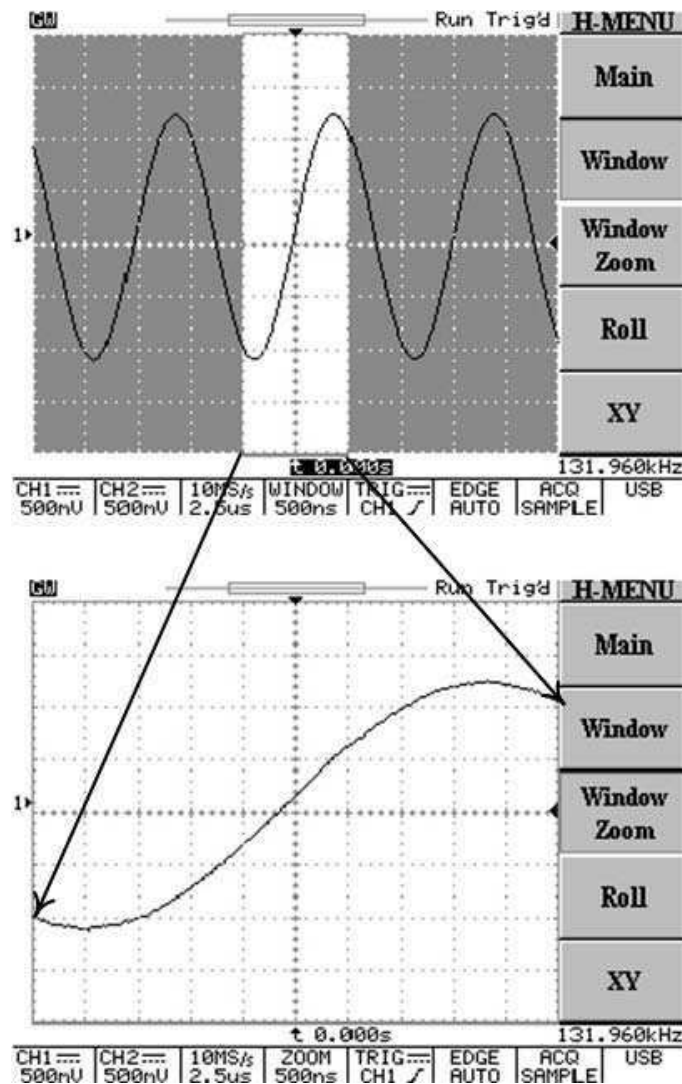

Figure 5-6: Operating the zoom function

- **Roll**: Press the **F4** softkey to obtain a rolling display similar to a strip-chart recorder. In the meantime, the system will select the roll mode from “Acquisition Mode” and the timebase of 200ms/div upper limited automatically.
- **XY**: Select XY display format if user want to show channel 1 in horizontal axis and channel 2 in vertical axis. The XY display controls as following:
 - ⊙ The channel 1 **VOLTS/DIV** knob and vertical **POSITION** knob controls the horizontal scale and position.
 - ⊙ The channel 2 **VOLTS/DIV** knob and vertical **POSITION** knob controls the vertical scale and position.

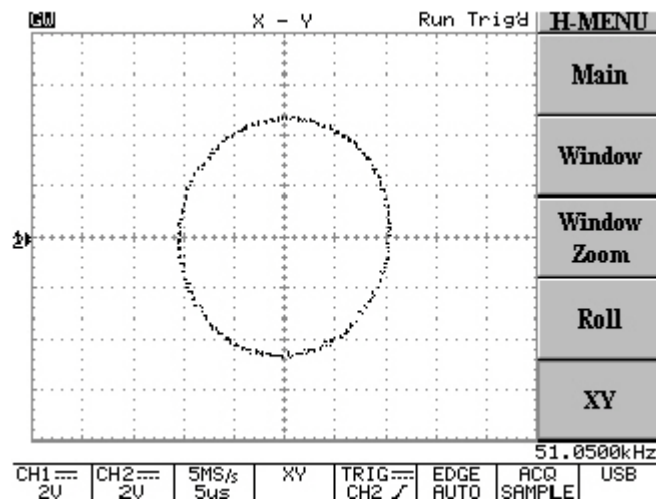

Figure 5-7: Operating the XY display function

These 500 points processed by the oscilloscope under run mode are characteristic points of real acquired long memory waveform. Due to the hardware limitation of LCD panel, always 250 points (300 points for side menu off) will be displayed. The way to explore the real acquired waveform on the oscilloscope's long memory is stopping the scope and change the time base. When the scope is stopped, users can observe any portion or all the waveform memory record by changing the time base or horizontal trigger position. Decreasing time base expands the waveform and is referred to as "zooming in". This feature performs the similar function to the time base windowing feature. But this feature is available under the real-time acquisition mode and is only operable when acquisition is stopped.

Users can shift the stopped waveform horizontally on the LCD screen. It is controlled by the horizontal's **POSITION** knob. Increasing "delay trigger indicator" shifts the waveform to the left and decreasing "delay trigger indicator" shifts the waveform to the right. By observing the memory bar and viewable area, user can see what portion of the memory is being displayed.

The memory length is also an important factor because the following formula.

$$\frac{1}{\text{SampleRate}} (\text{Record Length}) = \text{Time Duration of the Record}$$

For example, a signal is display on the screen as figure 5-8.

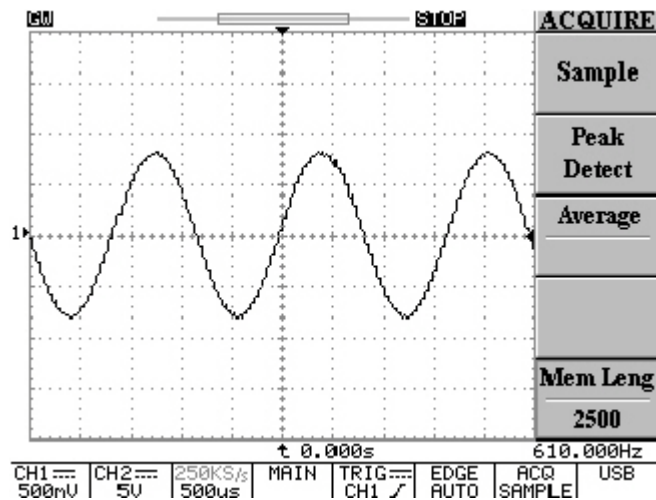

Figure 5-8: The stopped waveform

The sample rate is 250kS/s and the record length is 2500, according the formula we have

$$\frac{1}{250kSa/s} (2500) = 10ms$$

There are 10ms of data in the waveform record. Users may change the “delay trigger indicator” to observe the total waveform record.

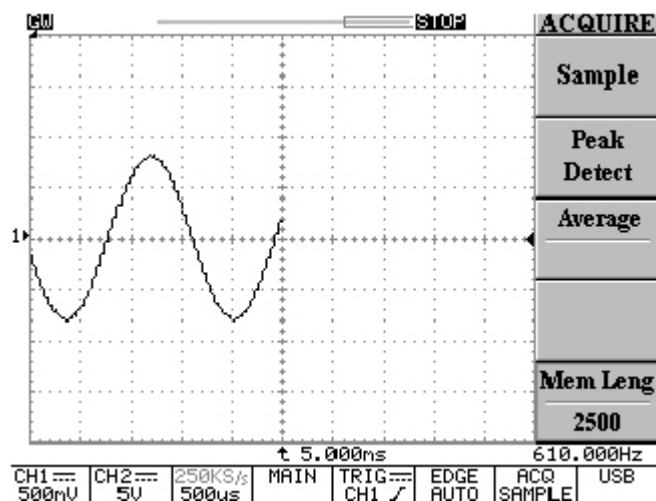

Figure 5-9: Increasing “delay trigger indicator” shifts the waveform to the left

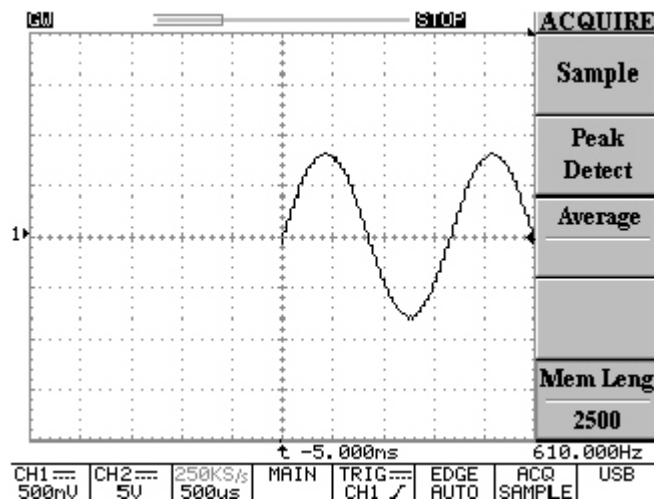

Figure 5-10: Decreasing “delay trigger indicator” shifts the waveform to the right

The sum of left-most “delay trigger indicator” and right-most “delay trigger indicator” is equal to 10ms (5ms+5ms). Therefore, the above formula is approved.

The maximum “exploring” factor for this oscilloscope is 7 faster “time/div” setting on the sample rate of original acquired waveform. In the meantime, the “exploring” factor is only based on the 500 points of memory length.

Users should check the sample rate in advance, and examine Table 5-2 (the row of memory length=500) to find out the interrelated timebase afterward. After the interrelated timebase is confirmed, just count 7 faster “time/div” setting from Table 5-2. The maximum “exploring” factor is appeared. In an easy way, users may just rotate the horizontal’s **TIME/DIV** knob directly. The oscilloscope will count automatically.

For example, the sample rate of figure 5-11 is 250kSa/s. The 250kSa/s on memory length 500 is $100 \mu\text{s/s}$ according to Table 5-2. Therefore, the maximum expand time/div will be “500ns/s”.

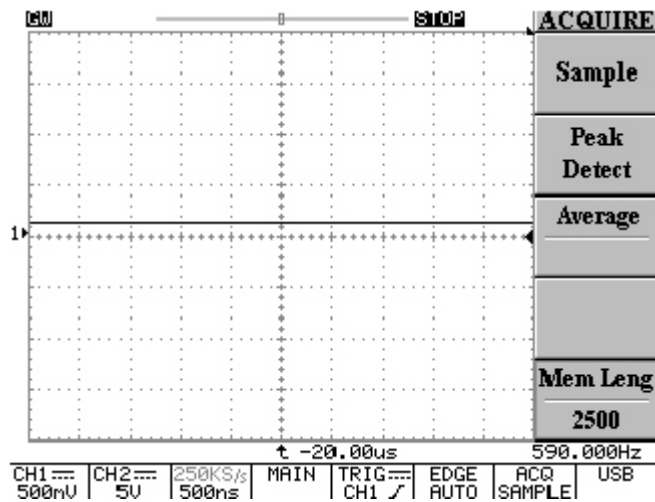

Figure 5-11: The maximum “zooming in” factor for 250kSa/s sample rate is 500ns/s. The viewable area is also adjusted properly for the varying of “exploring” factor.

Trigger Control

When the instrument starts acquiring and display a waveform, “trigger” help create meaningful waveforms from unstable jumbles or blank screen. To access the triggering controls, press trigger **MENU** key, the trigger menu will provide the **Type**, **SOURCE**, **MODE**, or **SLOPE/COUPLING** soft key to select the features.



Figure 5-12: Trigger controls

Type (Edge/Video/Pulse/Delay): The **F1** softkey provides four different kinds trigger type: Edge, video, pulse and delay.

Type Edge: Select edge triggering to trigger on the input signal’s edge.

SOURCE: Select the trigger source.

- **CH 1**: Select channel 1 as trigger source.
- **CH 2**: Select channel 2 as trigger source.
- **External**: Select “EXT TRIG” BNC input as trigger source. Note this instrument can trigger on external trigger signals, but cannot display them.
- **Line**: Select AC line voltage signal as trigger source.

MODE: Select a trigger mode.

- **Auto Level**: Press **F3** softkey to enable the auto level triggering. In this mode, the adjusting of “trigger level indicator” will be limited only between the top and bottom of input waveform. If the “trigger level indicator” adjusted over the range, the oscilloscope will shift the “trigger level indicator” to the central part of waveform automatically. External trigger is not support under this mode.

- **Auto**: In this mode, the oscilloscope will generate an internal trigger in the absence of other trigger events. Also, select Auto trigger mode when you want an un-triggered, rolling waveform at 250ms/div or slower timebase settings. This mode is able to continuously observe low speed phenomena in real time down to a speed of 10s/div.
- **Normal**: Normal trigger mode enables the oscilloscope to acquire a waveform only when instrument is triggered. If no trigger occurs, the instrument will not acquire waveform.
- **Single**: Press **F3** softkey to trigger on the next valid trigger event and then stop. If a trigger is required again, just press the **RUN/STOP** pushbutton. Signal shot events are waveforms that happen only once or infrequently. In order to capture a signal shot events, user needs to have knowledge of the waveform, which is trying to capture. Before user can setup the trigger, vertical, and horizontal controls to capture and display event, user must know the approximate amplitude, duration, and DC offset of the signal.

The trigger status (Page 13, item 5) indicates the following:

Trig'd: The oscilloscope displays acquired waveform only after all of the trigger conditions are met.

Trig?: The absence of triggers for normal and single mode.

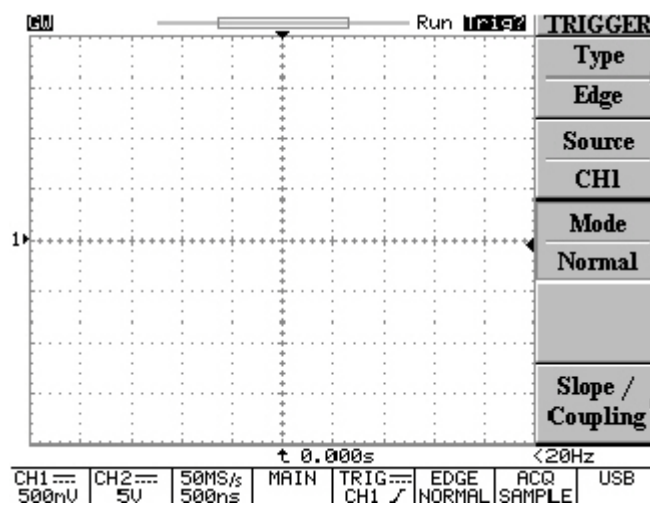

Figure 5-13: The absence of triggers for normal and single mode

AUTO: The oscilloscope is in auto mode and trigger conditions are not met.

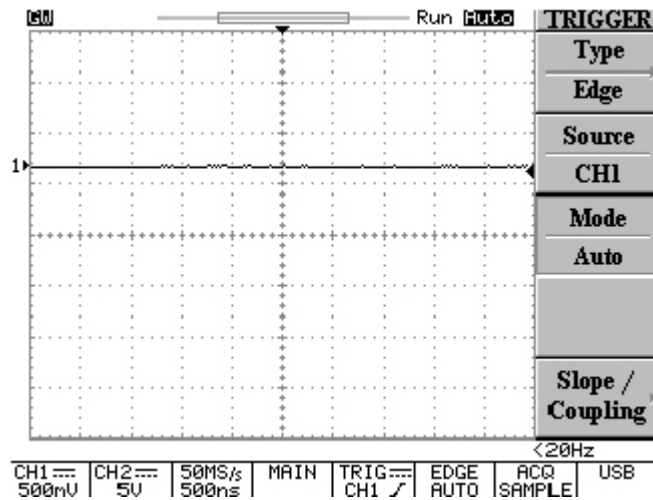
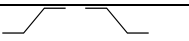





Figure 5-14: The oscilloscope is in auto mode and trigger conditions are not met

SLOPE/COUPLING: Change trigger slope and select trigger coupling by pressing **F5** softkey.

- **Slope** : Press the **F1** softkey to select the triggering slope; oscilloscope will change the “trigger slope” to the rising or falling edge.
- **Coupling DC/AC**: Press the **F2** softkey to select DC coupling () or AC coupling ().
- **Rejection LF/HF/Off**: Press **F3** softkey to select the frequency reject mode.
- **LF**: Press the **F3** softkey to enable low frequency reject mode. Low frequency reject mode removes the low frequency portion of the triggering signal. That allows only the high frequency components to pass on to the triggering system and start an acquisition afterward. Low frequency rejection attenuates signals below 50kHz.
- **HF**: High frequency reject mode does the opposite of low frequency reject mode. High frequency rejection attenuates signals above 50kHz.

- **Off** : Switch off frequency reject mode.
- **Noise Rej On/Off**: Press **F4** softkey to enable noise reject mode. Noise reject mode provides lower DC sensitivity. It requires additional signal amplitude for stable triggering, reducing the change of falsely triggering on noise.
- **Previous Menu**: Back to previous menu.

Video Triggering

Press **F1** softkey can select video triggering.

- **Type Video**: The video trigger gives user a variety of selections for triggering on video signals: the selection of NTSC, PAL or SECAM video signal; polarity; line, field 1 or field 2.
- **SOURCE**: Select the channel 1 or channel 2 as trigger source.
- **Standard NSTC/PAL/SECAM**: Press **F3** softkey to select predefined setups (NSTC, PAL or SECAM). NSTC has a line rate of 525 lines per frame and a field rate of 60Hz. PAL and SECAM have a line rate of 625 lines per frame and a field rate of 50Hz.
- **Polarity** : The video trigger can trigger on the negative-going sync pulses (default). If need to trigger on positive-going sync of a signal, simply invert the signal by pressing **F4** softkey again.
- **Field 1/Field 2/Line**:
 - **Field 1**: Press **F5** softkey to trigger on field 1 of the video signal. Rotate the **VARIABLE** knob to display the specific line. (The adjustable line range for NSTC: 1~263; for PAL/SECAM: 1~313)

- **Field 2**: Press **F5** softkey to trigger on field 2 of the video signal. Rotate the **VARIABLE** knob to display the specific line (The adjustable line range for NSTC: 1~262; for PAL/SECAM: 1~312)
- **Line**: Press **F5** softkey to trigger on all lines of the video signal

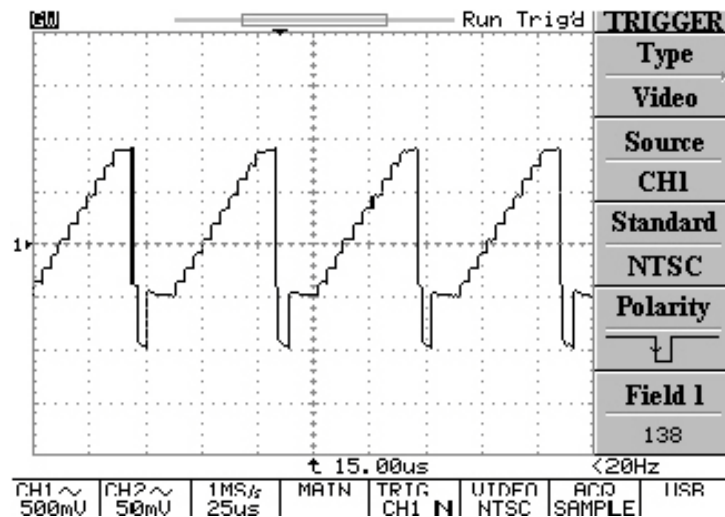

Figure 5-15: Vide trigger mode

Pulse Width Triggering

- **Type PULSE**: The pulse width triggering can provide the scope to trigger on a negative or positive pulse of a specified width. The range of pulse width can be adjusted from 20ns until 10 second. The relations for pulse width, pre scale and pulse width count are shown on Table 5-1.

Pulse Width	Pre scale	Pulse width count
20ns~980ns	20ns	1~49
1.00us~9.98us	20ns	50~499
10us~99.9us	20ns	500~4995
100us~999us	200ns	500~4995
1.00ms~9.99ms	200ns	5000~49950
10.0ms~99.9ms	2000ns	5000~49950
100ms~999ms	20000ns	5000~49950
1.00s~10.0s	200000ns	5000~50000

Table 5-1

- **SOURCE**: Select the input channel as trigger source.
- **Mode**: Select different triggering types.
- **When <>=≠**: Press **F4** softkey to select the different time compare factor.
 - **When <**: When the less than “<” time compare factor selected, the **VARIABLE** knob sets the scope to trigger on a pulse width less than the time value displayed on the **F4** softkey.
 - **When >**: When the greater than “>” time compare factor selected, the **VARIABLE** knob sets the scope to trigger on a pulse width greater than the time value displayed on the **F4** softkey.
 - **When =**: When the equal “=” time compare factor selected, the **VARIABLE** knob sets the scope to trigger on a pulse width equal to the time value displayed on the **F4** softkey.
 - **When ≠**: When the unequal “≠” time compare factor selected, the **VARIABLE** knob sets the scope to trigger on a pulse width unequal to the time value displayed on the **F4** softkey.

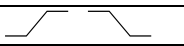
- **Slope** : Select positive or negative polarity for the pulse width triggering.

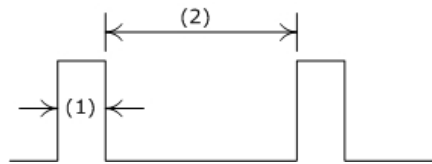

(1): When positive polarity selected, the trigger will take place on the high to low transition of the pulse if the compare condition is match. See figure 5-16.

(2): When negative polarity selected, the trigger will take place on the low to high transition of the pulse if the compare condition is match. See figure 5-17

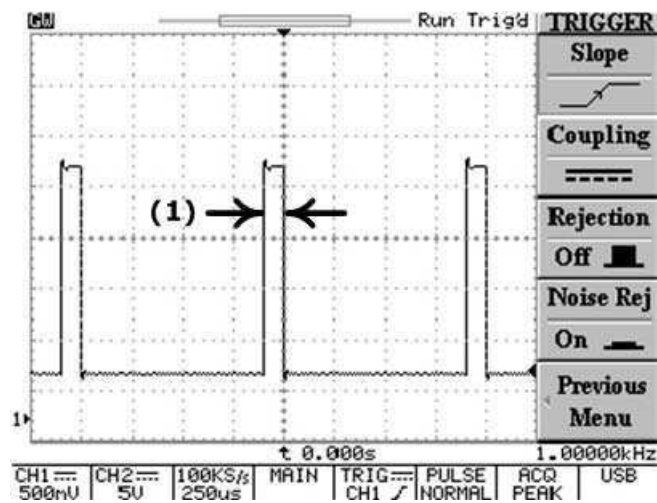

Figure 5-16: Pulse width trigger with positive polarity selected

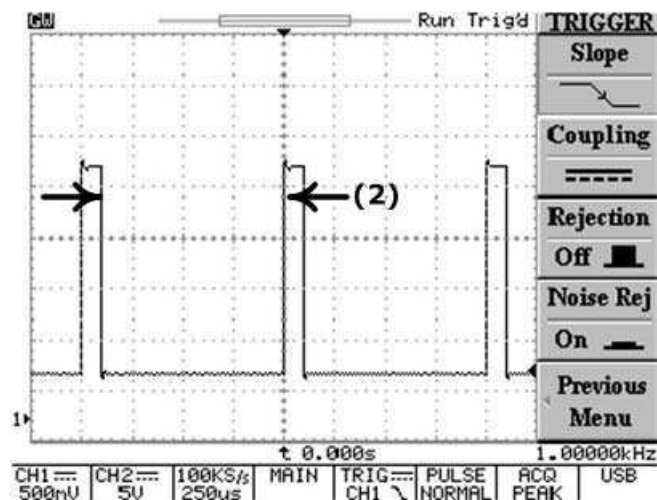

Figure 5-17: Pulse width trigger with negative polarity selected

- **Coupling DC/AC**: Press the **F2** softkey to select DC coupling or AC coupling.
- **Rejection LF/HF/Off**: Press **F3** softkey to switch off the frequency reject mode.
- **Previous Menu**: Back to previous menu.

Advance Triggering

- **Type Delay**: The advance delay trigger system includes a start trigger signal and a 2nd trigger source (main trigger). The start trigger signal generated from external trigger. When using the advance trigger system, user can delay the acquisition of a waveform for a user-defined time or a user-defined number of delayed trigger events after a start trigger signal. Press the **F2**, **F3**, and **F4** softkey to select three advance delay trigger settings: **By Time**, **By Event**, and **TTL/ECL/USER**.
- **By Time**: After the specified user-defined delay timer times out (from external trigger), the oscilloscope will triggers on the edge which been specified. Rotate the **VARIABLE** knob to select the specific delay time. (The adjustable delay time range: 100ns~1.3ms).
If the external trigger is applied, the true trigger will be applied by the CH1 (or CH2) trigger after the elapse of set time.

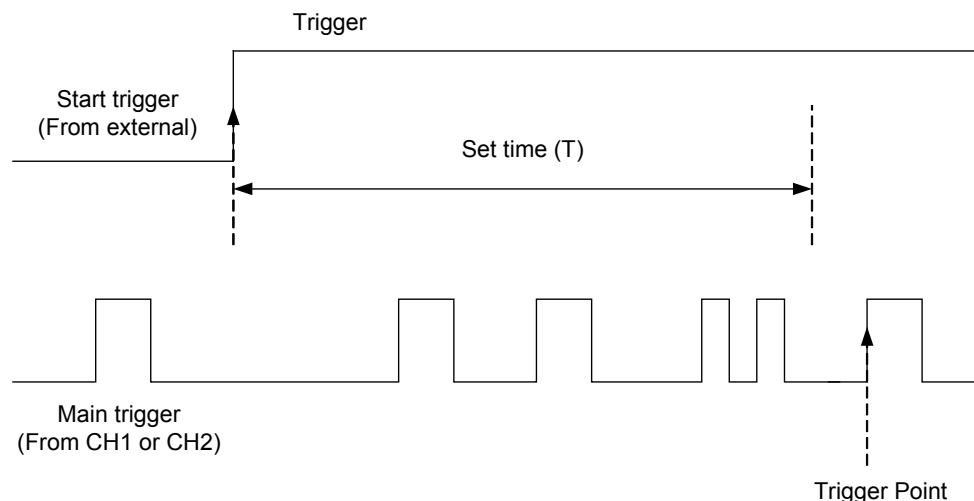

Figure 5-18: The start trigger signal is ignored during the set time interval (T); the start trigger signal caused first after elapse of the set time (T) becomes a trigger point.

If start trigger signal is selected, the DELAY time can be set by the **VARIABLE** knob.

If the main trigger is selected, presses the **F4** softkey to select the start trigger signal level from the following three levels.

TTL: This is the mode for the TTL signal measurement and start trigger signal are set to +1.4V.

ECL: This is the mode for the ECL signal measurement and start trigger signal are set to -1.3V.

USER: Select USER mode and rotate the **VARIABLE** knob to define the specific start trigger signal level. (The adjustable start trigger signal level range: $\pm 12V$)

Note: All accuracy of these signals' level are based on the probe $\times 1$ only

- **By Event**: Waits the user-defined delay trigger events and then acquires. Rotate the **VARIABLE** knob to select the specific delay event. (Numbers of events: 2~65000)

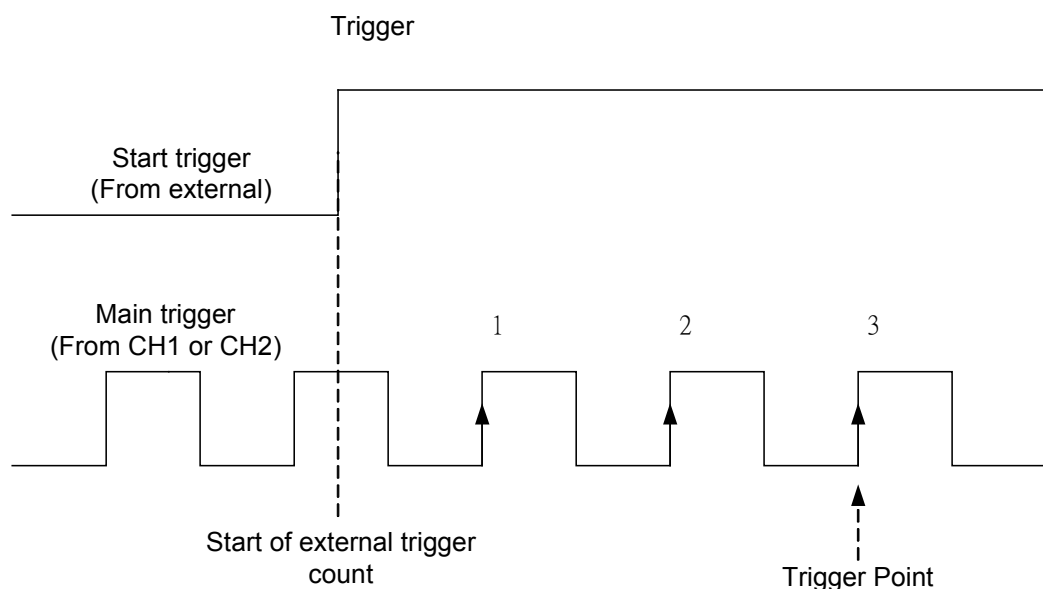

Figure 5-19: Event delay trigger. Number of set event: In case of three.

If start trigger signal is selected, the number of events can be selected by the **VARIABLE** knob.

If the main trigger is selected, press the **F4** softkey and to select the start trigger signal level from the following three levels.

TTL: This is the mode for the TTL signal measurement and start trigger signal are set to +1.4V.

ECL: This is the mode for the ECL signal measurement and start trigger signal are set to -1.3V.

USER: Select USER mode and rotate the **VARIABLE** knob to define the specific start trigger signal level. (The adjustable start trigger signal level range: $\pm 12V$)

Note: All accuracy of these signals' level are based on the probe $\times 1$ only

Miscellaneous Controls

To select the miscellaneous controls, press these pushbuttons to select specific features (see Figure 5-12).

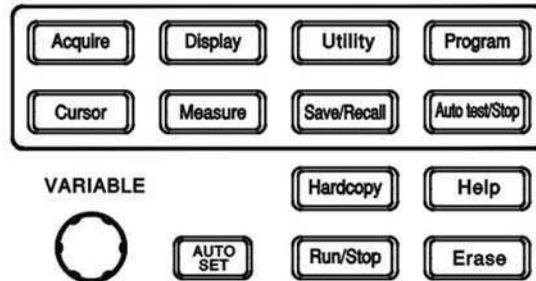

Figure 5-20: Miscellaneous controls

ACQUIRE: Press **ACQUIRE** pushbutton to select the different acquire mode: **Sample**, **Peak-Detect**, and **Average**. Acquisition is the process of sampling the analog input signal and converting it into digital format afterward, assembling it into a waveform record finally.

- **Sample:** Press **F1** to select the “sample” acquisition mode. In sample mode, the instrument generates a record point by saving the first sample during each acquisition interval.
- **Peak-Detect:** The “Peak-Detect” mode stores the minimum and maximum values (pairs) for each acquisition intervals. Use Peak-Detect acquisition mode which can detect glitches as narrow as 10ns and the aliasing can be limited possibly. This mode is effective when the horizontal scale (SEC/DIV) setting from 500ns/div to 10s/div
- **Average:** The average mode selects the number of waveform acquisitions that are averaged to generate the display waveform. The range for the averaging is from 2 to 256 in powers of 2.

Note: The number select of “average” only effectiveness on the record lengths of 500.

Average mode reduces displayed signal noise significantly. As the number of averages increases from 2 to 256, the display becomes less responsive to changes in the input signal. Using more averages reduces the effects of displayed signal noise and improves resolution.

If any of the record lengths (**except record lengths of 500**) and average number been selected (**for this moment, the selection of average number is ineffective**), the instrument will use the resolution improved technology to average entire waveform by different acquisition intervals automatically. Therefore, user can get an average result in a higher sample rate, and better resolution waveform.

Note: The different between record lengths of 500 and the rest is the “sampling”. If the “record lengths” is selected to 500, the sampling will be triggered individually. If “record lengths” is the rest number, the sampling is triggered for once.

- **Men Leng**: The number of points that make up the waveform record is defined by record length. This oscilloscope provides record lengths of 500, 1250, 2500, 5000, 12500, 25000, 50000, and 125000. For the relationship between memory length, timebase, and sample rate, please refer to Table 5-2. To ensure a full screen display of 500 points on the slower timebase ranges, as the timebase is slowed down the sample rate is also slowed down.

The relationship between memory bar, viewable area, and memory length setting are shown on Figure 5-21 and 5-22. The memory bar is always indicating the selected memory length but be compressed into 500 points. The viewable area will display 250 points, if the side menu turned on. If the side menu is turned off, the viewable area should display 300 points.

The entire 125k acquisition memory can be dumped to personal computer for further data analysis. Please refer to programming manual for details.

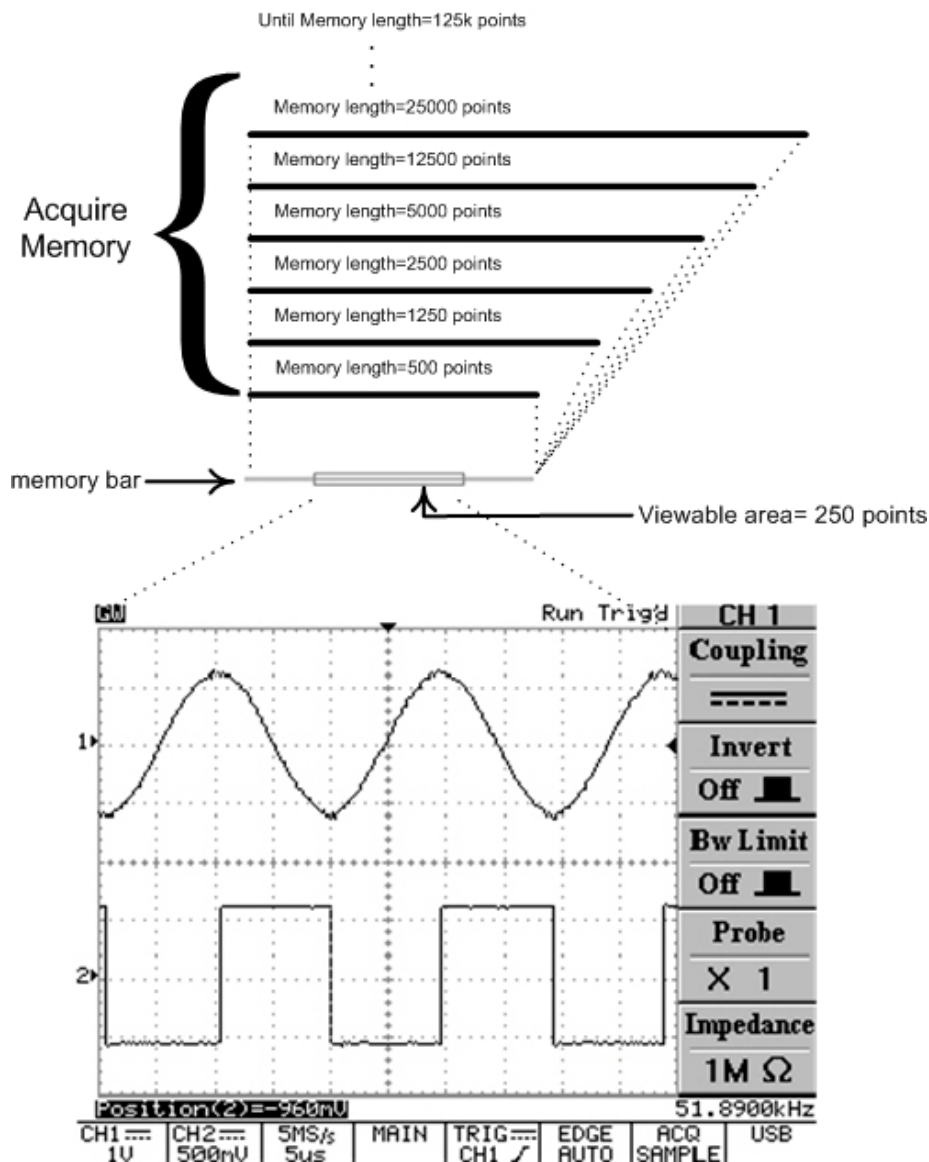

Figure 5-21: The relationship between “memory bar”, “memory length”, and “viewable area (menu on)”

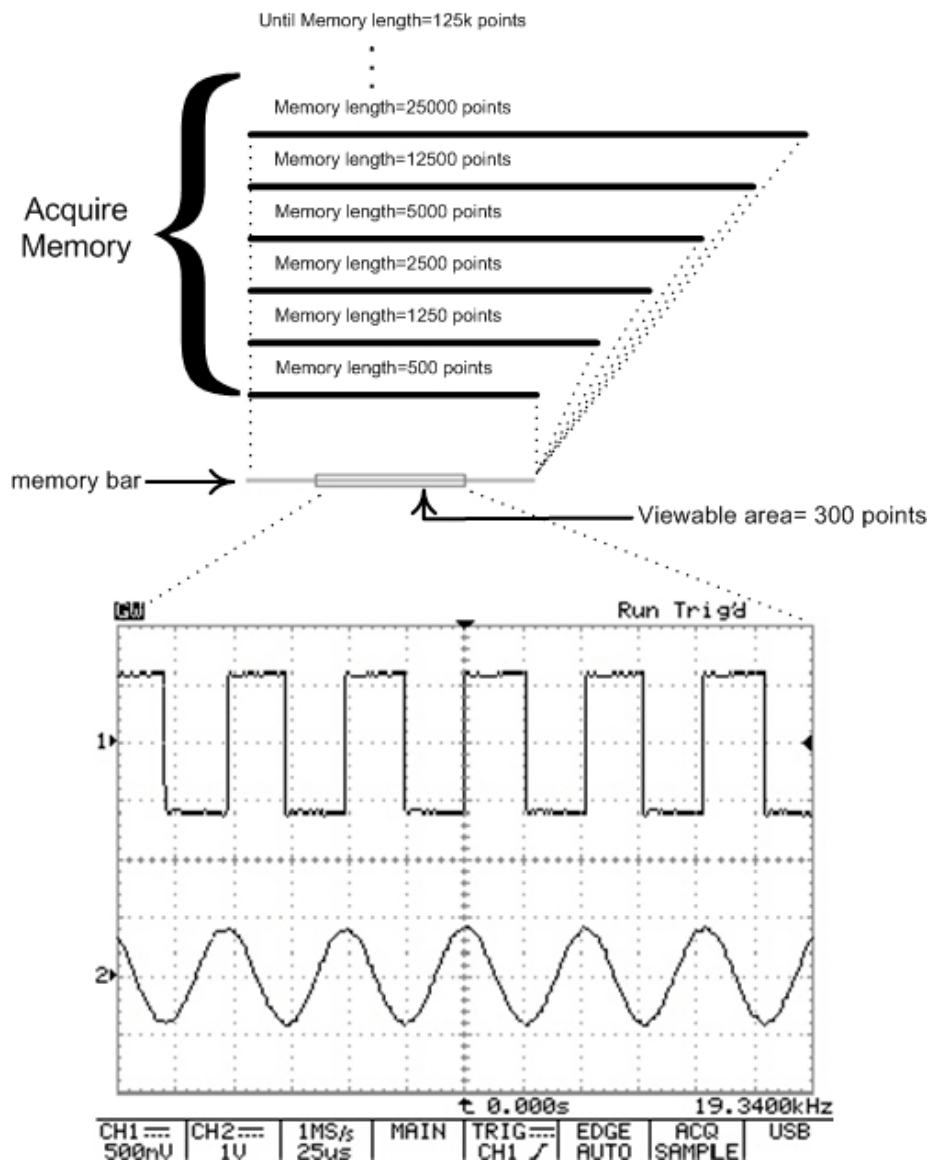

Figure 5-22: The relationship between “memory bar”, “memory length”, and “viewable area (menu off)”.

Memory length Timebase	500	1250	2500	5000	12500	25000	50000	125000
1ns/div	ET25Gsa/s	NA	NA	NA	NA	NA	NA	NA
2.5ns/div	ET10Gsa/s	NA	NA	NA	NA	NA	NA	NA
5ns/div	ET5Gsa/s	NA	NA	NA	NA	NA	NA	NA
10ns/div	ET2.5Gsa/s	NA	NA	NA	NA	NA	NA	NA
25ns/div	ET1Gsa/s	NA	NA	NA	NA	NA	NA	NA
50ns/div	ET500Msa/s	NA	NA	NA	NA	NA	NA	NA
100ns/div	ET250Msa/s	NA	NA	NA	NA	NA	NA	NA
250ns/div	100MSa/s	NA	NA	NA	NA	NA	NA	NA
500ns/div	50MSa/s	100MSa/s	NA	NA	NA	NA	NA	NA
1µs/div	25MSa/s	50MSa/s	100MSa/s	NA	NA	NA	NA	NA
2.5µs/div	10MSa/s	25MSa/s	50MSa/s	100MSa/s	NA	NA	NA	NA
5µs/div	5MSa/s	10MSa/s	25MSa/s	50MSa/s	100MSa/s	NA	NA	NA
10µs/div	2.5MSa/s	5MSa/s	10MSa/s	25MSa/s	50MSa/s	100MSa/s	NA	NA
25µs/div	1MSa/s	2.5MSa/s	5MSa/s	10MSa/s	25MSa/s	50MSa/s	100MSa/s	NA
50µs/div	500kSa/s	1MSa/s	2.5MSa/s	5MSa/s	10MSa/s	25MSa/s	50MSa/s	100MSa/s
100µs/div	250kSa/s	500kSa/s	1MSa/s	2.5MSa/s	5MSa/s	10MSa/s	25MSa/s	50MSa/s
250µs/div	100kSa/s	250kSa/s	500kSa/s	1MSa/s	2.5MSa/s	5MSa/s	10MSa/s	25MSa/s
500µs/div	50kSa/s	100kSa/s	250kSa/s	500kSa/s	1MSa/s	2.5MSa/s	5MSa/s	10MSa/s
1ms/div	25kSa/s	50kSa/s	100kSa/s	250kSa/s	500kSa/s	1MSa/s	2.5MSa/s	5MSa/s
2.5ms/div	10kSa/s	25kSa/s	50kSa/s	100kSa/s	250kSa/s	500kSa/s	1MSa/s	2.5MSa/s
5ms/div	5kSa/s	10kSa/s	25kSa/s	50kSa/s	100kSa/s	250kSa/s	500kSa/s	1MSa/s
10ms/div	2.5kSa/s	5kSa/s	10kSa/s	25kSa/s	50kSa/s	100kSa/s	250kSa/s	500kSa/s
25ms/div	1kSa/s	2.5kSa/s	5kSa/s	10kSa/s	25kSa/s	50kSa/s	100kSa/s	250kSa/s
50ms/div	500Sa/s	1kSa/s	2.5kSa/s	5kSa/s	10kSa/s	25kSa/s	50kSa/s	100kSa/s
100ms/div	250Sa/s	500Sa/s	1kSa/s	2.5kSa/s	5kSa/s	10kSa/s	25kSa/s	50kSa/s
250ms/div	100Sa/s	250Sa/s	500Sa/s	1kSa/s	2.5kSa/s	5kSa/s	10kSa/s	25kSa/s
500ms/div	50Sa/s	100Sa/s	250Sa/s	500Sa/s	1kSa/s	2.5kSa/s	5kSa/s	10kSa/s
1s/div	25Sa/s	50Sa/s	100Sa/s	250Sa/s	500Sa/s	1kSa/s	2.5kSa/s	5kSa/s
2.5s/div	10Sa/s	25Sa/s	50Sa/s	100Sa/s	250Sa/s	500Sa/s	1kSa/s	2.5kSa/s
5s/div	5Sa/s	10Sa/s	25Sa/s	50Sa/s	100Sa/s	250Sa/s	500Sa/s	1kSa/s
10s/div	2.5Sa/s	5Sa/s	10Sa/s	25Sa/s	50Sa/s	100Sa/s	250Sa/s	500Sa/s

Table 5-2: The available sample rate between different timebase and memory length.

DISPLAY: Press the **DISPLAY** pushbutton to change the appearance of the display and select how waveforms are presented.

Note: Always 250 points plotted to screen on each acquisition.

Type Vector/Dot:

- **Type Vector:** Press the **F1** softkey to select vector display style. The instrument draws a vector between each pair of waveform points.
- **Type Dot:** Displays only the individual sample points.
- **Accumulate (On/Off):** The “Accumulate” mode can acquire and display a waveform record that shows the totally variation over entire acquisitions.
- **Refresh:** Press **F3** softkey to refresh the waveforms.
- **Contrast (0~100%):** Press **F4** softkey to adjust the contrast of LCD screen. Use the **VARIABLE** knob to vary LCD screen contrast.

For GDS-806 and GDS-810 series only:

: Rotate the **VARIABLE** knob to vary LCD screen contrast. Rotating clockwise is increasing the contrast; Rotating counter-clockwise is decreasing the LCD contrast.

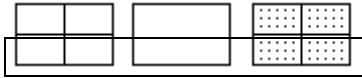
- : Press **F5** softkey to select three different graticular display mode.

- : Only X and Y axial are displayed.

- : Only outer frame is displayed.

- : Full grids are displayed

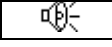
UTILITY: The utility menu provides abundant sub menus: **Printer menu**, **Interface menu**,  (Beep), **Language**, **self-cal menu**, **System Inform**, **Go-No Go menu**, and **No Go When**.

- **Printer Menu:** If a printer is connected and properly configured, GDS-820/GDS-840 series can print a hard copy of the LCD display. Press **F1** softkey again to select printer. This oscilloscope supports the following printers:

- **Type HP:** Both Hewlett-Packard's LaserJet laser printers and DeskJet inkjet printers supported.

Press the pushbutton of **HARDCOPY** pushbutton to start printing from any time after printer is properly configured.

Note: GDS-800 series oscilloscopes do not support any GDI printers.

Note: The USB of this oscilloscope is "DEVICE" only, this oscilloscope DO NOT support any USB printers.

Note: Printer menu is available for GDS-806S/C and GDS-810S/C with interface option, GDS-820S/C and GDS-840S/C.

- **Interface Menu:** This oscilloscope can transfer data between the scope and other instrument over the RS-232, USB, or GPIB interface. Press **F1** softkey to select the GPIB location.

Note: Interface menu is only available for GDS-806S/C and GDS-810S/C with interface option; Interface menu is standard for GDS-820S/C and GDS-840S/C.

Note: A total integrated of interface option for GDS-806S/C and GDS-810S/C is including the USB port, Printer port, and Go/NoGo output BNC, three kinds of output functions are in one option.

For RS232 setup

- **Type RS232:** Select RS-232 communication port.
- **Baud rate:** Transmission rate in characters per second. Transmission rate selections are: 2400, 4800, 9600, 19200, and 38400 baud.

- **Stop bit**: Press the adjacent pushbutton to select “1” or “2” bits.
- **Parity**: Press the adjacent pushbutton to select “Odd”, “Even”, or “None”.
- **Previous Menu**: back to previous menu.

Note: The “Data Bit” is always 8-bit.



For USB

- **Type USB**: Select USB port.

Note: In order to display the real-time waveform on personal computer, please download the “FreeView” communication software from our website <http://www.goodwill.com.tw>.

- **Previous Menu**: back to previous menu.

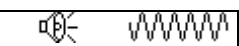
For GPIB

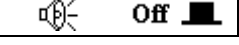
- **Type GPIB**: Select GPIB port.
- **Addr 1~30**: select the appropriate address for GPIB.
- **Previous Menu**: back to previous menu.
- : Select the tone for build-in buzzer.
 - : Select the tone in higher frequency.
 - : Select the tone in lower frequency.
 - : Select the tone in mixed frequency.
 - : Turn off the buzzer.
- **Language Menu**: English, tradition Chinese, simplified Chinese, French, German, Italian, Korean, Russian, Finnish, Spanish and Polish are supported for this moment.
- **More**: press **F5** softkey to other utilities.

- **Self Cal Menu**: Please refer to service menu for the details.
- **System Inform**: The company name, model name, and firmware version will be shown on the LCD screen.
- **Go- No Go Menu**: The Go- No Go judgment function can be used to judge if the acquired signal is matched with the pre-save patterns. The input waveforms are compared with the pattern and the measured waveform is evaluated to automatically determine which action to perform. The following actions can be selected based on this evaluation:
 1. The build-in buzzer.
 2. The “Go-No Go” BNC connector on the rear.

The level of output signals from “Go-No Go” BNC connector is defined as following:

If the result is “Good”, the output level is remained in low level.

If the result is “No Good”, a 10us pulse (5V Maximum/10mA TTL output) will be generated to the “Go-No Go” BNC connector.

Note: The signal of “Go-No Go” BNC connector is “open collect”.

- **Template Edit**: Edits the proper templates. Press **F1** softkey once and enter to sub-menu (Max/Min/Auto).

For Template Max and Min

- **Template Max/Min**: The “Go-No Go” templates are selected from Reference A or B of “Save/Recall” function, for the details operation, please refer to page 58.

Template Max: The maximum template is always selected from the Reference A of “Save/Recall” function or from the one hundred sets of custom-made waveforms.

Template Min: The minimum template is always selected from the Reference B of “Save/Recall” function or from the one hundred sets of custom-made waveforms.

Note: The maximum and minimum templates can not select the same custom-made waveform source. For example, if the custom-made waveform of “Template Max” is selected as number 10, the “Template Min” have to choice the different custom-made waveform number except number 10.

- **Source RefA/RefB/1~100**: Indication for the source of maximum template or minimum template (Reference A for maximum template; Reference B for minimum template).

This oscilloscope can accept one hundred custom-made waveforms from a personal computer with the advance “FreeCapture” software (this **freeware** can be downloaded from our website: <http://www.goodwill.com.tw>). The “FreeCapture” software can edit any specified waveforms from users and input to oscilloscope as maximum (or minimum) templates. The maximum custom-made waveforms input capacities are one hundred sets. For the details of “FreeCapture” operations, please refer to the “FreeCapture” operation manual.

User can select the different custom-made waveforms sets by rotating the **VARIABLE** knob. The maximum or minimum template CAN NOT select the identical custom-made waveforms location. The two maximum and minimum must be selected form the different custom-made waveforms location. Otherwise, the “Go- No Go” function will go wrong.

- **Position**: Adjust the vertical position for maximum template or minimum template or custom-made waveforms. The adjustable ranges are from ± 0.04 division to ± 4 division.
- **Save**: Press **F4** softkey to save the current settings. In the meantime, the original saved reference A or B from “Save/Recall” function will be also changed as current setting.

- **Previous Menu**: back to previous menu.

For Template Auto

- **Template Auto**: The two “Go-No Go” templates are generated automatically from the subject signal.

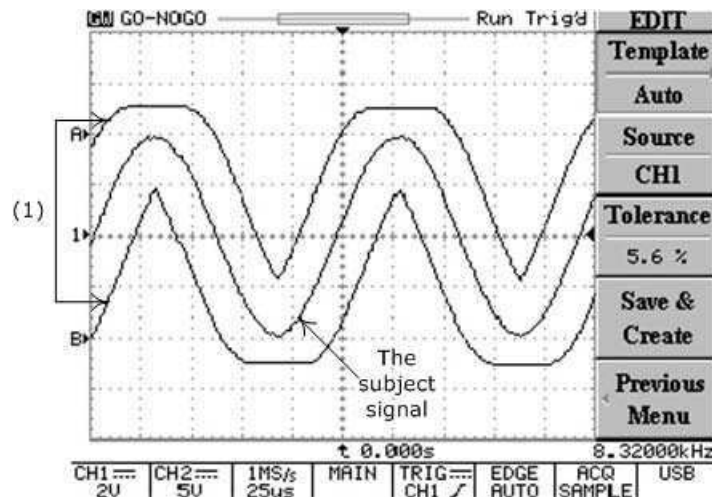

- (1): According to the subject signal, the two templates (RefA and RefB) are created by “Template Auto” automatically. The adjustable range (Tolerance) is available from $\pm 0.4\%$ to $\pm 40\%$ (or ± 0.04 division to ± 4 division).

Figure 5-23: Template created “Template Auto” function

- **Source CH1/CH2**: Select the input source of channel 1 or channel 2 as “Go-No Go” template.
- **Tolerance %**: Select the tolerance percentage (or division) range for vertical and horizontal scales from the subject signal. The adjustable range is available from $\pm 0.4\%$ to $\pm 40\%$ (or ± 0.04 division to ± 4 division).
- **Save & Create**: Press **F4** softkey to save the settings. In the meantime, the original saved reference A or B from “Save/Recall” function will be also changed as current setting

Previous Menu: Back to previous menu.

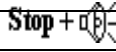
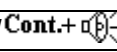
- **Source**: select channel 1 or channel 2 as subject signal input.
- **Violating Stop/ /Continue/Cont.+ **: Select the process after subject is violating the compared templates.

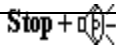

Violating Stop: If subject signal is judged to be “No Good”, the “Go-No Go” function will stop. The counts of violation will be recorded.

Violating : If subject signal is judged to be “No Good”, the “Go-No Go” function will stop and oscilloscope will beep once. The counts of violation will be recorded.

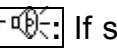
Violating Continue: If subject signal is judged to be “No Good”, the “Go-No Go” function will to be executed continually. The counts of violation will be recorded.

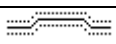

Violating : If subject signal is judged to be “No Good”, the “Go-No Go” function will be executed continually and oscilloscope will beep once. The counts of violation will be recorded.

Note: All the judgment condition are based on the setting of **No Go**

When  / . See next page for details.

- **Go- NoGo On/Off**: Starts the “Go- No Go” function.
- **Ratio** : Display the counts of “Go-No Go” test and failure. Press **F5** softkey to reset the counts of ratio to zero.

Press any pushbutton to exit the “Go-No Go” function.

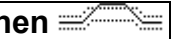
- **No Go When** : Select the judgment condition of violation for “Go-No Go” function.
 - **No Go When** : If the subject signal is not violating the templates, the system will judge such condition as “No Go” situation by selecting this function.
 - **No Go When** : If the subject signal is violating the templates, the system will judge such condition as “No Go” situation by selecting this function.
- **More**: Press **F5** softkey to other utilities.

CAL. OUTPUT: The adjustable signal output provides a range for a signal of probe compensation which can be adjusted from 1kHz to 100kHz, 1kHz per step; and duty cycle is adjusted from 5% to 95%, 5% per step. This function can satisfy user with the probe compensation more easily and accurately. **NOTE:**

This function is available for GDS-806S/C and GDS-810S/C only

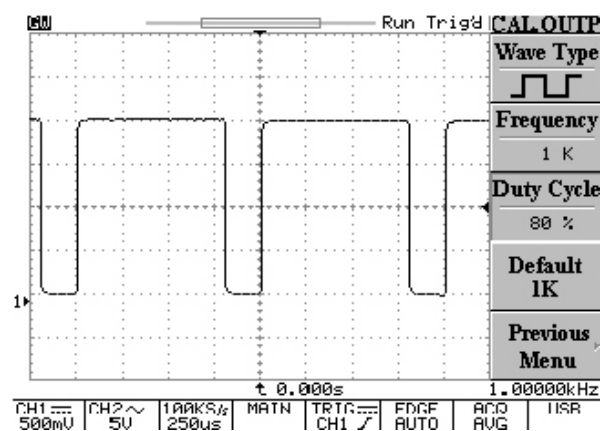



Figure 5-24: The menu for adjustable probe compensation signal

- **Wave Type**: Press **F1** soft key to select adjustable probe compensation signal or another two output signals for demonstration.

: A demonstration signal which designed for the purpose of long record length.

: A demonstration signal which designed for the purpose of peak detects.

- **Frequency**: The adjustable frequency range for probe compensation signal is from 1kHz to 100kHz, at 1kHz per step.
- **Duty Cycle**: The adjustable duty cycle range for probe compensation signal is from 5% to 95%, at 5% per step.
- **Default 1k**: Press **F4** soft key to output a 1k probe compensation signal.

NOTE: Always use 1k probe compensation signal to compensate the probes, DO NOT use another frequencies except 1k to compensate the probes.

- **Previous Menu**: Press **F5** softkey to previous menu.

PROGRAM: The advance “Program mode” function is able to let oscilloscope to remember certain steps and replay all the saved steps. There are two main operating classes for “Program mode”: Edit and Play. Users can edit preferred operating steps and replay all of the saved steps afterward.

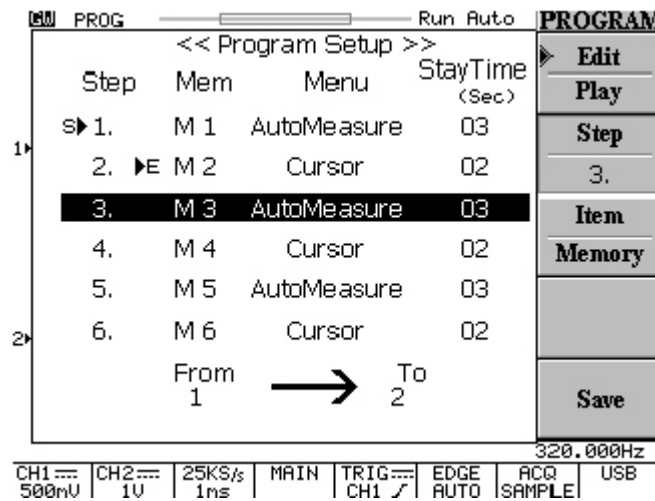

Figure 5-25: Press **PROGRAM** pushbutton and enter to “Program” mode

Steps Editing:

- **Edit:** Begin to edit entire steps. Press **F1** softkey again will go to replaying mode.
- **Step 1-15:** Select the step which to be edited and rotate the **VARIABLE** knob to select the preferred step. The setting of range is from 1 to 15.
- **Item Memory/Menu/Time:** Select the conditions for each step. Press the **F3** softkey continually to select three different conditions: Item Memory, Item Menu, and Item Time.
 - **Item Memory:** Select one of the pre-saved waveform from fifteen internal memory sets. Rotates the **VARIABLE** knob to pick proper memory set. The pre-saved memory is available from memory one to memory fifteen (M1~M15).
 - **Item Menu:** Select which menu to be shown on the LCD panel for present step running. Only two menus can be displayed during “Program Mode” running, the two menus are *measurement* and *cursor* menu. Rotates the **VARIABLE** knob to select preferred display menu.

- **Item Time**: Select the time of stop. The selectable range: 1~99 seconds. Or wait users to press **Run/Stop** pushbutton and stop the present replaying step.
- **Save**: Press **F5** softkey to save current steps of Program mode.

Steps Replaying:

- **Play**: Settings for replaying of saved steps.
- **Cycle 1~99**: The Program mode procedure can be replayed from 1 to 99 times repetitiously.
- **From/To**: Select any step of “Program mode” to be the first replay step and the final replay step.
- **Start**: Press F5 softkey to start replaying the “Program mode”.

Press **Auto test/Stop** pushbutton to quit the “Program mode”.

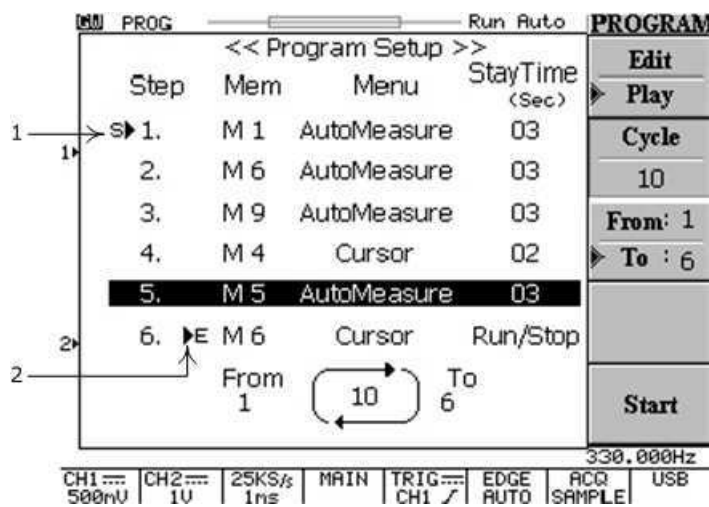

Figure 5-26: Programming for play function of “Program” mode

- (1): The starting step indicator for replaying.
 (2): The final step indicator for replaying.

Figure 5-25 shows a program which replay from step one to step six and run ten times repetitiously.

The first step is the settings which recalled from the memory one (M1), the “Auto Measurement” menu will be displayed on the LCD screen during step one replaying; the running time is three seconds.

The final step (step six) is recalled from sixth memory location (M6), the “Cursor” menu will be displayed on the LCD screen during step six replaying; the running time is controlled by pressing the **Auto test/Stop** pushbutton.

Example: editing a 2-step “program” which included two different signal input and monitoring the Vpp, Vavg, Frequency, duty cycle and rise-time. This program should be repeated five times, 10 seconds for each step.

1. The input for channel one is a 2Vpp, 10kHz sine wave from beginning; (a). Press **CURSOR** button and **F3** softkey to enable vertical cursors; (b). Adjusting the two cursors to proper position by rotating the **VARIABLE** knob.

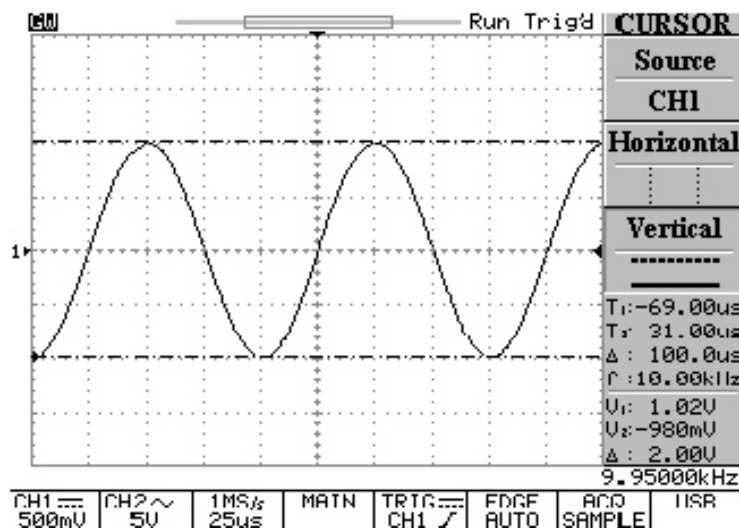

Figure 5-27: Adjusting the vertical position for channel one input of example

- Save all settings of channel one to memory location one (M 01). (a). Press **SAVE/RECALL** button and **F3** softkey to select memory location; select memory location one (M 01) by rotating the **VARIABLE** knob. (b). Press **F4** softkey to save the channel one settings.

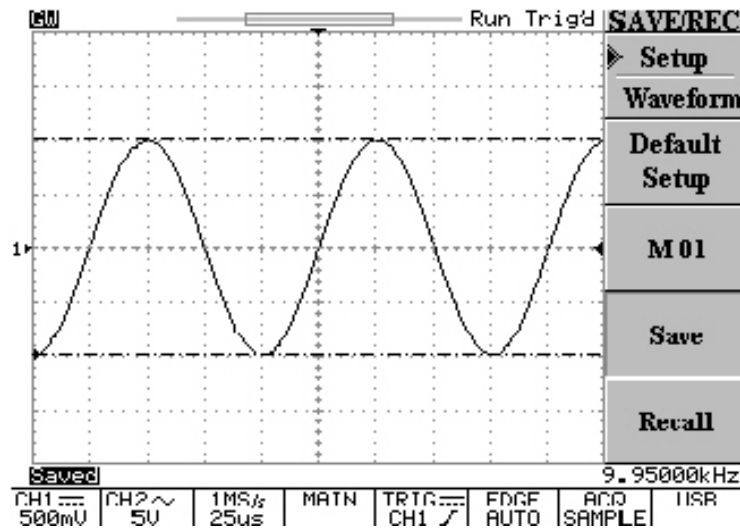

Figure 5-28: Save channel one settings to memory location one (M 01)

- The input for channel two is a 6Vpp, 1MHz square wave; (a). Press **CURSOR** button and **F1** softkey to select channel two as source; (b). Press **F2** and **F3** softkey to enable horizontal and vertical cursors; (c). Adjusting the two cursors to proper position by rotating the **VARIABLE** knob.

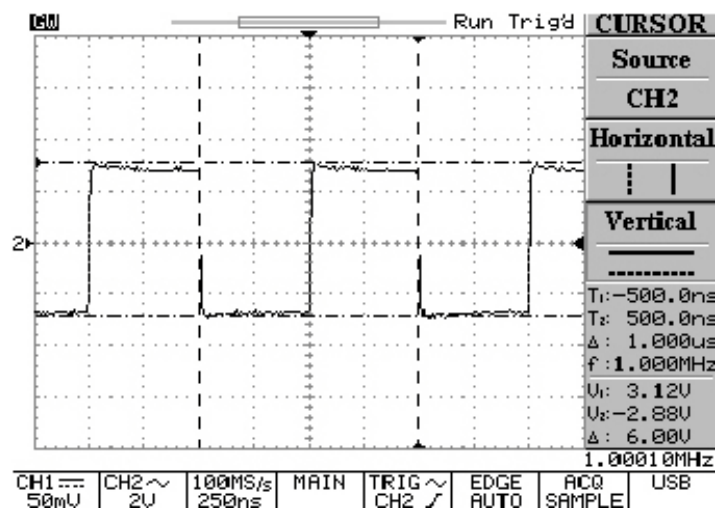

Figure 5-29: Adjusting the horizontal and vertical position for channel two inputs

4. Save all settings of channel two to memory location two (M 02). (a). Press **SAVE/RECALL** button and **F3** softkey to select memory location; select memory location one (M 02) by rotating the **VARIABLE** knob; (b). Press **F4** softkey to save the channel two settings afterward.

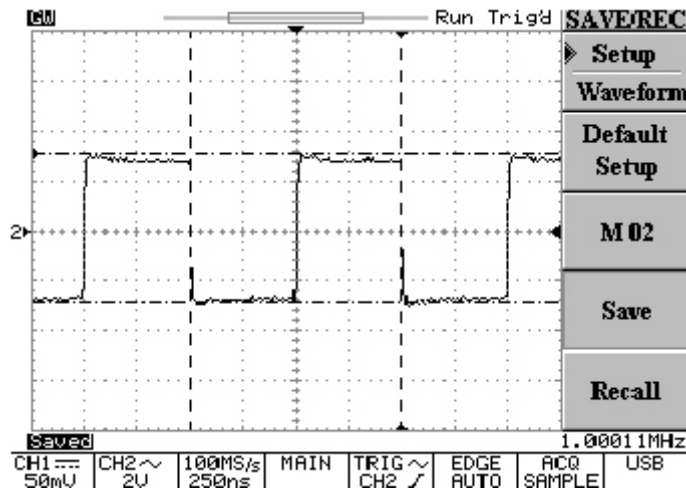

Figure 5-30: Save channel two settings to memory location two (M 02)

5. Press **PROGRAM** button to enter program mode.

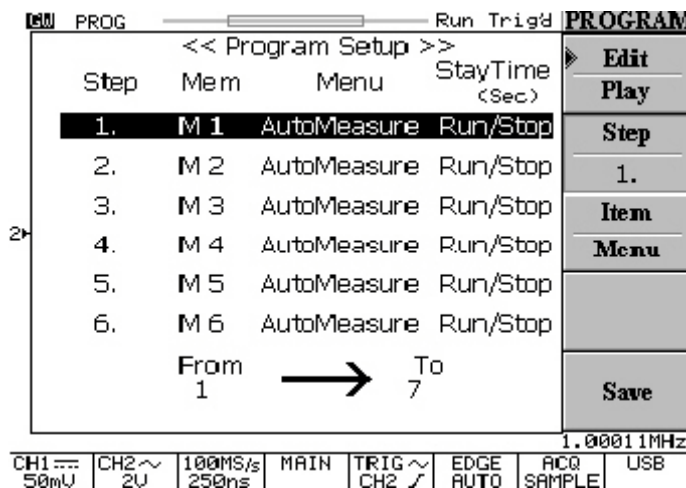

Figure 5-31: Enter to program mode

6. (a). Press **F2** softkey and rotate the **VARIABLE** knob to select “step 1”; (b). Press **F3** softkey to select “Item Memory” and rotate the **VARIABLE** knob to select memory location one (M1) ; (c). Press **F3** softkey again to select “Item Menu” and rotate the **VARIABLE** knob to select AutoMeasure menu; (d). Press **F3** softkey again to select “Item Time” and rotate the **VARIABLE** knob to select 10 seconds operation interval for step one.

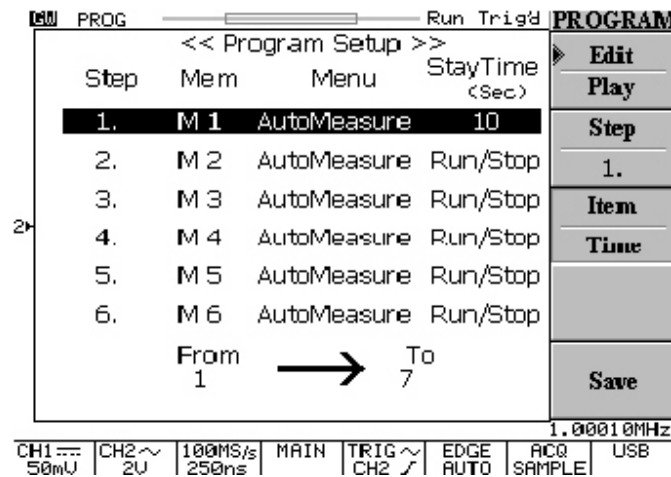

Figure 5-32: Editing the program condition of step one

7. (a). Press **F2** softkey to skip into “step 2”; (b). Press **F3** softkey to select “Item Memory” and rotate the **VARIABLE** knob to select memory location two (M2); (c). Press **F3** softkey again to select “Item Menu” and rotate the **VARIABLE** knob to select AutoMeasure menu; (d). Press **F3** softkey again to select “Item Time” and rotate the **VARIABLE** knob to select 10 seconds operation interval for step two.

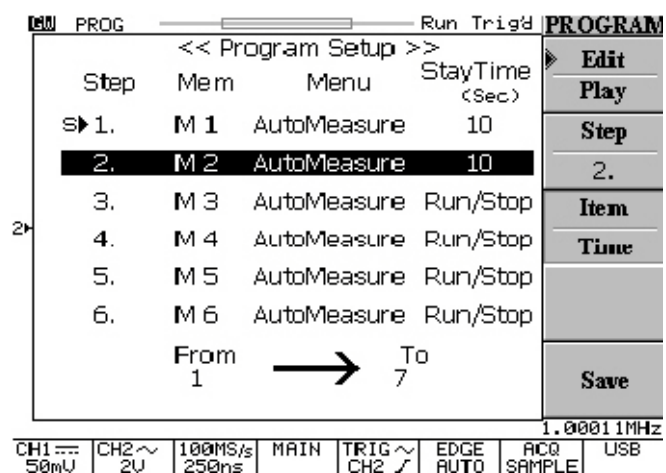

Figure 5-33: Editing the program condition of step two

8. The steps of program condition are completed now. And we need (a). Press **F5** softkey to save all steps on system. (b). Press **F1** softkey to “Program Play” menu; (c.) Press **F2** softkey to select running cycle for program and rotate the **VARIABLE** knob to select the operation repeated cycle. We select 5 times here; (d). Press **F3** softkey and rotate the **VARIABLE** knob to select to select the starting step. The step one is selected as starting step here; (e). Press **F3** softkey again and rotate the **VARIABLE** knob to select to select the last step for entire program. The step two is selected as the last step here. (f). Press **F3** softkey again to complete the settings. A **▶E** “the end” marker will be displayed on the place of step two.

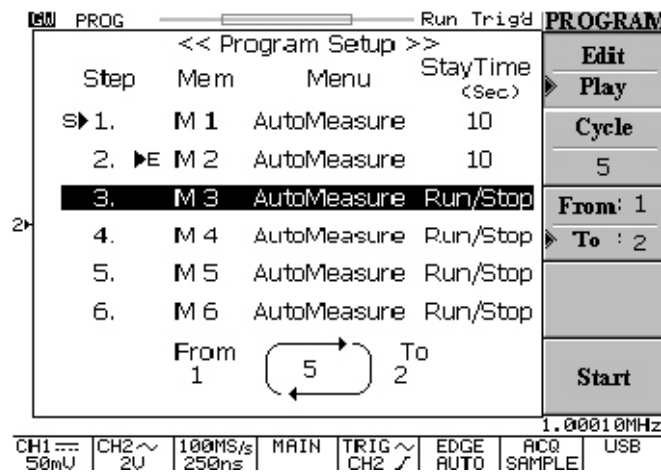

Figure 5-34: Editing the playing time condition

9. Now, we can press **F5** softkey to start the program.

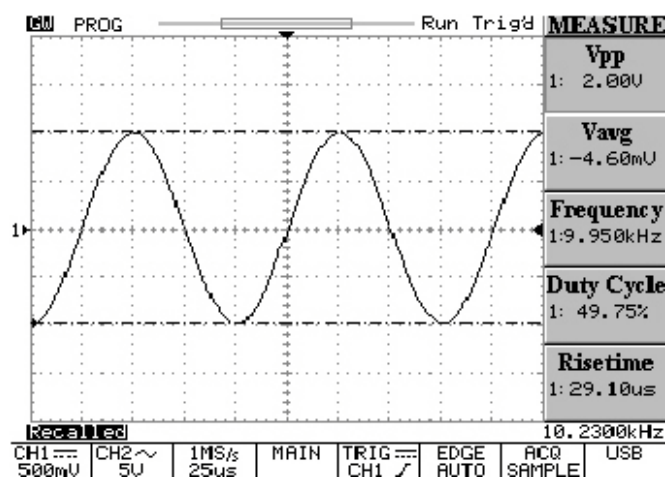

Figure 5-35: step one is continual running for 10 seconds on program mode

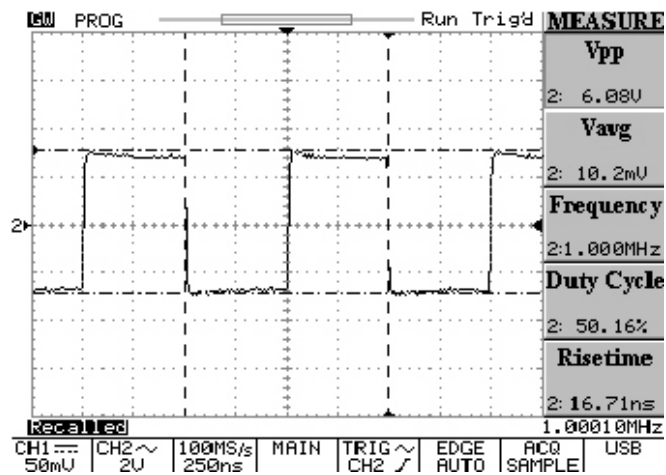

Figure 5-36: step two is continual running for 10 seconds on program mod

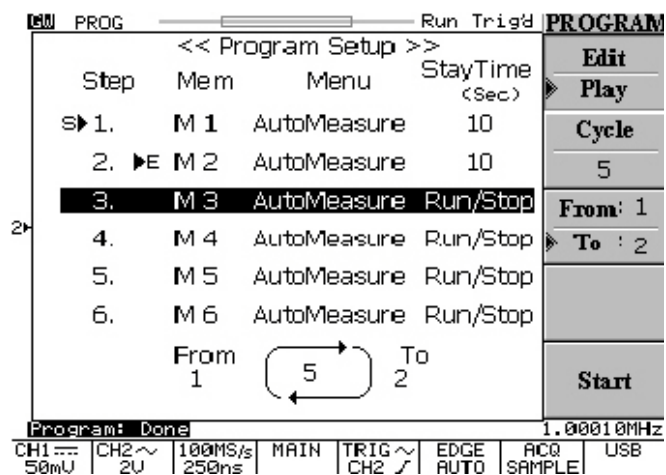

Figure 5-37: the Entire program running is finished

10.If want to quit during program running, just press **AUTO TEST/STOP** button in order to quit the program mode.

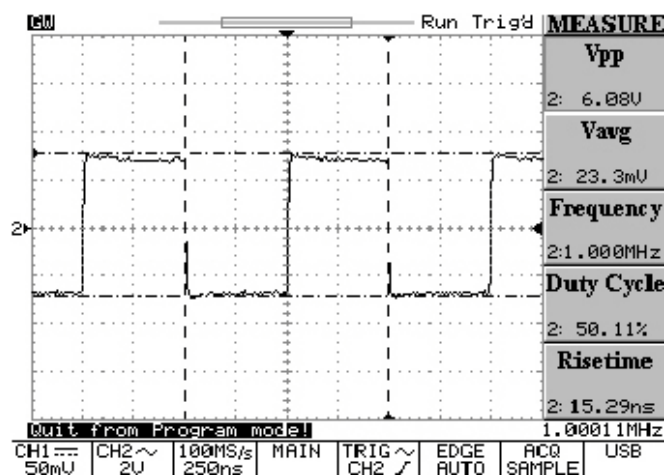

Figure 5-38: Quit the program mode by pressing **AUTO TEST/STOP** button

CURSOR: Select the different cursor measurement. Vertical cursors measure time; horizontal cursors measure voltage. For both vertical and horizontal cursors, the cursor readout T1 and T2 (V1 and V2) show the selected cursor relative to the center horizontal (or vertical) LCD graticule; the readout Δ symbol indicates the distance (time or voltage) between of two cursors (see Figure 5-26).

- **Source 1/2:** Press **F1** softkey to select the waveform signal of channel 1 or channel 2 to be measured.
- **Horizontal | : / | / | / | : :**: Press the **F2** softkey to switch two cursor modes: independent and tracking. Adjust vertical cursors by rotating the **VARIABLE** knob. In tracking mode, both cursors move in tandem by using the **VARIABLE** knob. The two cursors remain a fixed distance for each other. The T1 cursor is a solid line; the T2 cursor is a dot line.

Horizontal | : : : Only T1 cursor is available for adjusting.

Horizontal : | : : Only T2 cursor is available for adjusting.

Horizontal | | : : Both T1 and T2 cursor in tracking mode.

Horizontal : : : : Disable both horizontal cursors.

The reference values are also shown on the LCD screen:

T1: first cursor time indication

T2: second cursor time indication

Δ : The difference of T1 and T2

f: The frequency variation between T1 and T2

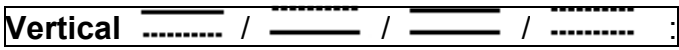
- **Vertical**  : Press **F3** softkey to switch two horizontal cursor modes: independent and tracking.

Vertical  : Only V1 cursor is available for adjusting.

Vertical  : Only V2 cursor is available for adjusting..

Vertical  : Both V1 and V2 cursor in tracking mode.

Vertical  : Disable both vertical cursors.

User can move only one cursor at a time using the **VARIABLE** knob in independent mode. The V1 cursor is a solid line; the V2 cursor is a dot line.

In tracking mode, both cursors move in tandem by using the **VARIABLE** knob. The two cursors remain a fixed distance for each other.

The reference values are also shown on the LCD screen:

V1: voltage indication of first cursor

V2: voltage indication of second cursor

△ : The difference of V1 and V2

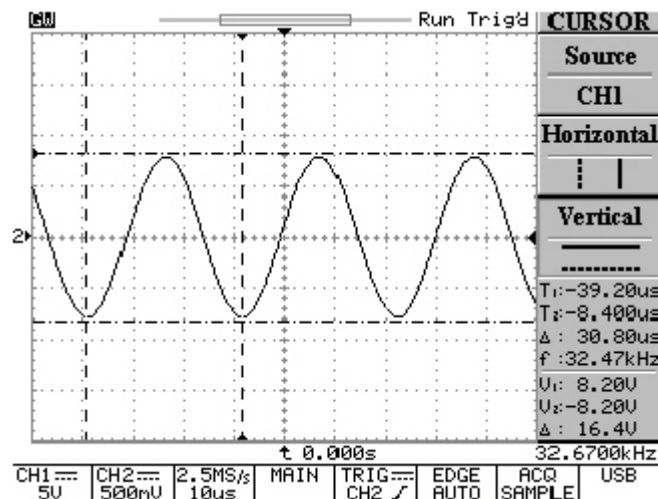

Figure 5-39: Vertical and horizontal cursors measurements

MEASURE: This oscilloscope provides various automatic measurements. Automatic measurements are taken over the entire waveform record, or the area specified by cursors.

Select the different measurement by pressing **F1** to **F5** softkey. Maximum 10 measurements can be displayed simultaneously (if both Channel 1 and Channel 2 are connected with signal). There are fifteen measurements can be selected by each softkey individually. And each softkey menu can display the same measurement for both channels.

- **Vpp:** Vmax-Vmin (over the entire waveform).
- **Vamp:** Vhi-Vlo (over the entire waveform).
- **Vavg:** Average voltage of the first cycle of the signal.
- **Vrms:** The true Root Mean Square voltage over the entire waveform or specified area.
- **Vhi:** Voltage of the global high value.
- **Vlo:** Voltage of the global low value.
- **Vmax:** Voltage of the maximum amplitude. The positive peak voltage measured over the entire waveform.
- **Vmin:** Voltage of the minimum amplitude. The negative peak voltage measured over the entire waveform.
- **Freq:** Frequency measurement for the first cycle in the waveform or specified area. The frequency is reciprocal of the period and measured in Hertz (Hz).
- **Period:** Timing measurement takes for the first complete signal cycle to happen in the waveform or specified area. The period is reciprocal of the frequency and measured in seconds.

- **Risetime**: Timing measurement taken for leading edge of the first pulse in the waveform.
- **Falltime**: Timing measurement taken for falling edge of the first pulse in the waveform.
- **+Width**: Measurement of the first positive pulse in the waveform or specified area. The time is between the 50% amplitude points.
- **-Width**: Measurement of the first negative pulse in the waveform or specified area. The time is between the 50% amplitude points.
- **Duty Cycle**: Timing measurement for the first cycle in the waveform or specified area. The ratio of pulse width of the signal period expressed as a percentage.

$$\text{DutyCycle} = (\text{Width} / \text{Period}) \times 100\%$$

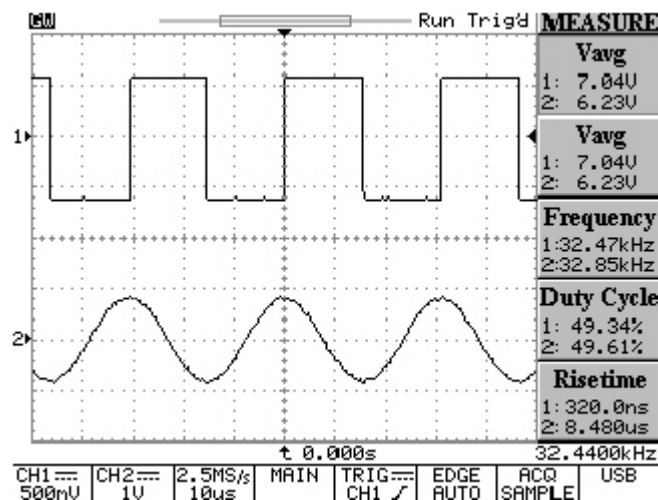

Figure 5-40: 10 measurements are displayed in the same time

SAVE/RECALL: User can save any waveform in one of two internal memories of the oscilloscope. These waveforms will be kept even the instrument turned off. The two saved waveforms also can be applied as the judgment pattern for “Go-No Go” function. The complete oscilloscope panel setups can be saved in the internal memory too. There are fifteen saved setup data can be recalled at any time to perform measurements under the same conditions. The fifteen saved setup data also can be applied as the item memory for “Program mode”. Press **F1** softkey to select “setup” save/recall or “waveform” save/recall.

Setup: The oscilloscope can save its complete front panel setups in the nonvolatile memory (15 set totally).

- **Default Setup:** .Recalls the factory default setup.
- **M01~M15:** Selects a destination setup memory location to save current setup by pressing **F3** softkey. Press **F3** softkey again in order to change the different memory location.
- **Save:** Save current setup into specific memory location.
- **Recall:** After specific memory location selected (M01~M15), press the **F5** softkey to recall the saved setup.

Waveform: Maximum two sets of waveform can be saved. Use the **VARIABLE** knob to adjust the vertical position of saved waveform.

- **Source CH1/CH2/MATH:** Press the **F2** softkey to select the waveform signal of channel 1, channel 2 or mathematical waveform to be saved.
- **Trace RefA/RefB:** Selects the memory 1 or memory 2 to save the waveform as reference A or reference B.

- **Save**: After **Trace RefA/RefB** selected, press **F4** softkey to save the waveform at present. Waveform position and scale factors are saved with each waveform.
- **Trace On/Off**: Disable the LCD display of reference 1 or reference 2 saved waveform.

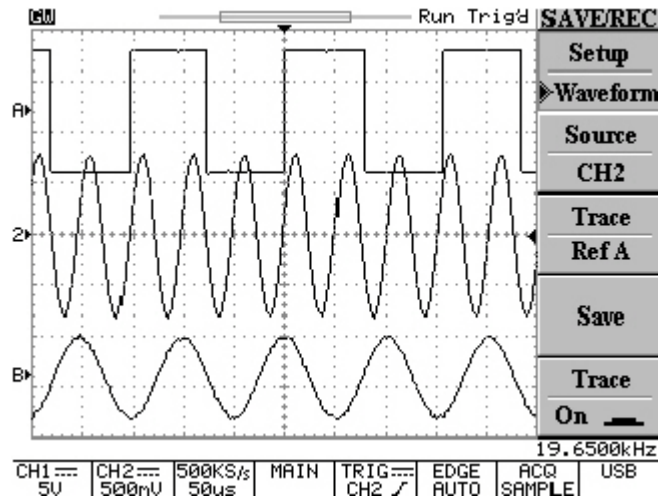

Figure 5-41: Both reference A and reference B are displayed on the waveform area

AUTO TEST/STOP: Quit the replaying of Program Mode.

HAEDCOPY: Print a hardcopy of the display if a printer is connected and properly configured.

HELP: Display on-line help document on the waveform display area. Press **HELP** pushbutton to enter the help function. The help function covers all the features of the oscilloscope. User can press any key to display the related help text on the screen and then rotate the **VARIABLE** knob to scroll all the contents. Press **HELP** pushbutton again to remove the help text from the screen and return to display waveforms. There are 11 different languages for the help manual at present time.

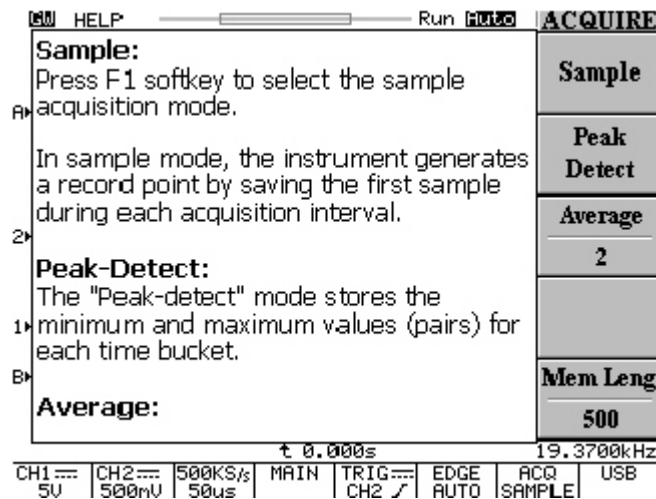

Figure 5-42: The help menu

AUTOSET: Press the pushbutton to analyze the unknown signal quickly. Then, the instrument sets up the vertical, horizontal, and trigger to best display that signal. For the detail, please refer to page 11. The “Autoset” function can not process a signal which under either frequency of 30Hz or 30mV.

- **Undo Autoset:** User may find situations where user has pressed the **AUTOSET** pushbutton unintentionally. When this happens, user can press **F5** softkey to return the instrument to the settings prior to pressing the **AUTOSET** pushbutton.

RUN/STOP: Press the pushbutton to start or stop acquiring data. The status area of the screen shows the message “RUN” or “STOP”. If the oscilloscope is stopped, it starts acquiring data on the next trigger event.

ERASE: Press the pushbutton to erase all waveform data from the graticule area, clears waveform of roll mode and accumulate mode. If the oscilloscope is stopped, the display remains empty of waveform data until the trigger circuit is rearmed and oscilloscope is triggered. Then, the new data is displayed and measurements are recalculated.

MENU ON/OFF: Select traditional ten division waveform display area with side menu or a large twelve division waveform display without side menu.

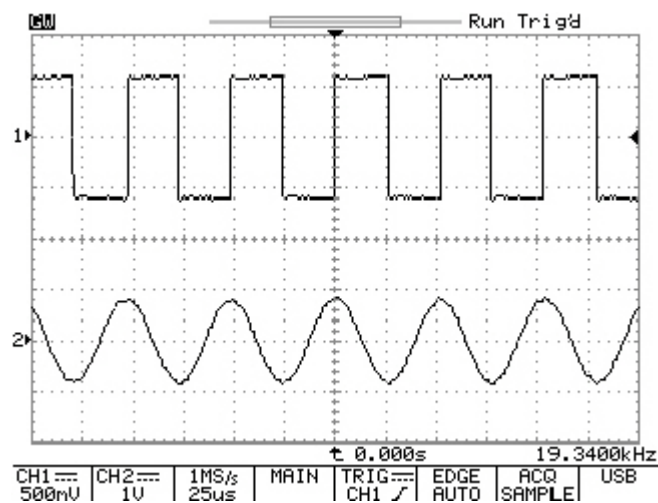
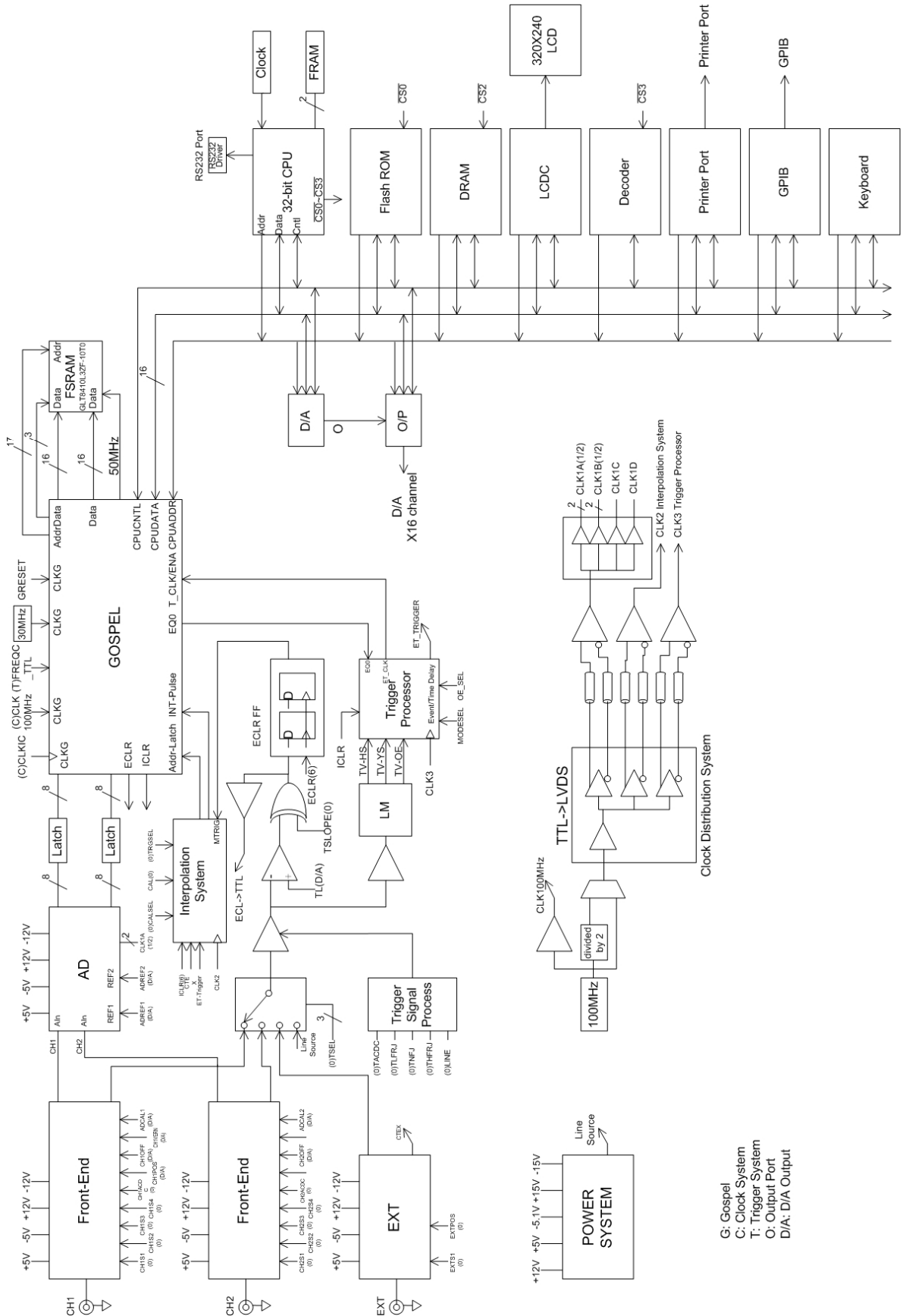

Figure 5-43: A large twelve division waveform display without side menu.

6. Block Diagram



7. RS-232 Configuration

This oscilloscope contains a DB 9-pin, male RS-232 connector for serial communication with a computer or terminal. The RS-232 interface of this oscilloscope is configured as an RS-232 “**Data Terminal Equipment**”, so that data is sent from pin 3 and received on pin 2. For remote controls, the RS-232 interface has to be connected with a computer or terminal.

Pin Assignments

The pin assignments for RS-232 interface of GDS-800 series are listed below.

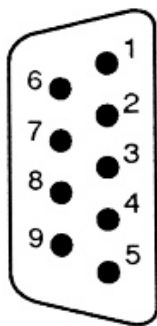

1. No connection
2. Receive Data(RxD) (input)
3. Transmit Data(TxD) (output)
4. No connection
5. Signal Ground (GND)
6. No connection
7. No connection
8. No connection
9. No connection

Figure 7-1: Pin assignments for the GDS-820's RS232 connector

DB9 to DB9 Wiring

The wiring configuration is used for computer with DB9 connectors that configured as Data Terminal Equipment.

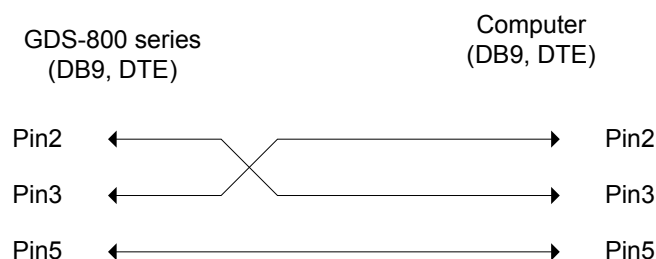

Figure 7-2: DB9 to DB9 wiring

When the oscilloscope is set up with a RS232 interface, please check the following points:

- ***Do not connect the output line of one DTE device to the output line of the other.***
- ***Many devices require a constant high signal on one or more input pins.***
- ***Ensure that the signal ground of the equipment is connected to the signal ground of the external device.***
- ***Ensure that the chassis ground of the equipment is connected to the chassis ground of the external device.***
- ***Do not use more than 15m of cable to connect devices to a PC.***
- ***Ensure the same configurations are used on the device as the one used on PC terminal.***
- ***Ensure the connector for the both side of cable and the internal connected line are met the demand of the instrument.***

Computer's Connection

A personal computer with a COM port is the essential facilities in order to operate the digitizing oscilloscope via RS232 interface.

The connections between oscilloscope and computer are as follows:

- I. Connect one end of a RS232 cable to the computer.
- II. Connect the other end of the cable to the RS232 port on the oscilloscope.
- III. Turn on the oscilloscope.
- IV. Turn on the computer.

The RS232 connection testing

If you want to test whether the RS232 connection is working or not, you can send a command from computer. For instance, using a terminal program send the query command

*idn?

should return the Manufacturer, model number, serial number and firmware version in the following format:

GW,GDS-820S,D130309,V.2.03

If you do not receive a proper response from the oscilloscope, please check if the power is on, the RS232 configurations are the same on both sides, and all cable connections are active.

8. Specifications

Performance Condition: The electrical specifications found in these tables of warranted specifications apply when the oscilloscope has been adjusted at an ambient temperature between +20°C and +30°C, a warm-up period at least 30 minutes are necessary. This oscilloscope is operating at an ambient temperature between 0°C and +50°C only.

Vertical system :

Channel 1(CH1) and Channel 2(CH2)	2mV/div to 5V/div
Accuracy	$\pm(3\% \times \text{Readout} + 0.05 \text{ div} \times \text{Volts/div} + 0.8\text{mV})$
Bandwidth	DC ~ 60MHz (-3dB) for GDS-806 series DC ~ 100MHz (-3dB) for GDS-810 series DC ~ 150MHz (-3dB) for GDS-820 series DC~250MHz (-3dB) for GDS-840 series AC couple, 10Hz~60MHz (-3dB) for GDS-806 series; 10Hz~100MHz (-3dB) for GDS-810 series; 10Hz~150MHz (-3dB) for GDS-820 series; 10Hz~250MHz (-3dB) for GDS-840 series
Rise time	< 5.8ns for GDS-806S/C; < 3.5ns for GDS-810S/C; < 2.3ns for GDS-820S/C; < 1.4ns for GDS-840S/C
Input Coupling	AC, DC & Ground
Input Impedance	1MΩ ±2% , ~ 18pF for GDS-806S/C, GDS-810S/C, and GDS-840S/C; 1MΩ ±2% ~22pF for GDS-820S/C

Polarity	Normal & Invert
Maximum Voltage Between Signal and Common at input BNC	300V (DC + AC peak), Installation Category II
Waveform Signal Process	CH1 – CH2 、 CH1 + CH2 、 FFT
Offset Range:	
2mV/div ~ 50mV/div	±0.5V
100mV/div ~ 500mV/div	±5V
1V/div ~ 5V/div	±50V
Bandwidth Limit	20MHz (– 3dB)
Trigger :	
Sources	CH1 、 CH2 、 LINE 、 EXT.
Modes	Auto-Level 、 AUTO 、 NORMAL 、 SINGLE 、 TV 、 Time-delay 、 Event- delay 、 Edge 、 Pulse Width
Time Delay Range	100ns to 1.3ms
Events Delay Range	2 to 65000
Start Trigger Level (For USER Mode)	±12V adjustable
Coupling	AC 、 DC 、 LFrej 、 HFrej 、 Noise rej

Sensitivity

DC ~ 25MHz	Approx. 0.5div or 5mV
25MHz ~ 60MHz	Approx. 1.5div or 15mV for GDS-806S/C
25MHz ~ 100MHz	Approx. 1.5div or 15mV for GDS-810S/C
25MHz ~ 150MHz	Approx. 1.5div or 15mV for GDS-820S/C and GDS-840S/C
150MHz ~ 250MHz	Approx. 2div or 20mV for GDS-840S/C

TV

TV trigger sensitivity: 0.5 division of synch signal

External Trigger :

Range

DC : $\pm 15V$, AC : $\pm 2V$

Sensitivity

DC ~ 25MHz	~ 50mV for GDS-806S/C and GDS-810S/C
DC ~ 30MHz	~ 50mV for GDS-820S/C and GDS-840S/C
25MHz~60MHz	~100mV for GDS-806S/C
25MHz~100MHz	~100mV for GDS-810S/C
30MHz ~ 150MHz	~ 100mV for GDS-820S/C and GDS-840S/C
150MHz ~ 250MHz	~ 150mV for GDS-840S/C

Input Impedance

$1M\Omega \pm 2\%$, ~ 18pF for GDS-806S/C, GDS-810S/C, and GDS-840S/C;
 $1M\Omega \pm 2\%$ ~22pF for GDS-820S/C

Maximum Input

300V (DC + AC peak), CATII

Horizontal :

Range	1ns/div ~ 10s/div (1-2-5 increments)
Modes	Main, Window, Window Zoom, Roll, X-Y
Accuracy	0.01%
Delay Range	
Pre-trigger	20 div maximum
Post-trigger	1000 div

X-Y mode :

X-Axis Input	Channel 1 (CH1)
Y-Axis Input	Channel 2 (CH2)
Phase shift	$\pm 3^\circ$ at 100kHz

Signal Acquisition System :

Real-time Sample Rate	100MSa/s maximum on each channel
Equivalent Sample Rate	25GSa/s E.T. maximum on each channel
Vertical Resolution	8 Bits
Record Length / Channel	125k Points
Single Shot Record Length	125k Points
Single Shot Bandwidth	10MHz
Acquisition Mode	Sample, Peak Detect, Average
Peak Detection	10ns (500ns/div ~ 10s/div)
Average	2 、 4 、 8 、 16 、 32 、 64 、 128 、 256

Cursors and Measurement :

Automated Voltage Measurement	V_{pp} , V_{amp} , V_{avg} , V_{rms} , V_{hi} , V_{lo} , V_{max} , V_{min}
Automated Time Measurement	Freq, Period, Rise Time, Fall Time, Positive Width, Negative Width, Duty Cycle
Cursors Measurement	Voltage difference between cursors (ΔV) Time difference between cursors (ΔT) Reciprocal of ΔT in Hertz ($1/\Delta T$)

Trigger Frequency Counter

Readout Resolution	6 digits
Frequency Range	20Hz minimum to rated bandwidth
Accuracy	±2%
Signal Source	All available trigger source except the Video trigger mode

Control Panel Functions :

Autoset	“Autoset” adjust Vertical VOLT/DIV, Horizontal SEC/DIV, and Trigger level automatically.
Save/Recall	Up to 15 sets of measurement conditions can be saved and recalled
Waveform Trace Save/Recall	2 sets of waveform can be saved and recalled
Template Waveform Save/Recall	100 sets of waveform can be saved and recalled

Display System :

LCD Type	5.7 inch Mono LCD (320*240) for GDS-806S, GDS-810S, GDS-820S, GDS-840S 5.7 inch Color LCD (320*240) for GDS-806C, GDS-810C, GDS-820C, GDS-840C
Waveform Display Graticule	8 × 10 divisions 8 × 12 divisions (menu off)
Display Contrast	Adjustable

Power Source :

Line Voltage Range	100V ~ 240V AC, auto selection
Line Frequency	47Hz ~ 63Hz
Power Consumption	45 Watts, 65VA maximum, with Fan
Fuse Rating	2 Ampere Slow, 250V,

Interface :

Centronics port	A 25-pin IBM PC type, parallel printer interface
<u>Not available for GDS-806S/C and GDS-810S/C without interface option</u>	
Printer Compatibility	
HP LaserJet with HP PCL5	Black & white @150×150dpi
HP DeskJet	Black & white @150×150dpi
USB Interface	USB 1.1 & USB 2.0 Full speed compatible.
<u>Not available for GDS-806S/C and GDS-810S/C without interface option</u>	<u>Device only, not support USB printers</u>
RS-232 Interface	A DB 9-pin male DTE RS-232 interface
<u>Standard for all GDS-800 series</u>	
GPIB Interface	Fully programmable with IEEE488.2 compliance
<u>Option for all GDS-800 series</u>	

Adjustable Probe Compensation Signal

Only available for GDS-806S/C and GDS-810S/C

Frequency Range	1kHz ~ 100kHz adjustable; 1kHz step
Duty Cycle	5% ~ 95% adjustable; 5% step

Miscellaneous :

Probe Compensation Output	$2V_{pp} \pm 3\%$
Probe	2 sets
Overall Dimensions	310(W) × 142(H) × 254(D) mm
Weight	~3.8 kg for GDS-806S/C and GDS-810S/C ~ 4.1 kg for GDS-820S/C and GDS-840S/C

Atmospherics :

Ambient Temperature	
Operating	0°C ~ 50°C
Storage	–20°C ~ 70°C
Relative Humidity	
Operating	80% R.H @ 35°C
Storage	80% R.H. @ 70°C

GTP-060A-2, GTP-100A-2, 150A-2 & GTP-250A-2 Probe :

Position ×10

Attenuation Ratio	10:1
Bandwidth	DC to 60MHz for GDS-806S/C DC to 100MHz for GDS-810S/C DC to 150MHz for GDS-820S/C DC to 250MHz for GDS-840S/C
Rise Time	5.8ns for GDS-806S/C; 3.5ns for GDS-810S/C; 2.3ns for GDS-820S/C 1.4ns for GDS-840S/C
Input Resistance	10M Ω when used with oscilloscope which have 1M Ω input
Input Capacitance	Approx. 17pF
Compensation Range	10 to 35pF
Maximum Input Voltage	500V CAT I, 300V CAT II (DC + peak AC) Derating with frequency.

Position ×1

Attenuation Ratio	1:1
Bandwidth	DC to 6MHz
Rise Time	58ns
Input Resistance	1M Ω (oscilloscope input resistance)
Input Capacitance	47pF plus oscilloscope capacitance
Compensation Range	10 to 35pF
Maximum Input Voltage	300V CAT I, 150V CAT II (DC + peak AC) Derating with frequency.
Operating Temperature	– 10°C ~ 55°C
Humidity	85% R.H or less @ 35°C
Safety	Meets EN 61010-031 CAT II

Declaration of Conformity

We
GOOD WILL INSTRUMENT CO., LTD.
 No. 7-1, Jhongsing Rd., Tucheng City, Taipei County 236, Taiwan
GOOD WILL INSTRUMENT (SUZHOU) CO., LTD.
 No.69 Lushan Road, Suzhou New District Jiangsu, China.

declares that the below mentioned product
GDS-820S,GDS-820C,GDS-840S,GDS-840C

are herewith confirmed to comply with the requirements set out in the Council Directive on the Approximation of the Law of Member States relating to Electromagnetic Compatibility (89/336/EEC, 92/31/EEC, 93/68/EEC) and Low Voltage Equipment Directive (73/23/EEC, 93/68/EEC).

For the evaluation regarding the Electromagnetic Compatibility and Low Voltage Equipment Directive, the following standards were applied:

© **EMC**

EN 61326-1: Electrical equipment for measurement, control and laboratory use — EMC requirements (1997+A1: 1998+A2: 2001)	
Conducted and Radiated Emission EN 55011: 1998 class A	Electrostatic Discharge EN 61000-4-2: 1995+A1: 1998
Current Harmonic EN 61000-3-2: 2000	Radiated Immunity EN 61000-4-3: 1996+A1: 1998
Voltage Fluctuation EN 61000-3-3: 1995	Electrical Fast Transients EN 61000-4-4: 1995
-----	Surge Immunity EN 61000-4-5: 1995
-----	Conducted Susceptibility EN 61000-4-6: 1996
-----	Voltage Dips/ Interrupts EN 61000-4-11: 1994

© **Safety**

Low Voltage Equipment Directive 73/23/EEC & amended by 93/68/EEC
IEC/EN 61010-1: 2001

Declaration of Conformity

We
GOOD WILL INSTRUMENT CO., LTD.
 No. 7-1, Jhongsing Rd., Tucheng City, Taipei County 236, Taiwan
GOOD WILL INSTRUMENT (SUZHOU) CO., LTD.
 No.69 Lushan Road, Suzhou New District Jiangsu, China.

declares that the below mentioned product
GDS-806S/C,GDS-810S/C

are herewith confirmed to comply with the requirements set out in the Council Directive on the Approximation of the Law of Member States relating to Electromagnetic Compatibility (89/336/EEC, 92/31/EEC, 93/68/EEC) and Low Voltage Equipment Directive (73/23/EEC, 93/68/EEC).

For the evaluation regarding the Electromagnetic Compatibility and Low Voltage Equipment Directive, the following standards were applied:

◎ **EMC**

EN 61326-1: Electrical equipment for measurement, control and laboratory use — EMC requirements (1997+A1:1998+A2:2001+A3:2003)	
Conducted and Radiated Emission EN 55011:1998+A1:1999+A2:2002 class A	Electrostatic Discharge EN 61000-4-2:1995+A1:1998+A2:2001
Current Harmonic EN 61000-3-2:2000	Radiated Immunity EN 61000-4-3:2002+A1:2002
Voltage Fluctuation EN 61000-3-3:1995+A1:2001	Electrical Fast Transients EN 61000-4-4:1995+A1:2001+A2 :2001
-----	Surge Immunity EN 61000-4-5:1995+A1:2001
-----	Conducted Susceptibility EN 61000-4-6:1996+A1:2001
-----	Power Frequency Magnetic Field EN61000-4-8:1993+A1:2001
-----	Voltage Dips/ Interrupts EN 61000-4-11:1994+A1:2001

◎ **Safety**

Low Voltage Equipment Directive 73/23/EEC & amended by 93/68/EEC
IEC/EN 61010-1:2001