

User's Guide

Thermoelectric Temperature Controller LDT-5910B



 **ILX Lightwave**
Photonic Test & Measurement Instrumentation

SAFETY AND WARRANTY INFORMATION



The Safety and Warranty Information section provides details about cautionary symbols used in the manual, safety markings used on the instrument, and information about the Warranty including Customer Service contact information.

Safety Information and the Manual

Throughout this manual, you will see the words *Caution* and *Warning* indicating potentially dangerous or hazardous situations which, if not avoided, could result in death, serious or minor injury, or damage to the product. Specifically:

CAUTION

Caution indicates a potentially hazardous situation which can result in minor or moderate injury or damage to the product or equipment.

WARNING

Warning indicates a potentially dangerous situation which can result in serious injury or death.

WARNING

Visible and/or invisible laser radiation. Avoid direct exposure to the beam.

General Safety Considerations

If any of the following conditions exist, or are even suspected, do not use the instrument until safe operation can be verified by trained service personnel:

- Visible damage
- Severe transport stress
- Prolonged storage under adverse conditions
- Failure to perform intended measurements or functions

If necessary, return the instrument to ILX Lightwave, or authorized local ILX Lightwave distributor, for service or repair to ensure that safety features are maintained.

All instruments returned to ILX Lightwave are required to have a Return Authorization Number assigned by an official representative of ILX Lightwave Corporation.

SAFETY SYMBOLS











This section describes the safety symbols and classifications.

Technical specifications including electrical ratings and weight are included within the manual. See the Table of Contents to locate the specifications and other product information. The following classifications are standard across all ILX Lightwave products:

- Indoor use only
- Ordinary Protection: This product is NOT protected against the harmful ingress of moisture.
- Class I Equipment (grounded type)
- Mains supply voltage fluctuations are not to exceed $\pm 10\%$ of the nominal supply voltage.
- Pollution Degree II
- Installation (overvoltage) Category II for transient overvoltages
- Maximum Relative Humidity: $< 80\%$ RH, non-condensing
- Operating temperature range of $0\text{ }^{\circ}\text{C}$ to $40\text{ }^{\circ}\text{C}$
- Storage and transportation temperature of $-40\text{ }^{\circ}\text{C}$ to $70\text{ }^{\circ}\text{C}$
- Maximum altitude: 3000 m (9843 ft)
- This equipment is suitable for continuous operation.

Safety Marking Symbols

This section provides a description of the safety marking symbols that appear on the instrument. These symbols provide information about potentially dangerous situations which can result in death, injury, or damage to the instrument and other components.

 Caution, refer to manual	 Earth ground Terminal	 Alternating current	 Visible and/or invisible laser radiation
 Caution, risk of electric shock	 Protective Conductor Terminal	 Caution, hot surface	 Frame or chassis Terminal
 On: In position of a bistable push control. The slash () only denotes that mains are on. or ()		 Off: Out position of a bistable push control. The circle (O) only denotes that mains are off. or (O)	

WARRANTY

ILX LIGHTWAVE CORPORATION warrants this instrument to be free from defects in material and workmanship for a period of one year from date of shipment. During the warranty period, ILX will repair or replace the unit, at our option, without charge.

Limitations

This warranty does not apply to fuses, lamps, defects caused by abuse, modifications, or to use of the product for which it was not intended.

This warranty is in lieu of all other warranties, expressed or implied, including any implied warranty of merchantability or fitness for any particular purpose. ILX Lightwave Corporation shall not be liable for any incidental, special, or consequential damages.

If a problem occurs, please contact ILX Lightwave Corporation with the instrument's serial number, and thoroughly describe the nature of the problem.

Returning an Instrument

If an instrument is to be shipped to ILX Lightwave for repair or service, be sure to:

- 1 Obtain a Return Authorization number (RA) from ILX Customer Service.
- 2 Attach a tag to the instrument identifying the owner and indicating the required service or repair. Include the instrument serial number from the rear panel of the instrument.
- 3 Attach the anti-static protective caps that were shipped with the instrument and place the instrument in a protective anti-static bag.
- 4 Place the instrument in the original packing container with at least 3 inches (7.5 cm) of compressible packaging material. **Shipping damage is not covered by this warranty.**
- 5 Secure the packing box with fiber reinforced strapping tape or metal bands.
- 6 Send the instrument, transportation pre-paid, to ILX Lightwave. Clearly write the return authorization number on the outside of the box and on the shipping paperwork. ILX Lightwave recommends you insure the shipment.

If the original shipping container is not available, place your instrument in a container with at least 3 inches (7.5 cm) of compressible packaging material on all sides.

Repairs are made and the instrument returned transportation pre-paid. Repairs are warranted for the remainder of the original warranty or for 90 days, whichever is greater.

Claims for Shipping Damage

When you receive the instrument, inspect it immediately for any damage or shortages on the packing list. If the instrument is damaged, file a claim with the carrier. The factory will supply you with a quotation for estimated costs of repair. You must negotiate and settle with the carrier for the amount of damage.

Comments, Suggestions, and Problems

To ensure that you get the most out of your ILX Lightwave product, we ask that you direct any product operation or service related questions or comments to ILX Lightwave Customer Support. You may contact us in whatever way is most convenient:

Phone (800) 459-9459 or (406) 586-1244

Fax (406) 586-9405

Email.....support@ilxlightwave.com

Or mail to:

ILX Lightwave Corporation
P. O. Box 6310
Bozeman, Montana, U.S.A 59771
www.ilxlightwave.com

When you contact us, please have the following information:

Model Number: _____

Serial Number: _____

End-user Name: _____

Company: _____

Phone: _____

Fax: _____

Description or sketch of what
is connected to the ILX
Lightwave instrument:

Description of the problem:

If ILX Lightwave determines that a return to the factory is necessary, you are issued a Return Authorization (RA) number. Please mark this number on the outside of the shipping box.

You or your shipping service are responsible for any shipping damage when returning the instrument to ILX Lightwave; ILX recommends you insure the shipment. If the original shipping container is not available, place your instrument in a container with at least 3 inches (7.5cm) of compressible packaging material on all sides.

We look forward to serving you even better in the future!

Table of Contents

CHAPTER 1 - GENERAL INFORMATION	1-1
1.1 Introduction	1-1
1.2 Product Overview	1-1
1.3 Specifications	1-2
1.4 Available Options and Accessories	1-4
1.5 Your Comments	1-4
CHAPTER 2 - OPERATION	2-1
2.1 Introduction	2-1
2.2 Installation	2-1
2.2.1 AC Power Considerations	2-1
2.2.2 Tilt-Foot Adjustment	2-1
2.2.3 Rack Mounting	2-1
2.3 Power-Up Sequence	2-2
2.4 LDT-5910B Front Panel Controls	2-3
2.4.1 Front Panel Familiarization	2-4
2.4.2 Main Control Knob	2-5
2.4.3 ACTUAL TEMP	2-5
2.4.4 SET TEMP	2-5
2.4.5 AUTO	2-5
2.4.6 LOCK	2-5
2.4.7 OUTPUT ON	2-6
2.4.8 GPIB REMOTE LOCAL/ ADR	2-6
2.5 PARAMETER SETUP	2-7
2.5.1 SELECT	2-7
2.5.2 SET	2-8
2.5.3 LIM I	2-8
2.5.4 LIM T _{HI}	2-8
2.5.5 LIM T _{LO}	2-9
2.5.6 RECALL	2-9
2.5.7 SAVE	2-9
2.5.8 GAIN	2-10
2.5.9 Calibration Constants - C1, C2 and C3	2-10
2.6 Error Reporting	2-11
2.7 Back Panel	2-12
2.7.1 Back Panel Connections	2-13
2.7.2 Grounding Considerations	2-13
2.7.3 SENSOR SELECT Switch	2-13
2.8 Operating Instructions	2-14
2.8.1 Warm Up and Environmental Considerations	2-14
2.8.2 General Operating Procedure	2-14

CHAPTER 3 - COMMAND REFERENCE.....	3-1
3.1 Introduction	3-1
3.2 Overview of the 5910B Command Set.....	3-1
3.2.1 Some 5910B Features Found Only in Remote Mode.....	3-1
3.2.2 Commands and Queries	3-2
3.2.3 Substitute Parameter Names.....	3-2
3.2.4 Compound Command Structure	3-3
3.3 Common Commands	3-6
3.4 5910B Device-Dependent Commands	3-7
3.4.1 Command Paths.....	3-8
3.4.2 5910B Device-Dependent Commands	3-9
3.5 Error Messages.....	3-83
3.6 5910B Programming Examples.....	3-83
 CHAPTER 4 - GPIB/IEEE-488.2 REMOTE OPERATION	 4-1
4.1 Introduction	4-1
4.1.1 Preparation for Bus Control.....	4-2
4.2 Getting Started with GPIB	4-2
4.2.1 Overview of the 5910B Syntax.....	4-2
4.2.2 Using Commands with Parameters.....	4-3
4.2.3 A 5910B Remote Command Sample.....	4-4
4.2.4 Old 5910 Compatibility.....	4-4
4.3 Common Commands and Queries.....	4-5
4.3.1 *CAL?.....	4-5
4.3.2 *CLS.....	4-5
4.3.3 *ESE.....	4-6
4.3.4 *ESE?	4-7
4.3.5 *ESR?.....	4-7
4.3.6 *IDN?	4-7
4.3.7 *IST?	4-8
4.3.8 *OPC.....	4-8
4.3.9 *OPC?.....	4-8
4.3.10 *PRE	4-9
4.3.11 *PRE?	4-10
4.3.12 *PSC.....	4-10
4.3.13 *PSC?.....	4-11
4.3.14 *PUD	4-11
4.3.15 *PUD?	4-11
4.3.16 *RCL.....	4-12
4.3.17 *RST.....	4-12
4.3.18 *SAV	4-13
4.3.19 *SRE.....	4-13
4.3.20 *SRE?.....	4-14
4.3.21 *STB?	4-15
4.3.22 *TST?	4-15
4.3.23 *WAI.....	4-15

4.4	Advanced Programming.....	4-16
4.4.1	Path Specification	4-16
4.4.2	Timing Consideration.....	4-17
4.5	Error Messages.....	4-18
4.6	ANSI/IEEE-488.2 Definitions	4-18
4.6.1	Syntax Diagrams	4-19
4.6.2	White Space	4-19
4.6.3	Power-On Conditions.....	4-20
4.6.4	<nrf value>.....	4-20
4.6.5	<PROGRAM MESSAGE TERMINATOR>	4-20
4.6.6	<PROGRAM MESSAGE UNIT SEPARATOR	4-21
4.6.7	<PROGRAM HEADER SEPARATOR	4-21
4.6.8	<compound command program header>.....	4-22
4.6.9	<PROGRAM DATA> (Parameters).....	4-23
4.6.10	<ARBITRARY BLOCK PROGRAM DATA>.....	4-23
4.6.11	<PROGRAM DATA SEPARATORS>	4-24
4.6.12	Default Parameters	4-24
4.7	Status Reporting.....	4-25
4.7.1	Event and Condition Registers	4-27
4.7.2	Operation Complete Definition.....	4-27
4.7.3	Command Timing and Completion.....	4-28
4.8	Output Off Registers.....	4-29
4.9	Input Buffer and Output Data	4-30
4.10	Remote Interface Messages.....	4-30
4.10.1	Interface Function Subsets.....	4-31
4.10.2	5910B Remote Messages	4-32
4.10.3	Non-Supported Remote Interface Messages	4-32

CHAPTER 5 - MAINTENANCE.....5-1

5.1	Introduction	5-1
5.2	Calibration Overview.....	5-1
5.2.1	Recommended Equipment.....	5-1
5.2.2	Environmental Conditions.....	5-2
5.2.3	Warm-Up.....	5-2
5.3	TEC Controller Calibration Adjustments.....	5-2
5.3.1	Local Operation Thermistor Calibration.....	5-3
5.3.2	Remote Operation Thermistor Calibration	5-3
5.3.3	Local Operation AD590 Sensor Calibration	5-4
5.3.4	Remote Operation AD590 Sensor Calibration.....	5-5
5.3.5	Local Operation LM335 Sensor Calibration	5-6
5.3.6	Remote Operation LM335 Sensor Calibration.....	5-6
5.3.7	Local Operation ITE Current Calibration	5-7
5.3.8	Remote Operation ITE Current Calibration.....	5-8
5.4	Fuse Replacement.....	5-9
5.5	Line Voltage Selection.....	5-10
5.6	Disassembly.....	5-10

Appendix A - The Steinhart-Hart Equation.....	A-1
Appendix B - Sensing Current and Thermistor Selection.....	B-1
Appendix C - AD590 and LM335 Sensor Calibration.....	C-1
Appendix D - LDT-5910B Error Messages	D-1
Index	vii

Chapter 1

GENERAL INFORMATION

1.1 Introduction

This manual explains how to operate and maintain the LDT-5910B Thermoelectric Temperature Controller and optional model 1233 GPIB/IEEE-488.2 Interface. This section gives a detailed overview of the LDT-5910B. If you want to get started using the LDT-5910B right away, go directly to Chapter 2 (Operation). Section 2.4.1 provides a quick familiarization of the 5910B front panel. Section 2.7.1 covers general operating procedure.

1.2 Product Overview

The LDT-5910B is a microprocessor-based, precision thermoelectric temperature controller designed for temperature control of laser diodes, detectors and other temperature sensitive devices. The LDT-5910B can be used for laser diode testing, laser diode frequency stabilization, IR detector cooling, and to determine the characteristics of electronic devices. The LDT-5910B combines high analog stability with the versatility of a microprocessor-based instrument. The internal microprocessor controls the operation of the LDT-5910B and performs the non-linear conversion of thermistor resistance to temperature based on three user defined constants. You can configure the LDT-5910B to operate with a wide variety of thermistor temperature sensors and TE modules, as well as AD590 series and LM335 series temperature sensors. The model 1233 GPIB/IEEE-488 interface allows remote programming and completely automated control of the LDT-5910B.

Features of the LDT-5910B include:

- * Intuitive front panel layout
- * Large and easy-to-read green LED display
- * Display resolution of 0.1 degree Centigrade
- * Output current limit control to safely operate all TE coolers
- * Configurable for a variety of thermal sensors
- * Output will supply 4 amps, 16 Watts
- * Closed-case calibration
- * Save and Recall parameter configurations automatically
- * GPIB interface available, meets IEEE-488.2 standard
- * Booster modules can be added to extend the output power

1.3 Specifications

Output¹

Output Type:	Bipolar constant current source
Compliance Voltage:	4 Volts at 4 Amps
Maximum Current Output:	4 Amps
Maximum Output Power ² :	4 Amps typical
Current Limit Control Range:	0 to 10.0 A, ± 20 mA
Current Limit Accuracy:	± 50 mA
Ripple/Noise ³ :	< 500 uA

Temperature Control

Temperature Range ⁴ :	-99°C to +150°C -20°C to +50°C with typical 10 K thermistor.
----------------------------------	---

Resolution and Accuracy ⁵ :	<u>Temperature</u>	<u>Resolution</u>	<u>Accuracy</u>
	-20°C	$\pm 0.1^\circ\text{C}$	$\pm 0.2^\circ\text{C}$
	0°C	$\pm 0.1^\circ\text{C}$	$\pm 0.2^\circ\text{C}$
	20°C	$\pm 0.1^\circ\text{C}$	$\pm 0.2^\circ\text{C}$
	50°C	$\pm 0.2^\circ\text{C}$	$\pm 0.2^\circ\text{C}$

LM335 Setting Accuracy:	$\pm 0.2^\circ\text{C}$
AD590 Setting Accuracy:	$\pm 0.2^\circ\text{C}$
Short Term Stability ⁶ :	0.005°C or better
Long Term Stability:	0.01°C or better
Sensor Type:	2-wire thermistor, LM335 voltage type, or AD590 current type

¹ Output current and power are rated into a 1 ohm load.

² Higher output powers can be accommodated by using an external booster. Contact ILX Lightwave for further information.

³ Broadband noise (10 Hz to 10 MHz) is measured at 1 Amp output current.

⁴ Temperature control range depends primarily on the type of thermistor and TE module used. The range can be extended higher and lower by selecting appropriate components. See Appendix B for more details.

⁵ Accuracy figures quoted are typical for a 10 K ohm thermistor and 100 uA source current setting. Accuracy figures are relative to calibration standard. Both resolution and accuracy are dependent on the user defined configuration of the instrument.

⁶ Short term temperature stability is a strong function of the thermal environment of the thermistor and TE module. Room air currents in particular can easily cause fluctuations of 0.1°C in an exposed mounting configuration.

Usable Thermistor Range:	25 ohms to 450 Kohms, typical
LM335 Voltage:	$V_{(25^{\circ}\text{C})} = 2.98 \text{ V}$, $V_T = 10 \text{ mV/K}$ over rated sensor range
LM335 Bias:	1 mA
AD590 Current:	$I_{(25^{\circ}\text{C})} = 2982 \text{ uA}$, $I_T = 1 \text{ uA/K}$ over rated sensor range
AD590 Reverse Bias:	+8 VDC
Thermistor Sensing Current:	10 uA or 100 uA (user selectable)
Calibration Methods:	LM335 or AD590 calibrated with two-point method. Thermistors are calibrated by storing three constants of the Steinhart-Hart equation, listed below, in internal non-volatile memory.
Thermistor:	$1/T = (C1 * 10^{-3}) + (C2 * 10^{-4})(\ln R) + (C3 * 10^{-7})(\ln R)^3$.
LM335:	$T = C1 + C2 * (V / (10 \text{ mV/K}) - 273.15)$
AD590:	$T = C1 + C2 * (I / (1 \text{ uA/K}) - 273.15)$

Display

Display Type:	4-digit green LED display
Maximum Current Reading:	4.0 Amps, 10.0 Amps with a current booster
Maximum Temp. Reading:	200.0°C
Current Resolution:	1.0 mA
Temperature Resolution	
Set Point:	0.1°C
Measurement:	0.01°C

Optional GPIB

Meets ANSI/IEEE Std 488.1-1987
Meets ANSI/IEEE Std 488.2-1987

General

Power Requirements:	90-105, 105-125, or 210-250 VAC (jumper selectable), @ 50-60 Hz
Size:	88 mm x 212 mm x 269 mm (3.5" x 8.4" x 10.6")
Ambient Temperature Range:	Operating: 0 to 50°C Storage: -40 to 70°C
Warmup:	1 hour to rated accuracy

1.4 Available Options and Accessories

The following options and accessories are available for the LDT-5910B.

<u>DESCRIPTION</u>	<u>MODEL NUMBER</u>
GPIB/IEEE-488.2 interface	1233
Rack mount, 1/2 width filler panel kit	124
Dual rack mount kit (includes rack mount flanges and enclosure interlocking kit)	122
Laser Diode Mount	4412
Temperature Controller/Unterminated Interconnect Cable	501
Calibrated 10 Kohm Thermistor	510
Uncalibrated 10 Kohm Thermistor	520
Uncalibrated AD590LH IC Temperature Sensor	530
Uncalibrated LM335 IC Temperature Sensor	540

Other Laser Diode Mounts and Thermistors models are available. Please contact ILX Lightwave for information on additional options for your applications.

The 1233 interface permits GPIB bus control of the LDT-5910B for automated test and measurement applications. Chapter 4 describes this option in detail.

The LDT-5910B enclosure can be rack mounted by itself or interlocked with other ILX Lightwave, 3.5 inch, 1/2 width instruments. The accessories listed above are for rack mounting and interlocking these instruments.

1.5 Your Comments

ILX Lightwave Corporation is committed to making the best laser diode instrumentation available anywhere. To serve you best, we need your ideas and comments on ways we can improve our products. We invite you to contact us at any time with your suggestions.

Chapter 2

OPERATION

2.1 Introduction

This chapter describes how to install, program, and operate the LDT-5910B. It is divided into sections covering installation, power-up sequence, front panel controls, procedures for setting the parameters, the back panel connections, and normal operating procedures for the LDT-5910B.

Section 2.4.1 is intended as a guide for the first-time user for quickly becoming familiar with the 5910B front panel. After the user is comfortable with the front and back panel features, he or she may begin operating the 5910B. Section 2.7.1 covers general operating procedure.

2.2 Installation

The following sections deal with the installation and power requirements of the LDT-5910B.

2.2.1 AC Power Considerations

You can configure the LDT-5910B to operate at line voltages from 90 to 105 VAC, 105 to 125 VAC, or 210 to 250 VAC. Before using the LDT-5910B, check that the voltage printed on the rear panel matches the power-line voltage supplied in your area. If it is necessary to reconfigure the input voltage range, refer to Chapter 5 (Maintenance).

WARNING

To avoid electrical shock hazard, connect the instrument only to properly earth-grounded, 3-prong receptacles. Failure to observe this precaution can result in injury or loss of life.

2.2.2 Tilt-Foot Adjustment

The LDT-5910B has front legs that extend to make it easier to view the LED display. To use them, place the LDT-5910B on a stable base and rotate the legs downward until they lock into position.

2.2.3 Rack Mounting

The LDT-5910B may be rack mounted by installing a rack mount flange on one side of the enclosure and a 1/2 width filler panel on the other side (Model 124). Alternately, two 1/2 width enclosures will interlock side-by-side, with a Dual

rack mount kit (Model 122). All rack mount accessory kits contain detailed mounting instructions. Refer to Section 1.4 for applicable rack mount accessory model numbers.

2.3 Power-Up Sequence

With the LDT-5910B connected to an AC power source, pressing the Power off/on switch will supply power to the instrument and start the power-up sequence.

During the power-up sequence the following takes place. For about two seconds all the front panel LEDs will become lit. During this time, the OUTPUT ON LED will alternate between green and red. Then, for a period of about two seconds, all of the LEDs will be off (unlit). After this, the display will show the firmware version number for about two seconds. Then, the display will show the thermistor current/sensor type for about two seconds. The sensor type will be indicated by a number from 1 to 4 as shown below:

"-01"	Thermistor, 100 uA range
"-02"	Thermistor, 10 uA range
"-03"	LM335 type sensor
"-04"	AD590 type sensor

After this code is displayed, the 5910B will recall the instrument configuration, as stored at the last power-down. If it is desired to reset the 5910B, the user may perform a recall of "bin" 0 (see Section 2.5.6) after the power-up sequence is completed. The default configuration, as shown below, is always stored in "bin" 0.

5910B DEFAULT CONFIGURATION

GPIB in local via front panel; in remote via GPIB
Constant T mode selected
Display showing actual temperature
Temperature Set Point = 0°C
Resistance/Reference Set Point = 1 ohm or 1 mV or 1 uA
(depending on the setting of the SENSOR SELECT switch)
PARAMETERS not selected
LIM I set to 1.0 Amps
LIM T_{HI} set to 99.9°C
LIM T_{LO} set to -99.9°C
RECALL BIN number = 0
GAIN = 30
C1 = 1.125 (x 10⁻³)
C2 = 2.347 (x 10⁻⁴)
C3 = 0.855 (x 10⁻⁷)
AUTO mode off
LOCK mode off
STEP value = 1

Table 2.1 5910B Default Settings

2.4 Introduction to the LDT-5910B Front Panel

The following sections describe the front panel controls on the LDT-5910B. Generally these controls are simple to operate. Setting the parameters, however, is intentionally awkward so that their values are not inadvertently changed.

Note: Section 2.4.1 gives a quick introduction to the front panel functions by briefly describing the switches and indicators.

Section 2.5 describes the procedures for setting the parameters. Figure 2.1 shows the LDT-5910B front panel and its controls.



Figure 2.1 LDT-5910B Front Panel

2.4.1 Front Panel Familiarization

Notice in Figure 2.1 the locations of the front panel switches. This section gives a brief synopsis of the functions of the front panel switches and indicators so that the first-time user may get started quickly. The key words in this section are in bold type for quick identification.

The **POWER** off/on switch is used to power-up and power-down the 5910B.

The **LOCAL/ADR** switch is used when the optional remote GPIB operations are implemented. (For more information, see Section 2.4.8).

The **OUTPUT** off/on switch is used to turn the TEC (thermoelectric cooler) output current on/off. The **OUTPUT** is off whenever the 5910B is first powered up. It may also be shut off automatically during operation, if certain adverse conditions occur. (For more information, see Section 2.4.7).

The **Main Control Knob** is used whenever a temperature set point, parameter value, or GPIB address is entered via the front panel. (For more information, see Section 2.4.2).

The **Parameter Selection** switches (**SET** and **SELECT**) are used primarily to read and adjust the parameters which allow the 5910B to convert the temperature sensor measurements to temperature values, or limit the temperature range.

The **SELECT** switch may be pressed repeatedly to cycle through the parameters while their values are displayed. A selected parameter's value may be changed by holding in the **SET** switch and adjusting the **Main Control Knob**. (For more information, see Section 2.5).

The **Display Mode** switches are used to select between set point and measured values. The **AUTO** switch is used to enter a special display mode in which the display automatically returns to the measured (**ACTUAL TEMP**) value after the user checks the set point value. (For more information, see Section 2.4.5).

The **LOCK** switch is used to disable the **Main Control Knob** so that the temperature set point cannot be inadvertently changed. The **LOCK** indicator will become lit whenever the **SELECT** or **LOCAL/ADR** switch is pressed to remind the user that the set point is "locked in" while using those functions. (For more information, see Section 2.4.6).

The **SAVE** and **RECALL** parameter functions are used to quickly configure the 5910B parameters to user-determined preset values. (For more information, see Sections 2.5.6 and 2.5.7).

When the 5910B is powered-up, the parameters will automatically be restored to the same values that were present at the last power-down. Furthermore, all of the saved setups will be "remembered", and easily recalled.

2.4.2 Main Control Knob

The Main Control Knob is a digital potentiometer that adjusts user-entered values for the set point temperature, setup parameters, calibration constants, and the GPIB address. Turning this knob clockwise (CW) will increase the value on the display. However, some parameters (such as GAIN) have their values "wrapped" so that if the knob is turned clockwise (CW) past the maximum value, the display will show the minimum value. Turning the knob further in the clockwise (CW) direction would then increase the value on the display.

When the parameters are adjusted, if the SELECT switch is held in, the Main Control Knob may then be turned in either direction to cycle through the parameters. This may be done to quickly reach the desired parameter, and avoid having to repeatedly press the SELECT switch.

2.4.3 ACTUAL TEMP

When the ACTUAL TEMP switch is pressed, the LDT-5910B displays the actual temperature (as determined by the sensor/software), and the LED on the switch becomes lit, indicating that the actual temperature is being displayed.

2.4.4 SET TEMP

This switch, when pressed, displays the temperature set point, and the LED on the switch becomes lit to indicate that the set temperature is displayed. Turn the Main Control Knob to enter a new set point value. In temperature (T) mode, the set point is bounded by the LIM T_{HI} and LIM T_{LO} parameter values. The default (front panel) mode is temperature (T).

2.4.5 AUTO

When in AUTO mode, the display shows the actual thermistor temperature until you turn the Main Control Knob. The LDT-5910B senses that you have turned the knob and "knows" that you want to input a new set temperature. The instrument displays the new set point temperature for 3 seconds and then returns to displaying the actual temperature. The AUTO mode allows you to accurately change the set point temperature and quickly see how your device is responding.

The AUTO switch has a toggling action; press it once to enter AUTO mode, and press it again to exit AUTO mode.

2.4.6 LOCK

When you press the front panel LOCK switch, the Main Control Knob becomes disabled. This disabled condition is indicated by the LOCK indicator becoming lit. Normally, when the display is showing temperature (SET TEMP or ACTUAL TEMP indicator is lit) the Main Control Knob is enabled, and turning it will change the set point value, even when the actual temperature is being displayed.

The LOCK mode is activated automatically whenever a new parameter value is selected (i.e. the SELECT switch is pressed), and the LOCK mode is automatically deactivated whenever a new parameter value is entered (i.e. the SET switch is pressed while a parameter is selected).

The set point value (and the parameter values) stays in memory even if the 5910B's power is shut off. If you use the same set point temperature day after day you will appreciate the LOCK feature.

2.4.7 OUTPUT ON

This switches the (TEC) output of the LDT-5910B on or off. The OUTPUT switch has a toggling action. If the output is off, pressing it will turn the output on, and vice versa. The LED indicator above the OUTPUT switch becomes lit when the output is active. The LED is green when the 5910B is cooling and red when it is heating.

When the OUTPUT is off it is safe to connect or remove sensitive devices from the LDT-5910B even though power is on. The OUTPUT is off when power is first applied to the instrument.

The OUTPUT may be automatically turned off by error conditions. The default conditions which will cause the 5910B OUTPUT to be shut off during operation are shown in Table 2.2.

DEFAULT CONDITIONS WHICH WILL TURN THE OUTPUT OFF

- | |
|---|
| <ol style="list-style-type: none">1. Low Temperature Limit Condition2. High Temperature Limit Condition3. Interlock (Remote TEMP LIMIT) Disabled Condition (See Section 5.5)4. Booster Status Changed Condition (See Section 5.6)5. Sensor Open Condition6. TEC Module (5910B Output) Open Condition7. Sensor Type (SENSOR SELECT switch) Change Condition8. AC Power Loss for more than 1/2 cycle |
|---|

Table 2.2 Automatic Output-Off Default Conditions

If the GPIB option is implemented, the conditions which will cause the OUTPUT to be shut off during operation can be user-determined via the 'ENABLE:OUTOFF' command (see Chapter 3).

2.4.8 GPIB REMOTE LOCAL/ADR

This switch returns the instrument to local control when it is in remote mode (with the optional Model 1233 GPIB/IEEE-488 interface installed). Any command sent to the LDT-5910B via the GPIB bus automatically places the instrument in remote mode and the REMOTE LED becomes lit.

In remote mode, all the front panel controls, except POWER and GPIB REMOTE LOCAL/ADR, are disabled and will only operate remotely. Pressing the LOCAL switch will return the instrument to local mode, and all the front panel controls will operate, unless a local lockout command has been sent over the GPIB.

If the instrument is in remote mode and a local lockout (LLO) message has been sent, the host has complete control of the LDT-5910B and the LOCAL button has no effect. For more information on GPIB programming, see Chapter 3.

If no command has been sent over the GPIB bus, the LDT-5910B is in LOCAL mode and its GPIB address will be displayed for three seconds when you press the LOCAL/ADR switch. After three seconds the 5910B will revert to its prior state.

To set the GPIB address, press the LOCAL/ADR switch so that the current GPIB address is displayed. Then, if a different GPIB address is desired, press and hold the SET switch in and adjust the Main Control Knob until the desired address is displayed. (It is not necessary to hold the LOCAL/ADR switch in at this point, but the SET switch must be pressed while the old address is being displayed.) Then release the SET switch to store the new GPIB address in non-volatile memory.

The GPIB address will be displayed in the form: -nn-, where nn is a value between 00 and 30.

2.5 PARAMETER SETUP

The PARAMETER SETUP controls allow the user to read and/or set the 5910B's operating (setup) parameters. The functions of the parameters, and the procedure for setting the parameters, are described below.

Use of the SET and SELECT switches will effect the LOCK mode state (see Section 2.4.6).

2.5.1 SELECT

The SELECT function displays the setup parameters so you can review or change their values to configure the LDT-5910B for your temperature sensor and TE cooler. Press the SELECT button once and the LIM I (current limit) will be displayed until you release the switch. After this switch is released, this value will be displayed for three seconds before the 5910B returns to its previous state. Press the SELECT switch again to sequence the display through LIM T_{HI} (maximum temperature), LIM T_{LO} (minimum temperature), RECALL ("bin" number), SAVE ("bin" number), GAIN, C1, C2, and C3. Sections 2.5.3 - 2.5.9 describe each of these parameters and how to change them.

If the SELECT switch is pressed and held in, the Main Control Knob may be used to cycle through the parameters more quickly. Turn the knob clockwise (CW) to cycle through the parameters in the forward direction, or turn the knob counterclockwise (CCW) to cycle through the parameters in the reverse direction.

The instrument will automatically go into LOCK mode to protect the present set point value when the SELECT switch is pushed.

2.5.2 SET

The SET switch, along with the Main Control Knob, is used to change the values of the setup parameters: LIM I, LIM T_{HI}, LIM T_{LO}, RECALL, SAVE, GAIN, C1, C2, and C3. Sequence to the setup parameter you wish to change and hold the SET switch in to continuously display its value.

Once the desired parameter is selected, it is not necessary to continue pressing the SELECT switch to enter SET mode. (However, the SET switch must be pressed while the parameter value is being displayed.) Turn the Main Control Knob until the desired value is displayed. Release the SET switch to store the parameter value in non-volatile memory.

The 5910B will automatically come out of LOCK mode to allow the user to save the parameter value when the SET switch is pushed.

The SET switch also is used when the GPIB address is set (Section 2.4.8) and during calibration (See Chapter 6).

2.5.3 LIM I

The LIM I function limits the output current so that the LDT-5910B does not provide more current than your device can safely handle. To read the current limit, press the SELECT switch until the LED by LIM I is lit. The display will show the value of the LIM I (in Amps).

To change the current limit, sequence to the LIM I value and hold in the SET switch. Turn the Main Control Knob until the desired new value is on the display, then release the SET switch. The LIM I should be entered in Amps.

The LDT-5910B will supply as much current as it can, up to a current limit set point of 4.0 Amps, to control the temperature via the TE cooler. The LDT-5910B can control much greater load currents if an optional power booster is used with the 5910B (see Section 5.6).

The LIM I indicator will flash during two special conditions, current and voltage limiting. If the output is current limited, as when the OUTPUT is first turned on, the LIM I LED will flash slowly (1 Hz). If the output is voltage limited, i.e. the compliance voltage is reached due to a increased resistance load or a reduced current limit value (maximum output voltage = LIM I value * load resistance), the LIM I LED will flash at a faster rate (2 Hz).

2.5.4 LIM T_{HI}

The LIM T_{HI} function sets the maximum output temperature in degrees C. To read the upper temperature limit, press the SELECT switch until the LED indicator by LIM T_{HI} is lit. The display will show the value of the LIM T_{HI} (in ? C).

To change the upper temperature limit, select the LIM T_{HI} parameter and hold in the SET switch. Turn the Main Control Knob until the desired new value is on the display, then release the SET switch. When the SET switch is released, the new parameter value will be stored in non-volatile memory. The LIM T_{HI} should be entered in ? C.

2.5.5 LIM T_{LO}

The LIM T_{LO} function is similar to the LIM T_{HI} function, only it sets the lower temperature limit. It is also displayed in ? C.

2.5.6 RECALL

The RECALL function is used to return the 5910B to a previously defined state or configuration. For example, you may have several experimental setups which are frequently used. One of these configurations of the 5910B may be stored in "bin" 1 - 10 by using the SAVE function. This configuration is then automatically recalled from non-volatile memory when the RECALL function is used.

To recall a saved configuration (or unconfigured "bin") of the 5910B, select the RECALL parameter. The display will show the value of the last used RECALL "bin" number. If this is not the "bin" number of the desired configuration, press and hold in the SET switch. Turn the Main Control Knob until the desired new "bin" number is on the display, then release the SET switch.

After the RECALL parameter is reset, the 5910B will immediately be configured to the desired settings. However, the OUTPUT will be turned off.

When the LDT-5910B is manufactured, all of the usable recall "bins" are initialized to the default values (see Section 2.3). Therefore the configurations are pre-initialized to that of "bin" 0, and they remain in that state until the user performs a SAVE operation on a particular "bin".

If the default parameter state is desired at any time during operation, the user may reconfigure the 5910B by recalling RECALL "bin" 0. The default parameter state is described in Section 2.3.

2.5.7 SAVE

The SAVE function is used to store the 5910B's current configuration into non-volatile memory. When a configuration is stored, all of the parameters, limit values, and the set point values are saved. There are 10 "bins" for user-storage. "bin" 0 is reserved for saving the default values, as described in Section 2.3. "Bins" 1 - 10 may be used to save any desired configuration for later use. This allows fast and easy setup for tests or other high-repeatability needs.

For example, you may wish to configure "bin" 1 for room temperature thermistor measurements, "bin" 2 for below 0? C thermistor measurements, "bin" 3 for AD590 measurements, and so on.

2.5.8 GAIN

The GAIN function sets the analog feedback gain which determines how fast the actual temperature reaches and settles to the set point temperature. If the gain is set too low (1 is the lowest setting), the TE cooler will take longer to reach the temperature set point. If it is set too high (300 is the highest setting), the actual temperature may oscillate around the set temperature.

To set the gain, sequence to the GAIN value and hold in the SET switch. Turn the Main Control Knob until the new value is displayed and then release the SET switch. The feedback loop gain can be selected in increments of 1, 3, 10, 30, 100 and 300.

The gain setting depends on the type of TE cooler and temperature¹ that you are using, but we offer these guidelines for selecting the proper gain. Set the gain to its lowest value and increase it until the actual temperature oscillates around the set temperature. Then reduce the gain one increment.

2.5.9 Calibration Constants - C1, C2, and C3

These are the constants of the Steinhart-Hart equation that you enter to calibrate the LDT-5910B for different thermistors. The Steinhart-Hart equation is used to derive temperature from the non-linear resistance of an NTC (Negative Temperature Coefficient) thermistor. When linear devices are used, such as the AD590 or LM335, only C1 and C2 are used. In those cases, the constants represent the linear (two-point) calibration constants for the linear sensor.

The range of the constant values is -9.999 to +9.999. If negative constant values are displayed on the front panel, they will be rounded up to fit the 4-digit display. However, they will be stored with their full precision.

To read a constant, press the SELECT button until it sequences to C1, C2 or C3. The LED next to the constant will become lit. To change the value, press the SET switch and turn the Main Control Knob until the correct value is displayed. Release the SET switch to store the new value in non-volatile memory.

¹ The efficiency and accuracy of the 5910B depends on the temperature difference (delta temperature) between the TE cooler and its immediate environment. For example, if you are working at room temperature, but trying to control a load (i.e. laser diode) temperature of -10°C, the delta temperature could be about 30°C. In many cases, this would cause the 5910B's output to go to the negative current rail and stay there, because the load temperature would tend to rise as a result of ambient heating.

Since the accuracy of the load temperature depends on the temperature gradient between the TE cooler and the temperature sensor, the 5910B's performance could be adversely affected. In this case, decreasing the 5910B's GAIN to reduce load temperature oscillation may not work because any fluctuations in ambient temperature may increase the measured error (difference between set point and measured value) to the point where the 5910B cannot overcome it. The 5910B cannot produce more than its maximum output current, and the load temperature could be unstable irregardless of the GAIN setting.

This situation may be remedied by thermally isolating the load and TE cooler, but in extreme cases further cooling may be required to reduce the delta temperature. For those situations we recommend the use of an ILX Model LDM-4442 High Power Laser Diode Mount with water cooling.

Appendix A contains an explanation of the Steinhart-Hart equation, the values of these constants for some common thermistors, two computer programs to determine these values for any thermistor, and a program for finding temperature or resistance when the Steinhart-Hart constants are known.

Appendix B contains information on selecting and using thermistors.

Appendix C contains information for the calibration constants for the AD590 and LM335 sensors. Since these devices are used over their linear range, the constants C1 and C2 are used in this case to determine a linear approximation of the temperature, rather than the Steinhart-Hart non-linear approximation which applies for thermistors. The appropriate algorithms are automatically implemented whenever the sensor type is selected via the back panel SENSOR SELECT switch. However, C1 and C2 must be changed by the user.

2.6 Error Reporting

A current limit condition will cause the LIM I indicator to flash at a 1 Hz rate. This condition indicates that the 5910B is driving the output current to its limit. This is not an error, but is a normal condition which may occur when a large change in temperature settings is made, and the output is turned on.

A voltage limit condition will cause the LIM I indicator to flash at a 2 Hz rate. This would indicate that the 5910B is at its compliance voltage limit of 4.0 volts. This is not necessarily an error, but it is a condition which may occur when a large TE load resistance and output current appear together. The maximum output voltage for a given current limit is found by Ohm's Law: $\text{Maximum Output Voltage} = \text{Limit Current} * \text{TEC Load Resistance}$.

The voltage limit will occur when the output voltage reaches, or tries to exceed, the compliance voltage (4.0 volts).

Error messages will appear on the display when error conditions occur in the 5910B. For example, a Sensor Open error will produce a message of "E402".

In most cases, the error message will appear for three seconds and then the display will revert to its former state. In the case of multiple error messages, the 5910B will show each message for three seconds in succession.

Appendix D contains an explanation of the error messages which may be reported by the 5910B on the displays or via remote operation.

2.7 Back Panel

The back panel contains the thermistor input, TE module output, AC power entry connector, fuse, and a thermistor source current/sensor type set switch. The back panel also contains the standard GPIB bus connector. The back panel is shown in Figure 2.2.



Figure 2.2 5910B Back Panel

2.7.1 Back Panel Connections

When connecting or disconnecting laser diode modules and other sensitive devices to the LDT-5910B, we recommend that the OUTPUT be turned off. You should also ensure that the output current limit (LIM I) is set to an acceptable level for the device you are controlling. If in doubt, refer to the manufacturer's specifications (many TE coolers in commercial laser diode packages should not be continuously driven over 1000 mA).

Connect the thermistor (or other sensor) and TE Cooler to the back panel binding posts or to the 15-pin sub-miniature D connector (Figure 2.3). The binding posts will suffice for most applications. The temperature sensor and TE Cooler can also be connected via the rear panel 15 pin sub-miniature D-type connector. Refer to Figure 2.3 for a pin-out description.

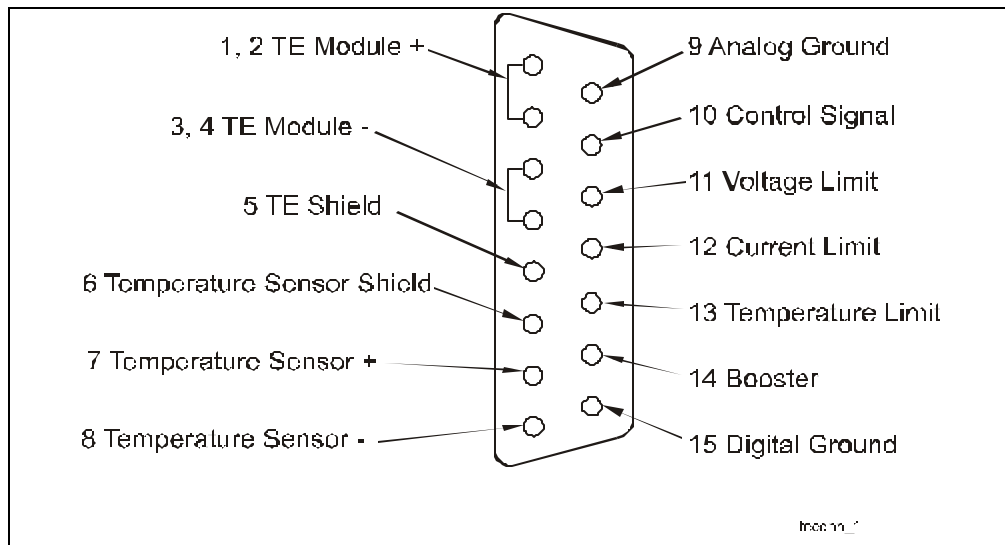

Figure 2.3 TEC Input/Output Connector Pinout

2.7.2 Grounding Considerations

The outputs of the LDT-5910B are isolated from chassis ground allowing either output terminal to be grounded at the user's option. The sensor (-) and the TE module (-) are internally connected.

2.7.3 SENSOR SELECT Switch

The SENSOR SELECT switch selects the sensor type, thermistor, LM335, or AD590. In the case of a thermistor sensor, a current supply of either 10 uA or 100 uA may be selected. Table 2.3 shows the SENSOR SELECT positions and corresponding position code. When the 5910B is first powered up, the sensor switch setting will be displayed on the front panel display. See Section 2.3.1.

If the SENSOR SELECT switch is reset while the 5910B is powered up, the new sensor code will be displayed on the 5910B for three seconds, and the OUTPUT will be shut off. Then the display will revert to its prior state.

SENSOR SELECT POSITION CODES

<u>SWITCH POSITION</u>	<u>CODE</u>
100 uA	--01
10 uA	--02
LM335	--03
AD590	--04

Table 2.3 SENSOR SELECT Switch Positions

When using a thermistor, the supply current depends on the thermistor operating temperature range and the required temperature resolution. Guidelines for setting this switch are contained in Appendix B.

Appendix A contains information on the Steinhart-Hart equation for calculating temperature from thermistor resistance, and vice versa. Appendix B is a guide for thermistor selection and usage. Appendix C contains information on using the AD590 and LM335 linear sensors.

2.8 Operating Instructions

The following sections describe the operating procedure for the 5910B, including warm-up and environmental considerations.

2.8.1 Warm Up and Environmental Considerations

Operate the LDT-5910B at an ambient temperature between 0 and 50 degrees centigrade. Storage temperatures should be in the range of -40 to 70 ° C. To achieve the rated accuracy, let the LDT-5910B warm up for about 1 hour before use.

2.8.2 General Operating Procedure

You can operate the LDT-5910B in several modes. The following operating procedure is applicable for most common use. Remote operation is described in Chapter 3.

- a. Plug the LDT-5910B into an AC power source supplying the correct voltage and frequency for your unit (refer to the rear panel for the correct ratings).
- b. Check the setting of the back panel SENSOR SELECT switch for the desired operation. The sensor code will be displayed for three seconds during the power-up sequence (see Section 2.3).

- c. Turn on the LDT-5910B. The OUTPUT stage will be off at power-up and the unit will automatically configure its parameters to the state which existed when the power was last shut off.
- d. Press the SELECT switch and check the setting of LIM I, LIM T_{HI}, LIM T_{LO}, GAIN, and C1, C2, and C3 to insure that they are compatible with the equipment you are using. Refer to Section 2.5 if you need to change them.

If a preconfigured setup is to be recalled, use the RECALL feature (see Section 2.5.6) and then recheck the parameter settings for confirmation.

- e. Press the SET TEMP switch (Section 2.4.4) and check the set point temperature. If it requires changing, turn the knob until the desired value is displayed. If the LOCK light is on, it will be necessary to exit LOCK mode by pressing the LOCK switch before it is possible to adjust the set point.
- f. Turn the TE current output on by pressing the OUTPUT ON switch (indicator will be lit when the OUTPUT is on).
- g. The LDT-5910B will automatically control the temperature to the set point.

If the SENSOR SELECT switch is changed while the OUTPUT is on, the OUTPUT will be forced off, and the newly selected sensor code will be displayed on the front panel for three seconds. Also, during operation, if certain adverse conditions are met, the OUTPUT will be forced off (see Section 2.4.7).

- h. When the 5910B is powered off, the state of the unit at power-down is saved in non-volatile memory.

Chapter 3

COMMAND REFERENCE

3.1 Introduction

This chapter is a guide to the syntax and usage of the various device-dependent commands for the 5910B. It contains a reference section for all of the device-dependent commands, including those which may only be accessed via remote operation. Therefore, it is of primary interest to users who wish to utilize the GPIB option.

This chapter is divided into two parts. The first part contains an overview of the remote commands and syntax used by the 5910B. If you are not interested in remote operation, skip Sections 3.2 and 3.3.

The second part contains all of the 5910B commands in alphabetical order. Figure 3.1 shows the format for the device command descriptions in this chapter. The commands which emulate local (front panel) operation are denoted by the solid box next to the Local label in the upper left corner of the command description. The error messages which may be displayed on the 5910B front panel are listed in Section 3.5.

The common GPIB (ANSI/IEEE-488.2) commands which are supported by the 5910B are described in Chapter 4.

3.2 Overview of the 5910B Command Set

This section describes some of the features of the 5910B which are accessible via remote operation, but not via local operation. It also introduces some important concepts which form the basis for the 5910B syntax, such as the difference between a command and a query.

3.2.1 Some 5910B Features Found Only in Remote Mode

If the 5910B is operated remotely (over the GPIB) the 5910B can be operated in R mode rather than T (temperature) mode. In R mode the 5910B controls the TE cooler to a sensor reference (R) value. The units of the R value are Kohms for thermistor sensors, mV for LM335 sensors, and uA for AD590 sensors. The units are determined by the position of the SENSOR SELECT switch.

R mode is useful when the sensor characteristics are not fully known, but a temperature is known for a given sensor parameter. For example, the Steinhart-Hart constants may not be known for a specific thermistor, but the thermistor is known to have a resistance of 10.23 Kohms at the temperature of interest. Rather than trying to determine the C1, C2, and C3 constants, the user could enter R mode and control the load to the desired temperature by setting the (R) set point to 10.23. (See the MODE:R, R, R?, and SET:R commands in Section 3.4).

Some other features which are accessible only via remote operation include the STEP, INC, and DEC commands which can be used to increment or decrement the set point value by a predetermined step amount. (See Section 3.4).

In remote operation, the status of the 5910B condition and event registers can be queried (see the EVENT? and COND? queries). Also, the conditions which force the OUTPUT off can be set by the user (see the ENABLE:OUTOFF command).

Commands and queries which are only available in remote mode are indicated in Section 3.4 by a solid box by the Remote label, and a hollow box by the Front Panel label.

3.2.2 Commands and Queries

There are two types of device "commands", Commands -which cause the 5910B to do something, and Queries -which return a stored value or state of the instrument. Queries must be terminated with a question mark (?), while Commands may require a parameter(s) to follow.

"Auto 1"

For example, the "1" in the command "Auto 1", activates the AUTO mode while a "0" would deactivate the AUTO mode. Table 3.1 (Section 3.2.1) contains the allowed substitute parameter names for values of 1 and 0.

This command emulates the front panel operation of (1) selecting the AUTO switch on the front panel, and (2) setting it on.

Most of the commands which emulate the front panel operation are just as intuitive (see Table 3.1). Section 3.4 contains a detailed account of each command and tells which are also supported by front panel operations.

3.2.3 Substitute Parameter Names

For clarity in programming, the values of one and zero may also be represented by the appropriate substitute parameter names, as shown in Table 3.1.

<u>SUBSTITUTE PARAMETER NAMES</u>	
<u>SUBSTITUTE NAME</u>	<u>VALUE</u>
ON	1
OFF	0
OLD	1
NEW	0
TRUE	1
FALSE	0

Table 3.1 Substitute Parameter Names

The ON parameter name could be used in place of the 1 in the example in Section 3.2 as follows:

"DIS ON"

3.2.4 Compound Command Structure

Many of the 5910B remote commands require a compound structure. This is done to distinguish between different commands of the same type.

The compound command structure is similar to a directory path structure, as found in DOS. For example, commands which deal with the 5910B's calibration have the path "CAL:", as in the command to enter the sensor calibration mode:

```
"CAL:SENsor"
```

This structure is illustrated in Figure 3.2. Table 3.2 lists all of the 5910B's device-dependent commands, with the full path shown for each command and a brief explanation of its usage. For more information, see Section 3.4.

Section 3.4 presents a more detailed look at the 5910B device-dependent commands, including syntax diagrams, and example usage.

5910B DEVICE-DEPENDENT COMMANDS

<u>NAME</u>	<u>NUMBER OF PARAMETERS EXPECTED</u>	<u>FUNCTION</u>
CAL:ITE	NONE	Used to set the constant current source calibration constants.
CAL:ITE?	NONE	Returns 1 if the 5910B is ready to receive the ITE calibration value, else returns 0.
CAL:SEN	NONE	Used to set a sensor calibration constant; sensor type depends on rear panel sensor switch setting.
CAL:SEN?	NONE	Returns 1 if the 5910B is ready to receive the sensor calibration value, else returns 0.
COND?	NONE	Returns the value of the condition register.
CONST	1 - 3	Used to enter the Steinhart-Hart constants for R-T conversion.
CONST?	NONE	Used to read back the Steinhart-Hart constants for R-T conversion.
DEC	NONE	Used with STEP command to decrement the set point value by one step.
DELAY	1	Used to delay the execution of further commands.
DIS	1	Turns the display on or off.
DIS?	NONE	Returns the display value.
DIS:AUTO	1	Same action as pushing AUTO switch.
DIS:AUTO?	NONE	Returns on/off status.
DIS:R	NONE	Turn on display to show actual thermistor resistance/linear sensor reference.
DIS:R?	NONE	Returns on/off status.
DIS:SET	NONE	Same action as pushing SET TEMP switch.
DIS:SET?	NONE	Returns on/off status.
DIS:T	NONE	Turns on display to show actual temperature.
DIS:T?	NONE	Returns on/off status.
ENAB:COND	1	Sets the bits of the enable register for 5910B conditions.
ENAB:COND?	NONE	Returns the enabled bits of the condition register.
ENAB:EVE	1	Sets the bits of the enable register for 5910B events.
ENAB:EVE?	NONE	Returns the enabled bits of the event register.
ENAB:OUTOFF	1	Sets the bits of the enable register for output off conditions.
ENAB:OUTOFF?	NONE	Returns the enabled bits of the output off register.
ERR?	NONE	Returns the list of errors generated since the last program message (command string).
EVE?	NONE	Returns the value of (and clears the contents of) the event status register.
GAIN	1	Used to set the 5910B control loop gain parameter.
GAIN?	NONE	Used to recall the 5910B control loop gain parameter.
INC	NONE	Used with STEP command to increment the set point value by one step.
ITE	1	Used to enter current calibration values.
ITE?	NONE	Returns the value of the TEC output current.
LIM:ITE	1	Used to set the constant current source limit value.
LIM:ITE?	NONE	Used to recall the constant current source limit value.
LIM:THI	1	Used to set the upper temperature limit value.
LIM:THI?	NONE	Used to recall the upper temperature limit value.
LIM:TLO	1	Used to set the lower temperature limit value.
LIM:TLO?	NONE	Used to recall the lower temperature limit value.

Table 3.2 5910B Device-Dependent Commands

5910B DEVICE-DEPENDENT COMMANDS

<u>NAME</u>	<u>NUMBER OF PARAMETERS EXPECTED</u>	<u>FUNCTION</u>
LOCK:ADJ	1	Same action as pressing the LOCK switch.
LOCK:ADJ?	NONE	Returns the switch status.
MES	1	Used to store a message of up to 16 bytes of ASCII characters.
MES?	NONE	Returns a previously stored ASCII string of 16 bytes.
MODE?	NONE	Returns the mode, R (sensor resistance/reference) or T (temperature).
MODE:R	NONE	Sets the 5910B to constant resistance/reference mode.
MODE:T	NONE	Sets the 5910B to constant temperature mode.
OUT	1	Same action as pressing the OUTPUT switch.
OUT?	NONE	Returns the switch status.
R	1	Used to set the constant R (thermistor resistance/linear sensor reference) set point.
R?	NONE	Returns the actual R value.
RAD	1	Used to set the radix type for numerical data. Decimal, binary, and hexadecimal are allowed.
RAD?	NONE	Used to recall the radix type for numerical data. Decimal, binary, and hexadecimal are allowed.
SECURE	1	To be used by authorized service personnel only, to gain access to protected data.
SEN?	NONE	Returns the position of the SENSOR SELECT switch.
SET:R?	NONE	Returns the constant R (thermistor resistance/linear sensor reference) set point.
SET:T?	NONE	Returns the constant T (temperature) set point.
STEP	1	Used to set the step value for use with DEC or INC commands. Defaults to a step of 1, 1step = 0.1°C or 1 ohm. Range is 1 - 9999 steps.
STEP?	NONE	Returns the value of the STEP size.
SYNTAX	1	Used to set the command set for 5910 or 5910B syntax. The default value is 0, 5910B syntax enabled.
SYNTAX?	NONE	Returns 1 or 0, for OLD or NEW syntax enabled.
T	1	Used to set the constant T (temperature) set point.
T?	NONE	Returns the actual T value.
TERM	1	Used to set the program message terminator.
TERM?	NONE	Returns the program message terminator.
TIME?	NONE	Returns the elapsed time, in seconds, since the 5910B was last powered up.
TIMER?	NONE	Returns the elapsed time since the timer was last reset.
TOL	2	Used to set the set point tolerance value and time period value for validation, i.e. used to determine if a set point has been reached -must be within tolerance for the time period.
TOL?	NONE	Used to recall the set point tolerance value and time period value for validation, i.e. used to determine if a set point has been reached -must be within tolerance for the time period.

Table 3.2 5910B Device-Dependent Commands (Cont.)

3.3 Common Commands

Another type of command is the "common command". These commands are common to instruments which support the ANSI-IEEE-488.2 standard and are not necessarily reflected by front panel operations. Some of the common commands are useful for advanced programming techniques, such as generating service request interrupts. However, common commands are not necessary for remote operation, and the beginning programmer may chose to ignore them entirely. The common commands for the 5910B are documented in Chapter 4.

3.4 5910B Device-Dependent Commands

This section contains all of the device-dependent commands for the 5910B, listed in alphabetical order. Sub-sections for each path are presented, listing the commands which are legal for that path. See Figure 3.2 for command path tree structure. All of the 5910B's common commands and queries are listed in Section 3.5. The lower level remote interface messages are listed in Section 3.6.

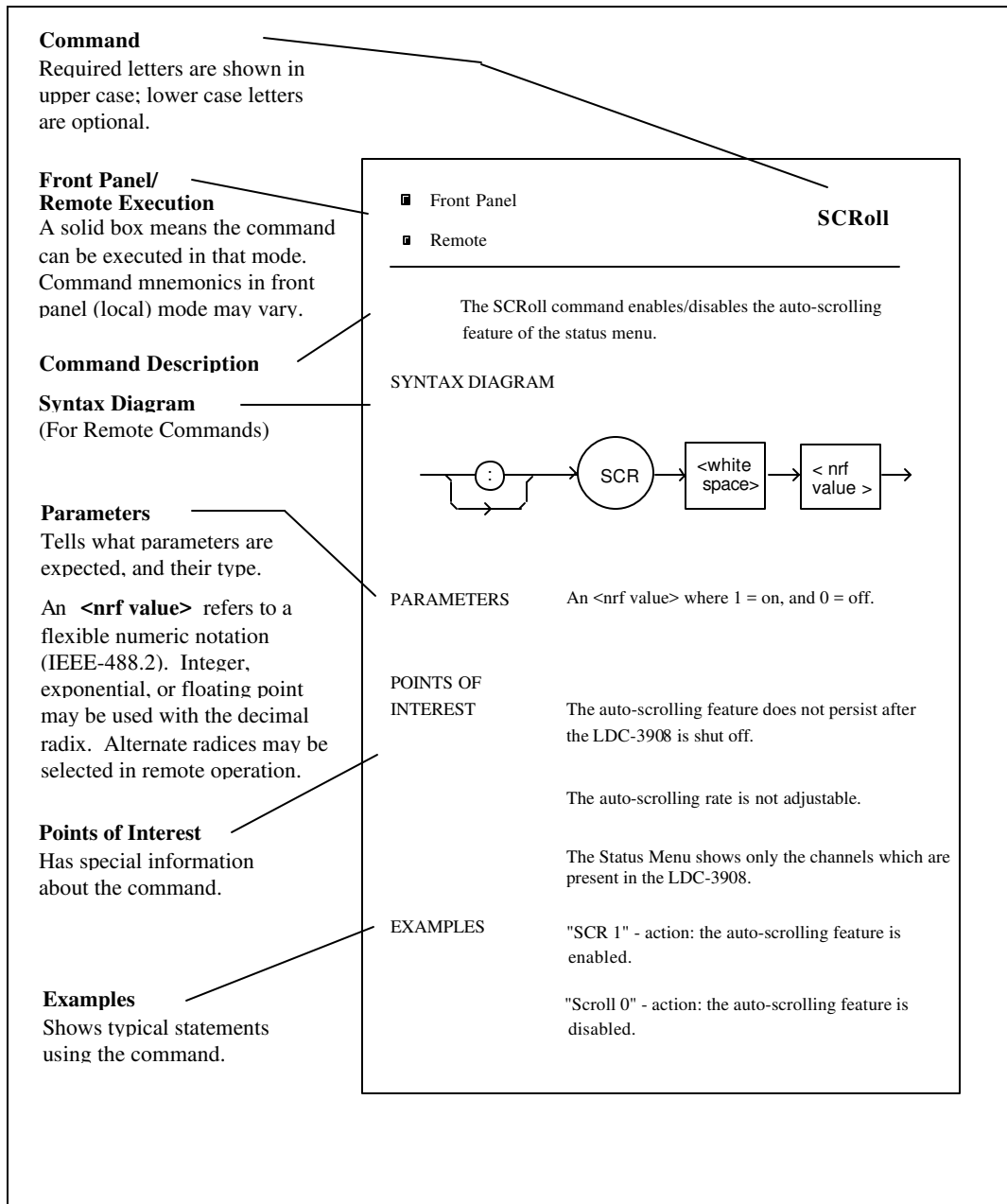

Figure 3.1 Command Description Format

3.4.1 Command Paths

The 5910B device-dependent commands are structured into tree format (see Figure 3.2). Each of the legal paths is listed below, followed by its list of path options, each of which is followed by the commands themselves.

It is recommended that the first-time user begin learning the commands by using the full path notation. Once the user is familiar with the commands, he or she may wish to take advantage of the shortcuts allowed for command paths (see Section 4.4).

(common cmds)	(root cmds)							
*CAL?								
*CLS								
*ESE								
*ESE?								
*ESR?	COND?	CAL:	DIS:	ENAB:	LIM:	LOCK:	MODE:	SET:
*IDN?	CONST							
*IST?	CONST?							
*OPC	DEC	ITE	AUTO	COND	ITE	ADJ	R	R?
*OPC?	DELAY	IIE?	AUTO?	COND?	IIE?	ADJ?	T	T?
*PRE	DIS	SEN	R	EVE	THI			
*PRE?	DIS?	SEN?	R?	EVE?	THI?			
*PSC	ERR?		SET	OUTOFF	TLO			
*PSC?	EVE?		SET?	OUTOFF?	TLO?			
*PUD	GAIN		T					
*PUD?	GAIN?		T?					
*RCL	INC							
*RST	ITE							
*SAV	IIE?							
*SRE	MES							
*SRE?	MES?							
*STB?	MODE?							
*TST?	OUT							
*WAI	OUT?							
	R							
	R?							
	RAD							
	RAD?							
	SECURE							
	SEN?							
	STEP							
	STEP?							
	SYNTAX							
	SYNTAX?							
	T							
	T?							
	TERM							
	TERM?							
	TIME?							
	TIMER?							
	TOL							
	TOL?							

Figure 3.2 5910B Command Path Structure

3.4.2 5910B Device-Dependent Command Reference

The following pages contain a reference for the device-dependent commands of the 5910B. This reference contains useful information for both local and remote operation of the 5910B.

- Front Panel
- Remote

CAL:

The CAL: command path is used to get to the 5910B's TEC calibration commands.

The following commands may be reached directly from the CAL: command path.

CAL:ITE
CAL:ITE?
CAL:SENsor
CAL:SENsor?

- Front Panel
- Remote

CAL:ITE

The CAL:ITE command sets the sensor calibration constant.

SYNTAX DIAGRAM

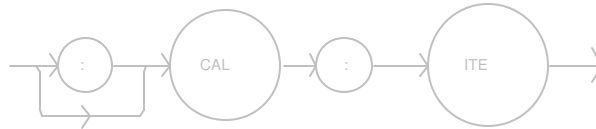

PARAMETERS

None.

POINTS OF INTEREST

From the front panel this command is entered by pressing the LOCAL and OUTPUT ON switches simultaneously.

Entering this mode forces the user to proceed with the Current calibration procedure (see Chapter 4).

After this command is issued, the 5910B will automatically determine its zero current offset, set the limit to 1.0 A, and drive the output to this value. When this value is reached, the user should enter the true measured value (via the "ITE <nrf value>" command) and continue with the calibration procedure. This procedure is outlined in Chapter 5.

In remote operation, the CAL:ITE? query may be used to determine if the 5910B is ready for the user to enter a value.

In local operation, the 5910B will display "--05" to indicate the calibration mode. Then, the user must press the SET switch to continue the calibration procedure.

EXAMPLES

"Cal:It" -action: enters the Current Calibration mode.

"CAL:It" -action: enters the Current Calibration mode.

- Front Panel
- Remote

CAL:ITE?

The CAL:ITE? query is used to determine that the 5910B is ready for a value to be entered during the calibration cycle of the CAL:ITE mode.

SYNTAX DIAGRAM

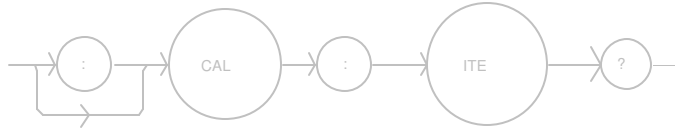

PARAMETERS

None. The response will be in the form:

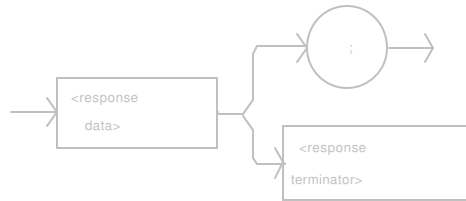

-where a response of 1 = ready, 0 = not ready.

POINTS OF INTEREST

After this query is issued and a response of 1 is received, the 5910B will wait for the user to enter a current value via the ITE command (see Chapter 5). This query may then be repeated for the second half of the calibration cycle.

EXAMPLES

"CAL:ITE?" -response: 1, means the 5910B is ready for the user to enter a current value via the ITE command.

"Cal:Ite?" -response: 0, means the 5910B is not yet ready for the user to enter a current value.

- Front Panel
- Remote

CAL:SENsor

The CAL:SENsor command sets the calibration constant for the TEC sensor.

SYNTAX DIAGRAM

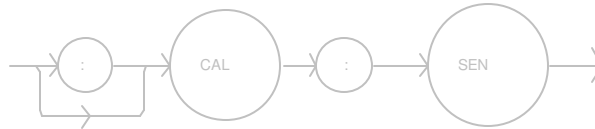

PARAMETERS None.

POINTS OF INTEREST

From the front panel this command is entered by pressing the LOCAL and SELECT switches simultaneously. Entering this mode forces the user to proceed with the Sensor calibration (see Chapter 5).

The back panel SENSOR SELECT switch should not be changed while in the Sensor Calibration mode.

In remote operation, the CAL:SENsor? query may be used to determine if the 5910B is ready for the user to enter a value.

In local operation, the 5910B will display "--0x", where x is a digit from 1 - 4, to indicate the calibration mode. (This number corresponds to the sensor switch display number).

EXAMPLES

"Cal:Sensor" -action: enters the Sensor Calibration mode.

"CAL:SEN" -action: enters the Sensor Calibration mode.

- Front Panel
- Remote

CAL:SENsor?

The CAL:SENsor? query is used to determine that the 5910B is ready for a value to be entered during the calibration cycle of the CAL:SENsor mode.

SYNTAX DIAGRAM

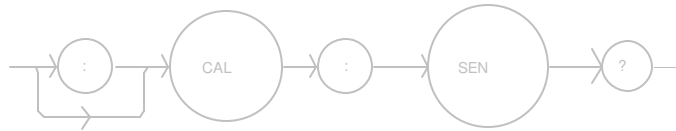

PARAMETERS

None. The response will be in the form:

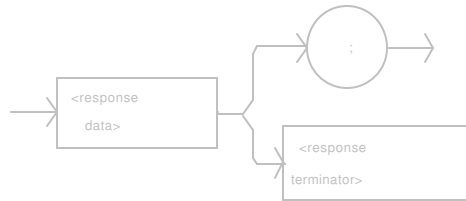

-where a response of 1 = ready, 0 = not ready.

POINTS OF INTEREST

After this query is issued and a response of 1 is received, the 5910B will wait for the user to enter a current value via the R command (see Chapter 5).

EXAMPLES

"CAL:SEN?" -response: 1, means the 5910B is ready for the user to enter a resistance value via the R command.

"Cal:Sensor?" -response: 0, means the 5910B is not yet ready for the user to enter a resistance value.

Front Panel

Remote

COND?

The COND? query returns the value of the status condition register.

SYNTAX DIAGRAM

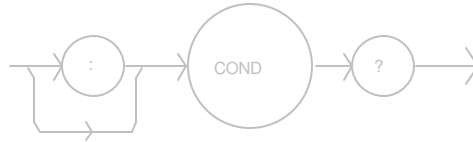

PARAMETERS

None. The response will be in the form:

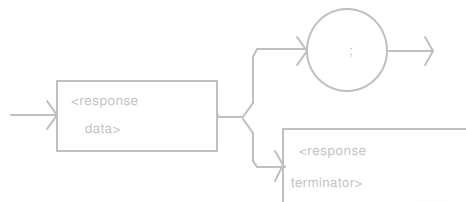

-where the response is the sum of the following:

- 1 - TE Current Limit
- 2 - Voltage Limit Error
- 4 - Low Temperature Limit
- 8 - High Temperature Limit
- 16 - Interlock Enable
- 32 - Booster Enable
- 64 - Sensor Open
- 128 - TE Module Open
- 256 - Sensor Shorted
- 512 - Output Out of Tolerance
- 1024 - Output On
- 2048 - Ready for Calibration Data
- 4096 - Calculation Error
- 8192 - Internal Communication Error with TEC Board
- 16384 - Software Error
- 32768 - EEPROM Checksum Error

POINTS OF INTEREST

The conditions which will be summarized and reported in the status byte can be selected by using the ENABLE:COND command. The condition status is constantly changing, while the event status is only cleared when the event status is read or a *CLS command is issued.

EXAMPLES

"COND?" -response: 513, means that the Output Out of Tolerance and TE Current Limit TEC conditions currently exist.

"Radix Hex; Cond?" -response: #H84, means that the TE Module Open and Low Temperature Limit conditions currently exist.

■ Front Panel

CONST

■ Remote

The CONST command sets the TEC's Steinhart-Hart equation constants for thermistors and two-point calibration constants for AD590 and LM335 sensors.

SYNTAX DIAGRAM

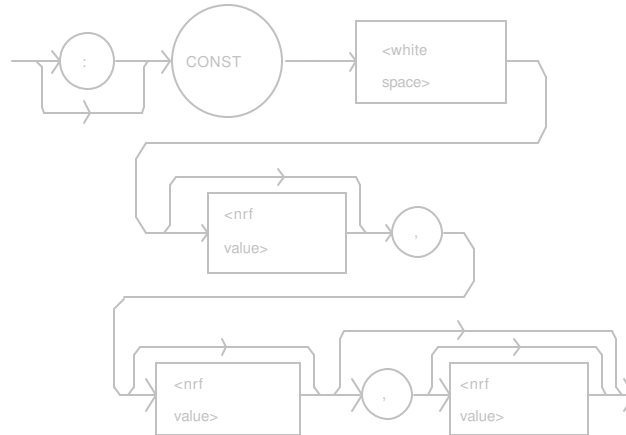

PARAMETERS

Two or three <nrf values>, for the two AD590 or LM335 sensor calibration constants, or the three Steinhart-Hart equation constants. The range of these values is -9.999 to +9.999.

POINTS OF INTEREST

If less than three parameters need to be changed, only the desired change needs to be specified, along with the separating commas (see example).

When the LM335 or AD590 sensors are selected via the SENSOR SELECT switch, only C1 and C2 are used. Therefore, only two parameters are expected in those cases.

In local operation, the constants are entered individually by selecting C1, C2 or C3 in the PARAMETER SETUP section of the 5910B front panel. Then, with the SET switch pressed and held in, the parameter value may be adjusted by turning the main knob. When the SET switch is released, the value is stored in non-volatile memory.

EXAMPLES

"CONST 1, 2.333, 0.5 " -action: sets C1 to 1.000, C2 to 2.333, and C3 to 0.500.

"const 1.4, ," -action: sets C1 to 1.400, C2 and C3 are unchanged.

"Const ,4.5,0.3" -action: sets C2 to 4.500, C3 to 0.300, and C1 is unchanged.

"CONST 1.4,2.01" -action: sets C1 to 1.400, C2 to 2.010 for two-point calibration of a linear sensor.

- Front Panel
- Remote

CONST?

The CONST? query returns the value of the TEC's Steinhart-Hart equation constants or the two-point linear sensor calibration constants.

SYNTAX DIAGRAM

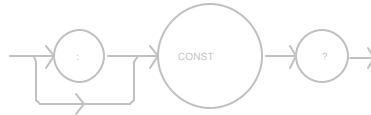

PARAMETERS None. The response will be in the form:

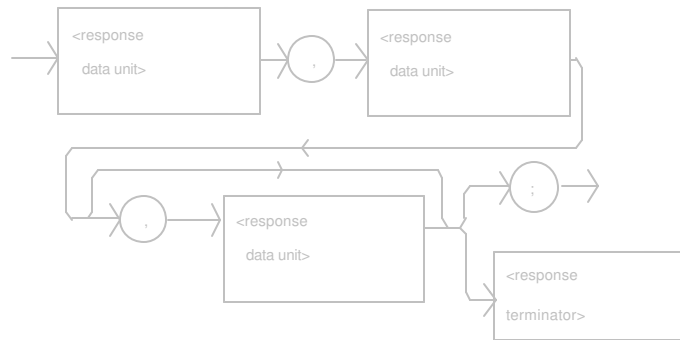

-where the response data represent C1, C2, and C3, respectively.

POINTS OF INTEREST

The response is always in the form: C1,C2,C3 when a thermistor is selected via the SENSOR SELECT switch.

When the LM335 or AD590 sensors are selected via the SENSOR SELECT switch, only C1 and C2 are used. Therefore, only C1 and C2 are returned in those cases.

In local operation, the constants may be read by selecting (LED lit) the desired parameter in the PARAMETER SETUP section of the front panel and visually reading the value on the display. If negative values are displayed, they are rounded up to fit the display, but are stored with full precision.

Appendices A, B and C contain information on the use of these constants with the various sensor types.

EXAMPLES

"CONST?" -response: 1.11,2.038,0.853 means C1 = 1.110, C2 = 2.038, and C3 = 0.853.

"Const?" -response: 1.0,2.22,0.077 means C1 = 1.000, C2 = 2.220, and C3 = 0.077.

"Const?" -response: 1.23,2.51 means C1 = 1.230, C2 = 2.510, and a two-point calibration is used (AD590 or LM335).

Front Panel

Remote

DEC

The DEC command decrements the selected control mode set point by one step.

SYNTAX DIAGRAM

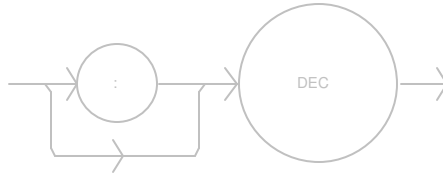

PARAMETERS None.

POINTS OF INTEREST

The decremental amount is one step. The step size can be edited via the STEP command, its default value is 1, 0.1° C, 1 ohm, 0.01 uA (AD590), or 0.1 mV (LM335) -depending on mode of operation.

EXAMPLES

"MODE:R; STEP 3; DEC" -action: The resistance set point is decremented by 3 ohms (0.003 Kohms), assuming that the SENSOR SELECT switch is in the 100 or 10 uA (thermistor current) position.

"STEP 10; MODE:T; DEC" -action: The temperature set point is decremented by 1.0° C.

The DELAY command causes the execution of commands to be delayed by a user-defined time. This command is similar to the *WAI common command, except that execution resumes after the specified number of milliseconds, instead of waiting for the Operation-Complete flag to be set.

SYNTAX DIAGRAM

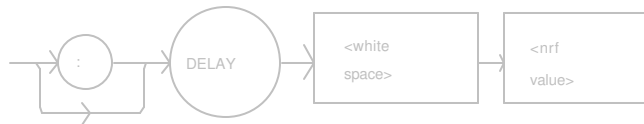

PARAMETERS An <nrf value> which represents the delay time, in milliseconds.

POINTS OF INTEREST The Operation-Complete flag is held false until the delay period elapses, but the *OPC? query will not execute until the delay period has elapsed.

This command is useful for creating delays which don't require a lot of program code and don't tie up the GPIB during execution.

EXAMPLES "DELAY 500" -action: Further commands and queries are not executed until 0.5 seconds have elapsed from the time this command is executed.

"T 22;Delay 2000;T?" -actions: The temperature is set to 22.0? C, then the 5910B waits for about 2.0 seconds before returning the measured temperature.

- Front Panel
- Remote

DISplay

The DISplay command enables or disables (turns off) the display and indicator LEDs.

SYNTAX DIAGRAM

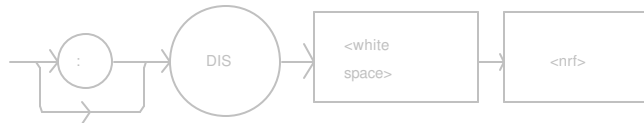

PARAMETERS 1 = on, 0 = off.

POINTS OF INTEREST

When the display is enabled, the value displayed will depend on the current mode of operation. When the display is disabled, it contains a blank message.

When the display is disabled, all of the LEDs on the front panel will also be disabled. This command is useful when it is necessary to work in a dark environment.

EXAMPLES

"DIS 1" -action: display is enabled.

"DISp 0" -action: display is disabled, blank.

"Disp On" -action: display is enabled.

- Front Panel
- Remote

DISplay?

The DISplay? query returns the value shown on the display.

SYNTAX DIAGRAM

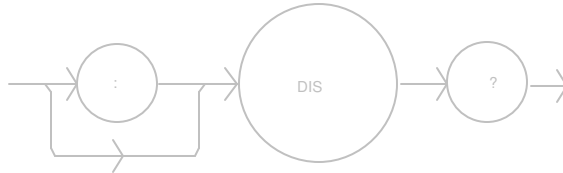

PARAMETERS

None. The response will be in the form:

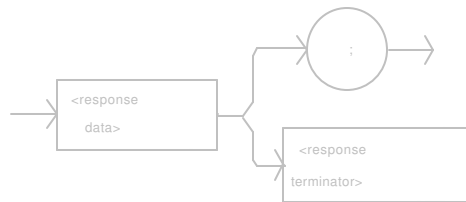

-where the response data is a string.

POINTS OF INTEREST

Returns the actual string from the output buffer to the display. If the display is disabled, it returns " ".

In local operation, the display is queried by visually reading the display value.

EXAMPLES

"DIS?" -response: "-99.9" means the value on the display is -99.9.

"DISp?" -response: " 0.6" means the value on the display is 0.6.

"Disp?" -response: "E402" means there is a E402 error message on the display (which means: sensor open -output off).

- Front Panel
 - Remote
-

DISplay:

The DISplay: command path is used to get to the 5910B's TEC display commands.

The following commands may be reached directly from the DISplay: command path.

- DISplay:AUTO
- DISplay:AUTO?
- DISplay:R
- DISplay:R?
- DISplay:SET
- DISplay:SET?
- DISplay:T
- DISplay:T?

- Front Panel
- Remote

DISplay:AUTO

The DISplay:AUTO command activates or deactivates the AUTO mode and sets the front panel switch accordingly.

SYNTAX DIAGRAM

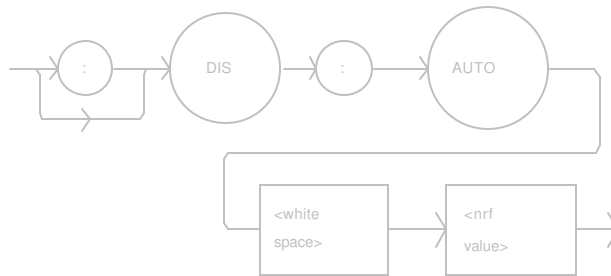

PARAMETERS

- 1 - activates AUTO mode.
- 0 - deactivates AUTO mode.

POINTS OF INTEREST

Effects the display only, just as during (local) front panel operation.

In local operation, pressing the AUTO switch while its LED is unlit will enable AUTO mode, and pressing the AUTO switch when the LED is lit will disable AUTO mode.

EXAMPLES

"Display:Auto 1" -action: activates the AUTO switch and sets the display to AUTO mode.

"DIS:AUTO 0" -action: deactivates the AUTO switch and AUTO mode.

- Front Panel
- Remote

DISplay:AUTO?

The DISplay:AUTO? query returns the status of the AUTO mode switch.

SYNTAX DIAGRAM

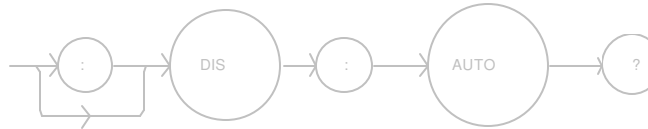

PARAMETERS

None. The response will be in the form:

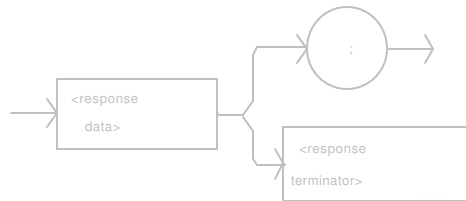

-where a response of 1 means on, and 0 means off.

POINTS OF INTEREST

Returns the status of the switch, regardless of whether the LED indicator is actually lit.

In local operation, the status of the AUTO mode is determined by visually inspecting the AUTO switch LED (lit = on).

EXAMPLES

"DIS:AUTO?" -response: 0, means the AUTO switch is not activated.

"Display:auto?" -response: 1, means the AUTO switch is activated.

□ Front Panel

■ Remote

DISplay:R

The DISplay:R command turns the ACTUAL TEMP switch on and enables the display for measured thermistor resistance, AD590 current, or LM335 voltage, depending on the setting of the back panel SENSOR SELECT switch.

SYNTAX DIAGRAM

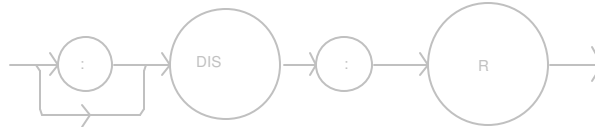

PARAMETERS None.

POINTS OF INTEREST

Disabling the ACTUAL TEMP switch is not necessary before enabling the SET TEMP switch. The ACTUAL TEMP (R) display will be disabled automatically when the SET TEMP switch is activated.

EXAMPLES

"DIS:R" -action: activates the ACTUAL TEMP switch and sets the display to show the measured thermistor resistance (in Kohms), AD590 current (in uA), or LM335 voltage (in mV) value.

"Display:R" -action: activates the ACTUAL TEMP switch and sets the display to show the measured thermistor resistance (in Kohms), AD590 current (in uA), or LM335 voltage (in mV) value.

- Front Panel
- Remote

DISplay:R?

The DISplay:R? query returns the status of the ACTUAL TEMP switch (on/off state) ANDed with the constant R mode status.

SYNTAX DIAGRAM

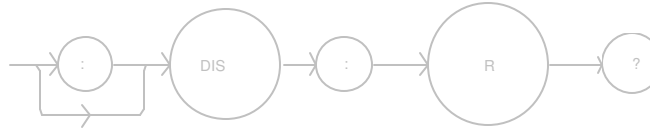

PARAMETERS

None. The response will be in the form:

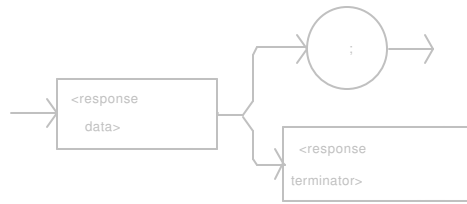

-where a response of 1 means on, and 0 means off.

POINTS OF INTEREST

The ACTUAL (TEMP) R value (shown on the display) may not be displayed, even when the switch status is 1 (on), if the 5910B is in calibration mode or the display is otherwise disabled.

EXAMPLES

"DIS:R?" -response: 1, means the display ACTUAL TEMP switch has been activated and the unit is in constant R mode.

"display:r?" -response: 0, means the ACTUAL TEMP switch is not activated or the 5910B is not in constant R mode.

- Front Panel
- Remote

DISplay:SET

The DISplay:SET command turns the set point switch on.

SYNTAX DIAGRAM

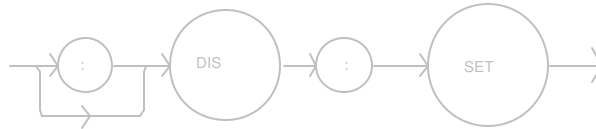

PARAMETERS

None.

POINTS OF INTEREST

The set point display will be de-activated automatically when the ACTUAL TEMP switch is activated.

In local operation, the set point display is activated by pressing the SET TEMP switch.

EXAMPLES

"DIS:SET" -action: activates the SET TEMP switch and sets the display to show the set point value of the existing control mode.

"Display:Set" -action: activates the SET TEMP switch and sets the display to show the set point value of the existing control mode.

- Front Panel
- Remote

DISplay:SET?

The DISplay:SET? query returns the status of the SET TEMP switch (on/off state).

SYNTAX DIAGRAM

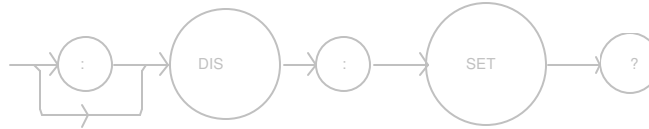

PARAMETERS

None. The response will be in the form:

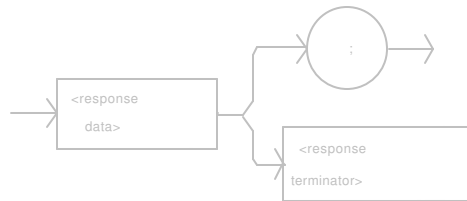

-where a response of 1 means on, and 0 means off.

POINTS OF INTEREST

The set point display value (shown on the display) will depend on the existing mode of operation, constant R (Resistance/Reference) or constant T (Temperature). The display may not show the set point, even when the switch status is 1 (on), if the 5910B is in calibration mode or the display is otherwise disabled.

In local operation, the status of the SET TEMP switch is determined by visually inspecting the SET TEMP switch LED (lit = on).

EXAMPLES

"DIS:SET?" -response: 1, means the SET TEMP switch is activated.

"display:set?" -response: 0, means the SET TEMP switch is not activated.

- Front Panel
- Remote

DISplay:T

The DISplay:T command turns the ACTUAL TEMP switch on, and it enables the display for measured temperature.

SYNTAX DIAGRAM

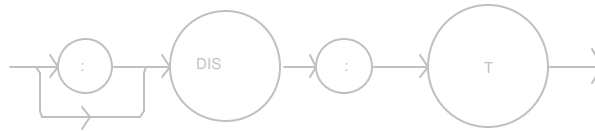

PARAMETERS

None.

POINTS OF INTEREST

The ACTUAL TEMP (T) display will be disabled automatically when the SET TEMP switch is activated.

In local operation, the actual temperature (T) display is activated by pressing the ACTUAL TEMP switch.

EXAMPLES

"DIS:T" -action: activates the ACTUAL TEMP switch and sets the display to show the measured temperature (T) value.

"Display:T" -action: activates the ACTUAL TEMP switch and sets the display to show the measured temperature (T) value.

- Front Panel
- Remote

DISplay:T?

The DISplay:T? query returns the status of the ACTUAL TEMP switch (on/off state) ANDed with the constant T mode status.

SYNTAX DIAGRAM

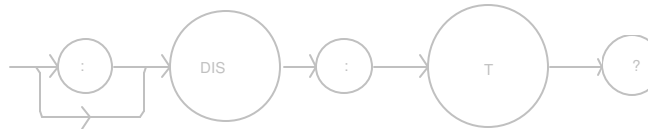

PARAMETERS

None. The response will be in the form:

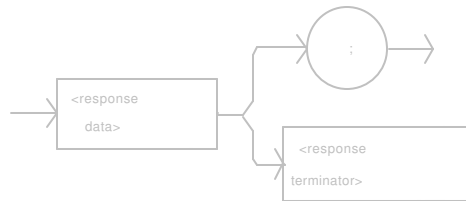

-where a response of 1 means on, and 0 means off.

POINTS OF INTEREST

The ACTUAL TEMP T value may not be displayed (on 5910B), even when the switch status is 1 (on), if the 5910B is in calibration mode or the display is otherwise disabled. In front panel operation, the Display T status is on if the SET T LED is on.

In local operation, the actual temperature display status is determined by visually inspecting the ACTUAL TEMP switch LED (lit = on).

EXAMPLES

"DIS:T?" -response: 1, means the display ACTUAL TEMP switch is activated and in the 5910B is in constant T mode.

"display:t?" -response: 0, means the ACTUAL TEMP switch is not activated or the 5910B is not in constant T mode.

Front Panel

Remote

ENABle:

The ENABle: command path is used to get to the 5910B's status enable commands and queries.

The following commands may be reached directly from the ENABle: command path.

ENABle:COND
ENABle:COND?
ENABle:EVEnt
ENABle:EVEnt?
ENABle:OUTOFF
ENABle:OUTOFF?

- Front Panel
- Remote

ENABLE:COND

The ENABLE:COND command sets the status condition enable register.

SYNTAX DIAGRAM

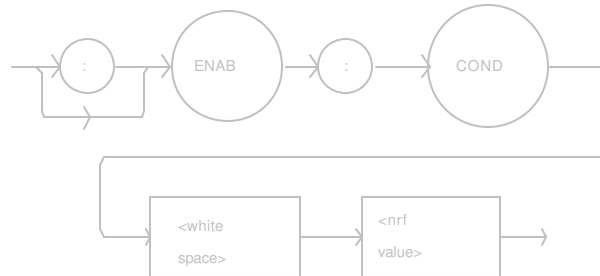

PARAMETERS

An <nrf value> whose sum represents the bits which are enabled:

- 1 - TE Current Limit
- 2 - Voltage Limit Error
- 4 - Low Temperature Limit
- 8 - High Temperature Limit
- 16 - Interlock Enable
- 32 - Booster Enable
- 64 - Sensor Open
- 128 - TE Module Open
- 256 - Sensor Shorted
- 512 - Output Out of Tolerance
- 1024 - Output On
- 2048 - Ready for Calibration Data
- 4096 - Calculation Error
- 8192 - Internal Communication Error with TEC Board
- 16384 - Software Error
- 32768 - EEPROM Checksum Error

POINTS OF INTEREST

The enabled and disabled conditions can be read by using the ENABLE:COND? query.
The condition status can be monitored by the COND? query.

EXAMPLES

"ENAB:COND 513" -action: enables the status condition register so that the Output Out of Tolerance and TE Current Limit conditions will be reported in the conditions register.
"Enable:Cond #HFFFF" -action: enables the status condition register so that all of the above conditions will be reported in the conditions register.

- Front Panel
- Remote

ENABLE:COND?

The ENABLE:COND? query returns the value of the status condition enable register.

SYNTAX DIAGRAM

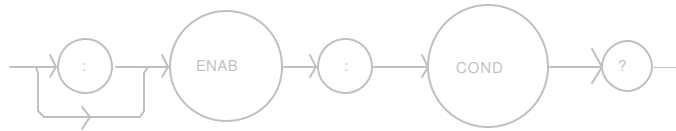

PARAMETERS None. The response will be in the form:

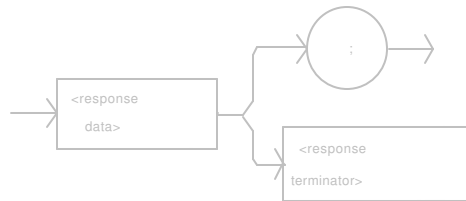

-where the response is the sum of the following:

- 1 - TE Current Limit
- 2 - Voltage Limit Error
- 4 - Low Temperature Limit
- 8 - High Temperature Limit
- 16 - Interlock Enable
- 32 - Booster Enable
- 64 - Sensor Open
- 128 - TE Module Open
- 256 - Sensor Shorted
- 512 - Output Out of Tolerance
- 1024 - Output On
- 2048 - Ready for Calibration Data
- 4096 - Calculation Error
- 8192 - Internal Communication Error with TEC Board
- 16384 - Software Error
- 32768 - EEPROM Checksum Error

POINTS OF INTEREST

The conditions which are reported to the status byte can be set by using the ENABLE:COND command.
The condition status can be monitored by the COND? query.

EXAMPLES

"ENAB:COND?" -response: 129, means that the TE Module Open and TE Current Limit conditions will be reported in the conditions register.
"Rad Hex; Enable:Cond?" -response: #HFFFF, means that all of the above conditions will be reported in the conditions register.

The ENABLE:EVEnt command sets the status event enable register.

SYNTAX DIAGRAM

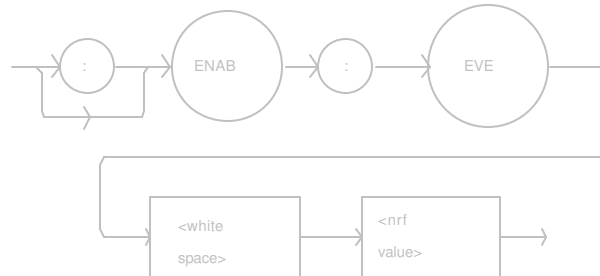

PARAMETERS

An <nrf value> whose sum represents the bits which are enabled:

- 1 - TE Current Limit
- 2 - Voltage Limit
- 4 - Low Temperature Limit
- 8 - High Temperature Limit
- 16 - Interlock Disabled
- 32 - Booster Changed
- 64 - Sensor Open
- 128 - TE Module Open
- 256 - Sensor Type Changed
- 512 - Output Changed to be In or Out of Tolerance
- 1024 - Output On/Off Changed
- 2048 - New Measurements Taken
- 4096 - Calculation Error
- 8192 - Internal TEC Control Communication Error
- 16384 - Software Error in TEC Control
- 32768 - EEPROM Checksum Error

POINTS OF INTEREST

The enabled and disabled events can be read by using the ENABLE:EVEnt? query.
 The event status can be read by the EVEnt? query, which then clears the Event Status Register.

EXAMPLES

"Enab:EVENT 160" -action: enables the TEC status event register so that the TE Module Open and Booster Changed conditions will be reported in the event register.
 "Enable:EVEnt #HFFFF" -action: enables the status event register so that all of the above events will be reported in the events register.

- Front Panel
- Remote

ENAB:EVEnt?

The ENAB:EVEnt? query returns the value of the status event enable register.

SYNTAX DIAGRAM

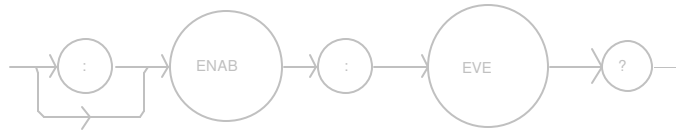

PARAMETERS None. The response will be in the form:

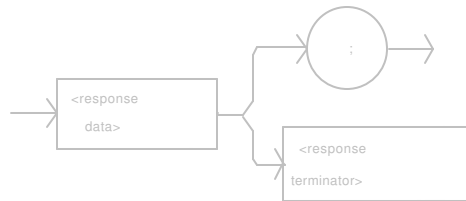

-where the response is the sum of the following:

- 1 - TE Current Limit
- 2 - Voltage Limit
- 4 - Low Temperature Limit
- 8 - High Temperature Limit
- 16 - Interlock Disabled
- 32 - Booster Changed
- 64 - Sensor Open
- 128 - TE Module Open
- 256 - Sensor Type Changed
- 512 - Output Changed to be In or Out of Tolerance
- 1024 - Output On/Off Changed
- 2048 - New Measurements Taken
- 4096 - Calculation Error
- 8192 - Internal TEC Control Communication Error
- 16384 - Software Error in TEC Control
- 32768 - EEPROM Checksum Error

POINTS OF INTEREST

The enabled and disabled events can be set by using the ENAB:EVEnt command.
The event status can be read by the EVEnt? query, which then clears the Event Status Register.

EXAMPLES

"ENAB:COND?" -response: 520, means that the High Temperature Limit and Output Out of Tolerance TEC events will be reported in the events register.

"Radix Hex; Enab:Eve?" -response: #HFFFF, means that all of the above events will be reported in the events register.

□ Front Panel **ENABLE:OUTOFF**
■ Remote

The ENABLE:OUTOFF command sets the status outoff enable register.

SYNTAX DIAGRAM

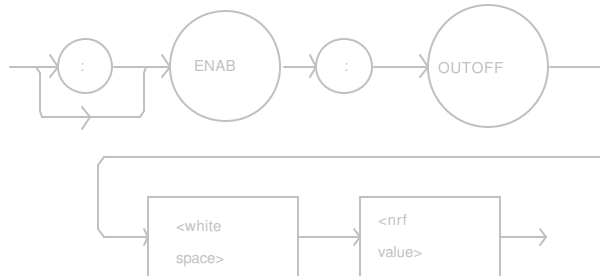

PARAMETERS

An <nrf value> whose sum represents the bits which are enabled:

- 1 - TE Current Limit Condition
- 2 - Voltage Limit Condition
- 4 - Low Temperature Limit Condition
- 8 - High Temperature Limit Condition
- 16 - Interlock Disabled Condition
- 32 - Booster Changed (While Output On) Event
- 64 - Sensor Open (While Output On) Condition
- 128 - Module Open (While Output On) Condition
- 256 - Sensor Type Change (While Output On) Event
- 512 - Output Out of Tolerance Condition
- 1024 - Sensor Shorted (While Output On) Condition
- 2048 - N/A
- 4096 - Software Error Condition
- 8192 - N/A
- 16384 - N/A
- 32768 - N/A

POINTS OF INTEREST

The enabled and disabled outoff bits can be read by using the ENABLE:OUTOFF? query.

EXAMPLES

"ENAB:OUTOFF 9" -action: enables the status outoff register so that a High Temperature Limit Condition or a TE Current Limit Condition will cause the TEC output to be turned off.

"Enab:Outoff #H17FF" -action: enables the status outoff register so that all of the above conditions will cause the TEC output to be turned off.

- Front Panel
- Remote

ENABLE:OUTOFF?

The ENABLE:OUTOFF? query returns the value of the status outoff enable register.

SYNTAX DIAGRAM

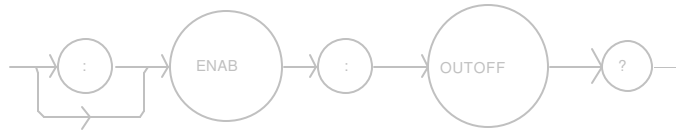

PARAMETERS None. The response will be in the form:

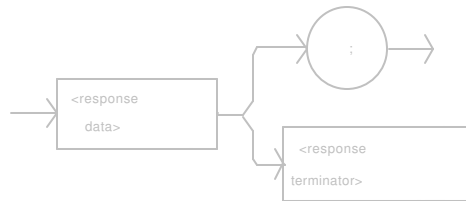

-where the response is the sum of the following:

- 1 - TE Current Limit Condition
- 2 - Voltage Limit Condition
- 4 - Low Temperature Limit Condition
- 8 - High Temperature Limit Condition
- 16 - Interlock Disabled Condition
- 32 - Booster Changed (While Output On) Event
- 64 - Sensor Open (While Output On) Condition
- 128 - Module Open (While Output On) Condition
- 256 - Sensor Type Change (While Output On) Event
- 512 - Output Out of Tolerance Condition
- 1024 - Sensor Shorted (While Output On) Condition
- 2048 - N/A
- 4096 - Software Error Condition
- 8192 - N/A
- 16384 - N/A
- 32768 - N/A

POINTS OF INTEREST

The enabled and disabled events can be set by using the ENABLE:OUTOFF command.

EXAMPLES

"ENAB:OUTOFF?" -response: 258, means that a Sensor Type Change Condition or a Voltage Limit Condition will cause the TEC output to be turned off.

"Radix Hex; Enab:Eve?" -response: #H17FF, means that all of the above conditions will cause the TEC output to be turned off.

The ERRors? query returns a list of the current errors (up to 10), since the last ERRors? query. These errors are notated by a number which corresponds to the type of error which occurred. See Appendix D for information regarding error handling.

SYNTAX DIAGRAM



PARAMETERS

None. The response will be in the form:

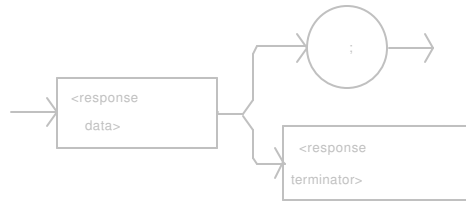

-where each <response data unit> is an integer which represents an error code value.

POINTS OF INTEREST

The response data will be a list of the errors since the last query. The errors are represented by integers and are separated by commas.
 A response of 0 indicates that no errors were reported. The response data is character data.
 In local operation, the errors are displayed (for three seconds) in the order that they are reported. After all of the errors which are currently reported have been displayed, the 5910B display will revert to its former state.
 See Appendix D for a complete list of error codes.

EXAMPLES

"ERR?" -response: 0, means no errors.
 "Errors?" -response: 205,404 means errors of program data not converting to a binary value, and current limit, respectively.

- Front Panel
- Remote

EVEnt?

The EVEnt? query returns the value of the status event register.

SYNTAX DIAGRAM



PARAMETERS

None. The response will be in the form:

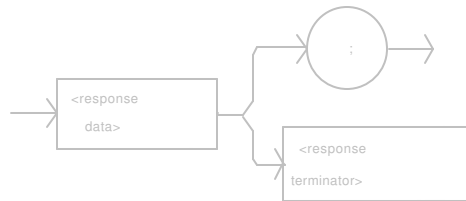

-where the response is the sum of the following:

- 1 - TE Current Limit
- 2 - Voltage Limit
- 4 - Low Temperature Limit
- 8 - High Temperature Limit
- 16 - Interlock Disabled
- 32 - Booster Changed
- 64 - Sensor Open
- 128 - TE Module Open
- 256 - Sensor Type Changed
- 512 - Output Changed to be In or Out of Tolerance
- 1024 - Output On/Off Changed
- 2048 - New Measurements Taken
- 4096 - Calculation Error
- 8192 - Internal TEC Control Communication Error
- 16384 - Software Error in TEC Control
- 32768 - EEPROM Checksum Error

POINTS OF INTEREST

The conditions which are reported to the status byte can be set by using the ENABLE:EVEnt command.

The event status is only cleared when the event status is read or a *CLS command is issued, while the condition status is constantly changing.

EXAMPLES

"EVE?" -response: 513, means that the Output went In or Out of Tolerance and the TE Current Limit TEC events have occurred since the last EVEnt? query.

"Radix Hex; Event?" -response: #H84, means that the Low Temperature Limit and TE Module Open events have occurred since the last EVEnt? query.

- Front Panel
- Remote

GAIN

The GAIN command sets the control loop gain.

SYNTAX DIAGRAM



PARAMETERS An <nrf value> between 1 - 300, the value will be stored to the nearest of: 1, 3, 10, 30, 100, or 300.

POINTS OF INTEREST

If the user enters a gain value which is greater than 300, a value of 300 will be stored. If the user enters a gain value which is less than 1, a value of 1 will be stored.

If the user enters a value which is not legal, the 5910B will round that value to the nearest legal value, if possible.

In local operation, the gain is entered by selecting the GAIN parameter, pressing and holding in the SET switch, and entering the desired value by adjusting the front panel knob. When the SET switch is released, the gain value is stored in non-volatile memory.

EXAMPLES

"GAIN 100" -action: the control loop gain is set to 100.0.

"gain 3" -action: the control loop gain is set to 3.0.

"Gain 200" -action: the control loop gain is set to 100.0 (the 5910B rounds 200 to the nearest valid number).

- Front Panel
- Remote

GAIN?

The GAIN? query returns the value of the control loop gain.

SYNTAX DIAGRAM



PARAMETERS

None. The response will be in the form:

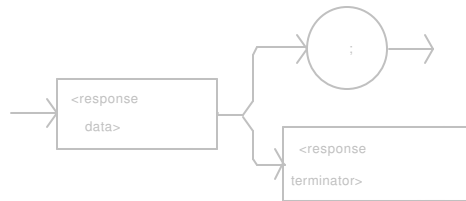

-where the response value is one of the following: 1.0, 3.0, 10.0, 30.0, 100.0, or 300.0.

POINTS OF INTEREST

If a value other than 1, 3, 10, 30, 100, or 300 is entered via the GAIN command, the nearest valid value will be stored.

In local operation, the gain value is queried by selecting the GAIN parameter and visually reading the display.

EXAMPLES

"Gain?" -response: 30.0, means the control loop gain is set to 30.

"GAIN?" -response: 100.0, means the control loop gain is set to 100.

Front Panel

Remote

INC

The INC command increments the selected control mode set point by one step.

SYNTAX DIAGRAM

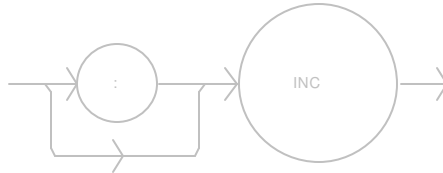

PARAMETERS

None.

POINTS OF INTEREST

A step of 1 corresponds to an increment of 0.1° C, 1 ohm (0.001 Kohms), 0.01 uA (AD590), or 0.1 mV (LM335) -depending on the control mode and SENSOR SELECT switch position. The INC command increments the set point which is currently being used.

EXAMPLES

"Mode:t; Step 10; Inc" -action: increments the temperature set point by 1.0° C.

"MODE:R; STEP 100; INC" -action: increments the resistance set point by 100 ohms, assuming the SENSOR SELECT switch is in the 100 or 10 uA (thermistor current) position.

Front Panel

Remote

ITE

The ITE command is used to enter the TEC current calibration values when current calibration is performed in remote mode.

SYNTAX DIAGRAM



PARAMETERS

An <nrf value> which represents the measured current in Amps.

POINTS OF INTEREST

This command is used only in conjunction with the "CAL:ITE" command, in order to enter the measured current values.

EXAMPLES

"ITE 1.002" -action: enters a calibration current value of 1.002 Amps.

"Ite .999" -action: enters a calibration current value of 0.999 Amps.

The ITE? query is used to read the actual TEC current output.

SYNTAX DIAGRAM

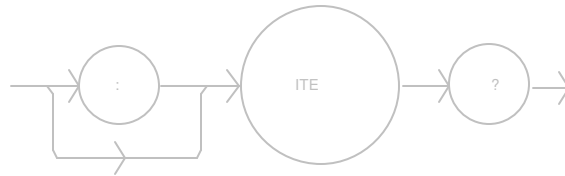

PARAMETERS

None. The response will be an `<nrf value>` which represents the measured current in Amps.

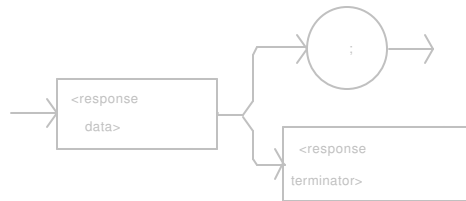

POINTS OF INTEREST

This query is used to read back the measured current values of the TEC output. This query is used primarily for troubleshooting diagnostics. For example, the measured LIM I value may be read (during the limit condition) to determine that it is calibrated correctly.

EXAMPLES

"ITE?" -response: 1.002, means the measured TEC output current is 1.002 Amps.

"Ite?" -response: 0.999, means the measured TEC output current is 0.999 Amps.

- Front Panel
 - Remote
-

LIMit:

The LIMit: command path is used to get to the 5910B's limit commands.

The following commands may be reached directly from the LIMit: command path.

- LIMit:ITE
- LIMit:ITE?
- LIMit:THI
- LIMit:THI?
- LIMit:TLO
- LIMit:TLO?

- Front Panel
- Remote

LIMit:ITE

The LIMit:ITE command sets the TEC TE current limit value.

SYNTAX DIAGRAM

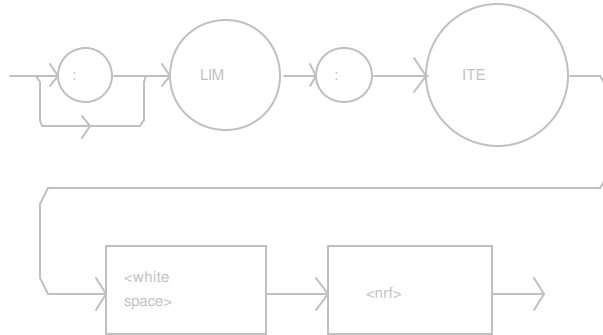

PARAMETERS

An <nrf value> representing the current limit in Amps.

POINTS OF INTEREST

This value limits the TE current for both positive and negative polarities (heating and cooling).

In local operation, the ITE limit is set by selecting the LIM I parameter, pressing and holding in the SET switch, and adjusting the knob until the desired value is shown on the display. When the SET switch is released, the value is stored in non-volatile memory.

EXAMPLES

"Lim:Ite 2" -action: limits the TE current to ± 2.000 A.

"LIMIT:ITE 4" -action: limits the TE current to ± 4.000 A.

- Front Panel
- Remote

LIMit:ITE?

The LIMit:ITE? query returns the value of the TE current limit.

SYNTAX DIAGRAM

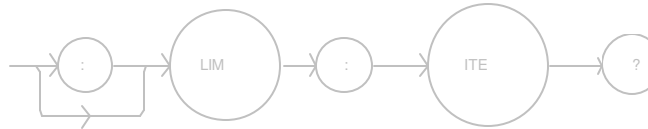

PARAMETERS

None. The response will be in the form:

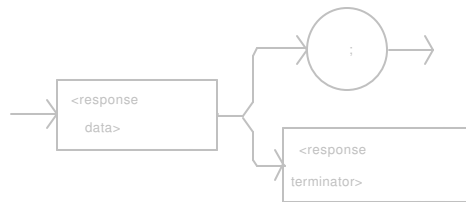

-where the response data represents the LIM ITE value, in Amps.

POINTS OF INTEREST

The limit value is for both polarities of the bipolar TE current.

In local operation, the ITE limit value is queried by selecting the LIM I parameter (LED lit) and visually reading the display.

EXAMPLES

"LIM:Ite?" -response: 2.0, means the TE current limit is ± 2.000 A.

"Limit:ITE?" - response: 4.0, means the TE current limit is ± 4.000 A.

- Front Panel
- Remote

LIMit:THI

The LIMit:THI command sets the TEC high temperature limit value.

SYNTAX DIAGRAM

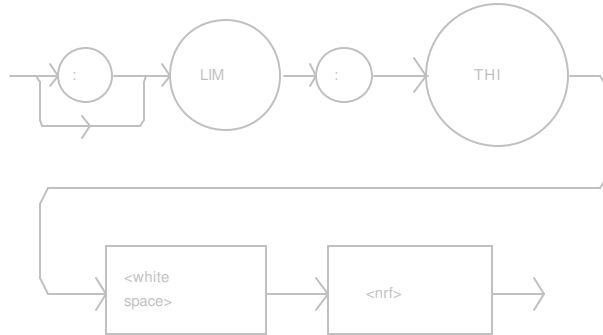

PARAMETERS

An <nrf value> which represents the high temperature limit, in ? C.

POINTS OF INTEREST

The high temperature limit must be greater or equal to the low temperature limit plus 10? C. The lower limit of the high temperature limit will not be exceeded. If the high temperature limit is to be below this point, the low temperature limit must first be changed to a lesser value.

This limit will be in effect for both constant T and constant R modes.

If the LIM T_{HI} value is set below the set point temperature, the set point temperature will automatically be changed to match the LIM T_{HI} value. However, the set point reference (R) value will not be changed.

EXAMPLES

"LIM:THI 30" -action: sets the upper bound of temperature to 30.0? C.

"limit:thi 10.4" -action: sets the upper bound of temperature to 10.4? C.

- Front Panel
- Remote

LIMit:THI?

The LIMit:THI? query returns the value of the TEC high temperature limit.

SYNTAX DIAGRAM

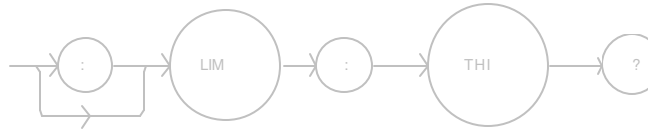

PARAMETERS

None. The response will be in the form:

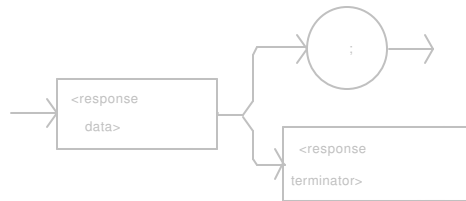

-where the response data represents the LIM T value, in ? C.

POINTS OF INTEREST

The limit will be in effect for both constant T and constant R modes.

In local operation, the high temperature limit can be queried by selecting the LIM T_{HI} parameter (LED lit) and visually reading the limit value on the display.

EXAMPLES

"LIM:THI?" -response: 30.0, means the upper bound of the temperature is 30.0? C.

"Lim:Thi?" -response: 100.4, means the upper bound of the temperature is 100.4? C.

- Front Panel
- Remote

LIMit:TLO

The LIMit:TLO command sets the TEC low temperature limit value.

SYNTAX DIAGRAM

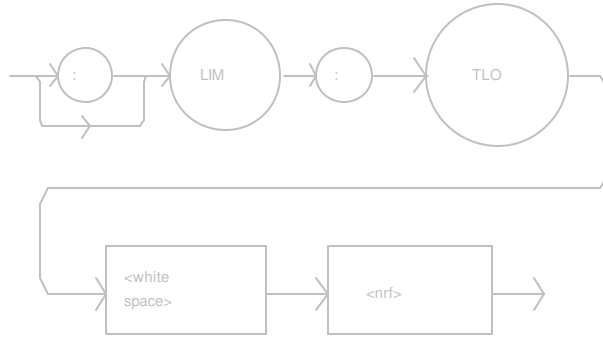

PARAMETERS

An `<nrf value>` which represents the lower temperature bound, in $^{\circ}\text{C}$.

POINTS OF INTEREST

The low temperature limit must be lesser or equal to the high temperature limit minus 10°C . The upper limit of the low temperature limit will not be exceeded. If the low temperature limit is to be above this point, the high temperature limit must first be changed to a greater value.

The limit will be in effect for both constant T and constant R modes.

If the $\text{LIM } T_{\text{LO}}$ value is set above the set point temperature, the set point temperature will automatically be changed to match the $\text{LIM } T_{\text{LO}}$ value. However, the set point reference (R) value will not be changed.

EXAMPLES

"Limit:TLO -30.5" -action: sets the lower temperature bound to -30.5°C .

"LIM:Tlo 0" -action: sets the lower temperature bound to 0.0°C .

- Front Panel
- Remote

LIMit:TLO?

The LIMit:TLO? query returns the value of the TEC low temperature limit.

SYNTAX DIAGRAM

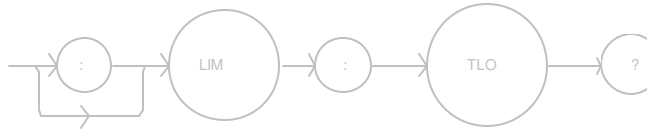

PARAMETERS

None. The response will be in the form:

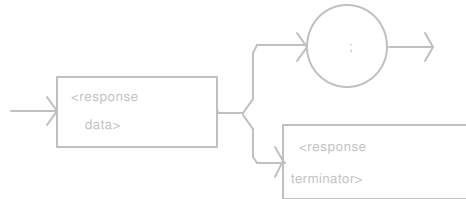

-where the response data represents the LIM TLO value, in ? C.

POINTS OF INTEREST

The limit will be in effect for both constant T and constant R modes.

In local operation, the lower temperature limit can be queried by selecting the LIM T_{LO} parameter (LED lit) and visually reading the value on the display.

EXAMPLES

"Lim:Tlo?" -response: 10.3, means the lower temperature limit is 10.3? C.

"LIM:TLO?" -response: 0, means the lower temperature limit is 0.0? C.

- Front Panel
 - Remote
-

LOCK:

The LOCK: command path is used to get to the 5910B's lock commands.

The following commands may be reached directly from the LOCK: command path.

LOCK:ADJ
LOCK:ADJ?

- Front Panel
- Remote

LOCK:ADJ

The LOCK:ADJ command activates or deactivates the LOCK mode of operation, and sets the front panel switch accordingly.

SYNTAX DIAGRAM

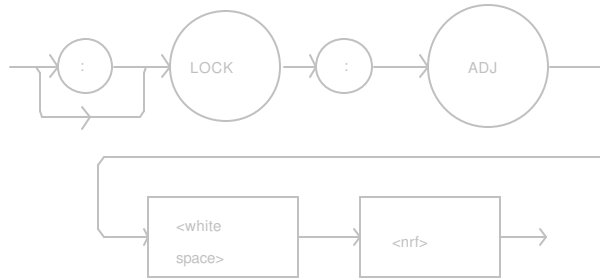

PARAMETERS An <nrf value>; 1 = on, 0 = off.

POINTS OF INTEREST

When LOCK mode is in operation, the set point temperature and resistance cannot be changed.

The LOCK mode is entered momentarily whenever a parameter is set.

In local operation, the LOCK mode is activated by pressing the LOCK switch when its LED is unlit, and deactivated by pressing the LOCK switch when its LED is lit.

EXAMPLES

"Lock:Adj 1" -action: activates the LOCK switch (and mode).

"LOCK:ADJ 0" -action: deactivates the LOCK switch (and mode).

"LOCK:Adj off" -action: deactivates the LOCK switch (and mode).

- Front Panel
- Remote

LOCK:ADJ?

The LOCK:ADJ? query returns the status of the LOCK switch (mode).

SYNTAX DIAGRAM

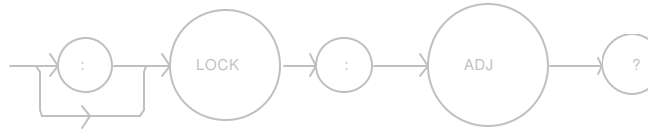

PARAMETERS

None. The response will be in the form:

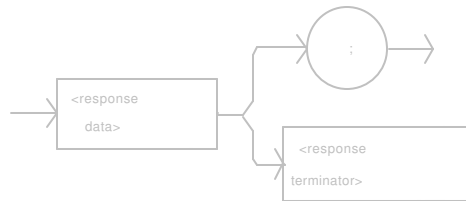

-where a response of 1 means on, and 0 means off.

POINTS OF INTEREST

LOCK mode may be in effect in remote operation as well as in local (front panel) operation. When the OUTPUT ON LED is on, the LOCK status is on.

In local operation, the LOCK mode status is queried by visually inspecting the LOCK switch LED (lit = on).

EXAMPLES

"LOCK:ADJ?" -response: 1, means LOCK mode is activated.

"Lock:adj?" -response: 0, means LOCK mode is deactivated.

The MESsage command allows the user to enter an ASCII string of up to 16 characters. This command may be useful for storing messages which relate to a test or configuration.

SYNTAX DIAGRAM



PARAMETERS An ASCII string which is 1 - 16 bytes in length.

POINTS OF INTEREST

The message may contain any ASCII character, but will be terminated when a NULL terminator character is received. If the message has less than 16 bytes, the software will fill the remaining message space with the space character. After 16 bytes have been entered, the software will null-terminate the string.

EXAMPLES

MESSAGE "This is a test." -action: The string, "This is a test." will be stored in non-volatile memory.

Mes "Test 3" -action: The string, "Test 3 " will be stored in non-volatile memory.

- Front Panel
- Remote

MESsage?

The MESsage? query returns the previously stored message. This message will always be 16 bytes long and enclosed in double quotes. The message is entered via the MESsage command.

SYNTAX DIAGRAM

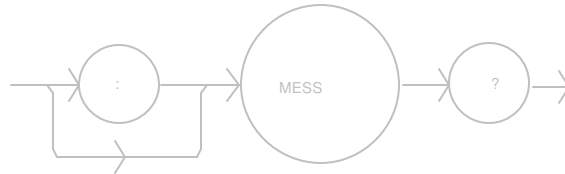

PARAMETERS

None. The response will be in the form:

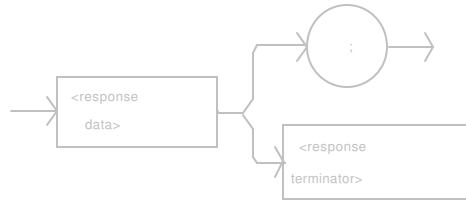

-where the data is a 16-byte long ASCII string.

POINTS OF INTEREST

The response data will be a 16-byte long ASCII string. If there is no previously stored message, the response will be " ", all spaces.

EXAMPLES

MES? -response: "Test 3 ", means the previously stored message was "Test 3".

Message? -response: "This is a test. ", means the previously stored message was "This is a test."

- Front Panel
- Remote

MODE?

The MODE? query returns the selected control mode.

SYNTAX DIAGRAM

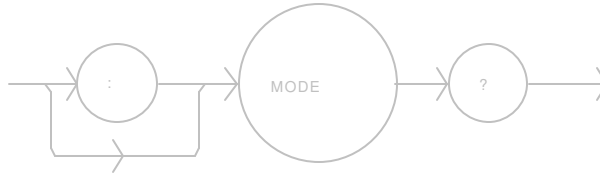

PARAMETERS

None. The response will be in the form:

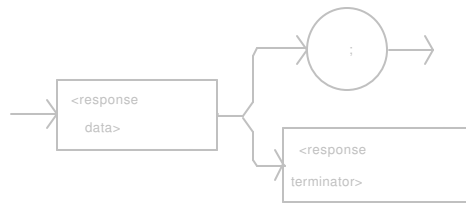

-where the response is a character data:

R - means the unit is in constant
Resistance/Reference mode

T - means the unit is in constant Temperature mode

POINTS OF INTEREST

Constant R mode can only be entered via remote operation.

EXAMPLES

"Mode?" -response: T, means the 5910B is operating in constant T mode (controlling to T set point).

"MODE?" -response: R, means the 5910B is operating in constant R mode (controlling to R set point).

Front Panel

Remote

MODE:

The MODE: command path is used to get to the 5910B's TEC mode selection commands.

The following commands may be reached directly from the MODE: command path.

MODE:R

MODE:T

□ Front Panel

■ Remote

MODE:R

The MODE:R command selects constant Resistance/(Linear Sensor) Reference operation mode.

SYNTAX DIAGRAM

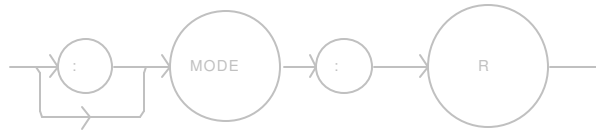

PARAMETERS None.

POINTS OF INTEREST

This mode is only accessible through remote operation.

Since sensor resistance (or linear sensor reference) is a function of temperature, this mode also controls the TEC output load temperature, but it bypasses the use of the conversion constants for set point calculation. This allows finer control of temperature in cases where the sensor's temperature model (and therefore the constants) is not known.

Changing modes causes the output to be forced off.

EXAMPLES

"Mode:r" -action: sets the 5910B to constant Resistance/Reference mode.

"MODE:R" -action: sets the 5910B to constant Resistance/Reference mode.

- Front Panel
- Remote

MODE:T

The MODE:T command selects constant Temperature mode.

SYNTAX DIAGRAM

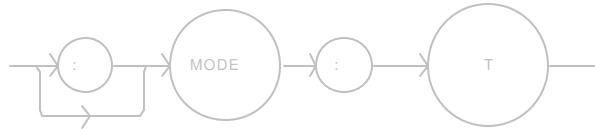

PARAMETERS

None.

POINTS OF INTEREST

The constant T mode is the default mode of operation, and it is the only mode of operation available from local (front panel) control.

EXAMPLES

"mode:t" -action: sets the 5910B to constant Temperature control mode.

"MODE:T" -action: sets the 5910B to constant Temperature control mode.

- Front Panel
- Remote

OUTput

The OUTput command turns the TEC output on or off.

SYNTAX DIAGRAM



PARAMETERS An <nrf value> -where 1 = on, 0 = off.

POINTS OF INTEREST

When the output is on, the OUTPUT indicator LED will be red if the output (TEC) current is positive (heating) or green if the output (TEC) current is negative (cooling).

EXAMPLES

"Output 1" -action: turns the output on.

"OUT 0" -action: turns the output off.

"output off" -action: turns the output off.

The OUTput? query returns the status of the TEC output setting.

SYNTAX DIAGRAM

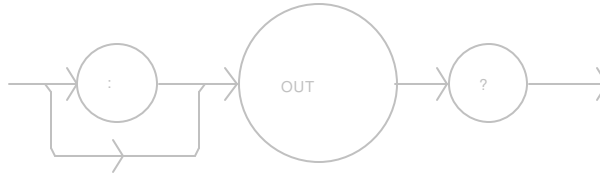

PARAMETERS

None. The response will be in the form:

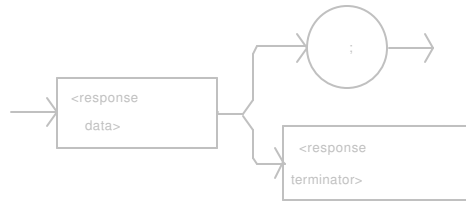

-where 1 = on, 0 = off.

POINTS OF INTEREST

The response will be a "1" if the switch status is "on", and it will be "0" if the switch status is "off". This response does not depend on the completion of the "OUT" command, only on the switch status. When the front panel LED is on, the OUTPUT status is on.

EXAMPLES

"Out?" -response: 0, means the OUTPUT switch is off.

"OUT?" -response: 1, means the OUTPUT switch is on.

The R command allows the setting of the thermistor resistance, AD590 current, or LM335 voltage set point, depending on the position of the back panel SENSOR SELECT switch.

SYNTAX DIAGRAM



PARAMETERS

An `<nrf value>`; this value represents thermistor resistance in Kohms, or the AD590 current in uA, or the LM335 voltage in mV.

POINTS OF INTEREST

Setting the R set point will not effect the controller operation unless constant R mode is used. R may be in the range: 0.001 - 500.0 Kohms, 0.01 - 5000.0 uA, or 0.1 - 50000.0 mV, for the respective sensor types.

EXAMPLES

"R 20.4" -action: the set point thermistor resistance is 20.4 Kohms, assuming the SENSOR SELECT switch is in the 100 or 10 uA (thermistor current) position.

"r .1" -action: the set point thermistor resistance is 100 ohms, assuming the SENSOR SELECT switch is in the 100 or 10 uA (thermistor current) position.

"r 2540" -action: the set point AD590 current is 25.4 uA, assuming the SENSOR SELECT switch is in the AD590 position.

"R 29.9" -action: the set point LM335 voltage is 2.99 mV, assuming the SENSOR SELECT switch is in the LM335 position..

- Front Panel
- Remote

R?

The R? query returns the reading of the measured thermistor resistance, AD590 voltage, or LM335 current, depending on the setting of the back panel SENSOR SELECT switch.

SYNTAX DIAGRAM

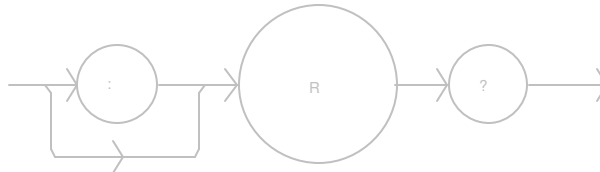

PARAMETERS

None. The response will be in the form:

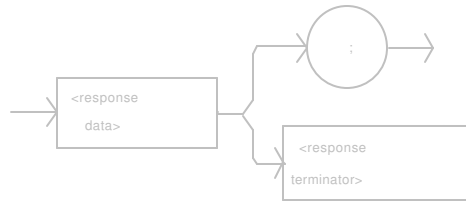

-where the response is an $\langle nrf \text{ value} \rangle$ which represents the measured thermistor resistance in Kohms, AD590 current in μA , or LM335 voltage in mV.

POINTS OF INTEREST

The measured temperature (T?) is a function of the measured resistance or sensor reference (R?).

EXAMPLES

"mode:t; R?" -response: 50.0, means 50.0 Kohms, or 0.50 μA (if AD590), or 5.0 mV (if LM335) is the measured resistance or sensor reference while the 5910B is controlling to the temperature set point value.

"MODE:R; R?" -response: 12.5, means 12.5 Kohms, or 12.5 μA (if AD590), or 12.5 mV (if LM335) is the measured resistance or sensor reference while the 5910B is controlling to the temperature set point value.

The RADix command allows the programmer to select the radix type for status, condition, and event query response data. Decimal, binary, octal, and hexadecimal are allowed.

SYNTAX DIAGRAM



PARAMETERS

Character data is expected, as shown above.

POINTS OF INTEREST

DECimal is the default type. Only the first three letters of the words decimal, hexadecimal, octal, or binary are required.

When the RADIX is selected, numeric response data for status, condition, and event queries will assume the new radix.

In the cases where the radix is not DECimal, the flexible numeric type <nrf value> (as shown in the Command Reference diagrams) will be replaced by HEX, BIN, or OCT representation.

All of the above radices may be used to enter program data at any time, without the need for issuing the RADix command. The proper prefix must also be used with Hex (#H), binary (#B), or octal (#Q).

This command may be useful for setting up status reporting blocks. The bit-wise status representation may be more easily read in BIN, HEX, or OCT.

EXAMPLES

"RAD dec" -action: the decimal radix is selected.

"rad hex; *ESR?" -action: the hexadecimal radix is selected; -response: #H80, means power-on was detected.

"rad BIN" -action: the radix is set to binary.

"radix Octal" -action: the radix is set to octal.

- Front Panel
- Remote

RADix?

The RADix? query allows the programmer to determine which radix type for status, condition, and event query response data is currently selected. Decimal, binary, octal, and hexadecimal are allowed.

SYNTAX DIAGRAM

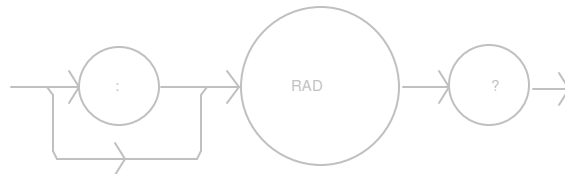

PARAMETERS

None. The response will be in the form:

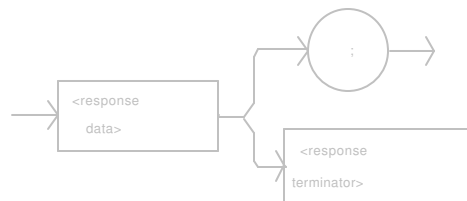

-where the response is character data; DEC means decimal, BIN means binary, OCT means octal, and HEX means hexadecimal.

POINTS OF INTEREST

DEC is the default type. The 5910B defaults to this radix at power-up.

The RADix command is used to select the desired radix. Once it is changed, the new radix will remain in effect until the power is shut off or a new RADix command is issued.

EXAMPLES

"RAD?" -response: Dec, means the selected radix is decimal.

"rad?" -response: Hex, means the selected radix is hexadecimal.

"RADIX?" -response: Oct, means the selected radix is octal.

"rad?" -response: Bin, means the selected radix is binary.

Front Panel

Remote

SECURE

The SECURE command allows the service technician access to the protected user data command, *PUD, which is a common command. This data is normally changed only at the factory, and therefore the SECURE command is not needed by the user.

Front Panel

Remote

SENsor?

The SENsor? query is used to read back the SENSOR SELECT switch position value. This value is a coded representation of the sensor type/thermistor sensor current.

SYNTAX DIAGRAM

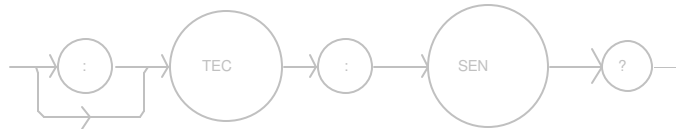

PARAMETERS

None. The response will be in the form:

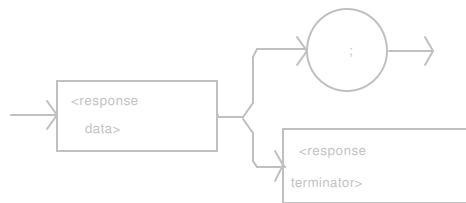

-where the response of 1 = thermistor, at 10 uA;
2 = thermistor, at 100 uA; 3 = LM335 sensor; 4 = AD590 sensor.

POINTS OF INTEREST

The sensor code is displayed on the TEC display whenever the back panel SENSOR SELECT switch position is changed.

The sensor selection must be made locally at the back panel SENSOR SELECT switch.

In local operation, the setting of the SENSOR SELECT switch may be read by visually inspecting the back panel SENSOR SELECT switch.

If the response is 0, the sensor type is undetermined and a hardware error must exist.

EXAMPLES

"Sensor?" -response: 1, means the SENSOR SELECT switch is in the 10 uA thermistor position.

"SEN?" -response: 4, means the AD590 sensor is selected by the back panel SENSOR SELECT switch.

- Front Panel
 - Remote
-

SET:

The SET: command path is used to get to the 5910B's set point queries.

The following commands may be reached directly from the SET: command path.

SET:R?
SET:T?

- Front Panel
- Remote

SET:R?

The SET:R? query returns the constant Resistance or Linear Sensor Reference set point value.

SYNTAX DIAGRAM

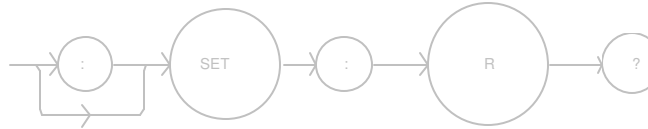

PARAMETERS

None. Response will be in the form:

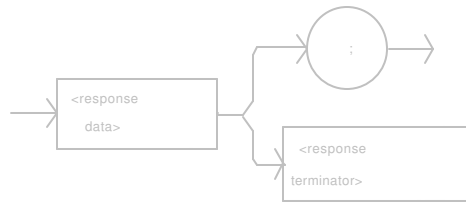

-where the response data is an <nrf value> for the set resistance/reference, in Kohms or mV (LM335) or uA (AD590).

POINTS OF INTEREST

The resistance/reference set point has no effect on the operation of the 5910B, except when it is in constant R mode.

The R set point value represents the resistance or reference set point, depending on the position of the SENSOR SELECT switch.

EXAMPLES

"SET:R?" -response: 20.0, means the resistance set point is 20.000 Kohms, assuming the SENSOR SELECT switch is in the 100 or 10 uA (thermistor current) position.

"MODE:R; OUT on; SET:r?" -response: 10.5, means the sensor reference set point is 10.5 mV, assuming the SENSOR SELECT switch is in the LM335 position (and the 5910B is controlling the sensor to this value).

- Front Panel
- Remote

SET:T?

The SET:T? query returns the constant Temperature set point value.

SYNTAX DIAGRAM

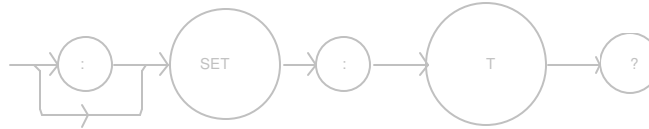

PARAMETERS

None. Response will be in the form:

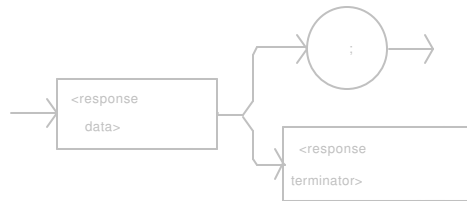

-where the response data is an <nrf value> for the set temperature, in ? C.

POINTS OF INTEREST

The temperature set point has no effect on the operation of the 5910B when in constant R mode. Front panel operation defaults to constant T mode.

In local operation, the set temperature is determined by pressing the SET TEMP switch and visually reading the display.

EXAMPLES

"SET:T?" -response: 10.1, means the temperature set point is 10.1? C.

"Mode:r; Output 1; Set:t?" -response: 0.0, means the temperature set point is 0.0? C (but not controlled to that value).

- Front Panel
- Remote

STEP

The STEP command increments/decrements the selected control mode set point by the given amount.

SYNTAX DIAGRAM



PARAMETERS

An integer value of the step amount, in the range 1 - 9999.

POINTS OF INTEREST

The step of 1 corresponds to the smallest incremental change of the mode. For example, a step of 1 means 0.1° C, 0.001 Kohms, 0.1 mV (LM335), or 0.01 uA (AD590).

EXAMPLES

"Mode:t; t 20; Step 10; set:t?" -action: sets the step to 1° C, so the set:t? query will return a value of 21° C.

"STEP 100" -action: sets the step size to 100; could mean 10° C, 0.1 Kohm, 10.0 mV (LM335), or 1.0 uA (AD590), depending on the mode and setting of the SENSOR SELECT switch.

The STEP? query returns the control mode step value.

SYNTAX DIAGRAM



PARAMETERS

None. The response will be in the form:

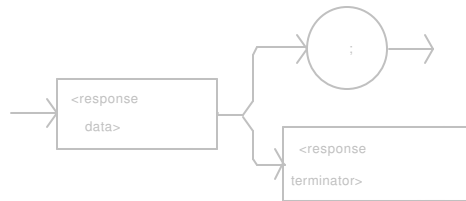

-where the response data is an integer value of the step amount, in the range 1 - 9999.

POINTS OF INTEREST

The step of 1 corresponds to the smallest incremental change of the mode. For example, a step of 1 means 0.1? C, 0.001 Kohms, 0.1 mV (LM335), or 0.01 uA (AD590).

EXAMPLES

"STEP?" -response: 100.0, means the step size is 100; could mean 10? C, 0.1 Kohms, 10.0 mV, or 1.0 uA, depending on the mode and the position of the SENSOR SELECT switch.

"Step?" -response: 10.0, means the step size is 10; could mean 1? C, 0.01 Kohms, 1.0 mV, or 0.1 uA, depending on the mode and position of the SENSOR SELECT switch.

The SYNTAX command sets the 5910B syntax for the old (5910) syntax and command set or the new (5910B) IEEE-488.2 standard syntax and command set.

SYNTAX DIAGRAM

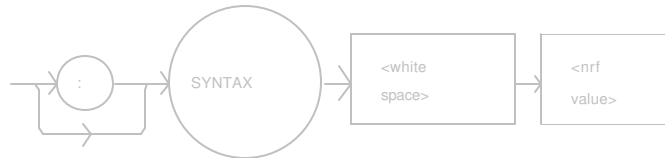

PARAMETERS An integer value, where 0 = NEW and 1 = OLD.

POINTS OF INTEREST

The old syntax is not documented here, but is allowed for users who have upgraded from the 5910 and wish to its command set and syntax.

The old syntax is not recommended for use with the 5910B because it does not comply with the IEEE-488.2 standard, and the new syntax and command set are more comprehensive than the old.

The 5910B defaults to the new syntax, unless this command is issued specifying the old syntax.

When the old syntax is specified by the "SYNTAX 1" command, it will be in effect until the new syntax is specified (by the "SYNTAX 0" command) or the 5910B is powered down.

See Section 4.2.1 for the differences between the commands which are supported via the "SYNTAX OLD" command and the OLD (5910) command set.

EXAMPLES

"SYNTAX 1 -action: sets the 5910B to work with the old 5910 syntax and command set.

"Syntax 0 -action: sets the 5910B to work with the new (5910B) IEEE-488.2 syntax and command set.

The SYNTAX? query returns the syntax type, old or new.

SYNTAX DIAGRAM

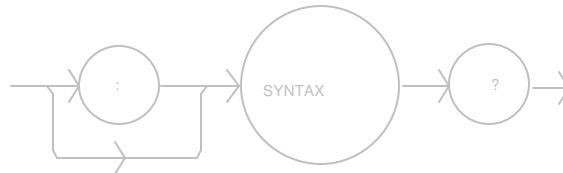

PARAMETERS

None. The response will be in the form:

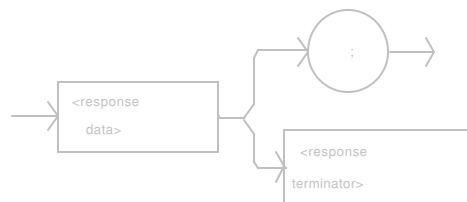

-where the response data is an integer value; 0 = new, 1 = old.

POINTS OF INTEREST

The 5910B defaults to the new syntax, unless this command is issued specifying the old syntax.

When the old syntax is specified by the "SYNTAX 1" command, it will be in effect until the new syntax is specified (by the "SYNTAX 0" command) or the 5910B is powered down.

See Section 4.2.4 for the differences between the commands which are supported via the "SYNTAX OLD" command and the OLD (5910) command set.

EXAMPLES

"Syntax?" -response: 1, means the old (5910) syntax is in effect.

"SYNTAX?" -response: 0, means the new syntax is in effect, all of the commands in this manual are valid.

The T command allows the setting of the temperature set point in ? C.

SYNTAX DIAGRAM

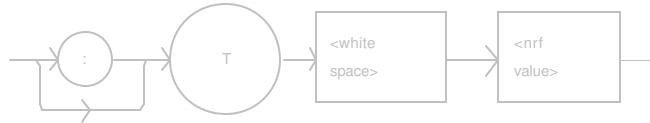

PARAMETERS

An <nrf value> representing temperature in the range: 99.9 - 199.9 ? C, maximum. The temperature set point will be bounded automatically by the LIM T_{HI} and LIM T_{LO} values.

POINTS OF INTEREST

Temperature set point will only effect operation in the constant Temperature mode.

Temperature resolution is to 0.1? C.

The T set point will be automatically adjusted to the LIM T_{HI} parameter value if that limit is set below the existing temperature set point. Likewise, the T set point will be automatically adjusted to the LIM T_{LO} parameter value if that limit is set above the existing temperature set point.

In local operation, the temperature set point is reset by turning the knob, when not in LOCK mode. If it is desired to view the temperature set point while changing it, use AUTO mode or press the SET TEMP switch before turning the knob. The temperature set point will then be shown on the display.

EXAMPLES

"T 33" -action: sets the temperature set point to 33? C.

"t 15.3" -action: sets the temperature set point to 15.3? C.

"T 40; LIM:THI 30" -action: sets the temperature set point to 40? C, then sets the upper temperature limit to 30? C, which forces the temperature set point value to also be 30? C.

"T 0; LIM:TLO 10" -action: sets the temperature set point to 0? C, then sets the lower temperature limit to 10? C, which forces the temperature set point value to also be 10? C.

The T? query returns the value of the measured temperature in °C.

SYNTAX DIAGRAM

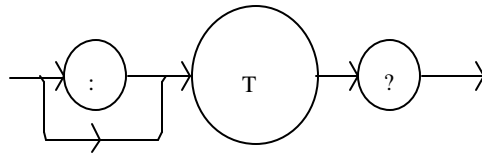

PARAMETERS None. Response is in the form:

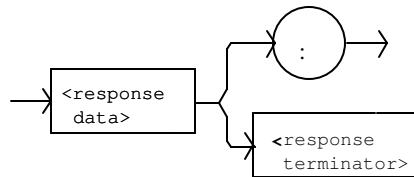

-where the response data value is an $\langle nrf \text{ value} \rangle$ which represents the measured temperature in °C.

POINTS OF INTEREST

Measured temperature may be read, even if from constant R mode.

In local operation, the temperature set point is determined by pressing the SET TEMP switch and visually reading the display.

EXAMPLES

"Mode:R; t?" -response: 30.12 means the measured temperature is 30.12°C, while in constant R (control) mode.

"mode:t; t?" -response: -12.35, means the measured temperature is -12.35°C, while in constant T (control) mode.

The TERM command allows the programmer to select the message terminator type for GPIB messages. <CR> (carriage return), <CR><NL> (new line), <CR><^END> (EOI), <CR><NL><^END>, <NL><^END>, <NL>, and <^END> are allowed.

SYNTAX DIAGRAM



PARAMETERS

An <nrf value>, where 0 = <CR><NL><^END>, 1 = <CR><NL>, 2 = <CR><^END>, 3 = <CR>, 4 = <NL><^END>, 5 = <NL>, 6 = <^END>, and 7 = No terminators are appended.

POINTS OF INTEREST

<CR><NL><^END> (0) is the default type.

EXAMPLES

"TERM 5" -action: the <NL> (new line) terminator is selected. The 5910B will terminate a message with the <NL> character.

"Term 4" -action: the <NL> (new line) <^END> (EOI) terminator is selected. The 5910B will terminate a message with the <NL><^END> characters, in succession, and in that order.

The TERM? query allows the programmer to determine which program message terminator is currently selected. <CR> (carriage return), <CR><NL> (new line), <CR><^END> (EOI), <CR><NL><^END>, <NL><^END>, <NL>, and <^END> are allowed.

SYNTAX DIAGRAM

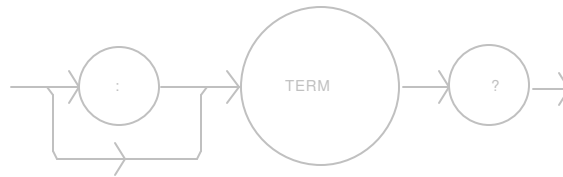

PARAMETERS

None. The response will be in the form:

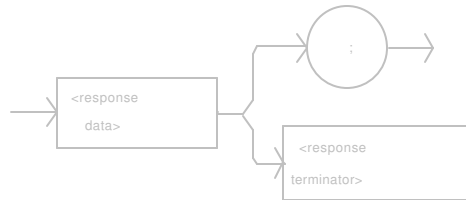

where 0 = <CR><NL><^END>, 1 = <CR><NL>, 2 = <CR><^END>, 3 = <CR>, 4 = <NL><^END>, 5 = <NL>, 6 = <^END>, and 7 = No terminators are appended.

POINTS OF INTEREST

<CR><NL><^END> (0) is the default type.

Although the <CR> is recognized as <white space> by the IEEE-488.2 standard, it is used as a possible terminator in order to be compatible with previous ILX products' command syntax.

EXAMPLES

"Term?" -response: 0, means the selected program message terminator is the <CR><NL><^END> characters, in succession, in that order.

"TERM?" -response: 2, means the selected program message terminator is the <CR><^END> characters, in succession, and in that order.

- Front Panel
- Remote

TIME?

The TIME? query allows the programmer to determine how much time has passed since the 5910B was last powered up.

SYNTAX DIAGRAM

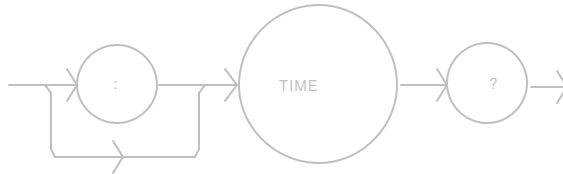

PARAMETERS

None. The response will be in the form:

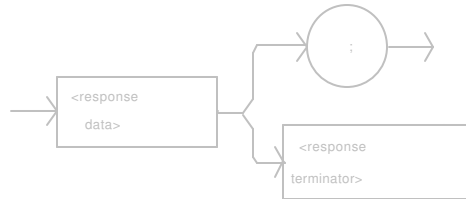

-where the response is character data in the form: hours:minutes:seconds.

POINTS OF INTEREST

The TIMER? query has no effect on the value of the TIME clock.

EXAMPLES

"Time?" -response: 0:01:02.0, means that 1 minute and 2.000 seconds have passed since the 5910B was powered up.

"TIME?" -response: 0:03:20.2, means that 3 minutes and 20.200 seconds have passed since the 5910B was powered up.

- Front Panel
- Remote

TIMER?

The TIMER? query allows the programmer to determine how much time has passed since the last TIMER query was issued.

SYNTAX DIAGRAM

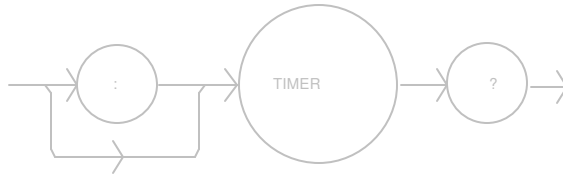

PARAMETERS

None. The response will be in the form:

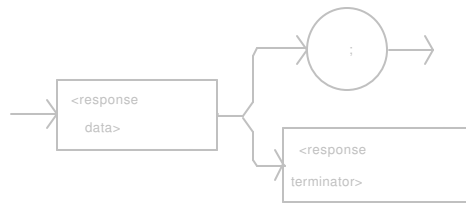

-where the response is character data which represents hours:minutes:seconds.

POINTS OF INTEREST

This query will return the elapsed time since the last TIMER? query or since the 5910B was last powered on, if no previous TIMER? query has been issued. Then it resets the timer to 0.

EXAMPLES

"Timer?" -response: 0:02:03.07 means the 5910B has been on for 2 minutes and 3.070 seconds since the last TIMER? query was issued.

"TIMER?" -response: 0:14:37.184, means the 5910B has been on for 14 minutes and 37.184 seconds since the last TIMER? query was issued.

The TOLerance command allows the programmer to determine the temperature tolerance, and time window for it to occur, in order that the operation complete flag be set after the output is turned on or the set point is changed.

SYNTAX DIAGRAM

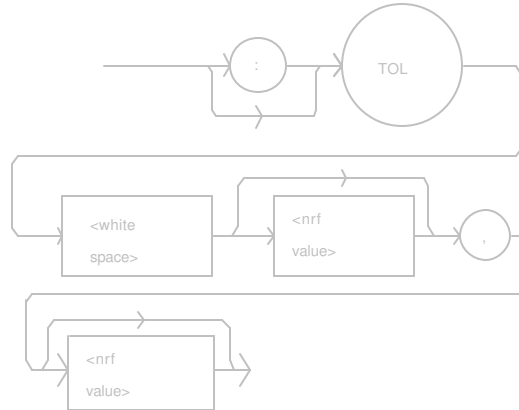

PARAMETERS

Two <nrf values>; the first represents the temperature tolerance, in ° C, with a range of 0.1 to 1.0 ° C; and the second represents the time window, in seconds, with a range of 0.001 to 50.0 seconds.

POINTS OF INTEREST

The 5910B defaults to a tolerance of 0.2° C for 5 seconds, unless changed by the TOLerance command.

This command may be used in conjunction with the common query *OPC? and common command *WAI to delay further program activities until the output temperature reaches its set point to the specifications of the TOLerance command.

For example, if the set point is 10° C, tolerance is 0.2° C for 5 seconds, and the output is turned on, the user may issue the *WAI command to ensure this set point is reached before continuing. In this case, the 5910B will wait until its TEC load temperature is within 0.2° C of 10° C for 5 seconds until the next command is executed.

EXAMPLES

"Tol 0.5,10" -action: the 5910B will be in tolerance when the temperature is within 0.5° C for 10 seconds.

"TOLer 0.1,1.05" -action: the 5910B will be in tolerance when the temperature is within 0.1° C for 1.05 seconds.

- Front Panel
- Remote

TOLerance?

The TOLerance? query allows the programmer to determine how the temperature tolerance is set.

SYNTAX DIAGRAM

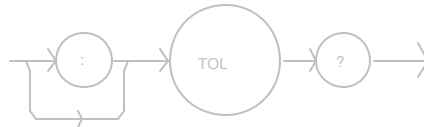

PARAMETERS None. The response will be in the form:

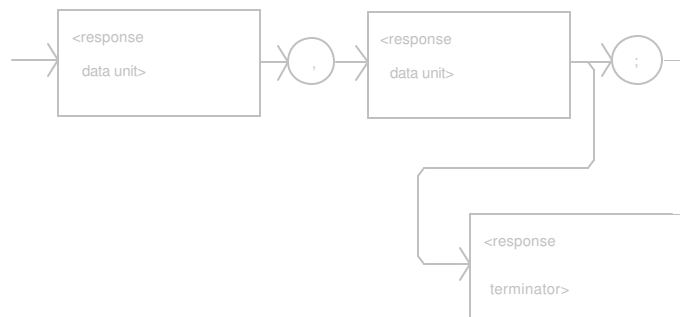

-where the response consists of two values, the first represents the temperature tolerance, in ? C; the second represents the time window, in seconds.

POINTS OF INTEREST

The tolerance of the 5910B temperature controller may be used to delay programming after an "OUTput 1" command is issued, or the TOLerance query may be used in a program loop as a check for temperature drift.

The tolerance flag is also used in the status event register, and so entering or exiting temperature tolerance may be used to generate interrupts.

EXAMPLES

"Tol?" -response: 0.2,5.0 -means the 5910B has a tolerance setting of 0.2? C with a time window of 5.000 seconds.

"TOL?" -response: 1.0,20.0 -means the 5910B has a tolerance setting of 1.0? C with a time window of 20.000 seconds.

3.5 Error Messages

Error messages may appear on the display when error conditions occur in the 5910B. In most cases, the error message will appear for three seconds and then the display will revert to its former state. In the case of multiple error messages, the 5910B will show each message for three seconds in succession.

In remote operation, the current error list can be read by issuing the "ERR?" query. When this is done, a string will be returned containing the error messages (up to 10 errors) which are currently in the error message queue.

Appendix D contains an explanation of the error messages which may be reported by the 5910B on the display or via GPIB.

3.6 5910B Programming Examples

This section is intended as a simple example of programming the 5910B over the GPIB. The first short examples contain sections of a BASIC program. These examples are not complete programs, and therefore cannot be used by themselves. However, they illustrate the simplicity of programming the 5910B, and show some possible uses of its features; but the initialization of variable and files has been omitted for simplicity. The last example contains a complete BASIC program.

The following BASIC programming example, Example Program 3.1, exercises the TEC controller of the 5910B, and it demonstrates the DELAY, and STEP commands.

This example assumes the use of a subroutine for talking to the 5910B over the GPIB. This subroutine is shown in Example Program 3.3.

```
200 CMD$ = "Const 1.125,2.347,0.855" : GOSUB 1000      'Set constants for typical 10K thermistor
210 CMD$ = "Gain 10" : GOSUB 1000                  'Set control loop gain
220 CMD$ = "Step 100; Mode:T" : GOSUB 1000         'Temperature mode, with 10°C step
230 CMD$ = "T 0; Output ON" : GOSUB 1000          'Start laser temperature at 0° C
240 FOR X=1 TO 10                                  'Step temperature from 0 to 100° C
250   CMD$ = "Delay 20000; Inc" : GOSUB 1000      'Wait 20 seconds for temperature to
260   'stabilize, and increment laser temp. by 10° C
270 NEXT X
```

Example Program 3.1 Step and Delay

The following BASIC programming example, Example Program 3.2, demonstrates the use of the MODE:R, R, and R? commands for working in constant R mode (in this case the R value is thermistor resistance).

This program example assumes the use of a subroutine for talking to the 3742 over the GPIB. This subroutine is shown in Example Program 3.3.

```

300 CMD$ = "Const 1.125,2.347,0.855" : GOSUB 1000      'Set constants for typical 10K thermistor
310 CMD$ = "Gain 30" : GOSUB 1000                    'Set control loop gain
320 CMD$ = "Mode:R; R 10.41" : GOSUB 1000           'R mode, with set point of 10.41 Kohms
330 CMD$ = "Output ON" : GOSUB 1000                 'Turn on TEC output
340 FOR X=1 TO 50                                     'Take 50 measurements
350   CMD$ = "Delay 1000; R?" : GOSUB 1000          'Wait 1 second between readings
360   INPUT#2,R$                                       'Input is thermistor resistance, in Kohms
370 NEXT X

```

Example Program 3.2 R Mode - Thermistor Resistance Measurement

The following example program, Example Program 3.3, is a BASIC program for use with the LDT-5910B. It may be used to step a load (i.e. laser diode) to several different stabilized temperatures.

```

10 '          *** STEP TEMP ***
20 '
30 'This program steps and measures the TEC load temperature for several temperatures.
40 'It is intended for use with an LDT-5910B, an IBM PC/XT or compatible using an IOTech
50 'GP488 controller card and PERSONAL488 software (IOTech, P.O.Box 21204, Cleveland,
60 'OH 44121). This program assumes that the GPIB address of the 5910B is "01".
70 '
80 'This program was written in GWBASIC (Microsoft Corp.)
90 '
100 '----- INITIALIZE PROGRAM PARAMETERS -----
110 '
120 'AD$ = "01"                                     'Set GPIB address for 3742
130 'OUT$ = "OUTPUT"                                'Used in output subroutine
140 '
200 '----- INITIALIZE THE GPIB DEVICE DRIVERS -----
210 '
220 OPEN "\DEV\IEEEOUT" FOR OUTPUT AS #1
230 OPEN "\DEV\IEEEIN" FOR INPUT AS #2
240 IOCTL#1,"BREAK"                                'Clear driver
250 PRINT#1,"RESET"
260 CMD$ = "*RST" : GOSUB 1000                       'Reset the 3742 to default values
270 '
300 '----- INITIALIZE THE OUTPUT/PRINT HEADER -----
310 '
320 CLS                                             'Clear the screen
330 '
340 PRINT " *** SET TEMPERATURE vs. MEASURED TEMPERATURE at 10°C steps *** "
350 PRINT
360 PRINT " Set Temp   Actual Temp "
370 PRINT "   (C)     (C) "
380 PRINT " ===== "
390 '
400 '----- INITIALIZE LDT-5910B -----
410 '
420 CMD$ = "Tol 0.5,0.5" : GOSUB 1000                'Set the tolerance to 0.5°C for 0.5 seconds
430 CMD$ = "Gain 100" : GOSUB 1000                  'Set control loop gain
440 CMD$ = "Step 100; Mode:T" : GOSUB 1000           'Temperature mode, with 10°C step
450 CMD$ = "Tec:T 30; Output ON" : GOSUB 1000        'Start laser temperature at 30°C
460 '

```

Example Program 3.3 Set Point vs. Measured Temperature

```

500 '----- TAKE DATA -----
510 '
520 FOR X=1 TO 3                                'Gather data over 3 temperatures
530 '
540 CMD$ = "*WAI;Tec:T?" : GOSUB 1000           'Wait until in tolerance, and take
550                                           'a temperature measurement
560 INPUT#2,T$                                  'Input the value
570 '
700 '----- PRINT OUT RESULTS -----
710 '
720 T = VAL(T$) : S = X * 10                    'Convert data type
720 IMAGE$ = " ###.##  ###.## "
730 PRINT USING IMAGE$,S,T
740 '
770 CMD$ = "Tec:Inc" : GOSUB 1000              'Increment the temperature
780 '
790 NEXT X
800 '
810 '----- DONE -----
820 '
830 CMD$ = "Output OFF"                         'Turn off output
840 END
850 '
1000'----- OUTPUT SUBROUTINE -----
1010'
1020 PRINT#1,OUT$;AD$;CMD$ : RETURN             'Output the command; and return

```

Example Program 3.3 Set Point vs Measured Temperature (Cont.)

Chapter 4

GPIB/IEEE-488.2 REMOTE OPERATION

4.1 Introduction

When the model 1233 GPIB/IEEE-488.2 interface is installed and the instrument is connected to a host computer, the LDT-5910B can be used as an automated laser diode testing instrument. Possible applications include automatic data gathering over a range of controlled temperatures.

In remote operating mode, the 5910B offers all of the features accessible from the front panel and some advanced features which can only be accessed via the interface bus. In remote mode you have access to commands for functions not found on the front panel, such as the STEP command which automatically increments or decrements the set point by a user-defined step value, calculation of measured temperature to 6-digit resolution, and control of the conditions which cause the TEC controller output to be shut off.

Also, in remote operation only, the 5910B can be operated in constant R mode. This mode controls the TEC load to a set point value which is given in terms of a sensor reference or thermistor resistance value, instead of a temperature value. This allows the user to control the TEC load with sensors whose temperature-to-reference conversion model (CONST values) are unknown, but a specific temperature is known at a reference point. For example, the C1, C2 and C3 values of a thermistor may not be known, but it is known that 12.5 Kohms represents 30° C. Constant R mode may be used in this case.

The model 1233 GPIB/IEEE-488.2 interface allows GPIB/IEEE-488.2 bus control of the LDT-5910B. Information can also be read by the host computer and printed or stored. Other features include:

- * A concise and simple command set
- * Full talk/listen capability
- * Full serial poll capability, with bit-maskable SRQ
- * Full local/remote capability including LOCAL LOCKOUT
- * Meets ANSI/IEEE-488.2-1987 standards

This chapter is a guide to the syntax and usage of the various IEEE/488.2 common commands available for the 5910B. It also includes advanced programming tips for remote use with the device-dependent commands, hardware diagrams, and other information relating to remote operation.

This chapter is divided into three parts. The first part has the information for using the GPIB with the 5910B. It also has sections for each common GPIB (ANSI/IEEE-488.2) command which is supported by the 5910B. The second part contains information on advanced programming techniques and status reporting. The third part contains information on remote interface messages; these low-level messages are generally transparent to the user.

4.1.1 Preparation for Bus Control

To use the LDT-5910B remotely, you will need to install an IEEE-488 interface adapter in your host computer. These adapters and support software are available from several manufacturers and can be installed in most computers.

This manual assumes that you have a basic knowledge of the GPIB/IEEE-488 interface bus and how to use it for instrument control. This chapter also assumes that you are familiar with the controls on the LDT-5910B. Review Chapter 2 if you need more details on how to operate the LDT-5910B.

The talk and listen addresses on the 5910B are identical. This GPIB address is read locally by pressing the GPIB LOCAL/ADR switch and reading the display. To set the GPIB address, press and hold in the SET switch while displaying the GPIB address. Turn the main control knob until the desired address value is displayed, then release the SET switch. The new GPIB address will then be stored in non-volatile memory. The allowable address range is 0 - 30 for primary GPIB addressing. It is not normally possible to exceed this range. However, if the GPIB address were to exceed 30, it will not hang up the bus. If the GPIB address is displayed to be greater than 30, service of the 5910B will be required. Extended GPIB addressing is not implemented on the 5910B at this time.

4.2 Getting Started with GPIB

This section is intended as a quick guide to the GPIB syntax and commands used by the 5910B. The 5910B's unique (device-dependent) commands are described in Chapter 3.

4.2.1 Overview of the 5910B Syntax

Generally, a command or query is entered (spelled) as shown in Table 3.1. Upper or lower case may be used in any combination, but the command/query **MUST** contain all of the letters which are shown in upper case in Figure 3.2 and Table 3.1. The lower case letters shown with the commands in Section 3.4 are optional, and may be used for clarity. For example, the following commands for enabling the display are equal:

"DIS 1", "DISPLAY 1", and "Disp 1".

The syntax of the 5910B follows the rules laid out in the IEEE-488.2 standard. Semicolons (:) indicate the start of a new command path, while semicolons (;) indicate a separation of commands within a command string. A leading semicolon on a command may be used to return the 5910B parser to the command path root (see Figure 3.2).

Spaces or white space (see Section 4.6.2 for a definition of white space) may be placed anywhere in a command string (after the command header or query question mark), and must be used to separate the command (header) from the first parameter (or program data). The following examples show valid syntax for commands with the 5910B:

```
"MODE:t; T 25; Const 1, 2, 0.5; OUT 1"  
":DIS 1; set?;  
"GAIN 30"  
"display:auto 1"
```

The following are examples of invalid syntax for the 5910B. These command strings would produce an erroneous result, as explained:

```
"MODE T"           -Missing colon, MODE? expected  
"MODE:R DEC"      -Missing semicolon, DEC command ignored  
"DIS ?"           -Space not allowed before question mark, DIS command  
                  expected.  
"T33;dis?"        -Space missing between T command and the parameter value,  
                  33.
```

4.2.2 Using Commands with Parameters

Some commands expect a parameter. For example, if the temperature set point is to be entered, the command could be "T 30". This would set the 5910B's set point temperature to 30? C. If a single parameter is expected, it should follow the command with at least one space between the command and the parameter.

The nominal value for on/off parameters is 1 = on, 0 = off. For example, the command:

```
"Display:Auto 1"   -turns AUTO mode on, and  
"Display:Auto 0"   -turns AUTO mode off.
```

The words "on" and "off" may be substituted in the above example:

```
"Display:Auto On"  -turns AUTO mode on, and  
"Display:Auto Off" -turns AUTO mode off.
```

For more information on parameter name substitutions, see Section 3.2.3.

If multiple parameters are expected, they should be separated with commas. For example, to set the Steinhart-Hart constants on the 5910B (C1, C2, and C3) the following command could be sent:

```
"CONST 1.111, 2.004, 0.456"
```

If not all of the parameters need to be changed, i.e. C2 only, the other parameters may be omitted as in:

```
"CONST ,2.004, "
```

A query has no space between the mnemonic and the question mark, as in:

"GAIN?"

The 5910B uses a default terminator of carriage return (CR) - new line (line feed) - end of input (EOI). In almost all cases, these terminators are automatically inserted by the host (user's) computer or GPIB driver. The terminator can be user-selected by issuing the "TERM" command. For more information, see Section 4.6.5 or the IEEE-488.2 standard definition.

4.2.3 A 5910B Remote Command Sample

This section presents a few typical commands for setting up the 5910B, similar to the steps outlined in Section 2.7.2, General Operating Procedure. These commands are presented without any reference to the language-specific input and output statements which would be required to implement them. This section is intended, therefore, only to familiarize the user with the 5910B command set and syntax.

<u>5910B COMMAND</u>	<u>COMMENTS</u>
"Limit:I 3000"	Set the current limit to 3000 mA.
"Limit:Thi 100"	Set the upper temperature limit to 100? C.
"Limit:Tlo 0"	Set the lower temperature limit to 0? C.
"Gain 30"	Set the control loop gain to 30.
"Const 1.245, 2.555, 0.555"	Set the Steinhart-Hart constants for the thermistor.
"Set:T?"	Check the set point temperature.
"T 25"	Set the set point temperature to 25? C.
"Output 1"	Turn the output on.

After this sequence of commands, the 5910B would be set for controlling the TEC load to 25? C, assuming the entered parameters are correct for the thermistor used. For more programming examples, see Section 3.6.

4.2.4 Old 5910 Compatibility

As a convenience to users who are familiar with the old 5910 command set, the 5910B may be remotely operated with the old command set. To do this, the user must enter the command:

"SYNTAX 1" or "SYNTAX OLD"

When this is done, only the old 5910 command set may be used with the 5910B. To return to the command set which is documented here, the user must enter the command:

"SYNTAX 0" or "SYNTAX NEW"

The old and new commands may be intermixed, but it is not recommended. The OLD syntax preparer is not guaranteed to handle all NEW syntax commands without error. Therefore, it is recommended that the SYNTAX commands be entered in one line, with no other commands on that line, as shown in the examples above.

Whenever the 5910B is operating under the OLD syntax, the LIM I value will be displayed in mA, and the P1 command (OLD equivalent of the LIM:ITE command) will expect parameter values in mA. Whenever the 5910B is operating under the NEW syntax (NEW is the default), the LIM I value will be displayed in Amps, and the LIM:ITE command will expect parameter values in Amps, as documented in Chapter 3. This was done to accommodate the difference in the LIM I parameter between the OLD (5910) and NEW (5910B) product versions.

Due to changes in the status reporting structures, as determined by the IEEE-488.2 standard, the old ILX commands for reading/setting the SRQ mask, G10 and P10, are not supported on the 5910B. The P10 command will do nothing, and the G10 command will always return 0 on the 5910B.

4.3 Common Commands and Queries

This section contains a list of the common commands and queries which are supported by the 5910B. The common commands and queries are distinguished by the * which begins each mnemonic. The common commands and queries are listed in alphabetical order, and a brief description of their functions is given. For more information on these commands, refer to an ANSI/IEEE 488.2-1987 standards reference.

4.3.1 *CAL?

This is the calibration query. When it is sent, the 5910B performs the TEC controller's A to D calibration procedure. After this query is sent, the 5910B responds with a message indicating that calibration has been completed successfully or unsuccessfully. A response of 0 means no errors, any other number means an error in calibration was detected.

An auto-calibration is performed each time the 5910B accumulates 1 minute of inactive time since the last auto-calibration.

4.3.2 *CLS

This is the Clear Status command. It is used to clear the status event registers. It may be used, for example, to clear the TEC Event Status Register, the

Standard Event Status Register, and the Error Queue before enabling SRQ generation from instrument events.

4.3.3 *ESE

This is the Standard Event Status Enable command. This command enables the Standard Event Status Register to update bit 5 of the status byte. The Structure of the Standard Event Status Enable Register and Standard Event Status Register are shown in Figure 4.1. The contents of these two registers is logically ANDed then the bits are ORed to get the Event Summary Bit message.

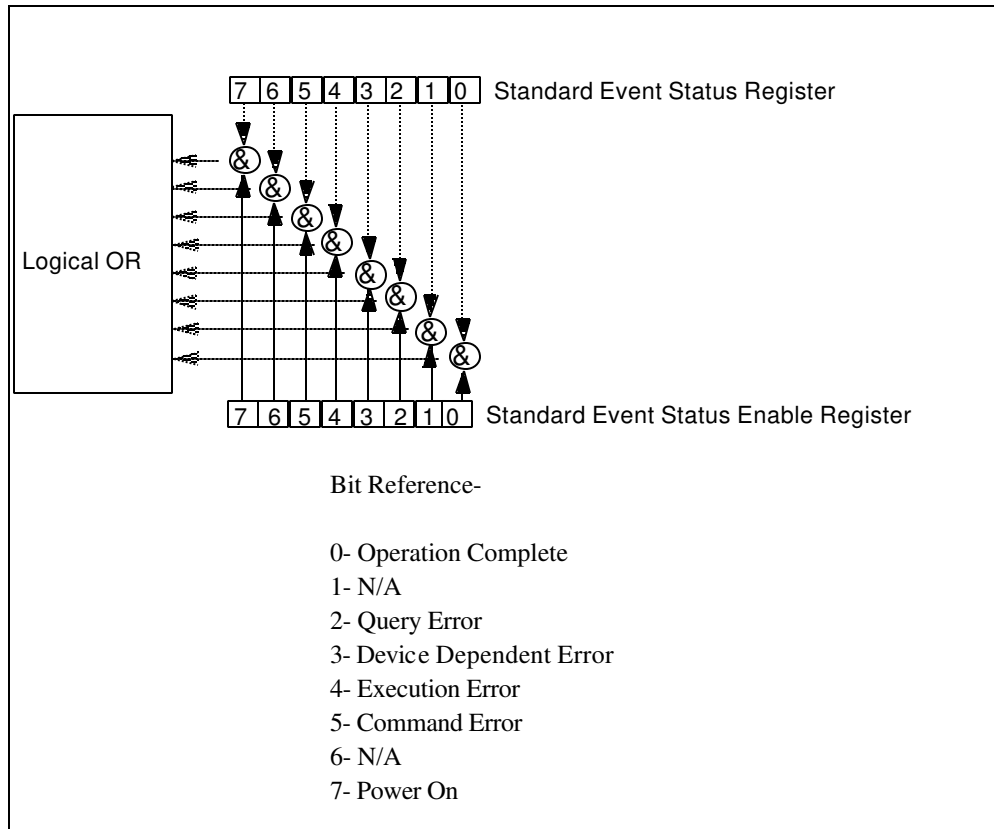

Figure 4.1 Standard Event Status Register/Status Enable Register

Setting bit 0 allows the user to poll or generate SRQ from any overlapped commands after any previous operations are completed. This may be useful for ensuring that an operation, such as TEC output on and within tolerance, is complete before a measurement is made. Although this could be performed without using service requests, an interrupt-driven program makes more efficient use of the GPIB than polling or waiting (*WAI) routines. (See also Section 4.7.2).

4.3.4 *ESE?

This query will cause the 5910B to return the value of the Standard Event Enable Register. This allows the user to determine which status bits can set the summary bit (bit 5) in the status byte register. The response will be the sum of all of the enabled bits, as represented in Figure 4.1.

4.3.5 *ESR?

This query will cause the 5910B to return the value of the Standard Event register. This allows the user to determine which type of error has occurred, for example. The value of the response will be the sum of the bits as represented in Figure 4.1.

4.3.6 *IDN?

This query will cause the 5910B to return the following identification string:
ILX,LDT-5910B,(7-digit serial number),(2-digit software version number). This identifies the specific device for the user. The manufacturer, model, serial number, and version number are listed in order.

4.3.7 *IST?

The Individual Status query allows the user to read the current state of the IEEE-488.1 'ist' local message in the 5910B. The response is a 1 or 0. A '1' indicates that the message is true, and a '0' indicates that the message is false.

4.3.8 *OPC

The *OPC command causes the 5910B to generate the operation complete message in the Standard Event Status Register when all pending overlapped commands have been completed.

4.3.9 *OPC?

This query places an ASCII character 1 into the 5910B's Output Queue when all pending operations have been finished. (See also Section 4.7.2)

4.3.10 *PRE

This is the Parallel Poll Register Enable command. It sets the parallel poll register enable bits for the format required by the 5910B in order that it may participate in parallel polling from the controller.

The value of the data must round off to an integer value between 0 and 65535

the value of the data corresponds to the sum of all of the enabled bits desired for parallel polling (see Figure 4.2).

The Parallel Poll Enable Register is ANDed with the Status Byte Register. This result is ORed to form the ist (individual status) local message, as seen in Figure 4.2.

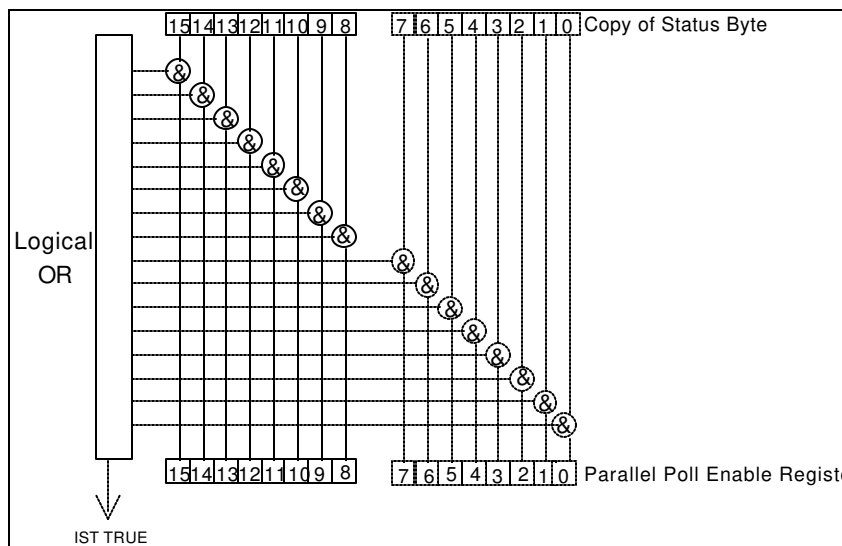

Bit Reference-

0- TEC Event Summary	8- N/A
1- TEC Condition Summary	9- N/A
2- N/A	10- N/A
3- N/A	11- N/A
4- Message Available	12- N/A
5- Event Status Summary	13- N/A
6- Master Status Summary	14- N/A
7- Error Message Available	15- N/A

Figure 4.2 Parallel Poll Response Handling Data Structure

4.3.11 *PRE?

This query allows the programmer to determine the contents of the Parallel Poll Enable Register. The response will be the sum of the register bits, as represented in Figure 4.2.

4.3.12 *PSC

The Power-on Status Clear command controls the automatic power-on clearing of the Service Request Enable Register, the Standard Event Status Enable Register, the TEC Event Status Enable Register, the TEC Condition Status Enable Register, and the Parallel Poll Enable Register.

a value which rounds to an integer value of 0 means the power-on-status-clear flag of the 5910B is set FALSE, therefore disallowing SRQ (interrupts) to be asserted after power-on.

a value which rounds to any non-zero integer value between -32767 and +32767 means the power-on-status-clear flag of the 5910B is set TRUE, therefore allowing SRQ (interrupts) to be asserted after power-on.

When the "*PSC 1" command is sent, the 5910B will clear the above mentioned enable registers (set them all to 0) at power-up. This may be done to avoid any undesirable service requests after a power on/off cycle of the 5910B.

The factory default value for this bit is 0, Power-on Status Clear is disabled. Therefore, the values of the enable registers are restored from their condition at the last power-down when a power-up occurs.

4.3.13 *PSC?

The Power-on Status Clear Query allows the programmer to query the 5910B's power-on-status-clear flag. A response of 0 means that the Standard Event Status Enable Register, Service Request Enable Register, the TEC Event Status Enable Register, the LASER Event Status Enable Register, the TEC Condition Status Enable Register, the LASER Condition Status Enable Register, and the Parallel Poll Enable Register will retain their values when power is restored to the 5910B. A returned value of 1 indicates that the registers listed above will be cleared when power is restored to the 5910B.

4.3.14 *PUD

The Protected User Data command stores data unique to the 5910B, such as calibration date, serial numbers, etc. This data is protected by restricted entry ("SECURE <rf>" command) and is usually only entered at the time of service or calibration.

This data is a fixed size of 18 bytes. The user's input (unique data) is exactly 18 bytes.

4.3.15 *PUD?

The Protected User Device query allows the user to retrieve the contents of the *PUD storage area. The response is the contents of the unique data which was last entered.

The initial (factory set) response value of the *PUD? query is:

#218nnnnnnnvMMDDYYABC

-where the response is <ARBITRARY BLOCK RESPONSE DATA>: nnnnnn represents the 7-digit serial number, vv represents the software version number, MMDDYY represents the date of calibration (month, day, year), and ABC represents the initials of the calibrating technician.

4.3.16 *RCL

The *RCL (Recall) command restores the 5910B to the setup state which is in its local memory (Bin 0 - 10). The following criteria are restored when the *RCL command is given:

1. The 5910B is in the parameter state which was last stored in that bin.
2. The TEC output is off.

The value must round-off to an integer between 0 and 10.

A value of 0 means the recalled state shall be the same as that of a *RST command.

Up to 11 different stored recall states can be used. Ten of these recall states (1 - 10) are saved by using the *SAV command.

4.3.17 *RST

The *RST (Reset) command performs a device reset. This has the same effect as *RCL 0, but with the 5910B's OCIS and OQIS idle states set.

The Operation Complete Command Idle State (OCIS) is the state which the 5910B is in when it is no longer waiting for any operation to complete, after an *OPC command has been executed.

The Operation Complete Query Idle State (OQIS) is the state which the 5910B is in when it is no longer waiting for any operation to complete, after an *OPC? query has been executed.

These idle states allow the 5910B to complete its reset process (and have no operations pending) before continuing with any other commands after the *RST is executed.

4.3.18 *SAV

The Save command stores the current state of the 5910B in non-volatile local memory. A particular state is then recalled by using the *RCL recall command (see Section 4.3.16). There are 10 unique states which can be stored. The syntax of the *SAV command is:

The value must round off to an integer between 1 and 10 the rounded integer value corresponds to a unique saved state which can be recalled by using the same value with the *RCL command

4.3.19 *SRE

The Service Request Enable command sets the Service Request Enable Register bits to allow the 5910B to generate the user-selectable service requests.

The value of the numeric data rounds off to an integer between 0 and 255, and corresponds to the bits enabled (see Figure 4.3).

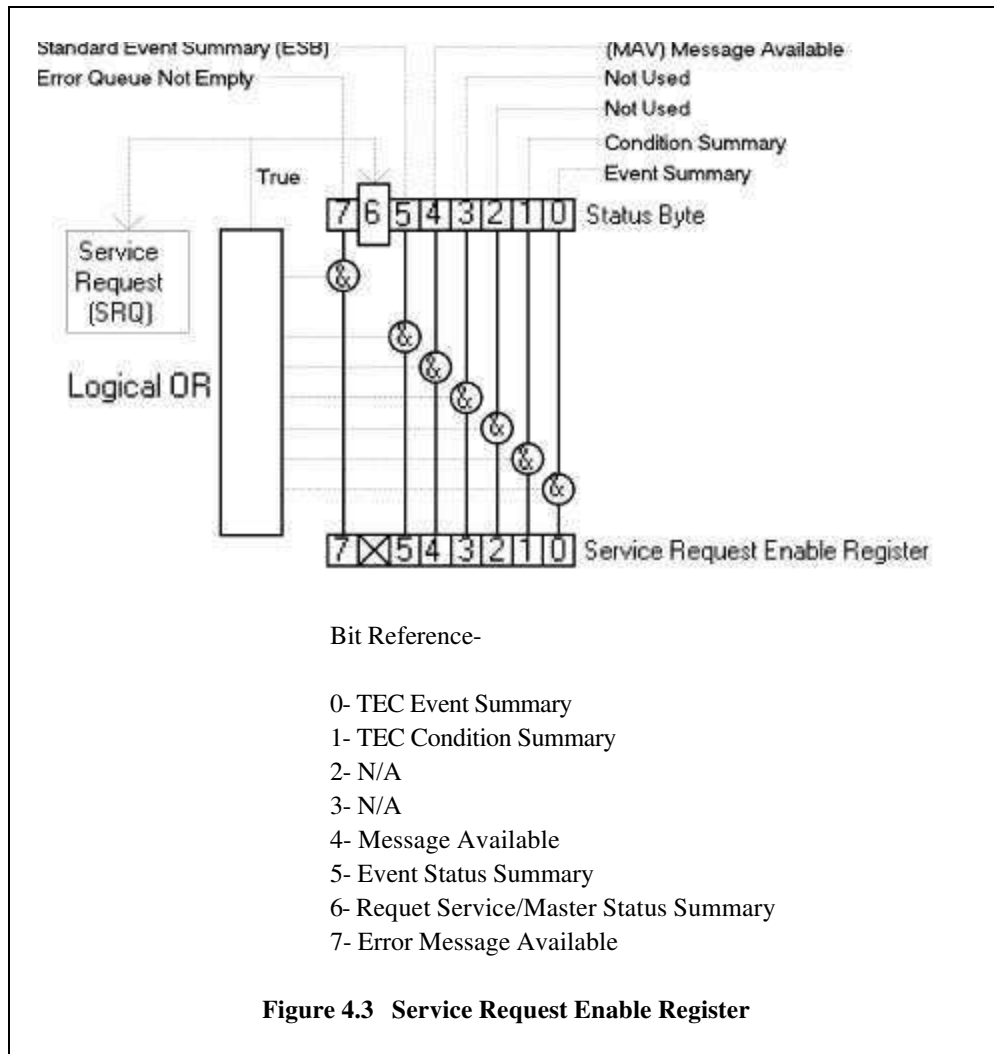

4.3.20 *SRE?

The Service Request Enable query allows the user to determine the current contents of the Service Request Enable Register. When this query is made, the response is the binary integer value of the contents of the register (see Figure 4.3).

4.3.21 *STB?

The Read Status Back query allows the programmer to read the status byte and Master Summary Status bit. The response to this query is an integer value of the contents of the Status Byte Register, where bit 6 represents the MSS (Master Summary Status) bit and not the RQS message (see Figure 4.3).

4.3.22 *TST?

The Self-Test query causes an internal self-test and returns a response when the self-test is complete.

The response is <DECIMAL NUMERIC RESPONSE DATA>, where the value of the response is 0 if the self-test completes with no errors. If the response is a value other than 0, the self-test was not completed or it was completed with errors detected.

4.3.23 *WAI

The Wait-to-Continue command prevents the 5910B from executing any further commands until the No-Operation-Pending flag is true. This allows the programmer to make the 5910B wait for the completion of an operation before continuing. For example, after a change in temperature is made the *WAI command may be used before a measurement is taken. This would ensure that the correct temperature had been reached.

4.4 Advanced Programming

Once you have become familiar with the command syntax and structure, you may take advantage of some programming shortcuts which are available. Due to the tree-walking capabilities of the 5910B software, the user may elect to write command strings without constantly repeating the entire command path for each command.

4.4.1 Path Specification

The first command in the string must have its entire path entered. But once a path level is reached, other commands which are at the same level (or higher level) may then be entered without repeating the path. To accomplish this, the semicolon (;) must be used to separate the commands in the string, as usual. However, the command following the semicolon need not specify its full path, if the same path which was previously written out could be used for the new command.

For example, the following legal command string could be used to (1) set the 5910B display to the measured temperature and (2) set the display for the (temperature) set point value:

```
"DIS:T; SET"
```

The path "DIS:" is "remembered" by the 5910B software in this case. If the "SET" command were not found at this level, the software would walk back to the "root" level and search for a "SET" command. If the command is not found, an error message will be generated.

The following is an example of command "tree-walking", where (1) the display is set for temperature, and (2) the TEC output is turned on:

```
"display:set; out on"
```

The command "out" is first searched at the "DIS:" level. Since the command "DIS:OUT" does not exist, the next higher level ("root" level) is searched. There the command "OUT" is found, and the parameter "on" is legal, so there is no error.

Care must be taken to avoid errors which are caused by trying to implement commands from the wrong path or level. For example, the following command string was intended to (1) read back the set point resistance and (2) read back the measured resistance:

```
"SET:R?; R?"
```

Instead, the output would return the set point resistance twice. When the second R? is found, the software will first search for that command at its current level. Since it finds it there it will be executed. If this command did not exist at this level, the software would search down to the "root" level and find and execute the intended command, "R?" (instead of "SET:R?").

In order to ensure the proper command is executed for the example above, the following command string should have been issued:

```
"SET:R?: :R?"
```

If you are not sure of the path level of a command, refer to the 5910B Command Path Structure diagram, Figure 3.2. For this discussion, the root level is the lowest level, and moving down the diagram (Figure 3.2) increases the level.

Once the software has "walked" to a lower path level, it remains at that level when it receives the next command. To reach a higher level, the path to that level must be specified. For example, to (1) set the display to show the set point, (2) decrement the set point, and (3) set the display to show the measured temperature, the following command string could be used:

```
"DIS:SET; DEC; DIS:T"
```

The reason that the full path must be specified for the last part (DIS:T) is that otherwise it would look for the T command in the root path, find it and expect a parameter, and generate an error.

After the second semicolon is reached (DEC;) the software will first look for the next word (DIS) at the current path. Since it is not found it will walk back up the tree until it finds it at the root level. Once the search walks up to the root level, it will not walk down any other paths, unless the path is specified.

The only exception to the rule described above is when common commands are used. In that case, the software remembers which level the user was at before the common command was found, and it returns to that same level after finding and executing the common command. Therefore the following command string is legal:

```
"DIS:T; *WAI; DEC"
```

Here, (1) the display is set to show the measured temperature (2) the software waits for the previous command to be executed, and (3) the set point is decremented one step.

4.4.2 Timing Considerations

Although the shortcuts mentioned in Section 4.4.1 reduce the command length, they may not necessarily optimize the speed of program execution. The following tip may be useful if speed of execution of a command is critical. If a command follows a semicolon (;) in a command string, and it is not at the root level, using the colon (:) will aid the software in locating the command, and time will be saved.

For example, the following command string will execute slightly faster (as shown) than it would if the first colon (:) after the second semicolon (;) was not included. This would save the time of a binary search at the DEC ("root") level.

```
"DIS:SET; DEC; :DIS:T"
```

In other cases, the hardware may not be able to react as quickly as the commands are executed. For example, if the set point is greatly incremented (i.e. by 10 °C) and a measurement is taken before that new set-point temperature has been reached, a decision based on the accuracy of the measured value may not produce the desired reaction. In other words, the test could be invalid due to a premature measurement. For cases like this, the *WAI command is useful. The *WAI command will suspend the execution of the next command until the previous command has been completed.

4.5 Error Messages

Error messages may appear on the display when error conditions occur which force the output off or reflect hardware errors in the respective functions of the 5910B.

In most cases, the error message will appear for three seconds and then the display will revert to its former state. In the case of multiple error messages, the 5910B will show each message for three seconds in succession.

In remote operation, the current error list can be read by issuing the "ERR?" query. When this is done, a string will be returned containing (up to 10 of) the error messages which are currently in the error message queue.

Appendix D contains an explanation of the error messages which may be reported remotely by the 5910B.

4.6 ANSI/IEEE-488.2 Definitions

The following sections contain the relevant definitions for syntax diagrams and syntax elements for the 5910B commands, as defined by the IEEE-488.2 standard. A complete listing of that standard is not practical here, but these definitions are applicable to the remote operation of the 5910B.

4.6.1 Syntax Diagrams

The syntax diagrams in Section 3.4 show the most complete form of command construction, but they don't show every possible construction. Some of the other possibilities which are not shown in the syntax diagrams of Section 3.4 are discussed in Section 4.4, Advanced Programming. These syntax diagrams conform to the ANSI/IEEE-488.2-1987 standard, and the terminology presented here reflects that standard.

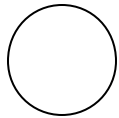

The oval (or round) shape contains a terminal syntactic element. These represent a basic function, such as a single ASCII character, which cannot be divided.

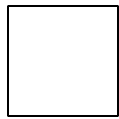

Rectangles contain non-terminal syntactic elements. These represent elements which are expandable to a diagram of terminal syntactic elements. However, they are presented as a unit for clarity or emphasis.

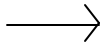

Lines and arrows indicate correct paths through the syntax diagram. A reverse line around an element indicates that the element may be repeated indefinitely. A forward arrow around an element indicates that the element may be omitted.

4.6.2 White Space

White space is defined by the syntactic diagram shown in Figure 4.4, where <white space character> is defined as a single ASCII-encoded byte in the range 00-09, 0B-20 (0-9, 11-32 decimal). This range includes the ASCII control characters and the space, but excludes the newline character.

In most practical programming situations, the space character would be used, as white space is generally used in separating syntactic elements. White space is processed by the 5910B without interpretation.

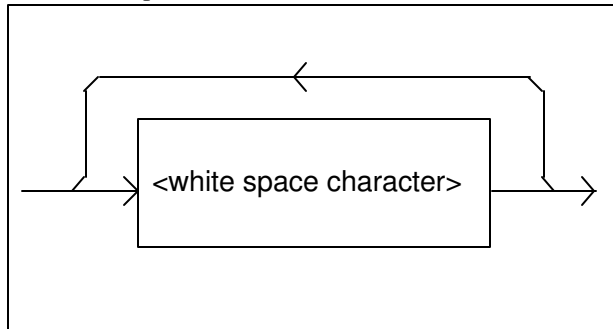

Figure 4.4 White Space Syntactic Diagram

4.6.3 Power-on Conditions

At power-on, the 5910B complies with the ANSI/IEEE Std 488.2-1987 requirements. It will initialize the setup parameters to be the same as when the power was last shut down. However, the TEC output will be off at power-up. The default conditions may be recalled by using the *RST command. The default conditions are outlined in Section 4.6.12.

4.6.4 <nrf value>

The symbol, <nrf value>, refers to the flexible numeric representation, as defined by the IEEE-488.2 standard. All this means is that numbers may be represented in one of three forms, integer, floating point, or engineering/scientific notation. For example the number "twenty" can be represented by an ASCII string of:

20 or +20,
20.0 or +20.0,
2.0E+1 or +2.0E+1 or 2.0e+1 or +2.0e+1

These three forms are denoted, NR1, NR2, and NR3, respectively, by the IEEE-488.2 standard. For more information on the precise syntax of these definitions, refer to the IEEE-488.2 standard.

4.6.5 <PROGRAM MESSAGE TERMINATOR>

When you send a command using the standard format, the host computer (or or GPIB driver) usually puts a <CR><LF><EOI> on the data bus following the command string. In this manner, a <PROGRAM MESSAGE TERMINATOR> is automatically sent. Some GPIB drivers allow the user to select the <PROGRAM MESSAGE TERMINATOR>.

The 5910B uses the definition shown in Figure 4.5 for a <PROGRAM MESSAGE TERMINATOR>, where a <CR> is defined as white space. Note, LF (line feed) is equivalent to NL (newline), and ^END is equivalent to the EOI (end or identify) message.

The 5910B's default value for a response terminator is: <CR><NL><^END>. This terminator may not be compatible with all host computers. Therefore, the TERM command (see Chapter 3) is available to set the 5910B's response terminator, if needed.

If you encounter problems with GPIB communications with the 5910B, refer to your GPIB driver manual for the exact syntax of the output terminator.

4.6.6 <PROGRAM MESSAGE UNIT SEPARATOR>

A <PROGRAM MESSAGE UNIT SEPARATOR> is used to separate sequential <PROGRAM MESSAGE UNIT> elements (commands) from one another within a <PROGRAM MESSAGE>. The syntax for a <PROGRAM MESSAGE UNIT SEPARATOR> is shown in Figure 4.6.

4.6.7 <PROGRAM HEADER SEPARATOR>

The <PROGRAM HEADER SEPARATOR> separates the <COMMAND PROGRAM HEADER> (5910B command) from the <PROGRAM DATA> (first parameter after the command). In the case of the 5910B, a single white space must be used to separate the command from the first parameter. Note however, commands may be compounded, see Section 4.6.8.

4.6.8 <compound command program header>

A <compound command program header> is a compound command heading which may be followed by <program data> (parameters). The 5910B command structure is a tree, as shown in Figure 3.2. A compound command or <compound command program header> determines the proper command by following a path from the root node. This is similar to determining a path for a file by starting with the root directory and listing the intermediate sub-directories. The syntax for a <compound command program header> is shown in Figure 4.8. The syntax diagram for a <compound query program header> is shown in Figure 4.9.

A <program mnemonic> is a command or command path identifier. For example, the <PROGRAM MESSAGE> "DISplay:T" consists of the command "T" and the path identifier "DISplay." All of the legal <compound command program headers> may be traced by starting from the root node of the command structure and moving down by levels to paths, and finally to the command (see Figure 3.2).

A <PROGRAM MESSAGE TERMINATOR> causes the next command search to begin at the root node. A leading colon (:) on a <PROGRAM MESSAGE UNIT> will cause the 5910B to begin searching for the command at the root node. Otherwise, the 5910B will first search the most recently used node for the command. It will continue to search the command tree until it finds a legal command path, by searching each previously used node up to the root. If no legal path is found, the 5910B will generate an error message. For more information on creating and using 5910B commands, see Section 4.4, Advanced Programming.

4.6.9 <PROGRAM DATA> (Parameters)

Parameters (and other <PROGRAM DATA>) may be entered after a command in a <PROGRAM MESSAGE UNIT>. The <COMMAND PROGRAM HEADER> (command) and first <PROGRAM DATA UNIT> (parameter) must be separated by a <PROGRAM HEADER SEPARATOR> (white space), see Section 4.6.6.

4.6.10 <ARBITRARY BLOCK PROGRAM DATA>

This element allows any 8-bit bytes (including extended ASCII) to be transmitted in a message. The syntax for an <ARBITRARY BLOCK PROGRAM DATA> element is:

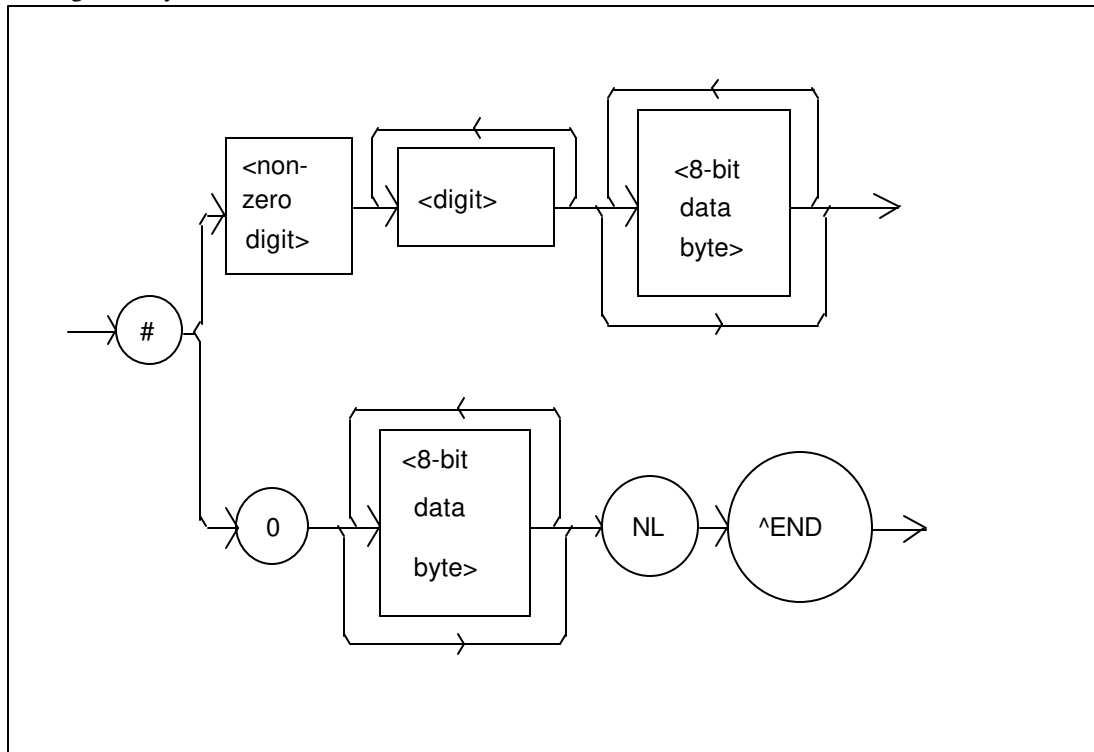

where- a non-zero digit is defined as a single ASCII encoded byte in the range 31 - 39 (49 - 57 decimal).

8-bit data byte is defined as an 8-bit byte in the range 00 -FF (0 -255 decimal).

NL is a new line (LF) and ^END is an end or identify (EOI).

Figure 4.10 <ARBITRARY BLOCK PROGRAM DATA> Syntax Diagram

This element is used only with a *PUD command to the 5910B.

4.6.11 <PROGRAM DATA SEPARATORS>

When there is a list of <PROGRAM DATA UNITS> (parameters) following a <PROGRAM HEADER SEPARATOR> (white space), the <PROGRAM DATA UNITS> must be separated with a <PROGRAM UNIT SEPARATOR>.

4.6.12 Default Parameters

There are no default values for omitted parameters. If a command is expecting a parameter and none is entered, an error will be generated.

However, if a reset is performed via a *RST command (or a RCL 0 command), the following parameters will be set to the default state shown in Table 4.1.

5910B CONFIGURATION AFTER *RST

GPIB in local via front panel; in remote via GPIB
PARAMETERS not selected
TEC output off
Display enabled, in T mode
Constant T mode selected
Display showing actual temperature
Temperature Set Point = 0°C
Resistance/Reference Set Point = 1 ohm or 1 mV or 1 uA
(depending on the setting of the SENSOR SELECT switch)
LIM I set to 1.0 Amps
LIM T_{HI} set to 99.9°C
LIM T_{LO} set to -99.9°C
STEP value = 1
GAIN = 30
C1 = 1.125 (x 10⁻³)
C2 = 2.347 (x 10⁻⁴)
C3 = 0.855 (x 10⁻⁷)
RECALL BIN number = 0

Table 4.1 State of the 5910B After *RST

4.7 Status Reporting

Figure 4.12 shows the status reporting scheme of the 5910B. Each of the registers which may be accessed by a command or query has the appropriate command or query written above or below the register representation. For example, the LASER Condition Register may be queried via the "LASer:COND?" query, as shown by its register heading in Figure 4.12.

The condition or event registers are logically ANDed with their respective enable registers. These bits are then logically ORed to form a summary message in the status byte for that particular register.

4.7.1 Event and Condition Registers

The Event Registers are used to report events which occur during the operation of the 5910B. Events differ from conditions in that events signal an occurrence once, and are not reset until the Event Register is queried or the 5910B is powered off. Conditions reflect the current state of the device, and therefore may change many times during operation. Querying a Condition Register does not change its contents.

The 5910B contains Event and Condition Registers for TEC controller operations. It also contains the Standard Event Status Register which reports events for general operation of the 5910B. The Standard Event Status Register conforms to the IEEE-488.2 standard.

4.7.2 Operation Complete Definition

Note that bit 0 of the Standard Event Status Register contains the status of the Operation Complete flag (see *OPC, Section 4.3.8). Enabling this bit via the *ESE command allows the user to update bits of the status byte. Then, if the SRE mask has bit 5 set, and the user issues an *OPC command, an SRQ will be issued upon completion of the currently processed commands. This may be used to initiate service request routines which depend on the completion of all previous commands.

For example, the user may set the TEC output to 30? C, enable the SRQ on Operation Complete, and have an SRQ handling routine in the user's software which begins a new measurement after the 30? C value has been reached.

This allows the use of the operation complete features of the 5910B, such as the "TOLerance" command, without the need for program looping or polling which can tie up the GPIB.

Operation Complete on the 5910B is defined as:

- 1) The TEC controller, which is updating the temperature controller hardware, is idle.
- 2) No EEPROM (non-volatile) memory write cycles are in progress.
- 3) New TEC sensor and ITE measurements are available, updated approximately every 400 mSec.
- 4) No Display timeout clocks are running.
- 5) No calibration routines are running.
- 6) TEC output is off, or it is on and within tolerance.

4.7.3 Command Timing and Completion

This section describes, for each command, whether that command is performed in an overlapped or sequential manner. In other words, it states whether the next command may begin while this command is being executed, or if the next command must wait until this command is completed before its execution begins. Also, the conditions for setting the operation complete flag are given for each command.

Most 5910B commands are executed in an overlapped manner, and the operation complete flag is set after the conditions outlined in Section 4.7.2 have been satisfied.

In normal operation, the overlapped commands execute faster than would appear by querying the OPC flag. This is due to the nature of the non-volatile memory storage process. Commands which change the status of the instrument limits, GAIN, C1, C2, C3, or change its mode, tolerance or step values, or status enable registers will not have their OPC flag set until all current writing to non-volatile memory has been completed. This is done to ensure that the OPC flag is never set prematurely. However, in most cases, the individual operation will be completed immediately.

The speed of writing to non-volatile memory (EEPROM) is slow compared to processor speed, and the new information (to be written) is placed on a queue to reduce the processor overhead for non-volatile storage operations. However, the new information (i.e. new parameter value) is buffered and is essentially stored as soon as the command which created it is parsed. Therefore, even though the OPC flag may not be set immediately after a new parameter value is created, the new value is stored for all intents and purposes, and command throughput is not directly related to the OPC rate.

Whenever there is any output (response) data in the Output Queue, bit 4 is set in the Status Byte Register. Whenever there is any error message in the Error Queue, bit 7 is set in the Status Byte Register.

4.8 Output Off Registers

The Output Off Enable Register allows the user to determine which conditions and events in the TEC controller will cause the output to be turned off. This register is configured in a manner which is similar to the status reporting registers. However, its output is not reported in the Status Byte Register. Rather, it goes to the hardware which controls the output switching. The events and conditions which may be set to cause the TEC output to be turned off are shown in Figure 4.13.

The default (factory) settings for this register is shown in Table 4.2. These settings are not effected by the *PSC (Power-On Status Clear) command.

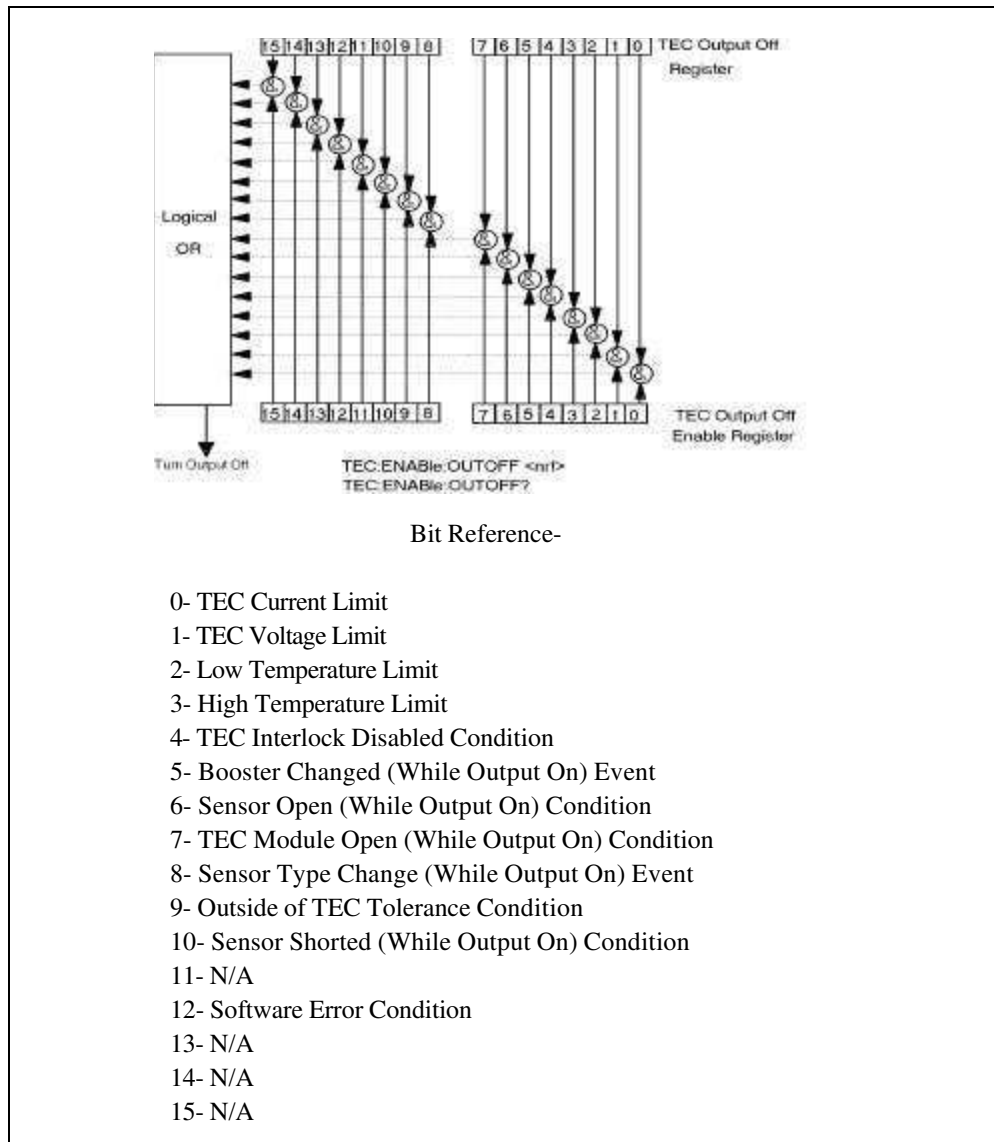

Figure 4.13 5910B TEC Output Off Register

5910B OUTPUT OFF REGISTERS' DEFAULT SETTINGS

<u>TEC Output Off Register</u>	
0- disabled	8- enabled
1- disabled	9- disabled
2- enabled	10- enabled
3- enabled	11- N/A
4- enabled	12- disabled
5- enabled	13- N/A
6- enabled	14- N/A
7- enabled	15- N/A

Table 4.2 5910B Default Settings for Output Off Register

4.9 Input Buffer and Output Data

The Input buffer of the 5910B is 80 bytes. However, the user's <PROGRAM MESSAGE> may be longer.

The output (response) data of the 5910B is sent in blocks of up to 80 bytes in length. It is sent using high speed DMA within the 5910B, but may be of indefinite length. Although some commands have a definite length response, such as the MESSage? query, the response length is indefinite because the 5910B will respond to multiple queries in a single response output. The user may enter as many queries as desired in a single input message, and the 5910B will respond to all of them in the same output message, if possible. For example, the user may enter the following command:

```
"Mes?; Rad?; T?; Err?"
```

The response may appear in this manner:

```
"TEST1      ,DEC,25.0,0"
```

All query responses are evaluated at the time the query is parsed, and not at the time the response message is sent. In most cases this does not create a problem since the time between parsing a query and sending its response is small, unless the GPIB controller takes a long time to request the response.

4.10 Remote Interface Messages

The following sections are intended as a reference for using the 5910B with the GPIB option when an understanding of the lower level interface messages is required. These sections deal with the remote interface messages which are available with the 5910B, and they contain a list of the Interface Function subsets. This information is generally not required by the user unless there is a question of compatibility of the 5910B with a specific controller. A list of interface messages which are not supported by the 5910B is shown in Section 4.10.3. These messages will be ignored by the 5910B.

The interface messages listed in this chapter are handled by the 9914 GPIB interface IC and the 80C188 processor in the 5910B, and are transparent to the higher level commands. However, they may be explicitly used in some GPIB programs. A list of the 5910B's allowable interface messages is shown in Section 4.10.2.

4.10.1 Interface Function Subsets

Table 4.3 contains the remote Interface Function Subsets which are supported by the 5910B. For more information, see the ANSI/IEEE-488.1-1987 standard.

5910B INTERFACE FUNCTION SUBSETS

SH1	Source Handshake - complete compatibility
AH1	Acceptor Handshake - complete capability
T6	Talker Functions
L4	Listener Functions
SR1	Service Request - complete capability
RL1	Remote Local Function - complete capability
PP0	Remote Configuration Parallel Poll - no capability
DC1	Device Clear - complete capability
DT0	Device Trigger - no capability
C0	Controller Function - no capability
E1, E2	Three-state bus drivers with automatic switch to open collector during Parallel Poll

Table 4.3 5910B Interface Function Subsets

4.10.2 5910B Remote Messages

The following list contains GPIB remote messages which are compatible with the 5910B GPIB driver.

5910B ALLOWED GPIB INTERFACE MESSAGES

ACG	LAG	PPR2	RQS
ATN	LLO	PPR3	SCG
DAB	MLA	PPR4	SDC
DAC	MTA	PPR5	SPD
DAV	OTA	PPR6	SPE
DCL	PCG	PPR7	SRQ
END	PPC	PPR8	STB
GTL	PPE	PPU	TAG
IDY	PPD	REN	UCG
IFC	PPR1	RFD	UNL
			UNT

Table 4.4 5910B Allowable GPIB Interface Messages

4.10.3 Non-Supported Remote Interface Messages

Table 4.5 contains GPIB interface messages which are known to be incompatible with the 5910B. Other interface messages which do not appear in Section 4.4.2 may also be incompatible with the 5910B.

NON-SUPPORTED INTERFACE MESSAGES FOR 5910B

EOS	MSA	NUL
GET	OSA	TCT

Table 4.5 Non-Supported Interface Messages for the 5910B

Chapter 5

MAINTENANCE

5.1 Introduction

This chapter describes how to maintain the LDT-5910B. Included are sections covering calibration, fuse replacement, line voltage selection, and disassembly.

WARNING

THE SERVICE PROCEDURES DESCRIBED IN THIS CHAPTER ARE FOR USE BY QUALIFIED PERSONNEL. POTENTIALLY LETHAL VOLTAGES EXIST WITHIN THE LDT-5910B. TO AVOID ELECTRIC SHOCK, DO NOT PERFORM ANY OF THE PROCEDURES DESCRIBED IN THIS CHAPTER UNLESS YOU ARE QUALIFIED TO DO SO.

QUALIFIED SERVICE PERSONNEL ARE REQUIRED TO WEAR PROTECTIVE EYEGLASSES AND ANTI-STATIC WRIST BANDS WHILE WORKING ON THE LDT-5910B CIRCUIT BOARDS.

CAUTION! HIGH VOLTAGES ARE PRESENT ON AND AROUND THE PRINTED CIRCUIT BOARDS OF THE LDT-5910B.

5.2 Calibration Overview

The 5910B should be calibrated every 12 months or whenever performance verification indicates that calibration is necessary.

All calibrations can be done with the case closed. The instrument is calibrated by changing the internally stored digital calibration constants.

5.2.1 Recommended Equipment

Recommended test equipment for calibrating the 5910B is listed in Table 5.1. Equipment other than that shown in the table may be used if the specifications meet or exceed those listed. If your 5910B is equipped with the model 1233 GPIB/IEEE-488.2 interface refer to sections 5.3.2, 5.3.4, 5.4.2, and 5.4.4 for calibration procedures using the GPIB.

RECOMMENDED TEST EQUIPMENT

<u>Description</u>	<u>Mfg./Model</u>	<u>Specification</u>
DMM	Fluke 8840A	DC Amps (@ 1.0 A): $\pm 1\%$ Resistance (@ 10 ohms): $.02\%$
Resistor	Metal Film	20 Kohm for 100 uA calibration 200 Kohm for 10 uA calibration 10 Kohm for LM335 calibration 8 Kohm for AD590 calibration High Power 1 ohm, 50 W for current calibrations

Table 5.1 Recommended Test Equipment

5.2.2 Environmental Conditions

Calibrate this instrument under laboratory conditions. We recommend calibration at $23^{\circ}\text{C} \pm 1.0^{\circ}\text{C}$. When necessary, however, the LDT-5910B may be calibrated at its intended use temperature if this is within the specified operating temperature range of 0 to 50°C .

5.2.3 Warm-Up

The LDT-5910B should be allowed to warm up for at least 1 hour before calibration.

5.3 TEC Controller Calibration Adjustments

There are only three calibration adjustments that need to be made for the 5910B for use with thermistors. They are calibration of the resistance at the 10 microamp and the 100 microamp source current settings, and calibration of the ITE current.

If linear temperature sensors are used, they should be calibrated as outlined in Sections 5.3.3 - 5.3.6.

If you have the optional Model 1233 IEEE-488.2/GPIB interface you may follow the procedure in sections 5.3.2, 5.3.4, 5.3.6, and 5.3.8 to calibrate the 5910B remotely.

5.3.1 Local Operations Thermistor Calibration

The following procedure is for calibrating the 10 uA and 100 uA constant current sources so that the thermistor resistances for these ranges will be as accurate as possible. This procedure is for local (front panel) operation. See Section 5.3.2 for remote calibration of the sensors.

- a. Set the SENSOR SELECT switch (back panel) to the 100 uA position.
- b. Measure and record the exact resistance of your metal film resistors.
- c. Connect the correct metal film resistor (20 Kohm for 100 uA) to the thermistor input of the 5910B.
- d. Enter the TEC sensor calibration mode by pushing the (GPIB) LOCAL and SELECT switches at the same time (the display will indicate the sensor switch position).
- e. Press and hold in the SET switch. The display will indicate sensor resistance in Kohm. Turn the main control knob until the display indicates the same resistance you recorded for the metal film resistor.
- f. Release the SET switch to store the new value into non-volatile memory. After the SET switch is released, the 5910B will return to its former state (before calibration).
- g. Switch the SENSOR SELECT switch (back panel) to the 10 uA position and repeat this procedure with the 200 Kohm resistor.

5.3.2 Remote Operation Thermistor Calibration

The following procedure is for calibrating the 10 uA and 100 uA constant current sources so that the thermistor resistances for these ranges will be as accurate as possible. This procedure is for remote (GPIB) operation. See Section 5.3.1 for local calibration of the sensors.

- a. Set the SENSOR SELECT switch (back panel) to the 100 uA position.
- b. Measure and record the exact resistance of your metal film resistors.
- c. Connect the correct metal film resistor (20 Kohm for 100 uA) to the 5910B thermistor input.
- d. Enter the "CAL:SENsor" command over the GPIB. The display will show the resistance value.
- e. Input the actual resistance of the metal film resistor (as an <nrf value>¹) via the "R <nrf value>" command.

¹ <nrf value> refers to the IEEE-488.2 standard for numeric data, flexible numeric representation. An <nrf value> may be in integer, floating point, or exponential (scientific) notation format.

If this value is to be measured and entered remotely via a GPIB controlled DMM, for example, the measured value of the resistance should not be entered until the 5910B is ready to receive it.

The 5910B will be ready to receive the resistance value when, after a "CAL:SEN?" query is sent, the response from the 5910B is "1".

After the "R" value is entered, the "*OPC?" query may be used to determine when the calibration sequence is done. However, the "*OPC", or "*WAI" command, or "*OPC?" query should not be issued until after the expected "R" value is entered, or the system will "hang". This happens because the 3742 will wait indefinitely for an input, yet not allow any input until the calibration is finished.

- f. Once the "R" value is sent, the 5910B will return to its former state (before calibration). The "OPC?" query may be used (after the "R" value is sent) to determine when the calibration is completed.

The operation complete flag (bit 0 of the Standard Event Status Register) may be used to trigger an interrupt. This type of interrupt is enabled by setting bit 0 of the Service Request Enable register and using the *OPC command.

- g. Switch the SENSOR SELECT switch (back panel) to the 10 uA position and repeat this procedure with the 200 Kohm resistor.

5.3.3 Local Operation AD590 Sensor Calibration

The following procedure is for calibrating the AD590 sensor so that the temperature measurement will be as accurate as possible. This procedure is for local (front panel) operation. See Section 5.3.4 for remote calibration of the AD590 sensor.

- a. Set the SENSOR SELECT switch (back panel) to the AD590 position.
- b. Connect a precision 8 Kohm (metal film) resistor and a precision ammeter in series at the sensor input of the 5910B.
- c. Enter the TEC sensor calibration mode by pushing the (GPIB) LOCAL and SELECT switches at the same time (the display will indicate the sensor switch position).
- d. Press and hold in the SET switch. The display will indicate sensor reference current in uA. Turn the main control knob until the 5910B display indicates the same current as shown on the precision ammeter.
- f. Release the SET switch to store the new value into non-volatile memory. After the SET switch is released, the 5910B will return to its former state (before calibration).

5.3.4 Remote Operation AD590 Sensor Calibration

The following procedure is for calibrating the AD590 sensor so that the measured temperature will be as accurate as possible. This procedure is for remote (GPIB) operation. See Section 5.3.3 for local calibration of the AD590 sensor.

- a. Set the SENSOR SELECT switch (back panel) to the AD590 position.
- b. Connect a precision 8 Kohm (metal film) resistor and a precision ammeter in series at the sensor input of the 5910B.
- c. Enter the "CAL:SENsor" command over the GPIB. The display will show the current value in uA.
- d. Input the actual current measured by the external ammeter (as an <nrf value>¹) via the "R <nrf value>" command.

If this value is to be measured and entered remotely via a GPIB controlled DMM, for example, the measured value of the current should not be entered until the 5910B is ready to receive it.

The 5910B will be ready to receive the current value when, after a "CAL:SEN?" query is sent, the response from the 5910B is "1".

After the "R" value is entered, the "*OPC?" query may be used to determine when the calibration sequence is done. However, the "*OPC", or "*WAI" command, or "*OPC?" query should not be issued until after the expected "R" value is entered, or the system will "hang". This happens because the 3742 will wait indefinitely for an input, yet not allow any input until the calibration is finished.

- e. Once the "R" value is sent, the 5910B will return to its former state (before calibration). The "OPC?" query may be used (after the "R" value is sent) to determine when the calibration is completed.

The operation complete flag (bit 0 of the Standard Event Status Register) may be used to trigger an interrupt. This type of interrupt is enabled by setting bit 0 of the Service Request Enable register and using the *OPC command.

¹ <nrf value> refers to the IEEE-488.2 standard for numeric data, flexible numeric representation. An <nrf value> may be in integer, floating point, or exponential (scientific) notation format.

5.3.5 Local Operation LM335 Sensor Calibration

The following procedure is for calibrating the LM335 sensor so that the temperature measurement will be as accurate as possible. This procedure is for local (front panel) operation. See Section 5.3.4 for remote calibration of the LM335 sensor.

- a. Set the SENSOR SELECT switch (back panel) to the LM335 position.
- b. Connect a precision 10 Kohm (metal film) resistor and a precision voltmeter in parallel at the sensor input of the 5910B.
- c. Enter the TEC sensor calibration mode by pushing the (GPIB) LOCAL and SELECT switches at the same time (the display will indicate the sensor switch position).
- d. Press and hold in the SET switch. The display will indicate sensor reference voltage in mV. Turn the main control knob until the 5910B display indicates the same voltage as shown on the precision voltmeter.
- f. Release the SET switch to store the new value into non-volatile memory. After the SET switch is released, the 5910B will return to its former state (before calibration).

5.3.6 Remote Operation LM335 Sensor Calibration

The following procedure is for calibrating the LM335 sensor so that the measured temperature will be as accurate as possible. This procedure is for remote (GPIB) operation. See Section 5.3.5 for local calibration of the LM335 sensor.

- a. Set the SENSOR SELECT switch (back panel) to the LM335 position.
- b. Connect a precision 10 Kohm (metal film) resistor and a precision voltmeter in parallel at the sensor input of the 5910B.
- c. Enter the "CAL:SENsor" command over the GPIB. The display will show the voltage in mV.
- d. Input the actual voltage measured by the external voltmeter (as an <nrf value>¹) via the "R <nrf value>" command.

If this value is to be measured and entered remotely via a GPIB controlled DMM, for example, the measured value of the current should not be entered until the 5910B is ready to receive it.

The 5910B will be ready to receive the voltage value when, after a "CAL:SEN?" query is sent, the response from the 5910B is "1".

¹ <nrf value> refers to the IEEE-488.2 standard for numeric data, flexible numeric representation. An <nrf value> may be in integer, floating point, or exponential (scientific) notation format.

After the "R" value is entered, the "*OPC?" query may be used to determine when the calibration sequence is done. However, the "*OPC", or "*WAI" command, or "*OPC?" query should not be issued until after the expected "R" value is entered, or the system will "hang". This happens because the 3742 will wait indefinitely for an input, yet not allow any input until the calibration is finished.

- e. Once the "R" value is sent, the 5910B will return to its former state (before calibration). The "OPC?" query may be used (after the "R" value is sent) to determine when the calibration is completed.

The operation complete flag (bit 0 of the Standard Event Status Register) may be used to trigger an interrupt. This type of interrupt is enabled by setting bit 0 of the Service Request Enable register and using the *OPC command.

5.3.7 Local Operation ITE Current Calibration

The following procedure is for calibrating the ITE constant current source for both polarities of current. This procedure calibrates the zero current set point automatically, then it automatically drives the TE current output to internally set limits of ± 1 amp. When each of these values is reached and is stable, the user enters the actual value of the current, as measured by an external DMM. The 5910B then automatically calibrates the TEC current source and limits.

This procedure is for local (front panel) operation. See Section 5.3.8 for remote calibration of the ITE current.

- a. With the output off, connect a 1 ohm, 50 W resistor across the TEC output terminals and use a calibrated DMM to measure the voltage across the resistor. Calculate the current in the following steps by using Ohm's Law:

$$I = E / R$$

-where E is the accurately measured voltage across the resistor, and R is the accurately measured load resistance.

- b. Press the (GPIB) LOCAL and (OUTPUT) ON switches at the same time to place the 5910B in its TEC Current Calibration mode (the display will show "--05"). Press the SET switch to continue.

The display will show a value of about zero amps as the 5910B calibrates itself for a zero current level. After a few seconds the TEC display will begin to change to show about 1 amp (the limit calibration value).

- c. After the value on the display is stable (has not changed by more than one digit for several seconds) the 5910B is ready for the actual I value to be entered.

Press and hold in the SET switch and turn the main control knob until the display shows the correct value, as calculated from Step a).

- d. Release the SET switch to store the new calibration value into non-volatile memory. The 5910B will then be ready for the user to enter the limit calibration value for its negative polarity output.
- e. Repeat Steps c and d for the negative polarity of the TEC output current. Enter the absolute value of this negative current. After the value for the negative polarity of the TEC output is entered, the 5910B will automatically calibrate its current limits and set points. After a few seconds, the 5910B will return to its former state (before calibration).

5.3.8 Remote Operation ITE Current Calibration

The following procedure is for calibrating the ITE constant current source for both polarities of current. This procedure calibrates the zero current set point automatically, then it automatically drives the TE current output to internally set limits of ± 1 amp. When each of these values is reached and is stable, the user enters the actual value of the current, as measured by an external DMM. The 5910B then automatically calibrates the TEC current source and limits.

This procedure is for remote (GPIB) operation. See Section 5.3.7 for local (front panel) calibration of the ITE current.

- a. With the output off, connect a 1 ohm, 50 W resistor across the TEC output terminals and use a calibrated DMM to measure the voltage across the resistor. Calculate the current in the following steps by using Ohm's Law:

$$I = E / R$$

-where E is the accurately measured voltage across the resistor, and R is the accurately measured load resistance.

- b. Enter the "CAL:ITE" command over the GPIB to place the 5910B in its TEC Current Calibration mode. The 5910B will automatically calibrate its zero output current.
- c. When the 5910B is ready for the actual I value to be entered, a remote query of "CAL:ITE?" will return a response of "1".

When the measured value (actual I) is stable and the 5910B is ready to proceed, enter the value by issuing the "I <nrf value>" command, where the actual I value is the <nrf value>¹.

To ensure measurement stability of the actual I value when the measurement is taken as a part of an automated test, the DMM measurement should be polled in a loop. When the measured value is consistent within one digit for 5 seconds (for example), the actual I value could be considered stable.

¹ <nrf value> refers to the IEEE-488.2 standard for numeric data, flexible numeric representation. An <nrf value> may be in integer, floating point, or exponential (scientific) notation format.

- d. Once the actual I value is entered via the "I" command, the new calibration value is stored into non-volatile memory. The 5910B will then be ready for the user to enter the limit calibration value for its negative polarity output.
- e. Repeat Steps c and d for the negative polarity of the TEC output current. Enter the absolute value of the negative current. After the value for the negative polarity of the TEC output is entered, the 5910B will automatically calibrate its current limits and set points. After a few seconds, the 5910B will return to its former state (before calibration).

After the last "I" value is entered, the "*OPC?" query may be used to determine when the calibration sequence is done. However, the "*OPC", or "*WAI" command, or "*OPC?" query should not be issued until after the last "I" value is entered, or the system will "hang". This happens because the 3742 will wait indefinitely for an input, yet not allow any input until the calibration is finished.

If the "*OPC?" query is issued during ITE calibration, the time out period of the GPIB driver should be at least 1 minute to prevent the GPIB driver from timing out and "hanging" the system. Refer to your GPIB driver instruction manual for information on setting the GPIB driver time out period.

The operation complete flag (bit 0 of the Standard Event Status Register) may be used to trigger an interrupt. This type of interrupt is enabled by setting bit 0 of the Service Request Enable register and using the *OPC command.

5.4 Fuse Replacement

The fuse is accessible from the back panel of the 5910B. Before replacing the fuse, turn power off and disconnect the line cord. Use only the fuses indicated below in Table 5.2.

FUSE REPLACEMENT

<u>Line voltage</u>	<u>Fuse Replacement</u>
100-118 VAC	3/4 Amp, 3AG, Slo Blo
230 VAC	3/8Amp, 3AG, Slo Blo

Table 5.2 Fuse Replacement

5.5 Line Voltage Selection

Line voltage selection is made by installing jumpers according to Figure 5.1. Normally these jumpers are factory preset. When necessary, however, they may be moved to accommodate new line voltage conditions. You must remove the 5910B top cover and then remove the power supply.

To remove the power supply, remove the four outside screws, closest to the side rails. Disconnect the cables from the power supply and lift the power supply straight up. Locate the zero-ohm jumpers on the Power Supply Board. Carefully remove the jumpers and then install them in the new position, as shown in Figure 5.1.

Appendix A

The Steinhart-Hart Equation

Two-terminal thermistors have a nonlinear relationship between temperature and resistance. The resistance versus temperature characteristics for a family of similar thermistors is shown in Figure A.1. It has been found empirically that the resistance versus temperature relationship for most common negative temperature coefficient (NTC) thermistors can be accurately modeled by a polynomial expansion relating the logarithm of resistance to inverse temperature. The Steinhart-Hart equation is one such expression and is given as follows:

$$1/T = A + B(\ln R) + C(\ln R)^3 \quad \text{Equation 1}$$

Where T is expressed in KELVIN.

Once the three constants A, B, and C are accurately determined, Equation 1 introduces small errors in the calculation of temperature over wide temperature ranges. Table A.1 shows the results of using equation 1 to fit the resistance versus temperature characteristic of a common 10K ohm (at room temperature) thermistor. Equation 1 will produce temperature calculation errors of less than 0.01 °C over the range -20 C to 50 °C.

CURVE-FITTING EQUATION COMPARISON

R ¹	Error T (°C)		Error T (°C)	
	T Actual	Third Order Fit Eq 1 ²	First Order Fit Eq 2 ³	
32128	0.00	-0.0000	-0.23	
19549	10.00	0.0005	-0.11	
12262	20.00	-0.0001	-0.06	
9814	25.00	-0.0002	-0.06	
7908	30.00	0.0009	-0.07	
5331	40.00	0.0003	-0.15	
3542	50.00	-0.0030	-0.30	

Table A.1 Comparison of Curve Fitting Equations

¹Resistance of a 10 kΩ, Dale 1T1002-5 thermistor.

²Constants A = 1.104 * 10⁻³ (C1 = 1.125)
 B = 2.389 * 10⁻⁴ (C2 = 2.347)
 C = 0.694 * 10⁻⁷ (C3 = 0.855)

³Constants A' = 0.994 * 10⁻³, B' = 2.569 * 10⁻⁴.

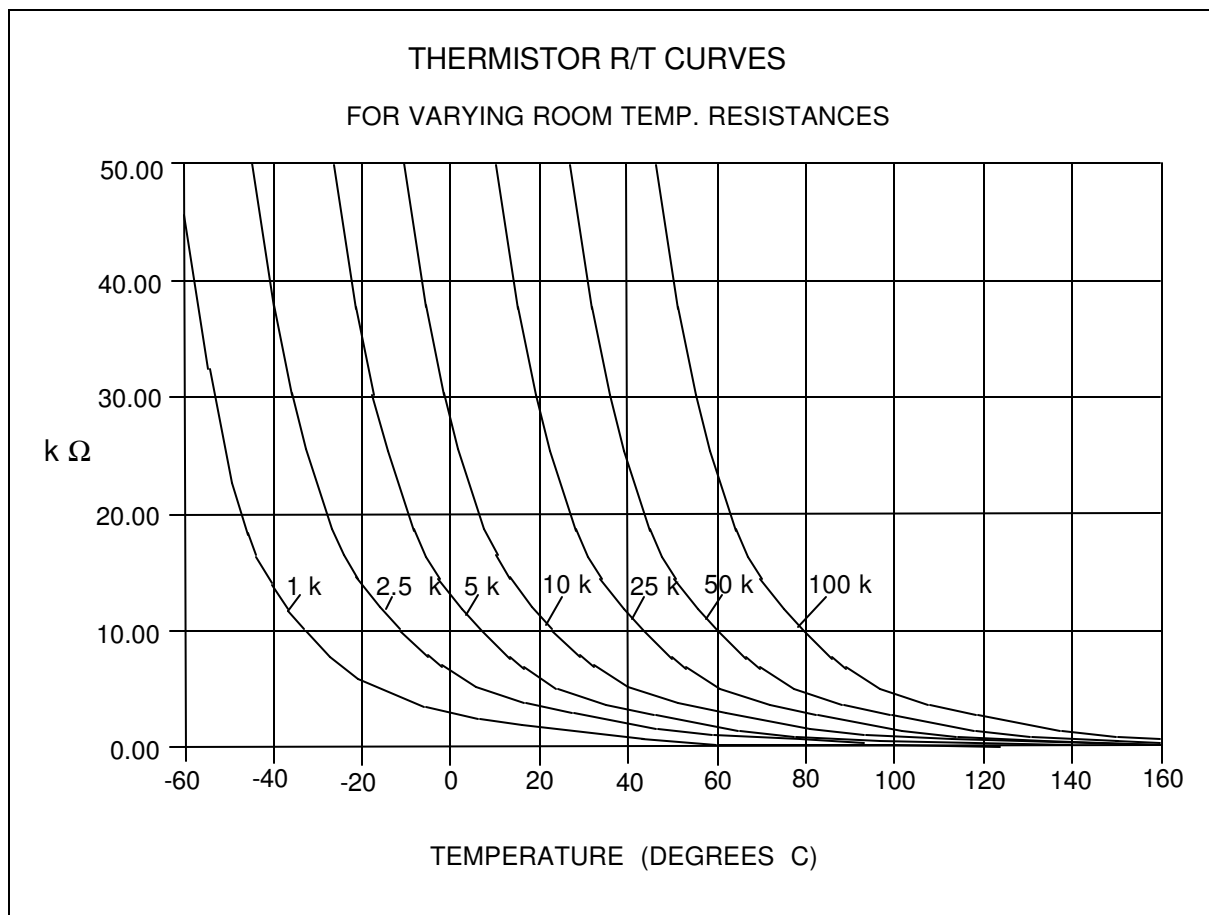

Figure A.1 Thermistor Resistance Versus Temperature

In practice we have found that the constants A, B and C for virtually all common thermistors lie within a narrow range. Consequently, we have defined the constants C1, C2, C3 as follows:

$$\begin{aligned}
 C1 &= A * 10^{+3} \\
 C2 &= B * 10^{+4} \\
 C3 &= C * 10^{+7}
 \end{aligned}$$

The constants C1, C2, And C3 may all be expressed in the form n.nnn simplifying entry into the LDT-5910B.

If high accuracy is not required, the Steinhart-Hart equation may be simplified to a first order polynomial:

$$1/T = A' + B' * \ln R \quad \text{Equation 2}$$

This equation is easier to solve and often provides adequate results. Table A.1 also shows that the use of Equation 2 introduces temperature errors of less than 0.5°C over the range -20 C to 50°C. Once the constants A' and B' are determined, the LDT-5910B is programmed with the following values of C1, C2 and C3:

$$\begin{aligned}
 C1 &= A' * 10^{+3} \\
 C2 &= B' * 10^{+4} \\
 C3 &= 0.000
 \end{aligned}$$

Table of Constants

We have tested or reviewed many thermistors and include the appropriate calibration constants for the temperature range -20 C to 50 C in most cases. Please contact ILX Lightwave Corporation if you require more information about these constants or would like other constants computed for you.

THERMISTOR CONSTANTS

<u>Manufacturer</u>	<u>Type</u>			<u>C1</u>	<u>C2</u>	<u>C3</u>
Fenwal	3K	@25C	Curve 1	1.557	2.162	1.259
Fenwal	5K	@25C	Curve 1	1.448	2.152	1.165
Fenwal	10K	@25C	Curve 1	1.302	2.137	1.058
Fenwal	3K	@25C	Curve 10A	1.089	2.712	1.812
Fenwal	5K	@25C	Curve 10A	0.957	2.690	1.707
Fenwal	10K	@25C	Curve 10A	0.780	2.660	1.582
Fenwal	3K	@25C	Curve 16	1.405	2.369	1.006
Fenwal	5K	@25C	Curve 16	1.286	2.360	0.939
Fenwal	10K	@25C	Curve 16	1.126	2.346	0.861
Fenwal	3K	@25C	Curve 17	0.999	2.807	2.091
Fenwal	5K	@25C	Curve 17	0.864	2.780	1.977
Fenwal	10K	@25C	Curve 17	0.685	2.742	1.840
Fenwal	3K	@25C	Curve 18	1.436	2.289	1.657
Fenwal	5K	@25C	Curve 18	1.324	2.271	1.553
Fenwal	10K	@25C	Curve 18	1.174	2.246	1.432
Dale	2K	@25C	Curve 1	1.500	2.377	1.067
Dale	3K	@25C	Curve 1	1.405	2.369	1.006
Dale	4K	@25C	Curve 1	1.338	2.364	0.968
Dale	5K	@25C	Curve 1	1.286	2.360	0.939
Dale	6K	@25C	Curve 1	1.244	2.356	0.918
Dale	7K	@25C	Curve 1	1.208	2.353	0.900
Dale	8K	@25C	Curve 1	1.177	2.351	0.885
Dale	9K	@25C	Curve 1	1.150	2.348	0.872
Dale	10K	@25C	Curve 1	1.126	2.346	0.861
Dale	2K	@25C	Curve 2	1.259	2.669	1.509
Dale	5K	@25C	Curve 2	1.024	2.638	1.349
Dale	10K	@25C	Curve 2	0.848	2.615	1.248
Dale	10K	@25C	Curve 9	1.031	2.388	1.576
Dale	2.252K	@25C	Curve 1	1.472	2.375	1.048
Spectra Diode Labs Modules				0.848	2.615	1.248
Lasertron Modules				1.126	2.346	0.861
General Optronics Modules				1.126	2.346	0.861

Table A.2 Thermistor Constants

Computer programs

We have included two computer programs that use a least squares curve fitting routine to determine the values of C1, C2 and C3. The programs, called STEIN3 and STEIN1, are written in IBM's advanced BASICA. STEIN3 calculates the values the coefficients C1, C2 and C3 using equation 1. STEIN1 calculates C1 and C2 using equation 2. Type one of these program into your computer.

Next you must create a data file for your thermistor that describes the resistance at various temperatures. The temperature verses resistance calibration data can be obtained from the thermistor manufacturer. Enter the resistance at various temperatures as data points into an ASCII file. You can write the data file on a word processor, but you must use non-document mode so special word processing characters are not inserted into the data file. Format the data with one temperature-resistance pair per line and at least one space separating the two numbers. Temperatures should be in centigrade and resistances in ohms. We recommend that you use at least twenty data points, uniformly spread over the intended range of use, for an accurate determination of the coefficients. Enter a -1 to signify the end of the resistance data and temperature data.

A small sample data file is included below as an example of the data format and end-of-data marker (R = -1).

<u>Temperature</u>	<u>Resistance</u>
-20	97072
-10	55326
0	32650
10	19899
20	12492
25	10000
30	8056.8
40	5326.4
50	3602.3
-1	-1

Run the STEIN3 or STEIN1 program. The best curve fitting values for C1, C2 and C3 will be displayed. Key these numbers into the LDT-5910B. If the computer program supplies negative values for constants C2 or C3 then the temperature verses resistance data was bad or incorrectly entered.

```

80 REM ***** STEIN1 *****
90 REM
92 REM   Rev: 3-11-87
94 REM   T is expressed in Kelvins.
100 REM  Least squares fit program to find the thermistor coefficients
110 REM  C1 and C2 in the following equation:
120 REM
130 REM          1/T = C1 + C2 * (ln R)
140 REM
200 REM
210 REM  Variables:
220 REM
230 REM  T[i], R[i]   temperature and resistance data values.
240 REM
250 REM  Y[i] = 1/T[i] the dependent variable (depends on R[i])
260 REM          in the Steinhart - Hart equation (above).
270 REM
280 REM  X[i] = ln(R[i]) the value of the ith function of the independent
290 REM          variable ln(R) (natural log of resistance)
330 REM
1000 DEFDBL A-Z
1010 DEFINT I, J, K, L
1020 DIM R[400], T[400], Y[400], X[400]
1025 C[3]=0
1030 PRINT "What is the data file name"; : INPUT D$
1040 OPEN "I", 1, D$
1050 REM   **** read and echo T(i), R(i) from the data file ****
1060 REM          (terminate read on R=-1)
1070 I=0
1080 PRINT "Data:"
1090 G$="Point   Temperature (Celsius)  Resistance (ohms)"
1100 H$="###      #####.##      #####.##"
1110 PRINT G$
1120 PRINT
1130 I=I+1
1140 INPUT #1, T(I), R(I)
1150 IF R(I)<0 THEN GOTO 1180
1155 X(I)=LOG(R(I)) : Y(I)=1/(T(I)+273.15)
1160 PRINT USING H$; I, T(I), R(I)
1170 GOTO 1130
1180 N=I-1
1190 CLOSE
1200 REM   **** accumulate sums ****
1205 SX=0 : SY=0 : SXY=0 : SXX=0
(Continued on next page)

```

(Program "STEIN1",continued from previous page)

```
1210 FOR I = 1 TO N
1220 SX=SX+X(I)
1230 SY=SY+Y(I)
1240 SXY=SXY+X(I)*Y(I)
1250 SXX=SXX+X(I)*X(I)
1260 NEXT I
1300 REM      **** print out results ****
1310 C[2]=(N*SXY -SX*SY)/(N*SXX-SX*SX)
1320 C[1] = (SY -C[2]*SX)/N
1620 PRINT
1630 G$="Key in:  C1      C2      C3"
1640 P$="      #.###  #.###  #.###"
1650 PRINT G$
1660 PRINT USING P$; C[1]*1000!, C[2]*10000!,C[3]
1700 '
1702 C1=INT(C[1]*1000000!)/1000000!
1704 C2=INT(C[2]*1E+07)/1E+07
1706 C3=0
1710 PRINT
1712 PRINT "      T      T      T"
1714 PRINT "  R    ACTUAL    CALC    ERROR"
1716 PRINT " =====  =====  =====  ====="
1718 P$= " #####.##  #####.##  #####.##  #####.##"
1720 FOR L=1 TO N
1730 X=LOG(R(L))
1740 TCALC=1/(C1+C2*X+C3*X*X*X) -273.15
1760 PRINT USING P$;R(L),T(L),TCALC,T(L)-TCALC
1780 NEXT L
```

```

80 REM ***** STEIN3 *****
90 REM
92 REM   Rev: 3-11-87
94 REM
100 REM   Least squares fit program to find the thermistor coefficients
110 REM   C1, C2 and C3 in the Steinhart-Hart equation:
120 REM
130 REM           1/T = C1 + C2 * (ln R) + C3 * (ln R)**3
140 REM
150 REM   Reference:
160 REM
170 REM   "Data Reduction and Error Analysis for the Physical Sciences"
180 REM       Philip R. Bevington (McGraw-Hill, New York, 1969)
190 REM       Library call no.: QA 278 B48
200 REM
210 REM   Variables:
220 REM
230 REM   T[i], R[i]   temperature and resistance data values.
240 REM
250 REM   Y[i] = 1/T[i] the dependent variable (depends on R[i])
260 REM               in the Steinhart - Hart equation (above).
270 REM
280 REM   X[n,i]       the value of the nth function of the independent
290 REM               variable R (resistance) evaluated at the ith
300 REM               data point R[i]
310 REM
320 REM           X[1,i] = 1 ; X[2,i] = ln(R[i]) ; X[3,i] = ln(R[i]) ** 3
330 REM
340 REM   c[j]         the value of the jth coefficient to be solved for
350 REM               in the expansion
360 REM
370 REM           Y[i] = c[1] * X[1,i] + c[2] * X[2,i] + c(3) * X[3,i]
380 REM
390 REM               which becomes the Steinhart - Hart equation
395 REM               which is the inverse of the alpha matrix
400 REM               with the above substitutions for Y[i] and X[n,i].
410 REM               c[j] corresponds to Bevington's a[j] vector
420 REM               in his eqn 8-26.
430 REM
440 REM   A[j,k]       Bevington's alpha matrix (j,k=1,2,3)
450 REM               and beta vector (j=4, k=1,2,3) (Bevington eqn 8-23).
460 REM
470 REM   E[j,k]       Bevington's epsilon (error) matrix (eqns 8-28, 8-30)
480 REM               and contains the uncertainties in the estimates
490 REM               of the c[j] coefficients. These uncertainties are
500 REM               the consequence of the scatter (errors) in the
510 REM               input temperature verses resistance data.

```

(Continued on next page)

(Program STEIN3, continued from previous page)

```
1000 DEFDBL A-Z
1010 DEFINT I, J, K, L
1020 DIM R[400], T[400], Y[400], X[4,400], A[4,3], B[3,3], E[3,3], C[3]
1030 PRINT "What is the data file name"; : INPUT D$
1040 OPEN "I", 1, D$
1050 REM **** read and echo T(i), R(i) from the data file ****
1060 REM (terminate read on R=-1)
1070 I=0
1080 PRINT "Data:"
1090 G$="Point Temperature (Celsius) Resistance (ohms)"
1100 H$="### #####.## #####.##"
1110 PRINT G$
1120 PRINT
1130 I=I+1
1140 INPUT #1, T(I), R(I)
1150 IF R(I)<0 THEN GOTO 1180
1160 PRINT USING H$; I, T(I), R(I)
1170 GOTO 1130
1180 N=I-1
1190 CLOSE
1200 REM **** calculate 4 x 3 matrix ****
1210 FOR I = 1 TO N
1220 H=LOG(R(I))
1230 X(1,I)=1
1240 X(2,I)=H
1250 X(3,I)=H*H*H
1260 REM (subscript 4 corresponds to y[i] = X[4,i])
1270 X(4,I)=1/(T(I)+273.15)
1280 NEXT I
1290 REM **** Calculate alpha (i=1 to 3) and beta (i=4) ****
1300 REM (Bevington eqns 8-23)
1310 FOR I=1 TO 4 : FOR J=1 TO 3 : A(I,J)=0 : NEXT J : NEXT I
1320 FOR I=1 TO N : FOR J=1 TO 4 : FOR K=1 TO 3
1330 A(J,K)=A(J,K)+X(J,I)*X(K,I)
1340 NEXT K : NEXT J : NEXT I
1350 REM **** Error matrix "E" = inverse of alpha (3x3 part of A) ****
1360 GOSUB 2010
1370 REM **** Coefficients = beta (fourth column of A) x E ****
1380 REM (eqn 8-26 of Bevington)
1390 FOR I=1 TO 3 : C(I)=0 : FOR J=1 TO 3
1400 C(I)=C(I)+E(I,J)*A(4,J)
1410 NEXT J : NEXT I
1420 SIGMA=0
1430 FOR I=1 TO N
1440 H=X(4,I)-C(1)*X(1,I)-C(2)*X(2,I)-C(3)*X(3,I)
1450 SIGMA=SIGMA+H*H
1460 NEXT I
```

(Continued on next page)

(Program STEIN3, continued from previous page)

```
1470 REM      **** sigma = mean square deviation ****
1480 REM      (Bevington eqn 8-29)
1490 SIGMA=SQR(SIGMA/(N-3))
1500 REM      **** print coefficients and estimated errors ****
1510 REM      (eqns 8-26 and 8-30 of Bevington)
1520 F$="##.##### +/- ##.#####)"
1530 PRINT
1540 PRINT "1/T = (";
1550 PRINT USING F$; C(1), SIGMA*SQR(E(1,1))
1560 PRINT " + (";
1570 PRINT USING F$; C(2), SIGMA*SQR(E(2,2));
1580 PRINT " * ln (R)"
1590 PRINT " + (";
1600 PRINT USING F$; C(3), SIGMA*SQR(E(3,3));
1610 PRINT " * ln (R) ** 3"
1620 PRINT
1630 G$="Key in:  C1      C2      C3"
1640 P$="      #.###   #.###   #.###"
1650 PRINT G$
1660 PRINT USING P$; C[1]*1000!, C[2]*10000!, C[3]*1E+07
1700 '
1710 PRINT
1712 PRINT "      T      T      T"
1714 PRINT "  R    ACTUAL    CALC    ERROR"
1716 PRINT " =====  =====  =====  ====="
1718 P$= " #####   ####.##   ####.##   ####.##"
1720 FOR L=1 TO N
1730 X=LOG(R(L))
1740 TCALC=1/(C(1)+C(2)*X+C(3)*X*X)-273.15
1760 PRINT USING P$;R(L),T(L),TCALC,T(L)-TCALC
1780 NEXT L
1890 REM      ***** program end *****
1892 END
2000 REM      ***** Begin Subroutines *****
2010 REM      **** Invert 3 x 3 matrix "A" by cofactors ****
2020 GOSUB 2160 : GOSUB 2120
2030 DET=SUM
2040 FOR K=1 TO 3 : FOR L=1 TO 3
2050 GOSUB 2160
2060 FOR J=1 TO 3 : B(J,L)=0 : B(K,J)=0 : NEXT J : B(K,L)=1
2070 GOSUB 2120
2080 REM      **** "E" = inverse = transpose of cofactor ****
2090 E(L,K)=SUM/DET
2100 NEXT L : NEXT K
2110 RETURN
```

(Continued on next page)

(Program STEIN3, continued from previous page)

```
2120 REM      **** 3 x 3 determinant routine ****
2130 SUM = B[1,1]*B[2,2]*B[3,3]+B[1,2]*B[2,3]*B[3,1]+B[1,3]*B[2,1]*B[3,2]
2140 SUM = SUM-B[1,1]*B[2,3]*B[3,2]-B[1,2]*B[2,1]*B[3,3]-B[1,3]*B[2,2]*B[3,1]
2150 RETURN
2160 REM      **** Copy matrix A onto "scratch" matrix B ****
2170 FOR I=1 TO 3 : FOR J=1 TO 3 : B(I,J)=A(I,J) : NEXT J : NEXT I
2180 RETURN
```

Once the constants, C1, C2, and C3 have been determined (using this program or other means), temperature can be calculated from resistance, or resistance calculated from temperature using the RandT.BAS program below.

For more information on using the S-H equation, refer to ILX Lightwave Application Note #4.

Using the S-H Equation to Find Resistance or Temperature

The program below, RandT.BAS, will calculate the thermistor resistance for a given temperature, or the temperature given the resistance, using the S-H equation above. The accuracy of this conversion depends on the accuracy of the S-H constants.

```
5  '***** RandT.BAS *****
10 CLS
20 '
30 'Program is in GWBASIC 3.2 for IBM or compatible computers.
40 'Enter the S-H constants in the form: C1, C2, C3
50 'This program calculates resistance or temperature, given the S-H
60 'constants and one known parameter.
70 'T is in degrees C, and R in ohms.
80 '
90 INPUT "C1, C2, C3"; C1!, C2!, C3!      'input S-H constants
100 '
110 PRINT "Enter R to find resistance, T to find temperature,"
120 PRINT "or Q to quit."
130 '
140 A$ = INKEY$          'input selection
150 IF A$ = "R" GOTO 190
160 IF A$ = "T" GOTO 290
170 IF A$ = "Q" GOTO 330 : ELSE GOTO 140
180 '
```

(Continued on next page)

(Program RandT.bas, continued from previous page)

```
190 INPUT "T"; T!           'find resistance given temperature
200 K! = T + 273.15         'convert to Kelvin
210 U! = C2! / (3! * C3!)   'intermediate steps
220 V! = ((1! / K!) - C1!) / (2! * C3!)
230 W! = SQR((V! * V!) + (U! * U! * U!))
240 X! = (V! + W!)^(1! / 3!)
250 Y! = (W! - V!)^(1! / 3!)
260 R! = EXP(X! - Y!)
270 PRINT " Resistance in ohms = "; R! : PRINT : GOTO 140
280 '
290 INPUT "R"; R!           'find temperature given resistance
300 T! = (1! / (C1! + C2! * LOG(R!) + C3! * (LOG(R!)^3))) - 273.15
310 PRINT " Temperature in C = "; T! : PRINT : GOTO 140
320 '
330 END
```

Appendix B

Sensing Current and Thermistor Selection

Introduction

Choosing the right sensing current depends on the range of temperature you want to measure and the resolution you require at the highest measured temperature. To correctly set the SENSOR SELECT switch you must understand how the thermistor and the LDT-5910B interact and how temperature range and resolution values are inherent in the nature of thermistors.

Thermistor Range

Thermistors can span a wide temperature range, but their practical range is limited by their non-linear resistance properties. As the sensed temperature increases, the resistance of the thermistor decreases significantly and the thermistor resistance changes less for an equivalent temperature change -the thermistor becomes less sensitive. Consider the temperature and sensitivity figures below.

<u>Temperature</u>	<u>Sensitivity</u>
-20°C	5600 ohms/°C
25°C	439 ohms/°C
50°C	137 ohms/°C

In the LDT-5910B the practical upper temperature limit is the temperature at which the thermistor becomes insensitive to temperature changes. The lower end of the temperature range is limited by the maximum A/D input voltage of the LDT-5910B. Thermistor resistance and voltage are related through Ohms Law ($V = I \times R$). The LDT-5910B supplies current to the thermistor, either 10 uA or 100 uA, and as the resistance changes a changing voltage signal is available to the thermistor inputs of the LDT-5910B. The LDT-5910B will over-range when the input voltage exceeds about 5 Volts. Figure B.1 graphically shows the lower temperature and upper voltage limits for a typical 10 K ohm thermistor. The practical temperature ranges for a typical 10 K thermistor (a 10 K thermistor has a resistance of 10 K ohms at 25 °C) are given in the table below.

<u>Sensing Current</u>	<u>Temperature Range</u>
10 uA	-51 to 40 °C
100 uA	-10 to 100 °C

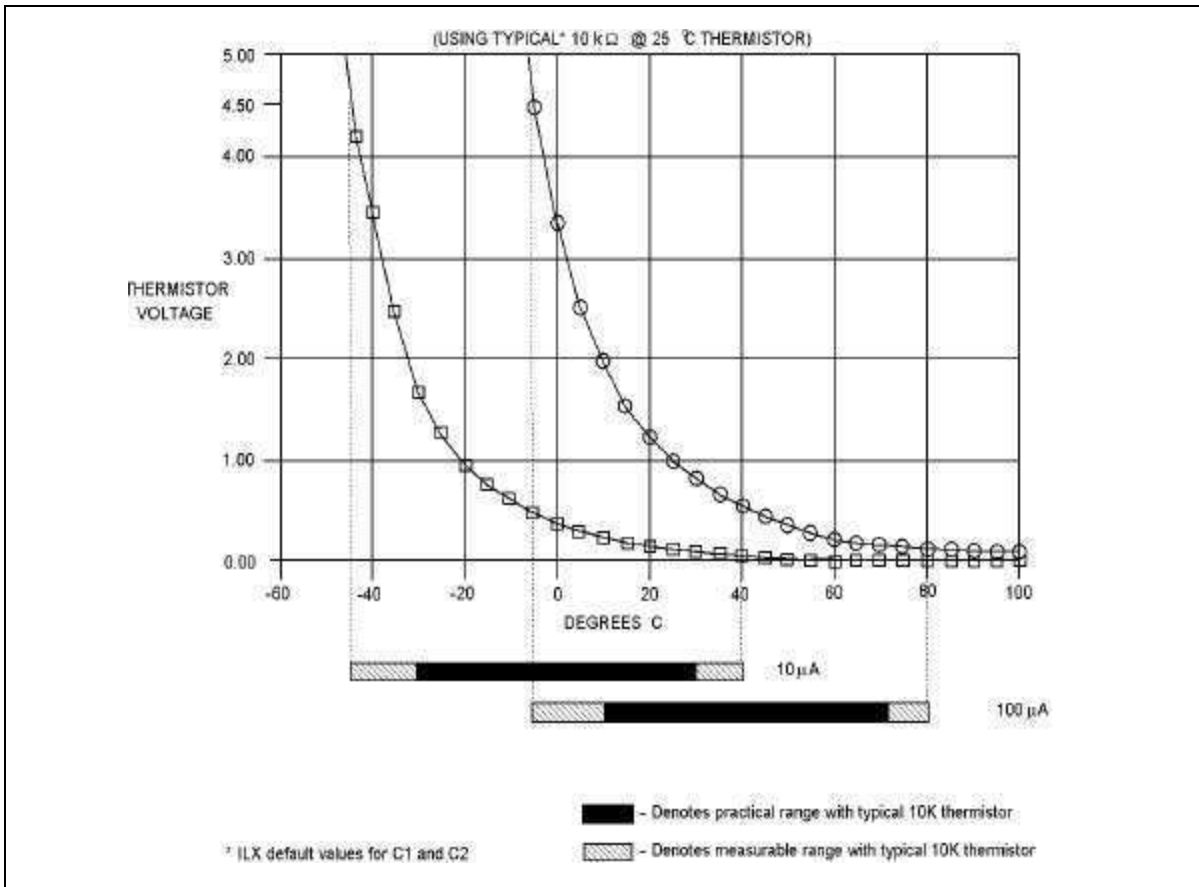

Figure B.1 Thermistor Temperature Range

Temperature Resolution

You must also consider measurement resolution since the resolution decreases as the thermistor temperature increases. The LDT-5910B uses an A/D converter that has a maximum resolution of about 76 $\mu\text{V}/\text{step}$. The microprocessor converts this digital number to resistance, stores this resistance, then converts it to a temperature using the Steinhart-Hart equation, and stores this temperature. A temperature change of one degree centigrade will be represented by a greater resistance increase (and therefore more A/D steps) at a lower temperature than at a higher temperature because of the non-linear resistance of the thermistor. Resolution figures for a typical 10 K ohm thermistor are given below.

<u>Temperature</u>	<u>Voltage at 10 μA</u>	<u>Resolution</u>
-20°C	56 mV/°C	0.018°C/mV
25°C	4.4 mV/°C	0.23°C/mV
50°C	1.4 mV/°C	0.70°C/mV

For this thermistor, a temperature change from -20 to -19°C will be represented by 737 A/D steps (if supplied with 10 μA). The same thermistor will only change about 18 A/D steps from 49 to 50°C!

The resolution you choose will impact the temperature displayed on the LDT-5910B. If you want to read a certain temperature with 0.2°C accuracy, you must set the SENSOR SELECT switch for that resolution. Since the thermistor is non-linear the resolution will also decrease as the temperature increases. The high temperature limit occurs when the temperature resolution drops below an acceptable level.

Selecting the Sensing Current

To select the current setting for a typical 10 K thermistor, determine the lowest temperature you will need to sample and set the SENSOR SELECT switch according to the range limits given above. If the temperature you want to sample is below -10°C you will need to set the switch to the 10 μA setting.

With the SENSOR SELECT switch set to 10 μA the best resolution you will see will be a 0.1°C temperature change. If, for example, the lower limit is 0°C you can choose either setting, but there is a tradeoff in terms of resolution. If you need better than 0.1°C measurement resolution you will have to change the setting of the SENSOR SELECT switch to 100 μA .

If you need high resolution over a narrow range, for a very accurate measurement, you can set the current setting for the maximum resolution. For example, at a high temperature of 15°C, you require a measurement resolution of at least 0.05°C. This resolution is within the range of either SENSOR SELECT switch setting, but at the 10 μA setting the resolution is only 0.2°C while at the 100 μA setting the resolution is better than .05°C. Set the switch to 100 μA .

Generally, it is best to use the 100 μA setting for all measurements of -10°C or greater with a 10 K thermistor.

Selecting and Using Thermistors

The type of thermistor you choose will depend primarily on the operating temperature range. These guidelines for selecting the range and resolution will apply to any thermistor. From Figure B.1 you can see that 10 K thermistors are generally a good choice for most laser diode applications where high stability is required near room temperatures. Similarly, 10 K thermistors are often a good choice for detector cooling applications where you want to operate at temperatures from -40°C to room temperature.

If you require a different temperature range or the accuracy you need can't be achieved with either switch setting, select another thermistor. Thermistor temperature curves, supplied by the manufacture, show the resistance verses temperature range for many other thermistors. ILX Lightwave Corporation will also offer help for your specific application.

Appendix C

AD590 and LM335 Sensor Calibration

Introduction

The LDT-5910B uses two constants (C1 and C2) for calibrating linear thermal sensing devices, such as the AD590 and the LM335. C1 is used as the linear or zero offset value, and C2 is used as the slope or gain adjustment. Therefore, C1 has a nominal value of 0, and C2 has a nominal value of 1 when the SENSOR SELECT switch is in the AD590 or LM335 positions.

In order to calibrate a linear sensor device, the sensor must be operated at an accurately known, stable temperature. For example, the sensor may be calibrated at 0°C if the sensor is placed in ice water until its temperature is stable. A highly accurate temperature probe, thermometer, environmental chamber, etc., may also be used to determine the known temperature for calibration. This appendix contains one and two point calibration methods for linear sensor devices. These methods will work for either type of device.

AD590 Sensor

The AD590 is a linear thermal sensor which acts as a constant current source. It produces a current, i , which is directly proportional to absolute temperature, over its useful range (-50°C to +150°C). This nominal value can be expressed as:

$$i = 1\mu\text{A} / \text{K}$$

-where i is the nominal current produced by the AD590, and K is in Kelvin.

The 5910B uses i to determine the nominal temperature, T_n , by the formula:

$$T_n = (i / (1\mu\text{A} / \text{K})) - 273.15$$

-where T_n is in °C.

The temperature, T_d , which is displayed by the 5910B is first calibrated as follows:

$$T_d = C1 + (C2 * T_n)$$

-where C1 and C2 are the constants stored in the 5910B for the AD590.

The AD590 is calibrated to 25°C, at the factory, so that $C2 = 1$ and $C1 = 0$. The AD590 grades of tolerance vary, but typically this means that without adjusting C1 or C2, the temperature accuracy is $\pm 1^\circ\text{C}$ over its rated operating range. However, the AD590 is not perfectly linear, and even with C1 accurately known there is a non-linear absolute temperature error associated with the device. This non-linearity is shown in Figure C.1, reprinted from Analog Devices specifications, where the error associated with C1 is assumed to be zero.

If a maximum absolute error of 0.8°C is tolerable, the one point calibration of C1 should be used. If a greater accuracy is desired, the two point method of determining C1 and C2 should be used. Note however, the absolute error curve is non-linear, therefore the constant C2 will vary over different temperature ranges.

LM335 Sensor

The LM335 is a linear thermal sensor which acts as a constant voltage source. It produces a voltage, v , which is directly proportional to absolute temperature, over its useful range (-40°C to +100°C). This nominal value can be expressed as:

$$v = 10\text{mV} / \text{K}$$

-where v is the nominal voltage produced by the LM335 and K is in Kelvin.

The 5910B uses v to determine the nominal temperature, T_n , by the formula:

$$T_n = (v / (10\text{mV} / \text{K})) - 273.15$$

-where T_n is in °C.

The temperature, T_d , which is displayed by the 5910B is first calibrated as follows:

$$T_d = C1 + (C2 * T_n)$$

-where C1 and C2 are the constants stored in the 5910B for the AD590.

When the LM335 is calibrated to 25°C, $C2 = 1$ and $C1 = 0$, and the temperature accuracy is typically $\pm 0.5^\circ\text{C}$ over the rated operating range. However, the LM335 is not perfectly linear, and even with $C1$ accurately known there is a non-linear absolute temperature error associated with the device. This non-linearity caused error is typically $\pm 0.3^\circ\text{C}$, with the error associated with $C1$ assumed to be zero.

If a maximum absolute error of $\pm 0.3^{\circ}\text{C}$ is tolerable, the one point calibration of C1 should be used. If a greater accuracy is desired, the two point method of determining C1 and C2 should be used. Note however, the absolute error associated with the constant C2 may vary over different temperature ranges.

Determining C1 and C2

The nominal values of C1 and C2 are 0 and 1, respectively, for both types of devices. These values should be used initially for determining C1 and C2 in the methods described below.

The One Point method is easiest, but it ignores the non-linearity of the device. It is most useful when a high degree of temperature accuracy is not required.

The Two Point method can achieve a high degree of accuracy over a narrower operating temperature range, but requires two accurate temperature measurements.

One Point Calibration Method

This procedure will work for either sensor type. The accuracy of this procedure depends on the accuracy of the known temperature, externally measured. It is used to determine the zero offset of the device, and it assumes that the gain offset (slope) is known and is correct.

1. Allow the 5910B to warm up for at least one hour. Set the SENSOR SELECT switch for the desired sensor type, and RECALL the constants for the particular device to be calibrated.
2. Select the C1 parameter. Read and record the value of C1.
3. Place the sensor at an accurately known and stable temperature, T_a . Connect the sensor to the 5910B for normal Constant temperature operation. Allow the 5910B to stabilize at the known temperature, T_a and read the displayed temperature, T_d .
4. Determine the new value of C1, $C1_n$, from the formula:

$$C1_n = C1 + T_a - T_d$$

and replace C1 with $C1_n$ by selecting the C1 parameter and entering the new $C1_n$ value.

Two Point Calibration Method

This procedure will work for either sensor type. The accuracy of this procedure depends on the accuracy of the known temperatures, externally measured. It is used to determine the zero offset of the device and the gain offset (slope).

1. Allow the 5910B to warm up for at least one hour. Set the SENSOR SELECT switch for the desired sensor type, and RECALL the constants for the particular device to be calibrated.
2. Select the C1 parameter. Read and record the value of C1. Select the C2 parameter. Read and record the value of C2.
3. Place the sensor at an accurately known and stable temperature, T_{a1} . Connect the sensor to the 5910B for normal Constant temperature operation. Allow the 5910B to stabilize at the known temperature, T_{a1} and read the displayed temperature, T_{d1} . Record these values.
4. Repeat Step 3 for another known temperature, T_{a2} , and the corresponding displayed temperature, T_{d2} .

The two known temperatures should be at the bounds of the intended operating range. For best results, make the range between T_{a1} and T_{a2} as narrow as possible.

5. Determine the new value of C1 ($C1_n$) and C2 ($C2_n$) from the following calculations.

First determine the intermediate values U and V, where

$$V = (T_{a1} - T_{a2}) / (T_{d1} - T_{d2}), \text{ and}$$

$$U = T_{a1} - (T_{d1} * V)$$

Then $C1_n$ and $C2_n$ can be determined by the following:

$$C1_n = U + (V * C1)$$

$$C2_n = V * C2$$

6. Replace C1 with $C1_n$ by selecting the C1 parameter and entering the new $C1_n$ value. Replace C2 with $C2_n$ by selecting the C2 parameter and entering the new $C2_n$ value.

Appendix D

LDT-5910B Error Messages

Introduction

Error messages may appear on the display when error conditions occur in the 5910B. In most cases, the error message will appear for three seconds and then the display will revert to its former state. In the case of multiple error messages, the 5910B will show each message for three seconds in succession.

In remote operation, the current error list can be read by issuing the "ERR?" query. When this is done, a string will be returned containing all of the error messages which are currently in the error message queue.

Table D.2 contains all of the error messages which may be generated by the 5910B. Not all of these messages may appear on the front panel display. Some refer to GPIB activities only, for example.

The errors codes are numerically divided into areas of operation. Errors which pertain to the following areas are listed in the ranges shown in Table D.1.

ERROR CODE CLASSIFICATIONS

<u>Error Code Range</u>	<u>Area of Operation</u>
E001 to E099	Internal Program Errors
E100 to E199	Parser Errors
E200 to E299	Execution Control Errors
E300 to E399	GPIB Errors
E400 to E499	TEC Control Errors

Table D.1 Error Code Classifications

5910B ERROR MESSAGES

ERROR CODE EXPLANATION

E001 Memory allocation failure.

E101 <program mnemonic> is too long.

E102 <PROGRAM MESSAGE UNIT> is too long.

E103 <DEFINITE LENGTH ARBITRARY BLOCK PROGRAM DATA>
length too long.

E104 <NON_DECIMAL NUMERIC PROGRAM DATA> type not defined.

E105 <DECIMAL PROGRAM DATA> exponent not valid.

E106 <DECIMAL PROGRAM DATA> digit expected.

E107 <DECIMAL PROGRAM DATA> digit not expected.

E108 <DECIMAL PROGRAM DATA> more than one decimal point.

E109 <DECIMAL PROGRAM DATA> more than one exponential indicator
(E).

E110 <SUFFIX PROGRAM DATA> must have digit following sign.

E111 <SUFFIX PROGRAM DATA> must have alpha character following
operator.

E113 <ARBITRARY BLOCK PROGRAM DATA> length less than digit
count.

E114 <DEFINITE LENGTH BLOCK PROGRAM DATA> premature end of
data.

E115 <PLACEHOLDER PROGRAM DATA> identifier not valid.

E116 Parser syntax error, character was not expected.

E120 <program mnemonic> Lookup, word as part of a header path, has no
commands.

E121 <program mnemonic> Lookup, word as part of a header path, is not
found.

E122 <program mnemonic> Lookup, cannot find a null entry.

E123 <program mnemonic> Lookup, word within context of current path, is
not found.

E124 <program mnemonic> Lookup, failed because query/command type
match failed.

E125 <program mnemonic> Lookup, word within context of common
command path, is not found.

E126 Too few or too many program data elements.

Table D.2 5910B Error Message Codes

5910B ERROR MESSAGES

ERROR CODE EXPLANATION

- E201<PROGRAM DATA> value out of range.**
 - E202<PROGRAM DATA> will not convert to valid type.**
 - E203Security violation, command is not available without clearance.**
 - E204<PROGRAM DATA> suffix type is not valid.**
 - E205 <PROGRAM DATA> is not a boolean value or word.**
 - E206<PROGRAM DATA> will not convert to a signed 16-bit value.**
 - E207<PROGRAM DATA> will not convert to an unsigned 16-bit value.**
 - E208<PROGRAM DATA> will not convert to a signed 32-bit value.**
 - E209<PROGRAM DATA> will not convert to an unsigned 32-bit value.**
 - E210<PROGRAM DATA> will not convert to a floating point value.**
 - E211<PROGRAM DATA> will not convert to a character value.**
 - E212<PROGRAM DATA> will not convert to a byte array pointer.**
 - E213<PROGRAM DATA> is incorrect block data length.**
 - E214<PROGRAM DATA> length exceeds maximum.**
- E301A <RESPONSE MESSAGE> was ready, but controller failed to read it.
(Query error).**
- E401(TEMP LIMIT) interlock disabled output.**
 - E402Sensor open disabled output.**
 - E403TEC module open disabled output.**
 - E404Current limit disabled output.**
 - E405Voltage limit disabled output.**
 - E407High temperature limit disabled output.**
 - E408Booster change disabled output.**
 - E409Sensor change disabled output.**
 - E410Out of tolerance disabled output.**
 - E411TEC control error disabled output.**
 - E412Analog section status is all 1's or all 0's (power down).**
 - E415 Sensor short disabled output.**
 - E416Incorrect configuration for calibration sequence to start.**

Table D.2 5910B Error Message Codes (Cont.)

Index

AC power	
connections	1-3, 2-14
fuse replacement	5-9
line voltage selection	5-10
AD590	1-2 to 1-4, 2-10, 2-13, 2-14, 3-62, 3-67, 3-70, 5-4, 5-5, C-1
Advanced Programming Techniques	4-16 to 4-18
ANSI/IEEE-488.2 definitions	4-18 to 4-27
Bin storage	2-9
Calibration Procedures	
AD590	5-4, 5-5
Current	5-7, 5-8
LM335	5-6, 5-7
Thermistor	5-3, 5-4
Command	
path structure	3-3, 3-8, 4-2, 4-3, 4-16, 4-17
reference	3-1 to 3-85
Compliance voltage	
specifications	1-2
voltage limit	2-8, 2-11
CONST	2-10, 3-15, 3-16
Current limit (LIM I)	2-8, 2-11, 3-45, 3-46
Default settings	2-2
Device-dependent command set	3-4, 3-5, 3-9 to 3-82
DELAY command	3-18, 3-83, 3-84
Disassembly	5-10
Display	1-3, 2-3 to 2-5, 2-7, 2-11, 3-19 to 3-29
Environmental conditions	1-3, 2-31, 5-2
Error messages	D-1 to D-3
Example programs	3-83
Fault (error) indicators	2-8, 2-11
Fuse replacement	5-9
GAIN adjustment	2-10, 3-39
GPIB/IEEE-488 interface	
address setting	2-6, 2-7, 4-2
common commands	4-5 to 4-15
interface messages	4-31, 4-32
REMOTE indicator	2-3, 2-7
specifications	1-3
IEEE-488.2 definitions	4-18 to 4-27
Input/output buffering	4-30

LIM I(TE)	2-3, 2-8, 2-11, 2-15, 3-45, 3-46
LIM T _{HI}	2-3, 2-8, 2-15, 3-47, 3-48
LIM T _{LO}	2-3, 2-9, 2-15, 3-49, 3-50
LM335 1-2 to 1-4, 2-10, 2-13, 2-14, 3-62, 3-67, 3-69, 5-6, 5-7, C-2 to C-4	
LOCAL/ADR switch	2-3, 2-4, 2-6, 2-7
Maintenance	5-1
MODE	
R.....	3-1, 3-58
T	2-2, 3-1, 3-59
No-Operation-Pending flag	4-15
<nrf value>.....	3-8, 4-20, 5-3, 5-5, 5-6, 5-8
Off/on switch.....	2-3, 2-4
Operation procedures	2-14, 2-15
Operation complete flag.....	3-81, 4-8, 4-27, 4-28
Output	1-3, 2-3, 2-4, 2-6, 2-8, 2-9, 2-14, 2-15
Output off conditions (automatic).....	2-6, 3-35, 3-36, 4-30
Output off register.....	3-35, 3-36, 4-29, 4-30
PARAMETER selection	2-4, 2-7 to 2-9, 2-15
Parameter, substitute names	3-2
Pin-out.....	2-13
POWER off/on switch.....	2-3, 2-4
Power-on conditions	2-2, 4-25
Program examples	A-6 to A-11
Program message terminators	3-77, 4-20
R mode.....	3-1, 3-5, 3-58
Rack mount option	1-4, 2-1
RADix command/query	3-5, 3-64, 3-65
RECALL operation	2-4, 2-9
Remote messages	4-32
Response structures	4-23, 4-24, 4-29, 4-30
SAVE operation	2-4, 2-9, 4-13
SENSOR SELECT switch.....	2-2, 2-11 to 2-15
Schematic diagrams	4-26, 7-2 to 7-12
Specifications	1-2, 1-3
Status Reporting.....	4-25 to 4-28
Steinhart-Hart equation	1-3, 2-10, A-1, A-2
STEP command/query	3-5, 3-71, 3-72
Syntax diagrams	4-19
T mode.....	2-2, 3-1, 3-59
Temperature requirements	1-3, 5-2
TERM command/query	3-5, 3-77, 3-78

Thermistor	
calibration	A-1 to A-10
range optimization	B-1 to B-3
selection	B-4
Steinhart-Hart equation	1-3, 2-10, A-1, A-2
temperature versus resistance	A-2, A-10, A-11
TIME? query	3-5, 3-79
TIMER? query	3-5, 3-80
Timing considerations	4-17, 4-18
TOLerance command/query	3-5, 3-81, 3-82
Warm-up	1-3, 5-2
Warranty and service information	second front page
White space	4-19
*CAL? query	4-5
*CLS command	4-5
*ESE command/query	4-6, 4-7
*ESR? query	4-7
*IDN? query	4-7
*IST? query	4-8
*OPC command/query	4-8, 4-12, 4-27
*PRE command/query	4-9, 4-10
*PSC command/query	4-10, 4-11
*PUD command/query	4-11
*RCL command	4-12
*RST command	4-12
*SAV command	4-13
*SRE command/query	4-13, 4-14
*STB? query	4-15
*TST? query	4-15
*WAI command	4-15