

User's Guide

Temperature Controller LDT-5525



 **ILX Lightwave**
Laser Diode Instrumentation & Test Systems

ILX Lightwave Corporation · P. O. Box 6310 · Bozeman, MT, U.S.A. 59771 · U.S. & Canada: 1-800-459-9459 · International Inquiries: 406-556-2481 · Fax 406-586-9405

ilx.custhelp.com · www.ilxlightwave.com

www.valuetronics.com

70019904 July 2001

TABLE OF CONTENTS

Safety Information and the Manual	vii
General Safety Considerations	vii
Safety Marking Symbols	viii
Comments, Suggestions, and Problems	xi

Chapter 1 Introduction and Specifications

Product Overview	1
Available Options and Accessories	2
Specifications	3

Chapter 2 Operation

AC Power Considerations	7
Rack Mounting	7
Power-Up Sequence	8
Introduction to the LDT-5525 Front Panel	8
Adjustments	9
Display	9
Parameters	9
Parameter Setup	10
SENSOR CAL	10
Output	11
Control Mode	11
Error Indicators	11
Analog Output	12
Back Panel Controls and Connections	12

SENSOR SELECT Switch	12
TEC Connector	13
TEC Grounding Considerations	14
General Operating Procedures	15
Warm-Up and Environmental Considerations	15
Temperature Mode Operation	15
Resistance Mode Operation	16
External Safety Switch Operation	16
Booster Operation	17

Chapter 3 Maintenance and Troubleshooting

Calibration Overview	19
Recommended Equipment	20
Environmental Conditions	20
Warm Up	20
Calibration Adjustments	21
Thermistor Calibration	21
AD590 Sensor Calibration	22
LM335 Sensor Calibration	23
ITE Current Calibration	24
Troubleshooting	25

Appendix A Steinhart-Hart Equation

Computer Program	29
------------------------	----

Appendix B Sensing Current and Thermistor Selection

Thermistor Range	33
Temperature Resolution	35
Selecting the Sensing Current	35
Selecting and Using Thermistors	35

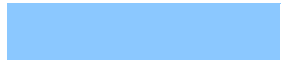

Appendix C AD590 and LM335 Sensor Calibration

AD590 Sensor	37
LM335 Sensor	38
One Point Calibration Method	40
Two Point Calibration Method	40

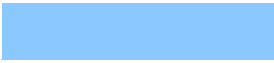

TABLE OF CONTENTS



LIST OF FIGURES



Figure 2.1	LDT-5525 Front Panel	8
Figure 2.2	LDT-5525 Back Panel	12
Figure 2.3	Back Panel TEC Connector	13
Figure A.1	Thermistor Resistance vs. Temperature	28
Figure B.1	Thermistor Temperature Range	34
Figure C.1	AD590 Nonlinearity	38

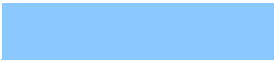

LIST OF FIGURES

SAFETY AND WARRANTY INFORMATION

The Safety and Warranty Information section provides details about cautionary symbols used in the manual, safety markings used on the instrument, and information about the Warranty including Customer Service contact information.

Safety Information and the Manual

Throughout this manual, you will see the words *Caution* and *Warning* indicating potentially dangerous or hazardous situations which, if not avoided, could result in death, serious or minor injury, or damage to the product. Specifically:

CAUTION

Caution indicates a potentially hazardous situation which can result in minor or moderate injury or damage to the product or equipment.

WARNING

Warning indicates a potentially dangerous situation which can result in serious injury or death.

WARNING

Visible and/or invisible laser radiation. Avoid direct exposure to the beam.

General Safety Considerations

If any of the following conditions exist, or are even suspected, do not use the instrument until safe operation can be verified by trained service personnel:

- Visible damage
- Severe transport stress
- Prolonged storage under adverse conditions
- Failure to perform intended measurements or functions

If necessary, return the instrument to ILX Lightwave, or authorized local ILX Lightwave distributor, for service or repair to ensure that safety features are maintained (see the contact information on page xi).

All instruments returned to ILX Lightwave are required to have a Return Authorization Number assigned by an official representative of ILX Lightwave Corporation. See Returning an Instrument on page ix for more information.

SAFETY SYMBOLS











This section describes the safety symbols and classifications.

Technical specifications including electrical ratings and weight are included within the manual. See the Table of Contents to locate the specifications and other product information. The following classifications are standard across all ILX Lightwave products:

- Indoor use only
- Ordinary Protection: This product is NOT protected against the harmful ingress of moisture.
- Class I Equipment (grounded type)
- Mains supply voltage fluctuations are not to exceed $\pm 10\%$ of the nominal supply voltage.
- Pollution Degree II
- Installation (overvoltage) Category II for transient overvoltages
- Maximum Relative Humidity: $< 80\%$ RH, non-condensing
- Operating temperature range of $0\text{ }^{\circ}\text{C}$ to $40\text{ }^{\circ}\text{C}$
- Storage and transportation temperature of $-40\text{ }^{\circ}\text{C}$ to $70\text{ }^{\circ}\text{C}$
- Maximum altitude: 3000 m (9843 ft.)
- This equipment is suitable for continuous operation.

Safety Marking Symbols

This section provides a description of the safety marking symbols that appear on the instrument. These symbols provide information about potentially dangerous situations which can result in death, injury, or damage to the instrument and other components.

	Caution, refer to manual		Earth ground Terminal		Alternating current		Visible and/or invisible laser radiation
	Caution, risk of electric shock		Protective Conductor Terminal		Caution, hot surface		Frame or chassis Terminal
 or (I)	On: In position of a bistable push control. The slash (I) only denotes that mains are on.	 or (O)	Off: Out position of a bistable push control. The circle (O) only denotes that mains are off.				

WARRANTY

ILX LIGHTWAVE CORPORATION warrants this instrument to be free from defects in material and workmanship for a period of one year from date of shipment. During the warranty period, ILX will repair or replace the unit, at our option, without charge.

Limitations

This warranty does not apply to fuses, lamps, defects caused by abuse, modifications, or to use of the product for which it was not intended.

This warranty is in lieu of all other warranties, expressed or implied, including any implied warranty of merchantability or fitness for any particular purpose. ILX Lightwave Corporation shall not be liable for any incidental, special, or consequential damages.

If a problem occurs, please contact ILX Lightwave Corporation with the instrument's serial number, and thoroughly describe the nature of the problem.

Returning an Instrument

If an instrument is to be shipped to ILX Lightwave for repair or service, be sure to:

- 1 Obtain a Return Authorization number (RA) from ILX Customer Service.
- 2 Attach a tag to the instrument identifying the owner and indicating the required service or repair. Include the instrument serial number from the rear panel of the instrument.
- 3 Attach the anti-static protective caps that were shipped with the instrument and place the instrument in a protective anti-static bag.
- 4 Place the instrument in the original packing container with at least 3 inches (7.5 cm) of compressible packaging material. **Shipping damage is not covered by this warranty.**
- 5 Secure the packing box with fiber reinforced strapping tape or metal bands.
- 6 Send the instrument, transportation pre-paid, to ILX Lightwave. Clearly write the return authorization number on the outside of the box and on the shipping paperwork. ILX Lightwave recommends you insure the shipment.

If the original shipping container is not available, place your instrument in a container with at least 3 inches (7.5 cm) of compressible packaging material on all sides.

Repairs are made and the instrument returned transportation pre-paid. Repairs are warranted for the remainder of the original warranty or for 90 days, whichever is greater.

Claims for Shipping Damage

When you receive the instrument, inspect it immediately for any damage or shortages on the packing list. If the instrument is damaged, file a claim with the carrier. The factory will supply you with a quotation for estimated costs of repair. You must negotiate and settle with the carrier for the amount of damage.



Comments, Suggestions, and Problems

To ensure that you get the most out of your ILX Lightwave product, we ask that you direct any product operation or service related questions or comments to ILX Lightwave Customer Support. You may contact us in whatever way is most convenient:

Phone (800) 459-9459 or (406) 586-1244

Fax (406) 586-9405

On the web at: ilx.custhelp.com

Or mail to:

ILX Lightwave Corporation
P. O. Box 6310
Bozeman, Montana, U.S.A 59771
www.ilxlightwave.com

When you contact us, please have the following information:

Model Number: _____

Serial Number: _____

End-user Name: _____

Company: _____

Phone: _____

Fax: _____

Description of what is connected to the ILX Lightwave instrument:

Description of the problem:

If ILX Lightwave determines that a return to the factory is necessary, you are issued a Return Authorization (RA) number. Please mark this number on the outside of the shipping box.

You or your shipping service are responsible for any shipping damage when returning the instrument to ILX Lightwave; ILX recommends you insure the shipment. If the original shipping container is not available, place your instrument



WARRANTY

in a container with at least 3 inches (7.5 cm) of compressible packaging material on all sides.

We look forward to serving you even better in the future!

INTRODUCTION AND SPECIFICATIONS

This manual contains operation and maintenance information for the LDT 5525 Temperature Controller. If you want to get started right away, read Chapter 2, which covers Operation, first.

Product Overview

The LDT-5525 Temperature Controller is a microprocessor-based, precision thermoelectric temperature controller designed for temperature control of laser diodes, detectors and other temperature sensitive devices. The LDT 5525 can be used for laser diode testing, laser diode frequency stabilization, IR detector cooling, and to determine the characteristics of electronic devices. The LDT-5525 combines high analog stability with the versatility of a microprocessor-based instrument. The internal microprocessor controls the operation of the LDT-5525 and performs the non-linear conversion of thermistor resistance to temperature based on two user-defined constants.

You can configure the LDT-5525 to operate with a wide variety of thermistor temperature sensors and TE modules, as well as AD590 series and LM335 series temperature sensors.

Features of the LDT-5525 include:

- Intuitive front panel layout
- Large and easy-to-read green LED display
- Display resolution of 0.1 degree Centigrade
- Output current limit control to safely operate all TE coolers
- Configurable for a variety of thermal sensors
- Output will supply 4 amps, 24 Watts
- Closed-case calibration

Available Options and Accessories

Options and accessories available for the LDT-5525 Temperature Controller include the following:

DESCRIPTION	MODEL NUMBER
Single Rack mount kit (enables installation into a standard 19" rack)	134
Dual Rack mount kit (enables installation of two LDT-5525 instruments into a standard 19" rack)	135
Temperature Controlled Laser Diode Mount	4407
Temperature Controlled Laser Diode Mount (available with collimating assembly)	4412
High Power Laser Diode Mount	4442
Temperature Controller Interconnect Cable (unterminated)	501
Calibrated 10 Kohm Thermistor	510
Uncalibrated 10 Kohm Thermistor	520
Uncalibrated AD590LH IC Temperature Sensor	530
Uncalibrated LM335 IC Temperature Sensor	540

Other Laser Diode Mounts are available. Please contact ILX Lightwave for information on additional options for your applications.

Specifications

Output ¹	
Output Type	Bipolar constant current source
Control Algorithm	Smart Integrator, Hybrid PI
Compliance Voltage	6 Volts at 4 Amps
Maximum Current Output	4 Amps
Maximum Output Power ²	24 Watts, typical
Current Limit Control Range	0 to 4.4 Amps
Current Limit Accuracy	±50 mA
Ripple / Noise ³	<1 mA
Temperature Control	
Temperature Range ⁴	-99 to 199.9°C -20 to +70°C with typical (NTC) 10K thermistor
Sensor Type	2-wire thermistor, LM335 voltage type or AD590 current type
Thermistor Sensing Current	10 µA or 100 µA
Temperature Set Point Resolution	0.1°C
Short Term Stability ⁵	±0.005°C
Long Term Stability	±0.01°C

- 1 Output current and power are rated into a 1 ohm load
- 2 Higher output powers can be accommodated by using an external booster. Contact ILX Lightwave for further information
- 3 Broadband noise (10 Hz to 10 MHz) is measured at 1 Amp output current
- 4 Temperature control range depends primarily on the type of thermistor and TE module used. The range can be extended higher or lower by selecting appropriate components; see Appendix B for more details
- 5 Short term temperature stability is a strong function of the thermal environment of the thermistor and TE module; room air currents in particular can easily cause fluctuations of 0.1°C in an exposed mounting configuration

Thermistor Range (10 μ A)	0.0 to 450.0 K Ω
Thermistor Range (100 μ A)	0.0 to 45.0 K Ω
Usable Thermistor Range	25 to 450,000 Ω , typical
Thermistor Resistance Resolution (10 μ A)	0.1 k Ω
Thermistor Resistance Resolution (100 μ A)	0.01 k Ω
Thermistor Resistance Accuracy	\pm 0.05% of FS
AD590 Reverse Bias	8 Volts
LM335 Bias	0.6 mA
User Calibration	
Thermistor	Steinhart-Hart equation (2 constants)
IC Sensor	2-point
Measurement (Display)	
Display Type	4-digit LED
TE Current Range	-4.00 to 4.00 Amps
TE Current Resolution	0.01 Amps
TE Current Accuracy	\pm 0.03 Amps
Temperature Range	-99.9 to 999.9 $^{\circ}$ C
Temperature Resolution	0.1 $^{\circ}$ C
Temperature Accuracy ⁶	0 $^{\circ}$ C: \pm 0.6 $^{\circ}$ C, typical 20 $^{\circ}$ C: \pm 0.3 $^{\circ}$ C, typical 30 $^{\circ}$ C: \pm 0.4 $^{\circ}$ C, typical 50 $^{\circ}$ C: \pm 0.6 $^{\circ}$ C, typical

⁶ Accuracy figures quoted are typical for a calibrated 10K thermistor; accuracy figures are relative to calibration standard and are dependent on the user-defined configuration of the instrument; variation from typical value is largely due to uncertainty in thermistor calibration

General	
Output Connectors	TEC I/O: 15-pin, D-sub Analog Output: BNC
Size	3.5" x 7.3" x 12"
Weight	8.0 pounds
Power Requirements	90 - 125 VAC, 105 - 250 VAC (jumper selectable) at 50-60 Hz
Ambient Temperature Range	0 to +40 °C operating -40 to +70 °C storage
Humidity	< 85% relative humidity, non-condensing
Warm-Up	1 hour to rated accuracy

Our goal is to make the best laser diode instrumentation available anywhere. To achieve this, we need your ideas and comments on ways we can improve our products. We invite you to contact us at any time with your suggestions.



This chapter describes how to install, adjust, and operate the LDT-5525 Temperature Controller. It is divided into sections covering installation, familiarization and adjustment, and normal operating procedures.

This chapter also gives an overview of the LDT-5525's front panel features, and it presents a guide to quickly familiarize the user with the front panel operations.

Installation procedures and considerations are also covered in this chapter.

AC Power Considerations

The LDT-5525 Series Controllers can be configured to operate at nominal line voltages of 100, 120 220, 230-240 VAC (all $\pm 10\%$). This is done at the factory and need not be changed before operating the instrument. However, check to be sure that the voltage printed on the back panel of the instrument matches the power-line voltage in your area.



WARNING

To avoid electrical shock hazard, connect the instrument to properly earth-grounded, 3-prong receptacles only. Failure to observe this precaution can result in severe injury or death.

Rack Mounting

The LDT 5525 Series Precision Temperature Controller may be rack mounted by installing a rack mount flange on either side of the enclosure. All rack mount accessory kits contain detailed mounting instructions. Refer to Chapter 1 for applicable rack mount accessory part numbers.

Power-Up Sequence

With the LDT-5525 Series Precision Temperature Controller connected to an AC power source, pressing the POWER switch will supply power to the instrument and start the power up sequence.

During the power-up sequence, the following takes place. For about two seconds all indicators light up, and all of the 7-segment displays indicate "8". Then all lamps are turned off for two seconds. Then, the sensor switch position is displayed for two seconds. After this, the unit is configured to the state it was in when the power was last shut off (except for the display mode which defaults to I TE measurement). The adjust knob is always disabled at power up.

Introduction to the LDT-5525 Front Panel

The LDT-5525 Temperature Controller's front panel contains displays and controls for the Temperature Controller hardware. Each of the labeled areas on the front panel (i.e. DISPLAY or MODE) is described in this chapter.

Refer to Figure 2.1 for the following discussions of the LDT-5525 Temperature Controller front panel sections. The key words are in capital letters for quick identification.

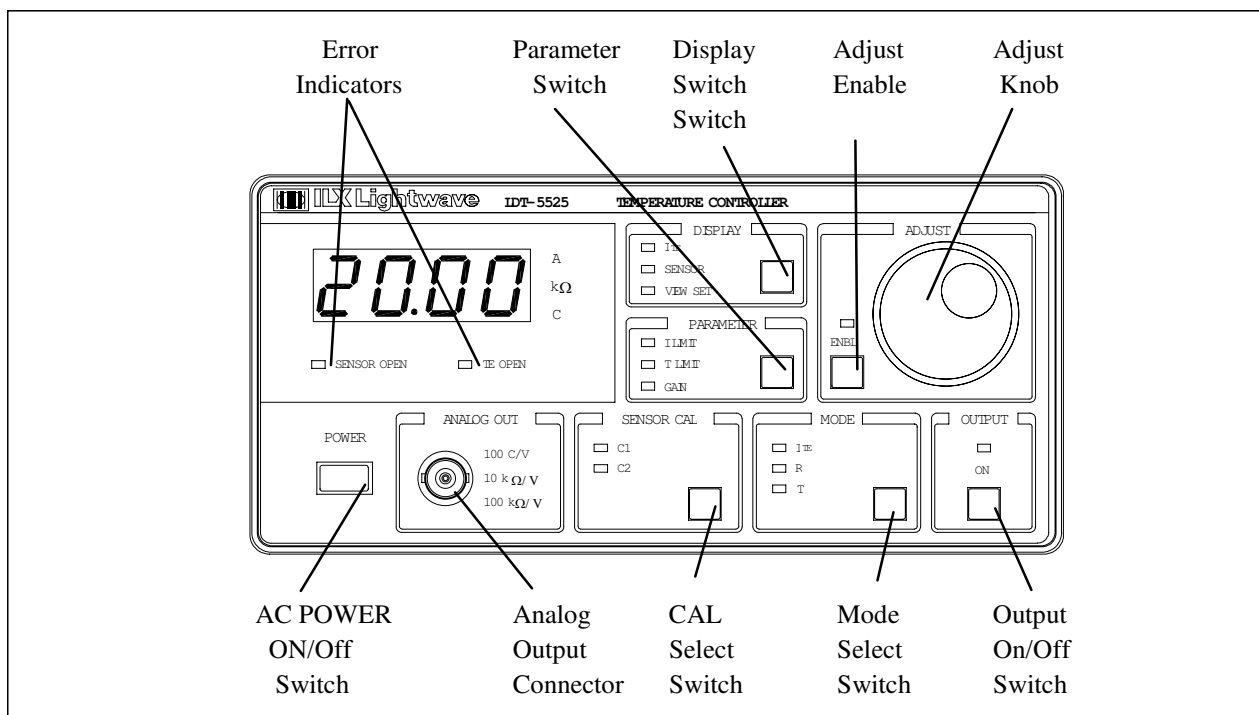

Figure 2.1 LDT-5525 Front Panel

Adjustments

The ADJUST section contains the Adjust knob for entering values, and it contains the ENBL (adjust enable) switch and indicator. In order to make any adjustment, the ENBL indicator must be lit. Pressing the ENBL switch toggles the ENBL indicator on or off.

Display

The display is used to show measurements, output set point, and parameter set points. Whenever a set point is being displayed, the VIEW SET indicator will be lit.

The DISPLAY switch is used to select the measured current (I TE), temperature, resistance, or the set point value. The set point type is determined by the MODE selection. Repeatedly pressing the DISPLAY switch will cycle the display from ITE to temperature to resistance (with thermistor sensors only) to set point and back to ITE, and so on.

When in I TE mode, the set point will be TE current.

When in R mode, the set point will be thermistor resistance in $K\Omega$. R mode is not available if the back panel SENSOR SELECT switch is set to LM335 or AD590. R mode operation may offer improved set point resolution (over T mode), depending on the desired temperature set point.

Note: The resistance set point is NOT maintained if the control mode is changed (e. g. from R mode to T mode). Also, if the SENSOR SELECT switch is moved from 10 μA to 100 μA while in R mode, the resistance set point will be rounded to match the display resolution.

When in T mode the set point will be temperature in $^{\circ}C$.

When the output is off and a measurement is displayed, if the adjust knob is turned the control mode set point will be displayed for three seconds. If the set point is adjusted (by turning the adjust knob) the set point timer will be restarted. Therefore, three seconds after the set point is adjusted the display will return to the last measurement.

Parameters

The LDT-5525 Temperature Controller allows adjustment of the following parameters, I LIMIT (TE current limit), T LIMIT (temperature limit) and GAIN (sensor feedback amplifier gain). In addition, the sensor calibration values may be entered.

The LDT-5525 will limit the I TE output to the I LIMIT value, regardless of the set point or control mode.

The temperature is limited (via the sensor feedback) to the T LIMIT value. If the sensor reads a temperature which is greater than T LIMIT, the I TE output will be shut off.

The GAIN value is used to control the sensor feedback gain, and thus the temperature settling time and overshoot. If the GAIN is set too low (1 is the lowest setting) the TE cooler will take longer to reach the temperature set point. If the GAIN is set too high (300 is the highest setting) the actual temperature may oscillate around the set temperature.

The optimum GAIN setting depends on the type of TE cooler and temperature that you are setting . Set the GAIN to its lowest value and then try increasing it until the temperature oscillates around the set temperature. Then, reduce the GAIN one step.

Parameter Setup

The PARAMETER switch is used to view and edit the parameters. Repeatedly pressing the PARAMETER switch will cycle through the parameters.

When a parameter is selected for viewing, its value will remain on the display for three seconds. If an adjustment is made to the parameter (by turning the adjust knob) the three second timer will be restarted. Three seconds after the parameter adjustment is done, the display will revert to the last measurement mode.

SENSOR CAL

These are the constants of the Steinhart-Hart equation that the user enters to calibrate the TEC for different thermistors' temperature conversions. The Steinhart-Hart equation is used to derive temperature from the non-linear resistance of an NTC (Negative Temperature Coefficient) thermistor. For information on setting C1 and C2 for thermistors, see Appendix A. For information on thermistor selection and sensor current selection, see Appendix B.

When a linear sensor device (such as an AD590 or LM335) is used, a linear equation is used. If a linear sensor's calibration is not known, set $C1 = 0.00$, $C2 = 1.00$. For more information on linear sensor calibration, see Appendix C.

The range of values for C1 and C2 are -9.99 to +9.99.

To read C1 or C2, press the CAL button until it sequences to the desired constant. The C1 or C2 indicator will become lit to indicate which constant is selected. To change the value, turn the ADJUST knob until the correct value is displayed.

Appendix A contains an explanation of the Steinhart-Hart equation and a computer program to determine these values for any thermistor.

Appendix C contains information on sensor calibration constants for AD590 and LM335 sensors. Since these devices are used over their linear range, the constants C1 and C2 are used in this case to determine a linear approximation of the temperature, rather than the Steinhart-Hart non-linear approximation which applies for thermistors. The appropriate algorithms are automatically implemented whenever the sensor type is selected via the back panel SENSOR SELECT switch. However, C1 and C2 must be changed by the user.

Output

The OUTPUT section contains the ON switch and indicator. The ON indicator is lit whenever the output is on. Pressing the ON switch will toggle the TEC current output on or off.

Conditions Which Will Automatically Shut Off the OUTPUT

- 1 Temperature Limit
- 2 External (Temp Limit) Safety Switch is closed (see Section 2.6.3)
- 3 Booster Changed (While Output On), (see Section 2.6.4)
- 4 Sensor Open (While Output On)
- 5 TEC Module Open (While Output On)
- 6 SENSOR SELECT Switch Moved (While Output On)

Control Mode

The MODE switch is used to select the control mode. Repeatedly pressing the MODE switch cycles through the current (I TE), sensor reference (R), or temperature (T) control modes. The LED indicators show the selected mode. Changing the control mode forces the output off.

Error Indicators

The ERROR indicators become lit when the corresponding conditions occur. The SENSOR OPEN light comes on whenever the sensor connections are open. The TE OPEN indicator becomes lit whenever an open circuit (or a high impedance condition) occurs on the TE module output when the output is on. When a TE OPEN condition occurs, the output will be shut off and the indicator will remain on until the problem is resolved and the output is turned on again.

The T LIMIT light will blink at 1 Hz whenever the temperature limit is reached. The I LIMIT light will blink at 1 Hz whenever the I TE current limit is reached.

Analog Output

An analog output signal is available at the ANALOG OUTPUT connector (BNC) on the front panel. This signal is a voltage between 0 - 5.0 volts which is proportional to the measurement signal. For example, an analog output signal of 2.5 volts (± 0.5 volts) would represent a measurement of 50% of full scale.

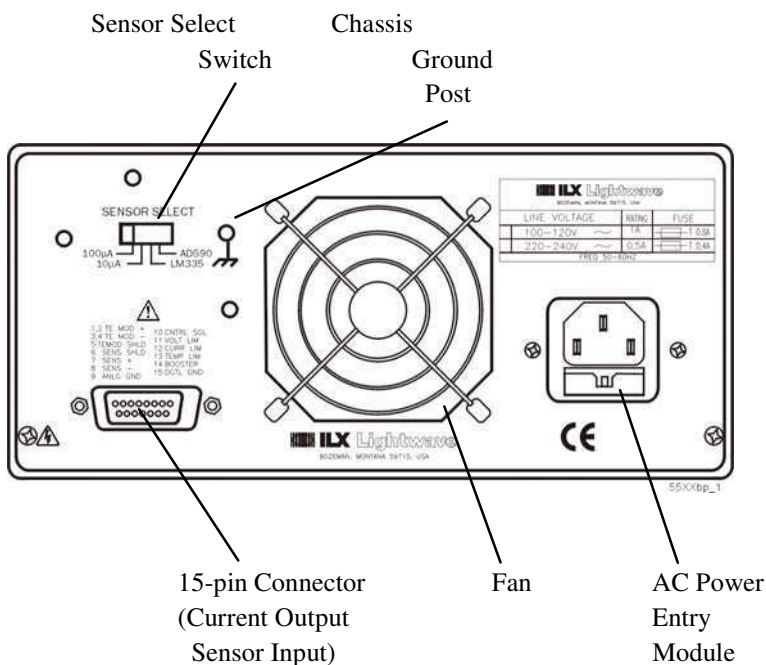

Figure 2.2 LDT-5525 Back Panel

Back Panel Controls and Connections

Refer to Figure 2.2 for the following discussions of back panel controls and connectors. There are no user serviceable parts in the instrument, including the external fuses in the AC power entry module.

SENSOR SELECT Switch

The SENSOR SELECT switch is used to select sensor type and, in the case of thermistor sensor, the source current level. Table 2.4 shows the SENSOR SELECT positions and corresponding position code. When the sensor switch is changed during TEC mode operation, the new sensor position code will be indicated on the TEC display for three seconds.

Table 2.1 SENSOR SELECT Switch Positions

SWITCH POSITION	CODE
100 μ A	-01-
10 μ A	-02-
LM335	-03-
AD590	-04-

The 10 μ A and 100 μ A designations are for the current source level; thermistor sensor type is implied. When using a thermistor, the supply current depends on the thermistor operating temperature range and the required temperature resolution. Guidelines for setting this switch are contained in Appendix B.

The AD590 sensor operates as a current source which is proportional to the sensed temperature. The LM335 sensor operates as a voltage source which is proportional to the sensed temperature. Both of these sensors are approximately linear over their operating ranges. When they are used, the constants C1 and C2 are used for a two-point conversion. For more information on setting the constants for use with these sensors, see Appendix C.

TEC Connector

At the right of center, when facing the back panel, you will find the 15-pin D-connector for the TEC MODULE. This connector is used for the input and output connections, as shown by the pin-out diagram of Figure 2.12.

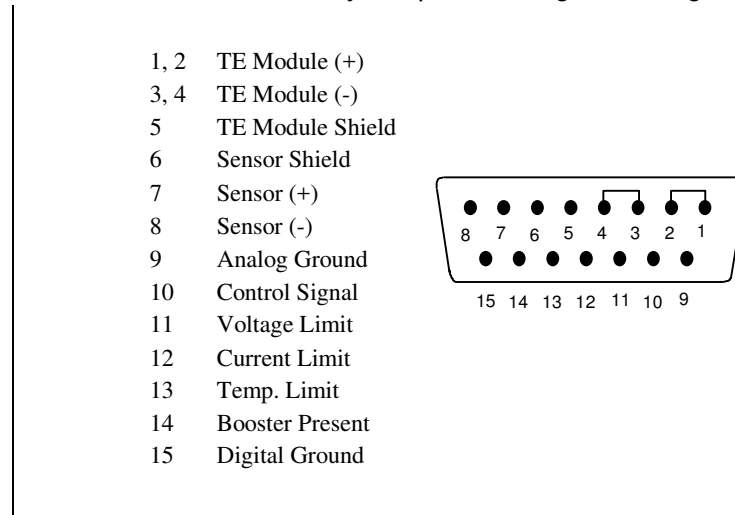

Figure 2.3 Back Panel TEC Connector

TEC Grounding Considerations

The TEC outputs of the LDT-5525 are isolated from chassis ground, allowing either output terminal to be grounded at the user's option.

Note: For the TEC connector, if any one terminal pin is grounded, then no other terminal pin should be grounded. Damage to external unit or temperature controller will occur.

General Operating Procedures

The following sections present some guidelines for operation, as well as some common operating procedures.

Warm-Up and Environmental Considerations

Operate the LDT-5525 Temperature Controller at an ambient temperature in the range of 0 to +40°C. Storage temperatures should be in the range of -40 to +70°C. To achieve rated accuracy, let the LDT-5525 Temperature Controller warm up for about 1 hour before use.

Temperature Mode Operation

You can operate the LDT-5525 Temperature Controller in several modes, constant current (I TE), constant thermistor resistance (R), or constant temperature (T). This example is for constant temperature (T) mode.

- a Plug the LDT-5525 Temperature Controller into an AC power source supplying the correct voltage and frequency for your unit (refer to the back panel for the correct ratings).
- b Turn on the LDT-5525 Temperature Controller. The OUTPUT stage will be off at power up and the unit will automatically configure its parameters to the state which existed when the power was last shut off.
- c Press the ENBL switch in the ADJUST section of the front panel so that the indicator is lit (adjustment enabled). Press the MODE switch until the T mode is selected.
- d Check the setting of the SENSOR SELECT switch for the desired operation. The sensor code will be displayed for two seconds during the power-up sequence.
- e Press the PARAMETER switch and check the setting of I LIMIT, T LIMIT, and GAIN. Press the CAL switch and check the setting of C1 and C2 to insure that they are compatible with the equipment you are using. Refer to Section 2.4.5 if you need to change them.
- f Press the DISPLAY switch until the VIEW SET indicator is lit and check the set point temperature. If it requires changing, turn the knob until the desired value is displayed.

Note: In some cases, a greater than 0.1°C temperature set point resolution may be attained by using R mode with the appropriate resistance value.

- g Turn the TEC output on by pressing the OUTPUT ON switch. The unit will automatically control the temperature to the set point.
- h When the unit is powered off, the state of the unit at power-down is saved in non-volatile memory.

Resistance Mode Operation

You can operate the LDT-5525 Temperature Controller in several modes, constant current (I TE), constant thermistor resistance (R), or constant temperature (T). This example is for constant resistance (R) mode.

- a Plug the LDT-5525 Temperature Controller into an AC power source supplying the correct voltage and frequency for your unit (refer to the back panel for the correct ratings).
- b Turn on the LDT-5525 Temperature Controller. The OUTPUT stage will be off at power up and the unit will automatically configure its parameters to the state which existed when the power was last shut off.
- c Press the ENBL switch in the ADJUST section of the front panel so that the indicator is lit (adjustment enabled). Press the MODE switch until the R mode is selected.
- d Check the setting of the SENSOR SELECT switch for the desired operation (10 μ A or 100 μ A). The sensor code will be displayed for two seconds during the power-up sequence.
- e Press the PARAMETER switch and check the setting of I LIMIT, T LIMIT, and GAIN. Press the CAL switch and check the setting of C1 and C2 to insure that they are compatible with the equipment you are using.
- f Press the DISPLAY switch until the VIEW SET indicator is lit and check the set point resistance. If it requires changing, turn the knob until the desired value is displayed.
- g Turn the TEC output on by pressing the OUTPUT ON switch. The unit will automatically control the thermistor to the set point resistance.

If the exact resistance is unknown (to control to a desired temperature), press the DISPLAY switch to view the measured temperature. Readjust the resistance set point and recheck the temperature until the desired result is attained.

Note: In some cases, a greater than 0.1 $^{\circ}$ C temperature set point resolution may be attained by using R mode with the appropriate resistance value.

If the mode is switched from R mode to T mode, the resistance set point will be lost. This is because in T mode, the temperature set point is converted and also stored as a resistance set point automatically.

- h When the unit is powered off, the state of the unit at power-down is saved in non-volatile memory.

External Safety Switch Operation

On the TEC connector, pins 13 (TEMP LIMIT) and 15 (DIGITAL GND) form a type of external safety switch (see Figure 2.3). These two pins are normally not connected (open circuit), and must remain open for the TEC output to be on. If there is a short circuit between these pins the TEC output will be disabled.

This circuit is useful for remote monitoring of temperature limit, and therefore is labeled TEMP LIMIT on the back panel connector. This switch may be used with

an external current booster. A switch or control circuit of the user's own design is required. It is left as an option which the user may or may not employ.

Booster Operation

The LDT-5525 Temperature Controller may be used to control a booster current source which accepts a control signal of up to ± 5.0 volts. A booster current source may be required if the LDT-5525 Temperature Controller's ± 4 A, 24 W output is not adequate to control a thermal load.

Whenever a connection is present between the BOOSTER PRESENT (pin 14) and DIGITAL GROUND (pin 15) of the back panel TEC connector (Figure 2.3) the TEC OUTPUT will be disabled. In this case, the BOOST CONTROL signal voltage will be available for controlling a booster current source.

The booster current source should use the control voltage which is available between the BOOST CONTROL (pin 10) and AGND (pin 9) of the back panel TEC connector.

During Booster operation, the normal ITE output is disabled, and the ITE display will measure about 0.0 Amps (± 0.05 Amps). The CONTROL SIGNAL voltage is linearly proportional to the control current (1 V/A), which is limited by the LIM I parameter. If LIM I is set to 4 Amps, the maximum CONTROL SIGNAL voltage will be approximately 4 volts. If a booster signal greater than ± 4.0 volts is required, a user-supplied control signal amplifier is required. For example, if the user's control signal amplifier has a gain of 2, an I LIMIT of 3 Amps would allow a control voltage of ± 6 volts.

Whether or not a booster current source is used, the LDT-5525 Temperature Controller uses a sensor for controlling the temperature.

The feedback loop GAIN may require adjustment when a booster current source is used. This is because a booster current source may be used with different thermal loads than those found with normal LDT-5525 Temperature Controller operation, and those loads may require larger or smaller GAIN values in order to settle to the set temperatures in a desirable fashion.

Contact ILX Lightwave for more information on using the LDT-5525 with a booster current source.

MAINTENANCE AND TROUBLESHOOTING

This chapter describes how to maintain and troubleshoot the LDT-5525 Temperature Controller. Included are sections covering calibration, disassembly, and troubleshooting.

WARNING

THE SERVICE PROCEDURES DESCRIBED IN THIS CHAPTER ARE FOR USE BY QUALIFIED PERSONNEL. POTENTIALLY LETHAL VOLTAGES EXIST WITHIN THE LDT 5525 TEMPERATURE CONTROLLER. TO AVOID ELECTRIC SHOCK, DO NOT PERFORM ANY OF THE PROCEDURES DESCRIBED IN THIS CHAPTER UNLESS YOU ARE QUALIFIED TO DO SO.

QUALIFIED SERVICE PERSONNEL ARE REQUIRED TO WEAR PROTECTIVE EYEGLASSES AND ANTI-STATIC WRIST BANDS WHILE WORKING ON THE LDT-5525 TEMPERATURE CONTROLLER CIRCUIT BOARDS.

CAUTION

HIGH VOLTAGES ARE PRESENT ON AND AROUND THE PRINTED CIRCUIT BOARDS OF THE LDT-5525 TEMPERATURE CONTROLLER.

Calibration Overview

The LDT-5525 Temperature Controller should be calibrated every 12 months or whenever performance verification indicates that calibration is necessary.

All calibrations can be done with the case closed. The instrument is calibrated by changing the internally stored digital calibration constants.

Recommended Equipment

Recommended test equipment for calibrating the LDT-5525 Temperature Controller is listed in Table 3.1. Equipment other than that shown in the table may be used if the specifications meet or exceed those listed.

Table 3.1

DESCRIPTION	MFG / MODEL	SPECIFICATION
DMM	HP 3457A	DC Amps (@ 1.0A): $\pm 0.02\%$ Resistance (@ 10 Ω): 0.02% 0.1 μ A or 0.1 mW resolution
Resistors	Metal Film	15 K Ω (for ITE calibration) 4 K Ω and 40 K Ω (for 100 mA calibration) 4 K Ω and 400 K Ω (for 10 mA calibration) 4 K Ω and 10 K Ω (for LM335 calibration) 10 K Ω and 20 K Ω (for AD590 calibration)
	High Power	1 Ω , 20W, low TCR (for ITE calibration)

Environmental Conditions

Calibrate this instrument under laboratory conditions. We recommend calibration at 23°C \pm 1.0°C. When necessary, however, the LDT-5525 Temperature Controller may be calibrated at its intended use temperature if this is within the specified operating temperature range of 0 to 40°C.

Warm Up

The LDT-5525 Temperature Controller should be allowed to warm up for at least 1 hour before calibration.

Calibration Adjustments

There are two calibration adjustments that need to be made for the LDT-5525 Temperature Controller. They are calibration of sensor measurement, and calibration of the ITE current measurement and limit circuits.

If a problem arises during calibration which prevents its normal completion, the calibration may be aborted with no ill effects by simply pressing the OUTPUT switch. This is possible because the calibration values are not saved to non-volatile memory until the last step of each calibration procedure.

Thermistor Calibration

The following procedure is for calibrating the 100 μA and 10 μA constant current sources so that the thermistor resistance measurements for these ranges will be as accurate as possible. This procedure calibrates the resistance measurements of the thermistor. This procedure does not calculate C1 and C2. For information on calibrating the thermistor sensor, see Appendix A.

Calibration may be aborted by pressing the OUTPUT switch.

- a** Set the SENSOR SELECT switch (back panel) to the 100 μA position. Set C1 to 0.99, C2 to 2.57.
- b** Measure and record the exact resistance of your 4 $\text{K}\Omega$, 40 $\text{K}\Omega$, and 400 $\text{K}\Omega$ metal film resistors. A 4-point probe resistance measurement is recommended.
- c** Connect the 4 $\text{K}\Omega$ metal film resistor to the sensor input of the LDT-5525 Temperature Controller (pins 7 and 8).
- d** Enter the sensor calibration mode by pushing the MODE and SENSOR CAL switches at the same time. After this, the display will indicate the sensor resistance in $\text{K}\Omega$. Allow the measurement to settle for about three seconds.
- e** Press and hold in the ENBL switch and turn the ADJUST knob until the display indicates the same resistance you recorded for the 4 $\text{K}\Omega$ metal film resistor.
- f** Release the ENBL switch and wait for the VIEW SET indicator (LED) to be unlit. Replace the 4 $\text{K}\Omega$ resistor with the 40 $\text{K}\Omega$ metal film resistor (for 100 μA) or 400 $\text{K}\Omega$ metal film resistor (for 10 μA). After three seconds, repeat Step e with this resistor. Ten seconds after the ENBL switch is released, the LDT-5525 Temperature Controller will store the calibration data in non-volatile memory.

Press the DISPLAY switch three times to rotate the display back to the SENSOR mode.

- g** Switch the SENSOR SELECT switch to the 10 μA position and repeat Steps c - f.
- h** After calibration, the I LIMIT will be automatically set to 4.00 Amps. Reset the I LIMIT to the desired value.

AD590 Sensor Calibration

The following procedure is for calibrating the AD590 sensor measurement so that the temperature measurement will be as accurate as possible. This procedure calibrates the current measurement of the AD590. This procedure does not calibrate C1 and C2. For information on calibrating the AD590 sensor, see Appendix C.

Calibration may be aborted by pressing the OUTPUT switch.

- a Set the SENSOR SELECT switch (back panel) to the AD590 position. Set C1 to 0.00, C2 to 1.00.
- b Connect a precision 20 K Ω metal film resistor and a precision ammeter in series at the sensor input of the LDT-5525 Temperature Controller.
- c Enter the sensor calibration mode by pushing the MODE and SENSOR CAL switches at the same time. After this, the TEC display will indicate sensor reference current in μ A. Wait for three seconds for the measurement to settle.
- d Press and hold in the ENBL switch and turn the ADJUST knob until the display indicates the same current as shown on the precision ammeter.
- e Release the ENBL and wait for the VIEW SET indicator (LED) to be unlit. Replace the 20 K Ω resistor with a 10 K Ω metal film resistor. Wait for three seconds, then repeat Step d using the 10 K Ω resistor.

Ten seconds after the ENBL switch is released, the LDT-5525 Temperature Controller will store the calibration data in non-volatile memory.

- f Press the DISPLAY switch three times to rotate the display back to the SENSOR mode. After calibration, I LIMIT will be automatically set to 4.00 Amps. Reset the I LIMIT to the desired value.

LM335 Sensor Calibration

The following procedure is for calibrating the LM335 sensor measurement so that the temperature measurement will be as accurate as possible. This procedure calibrates the voltage measurement of the LM335. This procedure does not calibrate C1 and C2. For information on calibrating the LM335 sensor, see Appendix C.

Calibration may be aborted by pressing the OUTPUT switch.

- a** Set the SENSOR SELECT switch (back panel) to the LM335 position. Set C1 to 0.00, C2 to 1.00.
- b** Connect a precision 4 K Ω metal film resistor and a precision voltmeter in parallel at the sensor input of the LDT-5525 Temperature Controller (pins 7 and 8).
- c** Enter the sensor calibration mode by pushing the MODE and SENSOR CAL switches at the same time. After this, the display will indicate sensor reference voltage in mV. Wait for three seconds for the measurement to settle.
- d** Press and hold in the ENBL switch and turn the ADJUST knob until the display indicates the same voltage as shown on the precision voltmeter multiplied by 10. For example, if the voltage across the resistor is 1.9871 Volts, turn the ADJUST knob until the display reads 19.87.
- e** Release the ENBL switch and wait for the VIEW SET indicator (LED) to be unlit. Replace the 4 K Ω resistor with a 10 K Ω metal film resistor. After three seconds, repeat Step d with the 10 K* resistor. Ten seconds after the ENBL switch is released, the LDT-5525 Temperature Controller will store the calibration data in non-volatile memory.
- f** Press the DISPLAY switch three times to rotate the display back to the SENSOR mode. After calibration, I LIMIT will be automatically set to 4.00 Amps. Reset the I LIMIT to the desired value.

ITE Current Calibration

The following procedure is for calibrating the ITE constant current source for both polarities of current. During this procedure the ITE current is driven to a series of pre-determined values. When each of these values is reached and is stable, the user enters the actual value of the current, as measured by an external DMM. The LDT-5525 Temperature Controller then automatically calibrates the TEC current source and limits.

Calibration may be aborted by pressing the OUTPUT switch.

- a Set the sensor select (back panel) switch to "100 uA." Set C1 to 0.99, C2 to 2.57. Connect an (approximately) 15 kΩ resistor to the sensor pins (7 and 8). Connect a 1Ω, 20 W, resistor across the TEC output terminals (pins 1 and 3) and use a calibrated DMM to measure the voltage across the resistor. Calculate the current in the following steps by using Ohm's Law:

$$I = E / R$$

-where E is the accurately measured voltage across the resistor, and R is the accurately measured load resistance. A 4-point probe resistance measurement is recommended.

- b Press and briefly hold in both the MODE and DISPLAY switches. This will put the LDT-5525 into ITE calibration mode. Wait for three seconds for the output to settle to about 3 Amps.
- c Press and hold in the ENBL switch and turn the ADJUST knob until the display shows the correct value (absolute value of the ITE measurement), as calculated from Step a.
- d Release the ENBL switch. Wait three seconds to allow the ITE current to settle at the new set point.
- e Repeat Steps c and d four more times, once for each of the (automatically set) set points -3 Amps, +3 Amps, +1 Amp, and -1 Amp. After the value for the -1 Amp (last) set point is entered, the LDT-5525 Temperature Controller will automatically calibrate its ITE current limits.

After about 10 seconds, the LDT-5525 Temperature Controller will store the new calibration data in non-volatile memory.

- f After calibration, the I LIMIT will be automatically set to 0.00 Amps. Reset the I LIMIT to the desired value.

Troubleshooting

This section is a guide to troubleshooting the LDT-5525 Temperature Controller. Some of the more common symptoms are listed here, and the appropriate troubleshooting actions are given. We recommend that the user start at the beginning of this guide. Read the symptom descriptions, and follow the steps for the corrective actions which apply. If you encounter problems which are beyond the scope of this guide, contact your ILX Lightwave representative.

Symptom	Causes and Corrective Actions
LDT-5525 Series unit will not power up	Check AC power line voltage and power cord connection
Power on, but display is frozen, switches don't work	This may occur if the unit loses power (AC line) briefly. Turn the power switch off and on again to restart
Power on, but no TE current output	If TE OPEN indicator is lit, check the load connections and then try again Check that pins 14 and 15 of the output connector are not connected (see Chapter 2: Booster Operation)
Power on, but measured ITE current is always about 0.0 A	Check that pins 14 and 15 of the output connector are not connected (see Chapter 2: Booster Operation)
Power on, but temperature is not controlled	If SENSOR OPEN indicator is lit, check the sensor connections and then try again Check that the back panel SENSOR SWITCH position is set to the proper sensor type Check that C1 and C2 are correct values for your sensor Check that the GAIN setting is not too low and that the I LIMIT value is not too low for your thermal load

Unable to adjust output or parameter	<p>Check the ADJUST ENBL switch; the indicator must be lit for any adjustments to be made</p> <p>Check the MODE or DISPLAY switch; if they do not respond, the unit may be in measurement calibration mode (see Chapter 3); press the OUTPUT switch to abort this mode.</p>
Unable to switch DISPLAY, MODE, SENSOR CAL or PARAMETER modes	The unit may be in measurement calibration mode (see Chapter 3); press the OUTPUT switch to abort this mode
Output goes off intermittently	<p>Check that the AC power cord connection is secure; power line drop outs may reset the unit and when the power is restored, the output will be off</p> <p>Check the TE module connections; a high impedance on the TE load may cause the output to exceed the compliance voltage momentarily, thus shutting the output off</p>
R Mode set point is not saved	The R mode set point value is not independent from the T mode set point value; if the control mode is changed from R mode to T mode, the R set value will change to a value which corresponds to the temperature, based on C1 and C2

STEINHART-HART EQUATION



Two-terminal thermistors have a nonlinear relationship between temperature and resistance. The resistance versus temperature characteristics for a family of similar thermistors is shown in Figure A.1. It has been found empirically that the resistance versus temperature relationship for most common negative temperature coefficient (NTC) thermistors can be accurately modeled by a polynomial expansion relating the logarithm of resistance to inverse temperature. The Steinhart Hart equation is one such expression and is given as follows:

$$1/T = A + B(\ln R) + C(\ln R)^3 \quad \text{Equation 1}$$

- where T is expressed in KELVIN.

Once the three constants A, B, and C are accurately determined, Equation 1 introduces small errors in the calculation of temperature over wide temperature ranges. Table A.1 shows the results of using equation 1 to fit the resistance versus temperature characteristic of a common 10K ohm (at room temperature) thermistor. Equation 1 will produce temperature calculation errors of less than 0.01 °C over the range -20 °C to 50 °C.

Table A.1 Comparison of Curve Fitting Equations

R ¹	T Actual	Error T (°C)	Error T (°C)
		Third Order Fit Eq 1	First Order Fit Eq 2
32128	0.00	-0.0000	-0.23
19549	10.00	0.0005	-0.11
12262	20.00	-0.0001	-0.06
9814	25.00	-0.0002	-0.06
7908	30.00	0.0009	-0.07
5331	40.00	0.0003	-0.15
3542	50.00	-0.0030	-0.30

For the LDT-5525, the Steinhart Hart equation has been simplified to a first order polynomial:

$$1/T = A' + B' * \ln R \quad \text{Equation 2}$$

This equation is easier to solve and provides adequate results. Table A.1 also shows that the use of Equation 2 introduces temperature errors of less than 0.3°C over the range -20°C to 50°C, with accuracies of up to 0.06°C over smaller temperature ranges near room temperature².

1 Resistance of a 10 k^W, Dale 1T1002-5 thermistor

2 Constants A' = 0.99 * 10⁻³, B' = 2.57 * 10⁻⁴ (C1 = 0.99, C2 = 2.57).

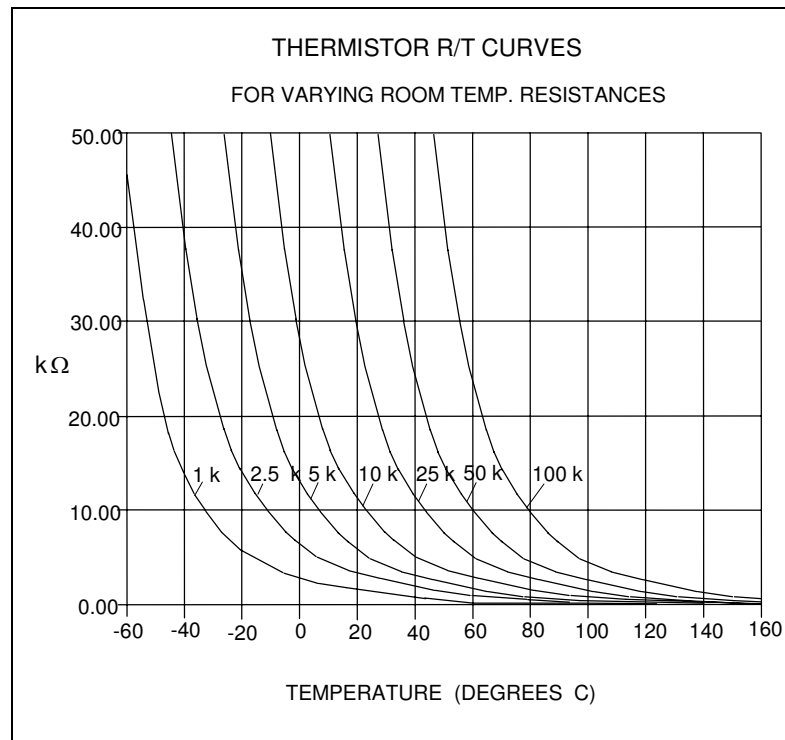

Figure A.1 Thermistor Resistance vs. Temperature

Once the constants A' and B' are determined, the LDT 5525 Temperature Controller is programmed with the following values of C1, and C2:

$$C1 = A' * 10^{+3}$$

$$C2 = B' * 10^{+4}$$

Computer Program

We have included a computer program called STEIN1 that uses a least squares curve fitting routine to determine the values of C1 and C2. The program is written in IBM's advanced BASICA.

You must create a data file for your thermistor that describes the resistance at various temperatures. The temperature verses resistance calibration data can be obtained from the thermistor manufacturer. Enter the resistance at various temperatures as data points into an ASCII file. You can write the data file on a word processor, but you must use non document mode so special word processing characters are not inserted into the data file. Format the data with one temperature resistance pair per line and at least one space separating the two numbers. Temperatures should be in centigrade and resistances in ohms. For an accurate determination of the coefficients, we recommend that you use at least twenty data points uniformly spread over the intended range of use. Enter a -1 to signify the end of the resistance data and temperature data.

A small sample data file is included below as an example of the data format and end of data marker (R = 1).

<u>Temperature</u>	<u>Resistance</u>
-20	97072
-10	55326
0	32650
10	19899
20	12492
25	10000
30	8056.8
40	5326.4
50	3602.3
-1	-1

Run the STEIN1 program. The best curve fitting values for C1, and C2 will be displayed. Enter these numbers into the LDT-5525 Temperature Controller.

```

80 REM * * * * * STEIN1 * * * * *
90 REM
92 REM     Rev: 3 11 87
94 REM     T is expressed in Kelvins.
100 REM    Least squares fit program to find the thermistor coefficients
110 REM    C1 and C2 in the following equation:
120 REM
130 REM          1/T = C1 + C2 * (ln R)
140 REM
200 REM
210 REM Variables:
220 REM
230 REM T[i], R[i]    temperature and resistance data values.
240 REM
250 REM Y[i] = 1/T[i] the dependent variable (depends on R[i])
260 REM                in the Steinhart Hart equation (above).
270 REM
280 REM X[i] = ln(R[i]) the value of the ith function of the independent
290 REM                variable ln(R) (natural log of resistance)
330 REM
1000 DEFDBL A Z
1010 DEFINT I, J, K, L
1020 DIM R[400], T[400], Y[400], X[400]
1030 PRINT "What is the data file name"; : INPUT D$
1040 OPEN "i", 1, D$
1050 REM     **** read and echo T(i), R(i) from the data file ****
1060 REM                (terminate read on R= 1)
1070 I=0
1080 PRINT "Data:"
1090 G$="Point      Temperature (Celsius)   Resistance (ohms)"
1100 H$=" ###          #####.##           #####.##"
1110 PRINT G$
1120 PRINT
1130 I=I+1
1140 INPUT #1, T(I), R(I)
1150 IF R(I)<0 THEN GOTO 1180

```

```

1155 X(I)=LOG(R(I)) : Y(I)=1/(T(I)+273.15)
1160 PRINT USING H$; I, T(I), R(I)
1170 GOTO 1130
1180 N=I 1
1190 CLOSE
1200 REM          **** accumulate sums ****
1205 SX=0 : SY=0 : SXY=0 : SXX=0
1210 FOR I = 1 TO N
1220 SX=SX+X(I)
1230 SY=SY+Y(I)
1240 SXY=SXY+X(I)*Y(I)
1250 SXX=SXX+X(I)*X(I)
1260 NEXT I
1300 REM          **** print out results ****
1310 C[2]=(N*SXY SX*SY)/(N*SXX SX*SX)
1320 C[1] = (SY C[2]*SX)/N
1620 PRINT
1630 G$="Key in:      C1      C2"
1640 P$="          #.##      #.##"
1650 PRINT G$
1660 PRINT USING P$; C[1]*1000!, C[2]*10000!
1700 '
1702 C1=INT(C[1]*1000000!)/1000000!
1704 C2=INT(C[2]*1E+07)/1E+07
1710 PRINT
1712 PRINT "          T          T          T"
1714 PRINT "      R      ACTUAL      CALC      ERROR"
1716 PRINT "  =====  =====  =====  ====="
1718 P$= "  #####  #####.##  #####.##  #####.##"
1720 FOR L=1 TO N
1730 X=LOG(R(L))
1740 TCALC=1/(C1+C2*X) 273.15
1760 PRINT USING P$;R(L),T(L),TCALC,T(L) TCALC
1780 NEXT L

```

SENSING CURRENT AND THERMISTOR SELECTION

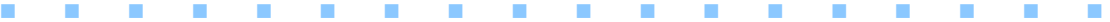

Choosing the right sensing current depends on the range of temperature you want to measure and the resolution you require at the highest measured temperature. To correctly set the SENSOR SELECT switch you must understand how the thermistor and the LDT-5525 Temperature Controller interact, and how temperature range and resolution values are inherent in the nature of thermistors.

Thermistor Range

Thermistors can span a wide temperature range, but their practical range is limited by their non-linear resistance properties. At high temperatures, the thermistor resistance changes less for an equivalent temperature change at lower temperatures (the thermistor becomes less sensitive). Consider the temperature and sensitivity figures in Table B.1 below for a 10 K thermistor.

Table B.1 Thermistor Sensitivity

TEMPERATURE	SENSITIVITY
-20°C	5600 ohms / °C
25°C	439 ohms / °C
50°C	137 ohms / °C

In the LDT-5525 Temperature Controller, the practical upper temperature limit is the temperature at which the thermistor becomes insensitive to temperature changes. The lower end of the temperature range is limited by the maximum input voltage of the LDT-5525 Temperature Controller. Thermistor resistance and voltage are related through Ohms Law ($V = I \times R$). The LDT-5525 Temperature Controller supplies current to the thermistor, either 10 μA or 100 μA . As the thermistor resistance changes, a changing voltage signal is available to the

thermistor inputs of the LDT-5525. The LDT-5525's measurement system will over-range when the input voltage exceeds about 4.5 volts. Figure B.1 graphically shows the lower temperature and upper voltage limits for a typical 10 K thermistor. (A 10 K thermistor has a resistance of 10 kΩ at 25 °C). The practical temperature ranges for a typical 10 K thermistor with the LDT-5525 are given in Table B.2, below. These temperature ranges may vary from thermistor to thermistor, even though both thermistors are nominally 10 K. This is due to manufacturing tolerances in the thermistor, and is compensated for by determining C1, and C2 (calibrating the thermistor). The practical temperature ranges for a 10 K thermistor are also shown as solid bars at the bottom of Figure B.1.

Table B.2 10K Thermistor Temperature Range

SENSING CURRENT	TEMPERATURE RANGE
10 μA	-30 to 30 °C
100 μA	10 to 70 °C

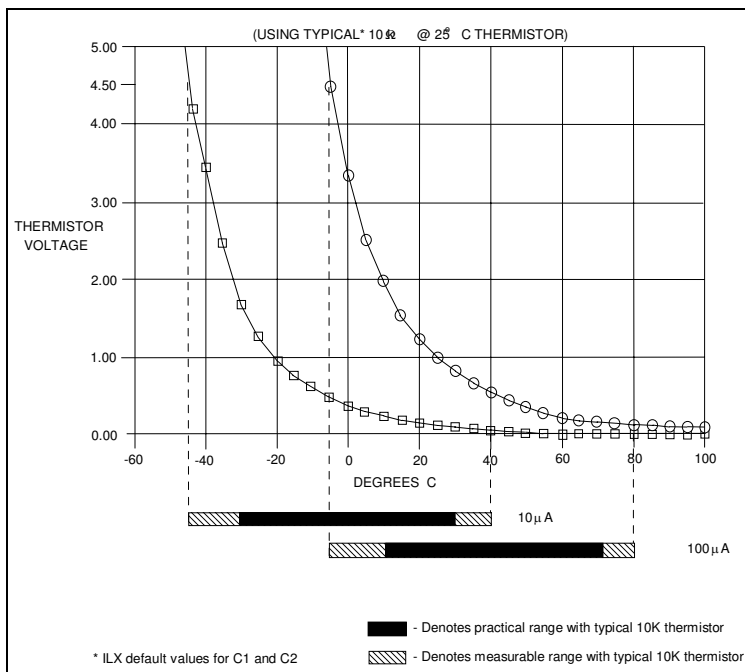

Figure B.1 Thermistor Temperature Range

Temperature Resolution

You must also consider measurement resolution since the measurement resolution decreases as the thermistor temperature increases. A temperature controller (such as the LDT-5525) has a limited measurement resolution. A temperature change of one degree centigrade will be represented by a greater resistance increase at a lower temperature than at a higher temperature because of the non-linear resistance of the thermistor. Resolution figures for a typical 10 K thermistor are given in Table B.3, below.

Table B.3 10K Thermistor Voltage vs. Resolution

TEMPERATURE	VOLTAGE AT 10 μ A	RESOLUTION
-20°C	56 mV / °C	0.018 °C / mV
25°C	4.4 mV / °C	0.23 °C / mV
50°C	1.4 mV / °C	0.70 °C / mV

For a typical 10 K thermistor, a temperature change from -20 °C to -19°C will be represented by a measurement change of about 56 mV (if supplied with 10 μ A). The same thermistor measurement will only change about 1.4 mV from 49 to 50°C! For that case, with the LDT-5525, the temperature measurement resolution would be reduced to about 0.2°C. If the 100 μ A setting were used instead, the thermistor measurement would change by 14 mV from 49 to 50°C, providing the maximum resolution of 0.1°C (with the LDT-5525).

Therefore, the sensor current you choose may impact the temperature measurement resolution as well as the set point control accuracy.

Selecting the Sensing Current

To select the current setting for a typical 10K thermistor, determine the lowest temperature you will need to sample and set the SENSOR SELECT switch according to the range limits in Table B.2. If the temperature you want to sample is below 10 °C you will probably need to set the switch to the 10 μ A setting.

If you require temperatures of 10 °C to 30 °C, either SENSOR SELECT setting (100 μ A or 10 μ A) will work with a 10K thermistor. However, the 100 μ A setting provides greater measurement resolution, and therefore better control.

Note: Generally, it is best to use the 100 μ A SENSOR SELECT setting for all measurements of 10°C or greater with a typical 10 K thermistor.

Selecting and Using Thermistors

The type of thermistor you choose will depend primarily on the operating temperature range. These guidelines for selecting the range and resolution will apply to any thermistor. From Figure B.1 you can see that 10 K thermistors are

generally a good choice for most laser diode applications where high stability is required near room temperatures. Similarly, 10 K thermistors are often a good choice for detector cooling applications where you want to operate at temperatures from -30°C to room temperature.

If you require a different temperature range or the accuracy you need can't be achieved with either switch setting, select another thermistor. Thermistor temperature curves, supplied by the manufacture, show the resistance versus temperature range for many other thermistors. ILX Lightwave Corporation will also offer help for your specific application.

AD590 AND LM335 SENSOR CALIBRATION

The LDT-5525 Temperature Controller uses two constants (C1 and C2) for calibrating linear thermal sensing devices, such as the AD590, and the LM335. C1 is used as the linear or zero offset value, and C2 is used as the slope or gain adjustment. Therefore, C1 should be set to a nominal value of 0, and C2 should be set to a nominal value of 1, when the SENSOR SELECT switch is in the AD590, or LM335 positions.

In order to calibrate a linear sensor device, the sensor must be operated at an accurately known, stable temperature. For example, the sensor may be calibrated at 0°C if the sensor is placed in ice water until its temperature is stable. A highly accurate temperature probe, thermometer, environmental chamber, etc., may also be used to determine the known temperature for calibration. This appendix contains one and two point calibration methods for linear sensor devices. These methods will work for either type of device.

AD590 Sensor

The AD590 is a linear thermal sensor which acts as a constant current source. It produces a current, i , which is directly proportional to absolute temperature, over its useful range (-50°C to +150°C). This nominal value can be expressed as:

$$i = 1\mu\text{A} / \text{K}$$

- where i is the nominal current produced by the AD590, and K is in Kelvin.

The LDT-5525 Temperature Controller uses i to determine the nominal temperature, T_n , by the formula:

$$T_n = (i / (1\mu\text{A} / \text{K})) - 273.15$$

- where T_n is in °C.

The temperature, T_d , which is displayed by the LDT-5525 Temperature Controller is first calibrated as follows:

$$T_d = C1 + (C2 * T_n)$$

- where C1 and C2 are the constants stored by the user in the LDT-5525 Temperature Controller for the AD590.

The AD590 measurement is calibrated, at the factory, with $C2 = 1$ and $C1 = 0$ (nominal values). The AD590 grades of tolerance vary, but typically this means that without adjusting C1 or C2, the temperature accuracy is ± 1 °C over its rated operating range. If C1 and C2 are also calibrated, the temperature accuracy is ± 0.2 °C over its rated operating range. However, the AD590 is not perfectly linear, and even with C1 accurately known there is a non-linear absolute temperature error associated with the device. This non-linearity is shown in Figure C.1, reprinted from Analog Devices specifications, where the error associated with C1 is assumed to be zero.

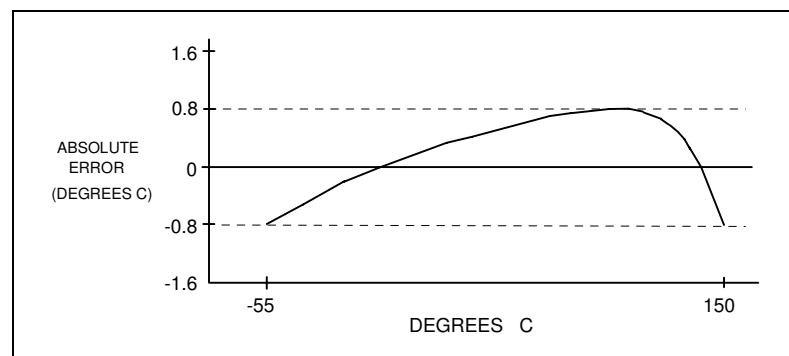

Figure C.1 AD590 Nonlinearity

If a maximum absolute error of 0.8 °C is tolerable (over the entire temperature range), the one point calibration of C1 should be used (see page C-5). If C1 is calibrated at 25 °C, and the intended operating range is 0 to 50 °C, a maximum error of about ± 0.2 °C may be expected over that operating range. If a greater accuracy is desired, the two point method of determining C1 and C2 should be used (see page C-6). Note however, the absolute error curve is non-linear, therefore the constant C2 will vary over different temperature ranges.

LM335 Sensor

The LM335 is a linear thermal sensor which acts as a constant voltage source. It produces a voltage, v , which is directly proportional to absolute temperature, over its useful range (-40°C to +100°C). This nominal value can be expressed as:

$$v = 10\text{mV} / \text{K}$$

- where v is the nominal voltage produced by the LM335 and K is in Kelvin.

The LDT-5525 Temperature Controller uses v to determine the nominal temperature, T_n , by the formula:

$$T_n = (v / (10\text{mV} / \text{K})) - 273.15$$

- where T_n is in $^{\circ}\text{C}$.

The temperature, T_d , which is displayed by the LDT-5525 Temperature Controller, is first calibrated as follows:

$$T_d = C1 + (C2 * T_n)$$

- where C1 and C2 are the constants stored by the user in the LDT-5525 Temperature Controller for the LM335.

When the LDT-5525 is shipped from the factory, the LM335 measurement system is calibrated, but the sensor (C1 and C2) is not. Nominally, $C1 = 0$, and $C2 = 1$. In that case, the temperature accuracy is typically $\pm 1^{\circ}\text{C}$ over the rated operating range. With C1 and C2 calibrated also, the temperature accuracy is typically $\pm 0.3^{\circ}\text{C}$ over the rated operating range. The temperature accuracy may be improved over a narrow temperature range by a two-point calibration of C1 and C2. However, the LM335 is not perfectly linear, and even with C1 accurately known (and C2 uncalibrated) there is a non-linear absolute temperature error associated with the device. This non-linearity caused error is typically $\pm 0.3^{\circ}\text{C}$, with the error associated with C1 assumed to be zero.

If a maximum absolute error of $\pm 1^{\circ}\text{C}$ is tolerable, no calibration of C1 or C2 is required, just set $C1 = 0$, $C2 = 1$. If a maximum absolute error of $\pm 0.5^{\circ}\text{C}$ is tolerable, the one point calibration of C1 may be used (see page C-5). If a greater accuracy is desired, the two point method of determining C1 and C2 should be used (see page C-6). Note however, the absolute error associated with the constant C2 may vary over different temperature ranges.

One Point Calibration Method

This procedure will work for any linear temperature sensor. The accuracy of this procedure depends on the accuracy of the known temperature, externally measured. It is used to determine the zero offset of the device, and it assumes that the gain offset (slope) is known and is correct.

- 1 Allow the LDT-5525 Temperature Controller to warm up for at least one hour. Set the SENSOR SELECT switch for the desired sensor type, and RECALL the constants for the particular device to be calibrated.
- 2 Select the C1 parameter. Read and record the value of C1.
- 3 Place the sensor at an accurately known and stable temperature, T_a . Connect the sensor to pins 7 and 8 of the LDT-5525's 15-pin connector. Set the LDT-5525 for normal constant temperature (T mode) operation. Allow the LDT-5525 Temperature Controller to stabilize at the known temperature, T_a and read the displayed temperature, T_d .
- 4 Determine the new value of C1, $C1_n$, from the formula:

$$C1_n = C1 + T_a - T_d$$

and replace C1 with $C1_n$ by selecting the C1 parameter and entering the new $C1_n$ value.

Two Point Calibration Method

This procedure will work for any linear temperature sensor. The accuracy of this procedure depends on the accuracy of the known temperatures, externally measured. It is used to determine the zero offset of the device and the gain offset (slope).

- 1 Allow the LDT-5525 Temperature Controller to warm up for at least one hour. Set the SENSOR SELECT switch for the desired sensor type, and RECALL the constants for the particular device to be calibrated.
- 2 Select the C1 parameter. Read and record the value of C1. Select the C2 parameter. Read and record the value of C2.
- 3 Place the sensor at an accurately known and stable temperature, T_{a1} . Connect the sensor to pins 7 and 8 of the LDT-5525's 15-pin connector. Set the LDT-5525 for normal constant temperature (T mode) operation. Allow the LDT-5525 Temperature Controller to stabilize at the known temperature, T_{a1} and read the displayed temperature, T_{d1} . Record these values.
- 4 Repeat Step 3 for another known temperature, T_{a2} , and the corresponding displayed temperature, T_{d2} .

The two known temperatures should be at the bounds of the intended operating range. The smaller the intended operating range, the better the calibration over that same range.

- 5 Determine the new value of C1 ($C1_n$) and C2 ($C2_n$) from the following calculations.

First determine the intermediate values U and V, where

$$V = (T_{a1} - T_{a2}) / (T_{d1} - T_{d2}), \text{ and } U = T_{a1} - (T_{d1} * V)$$

Then $C1_n$ and $C2_n$ can be determined by the following:

$$C1_n = U + (V * C1) \text{ and } C2_n = V * C2$$

- 6 Replace C1 with $C1_n$ by selecting the C1 parameter and entering the new $C1_n$ value.
Replace C2 with $C2_n$ by selecting the C2 parameter and entering the new $C2_n$ value.

