

# HIOKI

## LCR METER IM3536

**Test Equipment  
Depot**  
1-800-517-8431

99 Washington Street  
Melrose, MA 02176  
Phone 781-665-1400  
Toll Free 1-800-517-8431

Visit us at [www.TestEquipmentDepot.com](http://www.TestEquipmentDepot.com)



# DC, 4 Hz to 8 MHz

Measurement frequency

## The new standard

Introducing an LCR meter that brings exceptional specifications and cost performance to a wide range of applications, from R&D to production lines

Test fixtures and probes sold separately. Photograph depicts IM3536 used in combination with the SMD Test Fixture 9677.

One-eighth the precision variability and five times the measurement speed of legacy models means dramatically improved productivity.

# High speed Stability

Repeatability and measurement time  
(Comparison of IM3536 and 3532-50)

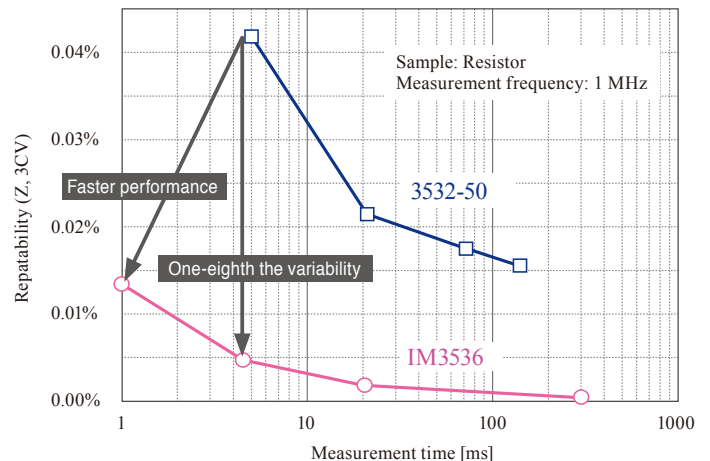

CE

[www.valuetronics.com](http://www.valuetronics.com)

# Raising the Bar for Basic Performance

High accuracy  $\pm 0.05\%$  rdg.

High speed 1 ms (fastest time)



## Guaranteed accuracy range from 1 m $\Omega$

The IM3536 delivers a guaranteed accuracy range that starts at 1 m $\Omega$ . Furthermore, the frequency band has been expanded to 8 MHz, broadening the array of measurement targets with which it can be used compared to legacy products.

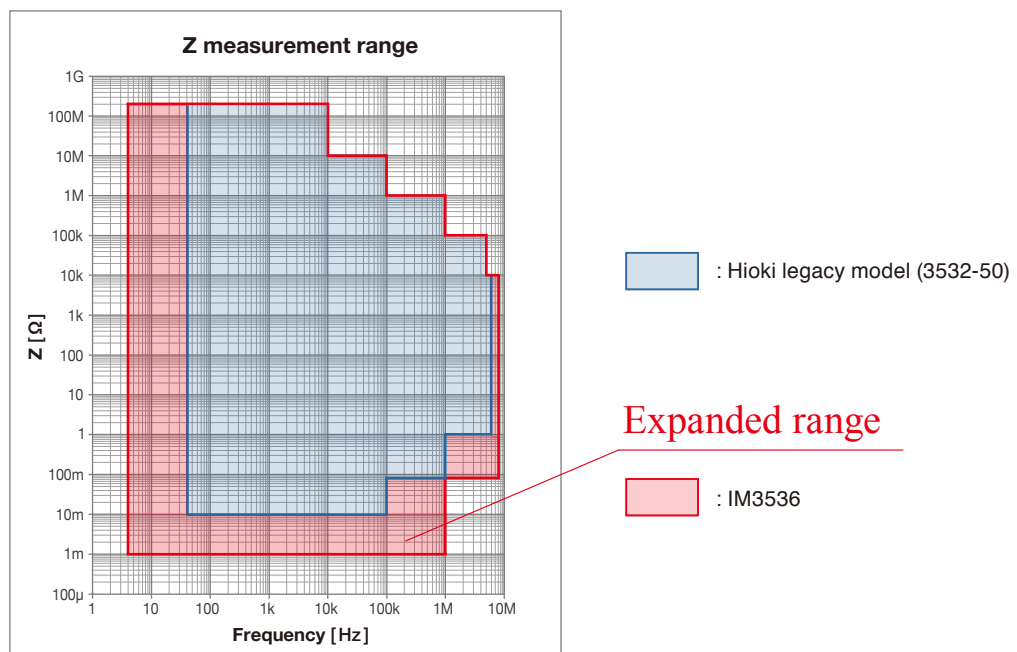

For more information about L and C measurable ranges, see page 14.



## Low-impedance measurement with unmatched repeatability

The IM3536 delivers repeatability that is an order of magnitude better than that of previous products. This level of performance makes the instrument ideal for use in applications such as electrolytic capacitor low-ESR measurement and power supply coil impedance testing, the latter of which demands excellent frequency characteristics.

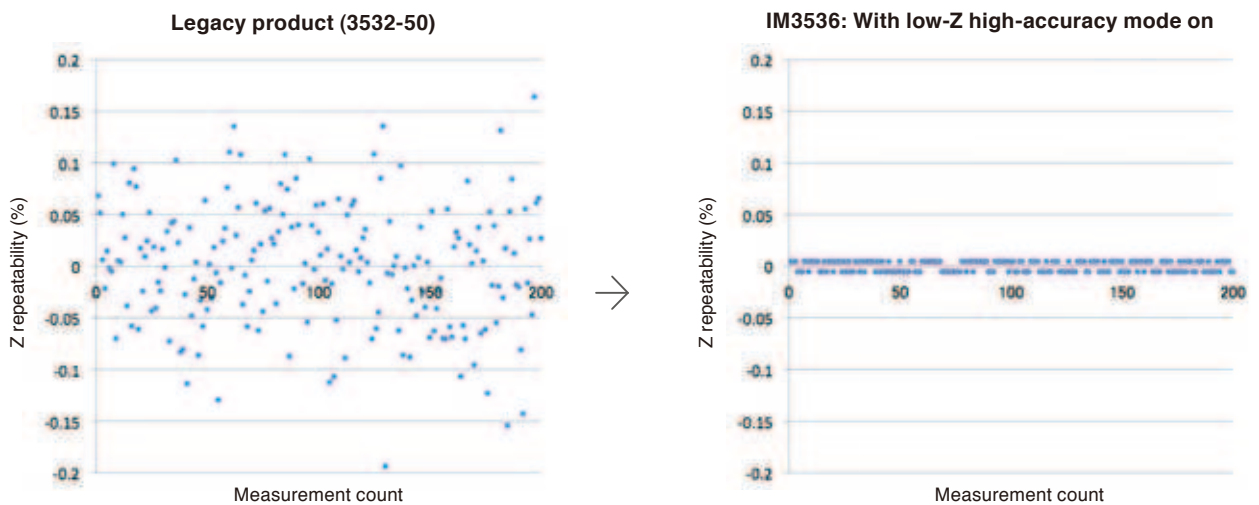

Graphs illustrate the results of measuring a resistance of 1 mΩ 200 times under the following conditions:

- Frequency: 1 kHz
- Measurement speed: FAST
- Measurement range: 100 mΩ



From measurement to analysis

Applications in development evaluation and research

Ideal for use in R&D work requiring a wide range of measurement conditions and for evaluation of devices under conditions of actual use

The IM3536 enables measurement conditions to be varied over a wide range, for example to analyze a coil's resonance point while varying the frequency or to perform measurement while changing the measurement signal during evaluation of a sample that exhibits signal dependency.

Variable frequency

DC, 4 Hz to 8 MHz

Variable voltage

10 mV to 5 V rms

(V mode/CV mode)

Variable current

10  $\mu$ A to 100 mA rms

(CC mode)

Example of measurement while varying the frequency from 1 MHz to 8 MHz



USB connection

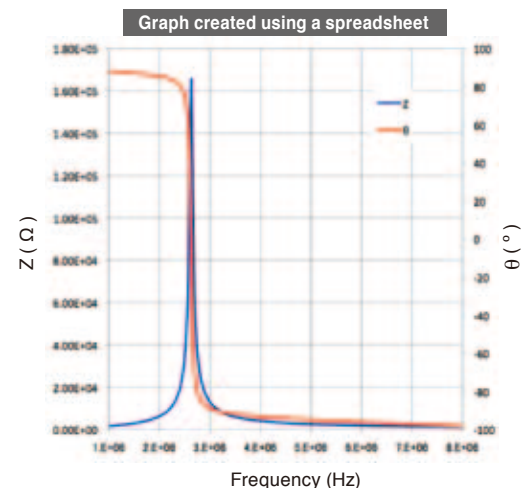

The IM3536 ships standard with application software that can save measurement data as an Excel file while sweeping through a range of frequencies pre-configured on a computer.

For more information, see page 5.

# DC bias function: Measure under conditions simulating actual use or in accordance with industry standards

## Internal DC bias (capacitor only)



A DC voltage can be superposed onto the measurement signal while measuring a capacitor.



The generated voltage can be varied from 0 V to 2.50 V DC (10 mV resolution).  
(Low-Z high-accuracy mode: 0 V to 1 V)

## External DC bias

(with support for L or C measurement, depending on the unit)



Requires a separate external DC bias power supply.

### DC BIAS VOLTAGE UNIT 9268-10



Measurement frequency range: 40 Hz to 8 MHz  
Maximum applied voltage:  $\pm 40$  V DC

### DC BIAS CURRENT UNIT 9269-10



Measurement frequency range: 40 Hz to 2 MHz  
Maximum applied current: 2 A DC

\* An internal 300 $\mu$ H inductance is connected in parallel to the DUT.

# Calculate conductivity and the dielectric constant

The conditions used to calculate conductivity and the dielectric constant can be set easily using the instrument's touch screen.

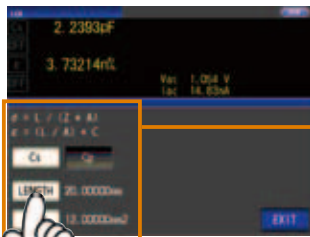

Enter the following parameters:  
Conductor length (LENGTH)  
Conductor cross-sectional area (AREA)



The instrument's touch keypad makes it easy to enter numbers.

# Evaluate samples that exhibit signal dependence using free application software

The bundled application allows you to save measurement data from the LCR meter as a Microsoft Excel or text file (CSV format) using the instrument's USB, LAN, GP-IB, or RS-232C interface.

### Standard accessory

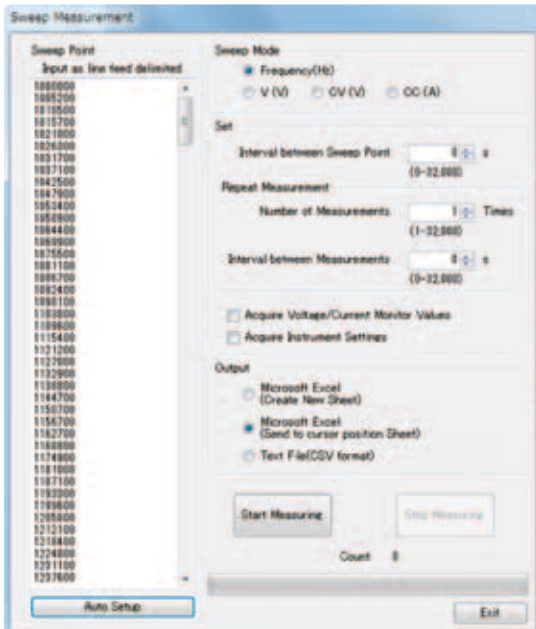

- Frequency characteristics (measurement while varying the frequency)
- Voltage characteristics (measurement while varying the voltage)
- Current characteristics (measurement while varying the current)
- Time interval measurement (measurement at a specified time interval)
- Capture measured value when the RETURN key is pressed (one-off measurement)

### Simple, automatic configuration of sweep points

Sweep points are generated automatically once you set the start value, end value, and number of intermediate data points.

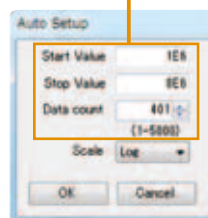

### Data saved in CSV format

	A	B	C	D	E
1	Frequency/AC Status	Z	PH		
2	1000000	0.154E+03	87.947		
3	1005200	0.155E+03	87.919		
4	1010500	0.156E+03	87.932		
5	1015700	0.157E+03	87.901		
6	1021000	0.158E+03	87.897		
7	1026300	0.159E+03	87.895		
8	1031700	0.161E+03	87.882		
9	1037100	0.162E+03	87.871		
10	1042500	0.163E+03	87.87		
11	1047900	0.164E+03	87.859		
12	1053400	0.165E+03	87.85		
13	1058900	0.166E+03	87.841		
14	1064400	0.168E+03	87.833		
15	1069900	0.169E+03	87.82		
16	1075500	0.170E+03	87.814		
17	1081100	0.171E+03	87.806		
18	1086700	0.173E+03	87.798		
19	1092400	0.174E+03	87.785		
20	1098100	0.175E+03	87.774		
21	1103800	0.176E+03	87.758		



# Simplifying the process of building production lines Increase convenience and efficiency

Perform two jobs with one instrument to save space and speed up the process of building a system

## Continuous measurement function

Suppose you wish to test power supply inductance L-Q at 1 kHz plus DC resistance (Rdc). The IM3536 steps up by delivering high-speed, continuous measurement of different conditions with a single instrument.

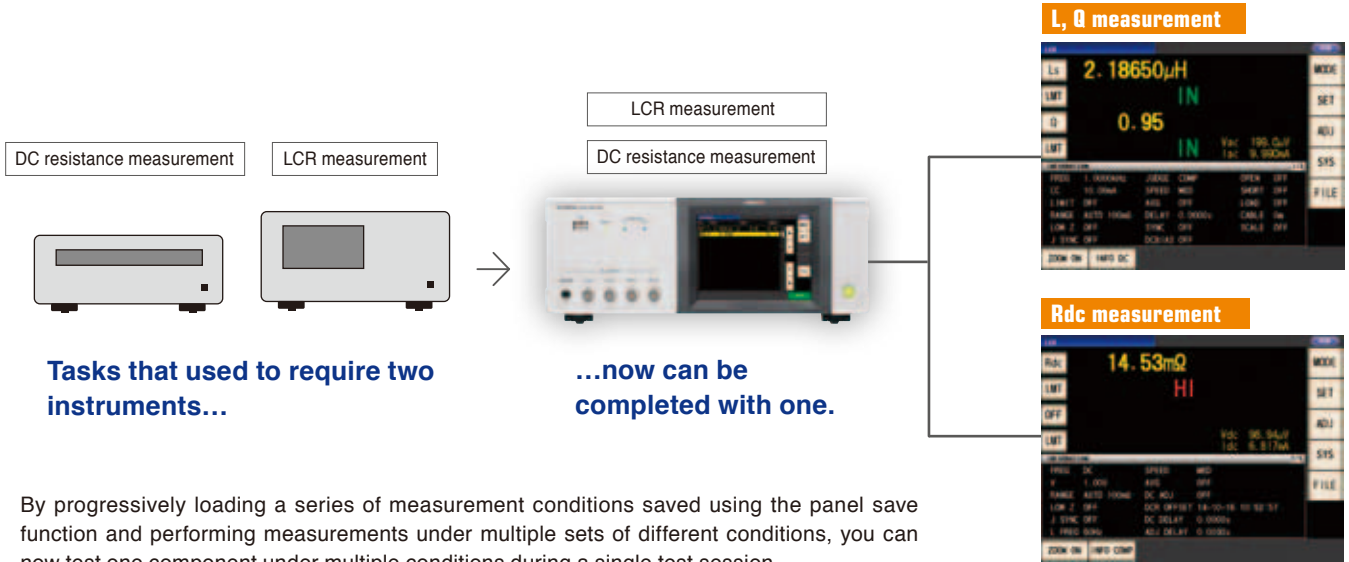

Tasks that used to require two instruments...

...now can be completed with one.

By progressively loading a series of measurement conditions saved using the panel save function and performing measurements under multiple sets of different conditions, you can now test one component under multiple conditions during a single test session.

# Display saved panels as a list and load them quickly

## Panel save and load functions

Save and load measurement conditions and compensation values.

### Ensure reliable application of settings during setup changes

Target A: Measurement conditions and judgment standards



- Measurement parameters: Ls, Q, Rdc
- Measurement frequency: 1 kHz
- Constant current: 1 mA

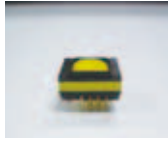

Target B: Measurement conditions and judgment standards

- Measurement parameters: Z,  $\theta$
- Measurement frequency: 1.5 kHz
- Constant current: 0.5 mA

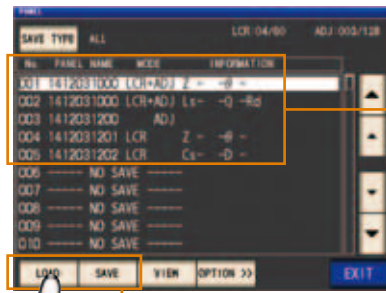

Easy-to-view list display  
Filename  
Measurement parameter name



Load or save using the touch screen keys

# Analyze the data you need on a computer quickly and easily

## Memory function and USB flash drive support



Save 32000 measurement results, copy them to a USB flash drive, and load them onto a computer. You can then open the measurement data using a spreadsheet to analyze variations and manage test data.

Even if both hands are full

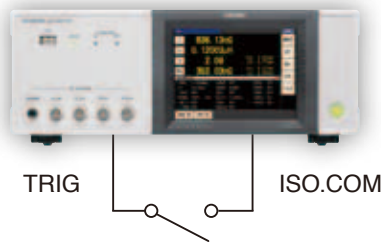

Select [External trigger] as the trigger setting and then control instrument operations such as measurement and saving of data from an external device such as a foot switch via the EXT. I/O terminal's TRIG signal.

**Measure and save multiple test results**

Measure the test target. ← Number of tests: n

Save the results to the instrument's internal memory.

Copy the saved data to a USB flash drive.



Load the data onto a computer.

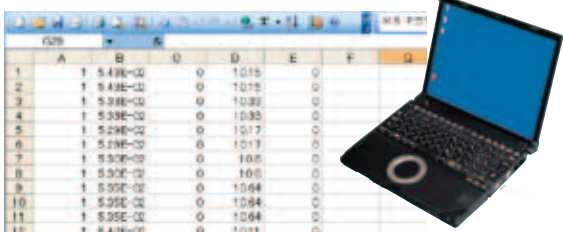

Analysis using a spreadsheet

# Improved protective functionality to reduce maintenance downtime

## Residual charge protection function

The IM3536 features an enhanced residual charge protection function that is designed to protect the instrument's internal circuitry from a capacitor discharge voltage in the event a charged capacitor is inadvertently connected to a measurement terminal.

Relationship between the capacitance from which LCR meters can be protected and residual voltage values

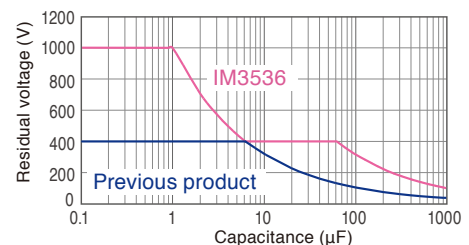



## Functionality supporting more accurate measurement Delivering reliability for production-line testing

### Compensate for anticipated errors

#### Cable length compensation

Select from cable length settings of 0 m, 1 m, 2 m, and 4 m, guaranteeing accuracy even when measurement cables have been extended.

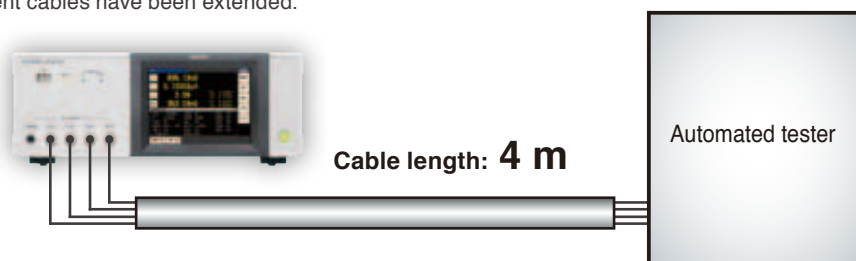

#### Load compensation

Up to five sets of compensation conditions can be saved.

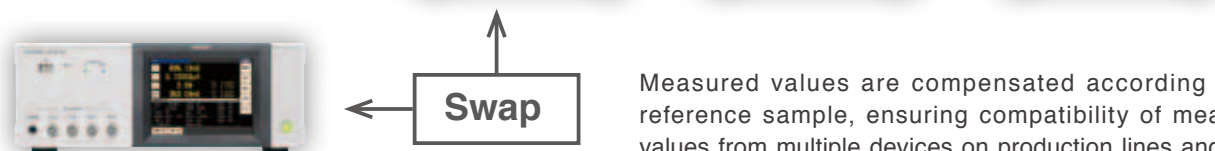

Measured values are compensated according to the reference sample, ensuring compatibility of measured values from multiple devices on production lines and when swapping out devices, for example when a unit needs to be calibrated.



## Low-Z high-accuracy mode for increasing the maximum applied current

When using low-Z high-accuracy mode, the output resistance changes to 10 Ω, allowing more current to flow to the sample being measured so that high-precision measurement is guaranteed.

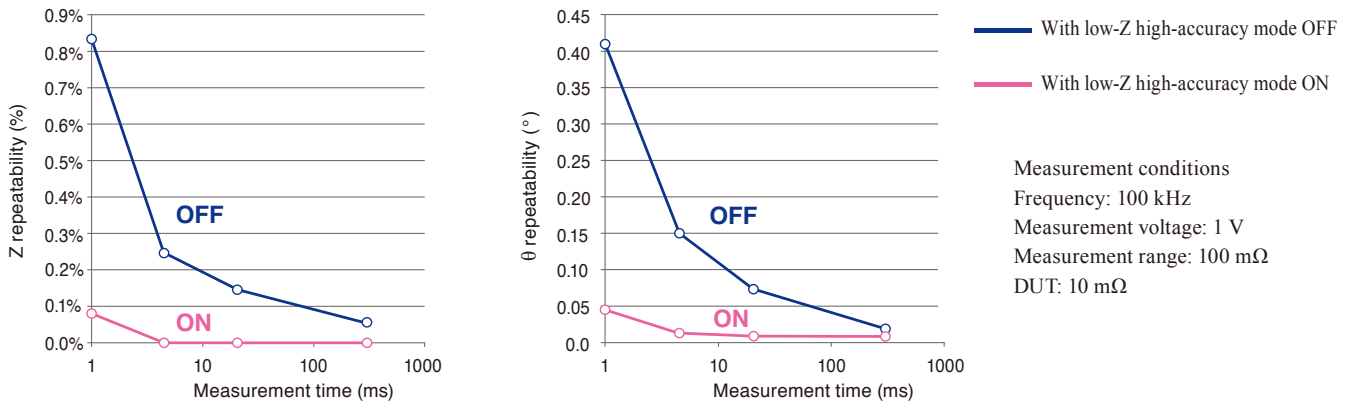

Low-Z high-accuracy mode can be used with the 100 mΩ, 1 Ω, and 10 Ω ranges.

This mode is especially effective when performing low-inductance L measurement of power supplies and ESR measurement of aluminum electrolytic capacitors.

## Contact check function

Detect faulty contact with the sample during four-terminal measurement.

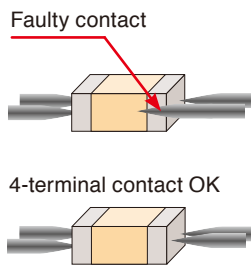

The contact check function measures the contact resistance between L<sub>POT</sub> and L<sub>CUR</sub> and between H<sub>POT</sub> and H<sub>CUR</sub> and displays an error if the readings are greater than or equal to a preset threshold.

H<sub>CUR</sub> terminal: Current generation terminal  
 H<sub>POT</sub> terminal: HI voltage detection terminal  
 L<sub>POT</sub> terminal: LO voltage detection terminal  
 L<sub>CUR</sub> terminal: Current detection terminal

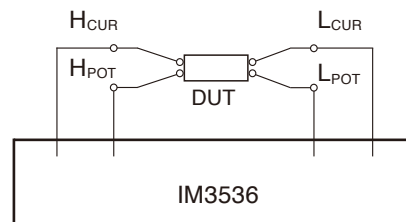

Set threshold values

Contact resistance
Approx. 1,000 Ω
Approx. 500 Ω
Approx. 100 Ω
Approx. 50 Ω
Approx. 20 Ω

## Hi-Z reject function

Detect contact errors during two-terminal measurement.

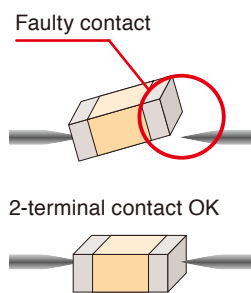

The Hi-Z reject function outputs an error if the measurement result exceeds a preset judgment standard. This capability enables the instrument to detect poor contact when performing measurement using a two-terminal fixture.



The judgment standard is calculated based on the measurement range and judgment reference value (valid setting range: 0% to 30,000%).

The instrument's touch keypad makes it easy to enter judgment reference values.

## Improve measurement precision with the waveform averaging function

The IM3536's waveform averaging function lets you set the number of measured waveforms for each frequency band determined by the measurement speed setting (FAST, MED, SLOW, SLOW2).

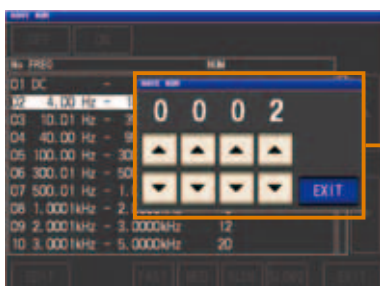

Number of waveforms → Many (increased measurement precision)

Normal (FAST, MED, SLOW, SLOW2) number of waveforms

Number of waveforms → Few (higher measurement speed)

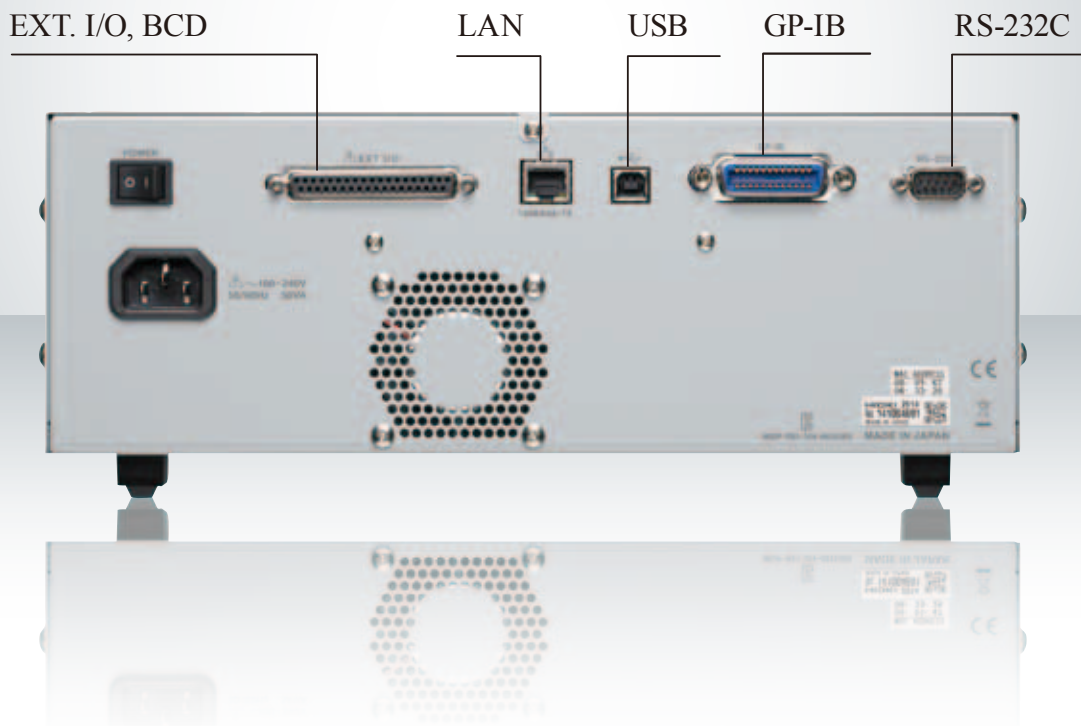

## Access an extensive range of interfaces in all model variants

### EXT. I/O

EXT. I/O allows you to output the measurement complete signal and judgment results signal and to control the instrument by inputting signals such as a measurement trigger signal. All signal lines are isolated from the instrument's measurement and control circuitry for maximum noise resistance.

#### ■ Example of EXT I/O timing (LCR mode)

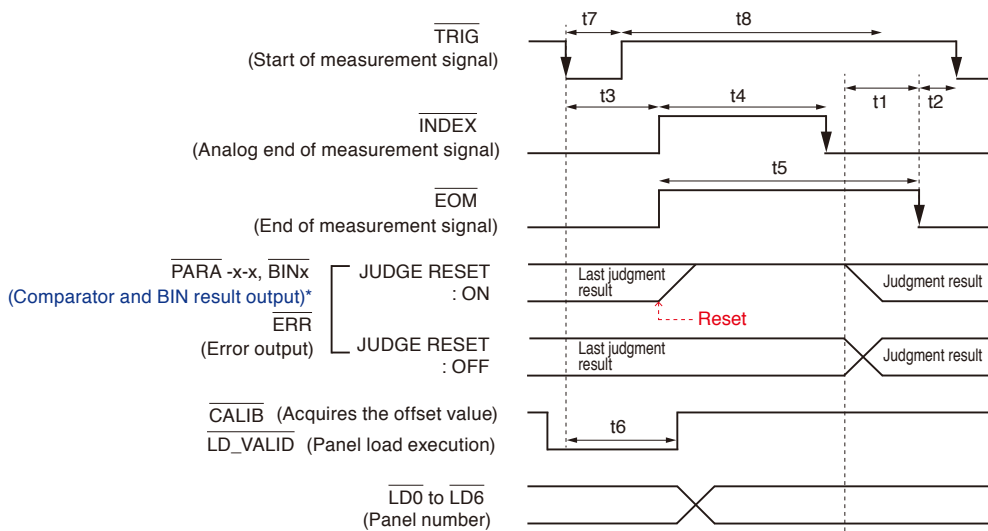

\*: PARAx-HI, PARAx-IN, PARAx-LO, AND, BINx, OUT\_OF\_BINS

- t1: From Comparator, BIN Judgement Result to  $\overline{\text{EOM}}$  (LO): Setting value for delay time <sup>\*1</sup> (Settable range: 0.0000 s to 0.9999 s) ; 40  $\mu$ s  
t2: From  $\overline{\text{EOM}}$  width (LO) to  $\overline{\text{TRIG}}$  (LO): Minimum time from end of measurement to next trigger <sup>\*2</sup> ; 400  $\mu$ s  
t3: From  $\overline{\text{TRIG}}$  (LO) to  $\overline{\text{INDEX}}$  (HI): Time from trigger to circuit response <sup>\*3</sup> ; 400  $\mu$ s  
t4:  $\overline{\text{INDEX}}$  width (HI): Analog measurement time (=Minimum chuck time), switching chuck with  $\overline{\text{INDEX}}$  (LO) is possible <sup>\*4</sup> ; 1 ms  
t5:  $\overline{\text{EOM}}$  width (HI): Measurement time <sup>\*4</sup> ; 1.5 ms  
t6: From  $\overline{\text{TRIG}}$  width (LO) to  $\overline{\text{LD\_VALID}}$  (HI),  $\overline{\text{CALIB}}$  (HI): Time to panel load execution and DC adjustment request signal detection: at least t3  
t7: Trigger pulse width (LO time) ; At least 100  $\mu$ s  
t8: Trigger off (HI time) ; At least 100  $\mu$ s

<sup>\*1</sup>. There is an approximate error of 100  $\mu$ s in the delay time entered for Judgement Result  $\leftrightarrow$  EOM for the setting value. t1 is the reference value for when the setting value is 0.0000 s.

<sup>\*2</sup>. t2 is the reference value for when trigger input for during measurement is disabled.

<sup>\*3</sup>. Additional time is required when loading panel numbers using the panel load function.

<sup>\*4</sup>. Reference value for Measurement frequency: 1 kHz, Measurement speed: FAST, Range: HOLD

■ EXT. I/O signal list

● Input signals

TRIG	: External trigger
LD0 to LD6	: Select panel number
LD_VALID	: Execute panel load
C1	: During BCD output, toggle between high-order and low-order digits
C2	: During BCD output, toggle between the No. 1 and No. 3 parameters
CALIB	: DC adjustment request

● Output signals

EOM	: End of measurement
INDEX	: End of capture
ERR	: Measurement error output
ISO_5V	: Isolated 5V power output
ISO_COM	: Isolated common signal ground

● Output signals (common signal line)

PARAx-HI, PARAx-IN, PARAx-LO (x=1,3), AND	: Comparator judgment result output
BIN1 to BIN10, OUT_OF_BINS	: BIN judgment result output
D1-0 to D1-3 D2-0 to D2-3 D3-0 to D3-3 D4-0 to D4-3	: BCD output signal

■ Electrical specifications

Input signals	Input type	Optocoupler-isolated, non-voltage contact inputs (current sink, active-low)
	Input asserted (on) voltage	0.9 V or less
	Input de-asserted (off) voltage	OPEN or 5 V to 24 V
	Input asserted (on) current	3 mA/ch
	Maximum applied voltage	30 V
Output signals	Output type	Isolated NPN open-collector outputs (current sink, active-low)
	Maximum load voltage	30V
	Maximum output current	50 mA/ch
	Residual voltage	1 V (10 mA), 1.5 V (50 mA)
Internally isolated power supply	Output voltage	4.5 V to 5.0 V
	Maximum output current	100 mA
	External power input	none

BCD

LCR mode output signals operate in two modes: judgment mode and BCD mode. In BCD mode, measured values for the No. 1 parameter and the No. 3 parameter are output using the BCD signals. \*LCR mode only

The BCD high-order digit and low-order digit (polarity and ERR information) can be switched with the C1 signal.

C1	D4	D3	D2	D1
HI (high-order)	No. 6 digit data	No. 5 digit data	No. 4 digit data	No. 3 digit data
LO (low-order)	No. 2 digit data	No. 1 digit data	Polarity	ERR

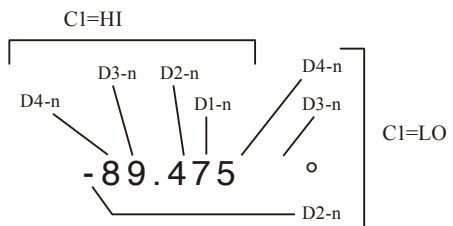

Interfaces

Control the instrument with communication commands from a computer via the USB, LAN, GP-IB, or RS-232C interfaces.

USB

Connector	USB Type B receptacle
Electrical specifications	USB2.0 (High Speed)

GP-IB

Connector	24-pin Centronics type connector
Standard	IEEE-488.1 1987
Reference standard	IEEE-488.2 1987
Terminator	LF, CR+LF

LAN

Connector	RJ-45 connector
Transmission method	10Base-T/100Base-T automatic detection
Protocol	TCP/IP

RS-232C

Connector	D-sub 9-pin connector
Flow control	Hardware/Software
Transmission speed	9600 bps, 19200 bps, 38400 bps, 57600 bps

■ IM3536 connector signal assignment (LCR mode operation)

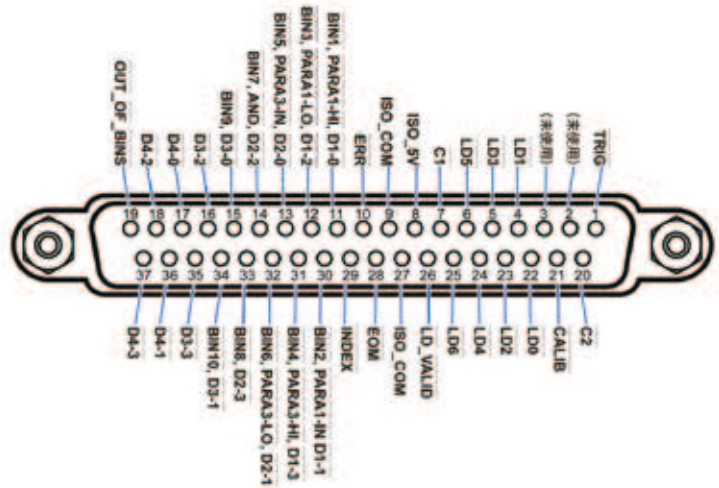

Signal assignment is different during continuous measurement mode. Signal logic is 0 V to 0.9 V for LO level and 5 V to 24 V for HI level.

■ Connectors

Connectors to use (unit side) : 37-pin D- sub female connector with #4-40 inch screws  
 Compliant connectors : DC-37P-ULR (solder type) and DCSP-JB37PR (pressure weld type)  
 For information on where to obtain connectors, consult your nearest HIOKI distributor.

## Measurement parameters and measurement conditions

Measurement parameters	Z	Impedance	Rs	Equivalent series resistance (ESR)
	Y	Admittance	Rp	Equivalent parallel resistance
	$\theta$	Phase angle	Ls	Equivalent series inductance
	X	Reactance	Lp	Equivalent parallel inductance
	G	Conductance	Cs	Equivalent series capacitance
	B	Susceptance	Cp	Equivalent parallel capacitance
	Q	Q-factor	D	Loss factor $\tan \delta$
	Rdc	DC resistance	$\sigma$	Conductivity
			$\epsilon$	Permittivity
Display range	Z	0.00 m to 9.99999 G $\Omega$	Rs	$\pm(0.00 \text{ m to } 9.99999 \text{ G}\Omega)$
	Y	0.000 n to 9.99999 GS	Rp	$\pm(0.00 \text{ m to } 9.99999 \text{ G}\Omega)$
	$\theta$	$\pm(0.000^\circ \text{ to } 180.000^\circ)$	Ls	$\pm(0.00000 \mu \text{ to } 9.99999 \text{ GH})$
	X	$\pm(0.00 \text{ m to } 9.99999 \text{ G}\Omega)$	Lp	$\pm(0.00000 \mu \text{ to } 9.99999 \text{ GH})$
	G	$\pm(0.000 \text{ n to } 9.99999 \text{ GS})$	Cs	$\pm(0.00000 \text{ p to } 9.99999 \text{ GF})$
	B	$\pm(0.000 \text{ n to } 9.99999 \text{ GS})$	Cp	$\pm(0.00000 \text{ p to } 9.99999 \text{ GF})$
	Q	$\pm(0.00 \text{ to } 9999.99)$	D	$\pm(0.00000 \text{ to } 9.99999)$
	Rdc	$\pm(0.00 \text{ m to } 9.99999 \text{ G}\Omega)$	$\Delta\%$	$\pm(0.000\% \text{ to } 999.999\%)$
			$\sigma$	$\pm(0.00000 \text{ to } 999.999 \text{ G})$
			$\epsilon$	$\pm(0.00000 \text{ to } 999.999 \text{ G})$
Measurable range	1 m $\Omega$ to 200 M $\Omega$			
Output impedance	Normal mode: 100 $\Omega$ , Low impedance high accuracy mode: 10 $\Omega$			
Measurement frequency	Range	4 Hz to 8 MHz		
	Resolution	4.00 Hz to 999.99 Hz ..... 10 mHz steps 1.0000 kHz to 9.9999 kHz ..... 100 mHz steps 10.000 kHz to 99.999 kHz ..... 1 Hz steps 100.00 kHz to 999.99 kHz ..... 10 Hz steps 1.0000 MHz to 8.0000 MHz ..... 100 Hz steps		
	Accuracy	$\pm 0.01\%$ of setting or less		
Measurement signal level [V mode] [CV mode]	Range	[Normal mode] 4 Hz to 1.0000 MHz: 10 mV to 5 V rms (maximum 50 mA) 1.0001 MHz to 8 MHz: 10 mV to 1 V rms (maximum 10mA) [Low impedance high accuracy mode] 4 Hz to 1.0000 MHz: 10 mV to 1 V rms (maximum 100 mA)		
	Resolution	10 mV rms to 1.000 V rms ..... 1 mV rms steps 1.01 V rms to 5 V rms ..... 10 mV rms steps		
Measurement signal level [CC mode]	Range	[Normal mode] 4 Hz to 1.0000 MHz: 10 $\mu$ A to 50 mA rms (maximum 5 V) 1.0001 MHz to 8 MHz: 10 $\mu$ A to 1 mA rms (maximum 1 V) [Low impedance high accuracy mode] 4 Hz to 1.0000 MHz: 10 $\mu$ A to 100 mA rms (maximum 1 V)		
	Resolution	10 $\mu$ A rms steps		
Monitor function	Monitor voltage range: 0.000 V to 5.000 V rms Monitor current range: 0.000 mA to 100.0 mA rms			
DC resistance measurement	Measurement signal level: Fixed at 1 V			
DC bias measurement	Generating range: DC voltage 0 V to 2.50 V (10mV resolution) In low Z high accuracy mode: 0 V to 1 V (10 mV resolution)			

## Measurement modes

Measurement modes	LCR mode: Measurement using a single set of conditions. Continuous measurement mode: Continuous measurement using previously saved conditions
-------------------	--

## LCR mode

Measurements	Bin measurement: 10 categories for 2 measurement parameters Judgment method: Set as absolute values, percentage, or deviation percentage
	Comparator measurement: Hi, IN, and Lo judgments for 2 parameters Judgment method: Set as absolute values, percentage, or deviation percentage
Display	Zoom display function: Enlarged display of measured values Number of display digits setting: Allows you to set the number of display digits for measured values for each measurement parameter. (Valid setting range: 3 to 6 digits)

## Continuous measurement mode

Measurements	Performs continuous measurement using measurement conditions that have been saved using the panel save function. Measurement is started by an external trigger (any of the three types described below)
Maximum number of measurements	60

## Speed and accuracy

Measurement speed	FAST/MED/SLOW/SLOW2
Averaging	Valid setting range: 1 to 256 (in steps of 1)
Basic accuracy	Z: $\pm 0.05\%$ rdg. $\theta$ : $\pm 0.03^\circ$ (representative value)
Guaranteed accuracy range	1 m $\Omega$ to 200 M $\Omega$ (impedance)
Guaranteed accuracy period	1 year
Warm-up time	60 minutes
Terminal structure	4-terminal structure

## Supplementary functionality

Trigger function	Uses a specific signal to time the start of measurement. [Trigger types] Internal trigger: Automatically generates a trigger signal internally to repeat measurement. External trigger: Allows you to control the instrument's measurement operation by inputting a trigger signal from an external device (trigger sources: manual, communications commands, EXT. I/O).
	[Trigger delay] Sets the delay time from trigger input to measurement. Setting range: 0.0000 s to 9.9999 s [Trigger synchronous output] Outputs the measurement signal after trigger input and applies it to the sample during measurement only. Allows you to set a wait time until data is acquired. Setting range: 0.0000 s to 9.9999 s
Compensation function	[Open/short compensation] [Load compensation] Number of sets of compensation conditions: Up to 5 [Cable length compensation] Cable length settings: 0 m, 1 m, 2 m, 4 m [Correlation compensation] Compensation of display values based on user-input compensation coefficient
Contact check	[4-terminal contact check] Performs a contact (disconnection) check between $H_{CUR}$ and $H_{POT}$ and between $L_{CUR}$ and $L_{POT}$ . [High-Z reject function] Detection of OPEN state during 2-terminal measurement.

## Recording and interface

Memory function	Measurement result items (maximum 32000 items) can be saved to the instrument. Memory can be read using communications commands or a USB flash drive.
Panel save and load functions	Measurement conditions: Up to 60 Compensation values: Up to 128
Interfaces	EXT. I/O (HANDLER), USB, USB flash drive, LAN, GP-IB, RS-232C
BCD output	[Output from EXT. I/O connector] Generates BCD output for the No.1 and No.3 parameter measured values. *Input and output signals are set to BCD mode (selection with judgment output).

## Display and sound

Key lock function	Lock operation of the instrument using the touch screen. Unlock by entering a passcode.
Beep tone	Enable or disable for judgment results and key operation.
Display settings	LCD display on/off Off: The display turns off 10 sec. after the touch panel is last touched.
Display	5.7-inch color TFT with touch panel

## Other

Operating temperature and humidity	0°C to 40°C (32°F to 104°F), 80% RH, non-condensing
Storage temperature and humidity	-10°C to 50°C (14°F to 122°F), 80% RH, non-condensing
Operating environment	Indoors, Pollution Degree 2, altitude up to 2000 m (6562-ft.)
Power supply and maximum rated power	100 V AC to 240 V AC (50/60 Hz), 50 VA
Dielectric strength	1.62 kV AC for 1 min. between power line and ground line
Standards compliance	EMC: EN 61326, EN 61000 Safety: EN 61010
Dimensions and Mass	Approx. 330 W $\times$ 119 H $\times$ 230 D mm (12.99 W $\times$ 4.69 H $\times$ 9.06 D in), approx. 4.2 kg (148.1 oz.)
Accessories	Power cord $\times$ 1, Instruction manual $\times$ 1, LCR application disc (Communications user manual) $\times$ 1

### Measurement accuracy

(Accuracy guaranteed for 1 year, Post-adjustment accuracy guaranteed for 1 year)

Measurement accuracy is calculated based on the following equation:

$$\text{Measurement accuracy} = \text{Basic accuracy} \times C \times D \times E \times F \times G$$

[C: Level coefficient] V: Setting value (corresponds to when V mode) [V]

Measurement level	1 V		
Coefficient (DC resistance measurement)	1		
Measurement level	0.010 V to 0.999 V	1 V	1.001 V to 5 V
Coefficient (AC measurement)	1+0.2/V	1	1+0.2/V

[D: Measurement speed coefficient]

	Measurement speed	FAST	MED	SLOW	SLOW2
Coefficient	DC resistance measurement	4	3	2	1
	AC measurement	8	4	2	1

[E: Measurement cable length coefficient]

Coefficient	0 m	1 m	2 m	4 m
	1	1.5	2	3

Settable range for frequency

0 m: Up to 8 MHz, 1 m: 8 MHz, 2 m: Up to 2 MHz, 4 m: Up to 1MHz

[F: DC bias coefficient]

DC bias coefficient	OFF	ON
Coefficient	1	2

[G: Temperature coefficient]

Operating temperature	t [°C]
Coefficient	1+0.1× t-23

When the operating temperature (t) is 23°C±5°C, use a coefficient of 1.

### Basic accuracy

Accuracy is calculated based on coefficients A and B from the basic accuracy chart shown below.

1 kΩ range or higher

100 Ω range or lower

$$\text{Basic accuracy} = \pm \left( A+B \times \left| \frac{10 \times Z_x}{\text{Range}} - 1 \right| \right) \quad \text{Basic accuracy} = \pm \left( A+B \times \left| \frac{\text{Range}}{Z_x} - 1 \right| \right)$$

Zx : Impedance of the measurement conductor

A: Noted in basic accuracy chart. (Upper value: Z accuracy [% rdg.]; lower value: θ accuracy [°])

B: Noted in basic accuracy chart. (Upper value: Z accuracy [% rdg.]; lower value: θ accuracy [°])

A is the accuracy of R when DC (± % rdg.)  
B is the coefficient for the resistance of the sample

Conditions

Temperature and humidity ranges: 23°C ± 5°C, 80% RH or less (no condensation), at least 60 minutes after power ON, after performing open and short compensation



### Free software for calculating accuracy

(LCR application disc)

Automatically calculate measurement accuracy based on user-entered measurement conditions and measurement results. Free download from the Hioki website.

### Basic accuracy

Range	Guaranteed accuracy rang	DC	4Hz to 99.99Hz	100Hz to 999.99Hz	1kHz to 10kHz	10.001kHz to 100kHz	100.01kHz to 1MHz	1.0001MHz to 8MHz
100MΩ	8MΩ to 200MΩ	A=1 B=1	A=6 B=5 A=5 B=3	A=3 B=2 A=2 B=2	A=3 B=2 A=2 B=2			
10MΩ	800kΩ to 10MΩ	A=0.5 B=0.3	A=0.8 B=1 A=0.8 B=0.5	A=0.5 B=0.3 A=0.4 B=0.2	A=0.5 B=0.3 A=0.4 B=0.2	A=2 B=1 A=2 B=1		
1MΩ	80kΩ to 1MΩ	A=0.2 B=0.1	A=0.4 B=0.08 A=0.3 B=0.08	A=0.3 B=0.05 A=0.2 B=0.02	A=0.3 B=0.05 A=0.2 B=0.02	A=0.5 B=0.1 A=0.6 B=0.1	A=3 B=0.5 A=3 B=0.5	
100kΩ	8kΩ to 100kΩ	A=0.1 B=0.01	A=0.3 B=0.03 A=0.2 B=0.02	A=0.2 B=0.03 A=0.1 B=0.02	A=0.2 B=0.03 A=0.1 B=0.02	A=0.25 B=0.04 A=0.2 B=0.02	A=1 B=0.3 A=1 B=0.3	A=2 B=0.5 A=2 B=0.3
10kΩ	800Ω to 10kΩ	A=0.1 B=0.01	A=0.3 B=0.03 A=0.3 B=0.01	A=0.2 B=0.02 A=0.1 B=0.02	A=0.05 B=0.02 A=0.03 B=0.02	A=0.3 B=0.02 A=0.2 B=0.02	A=0.5 B=0.05 A=0.5 B=0.05	A=2 B=0.5 A=1.5 B=0.3
1kΩ	80Ω to 1kΩ	A=0.1 B=0.01	A=0.3 B=0.02 A=0.2 B=0.02	A=0.2 B=0.02 A=0.1 B=0.02	A=0.2 B=0.02 A=0.1 B=0.02	A=0.2 B=0.02 A=0.15 B=0.02	A=0.4 B=0.02 A=0.5 B=0.02	A=1.5 B=0.2 A=1.5 B=0.2
100Ω	8Ω to 100Ω	A=0.1 B=0.02	A=0.3 B=0.02 A=0.2 B=0.01	A=0.2 B=0.02 A=0.15 B=0.01	A=0.2 B=0.02 A=0.1 B=0.01	A=0.2 B=0.02 A=0.15 B=0.02	A=0.5 B=0.03 A=0.5 B=0.03	A=1.5 B=0.2 A=1.5 B=0.2
10Ω	800mΩ to 10Ω	A=0.2 B=0.15	A=0.5 B=0.1 A=0.3 B=0.1	A=0.4 B=0.05 A=0.3 B=0.03	A=0.4 B=0.05 A=0.3 B=0.03	A=0.4 B=0.05 A=0.3 B=0.03	A=0.8 B=0.1 A=0.5 B=0.05	A=2 B=1.5 A=2 B=1
1Ω	80mΩ to 1Ω	A=0.3 B=0.3	A=1.5 B=1 A=0.8 B=0.5	A=1 B=0.3 A=0.5 B=0.2	A=1 B=0.3 A=0.5 B=0.2	A=1 B=0.3 A=0.5 B=0.2	A=1.5 B=1 A=0.7 B=0.5	A=3 B=3 A=3 B=2
100mΩ	1mΩ to 100mΩ	A=1 B=1	A=8 B=8 A=5 B=4	A=5 B=4 A=3 B=2	A=3 B=2 A=2 B=1.5	A=2 B=2 A=2 B=1.5	A=4 B=3 A=3 B=4	

#### ● Method of determining basic accuracy

- Calculate the basic accuracy from the sample impedance, measurement range, and measurement frequency and the corresponding basic accuracy A and coefficient B from the table above.
- The calculation expression to use differs for each of the 1 kΩ range and above and 100 Ω range and below.
- For C and L, obtain basic accuracy A and coefficient B by determining the measurement range from the actual measurement value of impedance or the approximate impedance value calculated with the following expression.

$$Z_x (\Omega) \approx \omega L (H) \quad (\theta \approx 90^\circ)$$

$$\approx \frac{1}{\omega C (F)} \quad (\theta \approx -90^\circ)$$

$$\approx R (\Omega) \quad (\theta \approx 0^\circ) \quad (\omega: 2 \times \pi \times \text{Measurement frequency [Hz]})$$

#### ● Calculation example

Impedance Zx of sample: 500 Ω (actual measurement value)

Measurement conditions: When frequency 10 kHz and range 1 kΩ

Insert coefficient A = 0.2 and coefficient B = 0.02 for the Z basic accuracy from the table above into the expression.

$$Z \text{ basic accuracy} = 0.2 + 0.02 \times \left| \frac{10 \times 500}{10^3} - 1 \right| = 0.28 (\pm \% \text{rdg.})$$

Similarly, insert coefficient A = 0.1 and coefficient B = 0.02 for the θ basic accuracy, as follows:

$$\theta \text{ basic accuracy} = 0.1 + 0.02 \times \left| \frac{10 \times 500}{10^3} - 1 \right| = 0.18 (\pm \text{deg.})$$

### Guaranteed accuracy measurement level range

The range of measurement levels for which accuracy is guaranteed varies with the setting conditions.

Range	Sample's impedance	DC	4 Hz to 99.99 Hz	100 Hz to 999.99 Hz	1 kHz to 10 kHz	10.001 Hz to 100 kHz	100.01 kHz to 1 MHz	1.0001 MHz to 5 MHz	5.0001 MHz to 8 MHz
100 MΩ	8 MΩ to 200 MΩ	1V (fixed)	0.010 V to 5 V	0.010 V to 5 V	0.501 V to 5 V	0.101 V to 5 V	0.501 V to 5 V	0.101 V to 1 V	0.101 V to 1 V
10 MΩ	10 MΩ to 100 MΩ								
	800 kΩ to 10 MΩ								
1 MΩ	1 MΩ to 10 MΩ								
	80 kΩ to 1 MΩ								
100 kΩ	100 kΩ to 1 MΩ								
	8 kΩ to 100 kΩ								
10 kΩ	10 kΩ to 100 kΩ								
	800 Ω to 10 kΩ								
1 kΩ	1 kΩ to 10 kΩ								
	80 Ω to 1 kΩ								
100 Ω	8 Ω to 100 Ω		0.050 V to 5 V	0.050 V to 5 V	0.101 V to 5 V	0.501 V to 5 V	0.101 V to 1 V	0.101 V to 1 V	0.101 V to 1 V
10 Ω	800 mΩ to 10 Ω								
1 Ω	80 mΩ to 1 Ω								
100 mΩ	1 mΩ to 100 mΩ								

The guaranteed accuracy range during DC bias operation is 10 mΩ or greater. The accuracy for DC resistance (Rdc) measurement is guaranteed only when offset values are acquired. The guaranteed accuracy range varies with the sample's impedance.

# Measurable ranges

**L measurement range**

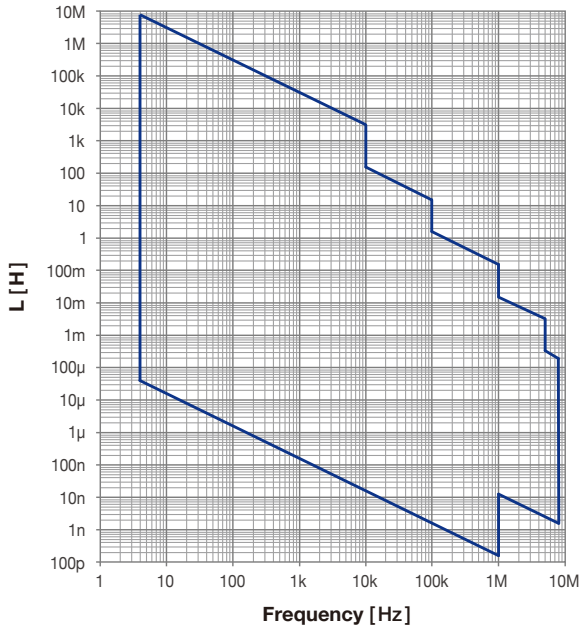

**C measurement range**

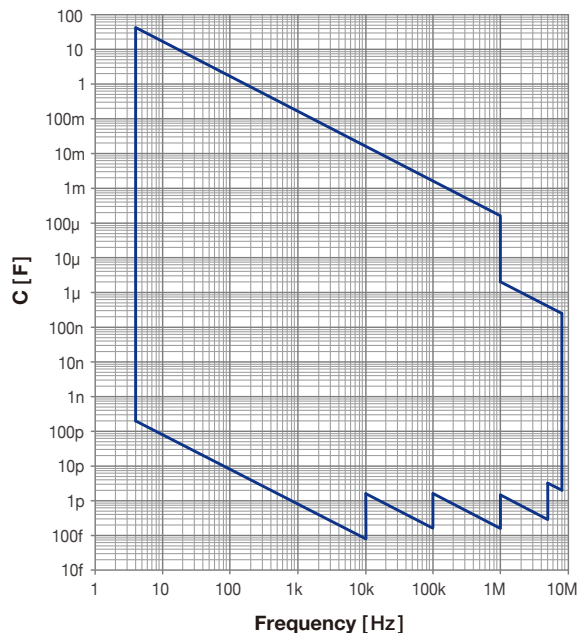

*This product is not supplied with measurement probes or test fixtures. Please select and purchase the measurement probe or test fixture options appropriate for your application separately. All probes are constructed with a 1.5D-2V coaxial cable. For an RS-232C connection: A crossover cable for interconnection can be used. You can use the RS-232C CABLE 9637 without hardware flow control.*

**Model : LCR METER IM3536**

Model No. (Order Code) (Note)

**IM3536**

Accessories: Power cord ×1, Instruction manual ×1, LCR application disc (Communications user manual) ×1



Free software for calculating accuracy (LCR application disc)

Automatically calculate measurement accuracy based on user-entered measurement conditions and measurement results. Free download from the Hioki website.

## Options

**RS-232C CABLE 9637**

**GP-IB CONNECTOR CABLE 9151-02**

**DC BIAS VOLTAGE UNIT 9268-10**

**DC BIAS CURRENT UNIT 9269-10**



For the PC, 9pin - 9pin, cross,  
1.8m (5.91 ft) length

2 m (6.56 ft) length

Measurement frequency range: 40 Hz to 8 MHz  
Maximum applied voltage: ±40 V DC

Measurement frequency range: 40 Hz to 2 MHz  
Maximum applied current: 2 A DC

\* An internal 300µH inductance is connected in parallel to the DUT.

## Probes and Test Fixtures for Lead Components

### 4-TERMINAL PROBE L2000

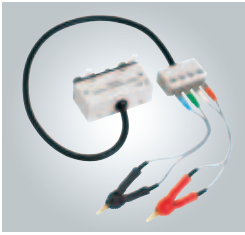

Measurable range: DC to 8 MHz  
Measurable terminal diameter:  
0.3 mm (0.01 in) to 5 mm (0.2 in)  
Cord length: 1 m (3.28 ft)

### 4-TERMINAL PROBE 9140-10

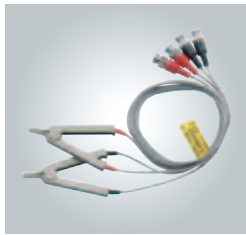

Measurable range: DC to 200 kHz  
Measurable terminal diameter:  
0.3 mm (0.01 in) to 5 mm (0.2 in)  
Cord length: 1 m (3.28 ft)

### TEST FIXTURE 9262

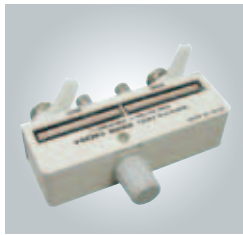

Measurable range: DC to 8 MHz  
Measurable terminal diameter:  
0.3 mm (0.01 in) to 2 mm (0.08 in)  
Direct connection type

### TEST FIXTURE 9261-10

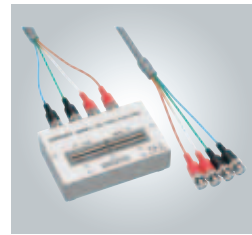

Measurable range: DC to 8 MHz  
Measurable terminal diameter:  
0.3 mm (0.01 in) to 1.5 mm (0.06 in)  
Cord length: 1 m (3.28 ft)

## Test Fixtures for SMDs

### 4-TERMINAL PROBE 9500-10



Measurable range: DC to 200 kHz  
Measurable terminal diameter:  
0.3 mm (0.01 in) to 2 mm (0.08 in)  
Cord length: 1 m (3.28 ft)

### SMD TEST FIXTURE 9263



Measurable range: DC to 8 MHz  
For SMD with electrodes on side  
Measurable sample sizes:  
0805 to 2220 (EIA)  
2012 to 5750 (JIS)  
Direct connection type

### SMD TEST FIXTURE 9699



Measurable range: DC to 120 MHz  
For SMD with electrodes on bottom  
Measurable sample sizes:  
0608 to 0805 (EIA)  
1608 to 2012 (JIS)  
Direct connection type

### SMD TEST FIXTURE 9677



Measurable range: DC to 120 MHz  
For SMD with electrodes on side  
Measurable sample sizes:  
0402 to 0603 (EIA)  
1005 to 1608 (JIS)  
Direct connection type

### SMD TEST FIXTURE IM9110\*



Measurable range: DC to 1 MHz  
For SMD with electrodes on side  
Measurable sample sizes:  
008004 (EIA), 0201 (JIS)  
Please contact Hioki for information  
about other sizes.  
Direct connection type

### SMD TEST FIXTURE IM9100\*



Measurable range: DC to 8 MHz  
For SMD with electrodes on bottom  
Measurable sample sizes:  
01005 to 0402 (EIA)  
0402 to 1005 (JIS)  
Direct connection type

### PINCHER PROBE L2001\*



Measurable range: DC to 8 MHz  
Replaceable tips  
Measurable sample sizes:  
IM9901: 0603 to 2220 (EIA)  
1608 to 5750 (JIS)  
IM9902: 0201 to 2220 (EIA)  
0603 to 5750 (JIS)  
Cord length: Approx. 730 mm (28.74 in)  
\*Ships standard with one set of IM9901

### Options for L2001 Replaceable contact tips

#### CONTACT TIPS IM9901











#### CONTACT TIPS IM9902

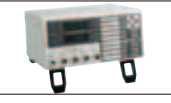

\*For more information, please see individual product catalogs.

## LCR Meter Series Full Product Lineup

Model (Order Code)	Measurement speed (Basic value)		Measurement frequency range																
	Applications and measurement object																		
LCR METER IM3536		1ms	DC	4Hz														8MHz	General-purpose LCR meter up to 8 MHz Measure electronic components such as capacitors and inductors
LCR METER IM3533		2ms	DC	1MHz														200kHz	Capable of special measurements of transformers including turn ratio and mutual inductance IM3533-01: High-end model of the IM3523 and IM3533 with sweep measurement
LCR METER IM3523		2ms	DC	40Hz														200kHz	Extremely cost-effective model suitable for production lines including integration into automated machinery For C-D and ESR measurement of electrolytic capacitors and L-Q and Rdc measurement of inductors
LCR HiTESTER 3511-50		5ms																	Compact LCR meter with single function For production lines of aluminum electrolytic capacitors
C METER 3506-10		1.5ms																	C meter for low-capacity capacitors For production of MLCC and film capacitors
C HiTESTER 3504		2ms																	C meter for large-capacity MLCCs For sorting machines of large-capacity MLCCs (3504-50/60) and taping machines (3504-40)
IMPEDANCE ANALYZER IM7580A		0.5ms																	High-frequency measurement up to 300 MHz Ideal for production lines of ferrite beads and inductors
IMPEDANCE ANALYZER IM3570		0.5ms	DC	4Hz															LCR meter integrated with impedance analyzer Measure the frequency characteristics of piezo-electric devices, functional polymer capacitors, and power inductors
CHEMICAL IMPEDANCE ANALYZER IM3590		2ms	DC	1MHz															Supports LCR impedance measurements for Cole-Cole plots and equivalent-circuit analyses Measure electrochemical components, materials, batteries, and electric double-layer capacitors (EDLCs)

Note: Company names and Product names appearing in this catalog are trademarks or registered trademarks of various companies.

**HIOKI**  
HIOKI E. E. CORPORATION

DISTRIBUTED BY

Test Equipment Depot - 800.517.8431 - 99 Washington Street Melrose, MA 02176

TestEquipmentDepot.com