



**Test Equipment
Depot**
1-800-517-8431

99 Washington Street
Melrose, MA 02176
Phone 781-665-1400
Toll Free 1-800-517-8431

HIOKI

Visit us at www.TestEquipmentDepot.com

DIGITAL MULTIMETER DT4200 Series



Super Fast Response Rate and Safety Features Take Professional Testing to a Higher Level

High-End Models
Standard Models
Pocket Models

DT4281 / 4282
DT4251 / 4252 / 4253
DT4221 / 4222



ISO 9001
JMI-0216



ISO 14001
JQA-E-90091



HIOKI company overview, new products, environmental considerations and other information are available on our website.



Guaranteed for 3 years

DMMs For
Every Application

www.valuetronics.com

To Be The World's Fastest

DT4280/4250/4220 Series Features



The world's fastest DMM engine

In striving to offer the world's fastest measurement response in a DMM, the custom ASIC is developed in-house at Hioki, allowing us to embody the concentration of our technological strengths.



Nearly 0.6 s measurement response

Get a stable reading in about half a second from probe contact to display. See for yourself how fast it really is with the DT4250 and DT4220 Series.

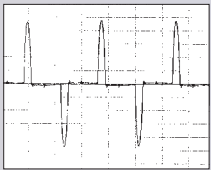

Measures distorted current values

Absolutely Reliable True RMS

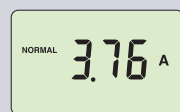

Signal measured with averaging method



Signal measured with true rms method

The True RMS method provides the best accuracy.



Operator Safety

Safety is our priority. Terminal shutters in the DT4280 Series and other safety features assist in preventing accidents to the operator and damage to the instrument.



Shock and Dust Resistant

Protective rubber edges around the DMM endure drop from 1 meter onto a concrete floor and a precise design shields against dusty environments.



The DT4280 series is rated IP40.



Bright Backlight

The super bright LED backlight is indispensable in dark locations to clearly capture the measured values. (Red LED backlight available only in the DT4280 series)



High-End

High accuracy, additional function enhancements, broad range of measurement items

■ CAT III 1000V/ CAT IV 600V

DT4281/4282 Measurement Parameters

DC voltage	AC voltage	DCV + ACV	Range	Resistance	Capacitance	Frequency	Temperature

Continuity	Diode



630 Hz low-pass filter cuts harmonics - ideal for measuring inverter systems.



Red display warns of over-range



Internal memory stores up to 400 data points



Transfer data to a PC **USB 2.0**

Requires optional DT4900-01 Communication Package



DT4281

Safety First / For electrical work and power line applications



clamp

No 'A' terminal

Includes clamp sensor connection terminals

The current terminal is intentionally excluded, for those who need the extra safety of a current measurement clamp.



DT4282

General Purpose / For laboratories and R&D

DCA	ACA	Conductance

6A and 10A ranges

Includes conductance measurement

For those with diverse measurement needs

Standard

Choose from 3 models according to your measurement situation

■ CAT III 1000V/ CAT IV 600V

DT4251/4252/4253 Measurement Parameters

DC voltage	AC voltage	Resistance	Capacitance	Frequency	Continuity	Diode



15 times better noise immunity over former models
Useable in noisy environments

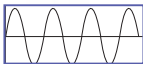

Noise suppression with 100/500 Hz low-pass filter



Red LED indicates over-range and aids in continuity checking

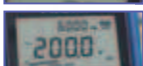

Dual-value and bar graph displays



Transfer data to a PC **USB 2.0**

Requires optional DT4900-01 Communication Package



DT4251

Safety First / For electrical work and power line applications

Clamp	Voltage Detector

No 'A' terminal

Includes clamp sensor connection terminals and voltage detector

For those who need the extra safety



DT4252

General Purpose / For laboratories and R&D

DCA	ACA	High precision mV range

High precision 600mV range
6A and 10A ranges

For those with diverse measurement needs



DT4253

Specialized applications / Instrumentation, air conditioning and gas equipment

Temperature	µA mA Range	Clamp

60µA to 60mA range

Includes temperature measurement

For HVAC, instrumentation and temperature testing

Pocket

Quick, simple and safe testing in a palm-sized unit

■ CAT III 600V/ CAT IV 300V

DT4221/4222 Measurement Parameters

DC voltage	AC voltage	Frequency	Continuity

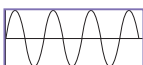

Noise suppression with 100/500 Hz low-pass filter



Runs on one AAA battery, for simple replacement

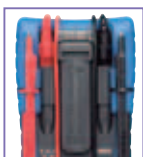

Effortless operation with probe storage clips behind the instrument



DT4221

Safety First / For electrical work and power line applications



Voltage Detector

No current or resistance functions

Auto DC/AC detection

Includes voltage detector

Ideal for safe voltage measurements



DT4222

General Purpose / For laboratories and electrical testing

Capacitance	Diode	Resistance

Resistance

Capacitance

Includes diode check

For those with diverse measurement needs

DT4200 Series Basic Comparison

	DT4281	DT4282	DT4251	DT4252	DT4253	DT4221	DT4222
Basic Characteristics							
True RMS	Yes		Yes			Yes	
DCV basic accuracy	±0.025 %rdg. ±2 dgt.		±0.3 %rdg. ±5 dgt.			±0.5 %rdg. ±5 dgt.	
Measurement items (Typical ranges are indicated; may not reflect maximum or minimum measurable signal)							
DC voltage	60mV to 1000V		600mV to 1000V			600mV to 600V	
AC voltage	60mV to 1000V		6V to 1000V			6V to 600V	
DCV + ACV	6V to 1000V		n/a			n/a	
DCA current	600µA to 600mA	600µA to 10A	n/a	6A to 10A	60µA to 60mA	n/a	
ACA current	600µA to 600mA	600µA to 10A	n/a	6A to 10A	n/a	n/a	
AC clamp	10A to 1000A	n/a	10A to 1000A	n/a	10A to 1000A	n/a	
Resistance	60Ω to 600MΩ		600Ω to 60MΩ			n/a	600Ω to 60MΩ
Temperature	-40°C to 800°C		n/a	n/a	-40°C to 400°C	n/a	
Capacitance	1nF to 100mF		1µF to 10mF			n/a	1µF to 10mF
Frequency	99Hz to 500kHz		99Hz to 99kHz			99Hz to 9.9kHz	
Continuity check	Yes		Yes			Yes	
Diode check	Yes		Yes			n/a	Yes
Conductance	n/a	Yes	n/a			n/a	
Voltage detection	n/a		Yes	n/a	n/a	Yes	n/a
Additional Functions							
AUTO AC/DCV	n/a		Yes	n/a	Yes	Yes	n/a
Peak measurement	DC/AC		n/a			n/a	
Low-pass filter	Analog filter Cut-off : 630 Hz		Digital filter Pass-band : 100Hz/500Hz			Digital filter Pass-band : 100Hz/500Hz	
Display update setting	Yes		n/a			n/a	
Hold display value	AUTO / MANUAL		AUTO / MANUAL			MANUAL	
Max/Min value display	Yes		Yes			n/a	
Relative display	Yes		Yes			Yes	
Decibel conversion	Yes		n/a			n/a	
Percentage conversion display	Yes		n/a	n/a	Yes	n/a	
Data storage							
Capacity	Max 400 data		n/a			n/a	
USB communication*1	Yes		Yes			n/a	
Operating time							
Continuous operating time	Approx. 100 hours*2		Approx. 130 hours			Approx. 40 hours	
Power supply	Alkaline (LR6) battery x4 / Manganese(R6P) battery x4		Alkaline (LR03) battery x4			Alkaline (LR03) battery x1	
Display							
Back light	Yes		Yes			Yes	
Dual display	Yes		Yes			n/a	
Bar graph display	n/a		Yes			Yes	
Safety							
Safety standard categories	CAT III 1000V/ CAT IV 600V		CAT III 1000V/ CAT IV 600V			CAT III 600V/ CAT IV 300V	
Mis-insertion prevention shutters	Yes		n/a			n/a	

*1. Requires optional DT4900-01 Communication Package

*2. When using four AA alkaline batteries

Glossary

Auto AC/DCV	Automatically detects and measures AC and DC voltage.
Peak measurement	After starting PEAK value measurement, check maximum and minimum instantaneous voltage and current values.
Low-pass filter	Cuts high frequency content to provide stable numerical values for measurement.
Display update setting	Reduces the display value update rate to stabilize measurements.
Hold display value	Manual: press the button to freeze the display. Auto: the display freezes automatically when the measurement value is stable.
Max/Min value display	Pressing the MAX/MIN button displays the maximum and minimum displayed measurement values.
Relative display	Pressing the REL button displays subsequent measurements as values relative to that displayed when the button was pressed.
Decibel conversion	Displays AC voltage measurements converted to decibel values (dbm/dbv)
Percentage conversion display	Displays 4 to 20 mA (or 0 to 20 mA) signals converted to 0 to 100% values. For the DT4253, only 4 to 20 mA.

Current Measurement Based Selection Guide

Why are there no current measurement terminals on some of the models?

Hioki's new digital multimeter series include models with **no directly accessible current measuring terminals**. These models reflect our mission to provide the highest level of safety in a DMM.

SAFE

- Voltage measurement ranges :: High input impedance measurements → Measures voltage
- Current measurement ranges :: Low input impedance measurements → Measures current

NOT SAFE

Current measurement ranges :: Low input impedance measurements → Voltage is measured by mistake

Accidentally measuring voltage with the low input impedance of a current measurement range may cause inadvertent breaker trip, short circuits, or fire hazards.

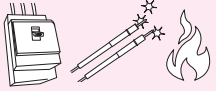

Solution DMMs that minimize the risk factor of a current measurement terminal.

Target Applications Voltage testing is the primary objective, with current testing using a clamp on sensor.

Quick Reference

	High-end		Standard			Pocket	
Usage / Model	DT4281	DT4282	DT4251	DT4252	DT4253	DT4221	DT4222
No current or resistance measurements						✓	
No current measurements			✓			✓	✓
High current measurements with clamp	✓		✓		✓		
mA measurements for instrumentation	✓				✓		
Need 6A and 10A		✓		✓			
Mis-insertion prevention shutters	✓	✓					

Size Comparison

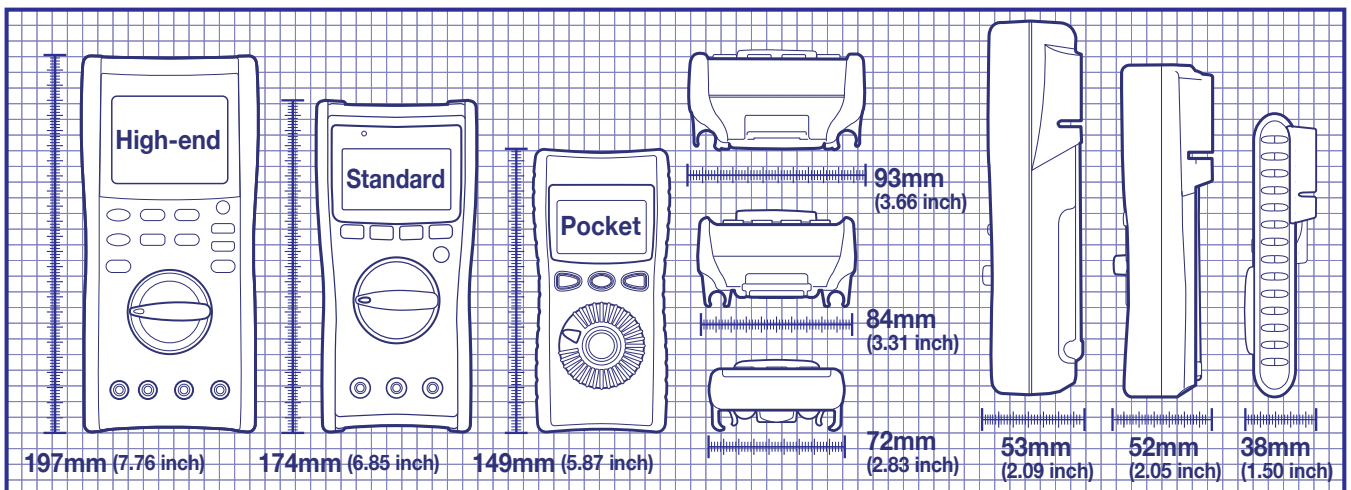

DT4281/DT4282

Display



Wide viewing angle display

Read measurements from any angle.



Easy to see even in dark worksites

White backlight ensures readable measurements even in dark locations.



Continuity check

Red screen indicates short circuits. Visual confirmation even in noisy worksites.

Hazard Prevention



When the 'A' range is selected*1 Only 'A' and COM terminals are accessible

When 'µA mA' range is selected Only 'µA mA' and COM terminals are accessible

*1. The 'A' range is only on the DT4282.

Terminal incorrect lead connections

Avoid incorrect function settings and terminal connections. When the rotary selector is turned to a current measurement position, only the corresponding current measurement terminals are accessible.



Over-range input indication

Input over 1000 V AC or DC is indicated by a red screen and a clear beep.

Data Management



Just press the MEM key to store data internally

To improve the efficiency of UPS maintenance, battery cell voltage can be stored on the spot. Save up to 400 data points.



Capturing measurement data

Using the optional DT4900-01 Communication Package, internally stored data can be displayed in graphs and stored in files at specified intervals. When connected to a PC while measuring, data can be displayed and stored in the PC in real time. Data saved in internal memory is stored in text format on the PC.

Handy Measurement Features

Optimized for inverter system measurements Low-pass filter 630Hz

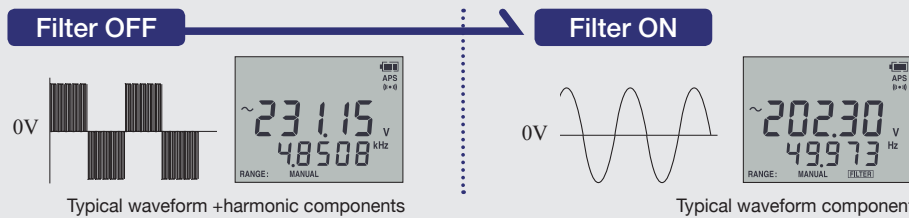

For inverter secondary output voltage measurements, harmonic contents are cut so that the fundamental waveform can be measured.

Ideal for checking ripple voltage in DC supply systems Peak measurement function & DC+AC voltage measurement

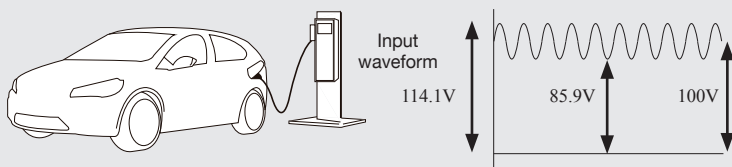

DC+AC V range

DC+AC measurement* > 100.49V
 +PEAK measurement > 114.10V
 -PEAK measurement > 85.90V

*DC+AC = $\sqrt{(AC)^2 + (DC)^2}$

Capture ripple voltage components on direct current signals.

Inspect burner systems DCµA range

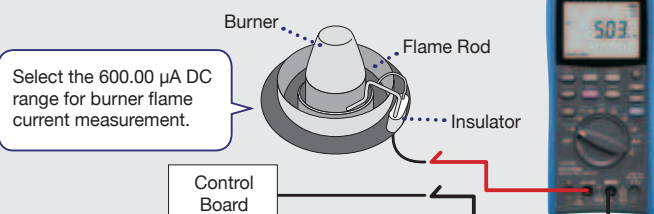

When a hand cannot be used AUTO Hold display value

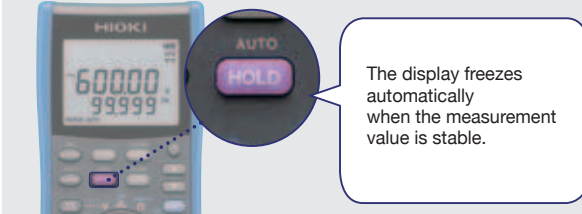

Accuracy Guaranteed for 1 Year @ 23 ± 5°C (73°F±41°F) , 80% RH or less (no condensation)

DC Voltage		
Range	Accuracy	Input Impedance
60.000 mV	±0.2 %rdg. ±25 dgt.	1GΩ or more
600.00 mV	±0.025 %rdg. ±5 dgt.	
6.0000 V	±0.025 %rdg. ±2 dgt.	11.0MΩ
60.000 V		10.3MΩ
600.0 V		10.2MΩ
1000.0 V		

AC Voltage								
Range	Accuracy							
	20 to 45Hz	45 to 65Hz	65 to 1kHz	1k to 10kHz	10k to 20kHz	20k to 100kHz		
60.000 mV	±1.3 %rdg.	±0.4 %rdg.	±0.6 %rdg.	±0.9 %rdg.	±1.5 %rdg.	±20 %rdg. ±80 dgt.		
600.00 mV	±60 dgt.	±40 dgt.	±40 dgt.	±40 dgt.	±40 dgt.	±8 %rdg. ±80 dgt.		
6.0000 V	±1 %rdg. ±60 dgt.	±0.2 %rdg. ±25 dgt.	±0.3 %rdg. ±25 dgt.	±0.4 %rdg. ±25 dgt.	±0.7 %rdg. ±40 dgt.	±3.5 %rdg. ±40 dgt.		
60.000 V	Undefined				Undefined	Undefined	Undefined	Undefined
600.0 V								
1000.0 V								

DCV + ACV Measurement							
Range	Accuracy						
	20 to 45Hz	45 to 65Hz	65 to 1kHz	1k to 10kHz	10k to 20kHz	20k to 100kHz	
6.0000 V	±1.2 %rdg. ±65 dgt.	±0.3 %rdg. ±30 dgt.	±0.4 %rdg. ±30 dgt.	±0.4 %rdg. ±30 dgt.	±1.5 %rdg. ±45 dgt.	±3.5 %rdg. ±125 dgt.	
60.000 V	Undefined			Undefined	Undefined	Undefined	Undefined
600.0 V							
1000.0 V							

Input impedance	1MΩ ± 4 %//100pF or less
Crest factor	3 or less (1.5 or less for the 1000.0V range)
Accuracy specification range	5% or more of each range With the filter ON, accuracy is defined only for frequencies 100Hz or less. Furthermore, 2% rdg. is added

DCA Measurement 6A, 10A range : DT4282 only			
Range	Accuracy / Display update : SLOW	Accuracy / Display update : NORMAL	Shunt Resistance
600.00 μA	±0.05 %rdg. ±5 dgt.	±0.05 %rdg. ±25 dgt.	101 Ω
6000.0 μA		±0.05 %rdg. ±5 dgt.	
60.000 mA		±0.15 %rdg. ±25 dgt.	
600.00 mA	±0.15 %rdg. ±5 dgt.	±0.15 %rdg. ±5 dgt.	1 Ω
6.0000 A	±0.2 %rdg. ±5 dgt.	±0.2 %rdg. ±25 dgt.	10m Ω
10.000 A		±0.2 %rdg. ±5 dgt.	

ACA Measurement 6A, 10A range : DT4282 only					
Range	Accuracy				
	20 to 45Hz	45 to 65Hz	65 to 1kHz	1k to 10kHz	10k to 20kHz
600.00 μA	±1.0 %rdg. ±20 dgt.	±0.6 %rdg. ±20 dgt.	±0.6 %rdg. ±20 dgt.	±2 %rdg. ±20 dgt.	±4 %rdg. ±20 dgt.
6000.0 μA	±1.0 %rdg. ±5 dgt.	±0.6 %rdg. ±5 dgt.	±0.6 %rdg. ±5 dgt.	±2 %rdg. ±5 dgt.	±4 %rdg. ±5 dgt.
60.000 mA	±1.0 %rdg. ±20 dgt.	±0.6 %rdg. ±20 dgt.	±0.6 %rdg. ±20 dgt.	±1 %rdg. ±20 dgt.	±2 %rdg. ±20 dgt.
600.00 mA	±1.0 %rdg. ±5 dgt.	±0.6 %rdg. ±5 dgt.	±0.6 %rdg. ±5 dgt.	±1.5 %rdg. ±10 dgt.	Undefined
6.0000 A	Undefined	±0.8 %rdg. ±20 dgt.	±0.8 %rdg. ±20 dgt.	Undefined	Undefined
10.000 A	Undefined	±0.8 %rdg. ±5 dgt.	±0.8 %rdg. ±5 dgt.	Undefined	Undefined

Shunt resistance	μA Range 101Ω/ mA Range 1Ω/ A Range 10mΩ
Crest factor	3 or less (Note that it applies to 1/2 of the range.)
Accuracy specification range	Accuracy is not defined for measurements below 5% of range

Continuity Check			
Range	Accuracy	Measurement Current	Open-terminal Voltage
600.0 Ω	±0.5 %rdg. ±5 dgt.	640 μA ±10%	2.5 V DC or less
Continuity threshold	20Ω (default)/50Ω/ 100Ω/ 500Ω		

Diode Check			
Range	Accuracy	Measurement Current	Open-terminal Voltage
3.600 V	±0.1 %rdg. ±5 dgt.	1.2 mA or less	DC4.5 V or less

Forward threshold	0.15V/ 0.5V (default)/1V/ 1.5V/ 2V/ 2.5V/ 3V If the reading is lower than the threshold during the forward connection, a buzzer sounds and the red backlight turns on.
-------------------	---

Peak Measurement (For AC V, DC V, DC+AC V, Clamp, DC μA, DC mA, DC A, AC μA, AC mA, AC A)		
Main measurement	Signal width	Accuracy
DCV	4ms or more (single)	±2.0 %rdg. ±40 dgt.
	1ms or more (repeated)	±2.0 %rdg. ±100 dgt.
Other than DCV	1ms or more (single)	±2.0 %rdg. ±40 dgt.
	250μs or more (repeated)	±2.0 %rdg. ±100 dgt.

Decibel Conversion Measurement : Standard impedance (dBm)	
4/8/16/32/50/75/93/110/125/135/150/200/250/300/500/600/800/900/1000/1200 Ω (default : 600 Ω)	

AC Clamp (AC Current) DT4281 only		
Range	Accuracy	
	40 to 65Hz	65 to 1kHz
10.00 A	±0.6 %rdg. ±2 dgt.	±0.9 %rdg. ±2 dgt.
20.00 A	±0.6 %rdg. ±4 dgt.	±0.9 %rdg. ±4 dgt.
50.00 A	±0.6 %rdg. ±10 dgt.	±0.9 %rdg. ±10 dgt.
100.0 A	±0.6 %rdg. ±2 dgt.	±0.9 %rdg. ±2 dgt.
200.0 A	±0.6 %rdg. ±4 dgt.	±0.9 %rdg. ±4 dgt.
500.0 A	±0.6 %rdg. ±10 dgt.	±0.9 %rdg. ±10 dgt.
1000 A	±0.6 %rdg. ±2 dgt.	±0.9 %rdg. ±2 dgt.

The optional 9010-50, 9018-50, or 9132-50 CLAMP ON PROBE is used.
Accuracy does not include the error of the clamp-on probe.
Crest factor 3 or less
Accuracy is not defined for measurements below 15% of range

Resistance Measurement			
Range	Accuracy	Measurement Current	Open-terminal Voltage
60.000 Ω	±0.3 %rdg. ±20 dgt.	640 μA ±10%	DC2.5 V or less
600.00 Ω	±0.03 %rdg. ±10 dgt.		
6.0000 kΩ	±0.03 %rdg. ±2 dgt.	96 μA ±10%	
60.000 kΩ		9.3 μA ±10%	
600.00 kΩ		0.96 μA ±10%	
6.0000 MΩ	±0.15 %rdg. ±4 dgt.	96 nA ±10%	
60.00 MΩ	±1.5 %rdg. ±10 dgt.		
600.0 MΩ	±3.0 %rdg. ±20 dgt.		
	±8.0 %rdg. ±20 dgt.		

Conductance (nS) DT4282 only			
Range	Accuracy	Measurement Current	Open-circuit Voltage
600.00 nS	±1.5 %rdg. ±10 dgt.	96 nA ±10%	DC2.5 V or less

Accuracy is defined for humidity 60% RH or less. Accuracy is defined for the range 20nS or more. In the case of 300 nS or more, ±20 dgt. is added

Capacitance Measurement			
Range	Accuracy	Measurement Current	Open-circuit Voltage
1.000 nF	±1.0 %rdg. ±20 dgt.	32 μA ±10%	DC2.5 V or less
10.00 nF	±1.0 %rdg. ±5 dgt.		
100.0 nF			
1.000 μF	±2.0 %rdg. ±5 dgt.	680 μA ±20%	DC3.1 V or less
10.00 μF			
100.0 μF			DC2.1 V or less
1.000 mF			
10.00 mF			
100.0 mF	±2.0 %rdg. ±20 dgt.		

Temperature		
Thermocouple Type	Range	Accuracy
K	-40.0 to 800.0 °C (-40.0 to 1472.0°F)	±0.5 %rdg. ±3 °C (5.4°F)

The optional K Thermocouple DT4910 is used. Accuracy does not include the error of the K thermocouple

Frequency (For AC V, DC+AC V, AC μA, AC mA, AC A)	
Range	Accuracy
99.999 Hz	±0.005 %rdg. +3 dgt.
999.99 Hz	
9.9999 kHz	
99.999 kHz	±0.005 %rdg. +3 dgt.
500.00 kHz	

Measurement range	0.5Hz or more ([---] is displayed when frequency is less than 0.5Hz)
Pulse width	1μs or more (DUTY ratio is 50%)
With the filter ON, accuracy is defined only for frequencies 100Hz or less. (For ACV, DC+ACV)	

General Specifications

Safety	
Maximum rated voltage between input terminals and ground	CAT III 1000V/ CAT IV 600V
Maximum rated voltage between terminals	Between the V and COM terminals : 1000 V DC/AC
Maximum rated current between terminals	Between the mA and COM terminals : 600mA DC/600mA AC Between the A and COM terminals : 10A DC/10A AC

Durability	
Drop proof	YES
Operating temperature and humidity*1	-15°C to 55°C
Storage temperature and humidity*2	-30°C to 60°C
Dielectric strength	AC8.54kV (Between all input terminals and case)
Applicable standards	Safety : EN61010, EMC: EN61326, Waterproof and dustproof: IP40

*1 : -15°C to 55°C (5°F to 131°F), Up to 40°C (104°F): at 80%RH or less (non-condensating),
40°C to 45°C (104°F to 113°F): at 60%RH or less (non-condensating),
45°C to 55°C (113°F to 131°F): at 50%RH or less (non-condensating)

*2 : 80%RH or less (non-condensating)

Dimensions/Mass	
93mm(W)×197mm(H)×53mm(D)(3.66"W 7.76"H 2.09"D Inch) / 650g (including batteries) (23 oz.)	

Accessories

TEST LEAD L9207-10 , Instruction Manual, LR6 alkaline battery×4

DT4251/DT4252/DT4253

Display



Bar graph refreshes 40 times/second. Acts just like an analog meter to intuitively expose changes in the measured signal.
Voltage and current are conveniently displayed simultaneously when either is being measured.

Dual-value and bar graph displays



Continuity check



Wide viewing angle display

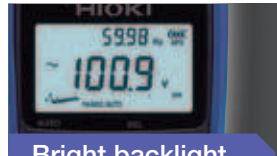

Bright backlight

The red LED serves for continuity checking. Read measurements from any angle. White backlight ensures easy reading of measured values even in dark worksites.

Hazard Prevention



The A terminal is omitted to enhance safety *1

Omitting the unused current measurement terminal helps to avoid operator faults such as short circuits, breaker tripping and fires.
*1 : DT4251 Only



Over-range input indication

The red LED indicates excessive input voltage and current.

Data Management



View real-time measurements on a PC

Use the optional DT4900-01 Communication Package to display real-time measurement values on a PC.



Optical communications link

The optical link electrically isolates the multimeter from the PC.



Save acquired data to files

Displayed data can be saved to a file on the PC, and specified intervals can then be displayed graphically.

Handy Measurement Features

Instrumentation signal percentage display

4-20 mA converted display

* DT4253 Only

Temperature

Pressure

Flow rate

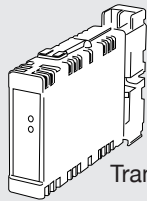

Transducer

4-20 mA converted display

With 4 mA output ▶ 0%
With 20 mA output ▶ 100%
Displays converted value as percentage



Check measured and converted values with a glance on the dual display.

Auto-detect function for mixed DC and AC voltage measurements

AC/DC auto-detect function

* DT4251,DT4253 Only

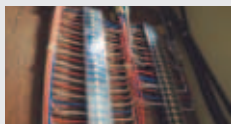

For sites requiring both AC and DC measurements.



Measuring DC voltage



Measuring AC voltage

Avoids measurement mistakes at sites with both AC and DC voltage, by eliminating the need to turn the selector.

Inspect burner systems

DC μ A range

* DT4253 Only

Select the 600.00 μ A DC range for burner flame current measurement.

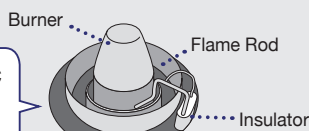

Control Board



When a hand cannot be used

AUTO Hold display value



The display freezes automatically when the measurement value is stable.



Accuracy Guaranteed for 1 Year @ 23 ± 5°C (73°F±41°F) , 80% RH or less (no condensation)

DC Voltage High precision 600mV range : DT4252 only		
Range	Accuracy	Input Impedance
High precision 600mV range	±0.2 %rdg. ±5 dgt.	10.2MΩ ± 1.5 %
600.0 mV	±0.5 %rdg. ±5 dgt.	11.2MΩ ± 2.0 %
6.000 V	±0.3 %rdg. ±5 dgt.	
60.00 V		10.3MΩ ± 2.0 %
600.0 V		10.2MΩ ± 1.5 %
1000 V		

AC Voltage			
Range	Accuracy		Input Impedance
	40 to 500Hz	500 or more to 1kHz	
6.000V	±0.9 %rdg. ±3 dgt.	±1.8 %rdg. ±3 dgt.	11.2MΩ ± 2.0%/100pF or less
60.00V			10.3MΩ ± 2.0%/100pF or less
600.0V			10.2MΩ ± 1.5%/100pF or less
1000V			

AUTO V (Identification) DT4251,DT4253 only			
Range	Accuracy		Input Impedance
	DC,40 to 500Hz	500 or more to 1kHz	
600.0 V	±2.0 %rdg. ±3 dgt.	±4.0 %rdg. ±3 dgt.	900kΩ ± 20%

Crest factor	3 up to 4000 counts and reduces linearly to 2 at 6000 counts.		
Accuracy specification range	For ACV, minimum 1% of range; add ±5 dgt. when measuring at or below 5% of range With the filter ON, the accuracy is not specified in 100Hz/500Hz or more		

DCA Measurement 60uA, 60mA range: DT4253 only / 6A, 10A range : DT4252 only		
Range	Accuracy	Input Impedance
60.00 μA	±0.8 %rdg. ±5 dgt.	1 kΩ±5 %
600.0 μA		15 Ω±40 %
6.000 mA		
60.00 mA	±0.9 %rdg. ±5 dgt.	35 mΩ±30 %
6.000 A		
10.00 A		

ACA Measurement DT4252 only			
Range	Accuracy		Input Impedance
	40 to 500Hz	500 or more to 1kHz	
6.000 A	±1.4 %rdg. ±3 dgt.	±1.8 %rdg. ±3 dgt.	35 mΩ±30 %
10.00 A			

Crest factor	3 up to 4000 counts and reduces linearly to 2 at 6000 counts.		
Accuracy specification range	Minimum 1% of range; add ±5 dgt. when measuring 300 counts or less		

Electric Charge DT4251 only	
Detection voltage range	Detection Target Frequency
80 VAC to 600 VAC	50Hz / 60Hz

During voltage detection, a continuous buzzer sounds and the red LED lights up.

Continuity Check			
Range	Accuracy	Measurement Current	Open-terminal Voltage
600.0 Ω	±0.7 %rdg. ±5 dgt.	Approx. 200 μA	DC1.8 V or less
Continuity ON threshold	Approx. 25Ω or less (continuous buzzer sound, red LED lights)		
Continuity OFF threshold	Approx.245Ω or more		

Diode Check			
Range	Accuracy	Measurement Current	Open-terminal Voltage
1.500 V	±0.5 %rdg. ±5 dgt.	Approx. 0.5 mA	DC5.0 V or less

Forward threshold Buzzer sounds intermittently at 0.15V to 1.5V, the red LED flashes

AC Clamp (AC Current) DT4251,DT4253 only	
Range	Accuracy
	40 to 1kHz
10.00 A	±0.9 %rdg. ±3 dgt.
20.00 A	
50.0 A	
100.0 A	
200.0 A	
500 A	
1000 A	

The optional 9010-50, 9018-50, or 9132-50 CLAMP ON PROBE is used.
Accuracy does not include the error of the clamp-on probe.

Crest factor	3 or less
Accuracy specification range	Minimum 1% of range; add ±5 dgt. when measuring at or below 5% of range

Resistance Measurement			
Range	Accuracy	Measurement Current	Open-terminal Voltage
600.0 Ω	±0.7 %rdg. ±5 dgt.	Approx. 200 μA	1.8 V DC or less
6.000 kΩ		Approx. 100 μA	
60.00 kΩ		Approx. 10 μA	
600.0 kΩ		Approx. 1 μA	
6.000 MΩ		±0.9 %rdg. ±5 dgt.	
60.00 MΩ	±1.5 %rdg. ±5 dgt.	Approx. 10 nA	

Accuracy guarantee condition After zero adjustment has been performed

Capacitance Measurement			
Range	Accuracy	Measurement Current	Open-circuit Voltage
1.000 μF	±1.9 %rdg. ±5 dgt.	Approx. 10n/100n/1 μA	1.8 V DC or less
10.00 μF		Approx. 100n/1μ/10 μA	
100.0 μF		Approx. 1μ/10μ/100 μA	
1.000 mF		Approx. 10μ/100μ/200 μA	
10.00 mF		±5.0 %rdg. ±20 dgt.	

Temperature DT4253 only		
Thermocouple Type	Range	Accuracy
K	-40.0 to 400.0 °C	±0.5 %rdg. ±2 °C

The optional K Thermocouple DT4910 is used. Accuracy does not include the error of the K thermocouple

Frequency	
Range	Accuracy
99.99 Hz	±0.1 %rdg. +1 dgt.
999.9 Hz	
9.999 kHz	
99.99 kHz (V AC Only)	

General Specifications

Safety	
Maximum rated voltage between input terminals and ground	CAT III 1000V / CAT IV 600V
Maximum rated voltage between terminals	Between the V and COM terminals : 1000 V DC/AC
Maximum rated current between terminals	Between the A and COM terminals : 10A DC/10A AC (DT4252 Only) Between the mA, mAand COM terminals : 60mA DC (DT4253 Only)

Durability	
Drop proof	YES
Operating temperature and humidity*1	-10°C to 50°C
Storage temperature and humidity*2	-30°C to 60°C
Dielectric strength	AC8.54kV (Between all input terminals and case)
Applicable standards	Safety : EN61010, EMC: EN61326, Waterproof and dustproof: IP42

*1 : -10°C to 50°C (14°F to 122°F), Up to 40°C (104°F): at 80%RH or less (non-condensing),
40°C to 45°C (104°F to 113°F): at 60%RH or less (non-condensing),
45°C to 50°C (113°F to 122°F): at 50%RH or less (non-condensing)

*2 : 80%RH or less (non-condensing)

Dimensions/Mass	
84mm(W)×174mm(H)×52mm(D)(3.31"×W 6.85"×H 2.05"D)	
390g (including batteries and holster) (13.8 oz.)	

Accessories

TEST LEAD L9207-10 / Instruction Manual / LR03 Alkaline battery×4
Holster (attached to the instrument, with a test lead holder)

DT4221/DT4222

Display



Wide viewing angle display

Read measurements from any angle.

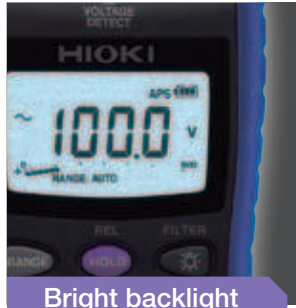

Bright backlight

White backlight ensures easy reading of measured values even in dark worksites.

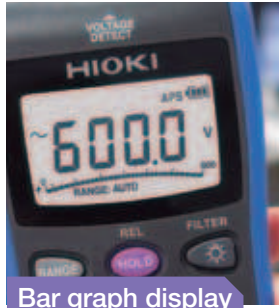

Bar graph display

Bar graph refreshes 40 times/second. Acts just like an analog meter to intuitively expose changes in the measured signal.

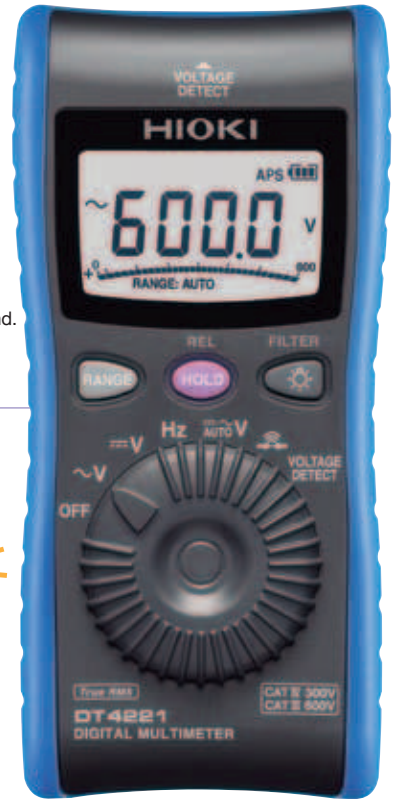

Hazard Prevention



The A terminal is omitted to enhance safety

Omitting the unused current measurement terminal helps to avoid operator faults such as short circuits, breaker tripping and fires.

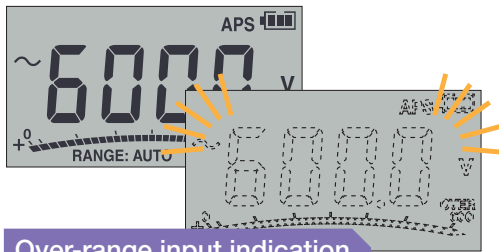

Over-range input indication

The screen flashes to indicate input overload and over-range conditions.

Designed for Effortless Handling



Compact for convenient portability

Small, light, and fits easily in a pocket.



Test leads plug into the rear

The display is not obscured by the leads when measuring.



Test lead storage

Just wrap the leads and clip the probes at the back. Resume operation smoothly without tangled leads.



Operates on one battery

Runs on one alkaline battery. Battery replacement is a snap.

Handy Measurement Features

Detects electricity just by touching a wire with the meter

Electric charge

* DT4221 only

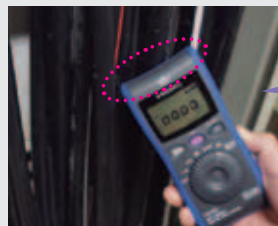
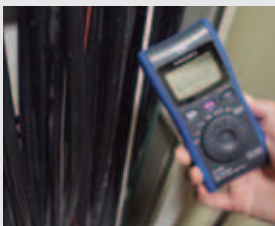

Beep

Detects energized conductors just by touching them with the top of the meter. A beep indicates an energized conductor.

Auto-detect function for mixed DC and AC voltage measurements

AC/DC auto-detect function

DT4221 only

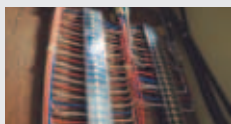

For sites requiring both AC and DC measurements.

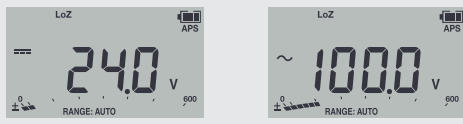

Measuring DC voltage

Measuring AC voltage

Avoids measurement mistakes at sites with both AC and DC voltage by eliminating the need to turn the selector.

Accuracy Guaranteed for 1 Year @ 23 ± 5°C (73°F±41°F) , 80% RH or less (no condensation)

DC Voltage		
Range	Accuracy	Input Impedance
600.0 mV	±0.5 %rdg. ±5 dgt.	11.2MΩ ± 2.0 %
6.000 V		
60.00 V		
600.0 V		
600.0 V		10.3MΩ ± 2.0 %
		10.2MΩ ± 1.5 %

AC Voltage			
Range	Accuracy		Input Impedance
	40 to 500Hz	500 or more to 1kHz	
6.000V	±1.0 %rdg. ±3 dgt.	±2.5 %rdg. ±3 dgt.	11.2MΩ ± 2.0%/100pF or less
60.00V		±2.0 %rdg. ±3 dgt.	10.3MΩ ± 2.0 %/100pF or less
600.0V			10.2MΩ ± 1.5 %/100pF or less

Crest factor 3 up to 4000 counts and reduces linearly to 2 at 6000 counts.
 Accuracy specification range For ACV, minimum 1% of range; add ±5 dgt. when measuring at or below 5% of range
 With the filter ON,the accuracy is not specified in 100Hz/500Hz or more

AUTO V (Identification) DT4221 only			
Range	Accuracy		Input Impedance
	DC,40 to 500Hz	500 or more to 1kHz	
600.0 V	±2.0 %rdg. ±3 dgt.	±4.0 %rdg. ±3 dgt.	900kΩ ± 20 %

Crest factor 3 up to 4000 counts and reduces linearly to 2 at 6000 counts.
 Accuracy specification range For ACV, minimum 1% of range; add ±5 dgt. when measuring at or below 5% of range
 With the filter ON,the accuracy is not specified in 100Hz/500Hz or more

Electric Charge DT4221 only	
Detection Voltage Range	Detection Target Frequency
80 V AC to 600 V AC	50Hz / 60Hz

During voltage detection, a continuous buzzer sounds.

Continuity Check			
Range	Accuracy	Measurement Current	Open-terminal Voltage
600.0 Ω	±1.0 %rdg. ±5 dgt.	Approx. 200 μA	DC1.8 V or less
Continuity ON threshold	Approx. 25Ω or less (continuous buzzer sound)		
Continuity OFF threshold	Approx.245Ω or more		

Diode Check DT4222 only			
Range	Accuracy	Measurement Current	Open-terminal Voltage
1.500 V	±0.9 %rdg. ±5 dgt.	Approx. 0.5 mA	DC2.5 V or less
Forward threshold	Buzzer sounds intermittently at 0.15V to 1.5V		

Resistance Measurement			DT4222 only
Range	Accuracy	Measurement Current	Open-terminal Voltage
600.0 Ω	±0.9 %rdg. ±5 dgt.	Approx. 200 μA	1.8 V DC or less
6.000 kΩ		Approx. 100 μA	
60.00 kΩ		Approx. 10 μA	
600.0 kΩ		Approx. 1 μA	
6.000 MΩ		Approx. 100 nA	
60.00 MΩ	±1.5 %rdg. ±5 dgt.	Approx. 10 nA	

Accuracy guarantee condition After zero adjustment has been performed

Capacitance Measurement			DT4222 only
Range	Accuracy	Measurement Current	Open-terminal Voltage
1.000 μF	±1.9 %rdg. ±5 dgt.	Approx. 10n/100n/1 μA	1.8 V DC or less
10.00 μF		Approx. 100n/1μ/10 μA	
100.0 μF		Approx. 1μ/10μ/100 μA	
1.000 mF	±5.0 %rdg. ±20 dgt.	Approx. 10μ/100μ/200 μA	
10.00 mF		Approx. 100μ/200 μA	

Frequency	
Range	Accuracy
99.99 Hz	±0.1 %rdg. +2 dgt.
999.9 Hz	
9.999 kHz	

General Specifications

Safety	
Maximum rated voltage between input terminals and ground	CAT III 600V/ CAT IV300V
Maximum rated voltage between terminals	Between the V and COM terminals : 600 V DC/AC

Durability	
Drop proof	YES
Operating temperature and humidity*1	-10°C to 50°C
Storage temperature and humidity*2	-30°C to 60°C
Dielectric strength	AC7.06kV (Between all input terminals and case)
Applicable standards	Safety : EN61010, EMC: EN61326, Waterproof and dustproof: IP42

*1 : -10°C to 50°C(14°F to 122°F), Up to 40°C(104°F): at 80%RH or less(non-condensating),
 40°C to 45°C (104°F to 113°F): at 60%RH or less(non-condensating),
 45°C to 50°C (113°F to 122°F): at 50%RH or less (non-condensating)
 *2 : 80%RH or less (non-condensating)

Dimensions/Mass	
72mm(W)×149mm(H)×38mm(D) (2.83"W 5.87"H 1.50"D)	
190g (including batteries and holster) (6.7 oz.)	

Accessories

TEST LEAD DT4911 / Instruction Manual / LR03 Alkaline battery×1
 Holster (attached to the instrument, with a test lead holder.)

Measurement categories (Overvoltage categories)

To ensure safe operation of measurement products, IEC 61010 establishes safety standards for various electrical environments, categorized as CAT II to CAT IV, and called measurement categories. These are defined as follows.

- CAT II : Primary electrical circuits in equipment connected to an AC electrical outlet by a power cord (portable tools, household appliances, etc.)
- CAT III : Primary electrical circuits of heavy equipment (fixed installations) connected directly to the distribution panel, and feeders from the distribution panel to outlets.
- CAT IV : The circuit from the service drop to the service entrance, and to the power meter and primary overcurrent protection device (distribution panel).

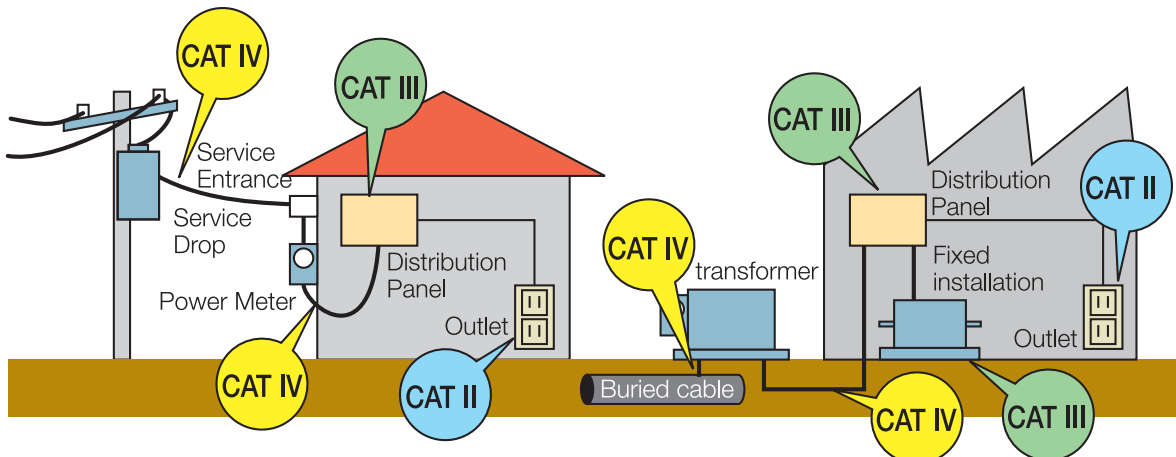

Higher-numbered categories correspond to electrical environments with greater momentary energy, so a measurement product designed for CAT III environments can endure greater momentary energy than one designed for CAT II .

L9207-10 / DT4911 Options

DT4280/DT4250 Series
(Bundled accessory)

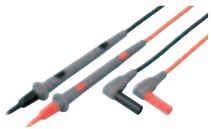

TEST LEAD L9207-10

Cable length 90 cm (2.9527 ft)
with one each red and black caps

- with cap
- CAT III 1000V/CAT IV 600V
- without cap
- CAT II 1000V

DT4220 Series
(Bundled accessory)



TEST LEAD DT4911

Cable length 54cm (1.77 ft)
with one each red and black caps

- with cap
- CAT IV 300V/ CAT III 600V
- without cap
- CAT II 600V

L4933 and L4934 probe tips
(at right) can be used
on L9207-10/DT4911 test leads.

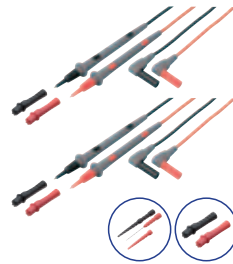

L4930 Options

Compatible DMMs:
DT4250 Series / DT4280 Series

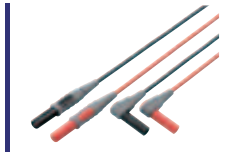



Length : 1.2m (3.937 ft)

CONNECTION CABLE L4930

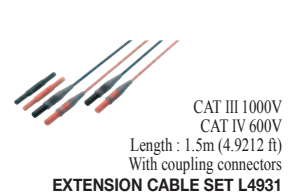
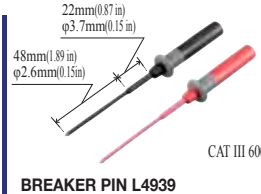
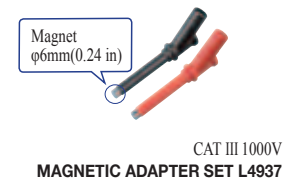
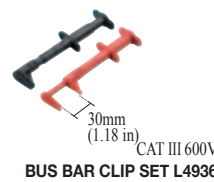
Probe tips (at right) can be
used on L4930 connection
cables.



AC CLAMP ON PROBES for DT4281, DT4251, DT4253 (Adapter 9704 required for connection)

Product appearance	 CAT III 600V	 CAT III 600V	 CAT III 600V
Model number	9010-50	9018-50	9132-50
Rated current	AC 10/20/50/100/200/500 A		AC 20/50/100/200/500/1000A
Amplitude accuracy (45 to 66Hz)	±2% rdg. ±1% f.s.	±1.5% rdg. ±0.1% f.s.	±3% rdg. ±0.2% f.s.
Frequency characteristics	40Hz to 1kHz:±6% rdg.	40Hz to 3kHz:±1% rdg.	40Hz to 1kHz:±1% rdg.
Output rate	AC 0.2 V f.s. (For each range)		
Max. circuit voltage	AC600 V (50/60Hz)		
Diameter	46mm (1.81 in) or less		55mm (2.17 in) or less, 80×20mm (3.15×0.79 in)
Dimensions, mass	78W×188H×35D mm (3.07W × 7.40H × 1.38D in) 420g (14.8oz.), cord length 3m (9.84 ft)		100W×224H×35D mm(3.94W ×8.82 H × 1.38D in) 600g(21.1oz.), cord length 3m(9.84 ft)

Adapter Model 9704 is required to connect
AC CLAMP ON PROBES 9010-50, 9018-50
and 9132-50 to the DT4281, DT4251, DT4253.



Other options

THERMOCOUPLES (K) DT4910

- Thermal junction form: exposed weld
- Sensor length: approx. 800 mm
- Measurement temperature range
-40 to 260°C (thermocouple)
-15 to 55°C (connector)
- Allowable tolerance:±2.5°C

COMMUNICATION PACKAGE (USB) DT4900-01

- Communication cable
- Communication adapter
- PC software
- Instruction manual
- OS: Windows 8, Windows 7, Vista (SP1 or later), XP (SP2 or later)

MAGNETIC STRAP Z5004

CARRYING CASE C0200
DT4220 Series

CARRYING CASE C0202
DT4250/DT4280 Series

CARRYING CASE C0201
DT4250 Series

Note: Company names and Product names appearing in this catalog are trademarks or registered trademarks of various companies.

HIOKI
HIOKI E. E. CORPORATION

DISTRIBUTED BY

Test Equipment Depot
1-800-517-8431

99 Washington Street
Melrose, MA 02176
Phone 781-665-1400
Toll Free 1-800-517-8431

Visit us at www.TestEquipmentDepot.com