

OPERATING AND SERVICE MANUAL

MODEL 6439B

DC POWER SUPPLY

MANUFACTURING CODE 6B

PART NUMBER 06439-90001

February, 1966.

TABLE OF CONTENTS

Section	Title	Page
I	GENERAL INFORMATION	1-1
	1-1. Description	1-1
	1-2. General	1-1
	1-4. Overload Protection	1-1
	1-7. Cooling	1-1
	1-9. Monitoring	1-1
	1-11. Output Terminals	1-1
	1-13. Instrument Identification	1-2
II	INSTALLATION	2-1
	2-1. Initial Inspection	2-1
	2-2. General	2-1
	2-4. Mechanical Check	2-1
	2-6. Electrical Check	2-1
	2-8. Installation Data	2-1
	2-9. General	2-1
	2-11. Location	2-1
	2-13. Power Requirements	2-2
	2-15. Power Cable	2-2
	2-18. Repackaging for Shipment.	2-2
III	OPERATING INSTRUCTIONS.	3-1
	3-1. Controls and Indicators	3-1
	3-3. Operation	3-1
	3-4. General	3-1
	3-6. Normal	3-1
	3-10. Connecting Load.	3-2
	3-14. Remote Sensing	3-2
	3-17. Remote Programming	3-3
	3-26. Parallel	3-5
	3-30. Series	3-5
	3-35. Auto-Tracking	3-6
	3-38. Operating Considerations.	3-7
	3-39. Pulse Loading	3-7
	3-41. Output Capacitance	3-7
	3-44. Negative Voltage Loading	3-7
	3-46. Negative Current Loading	3-7

TABLE OF CONTENTS (cont.)

Section	Title	Page
IV	PRINCIPLES OF OPERATION4-1
	4-1. Block Diagram Description4-1
	4-9. Circuit Description4-2
	4-10. AC Input4-2
	4-12. DC Output4-2
	4-14. Voltage Input4-2
	4-20. Current Input4-3
	4-24. Gating Circuit4-4
	4-27. Turn-On Circuit4-4
	4-29. SCR Regulator Control4-4
	4-37. SCR Regulator4-6
	4-42. Bias and Reference Circuit4-6
V	MAINTENANCE5-1
	5-1. General5-1
	5-3. Measurement Techniques5-1
	5-7. Performance Check5-2
	5-8. General5-2
	5-10. Rated Output and Meter Accuracy5-2
	5-13. Line Regulation5-3
	5-16. Load Regulation5-4
	5-19. Ripple and Noise5-4
	5-21. Transient Recovery Time5-5
	5-23. Additional Specification Check5-6
	5-24. Temperature Coefficient5-6
	5-27. Output Stability5-6
	5-30. Remote Programming5-7
	5-33. Output Impedance5-9
	5-35. Output Inductance5-9
	5-37. Cover Removal5-10
	5-39. Troubleshooting5-10
	5-40. General5-10
	5-42. Trouble Analysis5-10
	5-49. Repair and Replacement5-12
	5-51. Adjustments and Calibrations5-14
	5-52. General5-14
	5-54. Meter Zero5-14
	5-56. Voltmeter Tracking5-14
	5-58. Ammeter Tracking5-14
	5-60. Constant Voltage Programming Current5-15
	5-62. Zero Voltage Output5-15
	5-64. Constant Current Programming Current5-15

TABLE OF CONTENTS (cont.)

Section	Title	Page
5-66.	Zero Current Output	5-16
5-68.	Bias and Reference Line Regulation	5-16
5-70.	Line Imbalance	5-17
5-72.	Constant Current Load Regulation	5-18
VI	REPLACEABLE PARTS6-1
6-1.	Introduction6-1
6-4.	Ordering Information.6-1

MANUAL CHANGES

Model 6439B DC Power Supply
Manual HP Part Number 06439-90001

Make all corrections in the manual according to errata below, then check the following table for your power supply serial number and enter any listed change(s) in the manual.

SERIAL		MAKE CHANGES
Prefix	Number	
ALL	-	Errata
6B	0101 - 0250	1
6B	0251 - 0390	1, 2
6B	0391 - 0630	1, 2, 3
9D	0631 - 0720	1, 2, 3, 4
9D	0721 - 0795	1 thru 5
OK	0796 - 0855	1 thru 6
OK	0856 - 0870	1 thru 7
1145A	0871 - 0900	1 thru 8
1145A	0901 - 0995	1 thru 9
1145A	0996 - 1475	1 thru 10
1623A	1476 - 1535	1 thru 11
1644A	1536 - 1595	1 thru 12
1719A	1596 - 1735	1 thru 13
1821A	1736-1775	1 thru 14
1835A	1776-1855	1-15
1911A	1856-2228	1-16
1911A	2229-2235	1-17
2033A	2236-2380	1-18
2135A	2381-up	1-19

ERRATA:

Throughout the manual change Model from "6439A" to "6439B."

In Table 1-1 and in applicable portions of the specification checks in Section V, make the following changes:

LOAD REGULATION:

Constant Voltage. "Less than 120mV for no load to full load change in output current."

Constant Current. "Less than 150mA for no load to full load change in output voltage."

TRANSIENT RECOVERY TIME: "Less than 200 milliseconds is required for output voltage recovery to within 600mV of nominal output voltage following, etc."

TEMPERATURE COEFFICIENT:

Constant Voltage. "Less than 0.03% plus 10mV per degree Centigrade."

OUTPUT STABILITY:

Constant Voltage. "Less than 0.1% plus 30mV for 8 hours at constant temperature."

Add to Paragraphs 1-12 and 3-11 "The +, -, and GND front-panel banana jacks may be used for load less than 3 amp and for applications not requiring remote programming, remote sensing, auto-parallel, auto-series, and auto-tracking."

Change Paragraph 1-14 to read "Harrison power supplies are identified by a three-part designation. The first part is the model number, the second part is the manufacturing number/letter code, and the third part is the serial number. This manual applies to all Model 6439B power supplies with the same manufacturing code given in the title page. Change sheets are included in the manual to up-

date it to Model 6439B power supplies with different manufacturing codes."

In Figures 3-2 through 3-11, change the - and + terminals, located next to the -S and +S terminals, to A8 and A9, respectively.

Observe the following precaution when repairing the unit.

CAUTION

When replacing the SCRs, use a torque wrench. The SCR's must be installed with a torque of between 15 and 25 inch pounds. A torque below 15 inch pounds may result in a poor connection between the SCR and heat sink and the SCR will run too hot. If more than 25 pounds is used, the SCR could be broken.

Q10: Change to SS PNP Si., 2N2907A, Sprague, HP Part No. 1853-0099.

CHANGE 1:

In the replaceable parts table and on the schematic (where applicable) make the following changes:

C1: Should be fxd, elect .47 μ F 80Vdc, 192P4749R8, Sprague, HP Part No. 0160-0970.

C10: Delete C10.

C18,19: Add new capacitors (C18,C19) from chassis ground. Capacitors are fxd, paper .047 μ F 600Vdc, 160P47396, Sprague, HP Part No. 0160-0005.

C12,R21: Connect series combination of new capacitor and resistor across CR17 and CR18. C12 to anode of CR17 and R21 to cathode of CR17. R21 is fxd, comp 10 Ω \pm 5% 1W, GB-1005, A. B., HP Part No. 0689-1005. C12 is fxd, paper 0.1 μ F 400Vdc, 160P10494, Sprague, HP Part No. 0160-0013.

CR1,2: Connect anode of CR2 to cathode of CR1.
C8: Connect new capacitor (fxd, film .01 μ F 200Vdc, 192P10392, Sprague, HP Part No. 0160-0161) from gate to cathode of CR17.

C11: Delete original C11 and add new capacitor (fxd, paper .47 μ F 600Vdc, 161P47406, Sprague, HP Part No. 0160-2464) across AC input line between AC and ACC.

L2: Add inductor/filter, 09182 HP Part No. 9100-1834, in series with AC input line.

Q1-4, 6, 8, 9: Should be SS NPN Si., Type 2N3391, Sprague, HP Part No. 1854-0071.

CHANGE 2:

In the replaceable parts table and on the schematic (if applicable) make the following changes:

L2: Change Inductor-filter, 09182, HP Part No.

from 9100-1834 to 9100-2169.

VR3: Change to Zener Diode, 9.4V \pm 5%, 1N2163A, Semcor, HP Part No. 1902-0763.

CHANGE 3:

In the replaceable parts table and on the schematic, change R40 to fxd, ww 5.6K Ω \pm 3%, 3W, 3SX, W, L., HP Part No. 0812-0091.

CHANGE 4:

In replaceable parts list make the following changes:

CR17, 18: Change to HP Part No. 1884-0058.
Motor (fan): Add, HP Part No. 3140-0052.

CHANGE 5:

In the replaceable parts list and on the schematic, change R17 from selected to 3.9K, \pm 5%, $\frac{1}{2}$ W, HP Part No. 0686-3925.

CHANGE 6:

In the replaceable parts list, change L2, inductor-filter to HP Part No. 5080-7151.

ERRATA:

Add fan motor to schematic. Connect between AC and ACC in parallel with DS1 and R58.

CHANGE 7:

The following changes are made to allow the power supply to operate with Option 27 (208Vac input) or Option 28 (230Vac input).

In the replaceable parts table and on the schematic, make the following changes:

C7: Add C7, 1 μ F, 35V, HP Part No. 0180-0291.

C12: Change to .047 μ F, 600V, HP Part No. 0160-0005.

C26: Change to .22 μ F, 80V, HP Part No. 0160-2453.

CR24: Add CR24, Diode, S1, 200prv 200mW, HP Part No. 1901-0033.

R3 and R13: Change to 47.5k \pm 1%, 1/8W, HP Part No. 0757-0457.

R15: Change to 150k \pm 5%, $\frac{1}{2}$ W, HP Part No. 0686-1545.

R21: Change to 390 Ω \pm 5%, 2W, HP Part No. 0698-3633.

R32: Add R32, 12k, \pm 5%, $\frac{1}{2}$ W, HP Part No. 0686-1235.

R49: Add R49, 2k, \pm 5%, $\frac{1}{2}$ W, HP Part No. 0686-2025.

R56: Change to 270 Ω \pm 5%, $\frac{1}{2}$ W, HP Part No. 0686-2715.

T1: Change to HP Part No. 06439-80092.

T2: Change to HP Part No. 9100-2195.

T3: Change to HP Part No. 5080-7176.

C28: Change to 1 μ F, 200V, HP Part No. 0160-2465.

On the schematic diagram, the wiring of T1 and T2 and associated parts has been changed as shown in diagram.

On the schematic diagram, make the following changes:

In the SCR Regulator Control Circuit: Remove R56 (connected between C28 at the junction of R50, CR41-CR43) and replace with a short circuit. Reconnect new R56 (changed to 270 Ω) in series with the junction of CR41-CR43 (anodes) and the junction of C28, R50, CR44, and CR46.

In the Constant Voltage Input Circuit: Add C7 (1 μ F, 35V) in parallel with R18.

In the Constant Current Input Circuit: (1) Remove jumper and add R49 (2k) between C6 and R31; (2) Remove jumper and add R32 (12k) between base of Q8 and R43-A2 junction; (3) add CR24 between base of Q8 (cathode side) and A4.

208Vac (Option 27) and 230Vac (Option 28) operation.

If Option 27 or 28 is installed, change all references in the manual from 115Vac operation to the appropriate line voltage input.

In Chapter 2, add the following paragraph 2-19. CONNECTIONS FOR 208/230 VOLT OPERATION (Options 27 and 28, respectively)

T1 is rewired as follows:

Connection between terminals 1 and 3 is removed.

Connection between terminals 2 and 5 is removed.

Terminal 2 is connected to terminal 3.

For 208V (Option 27) only, the AC input connection to terminal 5 is removed and connected to terminal 4. Ensure that C18 (+) is connected to terminal 4, also.

T2 is rewired:

The AC input connection to the "115V" terminal is removed and connected to the "208V" or "230V" terminal as applicable.

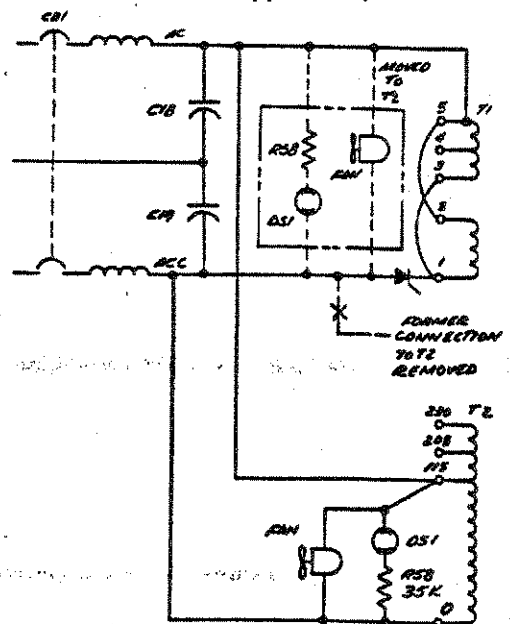

CHANGE 8:

The Serial Prefix of this unit has been changed to 1145A. This is the only change.

ERRATA:

The constant current resistance programming coefficient has been changed from 15 ohms/amp to 20 ohms/amp. In addition, the programming tolerance is now $\pm 20\%$. Make the following changes to reflect these new specifications:

Table 1-1: Change Remote Programming, Constant Current to 20 ohms per ampere.

Page 3-4, Paragraph 3-23:

Line 3 now reads "current) is 20 ohms per ampere...for each 20 ohms."

Line 5 now reads "...approximately 20% of 2.0mA at the..."

Page 5-15, Paragraph 5-65:

Step b: Change resistance to 300 ohms, 0.1%, $\frac{1}{2}$ W resistor.

Step e (Page 5-16): Adjust resistance box until voltmeter indicates 50 ± 10 mVdc.

Page 5-17, delete entire NOTE on bottom of page. Change waveform K (located on the apron of schematic 4-2) to read: "Must be < 0.1 V for line balance."

CHANGE 9:

In the replaceable parts table and on the schematic, change Resistor R46 to $10M\Omega \pm 5\%$, $\frac{1}{2}$ W, HP Part No. 0686-1065.

The standard colors for this instrument are now mint gray (for front and rear panels) and olive gray (for all top, bottom, side, and other external surfaces). Option X95 designates use of the former color scheme of light gray and blue gray. Option A85 designates use of a light gray front panel with olive gray used for all other external surfaces. New part numbers are shown at bottom.

CHANGE 10:

In the replaceable parts table and on the schematic, make the following changes:

R16: Change to $910\Omega \pm 5\%$ $\frac{1}{2}$ W, HP Part No. 0686-9115.

R59: Add R59, Var WW $500\Omega \pm 5\%$, HP Part No. 2100-0898.

R59 is added in the Q4 Gating Circuit as follows:

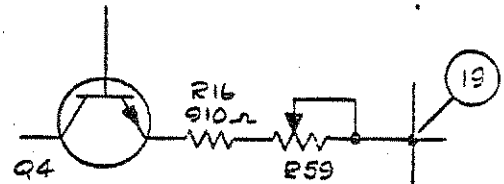

R59 allows the Gating circuit clamp voltage to be adjusted in order to prevent half-cycle operation. In the factory, R59 is adjusted as follows: with supply set for full output voltage and current rating at low line, adjust R59 for a forward bias across CR9 of 150mV to 200mV.

ERRATA:

In the parts list make the following HP Part No. changes:

CR19, 20: Change to 1901-0317

CR21-23: Change to 1901-0318

CB1: Change to 3105-0035

In parts list and on schematic change value of R17 to "factory selected for optimum performance".

In Table 1-1 and paragraph 5-33, change the Output Impedance specification to read as follows:

OUTPUT IMPEDANCE (TYPICAL): Approximated by a 10 milliohm resistance in series with a 1 microhenry inductance.

In the replaceable parts table, change the HP Part No. of pilot lamp DS1 to 1450-0566. The new pilot lamp is more reliable because its leads are crimped instead of being spot welded.

Add the following to the "Ordering Additional Manuals" paragraph in Section I: "Effective December 1975, extra manuals may be obtained by specifying Option 910 when ordering your instrument. The number of extra manuals depends upon the quantity of Option 910s ordered."

CHANGE 11:

Make the following changes to the parts list:

Delete C9, C10, and C11. Change C18 and C19 to 0.015 μ F, 250Vac, HP Part No. 0160-3969. Add

C30, 0.22 μ F, 250Vac, HP Part No. 0160-4259.

Add C31 and C32, 0.0047 μ F, 4kV, HP Part No.

0160-0543. Add resistor R60, $1M\Omega$, 5%, $\frac{1}{2}$ W,

HP Part No. 0686-1055. Capacitors C18, C19 and

C30, and resistor R60 are physically located on the RFI filter assembly.

DESCRIPTION.	HP PART NO.		
	STANDARD	OPTION A85	OPTION X95
Front Panel, Lettered	06439-60004	06439-60002	←
Cover	5000-9804	←	5000-6009
Rear Panel	06439-60005	←	06439-60001
Welding Assembly, Chassis	5060-7970	←	5060-6114

Electrically, they are connected as shown in the revised schematic of the ac input wiring shown below. Capacitors C31 and C32 are mounted on the output barrier strip and are connected from the positive output terminal to ground and from the negative output terminal to ground, respectively. Make these changes to the schematic in the manual. These new capacitors reduce the line leakage current for better safety and improve the RFI filtering.

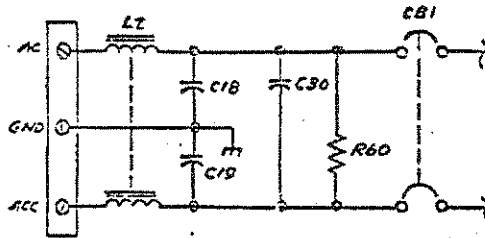

ERRATA:

In paragraph 2-16, change the second sentence to: This instrument should be used with a 3 conductor power cable (prepared by the user) that has #12 AWG wire.

CHANGE 12:

The three capacitors and one resistor in the revised RFI filter circuit shown in Change 11 have been relocated to a new RFI Assembly circuit board. The new circuit board assembly replaces the circuit board that was formerly part of the inductor-filter assembly. The capacitors have also been re-designated: C18 is now C101, C19 is now C102, and C30 is now C103. With these designations changed, the ac input wiring schematic accompanying Change 11 is correct.

The front panel binding posts have been changed to a type with better designed insulation. Delete the two types of posts listed on page 6-6 and add: black binding post, HP Part No. 1510-0107 (qty. 1), and red binding post, HP Part No. 1510-0091 (qty. 2)

In the parts list and on the schematic, change C12 in the SCR snubber circuit to 0.047 μ F, 250Vac, HP Part No. 0160-4323. Also add insulated standoff, 0380-0849 (qty. 2).

Add this note to the end of paragraph 2-17:

NOTE

No line cord is provided with this power supply.

CHANGE 13:

This change replaces SCR's CR17 and CR18 with a new type, HP Part No. 1884-0219, and adds a MOV varistor designated RV1 across the load side of the line switch. The part number of the varistor is 0837-0117.

ERRATA:

Add three 3/8-32 nylon hex nuts, HP Part No. 2950-0144, to the parts list. These hex nuts mount the new binding posts added by Change 12.

Change the part number of R59 (added to the gating circuit by Change 10) to 2100-1772. The resistor has not been changed; just its part number has.

CHANGE 14:

In the replaceable parts list and on the schematic: replace diodes CR19-22 with rectifier bridge U1, HP Part No. 1906-0218; replace CR17, CR18, R55, CR51, and C8 with triac CR52, HP Part No. 1884-0218; change C12 to C33, HP Part No. 0160-4323; change R21 to R61, 390 Ω , 0.5W, HP Part No. 0686-3915; change TS1 to HP Part No. 0440-0079; change T3 to HP Part No. 5080-1914. Replace the section of schematic shown below on the left with the drawing on the right.

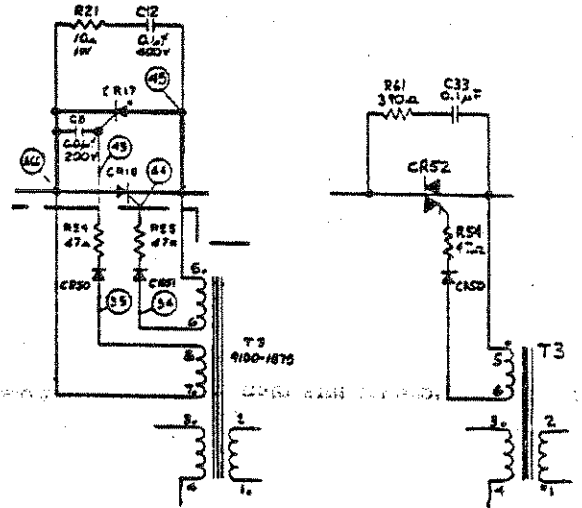

ERRATA:

Change the ZERO CURRENT OUTPUT ADJUSTMENT procedure given in paragraph 5-67 to read as follows:

5-67. Proceed as follows:

- a. Connect the test setup shown in Figure 5-3 except use a 0.04 Ω current monitoring resistor.
- b. Connect a jumper between the A1 and A3 terminals on the rear terminal strip of the power supply.
- c. Connect a resistance box in place of R46.
- d. Adjust the resistance box until the voltage across the 0.4 Ω resistor is 0 \pm 5.0mVdc.
- e. Select R46 equal to the resistance value required in step d. R46 should be between 3.9 Meg and 15 Meg ohms.

CHANGE 15:

Delete cover barrier strip, HP Part No. 5020-5513. Add strain relief, HP Part No. 5060-2791.

Change zener VR3 to 9V, HP Part No. 1902-0785. Change resistor R35 to 2.87K Ω , 1%, HP Part No. 0698-3151.

Change resistor R37 to 1.3K, 1%, HP Part No. 0757-0735.

CHANGE 16:

On page 6-6, change Barrier Strip HP Part Number 0360-1220 to Barrier Strip HP Part Number 0360-1259.

CHANGE 17:

On Page 6-5 and on the schematic, make the following changes:

R16: Change to 820 Ω , 5%, HP Part No. 0686-8215.

R59: Change to 1K Ω , 10%, HP Part No. 2100-3211.

On Option 005 (50 Hz) units only, change C7 to 1.8 μ F, 35 V, HP Part No. 0180-0101.

CHANGE 18:

In the replaceable parts list, change Fan (added in Change 4) to HP Part No. 3160-0056.

CHANGE 19:

In the Replaceable Parts List, page 6-5 add C34 .22 μ F, 250V HP Part No. 0160-4259. On the schematic insert C34 on the in-board side of circuit breaker (CB1) between AC and ACC.

ERRATA:

In the Replaceable Parts List, change FAN (added in Change 18) to FAN Ball Bearing HP Part No. 3160-0369.

▶ ERRATA

On page 3-8, Figure 3-5 delete the connection between A5 and +S.

1-18-82

Table 1-1. Specifications

INPUT:	105-125 vac, 57 to 63 cps, single phase, 17 amperes, 1200 watts max.
RATED OUTPUT:	Constant Voltage: 0 to 60 vdc Constant Current: 0 to 15 amperes dc
LINE REGULATION:	Constant Voltage: Less than 60 mv for 105-125 vac input change. Constant Current: Less than 150 ma for 105-125 vac input change.
LOAD REGULATION:	Constant Voltage: Less than 120 mv for 0 to 45 ampere load change. Constant Current: Less than 150 ma for 0 to 18 vdc load change.
RIPPLE AND NOISE:	60 mvrms
OPERATING TEMPERATURE RANGE:	0°C to 50°C
STORAGE TEMPERATURE RANGE:	-20°C to 71°C
TEMPERATURE COEFFICIENT:	Constant Voltage: 0.05% plus 15 mv per degree centigrade. Constant Current: 45 ma per degree centigrade
OUTPUT STABILITY: (after 30-minute warm-up)	Constant Voltage: 0.15% plus 45 mv for 8 hours at constant temperature. Constant Current: 150 ma for 8 hours at constant temperature.
REMOTE PROGRAMMING:	Constant Voltage: 300 ohms per volt $\pm 1\%$ Constant Current: 15 ohms per ampere
TYPICAL OUTPUT IMPEDANCE:	Less than 0.01 ohm from dc to 0.5 cps Less than 0.3 ohm from 0.5 to 100 cps Less than 0.2 ohm from 100 cps to 1kc Less than 0.6 ohm from 1kc to 100 kc
OUTPUT IMPEDANCE:	1.0 microhenry

Table 1-1. Specifications (cont.)

TRANSIENT RECOVERY TIME:	<p>In constant voltage operation, less than 300 milliseconds is required for output voltage recovery to within 400 millivolts of the nominal output voltage following a load change equal to one half the maximum current rating of the power supply. Nominal output voltage is defined as the mean between the no-load and full-load voltages. The transient amplitude is less than 0.4 volt per ampere for any load change between 20% and 100% of rated output current. (Excluding the initial spike of approximately 100 microseconds duration which is significant only for load rise times faster than 0.5 ampere per microsecond).</p>			
SIZE AND WEIGHT:	Height	Width	Depth	Weight
	5-1/4 in.	19 in.	16-3/4 in.	61 lb.
FINISH:	Light gray front panel with dark gray case.			

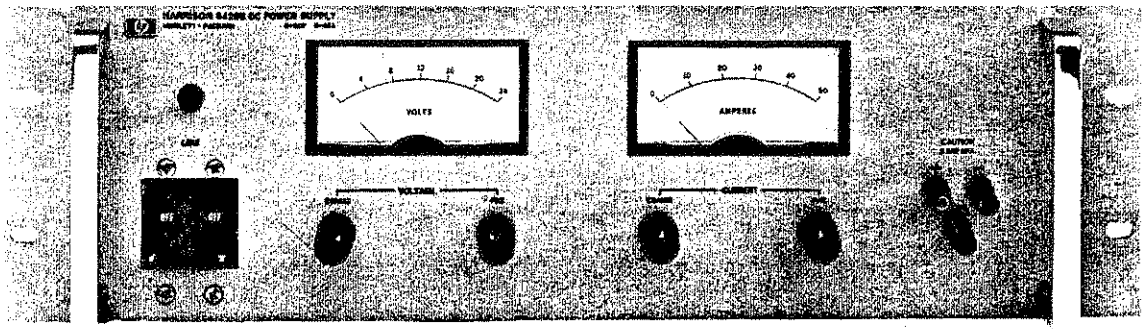

Figure 1-1. Model 6439B DC Power Supply

SECTION I

GENERAL INFORMATION

1-1. DESCRIPTION

1-2. GENERAL

1-3. The Harrison Model 6439A DC Power Supply (fig. 1-1) is a completely solid-state, compact, well-regulated, constant voltage/constant current dc power supply suitable for either bench or relay rack operation. Input power is connected to a terminal strip at the rear of the power supply. The output is continuously variable between 0 and 60 vdc, and between 0 and 15 amperes. Detailed specifications are given in table 1-1.

1-4. OVERLOAD PROTECTION

1-5. A crossover feature protects both power supply and load in constant voltage operation. Automatic crossover circuitry switches the power supply from constant voltage to constant current operation if the output current exceeds a preset limit. This crossover circuitry also protects the load from overvoltage during constant current operation by automatically switching the power supply into constant voltage operation. The user can adjust the crossover point via the front panel controls (para. 3-8 and 3-9).

1-6. The power supply is protected from reverse voltage (positive voltage applied to negative terminal) by a diode that shunts current across the output terminals when this condition exists. The ac input components are protected by a dual circuit breaker in the ac input line. This circuit breaker is located on the front panel and serves as the on/off switch.

1-7. COOLING

1-8. A fan is used to blow air from left to right (facing front panel) through a compartment containing the major heat producing elements.

1-9. MONITORING

1-10. Two front-panel meters are provided for monitoring output voltage and current. The voltmeter has a 0 to 60 volt range and the ammeter has a 0 to 15 ampere range. Each meter has a 2% accuracy at full range.

1-11. OUTPUT TERMINALS

1-12. Output power is available via a terminal strip on the rear panel. The rear panel terminal strip also enables the power supply to be connected for different modes of operation (para. 3-3). The output terminals are isolated from the chassis

and either the positive or the negative terminal may be connected to the chassis via a separate ground terminal located adjacent to the output terminals. The power supply is insulated to permit operation up to 300 vdc off ground.

1-13. INSTRUMENT IDENTIFICATION

1-14. Harrison power supplies are identified by a three-part designation. The first part is the model number; the second part is the serial number; and the third part is the manufacturing code letter. This manual applies to all Model 6439A power supplies with the same manufacturing code letter given in the title page. Change sheets will be supplied with the manual to make it apply to Model 6439A power supplies with different manufacturing code letters.

SECTION II
INSTALLATION

2-1. INITIAL INSPECTION

2-2. GENERAL

2-3. Before shipment, the power supply was inspected and found free of mechanical and electrical defects. If damage to the shipping carton is evident, ask that the carrier's agent be present when the power supply is unpacked. As soon as the power supply is unpacked, inspect it for any damage that may have occurred in transit. Also check the cushioning material for signs of severe stress (may be indication of internal damage). Save all packing materials until the inspection is completed. If damage is found, proceed as instructed in the Claim for Damage in Shipment notice on the inside of the back cover of this manual.

2-4. MECHANICAL CHECK

2-5. Check that there are no broken knobs or connectors, that the external surface is not scratched or dented, that the meter faces are not damaged, and that all controls move freely. Any external damage may be an indication of internal damage.

2-6. ELECTRICAL CHECK

2-7. Check that the straps on the terminal strip at the rear of the power supply are secure and that the strapping pattern is in accord with figure 3-2. Check the electrical performance of the power supply as soon as possible after receipt. A performance check that is suitable for incoming inspection is given in paragraphs 5-7 through 5-22.

2-8. INSTALLATION DATA

2-9. GENERAL

2-10. The power supply is shipped ready for bench or relay rack (19 inch) operation.

2-11. LOCATION

2-12. Because the power supply is cooled by convection, there must be enough space along the sides and rear of the power supply to permit free flow of cooling air. The power supply should be located in an area where the ambient temperature does not exceed 50°C.

2-13. POWER REQUIREMENTS

2-14. The power supply is operated from a 105 to 125 volt (115 volts nominal), 57 to 63 cps, single phase power source. At 115 volts, 60 cps, the full load requirement is 1200 watts at 16 amperes.

2-15. POWER CABLE

2-16. To protect operating personnel, the National Electrical Manufacturers Association (NEMA) recommends that the instrument panel and cabinet be grounded. This instrument is equipped with a three-conductor power cable. The third conductor is the ground conductor and when the cable is plugged into an appropriate receptacle, the instrument is grounded. The offset pin on the power cable three-prong connector is the ground connection.

2-17. To preserve the protection feature when operating the instrument from a two-contact outlet, use a three-prong to two-prong adaptor and connect the green lead on the adaptor to ground.

2-18. REPACKAGING FOR SHIPMENT

2-19. To insure safe shipment of the instrument, it is recommended that the package designed for the instrument be used. The original packaging material is reusable. If it is not available, contact your Hewlett-Packard field office for packing materials and information. A packing carton part number is included in the parts list.

2-20. Attach a tag to the instrument which specifies the owner, model number, full serial number, and service required, or a brief description of the trouble.

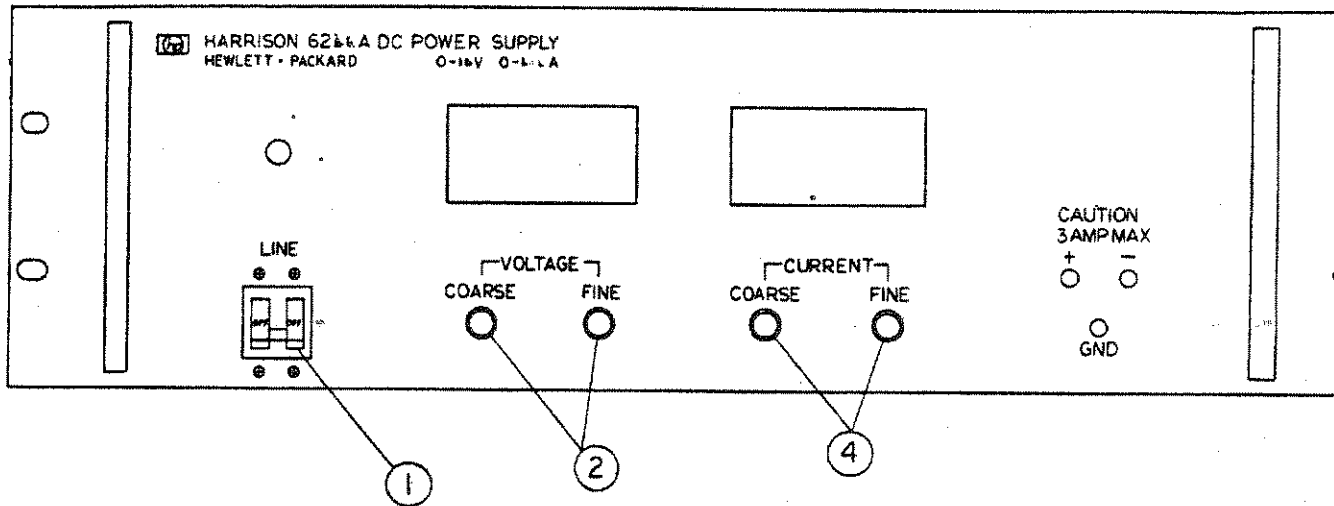

1. TURN AC POWER ON.
2. ADJUST COARSE AND FINE VOLTAGE CONTROLS UNTIL THE VOLTAGE ON THE OUTPUT VOLTAGE METER IS OF DESIRED VALUE.
3. SHORT CIRCUIT THE OUTPUT TERMINALS (AT REAR OF POWER SUPPLY)
4. ADJUST COARSE AND FINE CURRENT CONTROLS UNTIL THE CURRENT ON THE OUTPUT CURRENT METER IS OF DESIRED VALUE.
5. REMOVE SHORT AND CONNECT LOAD.

Figure 3-1. Controls and Indicators

SECTION III

OPERATING INSTRUCTIONS

3-1. CONTROLS AND INDICATORS

3-2. The controls and indicators are illustrated in figure 3-1.

3-3. OPERATION

3-4. GENERAL

3-5. The power supply is designed so that its mode of operation can be selected by making strapping connections between particular terminals on the terminal strip at the rear of the power supply. The terminal designations are stenciled in white on the power supply and are adjacent to their respective terminals. The strapping patterns illustrated in this section show neither terminal grounded. The operator can ground either terminal or operate the power supply up to 300 vdc off ground (floating)

3-6. NORMAL

3-7. GENERAL. The power supply is normally shipped with its rear terminal strapping connections arranged for constant voltage/constant current, local sensing, local programming, single unit mode of operation. This strapping pattern is illustrated in figure 3-2. The operator selects either a constant voltage or a constant current output using the front panel controls (local programming, no strapping changes are necessary).

3-8. CONSTANT VOLTAGE. To select a constant voltage output, proceed as follows:

a. Turn-on power supply and adjust VOLTAGE controls for desired output voltage (output terminals open).

b. Short output terminals and adjust CURRENT controls for maximum output current allowable (current limit), as determined by load conditions. If a load change causes the current limit to be exceeded, the power supply will automatically cross-over to constant current output at the preset current limit and the output voltage will drop proportionately. In setting the current limit, allowance must be made for high peak currents which can cause unwanted cross-over (refer to para. 3-40).

3-9. CONSTANT CURRENT. To select a constant current output, proceed as follows:

a. Short output terminals and adjust CURRENT controls for desired output current.

b. Open output terminals and adjust VOLTAGE controls for maximum output voltage allowable (voltage limit), as determined by load conditions. If a load change causes the voltage limit to be exceeded, the power supply will automatically crossover to constant voltage output at the preset voltage limit and the output current will drop proportionately. In setting the voltage limit, allowance must be made for high peak voltages which can cause unwanted crossover. (Refer to para. 3-40.)

3-10. CONNECTING LOAD

3-11. Two pairs of output terminals are provided on the terminal strip at the left rear side (facing rear) of the power supply. Either pair of terminals or both may be used. The terminals are marked + and -. A separate ground terminal is located adjacent to the output terminals. The positive or negative output terminal may be grounded, or neither grounded (floating operation; permitted to 300 vdc off ground).

3-12. Each load should be connected to the power supply output terminals using separate pairs of connecting wires. This will minimize mutual coupling effects between loads and will retain full advantage of the low output impedance of the power supply. Each pair of connecting wires should be as short as possible and twisted or shielded to reduce noise pickup. (If shield is used, connect one end to power supply ground terminal and leave the other end unconnected.)

3-13. If load considerations require that the output power distribution terminals be remotely located from the power supply, then the power supply output terminals should be connected to the remote distribution terminals via a pair of twisted or shielded wires and each load separately connected to the remote distribution terminals. For this case, remote sensing should be used (para. 3-14).

NOTE

It is recommended that the voltage drop in the connecting wires not exceed 2 volts. If a larger drop must be tolerated, please consult a Hewlett-Packard field representative.

3-14. REMOTE SENSING

3-15. Remote sensing is used to ameliorate the degradation of regulation which will occur at the load when the voltage drop in the connecting wires is appreciable. The use of remote distribution terminals (para. 3-13) is an example where remote sensing may be required. Due to the voltage drop in the load leads, it may be necessary to slightly increase the current limit in constant voltage operation.

CAUTION

Turn-off power supply before rearranging strapping pattern at the power supply rear terminal strip. If the -S terminal is opened while the power supply is on, the output voltage and current may exceed their maximum ratings and result in damage to the load. The power supply will not be damaged.

3-16. Proceed as follows:

a. Turn-off power supply and arrange rear terminal strapping pattern as shown in figure 3-3. The sensing wires will carry less than 10 ma and need not be as heavy as the load wires. It is recommended that sensing and load wires be twisted and shielded. (If shield is used, connect one end to power supply negative terminal and leave the other end unconnected.)

CAUTION

Observe polarity when connecting the sensing leads to the load.

b. In order to maintain low ac output impedance, a capacitor with a minimum rating of 10,000 μ fd and 75 vdcw should be connected across the load using short leads. This capacitor must have high-frequency characteristics as good or better than C17 has (see parts list).

c. Turn-on power supply.

3-17. REMOTE PROGRAMMING

3-18. GENERAL. The constant voltage and constant current outputs may be programmed (controlled) from a remote location. The front-panel controls are disabled in the following instructions. Changes in the rear terminal strapping arrangement are necessary. The wires connecting the programming terminals of the power supply to the remote programming device should be twisted or shielded to reduce noise pick-up. (if shield is used, connect one end to power supply ground terminal and leave the other end unconnected.) Remote sensing (para. 3-14) may be used simultaneously with remote programming. However, the strapping patterns shown in figures 3-4, 3-5, and 3-6 employ only local sensing and do not show the load connections.

CAUTION

Turn-off power supply before rearranging strapping pattern at the power supply rear terminal strip. If the current programming terminals are opened while the power supply is on, the output current will exceed its maximum rating and may result in damage to the load. The power supply will not be damaged. The constant voltage programming terminals have a zener diode connected internally across them to limit the programming voltage and thus prevent excessive output voltage.

3-19. **CONSTANT VOLTAGE.** In the constant voltage mode of operation, either a resistance or voltage source can be used for remote programming. For resistance programming, the programming coefficient (fixed by the programming current) is 300 ohms per volt (output voltage increases 1 volt for each 300 ohms in series with programming terminals). The programming current is adjusted to within 1% of 3.33ma at the factory. If greater programming accuracy is required, change R39 (shunt). The programming resistance should be a stable, low noise, low-temperature (less than 30 ppm per °C) resistor with a power rating at least 10 times its actual dissipation.

3-20. The output voltage of the power supply should be 0 ± 20 mv, -100 mv when the programming resistance is zero ohms. This tolerance can be improved by changing R6. For further information on improving this tolerance, refer to paragraph 5-63 and to H-Lab Tech Letter #1.

3-21. If the resistance programming device is controlled by a switch, make-before-break contacts should be used in order to avoid momentary opening of the programming terminals. To connect the remote programming resistance, arrange rear terminal strapping pattern as shown in figure 3-4. The front-panel VOLTAGE controls are disabled when the strap between A6 and A7 is removed.

3-22. If a voltage source is used as the remote programming device, the output voltage of the power supply will vary in a 1 to 1 ratio with the programming voltage. The load on the voltage source will not exceed 25 microamperes. To connect the programming voltage, arrange rear terminal strapping pattern as shown in figure 3-5.

3-23. **CONSTANT CURRENT.** In constant current operation, resistance programming is used. The resistance programming coefficient (fixed by the programming current) is 15 ohms per ampere (output current increases 1 ampere for each 15 ohms in series with programming terminals). The programming current is adjusted to within approximately 10% of 2.3ma at the factory. If greater programming accuracy is required, change R41 (shunt). The programming resistance should be a stable, low noise, low-temperature (less than 30 ppm per °C) resistor with a power rating at least 10 times its actual dissipation.

3-24. The output current of the power supply should be 0 ± 50 ma, -150 ma when the programming resistance is zero ohms. This tolerance can be improved by changing R20. For further information on improving this tolerance, refer to paragraph 5-67 and to H-Lab Tech Letter #1.

3-25. If the resistance programming device is controlled by a switch, make-before-break contacts should be used to avoid momentary opening of the programming terminals. To connect the remote programming resistance, arrange rear terminal strapping as shown in figure 3-6. The front-panel CURRENT controls are disabled when the strap between A1 and A2 is removed.

3-26. PARALLEL

3-27. GENERAL. Two or more power supplies can be connected in parallel to obtain a total output current greater than that available from one power supply. The total output current is the sum of the output currents of the individual power supplies. Each power supply can be turned-on or off separately. Remote sensing (para. 3-14) and programming (para. 3-17) can be used; however, the strapping patterns shown in figures 3-7 and 3-8 employ only local sensing and programming.

3-28. NORMAL. The strapping pattern for normal parallel operation of two power supplies is shown in figure 3-7. The output current controls of each power supply can be separately set. The output voltage controls of one power supply (master) should be set to the desired output voltage; the other power supply (slave) should be set for a slightly larger output voltage. The master will act as a constant voltage source; the slave will act as a constant current source, dropping its output voltage to equal the master's.

3-29. AUTO-PARALLEL. The strapping patterns for auto-parallel operation of two and three power supplies are shown in figures 3-8A and B, respectively. Auto-parallel operation permits equal current sharing under all load conditions, and allows complete control of output current from one master power supply. The output current of each slave is approximately equal to the master's. Because the output current controls of each slave is operative, they should be set to maximum to avoid having the slave revert to constant current operation; this would occur if the master output current setting exceeded the slave's.

3-30. SERIES

3-31. GENERAL. Two or more power supplies can be connected in series to obtain a total output voltage higher than that available from one power supply. The total output voltage is the sum of the output voltages of the individual power supplies. A single load can be connected across the series-connected power supplies or a separate load can be connected across each power supply. The power supply has a reverse polarity diode connected internally across the output terminals to protect the power supply against reverse polarity voltage if the load is short-circuited or if one power supply is turned off while its series partners are on.

3-32. The output current controls of each power supply are operative and the current limit is equal to the lowest control setting. If any output current controls are set too low with respect to the total output voltage, the series power supplies will automatically crossover to constant current operation and the output voltage will drop. Remote sensing (para. 3-14) and programming (para. 3-17) can be used; however, the strapping patterns shown in figures 3-9 and 3-10 employ only local sensing and programming.

3-33. NORMAL. The strapping pattern for normal series operation of two power supplies is shown in figure 3-9. The output voltage controls of each power supply must be adjusted to obtain the total output voltage.

3-34. AUTO-SERIES. The strapping patterns for auto-series operation of two and three power supplies are shown in figures 3-10A and B, respectively. Auto-series operation permits control of the output voltage of several power supplies (slaves) from one master power supply. The master must be the most negative power supply of the series. To obtain positive and negative voltages, the + terminal of the master may be grounded. For a given position of the slave output voltage controls, the total output voltage is determined by the master output voltage controls. The output voltage controls of a slave determines the percentage of the total output voltage that the slave will contribute. Turn-on and turn-off of the series is controlled by the master. In order to maintain the temperature coefficient and stability specifications of the power supply, the external resistors shown in figures 3-10A and B, should be stable, low-noise, low-temperature (less than 30 ppm per °C) resistors. The value of these resistors is determined by multiplying the output voltage of the applicable slave by the programming coefficient (300 ohms/volt).

3-35. AUTO-TRACKING

3-36. The strapping patterns for auto-tracking operation of two and three power supplies are shown in figures 3-11A and B, respectively. Automatic tracking operation permits the output voltages of two or more power supplies to be referenced to a common buss; one of the power supplies (master) controls the magnitude of the output voltage of the others (slaves) for a given position of the slave output voltage controls. The master must be the most negative power supply in the group. The output voltage of a slave is a percentage of the master output voltage. The output voltage controls of a slave determines this percentage. Turn-on and turn-off of the power supplies is controlled by the master. Remote sensing (para. 3-14) and programming (para. 3-17) can be used; however, the strapping patterns shown in figure 3-4 employ only local sensing and programming.

3-37. The value of the external resistor shown in figure 3-11 is determined by dividing the voltage difference between the master and the applicable slave by the programming current (nominally 3.33ma; refer to para. 3-19). Finer adjustment of the slave output voltage can be accomplished using the slave output voltage controls. In order to maintain the temperature coefficient and stability specifications of the power supply, the external resistors should be stable, low-noise, low-temperature (less than 30 ppm per °C) resistor.

3-38. OPERATING CONSIDERATIONS

3-39. PULSE LOADING

3-40. The power supply will automatically cross over from constant voltage to constant current operation, or the reverse, in response to an increase (over the preset limit) in the output current or voltage, respectively. Although the preset limit may be set higher than the average output current or voltage, high peak currents or voltages (as occur in pulse loading) may exceed the preset limit and cause crossover to occur. To avoid this unwanted crossover, the preset limit must be set for the peak requirement and not the average.

3-41. OUTPUT CAPACITANCE

3-42. There are capacitors (internal) across the output terminals of the power supply. These capacitors help to supply high-current pulses of short duration during constant voltage operation. Any capacitance added externally will improve the pulse current capability, but will decrease the safety provided by the constant current circuit. A high-current pulse may damage load components before the average output current is large enough to cause the constant current circuit to operate.

3-43. The effects of the output capacitors during constant current operation are as follows:

- a. The output impedance of the power supply decreases with increasing frequency.
- b. The rise time of the output voltage is increased.
- c. A large surge current causing a high power dissipation in the load occurs when the load impedance is reduced rapidly.

3-44. NEGATIVE VOLTAGE LOADING

3-45. A diode is connected across the output terminals. Under normal operating conditions, the diode is reverse biased (anode connected to negative terminal). If a negative voltage is applied to the output terminals (positive voltage applied to negative terminal), the diode will conduct, shunting current across the output terminals and limiting the voltage to the forward voltage drop of the diode. This diode protects the filter and output electrolytic capacitors.

3-46. NEGATIVE CURRENT LOADING

3-47. Certain types of loads may cause current to flow into the power supply in the direction opposite to the output current. If the reverse current exceeds 0.2 ampere, preloading will be necessary. For example; if the load delivers 1 ampere to the power supply with the power supply output voltage at 18 vdc, a resistor

18 ohms (18v/1a) should be connected across the output terminals. Thus, the 18 ohm resistor shunts the reverse current across the power supply. For more information on preloading, refer to paragraph C4 in the H-Lab Application Manual.

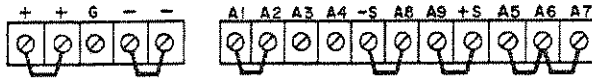

Figure 3-2.
Normal Strapping Pattern

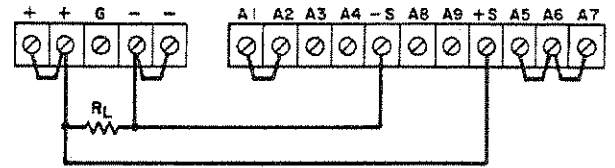

Figure 3-3.
Remote Sensing

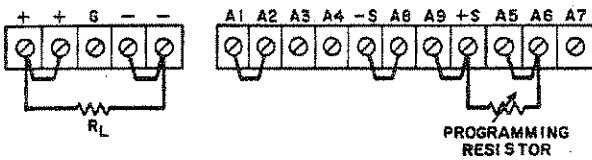

Figure 3-4.
Remote Resistance Programming
(Constant Voltage)

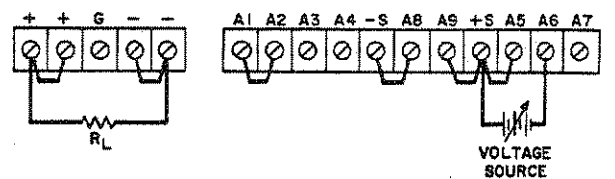

Figure 3-5.
Remote Voltage Programming
(Constant Current)

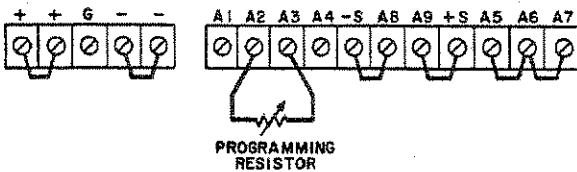

Figure 3-6.
Remote Resistance Programming
(Constant Current)

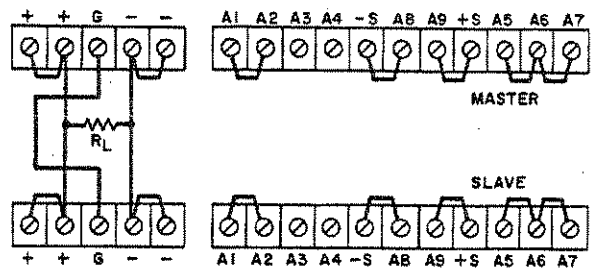
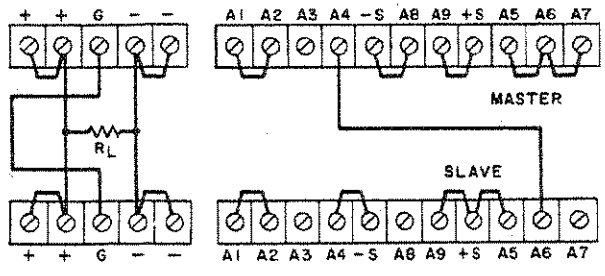
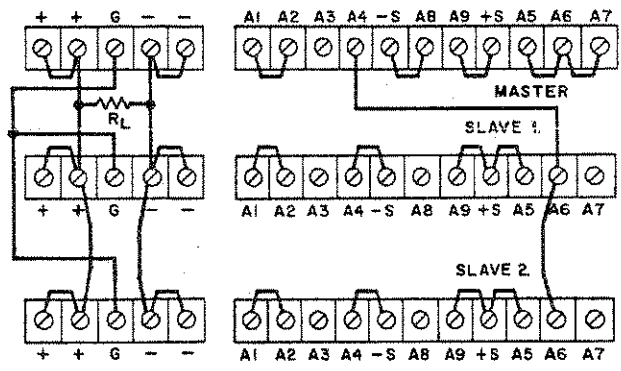

Figure 3-7.
Normal Parallel Operation



A. TWO POWER SUPPLIES.



B. THREE POWER SUPPLIES.

Figure 3-8.
Auto-Parallel Operation

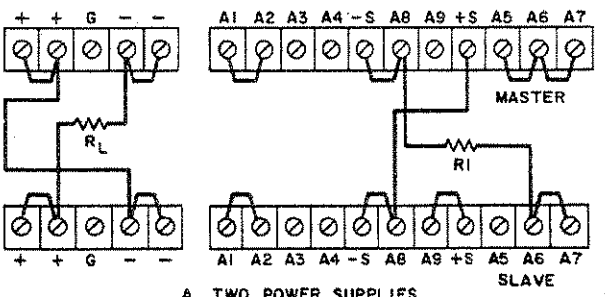

A. TWO POWER SUPPLIES.

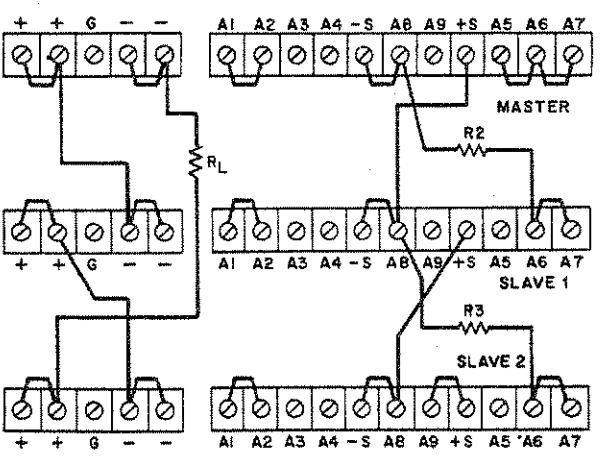

B. THREE POWER SUPPLIES.

Figure 3-10.
Auto-Series Operation

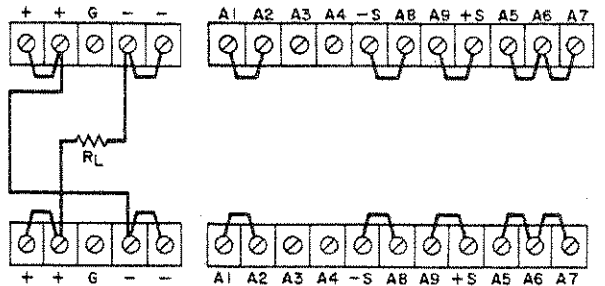
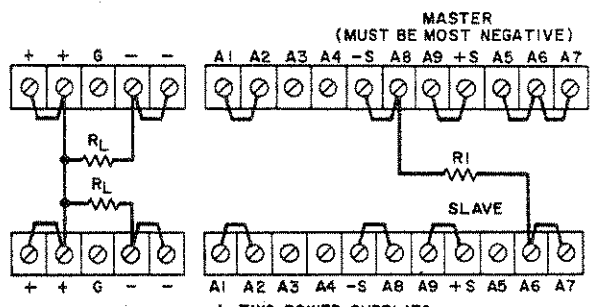
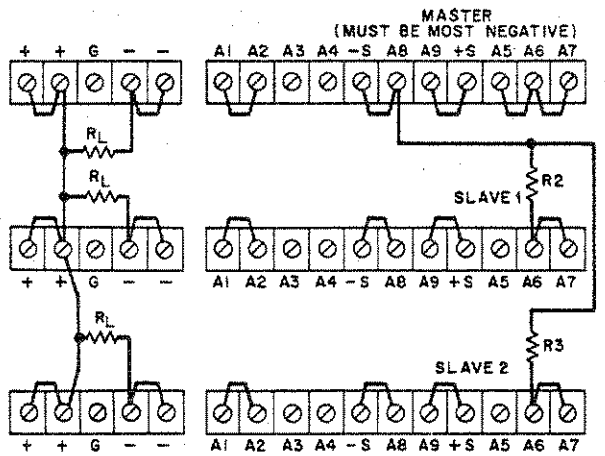

Figure 3-9.
Normal Series Operation



A. TWO POWER SUPPLIES.



B. THREE POWER SUPPLIES.

Figure 3-11.
Auto-Tracking Operation

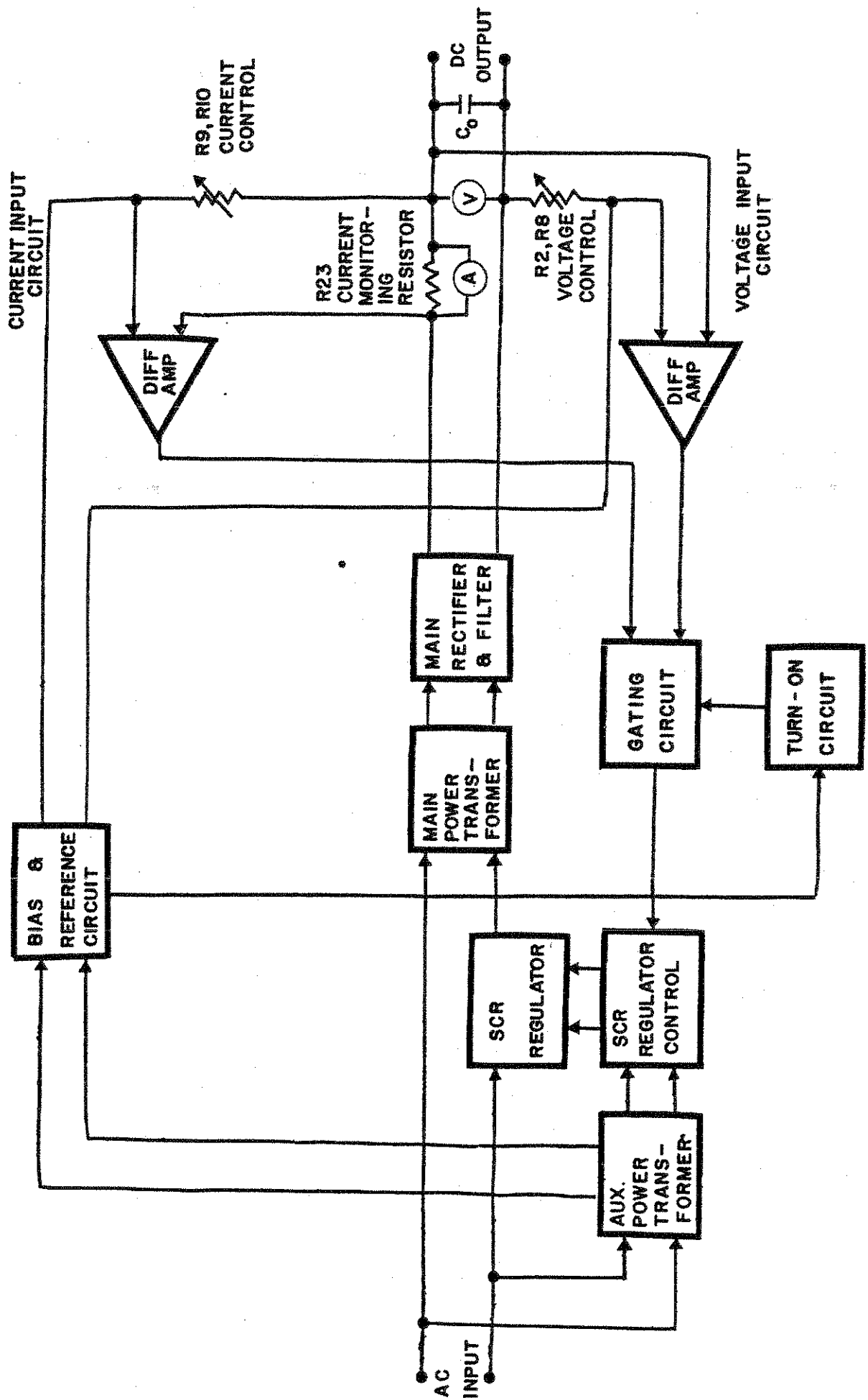

FIGURE 4-1. BLOCK DIAGRAM

SECTION IV

PRINCIPLES OF OPERATION

4-1. BLOCK DIAGRAM DESCRIPTION (See figure 4-1.)

4-2. The main power transformer isolates the ac input from the power supply and reduces it to the voltage level required. Rectification and filtering produces a smoothed dc output across the - and + terminals. A large capacitor (C_0) is connected across the - and + terminals for low ac output impedance and to help supply large pulse currents. An SCR regulator controls the ac input to provide good regulation of the dc output. The auxiliary power transformer powers the SCR regulator control circuit and the bias and reference circuit which produces dc bias and reference voltages for the power supply.

4-3. The SCR regulator is controlled by the SCR regulator control circuit which operates in response to signals developed by the voltage or current input circuit. A gating circuit assures that only one input circuit is used at a time.

4-4. The voltage and current input circuits operate in a similar manner. Each circuit has a differential amplifier that amplifies an error voltage that is proportional to the difference between the actual output and the programmed output. The programmed output is determined by the resistance of the programming resistors (voltage and current controls). Each programming resistor has a constant current through it which is maintained by the bias and reference circuit.

4-5. The voltage input circuit differential amplifier detects the error voltage that is proportional to the difference between the voltage across its programming resistors (R2-R8) and the dc output voltage. The error voltage is amplified and passed through the gating circuit to the SCR regulator control which triggers the SCR regulator. The SCR regulator increases or decreases the ac input voltage to the main power transformer as required to maintain a constant load voltage that is equal to the programmed voltage. In constant voltage operation, the gating circuit is biased to inhibit the input from the current input circuit.

4-6. The current input circuit differential amplifier detects the error voltage that is proportional to the difference between the voltage across its programming resistors (R9-R10) and the voltage across current monitoring resistor R23. The voltage across R23 is proportional to the load current. The SCR regulator responds to the amplified error voltage by increasing or decreasing the ac input current to the main power transformers as required to maintain a constant load current. In constant current operation, the gating circuit is biased to inhibit the input from the voltage input circuit.

4-7. To prevent overvoltage and excessive surge current when the power supply is turned-on, the turn-on circuit establishes initial conditions in the gating circuit. The turn-on circuit is activated by the bias and reference circuit when the power supply is turned-off.

4-8. A voltmeter is connected across the - and + terminals to monitor the output voltage. An ammeter is connected across current monitoring resistor R23 to monitor the output current (proportional to voltage across R23).

4-9. CIRCUIT DESCRIPTION (See figure 4-2 at back of manual.)

4-10. AC INPUT

4-11. The 105-125 vac, 57-63 cps, single phase input is applied to transformer T2 and to the series combination of transformer T1 and SCR's CR17 and CR18 which are in parallel opposition. The SCR's are used to regulate the dc output by controlling the average value of the ac input to transformer T1. Capacitors C11 and C12 smooth transients to prevent the SCR's from being triggered by a rapidly changing voltage from anode to cathode. Resistor R21 damps oscillations that may occur due to resonance of C12 and the leakage inductance of T1. The leakage inductance of T1 limits the peak input current.

4-12. DC OUTPUT

4-13. The output of the secondary of transformer T1 is full-wave rectified by bridge rectifier CR19 through CR22 and filtered by pi-section filter C13, C17, and R29. The dc output is regulated to a constant value by the SCR's in the ac input line. Capacitor C17 is the output capacitor. Diode CR23 is connected across the filtered dc output to protect the power supply from reverse voltage applied to the output terminals. Resistor R23 is the current monitoring resistor; the full load current flows through it. Resistors R25 and R27 are used to calibrate the voltmeter and ammeter, respectively.

4-14. VOLTAGE INPUT

4-15. GENERAL. The voltage input circuit is basically a differential amplifier (Q1-Q2) that detects any voltage difference between the programmed output voltage and the actual output voltage. The differential amplifier output voltage varies in proportion to the power supply output voltage variation.

4-16. Q2 INPUT. Voltage divider R6-R47 maintains a slightly negative base bias to ensure that the output voltage can be programmed to zero. The output of Q2 is emitter-coupled (resistor R4) to Q1.

4-17. Q1 INPUT. There are three inputs to the base of Q1; one determined by the programmed voltage (voltage controls R2-R8), the second determined by the collector voltage of Q1 (negative feedback), and the third is from the positive side of the main rectifier. The collector current of Q1 is determined by the difference between its base and emitter inputs. This difference is an error voltage that is proportional to the difference between the programmed output voltage and the actual output voltage. The negative feedback from collector to base (C4, and R17-R18 in parallel) improves the stability of the voltage-regulating feedback loop.

4-18. The input from the positive side of the main rectifier (C1 and R1) improves loop stability by making the differential amplifier insensitive to output voltage variations of ten cps or greater. Below ten cps this input is negligible. This input is necessary because the phase shift of the pi-section output filter begins to become excessive over ten cps. Resistors R1 and R5 are arranged so that the ten cps input is isolated from the negative feedback input; and so that necessary impedance levels are obtained looking out from the base of Q1. The collector output of Q1 is coupled to the gating circuit.

4-19. CLAMPING. In order to protect the differential amplifier, the base of Q1 is clamped with respect to -S by diodes CR1 and CR2 to prevent excessive base voltage in either direction. Diode CR1 clamps the base to approximately -0.7 vdc; CR2 and the base-emitter junction of Q1 clamp the base to approximately +1.4 vdc. Zener diode VR1 clamps the programming terminals to prevent an excessive error signal that would cause excessive output voltage. This would occur, for example, if the programming terminals were opened accidentally. To prevent overshoot when the power supply switches from constant current to constant voltage, diodes CR9 and CR10 clamp the collector of Q1. Resistor R30 provides a small bleed current for CR10.

4-20. CURRENT INPUT

4-21. GENERAL. The current input circuit is basically a differential amplifier (Q8-Q9) that detects any current difference between the programmed output current (proportional to voltage across current controls) and the actual output current (proportional to voltage across current monitoring resistor R23). The differential amplifier output voltage varies in proportion to the output current variation.

4-22. Q8-Q9 INPUT. The input to the differential amplifier (across bases of Q8-Q9) is the voltage difference across current controls R9-R10 and current monitoring resistor R23. Because the programming current is constant in constant current operation, the voltage input to the differential amplifier varies as the load current through R23 (error voltage). Capacitors C6 and C24 and resistor R22 provide gain roll-off at high frequencies. Diode CR26 clamps the voltage (0.7 vdc) across the emitter-base junction of Q9 and R20. This clamping action prevents excessive reverse base voltage in Q9 when very large load current is drawn (output terminals shorted). To prevent overshoot when the power supply switches from constant voltage to constant current operation, diodes CR10 and CR12 clamp the collector of Q8.

4-23. Q8-Q9 OUTPUT. Resistor R13 is the collector load for Q8. The collector output of Q8 is coupled to the gating circuit. Voltage divider R20-R46 biases the base of Q9 and maintains a slightly negative base bias to ensure that the output current can be programmed to zero. Resistor R44 provides positive feedback to improve load regulation during constant current operation.

4-24. GATING CIRCUIT

4-25. Transistor Q4 draws current from the SCR control circuit (capacitor C25). The magnitude of this current is determined by either the voltage or current input circuit. For constant voltage operation, diode CR7 is forward biased to permit the voltage input circuit to drive Q4; diode CR8 is reverse biased to inhibit the input from the current input circuit. For constant current operation, the reverse occurs.

4-26. To prevent transients in the dc output when the power supply is turned-on, the turn-on of Q4 is delayed by capacitor C2 which charges through R12, R15 and CR5. When C2 charges sufficiently to reverse bias CR5, all the current through R15 flows to the base of Q4 to turn it on. This base current is controlled by the voltage or current input circuits via CR7 or CR8, respectively. For example, during constant voltage operation the collector voltage of Q1 (voltage input) forward biases CR17 (CR8 reverse biased by Q8), the current through CR7 will vary as Q1 collector voltage varies and thus vary Q4 base current; therefore, the collector current of Q4 is controlled by the voltage input. In a similar manner, the current input circuit controls the collector current of Q4 during constant current operation.

4-27. TURN-ON CIRCUIT

4-28. Transistor Q3 provides a path for rapidly discharging C2 (in gating circuit) when the power supply is turned-off. This assures that C2 is discharged if the power supply is turned-on shortly after turn-off. The purpose of having C2 discharged each time the power supply is turned-on is to maintain the same time delay in the turn-on of the gating circuit (refer to para. 4-26).

4-29. SCR REGULATOR CONTROL (See waveshapes on figure 4-2.)

4-30. GENERAL. The SCR regulator control is basically a blocking oscillator (Q7 and T3) that applies pulses to the SCR regulator in response to error signals detected by the voltage or current input circuit. When transistor Q7 conducts, the pulse developed in winding 1-2 of transformer T3 is coupled to the base of Q7 (positive feedback) and to the SCR regulator (CR17 and CR18). Capacitor C27 charges in opposition to the feedback voltage and cuts off Q7. The charge time of C27 determines the pulse duration in the collector of Q7 (approximately 20 microseconds). The 39-vdc bias supplies current through R52, CR46, and CR44 to discharge C27 after Q7 stops conducting.

4-31. GATE INPUT. Throughout the operation of the blocking oscillator, capacitor C25 supplies most of the collector current for Q4 in the gating circuit (refer to para. 4-25). The amount of current pulled from C25 by Q4 is determined by the input (from the voltage or current input circuit) to the gating circuit. As a result of this current flow from C25, the voltage across C25 increases negatively with respect to the 6.0-vdc bias and has a waveshape that approximates a linear ramp. Thus, the slope of this ramp is determined by the voltage or current input circuit. Due to the time delay in the feedback loop, the slope of the ramp is constant for a half cycle of the ac input. The voltage on C25 is the emitter bias (forward bias when negative) for Q7 and therefore helps determine the point at which Q7 conducts.

4-32. AC INPUT. The ac input to transformer T2 is stepped-down and full-wave rectified by bridge rectifier CR39 through CR43. The output of the bridge rectifier is a negative-going pulsating dc (120 cps). Voltage divider R50-R51 supplies a portion of this pulsating dc through C27 to the base of Q7; thus, the base is reverse biased.

4-33. FIRING. A point is reached during each cycle of the 120-cps pulsating dc (each half cycle of the 60-cps ac input) when the reverse bias on the base and the forward bias (capacitor C25) on the emitter of Q7 are equal, and therefore Q7 has zero bias. As the ramp voltage across C25 goes more negative than the base voltage, the base-emitter junction of Q7 begins to become forward biased. When the emitter is more negative than the base by approximately 0.5 volts, Q7 conducts. The firing point of Q7 is therefore determined by both the dc output error and the line voltage change. Because Q7 saturates when it conducts, the collector voltage approximates a rectangular wave with a negative going pulse width of approximately 20 microseconds (determined by C27 and R51). The conduction of Q7 charges C25 in the positive direction (clamped by CR49). When Q7 stops conducting, the ramp across C25 begins again. However, Q7 is held cut-off by the charge on C27.

4-34. INITIAL CONDITIONS. At the beginning of each cycle of the 120-cps pulsating dc, certain initial conditions must be established on capacitors C25 and C27. When the negative-going pulsating dc is at the end of its cycle (C27 negatively charged earlier in the cycle by the feedback voltage), CR44 and CR45 become forward biased and current flows from the 39-vdc bias through R52, CR46, and CR44 to discharge C27 to approximately zero volts and through R52, CR46, and CR45 to charge C25 to approximately 0.7 volts (clamped by CR49). This discharge and charge occurs rapidly, so that it is completed before the next cycle begins and Q7 can conduct again. Diode CR47 provides another path for the current through CR44 so that the voltage to which C27 discharges remains predictable. As the negative-going pulsating dc increases in the next cycle, CR44 and CR45 become reverse biased.

4-35. BRIDGE RECTIFIER. At the zero cross-over region of the voltage waveform on secondary winding 3-4 of transformer T2, the voltage is insufficient to forward bias the rectifiers in the bridge. In order to maintain definition between the end of one cycle of the rectified output and the beginning of the next cycle, diode CR41 provides approximately 0.7 volts at the rectified output. The current for CR41 is supplied through CR46. As the voltage across the secondary winding moves away from the zero cross-over region, CR41 becomes reverse biased.

4-36. TRANSIENTS, DECOUPLING AND PROTECTION. Transients in the pulsating dc are reduced by R56 and C28. The base of Q7 is decoupled by C3. The voltage spike in the collector of Q7, induced by secondary winding 1-2 of transformer T3 when Q7 cuts-off, is clamped by CR48. The collector is decoupled by R53 and C26.

4-37. SCR REGULATOR

4-38. GENERAL. The SCR regulator (CR17 and CR18) controls the ac input voltage and current to main power transformer T1 in response to the voltage and current error signals. In constant voltage operation, the ac input voltage to T1 is adjusted so that the output voltage remains constant with changing loads. In constant current operation, the ac input current to T1 is adjusted so that the output current remains constant with changing loads and the output voltage is allowed to vary.

4-39. GATING. Each half cycle of the ac input, either CR17 or CR18 is forward biased. The pulse induced in secondary windings 5-6 and 7-8 of T3 by the SCR control, turns on the SCR that is forward biased when the pulse occurs. The other SCR is not affected by the gate pulse because it is reverse biased. A gate pulse occurs each half cycle of the ac input, unless the output is open. The timing of the gate pulse with respect to the ac input is determined by the error in the dc output via the loop action.

4-40. AC INPUT CONTROL. When an SCR is gated on, it conducts until its anode-to-cathode voltage goes to approximately zero. Thus, the earlier an SCR is gated on, the greater the portion of the ac input that will be applied to T1. Because of the leakage inductance of T1, the conduction of an SCR may extend into the next half cycle. The conduction period may be shortened at high output by the voltage across capacitor C13 and C14 being reflected back into the primary. By controlling the ac input to T1 each half cycle, the average value of the voltage or current at the output of bridge rectifier CR19 through CR21 is adjusted so that dc output voltage or current is maintained constant.

4-41. PROTECTION. Diodes CR50 and CR51 prevent anode induced reverse gate currents from being fed back to the control circuit. Resistors R54 and R55 limit current in the SCR gates.

4-42. BIAS AND REFERENCE CIRCUIT

4-43. GENERAL. The bias and reference circuit supplies three voltages (+39, +6.0, and -19.5 vdc) for internal power supply operation, and maintains the programming currents constant. The +39 vdc is not regulated. The -19.5 vdc, +6.0 vdc, and the programming currents are regulated.

4-44. +39 AND +6.0 VDC. The output of secondary winding 5-6 of transformer T2 is full-wave rectified by CR30 and CR31. Capacitors C20 and C21 each charge to the peak rectified voltage (voltage doubling). The +6.0 vdc (with respect to -S) is maintained by diodes CR6 and CR14 and by zener diode VR4. The +39 vdc includes the +6.0 vdc and the voltage across C21. The +6.0 vdc and the negative voltage across C20 provide the unregulated input to the -19.5 vdc regulator.

4-45. -19.5 VDC. For the -19.5 vdc, transistor Q10 is the error detector/amplifier. Zener diode VR3 and diode CR27 provide a reference voltage at the emitter of Q10. Voltage divider R35-R36 supplies an error voltage to the base of

Q10 which amplifies and applies it to the base of series regulator Q11. The base drive of Q11 adjusts the voltage across Q11 as required to compensate for the error in the -19.5 vdc. Resistor R37 sets the optimum current through temperature-compensated zener diode VR3. Resistor R45 improves the line regulation. Resistor R56 reduces power dissipation in Q11. Capacitor C22 stabilizes the loop.

4-46. PROGRAMMING CURRENTS. Each programming current is held constant in a similar manner. The voltage across emitter resistors R38 and R40 is held constant by VR3, CR27, and the base-emitter drop of each transistor. Thus, the emitter current in each transistor is constant and therefore the collector currents are nearly constant. The collector currents of Q5 and Q6 are the constant voltage and constant current programming currents, respectively. Resistors R39 and R41 are used for trimming. Resistors R42 and R43 are collector loads. Diode CR28 clamps the collector of Q5 to protect against excessive positive voltage (breakdown) which might occur if the voltage controls are reduced to zero rapidly (positive dc output voltage would appear at collector).

Table 5-1. Test Equipment

Type	Required Characteristics	Use	Recommended Model
Differential Voltmeter	Sensitivity: 1mv full scale (min.) Input impedance; 10 megohms	Measure regulation and dc voltages; calibrate meters	HP 741A (See note)
AC Voltmeter	Accuracy: 2% Sensitivity: 1mv full scale (min.)	Measure ac voltages and ripple	HP 403B
Variable Voltage Transformer	Range: 90-130 volts Equipped with voltmeter accurate within 1 volt	Vary and measure ac input voltage	-----
Oscilloscope	Sensitivity: 5mv/cm (min.). Diff. input	Measure ripple and transient response	HP 130C
Battery	60 vdc	Measure transient response	-----
Switch	15-ampere capacity	Transient response; Constant current load regulation	-----
Resistor	4 ohm, $\pm 5\%$, 1 kw	Load resistor	Rex Rheostat (See note 2)
Resistor	3.3 milliohm, 15 amperes 4 terminals	Current monitoring	Any 50 mv, 15 ampere meter shunt
Resistor	1,000 ohms, $\pm 1\%$ 2w non-inductive	Measure impedance	-----
Resistor	100 ohms, $\pm 5\%$, 10w	Measure impedance	-----
Capacitor	500 μ fd, 50 vdcw	Measure impedance	-----
Oscillator	Range: 1 cps to 100 kc Accuracy: 2% Output: 10 vrms	Measure impedance	HP 202C

Table 5-1. Test Equipment (cont.)

Type	Required Characteristics	Use	Recommended Model
Controlled-temperature oven	Range: 0-50°C	Measure temperature stability	-----
Resistance box	Range: 0-18,000 ohms Accuracy: 0.1% plus 1 ohm Make-before-break contacts	Measure programming coefficients	H-Lab 6931A

NOTE 1

A satisfactory substitute for a differential voltmeter is to arrange a reference voltage source and null detector as shown in figure 5-1. The reference voltage source is adjusted so that the voltage difference between the supply being measured and the reference voltage will have the required resolution for the measurement being made. The voltage difference will be a function of the null detector that is used. For measurements at the base of transistor Q4, a null detector with input impedance of 10 megohms or greater is required. Otherwise, satisfactory null detectors are: HP 405AR digital voltmeter, HP412A dc voltmeter, HP 419A null detector, a dc coupled oscilloscope utilizing differential input, or a 50 mv meter movement with a 100 division scale. A 2 mv change in voltage will result in a meter deflection of four divisions.

CAUTION

Care must be exercised when using an electronic null detector in which one input terminal is grounded to avoid ground loops and circulating currents.

NOTE 2

To obtain 4 ohms, connect rheostat across output terminals, turn front-panel CURRENT controls fully clockwise (maximum), adjust front-panel VOLTAGE controls for 60 vdc and adjust rheostat until current is 15 amperes. Use fan to cool rheostat.

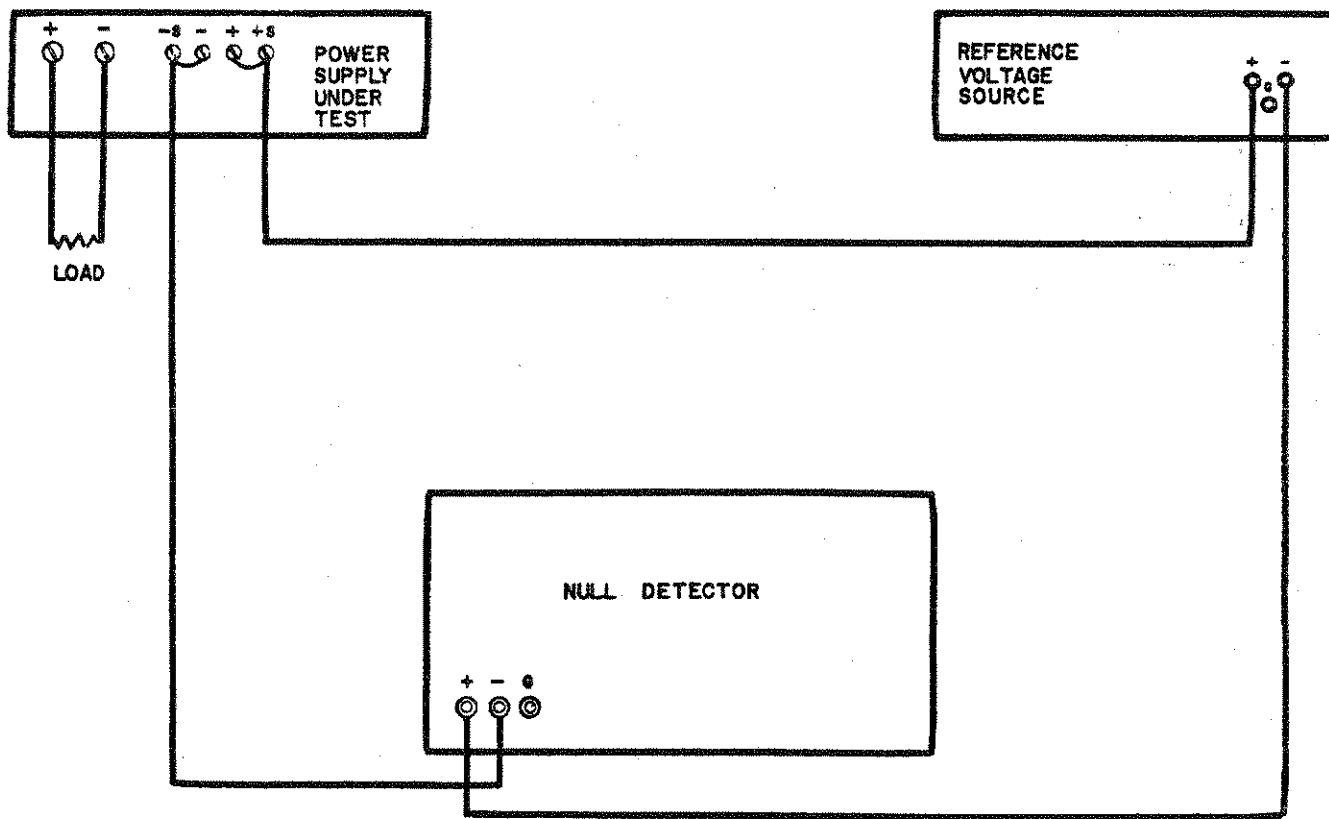

FIGURE 5-1. DIFFERENTIAL VOLTMETER SUBSTITUTE, TEST SETUP

SECTION V
MAINTENANCE

5-1. GENERAL

5-2. Table 5-1 lists the type of test equipment, its required characteristics, its use, and a recommended model for performing the instructions given in this section. Upon receipt of the power supply, the performance check (para. 5-7) should be made. This check is suitable for incoming inspection. Additional specification checks are given in paragraphs 5-24 through 5-36. If a fault is detected in the power supply while making the performance check or during normal operation, proceed to the troubleshooting procedures (para. 5-39). After troubleshooting and repair (para. 5-50), perform any necessary adjustments and calibrations (para. 5-51). Before returning the power supply to normal operation, repeat the performance check to ensure that the fault has been properly corrected and that no other faults exist. Before doing any maintenance checks, turn-on power supply, allow a half-hour warm-up, and read the measurement techniques (para. 5-3).

5-3. MEASUREMENT TECHNIQUES

5-4. A measurement made across the load includes the effect of the impedance of the leads connecting the load; these leads can have an impedance several orders of magnitude greater than the output impedance of the power supply. When measuring the output voltage of the power supply, use the -S and +S terminals.

5-5. For output current measurements, the current monitoring resistor should be a four-terminal resistor. The four terminals are connected as shown in figure 5-2.

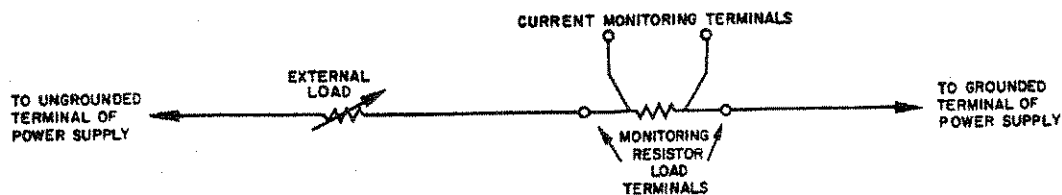

Figure 5-2. Output Current Measurement Technique

5-6. When using an oscilloscope, ground one terminal of the power supply and ground the case at the same ground point. Make certain that the case is not also grounded by some other means (power line). Connect both oscilloscope input leads to the power supply ground terminal and check that the oscilloscope is not exhibiting a ripple or transient due to ground loops, pick-up, or other means.

5-7. PERFORMANCE CHECK

5-8. GENERAL

5-9. The performance check is made using a 115-volt, 60-cps, single-phase input power source. The performance check is normally made at a constant ambient room temperature. The temperature range specification can be verified by doing the performance check at a controlled temperature of 0°C and at a controlled temperature of 50°C. If the correct result is not obtained for a particular check, do not adjust any controls; proceed to troubleshooting (para. 5-39).

5-10. RATED OUTPUT AND METER ACCURACY

5-11. CONSTANT VOLTAGE. Proceed as follows:

- a. Connect the 4 -ohm load resistor across the output terminals and the differential voltmeter across the -S and +S terminals.
- b. Turn front-panel CURRENT controls fully clockwise (maximum).
- c. Turn front-panel VOLTAGE controls until front-panel voltmeter indicates 60 vdc.
- d. The differential voltmeter should indicate 60 ± 1.2 vdc.

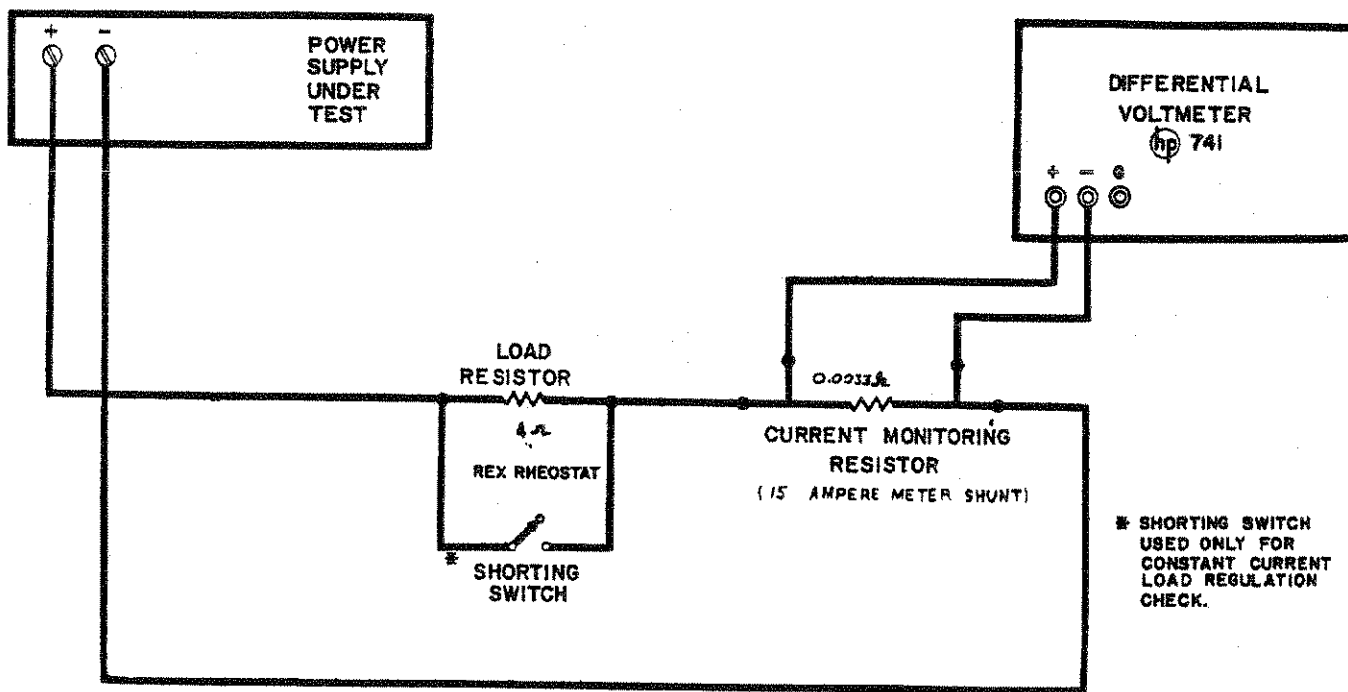

FIGURE 5-3. CONSTANT CURRENT TEST-SETUP

5-12. CONSTANT CURRENT. Proceed as follows:

- a. Connect test setup shown in figure 5-3.
- b. Turn front-panel VOLTAGE controls fully clockwise (maximum).
- c. Turn front-panel CURRENT controls until front-panel ammeter indicates 15 amperes.
- d. The differential voltmeter should indicate 50 ± 1.0 mvdc.

5-13. LINE REGULATION

5-14. CONSTANT VOLTAGE. Proceed as follows:

- a. Connect the 4 -ohm load resistor across the output terminals and the differential voltmeter across the -S and +S terminals.
- b. Turn front-panel CURRENT controls fully clockwise (maximum).
- c. Connect the variable voltage transformer between the input power source and the power supply power input. Adjust the variable voltage transformer to 105 vac.
- d. Turn front-panel VOLTAGE controls until the differential voltmeter indicates 60 vddt.
- e. Adjust the variable voltage transformer to 125 vac.
- f. Differential voltmeter indication should change by less than 60 mvdc.

5-15. CONSTANT CURRENT. Proceed as follows:

- a. Connect test setup shown in figure 5-3.
- b. Turn front-panel VOLTAGE controls fully clockwise (maximum).
- c. Connect the variable voltage transformer between the input power source and the power supply power input. Adjust the variable voltage transformer to 105 vac.
- d. Turn front-panel CURRENT controls until front-panel ammeter indicates 15 amperes.
- e. Record voltage indicated on differential voltmeter
- f. Adjust the variable voltage transformer to 125 vac.
- g. Differential voltmeter indication should change by less than 0.5 mvdc.

5-16. LOAD REGULATION

5-17. CONSTANT VOLTAGE. Proceed as follows:

- a. Connect the 4 -ohm load resistor across the output terminals and the differential voltmeter across the -S and +S terminals.
- b. Turn front-panel CURRENT controls fully clockwise (maximum).
- c. Turn the front-panel VOLTAGE controls until front-panel ammeter indicates 1.5 amperes.
- d. Record voltage indicated on differential voltmeter.
- e. Disconnect load resistor.
- f. Differential voltmeter indication should change by less than 120 mvdc.

5-18. CONSTANT CURRENT. Proceed as follows:

- a. Connect test setup shown in figure 5-3.
- b. Turn front-panel VOLTAGE controls fully clockwise (maximum).
- c. Turn front-panel CURRENT controls until front-panel ammeter indicates 45 amperes.
- d. Record voltage indicated on differential voltmeter.
- e. Close the shorting switch.
- f. Differential voltmeter indication should change by less than 0.5 mvdc.

5-19. RIPPLE AND NOISE

5-20. Proceed as follows:

- a. Connect the 4 -ohm load resistor across the output terminals and the ac voltmeter across the -S and +S terminals.
- b. Turn front-panel CURRENT controls fully clockwise (maximum).
- c. Connect the variable voltage transformer between the input power source and the power supply power input. Adjust the variable voltage transformer to 125 vac.
- d. Turn front-panel VOLTAGE controls until front-panel ammeter indicates 15 amperes.
- e. The ac voltmeter should indicate less than 60 mvrms.

5-21. TRANSIENT RECOVERY TIME

5-22. Proceed as follows:

- a. Connect test setup shown in figure 5-4.
- b. Turn front-panel CURRENT controls fully clockwise (maximum).
- c. Turn front-panel VOLTAGE controls until front-panel ammeter indicates 15 amperes.
- d. Open and close the switch several times and observe the oscilloscope display.
- e. Oscilloscope display should be as shown in figure 5-5.

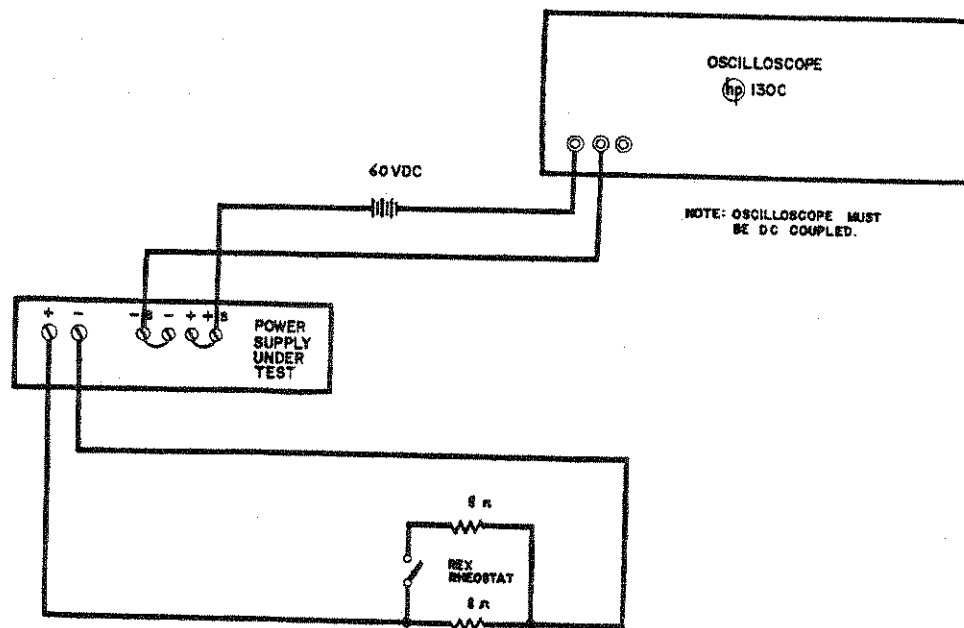

FIGURE 5-4 TRANSIENT RECOVERY TIME, TEST SETUP

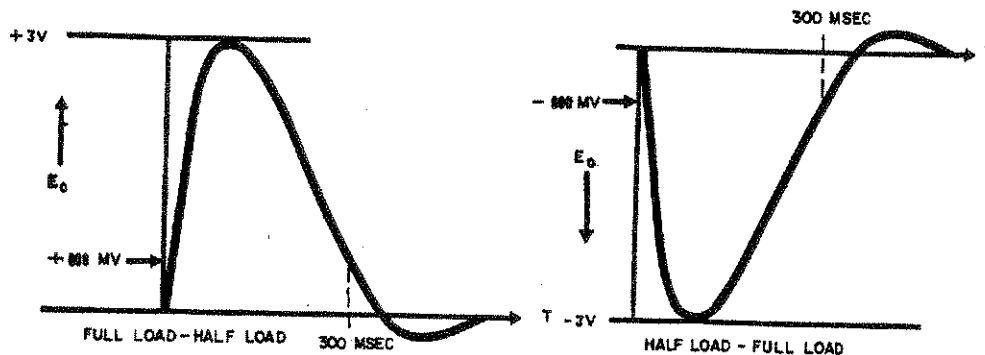

FIGURE 5-5 TRANSIENT RECOVERY TIME, WAVEFORM

5-23. ADDITIONAL SPECIFICATION CHECK

5-24. TEMPERATURE COEFFICIENT

5-25. CONSTANT VOLTAGE. Proceed as follows:

- a. Connect the 4 -ohm load resistor across the output terminals and the differential voltmeter across the -S and +S terminals.
- b. Turn front-panel CURRENT controls fully clockwise (maximum).
- c. Turn front-panel VOLTAGE controls until the differential voltmeter indicates 60 vdc.
- d. Insert the power supply into the controlled-temperature oven (differential voltmeter and load remain outside oven). Set the temperature to 30°C and allow a half-hour warm-up.
- e. Record the differential voltmeter indication.
- f. Raise the temperature to 40°C and allow a half-hour warm-up.
- g. Differential voltmeter indication should change by less than 450 mvdc. from indication recorded in step e.

5-26. CONSTANT CURRENT. Proceed as follows:

- a. Connect test setup shown in figure 5-3.
- b. Turn front-panel VOLTAGE controls fully clockwise (maximum).
- c. Turn front-panel CURRENT controls until the differential voltmeter indicates 50 mvdc.
- d. Insert the power supply into the controlled-temperature oven (differential voltmeter and load remain outside oven). Set the temperature to 30°C and allow a half-hour warm-up.
- e. Record the differential voltmeter indication.
- f. Raise the temperature to 40°C and allow a half-hour warm-up.
- g. Differential voltmeter indication should change by less than 1.5 mvdc from indication recorded in step e.

5-27. OUTPUT STABILITY

5-28. CONSTANT VOLTAGE. Proceed as follows:

- a. Connect the 4 -ohm load resistor across the output terminals and the differential voltmeter across the -S and +S terminals.
- b. Turn front-panel CURRENT controls fully clockwise (maximum).
- c. Turn front-panel VOLTAGE controls until the differential voltmeter indicates 60 vdc.
- d. allow a half-hour warm-up and then record the differential voltmeter indication.
- e. After eight hours, the differential voltmeter indication should change by less than 135 mvdc from indication recorded in step d.

5-29. CONSTANT CURRENT. Proceed as follows:

- a. Connect test setup shown in figure 5-3.
- b. Turn front-panel VOLTAGE controls fully clockwise (maximum).
- c. Turn front-panel CURRENT controls until the differential voltmeter indicates 50 mvdc.
- d. Allow a half-hour warm-up and then record the differential voltmeter indication.
- e. After eight hours, the differential voltmeter indication should change by less than 0.5 mvdc.

5-30. REMOTE PROGRAMMING

5-31. CONSTANT VOLTAGE. Proceed as follows:

- a. Turn-off power supply and arrange rear terminal strapping pattern for constant voltage remote programming as shown in figure 3-4; use the resistance box (set to 7,500 ohms) for the remote programming resistance. (Refer to para. 3-17 through 3-21.)
- b. Connect the 4 -ohm load resistor across the output terminals and the differential voltmeter across the -S and +S terminals.
- c. Turn front-panel CURRENT controls fully clockwise (maximum).
- d. Turn-on power supply, allow a half-hour warm-up and then record the differential voltmeter indication.
- e. Increase the remote programming resistance in 300-ohm steps to 9,000 ohms; record the differential voltmeter indication at each step. The voltage indication should increase 1.0 ± 0.01 vdc at each step.

f. Set the remote programming resistance to 16,500 ohms and repeat step e until the remote programming resistance reaches 18,000 ohms.

g. Turn-off power supply and reconnect normal strapping pattern (figure 3-2)

5-32. CONSTANT CURRENT. Proceed as follows:

a. Turn-off power supply and arrange rear terminal strapping pattern for constant current remote resistance programming as shown in figure 3-6; use the resistance box (set to 75 ohms) for the remote programming resistance. (Refer to para. 3-18 and 3-23 through 3-25.)

b. Connect test setup shown in figure 5-3.

c. Turn front-panel VOLTAGE controls fully clockwise (maximum).

d. Turn-on power supply, allow a half-hour warm-up and then record the differential voltmeter indication.

e. Increase the remote programming resistance in 15-ohm steps to 120 ohms; record the differential voltmeter indication at each step. The voltage indication should increase 3.3 ± 0.33 .

f. Set the remote programming resistance to 180 ohms and repeat step e until the remote programming resistance reaches 225 ohms.

g. Turn-off power supply and reconnect normal strapping pattern (figure 3-2)

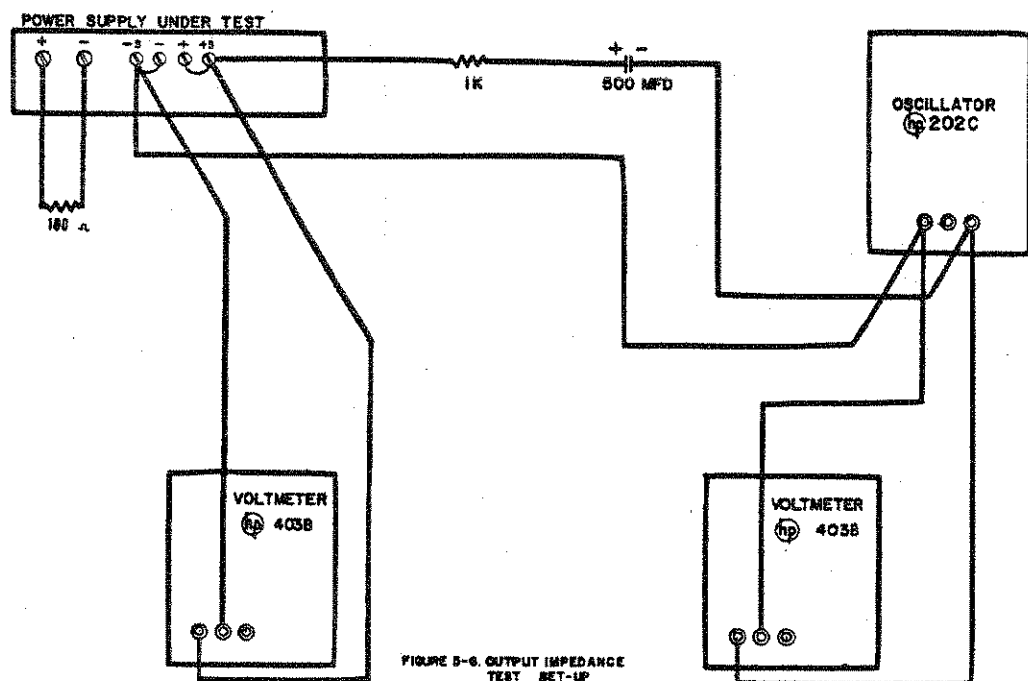

5-33. OUTPUT IMPEDANCE

5-34. Proceed as follows:

- a. Connect test setup shown in figure 5-6.
- b. Turn front-panel CURRENT controls fully clockwise (maximum).
- c. Turn front-panel VOLTAGE controls until front-panel voltmeter indicates 30 vdc.
- d. Adjust the oscillator for a 10-vrms (E_{in}), 0.5-cps output.
- e. Calculate and record the output impedance using the following formula:

$$Z_{out} = E_O R / (E_{in} - E_O)$$

$R = 1,000$ ohms; E_O measured across power supply -S and +S terminals using ac voltmeter; E_{in} measured across oscillator output terminals using the ac voltmeter.

f. Using the formula given in step e, calculate and record the output impedance for oscillator frequencies of 100 cps, 1 kc, and 100 kc.

g. The output impedance calculated and recorded in steps e and f should fall into the following ranges:

- (1) dc to 0.5 cps; less than 0.09 ohm
- (2) 0.5 cps to 100 cps; less than 0.3 ohm
- (3) 100 cps to 1 kc; less than 0.2 ohm
- (4) 1 kc to 100 kc; less than 0.6 ohm

5-35. OUTPUT INDUCTANCE

5-36. Proceed as follows:

- a. Repeat steps a through c of para. 5-34.
- b. Adjust the oscillator for a 10-vrms (E_{in}), 100 - kc output.
- c. Calculate and record the output inductance using the following formula:

$$L = X_L / 2\pi f$$

X_1 is the output impedance (Z_{out}) calculated in steps e and f of paragraph 5-34; f is the frequency of the oscillator (determines which Z_{out} is used).

NOTE

The equation assumes that $X_1 \gg R_{out}$ and therefore $X_1 = Z_{out}$.

d. The output inductance calculated in step c should not exceed 1.0 microhenry.

5-37. COVER REMOVAL

5-38. The top and bottom covers are removed by removing both sets of six attaching screws.

5-39. TROUBLESHOOTING

5-40. GENERAL

5-41. If a fault in the power supply is suspected, remove the covers (para. 5-38) and visually inspect for broken connections, burned components, etc. If the fault is not detected visually, proceed to trouble analysis (para. 5-42). If the fault is detected visually or via trouble analysis, correct it and then do the performance check (para. 5-7). If a part is replaced, refer to repair and replacement (para 5-50) and to adjustments and calibrations (para. 5-51).

5-42. TROUBLE ANALYSIS

5-43. GENERAL. Before attempting trouble analysis, a good understanding of the principles of operation should be acquired by reading Section IV of this manual. Once the principles of operation are understood, logical application of this knowledge in conjunction with significant waveforms (on figure 4-2) and with normal voltage information (table 5-2) should suffice to isolate a fault to a part or small group of parts. As additional aids, the following are given:

a. Procedure for checking the bias and reference circuit. (Refer to para. 5-45.) Trouble in this circuit could show up in many ways because it supplies internal operating voltages for the power supply and the programming currents.

b. Procedures for checking the voltage feedback loop for the two most common troubles; high or low output voltage (para. 5-46 or 5-47, respectively).

c. Paragraph 5-48 which discusses common troubles.

5-44. A defective part should be replaced (refer to the parts list in Section VI). Test points called out in the procedures are identified on the schematic diagram (figure 4-2).

5-45. BIAS AND REFERENCE CIRCUIT. Proceed as follows:

- a. Make an ohmmeter check to be certain that neither the positive nor negative terminal is grounded.
- b. Turn front-panel VOLTAGE and CURRENT controls fully clockwise (maximum).
- c. Turn-on power supply (no load connected).
- d. Using the ac voltmeter, check voltage across secondary winding 5-6 of transformer T2. If voltage indication is not 23 ± 1.5 vrms, transformer T2 may be defective.
- e. Using the differential voltmeter, proceed as instructed in table 5-3.

5-46. HIGH OUTPUT VOLTAGE. Proceed as follows:

- a. Turn front-panel CURRENT controls fully clockwise (maximum).
- b. Turn front-panel VOLTAGE controls to mid-position.
- c. Turn-on power supply (no load connected).
- d. Using the ac voltmeter, check voltage across test points ACC and 45. If voltage indication is less than 1.0 vac, CR17 or CR18 may be shorted.
- e. Using the differential voltmeter, check voltage across test points 33 and 36. If voltage is not 0.8 ± 0.12 vdc, check T2, CR39 through CR43, R50, and R51.
- f. Using the differential voltmeter, proceed as instructed in table 5-4.

5-47. LOW OUTPUT VOLTAGE. Proceed as follows:

- a. Turn front-panel CURRENT controls fully clockwise (maximum).
- b. Disconnect anode or cathode of diode CR8.
- c. Turn-on power supply (no load connected).
- d. Turn front-panel VOLTAGE controls clockwise and observe the front-panel voltmeter to see if the 60 vdc output can be obtained. If it can, the probable cause of the low output voltage is one or more of the following:

- (1) CR8 shorted.
- (2) Q8 shorted.
- (3) Q9 open.
- (4) Q6 open.
- (5) R40, R43 open.

e. If the 60 vdc output cannot be obtained in step d, reconnect diode CR8 and turn the front-panel VOLTAGE controls to mid-position.

f. Using the oscilloscope, check the following:

(1) Waveform across test points 31 (positive lead) and 33 (waveform on figure 4-2). If peak negative voltage is less than 15 volts, Q7, R53, CR48, C25, C26, or transformer T3 may be defective.

(2) Ripple waveform across test points 18 (positive lead) and 48 (waveform shown on figure 4-2). If waveform is correct (except for amplitude), proceed to step (3). If waveform is incorrect, proceed as follows:

(a) If the ripple waveform is half-wave (60 cps) instead of full-wave (120 cps), either SCR (CR17 or CR18) may be open or the applicable gate circuit for the SCR may be defective. To check the gate circuit, disconnect R54 or R55 (as applicable) and make an ohmmeter check from the open end of the resistor to test point ACC or 45 (as applicable). If the resistance is greater than 55 ohms, the gate circuit is defective.

(b) If there is no ripple waveform, both CR17 and CR18 may be open or T1 may be defective.

g. Using the differential voltmeter, proceed as instructed in table 5-5.

5-48. COMMON TROUBLES. Table 5-6 gives the symptoms, checks, and probable causes for common troubles. The checks should be made using a 115-volt, 60-cps, single-phase power input and the test equipment listed in table 5-1.

5-49. REPAIR AND REPLACEMENT

5-50. Before servicing etched circuit boards, refer to figure 5-7. After replacing a semiconductor device, refer to table 5-7 for checks and adjustments that may be necessary. If a check indicates a trouble, refer to paragraph 5-39. If an adjustment is necessary, refer to paragraph 5-51.

SERVICING ETCHED CIRCUIT BOARDS

Excessive heat or pressure can lift the copper strip from the board. Avoid damage by using a low power soldering iron (50 watts maximum) and following these instructions. Copper that lifts off the board should be cemented in place with a quick drying acetate base cement having good electrical insulating properties.

A break in the copper should be repaired by soldering a short length of tinned copper wire across the break.

Use only high quality rosin core solder when repairing etched circuit boards. NEVER USE PASTE FLUX. After soldering, clean off any excess flux and coat the repaired area with a high quality electrical varnish or lacquer.

When replacing components with multiple mounting pins such as tube sockets, electrolytic capacitors, and potentiometers, it will be necessary to lift each pin slightly, working around the components several times until it is free.

WARNING: If the specific instructions outlined in the steps below regarding etched circuit boards without eyelets are not followed, extensive damage to the etched circuit board will result.

1. Apply heat sparingly to lead of component to be replaced. If lead of component passes through an eyelet in the circuit board, apply heat on component side of board. If lead of component does not pass through an eyelet, apply heat to conductor side of board.
2. Reheat solder in vacant eyelet and quickly insert a small awl to clean inside of hole. If hole does not have an eyelet, insert awl or a #57 drill from conductor side of board.

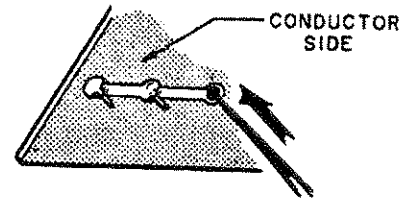
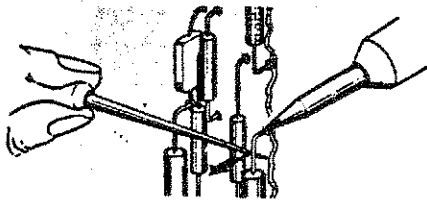

3. Bend clean tinned leads on new part and carefully insert through eyelets or holes in board.
4. Hold part against board (avoid overheating) and solder leads. Apply heat to component leads on correct side of board as explained in step 1.

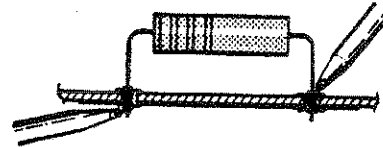
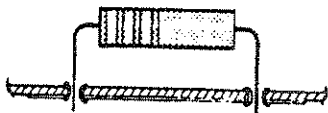

In the event that either the circuit board has been damaged or the conventional method is impractical, use method shown below. This is especially applicable for circuit boards without eyelets.

1. Clip lead as shown below.
2. Bend protruding leads upward. Bend lead of new component around protruding lead. Apply solder using a pair of long nose pliers as a heat sink.

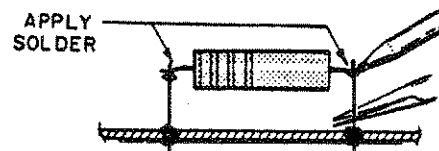
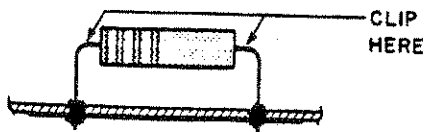

This procedure is used in the field only as an alternate means of repair. It is not used within the factory.

Figure 5-7. Servicing Etched Circuit Boards

5-51. ADJUSTMENTS AND CALIBRATIONS

5-52. GENERAL

5-53. Adjustments and calibrations may be required after performance testing (para. 5-7), additional specification testing (para. 5-23), troubleshooting (para. 5-39), or repair and replacement (para. 5-50). Test points called out in the procedures are identified on the schematic diagram (figure 4-2). If an adjustment or calibration cannot be performed, troubleshooting is required. Table 5-8 summarizes the adjustments and calibrations. The adjustments and calibrations are performed using a 115-volt, 60-cps, single-phase power input to the power supply.

5-54. METER ZERO

5-55. Proceed as follows:

a. Turn-off power supply and allow 2 minutes for all capacitors to discharge.

b. Rotate voltmeter zero-set screw (figure 3-1) clockwise until the meter pointer is to the right of zero and moving to the left towards zero. Stop when pointer is on zero. If the pointer overshoots zero, continue rotating clockwise and repeat this step.

c. When the pointer is exactly on zero, rotate the zero-set screw counter-clockwise approximately 15 degrees to free the screw from the meter suspension. If pointer moves, repeat steps a through c.

d. Repeat steps a through c for the ammeter.

5-56. VOLTMETER TRACKING

5-57. Proceed as follows:

a. Connect the differential voltmeter across the -S and +S terminals.

b. Turn front-panel VOLTAGE controls until the differential voltmeter indicates 120 vdc.

c. Adjust R25 until the front-panel voltmeter indicates 60 vdc.

5-58. AMMETER TRACKING

5-59. Proceed as follows:

a. Connect test setup shown in figure 5-3.

b. Turn front-panel VOLTAGE controls fully clockwise (maximum).

c. Turn front-panel CURRENT controls until the differential voltmeter indicates 50 vdc.

d. Adjust R27 until the front-panel ammeter indicates 15 amperes.

5-60. CONSTANT VOLTAGE PROGRAMMING CURRENT

5-61. Proceed as follows:

a. Connect a 18,000-ohm, 0.1%, 1/2 w resistor between terminals +S and A6 on the rear terminal strip of the power supply.

b. Disconnect the jumper between terminals A6 and A7.

c. Connect the resistance box in place of R39 (shunt).

d. Connect the differential voltmeter between the +S and -S terminals.

e. Adjust the resistance box until the differential voltmeter indicates 60 ± 0.3 vdc.

f. Choose resistor R39 (shunt) equal to the resistance required in step e.

5-62. ZERO VOLTAGE OUTPUT

5-63. Proceed as follows:

a. Connect a jumper between the +S and A7 terminals on the rear terminal strip of the power supply.

b. Connect the differential voltmeter between the +S and -S terminals.

c. Connect the resistance box in place of R6.

d. Adjust the resistance box so that the voltage indicated by the differential voltmeter is between zero and ± 10 mvdc.

e. Choose resistor R6 equal to the resistance value required in step d.

5-64. CONSTANT CURRENT PROGRAMMING CURRENT

5-65. Proceed as follows:

a. Connect test setup shown in figure 5-3.

b. Connect a 225-ohm, 0.1%, 1/2w resistor between terminals A2 and A3 on the rear terminal strip of the power supply.

c. Disconnect the jumper between terminals A1 and A2.

- d. Connect the resistance box in place of R41 (shunt)
- e. Adjust the resistance box until the differential voltmeter indicates 50 ± 5 mvdc.
- f. Choose resistor R41 (shunt) equal to the resistance value required in step e.

5-66. ZERO CURRENT OUTPUT

5-67. Proceed as follows:

- a. Connect test setup shown in figure 5-3.
- b. Connect a jumper between the A1 and A3 terminals on the rear terminal strip of the power supply.
- c. Connect the resistance box in place of R20.
- d. Adjust the resistance box until the voltage indicated by the differential voltmeter is between zero and 5.0mvdc.
- e. Choose resistor R20 equal to the resistance value required in step d.

NOTE

If the resistance value required is less than 7,000 ohms or greater than 17,000 ohms, change R46. Replace the original R20.

5-68. BIAS AND REFERENCE LINE REGULATION

5-69. Proceed as follows:

- a. Connect the variable voltage transformer between the input power source and the power supply power input. Adjust the variable voltage transformer to 105 vac.
- b. Connect the differential voltmeter between the +S and -S terminals.
- c. Connect the resistance box in place of R45.
- d. Turn front-panel VOLTAGE controls until the differential voltmeter indicates 60 vdc.
- e. Adjust the variable voltage transformer to 125 vac.

- f. Adjust the resistance box until the voltage indicated by the differential voltmeter is within 60 mvdc of 60 vdc.
- g. Choose resistor R45 equal to the resistance value required in step f.

NOTE

If the resistance value required is less than 20,000 ohms, troubleshooting is required. Replace the original R45.

5-70. LINE IMBALANCE

- 5-71. Proceed as follows:
 - a. Connect the 4 -ohm load resistor across the output terminals.
 - b. Turn front-panel CURRENT controls fully clockwise (maximum).
 - c. Connect the variable voltage transformer between the input power source and the power supply power input. Adjust the variable voltage transformer to 125 vac.
 - d. Turn front-panel VOLTAGE controls until front-panel ammeter indicates 15 amperes.
 - e. Connect the oscilloscope across test points 18 and 48. Use internal sync.
 - f. Connect the resistance box in place of R17.
 - g. Adjust the resistance box until the oscilloscope display is similar to the waveform for test points 18-48 shown on figure 4-2.
 - h. Choose resistor R17 equal to the resistance value required in step f.

NOTE

If the resistance value required is less than 5,000 ohms, troubleshooting is required. Replace the original R17.

5-72. CONSTANT CURRENT LOAD REGULATION

5-73. Proceed as follows:

- a. Perform steps a through e of para. 5-18.
- b. Place a 22-megohm resistor in place of R44.
- c. Adjust the variable voltage transformer to 125 vac.
- d. Close the shorting switch.
- e. Differential voltmeter indication should change by less than 0.5 mvdc. If voltage change is greater than 0.5 mvdc, reduce the 22-megohm resistor to 20 megohms, set the variable voltage transformer to 105 vac, open the shorting switch, record the differential voltmeter indication, and repeat steps c and d. Repeat this process, reducing the 22-megohm resistor in 2-megohm steps until the voltmeter change is less than 0.5 mvdc. Changes smaller than 2-megohms may be required to obtain the optimum resistance value for R44. Choose resistor R44 equal to the optimum resistance value required.

NOTE

If the resistance value required is less than 3 megohms, troubleshooting is required. Replace the original R44.

Table 5-2. Normal Voltage

From (+)	to (-)	Voltage	Typical Peak-to-Peak Values
-S	51	19.5 ±1.0 vdc	0.05 v
33	27	34.1 ±1.7 vdc	1.0 v
33	-S	6.0 ±0.3 vdc	0.1 v
40	33	33.0 ±1.7 vdc	0.6 v
24	51	10.3 ±0.6 vdc	---
22	51	9.7 ±0.5 vdc	---
21	51	9.7 ±0.5 vdc	---
23	22	7.1 ±0.7 vdc	---
20	21	3.1 ±0.3 vdc	---
39	38	0.81 ±0.1 vdc	---
51	27	6.6 ±2.0 vdc	1.0 v
33	12	6.0 ±0.6 vdc	---
26	27	0.59 ±0.1 vdc	---
-S	25	10.0 ±0.5 vdc	---
18	48	61.5 ± 1.0 vdc	2.0 v
14	19	0.83 ±0.1 vdc	---
-S	A6	0.04 ±0.1 vdc	---
-S	8	0.45 ±0.07 vdc	---
10	-S	0.06 ±0.1 vdc	---
19	-S	0.82 ±0.1 vdc	---
15	19	1.14 ±0.2 vdc	---
33	16	0.74 ±0.5 vdc	---
33	32	7.0 ±1.1 vdc	---
33	36	0.8 ±0.1 vdc	---
41	42	46.0 ±2.3 vpp	---
28	33	66.0 ±3.3 vpp	---
33	38	14.0 ±1.4 vdc	---

NOTE

These measurements were made with a 115-volt, 60-cps, single-phase power input; the front-panel CURRENT controls fully clockwise (maximum); the front-panel VOLTAGE controls set for 60 vdc output; and the 4-ohm load resistor across the output terminals (15 amperes). Differential voltmeter HP 741A was used for all measurements.

Table 5-3. Bias and Reference Circuit Troubleshooting

Step	Meter Common	Meter Positive	Normal Indication	If Indication is not Normal, Check the Following Parts
1	33	40	33 ± 1.7 vdc	CR31, C21
2	-S	33	6.2 ± 0.3 vdc	CR6, CR14, VR4
3	27	33	34.1 ± 1.7 vdc	CR30, C20
4	51	-S	19.5 ± 1.0 vdc	Q10, Q11
5	51	24	10.3 ± 0.6 vdc	CR27, VR3
6	51	22	9.7 ± 0.5 vdc	R40, R43, Q6
7	51	21	9.7 ± 0.5 vdc	R38, R42, Q5

Table 5-4. High Output Voltage Troubleshooting

Step	Meter Common	Meter Positive	Response	Probable Cause
1	Emitter of Q4	29	< 0.5 vdc	a. Q4 shorted b. R16 shorted c. R15 shorted
2	14	17	> 0.85 vdc	CR7 open
3	14	33	< 2 vdc	a. Q1 open b. Q2 shorted c. CR1 shorted d. R2-R8 open

Table 5-5. Low Output Voltage Troubleshooting

Step	Meter Common	Meter Positive	Response	Probable Cause
1	Emitter of Q4	29	> 5 vdc	a. Q4 open b. R16 open c. R15 open
2	14	17	< 0.4 vdc	CR7 shorted
3	14	33	> 6 vdc	a. Q1 shorted b. Q2 open c. R2-R8 shorted

Table 5-6. Common Troubles

Symptom	Checks and Probable Causes
Fuse blows when power supply is turned on.	Power supply has internal short. Disconnect Collector of Q7, turn-on power supply and check voltages (refer to table 5-2 or figure 4-2). If fuse blows with Q7 disconnected, check CR17, CR18, and T3.
Poor line regulation (constant voltage)	<ul style="list-style-type: none"> a. Check bias and reference circuit (para. 5-45). Refer to paragraph 5-69 for adjustment. b. Check line input to SCR regulator control circuit (T2, CR39 through CR43, R50, R51).
Poor load regulation (constant voltage)	<ul style="list-style-type: none"> a. Check bias and reference circuit (para. 5-45). b. Power supply going into current limit. Check constant current input circuit. c. Constant voltage loop oscillates. Check adjustment of R17 (para. 5-71).
Poor line and load regulation (constant current)	<ul style="list-style-type: none"> a. Check bias and reference circuit (para. 5-45). Refer to paragraph 5-69 for adjustment. b. Power supply going into voltage limit. Check constant voltage input circuit. c. Constant current loop oscillates. Check adjustment of R44 (para. 5-73).
High ripple	<ul style="list-style-type: none"> a. Check operating setup for ground loops. b. If output is floating (ungrounded) connect 1-μf capacitor between output and ground (unless particular application prohibits this). c. Check pi-section output filter C13, C17, and R29. d. Line imbalance. Check adjustment of R17 (para. 5-70).
Poor stability (constant voltage)	<ul style="list-style-type: none"> a. Check bias and reference circuit line regulation. (Refer to para. 5-69). b. Noisy programming resistors (R2-R8). c. CR1 or CR2 leaky. d. R1, R5, R40, or R41 noisy or drifting. e. Q1 or Q2 defective.
Poor stability (constant current)	<ul style="list-style-type: none"> a. Check bias and reference circuit line regulation. (Refer to para. 5-69). b. Noisy programming resistors (R9-R10). c. R20, R23, R38, or R39 noisy or drifting. d. Q8 defective.

Table 5-6. Common Troubles (cont.)

Symptom	Checks and Probable Causes
Oscillates (constant voltage)	Check R18, C1, C4, and adjustment of R17 (para. 5-71).
Oscillates (constant current)	Check C6, C24, R22, and adjustment of R20 (para. 5-66) and adjustment of R44 (para. 5-72).
Output voltage does not go to zero.	Check R6 and R47. (Refer to para. 5-63.)
Output current does not go to zero.	Check R20 and R46. (Refer to para. 5-67.)

Table 5-7. Checks and Adjustments after Replacement of Semiconductor Devices

Circuit Reference	Function	Check	Adjust
Q1, Q2	Constant voltage differential amplifier	Constant voltage line and load regulation; transient recovery time; zero voltage output	R6, R17
Q3	Turn-on circuit	Excessive transients at turn-on	-----
Q4	Gating Circuit	Constant voltage/constant current line and load regulation	-----
Q5	Constant voltage programming current regulator	Constant voltage programming coefficient	R38-R39
Q6	Constant Current programming current regulator	Constant current programming coefficient	R40-R41
Q7	SCR regulator control	Waveforms (shown in figure 4-2)	-----
Q8, Q9	Constant current differential amplifier	Constant current line and load regulation; zero current output	R20, R44
Q10	Bias and reference error detector/amplifier	Bias and reference circuit line regulation	R45
Q11	Bias and reference series regulator	Bias and reference circuit line regulation	R45
CR1, CR2, CR28	Constant voltage protection	Constant voltage load regulation	-----
CR6, CR9, CR10, CR11, CR12, CR14, CR27, CR46	Forward bias regulators	Voltage across each diode (0.6 to 0.85 vdc)	-----

Table 5-7. Checks and Adjustments after Replacement of Semiconductor Devices (cont.)

Circuit Reference	Function	Check	Adjust
CR17, CR18	SCR regulator	Constant voltage load regulation	-----
CR19, CR20 CR21, CR22	Bridge rectifier	Voltage across bridge at full output (120 vdc)	-----
CR23	Output Protection	Output voltage	-----
CR26	Constant current protection	Constant current line and load regulation	-----
CR30, CR31	Full-wave rectifier	Rectifier output (67 vdc)	-----
CR39, CR40 CR41, CR42 CR43	Bridge rectifier	Voltage across bridge (20-25 peak, full wave)	-----
CR5, CR7, CR8, CR44, CR45, CR47, CR48, CR49, CR50, CR51,	Diode switches	-----	-----
VR1	Constant voltage programming protection	Full output voltage and zero output voltage obtainable via VOLTAGE controls; voltage regulation at 120 vdc output	-----
VR3	Voltage reference	Bias and reference circuit line regulation	R45
VR4	Voltage reference	6.0 vdc line regulation	-----

Table 5-8. Adjustment and Calibration Summary

Adjustment or Calibration	Paragraph Reference	Control Device
Meter Zero	5-55	Meter Spring
Voltmeter Tracking	5-57	R25
Ammeter Tracking	5-59	R27
Constant Voltage Programming Current	5-61	R39
Zero Voltage Output	5-63	R6
Constant Current Programming Current	5-65	R41
Zero Current Output	5-67	R20
Bias and Reference Line Regulation	5-69	R45
Line Imbalance	5-71	R17
Constant Current Load Regulation	5-73	R44

SECTION VI REPLACEABLE PARTS

6-1 INTRODUCTION

6-2 This section contains information for ordering replacement parts. Table 6-4 lists parts in alpha-numeric order by reference designators and provides the following information:

- a. Reference Designators. Refer to Table 6-1.
- b. Description. Refer to Table 6-2 for abbreviations.
- c. Total Quantity (TQ). Given only the first time the part number is listed except in instruments containing many sub-modular assemblies, in which case the TQ appears the first time the part number is listed in each assembly.
- d. Manufacturer's Part Number or Type.
- e. Manufacturer's Federal Supply Code Number. Refer to Table 6-3 for manufacturer's name and address.
- f. Hewlett-Packard Part Number.
- g. Recommended Spare Parts Quantity (RS) for complete maintenance of one instrument during one year of isolated service.
- h. Parts not identified by a reference designator are listed at the end of Table 6-4 under Mechanical and/or Miscellaneous. The former consists of parts belonging to and grouped by individual assemblies; the latter consists of all parts not immediately associated with an assembly.

6-3 ORDERING INFORMATION

6-4 To order a replacement part, address order or inquiry to your local Hewlett-Packard sales office (see lists at rear of this manual for addresses). Specify the following information for each part: Model, complete serial number, and any Option or special modification (J) numbers of the instrument; Hewlett-Packard part number; circuit reference designator; and description. To order a part not listed in Table 6-4, give a complete description of the part, its function, and its location.

Table 6-1. Reference Designators

A = assembly	E = miscellaneous
B = blower (fan)	electronic part
C = capacitor	F = fuse
CB = circuit breaker	J = jack, jumper
CR = diode	K = relay
DS = device, signaling (lamp)	L = inductor
	M = meter

Table 6-1. Reference Designators (Continued)

P = plug	V = vacuum tube, neon bulb, photocell, etc.
Q = transistor	
R = resistor	
S = switch	VR = zener diode
T = transformer	X = socket
TB = terminal block	Z = integrated circuit or network
TS = thermal switch	

Table 6-2. Description Abbreviations

A = ampere	mfr = manufacturer
ac = alternating current	mod. = modular or modified
assy. = assembly	mtg = mounting
bd = board	n = nano = 10^{-9}
bkt = bracket	NC = normally closed
°C = degree Centigrade	NO = normally open
cd = card	NP = nickel-plated
coef = coefficient	Ω = ohm
comp = composition	obd = order by description
CRT = cathode-ray tube	OD = outside diameter
CT = center-tapped	p = pico = 10^{-12}
dc = direct current	P. C. = printed circuit
DPDT = double pole, double throw	pot. = potentiometer
DPST = double pole, single throw	p-p = peak-to-peak
elect = electrolytic	ppm = parts per million
encap = encapsulated	pvr = peak reverse voltage
F = farad	rect = rectifier
°F = degree Fahrenheit	rms = root mean square
fxd = fixed	Si = silicon
Ge = germanium	SPDT = single pole, double throw
H = Henry	SPST = single pole, single throw
Hz = Hertz	SS = small signal
IC = integrated circuit	T = slow-blow
ID = inside diameter	tan. = tantalum
incnd = incandescent	Ti = titanium
k = kilo = 10^3	V = volt
m = milli = 10^{-3}	var = variable
M = mega = 10^6	ww = wirewound
μ = micro = 10^{-6}	W = Watt
met. = metal	

Table 6-3. Code List of Manufacturers

CODE NO.	MANUFACTURER	ADDRESS
00629	EBY Sales Co., Inc.	Jamaica, N. Y.
00656	Aerovox Corp.	New Bedford, Mass.
00853	Sangamo Electric Co. S. Carolina Div.	Pickens, S. C.
01121	Allen Bradley Co.	Milwaukee, Wis.
01255	Litton Industries, Inc.	Beverly Hills, Calif.
01281	TRW Semiconductors, Inc.	Lawndale, Calif.
01295	Texas Instruments, Inc. Semiconductor-Components Div.	Dallas, Texas
01686	RCL Electronics, Inc.	Manchester, N. H.
01930	Amerock Corp.	Rockford, Ill.
02107	Sparta Mfg. Co.	Dover, Ohio
02114	Ferroxcube Corp.	Saugerties, N. Y.
02606	Fenwal Laboratories	Morton Grove, Ill.
02660	Amphenol Corp.	Broadview, Ill.
02735	Radio Corp. of America, Solid State and Receiving Tube Div.	Somerville, N. J.
03508	G. E. Semiconductor Products Dept.	Syracuse, N. Y.
03797	Eldema Corp.	Compton, Calif.
03877	Transitron Electronic Corp.	Wakefield, Mass.
03888	Pyrofilm Resistor Co. Inc.	Cedar Knolls, N. J.
04009	Arrow, Hart and Hegeman Electric Co.	Hartford, Conn.
04072	ADC Electronics, Inc.	Harbor City, Calif.
04213	Caddell & Burns Mfg. Co. Inc.	Mineola, N. Y.
04404	*Hewlett-Packard Co. Palo Alto Div.	Palo Alto, Calif.
04713	Motorola Semiconductor Prod. Inc.	Phoenix, Arizona
05277	Westinghouse Electric Corp. Semiconductor Dept.	Youngwood, Pa.
05347	Ultronix, Inc.	Grand Junction, Colo.
05820	Wakefield Engr. Inc.	Wakefield, Mass.
06001	General Elect. Co. Electronic Capacitor & Battery Dept.	Irmo, S. C.
06004	Bassik Div. Stewart-Warner Corp.	Bridgeport, Conn.
06486	IRC Div. of TRW Inc. Semiconductor Plant	Lynn, Mass.
06540	Amatom Electronic Hardware Co. Inc.	New Rochelle, N. Y.
06555	Beede Electrical Instrument Co.	Penacook, N. H.
06666	General Devices Co. Inc.	Indianapolis, Ind.
06751	Semcor Div. Components, Inc.	Phoenix, Arizona
06776	Robinson Nugent, Inc.	New Albany, Ind.
06812	Torrington Mfg. Co., West Div.	Van Nuys, Calif.
07137	Transistor Electronics Corp.	Minneapolis, Minn.

CODE NO.	MANUFACTURER	ADDRESS
07138	Westinghouse Electric Corp. Electronic Tube Div.	Elmira, N. Y.
07263	Fairchild Camera and Instrument Corp. Semiconductor Div.	Mountain View, Calif.
07387	Birtcher Corp.	Los Angeles, Calif.
07397	Sylvania Electric Prod. Inc. Sylvania Electronic Systems Western Div.	Mountain View, Calif.
07716	IRC Div. of TRW Inc.	Burlington Plant Burlington, Iowa
07910	Continental Device Corp.	Hawthorne, Calif.
07933	Raytheon Co. Components Div. Semiconductor Operation	Mountain View, Calif.
08484	Breeze Corporations, Inc.	Union, N. J.
08530	Reliance Mica Corp.	Brooklyn, N. Y.
08717	Sloan Company, The	Sun Valley, Calif.
08730	Vemaline Products Co. Inc.	Wyckoff, N. J.
08806	General Elect. Co. Minia- ture Lamp Dept.	Cleveland, Ohio
08863	Nylomatic Corp.	Norrisville, Pa.
08919	RCH Supply Co.	Vernon, Calif.
09021	Airco Speer Electronic Components	Bradford, Pa.
09182	*Hewlett-Packard Co. New Jersey Div.	Rockaway, N. J.
09213	General Elect. Co. Semiconductor Prod. Dept.	Buffalo, N. Y.
09214	General Elect. Co. Semiconductor Prod. Dept.	Auburn, N. Y.
09353	C & K Components Inc.	Newton, Mass.
09922	Burndy Corp.	Norwalk, Conn.
11115	Wagner Electric Corp. Tung-Sol Div.	Bloomfield, N. J.
11236	CTS of Berne, Inc.	Berne, Ind.
11237	Chicago Telephone of Cal. Inc.	So. Pasadena, Calif.
11502	IRC Div. of TRW Inc.	Boone Plant Boone, N. C.
11711	General Instrument Corp Rectifier Div.	Newark, N. J.
12136	Philadelphia Handle Co. Inc.	Camden, N. J.
12615	U. S. Terminals, Inc.	Cincinnati, Ohio
12617	Hamlin Inc.	Lake Mills, Wisconsin
12697	Clarostat Mfg. Co. Inc.	Dover, N. H.
13103	Thermalloy Co.	Dallas, Texas
14493	*Hewlett-Packard Co. Loveland Div.	Loveland, Colo.
14655	Cornell-Dubilier Electronics Div. Federal Pacific Electric Co.	Newark, N. J.
14936	General Instrument Corp. Semicon- ductor Prod. Group	Hicksville, N. Y.
15801	Fenwal Elect.	Framingham, Mass.
16299	Corning Glass Works, Electronic Components Div.	Raleigh, N. C.

*Use Code 28480 assigned to Hewlett-Packard Co., Palo Alto, California

Table 6-3. Code List of Manufacturers (Continued)

CODE NO.	MANUFACTURER	ADDRESS
16758	Delco Radio Div. of General Motors Corp.	Kokomo, Ind.
17545	Atlantic Semiconductors, Inc.	Asbury Park, N. J.
17803	Fairchild Camera and Instrument Corp Semiconductor Div. Transducer Plant	Mountain View, Calif.
17870	Daven Div. Thomas A. Edison Industries McGraw-Edison Co.	Orange, N. J.
18324	Signetics Corp.	Sunnyvale, Calif.
19315	Bendix Corp. The Navigation and Control Div.	Teterboro, N. J.
19701	Electra/Midland Corp.	Mineral Wells, Texas
21520	Fansteel Metallurgical Corp.	No. Chicago, Ill.
22229	Union Carbide Corp. Electronics Div.	Mountain View, Calif.
22753	UID Electronics Corp.	Hollywood, Fla.
23936	Pamotor, Inc.	Pampa, Texas
24446	General Electric Co.	Schenectady, N. Y.
24455	General Electric Co. Lamp Div. of Con- sumer Prod. Group	Nela Park, Cleveland, Ohio
24655	General Radio Co.	West Concord, Mass.
24681	LTV Electrosystems Inc Memcor/Com- ponents Operations	Huntington, Ind.
26982	Dynacool Mfg. Co. Inc.	Saugerties, N. Y.
27014	National Semiconductor Corp.	Santa Clara, Calif.
28480	Hewlett-Packard Co.	Palo Alto, Calif.
28520	Heyman Mfg. Co.	Kenilworth, N. J.
28875	IMC Magnetics Corp.	New Hampshire Div. Rochester, N. H.
31514	SAE Advance Packaging, Inc.	Santa Ana, Calif.
31827	Budwig Mfg. Co.	Ramona, Calif.
33173	G. E. Co. Tube Dept.	Owensboro, Ky.
35434	Lectrohm, Inc.	Chicago, Ill.
37942	P. R. Mallory & Co. Inc.	Indianapolis, Ind.
42190	Muter Co.	Chicago, Ill.
43334	New Departure-Hyatt Bearings Div. General Motors Corp.	Sandusky, Ohio
44655	Ohmite Manufacturing Co.	Skokie, Ill.
46384	Penn Engr. and Mfg. Corp.	Doylestown, Pa.
47904	Polaroid Corp.	Cambridge, Mass.
49956	Raytheon Co.	Lexington, Mass.
55026	Simpson Electric Co. Div. of American Gage and Machine Co.	Chicago, Ill.
56289	Sprague Electric Co.	North Adams, Mass.
58474	Superior Electric Co.	Bristol, Conn.
58849	Syntron Div. of FMC Corp.	Homer City, Pa.
59730	Thomas and Betts Co.	Philadelphia, Pa.
61637	Union Carbide Corp.	New York, N. Y.
63743	Ward Leonard Electric Co.	Mt. Vernon, N. Y.

CODE NO.	MANUFACTURER	ADDRESS
70563	Amperite Co. Inc.	Union City, N. J.
70901	Beemer Engrg. Co.	Fort Washington, Pa.
70903	Belden Corp.	Chicago, Ill.
71218	Bud Radio, Inc.	Willoughby, Ohio
71279	Cambridge Thermionic Corp.	Cambridge, Mass.
71400	Bussmann Mfg. Div. of McGraw & Edison Co.	St. Louis, Mo.
71450	CTS Corp.	Elkhart, Ind.
71468	I. T. T. Cannon Electric Inc.	Los Angeles, Calif.
71590	Globe-Union Inc.	Milwaukee, Wis.
71700	General Cable Corp. Cornish Wire Co. Div.	Williamstown, Mass.
71707	Coto Coil Co. Inc.	Providence, R. I.
71744	Chicago Miniature Lamp Works	Chicago, Ill.
71785	Cinch Mfg. Co. and Howard B. Jones Div.	Chicago, Ill.
71984	Dow Corning Corp.	Midland, Mich.
72136	Electro Motive Mfg. Co. Inc.	Willimantic, Conn.
72619	Dialight Corp.	Brooklyn, N. Y.
72699	General Instrument Corp.	Newark, N. J.
72765	Drake Mfg. Co.	Harwood Heights, Ill.
72962	Elastic Stop Nut Div. of Amerace Esna Corp.	Union, N. J.
72982	Erie Technological Products Inc.	Erie, Pa.
73096	Hart Mfg. Co.	Hartford, Conn.
73138	Beckman Instruments Inc. Helipot Div.	Fullerton, Calif.
73168	Fenwal, Inc.	Ashland, Mass.
73293	Hughes Aircraft Co. Electron Dynamics Div.	Torrance, Calif.
73445	Amperex Electronic Corp.	Hicksville, N. Y.
73506	Bradley Semiconductor Corp.	New Haven, Conn.
73559	Carling Electric, Inc.	Hartford, Conn.
73734	Federal Screw Products, Inc.	Chicago, Ill.
74193	Heinemann Electric Co.	Trenton, N. J.
74545	Hubbell Harvey Inc.	Bridgeport, Conn.
74868	Amphenol Corp. Amphenol RF Div.	Danbury, Conn.
74970	E. F. Johnson Co.	Waseca, Minn.
75042	IRC Div. of TRW, Inc.	Philadelphia, Pa.
75183	*Howard B. Jones Div. of Cinch Mfg. Corp.	New York, N. Y.
75376	Kurz and Kasch, Inc.	Dayton, Ohio
75382	Kilka Electric Corp.	Mt. Vernon, N. Y.
75915	Littlefuse, Inc.	Des Plaines, Ill.
76381	Minnesota Mining and Mfg. Co.	St. Paul, Minn.
76385	Minor Rubber Co. Inc.	Bloomfield, N. J.
76487	James Millen Mfg. Co. Inc.	Malden, Mass.
76493	J. W. Miller Co.	Compton, Calif.

*Use Code 71785 assigned to Cinch Mfg. Co., Chicago, Ill.

Table 6-3. Code List of Manufacturers (Continued)

CODE NO.	MANUFACTURER	ADDRESS	CODE NO.	MANUFACTURER	ADDRESS
76530	Cinch	City of Industry, Calif.	83508	Grant Pulley and Hardware Co.	West Nyack, N. J.
76854	Oak Mfg. Co. Div. of Oak		83594	Burroughs Corp. Electronic	Plainfield, N. J.
77068	Electro/Netics Corp.	Crystal Lake, Ill.	83835	Components Div.	Morristown, N. J.
77122	Bendix Corp., Electrodynamics Div.	No. Hollywood, Calif.	83877	U. S. Radium Corp.	New York, N. J.
77147	Palnut Co.	Mountainside, N. J.	84171	Yardeny Laboratories, Inc.	Great Neck, N. J.
77221	Patton-MacGuyer Co.	Providence, R. I.	84411	Arco Electronics, Inc.	Ogallala, Neb.
77252	Phaostron Instrument and Electronic Co.	South Pasadena, Calif.	86684	TRW Capacitor Div.	Harrison, N. J.
77342	Philadelphia Steel and Wire Corp.	Philadelphia, Pa.	86838	RCA Corp. Electronic Components	Newark, N. J.
77630	American Machine and Foundry Co.	Princeton, Ind.	87034	Rummel Fibre Co.	Anaheim, Calif.
77764	Potter and Brumfield Div.	Camden, N. J.	87216	Marco & Oak Industries a Div. of Oak	Lansdale, Pa.
78189	TRW Electronic Components Div.	Harrisburg, Pa.	87585	Philco Corp. Lansdale Div.	Philadelphia, Pa.
78452	Resistance Products Co.	Shakeproof Div.	87929	Stockwell Rubber Co. Inc.	Bridgeport, Conn.
78488	Illinois Tool Works Inc.	Elgin, Ill.	88140	Tower-Olschan Corp.	Lincoln, Ill.
78526	Everlock Chicago, Inc.	Chicago, Ill.	88245	Cutler-Hammer Inc. Power Distribution	Lincoln, Ill.
78533	Stackpole Carbon Co.	St. Marys, Pa.	90634	and Control Div. Lincoln Plant	Van Nuys, Calif.
78544	Stanwyck Winding Div. San Fernando	Newburgh, N. Y.	90763	Litton Precision Products Inc, USECO	Metuchen, N. J.
79136	Electric Mfg. Co. Inc.	Cleveland, Ohio	91345	Div. Litton Industries	Chicago, Ill.
79307	Tinnerman Products, Inc.	Yonkers, N. Y.	91418	Gulton Industries Inc.	El Monte, Calif.
79727	Stewart Stamping Corp.	L. I. C., N. Y.	91506	United-Car Inc.	Chicago, Ill.
79963	Waldes Kohinor, Inc.	New York, N. Y.	91662	Miller Dial and Nameplate Co.	Chicago, Ill.
80031	Whitehead Metals Inc.	Philadelphia, Pa.	91929	Radio Materials Co.	Attleboro, Mass.
80294	Continental-Wirt Electronics Corp.	Mt. Kisco, N. Y.	92825	Augat, Inc.	Columbus, Neb.
81042	Zierick Mfg. Co.	Morristown, N. J.	93332	Dale Electronics, Inc.	Willow Grove, Pa.
81751	Mepco Div. of Sessions Clock Co.	Riverside, Calif.	93410	Elco Corp.	Freeport, Ill.
82099	Bourns, Inc.	Racine, Wisc.	94144	Honeywell Inc. Div. MicroSwitch	Schiller Pk., Ill.
82142	Howard Industries Div. of Msl Ind. Inc.	La Grange, Ill.	94154	Whitso, Inc.	Livingston, N. J.
82219	Grayhill, Inc.	El Segundo, Calif.	94222	Sylvania Electric Prod. Inc. Semi-	Lester, Pa.
82389	International Rectifier Corp.	Yonkers, N. Y.	95263	conductor Prod. Div.	L. I. C., N. Y.
82647	Columbus Electronics Corp.	Yonkers, N. Y.	95354	Woburn, Mass.	Rolling Meadows, Ill.
82866	Goodyear Sundries & Mechanical Co. Inc.	New York, N. Y.	95712	Bendix Corp. Microwave	Franklin, Ind.
82877	Airco Speer Electronic Components	Du Bois, Pa.	95987	Devices Div.	Chicago, Ill.
82893	Sylvania Electric Products Inc.	Emporium, Pa.	96791	Weckesser Co. Inc.	Janesville, Wis.
83058	Electronic Tube Div. Receiving	Chicago, Ill.	97464	Amphenol Corp. Amphenol	Irvington, N. J.
83186	Tube Operations	Attleboro, Mass.	97702	Controls Div.	Westbury, N. Y.
83298	Switchcraft, Inc.	Madison, Wis.	98291	Industrial Retaining Ring Co.	Mamaroneck, N. Y.
83330	Research Products Corp.	Woodstock, N. Y.	98410	IMC Magnetis Corp. Eastern Div.	Cleveland, Ohio
83385	Rotron Inc.	Glendale, Calif.	98978	Westbury, N. Y.	Burbank, Calif.
83501	Vector Electronic Co.	Cambridge, Mass.	99934	Seaelectro Corp.	Boston, Mass.
	Carr Fastener Co.	Springfield, N. J.		ETC Inc.	
	Victory Engineering Corp.	Eatontown, N. J.		International Electronic Research Corp.	
	Bendix Corp. Electric Power Div.	Brooklyn, N. Y.			
	Herman H. Smith, Inc.	Chicago, Ill.			
	Central Screw Co.	Brookfield, Mass.			
	Gavitt Wire and Cable Div. of				
	Amerace Esna Corp.				

Reference Designator	Description	Quantity	Mfr. Part # or Type	Mfr.	Mfr. Code	Stock No.	RS
C1	fxd, elect .47 μ f 80vdc	1	192P4749R8	Sprague	56289	0160-0970	1
C2	fxd, elect 100 μ f 6vdc	1	30D107G006DB4	Sprague	56289	0180-1734	1
C3	fxd, film .0022 μ f 200vdc	1	192P22292	Sprague	56289	0160-0154	1
C4, 5	fxd, elect 5 μ f 65vdc	2	D33689	Sprague	56289	0180-1836	1
C6, 22, 25	fxd, elect 1 μ f 35vdc	3	150D105X9036A2	Sprague	56289	0180-0291	1
C7, 15, 16, 23	NOT ASSIGNED	-	-	-	-	-	-
C8	fxd, film .01 μ f 200vdc	1	192P10392	Sprague	56289	0160-0161	1
C9,10,18,19	fxd, paper .047 μ f 600vdc	4	160P47396	Sprague	56289	0160-0005	1
C11	fxd, paper .47 μ f 600vdc	1	161P47406	Sprague	56289	0160-2464	1
C12	fxd, paper 0.1 μ f 400vdc	1	160P10494	Sprague	56289	0160-0013	1
C13,14,17	fxd, elect 22000 μ f 75vdc	3	D38829	Sprague	56289	0180-1929	1
C20, 21	fxd, elect 300 μ f 40vdc	2	34D307G040GJ4	Sprague	56289	0180-1805	1
C24	fxd, elect 68 μ f 15vdc	1	150D686X0015R2	Sprague	56289	0180-1835	1
C26, 27	fxd, film .082 μ f 200vdc	2	192P82392	Sprague	56289	0160-0167	1
C28	fxd, film .22 μ f 80vdc	1	192P2249R8	Sprague	56289	0160-2453	1
CB1	Circuit breaker 20 amp 250VAC	1	AM33 Curve 4	Heineman	74193	2110-0212	1
CR1,5,7,8,11, 26,28,39-45, 48	Diode, si. 200prv 250mw	15	-	HLAB	09182	1901-0033	7
CR4,13,15,16, 24,25,29,32 33-38	NOT ASSIGNED	-	-	-	-	-	-
CR2,3,6,9,10, 12,14,27,46 47,49-51	Rect, si. 200ma 15prv	13	-	HLAB	09182	1901-0461	7
CR17, 18	SCR 25A 200prv	2	C30B	G. E.	03508	1884-0017	2
CR19, 20	Rect, si. 20A 100prv	2	A40A	G. E.	03508	1901-0322	2
CR21-23	Rect, si. 20A 100prv	3	A41A	G. E.	03508	1901-0324	3
CR30, 31	Rect, si. 500ma 200prv	2	1N3253	R. C. A.	20735	1901-0026	2
DS1	Indicator light, Neon	1	599-124	Drake	72765	1450-0048	1
L1	Choke - filter	1	-	HLAB	09182	9100-1874	1
L2	Inductor-filter	1	-	HLAB	09182	9100-1834	1
Q1-4, 6,8,9, Q5	SS NPN si.	7	2N3391	G. E.	03508	1854-0071	6
Q7, 11	SS NPN si.	2	2N3390	G. E.	03508	1854-0202	1
Q10	SS PNP si.	1	2N3417	G. E.	03508	1854-0087	2
			MPS-6517	Motorola	04713	1853-0065	1
R1, 5	fxd, met.film 20K Ω \pm 1% 1/8w	2	Type CEA T-O	I. R. C.	07716	0757-0449	1
R2	var, ww 22K Ω \pm 10%	1	-	HLAB	09182	2100-1850	1
R3, 13	fxd, met.film 43K Ω \pm 1% 1/8w	2	Type CEA T-O	I. R. C.	07716	0698-5090	1
R4, 19	fxd, met.film 100K Ω \pm 1% 1/8w	2	Type CEA T-O	I. R. C.	07716	0757-0465	1
R6, 35, 36	fxd, met.film 3K Ω \pm 1% 1/8w	3	Type CEA T-O	I. R. C.	07716	0757-1093	1
R7	fxd, met.film 4.75K Ω \pm 1% 1/8w	1	Type CEA T-O	I. R. C.	07716	0757-0437	1
R8, 10	var. ww 300 Ω \pm 5%	2	-	HLAB	09182	2100-1848	1
R9	var. ww 10 Ω \pm 5%	1	-	HLAB	09182	2100-1857	1
R11	fxd, comp 3K Ω \pm 5% 1w	1	GB-3025	A. B.	01121	0689-3025	1
R12, 15	fxd, comp 680K Ω \pm 5% 1/2w	2	EB-6845	A. B.	01121	0686-6845	1
R14,32,49,57	NOT ASSIGNED	-	-	-	-	-	-
R16, 33	fxd, comp 1K Ω \pm 5% 1/2w	2	EB-1025	A. B.	01121	0686-1025	1
R17,39,41,44	fxd, comp SELECTED \pm 5% 1/2w	4	Type EB	A. B.	01121	-	1
R18,34,53	fxd, comp 10K Ω \pm 5% 1/2w	3	EB-1035	A. B.	01121	0686-1035	1
R20	fxd, met.film 12K Ω \pm 1% 1/8w	1	Type CEA T-O	I. R. C.	07716	0698-5088	1
R21	fxd, comp 10 Ω \pm 5% 1w	1	GB-1005	A. B.	01121	0689-1005	1
R22,30,50	fxd, comp 3K Ω \pm 5% 1/2w	3	EB-3025	A. B.	01121	0686-3025	1
R23	fxd, ww 0.04 Ω \pm 5% 40w 20ppm	1	2BR-37	H. H.	73978	0811-1950	1

6439B

6-5

Reference Designator	Description	Quantity	Mfr. Part # or Type	Mfr.	Mfr. Code	Stock No.	RS
R24	fxd, met.film 68.1K Ω \pm 1% $\frac{1}{4}$ w	1	Type CEB T-O	I. R. C.	07716	0757-0772	1
R25	var. ww 5K Ω (Modify)	1	Type 110-F4	C. T. S.	11236	2100-1824	1
R26	fxd, met.film 560 Ω \pm 1% $\frac{1}{4}$ w	1	Type CEB T-O	I. R. C.	07716	0698-5146	1
R27	var. ww 250 Ω (Modify)	1	Type 110-F4	C. T. S.	11236	2100-0439	1
R28	fxd, ww 250 Ω \pm 5% 40w	1	40S/817 Mtg.	W. L.	63743	0811-1972	1
R29	fxd, ww 1 Ω \pm 5%	1	Type BWH	I. R. C.	07716	0811-1666	1
R31, 58	fxd, comp 33K Ω \pm 5% $\frac{1}{2}$ w	2	EB-3335	A. B.	01121	0686-3335	1
R37, 43	fxd, met.film 1K Ω \pm 1% $\frac{1}{4}$ w	2	Type CEB T-O	I. R. C.	07716	0757-0338	1
R38	fxd, met.film 3.01K Ω \pm 1% $\frac{1}{4}$ w	1	Type CEB T-O	I. R. C.	07716	0757-0339	1
R40	fxd, ww 4.3K Ω \pm 5% 3w	1	242E4325	Sprague	56289	0811-1811	1
R42	fxd, met.film 2K Ω \pm 1% $\frac{1}{4}$ w	1	Type CEB T-O	I. R. C.	07716	0757-0739	1
R45	fxd, comp 51K Ω \pm 5% $\frac{1}{2}$ w	1	EB-5135	A. B.	01121	0686-5135	1
R46	fxd, comp 15 meg Ω \pm 5% $\frac{1}{2}$ w	1	EB-1565	A. B.	01121	0686-1565	1
R47	fxd, comp .1 meg Ω \pm 5% $\frac{1}{2}$ w	1	EB-1055	A. B.	01121	0686-1055	1
R48	fxd, comp 43K Ω \pm 5% $\frac{1}{2}$ w	1	EB-4335	A. B.	01121	0686-4335	1
R51	fxd, comp 180 Ω \pm 5% $\frac{1}{2}$ w	1	EB-1815	A. B.	01121	0686-1815	1
R52	fxd, met. ox. 3K Ω \pm 5% 2w	1	Type C42S	Corning	16299	0698-3642	1
R54, 55	fxd, comp 47 Ω \pm 5% $\frac{1}{2}$ w	2	EB-4705	A. B.	01121	0686-4705	1
R56	fxd, comp 39 Ω \pm 5% $\frac{1}{2}$ w	1	EB-3905	A. B.	01121	0686-3905	1
T1	Power transformer	1	-	HLAB	09182	9100-1873	1
T2	Bias transformer	1	643392	HLAB	09182	-	1
T3	Pulse transformer	1	-	HLAB	09182	9100-1875	1
TS1	Thermal switch	1	-	HLAB	09182	0440-0042	1
VR1	Zener, 75.0V \pm 5%	1	-	HLAB	09182	1902-3393	1
VR2	NOT ASSIGNED	-	-	-	-	-	-
VR3	Zener, 9.4V \pm 5%	1	1N2163	U. S. Semcor	06751	1902-0762	1
VR4	Zener, 4.22V \pm 5%	1	-	HLAB	09182	1902-3070	1
	Barrier strip	1	602-5	Kulka	75382	0360-1220	1
	Barrier strip (Modify)	1	602-3	Kulka	75382	0360-1213	1
	Barrier strip	1	-	HLAB	09182	0360-1238	1
	Jumper	2	602J	Kulka	75382	0360-1280	1
	Jumper	5	422-13-11-013	Cinch	71785	0360-1274	1
	Meter, 0-70 volts	1	-	HLAB	09182	1120-1174	1
	Meter, 0-18 amps	1	-	HLAB	09182	1120-1177	1
	Meter bezel, $\frac{1}{4}$ mod.	2	-	HLAB	09182	5040-0653	1
	Meter spring	8	-	HLAB	09182	1460-0256	2
	Rubber bumpers	4	Type 2097W	Stockwell	87585	0403-0089	1
	5 Way binding post	1	DF21Mn	HLAB	09182	1510-0040	1
	5 Way binding post	2	DF21BC	Superior	58474	1510-0039	1
	Knob, $\frac{1}{4}$ insert pointer	4	-	HLAB	09182	0370-0084	1

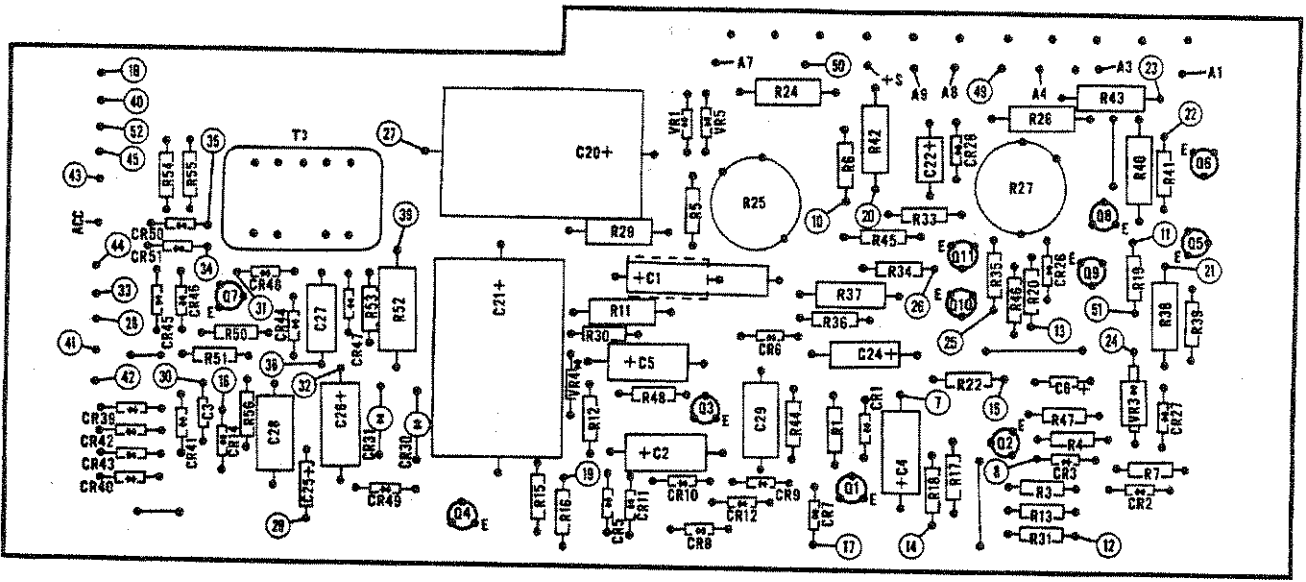

Model 6439B, Component Location Diagram

2-7

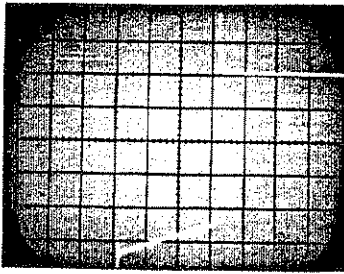

A. Test Points 31-33,
5µsec/cm, 5V/cm

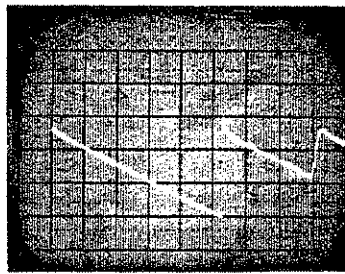

B. Test Points 29-33,
1ms/cm, 1V/cm

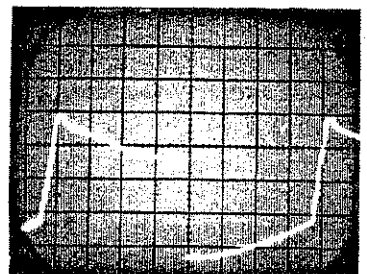

C. Test Points 37-33,
1ms/cm, 1V/cm

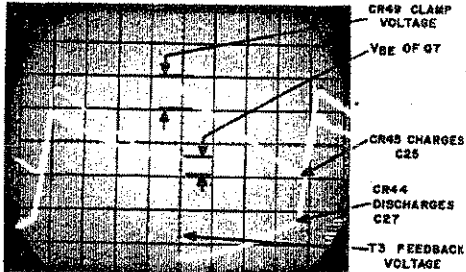

D. Waveforms B and C
Superimposed

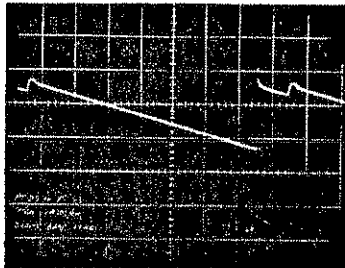

E. Same as B, Except Smaller
Load Used (2V, 3A)

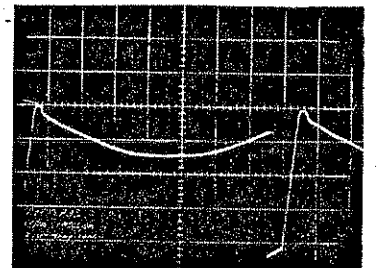

F. Same as C, Except Q7 Fires
Later Due to Smaller Load (2V, 3A)

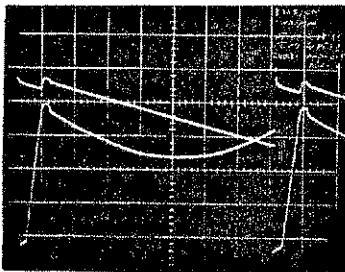

G. Waveforms E and F
Superimposed

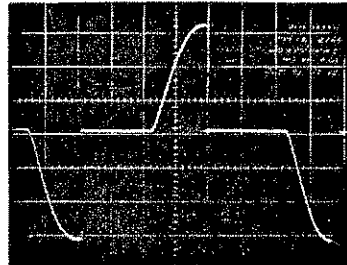

H. Test Points 45-ACC
2ms/cm, 50V/cm

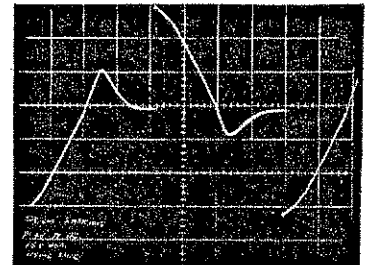

I. Test Points 45-AC
2ms/cm, 50V/cm

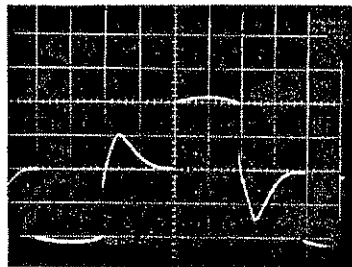

J. Test Points 47-46
2ms/cm, 10V/cm

MUST BE $\leq 0.5V$
FOR LINE BALANCE

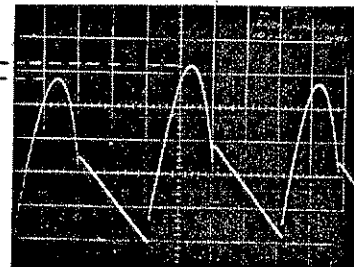

K. Test Points 48-18
2ms/cm, 0.2V/cm

All waveforms were taken with 115-volt, 60-cps, single-phase input and 60 vdc, 15 ampere load (except E and F as indicated). Waveforms H and I require the oscilloscope to be ungrounded. If it is not desirable to unground the oscilloscope, use a 2-kva isolation transformer between the input power source and the power supply power input.

WARNING

If the oscilloscope is ungrounded, injury can occur if personnel touch the oscilloscope case and other equipment simultaneously.

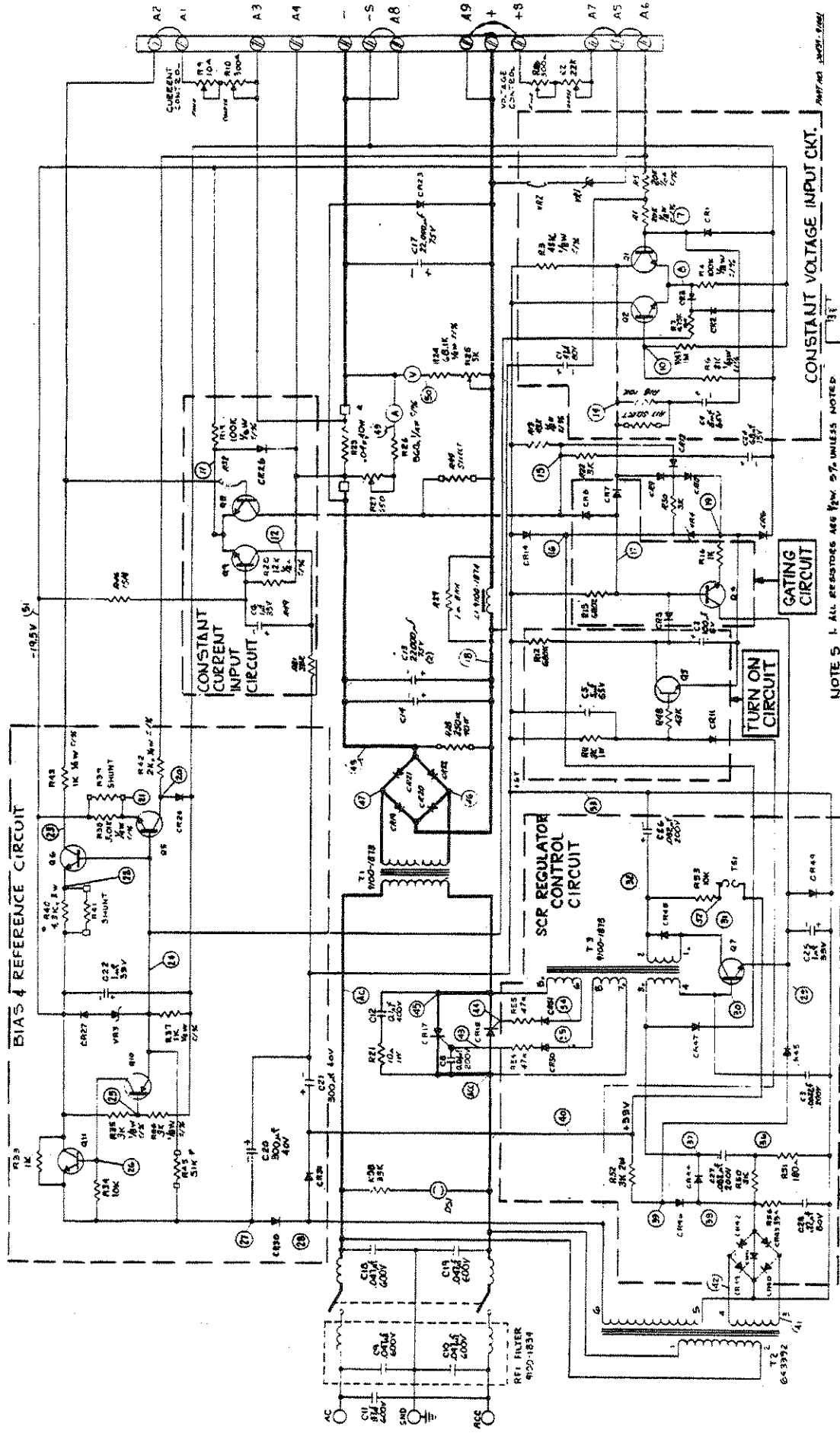

NOTE 5 1. ALL RESISTORS ARE 5% UNLESS NOTED.
 2. W DENOTES 20 PPM WIRE TRIM. COEFF.
 3. RES. TERMINALS SHOWN IN NORMAL STRAPPING.
 4. 100PF CAPACITORS MOUNTED AT 10V. NO LOAD.
 5. --- DENOTES VOLTAGE SIGNAL.
 6. - - - - DENOTES CURRENT SIGNAL.

PATENT APPLIED FOR ON THIS CIRCUIT. LICENSE TO USE MUST BE OBTAINED BY WRITING FROM HARRISON LABORATORIES, DIV. OF HEWLETT PACKARD

Model 6439B, Schematic Diagram

