



Internet Advisor

Mainframe Features User's Guide

J2300C/D, J3446C/D, J3754C

Copyright

© Hewlett-Packard Company 1998, 1999
All rights reserved.

Notice

The information contained in this document is subject to change without notice.

HEWLETT-PACKARD MAKES NO WARRANTY OF ANY KIND WITH REGARD TO THIS MATERIAL, INCLUDING, BUT NOT LIMITED TO, THE IMPLIED WARRANTIES OF MERCHANTABILITY AND FITNESS FOR A PARTICULAR PURPOSE.

Hewlett-Packard shall not be liable for errors contained herein or for incidental or consequential damages in connection with the furnishing, performance, or use of this material.

Warranty

A copy of the specific warranty terms applicable to your product and replacement parts can be obtained from your local Sales and Service Office.

Printing history

New editions of this guide are issued to reflect extensive changes made to the software. Revisions may be issued, between editions, to correct errors in the manual. There may not be a new edition issued in conjunction with every software release. The software release, at the date of printing, is noted in the following table.

Trademark

Microsoft®, Windows®, MS-DOS, and MS Windows® are U.S. registered trademarks of Microsoft Corp.

Acknowledgements**Document Name**

Mainframe Features User's Guide - J2300C/D, J3446C/D, J3754C

Part Number	Publication Date
5966-5340	June 1997
5966-5393	October 1997
5967-1449	January 1998
5967-4339	July 1998
5969-2248	July 1999

Product support

Call your local HP representative, or:

Tel: 1-800-698-0061

Fax: 303-754-4802

web: <http://www.hp.com/go/internetadvisor>

or call your local HP Sales and Service Office

Hewlett-Packard Company
5070 Centennial Boulevard
Colorado Springs, Colorado
80919-2497

Printed in the U.S.A.

Certification

Hewlett-Packard Company certifies that this product met its published specifications at the time of shipment from the factory. Hewlett-Packard further certifies that its calibration measurements are traceable to the United States National Institute of Standards and Technology (formerly National Bureau of Standards), to the extent allowed by that organization's calibration facility, and to the calibration facilities of other International Standards Organization members.

Restricted Rights Legend

Use, duplication, or disclosure by the Government is subject to the restrictions as set forth in subdivision (b)(3)(ii) of the Rights in Technical Data and Computer Software clause at 52.227-7-13. Hewlett-Packard Company; 3000 Hanover Street; Palo Alto, California 94304.

Before you use this instrument, read the "General Safety Precautions" and "Additional Safety Information" sections. Failure to comply with the precautions or with specific warnings in this book violates safety standards of design, manufacture, and intended use of this instrument. Hewlett-Packard Company assumes no liability for the customer's failure to comply with these requirements.

General Safety Precautions

The following warnings and operating information are shown in English followed by the French translation.

WARNING This product is a Safety Class I instrument with a protective earth terminal.

WARNING For protection from electric shock hazard, power cord ground must not be defeated.

Operating Restrictions

The following general safety precautions must be observed during all phases of operation,

service, and repair of this instrument. Failure to comply with these precautions with specific warnings in this manual violate safety standards of design, manufacture, and intended use of this instrument.

Grounding

To minimize shock hazard, the instrument chassis and cabinet must be connected to an electrical ground. The instrument is equipped with a three-conductor AC power cable compatible with an approved three-contact electrical outlet. The power jack and mating plug of the power cord must meet International Electrotechnical Commission (IEC) safety standards.

Environment

Do not operate the instrument in the presence of flammable gases or fumes. Operation of any electrical instrument in such an environment constitutes a definite safety hazard.

Service and Adjustment

Dangerous voltages exist within this instrument. Service and adjustment of this instrument is to be performed only by trained service personnel.

Do not replace components with the power cable connected. Dangerous voltages may be present even when the power cable is disconnected.

Do not perform internal servicing or adjustment unless another person, capable of rendering first aid and resuscitation is present.

Hazardous Material

Should the LCD be damaged the liquid crystal material can leak. Avoid all contact with this material, especially swallowing. Use soap and water to thoroughly wash all skin and clothing contaminated with the liquid crystal material.

Unauthorized Service

The installation of substitute parts or the installation of any instrument modification not authorized by Hewlett-Packard is specifically forbidden. The performance of such unauthorized service can negate the instrument warranty or any maintenance agreements.

Return the instrument to a Hewlett-Packard Sales and Service Office for authorized service and repair.

MISE EN GARDE Cet appareil répond aux normes de la «Classe de sécurité I» et est muni d'un fil de mise à la terre pour votre protection.

MISE EN GARDE Pour prévenir les risques de choc électrique, la broche de mise à la terre du cordon d'alimentation ne doit pas être désactivée.

Restrictions d'utilisation

L'utilisateur se doit d'observer les mesures de précaution énumérées ci-dessous pour toutes les phases d'utilisation, de service et de réparation de cet appareil. Le fait de ne pas s'y conformer équivaut à ne pas respecter les mises en gardes spécifiques contenues dans ce manuel et constitue une violation des normes de sécurité relatives à la conception, la fabrication et l'utilisation prévue de cet appareil. La société Hewlett-Packard n'assume aucune responsabilité envers un client qui manquerait de se conformer à ces exigences.

Mise à la terre

Afin de minimiser les risques de choc électrique, le châssis et le cabinet de l'appareil doivent être mis à la terre. L'appareil est équipé d'un cordon d'alimentation muni d'une fiche homologuée à trois lames, compatible c.a. La prise murale et la prise femelle de la rallonge électrique doivent respecter les normes de sécurité de la «Commission électrotechnique internationale» (IEC).

Environnement

Ne faites pas fonctionner cet appareil en présence de gaz inflammables ou de vapeurs dangereuses. L'utilisation de n'importe quel appareil électrique dans ces conditions constitue un risque élevé pour votre sécurité.

Service et ajustement

Des «tensions dangereuses» résident dans cet

appareil. Par conséquent, le service et l'ajustement doivent être effectués uniquement par une personne qualifiée.

Ne remplacez pas de composants lorsque le cordon d'alimentation est sous tension. Il pourrait y avoir présence de « tensions dangereuses » même lorsque l'appareil est déconnecté.

Ne faites pas de service interne ou d'ajustement sauf en présence d'une autre personne, capable de prodiguer les premiers soins et de pratiquer la réanimation.

Matière dangereuse

Si l'affichage LCD est endommagé, la matière constituant les cristaux liquides peut se répandre. Éviter tout contact avec cette matière, et en particulier ne pas l'avaler. Utiliser de l'eau et du savon pour nettoyer soigneusement la peau et les vêtements qui auraient été contaminés par la matière constituant les cristaux liquides.

Service non autorisé

L'installation de pièces étrangères, ou toute modification apportée à l'appareil sans le consentement de Hewlett-Packard est formellement interdit. Le fait de procéder à de tels modifications sans autorisation pourrait entraîner l'annulation de la garantie de l'appareil ou de tout contrat de service.

Pour un service et des réparations autorisées, retournez l'appareil à un point de vente et service Hewlett-Packard.

Additional Safety Information

Electric Shock Hazard

Do not remove the system covers. To avoid electric shock, use only the supplied power cords and connect only to properly grounded (3-pin) wall outlets.

Explosion Hazard

Do not operate in the presence of flammable gases.

Fire Hazard

For continued protection against fire hazard replace only with fuse of same type and rating.

Cleaning

To clean the product, use a damp cloth moistened with a mild solution of soap and water. *Do not* use harsh chemicals. *Do not* let water get into the product.

Product Damage

Do not use this product when the product shows visible damage, fails to perform, has been stored in unfavorable conditions, or has been subject to severe transport stresses.

Whenever this product has become damaged or wet, make the product inoperative and secure it against any unintended operation. Contact your nearest Hewlett-Packard Sales office for assistance.



Instruction book symbol - the product will be marked with this symbol when it is necessary for the user to refer to the instruction book in order to protect against damage.



A product marked with this symbol indicates it is a laser product. When necessary, this symbol will be included in the instruction book for the user to refer to in order to protect against personal injury and/or correct product handling.



Indicates potential for electrical shock.

WARNING

An operating procedure, practice, etc., that if not correctly followed could result in personal injury or loss of life.

CAUTION

An operating procedure, practice, etc., that if not strictly observed, could result in damage to, or destruction of, equipment or software.

This is an Installation Category II product.

This is a Pollution Degree 2 product.

This product is designed for indoor use only.

Mainframe Overview

Introduction	1-2
Product Matrix	1-3

Getting Started

Powering on the Internet Advisor	2-2
Starting the Internet Advisor the First Time	2-3
Setting the Date and Time	2-4
Starting an Internet Advisor Application	2-5
Connecting an External Display Monitor	2-6
Setting VGA Display Mode	2-7
Connecting a Printer	2-8

HP J2300C/D Specifications

HP J3446C/D Specifications

HP J3754C Specifications

Installing/Removing Interface Modules

Installing Interface Modules	6-2
Removing Interface Modules	6-3

Attaching/Removing Undercradles

Tools Required	7-2
Attaching an Undercradle	7-3
Removing an Undercradle	7-4
Using the Empty J2295A Undercradle	7-5
Disassembling the J2295A Undercradle	7-5
Installing Printed Circuit Cards	7-6
Re-assembling the J2295A Undercradle	7-6

Using Modem & Ethernet PC Cards

Introduction	8-2
Compatibility	8-2

Installing and Removing PC Cards	8-3
To Install a PC Card	8-4
To Remove a PC Card	8-5
Software Configuration	8-5
PC Card Modems	8-8
Setting Up the PC Card Modem in Toolkit	8-9

Specifications

Physical Specifications	A-2
Operating Conditions	A-3
The Keyboard and Button Mouse	A-4

Breakout Box, LEDs & Connectors

RS-232/V.24 Breakout Box and System LEDs	D-2
Mark/Space Indicator	D-3
Source Voltage	D-4
Active Interface LEDs	D-4
Lead Status LEDs	D-5
V-Series Interfaces	D-6
RS-232C/V.24	D-7
RS-449	D-8
V.35	D-9
Interface Pin-Out Comparison	D-10
AUI - 100Base-T	D-12
MII - 100Base-T	D-13
MDI - 100Base-TX	D-14

Declarations of Conformity

J2294C CEPT-E1 DB9 & RJ45 Interface Module	E-2
J2300C Internet Advisor WAN	E-3
J2300D Internet Advisor WAN	E-4
J2306B/J2309B Ether/Ether/TR Undercradles	E-5
J2307A LAN Token Ring Undercradle	E-6
J2524A FDDI Interface Undercradle	E-7
J2527A TIMS Undercradle	E-8
J2900A High Speed Acquisition System	E-9
J2901A Gigabit Ethernet Undercradle	E-10
J2904A ISDN BRI Module	E-11
J2904B, J2293, 94, 96, 97, 98, 99B ISDN Modules	E-12
J2905B ISDN BRI U Interface Module	E-13

J2908A DDS 4-Wire Interface Module	E-14
J2909A ATM DS-3/E3 Interface Module	E-15
J2912A ATM OC-3c/STM-1 Interface Module	E-16
J2912B ATM OC-3c/STM-1 Interface Module	E-17
J2913A ATM 155-UTP Interface Module	E-18
J2913B ATM 155-UTP Interface Module	E-19
J3444A Fast Ethernet LAN Undercradle	E-20
J3445A 100 Base-FX Interface Module	E-21
J3446C and J3447A Internet Advisor LAN	E-22
J3446D Internet Advisor LAN	E-23
J3754C Internet Advisor - pcAdvisor	E-24
J3759A DS3/E3 Cell/Frame Interface Module	E-25
J3762A HSSI Interface Module	E-26
J3763A/J3764A 622 Undercradle and Interface Module	E-27

1

- Introduction, page 1-2
- Product Matrix, page 1-3

Mainframe Overview

Mainframe Overview

Introduction

The HP J2300C/D, J3446C/D, and J3754C Internet Advisors are designed for testing your network needs in combination with available WAN, LAN, ISDN, and ATM Interface Modules or Undercradles.

With the Internet Advisor, you can look at decoded protocol information as it is traveling across a network so you can identify network problems quickly.

This manual provides information about Internet Advisor system hardware and software. Refer to the technology-specific Getting Started guides for information relating to LAN, WAN, or ATM testing. Refer to the Microsoft Windows® 98 Getting Started Guide for Windows-specific information.

The J2300C, J3446C, and J3754C Internet Advisors have:

- an Intel Pentium P5 chip
- a 133 MHz processor
- 32 Mbytes of PC memory
- a 1.44 MB flexible disk drive
- a 3 GB (or larger) hard drive

The J2300D and J3446D Internet Advisors have:

- an AMD K6-2 chip
- a 300 MHz processor
- 128 Mbytes of PC memory
- a 1.44 MB flexible disk drive
- a 4 GB (or larger) hard drive

In addition, each mainframe has a PC Card Type III slot, serial port, parallel port, external monitor port, microphone input jack, and an external audio output jack. The mainframes have available options of: a 56.6 Kbps Modem PC Card and/or a Xircom CBEM56G-100BTX CardBus Card.

There are two speakers in the mainframes for sound output. Volume control is included in the software. External speakers or a headset can be plugged into the jack labeled, "PHONES".

Product Matrix

Undercradles	Mainframes		
	J2300C/D WAN	J3446C/D Fast Ethernet LAN	J3754C pcAdvisor
J2295A	X	X	
J2306A Ethernet LAN	X	X	X
J2306B Ethernet LAN	X	X	X
J2307A Token Ring LAN	X	X	X
J2309A Ethernet/TR LAN	X	X	X
J2309B Ethernet/TR LAN	X	X	X
J2524A FDDI	X	X	X
J2527A TIMS	X		
*J2900A High Speed Acquisition	X	X	X
J2901A	X	X	X
J3444A Fast Ethernet	X		X
J3763A	X	X	X
E4594A TELCO	X		
E6323A E1 TELCO	X		

X =Supported Now

NOTE: * A J2900A High Speed Acquisition will accept any ATM Module (used with the "ATM for J2 and ATM Undercradles" application). This is an older version of the standard ATM application.

Mainframe Overview
Product Matrix

J2300C/D Mainframe

Interface Modules	WAN Application	ATM Application	ATM Application (for J2 and ATM undercradles only)
J2293B PRI-E1	X	X	X
J2294B PRI-E1	X	X	X
J2294C PRI-E1	X	X	X
J2296B PRI-E1	X	X	X
J2297B PRI-E1	X	X	X
J2298B PRI-T1	X	X	X
J2299B PRI-T1	X	X	X
J2904A ISDN BRI S/T	X		
J2904B ISDN BRI S/T	X		
J2905B ISDN BRI S/T & U	X		
J2908A DDS 4-Wire	X		
J2909A ATM DS-3	X	X	X
J2911A ATM J2	X		X
J2912A ATM OC-3	X	X	X
J2912B OC-3		X	
J2913A ATM-UTP	X	X	X
J2913B ATM-UTP		X	
J3759A ATM DS3/E3	X	X	
J3762A ATM HSSI	X		

NOTE: * Test Advisor Series Interface Modules are not compatible with the Internet Advisor.

Mainframes - with J2900A Undercradle

Interface Modules	J2300C/D WAN	J3446C/D Fast Ethernet LAN	J3754C pcAdvisor
*J2293B PRI-E1	X	X	X
*J2294B PRI-E1	X	X	X
*J2294C PRI-E1	X	X	X
*J2296B E1	X	X	X
*J2297B E1	X	X	X
*J2298B T1	X	X	X
*J2299B T1	X	X	X
J2909A ATM DS-3	X	X	X
J2911A ATM J2	X	X	X
J2912A ATM OC-3	X	X	X
J2912B ATM OC-3			
J2913A ATM-UTP	X	X	X
J2913B ATM-UTP			
J3759A ATM DS3/E3			
J3762A ATM HSSI			

NOTE: *You can use these Interface Modules in the undercradle for the ATM application (for J2 and ATM undercradles) only (this is an older version of the standard ATM application).

** Test Advisor Series Interface Modules are not compatible with the Internet Advisor.

Mainframe Overview
Product Matrix

Interface Module	J3446C Mainframe Fast Ethernet LAN
HP J3447A 100BaseFX	X

Interface Module	J2300C/D and J3754C (with J3444A Undercradle)
Media Independent Interface	X
J3445A Fiber Interface	X

- Powering on the Internet Advisor, page 2-2
- Starting the Internet Advisor the First Time, page 2-3
- Setting the Date and Time, page 2-4
- Starting an Internet Advisor Application, page 2-5
- Connecting an External Display Monitor, page 2-6
- Setting VGA Display Mode, page 2-7
- Connecting a Printer, page 2-8

Getting Started

Getting Started

Powering on the Internet Advisor

Connect the AC power cable (either 115V or 230V) as shown below. The mainframe automatically determines whether the power connection is 115V or 230V. To start the mainframe, turn the power on. The ON-OFF power switch is located on the left side adjacent the power cable connector.

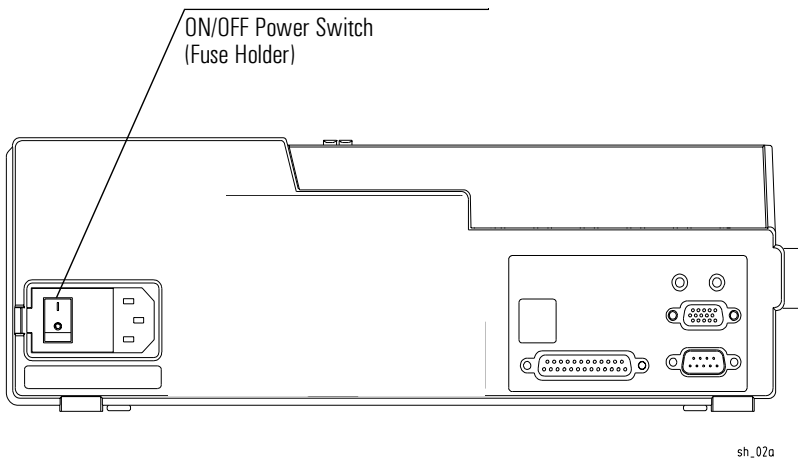

If the mainframe will not power-up, check the following:

- Power cable connections are good
- AC power is available at the outlet
- Examine the fuse

CAUTION

The mainframe is shipped with a three-conductor power cable that grounds the Internet Advisor when it is connected to an appropriate power outlet. Do not operate without ground protection.

Starting the Internet Advisor the First Time

Windows and Internet Advisor software is already installed on the hard drive at the factory. The software is included with your shipment for recovery/re-installation only.

When you first power up the Internet Advisor, you will need to enter some initial Microsoft Windows setup information.

- 1 Plug in the Internet Advisor and turn it on (the On/Off switch is located next to the power cord on the left side of the unit).
- 2 Follow the instructions on the screen to enter a first and last name, and to accept the Microsoft Windows license agreement.
- 3 Enter the Microsoft Windows authenticity product ID# (located on the front cover of the Microsoft Getting Started book - Certificate of Authenticity).
- 4 When the Date/Time Properties dialog is displayed, set the date and time, select the time zone, and press Enter.

The time and date features are used for many of the applications and reports generated by the Internet Advisor. It is important to set your local time and date when you receive your Internet Advisor. Setting the time and date also updates system configuration files. The time and date are maintained even when the Internet Advisor is off.

- 5 After Windows setup is complete, shut down and power off the unit to update setup files and to prepare the Internet Advisor for running measurements.

Setting the Date and Time

The time and date features are used for many of the applications and reports generated by the Internet Advisor. It is important to set your local time and date when you receive your Internet Advisor. Setting the time and date also updates system configuration files. The time and date are maintained even when power to the Internet Advisor is off.



① Open the Control Panel.



② Open the Date/Time Properties window and set the date and time.

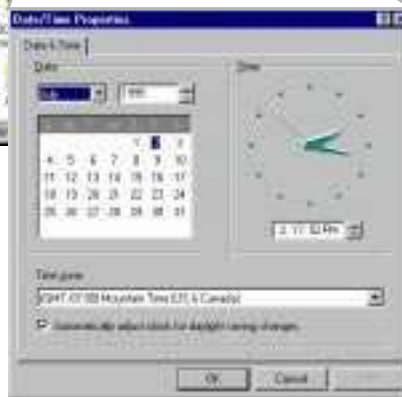

Starting an Internet Advisor Application

All of your applications can be started from Windows desktop. Depending on the type of mainframe you have and any undercradles or modules you have installed, the available applications will be displayed on the pull-up menu. Refer to the technology-specific (ATM, WAN, ATM) getting started guides for specific startup instructions.

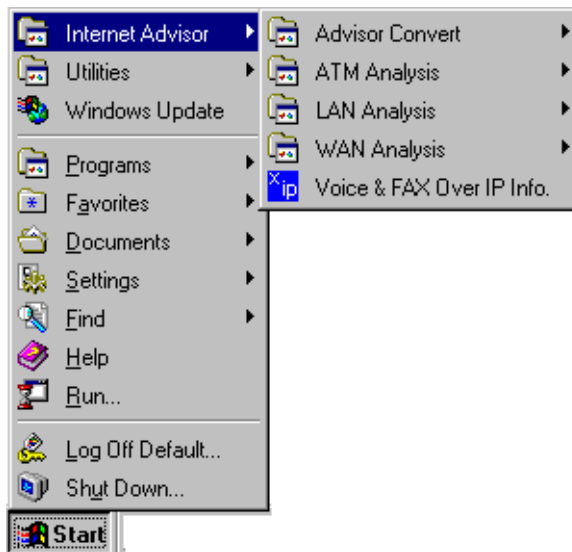

Connecting an External Display Monitor

You can connect an external display monitor to the Internet Advisor. Several external display monitors are available from Hewlett-Packard.

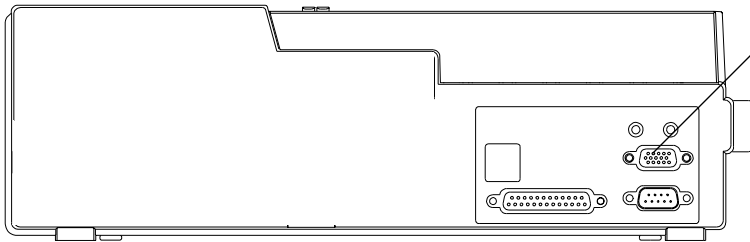

To connect an External Display Monitor:

1. Turn off the Internet Advisor.
2. Connect the monitor to the EXT MONITOR port on the mainframe.
3. The External Display Monitor will automatically be detected when you turn on the mainframe.

If you have an Active SVGA display, the external monitor display is SVGA resolution 800x600.

If you have a passive VGA color display, the external monitor display is VGA resolution 640x480.

If you want to adjust the display to a higher resolution you must explicitly change the display mode to External Monitor Only.



Set the Display Mode to External Monitor Only.

Setting VGA Display Mode

You can either disable or enable VGA Expansion Mode under Utilities on the pull-up Start menu.



Connecting a Printer

You can connect a printer to the Internet Advisor so you can print files, help topics, and measurements results. The default printer selection is No Printer. If you want to use a printer with your Internet Advisor, you must select the printer driver and output port.

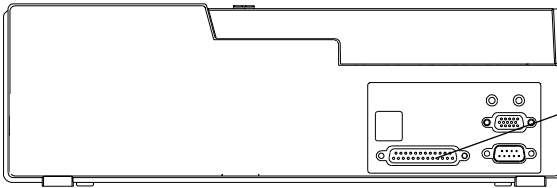

- 1 Connect a printer to the PARALLEL port on the mainframe.



- 2 Open the Printers window.



- 3 Open the Add Printer Wizard and follow the directions on the screen.

HP J2300C/D Specifications

HP J2300C/D Specifications

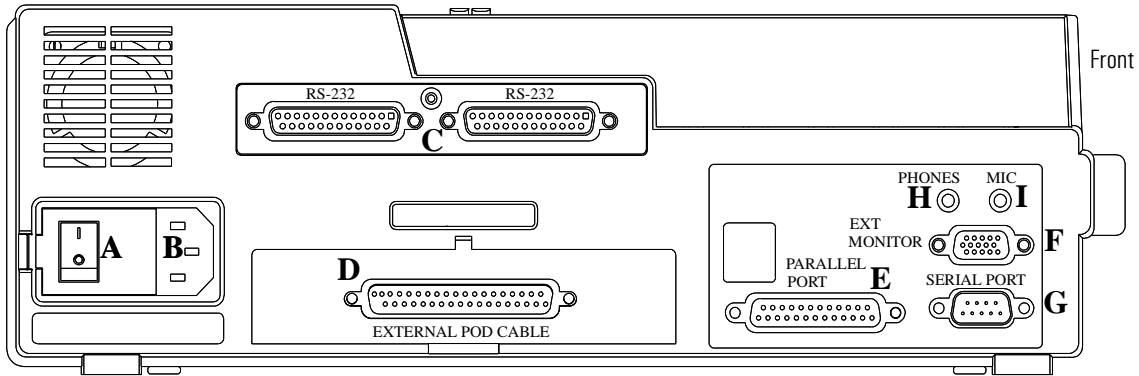

Left Side of J2300C/D Internet Advisor

- A On-Off Switch
- B Power cable receptacle
- C Two RS-232/V.24 connector
- D External Interface connector (not applicable on D model Internet Advisors)
- E Parallel Port
- F External Monitor
- G Serial Port
- H Headphones
- I Microphone

Refer to Appendix B, "Breakout Box, LEDs & Connectors" for connector pinouts.

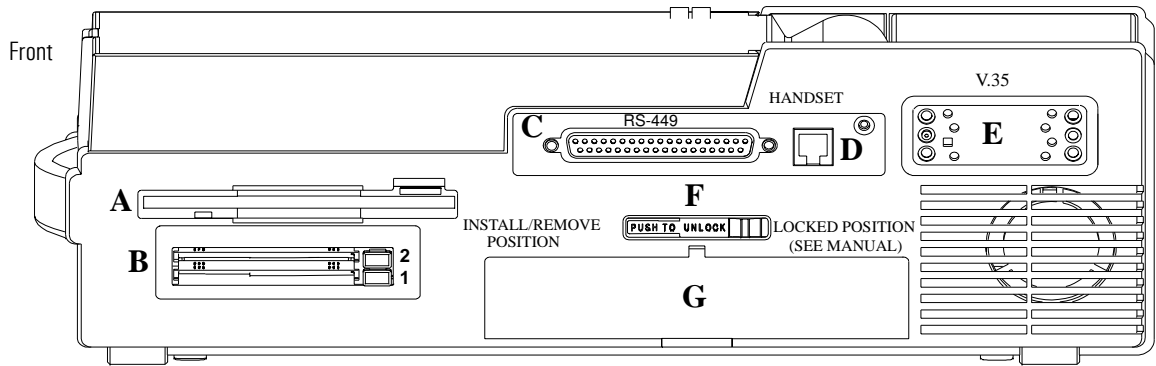

Right Side of J2300C/D Internet Advisor

- A 3-1/2 inch high density flexible disk drive
- B Dual PC Card slots
- C RS-449 connector
- D Handset connector
- E V.35 connector
- F Module Release Latch for Interface Modules
- G Interface Module slot

Refer to Appendix B, "Breakout Box, LEDs & Connectors" for connector pinouts.

HP J3446C/D Specifications

HP J3446C/D Specifications

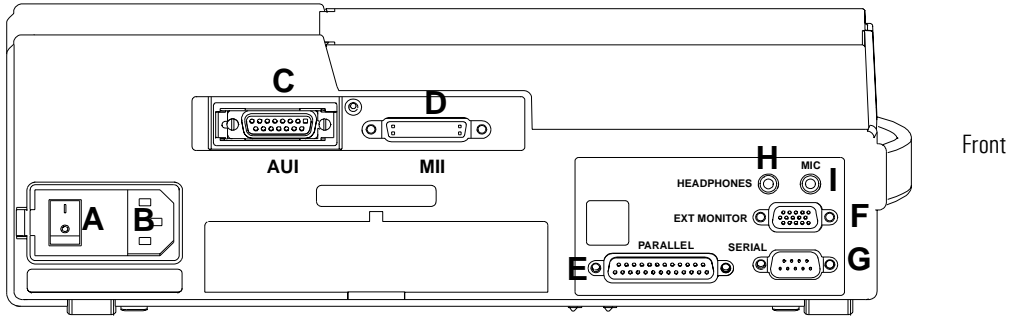

Left Side of J3446C/D Internet Advisor

- A On-Off Switch
- B Power Cord receptacle
- C Ethernet (AUI)
- D Fast Ethernet (MII)
- E Parallel Port
- F External Monitor
- G Serial Port
- H Headphones
- I Microphone

Refer to Appendix B, "Breakout Box, LEDs & Connectors" for connector pinouts.

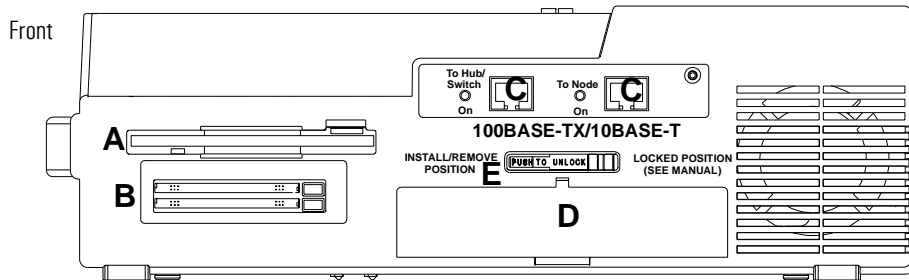

Right Side of J3446C/D Internet Advisor

- A 3 1/2 inch high density flexible disk drive
- B PC Card Slot
- C 100Base-TX/10Base-T Ethernet connector
- D 100Base-TX/10Base-T Ethernet connector
- E Interface Module slot
- F Module Release Latch for Interface Modules

Refer to Chapter 1, “Mainframe Overview” for the matrix of interface modules and undercradles that you can use with the J3446C/D.

Refer to Appendix B, “Breakout Box, LEDs & Connectors” for connector pinouts.

HP J3754C Specifications

HP J3754C Specifications

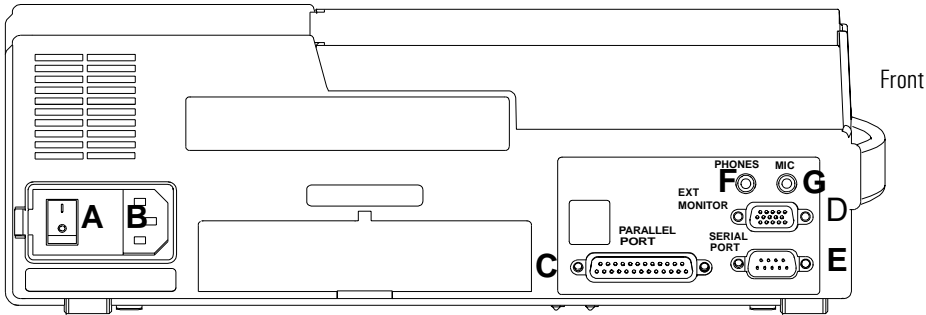

Left Side of J3754C pcAdvisor

- A On-Off Switch
- B Power cable receptacle
- C Parallel Port
- D External Monitor
- E Serial Port
- F Headphones
- G Microphone

Refer to Appendix B, “Breakout Box, LEDs & Connectors” for connector pinouts.

HP J3754C Specifications

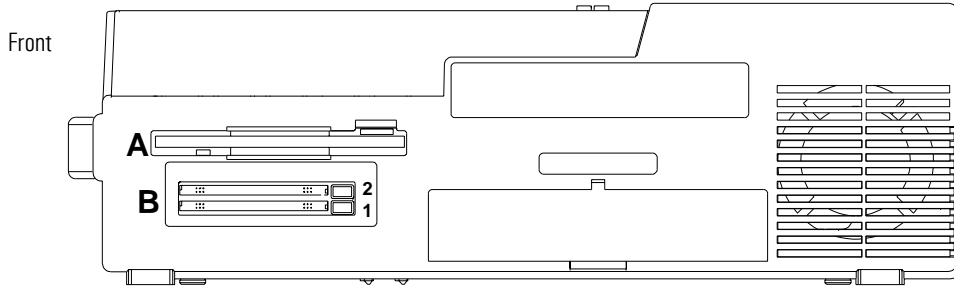

Right Side of J3754C pcAdvisor

- A 3-1/2 inch high density flexible disk drive
- B Dual PC Card slots

- Installing Interface Modules, page 6-2
- Removing Interface Modules, page 6-3

Installing/Removing Interface Modules

Installing/Removing Interface Modules

Installing Interface Modules

There are several Interface Modules and one Filler Panel available for use Internet Advisor. The Filler Panel acts as a cover for the Interface Module slot when no Interface Module is installed.

You can install interface modules directly into the mainframe or into a compatible undercradle. Refer to Chapter 1, “Mainframe Overview” for supported Interface Module configurations with the Internet Advisor and Undercradles.

CAUTION

Ensure that you turn off the power and unplug the Internet Advisor before attaching or removing undercradles.

- 1 Make sure the Module Release Latch is in the Install/Remove Position.
- 2 Slide the Interface Module or Filler Panel into the opening.
- 3 Push it firmly into place until it is seated and the Module Release Latch moves to the Locked Position. The Module Release Latch does not move when you install a Filler Panel. You will need to push the Module Release Latch to move the latch into its locked position.

Removing Interface Modules

- 1 Press the left end of the Module Release Latch (labeled “PUSH TO UNLOCK,”) then slide the latch toward the left (Install/Remove Position).
- 2 Pull the Interface Module or Filler Panel out of the Internet Advisor.

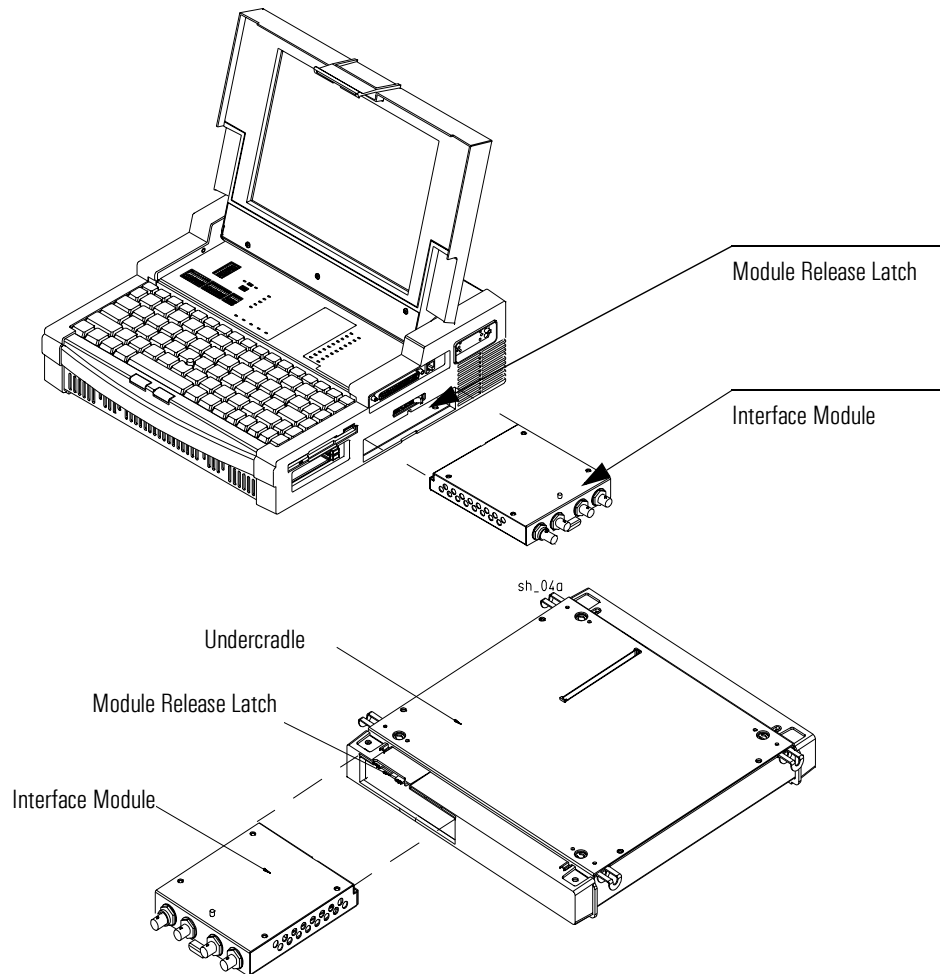

Installing/Removing Interface Modules
Removing Interface Modules

- Tools Required, page 7-2
- Attaching an Undercradle, page 7-3
- Removing an Undercradle, page 7-4
- Using the Empty J2295A Undercradle, page 7-5

Attaching/Removing Undercradles

Attaching/Removing Undercradles

Tools Required

Depending on which undercradle you have ordered, the following equipment/tools are included to attach and remove the undercradle:

- 4 rubber feet
- 4 Torx screws (for the undercradle)
- 2 Torx screws (not needed for HP J2300C/D and J3446C/D)
- 1 Right side endcap expander
- 1 Torx wrench
- 1 Small flat endcap
- 1 connector board
- 2 Grounding Strips (not needed for HP J2300C/D and J3446C/D).

NOTE

Any HP E4594A Telco Undercradle without the new E4594A Serial number label that includes the phrase "INT 15," must be modified at your nearest HP Service Center in order to operate correctly with the HP J2300C/D and J3446C/D Internet Advisor.

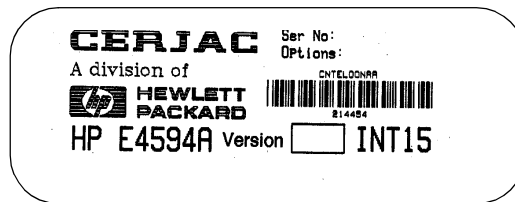

Attaching an Undercradle

CAUTION

Ensure that you turn off the power and unplug the Internet Advisor before attaching or removing undercradles.

- 1 If the metal plate (on the bottom of the Internet Advisor) is covering the opening for the Undercradle to attach to, remove the two screws from the metal plate. Use the wrench provided in the miscellaneous parts kit (or a T10 Torx screwdriver) to remove the screws.
- 2 Slide the metal plate over to the next set of drilled holes in the metal plate and re-attach it (with the same screws you removed in the previous step). This will leave an opening into which you can install your connector board. Ensure that the screws are flush with the metal plate.

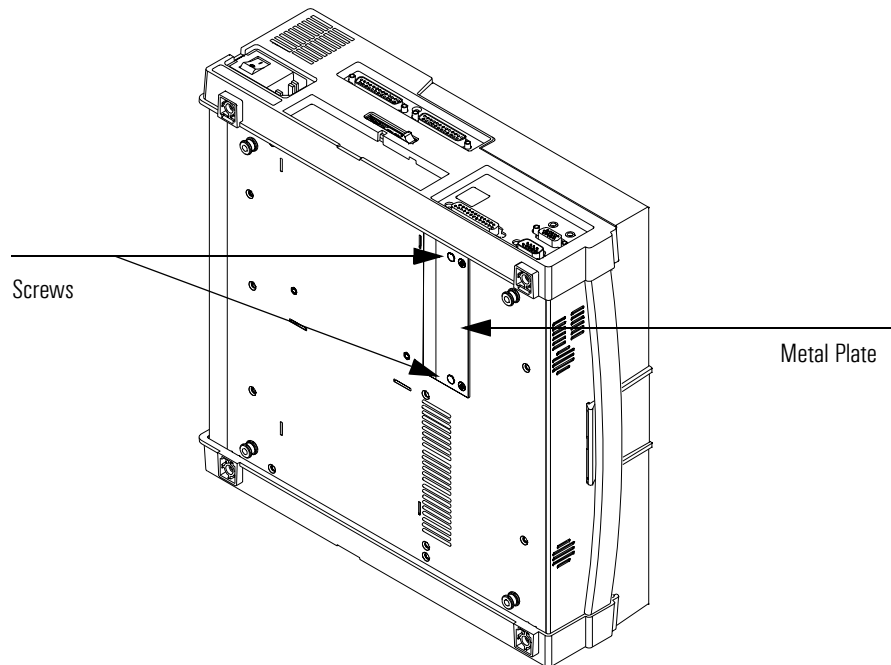

Attaching/Removing Undercradles

Removing an Undercradle

- 3 Insert the connector board into the slot uncovered by the metal plate.
- 4 Make sure all four silver tabs on the top of the undercradle are pulled out.
- 5 Place the mainframe on top of the undercradle, matching the connector on the bottom of the mainframe to the connector on the top of the undercradle.
- 6 Push in the four silver tabs, locking the undercradle to the mainframe.

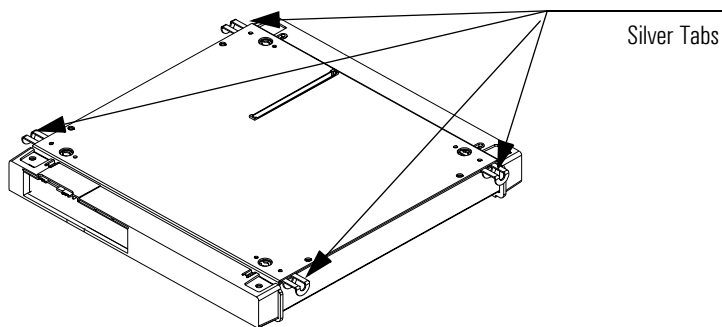

Removing an Undercradle

- 1 Turn off the power and unplug the Internet Advisor.
- 2 Pull out the four silver tabs on the front and the back of the undercradle.
- 3 Lift the Internet Advisor away from the undercradle.

Using the Empty J2295A Undercradle

The empty Undercradle (J2295A) can be used with the Internet Advisor so you can add one or two of your own ISA compatible printed circuit cards to customize your Internet Advisor.

Disassembling the J2295A Undercradle

CAUTION

Ensure that you turn off the power and unplug the Internet Advisor before attaching or removing undercradles.

- 1 If already attached, remove the undercradle from the Internet Advisor. Refer to Removing an Undercradle, page 7-4.
- 2 Turn the undercradle upside down, with the four black feet facing up.
- 3 Carefully remove the four black rubber feet using a small flat screwdriver to pull them out of their seating.
- 4 Remove the four screws using a #10 Torx driver.
- 5 Turn the undercradle over.
- 6 Remove the eight screws (four flat-head and four pan-head) from the top of the undercradle.
- 7 Slide the two plastic endcaps off both sides, and lift off the top of the undercradle.

Installing Printed Circuit Cards

You can install up to two printed circuit cards in the undercradle - full-length or smaller. For full-length cards, you will need to use the endcap expander. For smaller cards or only one card, you can use the flat endcap.

CAUTION

Be sure to follow Electro-Static Discharge (ESD) procedures when handling any cards.

- 1 Gently lift each corner of the connector board to disconnect it from the standoffs.
- 2 Turn the connector board over and fasten the card(s) in the slots provided.
- 3 Press the connector board onto the standoffs. The cards should be underneath the connector board as you secure it.

Re-assembling the J2295A Undercradle

- 1 Place the top back on the undercradle, aligning the slot in the top with the Internet Advisor connector. Fasten with the four flat-head screws.
- 2 On the side nearest to the Internet Advisor connector, slide the left side piece into place and secure it with four pan-head screws (two on the top and two on the bottom). If you are only installing one printed circuit card, insert the small flat endcap in the left side piece before you put it on the undercradle.
- 3 If you are installing full-length printed circuit cards, insert the endcap expander into the right side before you place it on the undercradle. If you are installing smaller printed circuit cards, insert the flat metal endcap in the right side before you place it on the undercradle.
- 4 Slide the undercradle right side piece into place and secure it with four pan-head screws (two on the top and two on the bottom).
- 5 Turn the undercradle over and replace the four black rubber feet into the foot indentations.

- Introduction, page 8-2
- Installing and Removing PC Cards, page 8-3
- PC Card Modems, page 8-8

Using Modem & Ethernet PC Cards

Using Modem & Ethernet PC Cards

Introduction

The Personal Computer Memory Card International Association (PCMCIA) has created a standard for credit card size devices with memory, mass storage, and I/O functionality. The standard makes compatibility possible by defining mechanical, electrical, and software requirements.

The purpose of the PC Card slots are to increase the flexibility in the Personal Computer section of the instrument. The primary use of this flexibility is for enhanced I/O capability with the Internet Advisor's software. This includes functions such as a modem, a LAN interface, and a CD-ROM Drive.

While integrated I/O is the primary focus for the PC Card slot, it can also serve other purposes. Other PC Card solutions include removable mass storage, speech, paging, encryption, global positioning, and even additional protocol testing.

Compatibility

The Internet Advisor conforms to PC Card specification 2.10. Each slot is capable of receiving one Type I or Type II card. A single Type III or larger card may be inserted into the bottom slot only. The following kinds of cards are compatible with the Internet Advisor:

- ATA Drive
- Audio
- Ethernet/Modem Combo
- Fax/Modem
- Network Interface
- SCSI Host Adapter
- CD ROM

Installing and Removing PC Cards

Before you install a PC Card, make sure the PC Card slot is active by selecting: | Start | Settings | Control Panel | and then double-click on the PC Card (PCMCIA) Wizard. If the slots are active you will see the PC Card (PCMCIA) Properties window. If the slot is not active, you will see the PCMCIA Welcome Window. To activate the PC Card slot: at the Welcome Window, press **Enter** to continue, press **Enter** to accept default PC Card drivers, then press **Enter** to close the PC Card Wizard.

If you are using a supported Modem or NIC PC Card, the drivers for these devices are already installed on your Internet Advisor. If you are using an “unsupported” device, follow the manufacturers instructions to install the necessary drivers.

Do not load the card vendor’s socket or card services software into Internet Advisor LAN or ToolKit WAN (DOS applications)

NOTE

The configuration will be different in some ways between the WAN and LAN software. Refer to the Internet Advisor WAN - High Speed Toolkit User’s Guide (under Configuring a Slave) for configuring the software for WAN PC Card operation. This guide is distributed as a PDF file on the Internet Advisor CDs.

To Install a PC Card

- 1 Slide the PC Card in the PC Card slot until you feel some resistance. All PC Cards are keyed for correct installation. The card's label will typically face up or will explain which side is up.
- 2 Push firmly, but gently, to ensure a good connection. Never attempt to force the card into position.
- 3 Listen for an audible double-beep tone within five seconds, confirming that the system recognizes a PC Card has been inserted.

NOTE

When using the alternate boot selection (in MS-DOS mode) or when you have a Gigabit Undercradle attached, install your PC Card before you turn on the Internet Advisor.

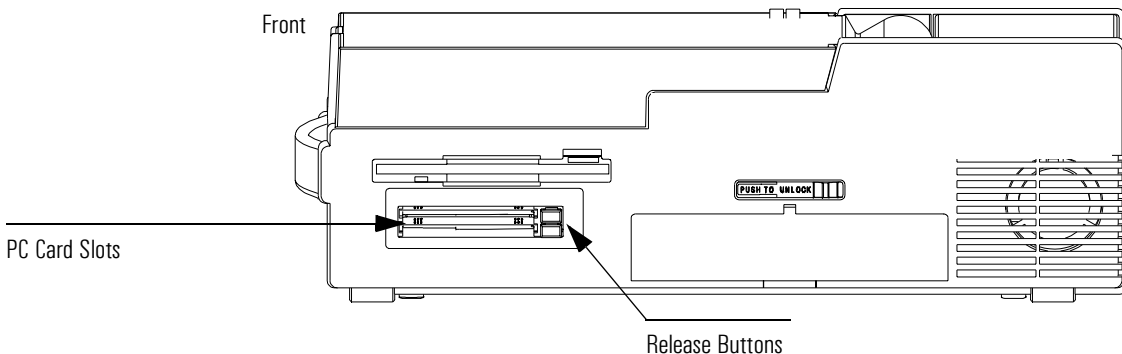

To verify that the system has properly identified the card, check the system properties of the installed PC Card. On the desktop, right click on My Computer and select Properties. From the System Properties window, select the Device Manager tab, select your PC Card device category, and double-click on the PC Card description. From there you can check either General or Resources information.

To Remove a PC Card

- 1 From the Windows desktop, select the PCMCIA icon (located in the Notification area near the clock).
- 2 Highlight and click the Stop PCMCIA card description. A message box will be displayed indicating that you can now safely remove the PCMCIA Card.
- 3 Push the release button on the side of the PC Card slot and pull out the card.
You can also exit any applications, properly shut down Windows, and then remove the PC Card.

NOTE

When using the alternate boot selection (MS-DOS mode) or when you have a Gigabit Undercradle attached, turn off the Internet Advisor before removing the PC Card.

Software Configuration

Windows - with a PC Card

- If a PC Card uses an interrupt, Windows will generally assign interrupt 15 to the card if it is available. If this interrupt is not available, Windows will assign the next available interrupt.
- If a PC Card uses I/O Addresses, Windows will dynamically allocate the next free range to the card. If the PC Card is a modem card, Windows must select an I/O Addresses range of COM 1, COM 2, COM 3, or COM 4. Generally, Windows will use COM 2. A Network PC Card will normally default to 130-13F.
- PC Card Modems are generally located at I/O address 02F8-02FF(COM2), with interrupt=11.
- ATA disks use available I/O space and reserve no interrupt.

Using Modem & Ethernet PC Cards
Installing and Removing PC Cards

MS-DOS - with a PC Card

The only PC Cards supported in the Toolkit are: the U.S. Robotics Megahertz PC Card Modem, the TDK Systems PC Card Modem, and the Xircom Modem.

The default modem for mainframes is the TDK Modem. If you want to change the default modem for Toolkit, select | Start | Utilities | Select Modem for Toolkit Remote |.

A point enabler is used to activate each modem for use with the Toolkit Remote package. Both modems are set for I/O space COM4, Interrupt 11, and memory region CC000-CCFFF.

PC Functions	Interrupt	Analyzer Functions	Interrupt
Keyboard Controller	1	Ethernet or Ethernet/Token Ring Undercradle	10
Programmable Interrupt Controller	2	FDDI Advisor Undercradle	MS-DOS mode only
COM 1	4	High Speed Acquisition Undercradle	none
Sound Hardware	5	TIMS Undercradle	15
Flexible Disk Controller	6	T1 Telco Undercradle	15
LPT1/Parallel	7	E1 Telco Undercradles	15
Real Time Clock	8	Gigabit Undercradle	11
Button Mouse	12	J3446C/D	9, 10, or 12
Numeric Data Processor	13	J3444A Undercradle	3, 5, 9, 10, 11, or 15
Hard Disk Controller	14		
Available to PC Card in Internet Advisor WAN	9,10,11		
Available to Undercradle in Internet Advisor WAN	9,10,11,15		

I/O Address	System/Analyzer Function	I/O Address	System/Analyzer Function
000-00F	DMA Controller Register	300-301	Sound H/W
020-021	PIC #1	320-32F	WAN Low Speed Hardware
040-043	Prog. Interval Timer Reg	330-331	T1 Telco Undercradle
060-	Keyboard Controller	330-33F	TIMS Undercradle
061-	System Speakers	376-377	IDE
064-	Keyboard Controller	378-37F	LPT1/Parallel
070-	RTC Index & NMI Mask	388-38B	Sound H/W
071	RTC Data Port	3B0-3BB	Video Registers
080-09F	DMA Page Register	3C0-3DF	Video Registers
0A0-0A1	PIC #2	3E0-3E1	PC Card Controller
0C0-0DF	DMA Controller Register	3E8-3EF	COM3
0F0-0FF	Numeric Data Processor	3F0-3F7	Flexible Disk Controller, Primary
110-12F	ATM Analyzer in Undercradle	3F8-3FF	COM1
150-16F	WAN/ATM Analyzer Hardware	B2-B3	Power Management
170-177	IDE	CF8-CFF	Chipset Configuration
1F0-1F	IDE	C2F0	LAN Hardware
200	Sound H/W	D2F0	LAN Hardware
220-22F	Sound H/W	E2F0	LAN Hardware
2E8-2EF	COM4		
2F0-2F1	LAN Analyzer Hardware		
2F8-2FF	COM2		

PC Card Modems

If your Internet Advisor software was installed at the factory, you do not need to set up the modem in Windows. However, you will need to set your Dialing Preferences for your modem to operate properly.

- 1 Set these preferences by selecting: | Start | Settings | Control Panel | Modems |.
- 2 Under General Modems Properties, select Dialing Properties. This opens another folder called, My Locations. The default area code from the factory is set at area code 719 and country USA. Change these and any other settings to meet your requirements.

NOTE

The modem requires an analog phone line and is not compatible with typical digital PBX systems.

The modem can be connected to a standard telephone line through an RJ-11 phone jack.

Transmission rates for the modem are up to 56.6 kbps (14.4 kbps for fax). The modem and fax operate with standard AT commands.

The modem is compatible with many commercially available software applications. Check the vendor's specifications to see if a particular application is compatible with the modem's capabilities.

NOTE

Be sure to choose a country using the country selection with your international TDK Modem, the same selection will apply for any MS-DOS mode program that uses a modem.

Setting Up the PC Card Modem in Toolkit

You can use the PC Card Modem for remote control of the WAN Toolkit . You must configure the Internet Advisor software for COM port 4 and Interrupt 11. Select the Remote Control option in the Toolkit Main Group to display the master controller Configuration Menu.

Press F4 (Slave Setup) softkey from with the Toolkit Main Group to display the slave Configuration Menu. Changing one configuration automatically changes the other. Change the settings to match the following screens.

Remote Configuraton Screen



Remote Configuration	
Modem Command Set	H Hayes
Emulation	On
Phone Type	Touch Tone
Baud Rate	9600bps
Con Port	OTHER
Hardware Handshaking	OFF
Con Base	744
IRQ (2-15)	11

The COMM 4 I/O Base address of 2E8 Hex has a decimal equivalent of 744.

Slave Setup Screen



Slave Setup	
Modem Command Set	H Hayes
Auto Answer	On
Hardware Handshaking	OFF
Baud Rate	9600bps
Con Port	Other
Con Base	744
IRQ (2-15)	11
	(a) COM1
	(b) COM2
	(c) COM3
	(d) Other

The other settings in the menus depend on the type of modem. However, it is recommended that you leave AutoAnswer ON when modifying the slave setup. This enables the instrument to remotely capture in an unattended setting.

A

- Physical Specifications, page A-2
- Operating Conditions, page A-3
- The Keyboard and Button Mouse, page A-4

Specifications

Specifications

Physical Specifications

Weight	J2300C/D Mainframe	6.45 kg (14.2 lbs)
	3446C/D Mainframe	6.81 kg (15 lbs)
	J3754C Mainframe	5.90 kg (13 lbs)
	J2295A Undercradle	1.04 kg (2.3 lbs)
	J2306B Undercradle	1.40 kg (3.1 lbs)
	J2307A Undercradle	1.40 kg (3.1 lbs)
	J2309B Undercradle	1.40 kg (3.1 lbs)
	J2524A Undercradle	2.0 kg (4.4 lbs)
	J2527A Undercradle	1.49 kg (3.3 lbs)
	J2900A Undercradle	2.0 kg (4.4 lbs)
J3444A Undercradle	2.08 kg (4.6 lbs)	
E4594A Undercradle	1.97 kg (4.35 lbs)	
Dimensions	J2300C/D, J3446C/D, J3754C Mainframe	10.16H x 31.43W x 31.75D cm (4.0H x 12.375W x 12.5D inches)
	Undercradles (exceptions noted)	3.7 cm (1.5 inches) height for undercradle
	J3444A Undercradle J2527A TIMS Undercradle	4.76 cm (1.875 inches) height for undercradle
	E4594A TELCO Undercradle	5.72 cm (2.25 inches) height for undercradle
Display	The standard display for the HP J2300C Mainframe is a 26.5 cm diagonal (10.4 inch) passive DSTN color LCD VGA. Option 221 is also available for the J2300C which is a 26.5 cm diagonal (10.4 inch) active matrix TFT color SVGA display.	
	The standard display for the HP J2300D, J3446C/D and J3754C Mainframes is a 26.5 cm diagonal (10.4 inch) active matrix TFT color SVGA display.	

Operating Conditions

Temperature	Operating	+5°C to +40°C (+41°F to +104°F)
	Non-operating	-25°C to +60°C (-13°F to +140°F)
Humidity	Operating	20% to 80% relative humidity non-condensing to 40°C
	Storage	10% to 90% relative humidity to 60°C
Altitude	Operation	4,575 meters (15,000 feet)
	Storage	15,250 meters (50,000 feet)
Power Requirements	External:	100 to 120 VAC, 50-60 Hz, 1.5A
		200 to 240 VAC, 50-60 Hz, 1.0A

The Keyboard and Button Mouse

The keyboard includes 88 keys with the integrated Button Mouse Joystick. See the following figure. The left and right mouse keys are located below the space bar on the chassis of the Internet Advisor. The Button Mouse responds quickly to pressure and the cursor will move in the direction and with the desired speed equal to pressure applied to the Button Mouse.

The keyboard has three extra keys - two Windows keys and one application key. The two Windows keys will automatically display the Start Menu, and the application key responds the same as pressing the right mouse key on any selected area of focus. There are 12 function keys.

NOTE

If you need to replace the keyboard button cover of your keyboard, please call you local sales representative. The replacement part number is 4320-0445

To use the control characters, hold down the **CTRL** key and press the control character you want. The control characters and their corresponding keys are shown in the following figure.

Specifications
The Keyboard and Button Mouse

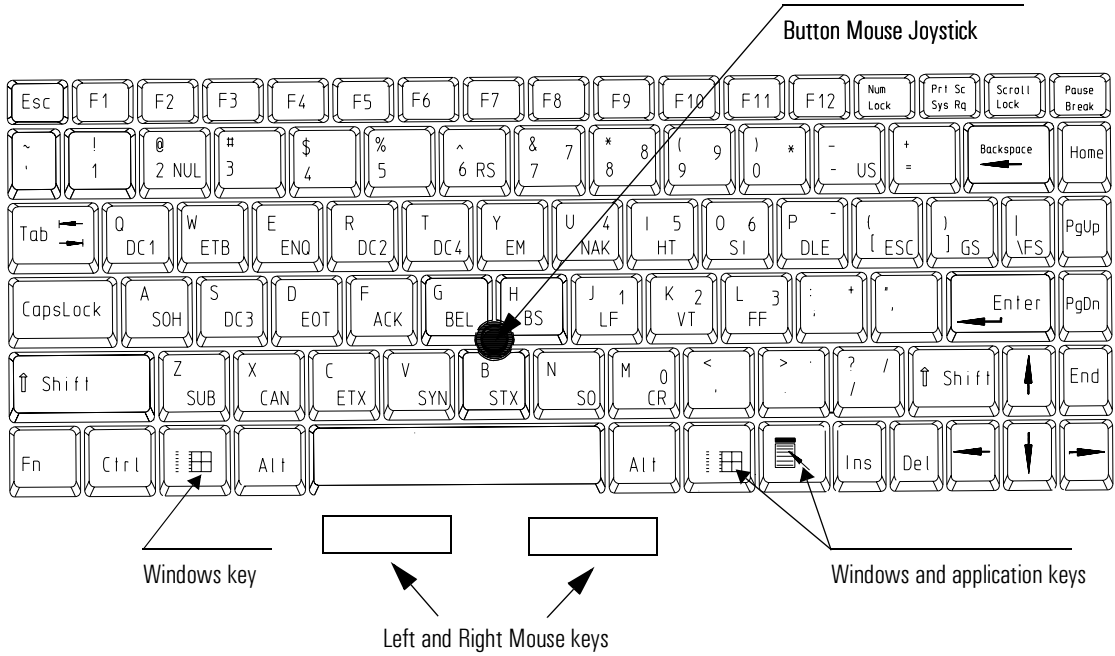

Specifications The Keyboard and Button Mouse

By pressing the **Num Lock** key, you can use the numeric keypad. The following figure shows the numeric keypad locations and numeric equivalents.

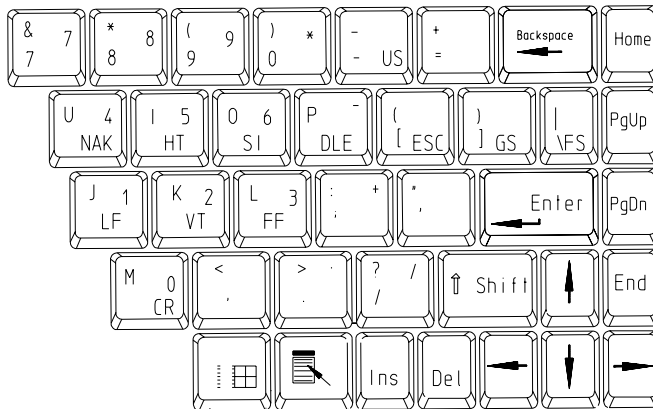

Keyboard Operation LEDs

Located above the keyboard are the following LEDs that show keyboard functions when they are active.

- Power On
- Caps Lock
- Num Lock
- Scroll Lock
- Hard Disk

B

- RS-232/V.24 Breakout Box and System LEDs, page B-2
- Lead Status LEDs, page B-5
- V-Series Interfaces, page B-6
- AUI - 100Base-T, page B-12
- MII - 100Base-T, page B-13
- MDI - 100Base-TX, page B-14

Breakout Box, LEDs & Connectors

Breakout Box, LEDs & Connectors

RS-232/V.24 Breakout Box and System LEDs

The Internet Advisor gives you breakout box and jumpering capabilities for RS-232/V.24 circuits. Figure E-1 shows the breakout box and its associated connections. Note that the large black arrows point to the RS-232/V.24 test connectors on the side of the Internet Advisor. The rearward connector is the preferred test input for most tests. The forward connector should only be used when signals need to be isolated by the rocker switches or cross-connected by way of the switch jacks and jumper leads.

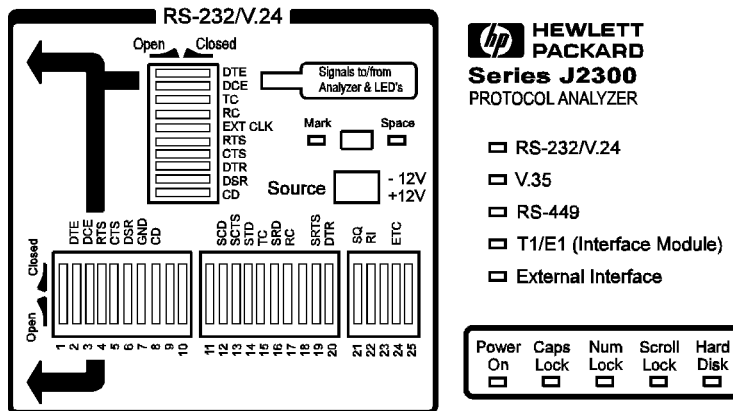

All 25 leads are accessible for jumpering on either side of the breakout switches (the lateral switch bank numbered 1 through 25.) If you want to monitor or simulate on auxiliary data channels or to observe control signals other than RTS, CTS, DTR, DSR and CD, you can perform the appropriate transpositions by opening the corresponding switches and jumpering between the appropriate leads. To do so, connect the circuit under test to the Internet Advisor through the forward RS-232 test connector and perform the necessary transpositions over the lateral switch bank.

The vertical switch bank provides hardware isolation of incoming or outgoing data and control signals for special purpose testing. An example would be using the Internet Advisor to supply terminal generated control signals without conflicting with existing data signals. In this case, you would want to open the DTE switch to isolate the circuit being tested from the internal data transmitter.

NOTE

Pin 1 of the RS-232 test port is Frame Ground or Protective Ground. It is connected to the case of the Internet Advisor and, through the third wire of the power cable, to Ground. If you have a data circuit that requires isolation of Frame Ground, use the forward RS-232 test port and open switch 1 on the lateral switch bank.

Pin 7 of the rearward RS-232 test port is Signal Ground, and it is isolated from Frame Ground by 100 KOhms to minimize ground-loop problems.

In monitor mode, the inputs to all V-Series signal receivers represent only 1/5 of a standard load, minimizing circuit loading effects. In Simulating and BERT testing modes, the transmitters are configured with normal source impedance.

Mark/Space Indicator

You can use the Mark/Space Indicator to test the state of any circuit on an RS-232/V.24 interface. The Mark/Space Indicator has two test jacks, which are connected together electrically. To do this, simply jumper from any test jack on either of the lateral or vertical switch banks to either of the Mark/Space Indicator jacks and observe the results. If the incoming signal is more positive than +3.0 volts, the Space LED lights. If the incoming signal is more negative than -3.0 volts, the Mark LED lights. If the Mark and the Space LEDs both light up, the incoming signal is actively changing states. This is normal for data and clock signals, but indicates a problem for control signals.

NOTE

EIA-232D (Formerly RS-232C) specifications consider interface signals in the range of -3.0 to +3.0 volts to be indeterminate (or not valid) Consistent with this recommendation, the Mark/Space Indicator treats signals in this range as “not present” and gives no indication.

Source Voltage

You can hard-wire any signal or control line as On or Off by jumpering it to the Source jacks. The rearward three jacks are connected together electrically and supply -12 volts through a 1 KOhm resistor. The forward three jacks are connected together electrically and supply +12 volts through a 1 KOhm resistor. If you connect a signal or control line to the -12 volts supply it creates a Mark or Off state and if you connect it to the +12 volts supply it creates a Space or On state.

Active Interface LEDs

The following is a list of the five LEDs that indicate which interface is currently configured:

- RS-232/V.24
- V.35
- RS-449
- Interface Module
- External Interface

CAUTION

Do not connect more than one Internet Advisor port at a time. The V.35, RS-449, RS-232, and External ports are not independent of one another. Connecting more than one port at a time can cause unreliable results.

Lead Status LEDs

On the right side, rearward of the keyboard, are ten pairs of LEDs that show a real-time indication of lead status for all of the interfaces. These LEDs also indicate data, clock and control information for the V-Series interfaces. The following list provides information on the meaning of the lighted LEDs:

Left column,	Red	Mark State for Data, Off State for Control Signals
Right column,	Green	Space State for Data, On State for Control Signals
Both LEDs	lighted	Active signal toggling
Neither LED	lighted	No signal present

When the selected interface is RS-232/V.24, the left column LEDs light when the signal level is more negative than -3.6 volts and the right column LEDs light when the signal level is more positive than +3.6 volts. This is a safety margin of 20% above EIA-232D minimum signal requirements of -3.0 and -3.6 volts. If the circuit under test is lighting the proper Internet Advisor LEDs, then there is enough signal present to allow any EIA-232D/RS-232 conforming device to receive the data and control signals. If the circuit under test cannot light these LEDs, the signal levels are too low for reliable reception.

For the Interface Modules, the left column shows the state of the Equipment (or user) signal and the right column shows the state of the Line (or central office) signal. Alarm and Error indications cause their respective red LEDs to light. The green Signal LEDs light if a signal is present. If there is no signal present, the topmost red LED lights to indicate a loss of signal.

These LEDs can provide a visual indication as to whether a V-Series device is physically DTE or DCE. First connect the Internet Advisor to the device under test and configure it for the Monitor mode. If either the DTE/SD Mark or Space LED lights, the device under test is DTE. If the DCE/RD Mark or Space LED lights, the device under test is DCE. If the Internet Advisor is to Simulate a device under test, it must complement the device's physical characteristic. If the device is DTE, the Internet Advisor must be DCE and vice versa.

V-Series Interfaces

The V-Series Interfaces are the RS-232, RS-449, and V.35 interfaces. The following signals are analyzed on the V-Series Interfaces:

V-Series Functions

Function	RS-232	V.35	RS-449
Send Data	DTE	SD	SD
Receive Data	DCE	RD	RD
DTE/Send Timing (DCE)	TC	SCT	ST
DCE/Receive Timing (DCE)	RC	SCR	RT
DTE/Send Timing (DTE)	ETC	SCE	TT
Request to Send	RTS	RS	RS
Clear to Send	CTS	CS	CS
Data Terminal Ready	DTR	DTR	TR
Data Set/Mode Ready	DSR	DSR	DM
Carrier Detect/Rec. Ready	CD	CD	RR

V-Series Functions for High Speed External Pods Only

Function	RS-232	V.35	RS-449
Local Loopback (Drv)		LLB	LLB
Remote Loopback (Drv)		RLB	RLB
Test Mode (Mon)		TM	TM

RS-232C/V.24

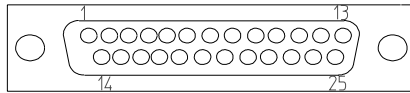

Pin	CCITT Circuit	Circuit Function	Pin	CCITT Circuit	Circuit Function
1	101	Protective Ground	14	118	Secondary Transmitted Data
2	103	Transmitted Data	15	114	Transmission Signal Element Timing (DCE Source)
3	104	Received Data	16	119	Secondary Received Data
4	105	Request to Send	17	115	Receiver Signal Element Timing (DCE Source)
5	106	Clear to Send	18		Unassigned
6	107	Data Set Ready	19	120	Secondary Request to Send
7	102	Signal Ground (common return)	20	108.2	Data Terminal Ready
8	109	Received Line Signal Detector	21	110	Signal Quality Detector
9		(Reserved for Data Set Testing)	22	125	Ring Indicator
10		(Reserved for Data Set Testing)	23	111/112	Data Signal Rate Selector (DTE Source)
11		Unassigned	24	113	Transmit Signal Element Timing (DTE Source)
12	122	Secondary Received Line Signal Detector	25		Unassigned
13	121	Secondary Clear to Send			

RS-449

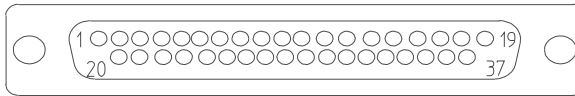

Pin	Circuit Name	Pin	Circuit Name
1	Shield	20	Receive Common
2	Send Timing	21	Spare
3	Spare	22	Send Data
4	Send Data	23	Send Timing
5	Send Timing	24	Receive Data
6	Receive Data	25	Request to Send
7	Request to Send	26	Receive Timing
8	Receive Timing	27	Clear to Send
9	Clear to Send	28	Terminal in Service
10	Local Loopback	29	Data Mode
11	Data Mode	30	Terminal Ready
12	Terminal Ready	31	Receiver Ready
13	Receiver Ready	32	Select Standby
14	Remote Loopback	33	Signal Quality
15	Incoming Call	34	New Signal
16	Select Frequency/Signal Rate Selector	35	Terminal Timing
17	Terminal Timing	36	Standby Indicator
18	Test Mode	37	Send Common
19	Signal Ground		

V.35

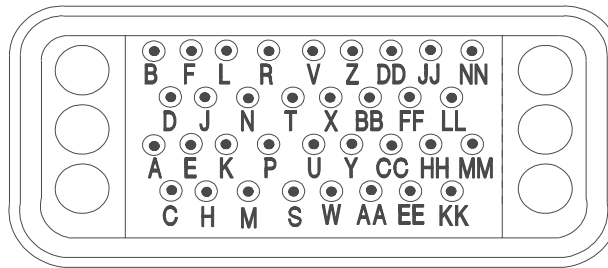

Pin	Circuit Name
A	Chassis Ground
B	Signal Ground
C	Request to Send
D	Clear to Send
E	Data Set Ready
F	Receive Line Signal Detect
P	Transmit Data (A)
R	Received Data (A)
S	Transmit Data (B)
T	Received Data (B)
U	Terminal Timing (A)
V	Receive Timing (A)
W	Terminal Timing (B)
X	Receive Timing (A)
Y	Transmit Timing (A)
AA	Transmit Timing (B)

Interface Pin-Out Comparison

RS-232C/CCITT V.24	CCITT V.35	RS-449
25 Pin	34 Pin	37 Pin
1-Protective Ground	A-Protective Ground	1-Shield 37-Send Common
2-Transmitted Data	P-Transmit Data (A) S-Transmit Data (B)	4-Send Data (A) 22-Send Data (B)
3-Received Data	R-Received Data (A) T-Received Data (B)	6-Received Data(A) 24-Received Data (B)
4-Request to Send	C-Request to Send	7-Request to Send (A) 25-Request to Send (B)
5-Clear to Send	D-Clear to Send	9-Clear to Send (A) 27-Clear to Send (B)
6-Data Set Ready	E-Data Set Ready	11-Data Mode (A) 29-Data Mode (B)
7-Signal Ground	B-Signal Ground	19-Signal Ground
8-Carrier Detect	F-Receive Line Signal Detect	13-Receiver Ready (A) 31-Receiver Ready (B)
9-Reserved for Testing	m-Reserved for DSU Testing	
		20-Receive Common
10-Reserved for Testing		10-Local Loop (A) 14-Remote Loop (B)
11-Unassigned		3-Spare 21-Spare
12-Sec. Carrier Detect		32-Select Standby
13-Sec. Clear to Send		

RS-232C/CCITT V.24	CCITT V.35	RS-449
25 Pin	34 Pin	37 Pin
14-Sec. Transmitted Data		
15-Transmit Clock (DCE Source)	Y-TX Signal Element Timing o-TX Signal Element Timing	5-Send Timing (A) DCE Source 23-Send Timing (B) DCE Source
16-Sec. Received Data		
17-Receive Clock	V-RX Signal Element X-RX Signal Element	8-Receive Timing (A) 26-Receive Timing (B)
18-Unassigned		18-Test Mode (A) 28-Term in Service (A) 34-New Signal
19-Sec. Request to Send		
20-Data Terminal Ready		12-Terminal Ready (A) 30-Terminal Ready (B)
21-Signal Quality Detector		33-Signal Quality (A)
22-Ring Indicator		15-Incoming Call (A)
23-Data Signal Rate Selector		2-Signaling Rate Indicator (A)
		16-Signaling Rate Selector (A)
24-Transmit Clock (DTE Source)		17-Terminal Timing (A) 35-Terminal Timing (B)
25-Busy		36-Stand by Indicator

AUI - 100Base-T

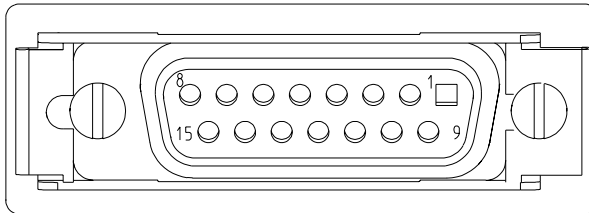

Pin	Circuit Name	Use
3	DO-A	Data Out circuit A
10	DO-B	Data Out circuit B
11	DO-S	Data Out circuit Shield
5	DI-A	Data In circuit A
12	DI-B	Data in circuit B
4	DI-S	Data In circuit Shield
7	CO-A	Control Out circuit A
15	CO-B	Control Out circuit B
8	CO-S	Control Out circuit Shield
2	CI-A	Control in circuit A
9	CI-B	Control in circuit B
1	CI-S	Control In circuit Shield
6	VC	Voltage Common
13	VP	Voltage Plus
14	VS	Voltage Shield
SHELL	PG	Protection Ground (Conductive Shell)

MII - 100Base-T

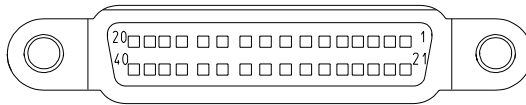

Pin	Circuit Name	Pin	Circuit Name
1	+5 V	21	+5 V
2	MDIO	22	COMMON
3	MDC	23	COMMON
4	RXD < 3 >	24	COMMON
5	RXD < 2 >	25	COMMON
6	RXD < 1 >	26	COMMON
7	RXD < 0 >	27	COMMON
8	RX_DV	28	COMMON
9	RX_CLK	29	COMMON
10	RX_ER	30	COMMON
11	TX_ER	31	COMMON
12	TX_CLK	32	COMMON
13	TX_EN	33	COMMON
14	TXD < 0 >	34	COMMON
15	TXD < 1 >	35	COMMON
16	TXD < 2 >	36	COMMON
17	TXD < 3 >	37	COMMON
18	COL	38	COMMON
19	CRS	39	COMMON
20	+5 V	40	+5 V

MDI - 100Base-TX

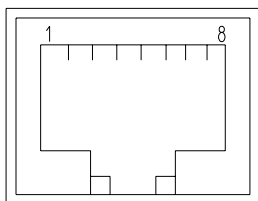

Pin	Circuit Name
1	TX_D1+
2	TX_D1-
3	RX_D2+
4	BI_D3+
5	BI_D3-
6	RX_D2-
7	BI_D4+
8	BI_D4-

Crossover Function

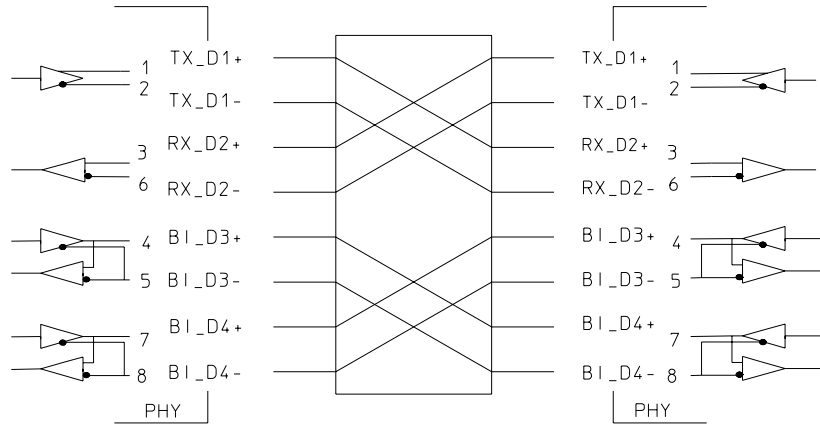

Breakout Box, LEDs & Connectors
MDI - 100Base-TX

C

Declarations of Conformity

Declarations of Conformity

J2294C CEPT-E1 DB9 & RJ45 Interface Module

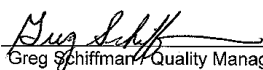
DECLARATION OF CONFORMITY <small>according to ISO/IEC Guide 22 and EN 45014</small>	
Manufacturer's Name:	Hewlett-Packard Co.
Manufacturer's Address:	Network Systems Test Division 5070 Centennial Boulevard Colorado Springs, Colorado 80919
declares that the product	
Product Name:	Internet Advisor - CEPT-E1 DB9 & RJ45 120 Ohm Balanced Module
Model Number(s):	J2294C
Product Option(s):	1A3, 8ZE
conforms to the following Product Specifications:	
Safety:	EN 61010-1:1993 / IEC 1010-1:1990 + A1
EMC:	EN 55011:1991 / CISPR 11:1990 (Group 1, Class A) ¹ EN 50082-1:1992 IEC 801-2:1991 4 kV CD, 8 kV AD IEC 801-3:1984 3 V/m IEC 801-4:1988 0.5 kV Signal Lines, 1 kV Power Lines EN 61000-3-2:1995 / IEC 1000-3-2:1995 + A1 EN 61000-3-3:1995 / IEC 1000-3-3:1994
Supplementary Information:	
The product herewith complies with the requirements of the Low Voltage Directive 73/23/EEC and the EMC Directive 89/336/EEC and carries the CE marking accordingly.	
¹ The product was tested in a typical configuration.	
Colorado Springs, CO	4 December 1997
	 Greg Schiffman, Quality Manager (acting)
<small>European Contact: Your local Hewlett-Packard Sales and Service Office or Hewlett-Packard GmbH, Department ZQ / Standards Europe, Herrenberger Strasse 130, D-71034 Boeblingen, Germany (FAX +49-7031-14-3143)</small>	

J2300C Internet Advisor WAN

DECLARATION OF CONFORMITY	
according to ISO/IEC Guide 22 and EN 45014	
Manufacturer's Name:	Hewlett-Packard Co.
Manufacturer's Address:	Network Systems Test Division 5070 Centennial Boulevard Colorado Springs, Colorado 80919
declares that the product	
Product Name:	Internet Advisor WAN
Model Number(s):	J2300C
Product Option(s):	001, 002, 005, 1A3, 220, 221
conforms to the following Product Specifications:	
Safety:	EN 61010-1:1993 / IEC 1010-1:1990 + A1
EMC:	EN 55011:1991 / CISPR 11:1990 (Group 1, Class A) ¹ EN 50082-1:1992 IEC 801-2:1991 4 kV CD, 8 kV AD IEC 801-3:1984 3 V/m IEC 801-4:1988 0.5 kV Signal Lines, 1 kV Power Lines EN 61000-3-2:1995 / IEC 1000-3-2:1995 + A1 EN 61000-3-3:1995 / IEC 1000-3-3:1994
Supplementary Information:	
The product herewith complies with the requirements of the Low Voltage Directive 73/23/EEC and the EMC Directive 89/336/EEC and carries the CE marking accordingly.	
¹ The product was tested in a typical configuration.	
Colorado Springs, CO 12 December 1997	 Jim Ledford, Quality Manager (acting)
European Contact: Your local Hewlett-Packard Sales and Service Office or Hewlett-Packard GmbH, Department ZQ / Standards Europe, Herrenberger Strasse 130, D-71034 Boeblingen, Germany (FAX +49-7031-14-3143)	

J2300D Internet Advisor WAN

DECLARATION OF CONFORMITY	
<small>according to ISO/IEC Guide 22 and EN 45014</small>	
Manufacturer's Name:	Hewlett-Packard Co.
Manufacturer's Address:	Network Systems Test Division 5070 Centennial Boulevard Colorado Springs, Colorado 80919
declares that the product	
Product Name:	Internet Advisor WAN
Model Number(s):	HP J2300D
Product Option(s):	All
conforms to the following Product Specifications:	
Safety:	EN 61010-1:1993 / IEC 1010-1:1990 + A1+ A2
EMC:	EN 55011:1991 / CISPR 11:1990 (Group 1, Class A) ¹ EN 50082-1:1992 IEC 801-2:1991 4 kV CD, 8 kV AD IEC 801-3:1984 3 V/m IEC 801-4:1988 0.5 kV Signal Lines, 1 kV Power Lines
Supplementary Information:	
The product herewith complies with the requirements of the Low Voltage Directive 73/23/EEC and the EMC Directive 89/336/EEC and carries the CE marking accordingly.	
¹ The product was tested in a typical configuration.	
Colorado Springs, CO 09 July 1999	 _____ Jack Haynes / Quality Manager
<small>European Contact: Your local Hewlett-Packard Sales and Service Office or Hewlett-Packard GmbH, Department ZQ / Standards Europe, Herrenberger Strasse 130, D-71034 Boeblingen, Germany (FAX +49-7031-14-3143)</small>	

J2306B/J2309B Ether/Ether/TR Undercradles

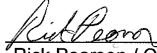
DECLARATION OF CONFORMITY	
according to ISO/IEC Guide 22 and EN 45014	
Manufacturer's Name:	Hewlett-Packard Co.
Manufacturer's Address:	Colorado Communications Operation 5070 Centennial Boulevard Colorado Springs, Colorado 80919
declares that the product	
Product Name:	Ethernet and Ethernet/Token Ring Undercradles for WAN Internet Advisors
Model Number(s):	J2306B, J2309B
Product Option(s):	None
conforms to the following Product Specifications:	
Safety:	EN 61010-1:1993 / IEC 1010-1:1990 + A1
EMC:	EN 55011:1991 / CISPR 11:1990 (Group 1, Class A) ¹ EN 50082-1:1992 IEC 801-2:1991 4 kV CD, 8 kV AD IEC 801-3:1984 3 V/m IEC 801-4:1988 0.5 kV Signal Lines, 1 kV Power Lines
Supplementary Information:	
The product herewith complies with the requirements of the Low Voltage Directive 73/23/EEC and the EMC Directive 89/336/EEC and carries the CE marking accordingly.	
¹ The product was tested in a typical configuration.	
Colorado Springs, CO 12 November 1996	 Rick Pearson / Quality Manager (acting)
European Contact: Your local Hewlett-Packard Sales and Service Office or Hewlett-Packard GmbH, Department ZQ / Standards Europe, Herrenberger Strasse 130, D-71034 Boeblingen, Germany (FAX +49-7031-14-3143)	

J2307A LAN Token Ring Undercradle

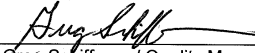
DECLARATION OF CONFORMITY <small>according to ISO/IEC Guide 22 and EN 45014</small>	
Manufacturer's Name:	Hewlett-Packard Co.
Manufacturer's Address:	Network Systems Test Division 5070 Centennial Boulevard Colorado Springs, Colorado 80919
declares that the product	
Product Name:	Internet Advisor LAN - Token Ring undercradle
Model Number(s):	J2307A
Product Option(s):	1A3, 8ZE
conforms to the following Product Specifications:	
Safety:	EN 61010-1:1993 / IEC 1010-1:1990 + A1
EMC:	EN 55011:1991 / CISPR 11:1990 (Group 1, Class A) ¹ EN 50082-1:1992 IEC 801-2:1991 4 kV CD, 8 kV AD IEC 801-3:1984 3 V/m IEC 801-4:1988 0.5 kV Signal Lines, 1 kV Power Lines EN 61000-3-2:1995 / IEC 1000-3-2:1995 + A1 EN 61000-3-3:1995 / IEC 1000-3-3:1994
Supplementary Information:	
The product herewith complies with the requirements of the Low Voltage Directive 73/23/EEC and the EMC Directive 89/336/EEC and carries the CE marking accordingly.	
¹ The product was tested in a typical configuration.	
Colorado Springs, CO 22 December 1997	 Greg Schiffman / Quality Manager (acting)
<small>European Contact: Your local Hewlett-Packard Sales and Service Office or Hewlett-Packard GmbH, Department ZQ / Standards Europe, Herrenberger Strasse 130, D-71034 Boeblingen, Germany (FAX +49-7031-14-3143)</small>	

J2524A FDDI Interface Undercradle

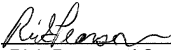
DECLARATION OF CONFORMITY	
according to ISO/IEC Guide 22 and EN 45014	
Manufacturer's Name:	Hewlett-Packard Co.
Manufacturer's Address:	Colorado Communications Operation 5070 Centennial Boulevard Colorado Springs, Colorado 80919
declares that the product	
Product Name:	FDDI Interface undercradle for WAN and LAN Internet Advisors
Model Number(s):	J2524A
Product Option(s):	None
conforms to the following Product Specifications:	
Safety:	EN 61010-1:1993 / IEC 1010-1:1990 + A1
EMC:	EN 55011:1991 / CISPR 11:1990 (Group 1, Class A) ¹ EN 50082-1:1992 IEC 801-2:1991 4 kV CD, 8 kV AD IEC 801-3:1984 3 V/m IEC 801-4:1988 0.5 kV Signal Lines, 1 kV Power Lines
Supplementary Information:	
The product herewith complies with the requirements of the Low Voltage Directive 73/23/EEC and the EMC Directive 89/336/EEC and carries the CE marking accordingly.	
¹ The product was tested in a typical configuration.	
Colorado Springs, CO 12 November 1996	 Rick Pearson / Quality Manager (acting)
European Contact: Your local Hewlett-Packard Sales and Service Office or Hewlett-Packard GmbH, Department ZQ / Standards Europe, Herrenberger Strasse 130, D-71034 Boeblingen, Germany (FAX +49-7031-14-3143)	

J2527A TIMS Undercradle

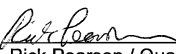
DECLARATION OF CONFORMITY	
<small>according to ISO/IEC Guide 22 and EN 45014</small>	
Manufacturer's Name:	Hewlett-Packard Co.
Manufacturer's Address:	Colorado Communications Operation 5070 Centennial Boulevard Colorado Springs, Colorado 80919
declares that the product	
Product Name:	TIMS undercradle for WAN and LAN Internet Advisors
Model Number(s):	J2527A
Product Option(s):	Opt. 001
conforms to the following Product Specifications:	
Safety:	EN 61010-1:1993 / IEC 1010-1:1990 + A1
EMC:	EN 55011:1991 / CISPR 11:1990 (Group 1, Class A) ¹ EN 50082-1:1992 IEC 801-2:1991 4 kV CD, 8 kV AD IEC 801-3:1984 3 V/m IEC 801-4:1988 0.5 kV Signal Lines, 1 kV Power Lines
Supplementary Information:	
The product herewith complies with the requirements of the Low Voltage Directive 73/23/EEC and the EMC Directive 89/336/EEC and carries the CE marking accordingly.	
¹ The product was tested in a typical configuration.	
Colorado Springs, CO 12 November 1996	 Rick Pearson / Quality Manager (acting)
<small>European Contact: Your local Hewlett-Packard Sales and Service Office or Hewlett-Packard GmbH, Department ZQ / Standards Europe, Herrenberger Strasse 130, D-71034 Boeblingen, Germany (FAX +49-7031-14-3143)</small>	

J2900A High Speed Acquisition System

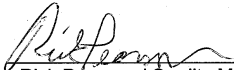
DECLARATION OF CONFORMITY	
<small>according to ISO/IEC Guide 22 and EN 45014</small>	
Manufacturer's Name:	Hewlett-Packard Co.
Manufacturer's Address:	Colorado Communications Operation 5070 Centennial Boulevard Colorado Springs, Colorado 80919
declares that the product	
Product Name:	High Speed Acquisition System Undercradle for Internet Advisor
Model Number(s):	J2900A
Product Option(s):	None
conforms to the following Product Specifications:	
Safety:	EN 61010-1:1993 / IEC 1010-1:1990 + A1
EMC:	EN 55011:1991 / CISPR 11:1990 (Group 1, Class A) ¹ EN 50082-1:1992 IEC 801-2:1991 4 kV CD, 8 kV AD IEC 801-3:1984 3 V/m IEC 801-4:1988 0.5 kV Signal Lines, 1 kV Power Lines
Supplementary Information:	
The product herewith complies with the requirements of the Low Voltage Directive 73/23/EEC and the EMC Directive 89/336/EEC and carries the CE marking accordingly.	
¹ The product was tested in typical configurations.	
Colorado Springs, CO	28 October 1996
	 Rick Pearson / Quality Manager (acting)
<small>European Contact: Your local Hewlett-Packard Sales and Service Office or Hewlett-Packard GmbH, Department ZQ / Standards Europe, Herrenberger Strasse 130, D-71034 Boeblingen, Germany (FAX +49-7031-14-3143)</small>	

J2901A Gigabit Ethernet Undercradle

DECLARATION OF CONFORMITY	
<small>according to ISO/IEC Guide 22 and EN 45014</small>	
Manufacturer's Name:	Hewlett-Packard Co.
Manufacturer's Address:	Network Systems Test Division 5070 Centennial Boulevard Colorado Springs, Colorado 80919
declares that the product	
Product Name:	Gigabit Ethernet interface undercradle for Internet Advisor LAN
Model Number(s):	HP J2901A
Product Option(s):	001, 1A3, 250, 8ZE
conforms to the following Product Specifications:	
Safety:	EN 61010-1:1993 / IEC 1010-1:1990 + A1+ A2
EMC:	EN 55011:1991 / CISPR 11:1990 (Group 1, Class A) ¹ EN 50082-1:1992 IEC 801-2:1991 4 kV CD, 8 kV AD IEC 801-3:1984 3 V/m IEC 801-4:1988 0.5 kV Signal Lines, 1 kV Power Lines
Supplementary Information:	
The product herewith complies with the requirements of the Low Voltage Directive 73/23/EEC and the EMC Directive 89/336/EEC and carries the CE marking accordingly.	
¹ The product was tested in a typical configuration.	
Colorado Springs, CO 12 March 1998	 Bob Eaton / Quality Manager (acting)
<small>European Contact: Your local Hewlett-Packard Sales and Service Office or Hewlett-Packard GmbH, Department ZQ / Standards Europe, Herrenberger Strasse 130, D-71034 Boeblingen, Germany (FAX +49-7031-14-3143)</small>	

J2904A ISDN BRI Module

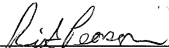
DECLARATION OF CONFORMITY	
according to ISO/IEC Guide 22 and EN 45014	
Manufacturer's Name:	Hewlett-Packard Co.
Manufacturer's Address:	Colorado Communications Operation 5070 Centennial Boulevard Colorado Springs, Colorado 80919
declares that the product	
Product Name:	ISDN Basic Rate Interface module for Internet Advisor series
Model Number(s):	J2904A
Product Option(s):	None
conforms to the following Product Specifications:	
Safety:	EN 61010-1:1993 / IEC 1010-1:1990 + A1
EMC:	EN 55011:1991 / CISPR 11:1990 (Group 1, Class A) ¹ EN 50082-1:1992 IEC 801-2:1991 4 kV CD, 8 kV AD IEC 801-3:1984 3 V/m IEC 801-4:1988 0.5 kV Signal Lines, 1 kV Power Lines
Supplementary Information:	
The product herewith complies with the requirements of the Low Voltage Directive 73/23/EEC and the EMC Directive 89/336/EEC and carries the CE marking accordingly.	
¹ The product was tested in a typical configuration.	
Colorado Springs, CO 12 November 1996	 Rick Pearson / Quality Manager (acting)
<small>European Contact: Your local Hewlett-Packard Sales and Service Office or Hewlett-Packard GmbH, Department ZQ / Standards Europe, Herrenberger Strasse 130, D-71034 Boeblingen, Germany (FAX +49-7031-14-3143)</small>	

J2904B,J2293,94,96,97,98,99B ISDN Modules

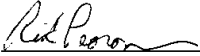
DECLARATION OF CONFORMITY	
according to ISO/IEC Guide 22 and EN 45014	
Manufacturer's Name:	Hewlett-Packard Co.
Manufacturer's Address:	Colorado Communications Operation 5070 Centennial Boulevard Colorado Springs, Colorado 80919
declares that the product	
Product Name:	ISDN analyzer modules for Internet Advisor
Model Number(s):	J2904B, J2293B, J2294B, J2296B, J2297B, J2298B, J2299B
Product Option(s):	All
conforms to the following Product Specifications:	
Safety:	EN 61010-1:1993 / IEC 1010-1:1990 + A1
EMC:	EN 55011:1991 / CISPR 11:1990 (Group 1, Class A) ¹ EN 50082-1:1992 IEC 801-2:1991 4 kV CD, 8 kV AD IEC 801-3:1984 3 V/m IEC 801-4:1988 0.5 kV Signal Lines, 1 kV Power Lines
Supplementary Information:	
The product herewith complies with the requirements of the Low Voltage Directive 73/23/EEC and the EMC Directive 89/336/EEC and carries the CE marking accordingly.	
¹ The product was tested in a typical configuration.	
Colorado Springs, CO 16 September 1996	 Rick Pearson / Quality Manager (acting)
European Contact: Your local Hewlett-Packard Sales and Service Office or Hewlett-Packard GmbH, Department ZQ / Standards Europe, Herrenberger Strasse 130, D-71034 Boeblingen, Germany (FAX +49-7031-14-3143)	

J2905B ISDN BRI U Interface Module

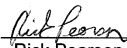
DECLARATION OF CONFORMITY	
according to ISO/IEC Guide 22 and EN 45014	
Manufacturer's Name:	Hewlett-Packard Co.
Manufacturer's Address:	Communications Meas Division - Colorado 5070 Centennial Boulevard Colorado Springs, Colorado 80919
declares that the product	
Product Name:	Dual U-Interface (2B1Q) Module for Internet Advisor ISDN analyzer
Model Number(s):	J2905B
Product Option(s):	None
conforms to the following Product Specifications:	
Safety:	EN 61010-1:1993 / IEC 1010-1:1990 + A1
EMC:	EN 55011:1991 / CISPR 11:1990 (Group 1, Class A) ¹ EN 50082-1:1992 IEC 801-2:1991 4 kV CD, 8 kV AD IEC 801-3:1984 3 V/m IEC 801-4:1988 0.5 kV Signal Lines, 1 kV Power Lines
Supplementary Information:	
The product herewith complies with the requirements of the Low Voltage Directive 73/23/EEC and the EMC Directive 89/336/EEC and carries the CE marking accordingly.	
¹ The product was tested in a typical configuration.	
Colorado Springs, CO 20 December 1996	 Rick Pearson / Quality Manager (acting)
European Contact: Your local Hewlett-Packard Sales and Service Office or Hewlett-Packard GmbH, Department ZQ / Standards Europe, Herrenberger Strasse 130, D-71034 Boeblingen, Germany (FAX +49-7031-14-3143)	

J2908A DDS 4-Wire Interface Module

DECLARATION OF CONFORMITY	
<small>according to ISO/IEC Guide 22 and EN 45014</small>	
Manufacturer's Name:	Hewlett-Packard Co.
Manufacturer's Address:	Colorado Communications Operation 5070 Centennial Boulevard Colorado Springs, Colorado 80919
declares that the product	
Product Name:	DDS 4-Wire Interface module for Internet Advisor series
Model Number(s):	J2908A
Product Option(s):	None
conforms to the following Product Specifications:	
Safety:	EN 61010-1:1993 / IEC 1010-1:1990 + A1
EMC:	EN 55011:1991 / CISPR 11:1990 (Group 1, Class A) ¹ EN 50082-1:1992 IEC 801-2:1991 4 kV CD, 8 kV AD IEC 801-3:1984 3 V/m IEC 801-4:1988 0.5 kV Signal Lines, 1 kV Power Lines
Supplementary Information:	
The product herewith complies with the requirements of the Low Voltage Directive 73/23/EEC and the EMC Directive 89/336/EEC and carries the CE marking accordingly.	
¹ The product was tested in a typical configuration.	
Colorado Springs, CO 12 November 1996	 Rick Pearson / Quality Manager (acting)
<small>European Contact: Your local Hewlett-Packard Sales and Service Office or Hewlett-Packard GmbH, Department ZQ / Standards Europe, Herrenberger Strasse 130, D-71034 Boeblingen, Germany (FAX +49-7031-14-3143)</small>	

J2909A ATM DS-3/E3 Interface Module

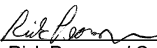
DECLARATION OF CONFORMITY	
according to ISO/IEC Guide 22 and EN 45014	
Manufacturer's Name:	Hewlett-Packard Co.
Manufacturer's Address:	Colorado Communications Operation 5070 Centennial Boulevard Colorado Springs, Colorado 80919
declares that the product	
Product Name:	DS-3/E3 Interface module for Internet Advisor ATM series
Model Number(s):	J2909A
Product Option(s):	None
conforms to the following Product Specifications:	
Safety:	EN 61010-1:1993 / IEC 1010-1:1990 + A1
EMC:	EN 55011:1991 / CISPR 11:1990 (Group 1, Class A) ¹ EN 50082-1:1992 IEC 801-2:1991 4 kV CD, 8 kV AD IEC 801-3:1984 3 V/m IEC 801-4:1988 0.5 kV Signal Lines, 1 kV Power Lines
Supplementary Information:	
The product herewith complies with the requirements of the Low Voltage Directive 73/23/EEC and the EMC Directive 89/336/EEC and carries the CE marking accordingly.	
¹ The product was tested in a typical configuration.	
Colorado Springs, CO 12 November 1996	 Rick Pearson / Quality Manager (acting)
European Contact: Your local Hewlett-Packard Sales and Service Office or Hewlett-Packard GmbH, Department ZQ / Standards Europe, Herrenberger Strasse 130, D-71034 Boeblingen, Germany (FAX +49-7031-14-3143)	

J2912A ATM OC-3c/STM-1 Interface Module

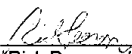
DECLARATION OF CONFORMITY	
<small>according to ISO/IEC Guide 22 and EN 45014</small>	
Manufacturer's Name:	Hewlett-Packard Co.
Manufacturer's Address:	Colorado Communications Operation 5070 Centennial Boulevard Colorado Springs, Colorado 80919
declares that the product	
Product Name:	OC-3c/STM-1 analyzer module for Internet Advisor ATM
Model Number(s):	J2912A
Product Option(s):	All
conforms to the following Product Specifications:	
Safety:	EN 61010-1:1993 / IEC 1010-1:1990 + A1
EMC:	EN 55011:1991 / CISPR 11:1990 (Group 1, Class A) ¹ EN 50082-1:1992 IEC 801-2:1991 4 kV CD, 8 kV AD IEC 801-3:1984 3 V/m IEC 801-4:1988 0.5 kV Signal Lines, 1 kV Power Lines
Supplementary Information:	
The product herewith complies with the requirements of the Low Voltage Directive 73/23/EEC and the EMC Directive 89/336/EEC and carries the CE marking accordingly.	
¹ The product was tested in a typical configuration.	
Colorado Springs, CO 18 September 1996	 Rick Pearson / Quality Manager (acting)
<small>European Contact: Your local Hewlett-Packard Sales and Service Office or Hewlett-Packard GmbH, Department ZQ / Standards Europe, Herrenberger Strasse 130, D-71034 Boeblingen, Germany (FAX +49-7031-14-3143)</small>	

J2912B ATM OC-3c/STM-1 Interface Module

DECLARATION OF CONFORMITY	
according to ISO/IEC Guide 22 and EN 45014	
Manufacturer's Name:	Hewlett-Packard Co.
Manufacturer's Address:	Network Systems Test Division 5070 Centennial Boulevard Colorado Springs, Colorado 80919
declares that the product	
Product Name:	OC-3c / STM-1 analyzer Module for Internet Advisor ATM
Model Number(s):	HP J2912B
Product Option(s):	All
conforms to the following Product Specifications:	
Safety:	EN 61010-1:1993 / IEC 1010-1:1990 + A1+ A2
EMC:	EN 55011:1991 / CISPR 11:1990 (Group 1, Class A) ¹ EN 50082-1:1992 IEC 801-2:1991 4 kV CD, 8 kV AD IEC 801-3:1984 3 V/m IEC 801-4:1988 0.5 kV Signal Lines, 1 kV Power Lines
Supplementary Information:	
The product herewith complies with the requirements of the Low Voltage Directive 73/23/EEC and the EMC Directive 89/336/EEC and carries the CE marking accordingly.	
¹ The product was tested in a typical configuration.	
Colorado Springs, CO 22 October 1998	 _____ Stephen Hale / Quality Manager
<small>European Contact: Your local Hewlett-Packard Sales and Service Office or Hewlett-Packard GmbH, Department ZQ / Standards Europe, Herrenberger Strasse 130, D-71034 Boeblingen, Germany (FAX +49-7031-14-3143)</small>	

J2913A ATM 155-UTP Interface Module

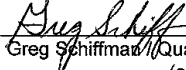
DECLARATION OF CONFORMITY	
according to ISO/IEC Guide 22 and EN 45014	
Manufacturer's Name:	Hewlett-Packard Co.
Manufacturer's Address:	Communications Meas Division - Colorado 5070 Centennial Boulevard Colorado Springs, Colorado 80919
declares that the product	
Product Name:	Internet Advisor ATM 155-UTP Module
Model Number(s):	J2913A
Product Option(s):	None
conforms to the following Product Specifications:	
Safety:	EN 61010-1:1993 / IEC 1010-1:1990 + A1
EMC:	EN 55011:1991 / CISPR 11:1990 (Group 1, Class A) ¹ EN 50082-1:1992 IEC 801-2:1991 4 kV CD, 8 kV AD IEC 801-3:1984 3 V/m IEC 801-4:1988 0.5 kV Signal Lines, 1 kV Power Lines
Supplementary Information:	
The product herewith complies with the requirements of the Low Voltage Directive 73/23/EEC and the EMC Directive 89/336/EEC and carries the CE marking accordingly.	
¹ The product was tested in a typical configuration.	
Colorado Springs, CO 8 September 1997	 Greg Schiffman, Quality Manager (acting)
European Contact: Your local Hewlett-Packard Sales and Service Office or Hewlett-Packard GmbH, Department ZQ / Standards Europe, Herrenberger Strasse 130, D-71034 Boeblingen, Germany (FAX +49-7031-14-3143)	

J2913B ATM 155-UTP Interface Module

DECLARATION OF CONFORMITY <small>according to ISO/IEC Guide 22 and EN 45014</small>	
Manufacturer's Name:	Hewlett-Packard Co.
Manufacturer's Address:	Network Systems Test Division 5070 Centennial Boulevard Colorado Springs, Colorado 80919
declares that the product	
Product Name:	155-UTP analyzer Module for Internet Advisor ATM
Model Number(s):	HP J2913B
Product Option(s):	All
conforms to the following Product Specifications:	
Safety:	EN 61010-1:1993 / IEC 1010-1:1990 + A1+ A2
EMC:	EN 55011:1991 / CISPR 11:1990 (Group 1, Class A) ¹ EN 50082-1:1992 IEC 801-2:1991 4 kV CD, 8 kV AD IEC 801-3:1984 3 V/m IEC 801-4:1988 0.5 kV Signal Lines, 1 kV Power Lines
Supplementary Information:	
The product herewith complies with the requirements of the Low Voltage Directive 73/23/EEC and the EMC Directive 89/336/EEC and carries the CE marking accordingly.	
¹ The product was tested in a typical configuration.	
Colorado Springs, CO 22 October 1998	 _____ Stephen Hale / Quality Manager
<small>European Contact: Your local Hewlett-Packard Sales and Service Office or Hewlett-Packard GmbH, Department ZQ / Standards Europe, Herrenberger Strasse 130, D-71034 Boeblingen, Germany (FAX +49-7031-14-3143)</small>	

J3444A Fast Ethernet LAN Undercradle

DECLARATION OF CONFORMITY	
according to ISO/IEC Guide 22 and EN 45014	
Manufacturer's Name:	Hewlett-Packard Co.
Manufacturer's Address:	Colorado Communications Operation 5070 Centennial Boulevard Colorado Springs, Colorado 80919
declares that the product	
Product Name:	Fast Ethernet LAN analyzer for Internet Advisor
Model Number(s):	J3444A
Product Option(s):	None
conforms to the following Product Specifications:	
Safety:	EN 61010-1:1993 / IEC 1010-1:1990 + A1
EMC:	EN 55011:1991 / CISPR 11:1990 (Group 1, Class A) ¹ EN 50082-1:1992 IEC 801-2:1991 4 kV CD, 8 kV AD IEC 801-3:1984 3 V/m IEC 801-4:1988 0.5 kV Signal Lines, 1 kV Power Lines
Supplementary Information:	
The product herewith complies with the requirements of the Low Voltage Directive 73/23/EEC and the EMC Directive 89/336/EEC and carries the CE marking accordingly.	
¹ The product was tested in a typical configuration.	
Colorado Springs, CO 15 August 1996	 Andy Ouderkerk / Quality Manager
European Contact: Your local Hewlett-Packard Sales and Service Office or Hewlett-Packard GmbH, Department ZQ / Standards Europe, Herrenberger Strasse 130, D-71034 Boeblingen, Germany (FAX +49-7031-14-3143)	

J3445A 100 Base-FX Interface Module

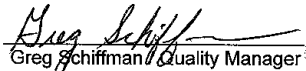
DECLARATION OF CONFORMITY	
according to ISO/IEC Guide 22 and EN 45014	
Manufacturer's Name:	Hewlett-Packard Co.
Manufacturer's Address:	Colorado Communications Operation 5070 Centennial Boulevard Colorado Springs, Colorado 80919
declares that the product	
Product Name:	100Base-FX Interface Module for Internet Advisor LAN analyzer
Model Number(s):	J3445A
Product Option(s):	None
conforms to the following Product Specifications:	
Safety:	EN 61010-1:1993 / IEC 1010-1:1990 + A1
EMC:	EN 55011:1991 / CISPR 11:1990 (Group 1, Class A) ¹ EN 50082-1:1992 IEC 801-2:1991 4 kV CD, 8 kV AD IEC 801-3:1984 3 V/m IEC 801-4:1988 0.5 kV Signal Lines, 1 kV Power Lines
Supplementary Information:	
The product herewith complies with the requirements of the Low Voltage Directive 73/23/EEC and the EMC Directive 89/336/EEC and carries the CE marking accordingly.	
¹ The product was tested in a typical configuration.	
Colorado Springs, CO 16 October 1996	 Greg Schiffman, Quality Manager (acting)
European Contact: Your local Hewlett-Packard Sales and Service Office or Hewlett-Packard GmbH, Department ZQ / Standards Europe, Herrenberger Strasse 130, D-71034 Boeblingen, Germany (FAX +49-7031-14-3143)	

J3446C and J3447A Internet Advisor LAN

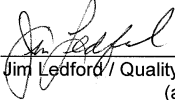
DECLARATION OF CONFORMITY <small>according to ISO/IEC Guide 22 and EN 45014</small>	
Manufacturer's Name:	Hewlett-Packard Co.
Manufacturer's Address:	Network Systems Test Division 5070 Centennial Boulevard Colorado Springs, Colorado 80919
declares that the product	
Product Name:	Internet Advisor LAN - Fast Ethernet
Model Number(s):	J3446C, J3447A
Product Option(s):	001, 005 (these affect J3446C only)
conforms to the following Product Specifications:	
Safety:	EN 61010-1:1993 / IEC 1010-1:1990 + A1
EMC:	EN 55011:1991 / CISPR 11:1990 (Group 1, Class A) ¹ EN 50082-1:1992 IEC 801-2:1991 4 kV CD, 8 kV AD IEC 801-3:1984 3 V/m IEC 801-4:1988 0.5 kV Signal Lines, 1 kV Power Lines EN 61000-3-2:1995 / IEC 1000-3-2:1995 + A1 EN 61000-3-3:1995 / IEC 1000-3-3:1994
Supplementary Information:	
The product herewith complies with the requirements of the Low Voltage Directive 73/23/EEC and the EMC Directive 89/336/EEC and carries the CE marking accordingly.	
¹ The product was tested in a typical configuration.	
Colorado Springs, CO 12 December 1997	 _____ Jim Ledford / Quality Manager (acting)
<small>European Contact: Your local Hewlett-Packard Sales and Service Office or Hewlett-Packard GmbH, Department ZQ / Standards Europe, Herrenberger Strasse 130, D-71034 Boeblingen, Germany (FAX +49-7031-14-3143)</small>	

J3446D Internet Advisor LAN

DECLARATION OF CONFORMITY <small>according to ISO/IEC Guide 22 and EN 45014</small>	
Manufacturer's Name:	Hewlett-Packard Co.
Manufacturer's Address:	Network Systems Test Division 5070 Centennial Boulevard Colorado Springs, Colorado 80919
declares that the product	
Product Name:	Internet Advisor LAN
Model Number(s):	HP J3446D
Product Option(s):	All
conforms to the following Product Specifications:	
Safety:	EN 61010-1:1993 / IEC 1010-1:1990 + A1+ A2
EMC:	EN 55011:1991 / CISPR 11:1990 (Group 1, Class A) ¹ EN 50082-1:1992 IEC 801-2:1991 4 kV CD, 8 kV AD IEC 801-3:1984 3 V/m IEC 801-4:1988 0.5 kV Signal Lines, 1 kV Power Lines
Supplementary Information:	
The product herewith complies with the requirements of the Low Voltage Directive 73/23/EEC and the EMC Directive 89/336/EEC and carries the CE marking accordingly.	
¹ The product was tested in a typical configuration.	
Colorado Springs, CO 09 July 1999	 _____ Jack Haynes / Quality Manager
<small>European Contact: Your local Hewlett-Packard Sales and Service Office or Hewlett-Packard GmbH, Department ZQ / Standards Europe, Herrenberger Strasse 130, D-71034 Boeblingen, Germany (FAX +49-7031-14-3143)</small>	

J3754C Internet Advisor - pcAdvisor

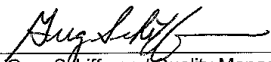
DECLARATION OF CONFORMITY	
<small>according to ISO/IEC Guide 22 and EN 45014</small>	
Manufacturer's Name:	Hewlett-Packard Co.
Manufacturer's Address:	Network Systems Test Division 5070 Centennial Boulevard Colorado Springs, Colorado 80919
declares that the product	
Product Name:	Internet Advisor - pc Advisor
Model Number(s):	J3754C
Product Option(s):	001, 005, 1A3, 506, 516, 8ZE
conforms to the following Product Specifications:	
Safety:	EN 61010-1:1993 / IEC 1010-1:1990 + A1
EMC:	EN 55011:1991 / CISPR 11:1990 (Group 1, Class A) ¹ EN 50082-1:1992 IEC 801-2:1991 4 kV CD, 8 kV AD IEC 801-3:1984 3 V/m IEC 801-4:1988 0.5 kV Signal Lines, 1 kV Power Lines EN 61000-3-2:1995 / IEC 1000-3-2:1995 + A1 EN 61000-3-3:1995 / IEC 1000-3-3:1994
Supplementary Information:	
The product herewith complies with the requirements of the Low Voltage Directive 73/23/EEC and the EMC Directive 89/336/EEC and carries the CE marking accordingly.	
¹ The product was tested in a typical configuration.	
Colorado Springs, CO 5 December 1997	 Greg Schiffman / Quality Manager (acting)
<small>European Contact: Your local Hewlett-Packard Sales and Service Office or Hewlett-Packard GmbH, Department ZQ / Standards Europe, Herrenberger Strasse 130, D-71034 Boeblingen, Germany (FAX +49-7031-14-3143)</small>	

J3759A DS3/E3 Cell/Frame Interface Module

DECLARATION OF CONFORMITY	
<small>according to ISO/IEC Guide 22 and EN 45014</small>	
Manufacturer's Name:	Hewlett-Packard Co.
Manufacturer's Address:	Network Systems Test Division 5070 Centennial Boulevard Colorado Springs, Colorado 80919
declares that the product	
Product Name:	DS3 / E3 Cells and Frames Module for Internet Advisor ATM
Model Number(s):	HP J3759A
Product Option(s):	All
conforms to the following Product Specifications:	
Safety:	EN 61010-1:1993 / IEC 1010-1:1990 + A1+ A2
EMC:	EN 55011:1991 / CISPR 11:1990 (Group 1, Class A) ¹ EN 50082-1:1992 IEC 801-2:1991 4 kV CD, 8 kV AD IEC 801-3:1984 3 V/m IEC 801-4:1988 0.5 kV Signal Lines, 1 kV Power Lines
Supplementary Information:	
The product herewith complies with the requirements of the Low Voltage Directive 73/23/EEC and the EMC Directive 89/336/EEC and carries the CE marking accordingly.	
¹ The product was tested in a typical configuration.	
Colorado Springs, CO 02 July 1998	 _____ Stephen Hale / Quality Manager
<small>European Contact: Your local Hewlett-Packard Sales and Service Office or Hewlett-Packard GmbH, Department ZQ / Standards Europe, Herrenberger Strasse 130, D-71034 Boeblingen, Germany (FAX +49-7031-14-3143)</small>	

J3762A HSSI Interface Module

DECLARATION OF CONFORMITY	
<small>according to ISO/IEC Guide 22 and EN 45014</small>	
Manufacturer's Name:	Hewlett-Packard Co.
Manufacturer's Address:	Network Systems Test Division 5070 Centennial Boulevard Colorado Springs, Colorado 80919
declares that the product	
Product Name:	HSSI Module for Internet Advisor ATM
Model Number(s):	HP J3762A
Product Option(s):	All
conforms to the following Product Specifications:	
Safety:	EN 61010-1:1993 / IEC 1010-1:1990 + A1+ A2
EMC:	EN 55011:1991 / CISPR 11:1990 (Group 1, Class A) ¹ EN 50082-1:1992 IEC 801-2:1991 4 kV CD, 8 kV AD IEC 801-3:1984 3 V/m IEC 801-4:1988 0.5 kV Signal Lines, 1 kV Power Lines
Supplementary Information:	
The product herewith complies with the requirements of the Low Voltage Directive 73/23/EEC and the EMC Directive 89/336/EEC and carries the CE marking accordingly.	
¹ The product was tested in a typical configuration.	
Colorado Springs, CO 02 July 1998	 Stephen Hale / Quality Manager
<small>European Contact: Your local Hewlett-Packard Sales and Service Office or Hewlett-Packard GmbH, Department ZQ / Standards Europe, Herrenberger Strasse 130, D-71034 Boeblingen, Germany (FAX +49-7031-14-3143)</small>	

J3763A/J3764A 622 Undercradle and Interface Module

DECLARATION OF CONFORMITY	
<small>according to ISO/IEC Guide 22 and EN 45014</small>	
Manufacturer's Name:	Hewlett-Packard Co.
Manufacturer's Address:	Network Systems Test Division 5070 Centennial Boulevard Colorado Springs, Colorado 80919
declares that the product	
Product Name:	Internet Advisor ATM 622 undercradle and OC-12c/STM-4c single-mode optical module
Model Number(s):	HP J3763A and J3764A
Product Option(s):	All
conforms to the following Product Specifications:	
Safety:	EN 61010-1:1993 / IEC 1010-1:1990 + A1+ A2
EMC:	EN 55011:1991 / CISPR 11:1990 (Group 1, Class A) ¹ EN 50082-1:1992 IEC 801-2:1991 4 kV CD, 8 kV AD IEC 801-3:1984 3 V/m IEC 801-4:1988 0.5 kV Signal Lines, 1 kV Power Lines
Supplementary Information:	
The product herewith complies with the requirements of the Low Voltage Directive 73/23/EEC and the EMC Directive 89/336/EEC and carries the CE marking accordingly.	
¹ The product was tested in a typical configuration. This product is used in conjunction with the HP F1454A AC/DC Adapter.	
Colorado Springs, CO 05 February 1999	 _____ Jack Haynes / Quality Manager
<small>European Contact: Your local Hewlett-Packard Sales and Service Office or Hewlett-Packard GmbH, Department ZQ / Standards Europe, Herrenberger Strasse 130, D-71034 Boeblingen, Germany (FAX +49-7031-14-3143)</small>	

Declarations of Conformity
J3763A/J3764A 622 Undercradle and Interface Module

100Base-TX/10Base-T Ethernet connector, 4-3

A

application key, A-4
AUI, 4-2

B

breakout box
 connections, D-2
 RS232/V.24, D-2
 switches, D-2
Button Mouse, A-4

C

cable
 power, D-3
CD control signals, D-2
circuits
 RS-232/V.24
 circuits jumpering, D-2
connections
 breakout box, D-2
 RS-232 test connector, D-2
 RS-232/V.24
 test connectors, D-2
connector board, 7-2
connector card, 7-4
connector pinouts
 RS-232/V.24, D-7
 RS-449, D-8
 V.35, D-9
country selection, 8-8
CTS control signals, D-2

D

data transmitter, internal, D-2
date, 2-4

Declaration of Conformity

J2293B,J2294B,J2296B,J2297B, E-12
J2294C, E-2
J2298B,J2299B, E-12
J2300C, E-3
J2300D, E-4
J2306B/J2309B, E-5
J2307A, E-6
J2524A, E-7
J2527A, E-8
J2900A, E-9
J2901A, E-10
J2904A, E-11
J2904B, E-12
J2905B, E-13
J2908A, E-14
J2909A, E-15
J2912A, E-16
J2912B, E-17
J2913A, E-18
J2913B, E-19
J3444A, E-20
J3445A, E-21
J3446C and J3447A, E-22
J3446D, E-23
J3754C, E-24
J3759A, E-25
J3762A, E-26
J3763A/J3764A, E-27

display

 connecting an external, 2-6
DSR control signals, D-2
DTE switch, D-2
DTR control signals, D-2

E

EIA-232D (Formerly RS-232C) specifications, D-3
empty Undercradle, 7-5
endcap expander, 7-2
external
 interface connector, 3-2
 monitor, 3-2
 port, D-4
External Monitor, 5-2

F

flat endcap, 7-2
frame ground, D-3

Index

functions

- V-Series
- interfaces, D-6

G

- grounding, D-3
 - ground-loop problems, D-3
 - power cable, D-3
 - protective ground, D-3
- Grounding Strips, 7-2

I

- I/O address space, 8-7
- impedance, source, D-3
- Indicators
 - Mark/Space Indicator, D-3
- Intel Pentium P5 Chip, 1-2
- Interface Module
 - Install, 6-2
 - Remove, 6-3
- Interfaces
 - Pin-out comparison
 - CCITT V.35, D-10
 - RS-232C/CCITT V.24, D-10
 - RS-449, D-10
- internal data transmitter, D-2
- interrupts, 8-6

J

- J2295A empty Undercradle, 7-5
- J2300C
 - External Interface connector, 3-2
- J2300C/D
 - Dual PC Card slots, 3-3
 - External Monitor, 3-2
 - flexible disk drive, 3-3
 - handset connector, 3-3
 - headphones, 3-2
 - Interface Module, 3-3
 - microphone, 3-2
 - module release latch, 3-3
 - parallel port, 3-2
 - Power cable receptacle, 3-2
 - RS-232/V.24 connectors, 3-2
 - RS-449 connector, 3-3
 - serial port, 3-2
 - V.35 connector, 3-3

J3446C/D

- 100Base-TX/10Base-T Ethernet connector, 4-3
- Ethernet, 4-2
- external
 - monitor, 4-2
- Fast Ethernet, 4-2
- flexible disk drive, 4-3
- Headphones, 4-2
- Interface Module slot, 4-3
- Microphone, 4-2
- Module Release Latch, 4-3
- on-off switch, 4-2
- parallel port, 4-2
- PC Card Slot, 4-3
- power cord
- receptacle, 4-2
- serial port, 4-2

J3754C

- Dual PC Card slots, 5-3
- flexible disk drive, 5-3
- headphones, 5-2
- parallel port, 5-2
- Power cable receptacle, 5-2

jacks

- source, D-4
- jumpering capabilities, RS-232/V.24
- circuits, D-2

K

- keyboard, A-4
- keypad, A-6
- LED, A-6

L

- lateral switch bank, D-2
- LCD VGA display, A-2
- LED lights
 - active interface LEDs
 - , D-4
 - RS-232/V.24
 - LED, D-4
 - RS-449 LED, D-4
 - T1/E1 LED, D-4
 - V.35

- LED, D-4
 - Lead status LEDs, D-5
 - Mark LEDs, D-3
 - Space LEDs, D-3
 - System LEDs, D-2
- LEDs, A-6

M

- Mark LEDs, D-3
- Mark/Space Indicator, D-3
- metal plate, 7-3
- Microphone, 5-2
- MII, 4-2
- modem
 - PC Card setup, 8-9
 - PC Cards, 8-8
 - transmission rates, 8-8
- module release latch, 6-2
- monitor, connecting an external, 2-6

N

- Num Lock key, A-6
- numeric
 - keypad, A-6

O

- on-off switch, 2-2, 3-2, 5-2
- operating
 - conditions, A-3

P

- PC Card, 8-2
 - compatibility, 8-2
 - configurations, 8-3
 - I/O address space, 8-7
 - insertion, 8-3
 - Modem, 8-8
 - removal, 8-5
 - slot, 4-3, 8-2
- PC Specifications, 2-2
- physical characteristics, A-2
- ports
 - external port, D-4
 - RS-449 port, D-4
 - V.35, D-4
- power cable, D-3
 - receptacle, 3-2, 5-2

- power cord, 2-2
- printer
 - connecting, 2-8
- Product Matrix, 1-3
- protective ground, D-3

R

- receivers
 - V-Series
 - signal receivers, D-3
- remote control, 8-9
- RS-232 test connector, D-2
- RS-232/V.24
 - circuits, jumpering, D-2
 - connector pinouts, D-7
 - LED, D-4
 - test connectors, D-2
- RS-449
 - connector pinouts, D-8
 - LED, D-4
 - port, D-4
- RTS control signals, D-2
- rubber feet, 7-2

S

- Serial Port, 5-2
- setting
 - time and date, 2-4
- signal ground, D-3
- signals
 - CD control signals, D-2
 - CTS control signals, D-2
 - DSR control signals, D-2
 - DTR control signals, D-2
 - RTS control signals, D-2
 - terminal generated control signals, D-2
 - V-Series
 - signal receivers, D-3
- slave setup, 8-9
- source
 - impedance, D-3
 - jacks, D-4
 - voltage, D-4
- Space LEDs, D-3
- speakers, 1-2
- Specifications
 - EIA-232D (Formerly RS-232C), D-3
- supported configurations, 1-4

Index

SVGA display, A-2

switches

breakout box switches, D-2

DTE switch, D-2

lateral switch bank, D-2

vertical switch bank, D-2

System LEDs, D-2

T

T1/E1 LED, D-4

terminal generated control signals, D-2

tests

RS-232 test connector, D-2

RS-232/V.24

test connectors, D-2

time, 2-4

Torx wrench, 7-2

transmitters

internal data transmitter, D-2

U

undercradle

assembly, 7-6

attaching, 7-3

connector board, 7-4

disassembly, 7-5

empty, 7-5

install PC Cards, 7-6

J2295A, 7-5

metal plate, 7-3

remove, 7-4

V

V.35

connector pinouts, D-9

LED, D-4

port, D-4

vertical switch bank, D-2

V-Series

functions, D-6

interfaces

RS-232, D-6

RS-449, D-6

V.35, D-6

signal receivers, D-3

W

Windows 95

keys, A-4