HP E5100A/B Network Analyzer

User's Guide

SERIAL NUMBERS

This manual applies directly to instruments which has the serial number prefix JP2KC,JP3KC,JP4KC and JP5KC, or firmware revision 2.xx and 3.xx.

For additional important information about serial numbers, read "Serial Number" in Appendix A.



HP Part No. E5100-90031
Printed in JAPAN December 1997

Third Edition

Manual Printing History

July 1995	First Edition
November 1995	Second Edition
December 1997	Third Edition

MS-DOS[®] is a registered trademark of Microsoft Corporation.
APC-7[®] is a registered trademark of Bunker Ramo Corporation.

Safety Summary

The following general safety precautions must be observed during all phases of operation, service, and repair of this instrument. Failure to comply with these precautions or with specific *WARNINGS* elsewhere in this manual may impair the protection provided by the equipment. In addition it violates safety standards of design, manufacture, and intended use of the instrument.

The Hewlett-Packard Company assumes no liability for the customer's failure to comply with these requirements.

Note



HP E5100A/B complies with INSTALLATION CATEGORY II and POLLUTION DEGREE 2 in IEC1010-1. HP E5100A/B is INDOOR USE product.

Note



LEDs in HP E5100A/B are Class 1 in accordance with IEC825-1. CLASS 1 LED PRODUCT

Ground The Instrument

To avoid electric shock hazard, the instrument chassis and cabinet must be connected to a safety earth ground by the supplied power cable with earth blade.

DO NOT Operate In An Explosive Atmosphere

Do not operate the instrument in the presence of flammable gasses or fumes. Operation of any electrical instrument in such an environment constitutes a definite safety hazard.

Keep Away From Live Circuits

Operating personnel must not remove instrument covers. Component replacement and internal adjustments must be made by qualified maintenance personnel. Do not replace components with the power cable connected. Under certain conditions, dangerous voltages may exist even with the power cable removed. To avoid injuries, always disconnect power and discharge circuits before touching them.

DO NOT Service Or Adjust Alone

Do not attempt internal service or adjustment unless another person, capable of rendering first aid and resuscitation, is present.

DO NOT Substitute Parts Or Modify Instrument

Because of the danger of introducing additional hazards, do not install substitute parts or perform unauthorized modifications to the instrument. Return the instrument to a Hewlett-Packard Sales and Service Office for service and repair to ensure that safety features are maintained.

Dangerous Procedure Warnings

Warnings , such as the example below, precede potentially dangerous procedures throughout this manual. Instructions contained in the warnings must be followed.

Warning



Dangerous voltages, capable of causing death, are present in this instrument. Use extreme caution when handling, testing, and adjusting this instrument.

Typeface Conventions

Bold	Boldface type is used when a term is defined. For example: icons are symbols.
<i>Italics</i>	Italic type is used for emphasis and for titles of manuals and other publications. Italic type is also used for keyboard entries when a name or a variable must be typed in place of the words in italics. For example: copy <i>filename</i> means to type the word copy, to type a space, and then to type the name of a file such as file1.
Computer	Computer font is used for on-screen prompts and messages.
HARDKEYS	Labeled keys on the instrument front panel are enclosed in □.
SOFTKEYS	Softkeys located to the right of the LCD are enclosed in ▣.

Certification

Hewlett-Packard Company certifies that this product met its published specifications at the time of shipment from the factory. Hewlett-Packard further certifies that its calibration measurements are traceable to the United States National Institute of Standards and Technology, to the extent allowed by the Institution's calibration facility, or to the calibration facilities of other International Standards Organization members.

Warranty

This Hewlett-Packard instrument product is warranted against defects in material and workmanship for a period of one year from the date of shipment, except that in the case of certain components listed in *General Information* of this manual, the warranty shall be for the specified period. During the warranty period, Hewlett-Packard Company will, at its option, either repair or replace products that prove to be defective.

For warranty service or repair, this product must be returned to a service facility designated by HP. Buyer shall prepay shipping charges to HP and HP shall pay shipping charges to return the product to Buyer. However, Buyer shall pay all shipping charges, duties, and taxes for products returned to HP from another country.

HP warrants that its software and firmware designated by HP for use with an instrument will execute its programming instruction when properly installed on that instrument. HP does not warrant that the operation of the instrument, or software, or firmware will be uninterrupted or error free.

Limitation Of Warranty

The foregoing warranty shall not apply to defects resulting from improper or inadequate maintenance by Buyer, Buyer-supplied software or interfacing, unauthorized modification or misuse, operation outside the environmental specifications for the product, or improper site preparation or maintenance.

No other warranty is expressed or implied. HP specifically disclaims the implied warranties of merchantability and fitness for a particular purpose.

Exclusive Remedies

The remedies provided herein are buyer's sole and exclusive remedies. HP shall not be liable for any direct, indirect, special, incidental, or consequential damages, whether based on contract, tort, or any other legal theory.

Assistance

Product maintenance agreements and other customer assistance agreements are available for Hewlett-Packard products.

For any assistance, contact your nearest Hewlett-Packard Sales and Service Office. Addresses are provided at the back of this manual.

Safety Symbols

General definitions of safety symbols used on equipment or in manuals are listed below.



Instruction manual symbol: the product is marked with this symbol when it is necessary for the user to refer to the instruction manual.



Alternating current.



Direct current.



On (Supply).



Off (Supply).



In position of push-button switch.



Out position of push-button switch.



Frame (or chassis) terminal. A connection to the frame (chassis) of the equipment which normally include all exposed metal structures.

Warning



This **Warning** sign denotes a hazard. It calls attention to a procedure, practice, condition or the like, which, if not correctly performed or adhered to, could result in injury or death to personnel.

Caution



This **Caution** sign denotes a hazard. It calls attention to a procedure, practice, condition or the like, which, if not correctly performed or adhered to, could result in damage to or destruction of part or all of the product.

Note



This **Note** sign denotes important information. It calls attention to a procedure, practice, condition or the like, which is essential to highlight.



Affixed to product containing static sensitive devices use anti-static handling procedures to prevent electrostatic discharge damage to component.

Documentation Guide

Please refer to the following manuals for the operation of the analyzer where necessarily.

HP E5100A/B User's Guide (HP E5100-90031)

This documents explains the method to set up and basic operations of HP E5100A/B in simple steps.

Function Reference (HP Part Number E5100-90040)

The Function Reference describes all function accessed from the front panel keys and softkeys. It also provides information on options and accessories available, specifications, system performance, and some topics about the analyzer's features.

Programming Manual (HP Part Number E5100-90057)

The Programming Manual shows how to write and use BASIC program to control the analyzer and provides a summary of all available HP-IB commands.

Using HP Instrument BASIC with the HP E5100A/B (HP Part Number E5100-90004)

The Using HP Instrument BASIC with the HP E5100A/B describes how HP Instrument BASIC works with the analyzer.

HP Instrument BASIC Manual Set (HP Part Number E2083-90005)



The HP Instrument BASIC User's Handbook introduces you to the HP Instrument BASIC programming language, provide some helpful hints on getting the most use from it, and provide a general programming reference. It is divided into three books, *HP Instrument BASIC Programming Techniques*, *HP Instrument BASIC Interface Techniques*, and *HP Instrument BASIC Language Reference*.

Service Manual (Option 0BW only), (HP Part Number E5100-90100)

The Service Manual explains how to adjust, troubleshoot, and repair the instrument. This manual is option 0BW only.

Contents

1. Introduction	
Overview of HP E5100A/B	1-1
Overview	1-2
2. Front and Rear Panel	
Front Panel	2-1
1. Front Panel Keys and Softkeys	2-2
Softkeys that are Joined by Vertical Lines	2-2
Softkeys That Toggle On or Off	2-2
Softkeys that Show Status Indications in Brackets	2-2
2. Built-in Flexible Disk Drive	2-3
3. Preset	2-3
4. PROBE POWER Connector	2-3
 5. Inputs R, A, B, and C	2-3
6. RF OUT Connector	2-3
7. LINE Switch	2-3
Screen display	2-3
1. Channel Number	2-4
2. Trace Number	2-4
3. Measured Input(s)	2-4
4. Format	2-4
5. Top and Bottom Value	2-4
6. Reference Level	2-5
7. Marker Data Readout	2-5
8. Marker Stimulus	2-5
9. Trace number	2-5
10. Service Notation	2-5
11. Stimulus Value	2-5
12. Sweep Notations	2-5
13. Reference Position	2-5
14. Status Notations	2-5
Rear Panel Features and Connectors	2-6
1. Reference Oven Output (Option 1D5 Only)	2-6
2. External Program RUN/CONT Input	2-6
3. Power	2-7
4. External Reference Input	2-7
5. Internal Reference Output	2-7
6. External Trigger Input	2-7
7. HP-IB Interface	2-7
8. Printer Interface	2-7
9. Video Outputs (VGA)	2-7
10. DIN Keyboard Connector	2-7
11. I/O Port	2-7

3. Installation and Set Up Guide	
Incoming Inspection	3-1
Power Cable	3-2
Power Requirements	3-4
Ventilation Requirements	3-4
Instruction for Cleaning	3-4
Rack/Handle Installation	3-4
Option 1CN Handle Kit	3-5
Installing the Handle	3-5
Option 1CM Rack Mount Kit	3-5
Mounting the Rack	3-5
Option 1CP Rack Mount & Handle Kit	3-6
Mounting the Handle and Rack	3-6
Connecting a BNC Adapter (Option 1D5 Only)	3-6
Connecting a Keyboard (Option 1F0 only)	3-7
Connecting a VGA Monitor	3-7
4. Quick Start Guide	
Overview	4-1
Required Equipment	4-2
 Step1 : Preparing for a measurement	4-3
Step 2 : Turning ON the analyzer	4-4
Line Input Receptacle	4-4
 Fuse	4-4
Steps to turn on the power	4-4
Step3 : Setting up the Analyzer	4-5
Setting the function	4-5
Selecting the input ports	4-5
Selecting the measurement format	4-5
Setting the frequency range	4-5
Performing the automatic scaling	4-5
Setting the IF band width	4-5
Step4 : Making a calibration	4-6
Performing a Response Calibration	4-6
Step5 : Reading a measurement result	4-7
Reading a measured value by using marker	4-7
Analyzing a filter parameter	4-7
5. Analyzer Feature Tutorial	
Multi-channel Measurement Tutorial	5-1
To setup measurement	5-1
To make response calibration	5-1
To measure dut	5-2
To display the trace of all channel	5-2
To measure a dut on different sweep parameter.	5-2
To setup measurement	5-2
To make response calibration	5-3
To measure dut	5-3
To display the trace of all channel	5-3
To split the display graticule	5-4
To make list sweep	5-4
To create sweep List	5-4
To perform list sweep	5-6

To increase Dynamic Range Enhancement	5-6
Use of Order Base Display Mode	5-7
Disk Drive Tutorial	5-8
Selecting Storage Devices	5-8
To save file to a floppy disk	5-8
To save file to a RAM disk	5-9
To recall a file	5-9
To change working directory	5-10
To recall a file at power on	5-10

A. Manual Changes

Introduction	A-1
Manual Changes	A-1
Serial Number	A-2

Index

Figures

1-1. Overview of HP E5100A	1-2
1-2. Overview of HP E5100B	1-2
2-1. Analyzer Front Panel	2-1
2-2. Screen Display	2-4
2-3. Analyzer Rear Panel	2-6
3-1. Power Cable Supplied	3-3
3-2. Rack Mount Kits Installation	3-5
3-3. Connecting a BNC Adapter	3-6
3-4. Connecting a Keyboard	3-7
3-5. Connecting a VGA Monitor	3-7
4-1. Required Equipment	4-2
4-2. Connection of Measurement Cables	4-3
4-3. Line Input Receptacle and Fuse	4-4
5-1. Sweep List Edit Display	5-5
5-2. List Sweep Measurement	5-6
5-3. List Sweep Example (Dynamic Range Enhancement)	5-7
A-1. Serial Number Plate	A-2

Tables

3-1. HP E5100A/B Contents	3-2
3-2. Rack Mount Kits	3-4
A-1. Manual Changes by Serial Number	A-1
A-2. Manual Changes by Firmware Version	A-1

Introduction

This manual explains setting up and starting the analyzer, basic measuring procedure.

Overview of HP E5100A/B

HP E5100A/B is a 10 kHz to 300 MHz network analyzer fitted for production lines of electric component manufactures.

HP E5100A/B has the following features:

- Frequency range from 10 kHz to 300 MHz.
- 0.04 ms/point (fastest) measurement speed
- Ramp sweep and step sweep
- Fine resolution IFBW (10 Hz to 30 kHz with 1, 1.5, 2, 3, 4, 5, 8 steps)
- Stable measurements (120 dB dynamic range @1 kHz IF BW)
- To provide fast waveform analysis commands
- 3-mode DOS flexible disk drive (720 kbyte, 1.2 Mbyte, and 1.44 Mbyte)

Overview

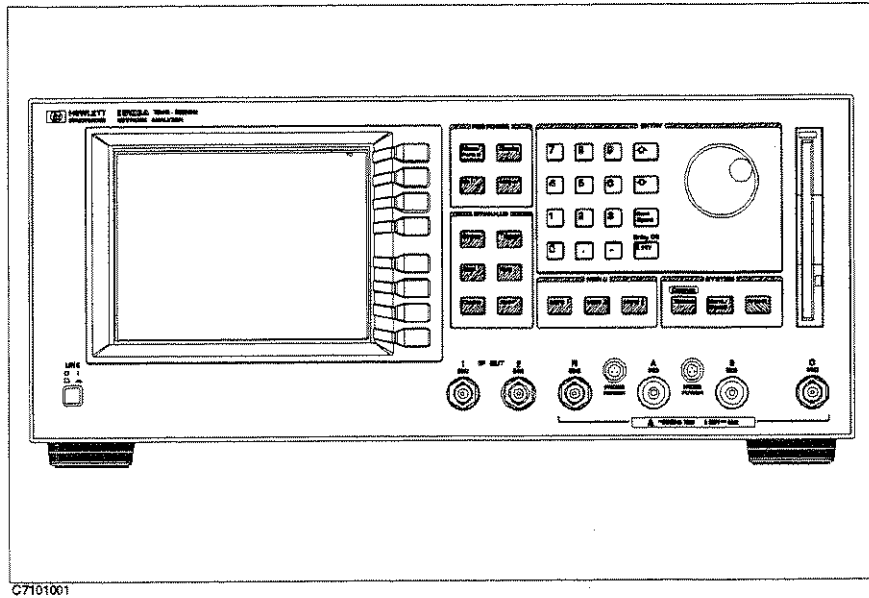

Figure 1-1. Overview of HP E5100A

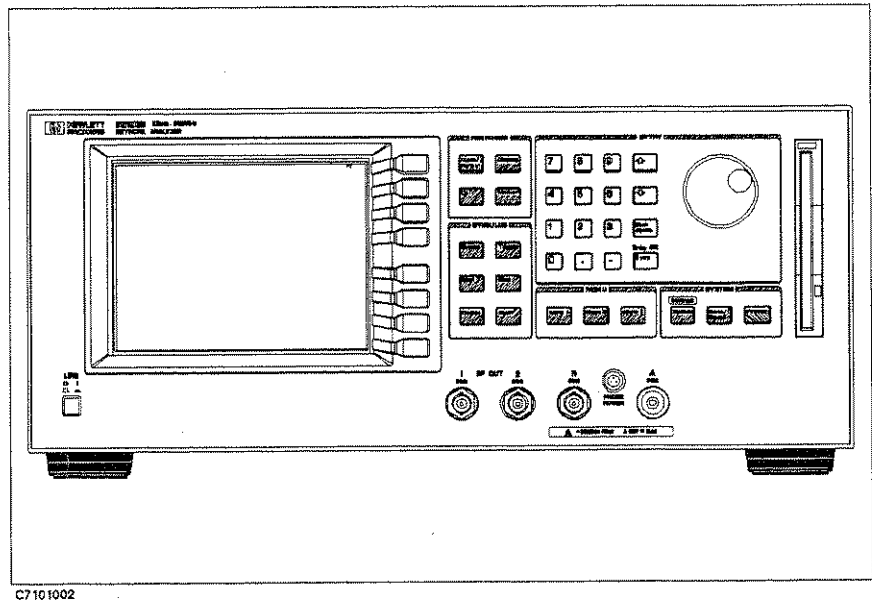

Figure 1-2. Overview of HP E5100B

Front and Rear Panel

This chapter describes the features of the front and rear panels of the analyzer. It provides illustrations and descriptions of the front panel features, the LCD display and its labels, and the rear panel features and connectors.

Front Panel

Analyzer functions are activated from the front panel (Figure 2-1) by using the front panel hardkeys or softkeys.

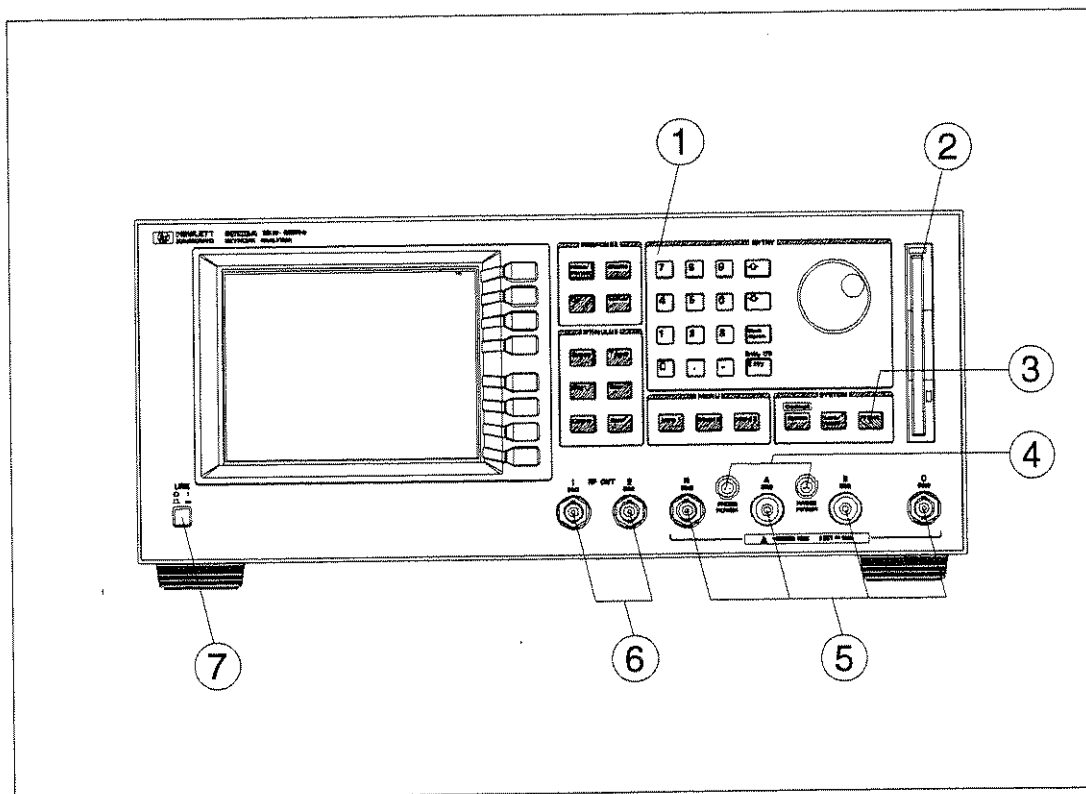

C7102001

Figure 2-1. Analyzer Front Panel

1. Front Panel Keys and Softkeys

Some of the front panel keys change instrument functions directly, and others provide access to additional functions available in softkey menus. Softkey menus are lists of up to eight related functions that can be displayed in the softkey label area at the right-hand side of the display. The eight keys to the right of the LCD are the softkeys. Pressing one of the softkeys selects the adjacent menu function. This either executes the labeled function and makes it the active function, causes instrument status information to be displayed, or presents another softkey menu.

Some of the analyzer's menus are accessed directly from front panel keys and some from other menus. For example, the sweep menu accessed by pressing the **Sweep** key presents all the sweep functions such as sweep type, number of points, and sweep time. Pressing **NUMBER of POINTS** allows the required number of points displayed per sweep to be entered directly from the number pad. **RETURN** softkeys return to previous menus. **DONE** indicates completion of a specific procedure and then returns to an earlier menu.

Usually, when a menu changes, the present active function is cleared.

Softkeys that are Joined by Vertical Lines

When several possible choices are available for a function, the softkeys are joined by vertical lines. For example, trigger menu under the **Trigger** key, the available inputs are listed: **HOLD**, **SINGLE**, **CONTINUOUS** with a vertical line between them. Note that only one softkey can be selected at a time. When a selection has been made from the listed alternatives, that selection is underlined until another selection is made.

Softkeys That Toggle On or Off

Some softkey functions can be toggled ON or OFF, for example averaging. This is indicated in the softkey label. The current state, ON or OFF, is capitalized in the softkey label.

Example:

SMOOTHING ON off

The word on is capitalized, showing that smoothing is currently on.

SMOOTHING on OFF

The word off is capitalized, showing that smoothing is currently off.

Softkeys that Show Status Indications in Brackets

Some softkey labels show the current status of a function in brackets. These include simple toggle functions and status-only indicators.

An example of a toggled function is the **SWEEP DIR [UP]** or **SWEEP DIR [DOWN]** softkey. The **TRIG EVENT []** softkey is an example of a status-only indicator, where the selected equation of the data math function is shown in brackets in the softkey label.

2. Built-in Flexible Disk Drive

Stores the measurement data, instrument status, and HP Instrument BASIC programs. The applicable disk format is DOS (disk operating system) format.

3.  This key returns the instrument to a known standard preset state from any step of any manual procedure.

4. PROBE POWER Connector

This connector (fused inside the instrument) supplies power to an active probe for in-circuit measurements of AC circuits.



5. Inputs R, A, B, and C

These inputs receive signals from source or DUT. The R input is used as the reference input. The number of inputs is depends on the option. The input impedance of each input is 50 Ω . When the analyzer is equipped with option 101 or 301, the input impedance can be selected, 50 Ω or 1 M Ω .

INSTALLATION CATEGORY I

6. RF OUT Connector

These two connectors output the RF signal. The same RF signals are outputted from these two connector because the power splitter is built in the analyzer. The output impedance at this connector is 50 Ω . When the analyzer is equipped with the option 001, the output is changed to single. When the analyzer is equipped with option 003, the switch is installed instead of the power splitter.

7. LINE Switch

This controls ac power to the analyzer. 1 is ON, 0 is OFF.

Screen display

Displays a grid on which the measurement data is plotted, the currently selected measurement traces, and other information describing the measurement. Figure 2-3 shows the locations of the different information labels.

In addition to the full-screen display shown in Figure 2-3, a split display is available. In this case, information labels are provided for each half of the display.

The screen can also be used as the HP Instrument BASIC display. HP Instrument BASIC uses either a full-screen display or a half-screen display below the graticule display as a text screen.

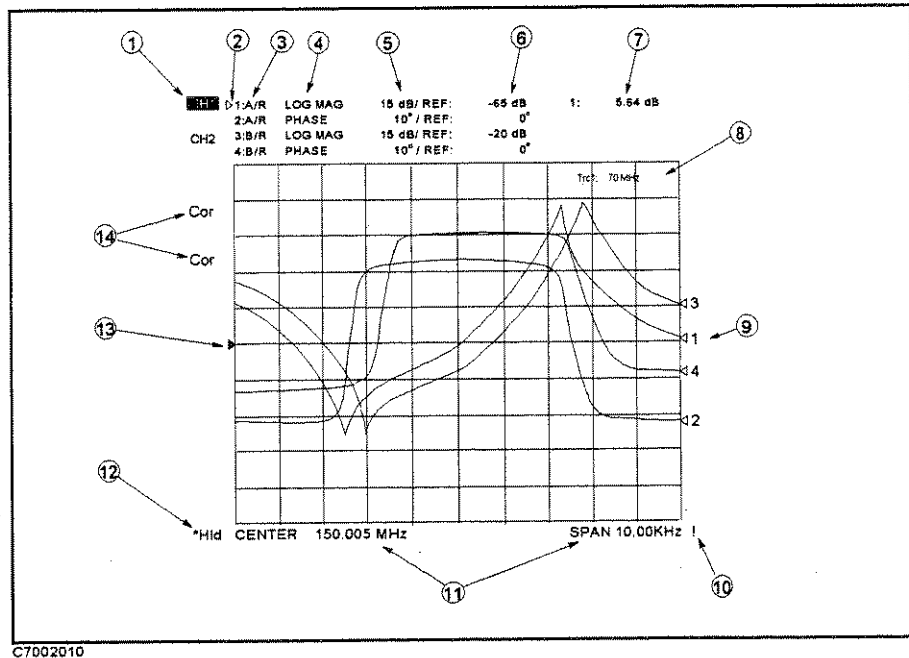

Figure 2-2. Screen Display

- 1. **Channel Number** Highlights the displayed channel number. The active channel is indicated by reverse display characters.
- 2. **Trace Number** Displays trace numbers. The active trace is indicated by a small triangle to the left of the trace number.
- 3. **Measured Input(s)** Shows the input or ratio of inputs currently measured as selected using **Meas** under the **Meas/Format** key. The measured inputs is shown when the function is set to gain-phase
- 4. **Format** Shows the format selected using **Format** under the **Meas/Format** key.

- 5. **Top and Bottom Value** Displays the top and bottom values of the grid selected by **SCALE MENU** under the **Display** key. When the function is set to impedance measurement and the Y-axis is set to log format, the grid scale is not scale/div format but top and bottom format.

- 6. Reference Level** Displays the value of a reference line in Cartesian formats. It is selected using **SCALE MENU** under the **Display** key. However, the reference line is invisible (it is indicated by a small triangle adjacent to the graticule at the left).
- 7. Marker Data Readout** Displays the values of the marker in units appropriate to the current measurement.
- 8. Marker Stimulus** Displays the stimulus value of the marker.
- 9. Trace number** Indicates the trace number for the measurement trace.
- 10. Service Notation** Indicates the analyzer is in service mode or self test was failed. See *E5100A/B Service Manual*
- 11. Stimulus Value** Displays the start/stop or the center/span values of frequency or power.
- 12. Sweep Notations** Displays one of the following the sweep conditions:
- Hld Hold sweep (**HOLD** under the **Trigger** key).
 - Ext Wait external trigger (**TRIG EVENT** under the **Trigger** key).
 - ↑ Under sweep
 - * Stimulus parameters changed: measured data in doubt until a complete fresh sweep has been taken.
- 13. Reference Position** Indicates the reference position.
- 14. Status Notations** Displays the current status of various functions for each channels. The following notations are used:
- Cor Error correction is on (**Correction on OFF** under the **Cal** key).
 - C? Stimulus parameters have changed, and interpolated error correction is on.
 - C! Stimulus parameters have changed, and interpolated error correction is not available.
 - Del Electrical delay or phase offset has been added or subtracted (**SCALE MENU** under the **Display** key).
 - Smo Trace smoothing is on (**SMOOTHING on OFF** under the **Display** key).

For example, the upper Cor in Figure 2-2 is for channel 1 and the lower one is for channel 2.

Rear Panel Features and Connectors

Figure 2-3 shows the features and connectors on the rear panel. Requirements for the input signals to the rear panel connectors are provided in the Specification chapter in the *E5100A/B Function Reference*.

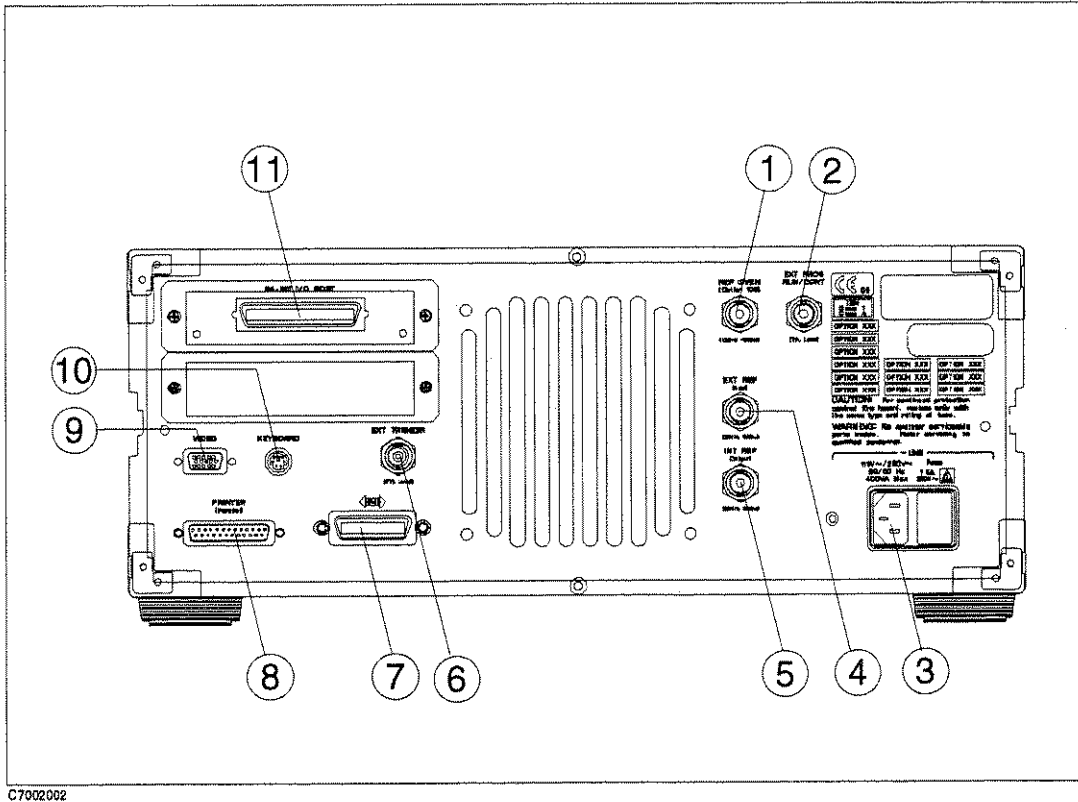

Figure 2-3. Analyzer Rear Panel

1. Reference Oven Output (Option 1D5 Only)

Connects to the EXT REF INPUT connector when Option 1D5 is installed. Option 1D5 improves the frequency accuracy and stability of the analyzer.

2. External Program RUN/CONT Input

Externally triggers RUN or CONT of the HP Instrument BASIC program. The positive edge of a pulse more than 20 μ s wide in the LOW state triggers RUN or CONT. The signal is TTL-compatible. When the analyzer is equipped with option UKR, this connector is deleted.

- 3. Power** This is input for the main power cable. Insert the main-power cable plug only into a socket outlet that has a protective ground contact.

4. External Reference Input

Connects an external frequency reference signal to the analyzer that is used to phase lock the analyzer for increased frequency accuracy.

When the analyzer is equipped with option 1D5, this connector must be connected to REF OVEN connector.

The external frequency reference function is automatically enabled when a signal is connected to this input. When the signal is removed, the analyzer automatically switches back to its internal frequency reference.

5. Internal Reference Output

Connects to the frequency reference input of an external instrument to phase lock it to the analyzer.

6. External Trigger Input

Triggers a measurement sweep. The positive edge of a pulse more than 20 μ s wide in the LOW state starts a measurement. The signal is TTL-compatible. To use this connector, set the trigger mode to external using softkey functions.

- 7. HP-IB Interface** Connects the analyzer to an external controller and other instruments in an automated system. This connector is also used when the analyzer itself is the controller of compatible peripherals.

- 8. Printer Interface** Connects the analyzer to an external printer. The interface is centronics compatible.

9. Video Outputs (VGA)

Connects the VGA video monitor.

10. DIN Keyboard Connector

Connects the keyboard that is usually used with HP Instrument BASIC. DIN keyboard is furnished when the analyzer is equipped with HP Instrument BASIC (option 1D5)

- 11. I/O Port** Connects to external devices such as a handler on a production line.

1

2

3

4

5

Installation and Set Up Guide

This chapter provides the information necessary for performing an incoming inspection and setting up HP E5100A/B.

The main topics in this chapter are:

- Incoming Inspection
- Power Cable
- Power requirements
- Ventilation Requirements
- Instruction for Cleaning
- Rack Mounting Installation

Incoming Inspection

Warning



To avoid hazardous electrical shock, do not turn on the HP E5100A/B when there are signs of shipping damage to any portion of the outer enclosure (for example, covers, panel, or display)

Inspect the shipping container for damage. If the shipping container or cushioning material is damaged, it should be kept until the contents of the shipment have been checked for completeness and the HP E5100A/B has been checked mechanically and electrically. The contents of the shipment should be as listed in Table 3-1. If the contents are incomplete, if there is mechanical damage or defect, or if the analyzer does not pass the power-on selftests, notify the nearest Hewlett-Packard office. If the shipping container is damaged, or the cushioning material shows signs of unusual stress, notify the carrier as well as the Hewlett-Packard office. Keep the shipping materials for the carrier's inspection.

Table 3-1. HP E5100A/B Contents

Description	Qty.	HP Part Number
HP E5100A/B		
Power cable ¹	1	—
Program disk set	1	E5100-61001
Function Reference	1	E5100-90040
Programming Manual	1	E5100-90057
User's Guide	1	E5100-90031
HP Instrument BASIC Users Handbook	1	E2083-90005 ²
Option 0BW Add Service Manual		
Service Manual	1	E5100-90100
Option 1CM Rack Mount Kit		
Rack mount kit	1	5062-3984
Option 1CN Front Handle Kit		
Front handle kit	1	5062-3990
Option 1CP Rack and Handle Kit		
Rack and handle kit	1	5062-3978
Option 1D5 High Stability Frequency		
BNC Adapter	1	1250-1859
Option 1F0 External Keyboard		
Keyboard	1	C3757-60401

¹ Power Cable depends on where the instrument is used, see Figure 3-1.

² When option UKR is equipped with the analyzer, this manual is deleted.

Power Cable

In accordance with international safety standards, this instrument is equipped with a three-wire power cable. When connected to an appropriate ac power outlet, this cable grounds the instrument frame. The type of power cable shipped with each instrument depends on the country of destination. Refer to Figure 3-1 for the part numbers of the power cables available.

Warning



For protection from electrical shock, the power cable ground must not be defeated. The power plug must be plugged into an outlet that provides a protective earth ground connection.



<p>OPTION 900</p>  <p>Plug : BS 1363A, 250V Cable : HP 8120-1351</p>	<p>OPTION 901</p>  <p>Plug : NZSS 198/AS C112, 250V Cable : HP 8120-1369</p>
<p>OPTION 902</p>  <p>Plug : CEE-VII, 250V Cable : HP 8120-1689</p>	<p>OPTION 903</p>  <p>Plug : NEMA 5-15P, 125V, 15A Cable : HP 8120-1378</p>
<p>OPTION 904</p>  <p>Plug : NEMA 6-15P, 250V, 15A Cable : HP 8120-0698</p>	<p>OPTION 906</p>  <p>Plug : SEV 1011.1959-24507 Type 12, 250V Cable : HP 8120-2104</p>
<p>OPTION 912</p>  <p>Plug : DHCR 107, 220V Cable : HP 8120-2956</p>	<p>OPTION 917</p>  <p>Plug : SABS 164, 250V Cable : HP 8120-4211</p>
<p>OPTION 918</p>  <p>Plug : JIS C 8303, 125V, 15A Cable : HP 8120-4753</p>	<p>OPTION 922</p>  <p>Plug : GB 1002, 250V Cable : HP 8120-8376</p>
<p>NOTE: Each option number includes a 'family' of cords and connectors of various materials and plug body configurations (straight, 90° etc.).</p>	

Figure 3-1. Power Cable Supplied

Power Requirements

HP E5100A/B requires a following power source:

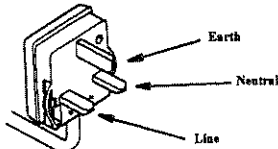
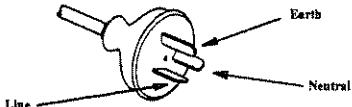
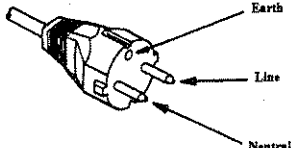
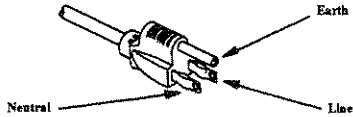
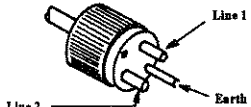
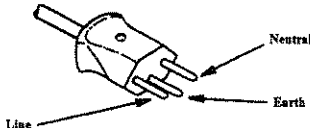
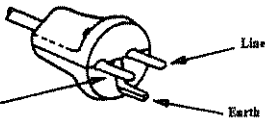
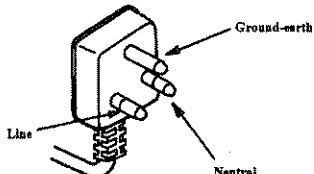
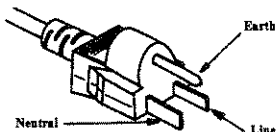
Voltage : 90 to 132 Vac, 198 to 264 Vac

Frequency : 47 to 63 Hz

Power : 400 VA maximum

Ventilation Requirements

To ensure adequate ventilation, make sure that there is adequate clearance of at least 180 mm behind, 60 mm sides and 15 mm above and below.

Instruction for Cleaning

For cleaning, wipe with soft cloth that is soaked with water and wrung tightly without undue pressure.

Rack/Handle Installation

The analyzer can be rack mounted and used as a component in a measurement system. Figure 3-2 shows how to rack mount the HP E5100A/B.

Table 3-2. Rack Mount Kits

Option	Description	HP Part Number
1CN	Handle Kit	5062-3990
1CM	Rack Mount Kit	5062-3984
1CP	Rack Mount&Handle Kit	5062-3978

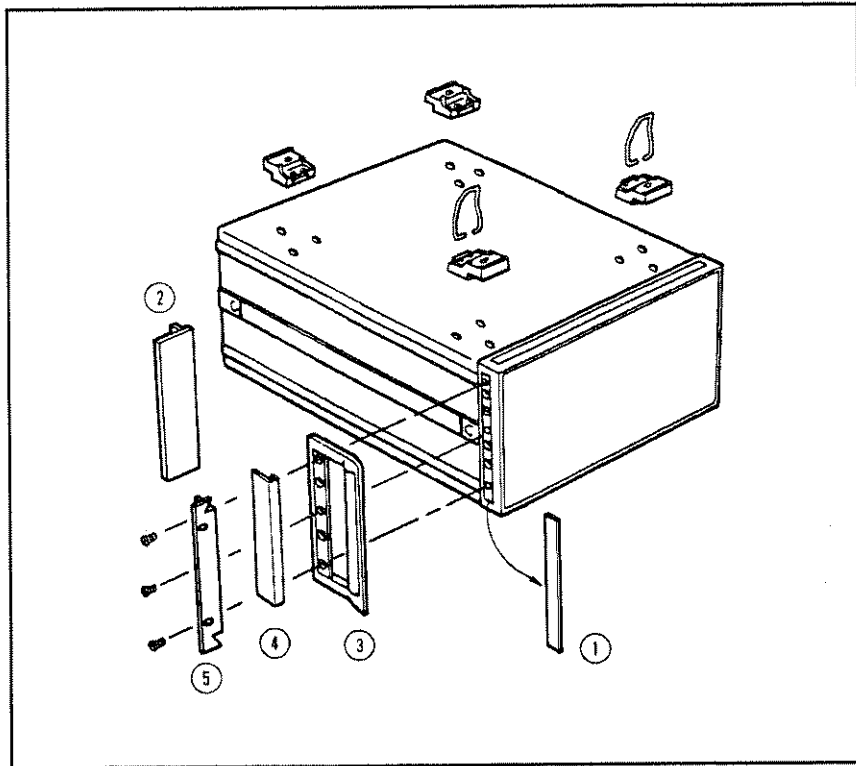

Figure 3-2. Rack Mount Kits Installation

Option 1CN Handle Kit

Option 1CN is a handle kit containing a pair of handles and the necessary hardware to attach them to the instrument.

Installing the Handle

1. Remove the adhesive-backed trim strips ① from the left and right front sides of the HP E5100A/B. (Refer to Figure 3-2.)
2. Attach the front handles ③ to the sides using the screws provided.
3. Attach the trim strips ④ to the handles.

Option 1CM Rack Mount Kit

Option 1CM is a rack mount kit containing a pair of flanges and the necessary hardware to mount them to the instrument in an equipment rack with 482.6 mm (19 inches) horizontal spacing.

Mounting the Rack

1. Remove the adhesive-backed trim strips ① from the left and right front sides of the HP E5100A/B. (Refer to Figure 3-2.)
2. Attach the rack mount flange ② to the left and right front sides of the HP E5100A/B using the screws provided.
3. Remove all four feet (lift bar on the inner side of the foot, and slide the foot toward the bar.)

Connecting a Keyboard (Option 1F0 only)

An DIN keyboard can be connected to the DIN connector on the rear panel of the analyzer. The DIN keyboard provides an easier way to enter characters for the file names, display titles, and Instrument BASIC programs. It can also access the analyzer softkey functions by using keyboard function keys. For more information on the DIN keyboard, see the *HP Instrument BASIC Manual Supplement*.

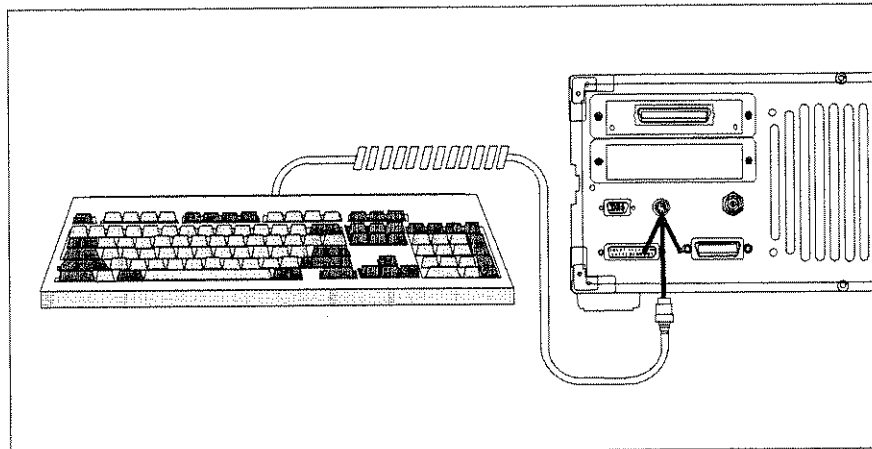

C7102001

Figure 3-4. Connecting a Keyboard

Connecting a VGA Monitor

A VGA monitor can be connected to the VGA connector on the rear panel of the analyzer. The VGA monitor provides an easier way to watch display.

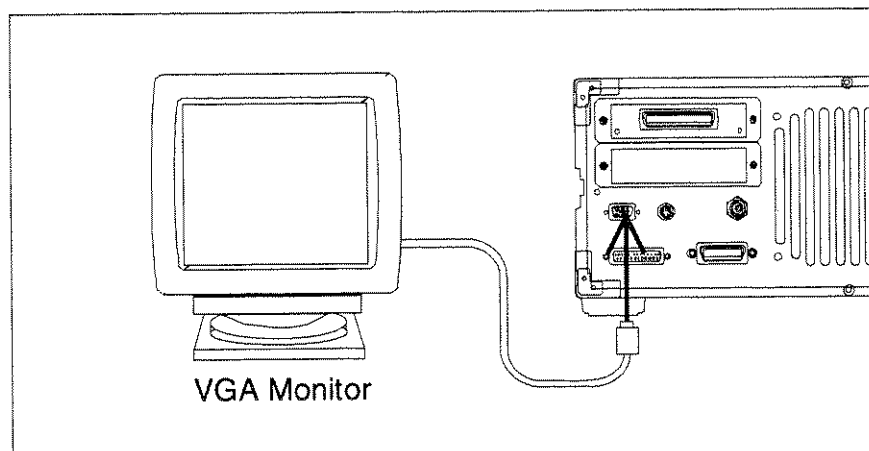

C7102003

Figure 3-5. Connecting a VGA Monitor

1

2

3

4

5

Quick Start Guide

In this chapter, you will learn how to make a basic network analyzer measurement by measuring the transmission characteristics of a bandpass filter.

Overview

The following is a short summary of this chapter:

1. Preparing for a measurement
 - Connecting peripherals
 - Connecting DUT
2. Turning ON the analyzer
3. Setting up the analyzer
 - Setting the function
 - Selecting the input ports
 - Selecting the measurement format
 - Setting the frequency range
 - Performing the automatic scaling
4. Making a calibration
 - Performing a Response Calibration
5. Reading a measurement result
 - Reading a measured value by using marker

Required Equipment

To perform all the steps in this chapter, you must have the following equipment:

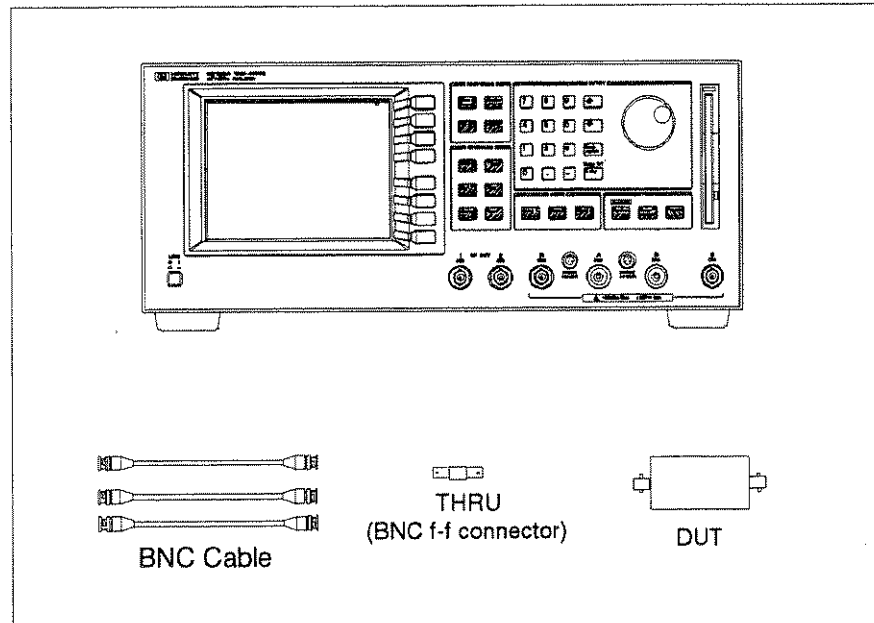

- HP E5100A/B Network Analyzer
- Measurement device:
 - This tour assumes the device under test (DUT) is a 70 MHz bandpass filter
- THRU (BNC female-to-female connector)
- Three BNC cables



C7109602

Figure 4-1. Required Equipment

Step1 : Preparing for a measurement

-  Connect the RF OUT 1 port to DUT with a BNC cable.
-  Connect the A port to DUT with a BNC cable.
-  Connect the RF OUT 2 port to the R port with BNC cable.

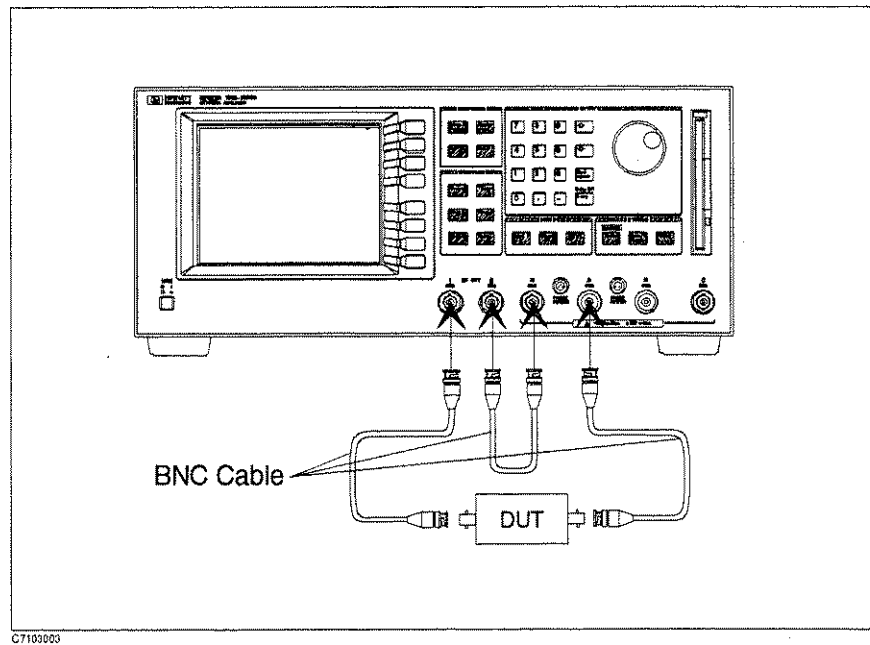

Figure 4-2. Connection of Measurement Cables

Step 2 : Turning ON the analyzer

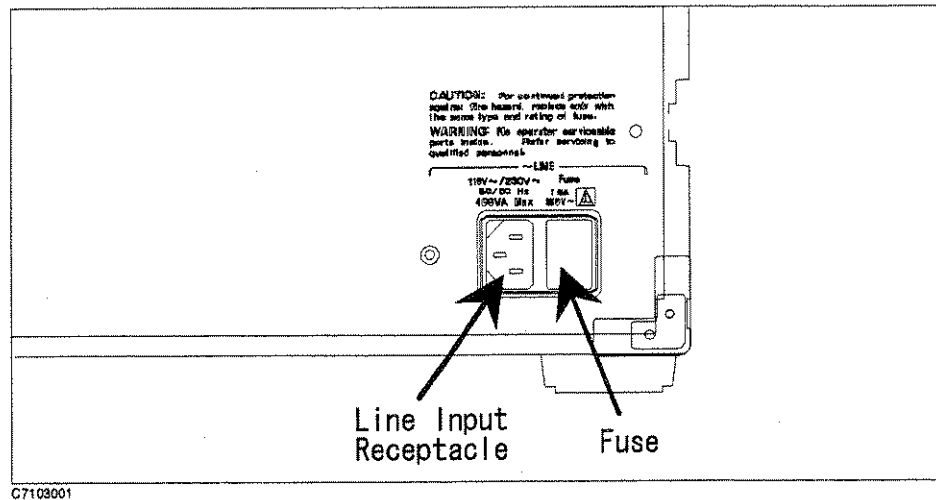

Figure 4-3. Line Input Receptacle and Fuse

Line Input Receptacle AC Power cable is connected to this receptacle.



Fuse

Use the following fuse:

HP Part Number : 2110-0030

(UL/CSA type, time delay 5 A 250 Vac)

If you need this fuse, contact your nearest Hewlett-Packard Sales and Service Office.

Steps to turn on the power

1. Connect AC power cable to the line input receptacle
2. Turn on HP E5100A/B (need 30 minutes warm up).

Step3 : Setting up the Analyzer

Before you start the measurement, you must set up the analyzer to fit your measurement requirements. For example, you must set the frequency range of the measurement. In this step, you will set the following parameters:

Function	Gain/Phase
Inputs	A/R
Format	Log magnitude (default)
Frequency Range	Center 70 MHz, Span 500 kHz

Setting the function ■ Press **Meas/Format** **FUNCTION[]** **GAIN-PHASE**.

Selecting the input ports

■ Press **Meas/Format** **MEAS[]** **A/R**.

Selecting the measurement format

■ Press **Meas/Format** **FORMAT** **LOG MAG & PHASE**.

Setting the frequency range

■ Press **Center** **7** **0** **x M**.

■ Press **Span** **5** **0** **0** **x k**.

Performing the automatic scaling

■ Press **Display** **AUTO SCALE**.

Setting the IF band width

■ Press **Sweep** **IF BW** **[]**.

■ Change the IF BW value using the numeric key, arrow key, or RPG knob so that the dynamic range can be increased.

Step4 : Making a calibration

To ensure accurate measurement results, calibrate the analyzer before making a measurement. Calibration reduces error factor due to uncertainty. In this example, you perform the response calibration to cancel a frequency response error. A THRU (BNC female-to-female connector) is necessary to perform a response calibration for the transmission measurement.

Performing a Response Calibration

- Press **Cal** **RESPONSE**.
 - Disconnect the DUT then, connect the THRU.
 - Press **THRU**. The **THRU** softkey label is underlined when the measurement is completed.
 - Press **DONE**:
 - Disconnect the THRU and reconnect the DUT.
- “Cor” is displayed on the left side of the display to show that the frequency response error is corrected.

The measured value is now corrected for the frequency response error.

Note



If the trace is changed, it requires an adjustment of the scale. Perform the automatic scaling again by pressing **Display** **AUTO SCALE**.

Step5 : Reading a measurement result

You may want to readout the measured values on the displayed trace. You can use the marker function for this purpose. The marker shows the frequency and response value at the marker point.

Reading a measured value by using marker

- Press **Marker**.
- Verify a marker labeled 1 appears on the trace of log mag.
- Turn the knob to the right to move the marker toward the right.
- Read the value at the right top of the display.
- Press **ACTIVE MARKER 2 RETURN**.
- Verify a marker labeled 2 appears on the trace of log mag.
- Turn the knob to the left to move the marker toward the left.
- Press **ACTIVE TRC [MAIN]** to change to **ACTIVE TRC [SUB]**.
- Press **Marker**.
- Press **7 0 0 1 x M**. The marker moves at 70 MHz points.
- Read the value for sub trace at the right top of display.

The marker has a search function that makes it easier and faster to evaluate the trace results. For example, to search for the maximum value and its frequency on the trace:

- Press **Marker MKR SEARCH [] SEARCH:MAX**. The marker immediately moves to the maximum point on the displayed trace. Read the frequency and response values displayed at the upper right of the display.

Note



When you want to move all markers together, Press **Marker MKR MODE MENU MARKERS: COUPLED**.

Analyzing a filter parameter

- Press **Menu 1 -3dB BAND WIDTH(MAX)**
- The filter parameter such as, band width, center, Q, insertion loss, delta frequency(left) and delta frequency(right) is displayed at the upper right of the display.



Analyzer Feature Tutorial

Multi-channel Measurement Tutorial

The analyzer has up to four channels. Each channel can measure independently.

To setup measurement

1. Press **Meas/Format** **NUM of CH 2**.
2. Confirm that the **ACTIVE CH [CH1]** at the bottom of softkey is displayed. When the **ACTIVE CH [CH2]** is displayed, press **ACTIVE CH [CH2]** to change the active channel to channel 1.
3. Press **Meas/Format** **MEAS A/R**.
4. Press **FORMAT LOGMAG & PHASE**.
5. Press **ACTIVE CH [CH1]** to change to **ACTIVE CH [CH2]**.
6. Press **Meas/Format** **MEAS A/R**.
7. Press **FORMAT LOGMAG & PHASE**.
8. Press **Center** **7 0 x M**.
9. Press **Span** **5 0 0 x k**.

Note



When the **NUM of CH** is set to 3 or 4, the format which has dual trace on one channel, such as **LOG MAG & PHASE**, is not available.

To make response calibration

1. Press **ACTIVE CH [CH2]** to change to **ACTIVE CH [CH1]**.
2. Verify that the measurement traces of channel 1 is displayed.
3. Connect a BNC cable between RF OUT2 and input R.
4. Connect a thru between RF OUT1 and input A.
5. Press **Cal** **RESPONSE THRU**.
6. The **THRU** softkey label is underlined when the measurement is completed.
7. Press **DONE**.

8. Verify that "Cor" is displayed on the left side of the display to show that the calibration done for channel 1.
9. Press **ACTIVE CH [CH1]** to change to **ACTIVE CH [CH2]**.
10. Connect that thru between RF OUT and input B.
11. Press **RESPONSE THRU**.
12. The **THRU** softkey label is underlined when the measurement is completed.
13. Press **DONE**.
14. Verify that "Cor" is displayed on the left side of the display to show that the calibration done for channel 2.

To measure dut

1. Connect dut between RF OUT1 and input A.
2. Select **ACTIVE CH [CH1]** to observe the trace for channel 1.
3. Press **(Display) AUTO SCALE** to scale automatically for channel 1.
4. Select **ACTIVE CH [CH2]** to observe the trace for channel 2.
5. Press **(Display) AUTO SCALE** to scale automatically for channel 2.

To display the trace of all channel

1. Press **(Display) MULTI CH** to change **MULTI CH on OFF** to **MULTI CH ON off**.
2. The all traces of channel 1 and channel 2 are displayed.
3. Verify that two "Cor" is displayed on the left side of the display. The upper one is for channel 1 and the lower one is for channel 2.

To measure a dut on different sweep parameter.

To setup measurement

1. Press **(Meas/Format) NUM of CH 2**.
2. Press **(Sweep) COUPLED CH** to change **COUPLED CH ON off** to **COUPLED CH on OFF**.
3. Confirm that the **ACTIVE CH [CH1]** at the bottom of softkey is displayed. When the **ACTIVE CH [CH2]** is displayed, press **ACTIVE CH [CH2]** to change the active channel to channel 1.
4. Press **(Meas/Format) MEAS A/R**.
5. Press **FORMAT LOGMAG & PHASE**.

6. Press **Center** **7** **0** x M.
7. Press **Span** **5** **0** **0** x k.
8. Press **Meas/Format** **ACTIVE CH [CH1]** to change to **ACTIVE CH [CH2]**.
9. Press **Meas/Format** **MEAS A/R**.
10. Press **FORMAT LOGMAG & PHASE**.
11. Press **Sweep** **SWEEP TYPE MENU POWER**.
12. Press **Start** **-** **6** **0** x 1.
13. Press **Stop** **0** x 1.

To make response calibration

1. Connect that thru between input R and input A.
2. Press **Cal** **RESPONSE THRU**.
3. The **THRU** softkey label is underlined when the measurement is completed.
4. Press **DONE**.

To measure dut

1. Connect dut between input R and input A.
2. Select **ACTIVE CH [CH1]** to observe the trace for channel 1.
3. Press **Display** **AUTO SCALE** to scale automatically.
4. Select **ACTIVE CH [CH2]** to observe the trace for channel 2.
5. Press **Display** **AUTO SCALE** to scale automatically.

To display the trace of all channel

1. Press **Display** **MULTI CH** to change **MULTI CH on OFF** to **MULTI CH ON off**.
2. The all traces of channel 1 and channel 2 are displayed.

To split the display graticule

1. Press **[Display] SPLIT DISP** to change **SPLIT DISP** on **OFF** to **SPLIT DISP ON** off.
2. The graticule for channel 1 and channel 2 is split one over another.

Note



With **COUPLED CH OFF**, the stimulus values of each channels depends on the number of channels as describes below.

NUM of CH	When COUPLED CH is OFF:
2	Ch1 and Ch2 can have different stimulus.
3	Ch1 and Ch2 have same stimulus. Ch3 can have different stimulus from Ch1 and Ch2.
4	Ch1 and Ch2 have same stimulus, and Ch3 and Ch4 have same stimulus. Ch1 and Ch2 can have different stimulus from Ch3 and Ch4.

To make list sweep

The analyzer has a list sweep function which can sweep frequency according to a predefined sweep segment list. Each sweep segment is independent and can have a different number of sweep points, power level, and IF bandwidth value. A segment looks like a normal stimulus sweep setting, and the list sweep function can combine up to 801 total sweep points into one sweep. The analyzer can have 2 different sweep lists (list 1 and list 2). Either one can be used, or both can be used for 2 channels (under the Coupled channel off condition). This section describes the following three applications:

- Sweep time reduction for filter testing (with setup procedure)
- Dynamic range enhancement
- Use of order base display mode

The following is an example of creating a list sweep to measure a filter that has a 70 MHz center frequency and a 20 kHz bandwidth. This example uses the list sweep to reduce the sweep time by setting coarse sweep points for the rejection band and fine sweep points for the passband.

To create sweep List

1. Press **[Sweep] SWEEP TYPE MENU MORE LIST EDITOR**.
2. The list table editor is displayed.
3. Confirm that the cursor positions at (SEG1, START).
4. Press **[6] [9] [0] [9] x M**.
5. Press **→** to move the cursor to the right cell.
6. Press **[6] [9] [0] [9] [6] x M**.
7. Press **→** to move the cursor to the right cell.

8. Press $\text{3} \text{0} \times 1$.
9. Press \rightarrow to move the cursor to the right cell.
10. Press $\text{0} \times 1$.
11. Press \rightarrow to move the cursor to the right cell.
12. Press $\text{2} \text{0} \text{0} \times 1$.
13. Press **INSERT SEGMENT**.
14. The cursor moves to (SEG2, IFBW).
15. Input the data for segment 2 and 3 as shown in Figure 5-1.
16. Press **MORE END EDIT** to exit the list editor.

Note



The segments do not have to be entered in any particular order: the analyzer automatically sorts them in increasing order of stimulus value when the list table editor is ended.

LIST1
START: 69.9MHz

SEG	START [Hz]	STOP [Hz]	NOP	POWER [dBm]	IFBW [Hz]
1	69.9 M	69.96 M	30	0	200
2	69.96 M	70.04 M	120	0	200
3	70.04 M	70.1 M	30	0	200

CF104001

Figure 5-1. Sweep List Edit Display

To perform list sweep

1. Press **[Sweep]** **SWEEP TYPE MENU LIST** to perform the list sweep measurement using the just edited list.

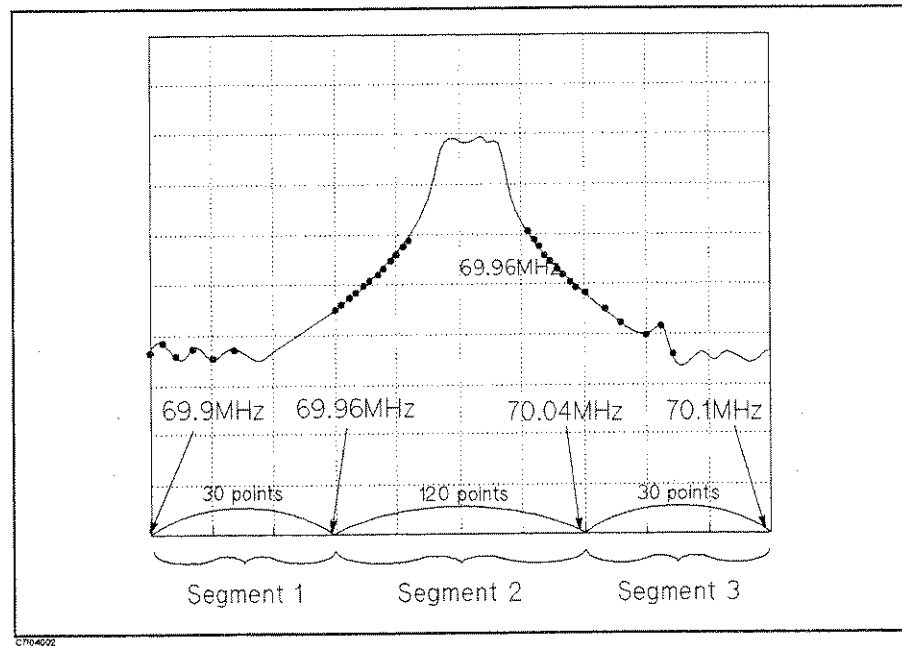

Figure 5-2. List Sweep Measurement

To increase Dynamic Range Enhancement

The sweep list modified from the list of the previous example to improve dynamic range. Segments 1 and 3 have a narrow IF bandwidth and a higher power level for the stopband of the filter. Segment 2 has wide IF bandwidth and lower power level for passband. These settings enhance the analyzer's dynamic range. Figure 5-3 shows a example.

LIST1
START: 69.9MHz

SEG	START [Hz]	STOP [Hz]	NOP	POWER [dBm]	IFBW [Hz]
1	69.9 M	69.96 M	30	15	20
2	69.96 M	70.04 M	120	-10	200
3	70.04 M	70.1 M	30	15	20

Figure 5-3. List Sweep Example (Dynamic Range Enhancement)

Use of Order Base Display Mode

The result of list sweep is displayed using one of the following two display modes.

- Frequency Base Display Mode : The X-axis is linearly scaled by frequency. The analyzer automatically linearly scales from the sweep list.
 - To select the frequency base display, press **[SWEEP] SWEEP TYPE MORE LIST DISP: FREQ BASE .**
- Order Base Display Mode : The X-axis is linearly scaled by the number of sweep points according to the sweep list.
 - To select the order base display, press **[SWEEP] SWEEP TYPE MORE ORDER BASE .**

Disk Drive Tutorial

The analyzer's 3.5 inch built-in disk drive, RAM disk and FLASH disk can be used to save instrument states, measurement data, and Instrument BASIC programs. The built-in disk drive supports the DOS file format which is used for IBM-PC and compatible computers. The RAM disk is 256kbyte volatile storage and the FLASH disk is 256kbyte non-volatile storage. The commands of save/recall access only the RAM disk directly. Pressing **BACKUP MEMO DISK** key makes the all contents in the RAM disk copy to the FLASH disk. At power on, the all files in the FLASH disk copy to the RAM disk. This section describes the basic procedure for using the analyzer's disk drive.

Selecting Storage Devices

1. Press **(Save/Recall)** then using **STOR DEV []** to select the built-in flexible disk drive and the memory. When the flexible disk drive is selected, **[A:DISK]** is displayed. When the RAM disk is selected, **[B:MEMO]** is displayed.

To save file to a floppy disk

1. Press **(Save/Recall)**, and select **STORE DEV [A:DISK]** by pressing that key.
2. Insert a disk into the disk drive.
3. If the floppy disk is new, you must initialize the disk. Press **FILE UTILITIES INITIALIZE INITIALIZE A:DISK: YES** to initialize disk.
4. The instrument will save the file to the current working directory of floppy disk. If you want to save the file in another directory, move the working directory. Refer to "To change working directory".
5. Press **(Save/Recall) SAVE**.
6. When both instrument state and measurement data are to be saved, press **ALL**. When only the instrument state is to be saved, press **STATE ONLY**. When only binary format measurement data is to be saved, press **DATA ONLY (BINARY)**. When only ASCII format measurement data is to be saved, press **DATA ONLY (ASCII)**.
7. Enter the file name by selecting letters or input from keyboard.
8. After entering the file name, press **DONE** to complete this task.

Note



Initialization *destroys* all current data on a disk. You can NOT recover the data once it has been destroyed by the initialization process.

Note



Saving DATA ONLY won't allow the recall of operating parameters such as start/stop frequency, list sweep tables and limit lines. You must save state only or a ALL for this information.

To save file to a RAM disk

9. Press **Save/Recall**, and select **STORE DEV [B:MEMO]** by pressing that key
10. Press **Save/Recall** **SAVE**.
11. The instrument will save the file to the current working directory of RAM disk. If you want to save the file in another directory, move the working directory. Refer to "To change working directory".
12. When both instrument state and measurement data are to be saved, press **ALL**. When only the instrument state is to be saved, press **STATE ONLY**. When only binary format measurement data is to be saved, press **DATA ONLY (BINARY)**. When only ASCII format measurement data is to be saved, press **DATA ONLY (ASCII)**.
13. Select letters for the input file name.
14. After entering the file name, press **DONE** to complete this task.
15. When you want to use all files in the RAM disk after power on again, press **BACKUP MEMO DISK**.

Note



Saving DATA ONLY won't allow the recall of operating parameters such as start/stop frequency, list sweep tables and limit lines. You must save state only or a ALL for this information.

To recall a file

At power on, all files in the FLASH disk copy to the RAM disk.

1. Press **Save/Recall** **RECALL** to display the file names in the center of display.
2. Change the working directory when you want to save a file to another directory. Refer to "To change working directory".
3. Select the file name you want to recall using arrow keys, and then press **ENTER**. If you can not find the file name you want to select, press **NEXT PAGES** or **PREV PAGES** until the file name is displayed.

Note



The file names are labeled with the following file type identification extensions after the file name:

- **.ALL**: means all (instrument state and measured data:binary)
 - **.STA**: means instrument state only (BINARY).
 - **.DAT**: means measured data only (BINARY).
-

To change working directory

Since all disk operations of the analyzer work on the current directory, you must change the desired directory before the disk operation is executed.

1. Press **Save/Recall** **FILE UTILITIES**.
2. The directory list is displayed on the center of display.
3. Select the desired directory name using arrow keys.
4. Press **CHANGE DIRECTORY**.

To recall a file at power on

By storing the instrument state in the special file named "AUTOREC" to the FLASH disk or flexible disk drive, you can automatically recall the instrument state from an inserted disk every time the analyzer is turned on.

Manual Changes

Introduction

This appendix contains the information required to adapt this manual to earlier versions or configurations of the HP E5100A/B than the current printing date of this manual. The information in this manual applies directly to the HP E5100A/B serial number prefix listed on the title page of this manual.

Manual Changes

To adapt this manual to your HP E5100A/B, see Table A-1 and Table A-2, and make all the manual changes listed opposite your instrument's serial number and firmware version.

Instruments manufactured after the printing of this manual may be different from those documented in this manual. Later instrument versions will be documented in a manual changes supplement that will accompany the manual shipped with that instrument. If your instrument's serial number is not listed on the title page of this manual or in Table A-1, it may be documented in a *yellow MANUAL CHANGES* supplement.

In additions to change information, the supplement may contain information for correcting errors (Errata) in the manual. To keep this manual as current and accurate as possible, Hewlett-Packard recommends that you periodically request the latest *MANUAL CHANGES* supplement.

For information concerning serial number prefixes not listed on the title page or in the *MANUAL CHANGE* supplement, contact the nearest Hewlett-Packard office.

To confirm the program version, LOAD and RUN the program or confirm the beginning part of the program by typing EDIT.

Table A-1. Manual Changes by Serial Number

Serial Prefix or Number	Make Manual Changes
JP1KC	none
JP2KC,JP3KC,JP4KC,JP5KC	none

Table A-2. Manual Changes by Firmware Version

Version	Make Manual Changes
REV.1.XX	none
REV.2.xx, 3.xx	none

Serial Number

Hewlett-Packard uses a two-part, ten-character serial number that is stamped on the serial number plate (see Figure A-1) attached to the rear panel. The first five characters are the serial prefix and the last five digits are the suffix.

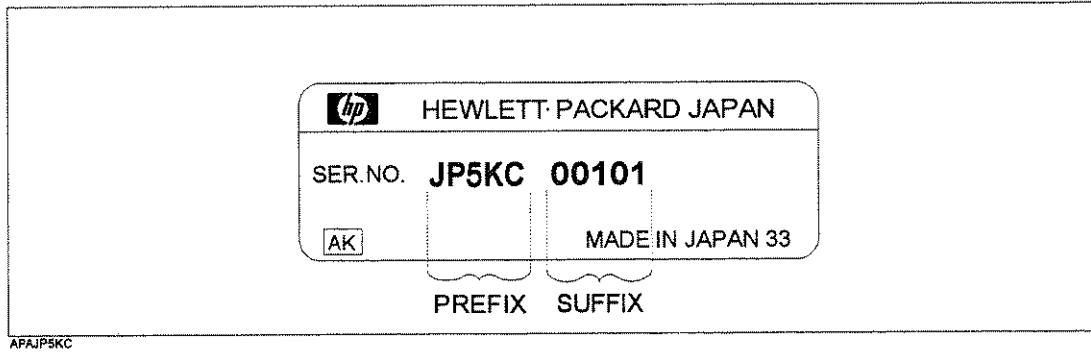

Figure A-1. Serial Number Plate

Index

Special characters ! , 2-5

- A** A port, 4-3
auto recall, 5-10

- B** bandpass filter , 4-1
BNC adapter , 3-6
bottom value , 2-4

- C** C! , 2-5
C? , 2-5
calibration, 4-6
 notation , 2-5
center value , 2-5
channel, 2-4
cleaning , 3-4
connectors , 2-6
content , 3-1
Cor , 2-5
crt , 2-3

- D** Del , 2-5
DIN keyboard , 3-7
disk
 auto recall, 5-10
 recall, 5-9
Disk
 DOS, 5-8
 Format, 5-8
 Initialize, 5-8
 Saving data, 5-8
 Saving instrument state, 5-8
display , 2-3
DOS, 5-8
dynamic range, 5-6

- E**
 - edit list, 5-4
 - electrical delay , 2-5
 - Ext , 2-5
 - external monitor , 3-7
 - external program run/cont input , 2-6
 - external reference input , 2-7
 - external trigger , 2-5
 - external trigger input , 2-7

- F**
 - feature, 1-1
 - flexible disk drive , 2-3
 - format , 2-4
 - front panel , 2-1
 - fuse, 4-4

- H**
 - handle , 3-4
 - Hld , 2-5
 - hold , 2-5
 - HP-IB interface , 2-7

- I**
 - incoming inspection , 3-1
 - inputs R, A, B, and C , 2-3
 - installation , 3-1
 - internal reference output , 2-7
 - i/o port , 2-7

- K**
 - keyboard , 3-7
 - keyboard connector , 2-7

- L**
 - line input receptacle , 4-4
 - line switch , 2-3
 - list sweep
 - frequency base display mode, 5-7
 - order base display mode, 5-7

- M**
 - manual changes, A-1
 - marker, 4-7
 - marker data readout , 2-5
 - marker search, 4-7
 - marker stimulus , 2-5
 - MAX search, 4-7
 - measured input , 2-4
 - menu , 2-2
 - monitor , 3-7

- N** notations , 2-5
number of points, 5-4
- O** operation, 4-1
option 1D5 , 2-6, 2-7
overview, 4-1
overview , 1-2
Overview of HP E5100A/B, 1-1
- P** part number , 3-1
phase offset , 2-5
port, 4-3
power , 2-7
power cable , 3-2
power requirement , 3-4
preparing , 4-3
Preset , 2-3
printer interface , 2-7
probe power connector , 2-3
- R** rack , 3-4
rear panel , 2-6
recall, 5-9
reference level , 2-5
reference oven output , 2-6
reference position , 2-5
REF oven , 3-6
required equipment, 4-2
response calibration, 4-6
rf out connector , 2-3
RF OUT port, 4-3
R port, 4-3
run/cont input , 2-6
- S** save, 5-9
screen display , 2-3
search, 4-7
serial number, A-2
setting up , 4-5
Smo , 2-5
smoothing , 2-5
span value , 2-5
start value , 2-5
status notations , 2-5
stop value , 2-5
sweep , 2-5
sweep notations , 2-5
sweep type menu, 5-4

- T** T&B , 2-4
thru, 4-6
top value , 2-4
trace number , 2-4
transmission characteristics , 4-1
trigger input , 2-7
turning on , 4-4

- U** ↑ , 2-5

- V** ventilation requirement, 3-4
VGA , 2-7, 3-7
video outputs , 2-7

REGIONAL SALES AND SUPPORT OFFICES

If you need technical assistance with a Hewlett-Packard test and measurement product or application, please contact the Hewlett-Packard office or distributor in your country.

Asia Pacific:

Hewlett-Packard Asia Pacific Ltd
17-21/F Shell Tower, Times Square,
1 Matheson Street, Causeway Bay,
Hong Kong
(852) 2599 7070

Australia/New Zealand:

Hewlett-Packard Australia Ltd.
31-41 Joseph Street
Blackburn, Victoria 3130
Australia
131 347 ext. 2902

Canada:

Hewlett-Packard Canada Ltd.
5150 Spectrum Way
Mississauga, Ontario
L4W 5G1
(905) 206 4725

**In Europe, Africa and Middle East
please call your local HP sales office
or representative:**

Austria/East Central Europe:
(1) 25000-0

Belgium and Luxembourg:
(02) 778 34 17

Czech Republic:
(2) 471 7327

Denmark:
45 99 10 00

Finland:
(90) 88 721

France:
(1) 69.82.65.00

Germany:
(0180) 532 62-33

Greece:
(1) 7264045

Hungary:
(1) 252 4705

Ireland:
(01) 284 4633

Israel:
(03) 5380 333

Italy:
02 - 92 122 999

Netherlands:
(020) 547 6669

Norway:
(22) 73 56 00

Poland:
(22) 37 50 65

Portugal:
(11) 301 73 30

Russia:
(095) 956 2126

South Africa:
(011) 806 1000

Spain:
900 123 123

Sweden:
(08) 444 20 00

Switzerland:
(01) 735 7111

Turkey:
(212) 224 59 25

United Kingdom:
(01344) 366 666

**For European countries
not listed,
contact:**

Hewlett-Packard
International Sales Europe
Geneva, Switzerland
Tel: +41-22-780-4111
Fax: +41-22-780-4770

Japan:

Hewlett-Packard Japan Ltd.
Measurement Assistance Center
9-1, Takakura-cho, Hachioji-shi,
Tokyo 192, Japan
Tel: (81) 426 48 0722
Fax: (81) 426 48 1073

Latin America:

Hewlett-Packard
Latin American Region Headquarters
5200 Blue Lagoon Drive
9th Floor
Miami, Florida 33126
U.S.A.
(305) 267 4245/4220

United States:

Hewlett-Packard Company
Test and Measurement Organization
5301 Stevens Creek Blvd.
Bldg. 51L-SC
Santa Clara, CA 95052-8059
1 800 452 4844

Mar. 1996 P/N 16000-99004

