HP E4915A Crystal Impedance Meter
HP E4916A Crystal Impedance/LCR Meter

User's Guide

SERIAL NUMBERS

This manual applies directly to instruments which have the serial number prefix JP1KD, or firmware revision 2.0x.
For additional important information about serial numbers, read "Serial Number" in Appendix A.



HP Part No. E4915-90031
Printed in JAPAN June 1997

Fourth Edition

©Copyright 1996,1997 Hewlett-Packard Japan, Ltd.

Manual Printing History

August 1996	First Edition
January 1997	Second Edition
April 1997	Third Edition
June 1997	Fourth Edition

Safety Summary

The following general safety precautions must be observed during all phases of operation, service, and repair of this instrument. Failure to comply with these precautions or with specific *WARNINGS* elsewhere in this manual may impair the protection provided by the equipment. In addition it violates safety standards of design, manufacture, and intended use of the instrument.

The Hewlett-Packard Company assumes no liability for the customer's failure to comply with these requirements.

Note



HP E4915A and HP E4916A comply with INSTALLATION CATEGORY II and POLLUTION DEGREE 2 in IEC1010-1. HP E4915A and HP E4916A are INDOOR USE product.

Note



LEDs in this product are Class 1 in accordance with IEC825-1.
CLASS 1 LED PRODUCT

Ground The Instrument

To avoid electric shock hazard, the instrument chassis and cabinet must be connected to a safety earth ground by the supplied power cable with earth blade.

DO NOT Operate In An Explosive Atmosphere

Do not operate the instrument in the presence of flammable gasses or fumes. Operation of any electrical instrument in such an environment constitutes a definite safety hazard.

Keep Away From Live Circuits

Operating personnel must not remove instrument covers. Component replacement and internal adjustments must be made by qualified maintenance personnel. Do not replace components with the power cable connected. Under certain conditions, dangerous voltages may exist even with the power cable removed. To avoid injuries, always disconnect power and discharge circuits before touching them.

DO NOT Service Or Adjust Alone

Do not attempt internal service or adjustment unless another person, capable of rendering first aid and resuscitation, is present.

DO NOT Substitute Parts Or Modify Instrument

Because of the danger of introducing additional hazards, do not install substitute parts or perform unauthorized modifications to the instrument. Return the instrument to a Hewlett-Packard Sales and Service Office for service and repair to ensure that safety features are maintained.

Dangerous Procedure Warnings

Warnings , such as the example below, precede potentially dangerous procedures throughout this manual. Instructions contained in the warnings must be followed.

Warning



Dangerous voltages, capable of causing death, are present in this instrument. Use extreme caution when handling, testing, and adjusting this instrument.

Certification

Hewlett-Packard Company certifies that this product met its published specifications at the time of shipment from the factory. Hewlett-Packard further certifies that its calibration measurements are traceable to the United States National Institute of Standards and Technology, to the extent allowed by the Institution's calibration facility, or to the calibration facilities of other International Standards Organization members.

Warranty

This Hewlett-Packard instrument product is warranted against defects in material and workmanship for a period of one year from the date of shipment, except that in the case of certain components listed in *General Information* of this manual, the warranty shall be for the specified period. During the warranty period, Hewlett-Packard Company will, at its option, either repair or replace products that prove to be defective.

For warranty service or repair, this product must be returned to a service facility designated by HP. Buyer shall prepay shipping charges to HP and HP shall pay shipping charges to return the product to Buyer. However, Buyer shall pay all shipping charges, duties, and taxes for products returned to HP from another country.

HP warrants that its software and firmware designated by HP for use with an instrument will execute its programming instruction when properly installed on that instrument. HP does not warrant that the operation of the instrument, or software, or firmware will be uninterrupted or error free.

Limitation Of Warranty

The foregoing warranty shall not apply to defects resulting from improper or inadequate maintenance by Buyer, Buyer-supplied software or interfacing, unauthorized modification or misuse, operation outside the environmental specifications for the product, or improper site preparation or maintenance.

No other warranty is expressed or implied. HP specifically disclaims the implied warranties of merchantability and fitness for a particular purpose.

Exclusive Remedies

The remedies provided herein are buyer's sole and exclusive remedies. HP shall not be liable for any direct, indirect, special, incidental, or consequential damages, whether based on contract, tort, or any other legal theory.

Assistance

Product maintenance agreements and other customer assistance agreements are available for Hewlett-Packard products.

For any assistance, contact your nearest Hewlett-Packard Sales and Service Office. Addresses are provided at the back of this manual.

Typeface Conventions

Bold

Boldface type is used when a term is defined. For example: **icons** are symbols.

Italics

Italic type is used for emphasis and for titles of manuals and other publications.

Italic type is also used for keyboard entries when a name or a variable must be typed in place of the words in italics. For example: copy *filename* means to type the word copy, to type a space, and then to type the name of a file such as *file1*.

Computer

Computer font is used for on-screen prompts and messages.

HARDKEYS

Labeled keys on the instrument front panel are enclosed in **□**.

SOFTKEYS

Softkeys located to the right of the CRT are enclosed in **■**.

Safety Symbols

General definitions of safety symbols used on equipment or in manuals are listed below.



Instruction manual symbol: the product is marked with this symbol when it is necessary for the user to refer to the instruction manual.



Alternating current.



Direct current.



On (Supply).



Off (Supply).



In position of push-button switch.



Out position of push-button switch.



Frame (or chassis) terminal. A connection to the frame (chassis) of the equipment which normally include all exposed metal structures.

Warning



This **Warning** sign denotes a hazard. It calls attention to a procedure, practice, condition or the like, which, if not correctly performed or adhered to, could result in injury or death to personnel.

Caution



This **Caution** sign denotes a hazard. It calls attention to a procedure, practice, condition or the like, which, if not correctly performed or adhered to, could result in damage to or destruction of part or all of the product.

Note



Note denotes important information. It calls attention to a procedure, practice, condition or the like, which is essential to highlight.

About This Manual

This manual explains about the operation of HP E4915A Crystal Impedance Meter and HP E4916A Crystal Impedance/LCR Meter. The manual consists of the following sections:

Introduction This chapter explains the outline of HP E4915A and HP E4916A.

Front Panel, Rear Panel, and Display

This chapter explains the features of the front and rear panels of the HP E4915A and HP E4916A.

Installation and Setup Guide

This chapter explains points to be checked when the distributed package is opened and the method to setup HP E4915A and HP E4916A. Please read this chapter before you set up HP E4915A and HP E4916A.

Quick Start Guide This chapter illustrates basic operational procedures.

Applications This chapter shows step-by-step instructions to measure a crystal resonator with a PI-fixture and other devices.

Documentation Guide

Please refer to the following manuals for the operation of the analyzer where necessarily.

HP E4915A and HP E4916A User's Guide

This document explains the method to set up and basic operations of HP E4915A and HP E4916A in simple steps.

HP E4915A and HP E4916A Operation Manual





This document describes all function accessed from the front panel keys and softkeys, and a summary of all available HP-IB commands. It also provides information on options and accessories available, specifications, and some topics about the meter's features.

Service Manual (Option 0BW only)

The Service Manual explains how to adjust, troubleshoot, and repair the instrument. This manual is option 0BW only.



Contents

1. Introduction	
Features of the HP E4915A/E4916A	1-1
2. Front Panel, Rear Panel, and Display	
Front Panel	2-1
Display	2-3
Character Display Area	2-3
Current Settings (▼)	2-3
Comparator Output (Comparator Pass/Fail) LED	2-4
 Rear Panel	2-5
3. Installation and Set Up Guide	
Incoming Inspection	3-1
Power Requirements	3-2
Power Cable	3-2
Ventilation Requirements	3-5
Instruction for Cleaning	3-5
Rack/Handle Installation	3-6
Option 1CN Handle Kit	3-7
Installing the Handle	3-7
Option 1CM Rack Mount Kit	3-8
Mounting the Rack	3-8
 Connecting a Probe (HP E4916A Option 001 Only)	3-8
4. Quick Start Guide	
Overview	4-1
Required Equipment	4-1
 Step 1: Preparing For Measurement	4-3
Step 2 : Turning ON the Meter	4-4
Line Input Receptacle	4-4
 Fuse	4-4
Steps To Turn On The Power	4-4
Step 3 : Setting Up the Meter	4-5
Step 4 : Performing OPEN/SHORT/LOAD Calibrations	4-6
OPEN/SHORT/LOAD Calibration	4-6
Step 5 : Connecting DUT and Reading Measurement Results	4-7
If an Error Message Appears When DUT Is Connected	4-7
If "—" Appears When DUT Is Connected	4-8

5. Applications	
Measuring Crystal Component Characteristics Using	
PI-Network Test Fixture	5-1
Required Parts and Equipment	5-1
Preparation	5-1
Connecting Fixture	5-1
Connecting Capacitive Load	5-1
Specifying Measurement Parameters	5-2
Calibration	5-2
Equivalent Circuit Analysis	5-2
Procedure	5-2
Displaying Analysis Results	5-3
Measurement with Capacitance Load (CL _a /CL _t	
Parameters)	5-3
Specifying Actual Load Capacitance	5-3
Specifying Target Capacitance	5-4
Measurement Procedure	5-5
Measuring Resonant Frequency (F _r)	5-5
Measuring Resonant frequency With Capacitive Load	
Connected (F _L)	5-6
CL Compensation Function	5-6
Measuring Spurious Signals	5-7
Procedure	5-7
Specifying Spurious Signal Search Range	5-7
Specifying Number of Spurious Signals and	
Selecting Target Signal	5-7
Displaying Fr and CI Simultaneously	5-8
High Q Mode	5-8
Procedure	5-8
Delta Mode	5-8
Specifying Reference CI	5-8
Specifying Reference Frequency	5-9
Displaying Δ	5-9
Specifying Target Signal Level and Using ALC Function	
(HP E4916A Only)	5-9
Specifying Signal Level	5-9
Specifying Nominal CI	5-10
Setting ALC Function	5-10
Analog Output	5-10
Specifying Reference Frequency	5-10
Specifying Rate of Change in Output Voltage	5-10
Turning Analog Output ON/OFF	5-11
Printing	5-11
Printers	5-11
Equipment Required for Printing	5-11
Connecting Printer	5-11
Printing Procedure	5-12
Changing Calibration Standard Values When Using	
PI-Network Test Fixture Other Than HP 41902A	5-13
Drive Level Dependency Test (HP E4916A Only)	5-14
Procedure	5-14
Specifying Frequency	5-14
Specifying Drive Level Sweep Settings	5-14
Stopping Measurement In Case Of Faulty Search	
During Sweep	5-16

Limit Tests	5-16
Primary and Secondary Parameters	5-17
Tertiary Parameter	5-17
Evaporation Monitoring Function (HP E4916A Only)	5-18
Measurement Using Filter (HP E4916A Only)	5-19
Procedure	5-19
Selecting Filter Mode	5-19
Specifying Frequency	5-20
Specifying Bandwidth	5-20
Selecting Constant or Minimum Loss	5-20
Displaying Measurement Results	5-20
Limit Tests	5-20
Primary and Secondary Parameters	5-20
Tertiary Parameter	5-20
Measuring LCR Using Impedance Probe (HP E4916A with Options 001 and 010 Only)	5-22
Required Equipment	5-22
Connection	5-22
Selecting LCR Mode	5-22
Selecting Measurement Circuit	5-22
Selecting Measurement Parameters	5-22
Measurement Frequency	5-23
Averaging	5-23
Voltage and Current Monitor	5-23
Calibrating Probe	5-23
Measurement	5-24
Measuring LCR Using Test Fixture Adapter (HP E4916A with Options 001 and 010 Only)	5-25
Required Equipment	5-25
Selecting Settings and Calibration	5-25
Connecting HP 16099A Test Fixture Adapter	5-25
Compensating for Fixture Loss	5-25
Load Compensation	5-25
Displaying Measurement Parameters	5-26
DC Bias Measurement	5-26
Connection	5-27
Handler Interface (Built-in Comparator Function; HP E4916A Only)	5-28
Specifying Comparator Function Settings	5-29
Specifying Limits for Primary Parameter	5-29
Specifying Limits for Secondary Parameter	5-29
Specifying Limits for Tertiary Parameter (during DLD Measurement Only)	5-30
Specifying Comparator Output Settings	5-30
Turning Comparator Function ON/OFF	5-30
A. Manual Changes	
Introduction	A-1
Manual Changes	A-1
Serial Number	A-2
B. Replacing the Fuse	
Index	

Figures

2-1. Front Panel of HP E4915A	2-1
2-2. Front Panel of HP E4916A	2-1
2-3. LCD Display	2-3
2-4. HP E4915A/E4916A LED	2-4
2-5. Rear Panel (HP E4915A)	2-5
2-6. Rear Panel (HP E4916A)	2-5
3-1. Power Cable Supplied	3-4
3-2. Rack Mount Kits Installation	3-7
3-3. Connecting a Probe	3-9
4-1. Required Equipment	4-2
4-2. Connection of Measurement Cables	4-3
4-3. Line Input Receptacle and Fuse	4-4
4-4. OPEN/SHORT/LOAD calibration	4-6
4-5. Connecting DUT	4-7
4-6. Measurement Result Display	4-7
5-1. Equivalent Circuit Analysis	5-2
5-2. Connecting Printer and Converter	5-12
5-3. Sweep Type	5-15
5-4. Example of DLD Measurement Result	5-16
5-5. Drive Level Dependency Test	5-17
5-6. Parameters That Can Be Obtained	5-19
5-7. Connecting the Filter	5-19
5-8. Connecting DC Bias Power Source	5-27
5-9. Sequential and Tolerance Modes	5-28
A-1. Serial Number Plate	A-2
B-1. Replacing the Fuse	B-1

Tables

1-1. Comparison Between HP E4915A and HP E4916A Functions	1-1
3-1. HP E4915A/E4916A Contents	3-2
3-2. Rack Mount Kits	3-6
5-1. Calibration Standard Values for HP PI-Network Test Fixture	5-13
A-1. Manual Changes by Serial Number	A-1
A-2. Manual Changes by ROM Version	A-1

Introduction

This user's guide describes basic operation procedures for the HP E4915A/E4916A; ranging from power-on and setup to CI measurement. This guide also shows how to access functions available with the HP E4915A/E4916A. This guide is intended to serve as a reference for beginning users of the HP E4915A Crystal Impedance Meter or HP E4916A Crystal Impedance/LCR Meter.

Features of the HP E4915A/E4916A

The HP E4915A Crystal Impedance Meter and HP E4916A Crystal Impedance/LCR Meter employ the network analyzer method (transmission π network method) to determine performance of crystal resonators. With a built-in receiver similar to that of a network analyzer and a wide measurement range between 1 to 180 MHz, these meters can measure and display parameters that are generally measured for crystal resonators; resonant frequency F_r , crystal impedance CI, and equivalent circuit constant.

In addition to the basic measurement functions of the HP E4915A, the HP E4916A can change the measurement signal level. It also offers the drive level dependency testing as well as the evaporation monitoring, LCR measurement, and analysis using filter. The HP E4916A can also make measurements using the optional probe 001.

The following list shows the difference between the HP E4915A and HP E4916A.

Table 1-1.
Comparison Between HP E4915A and HP E4916A
Functions

Function	HP E4915A	HP E4916A
Measurement Signal		
1 to 100 MHz	-5 dBm	-60 to +18 dBm
Output		
100 to 180 MHz	-5 dBm	-60 to +16 dBm
Drive Level Dependency Testing	No	Yes
Evaporation Monitoring	No	Yes
Measurement Using Filter (Insertion loss, -xdB bandwidth)	No	Yes
LCR Measurement	No	Option 010
Impedance Probe	No	Option 001
Internal Comparator	Yes	Yes

Front Panel, Rear Panel, and Display

Front Panel

2. Front Panel, Rear Panel, and Display

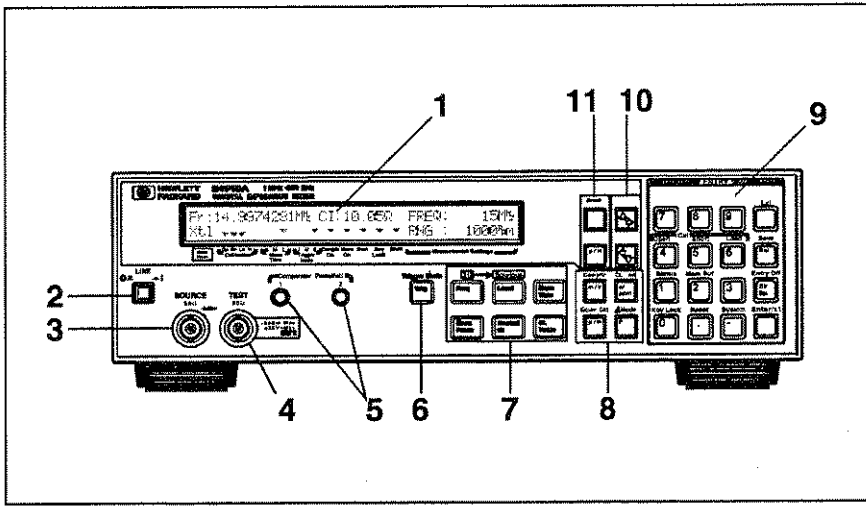

LE002001

Figure 2-1. Front Panel of HP E4915A

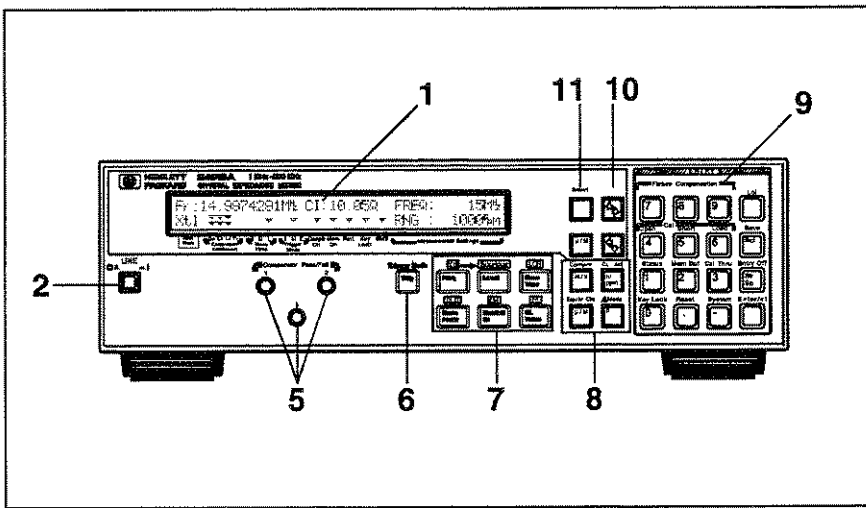



LE002002

Figure 2-2. Front Panel of HP E4916A

- 1. Display - Displays measurement results, instrument status, and messages.

2. **LINE Switch** - Turns HP E4915A/E4916A ON/OFF
3. **SOURCE port (HP E4915A only)** - Outputs test signal. This terminal will be connected to a test fixture. (HP E4916A provides this port on the rear panel.)

INSTALLATION CATEGORY I

4. **TEST port (HP E4915A only)** - Inputs test signal. This terminal will be connected to a test fixture. (HP E4916A provides this port on the rear panel.)
5. **Comparator Pass/Fail LED** - Shows limit test results (Pass=Acceptable, Fail=Not Acceptable) using the comparator function.
6. **Trig key** - Trigger Key
7. **Setting Key block** - The keys in this block are used to specify functions available with the HP E4915A/E4916A.
8. **Unit key** - The keys in this block are use to set the unit of each measurement parameter.
9. **Entry key block** - The keys in this block is used to input numerical data.
10. **Arrow keys** - Pressing  displays measurement items (softkeys) on the previous page. Pressing  displays those on the next page. You can also use these keys to move to the desired choice when there are 2 or more choices available.
11. **Select keys** - Two (2) select keys are provided. Pressing the upper select key selects the measurement parameter shown in the upper section of the LCD. Pressing the lower key select the parameter in the lower section.

Display The HP E4915A/E4916A has a LCD on the front panel that displays characters over 2 lines.

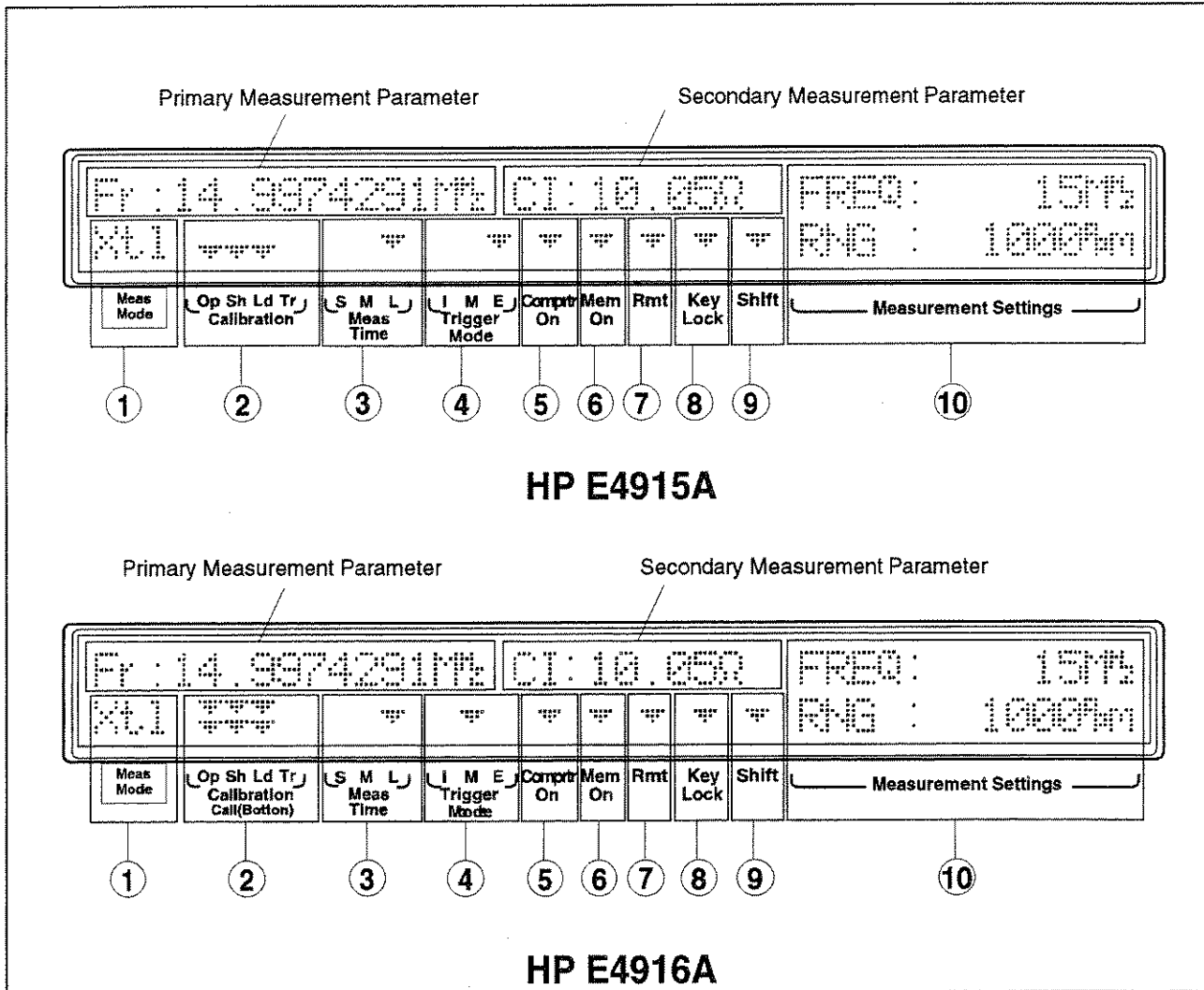

2. Front Panel, Rear Panel, and Display

Figure 2-3. LCD Display

Character Display Area

This area displays setting menus, Measurement Settings, and messages.

Current Settings (▼)

Each ▼ indicates the currently selected setting. The following shows the meaning of each label:

1. **Measurement Mode** - Shows the measurement mode
2. **Calibration (HP E4915A) or Compen and Cal (HP E4916A)** - Shows the calibration/compensation setting
3. **Meas Time** - Shows the measurement time setting
4. **Trigger** - Shows the trigger mode setting

5. **Comparator On** - Shows the comparator is ON
6. **Mem ON** - Shows the memory buffer function is ON
7. **Rmt ON** - Shows the HP-IB remote mode is ON
8. **Key Lock** - Shows the key lock is ON
9. **Shift** - Shows the shift key ((blue)) has been pressed and the shift function (blue label on top of key) is available.
10. **Measurement Settings** - Shows 2 parameters at a time. These parameters can be selected with the top and bottom (Select) keys. Pressing (↑⇒) and (⇐↓) with no parameter selected allows the previous and next pages to be displayed, respectively. These parameters are called softkeys. ▼ does not appear in this area.

Comparator Output (Comparator Pass/Fail) LED

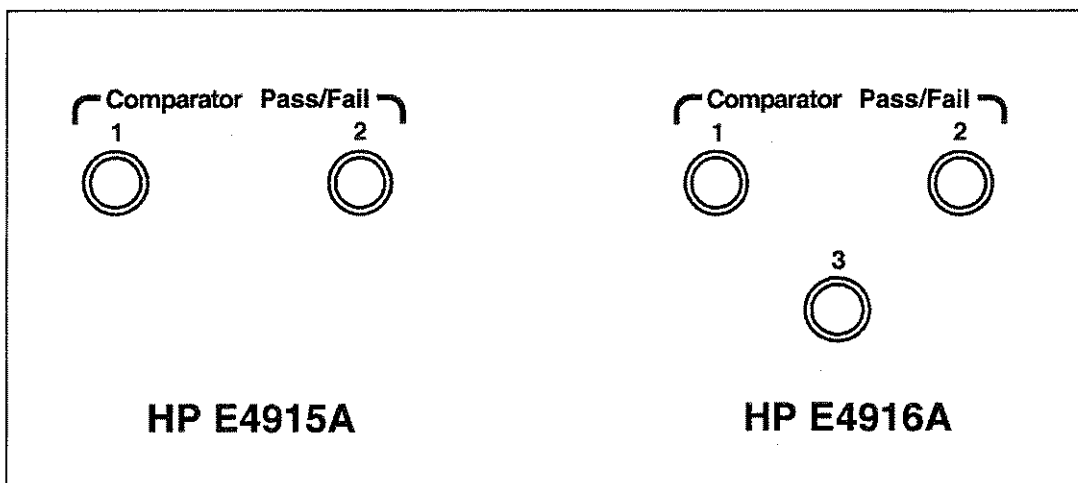

LE102009

Figure 2-4. HP E4915A/E4916A LED

1. **LED1** - For primary sorting of the primary measurement parameter actual value on the LCD screen using the comparator function, this LED turns ON depending on the result, "Pass" or "Fail."
2. **LED2** - For secondary sorting of the secondary measurement parameter actual value on the LCD screen using the comparator function, this LED turns ON depending on the result, "Pass" or "Fail."
3. **LED3** - (HP E4916A Only) For the $\Delta F/\Delta CI$ limit test or BW test using the tertiary sorting of the comparator function, this LED turns ON depending on the result, "Pass" or "Fail."

⚠ Rear Panel

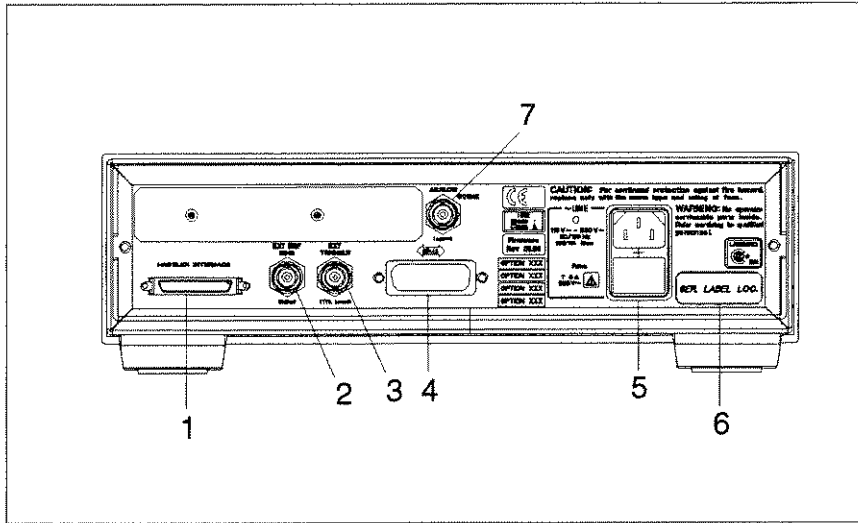

Figure 2-5. Rear Panel (HP E4915A)

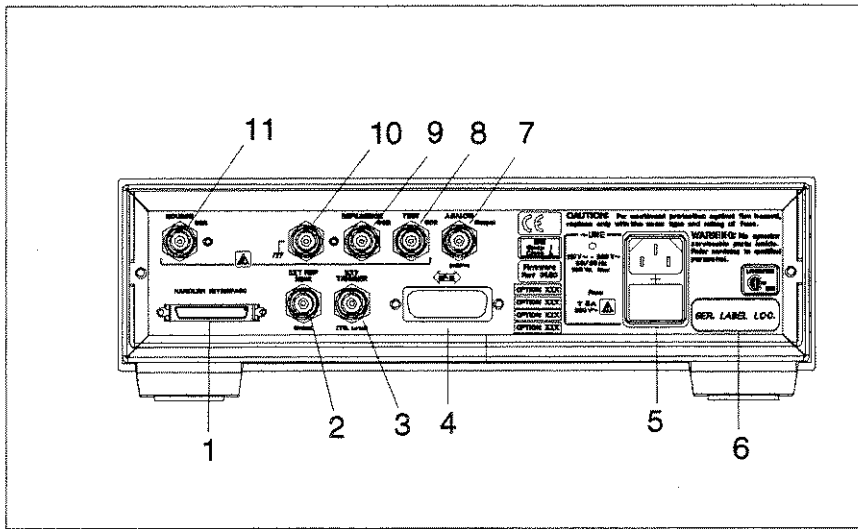



Figure 2-6. Rear Panel (HP E4916A)

1. **Handler Interface Connector** - Connects to an external handler.
2. **EXT REF Input** - Inputs an external reference signal.
3. **EXT Trigger Input** - Inputs an external signal to trigger a measurement.
4. **HP-IB Interface** - Connects the meter to an external controller for control through HP-IB.

5. **Power Cable Receptacle with Fuse Holder** - This is input for the main power cable.
6. **Serial Number Plate** - Shows the serial number of this unit.
7. **Analog Output** - Outputs measurement result as analog signal.
8.  **TEST Port (HP E4916A only)** - Inputs the test signal. This port and the SOURCE port connect to the fixture. (HP E4915A has the test port on the front panel.)
INSTALLATION CATEGORY I . 0 dBm,±25 Vdc Input Max.
9.  **REFERENCE Port (HP E4916A only)** - This port is used to connect the impedance probe to the HP E4916A.
INSTALLATION CATEGORY I . +20 dBm,±25 Vdc Input Max.
10. **Frame or Chassis Terminal (HP E4916A only)** - GND terminal
11. **SOURCE Port (HP E4916A only)** - Outputs test signal. This terminal and the TEST terminal connect to the fixture. (HP E4915A has the SOURCE port on the front panel.)

Installation and Set Up Guide

This chapter provides the information necessary for performing an incoming inspection and setting up the HP E4915A/E4916A. The main topics in this chapter are:

- Incoming Inspection
- Power requirements
- Ventilation Requirements
- Instruction for Cleaning
- Rack/Handle Installation
- Connecting a Probe (HP E4916A Option 001 only)

Incoming Inspection

Warning



To avoid hazardous electrical shock, do not turn on the HP E4915A/E4916A when there are signs of shipping damage to any portion of the outer enclosure (for example, covers, panel, or display)

Inspect the shipping container for damage. If the shipping container or cushioning material is damaged, it should be kept until the contents of the shipment have been checked for completeness and the HP E4915A/E4916A has been checked mechanically and electrically. The contents of the shipment should be as listed in Table 3-1. If the contents are incomplete, if there is mechanical damage or defect, or if the analyzer does not pass the power-on selftests, notify the nearest Hewlett-Packard office. If the shipping container is damaged, or the cushioning material shows signs of unusual stress, notify the carrier as well as the Hewlett-Packard office. Keep the shipping materials for the carrier's inspection.

Table 3-1. HP E4915A/E4916A Contents

Description	Qty.	HP Part Number
HP E4915A/E4916A		
Power cable ¹	1	—
Program disk set	1	E4915-18010
Operation Manual	1	E4915-90040
User's Guide	1	E4915-90041
30 cm BNC Leads ²	2	8120-1838
120 cm BNC Leads ³	2	8120-1840
Option 0BW Add Service Manual		
Service Manual	1	E4915-90100
Option 1CM Rack Mount Kit		
Rack mount kit	1	5063-9241
Option 1CN Front Handle Kit		
Front handle kit	1	5063-9226
Option 020 Add crystal measurement Software for HP VEE		
Crystal Measurement Software Disk	1	
Option 001 Add Impedance Probe Kit		
Impedance Probe	1	

1 Power Cable depends on where the instrument is used, see "Power Cable".

2 HP E4915A only

3 HP E4916A only

Power Requirements

The HP E4915A/E4916A requires the following power source:

Voltage : 90 to 132 Vac, 198 to 264 Vac

Frequency : 47 to 63 Hz

Power : 150 VA maximum

Power Cable

In accordance with international safety standards, this instrument is equipped with a three-wire power cable. When connected to an appropriate ac power outlet, this cable grounds the instrument frame.

The type of power cable shipped with each instrument depends on the country of destination. Refer to Figure 3-1 for the part numbers of the power cables available.

Warning



For protection from electrical shock, the power cable ground must not be defeated.

The power plug must be plugged into an outlet that provides a protective earth ground connection.

<p>OPTION 900</p> <p>United Kingdom</p>  <p>Plug : BS 1363A, 250V Cable : HP 8120-1351</p>	<p>OPTION 901</p> <p>Australia / New Zealand</p>  <p>Plug : NZSS 198/AS C112, 250V Cable : HP 8120-1369</p>
<p>OPTION 902</p> <p>European Continent</p>  <p>Plug : CEE-VII, 250V Cable : HP 8120-1689</p>	<p>OPTION 903</p> <p>U.S. / Canada</p>  <p>Plug : NEMA 5-15P, 125V, 15A Cable : HP 8120-1378</p>
<p>OPTION 904</p> <p>U.S. / Canada</p>  <p>Plug : NEMA 6-15P, 250V, 15A Cable : HP 8120-0698</p>	<p>OPTION 905*</p> <p>Any country</p>  <p>Plug : CEE 22-VI, 250V Cable : HP 8123-1396</p>
<p>OPTION 906</p> <p>Switzerland</p>  <p>Plug : SEV 1011.1959-24507 Type 12, 250V Cable : HP 8120-2104</p>	<p>OPTION 912</p> <p>Denmark</p>  <p>Plug : DHCR 107, 220V Cable : HP 8120-2956</p>
<p>OPTION 917</p> <p>India / Republic of S.Africa</p>  <p>Plug : SABS 164, 250V Cable : HP 8120-4211</p>	<p>OPTION 918</p> <p>Japan</p>  <p>Plug : JIS C 8303, 125V, 15A Cable : HP 8120-4753</p>
<p>NOTE: Each option number includes a 'family' of cords and connectors of various materials and plug body configurations (straight, 90° etc.).</p> <p>* Plug option 905 is frequently used for interconnecting system components and peripherals.</p>	

Figure 3-1. Power Cable Supplied

Ventilation Requirements

To ensure adequate ventilation, make sure that there is adequate clearance of at least 250 mm behind, 100 mm on the sides and 15 mm above and below.

Instruction for Cleaning

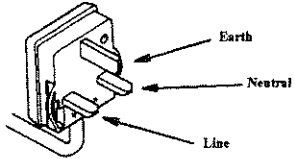
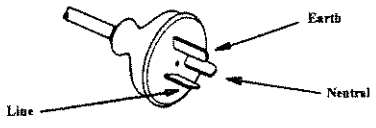
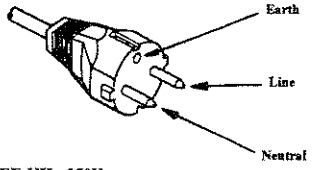
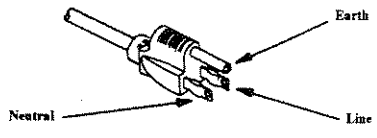
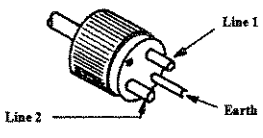
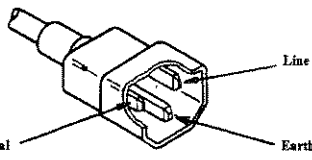
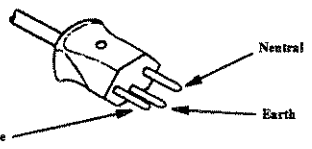
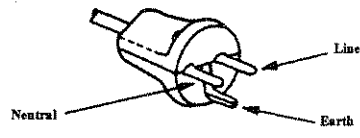
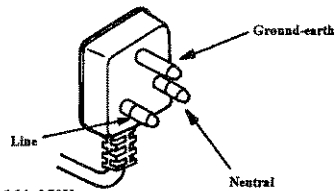
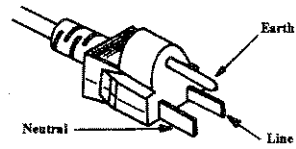
To prevent electrical shock, disconnect the HP E4915A/E4916A power cable from the receptacle before cleaning. Use a dry cloth or a cloth slightly dipped in water to clean the casing. Do not attempt to clean the HP E4915A/E4916A internally.

Rack/Handle Installation

The analyzer can be rack mounted and used as a component in a measurement system. Figure 3-2 shows how to rack mount the HP E4915A/E4916A.

Table 3-2. Rack Mount Kits

Option	Description	HP Part Number
1CN	Handle Kit	5063-9226
1CM	Rack Mount Kit	5063-9241

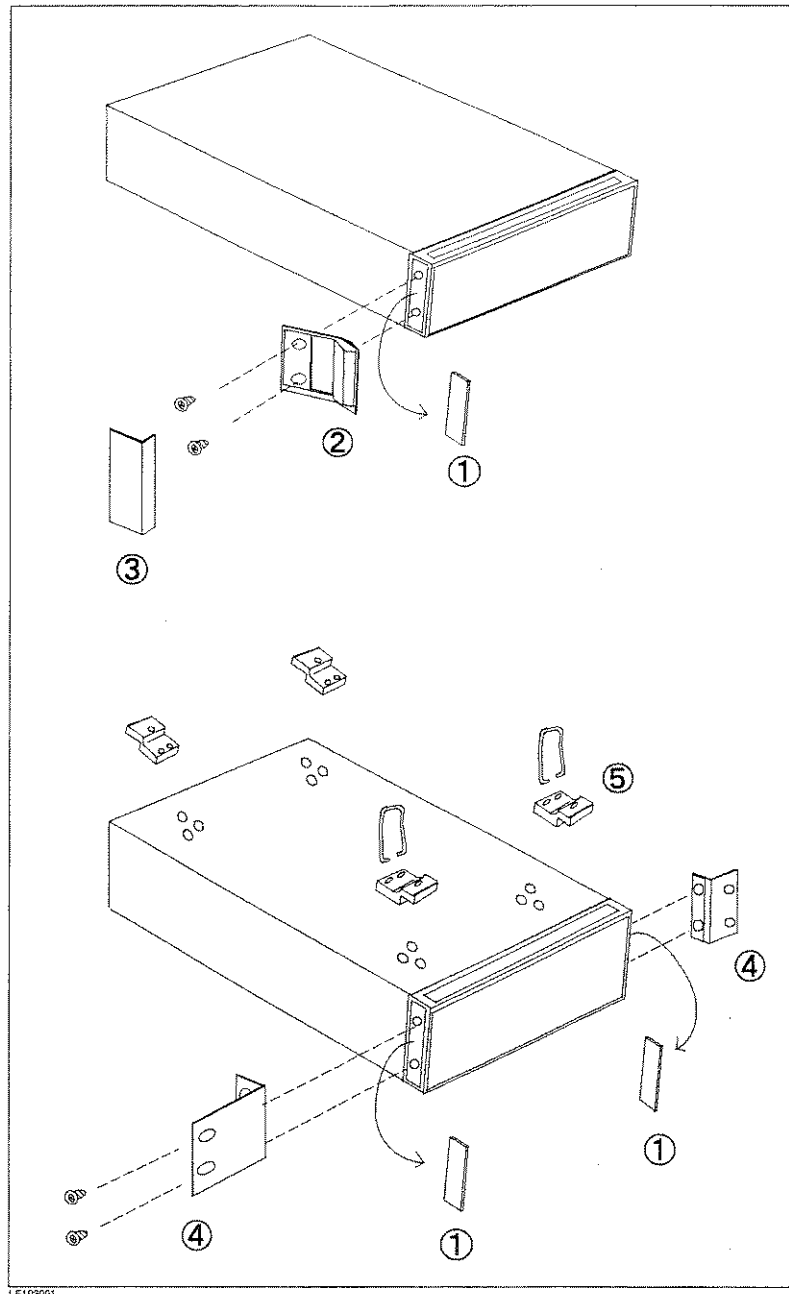

LE109001

Figure 3-2. Rack Mount Kits Installation

Option 1CN Handle Kit

Option 1CN is a handle kit containing a pair of handles and the necessary hardware to attach them to the instrument.

Installing the Handle

1. Remove the adhesive-backed trim strips ① from the left and right front sides of the HP E4915A/E4916A. (Refer to Figure 3-2.)
2. Attach the front handles ② to the sides using the screws provided.
3. Attach the trim strips ③ to the handles.

Option 1CM Rack Mount Kit

Option 1CM is a rack mount kit containing a pair of flanges and the necessary hardware to mount them to the instrument in an equipment rack with 482.6 mm (19 inches) horizontal spacing.

Mounting the Rack

1. Remove the adhesive-backed trim strips ① from the left and right front sides of the HP E4915A/E4916A. (Refer to Figure 3-2.)
2. Attach the rack mount flange ④ to the left and right front sides of the HP E4915A/E4916A using the screws provided.
3. Remove all four feet ⑤ (lift bar on the inner side of the foot, and slide the foot toward the bar.)



Connecting a Probe (HP E4916A Option 001 Only)

1. Connect the terminal of the probe to the rear panel as shown in the following figure.
2. Connect the white cable of the probe to the REFERENCE terminal on the rear panel.
3. Connect the black cable of the probe to the TEST terminal on the rear panel.

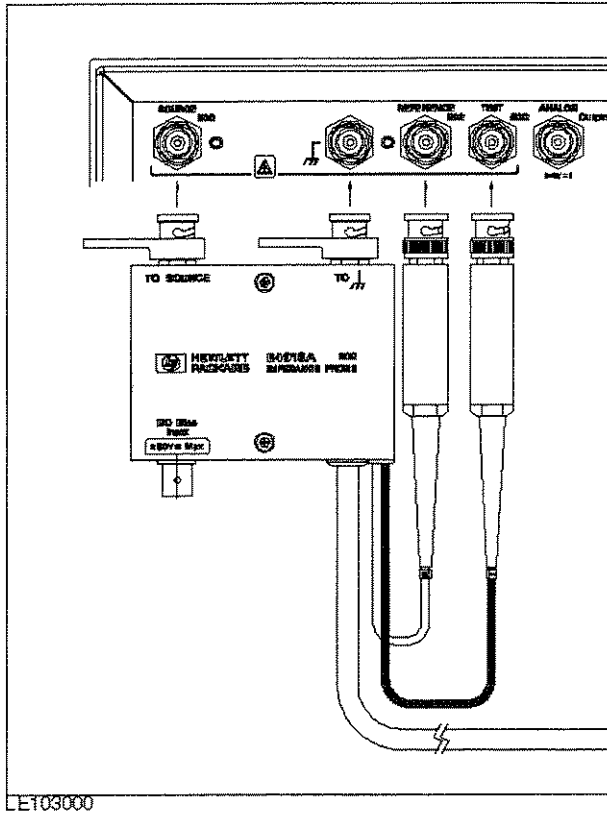

LET03000

Figure 3-3. Connecting a Probe

Caution



Make sure that the test signal level is 0 dBm or lower when using the probe. For more information, refer “EMC” in chapter 9 of *Operation Manual*.

Quick Start Guide

In this chapter, you will learn how to make basic F_T and CI measurement using the HP E4915A/E4916A.

Overview

This chapter describes how to make basic F_T and CI measurement in the following steps.

1. Preparing for measurement
 - Connecting peripherals
2. Turning ON the meter
3. Setting up the meter
 - Selecting the function
 - Selecting the measurement parameter
 - Setting the frequency and search range
4. Performing OPEN/SHORT/LOAD calibrations
5. Connecting DUT and reading measurement results (F_T and CI)

Required Equipment

To follow all the steps in this chapter, the following equipment is required:

- HP E4915A or HP E4916A
- HP 41902A PI-Network Test Fixture
- BNC cable x 2
- Shorting device
- 50- Ω load (50- Ω resistor)
- DUT

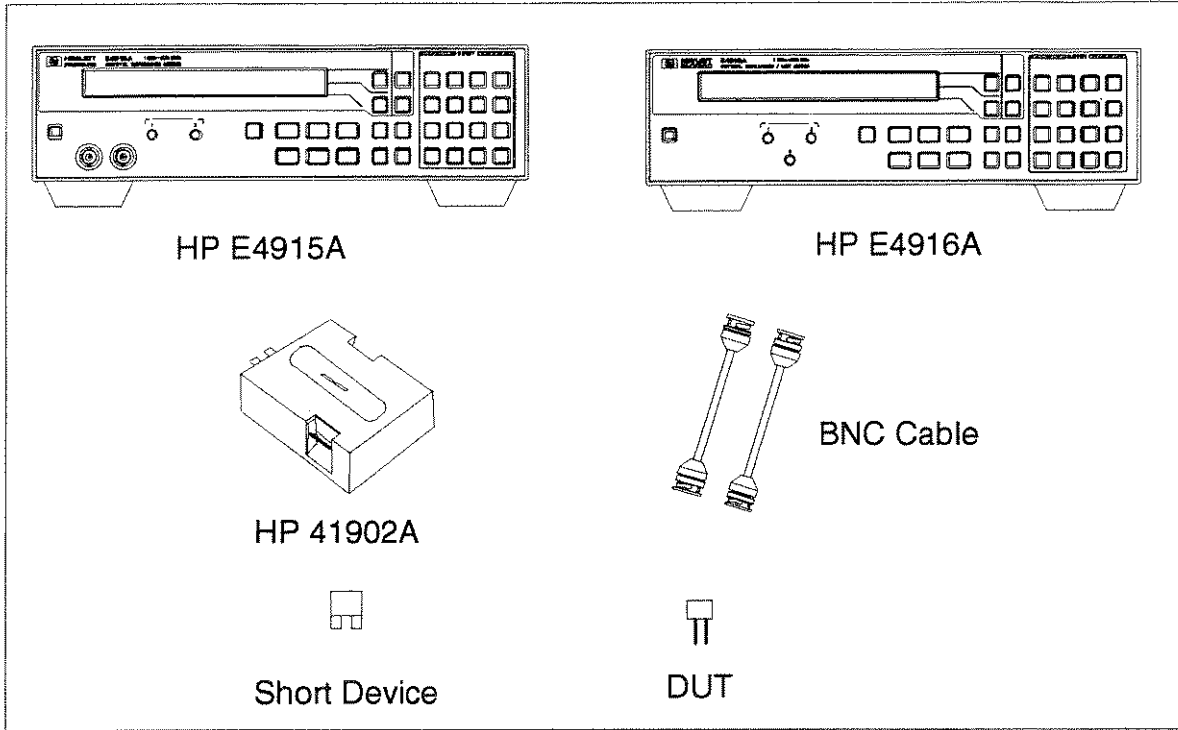

LE104001



Figure 4-1. Required Equipment

Step 1: Preparing For Measurement

Note



HP E4915A has the SOURCE port and TEST port on the front panel.
HP E4916A has the SOURCE port and TEST port on the rear panel.

-  Connect the SOURCE port to the PI-network test fixture with a BNC cable.
-  Connect the TEST port to the PI-network test fixture with a BNC cable.

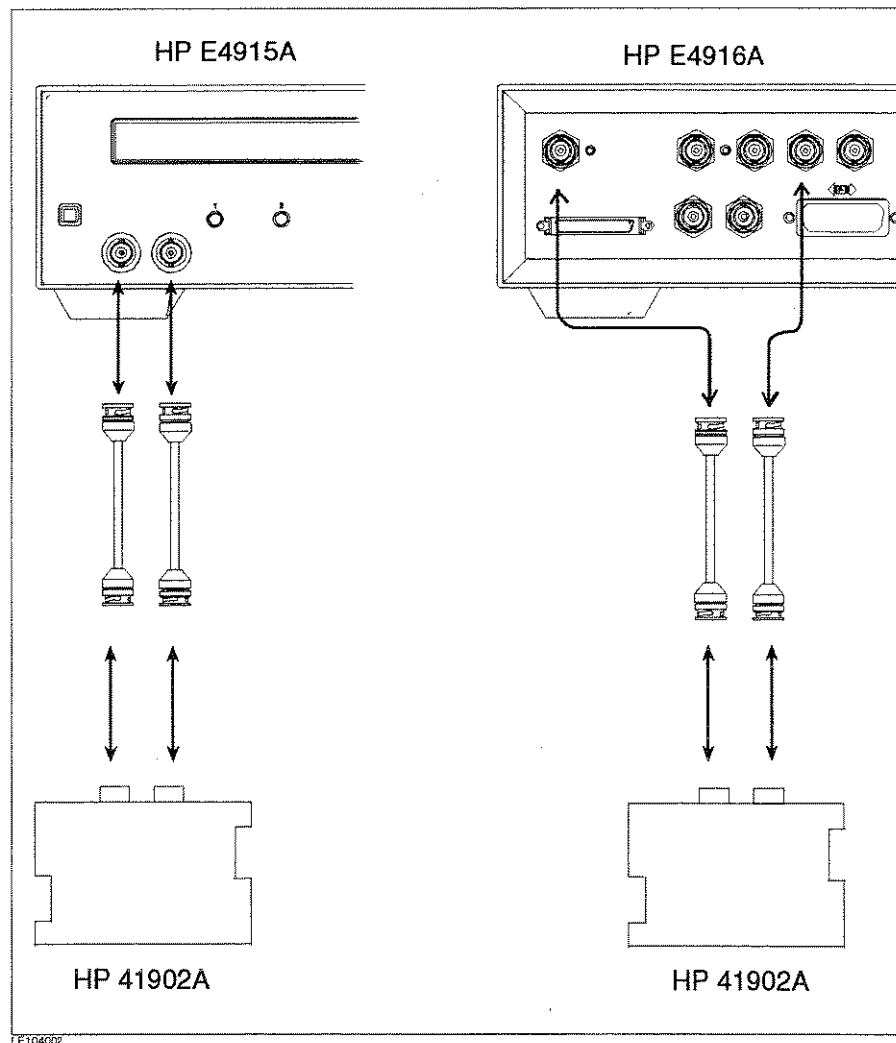

Figure 4-2. Connection of Measurement Cables

Step 2 : Turning ON the Meter

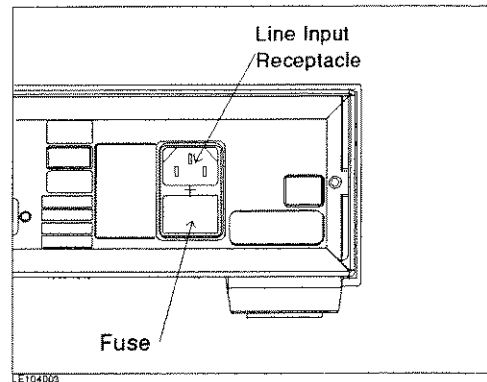

Figure 4-3. Line Input Receptacle and Fuse

Line Input Receptacle The AC Power cable is connected to this receptacle.



Fuse

Use the following fuse:

HP Part Number : 2110-038

(UL/CSA type, time delay 3 A 250 Vac)

If you need this fuse, contact your nearest Hewlett-Packard Sales and Service Office.

Steps To Turn On The Power

1. Connect the AC power cable to the line input receptacle
2. Turn on the HP E4915A/E4916A (you need 10 minutes for warming up).
3. Press **(blue)** **(Reset)** to preset the meter.

Step 3 : Setting Up the Meter

To measure CI, you need to specify the approximate resonant frequency (nominal frequency) of the resonator to be measured and the frequency range in which to search for the resonance point.

1. Sequentially press **Freq**, **2**, **0**, and **μ/M** to specify 20 MHz as the nominal frequency.
2. Then, press the lower Select key (Select key beside **RNG :nnnnn**) to specify the search range. (**nnnnn** shows the current setting.)
3. Sequentially press **5**, **0**, **0**, and **n/ppm** to specify the search range.

With the HP E4916A, you can also specify the level of test signal to be applied to the resonator. To specify this level, you need to specify the approximate CI of the resonator to be measured. Follow the steps below.

Note



The signal level specified with the HP E4916A indicates the power actually applied to a resonator. However, when you specify dBm as the unit of the signal level, the specified level shows the signal level at the port of the HP E4916A instead of the power applied to a resonator.

1. Sequentially press **Level**, **1**, **0**, **0**, and **μ/M** . (When the test signal level is set at 100 μ w.)
 2. Sequentially press **Nominal CI**, **2**, **0**, and **Enter**. (When CI is set at 20 Ω)
-

Note



With the HP E4915A, the output power level is fixed at -5 dBm. Therefore, you cannot specify the test signal level or CI.

Step 4 : Performing OPEN/SHORT/LOAD Calibrations

OPEN/SHORT/LOAD Calibration

1. Mount both CL adapter boards to the HP 41902A with the surface marked with THRU facing up.
2. Do not connect any device to the test fixture terminals so that the circuit of the fixture is open.
3. Sequentially press (blue) and 4 (OPEN).
4. Wait for a few seconds until the calibration is complete. When the beeper sounds, connect the shorting device to the fixture.
5. Sequentially press (blue) and 5 (SHORT) to start the short-circuit calibration.
6. Wait for a few seconds until the calibration is complete. When the beeper sounds, remove the shorting device from the fixture.
7. Connect a 50- Ω load (50 Ω resistor) to the fixture.
8. Sequentially press (blue) and 6 (LOAD).
9. Wait for a few seconds until the LOAD calibration is complete. When the beeper sounds, remove the 50- Ω load from the fixture.

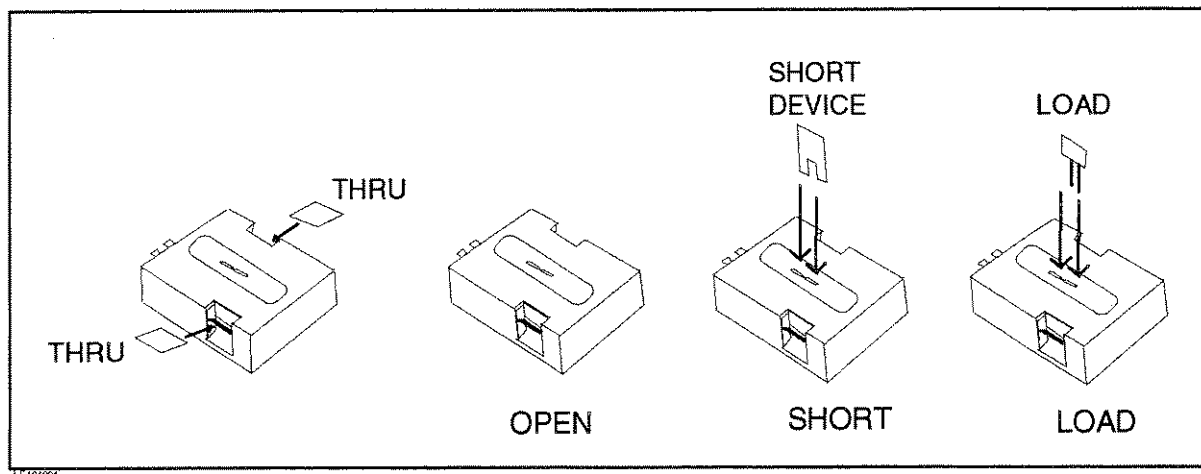

Figure 4-4. OPEN/SHORT/LOAD calibration

Step 5 : Connecting DUT and Reading Measurement Results

An error message appears when no DUT is connected. When the DUT is connected to the fixture, the HP E4915A/E4916A starts searching for the resonance point and then displays the resonant frequency and CI.

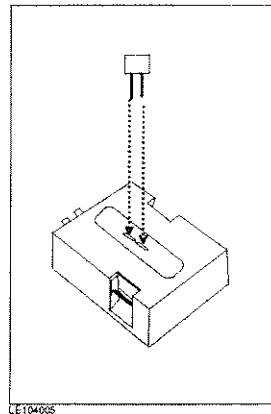

Figure 4-5. Connecting DUT

```
Fr: 19.4567891MHz CI:24.93 kΩ FREQ:20.000MHz  
Xt1          ▼▼▼          RNG : 500ppm
```

Figure 4-6. Measurement Result Display

If an Error Message Appears When DUT Is Connected

If an error message appears when the DUT is connected, the DUT resonant frequency may not be found within the specified frequency range or calibrations may not have been correctly performed. Check your measurement according to the following guidelines. For more information on each error message, refer to *HP E4915A/E4916A Operation Manual*.

- Check that both CL adapter boards (supplied with the HP 41902A) are mounted.

If no CL adapter board or only one of these boards is mounted, mount both of them.

- Check that the nominal DUT resonant frequency matches the frequency you have specified.

If these frequencies do not match, repeat the procedure from step 4.

If these frequencies match, expand the search range and repeat the procedure from step 4.

- Reduce the measurement speed.

The crystal resonator may be unable to respond quickly enough to the current measurement speed.

To reduce the measurement speed, press **Meas Time** and select Long.

To further reduce the measurement speed, press **HI Q:OFF** and turn ON the High Q mode.

Measurement speed is the highest with Short and becomes lower in descending order as follows: Short ▶ Medium ▶ Long ▶ High Q short ▶ High Q Medium ▶ High Q Long

Note



The High Q mode is also useful when measurement values do not settle into a steady state. In such cases, turn ON the High Q mode and reduce measurement speed.

If "—" Appears When DUT Is Connected

- Check that INT (internal trigger) is selected for trigger mode.

Sequentially press **(Blue)** and **Trig (Trigger Mode)** to display a screen where you can specify the trigger mode.

Check that INT is flashing and press **Enter**.

If MAN or EXT is flashing, use **↑⇒** or **⇐↓** to select INT and press **Enter**.

Applications

Measuring Crystal Component Characteristics Using PI-Network Test Fixture

This chapter describes the steps of the following measurements using the HP E4915A and the Economy PI-Network Test Fixture .

- Equivalent circuit analysis
- F_L measurement
- Spurious measurement
- Drive level dependency measurement
- Evaporation monitoring function
- Measurement using filter

Although the HP E4915A is used as an example, you can follow the same measurement steps with the HP E4916A.

Required Parts and Equipment

The following is required for this measurement:

- HP E4915A(or HP E4916A)
- HP 41902A Economy PI-Network Test Fixture
- 2 CL adapter boards (supplied with the HP 41902A. A capacitive load of 10 pF is used in this measurement.)
- 2 BNC cables (supplied with the HP 41902A)
- Shorting device (supplied with the HP 41902A)
- 50 Ω load (supplied with the HP 41902A)
- Crystal resonator (target component; A 20-MHz crystal resonator is used in this measurement.)

Preparation

Connecting Fixture

Connect the Economy PI-Network Test Fixture to the HP E4915A. (See Chapter 4 for how to connect the fixture.)

Connecting Capacitive Load

When you wish to use a capacitive load for measurement, be sure to connect the load to the CL adapter board before starting your measurement. (See the manual supplied with the HP 41902A for details.) In this measurement, we use a capacitive load of 10 pF.

Specifying Measurement Parameters

1. Specify 20 MHz as the nominal frequency of the crystal resonator.

Freq **20** **0** **μ/M**

2. Specify the range in which to search for the resonant frequency.

Press **(Lower select)** first to enter the search range as the deviation from the selected nominal frequency.

Calibration

1. Mount both of the CL adapter boards onto the HP 41902A with the surface marked with THRU facing up.
2. Perform the OPEN, SHORT, and LOAD calibrations. (See Chapter 4 for how to perform each calibration.)

Note



Before starting your calibration, make sure that each CL adapter board is mounted to the HP 41902A with the surface marked with THRU facing up. When using other PI-network test fixtures, perform your calibration with no capacitive load connected.

Calibration with a capacitive load connected will result in incorrect measurement results.

Equivalent Circuit Analysis

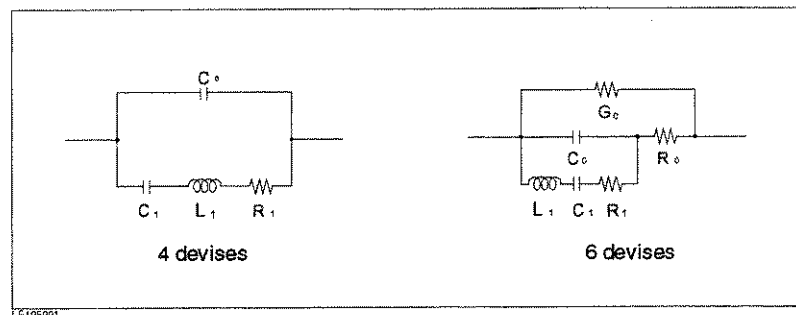

Figure 5-1. Equivalent Circuit Analysis

The HP E4915A/E4916A offers the 4-component and 6-component equivalent circuit analysis function. The HP E4915A/E4916A also allows the equivalent circuit constant and Q to be obtained.

Procedure

We assume that you perform equivalent circuit analysis after the crystal resonator characteristics measurement with the PI-network test fixture, described in the previous section.

1. Sequentially press **(blue)** and **Freq (Xtl)**. Then, use **(↑⇒)** or **(⇐↓)** to display **EQUC:OFF**.
2. Press **EQUC:OFF** to display the following:

EQUC:4DEV 6DEV OFF

3. Select **4DEV** to select the 4-component analysis or **6DEV** to select the 6-component analysis. At this time, press **DspQ** to toggle it ON for displaying the Q value.
4. Sequentially press **(blue)** and **μ/M (Equiv Ckt)** to turn ON the equivalent circuit analysis function. At this time, the status information disappears. Instead, values of the components included in the equivalent circuit appear.
5. Sequentially press **(blue)** and **μ/M (Equiv Ckt)** once again to turn OFF the analysis function. At this time, the status information appears again.

Displaying Analysis Results

Because the number of characters that can be displayed on the LCD is limited, the HP E4915A/E4916A cannot display all values it has obtained in the analysis. The following lists values that can be displayed for all combinations of settings. Note that you can load all values through HP-IB.

		4-component analysis	6-component analysis
DspQ	OFF	C_0, C_1, R_1, L_1	C_0, C_1, R_1, L_1
	ON	C_1, R_1, Q	R_0, G_0, Q

Measurement with Capacitance Load (CL_a/CL_t Parameters)

The HP E4915A/E4916A incorporates the following capability to measure the resonance point with capacitance load in addition to Fr measurement.

- By specifying a different capacitance from that of the load connected to the PI-network test fixture, HP E4915A/E4916A calculates and displays FL as if the target load was actually connected.

You need to specify 2 load capacitance values; actual and target values. The actual capacitance represents the capacitance of the load that is actually connected to the PI-network test fixture. You need to enter this value on the HP E4915A/E4916A in advance. You also need to enter a different capacitance from that of the load connected to the PI-network test fixture. This allows the HP E4915A/E4916A to calculate and display F_L as if the target load capacitance was actually connected.

Specifying Actual Load Capacitance

- Measurement for actual capacitance

Measure the capacitance of the connected load using CL Adj function.

1. Insert each CL adapter board into the HP 41902A with the surface marked with CL facing up when a capacitive load is connected to the board. Insert this board with the surface marked with THRU facing up when no load is connected to the

board. Be sure to insert both of the CL adapter boards into the HP 41902A. (Note that you need to insert both boards with the surface marked with CL facing up if you wish to connect a load to each side of the crystal resonator.)

2. Connect a shorting device to the HP 41902A.
3. Sequentially press **(blue)** and **n/ppm (CLAdj)** to display the measured value as shown below.

CL : nnnnnn pF CL_a : 0.000 F

(nnnnnn represents the measured capacitance.)

4. If you wish to adjust the capacitance, you can do so while looking at the measured capacitance on the LCD.

■ When entering the desired value as actual capacitance

You can use keys on the ENTRY block to enter the desired capacitance as the actual capacitance.

1. Sequentially press **CL Value**, **CL_a : nnnn F**, and **((Upper select))** to display a menu for selecting the CL value as shown below.

CL ACT: No-CL User

2. Select User and use keys on the ENTRY block to enter the capacitance of the connected load. In this case, enter 10 pF.

Note



The stray capacitance when a crystal resonator is connected is different from that when the shorting device is connected. When the HP 41902A is used, the stray capacitance when a crystal resonator is connected is 5pF more than that when the shorting device is connected. As the result, when actual capacitance is set, set the target capacitance to 5pF more than the CL Adj measurement result.

To know the stray capacitance of other test fixture, please refer to the manual of it.

Specifying Target Capacitance

You can obtain F_L for the capacitance different from that of the actual load. In this case, specify the capacitance for the desired F_L as the target capacitance to calculate this F_L .

In this example, the actual load capacitance is 10 pF. For example, when you wish to obtain F_L for 11-pF capacitance, specify 11 pF as CL_t. This allows the HP E4915A/E4916A to calculate F_L for 11 pF with the 10-pF load still connected.

■ When specifying different values as the actual and target capacitance

1. Press **CL Value** to display the following:

CL TGT: No-CL User =CLact

2. At this time, select User.
3. Then, use keys on the ENTRY block to enter the target capacitance.

Note



Use the capacitance with the similar capacitance value to the target capacitance to the π fixture practically. When the actual capacitance is set to be greatly different from the target capacitance, measurement result fluctuates because of the internal calculation result.

The DUT's Q and other factors influence the instability of the measurement results.

Note



When Capacitive Load Is Not Connected

Select No-CL for each of the actual and target load capacitance.

1. Press **CL Value** to select No-CL from the menu shown below.

CL TGT: No-CL User =CLact

2. Sequentially press **CL_a:nnnnn pF** and **(Upper select)** to select No-CL from the menu shown below.

CL ACT: No-CL User

Measurement Procedure

Make sure that both of the CL adapter boards are connected to the HP 41902A.

The HP E4915A/E4916A searches for and displays characteristics of a crystal resonator (DUT) such as Fr immediately when the DUT is connected to the fixture. Search Fail appears on the LCD when no DUT is connected to the fixture.

Note



Be sure to connect a capacitive load to the CL adapter board before mounting this board onto the HP 41902A with the surface marked with CL facing up.

The CL adapter board with a capacitive load must be mounted with the surface marked with CL facing up. The board with no load must be mounted with the surface marked with THRU facing up.

Even if you use no capacitive load, be sure connect both adapter boards to the HP 41902A with the surface marked with THRU facing up.

The HP 41902A cannot make measurement without CL adapter boards. Also, mounting one or both boards with the surface marked with CL facing up causes the circuit to become open. DUT characteristics cannot be measured if the circuit is open.

Measuring Resonant Frequency (F_r)

Although a load is actually connected, the HP E4915A/E4916A calculates and displays the DUT resonant frequency with no load.

1. Press **Meas Prmtr** to check that Fr appears as the parameter. Select Fr as the parameter if it does not appear on the LCD. Then, sequentially press **(blue)** and **Bk Sp (Entry Off)**.
2. Fr and CI values are displayed immediately when a DUT is connected to the HP 41902A.

Measuring Resonant frequency With Capacitive Load Connected (FL)

1. Press **Meas Prmtr** to display the following:

Param: Fs Fr Fa FL

2. At this time, select FL.
3. The FL and CI values are displayed immediately when the DUT is connected to the HP 41902A.

CL Compensation Function

The HP E4915A/E4916A have a function to calculate the capacitance load value which enables a crystal resonator to oscillate at the frequency of the reference resonator. The calculated capacitance load value is displayed as CL_t value, while the resonant frequency if the CL_t is connected as the capacitance load is calculated and displayed as FL value. Then softkey **CL Compn** should be used to use this function, and the softkey **Ftgt** is used to enter the frequency of the reference resonator.

It is required to adjust the capacitance load on the π fixture before using this function and enter the obtained load value into the actual capacitance. And the target capacitance should be set to User when use this function.

Note



Note that the CL measurement result when you use the CL Adj function after the capacitance load adjustment. The stray capacitance when a crystal resonator is connected is different from that when the shorting device is connected.

The resonant frequency when the actual capacitance is connected is displayed if Fr is selected as the measurement parameter in this setup. Furthermore, the both parameters Fr and FL can be displayed at the same time by pressing **(blue) + 1 (Status)** hardkeys after selecting FL as a measurement parameter.

To obtain the previous settings, press **(blue) + 1 (Status)** again.

Measuring Spurious Signals

The HP E4915A/E4916A searches through the spurious response in the specified frequency range and displays the frequency of the spurious signal and impedance at that frequency.

To measure spurious signals, you need to specify the frequency range in which to search for spurious signals. The HP E4915A/E4916A displays the frequency of the specified signal in the selected range and the ratio between the CI at F_r and that at the spurious signal frequency. This spurious ratio indicates the ratio between the measured impedance at the spurious signal frequency and the CI at F_r in dB ($20\log\{(Z \text{ value at the spurious frequency})/(CI \text{ value})\}$).

You can choose the desired spurious signal either by specifying the signal number starting from the lowest frequency signal or by selecting the signal with the highest peak.

Procedure

We assume that you perform spurious signal measurement after the crystal resonator characteristics measurement with the PI-network test fixture, described in the previous section.

Specifying Spurious Signal Search Range. To specify the frequency range in which to search for spurious signals, enter the center frequency of the desired range and the deviation (ppm) from this center frequency.

1. Sequentially press **(blue)** and **Level (Spurious)** to select the spurious signal mode.
2. Press **CENT:nn.nnnnMHz**. (**nn.nnnn** shows the currently selected value.)
3. Enter the center frequency of the desired frequency range.
4. Press **RNG :nnnnn ppm**. (**nnnnn** shows the currently selected value.)
5. Specify the desired frequency range by entering the deviation from the center frequency in ppm.

Specifying Number of Spurious Signals and Selecting Target Signal.

1. Sequentially press **(←↓)** and **DispSP:nn** to display the following. (At this time, **nn** shows the current setting.)

Nth Worst

2. Select **Worst** to display information on the spurious signal with the highest peak or **Nth** to display information on the nth signal from the lowest frequency signal.
3. When you select **Nth**, enter the number of the spurious signal you wish to search for. To do this, press **#SP** and enter the signal number.

Displaying Fr and CI Simultaneously

1. Sequentially press **(blue)** and **1 (Status)**. Then, the status information disappears and the normal Fr and CI are displayed together with measurement results.
2. Press **(blue)** and **1 (Status)** once again to display the status information.

Note



($\uparrow\Rightarrow$), **($\Leftarrow\downarrow$)**, **(Upper select)**, or **(Lower select)** cannot be used if the status information is not displayed. Be sure to display the status information before changing settings.

High Q Mode

Select the high Q mode when you need to measure characteristics of a crystal resonator with a high Q value.

Procedure

1. Sequentially press **(blue)** and **Freq (Xtl)**. Then, use **($\uparrow\Rightarrow$)** or **($\Leftarrow\downarrow$)** to display **HI Q:OFF**.
2. Press **HI Q:OFF** to toggle it **ON** for the high Q mode.

Note



Measurement speed is the highest with Short and becomes lower in descending order as follows: Short \blacktriangleright Medium \blacktriangleright Long \blacktriangleright High Q short \blacktriangleright High Q Medium \blacktriangleright High Q Long

Delta Mode

The HP E4915A/E4916A can display the difference between the measured and nominal values.

Specifying Reference CI

1. Sequentially press **(blue)** and **Freq (Xtl)**. Then, use **($\uparrow\Rightarrow$)** or **($\Leftarrow\downarrow$)** to display **Δ CI :nn**.
2. Press **Δ CI :nn** to display the following:
 Δ CI: Off DEV %
3. Select **Off** when you do not wish to display the difference (Δ) between the measured and reference CI values. Select **DEV** to display the difference or **%** to display the measured value in percentage of the reference value.
4. Next, specify the reference value that is used to display the Δ value. To do this, press **RefZ:n.nnnn Ω** to display the following:
RefZ: Nominal User
5. Select **Nominal** when you wish to use the specified nominal CI (value specified with **CI :nn.nnnn Ω** ; See "Specifying Target Signal Level and Using ALC Function (HP E4916A Only)" for details). Select **User** when you wish to specify a value other than this nominal CI as the reference value.
6. When you select **Nominal**, the nominal CI is automatically specified as the reference value for the Δ mode. When you select **User**,

use keys on the ENTRY block to enter the desired value as the reference value.

Specifying Reference Frequency

1. Sequentially press **(blue)** and **Freq (Xtl)**. Use **(↑⇒)** or **(⇐↓)** to display **ΔF :nn**.
2. Press **ΔF :nn** to display the following:
ΔF: Off DEV PPM
3. Select **Off** when you do not wish to display the difference (Δ) between the measured and reference frequencies. Select **DEV** to display the difference or **PPM** to display the measured frequency in ppm.
4. Next, specify the reference frequency that is used to display the Δ frequency. To do this, press **RefZ:n.mnnn Hz** to display the following:
RefZ: Nominal User
5. Select **Nominal** when you wish to use the measured frequency (frequency specified with **Freq**). Select **User** when you wish to specify a frequency other than the measured frequency as the reference frequency.
6. When you select **Nominal**, the measured frequency is automatically specified as the reference frequency for the Δ mode. When you select **User**, use keys on the ENTRY block to enter the desired frequency as the reference frequency.

Displaying Δ

1. Sequentially press **(blue)** and **p (ΔMode)** to turn ON the Δ mode. At this time, Δ appears on the left of measurement parameters to indicate that the parameter represents the difference from the nominal value. Note, however, that Δ does not appear if you have selected OFF for that item.
2. Sequentially press **(blue)** and **p (ΔMode)** once again to turn OFF the Δ mode.

Specifying Target Signal Level and Using ALC Function (HP E4916A Only)

With the HP E4916A, you can specify the target signal level. You can choose the unit from among W, V, A, and dBm.

Signal level can be affected by the CI of the component being measured. To make sure that the signal of the specified level is applied to the component, you need to specify the component CI as the nominal CI. You can use the ALC function to automatically set the signal at a proper level based on the measured CI.

Specifying Signal Level

1. Press **(Level)**.

2. Press **UNIT:nnnn** to specify the unit for the signal level. Choose the desired unit from among the following displayed when this key is pressed:

UNIT: dBm WATT AMP VOLT

3. When you finish entering the unit, you can enter the signal level. Use keys on the ENTRY block to enter the desired level.

Note



The signal level specified with the HP E4916A indicates the power actually applied to a resonator. However, when you specify dBm as the unit of the signal level, the specified level shows the signal level at the port of the HP E4916A instead of the power applied to a resonator.

Specifying Nominal CI

1. Press **(Nominal CI)**.
2. Use keys on the ENTRY block to enter the nominal CI.

Setting ALC Function

1. Press **(Nominal CI)**.
2. Press **ALC :OFF** to toggle it ON. At this time, CI: and ALC: OFF switch to CI:AUTO and ALC: ON, respectively.

Analog Output

The HP E4915A/E4916A can change its voltage output in proportion to change in deviation from the reference frequency such as F_r . The analog output terminal is provided on the rear panel of the HP E4915A/E4916A.

Specifying Reference Frequency

Specify the frequency used as a reference to determine the deviation.

1. Sequentially press **(blue)** and **(System)**. Use **($\uparrow \Rightarrow$)** or **($\Leftarrow \downarrow$)** to display **AnalogOut:OFF** and **Setting**.
2. Press **Setting** to display the following:

dFdV REF

3. Select REF to specify the reference frequency.
4. Next, use keys on the ENTRY block to enter the desired reference frequency.

Specifying Rate of Change in Output Voltage

Specify the rate of change in output voltage with change in frequency.

1. Sequentially press **(blue)** and **(System)**. Use **($\uparrow \Rightarrow$)** or **($\Leftarrow \downarrow$)** to display **AnalogOut:OFF** and **Setting**.
2. Press **Setting** to select dFdV.

3. Use keys on the ENTRY block to enter the rate of change in output voltage with change in frequency. (When you specify 1 dFdV, the output voltage changes by 1 V as the frequency changes by 1 Hz.)

Turning Analog Output ON/OFF

1. Sequentially press **(blue)** and **(System)**. Use **(↑⇒)** or **(⇐↓)** to display **AnalogOut:OFF**.
2. Press **AnalogOut:OFF** to toggle it **ON**.

Printing

The HP E4915A/E4916A allows measurement results to be printed after each measurement. Note that an optional HP-IB Centronics converter is required for printing.

Printers

PCL-compatible printers with Centronics interface can be used.

Equipment Required for Printing

The following is required for printing measurement results:

- PCL-compatible printer with Centronics interface
- Printer cable
- HP-IB Centronics converter (ITEL-45CHVU)
- HP-IB cable

Connecting Printer

Note



Be sure to turn OFF the HP E4915A/E4916A, printer, and HP-IB Centronics converter before connecting the printer to the HP E4915A/E4916A.

1. Check that the power for the printer and HP E4915A/E4916A is OFF.
2. Connect the printer and HP-IB Centronics converter with the printer cable.
3. Next, connect the HP-IB Centronics converter and HP E4915A/E4916A with the HP-IB cable.
4. When you finish making connections, turn ON the printer, HP E4915A/E4916A, and converter.

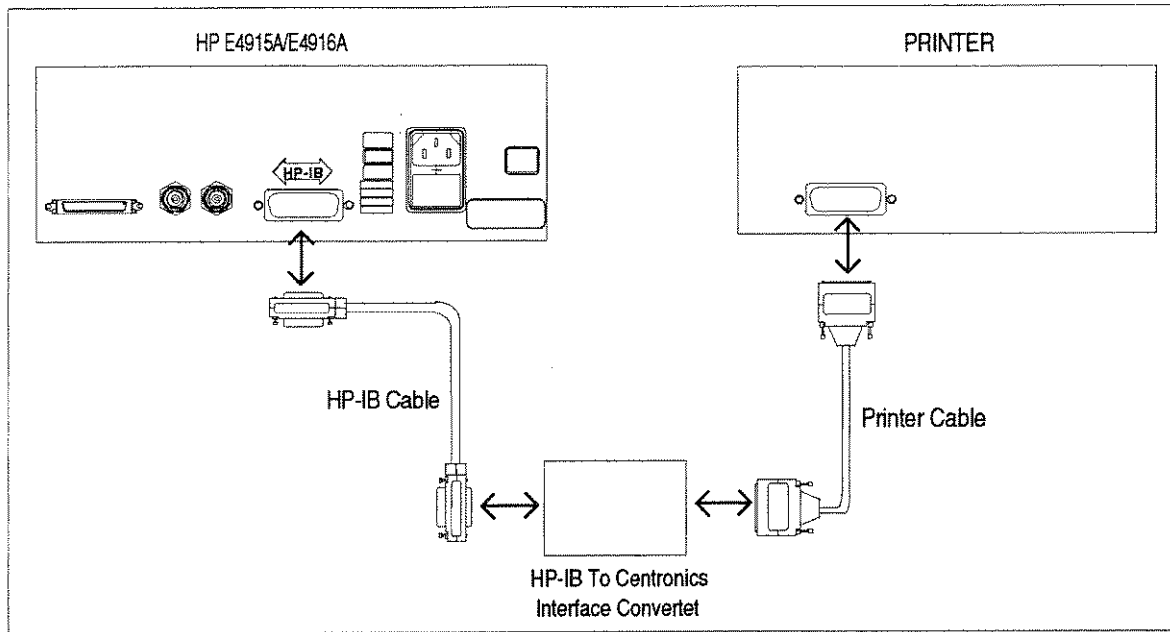

Figure 5-2. Connecting Printer and Converter

Printing Procedure

1. Sequentially press (blue) and (System). Use (↔) or (⇄) to display **HP-IB:nn**. (nn shows the current HP-IB address.)
2. Press **HP-IB: nn** first, then (3), (1), and (Enter) sequentially. Measurement results are printed after each measurement.

Note



The HP E4915A/E4916A assumes the talk-only mode when 31 is selected for its address.

Changing Calibration Standard Values When Using PI-Network Test Fixture Other Than HP 41902A

To use a PI-network test fixture other than the HP 41902A for the HP E4915A/E4916A, you need to enter new calibration standard data.

Note



Enter proper standard values. These values vary depending on the fixture used. See Table 5-1 for details.

The HP E4915A/E4916A is factory-set to HP 41902A calibration standard values. Your modification to the standard values is stored even when you turn OFF the HP E4915A/E4916A. If you wish to use the HP 41902A again, you need to preset the HP E4915A/E4916A.

1. Press **(blue)** and **(System)**. Use **(↕)** or **(⇄)** to display **CAL:Op,Sh,Ld.**
2. Press **CAL:Op,Sh,Ld** to display the following:
CAL: Open Short Load
3. Select Open to display the following:
OPEN: G C
4. Select G to enter open-circuit conductance G. The standard conductance varies depending on the fixture used. See Table 5-1 for details.
5. Select C to enter open-circuit capacitance C.
6. Select Short to display the following:
SHORT: R L
7. Select R to enter short-circuit resistance R.
8. Select L to enter short-circuit inductance L.
9. Select LOAD to display the following:
LOAD: R L
10. Select R to enter load resistance R.
11. Select L to enter load inductance L.

Table 5-1.
Calibration Standard Values for HP PI-Network Test Fixture

	OPEN		SHORT		LOAD	
	G ₀	C ₀	R ₀	L ₀	R ₀	L ₀
HP 41900A	0 S	0.1 pF	1 μΩ	0.6 nH	50 Ω	14 nH
HP 41901A	0 S	0.1 pF	1 μΩ	0.1 nH	50 Ω	3.4 nH
HP 41902A	0 S	0.1 pF	1 μΩ	3 nH	50 Ω	18.8 nH

Drive Level Dependency Test (HP E4916A Only)

In this section, we use the HP E4916A to test the drive level dependency of crystal resonator.

The HP E4916A searches for resonant frequency and crystal impedance of the resonator while changing the drive level (test signal level).

Also, the HP E4916A allows the following limit tests to be performed based on the results obtained after search:

- Limit test for measured value obtained at a specific drive level
- Limit test for F_r and CI at each drive level

Procedure

Specifying Frequency

To search for resonant frequency F_r , enter the nominal resonant frequency of the crystal resonator. In this section, we test the drive level of a 20-MHz crystal resonator as an example.

1. Sequentially press **(blue)** and **(Meas Prmtr (DLD))** to select the drive level dependency (DLD) measurement mode. DLD appears at the lower left corner of the LCD to indicate that the DLC measurement mode has been selected.
2. Sequentially press **(Freq)**, **(2)**, **(0)**, and **(μ /M)** to specify the frequency.
3. Press **RNG:nnnnn** and use keys on the ENTRY block to enter the search range in ppm.

Specifying Drive Level Sweep Settings

When you wish to use keys on the front panel to specify drive level sweep, specify the start and stop values for the drive level sweep as well as the sweep type. Once the minimum/maximum values and sweep type are specified, the HP E4916A uses its internally predefined series of level values (1, 2, 3, 5, 8, 10, 20, 30, 50, 80, 100, 200, 300 ...). That is, the HP E4916A automatically establishes all the individual drive levels between user-specified minimum and maximum drive levels.

You can also choose to start searching for the resonance point halfway through sweep, not from the beginning of sweep (minimum drive level). Or, you can specify wait time for each drive level so that the HP E4915A/E4916A does not immediately start measurement after having selected drive levels.

■ Specifying Start and Stop Values

1. Use **(\Rightarrow)** and **(\Leftarrow)** to display **MIN :nnnnnuW** and **MAX :nnnnnuW**. (**nnnnnuW** shows the current setting.)
2. Press **MIN :nnnnnuW** and use keys on the ENTRY block to enter the sweep start (minimum) value.

3. Press **MAX :nnnnuW** and use keys on the ENTRY block to enter the sweep stop (maximum) value.

■ **Specifying Sweep Type**

1. Use **(↑⇒)** or **(⇐↓)** to display **SWEP:nnnnn**. (**nnnnn** shows the current setting.)
2. Press **SWEP:nnnnn** to display the following:

Up Updown Upmin List

3. Use **(↑⇒)** or **(⇐↓)** to select the sweep type and press **(Enter)**.

■ **Specifying Search Start Point**

1. Use **(↑⇒)** or **(⇐↓)** to display **StartP:nnnnn**. (**nnnnn** shows the current setting.)
2. Press **StartP:nnnnn** and use keys on the ENTRY block to specify the drive level number.

■ **Specifying Wait Time After Applying Power**

1. Use **(↑⇒)** or **(⇐↓)** to display **WAIT:nnnnn**. (**nnnnn** shows the current setting.)
2. Press **WAIT:nnnnn** and use keys on the ENTRY block to enter the wait time in seconds.

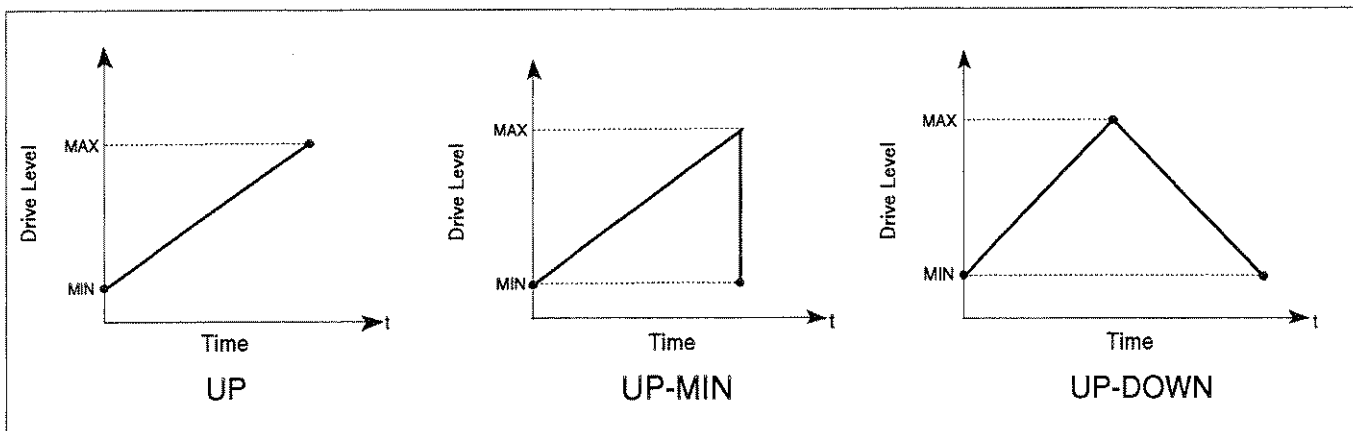

Figure 5-3. Sweep Type

Note



To select LIST for sweep type, you need to specify the sweep list using HP-IB commands. List sweep allows you to specify each drive level and perform sweep as desired. When you select LIST, "—" at each of **MIN:**, **MAX:**, **SWEP:**, and **STD:**.

Note



You can specify the following in the DLD measurement mode as in the crystal measurement mode.

- Measurement parameters
- Target phase angle
- CI for determining drive level

- ALC function ON/OFF
- Unit for drive level
- Measurement time (Short Mid Long)
- High Q mode

See “Measuring Crystal Component Characteristics Using PI-Network Test Fixture” for how to specify these data.

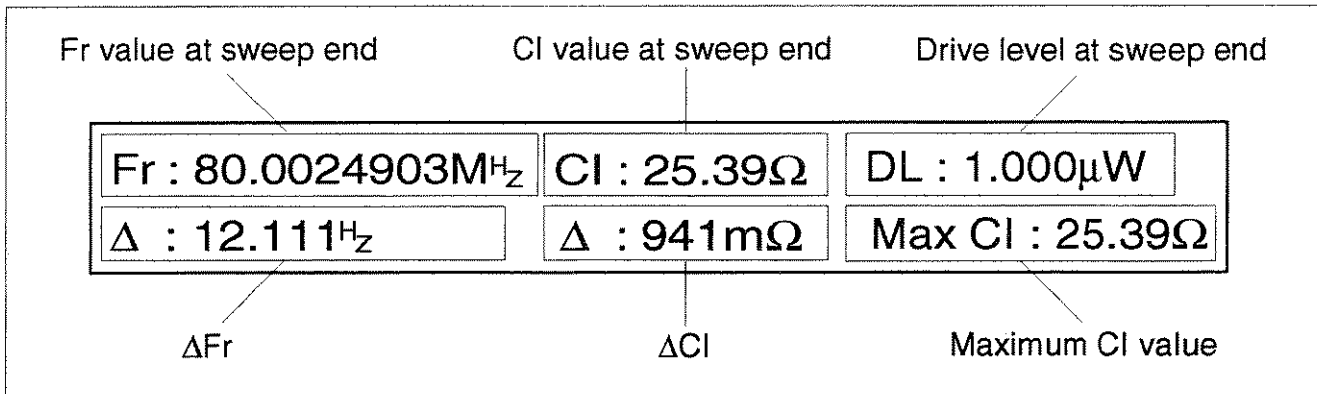

Figure 5-4. Example of DLD Measurement Result

Stopping Measurement In Case Of Faulty Search During Sweep

You can choose to stop measurement if the HP E4915A/E4916A cannot find the resonance point at a drive level during sweep.

1. Use $\uparrow \Rightarrow$ or $\Leftarrow \downarrow$ to display **ABORT:OFF**.
2. Press **ABORT:OFF** to toggle it **ON**. When **ABORT:ON** appears, measurement stops if the search fails during drive level sweep.

Limit Tests

You can set 3 limits for drive level dependency test. In the primary and secondary parameter limit tests, the value measured at one of the drive levels is checked against the limit.

In the tertiary parameter limit test, the value measured at each drive level is checked against the limit.

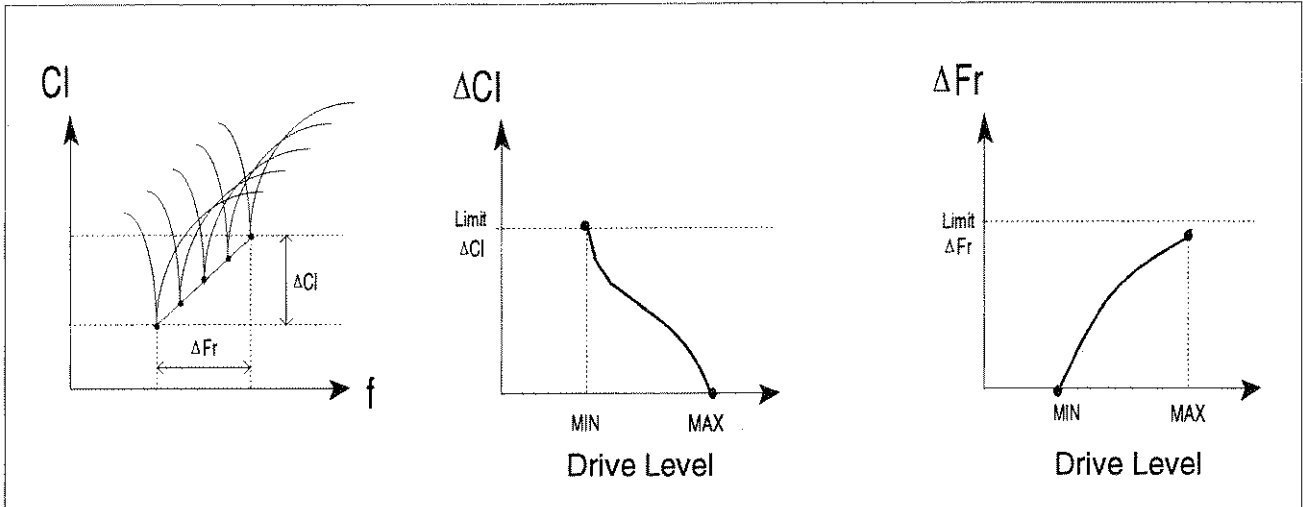

Figure 5-5. Drive Level Dependency Test

Primary and Secondary Parameters

Steps to specify the primary and secondary parameters are described later in “Handler Interface (Built-in Comparator Function; HP E4916A Only)”.

Tertiary Parameter

You can specify a limit for both F_r and CI at each drive level. The HP E4915A/E4916A checks the measured value at each level against the limit as this level changes.

1. Sequentially press **(blue)** and **(m/k (Comprtr))**.
2. Use **(↑⇒)** or **(⇐↓)** to display **Δ F_H:n.nn Hz**.
3. Press **Δ F_H:n.nn Hz** to enter the upper limit for frequency.
4. Press **(⇐↓)** to display **Δ Z_H:n.nn Hz**.
5. Press **Δ Z_H:n.nn Hz** to enter the upper limit for impedance.
6. Use **(↑⇒)** or **(⇐↓)** to display **Lm Δ F:OFF** and **Lm Δ Z:OFF**.
7. Press **Lm Δ F:OFF** to toggle it **Lm Δ F:ON**.
8. Press **Lm Δ Z:OFF** to toggle it **Lm Δ Z:ON**.
9. Use **(↑⇒)** or **(⇐↓)** to display **COMP:OFF**.
10. Press **COMP:OFF** to toggle it for turning ON the comparator function.

Evaporation Monitoring Function (HP E4916A Only)

The firmware of version 2.00 or later allows you to operate this function using the front panel. See *HP E4915A/E4916A Operation Manual* for details. In this reference, description of HP-IB commands is given in *Chapter 5*. Also, sample programs using the evaporation monitoring function are provided in *Chapter 7*.

Measurement Using Filter (HP E4916A Only)

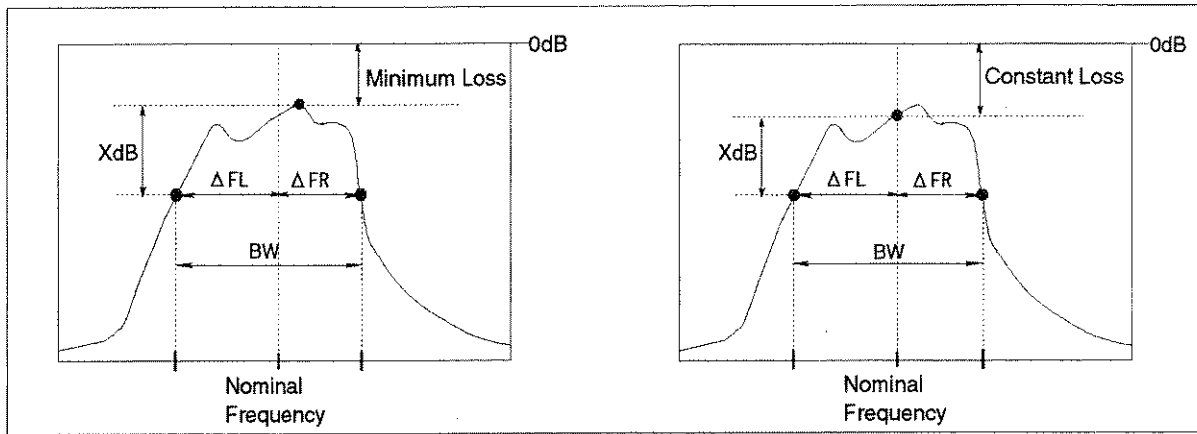

Figure 5-6. Parameters That Can Be Obtained

Procedure

Selecting Filter Mode

The HP E4916A can measure and display the band-pass filter insertion loss and $-X$ dB bandwidth. Also, you can choose between constant and minimum loss for insertion loss.

1. Sequentially press (blue) and CL Value (Fit) to select the filter mode.
2. Connect the filter to the Source port and the Test port using BNC cables.
3. Be sure to insert a 6 dB attenuator between the filter and the Source port.

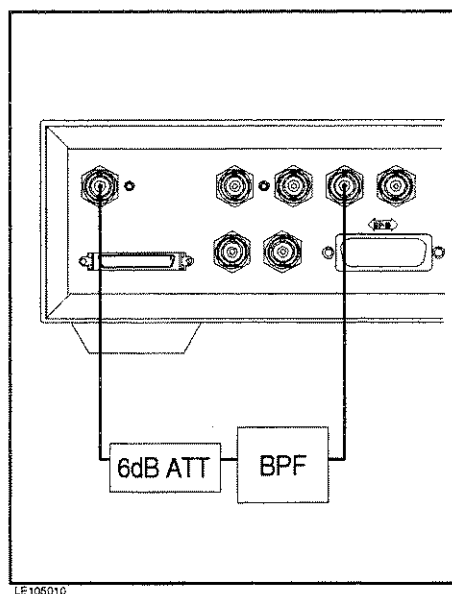

Figure 5-7. Connecting the Filter

Specifying Frequency

1. Press **Freq** to enter the nominal filter frequency.
2. Press **RNG: n.nnnMHz** to specify the range in which to search for the bandwidth.

Note



The search range must be larger than the bandwidth. If a range smaller than the bandwidth is specified, Search Fail appears to indicate that the attempt to search for the bandwidth failed.

Specifying Bandwidth

1. Use **(↑⇒)** or **(⇐↓)** to display **xdB: -n.nn dB**. (**n.nnn** shows the current setting.)
2. Press **xdB: -n.nn dB** to enter the desired bandwidth.

Selecting Constant or Minimum Loss

1. Use **(↑⇒)** or **(⇐↓)** display **LOSS:nnnn**. (**nnnn** shows the current setting.)
2. Press **LOSS:nnnn** to display the following:

Loss Type: Const Min

3. Select Const for constant loss or Min for minimum loss.

Displaying Measurement Results

1. Sequentially press **(blue)** and **1 (Status)**. At this time, the status information disappears. Instead, measurement results are displayed.
2. Sequentially press **(blue)** and **1 (Status)** once again to display the status information again.

Limit Tests

You can set 3 limits for filter measurement mode. In each of the primary and secondary parameter limit tests, the ΔF_L and ΔF_R values are checked against the limit. In the tertiary parameter limit test, the BW value is checked against the limit.

Primary and Secondary Parameters

Steps to specify the primary and secondary parameters are described later in "Handler Interface (Built-in Comparator Function; HP E4916A Only)".

Tertiary Parameter

You can specify a limit for the BW value.

1. Sequentially press **(blue)** and **m/k (Comprtr)**.
2. Use **(↑⇒)** or **(⇐↓)** to display **Δ BW_H:n.nn Hz**.
3. Press **Δ BW_H:n.nn Hz** to enter the upper limit for the bandwidth.

4. Press $\leftarrow \downarrow$ to display $\Delta BW_L:n.m\ Hz$.
5. Press $\Delta BW_L:n.m\ Hz$ to enter the lower limit for the bandwidth.
6. Use $\uparrow \Rightarrow$ or $\leftarrow \downarrow$ to display $Lm\ \Delta\ BW:OFF$.
7. Press $Lm\ \Delta\ BW:OFF$ to toggle it $Lm\ \Delta\ BW:ON$.
8. Use $\uparrow \Rightarrow$ or $\leftarrow \downarrow$ to display $COMP:OFF$.
9. Press $COMP:OFF$ to toggle it for turning ON the comparator function.

Measuring LCR Using Impedance Probe (HP E4916A with Options 001 and 010 Only)

Caution



Make sure that the test signal level is 0 dBm or lower when using the probe. For more information, refer “EMC” in chapter 9 of *Operation Manual*.

Required Equipment

- HP E4916A
 - Option 001 Impedance Probe Kit
 - Option 010 LCR Measurement Function

Connection

See “ Connecting a Probe (HP E4916A Option 001 Only)” in Chapter 3 for how to connect the impedance probe.

Selecting LCR Mode

- Sequentially press **(blue)** and **(Meas Time (LCR))**. At this time, LCR appears at the lower left corner of the LCD to indicate that the LCR mode has been selected.

Selecting Measurement Circuit

To use the impedance probe, you need to specify the probe as the measurement circuit.

1. Use **(↑⇒)** or **(⇐↓)** to display **CKT:nnnn**. (**nnnn** shows the current setting.)
2. Press **CKT:nnnn** to display the following:

```
CKT: PI PROBE BRIDGE NONE
```
3. Select PROBE.

Selecting Measurement Parameters

The HP E4916A can display up to 2 pairs of measurement parameters or 4 parameters at the same time. The following lists parameters that can be specified:

Parameter Specified with Pri1: and Pri2:	Parameter Specified with Sec1: and Sec2:
Z, Y, R, G, Cs, Cp, Ls, Lp	θ_z , θ_y , X, B, D, Q, Rs, Rp, G

1. Press **(Meas Printr)** to display the following:

```
Z Y R G Cs Cp Ls Lp
```
2. Select the desired parameter.
3. Next, press **Sec1:X** to display the following:

```
 $\theta Z$   $\theta Y$  X B D Q Rs Rp G
```

4. Select the desired parameter. Note that θZ and θY represent the phase for Z and Y, respectively.
5. Press $\left(\leftarrow\downarrow\right)$ to display sequentially **Pri2:X** and **Sec2:X** and specify the parameter in the same manner as described above.

Measurement Frequency

1. Press **(Freq)** and use keys on the ENTRY block to enter the frequency.

Averaging

1. Use $\left(\uparrow\Rightarrow\right)$ or $\left(\leftarrow\downarrow\right)$ to display **AVG: N**. (N shows the current averaging factor.)
2. Press **AVG: N** and use keys on the ENTRY block to enter the desired averaging factor. When you do not wish to use the averaging function, enter 1.

Voltage and Current Monitor

The HP E4916A can monitor the signal level applied to the DUT during LCR measurement.

1. Use $\left(\uparrow\Rightarrow\right)$ or $\left(\leftarrow\downarrow\right)$ to sequentially display **Imon:OFF** and **Vmon:OFF**.
2. To select the current monitor, press **Imon:OFF** to toggle it ON.
3. The monitored amperage appears in place of OFF in **Imon:OFF** on the left of the LCD.
4. You can turn ON the voltage monitor in the same manner as described above.

Note



When you make settings after having turned ON the current or voltage monitor, you may find that the amperage or voltage is not displayed. In this case, use $\left(\uparrow\Rightarrow\right)$ or $\left(\leftarrow\downarrow\right)$ to display the monitored amperage or voltage.

Note



The voltage monitor and current monitor will not show correct values if the meter is not properly calibrated.

Calibrating Probe

When using the probe, you need to mount standards onto the tip of the probe and calibrate the HP E4915A/E4916A.

1. Mount the open-circuit standard (supplied with the impedance probe) onto the tip of the probe and sequentially press **(blue)** and **4 (Open)**.
2. When you finish open-circuit measurement, remove the standard.
3. Mount the short-circuit standard (supplied with the impedance probe) onto the tip of the probe and sequentially press **(blue)** and **5 (Short)**.
4. When you finish short-circuit measurement, remove the standard.
5. Mount the load standard (supplied with the impedance probe) onto the tip of the probe and sequentially press **(blue)** and **6 (Load)**.

6. When you finish load measurement, remove the standard.

Measurement

Touch the DUT with the tip of the probe to determine the DUT characteristics such as impedance. You can also evaluate characteristics of on-board components or components with one of the terminals grounded.

Measuring LCR Using Test Fixture Adapter (HP E4916A with Options 001 and 010 Only)

Caution



Make sure that the test signal level is 0 dBm or lower when using the probe. For more information, refer “EMC” in chapter 9 of *Operation Manual*.

When you use the HP 16099A test fixture adapter, you can also use HP test fixtures for the APC-7 connector.

Required Equipment

- HP E4916A (with options 001 and 010)
- HP 16099A Test Fixture Adapter
- HP test fixture(e.g. HP 16092A)

Selecting Settings and Calibration

See “Measuring LCR Using Impedance Probe (HP E4916A with Options 001 and 010 Only)” for how to select settings and perform calibration.

Connecting HP 16099A Test Fixture Adapter

1. Perform calibration at the tip of the impedance probe. Then, connect the HP 16099 to the probe.
2. Connect the HP test fixture to the HP 16099.

(See the manual supplied with the HP 16099 for how to connect it to the probe and to the fixture.)

Compensating for Fixture Loss

1. Open-circuit the test fixture and sequentially press **(blue)** and **7 (Open)**.
2. Insert the shorting device into the test fixture and sequentially press **(blue)** and **8 (Short)**.

Load Compensation

You do not need to perform load compensation when you directly connect the HP test fixture to the HP 16099 for measurement. Load compensation is required to compensate for complicated residual impedance that may arise from the test fixture when you extend the cable from the HP 16099 or when you use your own fixture.

You must use a standard load whose impedance is known, constant, and nearly equal to that of the DUT being measured.

Enter the load impedance measured with a high precision LCR meter such as the HP 4284A and HP 4285A.

■ Specifying Load Impedance for Compensation

1. Sequentially press **(blue)** and **— (System)** and use **(↑⇒)** or **(⇐↓)** to display **COMP:Op,Sh,Ld**.

2. Press **COMP:Op,Sh,Ld** to display the following:

COMP STD: Open Short Load

3. Select Load to display the following:

LOAD: R L

4. Select R to enter the resistance or L to enter the inductance. Then, use keys on the ENTRY block to enter the value.

■ Performing Load Compensation

1. Connect the load to the test fixture.
2. Sequentially press **(blue)** and **9 (Load)**.

Displaying Measurement Parameters

The HP E4916A can display up to 4 measurement parameters at the same time.

1. When the status information is displayed, the parameters selected with **Pri1:** and **Sec1:** are displayed.
2. Sequentially press **(blue)** and **1 (Status)**. At this time, the status information disappears and the remaining 2 other parameters are displayed.
3. Sequentially press **(blue)** and **1 (Status)** once again to display the status information again.

Note



Use **Pri2:** and **Sec2:** to change the 3rd and 4th parameters, respectively.

DC Bias Measurement

The HP E4916A can evaluate DC bias characteristics when an external DC bias power source is connected to the external DC bias input terminal on the impedance probe.

Caution



Make sure that the bias voltage and current into the input terminal are respectively within ± 30 V and ± 0.5 A of the maximum ratings.

Application of power beyond the above levels can not only damage the HP E4916A but eventually cause fire.

Connection

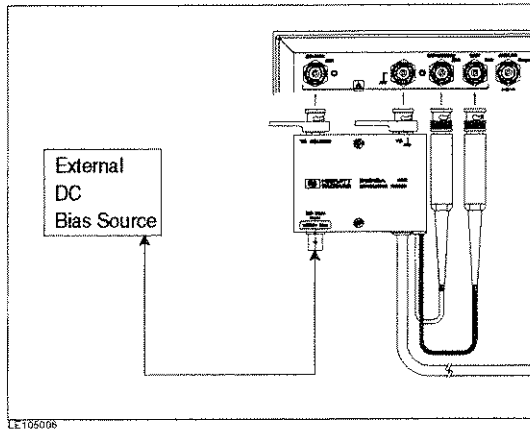

Figure 5-8. Connecting DC Bias Power Source

Handler Interface (Built-in Comparator Function; HP E4916A Only)

The HP E4916A has a comparator built into it for easy system upgrading using a handler. This section describes how to specify comparator data with keys on the front panel.

Only some of the comparator functions are made available with keys on the front panel. To make full use of its functions, you need to use HP-IB commands on an external controller. See *HP E4915A/E4916A Operation Manual* for details.

Comparator Function	Function Available with Front Panel Keys	Function Available with HP-IB	Corresponding HP-IB Command
Selection of primary parameter	Upper and lower limits only	Up to 10 BINs	COMPRI
Selection of sequence/tolerance mode	Yes	Yes	COMPTRIM
Selection of secondary parameter	Upper and lower limits	Upper and lower limits	COMPSLIM
Selection of tertiary parameter	Yes during DLD measurement	Yes during DLD measurement	COMPSECAUX

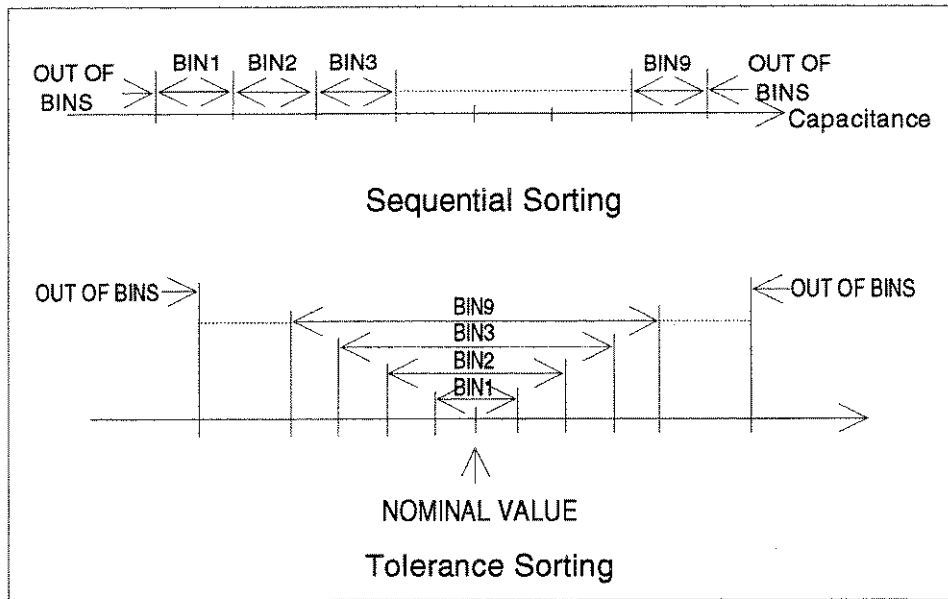

Figure 5-9. Sequential and Tolerance Modes

Specifying Comparator Function Settings

Specifying Limits for Primary Parameter

■ Selecting Sequence or Tolerance Mode

1. Sequentially press **(blue)** and **(m/k (Comprtr))**.
2. Use **(↑⇒)** or **(⇐↓)** to display **PRI:nnn**. (**nnn** shows the current setting.)
3. Press **PRI:nnn** to display the following:

PRI: ABS_TOL %TOL SEQ

4. Select **ABS_TOL** to select the tolerance mode and specify the deviation in absolute value. Select **%TOL** to select the tolerance mode and specify the deviation in percentage. Select **SEQ** to select the sequence mode.

■ Specifying Limits in Sequence Mode

1. Sequentially press **(blue)** and **(m/k (Comprtr))**.
2. Use **(↑⇒)** or **(⇐↓)** to display **PriH:+0.000** and **PriL:+0.000**.
3. Press **PriH:+0.000** and use keys on the ENTRY block to enter the upper limit.
4. Press **PriL:+0.000** to enter the lower limit in the same manner as for the upper limit.

■ Specifying Limits in Tolerance Mode

1. Sequentially press **(blue)** and **(m/k (Comprtr))**.
2. Use **(↑⇒)** or **(⇐↓)** to display **NOM:+0.000**.
3. Press **NOM:+0.000** to enter the reference value for the tolerance mode.
4. Press **(⇐↓)** to display **1stH:+0.000** and **1stL:+0.000**.
5. Press **PriH:+0.000** and use keys on the ENTRY block to enter the positive tolerance limit.
6. Press **PriL:+0.000** to enter the negative tolerance limit in the same manner as for the positive tolerance limit.

Specifying Limits for Secondary Parameter

1. Sequentially press **(blue)** and **(m/k (Comprtr))**.
2. Use **(↑⇒)** or **(⇐↓)** to display **SecH:+0.000** and **SecL:+0.000**.
3. Press **SecH:+0.000** and use keys on the ENTRY block to enter the upper limit.
4. Press **SecL:+0.000** to enter the lower limit in the same manner as for the upper limit.

Specifying Limits for Tertiary Parameter (during DLD Measurement Only)

The tertiary parameter is used for drive dependency level measurement. See "Drive Level Dependency Test (HP E4916A Only)" for how to specify limits for the tertiary parameter.

Specifying Comparator Output Settings

You can choose to sound the beeper and light the LED either when the test result is acceptable or when it is not acceptable.

Note



To sound the beeper for comparator output, sequentially press (blue) and (System), then select ON for BEEP.

If OFF is selected, the beeper does not sound regardless of comparator settings.

■ Setting Beeper

1. Sequentially press (blue) and (m/k (Comprtr)).
2. Use (↑⇒) or (⇐↓) to display BEEP:nnnn.
3. Press BEEP:nnnn to display the following:
BEEP: Pass Fail
4. Select Pass to sound the beeper when the test result is acceptable and Fail to sound it when the test result is not acceptable.

■ Setting LED

1. Sequentially press (blue) and (m/k (Comprtr)).
2. Use (↑⇒) or (⇐↓) to display LED:nnnn.
3. Press LED:nnnn to display the following:
LED: Pass Fail
4. Select Pass to light the LED when the test result is acceptable or Fail to light it when the test result is not acceptable.

Turning Comparator Function ON/OFF

- Sequentially press (blue) and (m/k (Comprtr)).
- Use (↑⇒) or (⇐↓) to display COMP:OFF and SEC:OFF.
- Press COMP:OFF to toggle it ON when you wish to perform the limit test using the primary parameter.
- Press SEC:OFF to toggle it ON when you wish to perform the limit test using the secondary parameter.

Manual Changes

Introduction

This appendix contains the information required to adapt this manual to earlier versions or configurations of the HP E4915A/E4916A than the current printing date of this manual. The information in this manual applies directly to the HP E4915A/E4916A serial number prefix listed on the title page of this manual.

Manual Changes

To adapt this manual to your HP E4915A/E4916A, see Table A-1 and Table A-2, and make all the manual changes listed opposite your instrument's serial number and firmware version.

Instruments manufactured after the printing of this manual may be different from those documented in this manual. Later instrument versions will be documented in a manual changes supplement that will accompany the manual shipped with that instrument. If your instrument's serial number or ROM version is not listed on the title page of this manual, in Table A-1, or Table A-2, make changes according to the *yellow MANUAL CHANGES* supplement.

In additions to information on changes, the supplement may contain information for correcting errors (Errata) in the manual. To keep this manual as current and accurate as possible, Hewlett-Packard recommends that you periodically request the latest *MANUAL CHANGES* supplement.

For information concerning serial number prefixes not listed on the title page or in the *MANUAL CHANGE* supplement, contact the nearest Hewlett-Packard office.

To confirm the ROM version, turn ON the power for the HP E4915A/E4916A or execute *IDN? on the external controller.

Table A-1. Manual Changes by Serial Number

Serial Prefix or Number	Make Manual Changes

Table A-2. Manual Changes by ROM Version

Version	Make Manual Changes

Serial Number

Hewlett-Packard uses a two-part, ten-character serial number that is stamped on the serial number plate (see Figure A-1) attached to the rear panel. The first five characters are the serial prefix and the last five digits are the suffix.

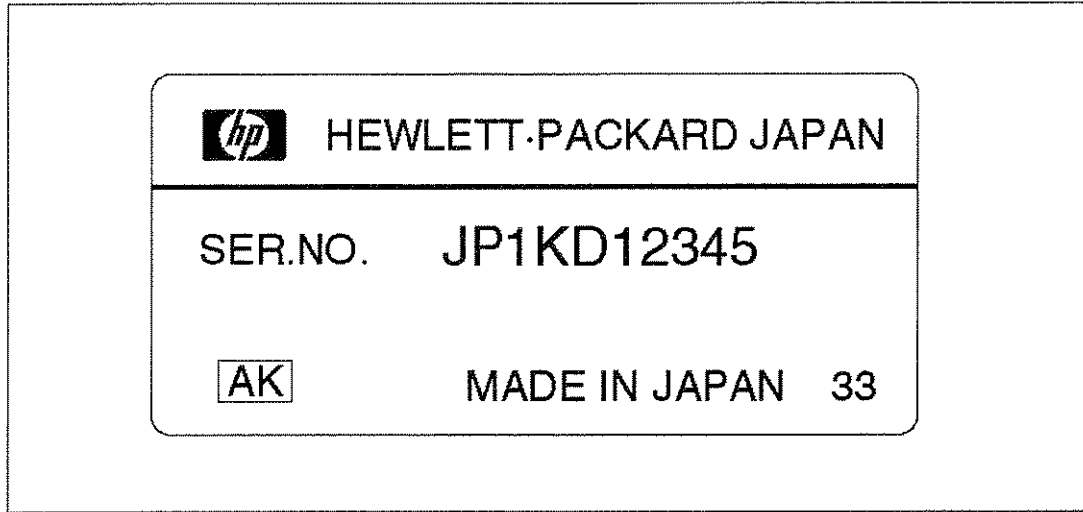

LE10A001

Figure A-1. Serial Number Plate

Replacing the Fuse

The HP part number of the fuse is 2110-0381. For more information on a fuse, see “⚠ Fuse” in Chapter 4.

Perform the following steps to exchange the fuse:

1. Remove the power cord if it is connected.
2. Remove the fuse holder of AC line receptacle on the rear panel using a small, flat-blade screwdriver.
3. To check or replace the fuse, remove the fuse from the fuse holder.
4. To reinstall the fuse, insert a fuse into the fuse holder.
5. Reinstall the fuse holder into the AC line receptacle.

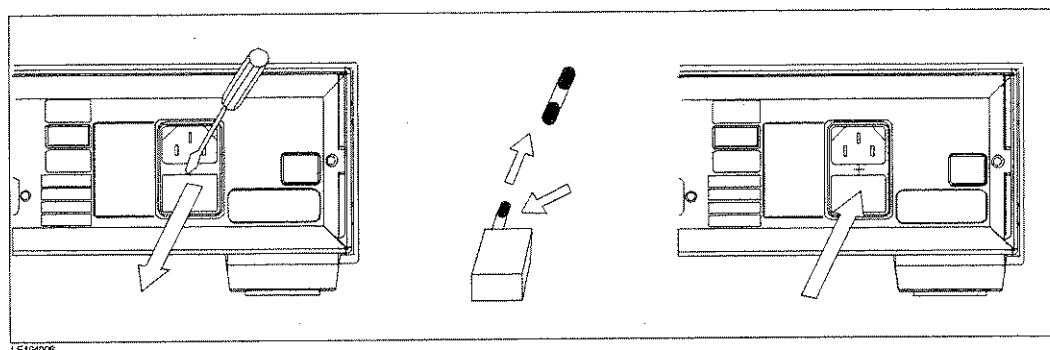

Figure B-1. Replacing the Fuse



Index

- A** actual capacitance , 5-3
ALC function, 5-9
analog output , 5-10
averaging , 5-23
- B** beeper , 5-30
built-in comparator function , 5-28
- C** capacitive load, 5-1
CI measurement , 4-1
CL adapter board, 5-1
cleaning , 3-5
constant loss , 5-19
content , 3-1
crystal component characteristics measurement , 5-1
crystal resonator , 4-1
current monitor , 5-23
- D** DC bias measurement , 5-26
delta mode , 5-8
DLD measurement , 5-14
drive level dependency , 5-14
- E** equivalent circuit analysis , 5-2
evaluation of components with one of the terminals grounded, 5-24
- F** fuse, 4-4
- H** handle , 3-6
handler interface , 5-28
high Q mode, 5-8
HP 16099A test fixture adapter, 5-25
- I** impedance probe, 5-22
incoming inspection , 3-1
insertion loss , 5-19
installation , 3-1

- L** LCR measurement , 5-22
LED , 5-30
limit , 5-29
limit tests, 5-16, 5-20
line input receptacle , 4-4

- M** making calibration, 4-6
manual changes, A-1
measurement using filter , 5-19
minimum loss , 5-19
monitor, 5-23

- O** operation, 4-1
overview, 4-1

- P** part number , 3-1
PI-Network Test Fixture, 5-1
power requirement , 3-2
printing , 5-11
probe calibration, 5-23

- R** rack , 3-6

- S** search range , 5-2
sequential mode , 5-28
serial number, A-2
setup, 4-5
signal level, 5-9
spurious signal measurement , 5-7

- T** target capacitance , 5-4
test fixture adapter , 5-25
tolerance mode , 5-28
turning on , 4-4

- U** upper and lower limits , 5-28
use of text fixture , 5-25

- V** ventilation requirement, 3-5
voltage monitor , 5-23

REGIONAL SALES AND SUPPORT OFFICES

If you need technical assistance with a Hewlett-Packard test and measurement product or application, please contact the Hewlett-Packard office or distributor in your country.

Asia Pacific:

Hewlett-Packard Asia Pacific Ltd
17-21/F Shell Tower, Times Square,
1 Matheson Street, Causeway Bay,
Hong Kong
(852) 2599 7070

Australia/New Zealand:

Hewlett-Packard Australia Ltd.
31-41 Joseph Street
Blackburn, Victoria 3130
Australia
131 347 ext. 2902

Canada:

Hewlett-Packard Canada Ltd.
5150 Spectrum Way
Mississauga, Ontario
L4W 5G1
(905) 206 4725

**In Europe, Africa and Middle East
please call your local HP sales office
or representative:**

Austria/East Central Europe:
(1) 25000-0

Belgium and Luxembourg:
(02) 778 34 17

Czech Republic:
(2) 471 7327

Denmark:
45 99 10 00

Finland:
(90) 88 721

France:
(1) 69.82.65.00

Germany:
(0180) 532 62-33

Greece:
(1) 7264045

Hungary:
(1) 252 4705

Ireland:
(01) 284 4633

Israel:
(03) 5380 333

Italy:
02 - 92 122 999

Netherlands:
(020) 547 6669

Norway:
(22) 73 56 00

Poland:
(22) 37 50 65

Portugal:
(11) 301 73 30

Russia:
(095) 956 2126

South Africa:
(011) 806 1000

Spain:
900 123 123

Sweden:
(08) 444 20 00

Switzerland:
(01) 735 7111

Turkey:
(212) 224 59 25

United Kingdom:
(01344) 366 666

**For European countries
not listed,
contact:**

Hewlett-Packard
International Sales Europe
Geneva, Switzerland
Tel: +41-22-780-4111
Fax: +41-22-780-4770

Japan:

Hewlett-Packard Japan Ltd.
Measurement Assistance Center
9-1, Takakura-cho, Hachioji-shi,
Tokyo 192, Japan
Tel: (81) 426 48 0722
Fax: (81) 426 48 1073

Latin America:

Hewlett-Packard
Latin American Region Headquarters
5200 Blue Lagoon Drive
9th Floor
Miami, Florida 33126
U.S.A.
(305) 267 4245/4220

United States:

Hewlett-Packard Company
Test and Measurement Organization
5301 Stevens Creek Blvd.
Bldg. 51L-SC
Santa Clara, CA 95052-8059
1 800 452 4844

Mar. 1996

P/N 16000-99004

