



HP 75000 SERIES C

Universal Counter
HP E1420B

User's Manual

(Also applies to the HP E1420A Universal Counter)



Copyright © Hewlett-Packard Company, 1990, 1994, 1996

Manual Part Number: E1420-90027

Printed: January 1996
Printed in U.S.A.

Safety Symbols



Instruction manual symbol affixed to product. Indicates that the user must refer to the manual for specific Warning or Caution information to avoid personal injury or damage to the product.



Indicates the field wiring terminal that must be connected to earth ground before operating the equipment—protects against electrical shock in case of fault.



OR



Frame or chassis ground terminal—typically connects to the equipment's metal frame.



Alternating current (AC).



Direct current (DC).



Indicates hazardous voltages.

WARNING

Calls attention to a procedure, practice, or condition that could cause bodily injury or death.

CAUTION

Calls attention to a procedure, practice, or condition that could possibly cause damage to equipment or permanent loss of data.

WARNINGS

The following general safety precautions must be observed during all phases of operation, service, and repair of this product. Failure to comply with these precautions or with specific warnings elsewhere in this manual violates safety standards of design, manufacture, and intended use of the product. Hewlett-Packard Company assumes no liability for the customer's failure to comply with these requirements.

Ground the equipment: For Safety Class 1 equipment (equipment having a protective earth terminal), an uninterruptible safety earth ground must be provided from the mains power source to the product input wiring terminals or supplied power cable.

DO NOT operate the product in an explosive atmosphere or in the presence of flammable gases or fumes.

For continued protection against fire, replace the line fuse(s) only with fuse(s) of the same voltage and current rating and type. DO NOT use repaired fuses or short-circuited fuseholders.

Keep away from live circuits: Operating personnel must not remove equipment covers or shields. Procedures involving the removal of covers or shields are for use by service-trained personnel only. Under certain conditions, dangerous voltages may exist even with the equipment switched off. To avoid dangerous electrical shock, DO NOT perform procedures involving cover or shield removal unless you are qualified to do so.

DO NOT operate damaged equipment: Whenever it is possible that the safety protection features built into this product have been impaired, either through physical damage, excessive moisture, or any other reason, REMOVE POWER and do not use the product until safe operation can be verified by service-trained personnel. If necessary, return the product to a Hewlett-Packard Sales and Service Office for service and repair to ensure that safety features are maintained.

Instructions for adjustments while covers are removed and for servicing are for use by service-trained personnel. Do not perform such adjustments or service unless you are qualified to do so.

DO NOT service or adjust alone: Do not attempt internal service or adjustment unless another person, capable of rendering first aid and resuscitation, is present.

DO NOT substitute parts or modify equipment: Because of the danger of introducing additional hazards, do not install substitute parts or perform any unauthorized modification to the product. Return the product to a Hewlett-Packard Sales and Service Office for service and repair to ensure that safety features are maintained.

When measuring power line signals, be extremely careful and always use a step-down isolation transformer that provides a compatible voltage for the input capabilities of this product. This product's front panel is typically at earth ground, so NEVER TRY TO MEASURE AC POWER LINE SIGNALS WITHOUT AN ISOLATION TRANSFORMER.

Table of Contents

Introduction	HP 75000 Series C Documentation 1-1
	Suggested Sequence for Using the Manuals 1-1
	Related Documents 1-1
	How to Use This Manual 1-2
	Manual Overview 1-2
	Manual Content 1-2
	Suggested Sequence for Using This Manual 1-2
Chapter 1	Chapter Guide 1-1
Getting Started	Where To Find Important Topics 1-1
	Chapter Summary 1-1
	Overall Description of the HP E1420B 1-2
	Measurement Features 1-2
	Measurement Features 1-2
	Input Conditioning 1-2
	Additional Measurement Capabilities 1-3
	HP E1420B Simplified Block Diagram Description 1-3
	HP E1420B Quick Installation 1-6
	Inspection 1-6
	Switch/Jumper Configuration 1-6
	Hardware Setup 1-6
	Verifying HP E1420B Operation 1-7
	HP E1420B Power-On State 1-8
	Executing Self-Test (*TST?) 1-8
	In Case of Difficulty 1-9
	Making Basic Measurements 1-9
	Maximum Input Voltage 1-9
	Making A Frequency Measurement 1-9
	Interpreting Frequency Measurement Results Display 1-10
	Making a Time Interval Measurement 1-11
	Interpreting Time Interval Measurement Results Display 1-12
	E1420B Service, Support and Options 1-13
	Manual Applicability 1-13
Chapter 2	Chapter Guide 2-1
HP E1420B	Where To Find Important Topics 2-1
Connections,	Chapter Summary 2-1
Configuration, and	Connectors and Indicators 2-2
Installation	Front Panel Signal Connectors 2-2
	Maximum Input Power 2-2
	Input 1 and 2 2-2
	Input 3, Option 030 2-2
	Arm Input 2-2
	INT/EXT Reference 2-2
	Warm-up 2-3
	Front Panel Indicators and Adjustments 2-3
	VXIbus Connectors 2-3

Chapter 2	Internal Configuration	2-5
HP E1420B	Logical Address Configuration Procedure	2-5
Connections,	Defining the Instrument Address	2-5
Configuration, and	Bus Grant and Request Configuration Procedure	2-6
Installation	System Default Logical Addresses	2-7
(Continued)	Installation and Verification	2-9
	Cooling Considerations	2-9
	Hardware Setup	2-9
	Verifying Operation	2-9
Chapter 3	Chapter Guide	3-1
Using the HP E1420B	Where To Find Important Topics	3-1
	Chapter Summary	3-1
	Programming the HP E1420B	3-2
	Controller Languages	3-2
	Series 200/300 HP BASIC	3-3
	QuickBASIC	3-3
	Initialization State	3-4
	Changing Default Parameters	3-4
	Measurement Task Tutorials	3-5
	Maximum Input Power	3-5
	Frequency Measurement	3-6
	Example: Making a Frequency Measurement	3-6
	Input Signal Conditioning	3-6
	Frequency Measurement Program Example	3-7
	Comments	3-7
	Period Measurement	3-8
	Example: Making a Period Measurement	3-8
	Input Signal Conditioning	3-8
	Period Measurement Program Example	3-9
	Comments	3-9
	Time Interval Measurement	3-10
	Example: Making a Time Interval Measurement	3-10
	Input Signal Conditioning	3-10
	Time Interval Measurement Program Example	3-11
	Comments	3-11
	Pulse Width Measurement	3-12
	Example: Making a Pulse Width Measurement	3-12
	Input Signal Conditioning	3-12
	Pulse Width Measurement Program Example	3-13
	Comments	3-13
	Ratio Measurement	3-14
	Example: Making a Ratio Measurement	3-14
	Input Signal Conditioning	3-14
	Ratio Measurement Program Example	3-15
	Comments	3-15
	Totalize Measurement	3-16
	Example: Making a Totalize Measurement	3-16
	Input Signal Conditioning	3-16
	Comments	3-17
	Totalize Measurement Program Example	3-17a
	Rise/Fall Time Measurement	3-18
	Example: Making a Rise Time Measurement	3-18

Chapter 3
Using the E1420B
(Continued)

Input Signal Conditioning	3-18
Rise Time Measurement Program Example	3-19
Comments	3-19
Voltage Measurement	3-20
Example: Making a Voltage Measurement	3-20
Input Signal Conditioning	3-20
Voltage Measurement Program Example	3-21
Comments	3-21

Chapter 4
Understanding
the HP E1420B
Universal Counter

Chapter Guide	4-1
Where to Find Important Topics	4-1
Chapter Summary	4-1
Counter Configuration and the Measurement Procedure	4-2
HP E1420B Configuration	4-2
HP E1420B Measurement Procedure	4-3
Making Measurements With SCPI	4-5
The MEASure, CONFigure, and SENSE Commands	4-7
Using MEASure	4-7
Using CONFigure	4-7
Using SENSE	4-8
The INITiate, READ?, and FETCH? Commands	4-9
Using READ?	4-9
Using INITiate	4-9
Using FETCH?	4-9
Measurement Functions	4-10
Frequency/Period Measurements	4-11
Measurement Definition and Range	4-11
Procedure	4-11
Input Signal Conditioning	4-11
Channels 1 and 2 Trigger Level	4-11
Channel 3 Trigger Level	4-11
Gate (APERture) Time	4-11
Pulse Width Measurements	4-12
Measurement Definition and Range	4-12
Procedure	4-12
Input Signal Conditioning	4-12
Ratio Measurements	4-13
Measurement Definition	4-13
Procedure	4-13
Gate Time	4-13
Rise/Fall Time Measurements	4-13
Measurement Definition And Range	4-13
Procedure	4-13
Time Interval Measurements	4-14
Measurement Definition And Range	4-14
Procedure	4-15
Slope Selection	4-15
Time Interval Delay Measurements	4-15
Totalize Measurements	4-16
Measurement Definition And Range	4-16
Procedure	4-16a
Input Signal Conditioning	4-16a
Trigger Event	4-16a

**Chapter 4
Understanding
the HP E1420B
Universal Counter
(Continued)**

Arming and Gating.....	4-16a
Reading Measurement Results	4-16c
Synchronizing Measurement (Totalize 1).....	4-16c
Voltage Measurements	4-17
Measurement Definition And Range	4-17
Procedure.....	4-17
Input Signal Conditioning.....	4-17
Input Signal Conditioning.....	4-18
Input Range.....	4-18
Input Sensitivity.....	4-20
Input Attenuation.....	4-22
Input Coupling.....	4-23
Trigger Level.....	4-24
Trigger Slope.....	4-26
Input Impedance.....	4-26
Damage Level.....	4-27
Separate/Common Input 1	4-27
Arming the Counter.....	4-28
Internal Arming.....	4-29
Immediate, Hold, and Bus.....	4-29
External Arming.....	4-30
Front Panel Arm Input Connection	4-30
TTL Trigger Lines.....	4-31
Measurement Resolution	4-32
Setting The Aperture Time	4-33
Resolution And Gate Time Calculations.....	4-33
Output Formats.....	4-34
Measurement Data Field.....	4-34
Exponent.....	4-34
Totalize Output.....	4-34
Min/Max/Ac/Dc.....	4-34

**Chapter 5
E1420B Command
Reference**

Chapter Guide.....	5-1
Where To Find Important Topics.....	5-1
Chapter Summary	5-1
Command Types.....	5-2
Common Command Format.....	5-2
SCPI Command Format.....	5-2
Command Separator.....	5-2
Abbreviated Commands.....	5-2
Implied Channel.....	5-2
Implied Commands.....	5-2
Parameter Types.....	5-3
Optional Parameters	5-3
Query Parameters	5-4
Linking Commands.....	5-4
Command Summary	5-5
IEEE 488.2 Common Commands.....	5-5
SCPI Commands.....	5-6
IEEE 488.2 Common Commands.....	5-11
*CLS (Clear Status).....	5-11
*DMC (Define Macro).....	5-11
*EMC (Enable Macro).....	5-12

Chapter 5
E1420B Command
Reference
(Continued)

*EMC? (Enable Macro Query)	5-12
*ESE (Standard Event Status Enable).....	5-13
*ESE? (Standard Event Status Enable Query)	5-13
*ESR? (Event Status Register Query).....	5-13
*GMC? (Get Macro Contents Query).....	5-13
*IDN? (Identification Query).....	5-13
*LMC? (Learn Macro Query).....	5-14
*WAI (Wait)	5-15
HP E1420B SCPI Commands.....	5-16
ABORt	5-16
ARM	5-17
[:SEquence[1] or:STARt].....	5-17
:SEquence2 or :STOP	5-17
[:LAyer[1]]	5-17
[:IMMediate]	5-17
:LEVel	5-18
:LEVel?	5-19
:SLOPe	5-19
:SLOPe?.....	5-19
:SOURce.....	5-19
:SOURce?.....	5-20
CONFigure.....	5-21
:AC	5-22
:DC	5-23
:FREQuency	5-23
:FREQuency:RATio	5-25
:FTIME and:FALL:TIME.....	5-26
:MAXimum	5-27
:MIInimum	5-28
:NWIDth.....	5-28
:PERiod	5-30
:PWIDth.....	5-31
:RTIME and:RISE:TIME.....	5-32
:TINTerval.....	5-34
:TOTALize.....	5-34
CONFigure?	5-36
DIAGnostics.....	5-37
:CALibrate.....	5-37
:ASSEMBly.....	5-38
:BLOCK	5-38
READ:MRC? <EREG I TREG>	5-38
READ:INT?.....	5-39
UFAil[?]	5-39
FETCh?	5-40
INITiate.....	5-42
[:IMMediate]	5-42
:CONTInuous	5-43
:CONTInuous?.....	5-44
INPut	5-45
:ATTenuation	5-45
:ATTenuation?.....	5-45
:COUPLing.....	5-45
:COUPLing?	5-46
:IMPedance.....	5-46

Chapter 5
E1420B Command
Reference
(Continued)

:IMPedance?	5-46
:ROUte	5-46
:ROUte?	5-47
MEASure	5-47
MEASure Command Details	5-49
MEASure Examples	5-49
MEMORY Subsystem	5-50
:VME:ADDRes	5-50
:VME:ADDRes?	5-51
:VME:SIZE	5-51
:VME:SIZE?	5-52
:VME:STATe?	5-52
:VME:STATe?	5-52
OUTPut	5-53
:TTLTrg<n> [:STATe]	5-53
:TTLTrg<n>:STATe?	5-53
:ROSCillator:STATe	5-53
:ROSCillator:STATe?	5-53
READ?	5-54
SENSe	5-55
:AVERage[:STATe]	5-56
:AVERage[:STATe]?	5-56
:AVERage:COUNT?	5-56
:EVENT:LEVel[:ABSolute]	5-56
:EVENT:LEVel[:ABSolute]?	5-57
:EVENT:LEVel [:ABSolute]:AUTO	5-58
:EVENT:LEVel [:ABSolute]:AUTO?	5-58
:EVENT:LEVel:RELative	5-58
:EVENT:LEVel:RELative?	5-58
:EVENT:LEVel?	5-59
:EVENT:SLOPe	5-59
:EVENT:SLOPe?	5-59
:EVENT:HYSTeresis	5-59
:EVENT:HYSTeresis?	5-59
:FREQuency:APERture	5-60
:FREQuency:APERture?	5-60
:FREQuency:RANGe	5-61
:FREQuency:RANGe:AUTO	5-61
:FREQuency:RANGe:UPPer	5-61
:FREQuency: RANGe[:UPPer]?	5-61
:SENSe:FUNCTion	5-61
:FUNCTion?	5-64
:PERiod:APERture	5-64
:PERiod:APERture?	6-54
:RATio:APERture	5-64
:RATio:APERture?	5-64
:ROSCillator:SOURce	5-64
:ROSCillator:SOURce?	5-65
:TINTerval:DELay	5-65
:TINTerval:DELay[:STATe]	5-65
:TINTerval:DELay[:STATe?]	5-65
:TINTerval:DELay:TIME	5-65
:TINTerval:DELay:TIME?	5-66
:TOTalize:GATE	5-66

Chapter 5
E1420B Command
Reference
(Continued)

:TOTAlize:GATE:STATe.....	5-66
:TOTAlize:GATE:STATe?	5-66
:TOTAlize:GATE:POLArity.....	5-67
:TOTAlize:GATE:POLArity?	5-67
:TOTAlize:GATE:SOURce?.....	5-67
STATus	5-68
Using the Operation Status Register	5-69
:OPERation:CONDition?	5-70
:OPERation:ENABle.....	5-70
:OPERation:ENABle?	5-70
:OPERation[:EVENT]?	5-70
Using the Questionable Data Register	5-71
:QUEStionable:CONDition?	5-71
:QUEStionable:ENABle.....	5-72
:QUEStionable:ENABle?	5-72
:QUEStionable[:EVENT]?	5-72
:SYSTem.....	5-73
:ERRor?.....	5-73
:PIMacro.....	5-74
:VERsion?	5-74

Appendix A
Specifications

Specifications.....	A-1
---------------------	-----

Appendix B
Error Messages

Error Messages	B-1
----------------------	-----

Appendix C
Performance Tests

Introduction.....	C-1
Where to Find Important Topics	C-1
Chapter Summary	C-1
Equipment Required	C-2
Calibration Cycle	C-3
Functional/Performance Test Records	C-3
Test Procedure Considerations	C-3
Software Implemented Full Performance Testing	C-4
Functional Tests.....	C-4
Preliminary Procedure.....	C-5
Power-up Self-Test.....	C-5
Auto Frequency Measurement Test	C-6
Ratio Measurement Test.....	C-7
Input Signal Conditioning Test	C-8
Time Interval Test.....	C-12
External Arm Input Test.....	C-14
Option 010 TCXO Timebase Test	C-15
Option 030, Input 3 Test	C-16
Full Performance Tests	C-18
Specifications Tested	C-20
Uncertainties Analysis Method	C-21
Alternate Test Equipment	C-22
Preliminary Procedure	C-22
Input 1/2: Measurement Sensitivity, Range, and Accuracy Tests.....	C-23

Appendix C	External Arm Range, Sensitivity, and Minimum Start-to-Stop Time Tests	C-28
Performance Tests	Auto Measurement Sensitivity, Range, and Accuracy Tests	C-31
(Continued)	(Option 030) Input 3: Sensitivity, Range, and Accuracy Tests	C-33
Appendix D Handling Problems	Appendix Guide.....	D-1
	Appendix Summary	D-1
	Software Versus Hardware Problems	D-2
	Monitoring Program Errors	D-2
	How the Error Queue Works	D-4
	Verifying System Integrity	D-5
	System Checklist.....	D-5
	Running Self-Test	D-5
Appendix E	Introduction	E-1
Using Option 040 —	Appendix Summary	E-1
High Throughput/	HP E1420B Shared RAM Description	E-2
Shared RAM	Shared Memory Programming	E-4
	Shared Memory Set-up Procedure	E-4
	Preparation	E-4
	Initiate Measurements	E-4
	Retrieve Data.....	E-4
	Example Programs	E-5
	HP BASIC Example.....	E-5
	"C" Example.....	E-6
Appendix F	Introduction	F-2
New Capabilities	New SCPI Commands Overview.....	F-2
	Phase Measurement Commands.....	F-2
	Acquisition Timeout Commands.....	F-2
	Input Impedance Default Control Commands.....	F-2
	Option Identification Query Common Command.....	F-3
	Firmware Version	F-3
	Determining Firmware Version	F-3
	Phase Measurement	F-4
	SCPI Commands.....	F-5
	Syntax	F-5
	Command Descriptions.....	F-5
	Query Response	F-7
	Phase Measurement Programming Example	F-7
	Specifications.....	F-9
	Range:	F-9
	Least Significant Digit.....	F-9
	RMS Resolution	F-9
	Systematic Uncertainty.....	F-9
	Maximum Frequency	F-9
	Definitions of Uncertainty Terms.....	F-9
	Performance Test	F-11
	Acquisition Timeout	F-12
	SCPI Commands	F-12
	Syntax.....	F-12

Appendix F
New Capabilities
(Continued)

Command Descriptions	F-12
Status Reporting	F-13
Query Response	F-13
Behavior	F-13
Acquisition Timeout Programming Example.....	F-13
Functional Limitations.....	F-16
Typical Performance Characteristics.....	F-16
Selectable Range and Resolution	F-16
Accuracy.....	F-16
Input Impedance Default Control	F-17
SCPI Commands	F-17
Syntax.....	F-17
Semantics.....	F-17
Input Impedance Default Control Programming Example.....	F-18
Comments	F-18
Option Identification Query.....	F-19
Common Command	F-19
Syntax.....	F-19
Query Response.....	F-19
Comments.....	F-19

HP 75000 SERIES C DOCUMENTATION

Suggested Sequence for Using the Manuals

1. **HP E1405 Command Module User's Manual.** Contains information on the logical addressing conventions used to create instruments that are programmed using Standardized Commands for Programmable Instruments (SCPI). This manual also describes the command module's resource manager functionality and how to implement user-defined configurations. Also included is HP-IB programming information.
2. **HP E1400B Mainframe User's Manual.** Contains installation information to prepare the mainframe for use and explains how to install plug-in modules. This manual also contains a detailed hardware description of the mainframe.
3. **Plug-In Module User's Manual.** Contains programming and configuration information for the plug-in modules. These manuals contain examples for the most commonly used functions and give a complete SCPI command reference for the module.

Related Documents

Beginner's Guide to TMSL. Explains the fundamentals of programming instruments using Hewlett-Packard's Test and Measurements System Language (TMSL) which is identical to Standardized Commands for Programmable Instruments (SCPI). We recommend this guide to anyone who is programming with SCPI for the first time. Hewlett-Packard part number H2325-90001.

Tutorial Description of the Hewlett-Packard Interface Bus. Describes the technical fundamentals of the Hewlett-Packard Interface Bus (HP-IB). This document also includes general information on IEEE 488.2 Common Commands. We recommend this document to anyone who is programming with IEEE 488.2 for the first time. The Hewlett-Packard part number is 5952-0156.

IEEE Standard 488.2-1987, IEEE Standard Codes, Formats, Protocols, and Common Commands. Describes the underlying message formats and data types used in SCPI and defines Common Commands. You will find this document useful if you need to know the precise definition of certain message formats, data types, or Common Commands. Available from: The Institute of Electrical and Electronic Engineers, Inc.; 345 East 47th Street; New York, NY 10017; U.S.A.

VXIbus System Specifications. Hewlett-Packard part number E1400-90006.

The VMEbus Specification. Available from: VMEbus International Trade Association; 10229 N. Scottsdale Road, Suite E; Scottsdale, AZ 85253; U.S.A.

HOW TO USE THIS MANUAL

Manual Overview

This manual shows how to operate, configure, and program the HP E1420B Universal Counter. This plug-in module is a VXIbus message-based device which can operate in C-size or (with an adapter) D-size mainframes.

If you are using the counter in a Hewlett-Packard 75000 Series C mainframe, refer to the "HP E1405 Command Module User's Manual" for system configuration information. If you are using the counter in another manufacturer's mainframe, refer to the applicable installation manual supplied by that manufacturer.

Most information in this manual applies to the counter operations in the HP 75000 Series C mainframe with an HP E1405 Command Module. Standardized Commands for Programmable Instruments (SCPI) is used as the programming language.

Manual Content

This manual has five chapters and four appendixes.

- Chapters 1 and 2 provide counter module description, configuration, and quick-start information. Chapter 3 shows several ways to use the counter to make measurements. For basic counter operations using SCPI, use these chapters.
- Chapter 4 explains the details of measurement programming and chapter 5 describes each of the SCPI commands used to program the counter.
- Appendix A gives the counter's specifications, Appendix B provides error message information, Appendix C provides complete performance test information, and Appendix D gives solutions to operating problems. Appendix E provides information about Shared Memory.

Suggested Sequence for Using This Manual

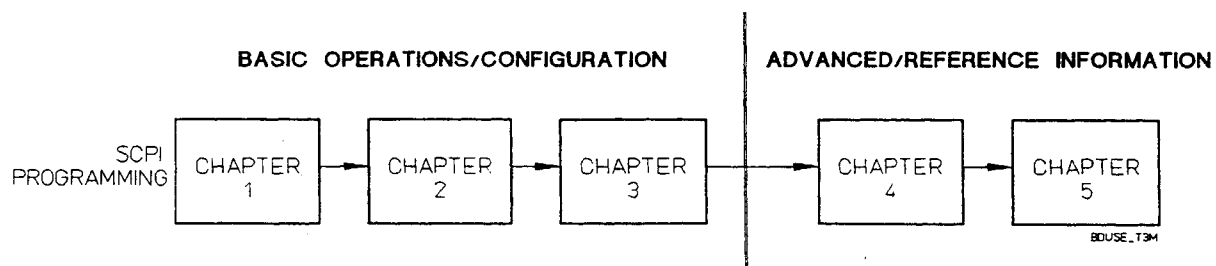

CHAPTER GUIDE

This chapter provides an overview of the HP E1420B Universal Counter, a simplified block diagram, and a hands-on tour of some basic functions. Also present are two simplified SCPI measurement program examples with measurement results and information about options, service, and support.

Where To Find Important Topics

- Block Diagram Description pg 1-3
- Counter Configuration pg. 1-6
- Example Programs pg. 1-10/12
- Hardware Set-up pg. 1-6
- Measurement Capabilities pg. 1-2/3
- Functional Verification pg. 1-8
- Simple Measurement Tasks pg. 1-9

Chapter Summary

- Overall Description of the HP E1420B pg. 1-2
- HP E1420B Quick Installation/Setup pg. 1-6
- Making Basic Measurements pg. 1-9
- HP E1420B Service, Support, and Options pg. 1-13

OVERALL DESCRIPTION OF THE HP E1420B

The HP E1420B is a fully programmable VXIbus universal counter with up to three input measurement channels. The frequency range is dc to 200/100 MHz for channels 1/2 respectively, and up to 2.5 GHz for the optional channel 3. The counter is a message-based device that uses Standardized Commands for Programmable Instruments (SCPI) to program commands and measurement responses. Measurement features and capabilities are presented first, followed by a simplified block diagram description of the counter.

Measurement Features

The measurement features of the HP E1420B include its functions, input signal conditioning and auxiliary measurement capabilities.

MEASUREMENT FUNCTIONS

HP E1420B measurement capabilities are:

- **Frequency** - provides frequency measurements up to 200/100 MHz on inputs 1 and 2 respectively and 2.5 GHz for input 3.
- **Period** - provides period measurements from 5 ns (10 ns for channel 2) to 1000 seconds on inputs 1 and 2.
- **Totalize** - provides totalize measurements of up to $10^{12} - 1$ on input 1.
- **Pulse Width** - provides pulse width measurements from 5 ns to 1 ms on inputs 1 and 2.
- **Time Interval** - provides time interval measurements from 1 nanosecond to 1000 seconds between inputs 1 and 2.
- **Ratio** - provides frequency ratio measurements via inputs 1 and 2, (input 3 optional).
- **Rise/Fall Time** - provides rise and fall time measurements from 15 ns to 1 ms on input 1.
- **Ac/Dc/Min/Max** - provides voltage measurements of the channel 1 or 2 input signal.

INPUT CONDITIONING

HP E1420B input signal conditioning includes:

- **Attenuation** - $\times 1$ or $\times 10$ (manual only)
- **Coupling** - Ac or Dc
- **Input Impedance** - 50Ω or $1\text{ M}\Omega$ ($500\text{ k}\Omega$ in Common Mode; $\times 1$ attenuation)
- **Input Switching** - Common or Separate inputs 1 and 2
- **Trigger Level** - Automatic or User-programmed
- **Trigger Slope** - Positive or negative

ADDITIONAL MEASUREMENT CAPABILITIES

HP E1420B additional measurement capabilities include:

- **External Arming** - provided via front panel BNC or VXIbus-programmable TTL trigger lines.
- **External Arming Slope and Level** - three programmable trigger levels can be selected (nominally TTL, ECL, and GND) along with positive or negative slope.
- **External Timebase Output** - provides the counter's internal 10 MHz timebase to the front panel Int/Ext Reference 10 MHz BNC for auxiliary use.
- **External Timebase Input** - allows the counter to use an external timebase as the frequency reference via the front panel Int/Ext Reference 10 MHz BNC.
- **100 Measurement Gate Averaging** - provides an additional digit of measurement resolution for all functions except totalize.
- **Shared Memory (Option 040)** - provides measurement throughput up to 160 measurements per second.

HP E1420B Simplified Block Diagram Description

Figure 1-1 is a simplified block diagram of the HP E1420B Universal Counter. The counter consists of five standard functional blocks: Input 1 and 2 (Input 3, optional), External Arming, Counter, Measurement Control, and VXIbus Interface. Some examples of SCPI commands/options that control various parts of the counter's circuits appear above and below the block diagram and can control the associated circuit elements.

Signals routed into the Input 1 and 2 block are conditioned, switched (for common/separate Input 1), and triggered before transfer to the Counter block. The Counter block uses HP's Reciprocal Counting Technique to generate time and event data which is passed to the Measurement Control block. (Refer to HP Application Note 200: "Fundamentals of the Electronic Counters", for details of the Reciprocal Counting technique.) The External Arming block allows measurement synchronization via one of two selectable external arming signal inputs: front panel BNC and VXIbus programmable TTLTrig lines.

The Measurement Control block uses the time and event information to generate measurement results. This block also determines when and how SCPI response messages are passed through the VXIbus Interface block. SCPI/common commands and any housekeeping tasks are also handled by this block. The VXIbus Interface block manages the transfer of all measurement and control data between the counter's internal circuits and the VXIbus.

MEASure[channel#]: <function>? {setup hardware, make measurement}

INPut[1|2] :IMPedance
:ROUte
:COUpling
:ATTenuation

SENSe[1|2]:EVENT :LEVel
:SLOPe
:HYSTeresis
INITiate[1|2] :IMMediate
:CONTinuous

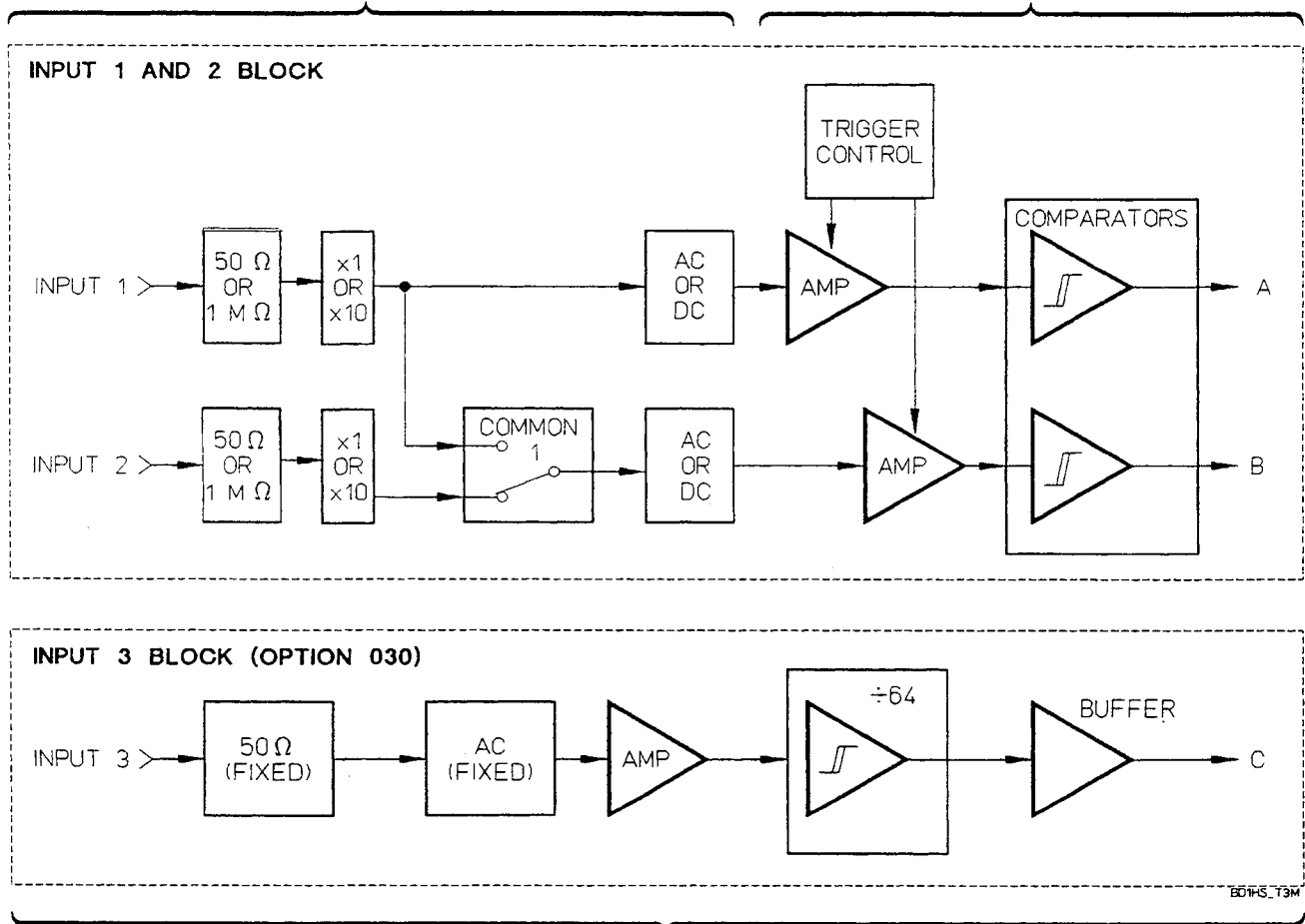

CONFigure3: <function> {setup hardware}

SENSe3: <command options> {specify input signal characteristics}

INITiate3: <command options> {perform measurement on channel 3}

FETCh3?: {transfer INITiated measurement results to output buffer}

READ3?: {perform configured measurement; put results in output buffer}

Figure 1-1. HP E1420B Simplified Block Diagram

ARM: START :
 STOP :IMMediate
 :SOURce <EXTErnal | IMMediate |
 HOLD | TTLTrg<n>>
 :LEVel <-1.3 | 0 | + 1.6>
 :SLOPe <POSitive | NEGative>

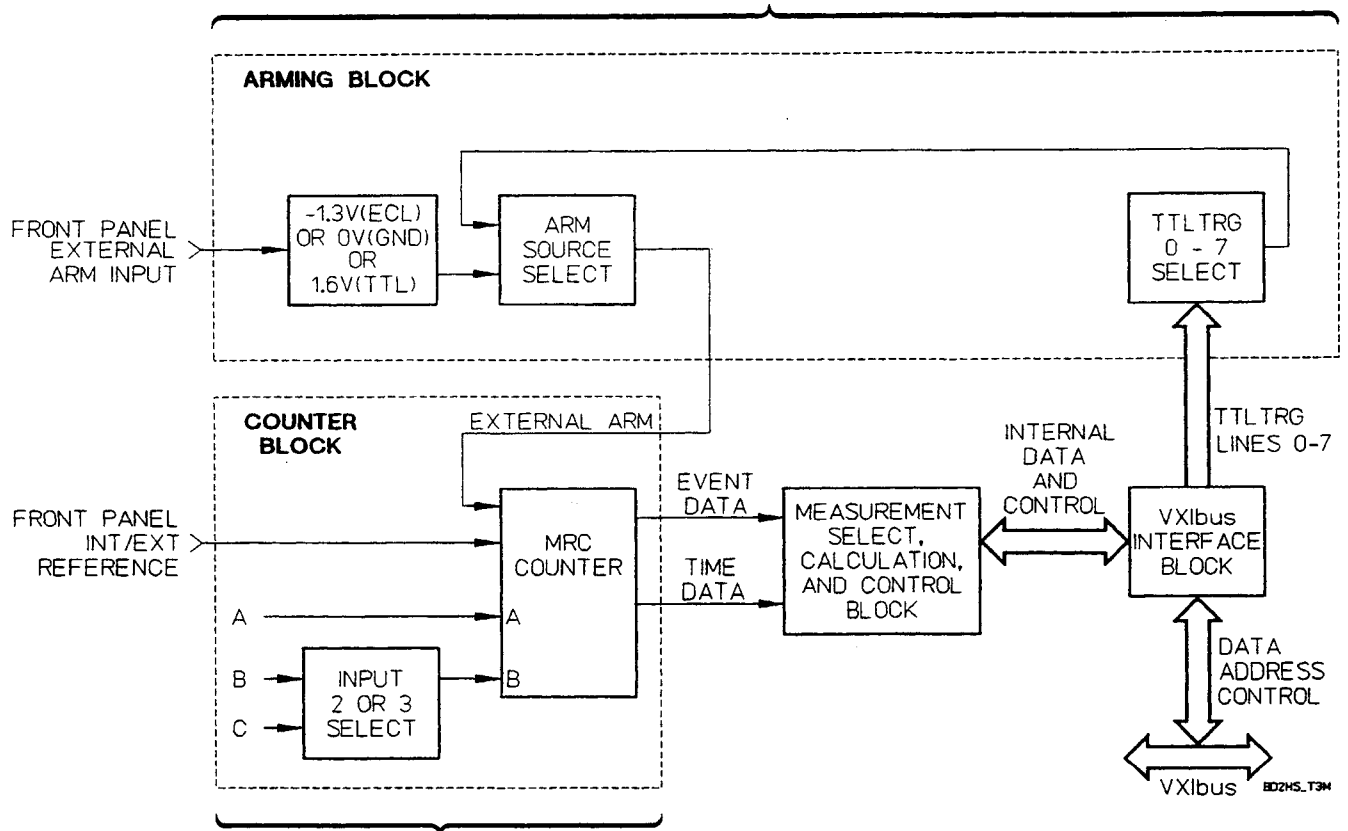

CONFigure3: <selected measurement function> {setup hardware}

Figure 1-1. HP E1420B Simplified Block Diagram (Continued)

HP E1420B QUICK INSTALLATION

This section provides you with information to get your HP E1420B Universal Counter up and running as soon as possible. This “hands-on” tour covers the following: inspection, configuration, installation, and functional verification.

Inspection

Inspect the shipping carton for damage before unpacking your HP E1420B. After the unit is unpacked, check for any damage (which may have occurred during shipment) as follows:

- Visually inspect all exterior surfaces for broken elements and damaged connectors.
- Report damaged shipments to the carrier and the nearest Hewlett-Packard Sales and Service office immediately.

NOTE

Do not discard the counter's packing materials. They may be needed for reshipment.

Switch/Jumper Configuration

The system controller must know the counter's location and bus arbitration level within the VXIbus system. The location is determined by the setting on the counter's logical address switch. Bus arbitration priority level is set by the position of the bus grant/request level jumpers.

- If you're using the counter in an HP 75000 Series C size mainframe, you may not have to do anything with either of these.
- If you're installing this counter in a mainframe that already contains other instruments, ensure that none of the module addresses conflict.
- Ensure that the logical address switch setting on the counter matches the factory default shown on page 2-6 in the next chapter. (Details of the addressing scheme are explained starting on page 2-5.)
- Ensure that the bus grant/request level is “3” (factory default) as shown on page 2-8, top of *Figure 2-3*, in the next chapter.

If you have another brand of C size mainframe refer to the configuration section of chapter 2 of this manual for detailed configuration instructions.

Hardware Setup

Install the HP E1420B with the following steps and refer to *Figure 1-2*:

1. Ensure that mainframe ac power is OFF before proceeding with this installation procedure.
2. Ensure that the metal shields on each side of the counter are securely attached to the counter before inserting the module into the mainframe.

3. Ensure that none of the pins on either of the counter's backplane connectors are broken or bent.
4. Ensure that the counter's P1 connector is correctly aligned with the corresponding connector on the mainframe backplane. (The front panel logo and lettering must be right-side up for both the HP counter and mainframe.)
5. Carefully slide the counter module edges into the carrier rails of the desired slot other than 0.
6. Ensure that the counter's P1 and P2 connector are fully seated without binding or jamming.
7. Secure the counter's top and bottom mounting screws with a $\frac{1}{8}$ -inch flat blade screwdriver.

NOTE

If you need to remove the counter from the VXibus mainframe reverse the order of the steps for installation after removing ac power to the mainframe.

**Verifying HP E1420B
Operation**

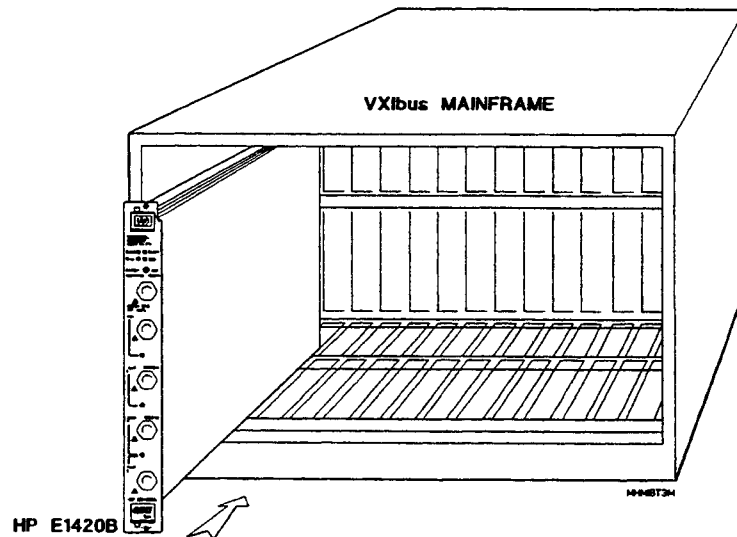

Figure 1-2. HP E1420B Mainframe Installation

Verify operation of the counter with the following procedure:

1. Power-up the Controller if separate from the VXIbus mainframe.
2. Power-up the VXIbus mainframe and verify Slot 0 functionality. (The Slot 0 module must be correctly set up, functional, and pass its own Self-test.)
3. Observe that the "Failed" LED on the HP E1420B is lit, then extinguishes after the Gate, Access, and Error LEDs momentarily flash indicating successful completion of Self-test. The counter is now in the power-on state and is ready for use.

HP E1420B POWER-ON STATE

The power-on state is the configuration that occurs immediately after the counter powers up and successfully completes Self-test. *Table 3-2* in chapter 3 gives a summary of the counter's default configuration parameters present in the power-on initialized state.

EXECUTING SELF-TEST (*TST?)

To execute the Self-test:

1. Connect a 10-MHz reference standard to the Int/Ext Reference BNC on the E1420B front panel.
2. Send the Self-test query command *TST?. The results of the test are placed in the output queue indicating whether or not the counter completed Self-test without any detected errors.

NOTE

If a 10-MHz reference standard is not available, the Slot 0 CLK10 resource may be routed from the Clk Out connector on the command Module's faceplate to the Int/Ext Reference BNC on the E1420B. An SMB(f)-to-BNC(f) connector with a BNC cable would be required.

Upon successful completion of *TST?, the counter configuration is left unchanged.

IN CASE OF DIFFICULTY

If the counter fails to successfully complete Self-test, refer to Appendix D for a checklist of simple instrument operating problems and their solutions or more information about troubleshooting and service.

MAKING BASIC MEASUREMENTS

After you've powered up the counter and successfully passed Self-test, you're ready to make a measurement. Use the information and procedures in this section to quickly make two basic counter measurements: **frequency** and **time interval**. You'll be shown two simple SCPI program examples along with how to retrieve and interpret the measurement results.

Maximum Input Voltage

The maximum allowable input voltage for all front panel inputs should not exceed five volts rms when $\times 1$ attenuation is active.

CAUTION

Input voltages in excess of five volts rms may cause permanent front-end hardware damage when $\times 1$ attenuation (default) is active.

Making A Frequency Measurement

Before you begin, make sure you have two signal sources available through two separate cables with standard BNC male connectors. For this demonstration we'll use:

- two signal generators capable of supplying 1 kHz and 1 MHz,
- an HP 9000 Series 200/300 instrument controller with HP BASIC,
- an HP-IB select code of 7, primary address of 09, and secondary address of 06 (logical address of 48) for the counter. (Primary and secondary addresses are defined in chapter 2.)

Follow these steps to make simple frequency measurements on input channels 1 and 2.

1. Enter the frequency measurement program listed in *Table 1-1*.
2. Set the first signal source for a 1 kHz square wave at 1 Vp-p and the second source for a 1 MHz sinewave at 500 mV rms.
3. Connect the first signal source to the counter's Input 1 front panel connector.
4. Connect the second signal source to the counter's Input 2 front panel connector.
5. Run the program.
6. Assess the measurement results shown on the controller display. Refer to "Interpreting Display Results" (next page) for frequency measurements if you don't understand the SCPI message response that appears on the instrument controller's display.

Table 1-1. Frequency Measurement Program Example

PROGRAM:	COMMENTS:
10 ASSIGN @E1420B TO 70906	— Assigns @E1420B to address 70906.
20 OUTPUT @E1420B;"*RST"	— Resets the counter to its default power-on state.
30 OUTPUT @E1420B;"MEAS1: FREQ? 1E3,.01"	— Configures Input channel 1 for frequency measurement, sets the target frequency to 1 kHz, resolution of at least 0.01 Hz., performs the measurement, then transfers the measurement results to the output buffer.
40 ENTER @E1420B;FREQ1	— Transfers the channel 1 measurement from the output buffer on the counter to the input of the instrument controller.
50 PRINT FREQ1	— Displays the measurement on the instrument controller's display.
60 OUTPUT @E1420B;"MEAS2:FREQ? 1E6, 1"	— Configures Input channel 2 for frequency measurement, sets the target frequency to 1 MHz, resolution of 1 Hz., performs the measurement, then transfers the measurement results to the output buffer.
70 ENTER @E1420B;FREQ2	— Transfers the channel 2 measurement from the output buffer on the counter to the input of the instrument controller.
80 PRINT FREQ2	— Displays the measurement on the instrument controller display.
90 END	— Terminates program and measurement.

**INTERPRETING
FREQUENCY
MEASUREMENT RESULTS
DISPLAY**

If you're having difficulty understanding the measurement results output shown on the instrument controller display, read this explanation.

All measurement results will appear in scientific notation (when more than 9 digits result) with as many digits to the right of the decimal point as needed for the requested resolution.

For the frequency measurement example program you'd see the display with the following formats:

1000.000 00

9.999999 E5

NOTE

The actual displayed value may not be exactly "10 MHz" depending upon factors such as timebase accuracy, input signal accuracy, cable length, or specified resolution.

Making A Time Interval Measurement

Before you begin, make sure you have one signal source available through two separate cables (use a "T" connector) with standard BNC male connectors. For this demonstration we'll use:

- a signal generator capable of generating 5 kHz,
- an HP 9000 Series 200/300 instrument controller with HP BASIC,
- an HP-IB select code of 7, primary address of 09, and secondary address of 06 (logical address of 48) for the counter. (Primary and secondary addresses are defined in chapter 2.)

Follow these steps to make a simple time interval measurement between input channels 1 and 2.

1. Enter the time interval measurement program listed in *Table 1-2*.
2. Set the signal source for a 5 kHz square wave at 1 Vp-p.
3. Connect a "T" BNC connector on the source output and attach a BNC cable to each side of it.
4. Connect one cable to the counter's Input 1 front panel connector.
5. Connect the second cable to the counter's Input 2 front panel connector.
6. Run the program.
7. Assess the measurement results shown on the controller display. Refer to "Interpreting Display Results" (next page) for time interval measurements if you don't understand the SCPI message response that appears on the instrument controller's display.

Table 1-2. Time Interval Measurement Program Example

PROGRAM:	COMMENTS:
10 ASSIGN @E1420B TO 70906	— Assigns @E1420B to address 70906.
20 OUTPUT @E1420B;"*RST"	— Resets the counter to its default power-on state.
30 OUTPUT @E1420B;"SENS2: EVEN:SLOP NEG"	— Selects channel 2 event slope to negative edge. Channel 1 event slope is defaulted to positive edge.
40 OUTPUT @E1420B;"MEAS1: TINT?"	— Configures Input channel 1 and 2 for time interval measurement, measures the time interval between the previously programmed edges of channels 1 and 2, then transfers the measurement results to the output buffer.
50 ENTER @E1420B;TINT1	— Transfers the measurement from the output buffer on the counter to the input of the instrument controller.
60 PRINT TINT1	— Displays the measurement on the instrument controller's display.
70 END	— Terminates program.

**INTERPRETING TIME
INTERVAL MEASUREMENT
RESULTS DISPLAY**

If you're having difficulty understanding the measurement results output as shown on the instrument controller display, read this explanation.

All measurement results will appear in scientific notation (when more than 9 digits result) with as many digits to the right of the decimal point needed for the requested resolution.

For the time interval measurement example program you'd see the display with the following format:

100E-06

NOTE

The actual displayed value may not be exactly "100 μsec" depending upon factors such as timebase accuracy, input signal accuracy, cable length, or specified resolution.

HP E1420B SERVICE, SUPPORT AND OPTIONS

Service and support is available through your nearest Hewlett-Packard Sales and Support office. Options available for the HP E1420B Universal Counter are listed in *Table 1-3*.

Table 1-3. HP E1420B Options

Description	HP Part Number
Extra Operating and Programming Manual (Option 0B2)	E1420-90020
Assembly-Level Service Manual (Option 0B3)	E1420-90015
Calibration Support (Option W32)	None
Input Channel 3 (Option 030)	None
Temperature Compensated Crystal Oscillator (TCXO) Timebase (Option 010)	None
Shared Memory (Option 040)	None

For more information about Service and Support, contact your nearest Hewlett-Packard Sales and Support office (offices are listed at the back of this manual).

MANUAL APPLICABILITY

The measurement function and SCPI programming information contained in this manual is inclusive for all HP E1420A features and specifications with the exception of the following:

- a. $\times 10$ attenuation is not present on the HP E1420A.
- b. Option 040, Shared Memory is not available on the HP E1420A.

HP E1420B Connections, Configuration, and Installation

CHAPTER GUIDE

This chapter briefly explains the counter's front-panel features, and shows how to configure the module hardware for use in a VXIbus mainframe. The chapter contains the following information and sections:

Where To Find Important Topics

- Arm Input Connector pg. 2-2
- Bus Grant/Request Setting pg. 2-6
- Cooling Considerations pg. 2-8
- Front Panel Indicators pg. 2-3
- Input Connectors pg. 2-2
- Logical Address Setting pg. 2-5
- Maximum Input Power pg. 2-2
- Power-up Verification pg. 2-9
- Timebase Adjustment pg. 2-3
- Timebase Input/Output pg. 2-2
- VXIbus Edge Connector pg. 2-3

Chapter Summary

- Connectors and Indicators pg. 2-2
- Internal Configuration pg. 2-5
- Installation and Verification pg. 2-8

CONNECTORS AND INDICATORS

The HP E1420B front panel has four signal connectors (five if Option 030 High Frequency Channel 3 is installed), seven LED indicators, and one adjustment. Front panel signal connectors are discussed first, followed by a short description of the indicators, adjustment, and on-board switches and jumpers. *Figure 2-1* shows the front panel connectors, indicators, and adjustment.

Front Panel Signal Connectors

The front panel signal connectors are all standard BNC providing up to three Input channels for signal measurement, one Arm Input for measurement synchronization, and a 10-MHz Timebase Input/Output connection for timebase synchronization. A BNC connector replaces a front-panel plug cover when Option 030 High Frequency Channel 3 Input is installed. The basic characteristics of these inputs are explained following a description of input power.

Maximum Input Power

The maximum allowable input voltage for all front panel inputs should not exceed 5 volts rms when $\times 1$ attenuation is active.

CAUTION

Input voltages in excess of 5 volts rms may cause permanent front-end hardware damage when $\times 1$ attenuation is active (default).

INPUT 1 AND 2

Inputs 1 and 2 are the main measurement channels of the counter. They can be used for all specified measurement functions from dc to 200 and 100 MHz respectively. Input impedance is selectable as either 50Ω or $1\text{ M}\Omega$. Input attenuation is selectable as either $\times 1$ or $\times 10$. Input coupling is selectable between ac and dc. The input channels can be used independently or together depending on the measurement functions and needs.

INPUT 3, OPTION 030

Input 3 is the optional high frequency channel and is used for frequency, period, or ratio measurements (see appendix A for specifications). Input impedance is fixed at 50Ω and coupling is ac only.

ARM INPUT

The Arm Input is used to provide a synchronizing signal to the counter that can start and/or stop the measurement process. Input impedance is $1\text{ M}\Omega$ with dc coupling. Input trigger level is programmable between 0V (GND), 1.6 V (TTL), or -1.3 V (ECL). The Arm Input frequency range is dc to 20 MHz.

INT/EXT REFERENCE

The INT/EXT REFERENCE connector can be used to lock the counter's circuits to an external timebase input. Input level is nominally 0.2 volts p-p into a $1.1\text{ k}\Omega$ load.

Send the following SCPI program message commanding the E1420B to select EXT input as its timebase signal through the front panel Int/Ext Reference BNC connector:

```
OUTPUT @E1420B;"SENS:ROSC:SOUR EXT"
```

If you want to program the counter to output its high stability timebase (Option 010) through the front-panel Int/Ext Reference BNC connector, send the following SCPI program message:

```
OUTPUT 70906;"OUTP:ROSC:STATe ON"
```

You can turn OFF this timebase output by sending either the *RST or "OUTP:ROSC:STATe OFF" program messages to the counter.

Warm-up

At power-up, the E1420B uses the VXIbus CLK10 as its timebase reference, hence no warm-up is needed. If the optional TCXO timebase is present and selected, a thirty minute warm-up period is recommended before making any measurement.

Front Panel Indicators And Adjustments

The counter's front panel has seven LED indicators that provide information about normal operation and errors. A single Timebase frequency reference adjustment provides fine-tuning of the optional TCXO timebase oscillator.

The seven LED indicators provide the following:

- **INPUTS:** Three green LEDs, located adjacent to each Input connector, flash to indicate signal arming and triggering. Channels 2 and 3 share the same LED and cannot be used for measurements at the same time.
- **GATE:** A green LED to indicate when the measurement gate is open.
- **ACCESS:** A green LED to indicate data transfer across the counter's VXIbus interface.
- **FAILED:** A red Failed LED to indicate a non-recoverable VXIbus error or failed Self-test.
- **ERROR:** A red Error LED to indicate that an error is present in the counter's error queue.

VXIbus Connectors

Two 96 pin (P1 and P2) connectors serve as the VXIbus electrical interface connection. See *Figure 2-1* for an end-on view of the P1 and P2 edge connectors.

If you need information about pin-out designation and signal functions, refer to page A-3 of the VXIbus Universal Counter Assembly-Level Service manual (P/N E1420-90015) or the VMEbus Specification: Rev. C.1 for P1 connector pin-outs, and the VXIbus Specification: Rev. 1.3 for P2 connector pin-outs.

CAUTION

Do not touch the connector pins. Take care to prevent accidental damage to the connector pins.

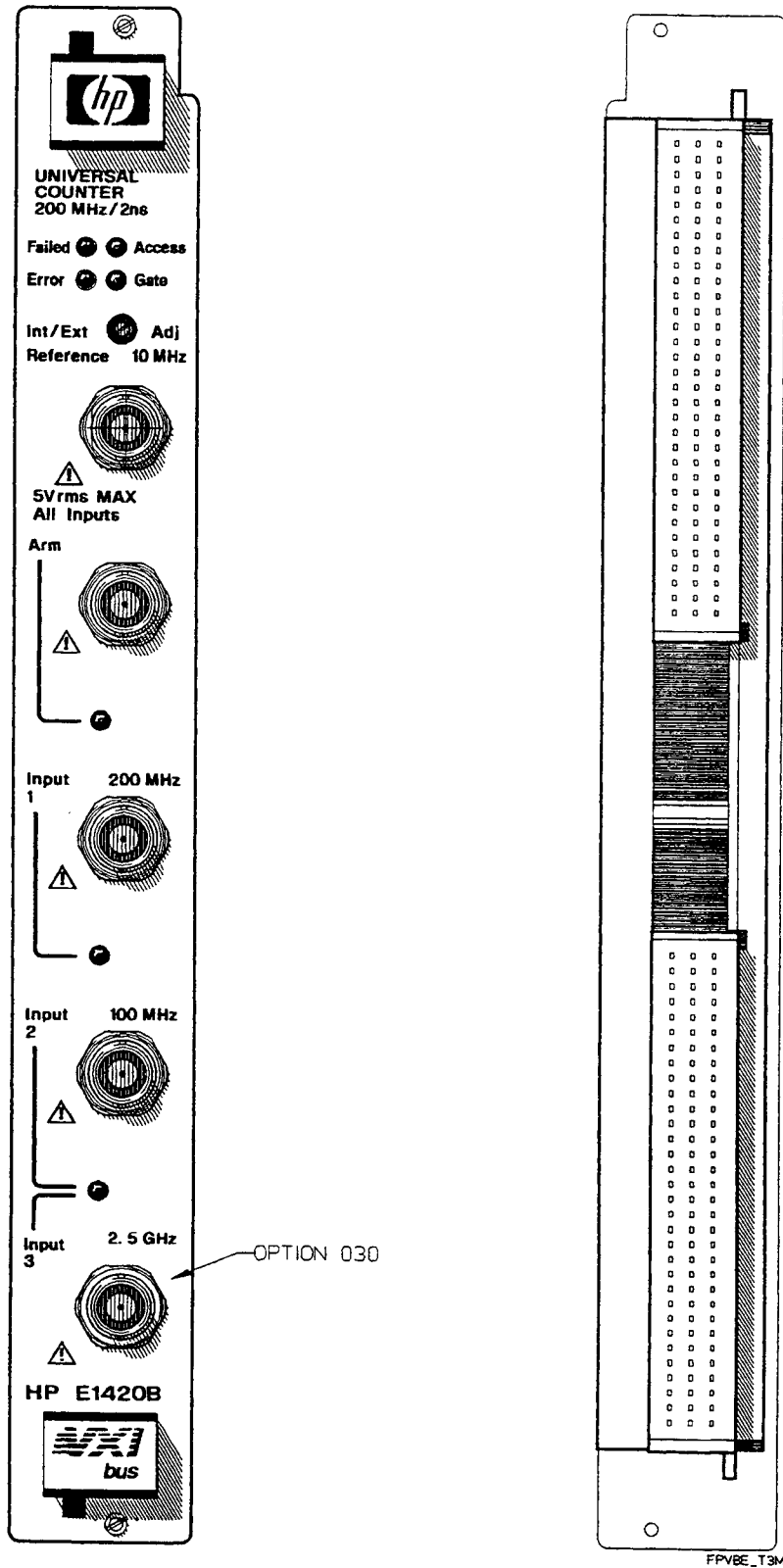

Figure 2-1. Front Panel and VXIbus Edge Connectors

INTERNAL CONFIGURATION

The following paragraphs provide you with the information needed to configure the counter hardware logical address and bus grant/request priority. On-board switch settings and jumpers are explained along with the factory shipped counter addresses and bus grant/request priority level settings.

Logical Address Configuration Procedure

The logical address switch (LADDR) factory setting is 48. (no two VXIbus modules within the same mainframe can have the same address.) You can change the switch setting by following the procedure listed below. Valid address values are from 0 to 240 (selected value must be a multiple of 8). The correct address value must be set before the counter is installed in a VXIbus mainframe.

Defining the Instrument Address

You need to specify a primary and secondary address to define the Universal Counter's HP-IB address. The primary address includes the Interface Select Code (ISC) and the Slot 0 address. The secondary value addresses the counter within the mainframe.

This procedure applies to an external controller with an HP-IB interface card and a Slot 0 command module.

The E1420B can also be programmed across the VXIbus backplane by an embedded PC controller. Consult the documentation supplied with the controller for information on addressing the E1420B.

Primary Address = ISC and Slot 0 address
 (ISC range = 00 through 09)
 (Slot 0 address range = 00 through 30)

Typically, the ISC is set to 7 and the Slot 0 address to 09 for primary address 709. (Valid selections are between 1 and 12.)

Secondary Address = (Logical Address)/8
 (Logical Address is set on the counter card with the logical address switch.)

The counter is shipped from the factory with logical address 48; secondary address 6 (secondary address = $48/8 = 6$). (Valid secondary selections are between 0 and 30.) The instrument address is the primary address and secondary address combined. For the above examples, the instrument address is 70906. This address is listed below as part of a typical program statement to show how the component parts make up the whole address:

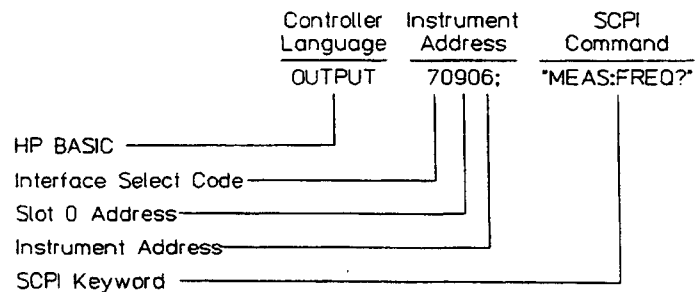

M400.T3M

If you need to set the counter's address, use the following procedure:

1. Locate the logical address 8-pin DIP switch bank located on the right side of the counter module. See *Figure 2-2* for the switch location and address selection.
2. Set the logical address switch for the correct address. Each individual switch is open when depressed to the "0" position and closed when depressed to the "1" position.

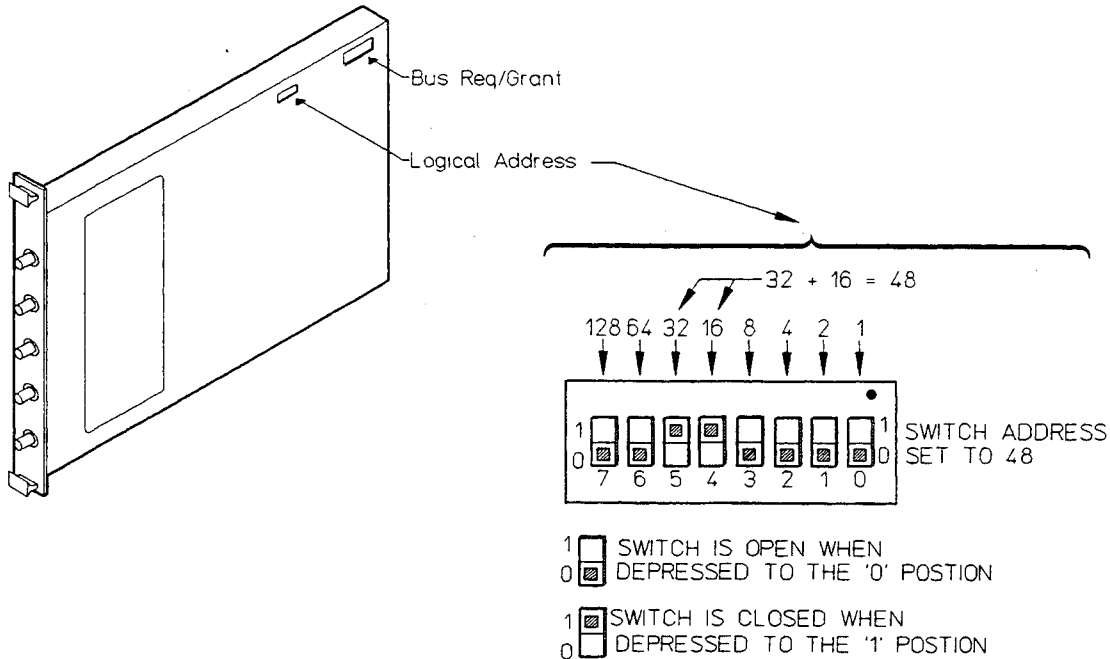

MAS.T3M

Figure 2-2. HP E1420B Address Switch Location and Selection

Bus Grant and Request Configuration Procedure

The HP E1420B message-based communication supports four levels of prioritized bus arbitration (BR0 through BR3). The counter is shipped with the highest bus grant/request level setting: BR 3. The Bus Grant/Request level is configured via six Bus Grant/Request configuration jumpers. The jumpers are correctly configured at the factory. They typically need not be changed unless a particular module within the mainframe requires a different data interface priority than other modules.

If you suspect that these jumpers are incorrectly placed, use the following procedure to check/correct the jumper placement:

1. Locate the bus grant/request jumpers located on the top-right side of the counter module adjacent to the P1 connector. See *Figure 2-3* for the jumper location and level selection.

2. Move the jumpers to the new bus grant/request position. See *Figure 2-3* for the individual jumper priority positions. The top right side of the figure shows the correct factory setting setting (priority level 3). The bottom right side shows how to change the jumpers for priority level 1.

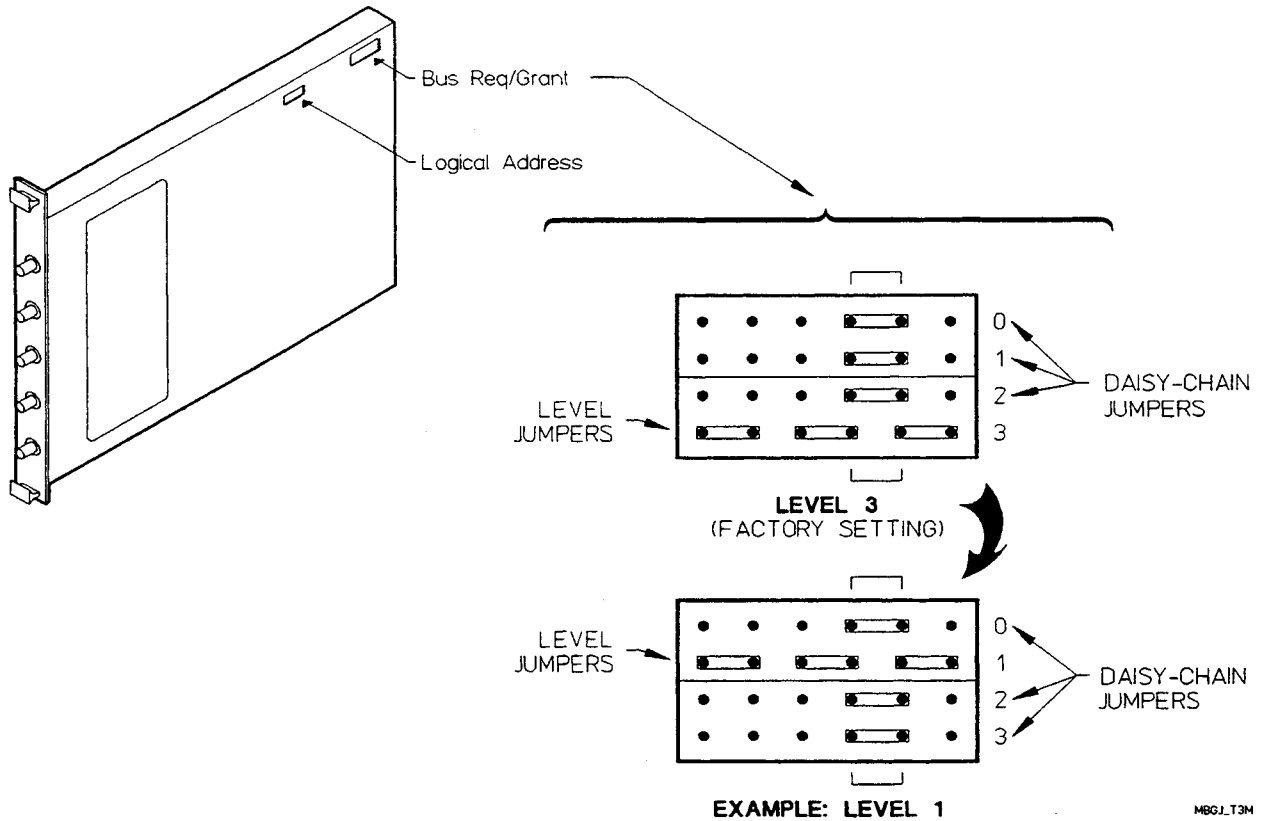

Figure 2-3. Bus Grant Jumper Location and Selection

SYSTEM DEFAULT LOGICAL ADDRESSES

HP VXIbus instruments have a set of logical addresses that correspond to instrument type. These are listed in *Table 2-1*. HP instrument factory switch settings will correspond with those listed in the table. If an application requires more than one of a particular instrument type, then the additional instrument(s) will require different address(es).

Table 2-1. Default HP Logical Addresses For VXIbus

Instrument Type	Switch Setting	Secondary Address
INTERFACES		
Command modules/Computers	00	00
Servant interfaces (RS-232, MS-1553)	08	01
Disk drives	16	02
ANALOG SENSORS		
DMMs	24	03
(Reserved for multiplexers of scanning DMMs)	32	04
Digitizers (A/Ds, Oscilloscopes)	40	05
Counters	48	06
Power Meters	56	07
Others (Spectrum analyzers)	64	08
ANALOG SOURCES		
DC output (D/As, power supplies)	72	09
Arbitrary Waveform Generators	80	10
Function/Pulse Generators	88	11
RF/Signal Generators	96	12
Others	104	13
SWITCHES		
Multiplexers	112	14
Others (Matrix, RF, uWave, Form C, GP, Power)	120	15
Reserved for additional switches	128	16
DIGITAL		
Digital Functional Test	136	17
Digital I/O (general purpose)	144	18
Others (BERT, Bus analyzers, etc.)	152	19
ALTERNATE address for computer/resource manager	160	20
IBASIC	240	30

NOTE

The multiplexers are set up adjacent to the multimeters to allow them to operate as a scanning voltmeter system.

A gap has been left in the assigned addresses so that as many as 11 multiplexers can operate with a single voltmeter without disturbing the default switch settings of the other instruments.

Logical address 32 is available if the multiplexers are to be used independent of the multimeter.

INSTALLATION AND VERIFICATION

The following paragraphs explain how to install the HP E1420B counter into the Series C mainframe, ensure proper ventilation, and verify initial operation.

Cooling Considerations

The HP E1420B counter automatically receives the correct ventilation when used with an HP 75000 Series C mainframe.

The cooling requirements for the HP E1420B counter are:

1.0 Liters/second
0.15mm H₂O

If a different mainframe is used, you must ensure that adequate cooling is provided to the module per VXIbus Specification described under title B.7.3, Mainframe specifications, paragraph B.7.3.5, Mainframe cooling.

Hardware Setup

After you've set the correct logical address (if needed) and bus request/grant level (if necessary), follow the procedure below to install the counter.

1. Ensure that ac power IS NOT applied to the mainframe.
2. Ensure that the metal shields on each side of the counter are securely attached to the counter before inserting the module into the mainframe.
3. Ensure that the bus grant/request switches/jumpers on the backplane are set correctly for the slot you want to use. (If you are using the HP 75000 Series C Mainframe, you may not have to do anything with them.)
4. Carefully slide the counter module into the appropriate slot.
5. Ensure that the module edge connectors align and seat correctly into the backplane slot connectors.
6. Secure the top and bottom module mounting screws with a 1/8" flatblade screw driver.
7. Ensure that proper ventilation is provided to the module as described above.
8. Verify initial operation as described in the next paragraph.

Verifying Operation

Refer to page 1-8 in chapter 1 for the operation verification procedure.

Using The HP E1420B

CHAPTER GUIDE

This chapter provides examples showing how to use the HP E1420B Universal Counter. The examples give you some familiarity with Standardized Commands for Programmable Instruments (SCPI) and with all of the counter measurement functions. Refer to chapter 4 (Understanding the HP E1420B Universal Counter) for more information. This chapter contains the following sections:

Where To Find Important Topics

- Controller Languages pg. 3-2
- Default/Power-On State pg. 3-4
- Frequency Measurement pg. 3-6
- Period Measurement pg. 3-8
- Time Interval Measurement pg. 3-10
- Pulse Width Measurement pg. 3-12
- Ratio Measurement pg. 3-14
- Totalize Measurement pg. 3-16
- Rise/Fall Time Measurement pg. 3-18
- Voltage Measurement pg. 3-20

Chapter Summary

- Programming The HP E1420B pg. 3-2
- Initialization State pg. 3-4
- Measurement Task Tutorials pg. 3-5

PROGRAMMING THE HP E1420B

The primary command language of the HP E1420B is SCPI (Similar to Test and Measurement Systems Language - TMSL). SCPI commands are sent from an instrument controller via word-serial protocol over the VXIbus. Two common ways to send SCPI command strings are: via a VXIbus embedded instrument controller module or by VXIbus to HP-IB modules that connect to external instrument controllers.

Typical external controller examples are the HP 9000 Series 200/300 computer or an IBM[®] AT- compatible PC. Instrument controllers can use a variety of languages to send program messages to a VXIbus module. Two popular examples are HP BASIC and Microsoft[®] QuickBASIC*.

The two BASIC languages are briefly discussed here to point out some differences between them and remind you to reference the language documentation to resolve any data transfer errors that might occur.

Controller Languages

The controller language determines the syntax used to send SCPI commands. *Table 3-1* lists some basic SCPI commands used in this chapter. The language only affects how to send commands (instrument addressing), not the actual SCPI command string. Two popular BASIC programming languages that you can use with the E1420B are:

- HP BASIC used in a HP 9000 Series 200/300 Instrument Controller.
- QuickBASIC used with a GPIB-PC Interface card.

Table 3-1. Selected SCPI Counter Commands Used in Chapter 3

Command	Description
*RST	Sets the hardware and firmware to a known state.
CONF[1 2 3]:<function>	Configures the Counter to the selected measurement function but does not initiate the measurement.
INIT[1 2 3]	Initiates the selected measurement and transfers the reading to counter module memory. Used with CONFIGure or SENSE.
FETC[1 2 3]?	Transfers the most recent measurement on the configured channel from the counter module memory to the output buffer. Used with INIT.
MEAS[1 2 3]:<function?>	Configures the Counter to the selected measurement function, initiates the measurement, and transfers the reading to the output buffer.
SENS[1 2 3]:<function>	Used to change selected measurement default parameters, such as event level, slope, etc.
INP[1 2]:<function>	Used to change the input conditioning default parameters on channels 1 and 2 (e.g. coupling, etc.).
[1 2 3] = channel numbers	

* Microsoft is a U.S. registered trademark of Microsoft Corporation.

Series 200/300 HP BASIC

Use the **OUTPUT** statement to send commands to the counter and the **ENTER** statement to read data from the counter. The destination specified in the **OUTPUT** statement is the instrument HP-IB address. The HP-IB address identifies the different instruments in the mainframe.

This address is a combination of an interface select code, primary address, and secondary address. (The exact placement of these values within the address is explained in chapter 2, "Internal Configuration" under "Defining the Instrument Address".)

Included in the **OUTPUT** statement is the counter's program string. This program string sends the appropriate SCPI commands to the counter such as:

```
OUTPUT 70906; "MEAS1:FREQ?"
```

The portion of the string enclosed in quotes is the SCPI command information. Complete examples of **OUTPUT** and **ENTER** statements can be found in any of the example measurement programs that appear later in this chapter. These examples show how to use the **ASSIGN** statement so you'll only have to enter the HP-IB address once (this makes future address changes easy).

QuickBASIC

Before you use QuickBASIC with the GPIB-PC Interface Card, be sure you have:

- installed the GPIB-PC Interface card,
- installed QuickBASIC
- configured and named the GPIB-PC card for the counter and other instruments in the HP E1400B mainframe,
- created a file containing the QuickBASIC language interface to the GPIB-PC card,
- selected the appropriate primary and secondary GPIB address for all the instruments.
- enabled QuickBASIC to access the GPIB-PC card codes

Use **CALL** statements to program the counter and read data to the controller. The **CALL** statement uses GPIB-PC I/O functions to manage the counter's processes and data transfer. A typical example of a **CALL** statement is:

```
CALL ibwrt(CNTR%, OUT$)
```

This statement sends the SCPI command string located in string variable **OUT\$** to the counter in variable **CNTR%**. The **OUT\$** and **CNTR%** variables must be defined according to QuickBASIC® convention before executing the statement.

INITIALIZATION STATE

The HP E1420B Initialization State is the configuration that the counter acquires on power-up or at Reset. *Table 3-2* summarizes this initialization state. The default expected value and resolution for the CONFigure and MEASure subsystems is the same as for the SENSE subsystem. The power on states are the same for both channels unless specified otherwise.

Table 3-2. HP E1420B Initialization State

Subsystem	Command/Parameter	State
INPut	ATTenuation COUPling IMPedance ROUte	× 1 DC 50Ω SEParate
ARM	EXTernal:LEVel START:SLOPe START:SOURce STOP:SLOPe STOP:SOURce	1.6 V (TTL) POSitive IMMediate POSitive IMMediate
SENSe	APERture AVERage:STATe Auto Trigger State DELay:STATe DELay:TIMe EVENT:LEVel (trigger level) EVENT:SLOPe FUNction EVENT:HYSTeresis Input Channel CH1 Prescaling RANGE:AUTO RELative (trigger level) ROSCillator:SOURce TOTalize:GATE:POLarity TOTalize:GATE:STATe	100 ms OFF OFF OFF 100 ms 0 volts POSitive FREQuency DEF 1 OFF OFF 50% CLK10 NORMAL OFF
OUTPut	ROSCillator:STATe TTLTrg<n>:STATe	OFF OFF

Changing Default Parameters

You can change the initialization state defaults by using the SCPI MEASure, CONFigure, and SENSE keyword commands. Refer to chapter 4, section “Making Measurements With MEASure, CONFigure, and SENSE” and chapter 5, “Dictionary Command Reference” for details of how to use these commands along with minimum and maximum parameter values.

MEASUREMENT TASK TUTORIALS

This section gives examples of each measurement function the counter can perform. Input signal conditioning for each example is itemized. All example programs use an HP Series 200/300 computer with HP BASIC. The program code appears on the left of the page with comments on the right.

The address for the counter uses an HP-IB select code of 7, mainframe address of 09, and secondary address of 06 (counter logical address is 48 as shipped from the factory).

Maximum Input Power

The maximum allowable input voltage for all front panel inputs should not exceed five volts rms when $\times 1$ attenuator is active.

CAUTION

Input voltages in excess of 5 volts rms may cause permanent front-end hardware damage when $\times 1$ attenuator is active (default).

The remaining pages provide lessons for these E1420B measurement functions:

- Frequency
- Period
- Time Interval
- Pulse Width
- Ratio
- Totalize
- Rise/Fall Time
- Voltage

Each measurement tutorial is presented on two facing pages for your convenience. More detailed programming and command information can be found in chapters 4 and 5 respectively.

Frequency Measurement

The following is a summary of the FREQuency function:

- Frequency can be measured on channels 1, 2, or 3 (optional). Channels 2 and 3 share the same LED and cannot be used for measurements at the same time. Signal connections to the other channels can be present.
- Measurement range is dc to 200/100 MHz for channels 1/2 respectively and as specified in Appendix A on optional channel 3.
- See chapter 5, STATus subsystem, for information on overflow indication.

EXAMPLE: MAKING A FREQUENCY MEASUREMENT

This example uses the counter to measure two different signal sources and exercises the frequency measurement capability of Input channels 1 and 2.

NOTE

Before making any signal connections, you should enter the example program to ensure that it is syntactically correct (error free) on your instrument controller.

- The channel 2 input is a 28-MHz sine wave.
- The channel 1 input is a 50-kHz sine wave.
- The signals to channels 1 and 2 are expected to have an amplitude of ± 1.5 V.

INPUT SIGNAL CONDITIONING

The input signal conditioning for this measurement example is as follows:

- **Event Level:** The default event level (input trigger level) of 0V can be used since all input signals are symmetrical about 0V.
- **Event Slope:** Changing event slope (input trigger slope) has no effect on frequency measurements.
- **Attenuation:** Default ($\times 1$) attenuation is used.
- **Coupling:** Dc coupling is used.
- **Impedance:** Input impedance is set to 50 Ω .

**FREQUENCY
MEASUREMENT PROGRAM
EXAMPLE**

PROGRAM:	COMMENTS:
10 ASSIGN @E1420B TO 70906	— Assigns @E1420B to address 70906.
20 OUTPUT @E1420B;"*RST"	— Resets the counter to its default state.
30 OUTPUT @E1420B;"INP1:IMP 50;COUP DC"	— Sets channel 1 input impedance to 50Ω and coupling to dc.
40 OUTPUT @E1420B;"INP2:IMP 50;COUP DC"	— Sets channel 2 input impedance to 50Ω and coupling to dc.
50 OUTPUT @E1420B;"MEAS1:FREQ?"	— Configures channel 1 for frequency measurement, performs the measurement, and transfers results to the output buffer.
60 ENTER @E1420B;FREQ1	— Transfers channel 1 measurement from output buffer to the input buffer of controller.
70 PRINT FREQ1	— Displays measurement on the controller.
80 OUTPUT @E1420B;"MEAS2:FREQ?"	— Configures channel 2 for frequency measurement, performs the measurement, and transfers results to output buffer.
90 ENTER @E1420B;FREQ2	— Transfers the channel 2 measurement from the output buffer to the input buffer of the controller.
100 PRINT FREQ2	— Displays measurement on the controller.
110 END	— Terminates program.

COMMENTS **Measurement Time:** Dependent on both the signal input frequency and the resolution specified. See chapter 4 for more information.

Related SCPI Commands: ABORt, CONFIgure, FETCh?, INITiate, READ?, and SENSE. See chapter 5 for more details.

Period Measurement

The following summarizes the PERiod function:

- Average Period can be measured on channel 1, 2, or 3.
- Measurement range is 5 nsec to 1000 sec for CH1 and 10 nsec to 1000 sec for CH2.
- See chapter 5, STATus subsystem, for information on overflow indication.

EXAMPLE: MAKING A PERIOD MEASUREMENT

This example uses the counter to measure the period of an input signal. The input trigger levels may be set anywhere between ± 10 volts in 2.5 mv increments.

NOTE

Before making any signal connections, you should enter the example program to ensure that it is syntactically correct (error free) on your instrument controller.

- Input to channel 1 is expected to be a 10-MHz TTL compatible clock pulse.

INPUT SIGNAL CONDITIONING

The input signal conditioning for this measurement example is as follows:

Event Level: Event level (input trigger level) is set to +1.2V.

Event Slope: Not used here.

Attenuation: Default ($\times 1$) attenuation is used.

Coupling: The default dc coupling is used.

Impedance: Input impedance is 1 M Ω .

PERIOD MEASUREMENT
PROGRAM EXAMPLE

PROGRAM:	COMMENTS:
10 ASSIGN @E1420B TO 70906	— Assigns @E1420B to address 70906.
20 OUTPUT @E1420B;"*RST"	— Resets the counter to its default state.
30 OUTPUT @E1420B;"INP1:COUP DC;IMP 1E6"	— Sets CH 1 input coupling to dc and input impedance to 1 M Ω .
40 OUTPUT @E1420B;"SENS1:EVEN:LEV 1.2V"	— Sets the event (trigger level) level for channel 1 to +1.2V. (The "V" suffix in "EVEN:LEV 1.2V" is optional)
50 OUTPUT @E1420B;"MEAS1:PER? 1E-7,1E-9"	— Configures channel 1 for period measurement, sets the expected period to 0.1 μ sec at a resolution of 1 ns, performs the actual measurement, then transfers the measurement results to the output buffer.
60 ENTER @E1420B;PER1	— Transfers the channel 1 measurement from the output buffer to the input buffer of the instrument controller.
70 PRINT PER1	— Displays measurement on the instrument controller.
80 END	— Terminates program.

COMMENTS

Measurement Time: Time needed to complete the measurement is dependent on both the signal input frequency and the resolution specified, and could take a maximum of 1000 seconds to complete. See chapter 4 (Understanding the HP E1420B Universal Counter) for additional information.

Related SCPI Commands: Commands associated with period measurements but not discussed in this example are: ABORt, CONFigure, FETCh?, INITiate, READ?, and SENSE.

Time Interval Measurement

The following is a summary of the TINTerval function:

- Time interval between any two events can be measured from channel 1 to 2.
- Time intervals can be selected to start and/or stop on rising or falling edge.
- Measurement range is 1 nsec to 1000 seconds.
- Maximum selectable resolution is 100 ps. If the requested resolution is less than 1 ns, 100 Gate Averaging is turned ON.
- See Chapter 5, STATus subsystem, for more information on overflow indication.

EXAMPLE: MAKING A TIME INTERVAL MEASUREMENT

This example uses the counter to measure the time interval between the edges of two pulses.

NOTE

Before making any signal connections, you should enter the example program to ensure that it is syntactically correct (error free) on your instrument controller.

- The example requires you to input the 10 MHz, TTL-compatible signal into both channels 1 and 2.

INPUT SIGNAL CONDITIONING

The input signal conditioning for this measurement example is as follows:

Event Level: Event level (input trigger level) is set to +1.2 V.

Event Slope: Event slope is set to NEGative for channel 1 (measurement starts from falling edge of signal input to channel 1). Channel 2 event slope is set to POSitive (measurement ends on the rising edge of the signal input to channel 2).

Attenuation: Default($\times 1$) attenuation is used.

Coupling: Dc coupling is used.

Impedance: Input impedance is set to 1 M Ω .

**TIME INTERVAL
MEASUREMENT PROGRAM
EXAMPLE**

PROGRAM:	COMMENTS:
10 ASSIGN @E1420B TO 70906	— Assigns the counter to address 70906.
20 OUTPUT @E1420B;"*RST"	— Resets counter to its default state.
30 OUTPUT @E1420B;"SENS1:EVEN:SLOP NEG"	— Selects channel 1 event slope to negative edge.
40 OUTPUT @E1420B;"SENS2:EVEN:SLOP POS"	— Selects channel 2 event slope to positive edge.
50 OUTPUT @E1420B;"SENS1:EVEN :LEV 1.2"	— Sets channel 1 event level to +1.2 V.
60 OUTPUT @E1420B;"SENS2:EVEN:LEV 1.2"	— Sets channel 2 event level to +1.2 V.
70 OUTPUT @E1420B;"INP2:COUP DC;IMP 1E6"	— Sets coupling to dc and input impedance for channel 2 to 1 MΩ.
80 OUTPUT @E1420B;"INP1:COUP DC;IMP 1E6"	— Sets coupling to dc and input impedance for channel 1 to 1 MΩ.
90 OUTPUT @E1420B;"MEAS1:TINT?"	— Configures channel 1 and 2 for time interval measurement (CH 1 as the start event), performs the actual measurement, then transfers the measurement results to the output buffer.
100 ENTER @E1420B;TINT1	— Transfers the measurement from the output buffer to the input buffer of the instrument controller.
110 PRINT TINT1	— Displays measurement on the instrument controller.
120 END	— Terminates program.

NOTE

The MEASure command in the above example does not specify a resolution. Therefore, the 1 nsec default resolution is used which requires only one measurement. When a resolution less than 1 nsec is requested, then 100-Gate Average mode is automatically turned ON. Refer to chapter 4, Measurement Resolution section.

COMMENTS

Measurement Time: Time Interval measurement continues until the second edge is detected.

Related SCPI Commands: Commands associated with time interval measurements but not discussed in this example are: ABORt, CONFIgure, FETCh?, INITiate, READ?, and SENSE.

Pulse Width Measurement

The following summarizes the pulse width function:

- Pulse width can be measured on channel 1 or 2.
- Positive and negative pulse widths can be measured. Positive pulse width is measured from rising to falling edge, and negative pulse width is measured from falling to rising edge.
- Default event level is halfway (50%) between +Ve (maximum) and -Ve (minimum) peaks of the signal. (See EVENT:LEVEL:RELATIVE in chapter 5 for more details.)
- Measurement range is 5 nsec to 1 msec.
- Maximum selectable resolution is 100 psec, which automatically turns 100 Gate Averaging ON.
- See chapter 5, STATus subsystem, for information on overflow indication.

EXAMPLE: MAKING A PULSE WIDTH MEASUREMENT

This example can use either channel of the counter to measure pulse width.

NOTE

Before making any signal connections, you should enter the example program to ensure that it is syntactically correct (error free) on your instrument controller.

- To accurately measure pulse width, the counter automatically sets the trigger level mid-way (50% in default value) between +Ve and -Ve peaks of the input signal.
- This example measures a negative-going pulse; we'll use the SCPI "NWID?" command for actual pulse measurement.
- The input signal should be 2 volts peak-to-peak at 100 kHz.

INPUT SIGNAL CONDITIONING

The input signal conditioning for this measurement example is as follows:

Event Level: Event level is automatically determined by the counter.

Event Slope: Automatically defined by the pulse width function.

Attenuation: Default ($\times 1$) attenuation is used.

Coupling: Dc coupling is used.

Impedance: Input impedance is programmed to 1 M Ω .

**PULSE WIDTH
MEASUREMENT PROGRAM
EXAMPLE**

PROGRAM:	COMMENTS:
10 ASSIGN @E1420B TO 70906	— Assigns @E1420B to address 70906.
20 OUTPUT @E1420B;"*RST"	— Resets the counter to its default state.
30 OUTPUT @E1420B;"INP1:COUP DC;IMP MAX"	— Sets input channel 1 impedance to 1M Ω and coupling to dc.
40 OUTPUT @E1420B;"MEAS1:NWID?"	— Configures channel 1 for negative pulse width measurement and automatically determines the event (trigger) level. Performs the actual measurement, then transfers the measurement results to the output buffer.
50 ENTER @E1420B; NWID1	— Transfers the channel 1 measurement from the output buffer to the input buffer of the instrument controller.
60 PRINT NWID1	— Displays measurement on the instrument controller.
70 END	— Terminates program.

NOTE

The MEASure command in the above example does not specify a resolution. Therefore, the 1 nsec default resolution is used which requires only one measurement. When a resolution less than 1 nsec is requested, then 100 Gate Average mode is automatically turned ON. Refer to Chapter 4, Measurement Resolution section.

COMMENTS

Measurement Time: Positive and Negative pulse width measurements will continue until the second edge is detected.

Related SCPI Commands: Commands associated with pulse width measurements but not discussed in this example are: ABORT, CONFIGure, INITiate, SENSE, FETCh?, and READ?.

Ratio Measurement

The following summarizes the ratio function:

- Ratio is measured on channel 1 in relation to channel 2, or on channel 2 in relation to channel 1, or on channel 3 in relation to channel 1. The channel specified in the command is the numerator of the ratio, for example MEAS1:RAT results in the ratio of frequencies of channel 1 to channel 2 (CH1/CH2).
- Minimum ratio value is 10^{-11} ; maximum ratio value is 10^{11} .
- The gate time over which the ratio is counted may be specified.

EXAMPLE: MAKING A RATIO MEASUREMENT

This example uses the counter to measure the ratio of two different frequencies.

NOTE

Before making any signal connections, you should enter the example program to ensure that it is syntactically correct (error free) on your instrument controller.

- The program shown measures the frequency ratio of TTL signals.
- The resulting measurement could assess the input/output pulse ratio of a TTL-compatible divider or multiplier. (The higher input frequency is typically connected to the channel in the numerator.)
- The input multiplier/divider signal (10 MHz) is routed to channel 1 with the output signal (5 MHz) routed to channel 2.

Input Signal Conditioning

The input signal conditioning for this measurement example is as follows:

Event Level: Since the two signals are TTL, the event level is set to +1.2V.

Event slope: Event slope does not affect ratio measurements.

Attenuation: Default ($\times 1$) attenuation is used.

Coupling: Dc coupling is used because of a TTL level.

Impedance: Input impedance is set to 1 M Ω .

**RATIO MEASUREMENT
PROGRAM EXAMPLE**

PROGRAM:	COMMENTS:
10 ASSIGN @E1420B TO 70906	— Assigns @E1420B to address 70906.
20 OUTPUT @E1420B;"*RST"	— Resets the counter to its default state.
30 OUTPUT @E1420B;"INP2:COUP DC;IMP 1E6"	— Sets channel 2 input coupling to dc and input impedance to 1 MΩ.
40 OUTPUT @E1420B;"INP1:COUP DC;IMP 1E6"	— Sets channel 1 input coupling to dc and input impedance to 1 MΩ.
50 OUTPUT @E1420B;"SENS1:EVEN:LEV 1.2"	— Sets channel 1 event level to +1.2 V.
60 OUTPUT @E1420B;"SENS2:EVEN:LEV 1.2"	— Sets channel 2 event level to +1.2 V.
70 OUTPUT @E1420B;"MEAS1:FREQ:RAT?"	— Configures channel 1 and 2 for ratio measurement with CH 1 as numerator, performs the actual measurement, then transfers the measurement results to the output buffer.
	You can obtain the inverse ratio of the measurement obtained in the example above (channel two as the numerator) by changing the MEAS command to MEAS2:FREQ:RAT?.
80 ENTER @E1420B;RAT1	— Transfers the ratio measurement from the output buffer to the input buffer of the instrument controller.
90 PRINT RAT1	— Displays measurement on the instrument controller.
100 END	— Terminates program.

COMMENTS **Measurement Time:** Time needed to complete the measurement is dependent on both the signal input frequency and the resolution specified. See Chapter 4 (Understanding the HP E1420B Universal Counter) for additional information.

Related SCPI Commands: Commands associated with ratio measurements but not discussed in this example are: ABORT, CONFIGure, FETCh?, INITiate, READ?, and SENSE.

Totalize Measurement

The following is a summary of the TOTAlize function:

- Will totalize events on channel 1 or 2. Measurement range is 0 to $10^{12} - 1$ events, with a maximum input frequency of 100 MHz.
- Reading the ongoing count does not stop the totalize function or reset the counter allowing for measurement on-the-fly.

EXAMPLE: MAKING A TOTALIZE MEASUREMENT

In this example, the counter measures a running total of events input via Input channel 1.

- The program shown measures the cumulative events of TTL signals. A FETCh? query returns the most recent measurement result to the instrument controller.
- In the example, this measurement is forced to ABORt. The measurement will also complete when a new function is programmed. For other ways of terminating TOTAlize, refer to chapter 4.

NOTE

Before making any signal connections, you should enter the example program to ensure that it is syntactically correct (error free) on your instrument controller.

INPUT SIGNAL CONDITIONING

The input signal conditioning for this measurement example is as follows:

Event Level: Input levels are TTL. Event level is set to +1.2V so the input signal will transition through the event level and trigger a count.

Event Slope: Changing event slope has no effect on totalize measurements.

Attenuation: Default ($\times 1$) attenuation is used.

Coupling: Dc coupling is used.

Impedance: 1 M Ω input impedance is used.

**TOTALIZE MEASUREMENT
PROGRAM EXAMPLE**

PROGRAM:	COMMENTS:
10 ASSIGN @E1420B TO 70906	— Assigns @E1420B to address 70906.
20 OUTPUT @E1420B;"*RST"	— Resets the counter to its default state.
30 OUTPUT @E1420B;"SENS1:EVEN:LEV 1.2"	— Sets event level for channel 1 to +1.2V.
40 OUTPUT @E1420B;"INP1:COUP DC;IMP 1E6"	— Enables dc coupling for channel 1 and sets impedance to 1 MΩ.
50 OUTPUT @E1420B;"CONF1:TOT"	— Configures channel 1 for totalize measurement.
60 OUTPUT @E1420B;"INIT1"	— Starts channel 1 counting.
70 FOR I=1 TO 100	— Define count: take 100 measurements.
80 OUTPUT @E1420B;"FETC1?"	— Transfers channel 1 count to the output buffer. Counting continues after transfer.
90 ENTER @E1420B;TOT1	— Transfers the measurement from the output buffer to the input buffer of the computer.
100 PRINT I,"CH-1 COUNT = ",TOT1," "	— Displays count on the instrument controller.
110 NEXT I	— Loop back to 70.
120 OUTPUT @E1420B;"ABORt"	— ABORt the measurement. The final value is lost. (See chapter 4 for measurement Start/Stop details.)
130 END	— Terminates program.

COMMENTS **Related SCPI Commands:** Commands associated with the totalize function but not discussed in this example are: ABORt, INPut, SENSE, ARM.

Totalize Programming Example

The following programming example shows typical command sequences for configuring totalize measurements.

```
10      ! *****
20      ! Program Example: Totalize Measurement
30      !
40      ! This program illustrates several techniques for totalizing
50      ! events with the E1420B Universal Counter. Configuration of
60      ! Totalize 1, Totalize 1 by 2, and Totalize 2 by 1 is highlighted.
70      !
80      ! It is presumed that signals of proper frequency and amplitude
90      ! are connected to the counter's Input 1, Input 2 and Arm
100     ! channels.
110     !
120     ! This program was written in HP BASIC for an HP Series 9000
130     ! computer.
140     ! *****
150     !
160     DIM Result$(21)           ! Declare string to hold meas. result
170     !
180     ! Determine the interface address of the E1420B with the HP E1405B
190     ! Command Module; these statements must be customized for other
200     ! environments
210     Select_code=7           ! HP-IB interface at Select Code 7
220     Cmd_addr=9             ! VXI Command Module at address 9
230     E1420_addr=4          ! E1420B at secondary address = 32/8
240     ASSIGN @E1420b TO (Select_code*10000)+(Cmd_addr*100)+E1420_addr
250     ! Define the I/O path via E1405B
260     !
270     ! Reset and initialize the counter
280     CLEAR @E1420b          ! Clear the output buffer
290     OUTPUT @E1420b;"*RST"  ! Select the default configuration
300     OUTPUT @E1420b;"*CLS"  ! Clear event registers, Error Queue
310     !
320     ! Totalize 1 Measurement: Manual Gating
330     ! -----
340     ! Totalize 1 counts the number of events of the Channel 1 signal.
350     ! In the following program segment, the measurement is initiated,
360     ! and the gate is opened and closed under program control.
370     ! The intermediate count is read 10 times while the gate is
380     ! open, and the final count is read after the gate has closed.
390     !
400     OUTPUT @E1420b;":CONF:TOT" ! Configure a Totalize 1 measurement
410     OUTPUT @E1420b;":SENS:EVEN:SLOP POS" ! Count positive Ch 1 edges
420     OUTPUT @E1420b;":ARM:STAR:SOUR HOLD" ! Open the gate manually
430     OUTPUT @E1420b;":ARM:STOP:SOUR HOLD" ! Close the gate manually
440     !
450     OUTPUT @E1420b;":INIT"      ! Initiate the measurement
460     OUTPUT @E1420b;":ARM:STAR:IMM" ! Open the gate to start counting
470     !
480     FOR Samples=1 TO 10
490         OUTPUT @E1420b;":FETC?" ! Query the intermediate result
500         ENTER @E1420b;Result$ ! Read it
510         PRINT "Totalize 1: ";Result$;" counts";" [intermediate count]"
520     NEXT Samples                ! Repeat 10 times
530     !
540     OUTPUT @E1420b;":ARM:STOP:IMM" ! Close the gate to stop counting
550     !
560     OUTPUT @E1420b;":FETC?"      ! Query the result (final count)
570     ENTER @E1420b;Result$        ! Read the result
580     PRINT "Totalize 1: ";Result$;" counts";" [final count]"
```

Totalize Programming Example (Continued)

```
590 !
600 ! Totalize 1 Measurement: External Gating
610 ! -----
620 ! By enabling external arming, the number of events that occur
630 ! between selected edges of the Arm input signal can be counted.
640 ! This example performs a "gated" measurement, selecting
650 ! opposite edges for starting and stopping the measurement.
660 ! Since the :FETCh? query returns the current count, the intent
670 ! of the WAIT statement is to provide sufficient delay for the
680 ! measurement to complete. This ensures that the final count
690 ! is retrieved. In an actual application, *WAI, *OPC or *OPC?
700 ! should be used to perform that function.
710 !
720 OUTPUT @E1420b;":CONF:TOT" ! Configure a Totalize 1 measurement
730 OUTPUT @E1420b;":SENS:EVEN:SLOP POS" ! Count positive Ch 1 edges
740 OUTPUT @E1420b;":ARM:STAR:SOUR EXT;SLOP POS" ! Start on positive
750 ! edge of Arm signal
760 OUTPUT @E1420b;":ARM:STOP:SOUR EXT;SLOP NEG" ! Stop on negative
770 ! edge of Arm signal
780 !
790 OUTPUT @E1420b;":INIT" ! Initiate the measurement
800 WAIT 1 ! Allow sufficient time for start and
810 ! stop arm signals to be detected
820 OUTPUT @E1420b;":FETC?" ! Query the result
830 ENTER @E1420b;Result$ ! Read the result
840 PRINT "Totalize 1: ";Result$;" counts";" [External Gating]"
850 !
860 ! Totalize 1 by 2 Measurement
870 ! -----
880 ! Totalize 1 by 2 counts the number of events of the Channel 1
890 ! signal during a pulse of the Channel 2 signal. This example
900 ! focuses on the configuration of this measurement for both
910 ! polarities of the Channel 2 gating pulse. Note that the
920 ! channel suffix for the gate polarity command must correspond
930 ! to the channel to be counted; in this case, "1."
940 !
950 OUTPUT @E1420b;":CONF:TOT" ! Configure a Totalize 1 measurement
960 OUTPUT @E1420b;":SENS:EVEN:SLOP POS" ! Count positive Ch 1 edges
970 OUTPUT @E1420b;":SENS:TOT:GATE:STAT ON" ! Count during a positive
980 OUTPUT @E1420b;":SENS1:TOT:GATE:POL NORM"! pulse of Ch 2
990 OUTPUT @E1420b;":ARM:STAR:SOUR IMM" ! Do not inhibit the Ch 2
1000 OUTPUT @E1420b;":ARM:STOP:SOUR IMM" ! gating signal with arming
1010 !
1020 OUTPUT @E1420b;":INIT" ! Initiate the measurement
1030 OUTPUT @E1420b;":FETC?" ! Query the result (final count)
1040 ENTER @E1420b;Result$ ! Read the result
1050 PRINT "Totalize 1 by 2[+]: ";Result$;" counts"
1060 !
1070 ! Measure during the negative polarity of Channel 2
1080 OUTPUT @E1420b;":SENS1:TOT:GATE:POL INV" ! Count during a negative
1090 ! pulse of Ch 2
1100 OUTPUT @E1420b;":INIT" ! Initiate the measurement
1110 OUTPUT @E1420b;":FETC?" ! Query the result (final count)
1120 ENTER @E1420b;Result$ ! Read the result
1130 PRINT "Totalize 1 by 2[-]: ";Result$;" counts"
```

Totalize Programming Example (Continued)

```
1140 !
1150 ! Totalize 2 by 1 Measurement
1160 ! -----
1170 ! Totalize 2 by 1 counts the number of events of the Channel 2
1180 ! signal during a pulse of the Channel 1 signal. This example
1190 ! focuses on the configuration of this measurement. Note that
1200 ! the :SENSe2:FUNCTION 'TOTALize' command (not :CONFIGure) must
1210 ! be used to select this measurement function.
1220 !
1230 OUTPUT @E1420b;":SENS2:FUNC 'TOT'" ! Configure a Totalize 2 meas.
1240 OUTPUT @E1420b;":SENS2:EVEN:SLOP POS" ! Count positive Ch 2 edges
1250 OUTPUT @E1420b;":SENS:TOT:GATE:STAT ON" ! Count during a positive
1260 OUTPUT @E1420b;":SENS2:TOT:GATE:POL NORM"! pulse of Ch 1
1270 OUTPUT @E1420b;":ARM:STAR:SOUR IMM" ! Do not inhibit the Ch 1
1280 OUTPUT @E1420b;":ARM:STOP:SOUR IMM" ! gating signal with arming
1290 !
1300 OUTPUT @E1420b;":INIT2" ! Initiate the measurement
1310 OUTPUT @E1420b;":FETC2?" ! Query the result (final count)
1320 ENTER @E1420b;Result$ ! Read the result
1330 PRINT "Totalize 2 by 1[+]: ";Result$;" counts"
1340 !
1350 END ! Done
```

Rise/Fall Time Measurement

The following summarizes the RTIME (or FTIME) function:

- Rise/Fall Time can be measured via channel 1 only.
- Channel 2 cannot be used when channel 1 is measuring rise/fall time because the counter channels are routed in COMMON mode. You have input signals connected to all inputs.
- All settings for channel 1 become active for channel 2.
- Measurement range is 15 nsec to 1 ms.
- See chapter 5, STATus subsystem, for information on overflow indication.

EXAMPLE: MAKING A TIME MEASUREMENT

This uses the counter to measure the rise time of an input signal.

NOTE

Before making any signal connections, you should enter the example program to ensure that it is syntactically correct (error free) on your instrument controller.

- The input to channel 1 is expected to be a 1 MHz sinusoidal signal.

INPUT SIGNAL CONDITIONING

The input signal conditioning for this measurement example is as follows:

Event Level: Using the MEAS command causes the counter to turn auto triggering ON. Channel 1 event level is programmed at 10% (90%) and channel 2 event level is programmed at 90% (10%) for risetime (falltime).

Event Slope: Event slope is set to positive by default (for both channels).

Attenuation: Default ($\times 1$) attenuation is used.

Coupling: Ac coupling is used.

Impedance: Input impedance is 50 Ω .

**RISE TIME MEASUREMENT
PROGRAM EXAMPLE**

PROGRAM:	COMMENTS:
10 ASSIGN @E1420B TO 70906	— Assigns @E1420B to address 70906.
20 OUTPUT @E1420B;"*RST"	— Resets the counter to its default state.
30 OUTPUT @E1420B;"INP1:COUP AC;IMP 50"	— Sets ch 1 input coupling to ac and input impedance to 50Ω.
40 OUTPUT @E1420B;"MEAS1:RTIM? DEF, DEF, 1E-6,1E-9"	— Configures channel 1 for rise time measurement, selects default values for trigger levels (10%, 90%), and sets the expected risetime with a resolution of 1E-9 seconds. Performs the actual measurement, then transfers the measurement results to the output buffer.
50 ENTER @E1420B;RTIM1	— Transfers the channel 1 measurement from the output buffer to the input buffer of the instrument controller.
60 PRINT RTIM1	— Displays measurement on the instrument controller.
70 END	— Terminates program.

COMMENTS **Measurement Time:** Time needed to complete the measurement is dependent on both the signal input rise/fall time and the resolution specified. See chapter 4, Understanding the HP E1420B Universal Counter for additional information.

Related SCPI Commands: Commands associated with rise/fall time measurements but not discussed in this example are: ABORt, CONFIgure, FETCh?, INITiate, READ?, SENSE, and ARM. The command :FALL:TIME is identical in function to FTIME and the command :RISE:TIME is identical in function to RTIME.

Voltage Measurement

The following summarizes the voltage measurement functions:

- Ac — If the input signal is sinusoidal, then the AC command measures the rms value of the input signal.
- Dc — Measures the offset voltage present on the input signal.
- Min/Max —The MINimum command reports/measures the -Ve peak of the input signal, and the MAXimum command reports/measures the +Ve peak of the input signal.
- Voltage measurements are made on channel 1 or 2.
- Minimum and Maximum voltage measurements are made with Auto triggering ON (cannot be disabled).

EXAMPLE: MAKING A VOLTAGE MEASUREMENT

This example uses the counter to measure all voltage parameters of the input signal.

NOTE

Before making any signal connections, you should enter the example program to ensure that it is syntactically correct (error free) on your instrument controller.

- The input signal to channel 1 is expected to be ± 0.5 volts (1 Vp-p).

INPUT SIGNAL CONDITIONING

Event Level: Automatically configured to Autotrigger ON

Event Slope: Not used

Attenuation: Default ($\times 1$) attenuation is used.

Coupling: Dc (default)

Impedance: 50Ω

**VOLTAGE MEASUREMENT
PROGRAM EXAMPLE**

PROGRAM:	COMMENTS:
10 ASSIGN @E1420B TO 70906	— Assigns E1420B to address 70906.
20 OUTPUT @E1420B;**RST"	— Resets the counter to its default state.
30 OUTPUT @E1420B;"MEAS:MIN?"	— Reports the -Ve peak of the input ac signal with "implied" channel 1.
40 ENTER @E1420B;V1	— Transfers the channel 1 MINimum voltage measurement from the output buffer to the input buffer of the instrument controller.
50 PRINT V1	— Displays the MINimum measurement on the instrument controller.
60 OUTPUT @E1420B;"MEAS1:MAX?"	— Reports the +Ve peak of the input ac signal.
70 ENTER @E1420B;V2	— Transfers the channel 1 MAXimum voltage measurement from the output buffer to the input buffer of the instrument controller.
80 PRINT V2	— Displays the MAXimum measurement on the instrument controller.
90 OUTPUT @E1420B;"MEAS1:AC?"	— Reports the ac rms voltage of the input signal.
100 ENTER @E1420B;V3	— Transfers the channel 1 AC voltage measurement from the output buffer to the input buffer of the instrument controller.
110 PRINT V3	— Displays the AC voltage measurement on the instrument controller.
120 OUTPUT @E1420B;"MEAS1:DC?"	— Reports the dc offset voltage present with the input signal.
130 ENTER @E1420B;V4	— Transfers the channel 1 DC voltage measurement from the output buffer to the input buffer of the instrument controller.
140 PRINT V4	— Displays the DC voltage measurement on the instrument controller.
150 END	— Terminates program.

COMMENTS Related SCPI Commands: Commands associated with all voltage measurement functions but not discussed in this example are ABORt, SENSE, ARM, CONFigure, READ?, INITiate, and FETCh?

Understanding the HP E1420B Universal Counter

CHAPTER GUIDE This chapter provides a comprehensive description of the operating characteristics of the HP E1420B Universal Counter. All measurement functions are explored with detailed procedures that include SCPI message examples and results interpretation. In addition, input triggering, sensitivity, and hysteresis are explained for various measurement situations.

The experienced operator who is familiar with Hewlett-Packard SCPI instrument technology, can refer directly to chapter 5, "Dictionary Command Reference" for complete E1420B programming details.

Where To Find Important Topics

- Aperture Time and Resolution pg. 4-33
- Configuration Tasks pg. 4-3
- Default Parameters pg. 4-2
- Frequency Measurements pg. 4-11
- Input Attenuation pg. 4-22
- Period Measurements pg. 4-11
- Pulse Width Measurements pg. 4-12
- Ratio Measurements pg. 4-13
- Rise/Fall Time Measurements pg. 4-13
- Time Interval Measurements pg. 4-14
- Totalize Measurements pg. 4-16
- Voltage Measurements pg. 4-17

Chapter Summary

- Counter Configuration and the Measurement Procedure pg. 4-2
- Making Measurements With SCPI pg. 4-5
- Measurement Functions pg. 4-10
- Input Signal Conditioning pg. 4-18
- Arming The Counter pg. 4-28
- Measurement Resolution pg. 4-32
- Output Formats pg. 4-34

COUNTER CONFIGURATION AND THE MEASUREMENT PROCEDURE

HP E1420B Configuration

Counter configuration is discussed first followed by a brief summary of measurement procedure recommendations and counter parameters you'll need to consider when writing SCPI program messages.

The HP E1420B makes a measurement when configured (set up) by the parameters sent from your SCPI program message. Various input and measurement command parameters can take on different values. *Table 3-2* shows the commands you can program along with their default values. The values shown define the counter's power-on/reset configuration.

Three SCPI commands let you "look at" or "measure" a signal of interest. They are MEASure, CONFigure, and SENSE. The MEASure command is the simplest to use and typically involves the least programming. The SENSE command has more programming "options" as part of its subsystem that allow it to "search" for very specific signals with greater speed.

A MEASure or CONFigure command (discussed in the next section) automatically sets the parameter configuration based on the function specified in the command. Not all parameters listed in *Table 3-2* are set by the MEASure or CONFigure command.

The configured parameters determine the measurement process for a specific counter function. The process controls events that occur in the counter's hardware from the moment an input signal is detected at the front end until measurement results are stored in the counter's output buffer or sent back to the controller.

The remaining sections of this chapter present the HP E1420B set-up and operation in a sequence similar to the way you would use this instrument if front panel switches and controls were present (see *Figure 4-1*).

Exact details of SCPI commands, options, and parameters are contained in chapter 5, "Dictionary Command Reference". (The actual order of set-up and measurement events within the counter is a function of the SCPI command tree structure/syntax and the counter's firmware.)

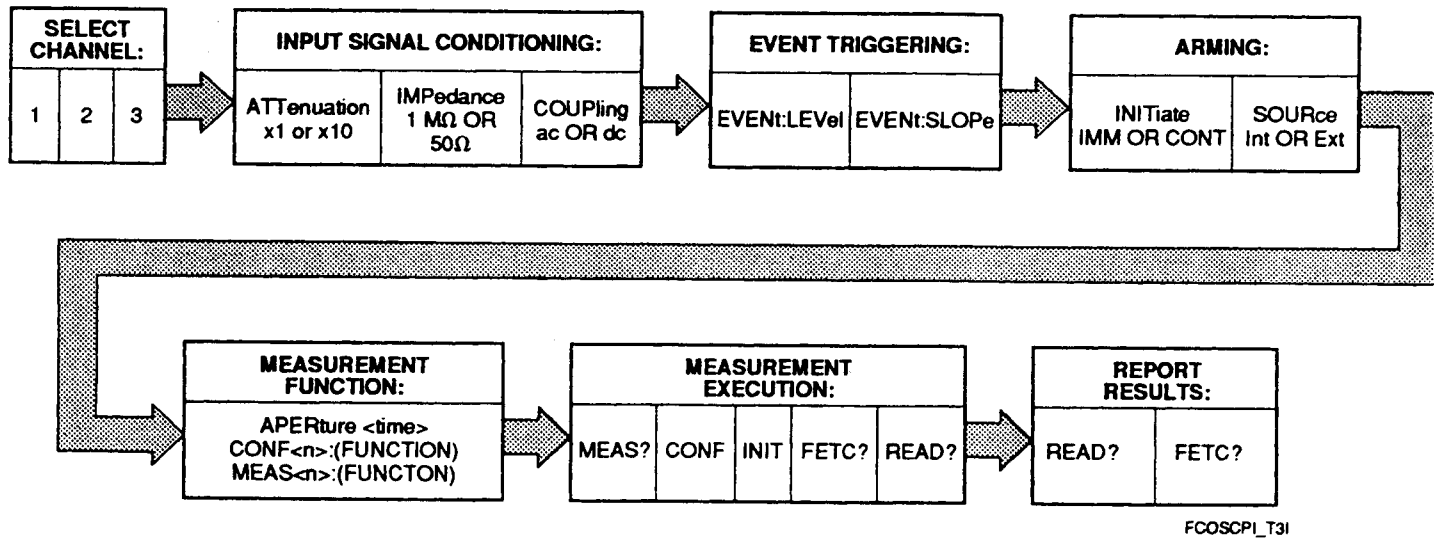

Figure 4-1. Overall SCPI Measurement Flow

HP E1420B MEASUREMENT PROCEDURE

Your counter measurements may be more successful if you follow these simple guidelines:

1. *Assess the kind of signal you want to measure:* its amplitude, frequency; is it periodic? This information lets you set the input signal conditioning, trigger level, and which channel(s) to use. You may also consider how complex your measurement is and what SCPI command subsystem is appropriate for it (MEASure, CONFigure, or SENSE).
2. *Determine the type of measurement you need to make:* FREQuency, PERiod, TOTAlize, PWIDth (positive pulse), NWIDth (negative pulse), TINTerval (time interval), RATio, RTIME/FTIME (rise/fall time), or AC/DC/MINimum/MAXimum (voltage). (Channel 3 is limited to frequency, period, or ratio measurements). Refer to the **Measurement Functions** section of this chapter for more detailed information.
3. *Set the input signal conditioning parameters for channels 1 and 2:* (channel 3 input characteristics are fixed). Refer to the **Input Signal Conditioning** section of this chapter for more detailed information.
4. *Set the appropriate trigger level and sensitivity (HYSTERESIS) if necessary* (to ensure that baseline noise doesn't initiate a measurement). You can put the counter into AUTO triggering mode with SENS:EVENT:LEV:AUTO ON. Refer to the **Input Signal Conditioning** section of this chapter for more detailed information.

5. *Set the counter arming if applicable* (ensure that the ARM command parameters match the arm input signal source and level). Refer to the **Arming The Counter** section of this chapter for more detailed information.
6. *Set the measurement resolution if desired*. Refer to the **Measurement Resolution** section of this chapter for more detailed information.
7. *Make the measurement with the MEASure, CONFigure, or SENSE commands: (explained in the next section). (When using CONFigure or SENSE, you'll also need to use READ? or INIT/FETCh? as explained in the CONFigure and SENSE sections.)*
8. *Assess the results of your measurement*. Refer to the **Output Formats** section of this chapter for more detailed information.

MAKING MEASUREMENTS WITH SCPI

You can customize measurements for your needs by using SCPI's three different measurement command "levels" to select and perform a measurement. The HP E1420B is fully compatible with SCPI Rev. 1990.0. The resulting command capability gives you these performance advantages:

- You gain greater programming flexibility,
- You can use the complete feature set of the HP E1420B,
- You can trade measurement speed/versatility for automatic parameter configuration convenience and vice-versa.
- You can also trade functional instrument compatibility for complete control of the counter's hardware.

For example, the MEASure, CONFigure, and SENSE commands can be used to make a frequency measurement. For example, the MEASure or CONFigure command automatically selects the aperture (Gate time) required to obtain a desired resolution.

The SENSE command lets you customize your measurements if the MEASure and CONFigure default values aren't appropriate for your needs. When customized, this way, your measurements gain precision and can execute faster by using the READ?, INIT, and FETCH? commands (see *Figure 4-2*).

Although an extra command is required for CONFigure, the counter's actual set up changes little when using either MEASure or CONFigure. These two commands set measurement function along with aperture time or expected value. The determination results from the programmed (or default) expected value and resolution.

The MEASure and CONFigure commands are signal-oriented. When using these commands, the counter automatically sets required measurement parameters to make the measurement as rapidly as possible.

The SENSE:FUNCTION commands are hardware-oriented. When used, the counter's ability to automatically set necessary measurement parameters and techniques is disabled. Measurements are performed using the techniques you specify, and all necessary parameters are under your control, for example:

The MEASure, CONFigure, and SENSE:FUNCTION commands can each set up a FREQUENCY measurement. The MEASure **or** CONFigure command automatically selects the aperture (Gate) time required to obtain nine digits of resolution, but the SENSE:FUNCTION command requires you to choose a specific APERTURE time.

Figure 4-2 illustrates how the MEASure, CONFigure, and SENSE:FUNCTION commands differ in how they are used with READ?, INITiate, and FETCH? commands, and how they ALL perform the same measurement and get the data to the output buffer.

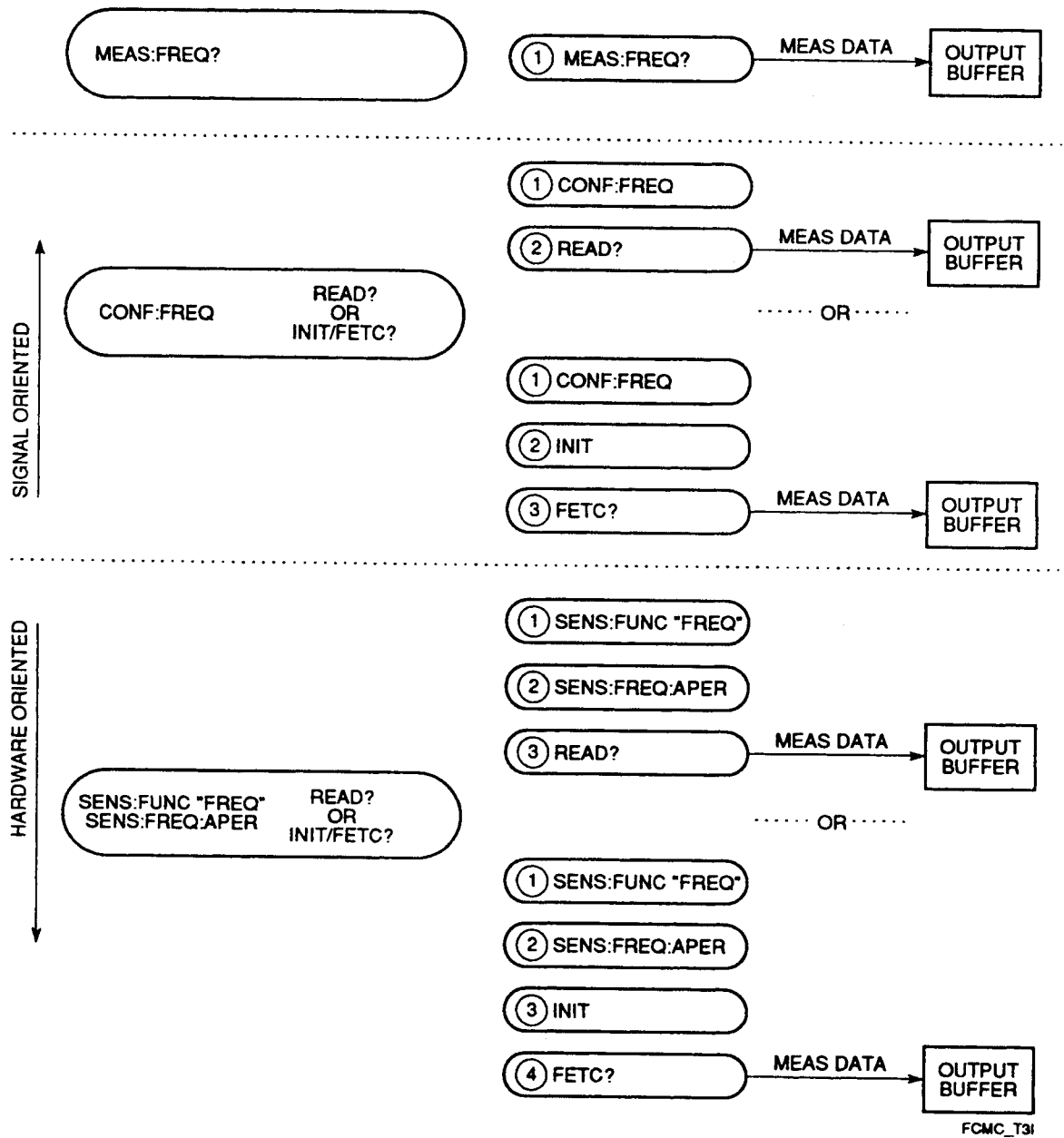

Figure 4-2. SCPI Measurement Capability

The MEASure, CONFigure, and SENSE Commands

All HP E1420B measurement functions can be performed using the MEASure command except for TOTAlize. All measurements can be configured with the CONFigure and SENSE commands, but at least one additional command must then be used to initiate the measurement.

USING MEASure

Use MEASure to take a measurement automatically after the configuration (primarily input signal conditioning) is set. No additional command is needed to initiate the measurement or store the results. (Exact details of SCPI commands, options, and parameters are contained in chapter 5, "Dictionary Command Reference".) You can select and perform a measurement with this command string:

```
MEAS:<function>?
```

where <function> is one of the following:

```
FREQ for frequency measurements  
PER for period measurements  
PWID (or) NWID for  $\pm$  pulse width measurements  
TINT for time interval measurements  
RTIM (or) FTIM for rise/fall time measurements  
FREQ:RAT for ratio measurements  
MIN/MAX/AC/DC for voltage measurements
```

For example, executing MEASure as:

```
MEAS2:FREQ? 1E7, 10
```

makes a measurement on input channel 2 setting the function to frequency, the target frequency to 10 MHz, and the resolution to 10 Hz. The remaining commands are as shown in *Table 3-2* or as you've set them prior to the MEASure command.

The resulting measurement data is stored in the output buffer of the counter. An ENTER statement can be used to transfer this information to the controller.

USING CONFigure

Use CONFigure when you need to specify a measurement function prior to the READ? or INIT/FETC? commands. You will also need to use CONFigure for TOTAlize measurements. (Exact details of SCPI commands, options, and parameters are contained in chapter 5, "Dictionary Command Reference".) CONFigure only sets up the configuration, and does not perform the measurement.

You can select a measurement function on input channel 1 with this command string:

```
CONF1:<function>
```

where <function> is one of the following:

FREQ for frequency measurements
PER for period measurements
TOT for totalize measurements
PWID (or) NWID for positive/negative pulse width measurements
TINT for time interval measurements
RTIM (or) FTIM for rise/fall time measurements
FREQ:RAT for ratio measurements
MIN/MAX/AC/DC for voltage measurements

Once the selected measurement is configured and any additional parameters are added, the measurement is performed using a READ? or INITiate command.

USING SENSE

Use the SENSE command when you need to configure not only the measurement function but also special characteristics of the input signal. Aperture time for FREQUency, PERiod, or RATio and gate options for the TOTalize function may also be set up. (Exact details of SCPI commands, options, and parameters are contained in chapter 5, "Dictionary Command Reference".) You can specify these additional parameters as follows:

- For frequency, period, and ratio measurements, allows you to set aperture time and expected value.
- For time-interval measurements, allows you to set and enable a delay time.
- For totalize measurements, allows you to set up GATE characteristics.
- For the EVENT parameter, allows you to specify input trigger characteristics.
- For all measurements, lets you set 100 gate average mode.

SENSE only sets up the configuration, and does not perform the measurement. You can select a measurement function for input channel 1 with this command string:

```
SENS1:FUNCTION "function"
```

where <function> is one of the following:

FREQ for frequency measurements along with APERTure time
PER for period measurements along with APERTure time
TOT for totalize measurements along with GATE:<options>
PWID (or) NWID for \pm pulse width measurements
TINT for time interval measurements
RTIM (or) FTIM for rise/fall time measurements
FREQ:RAT for ratio measurements along with APERTure time
MIN/MAX/AC/DC for voltage measurements

Once the selected measurement is configured and any additional parameters are added, the measurement is performed using a READ? or INITiate command.

The INITiate, READ?, and FETCh? Commands

After you've configured a measurement with CONFigure or SENSE use READ? or INITiate/FETCh? to perform the actual measurement.

USING READ?

READ? performs a configured measurement and transfers the result to the counter's output buffer. READ? cannot be used on totalize or gated totalize measurements. If a READ? is attempted on an unconfigured channel, an error will be generated. You can perform and read a configured measurement with this command string:

READn? where **n** = the channel number (1, 2, or 3)

An HP BASIC ENTER statement can be used to transfer this data to the controller.

USING INITiate

INITiate performs the configured measurement immediately for one measurement cycle or continuously if specified. The measurement results are not available in the counter's output buffer after INITiate has executed. The INITiate command must be used with CONFigure or SENSE followed by FETCh? for totalize or gated totalize measurements. You can perform the configured measurement with this command string:

INITn where **n** = the channel number (1, 2, or 3)

After a measurement has been INITiated, you'll need to use the FETCh? command to transfer the measurement data to the counter's output buffer. An HP BASIC ENTER statement can be used to transfer this data to the controller.

USING FETCh?

FETCh? loads the results of the most recent measurement into the counter's output buffer. You must precede this command with some SCPI measurement configuration program string and the INITiate command in order to get data with the FETCh? command. You can perform this command with the following command string:

FETCn? where **n** = the channel number (1, 2, or 3)

An HP BASIC ENTER statement can be used to transfer this data to the controller.

MEASUREMENT FUNCTIONS

The following paragraphs describe how the counter performs in each of the seven measurement modes:

- Frequency
- Period
- Pulse Width
- Ratio
- Rise/Fall Time
- Time Interval
- Totalize
- Voltage

For each measurement mode of the counter, the range, available channels, and operation are described. The Least Significant Digit (LSD) measured, Resolution, and Accuracy are described and specified in *Table A-1* of Appendix A. *Figure 4-3* shows the SCPI program task flow common to all measurement levels and functions. (Exact details of SCPI commands, options, and parameters are contained in chapter 5, "Dictionary Command Reference".)

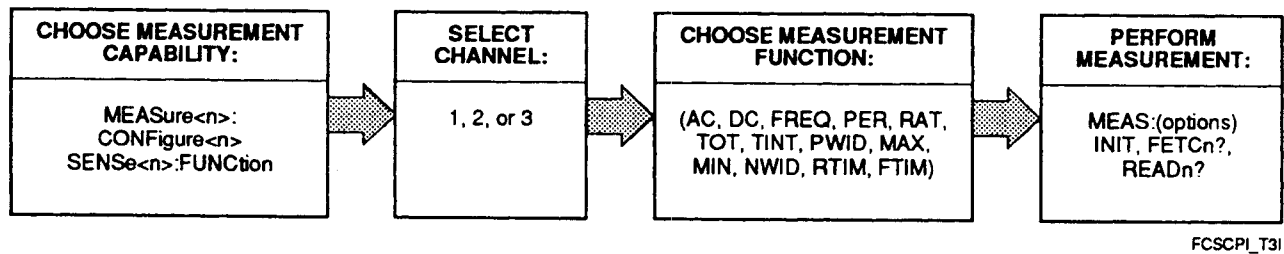

Figure 4-3. SCPI Measurement Configuration Flow

Frequency/Period Measurements

The frequency/period measurement function is specified as `FREQ/PER` respectively. All three counter channels (Channel 3 optional) can measure frequency or period. *Table A-1* describes the exact specifications for these measurements.

MEASUREMENT DEFINITION AND RANGE

The HP E1420B makes frequency measurements on repetitive input signals between the frequency limits shown below. Input signals are received through input channels 1, 2, or 3.

The frequency range for each channel is:

- Input 1: 0.001 Hz to 200 MHz
- Input 2: 0.001 Hz to 100 MHz
- Input 3: 90 MHz to 2500 MHz

PROCEDURE

You can make frequency (or period) measurements by simply connecting a signal to one of the inputs and executing a syntactically correct SCPI frequency measurement program message. Refer to the Frequency/Period Measurement program example in chapter 3 for a typical example of a SCPI frequency/period measurement programming sequence.

INPUT SIGNAL CONDITIONING

Input signal conditioning is setup by using one or more of the `SENSE`, and `INPut` commands. For low amplitude signals on inputs 1 and 2, the sensitivity may be changed by using the `LEVel` and `HYSTeresis` parameter of the `SENSE:EVENT` command. For higher amplitude signals, the `INPut:ATTenuation` command may be used.

CHANNELS 1 AND 2 TRIGGER LEVEL

You can adjust the optimum trigger level for input channel 1 and 2 frequency measurements by use of the `SENSE` command and parameters/options. Trigger level range is -10 V to $+10\text{ V}$ in 2.5 mV steps. The trigger slope is selectable for either `POSitive` or `NEGative`.

Event triggering is indicated by the flashing LED next to each input channel connector. An optimum trigger point is usually on that part of the waveform where voltage change is most rapid. This trigger point will define the trigger level. (Refer to the trigger level discussion for more details about trigger level and hysteresis.) The `SENS:EVENT:LEVel` parameter query gives you the currently programmed trigger level.

CHANNEL 3 TRIGGER LEVEL

The trigger level for input channel 3 is fixed at 0 V nominal. Channel 3 shares the measurement trigger display LED with input channel 2.

GATE (APERTURE) TIME

The gate time (`APERture`) range is one millisecond to 99.999 seconds (in 1 millisecond increments) and may be determined by using the `APER?` query. Frequency/Period is averaged over the gate time. When expected value and resolution are provided, the counter automatically determines the optimum gate time. If the programmed gate time is shorter than the input signal period, the actual gate time is increased to the signal period.

Pulse Width Measurements

The pulse width measurement function is specified as PWIDth or NWIDth. Only channels 1 and 2 can measure pulse width.

MEASUREMENT DEFINITION AND RANGE

The HP E1420B makes pulse width measurements on repetitive input pulse signals between 5 ns and 1 ms as shown in *Figure 4-4*. Input signals are received through input channels 1 or 2. Autotrigger is automatically enabled for pulse width measurements unless specifically disabled. The default pulse width trigger level is 50% of the peak input signal amplitude.

Pulse width measurements are not dependent on gate time. Greater resolution can be obtained by selecting 100 Gate Average mode via the SCPI "SENSE: AVERage ON" program message string.

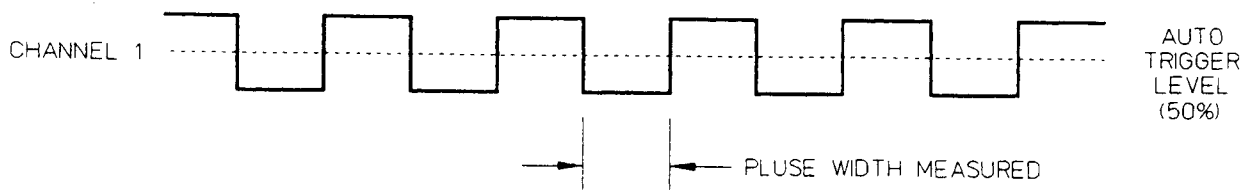

EXAMPLE SCPI PROGRAM MESSAGE: "MEAS: NWID?"

WFPWM.T3M

Figure 4-4. Pulse Width Measurement

PROCEDURE

You can make pulse width measurements by simply connecting a signal to one of the inputs and executing a syntactically correct SCPI pulse width measurement program message. Refer to the Pulse measurement program examples in chapter 3 for typical examples of SCPI pulse measurement programming sequence.

INPUT SIGNAL CONDITIONING

Input signal conditioning is set up by using one or more of the SENSE and INPUT commands. For low amplitude signals on inputs 1 and 2, the sensitivity may be changed by using the LEVEL and HYSTERESIS parameters of the SENSE: EVENT command. For higher amplitude signals, the INPUT: ATTENUATION command may be used.

Ratio Measurements	<p>The ratio measurement function is specified as <code>FREQ:RAT</code>. Three input channel combinations are permitted for <code>RATio</code> measurements:</p> <ul style="list-style-type: none"> ● Input 1 with respect to Input 2, ● Input 2 with respect to Input 1, ● Input 3 with respect to Input 1.
MEASUREMENT DEFINITION	<p>The Ratio measurement function provides measurement of the ratio between two frequencies. The HP E1420B measures the frequency ratio of signals on Input 1 in relation to signals on Input 2. Both input channels have 35 mV rms sensitivity up to 100 MHz. Although the HP E1420B can measure and report ratios of less than 1, the higher frequency must be connected to the channel listed in the numerator to meet the specifications. Note that Input 3 is prescaled by 64 internally.</p>
PROCEDURE	<p>You can make a frequency ratio measurement by first routing signals simultaneously to input channels 1 and 2. Then, execute the <code>FREQ:RATio</code> measurement function within a syntactically correct SCPI program message that includes the appropriate input signal conditioning.</p>
GATE TIME	<p>The <code>FREQ:APERture</code> time determines the resolution by selecting the number of cycles of the Input 2 signal over which the ratio is measured. Increasing aperture time or increasing the signal frequency at Input 1 results in greater resolution of the measurement.</p>
Rise/Fall Time Measurements	<p>The rise- or fall-time measurement function is specified as <code>RTIME</code> or <code>FTIME</code>. Only channel 1 can measure rise or fall time. The input signal must be repetitive.</p>
MESUREMENT DEFINITION AND RANGE	<p>The Rise- or Fall-time measurement function automatically configures the counter to perform either rise- or fall-time measurements, via the Input 1 connector, as shown in <i>Figure 4-5</i>. Rise- or Fall-time measurements can be made from 15 nanoseconds to 1 millisecond. The <code>COMMon</code> and <code>Auto-trigger</code> modes are automatically selected. In this way the counter automatically locates the 10% and 90% points of the input signal, and sets the trigger levels accordingly.</p> <p>Signal routing in <code>COMMon</code> mode cannot be disabled when the HP E1420B is making Rise- or Fall-Time measurements. The automatic level sensing can be disabled by specifically programming trigger levels as parameteres. Actual gate time is controlled by the rise/fall time interval. Greater resolution can be obtained by using 100 gate average mode via the <code>SENSE</code> subsystem.</p>
PROCEDURE	<p>You can make a rise- or fall-time measurement by first connecting a signal to input channel 1. Then execute either the <code>RTIME</code> or <code>FTIME</code> measurement function within a syntactically correct SCPI program message that includes appropriate input signal conditioning. Channel 2 is configured to match channel 1 input signal conditions.</p>

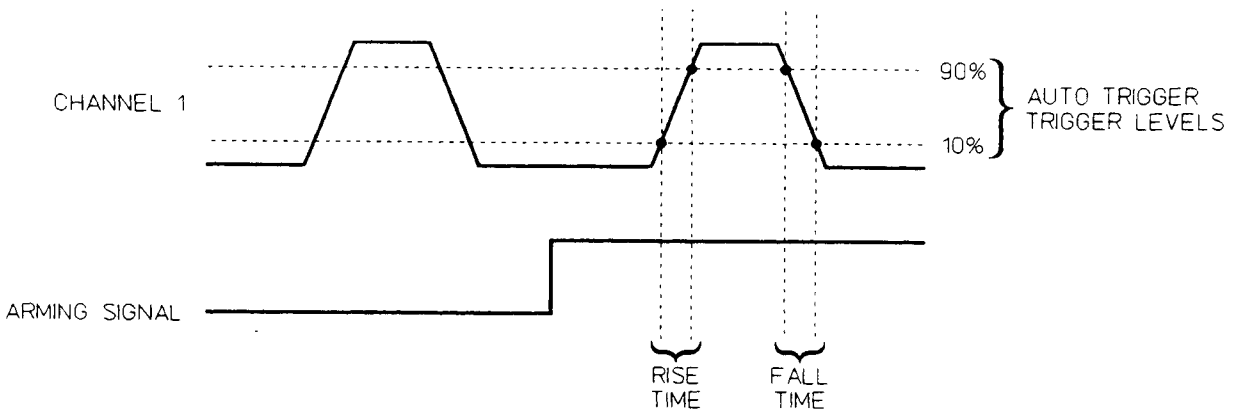

EXAMPLE SCPI PROGRAM MESSAGES: 'MEAS1:RTIM?'
 'MEAS1:FTIM?'

WFRM_T3M

Figure 4-5. Rise/Fall Time Measurements

Time Interval Measurements

The time interval measurement function is specified as TINTerval. Only channels 1 and 2 can measure time interval.

MEASUREMENT DEFINITION AND RANGE

The HP E1420B can make single-shot and average time interval measurements programmed over a range of 1 nanosecond to 1,000 seconds. The minimum START/STOP pulse width is 5 nanoseconds.

The time-interval function of the HP E1420B measures the length of time between a START signal at input channel 1 and a STOP signal at input channel 2, as shown in Figure 4-6. The START and STOP signals may be derived from separate signal sources, or they can originate from the same source. Trigger levels and slopes can be varied independently for each channel using the SENSE command as follows:

```
SENSn :EVEN:SLOP POS
SENSn :EVEN:SLOP POS (where n = 1 or 2)
```

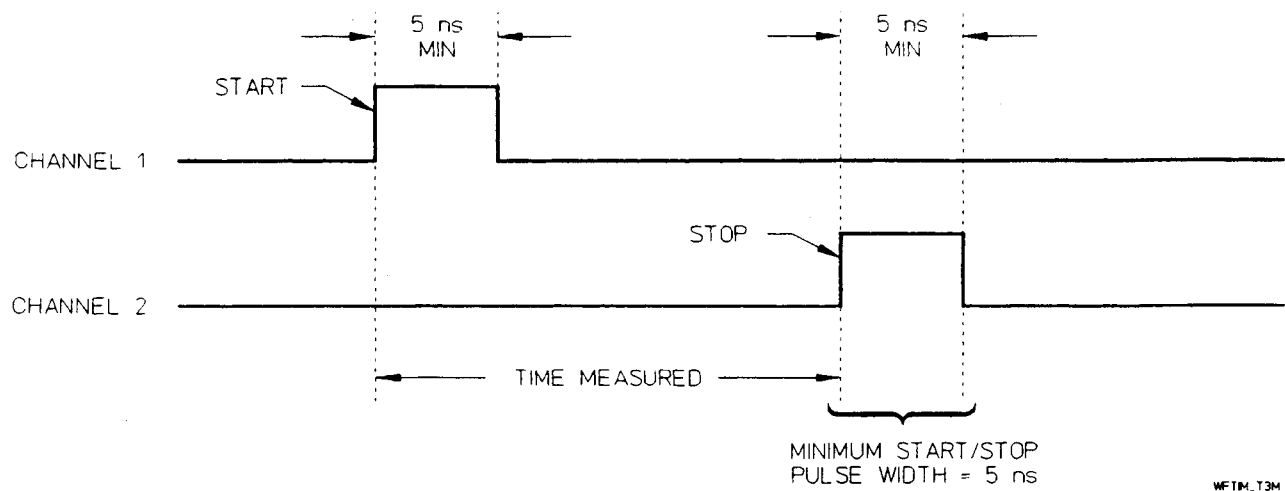

Figure 4-6. Time Interval Measurement

PROCEDURE You can make time-interval measurements between two events when both the start and stop events are derived from the same input signal. Simply connect the signal to Input Channel 1, and use the “INPut:ROUte COMMON” SCPI message string to select the common input 1 mode.

If you want to make time-interval measurements between two events on separate input signals, connect the signal with the start event to Input Channel 1, and the signal with the stop event to Input Channel 2. The appropriate input signal conditioning may then be selected. Ensure that the counter is not in COMMON mode.

SLOPE SELECTION The SLOPe parameter (POS or NEG) determines whether the trigger point for the START or STOP signal will be on the rising or falling edge. Auto Triggering may be used for a repetitive input signal.

TIME INTERVAL DELAY MEASUREMENTS The time interval delay measurement function is similar to time interval measurement function, but with the following additional control. The SENSE:TINTerval:DELay:TIME <time value> and SENSE:TINTerval:DELay:STATe ON command strings used prior to TINTerval, insert a variable delay between the START (Input 1) event and the enabling of the STOP (Input 2) event, as shown in Figure 4-7. Potential STOP events are ignored during the specified delay. The counter completes the measurement on the next STOP event after the delay time has expired.

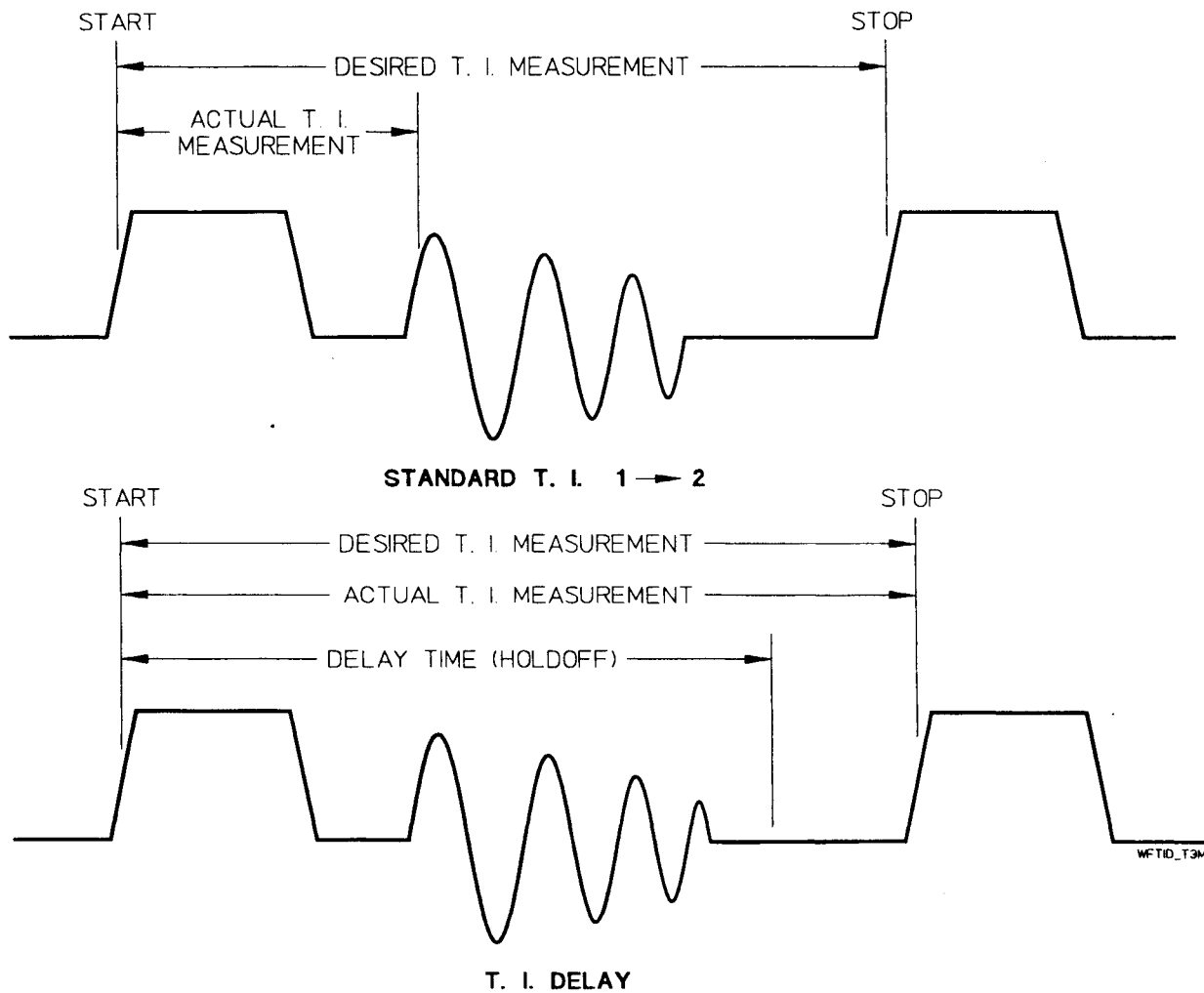

EXAMPLE SCPI PROGRAM MESSAGES: *SENS1:TINT:DEL:TIM 1MS*
 SENS1:TINT:DEL:STAT ON

Figure 4-7. Time Interval Delay Measurement

Totalize Measurements

The totalize measurement function is specified as TOT.

MEASUREMENT DEFINITION AND RANGE

The HP E1420B totalizes events up to a count of $10^{12} - 1$. Input signals are received through input channels 1, 2, or 3.

Totalize measures the number of counts (events) received through input channel 1. The count is accumulated from input cycle to input cycle and can be reported by using consecutive FETCh? queries. Totalize is independent of the APERTure time setting.

You can also program the counter to give you the number of counts it received on one channel during a single count on the other channel. This operation is called "TOTAlizing-by-GATE" mode. Refer to chapter 5 for more details.

PROCEDURE You can make totalize measurements by simply connecting a signal to one of the inputs and executing a syntactically correct SCPI measurement program message. Refer to the Totalized Measurement program example in chapter 3 for a typical example of a SCPI totalize measurement programming sequence.

INPUT SIGNAL CONDITIONING The appropriate input channel selection (1 or 2), GATE state (ON/OFF) and input signal conditioning (Input impedance/coupling) are set up by using one or more of the MEASure, SENSE, and INPut commands. For low amplitude signals on inputs 1 and 2, the sensitivity may be changed by using the LEVel parameter of the SENSE commands.

TRIGGER EVENT The trigger slope setting for the selected measurement channel determines whether the rising or falling edge of the input signal is counted. Trigger slope is specified by the [:SENSE[1|2]]:EVENT:SLOPe <slope> command.

ARMING AND GATING Events are counted while the measurement gate is open. Arming options synchronize the gate with input events by controlling when it opens and closes. The selected totalize function establishes the particular timing relationship between arm events and the measurement gate. When Totalize 1 is selected, the start arm and stop arm events open and close the gate, respectively. They are specified by the :ARM:STARt:SOURce <event> and :ARM:STOP:SOURce <event> commands (see Figure 1). Measurements can be synchronized with an external signal by selecting either EXTERNAL or TTLTrg as the arm event. IMMEDIATE, HOLD and BUS options are intended for applications requiring less precise control. For convenience, IMMEDIATE stop arming is aliased to HOLD; both options inhibit the closing of the gate until the :ARM:STOP:IMMEDIATE command is issued.

:CONFigure1:TOTAlize

or

:SENSe1:FUNction "TOTAlize"

:SENSe:TOTAlize:GATE:STATe OFF

Gate Open

:SENSe1:EVent:SLOPe POSitive|NEGative

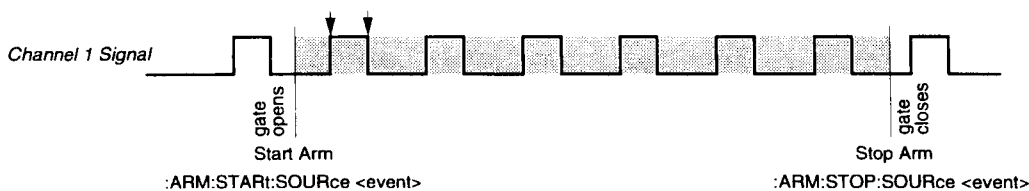

Figure 1. Totalize 1 Measurement

When either Totalize 1 by 2 or Totalize 2 by 1 is selected, the gate is directly controlled by the signal connected to the alternate input channel. Start and stop arm events *enable* recognition of the gating signal. Consequently the sequence of start arm, gate open, stop arm and gate close events must occur for these measurements to complete. If IMMEDIATE start and stop arming are specified, the gating signal alone controls the duration over which events are counted (See Figures 2 and 3).

:CONFigure1:TOTalize

or

:SENSe1:FUNCTION "TOTalize"

:SENSe:TOTalize:GATE:STATe ON

Gate Open

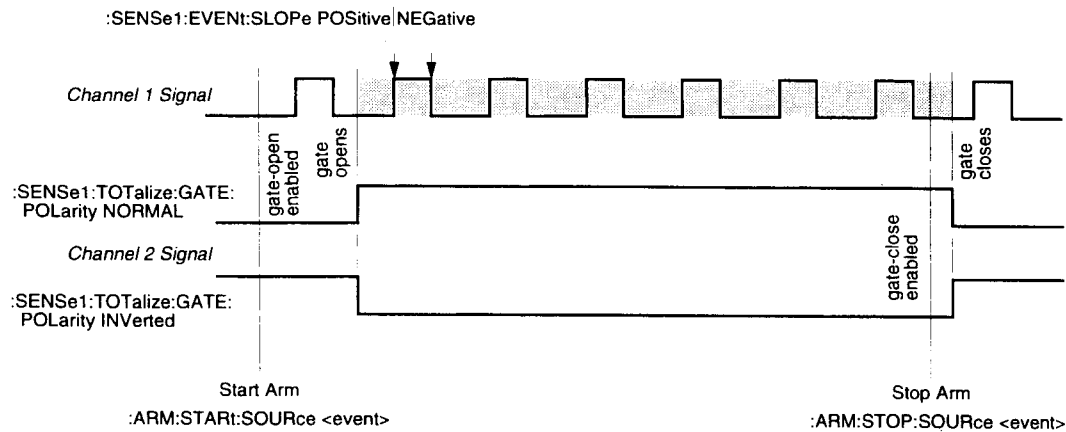

Figure 2. Totalize 1 by 2 Measurement

:SENSe2:FUNCTION "TOTalize"

:SENSe:TOTalize:GATE:STATe ON

Gate Open

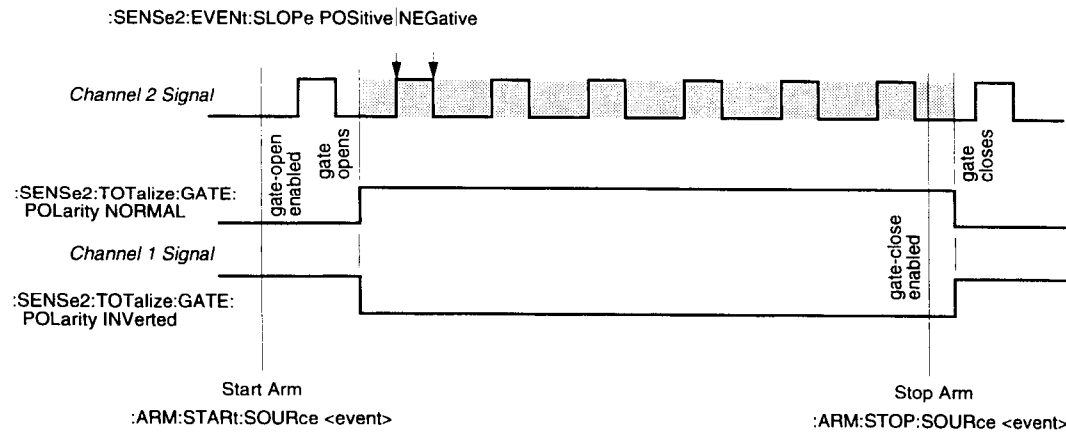

Figure 3. Totalize 2 by 1 Measurement

Reading Measurement Results The :FETCh? query should be used to query the totalize measurement result. Issuing this query while acquiring a Totalize 1 by 2 or Totalize 2 by 1 measurement generates a request for the final count. The final count is returned after the measurement gate has closed.

The Totalize 1 function allows data to be read "on-the-fly." When the :FETCh? query is issued, the counter returns the current count. An intermediate count ("subtotal") is returned if the gate is open; the final count is returned if the gate has closed. Reading an intermediate count neither halts the measurement nor resets the count.

For all totalize functions, the final count is automatically cleared when the next measurement is initiated. A count of zero is returned for the case where the gate opens and closes but no trigger events are detected.

Synchronizing Measurement Completion (Totalize 1) In many applications, only the final count of a Totalize 1 measurement is desired. Querying the result after the measurement gate has closed ensures the proper response.

A potential problem occurs when an external signal closes the gate. In this case, the timing relationship between the stop arm signal and the :FETCh? query may not be readily apparent. Measurement/:FETCh? synchronization can be maintained by the *WAI and *OPC commands and the *OPC? query. These commands suspend execution of the data retrieval operation until the measurement is complete. Note, however, that the "on-the-fly" mode is disabled. Consult the overview of IEEE 488.2 Common Commands in Chapter 5 for details on the functions of these commands.

You can also program the counter to give you the number of counts it received on one channel during a single count on the other channel. This operation is called "TOTalizing-by-GATE" mode. Refer to chapter 5 for more details.

PROCEDURE You can make totalize measurements by simply connecting a signal to one of the inputs and executing a syntactically correct SCPI measurement program message. Refer to the Totalize Measurement program example in chapter 3 for a typical example of a SCPI totalize measurement programming sequence.

INPUT SIGNAL CONDITIONING The appropriate input channel selection (1 or 2), GATE state (ON/OFF) and input signal conditioning (Input impedance/coupling) are set up by using one or more of the MEASure, SENSE, and INPut commands. For low amplitude signals on inputs 1 and 2, the sensitivity may be changed by using the LEVel parameter of the SENSE commands.

Voltage Measurements

The voltage measurement function is specified as AC/DC/MINimum/MAXimum. Only channels 1 and 2 can measure voltage. Channel 2 cannot measure 0 Hz (dc).

MEASUREMENT DEFINITION AND RANGE The HP E1420B measures input signal ac rms voltage from 0.1V to 5V when $\times 1$ attenuation is used. A dc offset, if present, can be measured from -10 to $+10$ volts. The maximum frequency is 20 MHz. Use of $\times 10$ attenuation will multiply the voltage measurement range accordingly. However, you need to scale the results accordingly.

PROCEDURE You can make voltage measurements by simply connecting a signal to input 1 or 2 and executing a syntactically correct SCPI measurement program message. Refer to the voltage measurement program example in chapter 3 for a typical example of an SCPI voltage measurement programming sequence.

INPUT SIGNAL CONDITIONING The event level is automatically set with Autotrigger ON.

INPUT SIGNAL CONDITIONING

Input 1 and Input 2 of the HP E1420B include several programmable input signal conditioning controls. Input 3 has a fixed set of input signal conditioning values. The major elements of the circuitry for each input channel are the amplifier and input trigger blocks.

The input trigger converts the analog output of the input amplifier to a pulse train, compatible with the counter's Multiple Register Counter (MRC) block. The data accumulated by the MRC is used by the counter's internal microprocessor (measurement control block) to compute and format measurement results. The input characteristics described in the following paragraphs are:

- Range
- Sensitivity
- Attenuation
- Ac-Dc Coupling
- Trigger Level
- Trigger Slope
- Input Impedance
- Damage Level
- Separate/Common Input

Specifications for the input characteristics of the HP E1420B are given in Appendix A. *Figure 4-8* depicts the SCPI process of signal conditioning that occurs at the front end of channels 1 and 2. (Exact details of SCPI commands, options, and parameters are contained in chapter 5, "Dictionary Command Reference".) Refer to *Figure 1-1* for a simplified block diagram of the HP E1420B front-end.

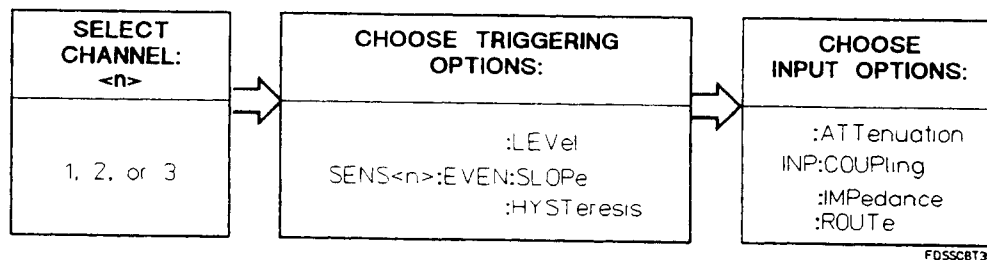

Figure 4-8. SCPI Signal Conditioning Flow

Input Range

Range defines the frequency range over which the input amplifier sensitivity is specified. The range varies with the selected coupling and input impedance. Although the specifications for Input 1 and Input 2 state that the input amplifiers have a range from dc to as high as 200 MHz, the range may vary for different operating modes. Consult the individual Signal Operating range and/or Dynamic range specifications under the appropriate OPERATING MODE in *Table A-1*.

SIGNAL OPERATING RANGE: Signal operating range defines the maximum positive and negative voltages within which the peak-to-peak

signal can reliably operate. If the signal peaks extend beyond the specified signal operating range, as shown *Figure 4-9* (bottom), one or more operating modes may give incorrect results; for example, frequency miscounting or time interval inaccuracies.

DYNAMIC RANGE: Dynamic range is the maximum allowable peak-to-peak signal range, specified with the trigger level set at midpoint of the input signal and centered within trigger level range. The instrument's dynamic range is limited by the input amplifier's linear range of operation. If the input signal exceeds this range, as shown in *Figure 4-9* (top), the input amplifier may saturate, causing transitions of the input to be missed.

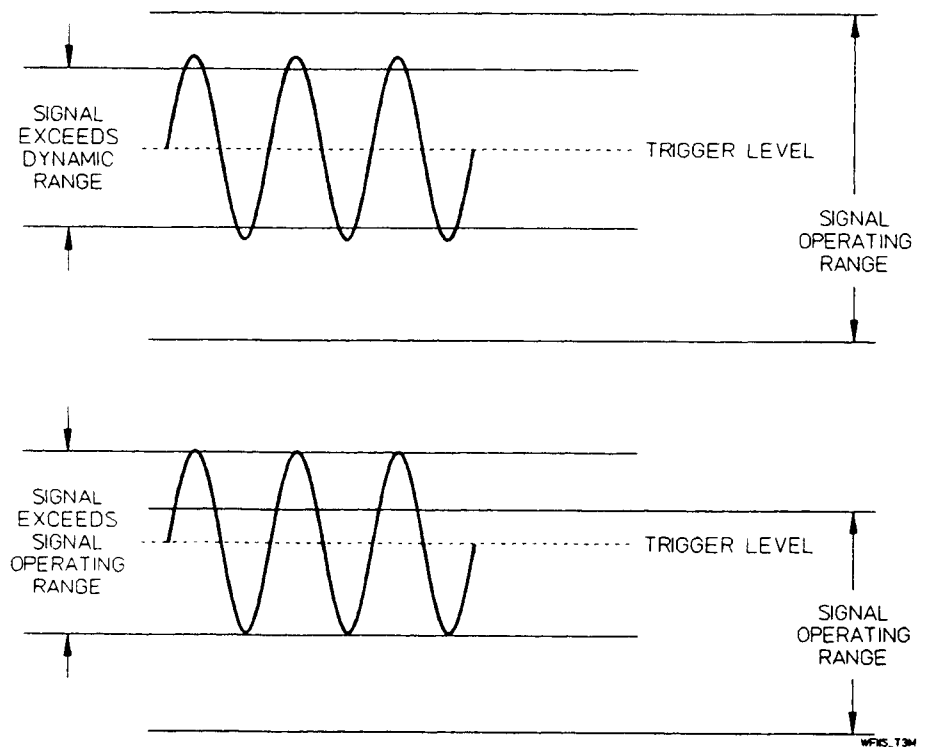

Figure 4-9. Invalid Input Signal Conditions

The dynamic range puts a further restriction on the allowable signal peaks as specified by the signal operating range. For optimum performance, the signal peaks must stay within the signal operating range specification, and the peak-to-peak value must stay within the maximum dynamic range specification, as shown in *Figure 4-10*.

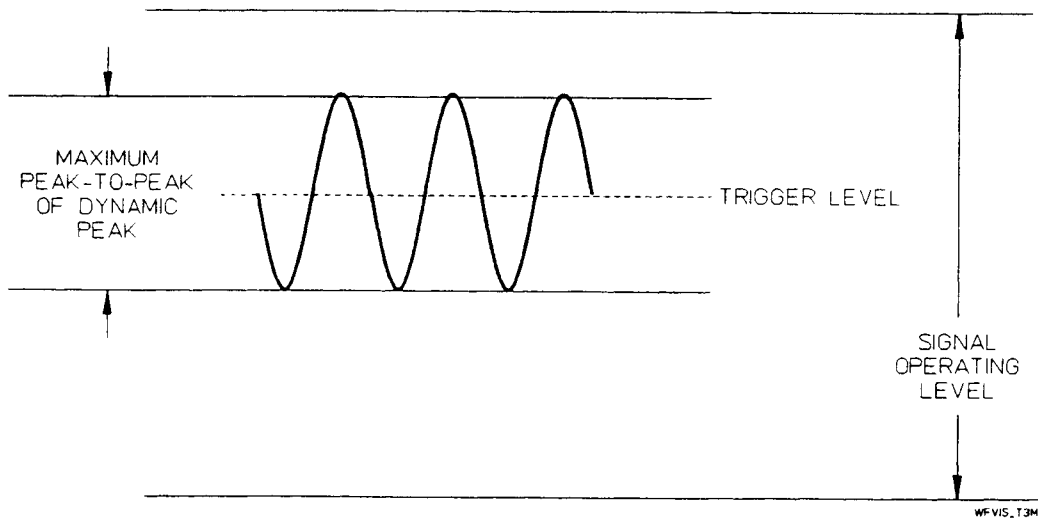
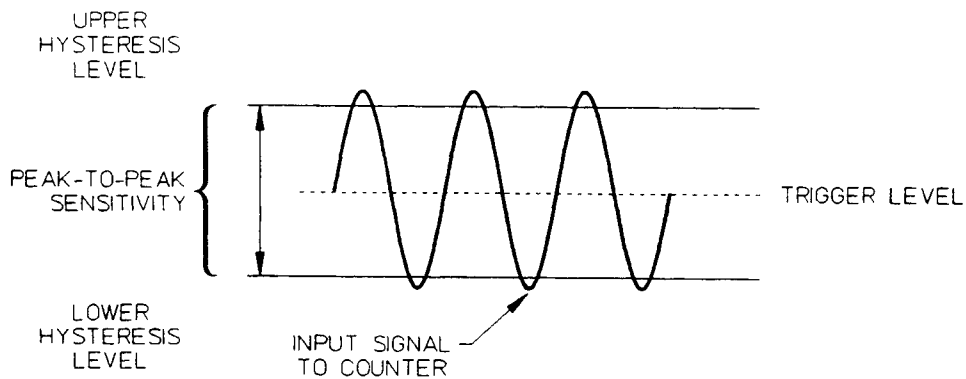

Figure 4-10. Valid Input Signal Conditions

Input Sensitivity

Sensitivity is the lowest amplitude signal at a particular frequency that the counter can measure. The amplifier gain and the voltage difference between the input trigger levels set at a value equal to the midpoint of the input signal. **The input waveform must cross both upper and lower hysteresis levels to generate a count, as shown in Figure 4-11.**



Signal crosses through both hysteresis limits to effect a count

WFAPP, T3M

Figure 4-11. Acceptable Peak-to-Peak Amplitude

If the signal peaks do not cross both hysteresis limits, the input signal will not generate a count. For example, if the peak-to-peak amplitude is insufficient, or the trigger level is set above or below the midpoint of the input signal, as shown in *Figures 4-12 and 4-13*, the counter can not make a measurement.

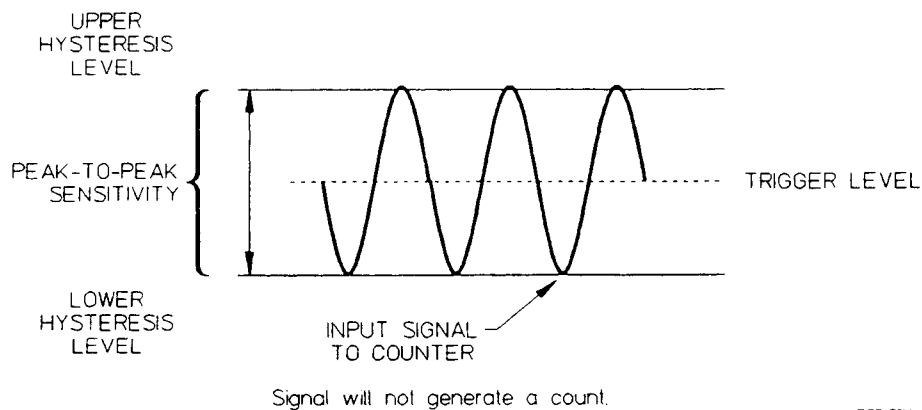

Figure 4-12. Insufficient Peak-to-Peak Amplitude

You can adjust the HYSTeresis (sensitivity) of the counter by sending the following SCPI program message to the E1420B:

```
SENS<n>:EVEN:HYST MIN/MAX/DEF
```

Where n is the selected channel 1 or 2.

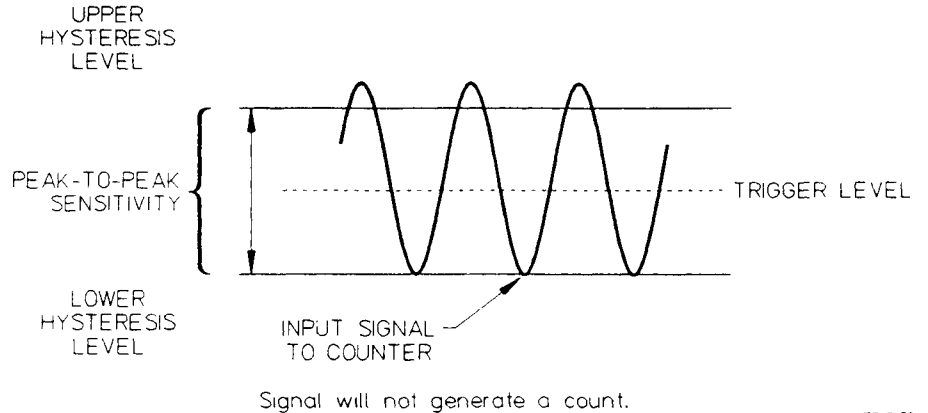

Figure 4-13. Trigger Level Set Below Midpoint of Input Signal

The sensitivity specification is given in terms of volts rms for applications that involve measuring a sine-wave signal. You should be aware that a different waveform with the same rms voltage may not trigger a count.

Since the counter input does not respond to the rms value of the waveform but only to the peak-to-peak value, the sensitivity specification is also given for volts peak-to-peak with a minimum pulse width.

NOTE

At minimum sensitivity, the hysteresis window is increased requiring a larger peak-to-peak voltage to generate a count, as shown in Figure 4-14. Optimum sensitivity depends on measurement application and other factors such as noise or interfering signals.

Input Attenuation

Selectable step attenuation of $\times 1$ or $\times 10$ is provided for input channels 1 and 2. Attenuation of $\times 10$ must be used for signals that might exceed 5 volts rms. $\times 10$ attenuation reduces the signal by a factor of 10. When $\times 10$ attenuation is selected, the user needs to scale the trigger levels or voltage measurements appropriately. The SCPI command for selecting $\times 1$ or $\times 10$ attenuation is `INPut:ATTenuation`. Refer to the command reference in chapter 5 for more detailed information.

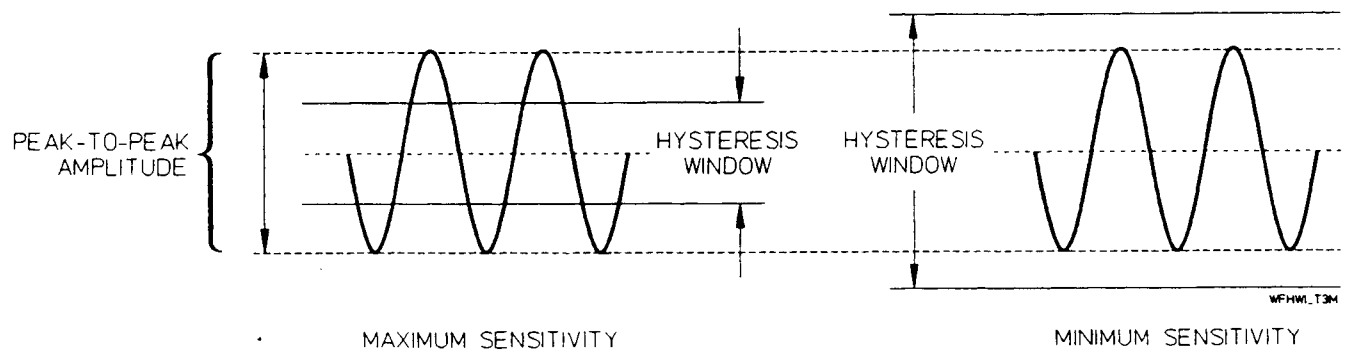

Figure 4-14. Hysteresis Window and Input Sensitivity

Input Coupling

Selectable ac or dc coupling is provided for input channels 1 and 2. Ac coupling must be used for signals with dc content exceeding the hysteresis limit of the input trigger. Figure 4-15 demonstrates the hysteresis limits and the use of ac coupling.

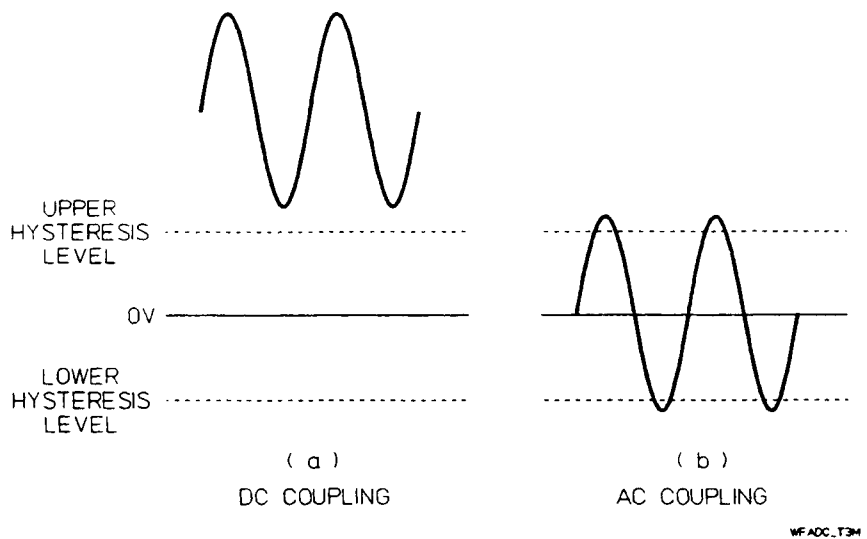

Figure 4-15. Ac-Dc Coupling

NOTE

An input signal with dc content (as shown in a) would not be counted unless ac coupling (as shown in b), was used to remove the dc offset, or the appropriate trigger level was used.

Trigger Level

Trigger level is the voltage at the center of the hysteresis window. The actual trigger points are typically at the upper hysteresis level (POS slope) and at the lower hysteresis level (NEG slope), as shown in Figure 4-16.

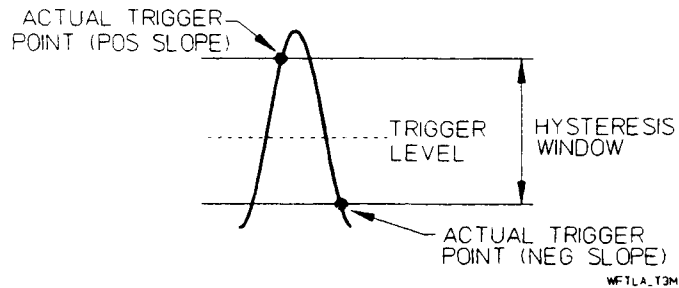

Figure 4-16. Trigger Level and Actual Trigger Point

The trigger levels are adjustable over the dynamic range of the counter when the SENS:EVENT:LEVel:AUTO command is OFF (Auto triggering OFF) and a specific LEVel is entered. This ensures that any signal of sufficient amplitude and within the dynamic range can be counted.

Event triggering on the input signal is indicated by the flashing front-panel Trigger LEDs (refer to page 2-3 of chapter 2).

When SENS:EVENT:LEVel:AUTO is ON (Auto triggering ON), trigger levels are controlled by the amplitude of the input signal and automatically set in accordance with the measurement application. With Auto trigger on, the input event trigger LEDs may flash randomly during the measurement.

NOTE

Auto Triggering does not affect input attenuation. You must select $\times 10$ attenuation for any input signal that exceeds the dynamic range of the counter in $\times 1$ attenuation.

For example, you can change the trigger level or select autotriggering for input channel 2 by using the LEV option of the SENSE:EVENT commands within the SCPI configuration program message as follows:

SENS2:EVENT:LEV (nnn) (to select a specific level)

- or -

SENS2:EVENT:LEV:AUTO ON (for automatic triggering)

One use of programming the trigger level is to shift the hysteresis levels above (example b) or below (example c) ground. This lets you count positive or negative pulse trains, respectively, as indicated in Figure 4-17.

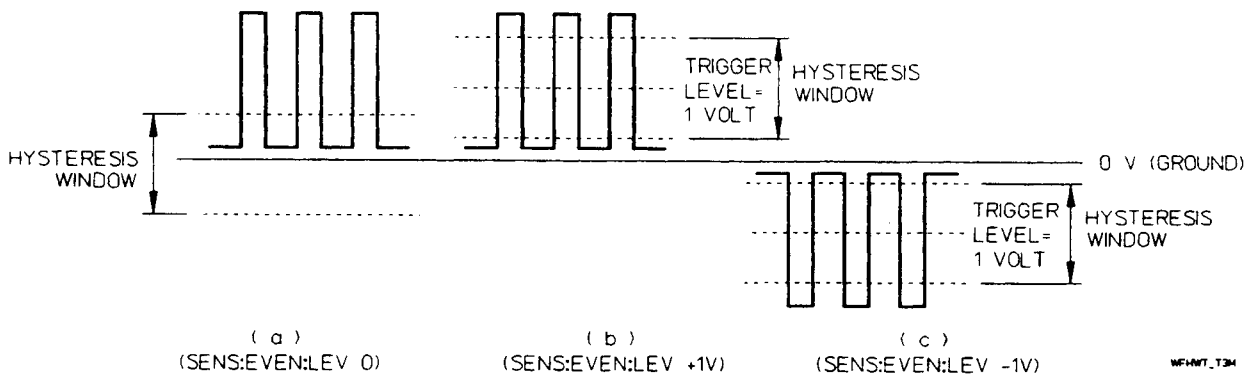

Figure 4-17. Hysteresis Window and Trigger Level

NOTE

The signal (example a) will not be counted. Programming the trigger level to shift the hysteresis levels above ground (example b), or below ground (example c), enables a count.

Trigger Slope

The SENS:EVENT:SLOPe command string determines which edge of the input signal triggers the count. With the POSitive slope selected, a signal going from one voltage level to a more positive level, regardless of polarity, will generate a trigger pulse at the upper hysteresis limit. With the NEGative slope selected, the negative going edge of the signal will generate a trigger pulse at the lower hysteresis limit.

Trigger points for positive and negative slopes are shown in *Figure 4-18*.

You can change the trigger slope of the HP E1420B by using the POSitive or NEGative parameters of the SENSE:EVENT:SLOPe commands within the SCPI configuration program message sent prior to initiating a measurement as follows:

SENS :EVENT:SLOPe POSitive (for a positive slope)

- or -

SENS :EVENT:SLOPe NEGative (for a negative slope)

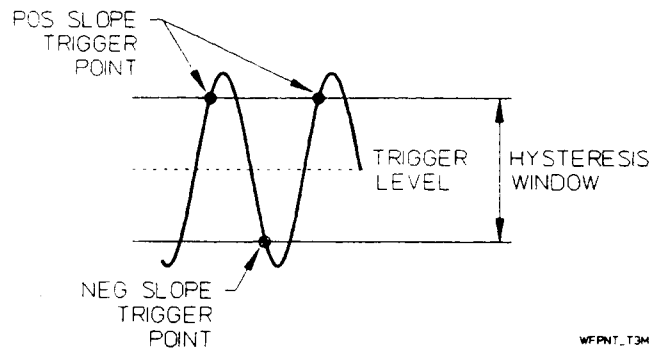

Figure 4-18. Positive and Negative Trigger Points

Input Impedance

Each input has a selectable impedance of 1 M Ω or 50 Ω . With 1 M Ω impedance, the input is shunted by <30pf. At the higher frequencies, the 50 Ω nominal input impedance is usually preferred, since the inherent shunt capacitance of high impedance input rapidly reduces input impedance.

For the lower frequencies, the 1 M Ω input impedance may be selected. The input impedance becomes 500 k Ω (shunted by 40 pf maximum) in the 1 M Ω position when signal routing is in COMMON mode and $\times 1$ attenuation is selected. When $\times 10$ attenuation is selected, it is 1 M Ω (shunted by 20 pf max). In the 50 Ω position, the impedance remains 50 Ω .

You can change the input impedance of the HP E1420B by using the IMPedance parameter of the INPut command and specifying the desired input impedance in ohms within the SCPI configuration program message sent prior to initiating a measurement as follows:

INP:IMP 50 (for a 50 Ω input impedance)

- or -

INP:IMP 1E6 (for a 1 M Ω input impedance)

Damage Level

Damage level is the maximum input voltage the counter can withstand without danger of permanent input hardware failure. The damage level value varies with input attenuation, impedance, coupling selection, and input waveform. For example, the maximum sine wave input signal must never exceed 5/50 volts rms depending on the attenuation setting in 1M Ω mode. In no case should 5 V rms be exceeded with 50 Ω input impedance. Refer to the damage level specifications in *Table A-1*. For accurate measurements, the input signals must stay within the dynamic range and the signal operating range of the counter.

Separate/Common Input 1

Two separate inputs are provided on the HP E1420B. Inputs 1 and 2 may be coupled together to allow maximum versatility. The INPut:ROUte command controls the selection of separate or common input. All specifications are the same for separate or common operation, except sensitivity and impedance. Refer to *Table A-1* for detailed specifications.

When the INP:ROUte command parameter is SEParate, inputs 1 and 2 function independently of each other for all measurements.

When the INP:ROUte parameter is programmed to COMMon, the Input 2 connector is disconnected and the 1 and 2 input amplifiers are connected together at Input 1. The channel 1 coupling and impedance condition the input signal to both channel 1 and 2 Input amplifiers. However, both channels can continue to be programmed independently for trigger levels and slopes. Rise- and Fall-time functions cause the input routing to be set in COMMon mode.

The input impedance becomes 500 k Ω (shunted by 40 pf maximum) when 1 M Ω impedance is active and the Common input and $\times 1$ attenuation are enabled. When 50 Ω impedance is active, the impedance remains 50 Ω for COMMon or SEParate programmed input states. The signal operating range, dynamic range and damage level remain unchanged.

You can change the configuration of HP E1420B input channels by using the COMMon parameter of the INPut command within the SCPI configuration program message sent prior to initiating a measurement as follows:

INPut:ROUte COMMon (for common channel 1 and 2 operation)

- or -

INPut:ROUte SEParate (for separate channel 1 and 2 operation)

The rise- or fall-time measurement functions automatically set up the appropriate routing.

ARMING THE COUNTER

This section describes the procedures (commands and, if necessary, signal connections) used to take advantage of the counter's arming system. It also explains how to abort a measurement by returning the counter to the Idle state before a measurement has completed, or before an arming sequence has completed. Arming provides a means of synchronizing measurements with external signals, internal sources, or other qualifiers such as the Group Execute Trigger (GET).

The SCPI arming selection flow is shown in *Figure 4-19*. (Exact details of SCPI commands, options, and parameters are contained in chapter 5, "Dictionary Command Reference".)

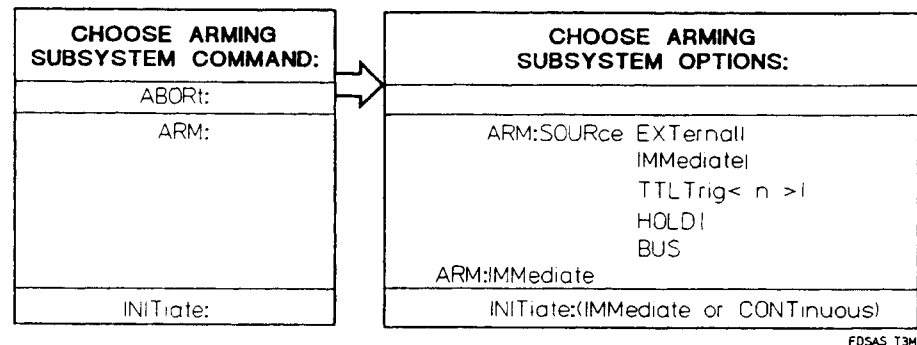

Figure 4-19. SCPI Arming Selection Flow

The HP E1420B may be armed (made ready to start or stop a measurement) via the ARM subsystem by arming sources internal or external to the counter. The counter's ARM subsystem operates in one of two states as shown in *Figure 4-20*:

- Idle state - Configuration of the counter and its arming system occurs while in the Idle state.
- Wait-for-arm state - When the START arm condition is satisfied, the measurement starts as soon as the input signal event crosses the trigger threshold. The next signal event that occurs after the STOP arm condition is satisfied, ends the measurement. This pair of signal events marks the measurement duration.

If INIT:CONT is ON, release from the idle state is immediate. If the measurement does not complete (e.g., totalize), the measurement must be terminated (aborted or reconfigured) before the counter returns to the Idle state.

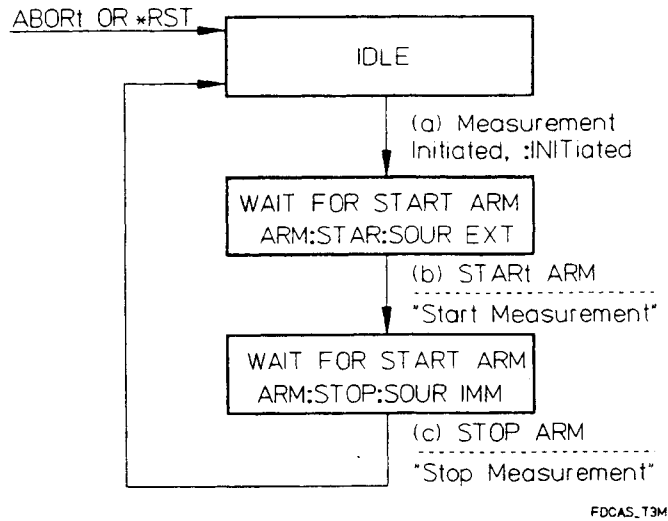

Figure 4-20. Counter Arming System

Internal Arming

Immediate source arming is used for measurements that do not require synchronization with an external signal. All internal arm states are controlled by the arming system commands and the *RST command. The *RST command always puts the counter's arming system in the Idle state. ABORT resets the arming system and places it in the Idle state. Details of these commands can be found in the Dictionary Command Reference (chapter 5).

IMMEDIATE, HOLD, AND BUS

The ARM[:IMMEDIATE] command provides a one-time override for recognition of the arming event (Start or Stop). This command initiates an event and has no *RST condition and cannot be queried.

HOLD suspends arming and hence measurement triggering. Once set, the counter can only resume measurement with the ARM[:IMMEDIATE] command.

If you want the counter to hold-off measurements upon execution of your measurement program messages, the arming system must be in the HOLD arming state. You can place the STOP arming system in the HOLD state by executing the following command string:

ARM:STOP:SOUR HOLD

BUS suspends arming and measurement triggering until the Group Execute Trigger (GET) command is received. A *TRG or word-serial GET command satisfies this condition.

External Arming

The HP E1420B may also be armed (made ready to start or stop a measurement) by applying an external arming signal. This signal can be supplied to the counter via the front-panel BNC Arm input connector or from the TTLTrig bus on the P2 backplane connections, but not simultaneously.

The external ARM input(s) lets you choose the point, on a waveform, at which the start and/or stop of a measurement occurs. Refer to *Table A-1* in Appendix A for specifications on the Arm input. *Figure 4-21* illustrates using external arming to measure frequency at various points along a modulated signal.

The external arm levels may be programmed for 1.6 V (TTL), -1.3 V (ECL), or 0V (GND). Details of these commands can be found in the Dictionary Command Reference (chapter 5).

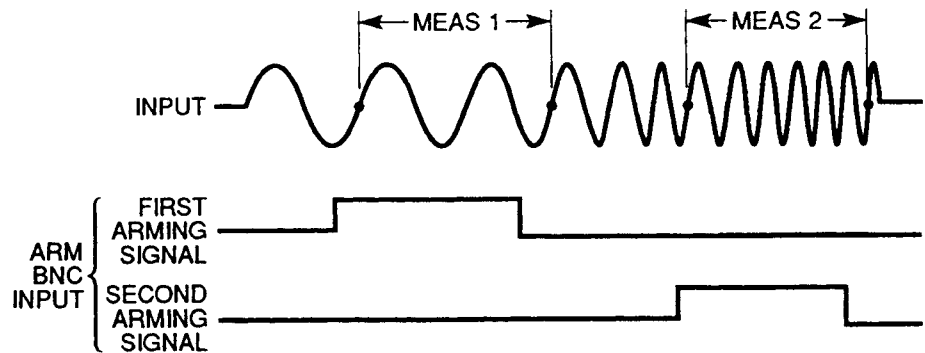

Figure 4-21. Use of External Arming to Measure Frequency

FRONT PANEL ARM INPUT CONNECTION

You can use external arming via the front panel BNC Arm input connector to make measurements that must coincide with a unique signal event outside the counter not available on the VXIbus TTLTrig lines.

You can use external arming via the front-panel BNC Arm input connector with the following command string:

```
ARM:(STOP or START):SOUR EXTERNAL
```

The front panel external Arm Input signal that you've connected to the counter must be within the following Arm input specifications:

<i>Frequency Range</i>	0 - 20 MHz
<i>Input Impedance</i>	1 M Ω (40 pF shunt)
<i>Input Sensitivity</i>	500 mV peak-to-peak
<i>Input Coupling</i>	dc
<i>Slope</i>	positive or negative selectable
<i>Trigger level</i>	Selectable: 0V, 1.6V, and -1.3V (Nominally: GND, TTL, and ECL)
<i>Damage Level</i>	0 to 3.5 kHz: 50V (dc + peak ac) >25 kHz: 5 Vrms

NOTE

You can change the input arming slope and level characteristics by using the LEVel and SLOPe options of the ARM command. Refer to the Dictionary Command Reference in chapter 5.

TTL TRIGGER LINES You can use external arming with the VXIbus backplane TTL trigger lines (TTLTrig0 - TTLTrig7) to facilitate greater measurement flexibility.

External arming via the VXIbus backplane TTL trigger lines can be selected with the following command string:

ARM:(START or STOP):SOURce TTLTrg <n> (Where "n" = VXIbus TTLTrig line #)

The signal on the TTL bus must comply with the VXIbus Specification 1.3 for TTL triggering.

NOTE

External arming may not be used when making Totalize measurements with Firmware Revision below 3401.

MEASUREMENT RESOLUTION

Resolution is the smallest change in a measurement that can be discerned. The more resolution you desire, the longer the gate time needed to sample the input signal. There are two ways to specify resolution. You can set it directly with the SENSE command by changing the Gate time via APERTure, or you can program a particular resolution as a parameter to the MEASure, CONFIgure, or SENSE commands.

The GATE TIME actually determines the resolution of the measurement. You can set it by changing the aperture time with the APERTure command of the SENSE subsystem. The gate time range is 1 millisecond to 99.999 seconds in 1 millisecond increments. The maximum resolution is nine digits, per second of gate time. Thus, one millisecond of gate time will display six digits of resolution.

On power-up, the HP E1420B initializes to the FREQ function on Input 1 with the GATE TIME set at 100 milliseconds and automatic trigger OFF (SENS:EVEN:LEV 0). *Figure 4-22* shows the resolution selection process. (Exact details of SCPI commands, options, and parameters are contained in chapter 5, "Dictionary Command Reference".)

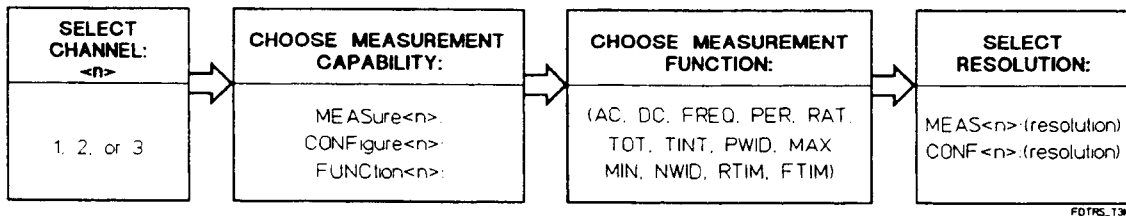

Figure 4-22. SCPI Resolution Selection Flow

Setting The Aperture Time

Aperture (Gate) time can be specified by using the APERTure command of the SENSE subsystem for FREQuency, PERiod, and RATio measurements only. Setting the aperture time selects a specific resolution. Aperture time can be set from 1 ms to 99.999 seconds in steps of 1 ms.

Use the following command string to specify a desired aperture time:

SENS:FREQ:APER n (Where n = aperture time in seconds)

NOTE

By specifying the resolution in a MEASure or CONFigure command, the counter automatically selects the aperture time required to obtain that resolution. Explicitly selecting an aperture time after a CONFigure command will override the automatic selection of the aperture time.

NOTE

The more resolution you ask for, the longer the aperture time required to obtain that resolution. Asking for more resolution than your needs require will decrease measurement speed.

Resolution And Gate Time Calculations

The number of digits of resolution is a direct function of gate time. The absolute resolution in Hertz (for frequency) is a function of both the measurement gate time and signal frequency. *Table 4-1* provides a listing of available digits of resolution, corresponding gate times, and effective resolution in Hertz for 1 MHz, 10 MHz, and 100 MHz.

Table 4-1. Resolution And Gate Time

Digits of Resolution	Gate Time	Resolution in Hertz		
		100 MHz	10 MHz	1 MHz
9	1 sec	0.1	0.01	0.001
8	100 ms	1.0	0.1	0.01
7	10 ms	10	1	0.1
6	1 ms	100	10	1
*5	1 ms	100	10	1
*4	1 ms	100	10	1
*3	1 ms	100	10	1

*The counter gives more resolution than required because the minimum gate time is 1 ms.

An additional digit of resolution is available via 100 Gate Average mode. When enabled, this mode accumulates 100 gated measurements, computes the average, and displays the results. It can be used with all functions except TOTalize, AC, DC, MINimum, and MAXimum.

For more details about exact calculation of resolution and gate time for a given function please refer to *Table A-1* in Appendix A, Specifications, and also to the description of each function contained in chapter 5.

OUTPUT FORMATS

The HP E1420B measurement results are output to the controller in scientific notation as shown in *Figure 4-23*. The output data contains 21 characters arranged in the following format:

- One digit
- Decimal point
- Fourteen Digits
- E ± sign
- Two exponent digits
- Carriage return
- Line Feed

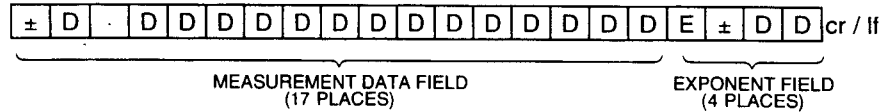
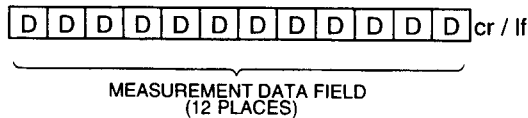

Figure 4-23. Numeric Output Format

Measurement Data Field The data field consists of a 12-character string as shown in the figure.

Exponent The exponent will always be two digits preceded by a ± sign.

Totalize Output For TOTAlize, output format differs from above as follows:



The digits are right justified, that is, if the returned results do not fill all twelve places, the spaces are inserted.

Min/Max/AC/DC The measurement data field for MINimum, MAXimum, AC and DC differs from the above as follows:

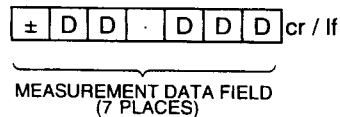

NOTE

15 Mantissa digits are always returned for Frequency, Period, Ratio, Time interval, Rise Time, Fall Time, Positive Pulse Width, and Negative Pulse Width measurements. The user should apply the LSD (Least Significant Digit) formulas to determine the number of significant digits.

E1420B Command Reference

CHAPTER GUIDE

This chapter describes the Standard Commands for Programmable Instruments (SCPI commands) and IEEE 488.2 Common (* - "Star") commands applicable to the HP E1420B Universal Counter. This chapter is organized into four sections summarized below.

Where To Find Important Topics

- Abbreviated Commands pg. 5-2
- Command Parameters pg. 5-3
- Command Separators pg. 5-2
- Command Types pg. 5-2
- Common Command Descriptions pg. 5-11
- Common Command Format/Syntax pg. 5-2
- Implied Commands pg. 5-2
- Linking Commands pg. 5-4
- SCPI Command Descriptions pg. 5-16
- SCPI Command Format/Syntax pg. 5-2

Chapter Summary

- Command Types pg. 5-2
- Command Summary pg. 5-5
- IEEE 488.2 Common Commands pg. 5-11
- HP E1420B SCPI Commands pg. 5-16

COMMAND TYPES

Commands are separated into two types: IEEE 488.2 Common Commands and SCPI Commands. The SCPI commands control instrument measurement/command functions unique to the HP E1420B Universal Counter. The IEEE 488.2 Common commands control and manage communications protocol/information interchange between the counter and the instrument controller.

Common Command Format

The IEEE 488.2 standard defines the Common commands that perform functions like reset, self-test, status byte query, etc. Common commands are four or five characters in length, always begin with the asterisk character (*), and may include one or more parameters. The command keyword is separated from the first parameter by a space character. Some examples of Common commands are shown below:

```
*RST *ESR 32 *STB?
```

SCPI Command Format

The SCPI commands perform functions like counter setup, making measurements, and querying instrument states or retrieving data. A subsystem command structure is a hierarchical structure that usually consists of a top level (or root) command, one or more lower level commands, and their parameters. The following example shows part of a typical subsystem:

```
INPut[1|2]
:IMPedance <number|MINimum|MAXimum|DEFault>
:IMPedance? <MINimum|MAXimum|DEFault>
```

INPut is the root command with :IMPedance and :IMPedance? the second level commands with parameters.

COMMAND SEPARATOR

A colon (:) always separates one command from the next lower level command as shown below:

```
INPut[1|2]:IMPedance?
```

ABBREVIATED COMMANDS

The command syntax shows most commands as a mixture of upper and lower case letters. The upper case letters indicate the abbreviated spelling for the command. For shorter program lines, send the abbreviated form. For better program readability, you may send the entire command. The instrument will accept either the abbreviated form or the entire command.

For example, if the command syntax shows MEASure, then MEAS and MEASURE are both acceptable forms. Other forms of MEASure, such as MEASU or MEASUR will generate an error. You may use upper or lower case letters. Therefore, MEASURE, measure, and MeAsUrE are all acceptable.

IMPLIED CHANNEL

Some commands contain channel numbers in square brackets e.g. [1|2|3]. The brackets indicate that the same programming sequence can be used for all three channels, one of which must be specified. If a channel number is not specified, it will default to 1.

IMPLIED COMMANDS

Implied commands are those which appear in square brackets ([]) in the command syntax. (Note that the brackets are not part of the

command and are not sent to the instrument.) Suppose you send a second level command but do not send the preceding implied command. In this case, the instrument assumes you intend to use the implied command and it responds as if you had sent it. Examine the portion of the SENSE subsystem shown below:

```
[SENSE]
:EVENT
  :SLOPe <POSitive|NEGative>
  :SLOPe?
  :LEVel <number|MINimum|MAXimum|DEFault>
  :LEVel?
```

The root command SENSE: is an implied command. To set the instrument's trigger level to +1.5, you can send either of the following command statements:

SENS:EVENT:LEV 1.5 or EVENT:LEV 1.5

If a command is an implied form but can also accept channel numbers, the implied form pertains to channel 1 only. To switch channels, you must use the channel number in the command string, for example, "SENS2:EVENT:LEV 1.5".

PARAMETER TYPES

Table 5-1 contains explanations and examples of parameter types you might see later in this chapter. Parameter types may be numeric, boolean, or discrete.

OPTIONAL PARAMETERS

Table 5-1. Parameter Types

Type	Explanations and Examples
Numeric:	<p>Accepts all commonly used decimal representations of numbers including optional signs, decimal points, and scientific notation:</p> <p>123, 123E2, -123, -1.23E2, .123, 1.23E-2, 1.23000E-01.</p> <p>Special cases include MIN, MAX, and DEF.</p> <p>MIN selects minimum value available, MAX selects maximum value available, and DEF selects the default or reset value. Queries on MIN, MAX, or DEF result in an associated numeric value. All decimal types also accept MIN, MAX, or DEF, and can be queried with them to produce a numeric value (except with MEASure or CONFigure, or Status Enable registers).</p>
Boolean:	<p>Represents a single binary condition that is either true or false:</p> <p>1 or ON, 0 or OFF (Query response returns only 1 or 0.)</p>
Discrete:	<p>Selects from a finite number of values. These parameters use mnemonics to represent each valid setting. An example is the ARM:SOURce <source> command where source can be BUS, TTLTrg<n>, HOLD, IMMEDIATE, or EXTERNAL.</p>

Parameters shown within square brackets ([]) are optional parameters. (Note that the brackets are not part of the parameter and are not sent to the instrument.) If you do not specify a value for an optional parameter, the instrument chooses an appropriate value.

For example, sending the MEAS:NWID? [ref [,expected value [,resolution]]] command without any parameter as “MEAS:NWID?” causes the counter to choose the value of “ref” as 50%, with the “expected value” and “resolution” being automatically determined.

QUERY PARAMETERS

All selectable numeric parameters can be queried to return the minimum, maximum, or default values they are capable of being set to by sending a MIN, MAX, or DEF optional parameter after the “?”. For example, consider the EVENT:LEVel? [<MIN | MAX | DEF>] command.

If you send the command without specifying a parameter, the present EVENT:LEVel value is returned. If you send the MIN parameter, the command returns the minimum level available. If you send the MAX parameter, the command returns the maximum level available. Be sure to place a space between the command and the parameter.

LINKING COMMANDS

To link IEEE 488.2 Common Commands with SCPI Commands, use a semicolon between the commands. For example:

```
*RST;CONF2:PER
```

Multiple SCPI commands with corresponding parameters can also be sent at the same time. Here, the first command is always referenced to the root node. Subsequent commands, separated by “;”, are referenced to the same level as the previous command if no “:” is present immediately after the command separator. For example, sending:

```
EVEN:LEV 1;SLOP POS
```

is equivalent to sending:

```
EVEN:LEV 1  
EVEN:SLOP POS
```

The “:” must be present to distinguish another root level command. For example:

```
EVEN:LEV 1;;ARM:SOUR EXT
```

is equivalent to sending:

```
EVEN:LEV 1  
ARM:SOUR EXT
```

If the “:” in front of ARM is omitted, the counter assumes that you’ve sent “EVEN:ARM:SOUR EXT” and will generate an error.

COMMAND SUMMARY

This section summarizes both the IEEE 488.2 Common and HP E1420B SCPI (Standardized Commands for Programmable Instruments) commands in tabular format. IEEE 488.2 Common commands appear first followed by SCPI commands for the HP E1420B Universal Counter. The SCPI command summary also includes information about the SCPI status of the HP E1420B SCPI commands.

The SCPI commands used in the counter are in conformance with the SCPI Standard 1990.0. The counter's SCPI commands consist of the following:

- Applicable Common commands as defined in IEEE 488.2.
- Subsystem commands as defined (and listed) in the SCPI Standard. (These are the commands contained in *Table 5-3* as Std.)
- Subsystem commands designed for the counter in conformance with SCPI standards but currently not listed in the SCPI standard. (These are the commands contained in *Table 5-3* as New and may or may not be incorporated in future versions of SCPI.)

IEEE 488.2 Common Commands

Table 5-2 lists the IEEE 488.2 Common commands implemented for the HP E4120A Universal Counter.

Table 5-2. Common Command Summary

COMMAND	DESCRIPTION
*CLS	Clears the Status Byte Register, Standard Event Status Register, and error queue.
*DMC	Assigns a sequence of program elements to a Macro label.
*EMC	Enables/disables the execution of macros.
*EMC?	Returns the current enable/disable status of a macro.
*ESE	Enable events in Standard Event Status Register to be reported.
*ESE?	Returns the sum of all enabled bits in the Standard Event Status Register.
*ESR?	Returns the sum of all set bits in the Standard Event Status Register.
*GMC?	Returns the current definition of a macro.
*IDN?	Returns identification string.
*LMC?	Returns the labels of all currently defined macros.
*OPC	Sets bit 0 in the Standard Event Status Register after all pending operations complete.
*OPC?	Returns ASCII "1" after all pending operations complete.
*PMC	Purges all currently defined macros.
*RCL	Recalls configuration previously stored via the *SAV command.
*RST	Resets the counter to a known power-on/reset status.
*SAV	Saves the current counter module configuration.
*SRE	Enable Status Register bits to assert SRQ.
*SRE?	Returns sum of enabled Status Byte register bits.
*STB?	Returns sum of all bits set in Status Byte Register.
*TRG	Triggers the counter.
*TST?	Executes the counter's internal self-test.
*WAI	Causes the counter to wait until all previous commands or queries complete.

SCPI Commands

Table 5-3 lists the SCPI commands implemented for the HP E4120A Universal Counter.

Table 5-3. SCPI Command Summary

KEYWORD/SYNTAX	PARAMETER FORM	CHANNEL NUMBER	SCPI STATUS
ABORt [1 2 3]		1,2,3	Std
ARM			Std
[:SEQuence[1]][:STARt[]]			Std
:SEQuence2[:STOP			Std
[:LAYer[1]]			Std
[:IMMediate]			Std
:LEVel	<value MINimum MAXimum DEFault>		Std
:LEVel?	[<MINimum MAXimum DEFault>]		Std
:SLOPe	<POSitive NEGative>		Std
:SLOPe?			Std
:SOURce	<EXTernal IMMediate BUS		Std
:SOURce?	HOLD TTLTrig<n>> n= 0-7		Std
CONFigure [1 2 3]			Std
[:VOLTage]			Std
:AC	[<expected value>,<resolution>]]	1,2	Std
:DC	[<expected value>,<resolution>]]	1,2	Std
:FREQuency	[<expected value>,<resolution>]]	1,2,3	Std
:RATio	[<expected value>,<resolution>]]	1,2,3	New
:FTIME			Std
- or -			
:FALL			
:TIME	[<lower reference>,<upper reference>	1	Std
	[,<expected value>,<resolution>]]]]		
:MAXimum	[<expected value>,<resolution>]]	1,2	Std
:MINimum	[<expected value>,<resolution>]]	1,2	Std
:NWIDth	[<reference>,<expected value>	1,2	Std
	[,<resolution>]]]		
:PERiod	[<expected value>,<resolution>]]	1,2,3	Std
:PWIDth	[<reference>,<expected value>	1,2	Std
	[,<resolution>]]]		
:RTIME			Std
- or -			
:RISE			
:TIME	[<lower reference>,<upper reference>	1	Std
	[,<expected value>,<resolution>]]]]		
:TINTerval	[<expected value>,<resolution>]]	1	New
:TOTalize	[<expected value>,<resolution>]]	1	New
CONFigure[1 2 3]?			Std

Table 5-3. SCPI Command Summary (Continued)

KEYWORD/SYNTAX	PARAMETER FORM	CHANNEL NUMBER	SCPI STATUS
DIAGnostics			Std
:CALibrate			New
:OFFSet?	<BOTH>		New
:FULLscale?	<BOTH>		New
:ASSEMBly			New
[:ALL]?			
:A1?			New
:A2?			New
:BLOCK			New
[:ALL]?			New
:CALRam?			New
:ROM?			New
:RAM?			New
:COUNTchain			New
[:ALL]?			New
:CONNECTor?			New
:INTERpolat?			New
:DINTERpolat?			New
:MRC?			New
:TIMEbase?			New
:READ			New
:INT?	<STS SPS STL SPL START STOP CAL ALL>		New
:MRC?	<EREG TREG ALL>		New
:UFAiI[?]	<OFF 0 ON 1> (N/A for Query)		New
FETCH[1 2 3]			Std
[:<function>]?		1,2,3	
INITiate[1 2 3]			Std
[:IMMediate]			Std
:CONTInuous	<OFF 0 ON 1>		Std
:CONTInuous?			Std
INPut[1 2]			Std
:ATTenuation	<value MINimum MAXimum DEFault>	1,2	Std
:ATTenuation?	[<MINimum MAXimum DEFault>]	1,2	Std
:COUPling	<AC DC>	1,2	Std
:COUPling?		1,2	Std
:IMPedance	<value MINimum MAXimum DEFault>	1,2	Std
:IMPedance?	[<MINimum MAXimum DEFault>]	1,2	Std
:ROUTE	<COMMOn SEParate>	1	New
:ROUTE?		1,2	New

Table 5-3. SCPI Command Summary (Continued)

KEYWORD/SYNTAX	PARAMETER FORM	CHANNEL NUMBER	SCPI STATUS
MEASure [1 2 3]			Std
[:VOLTage]			Std
:AC?	[<expected value>[,<resolution>]]	1,2	Std
:DC?	[<expected value>[,<resolution>]]	1,2	Std
:FREQuency?	[<expected value>[,<resolution>]]	1,2,3	Std
:RATio?	[<expected value>[,<resolution>]]	1,2,3	New
:FTIME?			Std
- or -			
:FALL			
:TIME?	[<lower reference>[,<upper reference> [,<expected value>[,<resolution>]]]]	1	Std
:MAXimum?	[<expected value>[,<resolution>]]	1,2	Std
:MINimum?	[<expected value>[,<resolution>]]	1,2	Std
:NWIDTH?	[<reference>[,<expected value> [,<resolution>]]]	1,2	Std
:PERiod?	[<expected value>[,<resolution>]]	1,2,3	Std
:PWIDth?	[<reference>[,<expected value> [,<resolution>]]]	1,2	Std
:RTIME?			Std
- or -			
:RISE			
:TIME?	[<lower reference>[,<upper reference> [,<expected value>[,<resolution>]]]]	1	Std
:TINTerval?	[<expected value>[,<resolution>]]	1	New
MEMory			
:VME:ADDRESS	<address>		New
:VME:ADDRESS?	[MINimum MAXimum]		New
:VME:SIZE	<bytes>		New
:VME:SIZE?	[MINimum MAXimum]		New
:VME:STATE	<OFF 0, ON 1>		New
:VME:STATE?			New
OUTPut			Std
:TTLTrg<n> n= 0-7		Backplane	Std
[:STATE]	<OFF 0 ON 1>	Trigger Lines	Std
[:STATE]?			Std
:ROSCillator		Int/Ext	New
[:STATE]	<OFF 0 ON 1>	Reference	New
[:STATE]?			New
READ [1 2 3]			Std
[:<function>]?		1,2,3	

Table 5-3. SCPI Command Summary (Continued)

KEYWORD/SYNTAX	PARAMETER FORM	CHANNEL NUMBER	SCPI STATUS
[SENSe[1 2 3]]			Std
:AVERage		1,2	New
[:STATe]	<OFF 0 ON 1>		New
[:STATe]?			New
:COUNT?			New
:EVENT		1,2	New
:LEVel			New
[:ABSolute]	<value MINimum MAXimum DEFault>		New
[:ABSolute]?	[<MINimum MAXimum DEFault>]		New
:AUTO	<OFF 0 ON 1 ONCE>		New
:AUTO?			New
:RELative	<value MINimum MAXimum DEFault>		New
:RELative?	[<MINimum MAXimum DEFault>]		New
:SLOPe	<POSitive NEGative>		New
:SLOPe?			New
:HYSTeresis	<MINimum MAXimum DEFault>		New
:HYSTeresis?			New
:FREQuency			Std
:APERture	<value MINimum MAXimum DEFault>	1,2,3	Std
:APERture?	[<MINimum MAXimum DEFault>]	1,2,3	Std
:RANGe		1	Std
[:UPPer]	<value MINimum MAXimum DEFault>		Std
[:UPPer]?	[<MINimum MAXimum DEFault>]		Std
:AUTO	<OFF 0 ON 1>		Std
:AUTO?			Std
:FUNction	"[VOLTage:]AC"	1,2	Std
	"[VOLTage:]DC"	1,2	Std
	"[VOLTage:]FREQuency"	1,2,3	Std
	"[VOLTage:]FREQuency:RATio"	1,2,3	New
	"[VOLTage:]FTIME"	1	New
	"[VOLTage:]FALL:TIME"	1	New
	"[VOLTage:]MAXimum"	1,2	New
	"[VOLTage:]MINimum"	1,2	New
	"[VOLTage:]NWIDth"	1,2	New
	"[VOLTage:]PERiod"	1,2,3	New
	"[VOLTage:]PWIDth"	1,2	New
	"[VOLTage:]RTIME"	1	New
	"[VOLTage:]RISE:TIME"	1	New
	"[VOLTage:]TINTerval"	1,2	New
	"[VOLTage:]TOTAlize"	1,2	New
:FUNction?		1,2,3	Std
:PERiod			New
:APERture	<value MINimum MAXimum DEFault>	1,2,3	New
:APERture?	[<MINimum MAXimum DEFault>]	1,2,3	New
:RATio			New
:APERture	<value MINimum MAXimum DEFault>	1,2,3	New
:APERture?	[<MINimum MAXimum DEFault>]	1,2,3	New

Table 5-3. SCPI Command Summary (Continued)

KEYWORD/SYNTAX	PARAMETER FORM	CHANNEL NUMBER	SCPI STATUS
[SENSe[1 2 3]] (continued)			
:ROSCillator			Std
:SOURce	<INTernal EXTernal CLK10>	Int/Ext Reference	New
:SOURce?			New
:TINTerval			New
:DELay			New
[:STATe]	<OFF 0 ON 1>		New
[:STATe]?			New
:TIME	<value MINimum MAXimum DEFault>		New
:TIME?	[<MINimum MAXimum DEFault>]		New
:TOTalize			New
:GATE			New
[:STATe]	<OFF 0 ON 1>		New
[:STATe]?			New
:POLarity	<NORMal INVerted>		New
:POLarity?			New
:SOURce?			New
STATus			Std
:OPERation			Std
:CONDition?			Std
:ENABle	<value> <non-decimal numeric>		Std
:ENABle?			Std
[:EVENt]?			Std
:QUEStionable			Std
:CONDition?			Std
:ENABle	<value> <non-decimal numeric>		Std
:ENABle?			Std
[:EVENt]?			Std
:PRESet			Std
SYSTem			Std
:ERRor?			Std
:PIMacro	<string>		New
:VERSion?	<string>		Std

IEEE 488.2 COMMON COMMANDS

This section describes the IEEE 488.2 Common commands and Queries for the HP E1420B Universal Counter. Descriptive information about function and operation are included for each command. For complete details of the common commands refer to ANSI/IEEE Standard 488.2 - 1987.

***CLS** **(Clear Status)**

The Clear Status command clears status data structures, the Request-for-OPC flag, and forces the counter into the Operation Complete Command Idle State and the Operation Complete Query Idle State. The status data structures include all Event registers and all Queues, except the Output Queue.

***DMC** **(Define Macro)**

The Define Macro command lets you assign a sequence of program elements to a macro label. The sequence is executed when the label is received as a command or query program header. This macro helps minimize backplane command traffic. The detailed description is described in the IEEE 488.2 - 1987 standard.

You can define a macro by sending the *DMC command, followed by a string designating the label. Following the label, you must send an <Arbitrary Block Program Data> element defining the macro. For example:

```
*DMC "TCXO",#214:ROSC:SOUR INT
```

defines a macro with the name "TCXO" that selects the internal timebase (option 010 if installed) as the counter's timebase.

The components of a macro command statement are composed of the following syntactic elements:

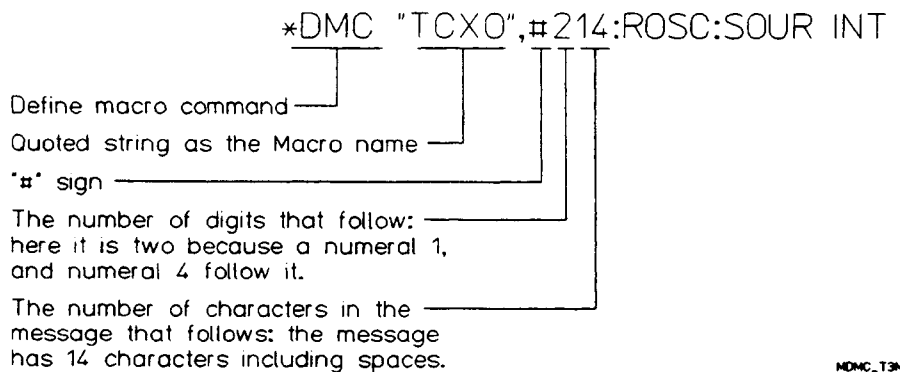

MDMC_T3M

Macro definitions also allow you to pass parameters with the macro. Placeholders for parameters appear as a dollar sign (ASCII \$, 36 decimal) followed by a single digit in the range 1 to 9 (49-57 decimal). For example:

```
*DMC "EXT_ARM",#243ARM:SOUR EXT;:ARM:STOP:SOUR  
EXT;:ARM:LEV $1
```

defines a macro with one parameter. Sending the command

```
"EXT_ARM -1.3"
```

would be equivalent to sending these three commands to the counter:

```
ARM:SOUR EXT  
ARM:STOP:SOUR EXT  
ARM:LEV -1.3
```

The macro label may be either a command or a query. The label cannot be the same as a common command or common query. It may be the same as a counter dependent command. When a macro label is the same as a counter dependent command, the counter will execute the macro rather than the counter command if macros are enabled.

***EMC (Enable Macro)**

This command enables and disables the expansion of macros by a counter. However, it does not affect the macro definitions. An example of the use of this command is to turn off macros in order to use a counter dependent command which has the same name as a macro. Sending this command followed by 0 will disable all macros. Sending an integer other than 0 in the range -32768 to 32767 will enable macros. If the number does not round to an integer within this range, execution error -200 will be reported.

For example, sending

```
*EMC 0
```

will disable macros. Sending

```
*EMC -12
```

will enable macros.

***EMC? (Enable Macro Query)**

The Enable Macro Query allows the user to determine whether or not macros are enabled on the counter. The counter will return a value of 1 (ASCII 49 decimal) when macros are enabled. It will return a value of 0 (ASCII 48 decimal) when macros are disabled.

***ESE
(Standard Event Status
Enable)**

The Standard Event Status Enable Command sets the Standard Event Status Enable Register bits. The data is defined as <Decimal Numeric Program Data>. The counter rounds this number to an integer., Expressing this number in base 2 (binary) represents values of the individual bits of the Standard Event Status Enable Register.

For example, to set bit 5 (Command Error) and bit 2 (Query Error) the command

*ESE 36

would be sent to the counter. The number sent to the counter must be in the range 0 to 255 or an Execution Error, -222, "Data out of range", occurs. (Refer to STATus command description for more information about the Standard Event Status Register.)

***ESE?
(Standard Event Status
Enable Query)**

The command reads the contents of the Standard Event Status Enable Register (SESER). In response to this query the counter sends the contents of the SESR in integer format. It will be in the range 0 to 255.

***ESR?
(Event Status Register
Query)**

The Event Status Register Query command reads the contents of the Standard Event Status Register. Reading this register clears it. It returns an integer, which, when converted to a binary number represents the contents of the individual bits of the register. This number will be in the range 0 to 255 decimal.

***GMC?
(Get Macro Contents
Query)**

The Get Macro Contents Query command allows you to obtain the current definition of a macro from the counter. Simply send the "GMC?" query followed by the label string of the macro. The counter responds with a <Definite Length Arbitrary Block Response Data> element which contains the macro definition.

For example, sending

*GMC? "TCXO"

to a counter will tell it to send the macro definition for the macro "TCXO" defined earlier. An attempt to retrieve the contents of an undefined macro returns a zero length block and reports an execution error, -270, "Macro error".

***IDN?
(Identification Query)**

The Identification Query causes the counter to send its "identity" over the bus as an <Arbitrary ASCII Response Data> element. The response string for the E1420B Universal Counter will appear as follows:

HEWLETT-PACKARD,E1420B,3401

The entire length of the response is 72 characters or less. The last field of the response (3401) is the firmware revision date code.

***LMC?**
(Learn Macro Query)

The Learn Macro Query instructs the counter to respond with the labels of all the currently defined macros. The counter will respond with strings separated by commas. If no macros are defined the counter will return a null string of two consecutive double quote (") marks. The response is the same whether or not macros are enabled or disabled.

***OPC**
(Operation Complete)

The Operation Complete command tells the counter to set bit 0 in the Standard Event Status Register when it completes all pending operations.

***OPC?**
(Operation Complete Query)

The Operation Complete Query tells the counter to place an ASCII '1' (decimal 49) in the counter's output queue when it completes all pending operations.

***PMC**
(Purge Macros)

The Purge Macros Command causes the counter to delete all macros in memory that were defined by the *DMC command. All macro sequences and labels are removed from memory. You can purge single macros by using the SYST:PIM command of the SYSTEM subsystem.

***RCL**
(Recall)

The Recall command restores the state of a counter from a copy previously stored in local memory through the *SAV command. The counter has I/O storage areas, so the command includes a numeric parameter to indicate which storage area to use. These numbers will begin at zero and end at nine.

***RST**
(Reset)

This command resets the counter.

The Reset command:

1. Sets the counter-dependent functions to a known state, independent of its current state. (Refer to Table 3-2.)
2. Disables macros
3. Aborts all pending operations
4. Forces the counter to forget about any previously received *OPC commands

The Reset command does NOT affect:

1. The Output Queue
2. The Error Queue
3. The Service Request Enable Register
4. The Standard Event Status Enable Register
5. The power-on flag
6. Macros (except to disable them)
7. Calibration data
8. The Protected User Data (e.g. Save/Recall states)

- *SAV
(Save)** The Save Command stores the present state of the counter in local memory. The counter has ten locations in which to store this data. Therefore, the command is followed by a numeric parameter designating the storage area to use. These numbers begin at zero and end at nine. The instrument states are stored until power is removed from the counter.
- *SRE
(Service Request Enable)** The Service Request Enable command sets the Service Request Enable Register. This register determines what bits in the Status Byte will cause a service request from the counter. The data sent with the command is a <Decimal Numeric Program Data>. The counter rounds this number to an integer. Expressing this number in base 2 (binary) would then represent the values of the individual bits of the Service Request Enable Register.
- For example, to set bit 4 (Message Available) the command
- *SRE 16**
- would be sent. The counter would then cause a service request when data is ready.
- *SRE?
(Service Request Enable Query)** The Service Request Enable Query command reads the contents of the Service Request Enable Register. The counter returns the data as an <NR1> (integer), in the range 0 to 63 or 128 to 191, since bit 6 (the RQS bit) cannot be set.
- *STB?
(Status Byte Query)** The Status Byte Query command reads the status byte with the Master Summary Status (MSS) bit. The counter responds with an integer in the range 0 to 255. These bits represent the contents of the status byte. Bit 6 represents MSS rather than RQS (Request Service). (Refer to STATUS command for more information about the Status Byte Register.)
- *TRG
(Trigger)** The Trigger command causes the counter to immediately start/stop a measurement if the corresponding ARM source is previously programmed to "BUS". When "BUS" is selected as a source, the word-serial command <GET> or *TRG will satisfy the arming condition. The measurement must be INITiated prior to sending *TRG (refer to the INITiate command).
- *TST?
(Self-Test Query)** The Self-Test Query command causes the counter to execute an internal self-test and report whether or not it detected any errors. When the counter indicates an error(s), execute "DIAG:ASS:ALL?" to assess hardware failure. The *TST? command may take up to 10 seconds to execute.
- A zero response means that the test completed without detecting any errors. A response of "1" indicates a failure.
- *WAI
(Wait)** The Wait to Continue command makes the counter wait until all the previous commands or queries complete. It thus forces the sequential execution of commands. The counter then continues executing commands that follow the *WAI command.

HP E1420B SCPI COMMANDS

This section describes the Standard Commands for Programmable Instruments (SCPI commands) for the HP E1420B Universal Counter. The listings are alphabetical by SCPI root command.

ABORt

The ABORt command terminates a measurement and places the counter into the idle state.

Syntax:

ABORt[1|2|3]

Parameters:

Only one channel number can be specified in the command. The channel number defaults to channel 1 if a channel number is not specified.

Comments

- If the continuous mode is active, the counter aborts the current measurement and resumes making measurements.
- Implied ABORt: In general, it is not necessary to abort a measurement using the ABORt command. Selecting a new function or initiating a new measurement will perform an implied abort.
- If the counter is waiting to respond to a query, a word-serial "Clear" must be sent to exit the query.
- *TRG following ABORt generates "trigger ignored error" (-210).

Example:

CONF2:PER	Channel 2 function is period
ARM:SOUR HOLD	Suspend the START ARM condition
INIT2	Channel 2 go to wait-for-arm state
.	
.	
.	
ABOR2	Channel 2 go to idle state

ARM The purpose of the ARM command is to qualify a single event to start or stop a measurement. The ARM subsystem of the E1420B provides:

- A selectable arming source,
- A selectable arming slope,
- A selectable arming trigger level for an external arming signal,
- A one-time software override of the arm event detection layer.

Subsystem Syntax:

```

ARM
  [:SEquence[1]:START]
  :SEquence2]:STOP
  [:LAYer[1]]
    [:IMMediate]
      :LEVel          <value|MINimum|MAXimum|DEFault>
      :LEVel?        [<MINimum|Maximum|DEFault>]
      :SLOPe         <POSitive|NEGative>
      :SLOPe?
      :SOURce        <EXTernal|IMMediate|BUS|
                    HOLD|TTLTrig<n>> n= 0-7
      :SOURce?

```

[:SEquence[1] or :START] Determines how “Start-Arm” (to start measurement) is programmed based on the command options and parameters in the command levels following START.

:SEquence2 or :STOP Determines how “Stop-Arm” (to stop measurement) is programmed based on the command options and parameters in the command levels following STOP.

[:LAYer[1]] This command provides entry into future arming and event detection schemes.

[:IMMediate] [:IMMediate] causes an immediate exit from the event detection layer for one measurement. The measurement cycle occurs immediately provided the arming system is initiated (see the INITiate subsystem). If [:IMMediate] is associated with ARM:START, the counter is armed to start measurement immediately, ignoring the arming source for the current measurement. If [:IMMediate] is associated with ARM:STOP, then the counter is armed immediately to stop measurement ignoring the arming source for the current measurement.

- Comments**
- All previously programmed values for :SOURce, :LEVel, and :SLOPe remain in effect after the single-shot exit from the arming subsystem initiated by [:IMMediate]
 - ARM commands configure the arming subsystem but do not arm the counter. The INITiate command enables the arming subsystem.
 - If an ARM:IMMediate command is sent prior to INITiating a measurement, error -212, “Arm ignored”, is returned.

<i>Example</i>	CONF1:FREQ	Function is frequency on channel 1.
	ARM:STAR:SOUR EXT ARM:STAR:SLOP POS	Start measurement armed with rising edge of external arming source.
	ARM:STOP:SOUR EXT ARM:STOP:SLOP NEG	Stop measurement armed with falling edge of external arming source.
	INIT	Initiate a measurement.
	ARM:STAR:IMMediate	For one measurement only, start arm is immediate. Counter doesn't wait for rising edge of the external Arm signal, but does wait for the falling edge.
	FETC?	Place measurement in the output buffer.
	INIT	Initiate a measurement that will not start until the counter receives the rising edge of an external arming source.

:LEVel ARM:LEVel <numeric value> configures the ARM subsystem to qualify the selected amplitude of a source signal arriving at the front panel ARM connector signal that generates a measurement. Parameter entry is -1.3, +1.6, or 0 volts.

Parameters	Parameter Name	Parameter Type	Range of Values	Default Value
	level	values	-5 to -.999 results as nominal -1.3 V for ECL -1 to +1 results as 0V for GND +1.001 to +5 results as nominal 1.6V for TTL	1.6
		discrete	MIN (-1.3 volts ECL) MAX (+1.6 volts TTL) DEF (0 volts GND)	

- Comments*
- LEVel is functional only when arming is EXTERNAL via the front panel BNC connector.
 - Even though values between -5 and +5 volts are accepted, the counter will program only three nominal values suitable for TTL, ECL, or ac-coupled signals.
 - For TTLTrg lines, this value is ignored as the counter automatically defaults to the TTL level (nominally 1.6 volts).
 - At *RST, this value is set to 1.6 volts.

Example ARM:STAR:LEVel 0 Trigger level for external arm signal is set to 0 volts.

:LEVel? ARM:LEVel? returns the discrete value currently assigned to the trigger subsystem LEVel command. The quoted string is sent to the output buffer. An example of the use of this query is shown below:

ARM:LEVel? Query counter to return trigger level setting.

“ENTER” statement Enter value into controller.

:SLOPe ARM:SLOPe <discrete value> configures the trigger subsystem to select the slope of a selected source (EXTernal or TTLTrg) that generates a measurement. SLOPe qualifies whether the event occurs on the rising edge or falling edge of the signal. Parameter entry is discrete: either positive or negative.

Parameters	Parameter Name	Parameter Type	Range of Values	Default Value
	slope	discrete	<POSitive NEGative>	POS

- Comments*
- At *RST, this value is set to POS.
 - Useful for EXTernal arm source or TTLTrg lines.

Example ARM:STOP:SLOPe POS Specify the SLOPe command of the ARM subsystem.

:SLOPe? ARM:SLOPe? returns the discrete value currently assigned to the trigger subsystem SLOPe command. The quoted string is sent to the output buffer. An example of the use of this query is shown below:

ARM:SLOPe? Query counter to return trigger slope setting.

“ENTER” statement Enter value into controller.

:SOURce ARM:SOURce <source> configures the trigger subsystem to respond to the specified source. The following sources are available:

- **BUS:** Enables the counter to arm a measurement when the Common *TRG or <GET> (Group Execute Trigger) command is sent over the VXIbus. The counter must be initiated to recognize the *TRG or <GET> command.
- **EXTernal:** The front-panel ARM input connector is selected as the source.
- **IMMediate:** The arming system is always true.
- **HOLD:** Suspend arming. Once in HOLD mode, the counter can only be armed by the “ARM:IMMediate” command.
- **TTLTrig:** The signal source is the specified VXI P2 backplane TTLTrig TRIGGER line. Valid lines are TTLTrig0 through TTLTrig7.

Parameters	Parameter Name	Parameter Type	Range of Values	Default Value
	source	discrete	<EXternal IMMEDIATE BUS HOLD TTLTrig<n>>	IMM
<i>Comments</i>	<ul style="list-style-type: none"> • If EXTERNAL is selected as the first Start/Stop source, then another source such as TTLTrg cannot be selected as the second Start/Stop source. If such a mixed-source combination is programmed, the counter will generate error -205, "Arming configuration conflict", upon initiation. • ARM[:IMMEDIATE] causes an arming cycle to occur immediately provided the Trigger subsystem has been initiated by the INITiate command. This command ignores the current arming source. • Because ARM:IMMEDIATE is an event, it has no query condition. • *RST Condition: ARM:SOUR IMM 			
<i>Example 1</i>	CONF1:PER		Function is period on channel 1.	
	ARM:STAR:SOUR TTLT0		Arming Start/Stop source is the specified TTLTrig 0 line of the VXIbus P2 bus.	
	ARM:STOP:SOUR TTLT0		Arming Stop source is the specified TTLTrig 0 line of the VXIbus P2 bus.	
	ARM:STAR:SLOP NEG		Arming Start specified as negative edge.	
	ARM:STOP:SLOP POS		Arming Stop specified as positive edge.	
	READ?		Place counter in wait-for-arm state.	
			Measurement is made when the specified VXIbus P2 TTLTrig line goes low.	
<i>Example 2</i>	CONF1:FREQ		Function is frequency on channel 1.	
	ARM:START:SOURce BUS		Arming START source is the BUS when *TRG is sent.	
	INIT		Initiate a measurement. The counter waits for *TRG or <GET> on the backplane.	
	*TRG		Satisfy arming subsystem, take a measurement.	
	FETCH?		Transfer the data to the output queue.	
<i>:SOURce?</i>	:SOURce? returns BUS, EXT, IMM, HOLD, or TTLT<n>, indicating the current arming source. The quoted string is sent to the output buffer. An example of the use of this query is shown below:			
	ARM:STOP:SOUR HOLD		Arming source for Stop arming is suspended.	
	ARM:STOP:SOUR?		Query counter to return arm source setting.	
	"ENTER" statement		Enter value into controller.	

CONFigure

The CONFigure command subsystem sets up the counter to perform a specified measurement but does not perform the actual measurement. Use the INITiate and FETCh? or READ? command to initiate and read the measurement.

Syntax:

```
CONFigure[1|2|3]
[:VOLTage]
:AC          [<expected value>[,<resolution>]]*
:DC          [<expected value>[,<resolution>]]*
:FREQuency  [<expected value>[,<resolution>]]
:RATio      [<expected value>[,<resolution>]]
:FTIME
- or -
:FALL
:TIME       [<lower reference>[,<upper reference>
            [,<expected value>[,<resolution>]]]]
:MAXimum    [<expected value>[,<resolution>]]*
:MINimum    [<expected value>[,<resolution>]]*
:NWIDth     [<reference>[,<expected value>
            [,<resolution>]]]
:PERiod     [<expected value>[,<resolution>]]
:PWIDth     [<reference>[,<expected value>
            [,<resolution>]]]
:RTIME
- or -
:RISE
:TIME       [<lower reference>[,<upper reference>
            [,<expected value>[,<resolution>]]]]
:TINTerval  [<expected value>[,<resolution>]]
:TOTALize   [<expected value>[,<resolution>]]*
```

*Expected value and resolution parameters are accepted but ignored for AC, DC, MINimum, MAXimum, and TOTALize measurements.

Comments

- Manually entered expected value: If the optional parameters expected value and resolution are specified, the state of the counter will be changed to obtain the requested resolution.
- Specifying optional parameters: The optional parameters can be defaulted from right-to-left. For example, if a value for resolution is to be entered, the expected value must be specified. If the parameter is explicitly omitted, the best possible value is chosen.
- [:VOLTage] is an implied node and may be omitted from the program message.
- Auto Acquire: If the optional parameters expected value and resolution are not entered, the gate time is set by the counter.
- Auto Trigger: Making measurements with Auto Trigger greatly reduces throughput as compared to measurement speed when trigger levels are programmed manually. During auto triggered frequency measurements, the counter determines the positive and negative voltage peaks of the input signal. It then programs

the trigger level according to the current SENSE:EVENT:LEVEL:RELATIVE parameter value. Auto trigger does not affect the attenuation factor.

During auto triggered rise/fall time measurements, channel 1 is programmed for 10% (90%) value and channel 2 is programmed for 90% (10%) value. Rise/fall time measurements use both input amplifiers (common input channel 1). A signal arriving at the channel 2 Input connector is not counted.

- CONFigure and MEASure versus SENSE: Most measurements can be performed using one of these three subsystems, and each has advantages and disadvantages over the other. The basic difference between the commands is as follows:

The CONFigure command can be used for all measurements except “gated totalize” and “time-interval delay” measurements. The CONFigure command only configures a channel for a specific function, and does not perform the measurement. Use of additional commands (READ?, or INIT/FETC?) to perform the measurement and read the results is necessary. Further customization of the counter set-up is provided, through the use of optional parameters.

The MEASure command can be used for all measurements except TOTAlize. The MEASure command configures a channel for a specific function, performs the measurement, and returns the result to the output buffer. Further customization of the counter set-up is provided, through the use of optional parameters.

The MEASure command is instrument independent and can be used in other instruments to perform similar functions. This command should be used when the portability of instrument syntax is important. CONFigure/READ? is less compatible if the counter re-configuration occurs between the CONFigure and READ? operations.

The SENSE subsystem can be used for all measurements. The SENSE:FUNCTION command only configures a channel for a specific function and does not perform the measurement. The state of the counter is not otherwise affected. Use of additional commands (READ?, or INIT/FETC?) to perform the measurement and store the results is required.

The SENSE commands should be used when direct control over the measurement is important.

:AC CONFigure[1 | 2][:VOLTage]:AC [<expected value>[,<resolution>]]
configures the counter to measure the rms ac voltage component of the input ac sinusoidal signal. This command does not initiate the measurement process.

Parameters There are no parameters for the AC function. However, expected value and resolution are accepted by the command but ignored.

- Comments*
- Channel Selection: Valid for channels 1 and 2 only.
 - If $\times 10$ attenuation is active, multiply the results by 10 to get the actual voltages.
 - Type of Signal Measured: Signals must be sinusoidal for the ac voltage function.
 - This function configures the counter for Auto triggered measurements on the selected channel.
 - Expected value and resolution are accepted but ignored.

:DC **CONFigure[1 | 2][:VOLTage]:DC** [<expected value>[,<resolution>]] configures the counter to measure the dc component of the input ac signal. This function assumes symmetrical signals because the dc value is calculated as a center point between positive and negative peak values of the signal. This command does not initiate the measurement process.

Parameters There are no parameters for the DC function. However, expected value and resolution are accepted by the command but ignored.

- Comments*
- Channel Selection: Valid on channels 1 and 2 only.
 - If $\times 10$ attenuation is active, multiply the results by 10 to get the actual voltages.
 - Type of Signal Measured: Signals must be periodic and symmetrical for the dc voltage function.
 - Channel 2 cannot make a measurement on a dc input signal.
 - This function configures the counter for Auto triggered measurements on the selected channel.
 - Expected value and resolution are accepted but ignored.

:FREQuency **CONFigure[1 | 2 | 3][:VOLTage]:FREQuency** [<expected value>[,<resolution>]] configures the counter for the frequency measurement function. This command does not initiate the measurement process.

<i>Parameters</i>	Parameter Name	Parameter Type	Range of Values	Default Value
	expected value	numeric	.001 to 200E6 Hz (ch 1) .001 to 100E6 Hz (ch 2) 90E6 to Per Spec (ch 3)	N/A
		discrete	DEF MIN MAX AUTO	
	resolution	numeric	1E-9 to 1E5 Hz	9 digits
		discrete	DEF MIN MAX	

Comments

- Channel Selection: Valid for channels 1, 2, and 3, but only one channel is selected at a time.
- Type of Signal Measured: Signals must be periodic for the frequency function as the counter measures average frequency over the gate time.
- Entering Expected value: Expected value can be entered as a number in Hz from 0.001 Hz to 200/100 MHz for channels 1 and 2 respectively. For channel 3, value can be entered as a number in Hz from 90 MHz to Per Spec. Selecting a value greater than 100 MHz, enables prescaling (divide by 2) on channel 1.
- Entering Resolution: Resolution is entered as a number from 1E-9 Hz to 100 kHz. Entries up to 1E8 for channels 1 and 2 and 1E9 for channel 3 will be accepted. Resolution is automatically set for 9 digits of resolution by not entering a value for the optional resolution parameter. If resolution is entered, expected value must also be entered.
- If no parameters are entered, the counter goes into auto-ranging mode using a gate time of 400 ms.
- If the entered parameters are out of range, then the counter returns error -209, "Data clipped to limit".

Refer to Chapter 4, Measurement Resolution, for more information regarding numeric entry. Refer to *Table 5-4* for instrument settings when using the command with discrete parameters.

Table 5-4 Frequency Resolution and Expected Value

		— EXPECTED VALUE* —					
		min	max	def	auto	no param	num
RESOLUTION	min	1ms, off	1ms, on	1ms, off	100ms, auto	N/A	If FREQ ≥ 100 MHz, then 800 ms, ON If FREQ < 100 MHz, then 400 ms, OFF
	max	800ms, off	800ms, on	400ms, off	1 sec, auto	N/A	
	def	100ms, off	100ms, on	100ms, off	100ms, auto	N/A	
	no param	400ms, off	400ms, on	400ms, off	400ms, auto	400ms, auto	
	num	1 sec, off	case B, on	case A, off	1 sec, auto	N/A	Gate time = (4ns/Res)*Freq.
Case A		4sec	400ms	40ms	4ms	4ms	
Case B		800ms	800ms	800ms	80ms	8ms	
Resolution (R)		0<R<0.05	0.05<R<0.5	0.5<R<5	5<R<50	50<R	
* Each cell entry = Gate time, Prescaler on/off/auto N/A = Not applicable							

Example CONF1:FREQ 1E6,0.1 Channel 1; Function: Frequency; expected value: 1 MHz; resolution: 0.1 Hz, Prescaler - off, gate time = 40 ms from formula.

READ? Take a reading

:FREQuency:RATio

CONFigure[1 | 2 | 3][:VOLTage]:FREQuency:RATio [<expected value>[,<resolution>]] configures the counter for the ratio measurement function. A ratio measurement requires two channels of input with the specified channel as the numerator of the ratio. This command does not initiate the measurement process.

Parameters

Parameter Name	Parameter Type	Range of Values	Default Value
expected value	numeric	10 E11 to 10 E-11	1
	discrete	MIN MAX DEF	
resolution	numeric	4 E-12 to 4000	4 E-7
	discrete	MIN MAX DEF	

Comments

- Channel Selection: Select only one channel at a time. Channels 1, 2, or 3 may be used for ratio measurements and the channel selected is the numerator of the ratio. For example, if channel 1 is specified (CONF1:FREQ:RAT), the result will be the ratio of channel 1/channel 2. If channel 2 is specified (CONF2:FREQ:RAT), the result will be the ratio of channel 2/channel 1. If channel 3 is specified (CONF3:FREQ:RAT), the result will be the ratio of channel 3/channel 1.
- Type of Signals Measured: Signals must be periodic for the ratio function.
- Entering Expected value: Expected value is entered as a number from 10 E-11 to 10 E11. The counter will automatically acquire the input signal when the expected value parameter is not specified.
- Entering Resolution: Resolution is entered as a number from 4E-12 to 4000. Nine digits of resolution is automatically set if resolution is not specified in the command. *Table 5-5* shows the relationship between resolution and expected value.
- Specifications are valid when a ratio is greater than 1 for a ratio 1/2 or 2/1. when using ratio 3/1, the ratio should be greater than 64, as input 3 is prescaled by 64.
- The default frequency range for both channel 1 and 2 is 100 MHz. The frequency range on channel 1 can be extended to 200 MHz by enabling channel 1 prescaling via the SENSE:FREQuency:RANGe[:UPPer] command, at the expense of resolution.

Table 5-5. Ratio Resolution and Expected Value

	— EXPECTED VALUE* —				
	min	max	def	num	no param
RESOLUTION min	1 sec	1 sec	1 sec	1 sec	N/A
max	1 sec	1 sec	1 sec	1 sec	N/A
def	1 sec	1 sec	1 sec	1 sec	N/A
num	1 sec	1 sec	1 sec	(See Formula)	N/A
no param	1 sec	1 sec	1 sec	1 sec	1 sec

* The actual gate time may be longer than listed depending on the period on channel 1.

$$\text{Gate Time} = \frac{4 * (\text{Ratio of freq x/freq y})}{(\text{freq x}) * \text{resolution}}$$

N/A = Not applicable

Example CONF:FREQ:RAT Function: Ratio (ch1/ch2)

 READ? Place counter in wait-for-arm state;
 make measurement; put data in the
 output buffer.

 "ENTER" statement Enter readings into computer

:FTIME and :FALL:TIME

CONFigure[1][:VOLTage]:FTIME -or- :FALL:TIME [<lower reference>[,<upper reference>[,<expected value>[,<resolution>]]]]
configures the counter to measure the fall time of the input signal. If the upper/lower reference levels are not specified, the default levels are set to 90% and 10% of peak values. This command does not initiate the measurement process. See also Table 5-6 for Average Mode status.

Parameters

Parameter Name	Parameter Type	Range of Values	Default Value
lower reference, upper reference	voltage	-10.2375 to +10.2375 volts	N/A
	percent	10 to 90	10%-lower, 90%-upper
	discrete	MIN MAX DEF	
expected value	numeric	15 ns to 30 ms	100 ns
	discrete	MIN MAX DEF AUTO	
resolution	numeric	100 ps to 1 ms	DEF (1 ns)
	discrete	MIN MAX DEF	

Comments

- Channel Selection: Channel 1 only.
- The input signal must be periodic.

- Automatically routes the channel 1 input to the channel 2 input amplifier (INP:ROUT COMM). All parameter settings for channel 2 are reconfigured with the parameter settings for channel 1. The COMMOn input mode cannot be overridden.
- Selecting PCT (%) as units turns Auto trigger ON, while choosing V (volts) turns Auto trigger OFF. The default unit for the lower/upper reference parameters is percent (PCT) however, absolute units V (volts) can also be specified. You must scale the values according to the selected attenuation.
- The CONF:FALL:TIME command is an alias (functional equivalent) to the :CONF:FTIME command.
- The counter's input configuration (coupling and impedance for CH2, routing for CH1, and state of auto trigger for both channels), before execution of either the CONF:FTIME or CONF:RTIME command, is restored whenever measurement function is changed. However, the absolute trigger levels are not affected.

<i>Example</i>	CONF:FTIME DEF, DEF, 100E-9, 1E-9	Configures channel 1 and 2 COMMON; Function - Fall time; selects 10% and 90% as lower and upper reference value (Auto trigger ON) expected value - 100 ns; resolution - 1 ns
	CONF:FTIME 0.4V, 3.5V, 1E-6, 10E-9	Configures lower reference to 0.4 volts and upper reference to 3.5 volts (turns Auto trigger OFF)

:MAXimum CONFigure[1 | 2][:VOLTage]:MAXimum [<expected value>[,<resolution>]] configures the counter to read the maximum value (+Ve Peak) of the input signal ac voltage. This command does not initiate the measurement process.

Parameters There are no parameters for the MAXimum function. However, expected value and resolution are accepted by the command but ignored.

- Comments**
- Channel Selection: Valid for channels 1 and 2 only.
 - Type of Signal Measured: Signals must be periodic for the MAXimum value function.
 - This function configures the counter for Auto triggered measurements on the selected channel, but does not affect the selected input attenuation.
 - If $\times 10$ attenuation is active, multiply the results by 10 to get the actual voltage levels.
 - Expected value and resolution are accepted but ignored.

:MINimum CONFigure[1 | 2]:[VOLTage]:MINimum [<expected value>[,<resolution>]] configures the counter to read the minimum value (-Ve Peak) of the input signal ac voltage. This command does not initiate the measurement process.

Parameters There are no parameters for the MINimum function. However, expected value and resolution are accepted by the command but ignored.

- Comments**
- Channel Selection: Valid for channels 1 and 2 only.
 - Type of Signal Measured: Signals must be periodic for the MINimum value function.
 - This function configures the counter for Auto triggered measurements on the selected channel, but does not affect the selected input attenuation.
 - If ×10 attenuation is active, multiply the results by 10 to get the actual voltage levels.
 - Expected value and resolution are accepted but ignored.

:NWIDth CONFigure[1 | 2]:[VOLTage]:NWIDth [<reference>[,<expected value>[,<resolution>]]] configures the counter for the negative pulse width measurement function on input channel 1 or 2. This command does not initiate the measurement process.

Negative pulse width is measured as the time between the falling edge and the next rising edge of the input signal. If the reference level is not specified, the default level is set to 50% of the peak-to-peak voltage.

<i>Parameters</i>	Parameter Name	Parameter Type	Range of Values	Default Value
	reference	voltage (V)	-10.2375 to +10.2375 volts	N/A
		percent (PCT)	10 to 90	50%
		discrete	MINimum MAXimum DEFault	
	expected value	numeric	5 ns to 10 ms	100 ns
		discrete	MIN MAX DEF AUTO	
	resolution	numeric	100 ps to 100 ns	1 ns
		discrete	MIN MAX DEF	

Entering reference value: The default units of measure for the reference parameter is percent (PCT). However, absolute units V (volts) can also be specified. Selecting percent (PCT) turns the Auto trigger mode ON while choosing V (volts) turns Auto trigger OFF. You must scale the voltage levels according to the selected input attenuation.

Entering Expected value: Measurement range is from 5 nsec to 10 ms. If expected value is to be entered, the reference parameter must be specified.

Entering Resolution: Resolution can be entered as a number in seconds from 100 ps to 100 nanoseconds. The 100 Gate Average mode is turned ON for resolutions less than 1 ns.

Default Resolution: Resolution is automatically set to 1 ns by not entering values for expected value and resolution. If resolution is entered, expected value and reference must also be entered. Refer to Table 5-6 for more information.

- Comments*
- Channel Selection: Select input channels 1 or 2. Channel 3 cannot make pulse width measurements.
 - You can override the 50% default by using the SENSE[1|2]:EVENT:EVel:RELative command or by explicitly providing a value in the command parameter.
 - Edge Select: Negative pulse width is measured from the falling edge to the rising edge. The measurement will not complete until the second edge is detected.
 - Refer to Table 5-6 for status of 100 Gate Average mode based on expected value versus resolution. The table is valid not only for NWIDth, but also PWIDth, FTIME, RTIME, TINTerval, and TINTerval DELay measurements.

Table 5-6. NWIDth Resolution and Expected Value**

Resolution	Expected Value**					
	min	max	def	auto	no parm	<value>
min	OFF	OFF	OFF	OFF	N/A	OFF
max	OFF	OFF	OFF	OFF	N/A	ON if exp. value ≤10 ms, otherwise OFF
def	OFF	OFF	OFF	OFF	N/A	OFF
no parm	OFF	OFF	OFF	OFF	OFF	OFF
<value>	OFF	OFF	≤1 ns=ON, >1 ns=OFF	OFF	N/A	ON if exp. value ≤10 ms and resolution ≤1 ns, otherwise OFF

* Also applies to PWIDth, FTIME, RTIME, TINTerval, and TINTerval DELay measurements.

**Each cell entry = Status of 100 Gate Average mode for combinations of discrete measurement parameters.

N/A = Not Applicable.

Example CONF:NWID 75,1.5E-6,500E-12 Channel 1; Function - Negative Pulse Width with reference set at 75% Auto trigger ON and 100 Gate Average mode ON.

READ? Take reading

"ENTER" statement Enter value into controller

:PERiod CONFigure[1|2|3][:VOLTage]:PERiod [<expected value>[,<resolution>]] configures the counter for the period average measurement function on channel 1, 2, or 3 (channel 1 is the default). This command does not initiate the measurement process.

<i>Parameters</i>	Parameter Name	Parameter Type	Range of Values	Default Value
	expected value	numeric	5 ns to 1000 sec (CH 1) 10 ns to 1000 sec (CH 2) Per spec (CH 3)	
		discrete	<MIN MAX AUTO DEF>	DEF (100 ns)
	resolution	numeric	1 E-18 to 10 E-4	
		discrete	<MIN MAX DEF>	DEF (100 ns)

- Comments*
- Channel Selection: Valid for channels 1, 2, and 3, but only one channel is selected at a time.
 - Type of Signal Measured: Signals must be periodic for the period function as the counter measures average period over the gate time.
 - Entering Expected value: Expected value entered should be within a range as specified above. Selecting a value less than 10 ns for channel 1 automatically turns prescaling ON (divide by 2).
 - Entering Resolution: Resolution is entered as a number in seconds from 1 E-18 to .001 seconds. Resolution is automatically set to 9 digits if expected value and resolution are not specified in the command. If resolution is entered, it must be preceded by an expected value. 1 E-18 will generate an ERROR -218, even though the counter will make a measurement. 1.1 E-18 will not generate an ERROR -218.
 - Refer to *Table 5-7* for instrument Gate time/Prescaler status when using the command with parameters.

Entering reference value: The default units of measure for the reference parameter is percent (PCT). However, absolute units V (volts) can also be specified. Selecting percent (PCT) turns the Auto trigger mode ON while choosing V (volts) turns Auto trigger OFF. You must scale the voltage levels according to the selected input attenuation.

Entering Expected value: Measurement range is from 5 nsec to 1 ms. If expected value is to be entered, the reference parameter must be specified.

Entering Resolution: Resolution can be entered as a number in seconds from 100 ps to 100 ns. The 100 Gate Average mode is turned ON for resolutions less than 1 ns.

Default Resolution: A preliminary measurement is done to determine the best resolution if the expected value and resolution are not entered. If resolution is entered, expected value and reference must also be entered.

- Comments*
- Channel Selection: Select input channels 1 or 2. Channel 3 cannot make pulse width measurements.
 - You can override the 50% default by using the SENSE[1|2]:EVENT:LEVEL:RELATIVE command or by explicitly providing a reference value in the configuration command parameter.
 - Edge Select: Positive pulse width is measured from the rising edge to the falling edge. The measurement will not complete until the second edge is detected.
 - Refer to *Table 5-6* for status of 100 Gate Average mode based on expected value versus resolution. The table is valid for not only PWIDTH, but also NWIDTH, FTIME, RTIME, TINTERVAL, and TINTERVAL DELAY measurements.

Example CONF:PWID 75,1.5E-6,500E-12 Channel 1; Function - Positive Pulse Width with reference set at 75% Auto trigger ON and 100 Gate Average mode ON.

READ? Take reading

“ENTER” statement Enter value into controller

:RTIME and :RISE:TIME

CONFigure[1][:VOLTage]:RTIME -or- :RISE:TIME [<lower reference>[,<upper reference>[,<expected value>[,<resolution>]]]]
 configures the counter to measure the rise time of the input signal. If the upper/lower reference levels are not specified, the default levels are set to 10% and 90% of peak values. This command does not initiate the measurement process. See also *Table 5-6* for Average Mode Status.

<i>Parameters</i>	Parameter Name	Parameter Type	Range of Values	Default Value
	lower reference, upper reference	voltage	-10.2375 to +10.2375 volts	N/A
		PCT	10 to 90 percent, MIN MAX DEF	90%-lower, 10%-upper
	expected value	numeric	15 ns to 30 ms	100 ns
		discrete	MIN MAX DEF AUTO	
	resolution	numeric	100 ps to 1 ms	DEF (1 ns)
		discrete	MIN MAX DEF	

Comments

- Channel Selection: Channel 1 only.
- The input signal must be periodic.
- Automatically routes the channel 1 input to the channel 2 input amplifier (INP:ROUT COMM). All parameter settings for channel 2 are reconfigured with the parameter settings for channel 1. The COMMOn input mode cannot be overridden.
- Selecting PCT (%) as units turns Auto trigger mode ON while choosing V (volts) turns Auto trigger OFF. The default unit of measure for the lower/upper reference parameters is percent (PCT) however, absolute units V (volts) can also be specified. You must scale the voltage levels according to the selected input attenuation.
- The CONF:RISE:TIME command is an alias (functional equivalent) to the CONF:RTIME command.
- The counter's input configuration (coupling and impedance for CH2, routing for CH1, and state of auto trigger for both channels), before execution of either the CONF:FTIME or CONF:RTIME command, is restored whenever measurement function is changed. However, the absolute trigger levels are not affected.

Example

```
CONF:RTIME DEF, DEF, 1E-6, 10E-9  Configures channel 1 and 2
                                   COMMON; Function - Rise time
                                   selects 10% and 90% as lower
                                   and upper reference values
                                   (Auto trigger ON); expected
                                   value - 1 us; resolution - 10 ns

READ?                               Take reading

CONF:RTIME 0.4V, 3.5V, 1E-6, 10E-9  Configures lower reference to 0.4
                                   volts and upper reference to
                                   3.5 volts (turns Auto trigger OFF)

READ?                               Take reading
```

:TINterval **CONFigure[1][:VOLTage]:TINterval [<expected value>[,<resolution>]]** configures the counter to measure the time interval from the signal edge on channel 1 to the signal edge on channel 2. This command does not initiate the measurement process.

Parameters You must send an expected value parameter for resolution to be accepted.

Parameter Name	Parameter Type	Range of Values	Default Value
expected value	numeric	1 ns to 1000 sec	100 ns
	discrete	MIN MAX DEF AUTO	
resolution	numeric	100 ps to 100 ns	1 ns
	discrete	MIN MAX DEF	

- Comments**
- Channel Selection: Valid only on channel 1.
 - Start and Stop Edges: The edges of both the start and stop channels can be selected using the **SENSE[1|2]:EVENT:SLOPe** command. Unless changed, the measurement will be performed using the currently selected slope.
 - Entering Expected value: Measurement range is 1 ns to 1000 sec.
 - Entering Resolution: Resolution is entered as a number from 100 ps through 100 ns. 1 ns default resolution is used if a resolution is not specified in the command. If a resolution better than 1 ns is specified, 100 Gate Average mode is automatically enabled. Refer to *Table 5-6* for the status of 100 Gate Average mode.
 - If you need to make time interval measurements with delay, then refer to the **SENSE:TINT:DEL** command description.
 - Maximum input frequency range is 100 MHz for channel 1 and 2.

Example

CONF:TINT	Function: Time Interval (Ch 1 to Ch 2)
READ?	Make measurement; put data in the output buffer.
"ENTER" statement	Enter readings into computer.

:TOTalize **CONFigure[1][:VOLTage]:TOTalize** configures the counter for the totalize function but does not initiate the measurement procedure. This function allows you to count events on channel 1. Once the measurement is started, the totalize function continues counting until the channel is reconfigured to another function or **ABORt** or the **ARM:STOP:IMM** command is received.

Parameters There are no parameters for the totalize function. However, expected value and resolution parameters are accepted by the command but ignored.

Comments

- **Reading Measurement Results:** The totalize measurement is started with the INITiate command. Measurement results are read using the FETCh? command which reads the current count without interrupting the measurement. The READ? command reinitializes the totalize measurement before returning results.
- **Expected value and Resolution:** Parameters are accepted but ignored. Measurement range is 1 E12 events with a maximum frequency of 1 MHz.
- **The Totalize measurements can be gated by an external arm signal, TTLTrg lines, or channel 2.** Refer to the SENSE:TOTAlize subsystem for further details.
- **Before you can change functions after completing a Totalize function (or between each "TOTAlize-by-GATE" function), you must use ABORT to halt the Totalize measurement process.**

Example

Changing function after Totalize

CONF1:TOT	Configure channel 1 for Totalize.
INIT	Initiate a measurement.
FETCh?	Acquire the first count.
FETCh?	Acquire a second count.
•	•
•	•
•	•
•	•
"ENTER" statement	Enter measurement into controller.
ABORT	Halt Totalize measurements.
SENSE:FREQ DEF, DEF	Change the function.

CONFigure?

CONFigure? returns the function with its associated parameters that the specified channel was configured for with the last CONFigure or MEASure command.

Syntax:

CONFigure[1|2|3]?

Parameters:

Select one channel for the command (1, 2, or 3). If a channel is not specified, the command acts on channel 1 which is the default.

Comments

- Output Format: The strings returned have the following format: "<function><parameters>", with multiple parameters separated by ",".
- If the query is made on a channel other than the one last configured, then error -204, "Channel not configured for measurement" is returned.
- The values of MIN, MAX, and DEF cannot be queried.

Example

CONF2:FREQ 1E5, 10 Channel 2 configured for frequency of 100 kHz with 10 Hz resolution.

CONF2? Query configuration of channel 2.

"ENTER" statement Returns "FREQ 1E5, 10"

CONF2:PER Channel 2 configured for period measurement.

CONF2? Query configuration of channel 2.

"ENTER" statement Returns "PER ,"

DIAGnostics

The DIAGnostic command subsystem provides access to both calibration and test functions via SCPI as options and parameters of the DIAGnostic root command. Most of the command options for this command node require the expertise of qualified service personnel and use of specific test equipment to ensure correct application and results. (Refer to the Assembly-Level Service manual for specific information about adjustment, diagnosis, and repair of the E1420B Universal Counter.)

The structure and syntax of the SCPI E1420B diagnostic subsystem tree is as follows:

Syntax:

```
DIAGnostics
  :CALibrate
    :OFFSet?          <BOTH>
    :FULLscale?      <BOTH>
  :ASSEMBly
    :ALL?
    :A1?
    :A2?
  :BLOCK
    [:ALL?]
    :CALRam?
    :ROM?
    :RAM?
    :COUNTchain
    [:ALL?]
    :CONNECTor?
    :DINTERpolat?
    :INTERpolat?
    :MRC?
    :TIMEbase?
  :READ
    :MRC?             <EREG|TREG|ALL>
    :INT?             <STS|STL|SPS|SPL|START|STOP|CAL|ALL>
    :UFAIL[?]        <OFF|0|ON|1> (N/A for Query)
```

:CALibrate

The DIAGnostics:CALibrate command causes the counter to perform calibrations of key parameters on the input amplifiers.

- **:CALibrate:OFFSet?** - Performs offset calibration on input amplifiers for both channel 1 and channel 2. Requires grounding the channel being calibrated. Successful completion of the calibration returns "PASSED OFFSET CH1, PASSED OFFSET CH2". If any "FAILED" messages appear, refer to chapter 4, Service, of the Assembly-Level Service manual.
- **:CALibrate:FULLscale?** - Performs fullscale calibration on input amplifiers CH1, CH2, or BOTH. Requires input of precision (+5V) dc supply voltage to the channel being calibrated. Successful completion of the calibration returns "PASSED FULLSCALE CH1, PASSED FULLSCALE CH2". If any "FAILED" messages appear, refer to chapter 4, Service, of the Assembly-Level Service manual.

:ASSEMBLY

The DIAGNOSTICS:ASSEMBLY command causes the counter to perform all diagnostics applicable on an assembly-level basis. The diagnostics provide a means of isolating hardware faults to either the A1 main printed-circuit assembly (PCA) or A2 input amplifier PCA.

- :ASSEMBLY:ALL? performs diagnostics on both the input amplifier PCA (A2) and the main PCA (A1). See the A1 and A2 diagnostic descriptions for information concerning tested hardware.
- :ASSEMBLY:A1? performs diagnostics for the main A1 PCA. These include CALRAM, ROM, RAM, MRC, Interpolators, and timebase. If repeated failures occur for one or more of these hardware elements, then replacement of the A1 PCA is indicated.
- :ASSEMBLY:A2? performs diagnostics for the input amplifier A2 PCA. These diagnostics test the Interface with A1. If repeated failures occur for one or more of these hardware elements, then replacement of the A2 PCA is indicated.

Successful completion of the ASSEMBLY diagnostics returns "PASSED, <A1|A2|ALL>". If a diagnostic fails, the counter returns "FAILED" along with failed blocks separated commas. For example, "FAILED, ALL, ROM, INT" would indicate that the ROMs and count interpolators failed the Self-test.

:BLOCK

The DIAGNOSTICS:BLOCK command causes the counter to perform all diagnostics applicable on a functional-block basis. The power-up default for this command is "ALL?". The other choices are CALRAM?, ROM?, RAM?, and COUNTchain.

Successful completion of BLOCK command tests is indicated by the "PASSED" response. The only exception to this is the COUNTchain node which requires an additional query option. The choices available are: ALL?, CONNECTor?, MRC?, INTERpolat?, DINTERpolat?, and TIMEbase?.

NOTE

If the external timebase source is selected, using "SENS:ROSC:SOUR EXT", a reference timebase of 10 MHz must be connected to the Int/Ext BNC in order to run the diagnostic "DIAG:BLOCK:ALL?".

All query options (except MRC?, INTERpolat?, and DINTERpolat?) will return only "PASSED" or "FAILED" results. The MRC?, INTERpolators?, and DINTERpolators? queries will return messages containing measurement data of their internal registers.

READ:MRC? <EREG|TREG>

This SCPI message string returns the value of the E register (ereg parameter), the T register (treg parameter) or both registers for the last measurement as follows:

- **EREG** - returns the count in the E (or Events) register, each count equivalent to one zero crossing (event) of the input signal.
- **TREG** - returns the count in the T (or Time) register, each count equivalent to 100 ns.
- **ALL** - returns the EREG value first, followed by the TREG value.

READ:INT?

This SCPI message string returns an interpolator calibration and/or measurement value as follows:

- **STS** - returns the start interpolator value for short calibration,
- **STL** - returns the start interpolator value for long calibration,
- **SPS** - returns the stop interpolator value for short calibration,
- **SPL** - returns the stop interpolator value for long calibration,
- **START** - returns the start interpolator value for measurement (The value should be between STS and SPL.),
- **STOP** - returns the stop interpolator value for measurement (The value should be between SPS and SPL.).
- **CAL** - returns calibration values in listed order (sts, sps, stl, spl),
- **ALL** - returns all the calibration values and values for measurement as follows: sts, sps, stl, spl, start, stop.

UFAIL[?]

The DIAGnostics:UFAIL <OFF|0|ON|1> enables the counter to execute the next diagnostic command in a continuous loop. When turned ON, the next diagnostic is executed continuously until halted (Device Clear is received) or until a failure occurs. The DIAGnostics:UFAIL? query returns the state of UFAIL.

FETCh? The FETCh? command retrieves the measurement stored in the counter's memory by the most recent INITiate command and places it in the output buffer. This command is most commonly used in conjunction with CONFIgure and SENSE.

Syntax:

```
FETCh[1|2|3]
[:<function>]?
```

Comments

- Channel Number: Select only one channel at a time.
- If the <function> is requested, the counter retrieves the value of the function derived from the data taken by the last measurement. If the value cannot be derived, error -230, "Data corrupt or stale", is returned. If a Frequency measurement is made, then a Period value may be fetched or vice-versa. If Auto triggered measurements are made, then all voltage measurements (AC, DC, MINimum, MAXimum) can also be fetched. You must multiply the results by 10 when $\times 10$ attenuation is active.
- When the <function> is omitted, the last function FETChed, READ?, or measured is used.
- You must execute INITiate before sending the FETCh? command. If the INITiate command has not been executed prior to FETCh?, error -206, "Measurement has not been initiated", is returned unless the counter has been INITiated in the CONTinuous state. Refer to the INITiate command.
- If the counter configuration changes during a measurement, FETCh? will return error -230, "Data corrupt or stale".
- If a FETCh? is made on a different channel than the one currently initiated, error -204, "Channel not configured for measurement", is returned.
- Multiple FETCh? queries are allowed on measurement data as long as the instrument set up has not been changed.
- TOTalize Measurements: If the selected channel is configured for totalize, FETCh? reads the current value from the counter and returns the result. This is the only mechanism to continue reading results for the TOTalize function.
- If the counter is in ARM:HOLD or BUS mode, an attempted FETCh? returns error -215, "ARM deadlock".

<i>Example</i>	CONF:FREQ 10E6,1	Function is frequency of channel 1.
	INIT	Makes a measurement.
	FETC?	Place readings in output buffer. As <function> is missing, frequency is assumed.
	"ENTER" statement	Enter measurement into controller.
	FETCH:PERiod?	Place period reading in output buffer. Does not make a measurement.
	"ENTER" statement	Enter measurement into controller.
	FETCH:TINTerval?	Generates error -230, "Data corrupt or stale".

INITiate The INITiate command is used to control the initiation of the measurement cycle.

Syntax:

```
INITiate[1|2|3]
[:IMMEDIATE]
:CONTinuous      <OFF|0|ON|1>
:CONTinuous?
```

- Comments*
- Channel Number: Select only one channel at a time.
 - If you attempt to initiate a measurement on a channel not previously configured for a measurement, the counter returns error -204, "Channel not configured for measurement"
 - Performing the Measurement: After the measurement is initiated using INIT, the state of the Arming subsystem controls when the actual measurement occurs. For example: if ARM:SOURce is IMMEDIATE (the default for ARM:SOUR), the measurement is performed as soon as INITiate is executed. The measurement result is stored in the counter's memory. A measurement stored in memory from a previous command is replaced by the new measurement data. (See the ARM command in this chapter for more information.)
 - Measurement Result: Use the FETCh? command to transfer a measurement result from the counter's memory to the output buffer.

[:IMMEDIATE] INITiate[1 | 2 | 3][:IMMEDIATE] causes an immediate exit from the idle state, executes one measurement cycle, and returns to idle upon completion.

- Comments*
- INITiate[1 | 2 | 3][:IMMEDIATE] is an event and cannot be queried as there is no state associated with it.
 - If a measurement has been initiated and the instrument set up changes, then the current measurement aborts, or:
 - If another INIT:IMM is received then error -213, "INIT ignored", is returned.
 - If the counter is not in the idle state or if INITiate:CONTinuous is set ON, an INIT:IMMEDIATE command has no effect on the Trigger subsystem and error -213, "INIT ignored", is returned.

<i>Example</i>	CONF:FREQ	Function is frequency.
	ARM:SOUR EXT	Start arm source is external.
	ARM:STOP:SOUR EXT	Stop arm source is external.
	INIT	Initiate a measurement. The counter makes a measurement during the external arm.
	FETCh?	Transfer measurement to output buffer.
	ENTER statement	Enter measurement into controller.
	FETCh?	Transfer old measurement to output buffer.
	INIT	Initiate a new measurement.

:CONTInuous INITiate[1 | 2 | 3]:CONTInuous determines whether the counter makes only one measurement or makes measurements continuously. If CONTInuous is set ON, then measurements will be made as long as arming conditions defined via the ARM command are satisfied. When CONTInuous is set OFF, the counter finishes the current measurement and returns to the idle state.

Comments

- The state of INIT[1 | 2 | 3]:CONTInuous: ON is not affected by the ABORt command, however the current measurement aborts, and the counter resumes measurement.
- Attempting to configure a different channel while INIT:CONTInuous is ON will generate error -200, "Execution Error". The state of the counter remains unchanged, continuing with measurement execution.
- Changing any parameters or functions associated with a configured channel is permitted when "Continuous" state is ON. The current measurement aborts, the requested change is made, and the counter resumes measurement.
- The MEASure? command turns the INIT:CONTInuous to OFF, and performs the desired measurement.
- An INIT:IMMEDIATE command while in continuous mode causes error -213, "INIT ignored".
- At *RST, CONTInuous is OFF.

<i>Example</i>	CONF:FREQ	Set up the counter to measure frequency.
	INIT:CONT ON	Counter will initiate measurements continuously.
	FETCH?	Transfers measurement results to output buffer.
	"ENTER" statement	Enter measurement into controller.
	FETCH?	Transfers new measurement results to output buffer.
	"ENTER" statement	Enter measurement into controller.

:CONTinuous? INITiate:CONTinuous? will return "1" if the Continuous state is ON and "0" if the Continuous state is OFF.

INPut The INPut subsystem commands provides control of attenuation, impedance, coupling, and signal routing (common channel 1 input) for the counter.

Syntax:

```
INPut[1|2]
  :ATTenuation <value|MINimum|MAXimum|DEFault>
  :ATTenuation? [<MINimum|MAXimum|DEFault->]
  :COUpling <AC|DC>
  :COUpling?
  :IMPedance <value|MINimum|MAXimum|DEFault>
  :IMPedance? [<MINimum|MAXimum|DEFault->]
  :ROUTE <COMMon|SEParate>
  :ROUTE?
```

:ATTenuation INPut[1 | 2]:ATTenuation <value | MINimum | MAXimum | DEFault> sets the selected input channel attenuation as 1 or 10. In $\times 10$ mode, the input signal level is reduced by the factor of 10.

Parameters	Parameter Name	Parameter Type	Range of Values	Default Value
	value	numeric	1 10	1
	MIN	discrete	1	
	MAX	discrete	10	
	DEF	discrete	1	

- Comments**
- $\times 10$ attenuation is used when input signal voltages exceed 5V rms.
 - Power-up and Reset condition is $\times 1$.

Example INP1:ATT 10 Sets channel 1 attenuation to 10.

:ATTenuation? INPut[1 | 2]:ATTenuation? returns the attenuation for channel 1 or 2 as either 1 or 10. An example of this query is shown below:

Example INP1:ATT? Queries the attenuation for channel 1.

:COUpling INPut[1 | 2]:COUpling <mode> sets the input coupling to ac or dc. The parameters for “<mode>” are AC and DC. The AC parameter is used to remove any dc component from the input signal.

Parameters	Parameter Name	Parameter Type	Range of Values	Default Value
	mode	discrete	AC DC	DC

- Comments**
- Power-up and *RST Condition is INP:COUP DC

Example INP2:COUP AC Sets channel 2 coupling to AC.

:COUPling? INPut[1 | 2]:COUPling? returns the coupling for channels 1 or 2 as either AC or DC. An example of the use of this query is shown below:

INP2:COUP? Queries the coupling for channel 2

:IMPedance INPut[1 | 2]:IMPedance <value | MINimum | MAXimum | DEFault> sets the input impedance to 50Ω or 1 MΩ where <value> is a floating point number.

<i>Parameters</i>	Parameter Name	Parameter Type	Range of Values	Default Value
	value	numeric	40 to 60 and .9E6 to 1.1E6	50Ω
	MIN	discrete	50Ω	
	MAX	discrete	1MΩ	
	DEF	discrete	50Ω	

- Comments*
- When channel 1 COMMON mode routing is active, input 1 impedance will drop to 500 kΩ if the 1 MΩ is selected.
 - Impedance values can be specified between 40 and 60 for 50Ω and 0.9E6 to 1.1E6 for 1 MΩ.
 - Power-up and *RST Condition: INP:IMP 50 (50 ohms)

Example INP2:IMP MIN Sets channel 2 impedance to 50Ω.

:IMPedance? INPut[1 | 2]:IMPedance? returns the impedance value for channels 1 or 2 as a floating point number. An example of the use of this query is shown below:

INP2:IMPedance? Queries the input impedance of channel 2.

:ROUTE INPut[1]:ROUTE <mode> routes input channel 1 signals to both channel 1 and 2 input circuits (Sets both inputs to common). The INP2:ROUTE command string will generate error -221 "Settings conflict".

<i>Parameters</i>	Parameter Name	Parameter Type	Range of Values	Default Value
	<mode>	discrete	COMMON SEPARate	SEPARate

- Comments*
- Front-panel Input channel 2 connector is not active when channel 1 is routed in COMMON mode.
 - Turn-on and *RST Condition: INP:ROUTE SEPARate
 - Rise/fall time measurements are automatically made using ROUTE set to COMMON. Channel 2 settings are the same as channel 1. When the function changes, the previous settings are reinstated.
 - Input impedance will drop to 500 kΩ if 1 MΩ is selected while in COMMON mode when ×1 attenuator is active.

Example INP:ROUTe COMMON Routes input channel 1 connector to both channel 1 and 2 input circuits.

:ROUTe? INPut[1 | 2]:ROUTe? returns the status of input routing as either SEParate or COMMON. Channel 2 route is always SEParate.

MEASure The MEASure command subsystem sets up the counter to perform a specified measurement either automatically-acquired or for a manually-entered expected value, and then performs the measurement. After making the measurement, the data is stored in the output buffer.

Syntax:

```
MEASure[1|2|3]
[:VOLTage]
:AC?           [<expected value>[,<resolution>]]*
:DC?           [<expected value>[,<resolution>]]*
:FREQuency?   [<expected value>[,<resolution>]]
:RATio?       [<expected value>[,<resolution>]]
:FTIME?
- or -
:FALL
:TIME?        [<lower reference>[,<upper reference>
               [,<expected value>[,<resolution>]]]]
:MAXimum?     [<expected value>[,<resolution>]]*
:MINimum?     [<expected value>[,<resolution>]]*
:NWIDth?      [<reference>[,<expected value>
               [,<resolution>]]]
:PERiod?      [<expected value>[,<resolution>]]
:PWIDth?      [<reference>[,<expected value>
               [,<resolution>]]]
:RTIME?
- or -
:RISE
:TIME?        [<lower reference>[,<upper reference>
               [,<expected value>[,<resolution>]]]]
:TINTerval?   [<expected value>[,<resolution>]]
```

*Expected value and resolution parameters are accepted but ignored for AC, DC, MINimum, and MAXimum measurements.

Comments

- **TOTALize:** The MEASure command CANNOT be used to totalize counts because totalize continues counting events until the function is changed.
- **Manually entered expected value:** If the optional parameters expected value and resolution are specified, the state of the counter will be changed to obtain the requested resolution.
- **Specifying optional parameters:** The optional parameters can be defaulted from right-to-left. For example, if a value for resolution is to be entered, the expected value must be specified. If the parameter is explicitly omitted, the best possible value is chosen.

- If you execute the MEASure command while the counter is in continuous measurement mode (INIT:CONTInuous ON), the INIT:CONTInuous state is turned OFF, and the counter then makes the measurement.
- [:VOLTage] is an implied node and may be omitted from the program message.
- When making voltage measurements, you must multiply the results by 10 if $\times 10$ attenuation is active.
- Auto Acquire: If the optional parameters expected value and resolution are not entered, the gate time is set by the counter.
- Auto Trigger: Making measurements with Auto Trigger greatly reduces throughput as compared to measurement speed when trigger levels are programmed manually. During auto triggered frequency measurements, the counter determines the positive and negative voltage peaks of the input signal. It then programs the trigger according to the current SENSE:EVENT:LEVel:RELAtive parameter value.

Rise/fall time measurements use both input amplifiers (common input channel 1). During auto triggered rise/fall time measurements, channel 1 is programmed for 10% (90%) value and channel 2 is programmed for 90% (10%) value. A signal arriving at the channel 2 Input connector is not counted.

- CONFigure and MEASure versus SENSE: Most measurements can be performed using one of these three subsystems, and each has advantages and disadvantages over the other. The basic difference between the commands is as follows:

The CONFigure command can be used for all measurements except for gated totalize and time-interval delay measurements. The CONFigure command only configures a channel for a specific function, and does not perform the measurement. Use of additional commands (READ?, or INIT/FETC?) to perform the measurement and read the results is necessary. Further customization of the counter set-up is provided, through the use of optional parameters.

The MEASure command can be used for all measurements except TOTAlize. The MEASure command configures a channel for a specific function, performs the measurement, and returns the result to the output buffer. Further customization of the counter set-up is provided, through the use of optional parameters.

The MEASure command is instrument independent and can be used in other instruments to perform similar functions. This command should be used when the portability of instrument syntax is important. CONFigure/READ? is less compatible if the counter re-configuration occurs between the CONFigure and READ? operations.

The SENSE subsystem can be used for all measurements. The SENSE:FUNCTION command only configures a channel for a specific function and does not perform the measurement. The state of the counter is not otherwise affected. Use of additional commands (READ?, or INIT/FETC?) to perform the measurement and store the results is required.

The SENSE commands should be used when direct control over the measurement is important.

MEASure Command Details

For detailed explanations of the MEASure command functions, parameters, examples, and comments, refer to the individual CONFIGure command measurement function descriptions of the CONFIGure subsystem. Three simple examples using the MEASure command are provided below.

All details of the MEASure command functions are identical to the CONFIGure command functions except for the following:

- TOTALize measurements are NOT available under the MEASure subsystem,
- The function is written as the query form by including a question mark (?) at the end of the measurement function name: for example, "TINterval" becomes "TINterval?" as the MEASure function. When the MEASure function queries are used, the READ?, and INITiate/FETCh? commands are not needed.

MEASure Examples

MEAS2:FREQ? 10E6, 1	Measures frequency on channel 2 with an expected value of 10 MHz and resolution of 1 Hz.
ENTER statement	Enter measurement into controller.
MEAS1:RTIM? 20, 80	Measures rise time on channel 1 between 20% and 80% of the input signal level transition.
ENTER statement	Enter measurement into controller.
MEAS1:PER?	Measure period; when no parameters are given, the counter autoranges the requested measurement providing the best possible resolution. Gate time is 400 ms.
ENTER statement	Enter measurement into controller.

MEMORY Subsystem (Option 040)

The MEMory:VME command subsystem controls the storage of counter readings (measurement results data) onto external VME memory cards or any module/card in the cardcage which supports VME addresses between #H200000 - #HDFFFF8. Refer to Appendix E for application details.

The stored data in external memory follows IEEE-754 64-bit notation (The IEEE standard for binary floating-point representation.).

Syntax:

```
MEMory
:VME:ADDRess <address>
:VME:ADDRess? [MINimum| MAXimum]
:VME:SIZE <bytes>
:VME:SIZE? [MINimum| MAXimum]
:VME:STATe OFF/0,ON|1
:VME:STATe?
```

:VME:ADDRess

MEMory:VME:ADDRess <address> accepts a nondecimal numeric type for address. The specified address in the command indicates the starting address of the shared memory space to which the counter writes data. The depth of this space is set or queried by the MEMory:VME:SIZE and MEMory:VME:SIZE? commands respectively.

If the sum of the size allocated and the requested address exceed the allowed address range (#HDFFFF8), an error is generated and the memory size is readjusted. To ensure that the data is correctly aligned, the starting address adjusts to the next divisible-by-8 value if necessary.

Parameters

Parameter Name	Parameter Type	Range of Values	Default Value
address	non-decimal	#H200000-#HDFFFF8	
	numeric	2097152-14680056	2097152

Example

Setting the VME Memory Address:

```
MEMory:VME:ADDRess #H200000 Set memory address location.
```

Comments

- You can specify the Address location in decimal or Hexidecimal (#H....)
- MIN sets the address to #H200000 and MAX sets the address to #HDFFFF8.
- The address and size are interdependent; setting one may affect the other.
- *RST condition MEM:VME:ADDR #H200000.

:VME:ADDRess?

MEMory:VME:ADDRess? [MINimum, MAXimum] returns one of the following numbers to the output buffer:

- The present decimal address if no parameters are specified.
- The lowest allowed address if MINimum is specified.
- The highest allowed address if MAXimum is specified.

Example

Querying the VME Memory Address:

DIM Addr\$[120]	Dimension address string array
MEM:VME:ADDR #H250000	Set shared Memory Address location
MEM:VME:ADDR?	Query Counter to return memory address in decimal (2424832)
"ENTER" statement	Enter current address location into string.

:VME:SIZE

MEMory:VME:SIZE <bytes> allocates a portion of the memory block available on the external VME memory to the counter. The memory block size is specified in <bytes> and the starting address is specified by the **MEMory:VME:ADDR** command.

If the sum of the starting address and the requested size exceed the allowed address range (#HDFFFF8), an error is generated and the starting address readjusted. To ensure that the data is correctly aligned, the size adjusts to the next divisible-by-8 value if necessary.

Parameters

Parameter Name	Parameter Type	Range of Values	Default Value
size	non-decimal	0 - #HC00000	#HC00000
	numeric	0 - 12582912	

Example

Setting the VME memory size:

MEM:VME:SIZE 64000 sets memory size to 64 kbytes

Comments

- Memory size can be specified in decimal or Hexadecimal (#H...).
- The MIN parameter sets the memory size to 0 bytes and MAX sets the memory size to 12582912 bytes (#HC00000).
- The Address and size are interdependent and setting one may affect the other.
- *RST condition: VME:MEM:SIZE 0.

:VME:SIZE? **MEMory:VME:SIZE?** [MINimum | MAXimum] returns one of the following numbers to the output buffer:

- The present memory size (in decimal) selected if no parameters are specified.
- The smallest memory size available (0) if MIN is specified.
- The largest memory size available (12582912) if MAX is specified.

Example Querying the VME memory size:

```
MEM:VME:SIZE 64000          Set memory size to 64 Kbytes
MEM:VME:SIZE?              Query counter to return allocated
                             VME memory size.
"ENTER" statement.         Enter the value into computer
```

:VME:STATE **MEMory:VME:STATE** <mode> enables or disables the use of external VME memory for data storage.

<i>Parameters</i>	Parameter Name	Parameter Type	Range of Values	Default Value
	mode	Boolean	OFF,0 ON,1	OFF, 0

Example Enabling VME memory:

```
CONF:FREQ DEF,DEF          Function: Setup for a 10Mhz frequency
                             measurement.
MEM:VME:ADDR #H250000      Set memory address location to
                             #H250000
MEM:VME:SIZE 64000         Set memory to 64 kBytes.
MEM:VME:STAT ON            Enable use of external VME memory
                             starting from address 250000H not
                             exceeding 64 kBytes.
INIT                       Place counter in wait-for-arm state;
                             store measurements in local memory
                             as well as external VME memory.
                             Increment address location pointer and
                             decrement size.
```

- Comments*
- Decimal values for OFF (0) and ON (1) may be substituted.
 - *RST condition is MEMory:VME:STATE OFF.

:VME:STATE? **MEM:VME:STATE?** returns either 1 or 0 to indicate whether the use of external VME memory is enabled (1) or disabled (0).

Example

```
MEM:VME:STAT ON            Enable use of external VME memory.
MEM:VME:STAT?              Query counter to determine whether
                             external VME memory is used as
                             storage for measurement data.
"ENTER" statement          Enter statement. (Returned value should
                             be "1").
```

OUTPut The Output subsystem controls two signals that can be output from the counter. The internal timebase reference signal can be output via the front panel Int/Ext Reference BNC connector if option 010 is installed. In addition, the counter's internal measurement gate signal (GATE_OUT) can be output to any one of the VXIbus backplane TTLTrg lines (0-7).

If the counter has been configured to provide its gate signal (GATE_OUT) to one of the VXIbus backplane TTLTrg lines, then it is not recommended to select a TTLTrg line as an arming source.

Syntax:

```

OUTPut
  :TTLTrg<n>          n= 0-7
    [:STATE]         <OFF|0|ON|1>
    [:STATE]?
  :ROSCillator
    [:STATE]         <OFF|0|ON|1>
    [:STATE]?

```

:TTLTrg<n>[:STATE]

OUTPut:TTLTrg<n>[:STATE] specifies whether or not the counter's internal measurement GATE_OUT signal is output to the selected VXIbus backplane line<n> (0-7). The GATE_OUT signal is TTL active low. This output provides convenient measurement synchronization for other instrument modules resident in the VXIbus mainframe.

Example

OUTPut:TTLTrg3:STATE ON Routes the GATE_OUT signal to the VXIbus backplane TTLTrg line 3.

CAUTION

Ensure that no other source drives the same trigger line on the VXIbus backplane, otherwise permanent hardware damage may occur.

:TTLTrg<n>:STATE?

OUTPut:TTLTrg<n>:STATE? returns "1" (ON) if the GATE_OUT signal has been routed to one of the VXIbus TTLTrg lines. Simultaneous use of the TTLTrg lines for input and output is NOT RECOMMENDED.

:ROSCillator:STATE

OUTPut:ROSCillator:STATE specifies whether or not the optional internal timebase is routed to the front panel Int/Ext Reference BNC as its output. OUTPut:ROSCillator:STATE ON enables this output. OUTPut:ROSCillator:STATE OFF disables this output.

:ROSCillator:STATE?

The OUTPut:ROSCillator:STATE? query returns the current output status of the reference oscillator source selected and routed to the front panel Int/Ext Reference BNC connector.

READ? The READ? command is used to initiate a measurement and then transfer the measurement result to the output buffer. The READ? command performs the identical function as sending the sequence ABORt, INITiate:IMMediate, FETCh?.

Syntax:

```
READ[1|2|3]
[:<function>]?
```

Comments

- Channel Selection: Specify only one channel at a time. If a channel is not specified, the command defaults to channel 1.
- If you enter a <function> that does not correspond to the last configured measurement function, the <function> will be ignored. The results of the most recent measurement function will be returned.
- TOTalize: The READ? command should not be used with the TOTalize function since it will reinitialize a measurement. See INIT and FETC? commands for reading results of these functions.
- Attempting to READ? on a non-configured channel will return error -204, "Channel not configured for measurement".
- If INITiate:CONTinuous is set ON, executing READ? will generate error -213, "INIT ignored".

Example

CONF:FREQ:RAT	Function is ratio.
READ?	Take measurement; transfer data to output buffer.
"ENTER" statement	Enter readings into controller.
READ:FREQ?	Counter ignores the FREQuency? query and returns ratio.

SENSe The SENSe command subsystem can be used to manually configure all available measurements, and/or to enter various measurement parameters. The SENSe command also offers direct manual control of the counter hardware.

SENSe enables you to change/verify the following settings:

- Trigger Level, Slope, or Hysteresis
- Measurement Function
- Aperture Time and Gate State
- Average mode selection
- Time-Interval Delay
- Frequency Range
- Timebase Selection
- Totalize Measurement Setup

Syntax:

```
[SENSe[1|2|3]]
:AVERage
  [:STATe]           <OFF|0|ON|1>
  [:STATe?]
  :COUNT?
:EVENT
:LEVel
  [:ABSolute]       <value|MINimum|MAXimum|DEFault>
  [:ABSolute?]     [<MINimum|MAXimum|DEFault>]
  :AUTO            <OFF|0|ON|1|ONCE>
  :AUTO?
  :RELative        <value|MINimum|MAXimum|DEFault>
  :RELative?      [<MINimum|MAXimum|DEFault>]
:SLOPe
:SLOPe?
:HYSTeresis       <MINimum|MAXimum|DEFault>
:HYSTeresis?
:FREQuency
:APERture        <value|MINimum|MAXimum|DEFault>
:APERture?      [<MINimum|MAXimum|DEFault>]
:RANGe
  [:UPPer]         <value|MINimum|MAXimum|DEFault>
  [:UPPer?]       [<MINimum|MAXimum|DEFault>]
  :AUTO           <OFF|0|ON|1>
  :AUTO?
```

```

:FUNCTION          "[VOLTage:]AC"
                   "[VOLTage:]DC"
                   "[VOLTage:]FREQuency"
                   "[VOLTage:]FREQuency:RATio"
                   "[VOLTage:]FTIME"
                   "[VOLTage:]FALL:TIME"
                   "[VOLTage:]MAXimum"
                   "[VOLTage:]MINimum"
                   "[VOLTage:]NWIDth"
                   "[VOLTage:]PERiod"
                   "[VOLTage:]PWIDth"
                   "[VOLTage:]RTIME"
                   "[VOLTage:]RISE:TIME"
                   "[VOLTage:]TINTerval"
                   "[VOLTage:]TOTAlize"

:FUNCTION?
:PERiod
  :APERTure        <value|MINimum|MAXimum|DEFault>
  :APERTure?      [<MINimum|MAXimum|DEFault>]
:RATio
  :APERTure        <value|MINimum|MAXimum|DEFault>
  :APERTure?      [<MINimum|MAXimum|DEFault>]
:ROSCillator
  :SOURce          <INTernal|EXTernal|CLK10>
  :SOURce?
:TINTerval
  :DELay
    [:STATe]       <OFF|0|ON|1>
    [:STATe]?
  :TIME           <value|MINimum|MAXimum|DEFault>
  :TIME?         [<MINimum|MAXimum|DEFault>]
:TOTAlize
  :GATE
    [:STATe]       <OFF|0|ON|1>
    [:STATe]?
  :POLarity       <NORMAl|INVerted>
  :POLarity?
  :SOURce?

```

```

:AVERage[:STATe] :AVERage[:STATe] ON causes the counter to enter 100 Gate Average
mode. This measurement mode provides 100 picosecond resolution for
time-interval measurements. AVERage[:STATe] OFF causes the
counter to return to single-shot measurement. If the resolution
parameter of CONFigure/MEASure is less than 1 ns, the AVERage
state is automatically turned ON.

```

```

:AVERage[:STATe]? :AVERage[:STATe?] query returns the AVERage[:STATe] status.

```

```

:AVERage:COUNT? The :AVERage:COUNT? query returns 100, indicating the current
number of averages is 100. There is no command to change this number.

```

```

:EVENT:LEVel[:ABSolute] :EVENT:LEVel[:ABSolute] <value|MIN|MAX|DEF> specifies the
trigger level for channels 1 and 2.

```

<i>Parameters</i>	Parameter Name	Parameter Type	Range of Values	Default Value
	value	numeric	-10.2375V to +10.2375V MIN MAX DEF	0 volts
	MIN	discrete	-10.2375V	
	MAX	discrete	+10.2375V	
	DEF	discrete	0V	

- Comments*
- The user must scale the desired trigger level by the input attenuation factor (1 or 10) before programming the counter.
 - Event level is programmable in 2.5 mV steps on channels 1 and 2. Each channel can be programmed for a different trigger level. Values entered outside the range will return error -209, "Data clipped to limit". Levels are truncated to nearest 2.5 mV.
 - When the counter is in Auto trigger mode, executing this command turns Auto trigger OFF. The trigger level is set as requested.
 - The event level is set to 0 volts for both channels 1 and 2 at power-on or reset (*RST).

Example

SENS2:EVEN:LEV 1.2	Sets channel 2 event level to +1.2V.
INP2:ATT 10	Selects ×10 attenuator for channel 2.
SENS2:EVEN:LEV 1.2	Sets channel 2 event level to trigger at 12 volts.

:EVENT:LEVel[:ABSolute]?

:EVENT:LEVel[:ABSolute]? query returns the current level setting as one of these numeric values:

- The user must multiply the results by the attenuation factor (1 or 10) to get the correct trigger levels.
- The current trigger level in volts if no parameter is specified.
- The minimum trigger level available (-10.2V) if MIN is specified.
- The maximum trigger level available (+10.2V) if MAX is specified.
- The default trigger level (0V) if DEF is specified.

An example of querying the trigger level for channel 2 is shown below:

SENS2:EVEN:LEV:ABSolute?	Both of these commands are the same, querying channel 2.
- or -	
SENS2:EVEN:LEV?	
"ENTER" statement	Enter the queried value.

**:EVENT:LEVel
[:ABSolute]:AUTO**

:EVENT:LEVel[:ABSolute]:AUTO ON specifies counter operation in the Auto trigger mode. In this mode, the trigger point, [LEVel:ABSolute] is automatically set between the negative and positive detected peaks. The level is calculated as a percentage of the peak-to-peak voltage, added to the negative -Ve peak value. The percentage is defined in EVENT:LEVel:RELative. The actual level determination does not occur unless a measurement is initiated. If "ONCE" is selected, counter determines the level automatically for one measurement only.

CAUTION

Autotrigger does not automatically select an appropriate attenuation factor. It is the User's responsibility to set proper attenuation (1 or 10) before selecting autotrigger to prevent front-end and hardware damage.

**:EVENT:LEVel
[:ABSolute]:AUTO?**

The :EVENT:LEVel[:ABSolute]:AUTO? query returns the EVENT:LEVel[:ABSolute]:AUTO status auto triggering mode as either 1 (ON) or 0 (OFF). If "ONCE" was selected, query returns 0.

:EVENT:LEVel:RELative

:EVENT:LEVel:RELative specifies the peak-to-peak signal range percentage used to set the LEVel when AUTO is ON.

- The *RST and power-up condition is 50%.

Parameters

Parameter Name	Parameter Type	Range of Values	Default Value
value	PCT	10% to 90%	50
MIN	PCT	10%	
MAX	PCT	90%	
DEF	PCT	50%	

Example

CONF:RTIM	Configure the counter for 10% and 90% rise time measurement.
SENS:EVEN:LEV:REL 20	Sets trigger level on channel 1 to the 20% point.
SENS2:EVEN:LEV:REL 80	Sets trigger level on channel 2 to the 80% point.
READ?	Causes the counter to make a measurement and report rise time from the 20% to 80% transition point.

:EVENT:LEVel:RELative?

:EVENT:LEVel:RELative? query returns the EVENT:LEVel:RELative status as one of these numeric values:

- The current relative trigger level in percent if no parameter is specified.
- The minimum relative trigger level in percent (10%) available if MIN is specified.

- The maximum relative trigger level in percent (90%) available if MAX is specified.
- The default relative trigger level in percent (50%) if DEF is specified.

:EVENT:LEVel? :EVENT:LEVel? query returns the current level setting as a numeric value. This query is identical to :EVENT:LEVel[:ABSolute]?

:EVENT:SLOPe :EVENT:SLOPe <POSitive | NEGative> specifies either the POSitive (rising) or NEGative (falling) edge of the input signal to be used in the measurement.

Comments • At turn-on or *RST the slope is positive for all channels.

Example SENS2:EVENT:SLOP NEG Sets channel 2 slope to negative.

:EVENT:SLOPe? :EVENT:SLOPe? returns one of the following responses:

- POS if slope was programmed to the rising edge.
- NEG if slope was programmed to the falling edge.

An example of this query is shown below:

SENS2:EVENT:SLOP? Query counter to return the slope of Ch 2.

"ENTER" statement Enter value into controller

:EVENT:HYSTeresis :EVENT:HYSTeresis <MINimum | MAXimum | DEFault> specifies the sensitivity of the counter. If the input signal peaks do not extend beyond both hysteresis limits, then the input signal does not generate a count. If the input signal has a significant noise content, then the hysteresis must be increased to prevent the counter from counting false events.

<i>Parameters</i>	Parameter Name	Parameter Type	Range of Values	Default Value
	MIN	character	35 mV (p-p)	60 mV (p-p)
	MAX	character	100 mV	
	DEF	character	60 mV	

Comments • Selecting MAX provides the greatest noise immunity (lowest sensitivity) while selecting MIN gives the most sensitivity (least noise immunity).

Example SENS:EVENT:HYST MAX Sets the counter hysteresis to MAXimum.

:EVENT:HYSTeresis? :EVENT:HYSTeresis? returns the current (MIN, MAX, or DEF) value set by EVENT:HYSTeresis.

:FREQuency:APERture

:FREQuency:APERture <number | MINimum | MAXimum | DEFault> specifies the aperture time for a frequency measurement. APERture time is the same as measurement gate time and can be calculated from the following formula:

$$\text{Resolution in Hz} = 4\text{E}-9 \times (\text{F}/\text{T}),$$

where F=frequency, and T=gate or APERture time.

<i>Parameters</i>	Parameter Name	Parameter Type	Range of Values	Default Value
	value	numeric	1 mS to 99.999 S	100 mS
	MIN	discrete	1 mS	
	MAX	discrete	99.999 S	
	DEF	discrete	100 mS	

Comments

- Aperture Time versus Resolution: Aperture time is the minimum gate time during which frequency measurements are made. The actual gate time depends on the period of the input signal. A larger aperture time is required to obtain greater resolution. Refer to “CONFigure:FREQuency” in this chapter for more information.
- Selecting Aperture Time: Aperture time is programmable in 1 mS steps. If an aperture time is specified that is not an exact step, it is truncated. Specifying a value out of range causes the counter to default to the closest MINimum or MAXimum value. It Also generates error -209, “Data clipped to limit”.
- Power-up and *RST condition is 100 mS.

Example

FREQ:APER 100.6E-3 Specifies aperture time as 100 ms.

:FREQuency:APERture?

:FREQuency:APERture? [<MINimum | MAXimum | DEFault>] returns one of the following numbers to the output buffer:

- The current aperture time in seconds if no parameter is specified.
- The minimum aperture time available if MIN is specified.
- The maximum aperture time available if MAX is specified.
- The default aperture time if DEF is specified.

An example of this query is shown below:

SENS:FREQ:APER 256E-03 Aperture time is 256 mS.

FREQ:APER? MAX Maximum aperture time (99.999 S) is returned.

FREQ:APER? Returns 0.256

:FREQUENCY:RANGE :FREQUENCY:RANGE subsystem is used to specify the frequency range for channel 1.

:FREQUENCY:RANGE:AUTO :FREQUENCY:RANGE:AUTO <OFF|0|ON|1> specifies whether or not the counter will automatically determine the frequency range.

Comments

- This command has no effect on channels 2 or 3.
- Enables prescaling (divide by 2) on channel 1 when the input signal frequency is greater than 100 MHz.
- If AUTO is ON, then manually selecting range turns AUTO OFF.
- This command can be used only for frequency, period, and ratio measurements.

:FREQUENCY:RANGE:UPPER :FREQUENCY:RANGE:UPPER <value|MIN|MAX|DEF> specifies the maximum frequency that the counter will acquire as its input.

Parameters

Parameter Name	Parameter Type	Range of Values	Default Value
number	value	0.001 to 200 E6	100 E6 Hz
MIN	discrete	0.001 (channels 1/2)	
MAX	discrete	200 E6 (channel 1) 100 E6 (channel 2)	
DEF	discrete	100 E6 (channels 1/2)	

Comments

- This command has no effect on channels 2 or 3.
- If the range ≥ 100 MHz for channel 1, prescaling is enabled and the UPPER value is set to 200 MHz. When prescaling is ON, only frequency, period, and ratio measurements can be made. If the entered value is less than 100 MHz, prescaling is turned OFF and the UPPER value is set to 100E6.
- If range determination is currently automatic ((SENSE:FREQ:RANGE:AUTO ON), then setting the value of RANGE will disable auto ranging ((SENSE:FREQ:RANGE:AUTO OFF).

Example

FREQ:RANGE:UPP 170E6

Turns prescaling ON and sets the upper value to 200 MHz.

:FREQUENCY:RANGE[:UPPER]?

:FREQUENCY:RANGE[:UPPER]? [<MIN|MAX|DEF>] is used to query the value of UPPER frequency range. Querying on channel 1 returns 100 or 200 MHz while querying on channel 2 will return 100 MHz.

If the query returns 200E6, then prescaling ($\div 2$) on channel 1 is ON.

:SENSE:FUNCTION

You can specify the measurement function with the following command string:

[SENSE[1|2|3]] :FUNCTION "[VOLTage:]<function>"

This command is used to set up the counter to perform a specified measurement function without affecting any other measurement parameters or set up. Some measurement functions such as TOTALize by gate may require additional SENSE commands.

<i>Parameters</i>	Parameter Name	Parameter Type	Range of Values	Default Value
	function	discrete	"[VOLTage:]AC" "[VOLTage:]DC" "[VOLTage:]FREQuency" "[VOLTage:]FREQuency:RATio" "[VOLTage:]FTIME" "[VOLTage:]FALL:TIME" "[VOLTage:]MAXimum" "[VOLTage:]MINimum" "[VOLTage:]NWIDth" "[VOLTage:]PERiod" "[VOLTage:]PWIDth" "[VOLTage:]RTIME" "[VOLTage:]RISE:TIME" "[VOLTage:]TINTerval" "[VOLTage:]TOTAlize"	"FREQ"

Comments

- Channel Number: Select only one channel at a time.
- If the counter is in continuous measurement mode (INITiate:CONTInuous is set ON), specifying function on the other channel generates error -204, "Channel not configured" with no change made. However, function may be changed on the configured channel.
- TOTALize on channel 2 is not allowed but TOTALize on channel 2 by channel 1 is permitted. Refer to the TOTALize:GATE subsystem.
- Measurement Description: See the CONFIGure subsystem for a description of all available measurements.
- [VOLTage:] is an implied node and may be omitted from the program message.
- Auto Trigger: Making measurements with Auto Trigger greatly reduces throughput as compared to measurement speed when trigger levels are programmed manually. During auto triggered frequency measurements, the counter determines the positive and negative voltage peaks of the input signal. It then programs the trigger level according to the current SENSE:EVENT:RELative parameter value.

Rise/fall time measurements use both input amplifiers (common input channel 1). During auto triggered rise/fall time measurements, channel 1 is programmed for 10% (90%) value and channel 2 is programmed for 90% (10%) value. A signal arriving at the channel 2 Input connector is not counted.

- **CONFigure and MEASure versus SENSE:** Most measurements can be performed using one of these three subsystems, and each has advantages and disadvantages over the other. The basic difference between the commands is as follows:

The **CONFigure** command can be used for all measurements except gated totalize and time interval delay. The **CONFigure** command only configures a channel for a specific function, and does not perform the measurement. Use of additional commands (**READ?**, or **INIT/FETC?**) to perform the measurement and read the results is necessary. Further customization of the counter set-up is provided, through the use of optional parameters.

The **MEASure** command can be used for all measurements except **TOTALize**. The **MEASure** command configures a channel for a specific function, performs the measurement, and returns the result to the output buffer. Further customization of the counter set-up is provided, through the use of optional parameters.

The **MEASure** command is instrument independent and can be used in other instruments to perform similar functions. This command should be used when the portability of instrument syntax is important. **CONFigure/READ?** is less compatible if the counter re-configuration occurs between the **CONFigure** and **READ?** operations.

The **SENSE** subsystem can be used for all measurements. The **SENSE:FUNCTION** command only configures a channel for a specific function and does not perform the measurement. The state of the counter is not otherwise affected. Use of additional commands (**READ?**, or **INIT/FETC?**) to perform the measurement and store the results is required.

The **SENSE** commands should be used when direct control over the measurement is important.

<i>Example</i>	SENS2:FUNC "PWID"	Sets channel 2 function to positive pulse width.
	READ2?	Make pulse width measurement.
	FUNC "PWID"	Abbreviated command for setting "PWID" function on channel 1.

:FUNCTION? [SENSe[1|2|3]:]FUNction? returns one of the following functions listed in the SENSe:FUNction command section. Only one channel may be selected for the FUNction query at a time. If the query is made on a channel other than the last configured channel, then error -302, "Channel not configured for measurement" is returned. An example of the use of this query is shown below:

FUNC "FREQ:RAT"	Function is ratio.
FUNC?	Query counter to return selected function.
"ENTER" statement	Enter quoted string into controller.

:PERiod:APERture :PERiod:APERture determines the gate time used for PERiod measurements. The gate time you program is the minimum value, the actual gate depends on the measured period. Refer to *Table 5-7* in CONFigure:PERiod for more details about APERture (Gate time) and resolution.

:PERiod:APERture? The :PERiod:APERture? query returns the PERiod:APERture value.

:RATio:APERture :RATio:APERture programs the gate time during which ratio measurements are calculated. Refer to *Table 5-5* in CONFigure:RATio for more details about APERture (Gate time) and resolution.

:RATio:APERture? The :RATio:APERture? query returns the RATio:APERture value.

NOTE

The counter does not distinguish between "apertures" for differing measurement functions or channels. The aperture time most recently programmed is the one that is used.

:ROSCillator:SOURce :ROSCillator:SOURce <CLK10|INT|EXT> controls selection of the reference oscillator source used as the counter's timebase. The SOURce parameters are CLK10, INT, and EXT. The parameters have the following meaning:

CLK10: The counter uses the VXIbus backplane +CLK10 and -CLK10 lines as the timebase reference signal.

INTernal: The counter uses an internal precision oscillator (option 010)

EXTernal: The counter uses an external timebase signal supplied through the front panel Int/Ext Reference BNC connector.

Comments

- At *RST or power-up the counter is locked to the VXibus CLK10 lines.
- If Option 010 is installed and selected (ROSC:SOUR INT), then a 30 minute warm-up period is recommended before making measurements.
- If the selected oscillator is not found, error -241, "Hardware missing" is returned.

:ROSCillator:SOURce?

The :ROSCillator:SOURce? query returns the current source of the counter's timebase.

:TINterval:DELay

The :TINterval:DELay subsystem controls whether time-interval measurement is made with or without a delay time. Refer to chapter 4, "Time Interval Delay Measurements" section for details of use. This subsystem affects only time interval measurements.

Syntax:

```

:TINterval
:DELay
  [:STATe]           <OFF|0|ON|1>
  [:STATe]?
  :TIME             <value|MINimum|MAXimum|DEFault>
  :TIME?           [<MINimum|MAXimum|DEFault>]
    
```

:TINterval:DELay[:STATe]

:TINterval:DELay[:STATe] command enables/disables time-interval delay measurements. If :STATe is ON, the counter will ignore all STOP:ARM events for the duration determined by the TINterval:DELay:TIME command. If [:STATe] is OFF, and time interval measurement is programmed, routine time interval measurements will be made according to current ARMing subsystem status.

:TINterval:DELay[:STATe?]

:TINterval:DELay[:STATe?] query returns the TINterval:DELay[:STATe] status. If time interval delay measurements are enabled, the query returns 1 (ON), otherwise it will return 0 (OFF).

:TINterval:DELay:TIME

:TINterval:DELay:TIME <value | MINimum | MAXimum | DEFault> command determines the delay time for time interval delay measurements.

Parameters

Parameter Name	Parameter Type	Range of Values	Default Value
value	numeric	0 to 99.999 S	100 mS
MIN	discrete	1 mS	
MAX	discrete	99.999 S	
DEF	discrete	100 mS	

Comments

- The <value> should be programmed in 1 mS increments. If an entered <value> is not in millisecond increments, it will be truncated.
- The counter ignores all STOP arm events for the requested delay time if TINTerval:DELAy:STATe is ON. If TINTerval:DELAy:STATe is OFF, setting a delay time will not affect any measurement.

:TINTerval:DELAy:TIME?

:TINTerval:DELAy:TIME? query returns a delay time <value> regardless of the TINTerval:DELAy[:STATe] status (ON or OFF).

:TOTAlize:GATE

The TOTAlize:GATE subsystem is used to define a measurement gating signal for alternative measurement features of the TOTAlize function. TOTAlize by GATE means that the counter will accumulate events only when a specified gate signal is present. The GATE signal source will always be the other input channel (1 or 2). The events accumulate for only one pulse of the gating signal. If the EXTERNAL ARM input is to be used as the source, the ARMing subsystem must be configured.

Syntax:

```

:TOTAlize
:GATE
[:STATe]           <OFF|0|ON|1>
[:STATe]?
:POLarity         <NORMAl|INVerted>
:POLarity?
:SOURce?

```

:TOTAlize:GATE:STATe

:TOTAlize:GATE:STATe <OFF|0|ON|1> command enables/disables the TOTAlize-by-GATE measurement feature. Selecting ON or 1 enables the feature while choosing OFF or 0 disables it.

Parameters

Parameter Name	Parameter Type	Range of Values	Default Value
mode	boolean	<OFF 0 ON 1>	OFF

Comments

- If TOTAlize:GATE:STATe is ON, the counter will accumulate events on the selected channel for the duration of time defined by the signal present on the other input channel and the TOTAlize:GATE:POLarity command.
- If GATE:STATe ON, events are accumulated for a single pulse (polarity defined by the GATE:POLarity command) on the other channel.

:TOTAlize:GATE:STATe?

The :TOTAlize:GATE:STATe? query returns the TOTAlize:GATE:STATe status: 0 if "OFF" and 1 if "ON".

:TOTalize:GATE:POLarity

:TOTalize:GATE:POLarity <NORMal|INVerted> command sets the polarity of the GATE signal for gated TOTalize measurements. The events are accumulated when the GATE source is either high (NORMal) or low (INVerted) depending on the configured polarity.

<i>Parameters</i>	Parameter Name	Parameter Type	Range of Values	Default Value
	polarity	discrete	<NORMal INVerted>	NORMal

- Comments*
- The power-up and reset (*RST) value is NORMal.
 - Before you can change functions after completing a Totalize function (or between each "Totalize-by-GATE" function), you must use ABORT to halt the totalize measurement process.

Example This example shows how to TOTalize 2 by 1.

SENS2:FUNC "TOT"	Configure channel 2 for TOTalize (Not valid unless gated by channel 1.)
SENS2:TOT:GATE:POL INV	Sets polarity of GATE signal to INVerted.
SENS2:TOT:GATE:STAT ON	Turns ON gating by channel 1.
READ2	Make a measurement. Counts number of events on channel 2 for one negative pulse on channel 1.

Example TOTalize channel 2 by channel 1 as the Gate.

SENSe2:FUNC "TOT"	Configure channel 2 for TOTalize
SENSe2:TOT:GATE:STATe ON	Enable channel 1 as the Gate
SENSe2:TOT:POL INV	Select channel 1 polarity
for I=1 to 10	Initiate a measurement
INIT2	
FETCH2?	
ABORT2	Halt the measurement
NEXT I	

:TOTalize:GATE:POLarity?

:TOTalize:GATE:POLarity? query returns the TOTalize:GATE:POLarity status, either NORMal or INVerted of the gating source.

:TOTalize:GATE:SOURce?

:TOTalize:GATE:SOURce? query returns the source of the gating signal. If channel 2 is totalized with channel 1 as the gate, then the query returns "INT1". If channel 1 is totalized with channel 2, then the query returns "INT2".

STATUS The STATUS subsystem lets you examine the status of the counter by monitoring the Operation Status Register and the Questionable Data/Signal Register. *Figure 5-1* shows all of the counter's status registers.

Syntax:

```

STATUS
:OPERation
:CONDition?
:ENABle      <value>|<non-decimal numeric>
:ENABle?
[:EVENT]?
:QUESTionable
:CONDition?
:ENABle      <value>|<non-decimal numeric>
:ENABle?
[:EVENT]?

```

The STATUS system contains four registers (and the Output Queue), two of which are under IEEE 488.2 control. These are the Standard Event Status Register (ESR) and the Status Byte Register (SBR). The other two are the Standard Operation Status register and Questionable Data register. Refer to the description of common commands for more details.

The two registers under the counter's control are the Standard Operation Status Register, and the Questionable Data Register. These registers may be set and queried.

Parameters Parameter entry for both of these registers is numeric only. Numeric types may be Decimal, Hexadecimal, Octal, or Binary. The decimal numeric range is between 0 and 32767. The power-on/reset default value is 0.

Bit Number to Decimal Value Conversion																
Bit Number	0	1	2	3	4	5	6	7	8	9	10	11	12	13	14	15
Decimal Value	1	2	4	8	16	32	64	128	256	512	1024	2048	4096	8192	16384	32768

Sending a decimal value of 64 will set bit 6.

Using the Operation Status Register

The 16-bit Operation Status Register monitors counter operations currently being performed. The counter implements bit 6 only and is defined as follows:

- Bit 6: has a decimal weight of "64" when the counter is in the wait-for-arm state.

The Operation Status Register group consists of a condition (C) register, an event (EV) register, and an enable (EN) register as shown in *Figure 5-1*. The commands in the STATUS:OPERation subsystem control and monitor these registers.

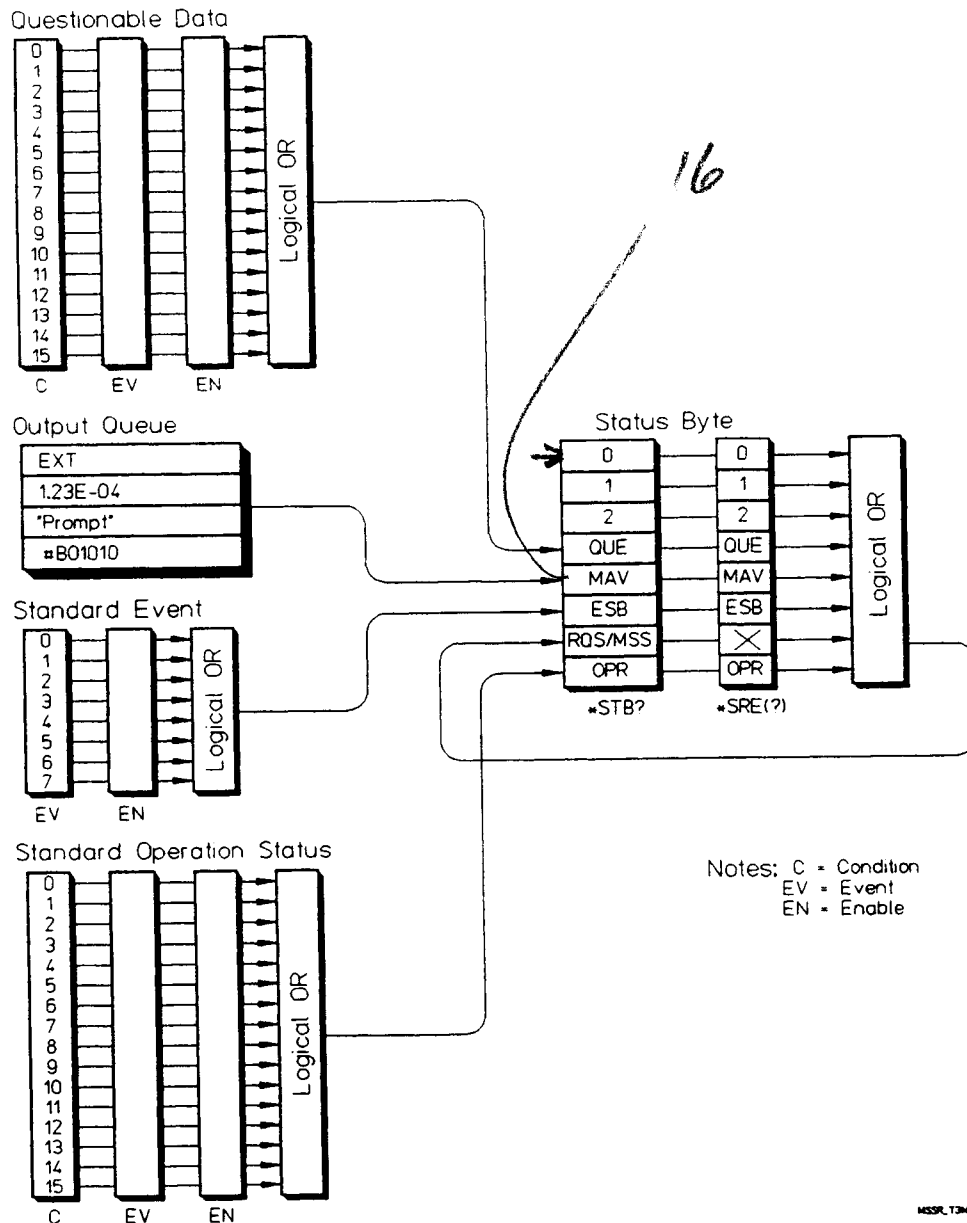

Figure 5-1. Status System Registers

:OPERation:CONDition?

STATus:OPERation:CONDition? returns a decimal-weighted number representing the bits set in the Operation Status Register's condition register. Reading the condition register does not destroy its contents.

Comments

- This command returns "0" (no bits set) or "64" (bit 6 set).
- The condition register does not implement latching and buffering. The register is updated in real-time whenever the counter makes a measurement.
- The *CLS (clear status) command clears all status registers.

An example of querying the condition register is shown below:

STAT:OPER:COND?	Read condition register
ENTER statement	Enter value into controller

:OPERation:ENABle

STATus:OPERation:ENABle <number> enables bits in the Operation Status Register's event register to be reported to the summary bit (setting Status Byte Register bit 7 true). The event register bits are not reported in the Status Bytes Register unless specifically enabled. Although values 0 - 32767 are accepted, setting bit 6 (decimal 64) is the only recommended operation.

Example

STAT:OPER:ENAB 64	Enable bit 6
-------------------	--------------

Comments

- If any bits are enabled in the enable register, the corresponding bits set in the Operation Status Register's event register are reported to the Status Byte Register.
- The *CLS (clear status) command clears all status registers. The *CLS command does not affect which bits are enabled to be reflected in the Status Byte Register.

:OPERation:ENABle?

STATus:OPERation:ENABle? returns a decimal-weighted number representing the bits set in the Operation Status Register's enable register.

An example of querying the enable register is shown below:

STAT:OPER:ENAB?	Read enable register; clear register contents
ENTER statement	Enter value into controller

:OPERation[:EVENT]?

STATus:OPERation[:EVENT]? returns a decimal-weighted number representing the bits set in the Operation Status Register's event register. Reading the event register clears its contents.

Comments

- The :EVENT parameter is optional. Both of the following command statements read the event register:

STAT:OPER:EVEN? or STAT:OPER?

- The event register latches conditions from the condition register. Bits in the event register are latched, and remain set until cleared by STAT:OPER:EVEN? or the *CLS (clear status) command.
- The *CLS (clear status) command clears all status registers (Standard Event Status Register, Operation Status Register, Questionable Data Register).

An example of querying the event register is shown below:

STAT:OPER:EVEN? Read event register; clear register contents

ENTER statement Enter value into controller

Using the Questionable Data Register

The Questionable Data Register conveys information about the quality of the measurements made by the counter. The counter implements bits 0, 8, and 9 as follows:

- Bit 0: has a decimal weight of “1” when voltage measurement is questionable. This is useful in Auto trigger measurements for AC, DC, MAXimum, and MINimum where one of the voltages is at the trigger limit or MIN and MAX are the same.
- Bit 8: has a decimal weight of “256” when the interpolator has overflowed. This may occur during a hardware failure or when too many external gates have been used to take average measurements. Decreasing the configured APERTure time may remedy this overflow.
- Bit 9: has a decimal weight of “512” when the internal interpolator values are questionable. If this bit is set repeatedly, then a hardware problem is suspect.

The Questionable Data Register group consists of a condition register, an event register, and an enable register as shown in *Figure 5-1*. The commands in the STATus:QUESTionable subsystem control and monitor these registers.

The STATus:QUESTionable subsystem commands query the QUESTionable Register to indicate whether an overflow has occurred on a given channel after an INIT, FETC?, READ?, or MEASure command has executed. When any of the bits are set (questionable data), bit 3 of the Status Register is set to 1 if enabled by the STAT:QUES:ENAB command.

:QUESTionable:CONDition?

STATus:QUESTionable:CONDition? query is accepted and returns 0 as the condition register is not accessible.

:QUESTIONable:ENABLE

STATUS:QUESTIONable:ENABLE <number> sets the enable mask which allows true conditions in the Questionable Data/Signal EVENT Register to be reported in the summary bit (setting Status Byte Register bit 3 true).

Parameters

Parameter Name	Parameter Type	Range of Values	Default Value
number	numeric	0 to 32767	0

Comments

- **Summary Bit:** If any of the bits are set in the Questionable Data/Signal ENABLE Register, a transition of these EVENT register bits causes the associated summary bit to be true.

Example

STAT:QUES:ENAB 768 Sets bits 8 and 9 true

:QUESTIONable:ENABLE?

STATUS:QUESTIONable:ENABLE? query returns the bit value of the Questionable Data ENABLE Register.

Comments

- **Output Format:** The command returns a decimal weighted value from 0 to 1023 indicating which bits are set true.
- **Maximum Value Returned:** The maximum decimal weighted value used in the counter module is 1023 (bits 1 through 9 set true).

An example of querying the Questionable Enable Register is shown below:

STAT:QUES:ENAB? Queries the enable register.
"ENTER" data Enter data into the controller.

:QUESTIONable[:EVENT]?

STATUS:QUESTIONable[:EVENT]? Queries the status of the Questionable Data/Signal EVENT Register.

Comments

- **Information Updated:** The EVENT Register latches only low to high events from the CONDITION Register.
- **Output Format:** Returns a decimal weighted value from 0 to 32767 indicating which bits are set true.
- **Reading Contents:** Reading the EVENT Register by a query will clear its contents.

An example of querying the event register is shown below:

STAT:QUES:EVENT? Queries the Questionable Event Register.

STAT:QUES? The short version of the command.

SYSTEM The **SYSTEM** command subsystem returns error numbers and messages in the error queue.

Syntax:

```
SYSTEM
:ERRor?
:PIMacro      <string>
:VERSion?
```

:ERRor? **SYSTEM:ERRor?** returns the error numbers and corresponding error messages in the error queue. See Appendix B in this manual for a listing of the error numbers and messages.

Comments

- When an error is generated by the counter, it stores an error number and corresponding message in the error queue.
- One error is removed from the error queue each time the **SYSTEM:ERRor?** command is executed. The errors are cleared in a first-in, first-out order. This means that if several errors are waiting in the queue, each **SYSTEM:ERRor?** query will return the oldest (not the most recent) error. That error is then removed from the queue.
- When the error queue is empty, subsequent **SYSTEM:ERRor?** queries returns +0, "No error". To clear all errors from the queue, execute the ***CLS** command.
- The error queue has a maximum capacity of 30 errors. If the queue overflows, the last error is replaced with -350, "Too many errors". No further errors are accepted by the queue until space becomes available.
- ***RST** Condition: ***RST** does not clear the error queue.
- Power-on condition: The error queue is empty unless an error occurs during power-up.

An example of querying the error queue is shown below:

CONF:FRQ 10E6, 1	Enter misspelled FREQuency function (FRQ). Front-panel Error LED turns on.
SYST:ERR?	Query the error queue
"ENTER" Statement	Counter returns error -113, "Undefined header"

- :PIMacro** **SYSTem:PIMacro**<string> command (Purge Individual Macro) will delete the macro described by the string name. If the string is not defined, error -270, "Macro error", will be returned. Use the *PMC command to delete all macros.
- :VERsion?** **SYSTem:VERsion?** query returns the current SCPI version identifier (currently 1990.0). The returned version number signifies that the counter's programmable functions conform to the equivalent date of the SCPI standard. As software is updated, or new commands added, the response to this query may change to reflect the latest version.

Specifications

SPECIFICATIONS

Instrument specifications are listed in *Table A-1*. These are the performance standards, or limits against which the instrument may be tested including typical characteristics as additional information for the user. (Only specifications are warranted.)

Table A-1. HP E1420B Specifications

I. Operating Mode Specifications

(Circled numbers indicate definition references, page A-4.)

FREQUENCY 1,2

Range: .001 Hz to 200 MHz (100 MHz for input 2)

LSD[ⓐ]: (4 ns / Gate Time) * FREQ

Resolution: (See Graph 1)

$$\pm \text{LSD} \frac{\pm(1 \text{ ns rms} + 1.4 * \text{Trigger Error}^{\text{ⓑ}}) * \text{FREQ}}{\text{Gate Time}}$$

Accuracy:

$$\pm \text{Resolution} \pm \text{Time Base Error}^{\text{Ⓒ}}$$

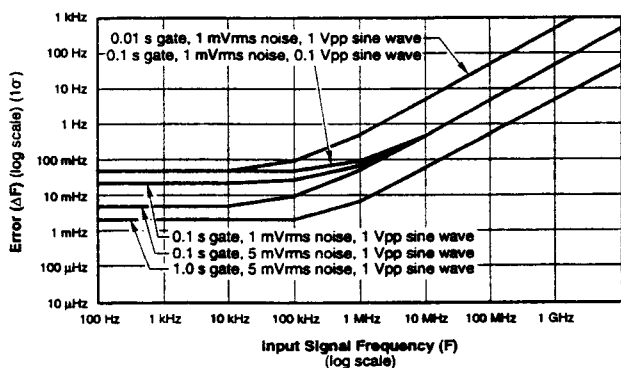

Graph 1. Frequency Resolution Error: Noise on the input signal and internal uncertainties affects Frequency and Period measurements. For Period, invert the period (P) of the input

signal ($F = \frac{1}{P}$), and find frequency error (ΔF). Period error

$$(\Delta P) = \left(\frac{\Delta F}{F} \right) \times P.$$

† 100 ps using 100 gate average

†† Systematic error due to differential channel delay. Can be eliminated with optimized measurement technique (offsets, cable length, etc.).

PERIOD 1,2

Range: 10 ns to 1000 s (5 ns to 1000 s on Input 1)

LSD[ⓐ]: (4 ns / Gate Time) * PER

Resolution: (See Graph 1)

$$\pm \text{LSD} \frac{\pm(1 \text{ ns rms} + 1.4 * \text{Trigger Error}^{\text{ⓑ}}) * \text{PER}}{\text{GateTime}}$$

Accuracy:

$$\pm \text{Resolution} \pm \text{Time Base Error}^{\text{Ⓒ}}$$

TIME INTERVAL 1→2[ⓐ]

Range: 1 ns to 1000 s (single-shot), 10 s (100 gate average)

LSD[ⓐ]: 1 ns (100 ps using 100 gate average)

Resolution:

$$\pm \text{LSD} \pm \text{Start Trigger Error}^{\text{ⓑ}} \pm \text{Stop Trigger Error}^{\text{ⓑ}} \pm 1 \text{ ns rms} \dagger$$

Accuracy:

$$\pm \text{Resolution} \pm \text{Time Base Error}^{\text{Ⓒ}}$$

$$\pm \text{Trigger Level Timing}$$

$$\text{Error}^{\text{Ⓒ}} \pm \text{Trigger Level Setting Error}^{\text{Ⓒ}} \pm 2 \text{ ns.} \dagger\dagger$$

TIME INTERVAL DELAY 1→2[ⓐ]

Used with TI 1→2, a selectable delay can be inserted between START (Input 1 trigger) and STOP (Input 2 trigger). Electrical inputs during delay are ignored. Specifications are the same as TI 1→2.

Delay Range: 1 ms to 99.999 s (1 ms steps), typical

Delay Accuracy: $\pm 100 \mu\text{s} \pm 0.05\% * \text{Delay Time}$, typical

FREQUENCY RATIO 1/2, 2/1

Specified for higher frequency signal connected to Numerator Input (i.e., to input 1 for Ratio 1/2).

Range: .001 Hz to 100 MHz (200 MHz on input 1 if divider is selected)

$$\text{LSD}^{\text{ⓐ}}: \frac{4 * \text{RATIO}}{\text{Numerator Input FREQ} * \text{Gate Time}}$$

Table A-1. HP E1420B Specifications (Continued)

Resolution:

$$\pm \text{LSD} \pm \frac{\text{Denominator Input Trigger Error}^{\textcircled{3}}}{\text{Gate Time}} * \text{RATIO}$$

Accuracy: Same as resolution

TOTALIZE 1,1 BY 2,2 BY 1

Range: 0 to 1×10^{12} -1 events

LSD^①: 1 count of input signal

Resolution: ± 1 count

Accuracy: ± 1 count^②

NOTE: Input slew rate at trigger point of gating signal determines when the gate opens and closes. This is known as trigger level timing error.

RISE/FALL TIME 1

With Automatic Triggering:

Range:

× 1 Mode: 15 ns to 400 μ sec (maximum for both modes)

× 10 Mode: for freq ≥ 500 kHz, 75 ns minimum
for freq. <500 kHz, 150 ns minimum

Minimum Amplitude: 750 mV (× Attn) pk-pk

Frequency Range: 1 kHz to 20 MHz

With Manual Level Settings (TI 1>2):

Range: (10 s max with 100 gate Average):

× 1 Mode: 15 ns to 800 s

× 10 Mode: 75 ns to 800 s

LSD^①: 1 ns (100 ps using 100 gate average)

Resolution:

$\pm \text{LSD} \pm \text{Start Trigger Error}^{\textcircled{3}} \pm \text{Stop Trigger Error}^{\textcircled{3}} \pm 1$ ns rms †

Accuracy:

$\pm \text{Resolution} \pm \text{Trigger Level Timing Error}^{\textcircled{4}} \pm \text{Trigger Level Setting Error} \pm \text{Time Base Error}^{\textcircled{2}} \pm 2$ ns ††

POSITIVE, NEGATIVE PULSE WIDTH 1,2

Range: 5 ns to 1 ms

LSD^①: 1 ns (100 ps using 100 gate average)

Resolution:

$\pm \text{LSD} \pm \text{Start Trigger Error}^{\textcircled{3}} \pm \text{Stop Trigger Error}^{\textcircled{3}} \pm 1$ ns rms †

Accuracy:

$\pm \text{Resolution} \pm \text{Trigger Level Timing Error}^{\textcircled{4}} \pm \text{Trigger Level Setting Error}^{\textcircled{5}} \pm \text{Time Base Error}^{\textcircled{2}}$

With Automatic Triggering:

Minimum Amplitude: 70 mV (× Attn) rms sine wave, 200 mV (× Attn) pk-pk

Frequency Range: 1 kHz to 20 MHz

MINIMUM, MAXIMUM AC, DC VOLTAGES 1,2

Frequency Range: dc (Input 1 only), 1 kHz to 20 MHz

Dynamic Range:

dc signals: ± 10 V (× Attn)

ac signals: 200 mV (× Attn) pk-pk to 10V (× Attn) pk-pk

Resolution:

Min, Max, AC/DC: 30 mV (× Attn)

Accuracy:

Min, Max: AC ± 50 mV (× Attn) $\pm 5\%$ of pk-pk voltage ($\pm 10\%$ if × 10 mode)

DC: ± 50 mV (× Attn) $\pm 5\%$ of pk-pk voltage ($\pm 10\%$ if × 10 mode)

† 100 ps using 100 gate average

†† Systematic error due to differential channel delay. Can be eliminated with optimized measurement technique (offsets, cable length, etc.).

II. Input Specifications

INPUT 1 RANGE

dc coupled: 0 to 200 MHz

ac coupled: 100 Hz to 200 MHz

INPUT 2 RANGE

dc coupled: 0 to 100 MHz

ac coupled: 100 Hz to 100 MHz

SENSITIVITY 1,2 (MAX)

35 mV (× Attn) rms sine wave

100 mV (× Attn) pk-pk at a minimum pulse width of 5 ns

1 M Ω :

Dynamic Range (ac) 10V (× Attn) peak to peak

Signal Operating Range (dc) ± 10 Volts (× Attn)

50 Ω :

Dynamic Range (ac) 10V peak to peak

Signal Operating Range (dc) ± 5 Volts

AC + DC not to exceed 5 Vrms

TRIGGER LEVEL RANGE 1,2 (Not scaled by Attenuation Factor)

± 10.2 V with step size of 2.5 mV

TRIGGER LEVEL ACCURACY 1,2

± 30 Mv (× Attn) $\pm 1\%$ of trigger level (Same as

Autotrigger Level Accuracy)

AUTO TRIGGER

Can be selected to determine trigger levels for all measurements except totalize and Input 3 measurements.

Frequency Range: 1 kHz to 20 MHz

Minimum Amplitude: 70 mV (× Attn) rms sine wave, 200 mV (× Attn) pk-pk

EXTERNAL ARMING

Input: Front-panel BNC or VXIbus TTLTRIG lines

Minimum Start to Stop Time: 50 ns

Sensitivity: 500 mV pk-pk

Signal Operating Range: -5 Vdc to +5 Vdc

Dynamic Range: 500 mV to 5 V pk-pk

III. Option 010 TCXO Time Base Specifications

Frequency: 10 MHz

Stability:

Aging Rate: $< 1 \times 10^{-7}$ /month

Temperature: $< 1 \times 10^{-6}$, 0 to 40 °C (when set to offset frequency at 25 °C)

Line Voltage: $< 5 \times 10^{-7}$ for 10% change

(Note that the TCXO is not specified between 40 °C and 55 °C.)

Table A-1. HP E1420B Specifications (Continued)

IV. Option 030 Input 3 Specifications

Measurements: Frequency, Ratio 3/1, Period

Range: 90 MHz to 2500 MHz

Resolution: Same as Frequency 1,2

Accuracy: Same as Frequency 1,2

FREQUENCY RATIO 3,1

Specified for higher frequency signal connected to Numerator Input (i.e., to input 3 for Ratio 3/1).

$$\text{LSD}^{\dagger}: \frac{4 * \text{Ratio}}{(\text{C-channel Freq}/64) * \text{gate-time}}$$

Sensitivity:

- 25 dBm (12.5 mv rms) to 1 GHz
- 20 dBm (22.5 mv rms) from >1 GHz to 1.8 GHz
- 12 dBm (56.5 mv rms) from >1.8 GHz to 2.5 GHz

Maximum Input Level: +7 dBm (500.6 mv rms)

Damage Level: +15 dBm (1.25v rms)

Dynamic Range: from minimum sensitivity spec to +7 dBm

V. Input Characteristics

HYSTERESIS 1,2 (@1 MHz)

Adjustable to:

- MINimum (35 mV pk-pk)
- MAXimum (100 mV pk-pk)
- DEFault (60 mV pk-pk)

COUPLING

ac,dc

TRIGGER SLOPE 1,2

Independent selection of + or - slope

ATTENUATOR 1,2

× 1 or × 10 Nominal

IMPEDANCE 1,2

- × 1: 1 MΩ shunted by <30 pf or 50Ω †
- × 10: 1 MΩ shunted by <20 pf or 50Ω †

DAMAGE LEVEL 1,2

50Ω: 5 V rms

1 MΩ, × 1:

- dc - 5 kHz: 250 V (dc + peak ac)
- 5 kHz - 175 kHz: 8.75×10^5 Vrms Hz/FREQ
- >175 kHz: 5 Vrms

1 MΩ, × 10:

- dc - 50 kHz: 250 V (dc + peak ac)
- 50 kHz - 175 kHz: 8.75×10^6 Vrms Hz/FREQ
- >175 kHz: 50 Vrms

COMMON INPUT:

All specifications are the same as separate operation except for the following:

Input 1 Range

Limited to 100 MHz

Impedance

- × 1: 500 kΩ shunted to <40 pf or 50Ω †
- × 10: 1 MΩ shunted to <20 pf or 50Ω †

EXTERNAL ARM:

Front panel ARM input or VXibus TTL TRIG lines can be used to determine Start and/or Stop point of a measurement. External Arm can be used with all measurements.

Range: 0 to 20 MHz

Trigger Levels: 0V (GND), 1.6V (TTL), -1.3V (ECL)

Slope: Independent Selection of START and STOP ARM slopes, +, -, or OFF.

Impedance: dc coupled. 1 MΩ shunted by <20 pF †

Damage Level:

- <5 kHz: 40 V rms
- >5 kHz: 5 V rms

OPTION 030 INPUT 3:

Trigger Level: Fixed at 0 V

Impedance: ac coupled, 50Ω

Damage Level: +15 dBm (1.25 Vrms)

VI. Time Base Characteristics

Standard Time Base: Uses VXibus CLK10 as default

External Reference Input: Front-panel BNC accepts 10 MHz, 500 mV to 5 V rms into 1kΩ shunted by <20 pF.

External Reference Output: The option 010 TCXO Time Base signal can be routed out the front-panel BNC.

Signal: 10 MHz, Square wave into 50Ω amplitude 400 mV (-0.2V to +0.2V).

VII. Gate Time Characteristics

Range: 1 ms to 99.999 seconds in 1 ms increments. (100 ms default)

Resolution: 1 ms

Accuracy: $\pm 100 \mu\text{s} \pm (0.05\% \times \text{Gate Time})$ + two periods of input signal.

100 Gate Average: 100 gates accumulated and average is returned. This adds an additional digit of resolution. It can be used with all functions except Totalize.

Gate Output: Can be routed to any one of the 8 VXibus TTLTRIG lines. Level is low while gate is open during all measurements except Totalize.

VIII. Measurement Throughput Characteristics

(Definitions are located on page A-4.)

A. Short Speeds

Free-run: Up to 60 measurements / second

Switching: Up to 40 measurements / second

† Resistance values are measured at dc and capacitance at 1 MHz.

Table A-1. HP E1420B Specifications (Continued)

B. Comprehensive Single Reading Times:

1. Frequency Period

- a. 100 Hz signal, .1 Hz resolution (3 digits)
60 ms
- b. 100 Hz signal, .0001 Hz resolution (6 digits)
60 ms
- c. 10 MHz signal, 10 kHz resolution (3 digits)
24 ms
- d. 10 MHz signal, 10 Hz resolution (6 digits)
25 ms

2. Totalize

- a. 10 MHz signal, Time to read total (Fetch?)
9 ms

3. Ratio

- a. 100 kHz signal, .0001 resolution (4 digits)
426 ms
- b. 10 MHz signal, .0001 resolution (4 digits)
31 ms

4. Time Interval

- a. 10 ms signal, 10 ns resolution (6 digits)
40 ms
- b. 100 μ s signal, 100 ns resolution (3 digits)
21 ms
- c. 100 μ s signal, 1 ns resolution (5 digits)
173 ms

5. Automatic Pulse Width

- a. 5 ms signal, 5 ns resolution (6 digits)
290 ms
- b. 50 μ s signal, 50 ns resolution (3 digits)
280 ms

6. Automatic Rise/Fall Time

- a. 1 ms per, 6 Vpp, 1 μ s rt/ft, resolution 1 ns
(3 digits) 284 ms

7. Voltage

- a. 1 MHz, 6 Vpp, .06 V resolution (2 digits)
438 ms

C. Option 040

1. Frequency Period

- a. 10 MHz, 1 ms gate time, "MIN" resolution
7.2 ms

2. Time Interval

- a. 50 nsec, "MIN" resolution
6.2 ms

IX. General Characteristics

Memory: Ten measurement set-ups, including trigger levels, may be stored in memory and subsequently recalled. Set-ups are lost when power is removed from the instrument.

Programming Language: SCPI 1991.0

Operating Temperature: 0 to 55 °C

Power Requirements:

DC Peak current (IPm):

- +5V= 2A
- +12V= 0.25A
- 12V = 0.15A
- 5.2V=0.8A

Dynamic current (IDm):

- +5V= 0.15A
- +12V= 0.01A
- 12V = 0.02A
- 5.2V=0.03A

Size: Occupies one slot of a C-size VXIbus cardcage.

234 mm H \times 30.5 mm W \times 340 mm D
(9.2 in H \times 1.2 in W \times 13.4 in D)

Weight: Net 1.5 kg (3.2 lb), Shipping 2.3 kg (5 lb)

VXIbus Revision Compliance: 1.3

Connectors: P1, P2

Device type: Message-based

Δ Pressure: 0.15mm H₂O

Air flow: 1 liter/sec

Auto Trigger:

Auto-trigger can be used to automatically set trigger levels at 50% point (10%, 90% for Rise/Fall Time) of the input signal. The standard auto-trigger will evaluate the input signal, set the trigger level, measure and repeat. Single-measurement auto-trigger will evaluate the input signal only once, and then measure repeatedly, speeding up the process.

Trigger levels can be specified in Volts or percentage of signal height. Percentage trigger levels will activate the auto-trigger to evaluate the signal amplitude.

X. Definitions*

1. LSD

Unit value of Least Significant Digit. Calculations should be rounded to the nearest decade (i.e., 5 Hz becomes 10 Hz and 4 ns becomes 1 ns).

2. Time Base Error (See Graph 2)

Maximum fractional frequency change in the time base frequency due to all errors (aging, temperature, line voltage) multiplied by the measurement result.

* Note that rms values in operating mode specifications indicate 1 σ confidence value. All graphs use 1 σ confidence values. For 99.9% confidence, 3 σ values are advised.

Table A-1. HP E1420B Specifications (Continued)

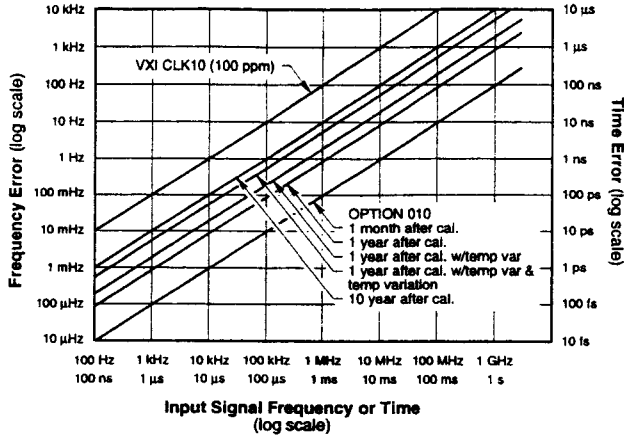

Graph 2. Timebase Error: Crystal environment and aging affects all measurements.

3. Trigger Error (See Graph 3)

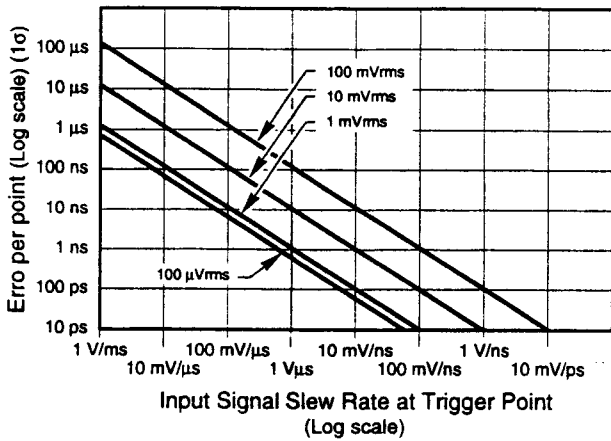

Graph 3. Input Noise Trigger Error: Noise on the input signal affects both the Start and Stop points of all time interval measurements.

$$TE = \frac{\sqrt{(ei)^2 + (en)^2}}{\text{Input Slew Rate at Trigger Point}}$$

ei = Effective rms noise of counter's input channel (500 μV typical)

en = rms noise of input signal for input bandwidth

4. Trigger Level Timing Error (See Graph 4)

Larger of:

0.5 hysteresis band / input slew rate at start trigger point[Ⓞ]

0.5 hysteresis band / input slew rate at stop trigger point[Ⓞ]

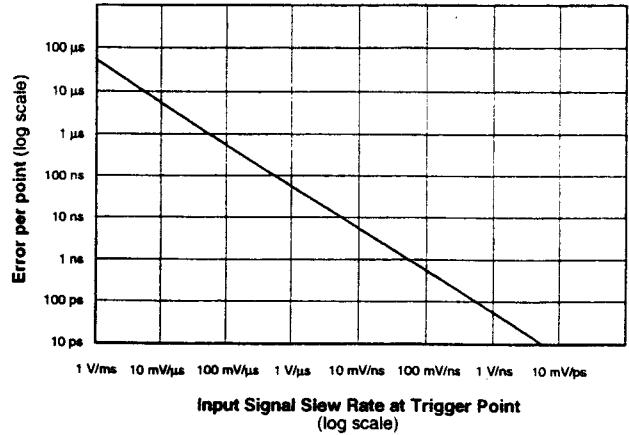

Graph 4. Trigger Level Timing Error: Affects the Start and Stop points of all time interval measurements. Total error is the larger of the two trigger point errors. (For sine waves, Slew rate at 50% level = $2 \times \pi \times \text{frequency} \times \text{amplitude}$, where amplitude is $\frac{1}{2}$ of the peak-to-peak voltage.)

5. Trigger Level Setting Error (See Graph 5)

$$\pm \frac{30 \text{ mV} \pm (1\% \times \text{Start Trigger Level Setting})}{\text{Input Signal Slew Rate at Start Trigger Point}}$$

$$\pm \frac{30 \text{ mV} \pm (1\% \times \text{Stop Trigger Level Setting})}{\text{Input Signal Slew Rate at Stop Trigger Point}}$$

Note that rise/fall times use 10% and 90% points of signal for trigger points, unless programmed differently.

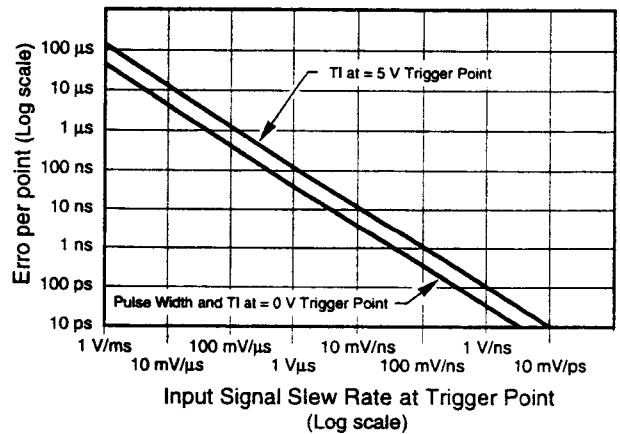

Graph 5. Trigger Level Setting Error: Affects both the Start and Stop points of all time interval measurements.

Table A-1. HP E1420B Specifications (Continued)

6. **Trigger Point and Hysteresis**

Auto trigger disabled: trigger point = trigger level reading

Auto trigger enabled: For all measurements except Rise/Fall Time,

$$\text{trigger points} = \frac{\text{Max peak} + \text{Min peak}}{2}$$

For Rise/Fall Time,

$$10\% \text{ trigger point} = .1 * \text{max peak} + .9 \text{ min peak}$$

$$90\% \text{ trigger point} = .9 * \text{max peak} + .1 \text{ min peak}$$

Min/Max voltage function is used to measure peaks.

$$\text{For X\% trigger point} = \left(\frac{X}{100} \right) \times \text{Max peak} + \left(1 - \frac{X}{100} \right) \times \text{Min peak}$$

7. Specification for all TI and PW measurements in $\times 10$ attenuation mode are only valid for trigger level settings between 20% and 80% of input signal level (pk-pk).

8. For Totalize 1BY2, 2BY1 on a repetitive input signal, the Totalize accuracy becomes:

$$\pm 1 \text{ count} \pm (\text{Gate Trigger Error}) \times \text{FREQ},$$

where Gate Trigger Error, which affects the start and stop points of the Totalize measurement, is the Trigger Error³, Trigger Level Timing Error⁴, and Trigger Level Setting Error⁵ at the start and stop trigger points of a gate input.

For Example, Gate Trigger Error on a normal polarity gate is :

$$\begin{aligned} & \text{Start Trigger Error}^3 + \text{Stop Trigger Error}^3 \\ & + \text{Start Trigger Level Timing Error}^4 \\ & - \text{Stop Trigger Level Timing Error}^4 \\ & + \text{Trigger Level Setting Error}^5 \end{aligned}$$

XI. Measurement Throughput Definitions

A. Short Speeds: Quick indicator of maximum counter speeds.

Setup: Embedded controller

Signal: >1 MHz; signal does not limit speed of measurement

Gate: 1 ms; measurement \ll counter processing time.

Triggering: Manual

1. Free Run:

Indicates speed of measuring and outputting results. Important if many measurements are made from one setup.

Algorithm: Setup Frequency Measurement, then do multiple reads.

2. Switching:

Indicates speed of setup, measurement and output. Important if measurement mode or parameters are changed frequently.

Algorithm:

Setup Frequency Measurement, then make one read;
Setup Time Interval Measurement, then make one read;
Setup Period Measurement, then make one read;
Repeat.

Setups:

Frequency setup: Input 1 AC, Neg Slope, 50 Ω , Trig Level 0.2 V.
Time Interval setup: COMMON, Input 2 Pos Slope, 50 Ω , Trig Level 0.2 V.
Period setup: Input 1 DC, Pos Slope, 1 M Ω , Trig Level -.35 V.

B. Comprehensive Single Reading Times:

Single Reading Times indicate the times needed for command transfer, instrument setup, measurement, and result transfer.

Hardware Setup:

HP 9000 Series 300 computer (320)
HP E1405B Command Module
HP E1400B Cardcage

Software Setup: HPBASIC Version 5.xx

Error Messages

CODE	MESSAGE	CAUSE
-100	Command error	
-101	Invalid character	Unrecognized character in specified parameter
-102	Syntax error	Command missing space/comma between parameters
-103	Invalid separator	Command parameter separated by space not comma
-104	Data type error	Wrong data type specified in parameter
-105	GET not allowed	Group Execute Trigger was received
-108	Parameter not allowed	Parameter specified in parameterless command
-109	Missing parameter	Parameter missing in entered command
-112	Program mnemonic too long	Header contains more than 12 characters
-113	Undefined header	Command header incorrectly specified
-121	Invalid character in number	Entered character for numeric data is incorrect
-123	Numeric overflow	Exponent larger than 32000
-124	Too many digits	More than 256 digits specified
-128	Numeric data not allowed	Number specified for parameter not letter
-131	Invalid suffix	Parameter suffix incorrectly specified (e.g. 50 M instead of 50 MHz)
-138	Suffix not allowed	Parameter suffix specified when not allowed
-141	Invalid character data	Parameter type specified not allowed (e.g. "MEAS:FREQ HIGH" instead of "MEAS:FREQ MAX")
-144	Character data too long	Character data element has more than 12 characters
-148	Character data not allowed	Entered character data not recognized by counter
-150	String data error	Entered string data contained a non-specific error
-151	Invalid string data	Entered string data syntax invalid

CODE	MESSAGE	CAUSE
-158	String data not allowed	String data encountered but not allowed
-160	Block data error	Entered block data contained a non-specific error
-161	Invalid block data	Entered block data syntax invalid
-168	Block data not allowed	Block data encountered but not allowed
-170	Expression error	Entered expression contained a non-specific error
-171	Invalid expression	Entered block data syntax invalid
-178	Expression data not allowed	Expression data encountered but not allowed
-180	Macro error	Entered macro command or parameter contained a non-specific error
-181	Invalid outside macro definition	Macro parameter placeholder encountered outside a macro definition
-183	Invalid inside macro definition	Program message sent with *DMC is syntactically invalid
-200	Execution error	Requested measurement is not available
-201	Invalid while in local	Command not executeable while device in local
-203	Measurement timeout	Measurement execution exceeded maximum time
-204	Channel not configured for measurement	Appropriate channel was not set up for the requested measurement
-205	Arming configuration conflict	External arm source inconsistent for start and stop within the same program message
-206	Measurement has not been initiated	Executed FETCh? without initiating measurement for new configuration
-207	Invalid totalize	Totalize on channel 2 (totalize on 1 or totalize 2 by 1)
-208	Value out of range	Calculated parameter outside allowed range
-209	Data clipped to limit	Entered parameter(s) outside of range - data truncated at limit
-212	ARM ignored	ARM:IMMEDIATE set without being INITIALIZED
-213	INIT ignored	Another measurement already in progress
-215	Arm deadlock	Attempted FETCh? while arming was in HOLD or BUS mode
-221	Setting conflict	A valid command but not supported for the specified channel
-222	Data out of range	Specified parameter value too large/small
-223	Too much data	Excess data for memory/device-specific process requirements

CODE	MESSAGE	CAUSE
-224	Illegal parameter value	Specified numeric value not allowed
-230	Data corrupt or stale	New measurement started but not completed since last access
-231	Data questionable	Measurement accuracy is suspect
-240	Hardware error	Execution error due to hardware fault
-241	Hardware missing	Option 010 or 030 not installed
-270	Macro error	Non-specific execution related macro error
-271	Macro syntax error	Illegal macro syntax entered
-272	Macro execution error	Macro execution error due to macro definition error
-273	Illegal macro label	Entered macro label not accepted by device
-274	Macro parameter error	Macro definition contains improperly used macro parameter
-276	Macro recursion error	Device found macro recursive
-277	Macro redefinition not allowed	Macro label already defined
-301	Exceeded shared memory	Allotted VXIbus shared memory is full.
-310	System error	Non-specific system error has occurred
-331	Selftest failed; EPROM checksum failure	Specified hardware failed
-332	Selftest failed; RAM failure	Specified hardware failed
-333	Selftest failed; Clock 10 failed	Specified hardware failed
-334	Selftest failed; Front-end failed	Specified hardware failed
-335	Selftest failed; Calibration RAM failure	Specified hardware failed
-350	Too many errors	The error queue is full — more than 30 errors have occurred
-400	Query error	
-410	Query interrupted	Data not read from output buffer before another command was executed
-420	Query unterminated	Command generating data unable to complete due to configuration error
-430	Query deadlocked	Command cannot complete output due to controller request for input

Performance Tests

INTRODUCTION

This appendix provides two separate groups of tests designed to check for proper operation of the HP E1420B VXIbus Universal Counter; functional tests and performance tests. The functional tests provide a quick method of verifying the basic functioning of the counter when its normal operation is in question. The more thorough performance tests are used to conduct a complete investigation of the instrument's electrical performance, using the specifications of *Table A-1* (*Table C-3* in this appendix) as the performance standards.

Where to Find Important Topics

- Alternate Test Equipment pgs. C-2/22
- Auto Frequency Measurement Test pg. C-6
- Auto Measurement Sensitivity, Range, and Accuracy pg. C-31
- E1420B Specifications Table pg. C-21
- External-Arm Input Test pg. C-12
- External-Arm Sensitivity, Range, and Minimum Start-to-Stop Time pg. C-28
- Functional Test Record pg. C-18
- Input 1/2: Measurement Sensitivity, Range, and Accuracy pg. C-23
- Input 3: Measurement Sensitivity, Range, and Accuracy pg. C-33
- Input Signal Conditioning Test pg. C-8
- Option Tests pgs. C-15, 16, 33
- Power-up Self Test pg. C-5
- Ratio/Time-Interval Measurement Test pgs. C-7/12
- Performance Test Record pg. C-37

Chapter Summary

- Equipment Required pg. C-2
- Calibration Cycle pg. C-3
- Test Procedure Considerations pg. C-3
- Software Implemented FPT pg. C-4
- Functional Tests pg. C-4
- Full Performance Tests pg. C-18
- Functional/Performance Test Records pgs. C-18/37

EQUIPMENT REQUIRED

Equipment required for the performance tests is listed in *Table C-1, Recommended Test Equipment*. Any substitutes to this recommended list are valid only if the substituted equipment satisfies all critical requirements of the recommended model(s) given in the table.

Table C-1. HP E1420B Recommended Test Equipment

Equipment	Critical Requirements	Recommended Model
For All Functional and Performance Tests:		
VXIbus Mainframe	Meets VXIbus System Specs, Rev. 1.3	HP 75000 Series C
Slot-0 Command Module	HP-IB or RS-232 to VXIbus compatible SCPI command language compatible	HP E1405B
Interface Controller	HP-IB or RS-232 compatible	HP 9000 Series 200/300
For Input 1 and Input 2 Functional and Performance Tests:		
Function Generator	Frequency Range: 0 → 20 MHz Output Level: 25 mVrms → 10 V p-p (With dc offset capability) Resolution: 0.01 Hz	HP 3325B
Signal Generator	Frequency Range: 100 MHz → 200 MHz Output Level: 25 mVrms → 100 mVrms Resolution: 0.1 Hz Internal Timebase w/ Ref. Output	HP 8663A
Pulse Generator	Period: 50 ns → 1.0 ms Min. Pulse Width: 20 ns Max. Output Level: 5 Vp-p 3% pulse parameter accuracy	HP 8161A
BNC "T" connector		HP 1250-0781
For Option 030 UHF Input 3 Functional and Performance Tests:		
Signal Generator	Frequency Range: 90 MHz → Per Spec Output Level: +0.5 → +2.5 dBm Resolution: 0.1 Hz Internal Timebase w/ Ref. Output	HP 8663A
Fixed Attenuator	Attenuation 10 dB	HP 8491A (Option 010)
Connectors: BNC(m) to N(m) N(f) to BNC(f) N(m) to BNC(f)		HP 1250-0082 HP 1250-1474 HP 1250-0780

CALIBRATION CYCLE

To maintain the E1420B within specified operating limits, the instrument should be checked using the full performance tests at least once each year. This annual time frame may be accelerated as demanded by specific environmental conditions and user needs. If installed, the optional TCXO reference oscillator must be checked and, if necessary, adjusted to a house frequency standard before beginning the performance tests. Refer to the TCXO Adjustment Procedure in Chapter 3 of the E1420B assembly level service manual. Follow the preliminary instructions given in the INTRODUCTION and SAFETY CONSIDERATIONS paragraphs of Chapter 3.

FUNCTIONAL/ PERFORMANCE TEST RECORDS

Results of the functional tests may be recorded on a copy of the Functional Test Record (*Table C-2*), which follows the functional test procedures. Results of the full performance tests may be recorded on a copy of the Performance Test Record (*Table C-4*), which follows the performance test procedures.

NOTE

The software version of E1420B testing will record its own test results, then print these results on computer generated Functional/Performance Test Records.

TEST PROCEDURE CONSIDERATIONS

The person performing the following tests must understand how to operate the specified test equipment. Equipment settings, other than for the Universal Counter, are stated in general terms. Unless otherwise specified, use straight (not 50 ohm feedthrough) BNC connectors when applying input signals to the E1420B during performance testing. All cables, connectors, and adapters needed are also to be supplied by test personnel.

Only the SCPI command strings for the counter are given in the procedures. The user must send the string to the counter via a controller and command module. To make a measurement or read back a value, the user reads back a string from the output queue of the counter. The user must properly dimension strings to accept at least 20 characters as a query response to a measurement request. More details on configuring and operating the counter are given in Chapter 2 of this manual.

CAUTION

Throughout these testing procedures, the ***RST** command is used frequently to reinitialize the counter to its preset default values. Failure to issue the ***RST** command at the specified times (and only at these times) will result in testing errors, since the procedures are written to assume that the default values are present after sending the ***RST** command.

SOFTWARE IMPLEMENTED FULL PERFORMANCE TESTING

Available upon order of the E1420B assembly level service manual is a software program designed to expedite the Functional and Performance Testing processes. The program steps the user through any or all parts of E1420B performance testing, sends pertinent SCPI commands to the counter, receives and analyzes measurements sent back from the counter, and helps the user configure the E1420B and set up all test equipment input conditions. This software program, available in 5 1/4" or 3 1/2" floppy format, was written in HP BASIC for a HP 9000 Series 200/300 system communicating over HP-IB with a HP E1405B VXibus Slot-0 Command Module. The software part numbers are: 3 1/2" disk, E1420-13503, Rev. C.00.00; 5 1/4" disk, E1420-13504, Rev. C.00.00. The software also includes verification checks for the read and write functions of Option 040, Shared Memory.

FUNCTIONAL TESTS

The tests included here are not as thorough and rigorous as the full performance tests. This group of tests is intended to serve only as a method for giving the operator a high degree of confidence that the instrument is performing properly. No attempt is made to check the specifications of the instrument.

These tests are useful for incoming QA or as a first check on an instrument suspected of having a problem.

NOTE

The following functional test procedures frequently call upon the use of a low amplitude (less than 10v p-p) 10 MHz signal as a test input. This signal exists on the CLK 10 SMB output of the HP E1405 Slot-0 command module, if present. This signal can also be generated by routing the TCXO timebase, if present, to the E1420B front panel Int/Ext BNC output (Refer to page C-13).

If neither of the above are available, the user must provide a signal source capable of generating a 1v p-p sinusoidal signal at a frequency of 10 MHz. Example source: HP 3325B.

CAUTION

Before the E1420B is installed into the VXibus Mainframe, make certain that the counter is properly configured as specified in Chapter 2 of this manual. Verify that the VXibus Mainframe meets VXibus System Specifications, Rev 1.3.

NOTE

These tests only specify the command strings that need to be sent to the counter in word-serial protocol over the VXibus. Procedures used in getting the command strings to the counter are controller and slot-0 dependent. See Chapter 2 of this manual for details.

Preliminary Procedure

Use the following steps to set up the E1420B for functional testing:

1. Turn off power to the VXIbus Mainframe.
2. Plug the HP E1420B into an empty slot on the VXIbus Mainframe.
3. Turn on power to the VXIbus Mainframe.
4. Verify proper operation of the VXIbus slot-0 command module.
5. Generate an external sinusoidal signal at a frequency of 10 MHz and an amplitude of approximately 0.5v peak (1V p-p) with no dc offset. (See NOTE on page C-4.)
6. For now, DO NOT connect this signal to the input channels of the HP E1420B.

Power-up Self-Test

Description: During the power-up sequence, the HP E1420B performs a diagnostic check of major components.

Procedure: Use the following steps to run the E1420B Self-test.

1. Cycle the VXIbus Mainframe power switch to ON.

Observe:

- a. All E1420B front panel LED's light momentarily.
 - b. The "Failed" LED extinguishes after a few seconds, indicating successful completion of the self test.
2. Connect the 10-MHz test input signal to the Int/Ext Reference BNC input of the E1420B.
 3. Ask the counter to report its power-up status by sending the "**TST?" command to the E1420B.

Observe:

The E1420B "Access" LED momentarily lights, acknowledging the counter's acceptance of the "**TST?" command.

4. Read the output string from the E1420B.

Observe:

The result should be "+0", which means "NO ERRORS".

Test Record: Mark Pass or Fail on the Functional Test Record, line 1.

Here's what was Checked:

1. All LED's lighting indicates that all front panel LED's are operational.
2. The extinguished "Failed" LED indicates that the microprocessor, bus controller, latches, and ROM are functioning.
3. The ability of the command module to communicate with the counter, indicated by the lighting of the "Access" LED, shows that the controller is sending the appropriate control signals to the logical address occupied by the E1420B.
4. Reading back information from the counter indicates that the VXibus interface and associated latches are functioning.
5. A "+0" message indicates that the diagnostic self-test has passed. The self-test verifies the following:
 - ROM
 - RAM
 - MRC
 - Interpolators
 - CLK10 Timebase presence
 - Input amplifier/main board connector integrity
 - Control latches and buffers

Failure: Any failures during the power-up self test will cause the "Failed" LED to remain lit. If the failure does not affect the microprocessor, bus controller, VXibus interface, ROM, RAM, or associated latches, the output queue will contain a "+1" message indicating a need for further diagnostic testing. Further instructions on failure handling are given in Chapter 4 of the assembly level service manual.

Auto Frequency Measurement Test

Description: This test checks the auto-triggering capability and frequency interpolation process of the E1420B.

NOTE

This test requires a signal source capable of providing a 10 MHz 1 Vp-p sine wave with varying dc content. (Example: HP 3325B.)

Procedure: Use the following steps to conduct the Auto Frequency measurement test.

1. Generate the 10 MHz signal of preliminary procedure Step 5 and give it an offset of +2 dc volts.
2. Connect a 10-MHz timebase standard to the Int/Ext ref. BNC and configure the counter by sending "SENS:ROSC:SOUR EXT".
3. Connect this signal to Input 1 on the E1420B.

4. Reinitialize the HP E1420B by sending " *RST".
5. Configure the E1420B with the following command:

Description of Command	SCPI Command String
Place counter in auto-trigger mode	"EVEN:LEV:AUTO ON"

6. Make a frequency measurement on Input 1:

Description of Command	SCPI Command String
Measure Frequency Input 1	"MEAS1:FREQ?"

Observe:

The Input 1 trigger LED should be flashing, and the frequency measurement should read 10 MHz, within the tolerance limits of the generated input signal.

Test Record: Mark Pass or Fail on the Functional Test Record Card, line 2.

Here's what was checked:

1. The interpolators which provide the accuracy of the frequency count. Defective interpolators could cause a reading error of +100 Hz.
2. The auto-trigger functioning of the E1420B.

Failure: If this test does not cause the Input 1 trigger LED to flash and will not return a legitimate frequency reading, the probable cause of error is the auto-triggering circuitry.

If the test returns a measurement not consistent with the true input signal, then the frequency interpolators are most likely at fault and the Main Board is a candidate for replacement. Refer to the trouble shooting procedures found in Chapter 4 of the assembly level service manual for more information.

Ratio Measurement Test

Description: This test uses a 10 MHz signal to drive the channel 1 and 2 input amplifiers in a test of the Multiple-Register Counter IC (MRC).

Procedure: Use the following steps to conduct the Ratio measurement test.

1. Connect the 1V p-p 10 MHz with no dc offset to Input 1.
2. Reinitialize the HP E1420B by sending " *RST".
3. Configure the E1420B with the following SCPI command:

Description of Command	SCPI Command String
Common input mode ON	"INP:ROUT COMM"

4. Measure the frequency ratio of Input 1 to Input 2.

<u>Description of Command</u>	<u>SCPI Command String</u>
-------------------------------	----------------------------

Measure Frequency Ratio IN1/IN2	"MEAS:FREQ:RAT?"
---------------------------------	------------------

Observe:

The ratio measurement should return as 1.000000000E+00 and both input trigger lights should be flashing.

Test Record: Mark Pass or Fail on the Functional Test Record Card, line 3.

Here's what was checked:

The operation of the internal count circuitry (contained in the MRC chip) and microprocessor math circuitry is checked using the ratio function.

Failure: Should this test fail, the MRC is the probable cause, and the Main Board is a likely candidate for replacement. Other circuit blocks involved are the channel 1 and 2 input amplifier circuitry, along with the measurement select-calculation-control block. Refer to the trouble shooting procedures found in Chapter 4 of the assembly level service manual for more information.

Input Signal Conditioning Test

Description: This series of checks comprises a functional test of the input amplifier relays and circuitry associated with those relays.

NOTE

This test requires a signal source capable of providing a 10 MHz 1 Vp-p sine wave with varying dc content. (Example: HP 3325B)

Procedure: Use the following steps to conduct the Input Signal Conditioning test.

1. Connect the 10 MHz signal of preliminary procedure Step 5 to Input 1.
2. Reinitialize the HP E1420B by sending "**RST**".
3. Configure the HP E1420B with the following SCPI command string:

<u>Description of Command</u>	<u>SCPI Command String</u>
-------------------------------	----------------------------

Common input mode ON	"INP:ROUT COMM"
----------------------	-----------------

Observe:

The Input 1 and Input 2 trigger LED's should both be flashing. Steps 3 and 4 verify operation of the trigger level LED's.

4. Gradually increase the trigger levels of Input 1 and Input 2 until the trigger lights just go off. Use the following SCPI command strings to make the trigger levels increase:

Description of Command	SCPI Command String
Input 1,2: Trigger Level x.x V	"SENS1:EVEN:LEV x.x" "SENS2:EVEN:LEV x.x"

(where x.x is the trigger level value.)

5. Set the HP E1420B with the following SCPI commands:

Description of Command	SCPI Command String
Inputs 1,2: 1 Mohm impedance	"INP1:IMP 1E6" "INP2:IMP 1E6"
Common input mode OFF	"INP:ROUT SEP"

Observe:

The Input 1 trigger LED should be flashing and the Input 2 trigger LED should not be flashing.

6. Issue the following SCPI command to the E1420B:

Description of Command	SCPI Command String
Common Input Mode ON	"INP:ROUT COMM"

Observe:

The Input 1 and Input 2 trigger LED's should both be flashing. Steps 5 and 6 check the input common/separate relay.

7. Change both input impedance levels to 50 ohms.

Description of Command	SCPI Command String
Input 1,2: 50 ohm impedance	"INP1:IMP 50" "INP2:IMP 50"

Observe:

The Input 1 and Input 2 trigger LED's should both be off (not flashing). Steps 5 and 7 are aimed at checking the input impedance relays.

8. Reinitialize the HP E1420B by sending "**RST".

9. Configure the HP E1420B with the following SCPI commands:

Description of Command	SCPI Command String
Inputs 1 and 2, ac coupling	"INP1:COUP AC" "INP2:COUP AC"

10. Use the following SCPI commands to turn on the x10 attenuator:

<u>Description of Command</u>	<u>SCPI Command String</u>
Inputs 1 and 2, attenuator $\times 10$	"INP1:ATT 10" "INP2:ATT 10"

11. Generate a 10 MHz signal with an amplitude of 3V rms.

12. Connect this signal to inputs 1 and 2 on the HP E1420B.

13. Measure the ac rms voltage of the input signal through the $\times 10$ attenuators by sending the following SCPI commands:

<u>Description of Command</u>	<u>SCPI Command String</u>
Measure ac rms voltage; Inputs 1 and 2.	"MEAS1:AC?" "MEAS2:AC?"

Observe:

The Input 1 and 2 trigger LEDs should both be flashing, and the voltage measurement should return as 300 mV rms, within the tolerance limits of the generated input signal. Note that this test is verifying the $\times 1/\times 10$ attenuator relays, not the accuracy of the measurement process.

14. Use the following SCPI commands to return the HP E1420B attenuators to $\times 1$ operation:

<u>Description of Command</u>	<u>SCPI Command String</u>
Inputs 1 and 2, Attenuation $\times 1$.	"INP1:ATT 1" "INP2:ATT 1"

15. Measure the ac rms voltage of the signal through the $\times 1$ attenuator:

<u>Description of Command</u>	<u>SCPI Command String</u>
Measure ac rms voltage; Inputs 1 and 2.	"MEAS1:AC?" "MEAS2:AC?"

Observe:

The Input 1 and 2 LEDs should be flashing and the voltage measured should return as 3.00 Vrms within the tolerance limits of the generated input signal.

16. Reinitialize the HP E1420B by sending "*RST".

17. Configure the E1420B with this SCPI command:

<u>Description of Command</u>	<u>SCPI Command String</u>
Common input mode ON	"INP:ROUT COMM"

18. Measure the Input 1 and 2 signal frequencies with these SCPI commands:

Description of Command	SCPI Command String
Measure Frequency: Input 1	"MEAS1:FREQ?"
Input 2	"MEAS2:FREQ?"

Observe:

The measurements should read 10 MHz, within the tolerance limits of the external source. Note that this test is verifying the ac/dc relay, not the accuracy of the measurement process.

19. Carefully increase the dc offset level of the input signal until both Input 1 and Input 2 trigger lights stop flashing.
20. Issue the following SCPI commands to the E1420B:

Description of Command	SCPI Command String
Inputs 1,2: ac coupling	"INP1:COUP AC"
	"INP2:COUP AC"

Observe:

The Input 1 and Input 2 trigger lights should resume flashing.

21. Measure frequencies with the following SCPI commands:

Description of Command	SCPI Command String
Measure Frequency: Input 1	"MEAS1:FREQ? 1E7,1"
Input 2	"MEAS2:FREQ? 1E7,1"

Observe:

The measurements should read 10 MHz, within the tolerance limits of the external source. Note that this test is verifying the ac/dc relay, not the accuracy of the measurement process.

Test Record: Mark Pass or Fail on the Functional Test Record Card, line 4.

Here's what was checked:

All input amplifier relays and associated circuitry.

Failure: The circuit blocks that are added to the testing process are the ac/dc relays, the 50/1 Mohm relays, the $\times 1/\times 10$ attenuator relays, and the common/separate relay. If any part of the preceding test fails, the Input Amplifier Board is a likely candidate for replacement. Refer to the trouble shooting procedures found in Chapter 4 of the assembly level service manual for more information.

Time Interval Test

Description: This test uses the Time Interval function to verify proper slope switching and trigger level accuracy in the input amplifier assembly.

Procedure: Use the following steps to conduct the Time Interval test.

1. Connect the 10 MHz signal of preliminary procedure Step 5 to Input 1.
2. Reinitialize the HP E1420B by sending "*RST".
3. Configure the E1420B with the following SCPI command strings:

Description of Command	SCPI Command String
Common input mode ON	"INP:ROUT COMM"
Input 1 trigger on positive slope	"SENS1:EVENT:SLOP POS"
Input 2 trigger on negative slope	"SENS2:EVENT:SLOP NEG"

4. Measure the time interval from Input 1 to Input 2.

Description of Command	SCPI Command String
Measure Time Interval 1 → 2	"MEAS1:TINT?"

Observe:

The measurement should be approximately 1/2 period of the input signal, or 50 ns.

5. Use the following SCPI commands to turn on ×10 attenuation and ac coupling:

Description of Command	SCPI Command String
Inputs 1 and 2, ac coupling and ×10 attenuation.	"INP1:COUP AC;ATT 10" "INP2:COUP AC;ATT 10"

6. Increase the signal amplitude to 3V rms.
7. Measure the interval from Input 1 to Input 2:

Description of Command	SCPI Command String
Measure Time Interval 1 → 2.	MEAS1:TINT?"

Observe:

The measurement should be approximately 1/2 period of the input signal, or 50 ns.

8. The preceding measurement was triggered to measure the positive portion of the 10 MHz input waveform. Now configure the HP E1420B to measure the negative portion by sending the following SCPI commands:

Description of Command	SCPI Command String
Reinitialize the counter.	"*RST"
Common input mode ON.	"INP:ROUT COMM"
Input 1 trigger on negative slope.	"SENS1:EVENT:SLOP NEG"
Input 2 trigger on negative slope.	"SENS2:EVENT:SLOP POS"

9. Once again measure the time interval from Input 1 to Input 2:

Description of Command	SCPI Command String
Measure Time Interval 1 → 2.	"MEAS1:TINT?"

Observe:

The measurement should be approximately 1/2 period of the input signal, or 50 ns.

10. Use the following SCPI commands to turn on the HP E1420B ×10 attenuators:

Description of Command	SCPI Command String
Inputs 1 and 2, Attenuation ×10.	"INP1:ATT 10" "INP2:ATT 10"

11. Measure the time interval from Input 1 to Input 2:

Description of Command	SCPI Command String
Measure Time Interval 1 → 2.	"MEAS1:TINT?"

Observe:

The measurement should be approximately 1/2 period of the input signal, or 50 ns.

Description of Command	SCPI Command String
Reinitialize counter	"*RST"
Common input mode ON	"INP:ROUT COMM"
Input 1 trigger on negative slope	"SENS1:EVENT:SLOP NEG"
Input 2 trigger on positive slope	"SENS2:EVENT:SLOP POS"

12. Once again measure the time interval from Input 1 to Input 2.

Description of Command	SCPI Command String
Measure Time Interval 1 → 2	"MEAS1:TINT?"

Observe:

The measurement should be approximately 1/2 period of the input signal, or 50 ns.

NOTE

Depending on distortion in the input signal, the preceding measurements may not be equal to exactly 1/2 of the 100 ns period. However, the two measurements should sum to one period of the input signal. (Allow for accuracy limits of the input source.)

Test Record: Mark Pass or Fail on the Functional Test Record, line 5.

Here's what was checked:

The trigger level and control circuitry in both $\times 1$ and $\times 10$ attenuator modes; particularly the slope switch control operation.

Failure: If the accuracy of the measurement(s) is slightly out of the specified range, the probable cause is the Input Board and the trigger level circuitry.

If the measurement is totally inaccurate (on the order of more than 50 ns), the probable cause is a malfunction in slope switching, which is controlled by the MRC on the Main Board. Refer to the trouble shooting procedures found in Chapter 4 of the assembly level service manual for more information.

**External Arm
Input Test**

Description: This test checks the front panel external arm input amplifier circuitry by configuring the arm to act as the gate for measuring a signal input on channel 1.

Procedure: Use the following steps to conduct the External Arm Input test.

1. Connect the 10 MHz signal of preliminary procedure Step 5 to Input 1 and the front panel BNC Arm Input using a BNC T-connector and two BNC cables of equal length.
2. Reinitialize the HP E1420B by sending "*RST".

3. Configure the E1420B with the following SCPI command strings:

Description of Command	SCPI Command String
Arm Input: Start, Stop on positive edges of External Source with an arm trigger level of 0 volts.	"ARM:STAR:SOUR EXT;LEV 0" "ARM:STAR:SLOP POS :" "ARM:STOP:SOUR EXT;LEV 0" "ARM:STOP:SLOP POS "

Observe:

The Arm input trigger LED should be flashing.

4. The E1420B is now configured to make measurements using the first positive edge of the arm input to open (start) the aperture gate, and the second positive edge of the arm input to close (stop) the gate; the aperture time is therefore the period of the arm input signal: 100 ns.

5. Now measure the frequency on Input 1.

Description of Command	SCPI Command String
Measure Frequency: Input 1	"MEAS1:FREQ?"

Observe:

The HP E1420B returns 10 MHz with a resolution of ± 1 MHz, within the tolerance limits of the external source. Note that this test is verifying the ability of the E1420B to trigger on an external Arm Input, not the accuracy of the measurement process.

Test Record: Mark Pass or Fail on the Functional Test Record Card, line 6.

Here's what was checked:

External Arm input circuitry on the Input Board.

Failure: The functional block being tested is the external arm input amplifier circuitry. If this test fails, the likely candidate for replacement is the Input Board. Refer to the trouble shooting procedures found in Chapter 4 of the assembly level service manual for more information.

**Option 010 TCXO
Timebase Test**

Description: This test uses the frequency ratio function to ensure proper installation and operation of the E1420B's optional TCXO internal timebase.

Preliminary Procedures:

If you are running this test out of sequence with the previous functional tests, be sure to follow preliminary procedure Steps 1-4 for functional testing, found on page C-5.

CAUTION

After following preliminary procedures, ALLOW 30 MINUTES OF TCXO WARM UP TIME BEFORE ATTEMPTING THE FOLLOWING TEST!!!

Procedure: Use the following steps to conduct the TCXO Timebase test.

1. Connect the front panel Int/Ext Reference signal to Input 1.
2. Reinitialize the HP E1420B by sending "*RST".
3. Configure the E1420B with the following SCPI command strings:

Description of Command	SCPI Command String
Route TCXO timebase to front panel Int/Ext Ref. as an output	"SENS:ROSC:SOUR INT"
Common input mode ON	"OUTP:ROSC:STAT ON"
	"INP:ROUT COMM"

4. Measure the frequency ratio of Input 1 to Input 2.

Description of Command	SCPI Command String
Measure Frequency Ratio IN1/IN2	"MEAS:FREQ:RAT?"

Observe:

The ratio measurement should return as 1.00000000E+00 and both input trigger lights should be flashing.

Test Record: Mark Pass or Fail on the Functional Test Record Card, line 7.

Here's what was checked:

1. The 10 MHz reference oscillator signal at the front panel connector is verified for TCXO sourcing.
2. The reference oscillator selection circuitry is exercised.

Failure: Should this test fail, first refer to the TCXO adjustment procedure found in Chapter 3 of the assembly level service manual. Other possible sources of error are the reference oscillator selection circuitry, input amplifier circuitry, and internal count circuitry. Refer to the trouble shooting procedures found in Chapter 4 of the assembly level service manual for more information.

Option 030, Input 3 Test

Description: The general functioning of Input 3 (Option 030) is checked by measuring a frequency within its specified range of 90 MHz to 2.5 GHz.

Requirements: Option 030 must be installed and a signal source capable of output between 90 MHz and 2.5 GHz must be provided. (Suggestion: HP 8663A.)

Procedure: Use the following steps to conduct the option 030 Input 3 test.

1. Set the signal source to generate a frequency between 90 MHz and 2.5 GHz at 300 mV rms (+2.5 dBm).
2. Connect the signal source to the HP E1420B Input 3.
3. Reinitialize the counter by sending "*RST".
4. Measure the frequency on Input 3 with the following SCPI command string:

<u>Description of Command</u>	<u>SCPI Command String</u>
Measure Frequency: Input 3	"MEAS3:FREQ?"

Observe:

The HP E1420B returns the generated frequency. Note that this test is checking the overall integrity of Input 3, not the accuracy.

Test Record: Mark Pass or Fail on the Functional Test Record Card, line 8.

Here's what was checked:

Basic operation of Input 3.

Failure: Refer to Chapter 4 of the assembly level service manual. The functional block being tested is the Input 3 input amplifier circuitry. If this test fails, the likely candidate for replacement is the Input Amplifier board A2.

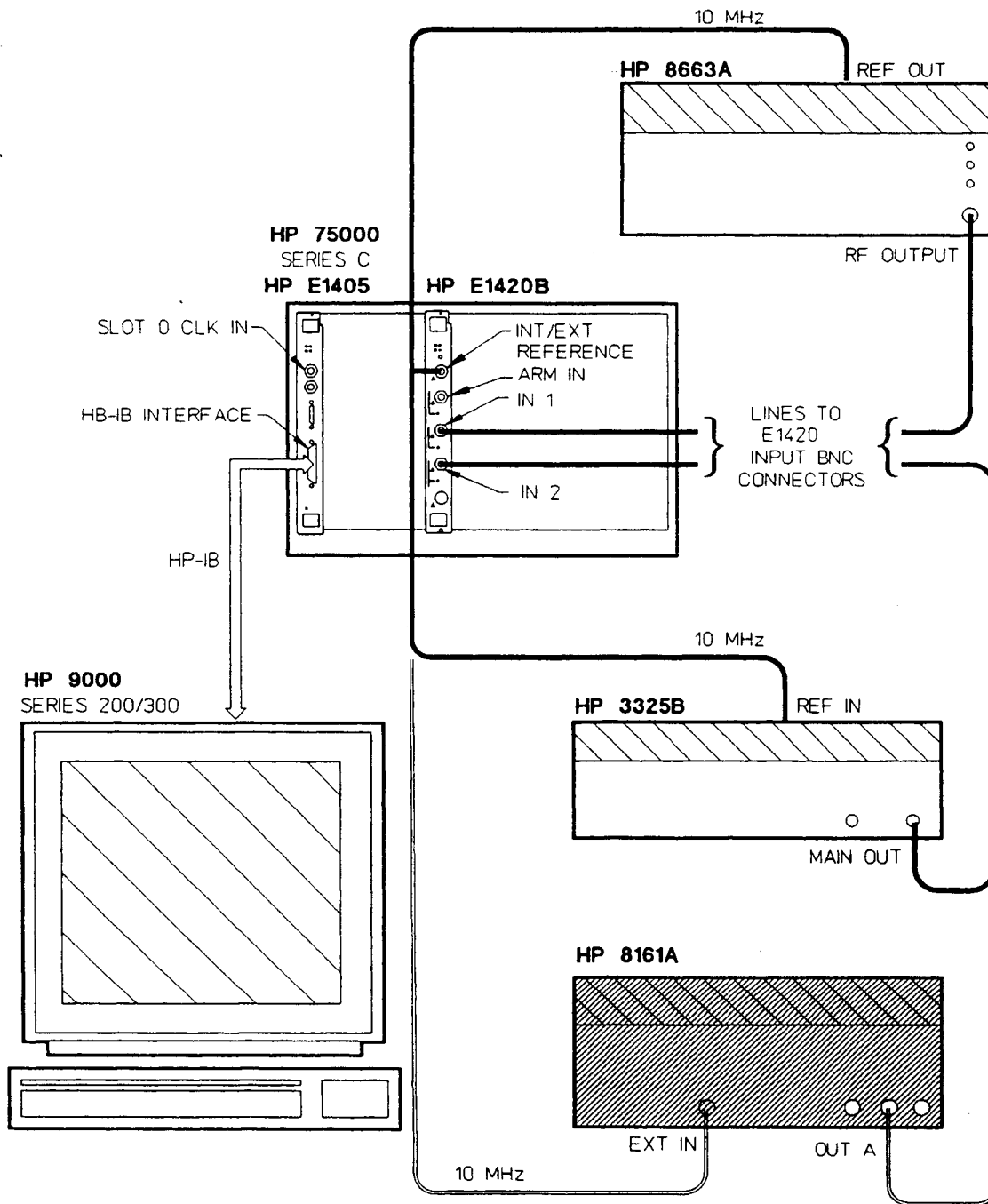

TSGSBT3M

Figure C-1. General Test Setup

NOTE

The resolution limits specified in the following procedures assume that the test equipment used is calibrated and operating at its performance limits. When this is not the case, problems can occur. For example, noise on an input signal will result in what seems to be an inaccurate measurement. This condition must be considered when observed measurements do not agree with the performance test limits.

Specifications Tested

All specifications listed in *Table C-3* (same as in *A-1*) will be verified through the performance testing. However, each specification does not have a stand-alone test. Duplication of effort is avoided by noting that a single test can fully verify the functionality of a circuit block and that further tests of that circuit block are redundant and unnecessary.

Table C-3 also gives a reference number to each specification being tested. Throughout the test procedures, these reference numbers will be used as a convenient method of telling the user exactly what specifications are checked in each successive test.

Summary of Tests:

1. Input 1/2: Measurement Sensitivity, Range, and Accuracy
2. External-Arm Sensitivity, Range, and Minimum Start-to-Stop Time
3. Auto Measurement Sensitivity, Range, and Accuracy
4. Input 3: Measurement Sensitivity, Range, and Accuracy

Table C-3. HP E1420B Specifications Test List

Area Tested	Ref No.	Specification Tested
Inputs 1, 2:	1	Input 1 Range DC: 0 - 200 MHz
	2	Input 2 Range DC: 0 - 100 MHz
	3	Input 1 Range AC: 100 Hz - 200 MHz
	4	Input 2 Range AC: 100 Hz - 100 MHz
	5	Sensitivity: 35 mV rms sine wave
	6	Dynamic Range: 100 mVpp - 10.0 Vp-p
	7	Common Input: range and accuracy
External Arm:	8	Range: 0 - 25 MHz
	9	Minimum Start/Stop Time : 50 ns
	10	Sensitivity: 500 mV p-p
	11	Dynamic Range: 500 mV p-p - 5 Vp-p
Measurement Ranges:	12	Measurement-dependent; see <i>Table A-1</i>
Measurement Accuracy:	13	Frequency Inputs 1,2
	14	Period Inputs 1,2
	15	Time Interval 1-2
	16	Ratio 1/2
	17	Totalize
Auto Trigger:	18	DC Coupled Range: 1 kHz - 20 MHz
	19	AC Coupled Range: 1 kHz - 20 MHz
	20	Minimum Amplitude: 70 mVrms Sine Wave
Automatic Measurement	21	Rise/Fall Time 1
Range and Accuracy:	22	Pulse Width 1

Uncertainties Analysis Method

The E1420B Performance Test Record Card contains a column that lists measurement uncertainties. This column represents an accumulation of uncertainties from the national standard to the instrument, taking both random and systematic uncertainties into account.

When comparing measurement results to counter specifications, the person administering the test must allow compensation for measurement uncertainty. This means that if an obtained measurement falls outside of its specified Min/Max bounds (also listed on the performance test record card), yet is within the bounds of [true input \pm measurement uncertainty], the measured value DOES conform to specification and DOES NOT constitute a failed test point.

For example:

Input_Signal	Min	Measured	Max	Meas._Uncer.	Test_Status
100 Hz	98 Hz	103 Hz	102 Hz	±4 Hz	Passed
100 Hz	98 Hz	105 Hz	102 Hz	±4 Hz	Failed

NOTE

For the E1420B performance tests, random uncertainties were figured using the RSS method, calculated to a confidence interval of 2 sigma (95%).

Alternate Test Equipment

Test equipment other than that specified in *Table C-1* may be used only if the critical specifications of each test can still be accurately checked. If alternate test equipment is used, adjust the tolerance limits to reflect actual test equipment specifications. Note that to comply with MIL-STD-45662A calibration system requirements, the test equipment being used should be at least four (4) times more accurate than the instrument making the test measurement.

CAUTION

Before the E1420B is installed into the VXIbus Mainframe, verify that the counter is properly configured as specified in Chapter 2 of this manual. Verify that the VXIbus Mainframe meets the specifications of the VXIbus System Specifications, Rev 1.3.

NOTE

These tests only specify the command strings that need to be sent to the counter in word-serial protocol over the VXIbus. These strings must be sent exactly as they appear in the test procedures for the performance tests to be considered valid.

Procedures used in getting the command strings to the counter are controller and slot-0 dependent. See Chapter 2 and 3 of this manual for details.

Preliminary Procedure

Use the following steps to set up the E1420B for full performance testing:

1. Turn off power to the VXIbus Mainframe.
2. Plug HP E1420B into the VXIbus Mainframe.
3. Turn on power to the VXIbus Mainframe.

4. Connect 10 MHz reference output of the HP 8663 Signal Generator (back panel) to the E1420B Int/Ext Reference BNC input and all valid testing equipment external reference frequency inputs, as shown in *Figure C-1*.
5. Verify proper operation and port addressing of the Slot-0 command module and the HP E1420B Universal Counter. Refer to "Internal Configuration" of Chapter 2 for details.

Input 1/2: Measurement Sensitivity, Range, and Accuracy Tests

Description: The input frequency range and sensitivity of the E1420B is tested, along with the dynamic range and accuracy of all critically specified non-auto measurements.

Specifications Tested:

Referring to the reference numbers of *Table C-3*, this test verifies:

- 1, 2 - Inputs 1, 2 dc range
- 3, 4 - Inputs 1, 2 ac range
- 05 - Sensitivity
- 06 - Dynamic range
- 07 - Common input specifications
- 12 - Non-auto measurement ranges

Accuracy of:

- 13 - frequency,
- 14 - period,
- 15 - time interval,
- 16 - ratio, and
- 17 - totalize measurements

Equipment Used:

HP 3325B Synthesizer/Function Generator
HP 8663A Synthesized Signal Generator

Input Condition A:

35 mV rms @ 10 Hz @ Z_{in}=50 ohm @ dc coupling

Procedure A:

1. Use the HP 3325B to generate a 35 mV rms sine wave at a frequency of 10 Hz.
2. Connect this signal to Input 1 on the E1420B.
3. Reset the counter by sending "*RST" as a command string. This will automatically set the counter input defaults to 50 ohm input impedance and dc coupling. This will also set trigger levels to 0.0 V.

4. Program the E1420B to use the 10 MHz external signal of preliminary procedure Step 4 as its timebase by issuing the following SCPI command:

Description of Command	SCPI Command String
Route external timebase to E1420B	"SENS:ROSC:SOUR EXT"

5. Configure the E1420B to operate on its maximum sensitivity (minimum hysteresis) setting.

Description of Command	SCPI Command String
Maximum input sensitivity	"SENS:EVEN:HYST MIN"

6. Measure the frequency on Input 1.

Description of Command	SCPI Command String
Measure Frequency: Input 1	"MEAS1:FREQ? DEF,DEF"

Verify: That the counter measures a frequency of 10.000 000 0 Hz \pm 0.1 Hz.

7. Record the measurement on the Performance Test Record Card, line 1.
8. Change the input connection from Input 1 to Input 2.
9. Measure the frequency on Input 2.

Description of Command	SCPI Command String
Measure Frequency: Input 2	"MEAS2:FREQ? DEF,DEF"

Verify: The counter measures 10.000 000 0 Hz \pm 0.1 Hz.

10. Record the measurement on the Performance Test Record Card, line 2.

Input Condition B:

35 mV rms @ +100 mV dc @ 100 Hz @ Zin=50 ohm @ ac coupling

Procedure B:

1. Use the HP 3325B to generate a 35 mV rms sine wave with a dc level of +100 millivolts at a frequency of 100 Hz.
2. Connect the signal to Input 2 on the E1420B.
3. Reset the counter by sending the "*RST" command.

4. Program the E1420B to use the 10 MHz external signal of preliminary procedure Step 4 as its timebase by issuing the following SCPI command:

Description of Command	SCPI Command String
Route external timebase to E1420B	"SENS:ROSC:SOUR EXT"

5. Configure the HP E1420B to use maximum sensitivity, ac coupling, 50 ohm input impedance, and a trigger level of 0.0V (trig level will default to 0.0V, Zin to 50 ohms after "*RST" command).

Description of Command	SCPI Command String
Maximum input sensitivity	"SENS:EVEN:HYST MIN"
Use ac coupling Input 1	"INP1:COUP AC"
Input 2	"INP2:COUP AC"

6. Measure the frequency on Input 2.

Description of Command	SCPI Command String
Measure Frequency: Input 2	"MEAS2:FREQ? DEF,DEF"

Verify: The counter measures a frequency of 100.000 000 Hz ± 0.1 Hz.

7. Record the measurement on the Performance Test Record Card, line 3.
8. Change the input connection from Input 2 to Input 1.
9. Measure the frequency on Input 1.

Description of Command	SCPI Command String
Measure Frequency: Input 1	"MEAS1:FREQ? DEF,DEF"

Verify: The counter measures 100.000 000 Hz ± 0.1 Hz.

10. Record the measurement on the Performance Test Record Card, line 4.

Input Condition C: 35 mV rms @ 200 MHz @ Zin=50 ohm @ dc coupling

Procedure C:

1. Use the HP 8663A to generate a 35 mV rms (100 mVp-p) signal at 200 MHz.
2. Connect the signal to Input 1 on the E1420B.
3. Reset the counter by sending the "*RST" command.

4. Program the E1420B to use the 10 MHz external signal of preliminary procedure Step 4 as its timebase by issuing the following SCPI command:

Description of Command	SCPI Command String
Route external timebase to E1420B	"SENS:ROSC:SOUR EXT"

5. Configure the E1420B to operate on its maximum sensitivity (minimum hysteresis) setting.

Description of Command	SCPI Command String
Maximum input sensitivity	"SENS:EVEN:HYST MIN"

6. Measure the frequency on Input 1.

Description of Command	SCPI Command String
Measure Frequency: Input 1	"MEAS1:FREQ? 2E8,DEF"

Verify: The counter measures a frequency of 200.000 000 MHz ± 14 Hz.

7. Record the measurement on the Performance Test Record Card, line 5.

Input Condition D:

35 mV rms @ 100 MHz @ Zin=50 ohm @ dc coupling

Procedure D:

1. Use the HP 8663A to generate a 35 mV rms (100 mVp-p) signal at 100 MHz.
2. Connect the signal to Input 2 on the E1420B.
3. Reset the counter by sending the "*RST" command.
4. Program the E1420B to use the 10 MHz external signal of preliminary procedure Step 4 as its timebase by issuing the following SCPI command:

Description of Command	SCPI Command String
Route external timebase to E1420B	"SENS:ROSC:SOUR EXT"

5. Configure the E1420B to operate on its maximum sensitivity (minimum hysteresis) setting.

Description of Command	SCPI Command String
Maximum input sensitivity	"SENS:EVEN:HYST MIN"

6. Measure the frequency on Input 2.

Description of Command	SCPI Command String
Measure Frequency on Input 2	"MEAS2:FREQ? DEF,DEF"

Verify: The counter measures a frequency of 100.000 000 MHz ± 3 Hz.

7. Record the measurement on the Performance Test Record Card, line 6.

Input Condition E:

10.0 Vp-p @ 20 MHz @ Zin=50 ohm @ dc coupling

Procedure E:

1. Set the HP 3325B to generate a 10.0 volt peak-to-peak sinusoidal signal with no dc offset at a frequency of 20 MHz.
2. Connect this signal to Input 1 on the E1420B.
3. Reset the counter by sending the "*RST" command.
4. Program the E1420B to use the 10 MHz external signal of preliminary procedure Step 4 as its timebase by issuing the following SCPI command:

Description of Command	SCPI Command String
Route external timebase to E1420B	"SENS:ROSC:SOUR EXT"

5. Configure the HP E1420B to operate in COMMON input mode:

Description of Command	SCPI Command String
Common input mode ON	"INP:ROUT COMM"

6. Measure the period on Input 1.

Description of Command	SCPI Command String
Measure Period: Input 1	"MEAS1:PER? DEF,DEF"

Verify: The counter measures a period equal to 50.000 000 ns ± 250 E-15 s.

7. Record the measurement on the Performance Test Record Card, line 7.

8. Without reinitializing OR changing input connections, measure the period on Input 2.

Description of Command	SCPI Command String
Measure Period: Input 2	"MEAS2:PER? DEF,DEF"

Verify: The counter measures 50.000 000 ns \pm 250 E-15 s.

9. Record the measurement on the Performance Test Record Card, line 8.
10. Without reinitializing, configure the E1420B to have Input 2 trigger on the negative slope of the input signal.

Description of Command	SCPI Command String
Trigger on negative slope: Input 2	"SENS2:EVEN:SLOP NEG"

11. Measure the Time 1 -> 2 interval, using the 100 Gate Average mode.

Description of Command	SCPI Command String
Set 100 Gate Average	"SENS:AVER ON"
Measure Time Interval	"MEAS1:TINT? DEF,DEF"

Verify: The counter measures a time interval of 25.0 ns \pm 2.9 ns.

12. Record the measurement on the Performance Test Record Card, line 9.
13. Without reinitializing, measure the ratio of Input 1 to Input 2.

Description of Command	SCPI Command String
Set 100 Gate Average OFF	"SENS:AVER OFF"
Measure Ratio of IN 1/IN 2	"MEAS:FREQ:RAT? DEF,DEF"

Verify: The counter measures the ratio as 1.000 000 0 \pm 0.000 000 1.

14. Record the measurement on the Performance Test Record Card, line 10.

**External Arm Range,
Sensitivity, and
Minimum Start-to-Stop
Time Tests**

Description: The external arm input is characterized.

Specifications Tested: Referring to the reference numbers of *Table C-3*, this test verifies:

- 08 - Range
- 09 - Minimum Start to Stop Time
- 10 - Sensitivity
- 11 - Dynamic Range (lower limit)

Equipment Used:

HP 3325B Synthesizer/Function Generator
HP 8663A Synthesized Signal Generator
HP 8161A Programmable Pulse Generator

Input Condition A:

Input 1: 100 mV rms @ 100 MHz @ Zin=50 ohm @ dc coupling
Arm Input: 500 mV p-p @ 10 Hz @ pulse width = 50 ms

Procedure A:

1. Use the HP 8663A to generate a 100 mV rms (280 mVp-p signal) at a frequency of 100 MHz and no dc offset.
2. Configure the HP 3325B to generate a 500 mVp-p SQUARE wave at a frequency of 10 Hz with no dc offset.
3. Connect the 8663A output signal to Input 1 on the E1420B.
4. Connect the 3325B output signal to the Arm Input on the E1420B.
5. Reset the counter by sending the "*RST" command.
6. Program the E1420B to use the 10 MHz external signal of preliminary procedure Step 4 as its timebase by issuing the following SCPI command:

Description of Command	SCPI Command String
Route external timebase to E1420B	"SENS:ROSC:SOUR EXT"

7. Configure the E1420B to be armed externally, with an Arm Input trigger level of 0 V. Then set the arm to START on the positive slope of the external source, and STOP on the internal gate time.

Description of Command	SCPI Command String
Externally armed, trigger level = 0V	"ARM:STAR:SOUR EXT;LEV 0"
Arm start on external positive slope	"ARM:STAR:SLOP POS"
Arm stop on internal gate time	"ARM:STOP:SOUR IMM"

8. The E1420B is automatically placed in its "Wait-for-Arm" state (continuous mode). The counter should now operate on a 100 ms gate time (default internal), triggered by the rising edges of the 10 Hz input arm signal.
9. Measure the frequency on Input 1.

Description of Command	SCPI Command String
Measure Frequency on Input 1	"MEAS1:FREQ? DEF,DEF"

Verify: The counter measures a frequency of 100.000 000 MHz ± 3 Hz.

- Record the measurement on the Performance Test Record Card, line 11.

Input Condition B:

Input 1: 100 mV rms @ 100 MHz @ Zin=50 ohm @ dc coupling
 Arm Input: 5.0 Vp-p @ 20 MHz @ pulse width = 20 ns

Procedure B:

- Use the HP 8663A to generate a 100 mVrms (280 mVp-p) signal at a frequency of 100 MHz and no dc offset.
- Set the HP 8161A Channel A Output to the following:
 - High Level = +2.5 V
 - Low Level = -2.5 V
 - Period = 50 ns (f=20 MHz)
 - Pulse Width = 20 ns
 - Leading Edge (Rise Time) = 1.3 ns
 - Trailing Edge (Fall Time) = 1.3 ns
- Connect the 8663A output signal to Input 1 on the E1420B.
- Connect the 8161A output signal to the Arm Input on the E1420B.
- Reset the E1420B by sending the `*RST` command.
- Program the E1420B to use the 10 MHz external signal of preliminary procedure Step 4 as its timebase by issuing the following SCPI command:

Description of Command	SCPI Command String
Route external timebase to E1420B	<code>"SENS:ROSC:SOUR EXT"</code>

- Configure the counter to be armed externally, once again using a trigger level of 0 volts. Then set the arm to START on the first positive slope of the external source, and STOP on the second positive slope of the external source.

Description of Command	SCPI Command String
Externally armed, trigger level = 0V	<code>"ARM:STAR:SOUR EXT;LEV 0"</code> <code>"ARM:STOP:SOUR EXT;LEV 0"</code>
Arm start on external positive slope	<code>"ARM:STAR:SLOP POS"</code>
Arm stop on external positive slope	<code>"ARM:STOP:SLOP POS"</code>

- Once again, the E1420B is in its continuous "Wait-for-Arm" state. Now the counter's aperture time will essentially be the period of the input arm signal.

9. Measure the frequency on Input 1.

<u>Description of Command</u>	<u>SCPI Command String</u>
Measure Frequency on Input 1	"MEAS1:FREQ? DEF,DEF"

Verify: The counter measures a frequency of 100 MHz ± 15 MHz.

10. Record the measurement on the Performance Test Record Card, line 12.

Auto Measurement Sensitivity, Range, and Accuracy Tests

Description: The frequency range, signal sensitivity, and measurement accuracy of all critically specified auto measurements is tested.

Specifications Tested: Referring to the reference numbers of *Table C-3*, this test verifies:

- 18 - Auto Trigger dc range
- 19 - Auto Trigger ac range
- 20 - Auto Trigger Sensitivity

Accuracy of auto measurement:

- 21 - rise/fall time and,
- 22 - pulse width

Equipment Used:

HP 8161A Programmable Pulse Generator
HP 8663A Synthesized Signal Generator

Input Condition A:

750 mVp-p @ 1 kHz @ pulse width = 0.5 ms @ rise time/fall time = 15 ns

Procedure A:

1. Set the HP 8161A Channel A Output to the following:

High Level = + 0.75 V
Low Level = 0.0 V
Period = 1.0 ms (f=1 kHz)
Pulse Width = 0.5 ms
Leading Edge (Rise Time) = 15 ns
Trailing Edge (Fall Time) = 15 ns

2. Connect this signal to Input 1 on the E1420B.
3. Reset the counter by sending the "*RST" command.

4. Program the E1420B to use the 10 MHz external signal of preliminary procedure Step 4 as its timebase by issuing the following SCPI command:

Description of Command	SCPI Command String
Route external timebase to E1420B	"SENS:ROSC:SOUR EXT"

5. Measure the rise time of the input signal by issuing the following SCPI command:

Description of Command	SCPI Command String
Measure Rise Time Input 1	"MEAS:RTIM? DEF,DEF"

Verify: The counter measures a rise time of 15 ns \pm 9.5 ns.

6. Record the measurement on the Performance Test Record Card, line 13.
7. Change the input coupling from dc to ac.

Description of Command	SCPI Command String
Use ac coupling Input 1	"INP1:COUP AC"

8. Measure the fall time of the input signal using the following command:

Description of Command	SCPI Command String
Measure Fall Time Input 1	"MEAS:FTIM? DEF,DEF"

Verify: The counter measures a fall time of 15 ns \pm 9.5 ns.

9. Record the measurement on the Performance Test Record Card, line 14.

Input Condition B:

70 mV rms @ 100 MHz @ pulse width = 5 ns

Procedure B:

1. Use the HP 8663A to generate a 70 mV rms (200 mV_{p-p}) signal at a frequency of 100 MHz.
2. Connect this signal to Input 1 on the E1420B.
3. Reset the counter by sending the "*RST" command.

4. Program the E1420B to use the 10 MHz external signal of preliminary procedure Step 4 as its timebase by issuing the following SCPI command:

Description of Command	SCPI Command String
Route external timebase to E1420B	"SENS:ROSC:SOUR EXT"

5. Measure the positive pulse width of the input signal, using the 100 Gate Average mode.

Description of Command	SCPI Command String
Set 100 Gate Average	"SENS:AVER ON"
Measure positive pulse width Input 1	"MEAS:PWID? DEF,DEF"

Verify: The counter measures a pulse width of 5.0 ns \pm 2.6 ns.

6. Record the measurement on the Performance Test Record Card, line 15.

(Option 030) Input 3: Sensitivity, Range, and Accuracy Tests

Description: The input frequency range and sensitivity of the E1420B Option 030 Input 3 is tested, along with the dynamic range and accuracy of the Input 3 frequency measurement.

Specifications Tested: Refer to *Table 1-1*, HP E1420B Specifications, for the Input 3 critical specifications.

Equipment Used:

HP 8663A Synthesized Signal Generator
HP 8491A Option 010 10 dB Coaxial Fixed Attenuator

Procedure:

1. Set the HP 8553A to generate a sinusoidal signal at 90 MHz with an amplitude of +0.5 dBm. This amplitude will provide 75 mV rms to Input 3 when using the 10 dB attenuator.
2. Connect this signal to Input 3 of the E1420B through the 10 dB attenuator, as shown in *Figure C-2*. The 10 dB attenuator is used here for impedance matching.
3. Reset the counter by sending the "RST" command.
4. Program the E1420B to use the 10 MHz external signal of preliminary procedure Step 4 as its timebase by issuing the following command:

Description of Command	SCPI Command String
Route external timebase to E1420B	"SENS:ROSC:SOUR EXT"

5. Measure the frequency on Input 3 by issuing the SCPI command:

Description of Command	SCPI Command String
Measure Frequency: Input 3	"MEAS3:FREQ? 9E7,DEF"

Verify: the HP E1420B measures a frequency of 90.000 000 MHz \pm 2 Hz.

6. Record the measurement on the Performance Test Record Card, line 16.
7. Change the 8663A frequency to 2.5 GHz (keep the amplitude the same, at +0.5 dBm).
8. Measure the frequency on Input 3:

Description of Command	SCPI Command String
Measure Frequency: Input 3	"MEAS3:FREQ? 2.5E9,DEF"

Verify: The HP E1420B measures a frequency of 2.500 000 00 GHz \pm 20 Hz.

9. Record the measurement on the Performance Test Record Card, line 17.
10. Change the 8663A frequency back to 90 MHz with an amplitude of -15 dBm. This amplitude will provide 12.6 mV rms to Input 3 when using the 10 dB attenuator, and verifies the maximum input sensitivity.

11. Measure the frequency on Input 3:

Description of Command	SCPI Command String
Measure Frequency: Input 3	"MEAS3:FREQ? 9E7,DEF"

Verify: The HP E1420B measures a frequency of 90.000 000 MHz \pm 2 Hz.

12. Record the measurement on the Performance Test Record Card, line 18.
13. Change the 8663A frequency to 1.5 GHz with an amplitude of -10 dBm. This amplitude will provide 22.36 mV rms to Input 3 when using the 10 dB attenuator, and verifies the maximum input sensitivity at the mid-range frequency values.
14. Measure the frequency on Input 3:

15. Record the measurement on the Performance Test Card, line 19.
16. Change the 8663A frequency to 2.5 GHz with an amplitude of -2 dBm. This amplitude will provide the 55.17 mV rms to Input 3 when using the 10 dB attenuator, and verifies maximum sensitivity.
17. Measure the frequency on Input 3:

Description of Command	SCPI Command String
Measure Frequency: Input 3	"MEAS3:FREQ? 2.5E9,DEF"

Verify: The HP E1420B measures a frequency of 2.500 000 000 GHz ± 20 Hz.

18. Record the measurement on the Performance Test Record Card, line 20.

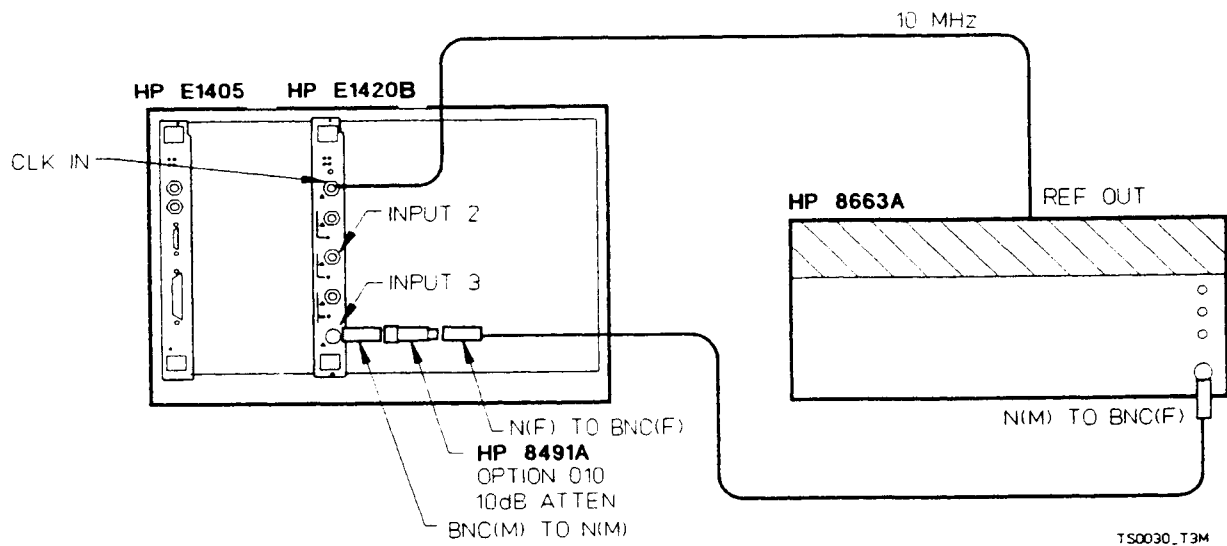

Figure C2. Option 030 Test Setup

Table C-4. HP E1420B Performance Test Record (Page 1 of 2)

HEWLETT-PACKARD E1420B UNIVERSAL COUNTER

Test Facility: _____ Report Number: _____
 Serial Number: _____ Ambient Temperature: _____ C
 Customer: _____ Relative Humidity: _____ %
 Tested By: _____ Line Frequency: _____ Hz
 Date: _____ Installed Options: 010 030 040
 _____ -Calibration Test: pre post

Notes: _____

Test Equipment Used:	Description	Model No.	Trace No.	Cal Due Date
1.	Function Generator	_____	_____	_____
2.	Signal Generator	_____	_____	_____
3.	Pulse Generator	_____	_____	_____
Option 030 Equipment:				
4.	UHF Signal Generator	_____	_____	_____
5.	Fixed Attenuator	_____	_____	_____
Other Equipment:				
6.	_____	_____	_____	_____
7.	_____	_____	_____	_____
8.	_____	_____	_____	_____
9.	_____	_____	_____	_____
10.	_____	_____	_____	_____

Table C-4. HP E1420B Performance Test Record (Page 2 of 2)

Page No.	Test Description	No.	Reading	Specified Minimum	Measured Result	Specified Maximum	Meas. Uncer.
C-21	Input Range and Sensitivity; Measurement Range and Accuracy (Inputs 1 and 2 only) Input conditions: 35 mVrms, 10 Hz, 50 ohm, DC 35 mVrms, 10 Hz, 50 ohm, DC 35 mVrms (+100 mV DC), 100 Hz, 50 ohm, AC 35 mVrms (+100 mV DC), 100 Hz, 50 ohm, AC 35 mVrms, 200 MHz, 50 ohm, DC 35 mVrms, 100 MHz, 50 ohm, DC 10.0 Vp-p, 20 MHz, 50 ohm, DC 10.0 Vp-p, 20 MHz, 50 ohm, DC 10.0 Vp-p, 20 MHz, 50 ohm, DC 10.0 Vp-p, 20 MHz, 50 ohm, DC	1	Freq 1	9.9500000 Hz	Hz	10.0500000 Hz	±0.1 Hz
		2	Freq 2	9.9500000 Hz	Hz	10.0500000 Hz	±0.1 Hz
		3	Freq 2	99.9500000 Hz	Hz	100.0500000 Hz	±0.1 Hz
		4	Freq 1	99.9500000 Hz	Hz	100.0500000 Hz	±0.1 Hz
		5	Freq 1	199.9999988 Hz	Hz	200.000012 Hz	±14 Hz
		6	Freq 2	99.999998 Hz	Hz	100.000002 Hz	±3 Hz
		7	Per 1	49.999998 ns	ns	50.000002 ns	±250×10 ⁻¹⁵ s†
		8	Per 2	49.999998 ns	ns	50.000002 ns	±250×10 ⁻¹⁵ s†
		9	T-Int *	22.4 ns	ns	27.6 ns	±2.9 ns
		10	Ratio	0.9999999		1.0000001	±1×10 ⁻⁷
C-26	External Arm Range, Sens. and Min. Start to Stop Time Input conditions: 100 mVrms, 100 MHz, 50 ohm, DC Arm Input conditions: 500 mVp-p, 10 Hz, pw = 50 ms 5.0 Vp-p, 20 MHz, pw = 20 ns	11	Freq 1	99,999,998 Hz	Hz	100,000,002 Hz	±3 Hz
		12	Freq 1	88 MHz	MHz	112 MHz	±15 MHz
C-29	Automatic Measurement Range, Sensitivity, and Accuracy Input conditions: 750 mVp-p, 1 kHz, pw = 0.5 ms tr = tf = 15 ns 750 mVp-p, 1 kHz, pw = 0.5 ms tr = tf = 15 ns 70 mVrms, 100 MHz, pw = 5 ns	13	Tr 1	6 ns	ns	24 ns	±9.5 ns
		14	Tf 1	6 ns	ns	24 ns	±9.5 ns
		15	PW 1*	2.8 ns	ns	7.2 ns	±2.6 ns
C-31	Input 3: Input Range and Measurement Accuracy Input conditions: 75 mVrms, 90 MHz 75 mVrms, 2 GHz -25 dBm, 90 MHz -20 dBm, 1.5 GHz -12 dBm, 2.5 GHz	16	Freq 3	89,999,998 Hz	Hz	90,000,002 Hz	±2 Hz
		17	Freq 3	2.49999998 GHz	GHz	2.50000002 GHz	±20 Hz
		18	Freq 3	89,999,998 Hz	Hz	90,000,002 Hz	±2 Hz
		19	Freq 3	1.49999998 GHz	GHz	1.50000002 GHz	±20 Hz
		20	Freq 3	2.49999998 GHz	GHz	2.50000002 GHz	±20 Hz

* Measurement taken using 100 Gate Average mode.

† High measurement uncertainty due to accuracy limits of input source.



Handling Problems

APPENDIX GUIDE

This appendix provides information for handling problems with programming, system interface errors, and hardware. Checking for errors during program development is presented first followed by a checklist for system and hardware integrity. The appendix is organized as follows:

Appendix Summary

- Software Versus Hardware Problemspg. D-2
- Monitoring Program Errorspg. D-2
- Verifying System Integritypg. D-5

SOFTWARE VERSUS HARDWARE PROBLEMS

You can usually distinguish software from system/hardware errors during normal operation by observing for the following indications:

- **ERROR** Indicator is lit when a software error has occurred. If this indicator is ON, go to the next section of this appendix.
- **FAILED** Indicator is lit when a bus error has occurred or Self-test subroutine has failed. If this indicator is ON, go to the third section of this appendix, verify the system integrity, then run the counter's self-test as described in the last section of this appendix.

If the system has a problem other than the E1420B counter, correct the system fault then re-verify all system checklist items.

If the system checks OK but the counter's self-test fails, do the following:

1. Verify that the counter's input signals are active at the BNC connector tips.
2. Ensure that the SCPI program commands for counter measurement are really triggering counter measurements as a result of the signals arriving at the front-panel BNC connectors.
3. Remove power from the counter by turning OFF power to the VXIbus mainframe.
4. Disconnect all front-panel counter input signals.
5. Remove the counter from the mainframe and reseal it into the backplane connectors.
6. Restore power to the mainframe and attempt system verification.
7. If the system checks OK but counter self-test still fails refer service to qualified personnel.

MONITORING PROGRAM ERRORS

The example program below shows you how to check for errors as you program the counter. The program monitors the counter's Standard Event Status Register for an error condition. If no error occur, the counter operates as programmed. If errors do occur, the counter interrupts the computer and the error codes and messages are read from the counter's error queue. Refer to the "HP E1405A Command Module User's Manual" or "Beginner's Guide To TMSL" for more information on using the status registers.

Use the following steps and SCPI program messages to set up the counter for program error checking:

1. Configure the counter and instrument controller to send/receive error interrupts:

PROGRAM:	COMMENTS:
10 ASSIGN @E1420B TO 70906	— Assigns @E1420B to address 70906.
20 OUTPUT @E1420B;"CLS"	— Clear all status registers and the error queue.
30 OUTPUT @E1420B;"SRE 32"	— Unmask the Event Status bit (bit5) in the counter's Status Byte Register.
40 OUTPUT @E1420B;"ESE 60"	— Unmask the counter's error conditions in the counter's Standard Event Status Register (unmask bits 2, 3, 4, and 5)
50 OUTPUT @E1420B;"ESR?"	— Read and clear Standard Event Status Register.
60 ENTER @E1420B;Esr	— Enter result.
70 ON INTR 7 CALL Errmsg	— Call subprogram if error occurs.
80 ENABLE INTR 7;2	— Enable instrument controller to respond to service request interrupt.

2. At this point, send commands for your specific application. In this example, you'll make a measurement using the MEASure command:

PROGRAM:	COMMENTS:
90 OUTPUT @E1420B;"MEAS:FREQ?"	— Configure the counter and make a frequency measurement; send reading to output buffer.

3. Monitor the "Message Available" bit (bit 4) and "Standard Event Status Register" summary bit (bit 5) in the Status Byte Register:

PROGRAM:	COMMENTS:
100 REPEAT	
110 Spoll_val = SPOLL(@E1420B)	
120 UNTIL BINAND(Spoll_val,48)	
130 IF BIT(Spoll_val,5) THEN CALL Errmsg	— Reading a Serial Poll (SPOLL) can occasionally clear the interrupt before the controller can respond.

4. Enter results from the MEASure command:

PROGRAM:	COMMENTS:
140 ENTER @E1420B;Reading	— Enter measurement result if no errors occur.
150 PRINT Reading	— Display results on instrument controller.
160 END	

The following subprogram is executed if an error occurs while the counter is configured or during the measurement:

PROGRAM:	COMMENTS:
500 SUB Errmsg	
505 ASSIGN @E1420B TO 70906	— Assigns @E1420B to address 70906.
510 DIM Message\$[256]	— Dimension controller string array to store error messages.
520 CLEAR @E1420B	— Clear the counter to regain control.
530 B - SPOLL(@E1420B)	— Execute a serial poll to clear the Service Request bit in the Status Byte Register.
540 REPEAT	— Read all error messages in the counter's error queue.
550 OUTPUT @E1420B;"SYST:ERR?"	— Read error queue.
560 ENTER @E1420B;Code,Message\$	— Enter error code and message.
570 PRINT Code,Message\$	— Print results.
580 UNTIL Code = 0	
590 OUTPUT @E1420B; "*CLS"	— Clear all bits in the counter's Standard Event Status Register.
600 STOP	
610 SUBEND	

How the Error Queue Works

As counter errors are detected, they are placed in its error queue. The error queue is first-in, first-out. This means that if several error messages are in the queue, each SYST:ERR? query returns the oldest error message, deleting it from the queue.

If the error queue fills to 30 entries, the last error in the queue is replaced with ERROR -350, "Too many errors". No additional errors are accepted by the queue until space becomes available using SYST:ERR?, or the queue is cleared using the *CLS command. When SYST:ERR? is sent while the error queue is empty, the counter responds with +0, "No error" is displayed (if no other errors are in the error queue).

For Overflow conditions (for example, 9.90000000 E+37), the Device Dependent Error bit is set in the Standard Event Status Register. The monitor program presented here handles the overflow condition by interrupting the instrument controller to execute the error subprogram. However, an overflow doesn't generate an error message and +0, "No error" is displayed (if no other errors are in the error queue).

VERIFYING SYSTEM INTEGRITY

Verify the counter with the following procedure:

1. Power-up the Controller if this is separate from the VXIbus mainframe.
2. Power-up the VXIbus mainframe and verify Slot 0 functionality. (The Slot 0 module must be correctly set-up, functional, and pass its own self-test.)
3. Observe that the "Failed" LED on the HP E1420B is lit, then extinguishes after a few seconds indicating successful completion of Self-test. The counter is now in the power-on state and is ready for use.
4. If the counter's self-test fails repeatedly, refer service to qualified personnel.

System Checklist

If the counter fails to successfully complete Self-test, doublecheck the following items:

- System controller present and operational (passes own self-test),
- Slot 0 module present and operational (passes own self-test),
- VXIbus C sized cardcage present and operational (cooling and power supplies OK),
- HP-IB connection between controller and VXIbus cardcage present and operational,
- A 10-MHz reference signal should be applied to the Int/Ext Reference BNC input of the E1420B. See Appendix C, Power-up Self Test, for more information.
- Syntactically correct Common/SCPI command messages sent to E1420B via BASIC over the HP-IB and VXIbus interface,
- Correct use of the particular instrument control language to transfer commands from the controller to the E1420B counter. (Refer to pg. 3-2/4 of the E1420B Operating and Programming manual for more information.)

Running Self-Test

You can run the counter's self-test by sending the IEEE 488.2 Self-test query Common command *TST?. The results of the test are placed in the output queue indicating whether the counter completed self-test without any errors.

When self-test passes the counter's configuration is set to the default values of the power-on/reset state.

If the counter's self-test fails repeatedly, refer service to qualified personnel.

Using Option 040 — High Throughput/Shared RAM

INTRODUCTION

This appendix provides information for using Option 040, High Throughput/Shared RAM. The option is briefly explained followed by an example program (HP BASIC) for Frequency measurements. Specific information for the memory subsystem commands is contained in the MEMory Subsystem command reference in chapter 5. The topics covered are:

Appendix Summary

- HP E1420B Shared RAM Descriptionpg. E-2
- VXibus Shared RAM Model Address Spacepg. E-3
- Shared RAM Programmingpg. E-4
- Example Programspg. E-5

HP E1420B SHARED RAM DESCRIPTION

These paragraphs briefly describe how Option 040 works with the counter and any available VXibus Shared RAM. The discussion mentions the SCPI commands that are used to configure the RAM and control its access. These commands are described in greater detail in chapter 5 as the MEMory Subsystem.

Attempting to access this capability when Option 040 is not installed will generate error -241, “Hardware Missing”.

Figure E-1 illustrates the VXibus shared RAM model for the HP E1420B. The VXibus shared RAM is the portion of memory labeled VME A24. During normal operation MEMory:VME:STATE is set OFF. The counter acquires measurements that are stored locally in the VME A16 address space.

When shared RAM is enabled (MEMory:VME:STATE ON), a copy of each measurement result, except for AC, DC, Maximum and Minimum (amplitude) measurement results, is stored in two places: the VME A24 space (every new measurement result incrementing to a new address) and in the counter’s local memory as well. This VME A24 memory area is 12 megabytes wide and is accessible to all VME/ VXibus instruments.

Because shared RAM is not specifically supported by the VME/VXibus standards, each application program that uses it must also contain correct memory configuration statements and optimal parameters. These will ensure that proper memory management occurs with no instances of memory contention.

When these conditions are met and memory management has been optimized, the HP E1420B operates identically as when shared RAM is absent. Measurements can still be FETCh-ed with shared RAM enabled and a current value will be retained. There is one exception: the behavior of *OPC in CONTInuous mode.

During CONTInuous mode, the OPeration Complete flag is set when the allocated shared RAM runs out (determined by MEM:VME:SIZE). The total number of measurements captured in shared RAM is equal to the set size (MEMory:VME:SIZE<value> divided by 8. During CONTInuous mode, the E1420B will loop back to the starting address location in shared RAM when the entire available memory space (#HC00000) has been allocated to the E1420B and is completely filled with measure-ment data.

Maximum throughput for a given gate time can be obtained at the expense of some accuracy by calibrating the counter only once before the block measurement begins. You can do this by configuring the counter for the frequency or time interval measurements with “MIN” as a resolution parameter; for example,

“CONF:FREQ DEF,MIN”

Selecting any other resolution will cause the counter to behave normally — calibrating the interpolators before every measurement in the block. Throughput reduces from 140 meas/sec (1 msec gate time) to 110 meas/sec (1 msec gate time) for frequency measurements.

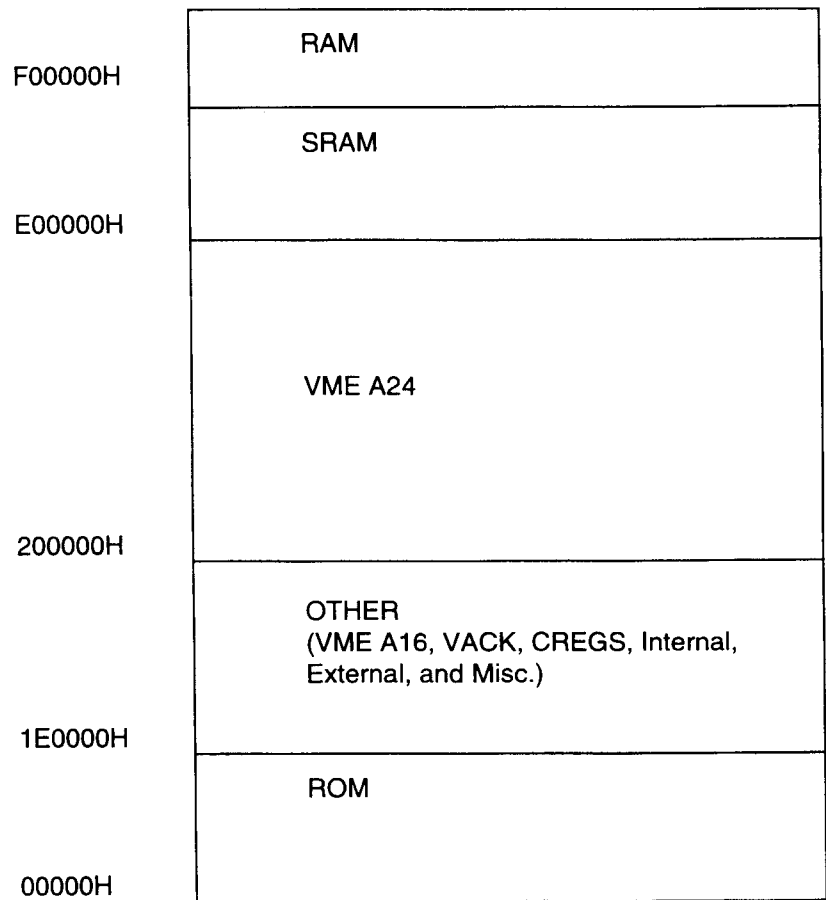

Figure E-1 VXIbus Shared Memory Model Address Space

NOTE

The programs included at the end of this section are provided "as is". These programs are intended for example only on the use of Share Memory. Support of these programs is limited (see WARRANTY, paragraph 3, on the inside front cover). Some library files needed to actually run the "C" program example may not be shown here, and are not available.

NOTE

Results are not resolved to significant digits; the user should apply the LSD formulas.

Only valid measurement results are stored. For example, NaN (9.91E+37) is not stored.

SHARED MEMORY PROGRAMMING

The procedure and programs listed here will make frequency high-throughput burst measurements that utilize shared memory. The programs are in HP BASIC and "C", requiring the same hardware and software described in previous chapters. The Shared memory Set-up procedure prepares your hardware for the example program and can also be used to set up your counter for programs that you create.

Shared Memory Set-up Procedure

PREPARATION

1. Set all I/O paths and data variables
2. Reset the counter: `"*RST"`
3. Obtain the current shared memory address and available size:

`"MEM:VME:ADDR?"`
enter variable

`"MEM:VME:SIZE?"`
enter variable

4. Enable external VME memory:

`"MEM:VME:STAT ON"`

INITIATE MEASUREMENTS

1. Check that #Measurements does not exceed available memory size divided by 8 to avoid memory contention.
2. Configure the counter to make a measurement:

`"CONF:FREQ DEF,DEF"`

3. Initiate continuous measurements:

`"INIT:CONT ON"`

4. Check for an Operation Complete indication:

`"*OPC?"`

RETRIEVE DATA

1. If desired, the data can be read from shared memory to the controller, or can reside in shared memory to be accessed by other instruments on the bus.
2. For command descriptions and sample program examples, refer to the User's Manual for the Command Module being used, for example, the HP E1405B.

NOTE

The HP 1405B command functionality is required for the example programs shown. The HP 1405A command module will not support shared RAM.

HP BASIC EXAMPLE PROGRAM

```
10 ! Program Example : Enabling Shared RAM for Option 040
20 ! AI 10/3/91 HP BASIC 5.13
30 !
40 ! The purpose of this example program is to demonstrate the
50 ! E1420B's use of the shared memory of an E1405B slot-0 controller.
60 !
70 ! 100 Frequency measurements are taken continuously and stored
80 ! in the A24 Shared memory space of the E1405B. The size of memory allocation
90 ! is specified to be 800 bytes. When all measurements have been stored,
100 ! the *OPC? query will return a '1', indicating operation complete status.
110 !
120 ! Although this example was created using an external controller,
130 ! the real advantages of shared memory are maximized when used in
140 ! conjunction with an embedded controller, such as the HP V/360.
150 !
160 ASSIGN @E1405b TO 70900;EOL CHR$(10) END ! Open a path @E1405B between the
165 ! computer and the Command Module,
170 ! specifying the Line Feed (LF) and EOI
175 ! as the EOL sequence
180 ASSIGN @Speed TO 70900;FORMAT OFF ! Open a data transfer path
190 ASSIGN @E1420b TO 70906;EOL CHR$(10) END ! Open a path @E1420B between the
195 ! computer and the counter
200 OUTPUT @E1405b;"*RST" ! Reset the command module to its default
205 ! state
210 OUTPUT @E1420b;"*RST" ! Reset the counter to its default state.
220 ! Default setting is MEM:VME:ADDR #H200000
230 OUTPUT @E1420b;"MEM:VME:ADDR?" ! Query counter to return the first
235 ! available shared memory address
240 ENTER @E1420b;Addr ! Return memory address
250 PRINT "The first available Shared VME A24 Memory Address Location is : ",Addr
260 OUTPUT @E1420b;"MEM:VME:SIZE 800" ! Sets the shared memory size to 800
265 ! bytes, or 100 measurements
270 OUTPUT @E1420b;"MEM:VME:STAT ON" ! Enable use of external VME memory from
275 ! the starting address
280 OUTPUT @E1420b;"CONF:FREQ DEF,MIN" ! Set up the counter for a frequency
285 ! measurement with "MIN" resolution
290 ! selects a minimum gate time
300 Starttime=TIMEDATE
310 OUTPUT @E1420b;"INIT:CONT ON" ! Initiate the counter to make continuous
315 ! measurements
320 OUTPUT @E1420b;"*OPC?" ! Query the counter for an Operation
325 ! Complete indication
330 ENTER @E1420b;Complete ! A '1' is returned if the measurements
335 ! are completed
340 Stoptime=TIMEDATE
350 Deltat=Stoptime-Starttime ! Timestamp the measurement throughput
360 PRINT "Time elapsed = ",Deltat
370 PRINT "OPC COMPLETE STATUS = ",Complete
380 PRINT ""
390 PRINT "Measurements from Shared RAM:"
400 Start_read: ! Read back data from the E1405B
410 DIM Ndig$(1),Count$(9),Data(1:100)
420 OUTPUT @E1405b;"DIAG:UPL?";Addr,800 ! Request the data + header from the
425 ! shared RAM
430 ENTER @Speed USING "#,X,K,K";Ndig$;Count$(1;VAL(Ndig$)) ! Extract the data header from the
440 ! measurement block
445 ! Transfer measurements to Data array
450 ENTER @Speed;Data(*) ! Print each measurement from Shared RAM
460 PRINT Data(*) ! Turn off continuous measurements
470 OUTPUT @E1420b;"INIT:CONT OFF"
480 END
```

"C" EXAMPLE PROGRAM

```
#include "shared_mem.h"                /* constant definitions and other */
                                        /* include files. */

/*
*****
* int open_vxi()
*
* This routine requires a logical address (integer) as an input.
* It returns the file descriptor of the device at logical address
* lad.
* The Master vxi device is first opened for reading and writing
* and a servant is subsequently selected at logical address lad.
* The vxi structures that are represented here are required to
* be used with the VIXEN drivers.
*****
*/
int open_vxi(lad)
int lad;
{
    int g_fd;
    int ret;
    vxi_ctl_status vxi_control;

    g_fd = open("/dev/vxi/primary",O_RDWR);    /* open vxi backplane interface */
    if (g_fd == -1)
    {
        perror("open: /dev/vxi/primary failed\n"); /* report error */
        exit(-1);
    }

    vxi_control.type = VXI_TIMEOUT;           /* set an infinite timeout for */
    vxi_control.arg[0] = 0;                   /* VXI transaction */
    ret = ioctl(g_fd,VXI_CONTROL,&vxi_control);
    if (ret == -1)
    {
        perror("ioctl: open_vxi: a\n");       /* report error */
        exit(-1);
    }

    vxi_control.type = VXI_ABET;              /* Set the access bus error */
    vxi_control.arg[0] = 7;                  /* timer to 1.1 secs */
    ret = ioctl(g_fd,VXI_CONTROL,&vxi_control);
    if (ret == -1)
    {
        perror("ioctl: open_vxi: b\n");       /* report error */
        exit(-1);
    }

    vxi_control.type = VXI_END;              /* Set the END bit in the last */
    vxi_control.arg[0] = 1;                  /* byte available word serial */
    ret = ioctl(g_fd,VXI_CONTROL,&vxi_control); /* command sent to the servant */
    if (ret == -1)                           /* using the write() command */
    {
        perror("ioctl: open_vxi: c\n");       /* report error */
        exit(-1);
    }

    vxi_control.type = VXI_SELECT_SERVANT;   /* Specify that all future */
    vxi_control.arg[0] = lad;                /* read() and write() system */
    ret = ioctl(g_fd,VXI_CONTROL,&vxi_control); /* calls should talk to the */
    if (ret == -1)                           /* servant specified by lad */
    {
        perror("ioctl: open_vxi: d\n");       /* report error */
        exit(-1);
    }

    vxi_control.type = VXI_MAP_SHARED;       /* map address 200000h to the*/
    vxi_control.arg[0] = 0x200000;          /* current users memory space */
    vxi_control.arg[1] = 0;                 /* No offset */
}
```



```

vxi_control.arg[2] = 1; /* size to be mapped = 64k */
ret = ioctl(g_fd,VXI_CONTROL,&vxi_control);
if (ret == -1)
{
    perror ("ioctl: open_vxi: f\n"); /* report error */
    exit (-1);
}

/* report the starting address*/
/* for shared memory */
printf ("Actual content memory mapped = %d\n", vxi_control.arg[0]);

return g_fd; /* return file descriptor */
}

/*
*****
* main()
* This is the main routine that gets invoked. It calls open_vxi
* and takes two input arguments: logical address and number of
* iterations. Once the device driver is successfully opened it
* proceeds to make <iterations> number of regular frequency
* measurements and 100 shared memory measurements. The number of
* shared memory measurements can be modified by changing the size
* parameter in the command mem:vme:size <size> in shared_mem.h
*****
*/

main(argc, argv)
int argc;
char ** argv;
{
    char input_str[1000][100];
    char in_input[1];

    int num_meas,num_meas_store;
    int g_fd; /* E1420 file discriptor */
    int lad; /* logical address */
    int ret;

    vxi_ctl_status vxi_control;
    double *p;

    p =0x200000; /* set a pointer to the starting */
                /* address in shared memory */

    if (argc < 2) /* Check for input arguments */
    {
        printf("%s: usage\n%s <logical address> <iterations>\n",argv[0], argv[0]);
        exit(1);
    }

    lad = atoi(argv[1]); /* convert argument 1 to integer */

    g_fd = open_vxi(lad); /* open the vxi device at logical */
    if (g_fd == -1) /* address lad */
    {
        exit(1); /* exit if error */
    }

    if ( argc < 3 ) /* Check if less than 3 input arguments */
    {
        /* print message */
        printf("enter number of measurements desired ( 100 maximum)\n");
        ret = gets( input_str ); /* get the input string */
        if ( ret = NULL )
        {
            perror("No measurements requested'\n"); /* report error */
        }
    }
    else
    {
        ret = strcpy(input_str, argv[2]); /* If not record the third argument */
    }
}

```

```

}
num_meas = atoi( input_str );          /* Convert it to integer */
num_meas_store = num_meas;

write(g_fd,RST,strlen(RST));          /* send a '*rst' to the card */
write(g_fd,CLS,strlen(CLS));          /* send a '*cls' to the card */
write(g_fd,ROSC,strlen(ROSC));        /* configure oscillator for TCXO */
write(g_fd,OUTP,strlen(OUTP));        /* 'rosc:sour int' */
write(g_fd,CONF,strlen(CONF));        /* configure card to source the */
write(g_fd,APER,strlen(APER));        /* oscillator out. 'outp:rosc on' */

write(g_fd,CONF,strlen(CONF));        /* configure card for a frequency */
write(g_fd,APER,strlen(APER));        /* measurement. 'conf:freq def,def' */
write(g_fd,ABORT,strlen(ABORT));      /* set aperture to min gate time */
write(g_fd,ON_INIT,strlen(ON_INIT));  /* 'freq:aper min' */
write(g_fd,ON_INIT,strlen(ON_INIT));  /* 'abort' any previous measurement */
write(g_fd,ON_INIT,strlen(ON_INIT));  /* Set continuous measurements on */
write(g_fd,ON_INIT,strlen(ON_INIT));  /* init:cont on */

/* configure the shared memory size for 100 readings */
write(g_fd,VME_MEM_SIZE,strlen(VME_MEM_SIZE)); /* 'mem:vme:size 800' */

/* Set shared memory on: 'mem:vme:state on' */
write(g_fd,VME_MEM_STATE_ON,strlen(VME_MEM_STATE_ON));

num_meas = num_meas_store;

while (num_meas-- >0)                 /* Clear out memory */
{
    *p = 0.0;
    p++;
}

write(g_fd,CONF,strlen(CONF));
write(g_fd,APER,strlen(APER));
write(g_fd,ABORT,strlen(ABORT));

write(g_fd,ON_INIT,strlen(ON_INIT));

write(g_fd,OPC_Q,strlen(OPC_Q));      /* send a *opc? to the card */

read(g_fd,in_input,1);                /* read returned value */
printf("%s\n", in_input);             /* All 100 readings are done */

write(g_fd,OFF_INIT,strlen(OFF_INIT)); /* turn init:cont off */

}

Include File listing:

#include "/usr/include/sys/vxi.h"      #define RETURN "\n"
#include <time.h>                      #define ROSC "rosc:sour int"
#include <math.h>                       #define OUTP "outp:rosc on"
#include <stdio.h>                      #define CONF "conf:freq def,def"
#include <string.h>                     #define APER "freq:aper min"
#include <stdlib.h>                     #define ON_INIT "init:cont on"
#include <sys/times.h>                  #define OFF_INIT "init:cont off"
#include <sys/types.h>                 #define FETCH_Q "fetch?"
#include <sys/stat.h>                  #define OPC_Q "**opc?"
#include <fcntl.h>                     #define IDN_Q "**idn?"
#include <sys/param.h>

#define ABORT "abort"
#define CLS "**cls"
#define RST "**rst"
#define TERM_STR "end"
#define QUESTION "?"
#define QUOTE "\""
#define SPACE " "

#define ARM_EXT "arm:sour ext"
#define ARM_IMM "arm:sour imm"
#define VME_MEM_STATE_ON "mem:vme:state on"
#define VME_MEM_SIZE_Q "mem:vme:size?"
#define VME_MEM_SIZE "mem:vme:size 800"
#define VXISEND "/usr/vxi/bin/vxisend "
#define VXIRCV "/usr/vxi/bin/vxircv "

```

F

New Capabilities

New Capabilities

Introduction

Introduction

This appendix provides the information required to use the following new capabilities:

- Phase Measurement
- Acquisition Timeout
- Input Impedance Default Control
- Option Identification Query

New SCPI Commands Overview

The following new Standard Commands for Programmable Instruments (SCPI) commands have been added to the firmware.

Phase Measurement Commands

The following phase measurement commands have been added:

:CONFigure[1][:VOLTage]:PHASe [<expected value>[,<resolution>]]

:MEASure[1][:VOLTage]:PHASe? [<expected value>[,<resolution>]]

:READ[1][:PHASe]?

[:SENSe[1]]:FUNCTION "[VOLTage:]PHASe"

Acquisition Timeout Commands

The following acquisition timeout commands have been added:

[:SENSe]:ATIMEout[:CHECK] OFFIONISTARt

[:SENSe]:ATIMEout[:CHECK]?

[:SENSe]:ATIMEout:TIME <duration>

[:SENSe]:ATIMEout?

Input Impedance Default Control Commands

The following input impedance default control commands have been added:

:DIAGnostics:RState:INPut[1|2]:IMPedance
<value>|MINimum|MAXimum|DEFault

:DIAGnostics:RState:INPut[1|2]:IMPedance? [MINimum|MAXimum|DEFault]

Option Identification Query Common Command

The following standard common command has been added:

```
*OPT?
```

Firmware Version

Firmware version 3401 must be installed to access these capabilities.

Determining Firmware Version

Use the *IDN? query as shown in the following example to determine the firmware version installed in your instrument:

```
OUTPUT @E1420b; "*IDN?"
```

```
ENTER @E1420b; Response$
```

The query response is as follows:

```
HEWLETT-PACKARD, E1420B, 0, 3401
```

Phase Measurement

The HP E1420B derives the relative phase between the Channel 1 and Channel 2 signals from the following two consecutive measurements:

1. The Time Interval 1→2 Measurement.
2. The Period 2 Measurement.

Figure F-1 shows the definition and timing relationship between these measurements.

Phase Measurement Definition

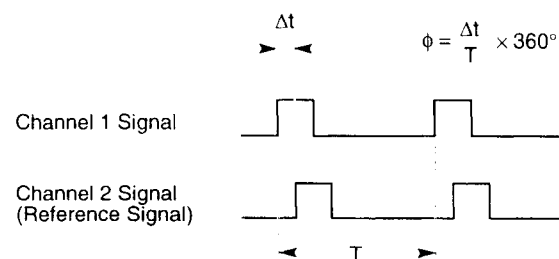

Measurement Timing

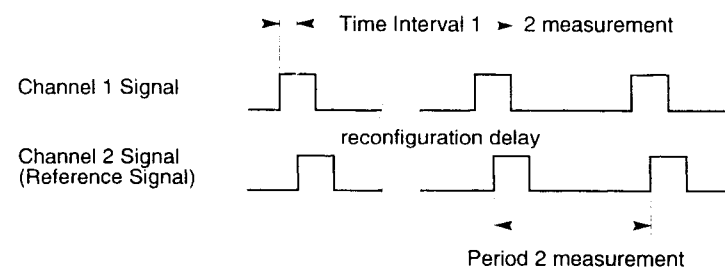

Figure F-1. Phase Measurement Definition and Timing

The relative phase (phase difference) between two signals of identical frequency is defined by the following equation:

$$\text{Phase (degrees)} = \frac{\text{Time Interval } 1 \rightarrow 2}{\text{Period 2}} \times 360^\circ$$

SCPI Commands

Syntax

The following phase measurement commands have been added:

```
:CONFigure[1][:VOLTage]:PHASe [<expected value>[,<resolution>]]
```

```
:MEASure[1][:VOLTage]:PHASe? [<expected value>[,<resolution>]]
```

```
:READ[1][:PHASe]?
```

```
[:SENSe[1]]:FUNction "[VOLTage:]PHASe"
```

The syntax for the phase measurement commands is shown above. While the <expected value> and <resolution> parameters are accepted, they are ignored. Furthermore, the optional numeric suffix of 1 implies a Phase 1 relative to 2 measurement.

Command Descriptions

The :CONFigure, :MEASure?, and [:SENSe]:FUNction commands reconfigure several instrument settings to optimize the measurement of Phase 1 relative to 2. The :CONFigure and :MEASure? commands invoke identical settings to set a generic configuration for this measurement. For those applications that require finer control of the instrument configuration, the [:SENSe]:FUNction command presets fewer settings. This allows you to set the instrument to a specific configuration using other [:SENSe] commands.

Table F-1 lists the instrument settings that are initialized whenever a phase measurement is selected. Bold type indicates mandatory settings. Attempting to change these settings generates the **-221, Settings conflict** error message. The other settings can be changed to customize the measurement for a specific application.

New Capabilities
Phase Measurement

Table F-1. Initialized Instrument Settings for a Phase 1 Relative to 2 Measurement

Instrument Parameter	:CONFigure or :MEASure?		:SENSe:FUNCTion	
	TimeInterval 1→2	Period 2	Time Interval 1→2	Period 2
Input Routing	Separate	Separate	Separate	Separate
Channel 1 Trigger Slope	Channel 2 Trigger Slope	NA	Current Setting	NA
Channel 1 Prescaler	Off	NA	Off	NA
Channel 1 Auto Ranging	Off	NA	Off	NA
Channel 1 Auto Triggering	On/ Repetitive	NA	Current Setting	NA
Channel 1 Auto Trigger Level	50% of V_{pp}	NA	Current Setting	NA
Channel 2 Auto Triggering	On/ Repetitive	On/ Repetitive	Current Setting	Current Setting
Channel 2 Auto Trigger Level	50% of V_{pp}	50% of V_{pp}	Current Setting	Current Setting
Start Arm Source	Immediate	Immediate	Current Setting	Immediate
Stop Arm Source	Immediate	Immediate	Immediate	Immediate
Measurement Averaging	Off	Off	Off	Off
Aperture	NA	NA (1-period acquisition)	NA	NA (1-period acquisition)

NA = Not Applicable to this measurement.

Shading = Internal selection, not user-accessible.

Bold = Mandatory settings.

Query Response

The measurement results are formatted as IEEE 488.2 <NR3> values, without a response header. Each value is truncated to the number of significant digits implied by the "LSD Displayed" formula. The value derived from this expression is always rounded down to the next lower decade, thereby yielding at most one extra digit of resolution.

Phase Measurement Programming Example

The following program shows several ways to perform a phase measurement.

```

10      ! *****
20      ! Program Example: Phase Measurement
30      !
40      ! This program contrasts several ways to perform a Phase 1 rel. 2
50      ! measurement with the E1420B Universal Counter.
60      !
70      ! Three program segments illustrate typical applications of the
80      ! :MEASure:PHASe?, :CONFigure:PHASe, and :SENSe:FUNCTION 'PHASe'
90      ! commands. Comments preceding each segment summarize the
100     ! relative merits of each approach.
110     !
120     ! It is presumed that signals of proper frequency and amplitude
130     ! are connected to the counter's Input 1 and Input 2 channels.
140     !
150     ! This program was written in HP BASIC for an HP Series 9000
160     ! computer.
170     ! *****
180     !
190     DIM Result$(21)                ! Declare string to hold meas. result
200     !
210     ! Determine the interface address of the E1420B with the HP E1405B
220     ! Command Module; these statements must be customized for other
230     ! environments
240     Select_code=7                  ! HP-IB interface at Select Code 7
250     Cmd_addr=9                    ! VXI Command Module at address 9
260     E1420_addr=4                  ! E1420B at secondary address = 32/8
270     ASSIGN @E1420b TO (Select_code*10000)+(Cmd_addr*100)+E1420_addr
280     ! Define the I/O path via E1405B
290     !
300     ! Reset and initialize the counter
310     CLEAR @E1420b                ! Clear the output buffer
320     OUTPUT @E1420b;"*RST"        ! Select the default configuration
330     OUTPUT @E1420b;"*CLS"        ! Clear event registers, Error Queue
340     !
350     ! Measure Phase 1 relative to 2
360     !
370     ! :MEASure:PHASe? Query
380     ! -----
390     ! The :MEASure:PHASe? query provides the simplest (though least
400     ! flexible) means of performing a measurement. The counter is
410     ! programmed to a generic phase measurement configuration, an
420     ! acquisition is initiated, and the result is queried in a single
430     ! operation.
440     !
450     OUTPUT @E1420b;" :MEAS:PHAS?" ! Configure, acquire and query the
460     ! result of a phase measurement
470     ENTER @E1420b;Result$        ! Read the result

```

New Capabilities

Phase Measurement

Phase Measurement Programming Example (Continued)

```
480 PRINT "Phase: ";Result$;" degrees", " (:MEASure? query)"
490 !
500 ! :CONFigure:PHASe Command
510 ! -----
520 ! The :CONFigure command, in conjunction with :READ?, offers more
530 ! precise control of this measurement. :CONFigure configures the
540 ! measurement, while :READ? initiates an acquisition and queries
550 ! the measurement result.
560 !
570 ! In the following program segment, the counter is programmed
580 ! to its generic phase measurement configuration by :CONFigure.
590 ! Auto triggering, which was enabled by :CONFigure, is then
600 ! disabled to illustrate how :CONFigure-invoked settings may
610 ! be customized for a particular application.
620 !
630 OUTPUT @E1420b;":CONF:PHAS" ! Configure a phase measurement
640 ! (and enable auto triggering)
650 OUTPUT @E1420b;":SENS1:EVEN:LEV:AUTO OFF" ! Disable Ch 1 auto trig
660 OUTPUT @E1420b;":SENS1:EVEN:LEV 1.0" ! Set threshold to 1 V
670 OUTPUT @E1420b;":SENS2:EVEN:LEV:AUTO OFF" ! Disable Ch 2 auto trig
680 OUTPUT @E1420b;":SENS2:EVEN:LEV 2.0" ! Set threshold to 2 V
690 OUTPUT @E1420b;":READ?" ! Query the result
700 ENTER @E1420b;Result$ ! Read the result
710 PRINT "Phase: ";Result$;" degrees", " (:CONFigure command)"
720 !
730 ! :SENSe:FUNCTion 'PHASe' Command
740 ! -----
750 ! The :SENSe:FUNCTion 'PHASe' command selects the phase function
760 ! directly. Compared to :MEASure? and :CONFigure, this command
770 ! invokes a smaller number of default settings.
780 !
790 ! This concept is applied in the following program segment, which
800 ! changes the Channel 1 trigger level. As :SENSe:FUNCTion 'PHASe'
810 ! does not alter the auto trigger state, auto triggering remains
820 ! disabled, and the trigger level is properly configured to the
830 ! specified manual setting.
840 !
850 ! Selection of measurement averaging is also illustrated. Note
860 ! that :SENSe:AVERage:STATe ON must follow :SENSe:FUNCTion 'PHASe'
870 ! (or :CONFigure:PHASe) since the latter disables averaging.
880 !
890 ! :READ? then initiates an acquisition and queries the result.
900 !
910 OUTPUT @E1420b;":SENS:FUNC 'PHASe'" ! Select the phase function
920 ! (trigger mode remains
930 ! set to manual levels)
940 OUTPUT @E1420b;":SENS1:EVEN:LEV 2.0" ! Set Ch 1 threshold to 2 V;
950 ! (both channels now trigger
960 ! at a threshold of 2 V)
970 OUTPUT @E1420b;":SENS:AVER:STAT ON" ! Average 100 measurements
980 ! (this command must follow
990 ! :SENS:FUNC 'PHASe')
1000 OUTPUT @E1420b;":READ?" ! Query the result
1010 ENTER @E1420b;Result$ ! Read the result
1020 PRINT "Phase: ";Result$;" degrees", " (:SENS command, average phase)"
1030 !
1040 END ! Done
```

Specifications

The following is a summary of the key performance specifications for the Phase 1 relative to 2 measurement:

Range:

0° to 360°

Least Significant Digit:

$$\sqrt{(2 \text{ ns})^2 \times ((360^\circ)^2 + \text{Phase}^2)} \times \text{Frequency}$$

NOTE

1. Value is rounded to the next lower integer for purposes of truncating the measurement result.
2. 100-acquisition averaging adds another digit of resolution.

RMS Resolution:

$$\pm \sqrt{((2 \text{ ns})^2 + (2 \times \text{Trigger Error}^2)) \times \left(1 + \left(\frac{\text{Phase}}{360^\circ}\right)^2\right)} \times \text{Frequency} \times 360^\circ$$

Systematic Uncertainty:

$$(\pm \text{Trigger Level Timing Error} \pm 2 \text{ ns Differential Channel Error}) \times \text{Frequency} \times 360^\circ$$

Maximum Frequency:

100 MHz

Definitions of Uncertainty Terms

Trigger Error

External source and input amplifier noise may advance or delay the trigger points that define the beginning and end of a measurement. The resulting timing uncertainty is a function of the slew rate and the amplitude of spurious noise spikes (relative to the input hysteresis band).

New Capabilities

Phase Measurement

The (rms) trigger error associated with a single trigger point is:

$$\text{Trigger Error} = \frac{\sqrt{(E_{\text{input}})^2 + (E_{\text{signal}})^2}}{\text{Input Signal Slew Rate at Trigger Point}}$$

where,

E_{input} = RMS noise of the input amplifier (500 μV , nominal)

E_{signal} = RMS noise of the signal over a 100 MHz bandwidth

Trigger Level Timing Error

Trigger level timing error results from a deviation of the actual trigger level from the specified (indicated) level. The magnitude of the measurement timing error depends on several factors, primarily: resolution and accuracy of the trigger level circuit, fidelity of the input amplifier, slew rate of the input signal at the trigger point, and width of the input hysteresis band as shown in the following figure.

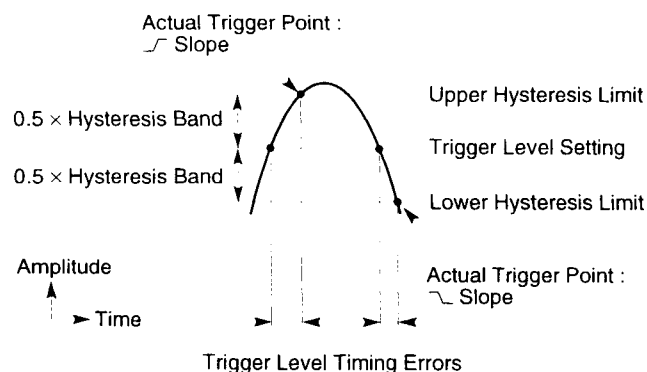

The following equations define the general interpretation of its component error terms for a measurement. These equations should be summed together to obtain the overall Trigger Level Timing Error.

Input Hysteresis:

$$\frac{0.5 \times \text{Hysteresis Band}}{\text{Input Signal Slew Rate at Start Trigger Point}} \pm \frac{0.5 \times \text{Hysteresis Band}}{\text{Input Signal Slew Rate at Stop Trigger Point}}$$

Trigger Level Setting:

$$\pm \frac{30 \text{ mV} \pm (1\% \times \text{Start Trigger Level Setting})}{\text{Input Signal Slew Rate at Start Trigger Point}} \pm \frac{30 \text{ mV} \pm (1\% \times \text{Stop Trigger Level Setting})}{\text{Input Signal Slew Rate at Stop Trigger Point}}$$

Differential Channel Error

The 2-nanosecond error term stated in the Systematic Uncertainty equation accounts for the channel-to-channel mismatch and internal noise.

Performance Test

The Phase 1 relative to 2 measurement is mathematically derived from the parameters verified by other performance tests. If the instrument passes its operational verification and present performance tests, this measurement is functioning to specifications.

Acquisition Timeout

The acquisition timeout capability aborts an acquisition whenever its duration exceeds a user-specified limit. This capability prevents an indefinite hang-up that could occur if the input signals are missing or if the instrument is not properly configured.

SCPI Commands

Syntax

The following acquisition timeout commands have been added:

```
[[:SENSe]:ATIMEout[:CHECK] OFF|ON|START
```

```
[[:SENSe]:ATIMEout[:CHECK]?
```

```
[[:SENSe]:ATIMEout:TIME <duration>
```

```
[[:SENSe]:ATIMEout?
```

Command Descriptions

The `[[:SENSe]:ATIMEout[:CHECK] OFF|ON|START` command enables or disables the timeout capability. `ON` enables the start-to-stop mode. `START` enables the start-only mode. The power-up default is `OFF`. The timeout mode is unaffected by `*RST`.

The `[[:SENSe]:ATIMEout[:CHECK]?` command queries the timeout mode.

The `[[:SENSe]:ATIMEout:TIME <duration>` command sets the timeout duration in seconds. The power-up default is 5 seconds. The timeout duration is unaffected by `*RST`.

The `[[:SENSe]:ATIMEout?` command queries the timeout duration.

These settings apply globally to all measurement functions for which timeout is supported. Measurement-specific settings are not supported.

Timeout can be enabled for all functions except voltage measurements (which complete even when no signals are applied). Selecting a voltage measurement disables the timeout mode; it must be reenabled if required for another measurement function. Issuing these commands will abort an acquisition in progress.

Timeout mode and duration settings are retained as part of the instrument state saved by the ten setup registers.

Status Reporting

Error **+2100, Acquisition timed out** is reported if the required arm and trigger events were not detected within the number of seconds specified. This condition, in turn, sets the Device-specific Error bit (bit 3) of the Standard Event Status Register. A service request (SRQ) is generated if bit 3 of the Standard Event Status Enable Register and bit 5 of the Service Request Enable Register are also set.

Query Response

The Not a Number value of **9.91E+37** is returned as the formatted response to a measurement query. This unique value is used in this context to indicate that no measurement data is available.

Error **-230, Data corrupt or stale** is reported with this response.

Behavior

Timeouts apply to the automatic frequency ranging acquisition and to the actual measurement acquisition. Auto triggering, measurement configuration, and result processing operations (which can never be suspended indefinitely) are not timed (see Figure F-2).

The acquisition timer is initialized prior to each timed process. In the case where 100-gate averaging is enabled, each of the 100 acquisitions is individually timed. Consequently, it is not necessary to adjust the specified duration when alternating between single and averaged measurements.

When the START option is selected, the measurement aborts if the start arm and start trigger events have not been detected within the number of seconds specified. This duration is measured from the point at which an acquisition is enabled (that is, when the start arm event can be recognized).

When the ON option is selected, the measurement aborts if an acquisition has not completed within the number of seconds specified (again, measured from the point at which the acquisition is enabled). This mode times the complete acquisition cycle, and can be used to ensure that a valid measurement result can be fetched (see Figure F-2). If the stop arm is inhibited by the gate time or the TI delay, the time remaining (the specified time less the elapsed time to the start event) is compared with the gate time or TI delay. The acquisition aborts immediately if the remaining time is less than or equal to the gate time or TI delay. Consequently, the timeout function is never deferred by the gate time or TI delay setting.

New Capabilities

Acquisition Timeout

Issuing the :ABORt command or reconfiguring the instrument halts the acquisition timer. Error conditions resulting from these actions take precedence over a coincident timeout condition.

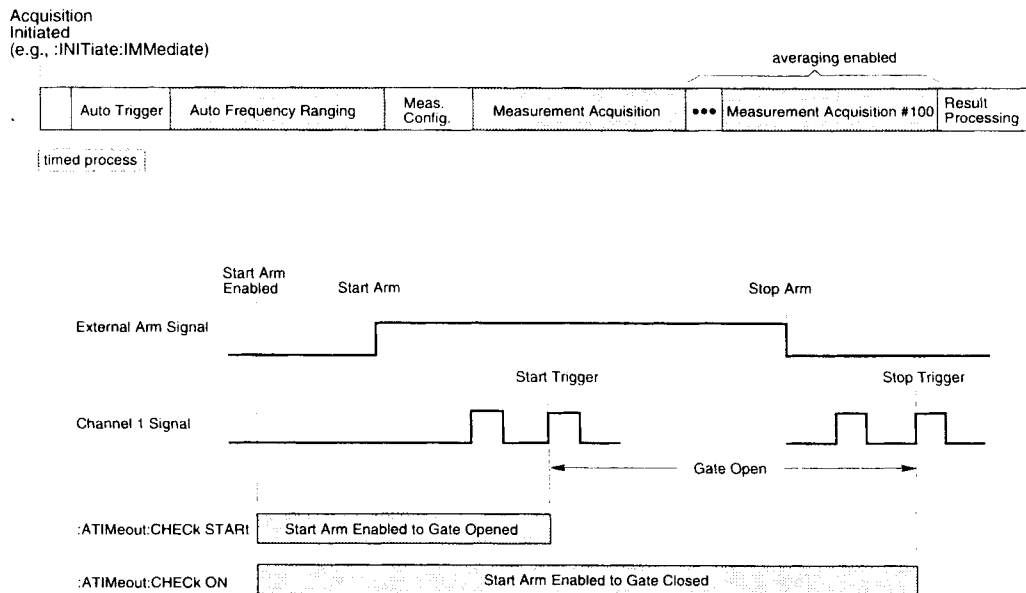

Figure F-2. Acquisition Timeout Timing Example

Acquisition Timeout Programming Example

The following program shows how to use the acquisition timeout capability.

```
10 !*****
20 !
30 ! Program Example: Acquisition Timeout
40 !
50 ! This program illustrates a simple application of the acquisition
60 ! timeout capability of the HP E1420B Universal Counter.
70 !
80 ! The E1420B is configured to measure the average frequency of the
90 ! signal connected to the Input 1 channel. In this example, each
100 ! acquisition (within the set of 100) is expected to complete
110 ! within 100 milliseconds. Otherwise, the counter will abort the
120 ! measurement immediately and report the timeout condition to the
130 ! computer via a service request and the "+2100, Acquisition timed
140 ! out" error message.
150 !
160 ! This program was written in HP BASIC for an HP Series 9000
170 ! computer.
180 !*****
```

Acquisition Timeout Programming Example (Continued)

```

190  !
200  DIM Result$(21)           ! Declare string to hold meas. result
210  DIM Err_msg$(255)       ! Declare string to hold error msg.
220  Timed_out=0             ! Initialize timeout status flag
230  !
240  ! Determine the interface address of the E1420B with an HP E1405B
250  ! Command Module; these statements must be customized for other
260  ! environments
270  Select_code=7           ! HP-IB interface at Select Code 7
280  Cmd_addr=9              ! VXI Command Module at address 9
290  E1420_addr=4           ! E1420B at secondary address = 32/8
300  ASSIGN @E1420b TO (Select_code*10000)+(Cmd_addr*100)+E1420_addr
310  ! Define the I/O path via E1405B
320  !
330  ! Reset and initialize the counter
340  CLEAR @E1420b           ! Clear the output buffer
350  OUTPUT @E1420b;"*RST"   ! Select the default configuration
360  OUTPUT @E1420b;"*CLS"   ! Clear event registers, Error Queue
370  !
380  ! Enable the acquisition timer
390  OUTPUT @E1420b;":SENS:ATIM:TIME 0.1" ! Maximum duration is 100 ms
400  OUTPUT @E1420b;":SENS:ATIM:CHEC ON" ! Time acquisition from start
410  ! to stop
420  ! Enable reporting of device-specific errors
430  OUTPUT @E1420b;"*ESE 8"   ! Generate a service request (SRQ)
440  OUTPUT @E1420b;"*SRE 32" ! on a device-specific error
450  ON INTR Select_code GOSUB Device_error ! If SRQ, call Device_error
460  ENABLE INTR Select_code;2 ! Enable program interrupt on SRQ
470  !
480  ! Configure an averaged frequency measurement
490  OUTPUT @E1420b;":CONF:FREQ DEF,DEF" ! Measure frequency of Ch 1;
500  ! disable auto ranging mode
510  OUTPUT @E1420b;":SENS:AVER:STAT ON" ! Average 100 acquisitions
520  OUTPUT @E1420b;":SENS:FREQ:APER 0.05" ! Acquire each acquisition
530  ! over a gate time of 50 ms
540  !
550  ! Initiate the measurement, start the timer, then query the result
560  OUTPUT @E1420b;":READ?"
570  !
580  ! Retrieve the measurement result
590  ! Note: The value 9.91E+37 will be returned if a timeout occurred,
600  ! so the fetch operation will not be suspended indefinitely
610  ENTER @E1420b;Result$    ! Read the result
620  PRINT "Frequency 1: ";Result$;" Hz" ! Print it
630  !
640  ! Print an advisory message regarding the timeout status
650  IF Timed_out THEN
660  PRINT "*** Acquisition timed out. Result is invalid. ***"
670  ELSE
680  PRINT "Acquisition completed within the specified duration."
690  END IF
700  !
710  STOP                      ! Done
720  !
730  !
740  Device_error: !
750  !
760  ! Subroutine that returns the acquisition timeout status:
770  ! Timed_out = 1, if a timeout occurred; 0, otherwise
780  !
790  Timed_out=0              ! Timeout has not yet occurred
800  !
810  ! Examine the contents of the Error Queue for the timeout message

```

New Capabilities

Acquisition Timeout

Acquisition Timeout Programming Example (Continued)

```
820 ! Note: It is necessary to search for the timeout message since
830 !       other device-specific errors may have been detected.
840 !       Since these error conditions are rarely encountered,
850 !       however, they are ignored by this subroutine.
860 REPEAT
870   OUTPUT @E1420b;":SYST:ERR?" ! Query the next error in the queue
880   ENTER @E1420b;Error_code,Err_msg$ ! Read the error code
890                                     ! and message
900   IF Error_code=2100 THEN Timed_out=1 ! Indicate if timed out
910   UNTIL Error_code=0                ! Repeat until the queue is empty
920   RETURN
930   !
940   END
```

Functional Limitations

The following functional limitations apply to the acquisition timeout capability:

1. This capability provides a coarse assessment of the acquisition time and should not be used in critical timing applications.
2. Information on the specific condition that caused the timeout (for example, a missing start arm event) or its source (for example, Channel 1) is not reported.

Typical Performance Characteristics

The following is a summary of the typical characteristics for acquisition timeout:

Selectable Range and Resolution:

100 ms to 1500 seconds in 100 ms increments

Accuracy:

$\pm 100 \mu\text{s} \pm (0.5\% \times \text{Timeout Duration})$

Because the timeout acquisition performance can be influenced by several external factors, the timeout accuracy is a typical characteristic and not a warranted specification.

Input Impedance Default Control

This command defines the default impedance setting invoked by the *RST command and at power-up. The parameter of this command evaluates to one of two settings, 50 Ω or 1M Ω for the specified input channel.

SCPI Commands

Syntax

The following input impedance default control commands have been added:

```
:DIAGnostics:RState:INPut[1|2]:IMPedance <value>MINimumMAXimum  
IDefault
```

```
:DIAGnostics:RState:INPut[1|2]:IMPedance? [MINimumMAXimumIDefault]
```

The syntax for these commands is shown above. It is analogous to the structure of the :INPut:IMPedance command, which selects the input impedance for Channels 1 and 2.

The format of this command permits independent specification of the input impedance for Channels 1 and 2. If the optional channel parameter is omitted, Channel 1 is assumed.

The impedance parameter is interpreted as follows:

- <value>

A numeric parameter that evaluates to a value between 40 and 60 (inclusive) sets the default impedance to 50 Ω . Conversely, a numeric parameter that evaluates to a value between 900,000 and 1,100,000 (inclusive) sets the default impedance to 1 M Ω . If any other parameter value is entered, an error message is generated and the current setting is not changed.

- <discrete>

The MINimum and DEFault parameters specify the low impedance setting (50 Ω). The MAXimum parameter specifies the high impedance setting (1 M Ω).

Semantics

The *RST default impedance settings are retained in non-volatile memory. These settings are restored at power-up. If a setting cannot

New Capabilities

Input Impedance Default Control

be restored, it is set to 50 Ω . Channel 1 and 2 input impedances are also initialized to the respective default impedances at power-up.

The *RST default impedance settings are not altered by save/recall operations.

Input Impedance Default Control Programming Example

The following sequence of commands programs the default impedance settings for Channels 1 and 2 to 1 M Ω :

```
:DIAG:RST:INP1:IMP MAX !Sets *RST input impedance of
                        !channel 1 to 1 Mohm.
:DIAG:RST:INP2:IMP MAX !Sets *RST input impedance of
                        !channel 2 to 1 Mohm.
.
.
.
*RST                    !Select default instrument
                        !state; configures 1 Mohm input
                        !impedance
```

Comments

Some instrument functions may momentarily alter the current impedance setting to perform requested operations. For example, the Rise Time and Fall Time measurements program the Channel 2 impedance setting to match the Channel 1 setting. (The previous setting is restored when another measurement function is selected.) In addition, the calibration process configures the input impedance to 50 Ω for both channels. This behavior should be considered when it is necessary to maintain the impedance setting in order to avoid mismatching or potential damage to the input circuits.

Option Identification Query

The Option Identification Query (*OPT?) queries the instrument to identify any reportable options that are installed. In the HP E1420B, the only reportable option is Option 040 (Shared Memory).

Common Command

Syntax

The following common command has been added:

*OPT?

Query Response

The query response is a sequence of ASCII-encoded bytes indicating

<shared memory option>

terminated with a newline and EOI.

- The <shared memory option> is 040.
- A missing option is identified by an ASCII 0 (zero).

Comments

This query should be the last query in a terminated program message. If it is not, an error **-440, Query UNTERMINATED after indefinite response** is generated.

Option 010 (TCXO Time Base), and Option 030 (Input 3) are not detectable with this query.

A

Abbreviated commands	5-2
ABORt	1-4, 5-16
Ac power	1-6, 2-9, D-2
Access LED	2-3
Address	
Conflict	1-6
Counter module	2-5
Factory default	1-6
Factory setting	2-5
HP-IB select code	1-9, 1-11
Interface select code	2-5, 3-3
Logical	1-6, 1-9, 1-11
Primary	1-9, 1-11, 2-5, 3-3
Primary, GPIB	3-3
Range	2-5
Secondary	1-9, 1-11, 2-5, 3-3
Secondary, GPIB	3-3
Setup procedure	2-6
Slot 0 module	2-5
Switch	1-6
Switch location	2-6
Addressing scheme	1-6
Aperture time	4-11, 4-32
Aperture time selection	4-33
Appendix D	1-8
ARM	1-5, 5-17
:LEVel	5-18
:LEVel?	5-19
:SEQuence2 or STOP	5-17
:SLOPe	5-19
:SLOPe?	5-19
:SOURce	5-19
:SOURce?	5-20
Arm input connector	2-2
ARM Start/Stop	2-2
ARM subsystem	4-28
Arming	
External	4-30
Front-panel BNC	4-30
Hold state	4-29
TTLTrg lines	4-31
TTLTrig bus	4-30
Attenuation	1-2, 1-4, 2-2, 4-3, 4-17, 4-18, 4-22, 5-45
Auto frequency measurement test	C-6
Auto measurement sensitivity, range, and accuracy tests	C-31
Auxiliary measurement capabilities	1-3
100 measurement gate averaging	1-3
External arming	1-3
External arming slope/level	1-3
External timebase input	1-3
External timebase output	1-3

B

Backplane connector	
Inspection	1-7
Reseating	D-2
VXIbus, P1	1-7
VXIbus, P2	1-7

Block diagram	1-2, 1-4 - 1-5
Circuits	1-3
Simplified description	1-3
BNC connectors	2-2
Boolean parameters	5-3
Bus arbitration	
Factory default	1-6
Factory setting	2-6 - 2-7
Jumper location	2-6
Jumper location/selection	2-7
Jumper settings	2-6
Jumpers, grant/request level	1-6
Priority level	1-6, 2-6

C

C-size mainframe	
HP 75000	1-6
Non-HP	1-6
Calibration cycle	C-3
Calibration data	5-14
Changing default parameters	3-4
Channel numbers	5-3
Command	
Instrument program message	3-3
Keyword	5-2
Language documentation	3-2
Language syntax check	D-5
Language syntax, controller	3-2
Separator	5-2
Summary	5-5
Syntax	5-2
Types	5-2
Word-serial protocol	3-2
Common command format	5-2
Common commands	
*CLS (Clear Status)	5-11, D4
*DMC (Define Macro)	5-11
*EMC (Enable Macro)	5-12
*EMC? (Enable Macro Query)	5-12
*ESE (Standard Event Status Enable)	5-13
*ESE? (Standard Event Status Enable Query)	5-13
*ESR (Event Status Register Query)	5-13
*GMC? (Get Macro Contents Query)	5-13
*IDN? (Identification Query)	5-13
*LMC? (Learn Macro Query)	5-14
*OPC (Operation Complete)	5-14
*OPC? (Operation Complete Query)	5-14
*PMC (Purge Macros)	5-14
*RCL (Recall)	5-14
*RST (Reset)	2-3, 3-2, 4-29, 5-14
*SAV (Save)	5-15
*SRE (Service Request Enable)	5-15
*SRE? (Service Request Enable Query)	5-15
*STB? (Status Byte Query)	5-15
*TRG (Trigger)	5-15
*TST	1-8, D-5
*TST? (Self-Test Query)	5-15
*WAI (Wait)	5-15
Common input channels	2-2
Configuration	
Bus grant/request jumpers	2-6

Default parameteres	3-4
Default parameters	D-5
Hardware setup	2-5
Measurement details	4-2
Setting bus/grant request level	2-6 - 2-7
CONFigure	1-4 - 1-5, 3-2, 4-2, 4-33, 5-21
:AC	3-21,5-22
:DC	3-21, 5-23
:FREQuency	5-23
:FREQuency;RATio	5-25
:FTIME/:FALL:TIME	5-26
:MAXimum	5-27
:MINimum	5-28
:NWIDTH	5-28
:PERiod	5-30
:PWIDth	5-31
:RTIME/:RISE:TIME	5-32
:TINTerval	5-34
:TOTALize	5-34
CONFigure?	5-36
Connectors	
Front-panel	2-2
Controls and indicators	2-2
Cooling requirements	2-9
Counter	
Address	3-5
Arming details	4-28
Arming system	4-28 - 4-29
Bus arbitration selection	2-6
Command language	3-2
Control data	1-3
Error queue	2-3
Front-panel connectors	2-2
Internal arming	4-29
LED indicators	2-3
Main inputs	2-2
Measurement configuration details	4-2
Message-based bus arbitration	2-6
Message-based device	1-2
Output queue	1-8
Programming	1-2, 3-2
Removing	1-7
SCPI commands	3-3
Selected SCPI commands	3-2
Switchs/jumpers	2-2
Timebase adjustment	2-2
Coupling	
Ac or dc	2-2
External arm input	2-2
Fixed 50 OHM, channel 3	2-2

D

Damage	
Front end hardware	1-9, 3-5
Front-end hardware	2-2
Level	4-27
VXIbus connector precaution	2-3
Damaged shipments	1-6
Data transfer errors	3-2
DIAGnostics	5-37
:ASSEMBly	5-38
:BLOCK	5-38
:CALibrate	5-37
:UFAIL	5-39
Discrete parameters	5-3
Dynamic range	4-19

E

Embedded instrument controller	3-2
Engineering notation	1-10, 1-12
Error condition	D-2
Error indicators	2-3
Error LED	2-3, D-2
Error queue	D-2, D-4
Event registers	5-11
Event triggering	4-24
Example command strings	1-3
External arm input test	C-14
External arm range, sensitivity, and minimum start-to-stop time tests	C-28
External arming	4-30
BNC/VXIbus TTLTrig lines	1-3
Front-panel BNC input	2-2
Input frequency range	2-2
Input level selection	2-2
External timebase	
Input specifications	2-2

F

Failed LED	1-8, 2-3, D-2, D-5
Fault isolation	D-2
FETCH	3-2
FETCH?	1-4, 5-40
Frequency measurement	1-9
Frequency measurement program example	1-10
Frequency resolution/expected value	5-24
Front panel	
Connectors	2-4
Front panel connector	
Input 1	1-9, 1-11
Input 2	1-9, 1-11
Front panel indicators and adjustments	2-3
Front-panel connector	
Input 1	D-2
Input 2	D-2
Full performance testing	C-18
Functional block	
Counter (MRC)	1-3, 4-18
External arming	1-3
Input 1 and 2	4-18
Inputs 1 and 2	1-3
Measurement control	1-3, 4-18
VXIbus interface	1-3
Functional test record	C-3
Functional tests	C-1, C-4
Auto frequency measurement test	C-6
External arm input test	C-14
Input signal conditioning test	C-8
Option 010 TCXO timebase test	C-15
Option 030, input 3 test	C-16
Ratio measurement test	C-7
Time interval test	C-12
Functional tests:Required equipment	C-2

G

Gate LED	2-3
Gate time	4-32
Frequency/period	4-11
Gate time determination	4-33
GPIB interface card	3-2
GPIB-PC Interface card	3-3

H

Hardware installation	2-9
Hardware problems	D-2
HP BASIC	3-2 - 3-3, 3-5, C-4
OUTPUT,HP-IB address	3-3
HP BASIC statement	
ASSIGN	3-3
ENTER	3-3
OUTPUT	3-3
HP VXIbus factory set addresses	2-8
HP-IB Address	2-5
HP-IB connection	
Verification	D-5
Hysteresis band	4-23

I

Idle state	4-28
IEEE 488.2 Common Commands	5-2, 5-5, 5-11
Impedance	
1 MOHM or 50 OHM	2-2
External arm input	2-2
Fixed 50 OHM, channel 3	2-2
Implied channel	5-2
Implied commands	5-2
Indicators	
Normal operation	2-3
Indicators, front- panel	2-2
Initialization state	1-8, 3-4
INITiate	1-4, 3-2, 5-42
:CONTinuous	5-43
:IMMediate	5-42
INPut	5-45
:ATTenuation	5-45
:ATTenuation?	5-45
:COUPling	5-45
:COUPling?	5-46
:IMPedance	5-46
:IMPedance?	5-46
:ROUte	5-46
:ROUte?	5-47
Input	1-4, 3-2
Arming, external	2-2
Attenuation	1-2, 1-4, 2-2, 4-3, 4-17, 4-18, 4-22, 5-45
Channel 3, option 030	2-2
Channels 1 and 2	2-2
Channels,frequency	3-6
Maximum voltage	1-9, 2-2
Common channel 2/3 indicator	2-3
Common channels 1 & 2	2-2
Coupling	4-23
External arm levels	2-2
Hysteresis band	4-22, 4-24
Impedance	4-26
LED indicators	2-3, 4-24
Maximum voltage	3-5
Measurement channels	1-2
Selectable coupling	2-2
Selectable impedance	2-2
Sensitivity	4-20
Signal conditioning	1-2
Signal connectors	2-2
Trigger level	4-24
Input 1, separate/common	4-27
Input 1/2: measurement sensitivity, range, and accuracy tests	C-23

Input signal	
conditioning	1-3
Conditioning details	4-18
Dynamic range	4-19
Range	4-18
triggering	1-3
Input signal conditioning test	C-8
Inspection	
Module connectors	1-6
Shipping materials	1-6
Installation	
Configuration	1-6
Configuration addressing/details	1-6, 2-5
Detailed procedure	2-9
Hardware	1-6 - 1-7, 2-9
Inspection	1-6
Mounting screws	1-7
Quick procedure	1-6
Instrument	
Address definition	2-5
Address range	2-5
Address switch location	2-6
Calibration cycle	C-3
Circuit control	4-2
Configuration	2-5, 4-2
Controller	3-2
Controller power-up	1-8
Controller verification	D-5
Data interface priority	2-6
External controllers	3-2
Features/functions	1-2
Full performance testing	C-18
General test setup	C-19
Module mounting	2-9
Overflow condition	D-4
Primary/secondary address	2-5
Problem checklist	1-8
Shields	2-9
Specifications tested	C-20
Test specifications	C-21
Testing considerations	C-3
Warm-up	2-3
Instrument controller	
9000 series 200/300	1-11
Display results	1-9
Frequency display results	1-10
GPIB-PC Interface card,	3-3
HP 9000 series 200/300	1-9, 3-2, 3-5
HP BASIC	1-9, 1-11, 3-2
Language interface file, GPIB	3-3
Languages	3-2
PC/AT compatible	3-2
QuickBASIC(R)	3-2
QuickBASIC(R) access	3-3
QuickBASIC(R) CALL statements	3-3
Time interval display results	1-12
INT/EXT REFERENCE	
Connector	2-2
Internal arming	4-29

L

Linking commands	5-4
Logical Address Configuration	2-5

M

Macro definition/label	5-11 - 5-14
Mainframe	
HP 75000 Series C	2-9
Making basic measurements	
frequency/time interval	1-9
Making measurements	
Frequency	3-6
Pulse width	3-12
Ratio	3-14
Rise/fall time	3-18
SCPI considerations	4-5
Time interval	3-10 - 3-11
Totalize	3-16
Voltage	3-20
Making measurements	
Period	3-8
MAX	3-21
Maximum input power	3-5
Maximum input voltage	1-9, 2-2
MEASure	1-4 - 1-5, 3-2, 4-2, 4-33, 5-47, D-3
:AC?	3-21, 5-22
:DC?	3-21, 5-23
:FREquency:RATio?	5-25
:FREquency?	5-23
:FTIME?/:FALL:TIME?	5-26
:MAXimum?	5-27
:MINimum?	5-28
:NWIDth?	5-28
:PERiod?	5-30
:PWIDth?	5-31
:RTIME?/:RISE:TIME?	5-32
:TINTerval?	5-34
:TOTALize?	5-34
Command details	5-49
Measurement	
Arming indicator	2-3
Arming, external	1-3
Auxiliary capabilities	1-3
Capabilities	1-2
Channel input functions	2-2
Configuration details	4-2
Data	1-3
Event data	1-3
Features	1-2
Frequency	1-2, 3-6
Frequency range	1-2, 3-6
Functions	1-2, 3-5, 4-10
Gating indicator	2-3
General procedure	4-3
Input channels	1-2, 2-2
Interpreting frequency results	1-10
Making frequency	1-9
Making time interval	1-9
Period	1-2, 3-8
Pulse width	1-2, 3-12
Ratio	1-2, 3-14
Resolution	1-10, 1-12
Resolution details	4-32
Results, frequency	1-9
Rise/fall time	1-2, 3-18
Signal input channels	2-2
Start/stop, arming	2-2
Synchronization	1-3, 2-2
Task tutorials	3-5
TCXO warm-up period	2-3

Time data	1-3
Time interval	1-2, 3-10
Timebase synchronization	2-2
Totalize	1-2, 3-16
Triggering indicator	2-3
Voltage	3-20
Measurement details	
Frequency/period	4-11
Pulse width	4-12
Ratio	4-13
Rise/fall time	4-13
Time interval	4-14
Time interval delay	4-15
Totalize	4-16
Measurement example	
Frequency	3-6
Period	3-8
Pulse width	3-12
Ratio	3-14
Rise/fall time	3-18
Time interval	3-10 - 3-11
Totalize	3-16
Measurement program	
Frequency	1-9
Time interval	1-11
Measurement program example	
Frequency	1-10, 3-7
Period	3-9
Pulse width	3-13
Ratio	3-15
Rise/fall time	3-19
Time interval	1-12
Totalize	3-17
Measurement results	1-10, 1-12
Measurement time	3-15
Frequency	3-7
Period	3-9
Pulse width	3-13
Rise/fall time	3-19
Time interval	3-11
Measurements	
Frequency/time interval	1-9
MEMORY subsystem	5-50
:VME:ADDRESS	5-50
:VME:ADDRESS?	5-51
:VME:SIZE	5-51
:VME:SIZE?	5-52
:VME:STATe	5-52
:VME:STATe?	5-52
Microsoft® QuickBASIC®	3-2 - 3-3
Instrument control	3-3
MIN	3-21
Module shields	1-6

N

Numeric parameters	5-3
--------------------	-----

O

Option	
010 TCXO Timebase	1-13, C-3
010 TCXO timebase test	C-15
030 Channel 3, 2 GHz	1-13
030, input 3 test	C-16
033 Service manuals	1-13
910 Extra user manuals	1-13
W32 Calibration support	1-13

Optional parameters	5-3
Options	1-13
OUTPut	5-53
:ROSCillator:STATe	5-53
:ROSCillator:STATe?	5-53
:TTLTrg	5-53
:TTLTrg :STATe?	5-53
Output format	4-34
Output Queue	5-11
Overall description	1-2
Overflow indication	3-6

P

Packing materials	1-6
Parameter types	5-3
Performance tests	C-1
Performance test record	C-3
Performance tests	C-18
Alternate test equipment	C-22
Auto measurement sensitivity, range, and accuracy tests	C-31
External arm range, sensitivity, and minimum start-to-stop time tests	C-28
Input 1/2: measurement sensitivity, range, and accuracy tests	C-23
Recommended test equipment	C-2
Software implemented	C-4
Specifications	C-20 - C-21
Uncertainties analysis method	C-21
Performance tests:Required equipment	C-2
Performance tests	C-18
General test setup	C-18
Period resolution/expected value	5-31
Power-on state	1-8
APERture time	4-32
Power-on status	3-4
Prescaling	5-24, 5-31
Problems and solutions	1-8
Program errors	D-2
Monitoring	D-2
Programming the counter	3-2
Programming, shared memory	E-1
Pulse width resolution/expected Value	5-29

Q

Query parameters	5-4
Questionable data register	5-71

R

Ratio	
Frequency 1/2	5-26
Ratio measurement test	C-7
Ratio resolution/expected value	5-26
READ?	1-4, 5-54
Reciprocal counting technique	1-3
Recommended test equipment	C-2
Reset status	3-4
Resolution	
100 gate average mode	5-29
Gate time	4-33, 5-24, 5-26, 5-31
Measurement time	3-7, 3-19
Pulse width, default	3-13
Ratio	3-15
Time interval	3-11
Resolution selection	4-33
Root command	5-2 - 5-3

S

SCPI	
Circuit control	1-3
Command format	5-2
Command use details	5-2
Commands	5-5 - 5-6, 5-16
Commands/options	1-3
Common commands	1-3
Configuration details	4-2
Measurement capability	4-6
Program message, timebase	2-2
Response messages	1-3
SCPI command string	
Microsoft(R) QuickBASIC(R)	3-3
Program error checking	D-3
SCPI Standardized commands for programmable instruments	3-1
SCPI subsystem defaults	
CONFigure	3-4
MEASure	3-4
SCPI/TMSL	3-2
SCPI:Error checking	D-2
Self-test	5-15, C-5
Errors	1-8, 2-3
Executing	1-8, D-5
Failed LED	1-8, D-2
Subroutines	5-37
System verification	D-5
Verified hardware	C-6
SENSe	1-4, 3-2, 4-2, 5-55
:AVERage	5-56, 5-65
:AVERage:COUNT?	5-56
:EVENT:HYSTeresis	5-59
:EVENT:HYSTeresis?	5-59
:EVENT:LEVel	5-56 - 5-57
:EVENT:LEVel?	5-59
:EVENT:LEVel:ABSolute:AUTO	5-58
:EVENT:LEVel:ABSolute:AUTO?	5-58
:EVENT:LEVel:RELative	5-58
:EVENT:LEVel:RELative?	5-58
:EVENT:SLOPe	5-59
:EVENT:SLOPe?	5-59
:FREQuency:APERture	5-60
:FREQuency:APERture?	5-60
:FREQuency:RANGe	5-61
:FREQuency:RANGe:AUTO	5-61
:FREQuency:RANGe:UPPer	5-61
:FUNction	5-61
:FUNction?	5-64
:PERiod:APERture	5-64
:PERiod:APERture?	5-64
:RATio:APERture	5-64
:RATio:APERture?	5-64
:ROSCillator:SOURce	2-2, 2-3, 5-64
:ROSCillator:SOURce?	5-65
:TINTerval:DELay	5-65
:TINTerval:DELay?	5-65
:TINTerval:DELay:TIME	5-65
:TINTerval:DELay:TIME?	5-66
:TOTalize:GATE	5-66
:TOTalize:GATE:POLarity	5-67
:TOTalize:GATE:POLarity?	5-67
:TOTalize:GATE:STATe	5-66
:TOTalize:GATE:STATe?	5-66
Service request enable register	5-14 - 5-15
Service/support	1-13

Shared memory (see also Memory subsystem)	E-1
Signal conditioning	
Coupling	1-2
Input	1-2
Input impedance	1-2
Input switching	1-2
Pulse width	3-12
Trigger level	1-2
Trigger slope	1-2
Signal conditioning details	
Frequency/period	4-11
Pulse width	4-12
Totalize	4-17
Signal conditioning example	
Ac/Dc/Min/Max	3-20
Ratio	3-14
Rise/fall time	3-18
Totalize	3-16
Signal conditioning, example	
Frequency	3-6
Period	3-8
Time interval	3-10
Signal Generator	1-9, 1-11
1 kHz source	1-9
1 MHz source	1-9
5 kHz source	1-11
Signal operating range	4-18
Simplified block diagram	1-4 - 1-5
Slot 0 module	
Address range	2-5
Power-on	1-8
Self-test	1-8
Status registers	D-2
Verifying functionality	D-5
Software problems	D-2
Standard event status enable register	5-13 - 5-14
Standard event status register	5-13
Error checking	D-2
Overflow condition	D-4
Summary bit	D-3
Standardized Commands for Programmable Instruments (SCPI)	1-2, 3-2
STATUS	5-13, 5-15, 5-68
:OPERation	5-70
:OPERation:CONDition?	5-70
:OPERation:ENABle	5-70
:OPERation:ENABle?	5-70
:QUEStionable	5-71
:QUEStionable:CONDition?	5-71
:QUEStionable:ENABle	5-72
:QUEStionable:ENABle?	5-72
Status data structures	5-11
STATUS subsystem	3-6
Syntax	
Controller language	3-2
SYSTEM	5-73
:ERRor?	5-73
:VERsion?	5-74
System configuration	1-6, 2-7
System problems	D-2
System verification	D-5
checklist	D-5

T

TCXO adjustment	2-3
TCXO timebase	2-3
Test and measurement systems language (TMSL)	3-2

Test equipment,Alternate	C-22
Test setup	
Performance tests	C-18
Time interval measurement	1-11
Time interval measurement program example	1-12
Time interval resolution	5-29
Time interval test	C-12
Timebase	
External input	2-2
Frequency adjustment	2-3
Input termination	2-2
Input/output	2-2
Int/ext reference	2-2
Warm-up	2-3
Trigger level	4-24
Automatic	4-24
Selection	4-24 - 4-25
Trigger point	4-24
Trigger slope	4-26
Troubleshooting	1-8

U

Uncertainties analysis method	C-21
Using	
CONFigure	4-7
FETCh?	4-9
INITiate	4-9
MEASure	4-7
READ?	4-9
SENSe	4-8

V

Verifying operation	1-7, 2-9, D-5
VMEbus Specification	2-3
Voltage measurement	3-20
VXIbus	
Bus arbitration setting	2-6
Connector alignment	2-9
Connectors	2-3 - 2-4
Error indicator	2-3
HP-IB modules	3-2
Logical address, HP system defaults	2-7
Mainframe	C-4
Specification	2-3
Word-serial protocol	3-2
VXIbus interface	
Access indicator	2-3
VXIbus Specification	
Cooling requirements	2-9

W

Wait-for-arm state	4-28
Warm-up	2-3

DECLARATION OF CONFORMITY

according to ISO/IEC Guide 22 and EN 45014

Manufacturer's Name: Hewlett-Packard Company

Manufacturer's Address: Santa Clara Division
5301 Stevens Creek Boulevard
Santa Clara, California 95052-8059
U. S. A.

declares, that the product

Product Name: Universal Counter, VXI

Model Number: HP E1420B

Product Options: This declaration covers all options of the product.

conforms to the following Product Specifications:

Safety: IEC 1010-1: 1990 + A1 / EN 61010-1: 1993

EMC: CISPR 11: 1990 / EN 55011: 1991 Group 1, Class A
IEC 801-2: 1991 / EN 50082-1: 1992 4 kV CD, 8 kV AD
IEC 801-3: 1984 / EN 50082-1: 1992 3 V/m, 1kHz 80% AM, 27-1000MHz
IEC 801-4: 1988 / EN 50082-1: 1992 1 kV Power Lines, 0.5 kV Signal Lines

Supplementary Information:

The product models listed above comply with the requirements of the Low Voltage Directive 73/23/EEC and the EMC Directive 89/336/EEC.

Santa Clara, California, November 11, 1995

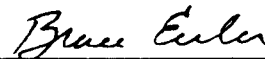

Bruce Euler, Quality Engineering Manager

European Contact: Your local Hewlett-Packard Sales and Service Office or Hewlett-Packard GmbH,
Dept. ZQ/Standards Europe, Herrenberger Straße 130, D-71034 Böblingen (FAX: +49-7031-143143)

F

New Capabilities

Introduction

This appendix provides the information required to use the following new capabilities:

- Phase Measurement
- Acquisition Timeout
- Input Impedance Default Control
- Option Identification Query

New SCPI Commands Overview

The following new Standard Commands for Programmable Instruments (SCPI) commands have been added to the firmware.

Phase Measurement Commands

The following phase measurement commands have been added:

```
:CONFigure[1][:VOLTage]:PHASe [<expected value>[,<resolution>]]
```

```
:MEASure[1][:VOLTage]:PHASe? [<expected value>[,<resolution>]]
```

```
:READ[1][:PHASe]?
```

```
[:SENSe[1]]:FUNCTION "[VOLTage:]PHASe"
```

Acquisition Timeout Commands

The following acquisition timeout commands have been added:

```
[:SENSe]:ATIMEout[:CHECK] OFFIONISTARt
```

```
[:SENSe]:ATIMEout[:CHECK]?
```

```
[:SENSe]:ATIMEout:TIME <duration>
```

```
[:SENSe]:ATIMEout?
```

Input Impedance Default Control Commands

The following input impedance default control commands have been added:

```
:DIAGnostics:RState:INPut[1|2]:IMPedance  
<value>|MINimum|MAXimum|DEFault
```

```
:DIAGnostics:RState:INPut[1|2]:IMPedance? [MINimum|MAXimum|DEFault]
```

Option Identification Query Common Command

The following standard common command has been added:

*OPT?

Firmware Version

Firmware version 3401 must be installed to access these capabilities.

Determining Firmware Version

Use the *IDN? query as shown in the following example to determine the firmware version installed in your instrument:

```
OUTPUT @E1420b; "**IDN?"
```

```
ENTER @E1420b; Response$
```

The query response is as follows:

```
HEWLETT-PACKARD, E1420B, 0, 3401
```

Phase Measurement

The HP E1420B derives the relative phase between the Channel 1 and Channel 2 signals from the following two consecutive measurements:

1. The Time Interval 1→2 Measurement.
2. The Period 2 Measurement.

Figure F-1 shows the definition and timing relationship between these measurements.

Phase Measurement Definition

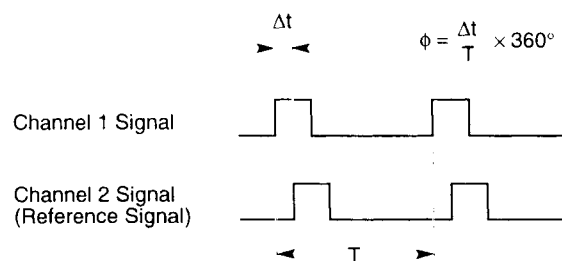

Measurement Timing

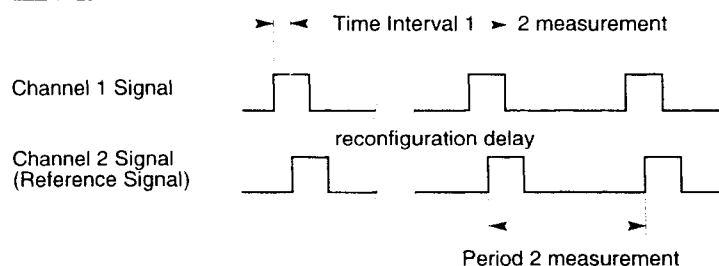

Figure F-1. Phase Measurement Definition and Timing

The relative phase (phase difference) between two signals of identical frequency is defined by the following equation:

$$\text{Phase (degrees)} = \frac{\text{Time Interval } 1 \rightarrow 2}{\text{Period } 2} \times 360^\circ$$

SCPI Commands

Syntax

The following phase measurement commands have been added:

```
:CONFigure[1][:VOLTage]:PHASe [<expected value>,<resolution>]]
```

```
:MEASure[1][:VOLTage]:PHASe? [<expected value>,<resolution>]]
```

```
:READ[1][:PHASe]?
```

```
[:SENSe[1]]:FUNction "[VOLTage:]PHASe"
```

The syntax for the phase measurement commands is shown above. While the <expected value> and <resolution> parameters are accepted, they are ignored. Furthermore, the optional numeric suffix of 1 implies a Phase 1 relative to 2 measurement.

Command Descriptions

The :CONFigure, :MEASure?, and [:SENSe]:FUNction commands reconfigure several instrument settings to optimize the measurement of Phase 1 relative to 2. The :CONFigure and :MEASure? commands invoke identical settings to set a generic configuration for this measurement. For those applications that require finer control of the instrument configuration, the [:SENSe]:FUNction command presets fewer settings. This allows you to set the instrument to a specific configuration using other [:SENSe] commands.

Table F-1 lists the instrument settings that are initialized whenever a phase measurement is selected. Bold type indicates mandatory settings. Attempting to change these settings generates the **-221, Settings conflict** error message. The other settings can be changed to customize the measurement for a specific application.

New Capabilities
Phase Measurement

Table F-1. Initialized Instrument Settings for a Phase 1 Relative to 2 Measurement

Instrument Parameter	:CONFIgure or :MEASure?		:SENSe:FUNCTion	
	TimeInterval 1→2	Period 2	Time Interval 1→2	Period 2
Input Routing	Separate	Separate	Separate	Separate
Channel 1 Trigger Slope	Channel 2 Trigger Slope	NA	Current Setting	NA
Channel 1 Prescaler	Off	NA	Off	NA
Channel 1 Auto Ranging	Off	NA	Off	NA
Channel 1 Auto Triggering	On/ Repetitive	NA	Current Setting	NA
Channel 1 Auto Trigger Level	50% of V_{pp}	NA	Current Setting	NA
Channel 2 Auto Triggering	On/ Repetitive	On/ Repetitive	Current Setting	Current Setting
Channel 2 Auto Trigger Level	50% of V_{pp}	50% of V_{pp}	Current Setting	Current Setting
Start Arm Source	Immediate	Immediate	Current Setting	Immediate
Stop Arm Source	Immediate	Immediate	Immediate	Immediate
Measurement Averaging	Off	Off	Off	Off
Aperture	NA	NA (1-period acquisition)	NA	NA (1-period acquisition)

NA = Not Applicable to this measurement.

Shading = Internal selection, not user-accessible.

Bold = Mandatory settings.

Query Response

The measurement results are formatted as IEEE 488.2 <NR3> values, without a response header. Each value is truncated to the number of significant digits implied by the "LSD Displayed" formula. The value derived from this expression is always rounded down to the next lower decade, thereby yielding at most one extra digit of resolution.

Phase Measurement Programming Example

The following program shows several ways to perform a phase measurement.

```

10      ! *****
20      ! Program Example: Phase Measurement
30      !
40      ! This program contrasts several ways to perform a Phase 1 rel. 2
50      ! measurement with the E1420B Universal Counter.
60      !
70      ! Three program segments illustrate typical applications of the
80      ! :MEASure:PHASe?, :CONFigure:PHASe, and :SENSe:FUNCTion 'PHASe'
90      ! commands. Comments preceding each segment summarize the
100     ! relative merits of each approach.
110     !
120     ! It is presumed that signals of proper frequency and amplitude
130     ! are connected to the counter's Input 1 and Input 2 channels.
140     !
150     ! This program was written in HP BASIC for an HP Series 9000
160     ! computer.
170     ! *****
180     !
190     DIM Result$(21)                ! Declare string to hold meas. result
200     !
210     ! Determine the interface address of the E1420B with the HP E1405B
220     ! Command Module; these statements must be customized for other
230     ! environments
240     Select_code=7                  ! HP-IB interface at Select Code 7
250     Cmd_addr=9                    ! VXI Command Module at address 9
260     E1420_addr=4                  ! E1420B at secondary address = 32/8
270     ASSIGN @E1420b TO (Select_code*10000)+(Cmd_addr*100)+E1420_addr
280     ! Define the I/O path via E1405B
290     !
300     ! Reset and initialize the counter
310     CLEAR @E1420b                 ! Clear the output buffer
320     OUTPUT @E1420b;"*RST"        ! Select the default configuration
330     OUTPUT @E1420b;"*CLS"        ! Clear event registers, Error Queue
340     !
350     ! Measure Phase 1 relative to 2
360     !
370     ! :MEASure:PHASe? Query
380     ! -----
390     ! The :MEASure:PHASe? query provides the simplest (though least
400     ! flexible) means of performing a measurement. The counter is
410     ! programmed to a generic phase measurement configuration, an
420     ! acquisition is initiated, and the result is queried in a single
430     ! operation.
440     !
450     OUTPUT @E1420b;":MEAS:PHAS?" ! Configure, acquire and query the
460     ! result of a phase measurement
470     ENTER @E1420b;Result$        ! Read the result

```

New Capabilities

Phase Measurement

Phase Measurement Programming Example (Continued)

```
480 PRINT "Phase: ";Result$;" degrees", " (:MEASure? query)"
490 !
500 ! :CONFigure:PHASe Command
510 ! -----
520 ! The :CONFigure command, in conjunction with :READ?, offers more
530 ! precise control of this measurement. :CONFigure configures the
540 ! measurement, while :READ? initiates an acquisition and queries
550 ! the measurement result.
560 !
570 ! In the following program segment, the counter is programmed
580 ! to its generic phase measurement configuration by :CONFigure.
590 ! Auto triggering, which was enabled by :CONFigure, is then
600 ! disabled to illustrate how :CONFigure-invoked settings may
610 ! be customized for a particular application.
620 !
630 OUTPUT @E1420b;":CONF:PHAS" ! Configure a phase measurement
640 ! (and enable auto triggering)
650 OUTPUT @E1420b;":SENS1:EVEN:LEV:AUTO OFF" ! Disable Ch 1 auto trig
660 OUTPUT @E1420b;":SENS1:EVEN:LEV:1.0" ! Set threshold to 1 V
670 OUTPUT @E1420b;":SENS2:EVEN:LEV:AUTO OFF" ! Disable Ch 2 auto trig
680 OUTPUT @E1420b;":SENS2:EVEN:LEV:2.0" ! Set threshold to 2 V
690 OUTPUT @E1420b;":READ?" ! Query the result
700 ENTER @E1420b;Result$ ! Read the result
710 PRINT "Phase: ";Result$;" degrees", " (:CONFigure command)"
720 !
730 ! :SENSe:FUNCTion 'PHASe' Command
740 ! -----
750 ! The :SENSe:FUNCTion 'PHASe' command selects the phase function
760 ! directly. Compared to :MEASure? and :CONFigure, this command
770 ! invokes a smaller number of default settings.
780 !
790 ! This concept is applied in the following program segment, which
800 ! changes the Channel 1 trigger level. As :SENSe:FUNCTion 'PHASe'
810 ! does not alter the auto trigger state, auto triggering remains
820 ! disabled, and the trigger level is properly configured to the
830 ! specified manual setting.
840 !
850 ! Selection of measurement averaging is also illustrated. Note
860 ! that :SENSe:AVERAge:STATe ON must follow :SENSe:FUNCTion 'PHASe'
870 ! (or :CONFigure:PHASe) since the latter disables averaging.
880 !
890 ! :READ? then initiates an acquisition and queries the result.
900 !
910 OUTPUT @E1420b;":SENS:FUNC 'PHASe'" ! Select the phase function
920 ! (trigger mode remains
930 ! set to manual levels)
940 OUTPUT @E1420b;":SENS1:EVEN:LEV:2.0" ! Set Ch 1 threshold to 2 V;
950 ! (both channels now trigger
960 ! at a threshold of 2 V)
970 OUTPUT @E1420b;":SENS:AVER:STAT ON" ! Average 100 measurements
980 ! (this command must follow
990 ! :SENS:FUNC 'PHASe')
1000 OUTPUT @E1420b;":READ?" ! Query the result
1010 ENTER @E1420b;Result$ ! Read the result
1020 PRINT "Phase: ";Result$;" degrees", " (:SENS command, average phase)"
1030 !
1040 END ! Done
```

Specifications

The following is a summary of the key performance specifications for the Phase 1 relative to 2 measurement:

Range:

0° to 360°

Least Significant Digit:

$$\sqrt{(2 \text{ ns})^2 \times ((360^\circ)^2 + \text{Phase}^2)} \times \text{Frequency}$$

NOTE

1. Value is rounded to the next lower integer for purposes of truncating the measurement result.
2. 100-acquisition averaging adds another digit of resolution.

RMS Resolution:

$$\pm \sqrt{((2 \text{ ns})^2 + (2 \times \text{Trigger Error}^2)) \times \left(1 + \left(\frac{\text{Phase}}{360^\circ}\right)^2\right)} \times \text{Frequency} \times 360^\circ$$

Systematic Uncertainty:

$$(\pm \text{Trigger Level Timing Error} \pm 2 \text{ ns Differential Channel Error}) \times \text{Frequency} \times 360^\circ$$

Maximum Frequency:

100 MHz

Definitions of Uncertainty Terms

Trigger Error

External source and input amplifier noise may advance or delay the trigger points that define the beginning and end of a measurement. The resulting timing uncertainty is a function of the slew rate and the amplitude of spurious noise spikes (relative to the input hysteresis band).

New Capabilities

Phase Measurement

The (rms) trigger error associated with a single trigger point is:

$$\text{Trigger Error} = \frac{\sqrt{(E_{\text{input}})^2 + (E_{\text{signal}})^2}}{\text{Input Signal Slew Rate at Trigger Point}}$$

where,

E_{input} = RMS noise of the input amplifier (500 μV , nominal)

E_{signal} = RMS noise of the signal over a 100 MHz bandwidth

Trigger Level Timing Error

Trigger level timing error results from a deviation of the actual trigger level from the specified (indicated) level. The magnitude of the measurement timing error depends on several factors, primarily: resolution and accuracy of the trigger level circuit, fidelity of the input amplifier, slew rate of the input signal at the trigger point, and width of the input hysteresis band as shown in the following figure.

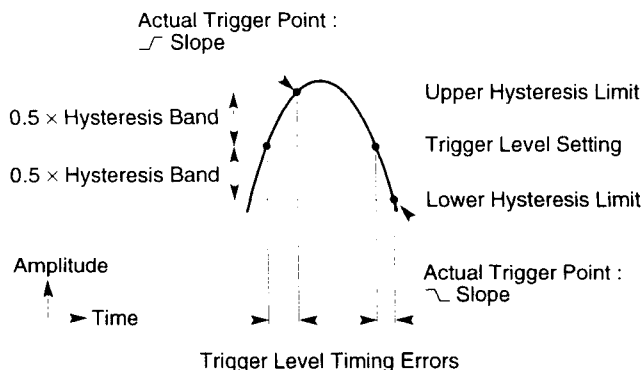

The following equations define the general interpretation of its component error terms for a measurement. These equations should be summed together to obtain the overall Trigger Level Timing Error.

Input Hysteresis:

$$\frac{0.5 \times \text{Hysteresis Band}}{\text{Input Signal Slew Rate at Start Trigger Point}} \pm \frac{0.5 \times \text{Hysteresis Band}}{\text{Input Signal Slew Rate at Stop Trigger Point}}$$

Trigger Level Setting:

$$\pm \frac{30 \text{ mV} \pm (1\% \times \text{Start Trigger Level Setting})}{\text{Input Signal Slew Rate at Start Trigger Point}} \pm \frac{30 \text{ mV} \pm (1\% \times \text{Stop Trigger Level Setting})}{\text{Input Signal Slew Rate at Stop Trigger Point}}$$

Differential Channel Error

The 2-nanosecond error term stated in the Systematic Uncertainty equation accounts for the channel-to-channel mismatch and internal noise.

Performance Test

The Phase 1 relative to 2 measurement is mathematically derived from the parameters verified by other performance tests. If the instrument passes its operational verification and present performance tests, this measurement is functioning to specifications.

Acquisition Timeout

The acquisition timeout capability aborts an acquisition whenever its duration exceeds a user-specified limit. This capability prevents an indefinite hang-up that could occur if the input signals are missing or if the instrument is not properly configured.

SCPI Commands

Syntax

The following acquisition timeout commands have been added:

```
[[:SENSe]:ATIMEout[:CHECK] OFF|ON|START
```

```
[[:SENSe]:ATIMEout[:CHECK]?
```

```
[[:SENSe]:ATIMEout:TIME <duration>
```

```
[[:SENSe]:ATIMEout?
```

Command Descriptions

The `[[:SENSe]:ATIMEout[:CHECK] OFF|ON|START` command enables or disables the timeout capability. ON enables the start-to-stop mode. START enables the start-only mode. The power-up default is OFF. The timeout mode is unaffected by *RST.

The `[[:SENSe]:ATIMEout[:CHECK]?` command queries the timeout mode.

The `[[:SENSe]:ATIMEout:TIME <duration>` command sets the timeout duration in seconds. The power-up default is 5 seconds. The timeout duration is unaffected by *RST.

The `[[:SENSe]:ATIMEout?` command queries the timeout duration.

These settings apply globally to all measurement functions for which timeout is supported. Measurement-specific settings are not supported.

Timeout can be enabled for all functions except voltage measurements (which complete even when no signals are applied). Selecting a voltage measurement disables the timeout mode; it must be reenabled if required for another measurement function. Issuing these commands will abort an acquisition in progress.

Timeout mode and duration settings are retained as part of the instrument state saved by the ten setup registers.

Status Reporting

Error **+2100, Acquisition timed out** is reported if the required arm and trigger events were not detected within the number of seconds specified. This condition, in turn, sets the Device-specific Error bit (bit 3) of the Standard Event Status Register. A service request (SRQ) is generated if bit 3 of the Standard Event Status Enable Register and bit 5 of the Service Request Enable Register are also set.

Query Response

The Not a Number value of **9.91E+37** is returned as the formatted response to a measurement query. This unique value is used in this context to indicate that no measurement data is available.

Error **-230, Data corrupt or stale** is reported with this response.

Behavior

Timeouts apply to the automatic frequency ranging acquisition and to the actual measurement acquisition. Auto triggering, measurement configuration, and result processing operations (which can never be suspended indefinitely) are not timed (see Figure F-2).

The acquisition timer is initialized prior to each timed process. In the case where 100-gate averaging is enabled, each of the 100 acquisitions is individually timed. Consequently, it is not necessary to adjust the specified duration when alternating between single and averaged measurements.

When the START option is selected, the measurement aborts if the start arm and start trigger events have not been detected within the number of seconds specified. This duration is measured from the point at which an acquisition is enabled (that is, when the start arm event can be recognized).

When the ON option is selected, the measurement aborts if an acquisition has not completed within the number of seconds specified (again, measured from the point at which the acquisition is enabled). This mode times the complete acquisition cycle, and can be used to ensure that a valid measurement result can be fetched (see Figure F-2). If the stop arm is inhibited by the gate time or the TI delay, the time remaining (the specified time less the elapsed time to the start event) is compared with the gate time or TI delay. The acquisition aborts immediately if the remaining time is less than or equal to the gate time or TI delay. Consequently, the timeout function is never deferred by the gate time or TI delay setting.

New Capabilities

Acquisition Timeout

Issuing the :ABORt command or reconfiguring the instrument halts the acquisition timer. Error conditions resulting from these actions take precedence over a coincident timeout condition.

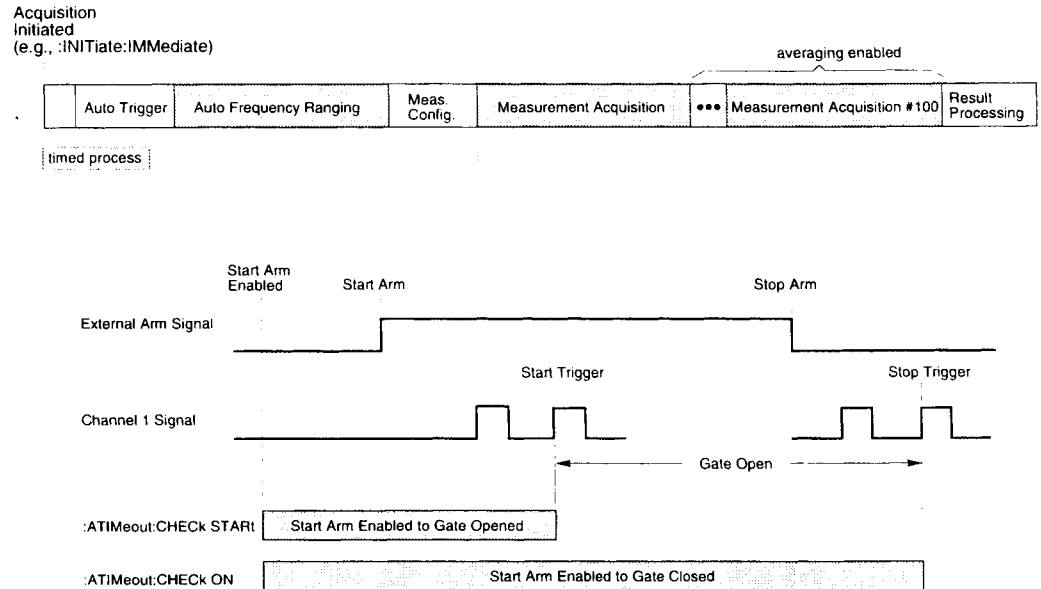

Figure F-2. Acquisition Timeout Timing Example

Acquisition Timeout Programming Example

The following program shows how to use the acquisition timeout capability.

```
10 !*****
20 !
30 ! Program Example: Acquisition Timeout
40 !
50 ! This program illustrates a simple application of the acquisition
60 ! timeout capability of the HP E1420B Universal Counter.
70 !
80 ! The E1420B is configured to measure the average frequency of the
90 ! signal connected to the Input 1 channel. In this example, each
100 ! acquisition (within the set of 100) is expected to complete
110 ! within 100 milliseconds. Otherwise, the counter will abort the
120 ! measurement immediately and report the timeout condition to the
130 ! computer via a service request and the "+2100, Acquisition timed
140 ! out" error message.
150 !
160 ! This program was written in HP BASIC for an HP Series 9000
170 ! computer.
180 !*****
```

Acquisition Timeout Programming Example (Continued)

```

190 !
200 DIM Result$(21) ! Declare string to hold meas. result
210 DIM Err_msg$(255) ! Declare string to hold error msg.
220 Timed_out=0 ! Initialize timeout status flag
230 !
240 ! Determine the interface address of the E1420B with an HP E1405B
250 ! Command Module; these statements must be customized for other
260 ! environments
270 Select_code=7 ! HP-IB interface at Select Code 7
280 Cmd_addr=9 ! VXI Command Module at address 9
290 E1420_addr=4 ! E1420B at secondary address = 32/8
300 ASSIGN @E1420b TO (Select_code*10000)+(Cmd_addr*100)+E1420_addr
310 ! Define the I/O path via E1405B
320 !
330 ! Reset and initialize the counter
340 CLEAR @E1420b ! Clear the output buffer
350 OUTPUT @E1420b;"*RST" ! Select the default configuration
360 OUTPUT @E1420b;"*CLS" ! Clear event registers, Error Queue
370 !
380 ! Enable the acquisition timer
390 OUTPUT @E1420b;":SENS:ATIM:TIME 0.1" ! Maximum duration is 100 ms
400 OUTPUT @E1420b;":SENS:ATIM:CHEC ON" ! Time acquisition from start
410 ! to stop
420 ! Enable reporting of device-specific errors
430 OUTPUT @E1420b;"*ESE 8" ! Generate a service request (SRQ)
440 OUTPUT @E1420b;"*SRE 32" ! on a device-specific error
450 ON INTR Select_code GOSUB Device_error ! If SRQ, call Device_error
460 ENABLE INTR Select_code;2 ! Enable program interrupt on SRQ
470 !
480 ! Configure an averaged frequency measurement
490 OUTPUT @E1420b;":CONF:FREQ DEF,DEF" ! Measure frequency of Ch 1;
500 ! disable auto ranging mode
510 OUTPUT @E1420b;":SENS:AVER:STAT ON" ! Average 100 acquisitions
520 OUTPUT @E1420b;":SENS:FREQ:APER 0.05" ! Acquire each acquisition
530 ! over a gate time of 50 ms
540 !
550 ! Initiate the measurement, start the timer, then query the result
560 OUTPUT @E1420b;":READ?"
570 !
580 ! Retrieve the measurement result
590 ! Note: The value 9.91E+37 will be returned if a timeout occurred,
600 ! so the fetch operation will not be suspended indefinitely
610 ENTER @E1420b;Result$ ! Read the result
620 PRINT "Frequency 1: ";Result$;" Hz" ! Print it
630 !
640 ! Print an advisory message regarding the timeout status
650 IF Timed_out THEN
660 PRINT "*** Acquisition timed out. Result is invalid. ***"
670 ELSE
680 PRINT "Acquisition completed within the specified duration."
690 END IF
700 !
710 STOP ! Done
720 !
730 !
740 Device_error: !
750 !
760 ! Subroutine that returns the acquisition timeout status:
770 ! Timed_out = 1, if a timeout occurred; 0, otherwise
780 !
790 Timed_out=0 ! Timeout has not yet occurred
800 !
810 ! Examine the contents of the Error Queue for the timeout message

```

New Capabilities

Acquisition Timeout

Acquisition Timeout Programming Example (Continued)

```
820 ! Note: It is necessary to search for the timeout message since
830 !       other device-specific errors may have been detected.
840 !       Since these error conditions are rarely encountered,
850 !       however, they are ignored by this subroutine.
860 REPEAT
870   OUTPUT @E1420b;":SYST:ERR?" ! Query the next error in the queue
880   ENTER @E1420b;Error_code,Err_msg$ ! Read the error code
890                                     ! and message
900   IF Error_code=2100 THEN Timed_out=1 ! Indicate if timed out
910   UNTIL Error_code=0                ! Repeat until the queue is empty
920 RETURN
930 !
940 END
```

Functional Limitations

The following functional limitations apply to the acquisition timeout capability:

1. This capability provides a coarse assessment of the acquisition time and should not be used in critical timing applications.
2. Information on the specific condition that caused the timeout (for example, a missing start arm event) or its source (for example, Channel 1) is not reported.

Typical Performance Characteristics

The following is a summary of the typical characteristics for acquisition timeout:

Selectable Range and Resolution:

100 ms to 1500 seconds in 100 ms increments

Accuracy:

$\pm 100 \mu\text{s} \pm (0.5\% \times \text{Timeout Duration})$

Because the timeout acquisition performance can be influenced by several external factors, the timeout accuracy is a typical characteristic and not a warranted specification.

Input Impedance Default Control

This command defines the default impedance setting invoked by the *RST command and at power-up. The parameter of this command evaluates to one of two settings, 50 Ω or 1M Ω for the specified input channel.

SCPI Commands

Syntax

The following input impedance default control commands have been added:

```
:DIAGnostics:RState:INPut[1|2]:IMPedance <value>IMINimumIMAXimum
IDEFault
```

```
:DIAGnostics:RState:INPut[1|2]:IMPedance? [MINimumIMAXimumIDEFault]
```

The syntax for these commands is shown above. It is analogous to the structure of the :INPut:IMPedance command, which selects the input impedance for Channels 1 and 2.

The format of this command permits independent specification of the input impedance for Channels 1 and 2. If the optional channel parameter is omitted, Channel 1 is assumed.

The impedance parameter is interpreted as follows:

- <value>

A numeric parameter that evaluates to a value between 40 and 60 (inclusive) sets the default impedance to 50 Ω . Conversely, a numeric parameter that evaluates to a value between 900,000 and 1,100,000 (inclusive) sets the default impedance to 1 M Ω . If any other parameter value is entered, an error message is generated and the current setting is not changed.

- <discrete>

The MINimum and DEFault parameters specify the low impedance setting (50 Ω). The MAXimum parameter specifies the high impedance setting (1 M Ω).

Semantics

The *RST default impedance settings are retained in non-volatile memory. These settings are restored at power-up. If a setting cannot

New Capabilities

Input Impedance Default Control

be restored, it is set to 50 Ω . Channel 1 and 2 input impedances are also initialized to the respective default impedances at power-up.

The *RST default impedance settings are not altered by save/recall operations.

Input Impedance Default Control Programming Example

The following sequence of commands programs the default impedance settings for Channels 1 and 2 to 1 M Ω :

```
:DIAG:RST:INP1:IMP MAX !Sets *RST input impedance of
                        !channel 1 to 1 Mohm.
:DIAG:RST:INP2:IMP MAX !Sets *RST input impedance of
                        !channel 2 to 1 Mohm.
.
.
.
*RST                    !Select default instrument
                        !state; configures 1 Mohm input
                        !impedance
```

Comments

Some instrument functions may momentarily alter the current impedance setting to perform requested operations. For example, the Rise Time and Fall Time measurements program the Channel 2 impedance setting to match the Channel 1 setting. (The previous setting is restored when another measurement function is selected.) In addition, the calibration process configures the input impedance to 50 Ω for both channels. This behavior should be considered when it is necessary to maintain the impedance setting in order to avoid mismatching or potential damage to the input circuits.

Option Identification Query

The Option Identification Query (*OPT?) queries the instrument to identify any reportable options that are installed. In the HP E1420B, the only reportable option is Option 040 (Shared Memory).

Common Command

Syntax

The following common command has been added:

*OPT?

Query Response

The query response is a sequence of ASCII-encoded bytes indicating

<shared memory option>

terminated with a newline and EOI.

- The <shared memory option> is 040.
- A missing option is identified by an ASCII 0 (zero).

Comments

This query should be the last query in a terminated program message. If it is not, an error **-440, Query UNTERMINATED after indefinite response** is generated.

Option 010 (TCXO Time Base), and Option 030 (Input 3) are not detectable with this query.

