



HP E1330B Quad 8-Bit Digital I/O Module

User's Manual and SCPI Programming Guide

Where to Find it - Online and Printed Information:

System installation (hardware/software) VXIbus Configuration Guide*
HP VIC (VXI installation software)*

Module configuration and wiring This Manual
SCPI programming This Manual
SCPI example programs This Manual, Driver Disk
SCPI command reference This Manual
Register-Based Programming This Manual

VXIplug&play programming VXIplug&play Online Help
VXIplug&play example programs VXIplug&play Online Help
VXIplug&play function reference VXIplug&play Online Help
Soft Front Panel information VXIplug&play Online Help



VISA language information HP VISA User's Guide

HP VEE programming information HP VEE User's Manual

**Supplied with HP Command Modules, Embedded Controllers, and VXLink.*



Manual Part Number: E1330-90007
Printed in U.S.A. E0597

Contents

HP E1330B User's Manual

Warranty	5
Safety Symbols	6
WARNINGS	6
Declaration of Conformity	7
Reader Comment Sheet	9
Chapter 1	
Getting Started	11
Using This Chapter	11
Technical Description	11
Instrument Definition	13
Downloading SCPI Drivers	13
Programming the Digital I/O Module	13
SCPI Command Format Used in This Manual	14
Specifying SCPI Commands	14
Initial Operation	16
Chapter 2	
Configuring the HP E1330B Digital I/O Module	17
Using This Chapter	17
Setting the Address Switch	18
Enabling Pull-ups	19
Selecting the Interrupt Line	20
Combining the Flag Lines	21
Digital I/O Module Peripheral Pinout	22
Configuring for Isolated Digital I/O	25
Connecting to a GPIO Peripheral	26
Using with External Pull-ups	28
Typical Connection	29
Chapter 3	
Using the HP E1330B Digital I/O Module	31
Using This Chapter	31
Addressing the Module	31
Operation Overview	32
Default and Reset States	33
Setting the Polarity	33
Setting the Handshake Mode	34
Handshake Timing	34
Inputting Data Bytes and Bits	35
Input	35
Outputting Data Bytes and Bits	36
Output	36
Multiple Port Operations	37
Using Trace Memory	38

Chapter 4

Understanding the HP E1330B Digital I/O Module	41
Using This Chapter	41
Port Description	41
Data Lines	41
The FLG Line (Input)	42
The CTL Line (Output)	42
The I/O Line (Output)	42
The STS Line	43
The PIR Line	43
The RES Line	43
Default and Reset States	43
Setting the Polarity	43
Using the Handshake Modes	44
Handshake Modes	45
Inputting Data Bytes and Bits	50
Bit Input	50
Byte Input	50
Outputting Data Bytes and Bits	51
Bit Output	51
Byte Output	52
Multiple Port Operations	53
Multiple Port Handshaking	53
Multiple Port Input/Output	54

Chapter 5

HP E1330B Digital I/O Module Command Reference	57
Using This Chapter	57
Command Types	57
Common Command Format	57
SCPI Command Format	57
Linking Commands	59
SCPI Command Reference	60
DISPlay Subsystem	61
:MONitor:PORT	61
:MONitor:PORT?	62
:MONitor[:STATe]	62
:MONitor[:STATe]?	63
MEASure Subsystem	64
:DIGital:DATA <i>n</i> [:type]:BIT <i>m</i> ?	64
:DIGital:DATA <i>n</i> [:type]:TRACe	65
:DIGital:DATA <i>n</i> [:type][:VALue]?	66
:DIGital:FLAG <i>n</i> ?	67
MEMory Subsystem	68
:DELete:MACRO	68
:VME:ADDRess	69
:VME:ADDRess?	69
:VME:SIZE	70

Chapter 5

HP E1330B Digital I/O Module Command Reference (continued)

MEMory Subsystem (continued)

:VME:SIZE?	70
:VME:STATE	71
:VME:STATE?	71
[SOURce:] Subsystem	72
DIGital:CONTRoln:POLarity	74
DIGital:CONTRoln:POLarity?	74
DIGital:CONTRoln[:VALue]	75
DIGital:CONTRoln[:VALue]?	75
DIGital:DATAn[:type]:BITm	76
DIGital:DATAn[:type]:BITm?	77
DIGital:DATAn[:type]:HANDshake:DELay	78
DIGital:DATAn[:type]:HANDshake:DELay?	79
DIGital:DATAn[:type]:HANDshake[:MODE]	80
DIGital:DATAn[:type]:HANDshake[:MODE]?	81
DIGital:DATAn[:type]:POLarity	82
DIGital:DATAn[:type]:POLarity?	82
DIGital:DATAn[:type]:TRACe	83
DIGital:DATAn[:type][:VALue]	84
DIGital:DATAn[:type][:VALue]?	85
DIGital:FLAGn:POLarity	86
DIGital:FLAGn:POLarity?	86
DIGital:HANDshaken:DELay	87
DIGital:HANDshaken:DELay?	88
DIGital:HANDshaken[:MODE]	88
DIGital:HANDshaken[:MODE]?	89
DIGital:IOn?	89
DIGital:TRACe:CATalog?	90
DIGital:TRACe[:DATA]	90
DIGital:TRACe[:DATA]?	91
DIGital:TRACe:DEFine	91
DIGital:TRACe:DEFine?	92
DIGital:TRACe:DELete:ALL	92
DIGital:TRACe:DELete[:NAME]	92
STATus Subsystem	93
:OPERation:CONDition?	94
:OPERation:ENABLE	94
:OPERation:ENABLE?	94
:OPERation[:EVENT]?	94
:PRESet	94
:QUEStionable:CONDition?	95
:QUEStionable:ENABLE	95
:QUEStionable:ENABLE?	95
:QUEStionable[:EVENT]?	95

Chapter 5 (continued)	
SYSTEM Subsystem	96
:CDEscription?	96
:CTYPe?	96
:ERRor?	97
:VERSion?	97
IEEE 488.2 Common Commands.....	98
Command Quick Reference.....	99
Appendix A	
HP E1330B Digital I/O Specifications	103
Appendix B	
HP E1330B Digital I/O Module Register Information	105
Using This Appendix	105
Addressing the Registers	105
The Base Address	106
Register Offset	108
Reset and Registers.....	109
Register Definitions	109
Register Descriptions	111
Manufacturer Identification Register	111
Device Identification Register	111
Card Status/ Control Register	111
Port Interrupt Control Register	112
Port Transfer Control Register	113
Port Control/ Status Register	114
Port Data Register	115
Port Handshake Register	116
Port Delay Register	117
Port Normalization Register	118
A Register-Based Output Algorithm	119
A Register-Based Input Algorithm	120
Programming Examples.....	121
System Configuration	121
Resetting the Module	122
Reading the ID, Device Type, and Status Registers	123
Writing an 8-Bit Byte	125
Writing a 16-Bit Word	127
Reading an 8-Bit Byte	128
Reading a 16-Bit Word	130
Debugging Basic Register-Based Programs	130
PIR Interrupts on the HP E1330	131
HP E1330B Non-data Line I/O	136
Embedded Computer Example	140
Appendix C	
Error Messages	143

Certification

Hewlett-Packard Company certifies that this product met its published specifications at the time of shipment from the factory. Hewlett-Packard further certifies that its calibration measurements are traceable to the United States National Institute of Standards and Technology (formerly National Bureau of Standards), to the extent allowed by that organization's calibration facility, and to the calibration facilities of other International Standards Organization members.

Warranty

This Hewlett-Packard product is warranted against defects in materials and workmanship for a period of three years from date of shipment. Duration and conditions of warranty for this product may be superseded when the product is integrated into (becomes a part of) other HP products. During the warranty period, Hewlett-Packard Company will, at its option, either repair or replace products which prove to be defective.

For warranty service or repair, this product must be returned to a service facility designated by Hewlett-Packard (HP). Buyer shall prepay shipping charges to HP and HP shall pay shipping charges to return the product to Buyer. However, Buyer shall pay all shipping charges, duties, and taxes for products returned to HP from another country.

HP warrants that its software and firmware designated by HP for use with a product will execute its programming instructions when properly installed on that product. HP does not warrant that the operation of the product, or software, or firmware will be uninterrupted or error free.

Limitation Of Warranty

The foregoing warranty shall not apply to defects resulting from improper or inadequate maintenance by Buyer, Buyer-supplied products or interfacing, unauthorized modification or misuse, operation outside of the environmental specifications for the product, or improper site preparation or maintenance.

The design and implementation of any circuit on this product is the sole responsibility of the Buyer. HP does not warrant the Buyer's circuitry or malfunctions of HP products that result from the Buyer's circuitry. In addition, HP does not warrant any damage that occurs as a result of the Buyer's circuit or any defects that result from Buyer-supplied products.

NO OTHER WARRANTY IS EXPRESSED OR IMPLIED. HP SPECIFICALLY DISCLAIMS THE IMPLIED WARRANTIES OF MERCHANTABILITY AND FITNESS FOR A PARTICULAR PURPOSE.

Exclusive Remedies

THE REMEDIES PROVIDED HEREIN ARE BUYER'S SOLE AND EXCLUSIVE REMEDIES. HP SHALL NOT BE LIABLE FOR ANY DIRECT, INDIRECT, SPECIAL, INCIDENTAL, OR CONSEQUENTIAL DAMAGES, WHETHER BASED ON CONTRACT, TORT, OR ANY OTHER LEGAL THEORY.

Notice

The information contained in this document is subject to change without notice. HEWLETT-PACKARD (HP) MAKES NO WARRANTY OF ANY KIND WITH REGARD TO THIS MATERIAL, INCLUDING, BUT NOT LIMITED TO, THE IMPLIED WARRANTIES OF MERCHANTABILITY AND FITNESS FOR A PARTICULAR PURPOSE. HP shall not be liable for errors contained herein or for incidental or consequential damages in connection with the furnishing, performance or use of this material. This document contains proprietary information which is protected by copyright. All rights are reserved. No part of this document may be photocopied, reproduced, or translated to another language without the prior written consent of Hewlett-Packard Company. HP assumes no responsibility for the use or reliability of its software on equipment that is not furnished by HP.

U.S. Government Restricted Rights

The Software and Documentation have been developed entirely at private expense. They are delivered and licensed as "commercial computer software" as defined in DFARS 252.227-7013 (Oct 1988), DFARS 252.211-7015 (May 1991) or DFARS 252.227-7014 (Jun 1995), as a "commercial item" as defined in FAR 2.101(a), or as "Restricted computer software" as defined in FAR 52.227-19 (Jun 1987)(or any equivalent agency regulation or contract clause), whichever is applicable. You have only those rights provided for such Software and Documentation by the applicable FAR or DFARS clause or the HP standard software agreement for the product involved.



HP E1330B Quad 8-Bit Digital I/O User's Manual
Edition 7

Copyright © 1997 Hewlett-Packard Company. All Rights Reserved.

Documentation History

All Editions and Updates of this manual and their creation date are listed below. The first Edition of the manual is Edition 1. The Edition number increments by 1 whenever the manual is revised. Updates, which are issued between Editions, contain replacement pages to correct or add additional information to the current Edition of the manual. Whenever a new Edition is created, it will contain all of the Update information for the previous Edition. Each new Edition or Update also includes a revised copy of this documentation history page.

Edition 1
Edition 2September 1990
Edition 3April 1992
Edition 4September 1992
Edition 5November 1993
Edition 6June 1995
Edition 7May 1997

Safety Symbols



Instruction manual symbol affixed to product. Indicates that the user must refer to the manual for specific **WARNING** or **CAUTION** information to avoid personal injury or damage to the product.



Alternating current (AC)



Direct current (DC).

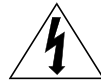

Indicates hazardous voltages.



Indicates the field wiring terminal that must be connected to earth ground before operating the equipment—protects against electrical shock in case of fault.

WARNING

Calls attention to a procedure, practice, or condition that could cause bodily injury or death.

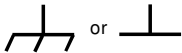

Frame or chassis ground terminal—typically connects to the equipment's metal frame.

CAUTION

Calls attention to a procedure, practice, or condition that could possibly cause damage to equipment or permanent loss of data.

WARNINGS

The following general safety precautions must be observed during all phases of operation, service, and repair of this product. Failure to comply with these precautions or with specific warnings elsewhere in this manual violates safety standards of design, manufacture, and intended use of the product. Hewlett-Packard Company assumes no liability for the customer's failure to comply with these requirements.

Ground the equipment: For Safety Class 1 equipment (equipment having a protective earth terminal), an uninterruptible safety earth ground must be provided from the mains power source to the product input wiring terminals or supplied power cable.

DO NOT operate the product in an explosive atmosphere or in the presence of flammable gases or fumes.

For continued protection against fire, replace the line fuse(s) only with fuse(s) of the same voltage and current rating and type. DO NOT use repaired fuses or short-circuited fuse holders.

Keep away from live circuits: Operating personnel must not remove equipment covers or shields. Procedures involving the removal of covers or shields are for use by service-trained personnel only. Under certain conditions, dangerous voltages may exist even with the equipment switched off. To avoid dangerous electrical shock, DO NOT perform procedures involving cover or shield removal unless you are qualified to do so.

DO NOT operate damaged equipment: Whenever it is possible that the safety protection features built into this product have been impaired, either through physical damage, excessive moisture, or any other reason, REMOVE POWER and do not use the product until safe operation can be verified by service-trained personnel. If necessary, return the product to a Hewlett-Packard Sales and Service Office for service and repair to ensure that safety features are maintained.

DO NOT service or adjust alone: Do not attempt internal service or adjustment unless another person, capable of rendering first aid and resuscitation, is present.

DO NOT substitute parts or modify equipment: Because of the danger of introducing additional hazards, do not install substitute parts or perform any unauthorized modification to the product. Return the product to a Hewlett-Packard Sales and Service Office for service and repair to ensure that safety features are maintained.

Declaration of Conformity
according to ISO/IEC Guide 22 and EN 45014

Manufacturer's Name: Hewlett-Packard Company
Loveland Manufacturing Center

Manufacturer's Address: 815 14th Street S.W.
Loveland, Colorado 80537

declares, that the product:

Product Name: Quad 8-Bit Digital I/O Module

Model Number: HP E1330B

Product Options: All

conforms to the following Product Specifications:

Safety: IEC 1010-1 (1990) Incl. Amend 1 (1992)/EN61010-1 (1993)
CSA C22.2 #1010.1 (1992)
UL 1244

EMC: CISPR 11:1990/EN55011 (1991): Group 1 Class A
EN50082-1:1992
IEC 801-2:1991: 4kVCD, 8kVAD
IEC 801-3:1984: 3 V/m
IEC 801-4:1988: 1kV Power Line, .5kV Signal Lines

Supplementary Information: The product herewith complies with the requirements of the Low Voltage Directive 73/23/EEC and the EMC Directive 89/336/EEC (inclusive 93/68/EEC) and carries the "CE" marking accordingly.

Tested in a typical configuration in an HP B-Size VXI mainframe.

June 15, 1995



Jim White, QA Manager

European contact: Your local Hewlett-Packard Sales and Service Office or Hewlett-Packard GmbH, Department HQ-TRE, Herrenberger Straße 130, D-71034 Böblingen, Germany (FAX +49-7031-14-3143)

Notes:

Please fold and tape for mailing

Reader Comment Sheet

HP E1330B Quad 8-Bit Digital I/O User's Manual
Edition 7

You can help us improve our manuals by sharing your comments and suggestions. **In appreciation of your time, we will enter you in a quarterly drawing for a Hewlett-Packard Palmtop Personal Computer** (U.S. government employees are not eligible for the drawing).

_____	_____
Your Name	City, State/Province
_____	_____
Company Name	Country
_____	_____
Job Title	Zip/Postal Code
_____	_____
Address	Telephone Number with Area Code

Please list the system controller, operating system, programming language, and plug-in modules you are using.

fold here

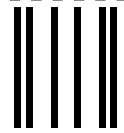

NO POSTAGE
NECESSARY
IF MAILED
IN THE
UNITED STATES

BUSINESS REPLY MAIL
FIRST CLASS PERMIT NO. 37 LOVELAND, CO

POSTAGE WILL BE PAID BY ADDRESSEE

HEWLETT-PACKARD COMPANY

Measurement Systems Division
Learning Products Department
P.O. Box 301
Loveland, CO 80539-9984

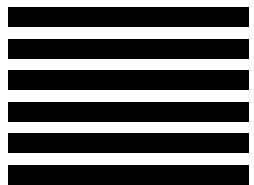

cut along this line



fold here

Please pencil-in one circle for each statement below:

- The documentation is well organized.
- Instructions are easy to understand.
- The documentation is clearly written.
- Examples are clear and useful.
- Illustrations are clear and helpful.
- The documentation meets my overall expectations.

Disagree ←————→ Agree

<input type="radio"/>	<input type="radio"/>	<input type="radio"/>	<input type="radio"/>	<input type="radio"/>
<input type="radio"/>	<input type="radio"/>	<input type="radio"/>	<input type="radio"/>	<input type="radio"/>
<input type="radio"/>	<input type="radio"/>	<input type="radio"/>	<input type="radio"/>	<input type="radio"/>
<input type="radio"/>	<input type="radio"/>	<input type="radio"/>	<input type="radio"/>	<input type="radio"/>
<input type="radio"/>	<input type="radio"/>	<input type="radio"/>	<input type="radio"/>	<input type="radio"/>
<input type="radio"/>	<input type="radio"/>	<input type="radio"/>	<input type="radio"/>	<input type="radio"/>

Please write any comments or suggestions below—be specific.

Using This Chapter

This chapter describes the Quad 8-bit Digital I/O Module and how to program the Module using SCPI (Standard Commands for Programmable Instruments) commands. This chapter contains the following sections:

- Technical Description Page 11
- Instrument Definition Page 13
- Downloading SCPI Drivers Page 13
- Programming the Digital I/O Module Page 13
- Initial Operation Page 16

Technical Description

The HP E1330B Quad 8-Bit Digital I/O Module (referred to as the Digital I/O module) is a four port digital input/output module intended for data communication and digital control in electronic environments. The Digital I/O module is compatible with TTL levels (0-5V) or CMOS levels (using external pull-ups). The Digital I/O module complies with VXIbus (VMEbus Extensions for Instrumentation) definitions for the P1 bus connector on B-sized modules. A jumper on the module sets the VXIbus interrupt level.

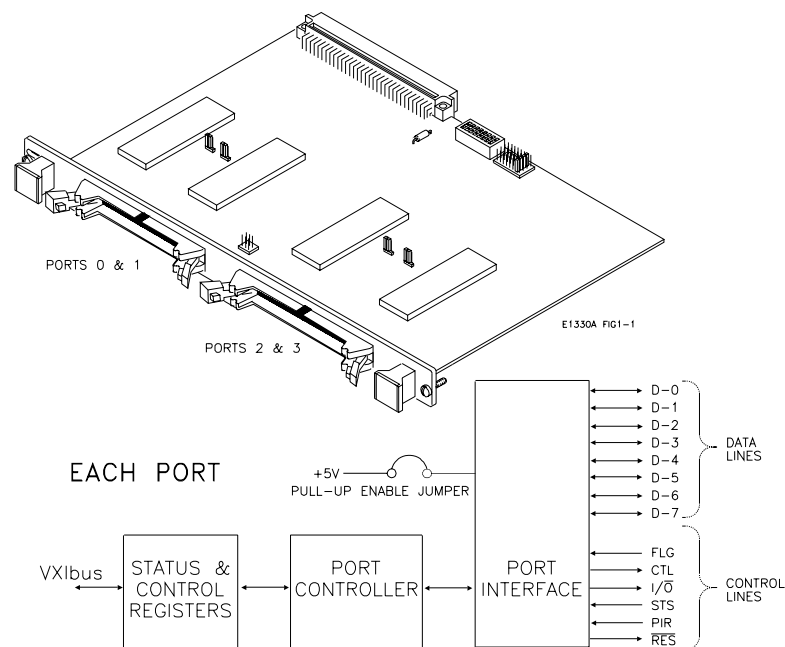

Figure 1-1. HP E1330B Digital I/O Module

Each port is identical and consists of 6 control lines and 8 data lines. There are 7 registers for control and status on each port. In addition, the module also has Manufacturer ID, Device Type, and Module Status/Control Registers. Figure 1-1 shows the locations of the ports and a simplified diagram of a single port. Of the seven control lines, three (I/\overline{O} , CTL, and FLG) are used with SCPI commands and three (\overline{RES} , STS, and PIR) are controlled through register access. Chapter 4 — “Understanding the HP E1330B Digital I/O Module” contains detailed descriptions of these lines.

Each port has two sets of hardware configuration jumpers. One set of jumpers allows you to connect the FLG lines together for multi-port data transmission. Another jumper selects either open collector operation or internal pull-up to TTL compatible levels on the data lines. Chapter 2 — “Configuring the HP E1330B Digital I/O Module” describes how to set these jumpers.

SCPI commands provided for the Digital I/O allow operation on a single bit, 8-bit "BYTE" format, 16-bit "WORD" format (using 2 ports), or 32-bit "LWORD" format (using 4 ports).

Table 1-1 shows the mapping of bit numbers from the 8-bit ports to the 16- or 32-bit ports. Chapter 5 — “HP E1330B Digital I/O Command Reference” describes each command in detail and Chapter 3 — “Using the HP E1330B Digital I/O Module” gives examples of the use of SCPI commands.

Table 1-1. Data Lines

8-bit (BYTE) Operations				
Port #	0	1	2	3
Bit designations	7-----0	7-----0	7-----0	7-----0
16-bit (WORD) Operations				
Port #	0		2	
Bit designations	15-----8	7-----0	15-----8	7-----0
32-bit (LWORD) Operations				
Port #	0			
Bit designations	31-----24	23-----16	15-----8	7-----0

Two 3-meter, 60-wire ribbon cables with an insulation displacement header connector (ribbon cable connector) on one end are included with the Digital I/O module. Additional cable sets can be ordered (HP part number E1330-61601) from your nearest Hewlett-Packard Sales Office.

Instrument Definition

Each Digital I/O module installed in an HP mainframe is treated as an independent instrument; having a unique secondary HP-IB address. Each instrument is also assigned a dedicated error queue, input and output buffers, status registers and, if applicable, dedicated mainframe memory space for readings or data. Multiple Digital I/O modules cannot be combined into a single instrument.

Downloading SCPI Drivers

The HP Digital I/O Driver allows the HP E1330B module to operate with either B-size mainframes or HP E1405/06 Command Modules in a C-size mainframe. The driver implements the Standard Commands for Programmable Instrumentation (SCPI) command language. The B-size HP E1300/E1301 Mainframe has a built in driver, or can use a downloadable driver. The two drivers are slightly different and the differences are detailed in Chapter 5 — “HP E1330B Digital I/O Command Reference”.

To use the HP E1330B with a C-size mainframe and command module, you must use a downloadable driver. The downloadable driver name for the Digital I/O module is “DIG_IO”. The procedure for downloading the drivers is contained in the HP E1405B and HP E1406A *Command Module User Guides*.

Programming the Digital I/O Module

To program the Digital I/O module using SCPI commands, you will need to know the controller language and interface addresses you will be using. See the *HP 75000 Series B or Series C Installation and Getting Started Guide* for detailed interface addressing and controller language information.

Note This discussion applies only to SCPI (Standard Commands for Programmable Instruments) programming. See Appendix B — “Digital I/O Register Information” for details on register addressing. Do not mix SCPI programming and direct register access.

SCPI Command Format Used in This Manual

SCPI commands can be used in either long or short form. A long form example is:

```
DISPlay:MONitor ON
```

The same command, without the lower case letters, is the short form. For example:

```
DISP:MON ON
```

Either the long form or the short form commands can be used to perform the same result. The long and short forms can also be mixed within the same program code. The commands are case insensitive, either upper or lower case letters are accepted.

In the command examples shown above, the item enclosed in <> is a parameter required to use the command, however, do not include the brackets when sending the command. In this example, the parameter input can be replaced with any one of the following: 0, 1, OFF, or ON. The allowable values of the parameters are given in Chapter 5 — “HP E1330B Digital I/O Module Command Reference”. You must include at least one space between the keywords and the parameter.

Some commands are shown with items enclosed in square brackets ([]). These are implied or optional items that do not have to be included. For example, the complete command syntax listing for the first example is:

```
DISPlay:MONitor[:STATe] <0|1 or OFF|ON>
```

The item enclosed in brackets, [:STATe], does not have to be included for the command to work. Complete descriptions of the SCPI command language, syntax, parameter types, and usage are in Chapter 5 of this manual.

Specifying SCPI Commands

SCPI commands related to the Digital I/O module use three types of parameters to specify a port number, a bit number, or a multiple port combining operation. Each type is briefly described here. Descriptions and examples of usage can be found in Chapter 3 of this manual.

Specifying a Port

The Digital I/O module has four identical ports numbered from 0 to 3. SCPI commands that relate to a specific port use a special parameter to indicate the port number. For example:

```
[SOURce:]DIGital:DATA $n$  <value>
```

This command writes the parameter <value> to the port specified by the n portion of the DATA keyword. Replace the n with the port number, making the number the last character of the DATA keyword without spaces. For example, to set all port 2 data lines to logical zero, use the command:

```
[SOURce:]DIGital:DATA2 0
```

The value of n may vary for multiple port commands and operations. A description of multiple port commands is on page 15.

Specifying a Bit

Each of the four ports on the module has eight bi-directional data lines, corresponding to eight programmable data bits. Some SCPI commands allow you to manipulate or read these bits individually. For example:

```
MEASure:DIGital:DATA $n$ :BIT $m$ ?
```

This command reads the state of a bit, specified by m , on port n . The result will be either 0 or 1, indicating the current logical state of the bit. Replace m with the desired bit number, and n with the desired port number, making each number the last characters of the DATA and BIT keywords without spaces. For example, to read bit 7 on port 0, use the following command:

```
MEASure:DIGital:DATA0:BIT7?
```

For single ports, the value of m can range from 0 to 7. Some multiple port operations and commands may allow bit numbers to range from 0 to 31.

Specifying Multiple Port Operations

The Digital I/O module allows you to set or read multiple ports or bits with a single command. For example:

```
MEASure:DIGital:DATA $n$ [:type]?
```

This command uses an optional keyword, **[:type]**, to specify how many ports are combined in a single returned value. The lower case keyword **[:type]** is replaced with one of a fixed set of keywords. For example, to read all 4 ports (all 32-bits) as a single returned value, use the command:

```
MEASure:DIGital:DATA0:LWORD?
```

Keywords are provided to allow port combinations of 16- or 32-bits. Using multiple ports is described in more detail in Chapter 4 of this manual.

Initial Operation

Use the following example to verify initial operation. The example first sets and then queries the polarity of a logical true condition on the port 0 FLG line. The example uses an HP Series 200/300 Computer with HP BASIC as the programming language. The computer is connected to an HP E1301 Mainframe using the Hewlett-Packard Interface Bus (HP-IB)*. The HP-IB interface select code is 7, the HP-IB primary address is 09, and the HP-IB secondary address (used to specify the Digital I/O module) is 18. Refer to the *B-Size Installation and Getting Started Guide* for more details.

```
10 ASSIGN @Dio TO 70918           !Sets an I/O path to the module.
20 DIM Polarity${3}
30 OUTPUT @Dio;"*RST"             !Reset the module.
40 OUTPUT @Dio;"*OPC?"           !Wait for the module to finish.
50 ENTER @Dio;Ready              !Hold here until command is
                                !finished.
60 OUTPUT @Dio;"SOUR:DIG:FLAG0:POL POS;*OPC?"
                                !Set POSitive polarity.
70 ENTER @Dio;Ready              !Wait for finish.
80 OUTPUT @Dio;"SOUR:DIG:FLAG0:POL?"
                                !Query the polarity state.
90 ENTER @Dio;Polarity$          !Get the result.
100 IF Polarity$ <> "POS" THEN    !Check the result.
110   DISP "Polarity Check ERROR" !Error discovered.
120   PAUSE                      !Pause on error.
130 ELSE
140   DISP"Polarity set to "&Polarity$
150 END IF
160 OUTPUT @Dio;"SOUR:DIG:FLAG0:POL NEG;*OPC?"
                                !Set NEGative polarity.
170 ENTER @Dio;Ready             !Wait for finish.
180 OUTPUT @Dio;"SOUR:DIG:FLAG0:POL?"
                                !Query the polarity state.
190 ENTER @Dio;Polarity$         !Get the result.
200 IF Polarity$ <> "NEG" THEN    !Check the result.
210   DISP "Polarity Check ERROR" !Error discovered.
220   PAUSE                      !Pause on error.
230 ELSE
240   DISP"Polarity set to "&Polarity$
250 END IF
260 OUTPUT @Dio;"*RST"           !Restore the module.
270 OUTPUT @Dio;"*OPC?"         !Wait for the module to finish.
280 ENTER @Dio;Ready
290 END
```

* HP-IB is Hewlett-Packard's implementation of IEEE Std 488.1-1984.

Chapter 2

Configuring the HP E1330B Digital I/O Module

Using This Chapter

This chapter shows how to configure the Digital I/O module for use in a VXIbus mainframe, connect peripheral devices, and configure the module for operation. Refer to Figure 2-1 for locations of jumpers and switches. This chapter contains the following sections:

- Setting the Address Switch Page 18
- Enabling Pull-ups Page 19
- Selecting the Interrupt Line. Page 20
- Combining the Flag Lines. Page 21
- Digital I/O Module Peripheral Pinout. Page 22
- Configuring for Isolated Digital I/O Page 25
- Connecting to a GPIO Peripheral Page 26
- Using with External Pull-ups Page 28
- Typical Connection Page 29

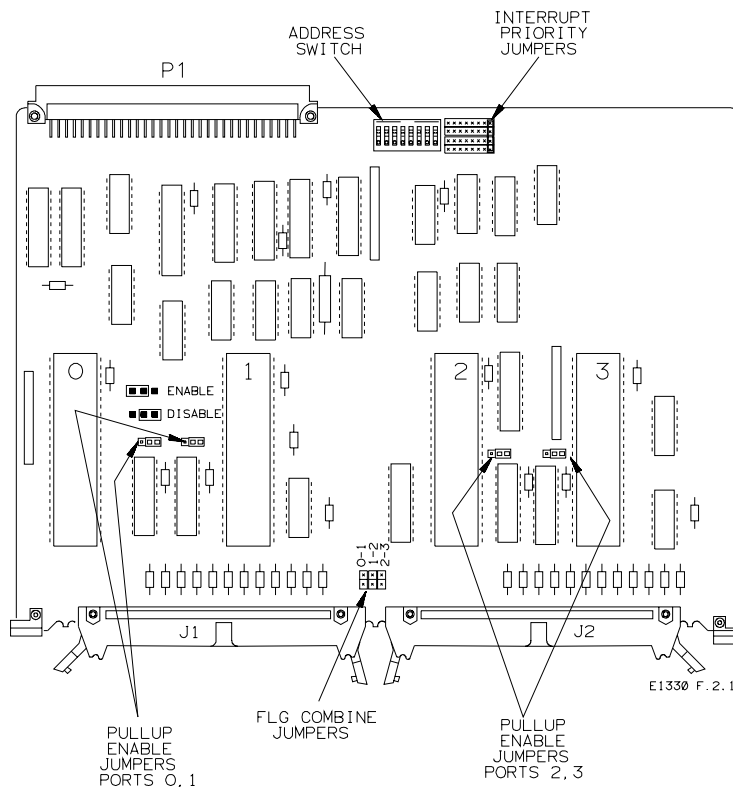

Figure 2-1. HP E1330B Digital I/O Module

Setting the Address Switch

Refer to Figure 2-1. In the center rear of the module, next to the P1 connector, you will find the logical address switch. Its factory setting is 144; rockers 4 and 7 are closed, all others are open. You can select the address of the Digital I/O module to any number 0–255 (decimal). The default setting of the address switch is shown in Figure 2-2.

Note To be recognized as an instrument when you are using the Digital I/O module in an HP E1300/1301 Mainframe or with an HP E1405 or E1406 Command Module, the logical address *must* be set to a multiple of 8.

LOCATE AND SET THE LOGICAL ADDRESS SWITCH

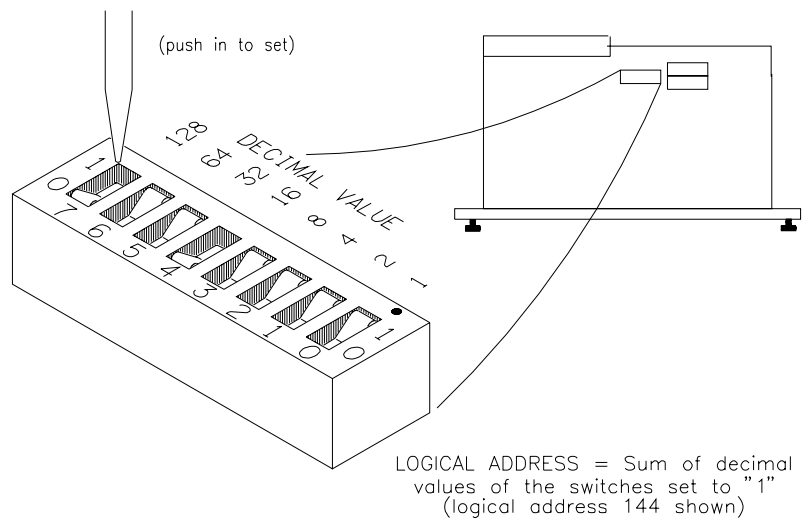

Figure 2-2. Logical Address Switch Set at 144

Enabling Pull-ups

Referring to Figure 2-1, note the pull-up enable jumpers near the middle of each of the large ICs. The data lines of each port can be independently configured for either passive or active pull-up to TTL high levels. The factory-shipped condition is pull-up disabled for all ports. The data lines may be either inputs or outputs. When the data lines are outputs, and the jumper is in the enabled position, the outputs are actively forced high. When the data lines are inputs, the jumper position makes no difference.

Note The jumper in the enabled position does not add an input pull-up resistor to each data line, it enables a chip-internal pull-up network.

Each data line has an active resistive terminating network. The active circuitry ensures that when power is removed from the module, the data lines are not loaded. With power applied, the resistive terminating network is equivalent to that shown in Figure 2-3.

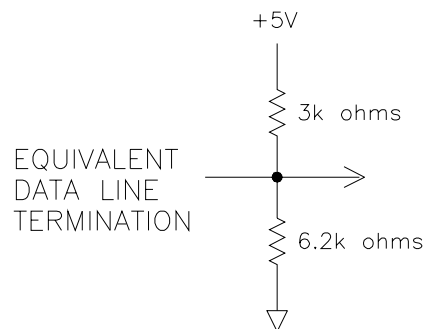

Figure 2-3. Equivalent Data Line Termination

Selecting the Interrupt Line

The VXI peripheral interrupt bus consists of seven lines which can carry the interrupt signal to the commander. The most common line to be used is line one, as this is the usual default interrupt line. Many VXIbus commanders have a way to change the interrupt line they manage (for example, the E1405/06 has an interrupt line allocation table). When doing direct register-based programming, instead of using the SCPI driver, set the interrupt line to a line that is not used by the SCPI driver. Module interrupt priority can be established with these lines. In general, the higher the line number, the higher the priority.

Referring to Figure 2-1, near the P1 connector you will find two sets of jumper pins labeled X and 1 through 7 (JM15 and JM16). The Digital I/O module is factory-shipped with the interrupt set to 1. If you need to change the interrupt level you must move *both* jumpers on the blocks. Spare jumpers, used for combining the flag (FLG) lines, are stored on the unused ground pins of this connector when it ships from the factory.

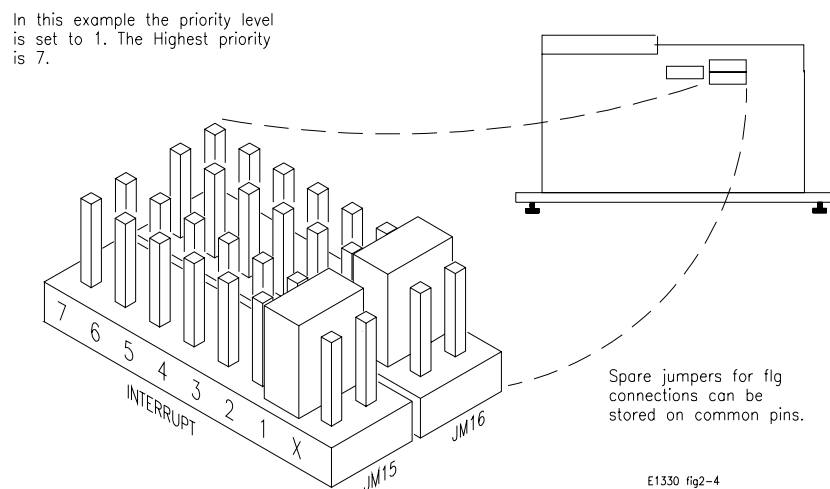

Figure 2-4. Priority Interrupt Connector (Factory Setting)

Note The interrupt circuitry for the HP E1330B is implemented as release on interrupt acknowledge (ROAK). The HP E1330B Digital I/O module will de-assert (or release) the interrupt request line during an interrupt acknowledge cycle.

The interrupt circuitry on the HP E1330A is implemented as release on register access (RORA). The HP E1330A Digital I/O module will continue to assert the interrupt request line until the Port Control/Status Register on the Digital I/O module is accessed.

Both the HP E1330A and HP E1330B may be used with the HP E1300A/E1301A and with the HP E1405A/B and HP E1406A. If you are using HP Compiled SCPI (i.e., HP E1570A), you must use the HP E1330B.

Combining the Flag Lines

Each port contains a Flag Line, labeled FLG, that can be used to implement a handshake scheme with a peripheral. For single port operations, the FLG lines can be used in the factory default setting (no flag lines combined) to handshake with a peripheral. For multi-port operations with a single handshake line, you can combine the flag line from multiple ports. The combined flag lines are physically tied together. An action on any of the combined flag lines performs that action for all combined flag lines.

Figure 2-5 shows the locations of the flag combining switches and how to set them. Before setting any flag combine switches, you may wish to read the discussion regarding allowable port combinations and handshaking in Chapter 4 of this manual.

Note When using FLG and CTL for handshaking on multiple port operations, CTL is set for each port sequentially, beginning at the lowest numbered port.

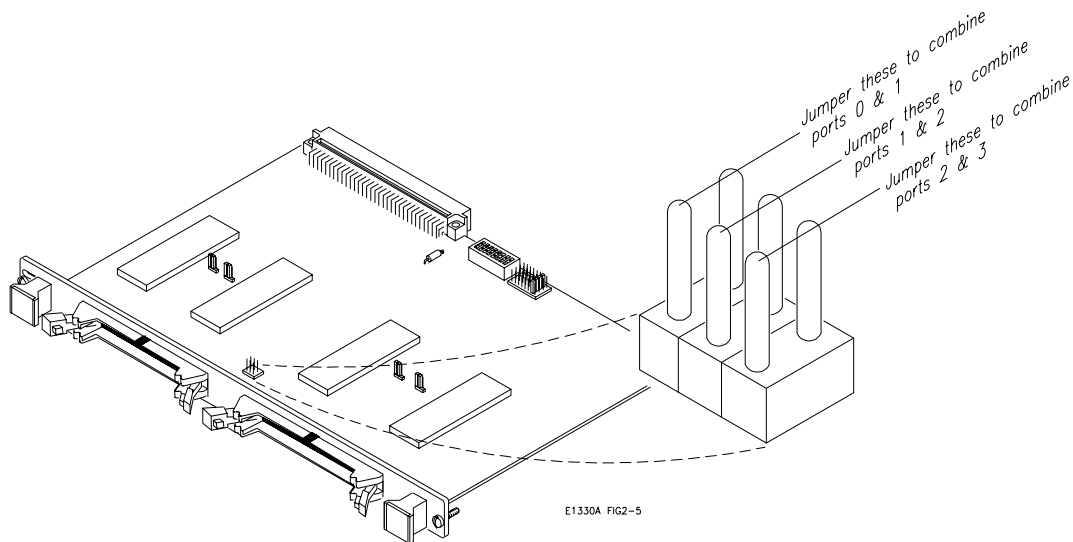
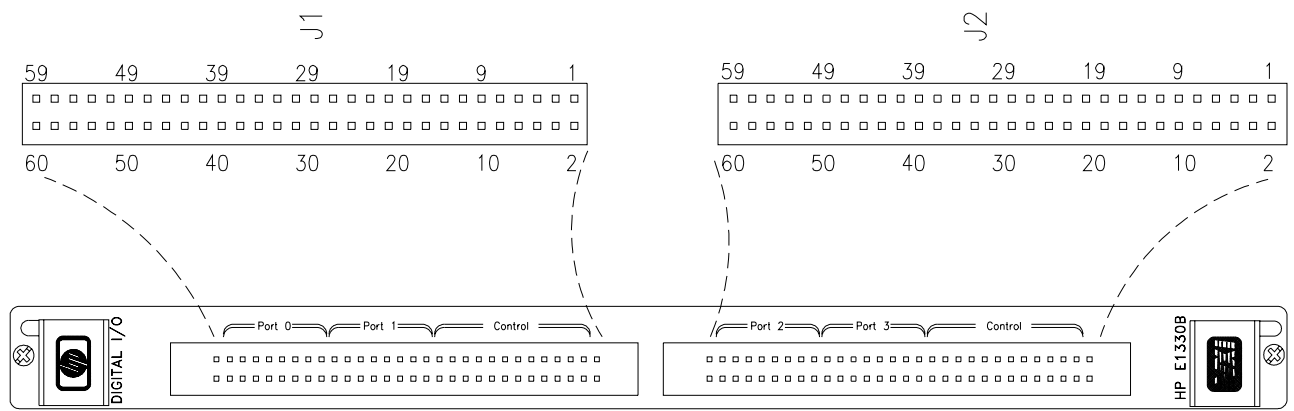

Figure 2-5. Flag Combine Switches

Digital I/O Module Peripheral Pinout

Figure 2-6 shows pinouts for the Digital I/O module connectors. Each is compatible with easy crimp connections to ribbon cables for standard digital I/O interfacing. Figure 2-7 shows the data line location on the supplied ribbon cables. Figure 2-8 shows how to connect the cables. Details about the functioning of these pins is covered in Chapter 4 — “Understanding the HP E1330B Digital I/O Module but line names are as follows:

$\overline{\text{RES}}$	Reset Line - used to reset a peripheral. Output from the Digital I/O module.
STS	Status Line - used as an auxiliary handshake line. Input to the Digital I/O module.
PIR	Peripheral Interrupt Line - used to signal a peripheral interrupt. Input to the Digital I/O module.
FLG	Flag Line - used to handshake data between a peripheral and the Digital I/O module. Controlled by the peripheral. Input to the Digital I/O module.
CTL	Control Line - used to handshake data between a peripheral and the Digital I/O module. Controlled by the Digital I/O module. Output from the Digital I/O module.
$\text{I}/\overline{\text{O}}$	Input/Output Line - used to establish input or output on a port. Controlled by the Digital I/O module. Input to the Digital I/O module.



E1330 Fig2-6b

J1				J2			
Pin	Assignment	Pin	Assignment	Pin	Assignment	Pin	Assignment
1	-	31	D1-2	1	-	31	D3-2
3	RES1	33	D1-3	3	RES3	33	D3-3
5	RES0	35	D1-4	5	RES2	35	D3-4
7	STS1	37	D1-5	7	STS3	37	D3-5
9	STS0	39	D1-6	9	STS2	39	D3-6
11	PIR1	41	D1-7	11	PIR3	41	D3-7
13	PIR0	43	D0-0	13	PIR2	43	D2-0
15	FLG1	45	D0-1	15	FLG3	45	D2-1
17	FLG0	47	D0-2	17	FLG2	47	D2-2
19	CTL1	49	D0-3	19	CTL3	49	D2-3
21	CTL0	51	D0-4	21	CTL2	51	D2-4
23	I/O1	53	D0-5	23	I/O3	53	D2-5
25	I/O0	55	D0-6	25	I/O2	55	D2-6
27	D1-0	57	D0-7	27	D3-0	57	D2-7
29	D1-1	59	-	29	D3-1	59	-

All even pins are grounded

Figure 2-6. J1 and J2 Connector Pinouts

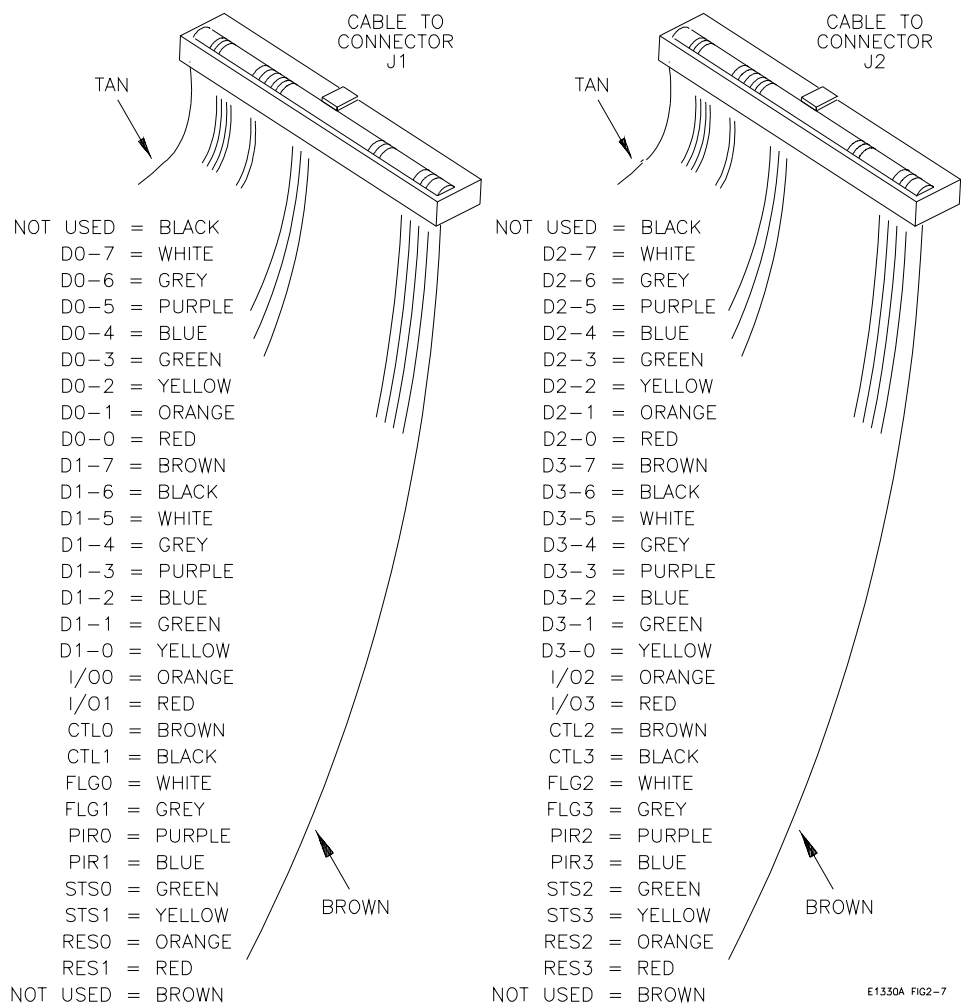

Figure 2-7. Data Line Location on Ribbon Cables

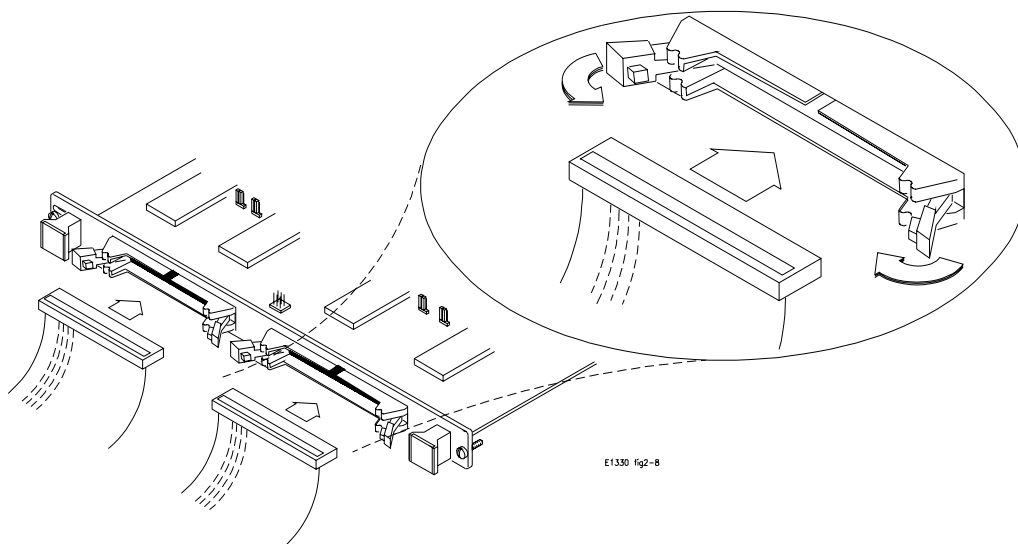

Figure 2-8. Connecting the Digital I/O Cable

Configuring for Isolated Digital I/O

The two Digital I/O module peripheral connectors, J1 and J2, each have 60 pins. An industry standard isolated digital I/O peripheral, like the **Opto 22[®]** 16 Position Single Channel Mounting Rack, is a 50-pin connection. The connector is either a card edge or a header connector (similar to J1 on the Digital I/O module). For example, the Opto 22[®] rack, PB16C, uses a card edge connector; PB16H uses a header connector. They both have the same pin-out for the ribbon cable. Both can accommodate up to 16 single channel I/O lines.

12 of the wires on the supplied ribbon cable are not connected. Figure 2-8 shows the ribbon cable connections. The method of connection to the ribbon cable can be facilitated by the use of specialty fixtures for these connectors, but there is no standard for connector keys or spacing.

For the Opto 22[®] rack, lines 1–10 are not used on the peripheral connector. Pins 27–57 on the ribbon cable, odd numbered pins only, correspond to pins 17–47 on the Opto 22[®] rack. All even numbered pins are ground. Do not connect pins 1 and 49 on the Opto 22[®] rack connector.

Procedure

1. Carefully cut lines 1-11 on the ribbon cable and line 59. A tan wire should be the first wire on the ribbon cable after you make the cut.
2. Select the 50-pin connector you need, either edge connector or header connector and attach the ribbon cable.
3. Connect the ribbon cable to the Opto 22[®] rack for optically isolated digital operation.

Opto 22[®] is a registered trademark of Opto 22, Huntington Beach, CA 92649

Connecting to a GPIO Peripheral

The GPIO interface is a widely used standard parallel interface for connecting computers to peripherals. The GPIO interface may employ up to 32-bits of bi-directional data transfer. The Digital I/O module and the GPIO interface have identical line definitions but different pin assignments. Ports A-D on the GPIO are defined as ports 0-3 on the Digital I/O module. Ports A-D on the GPIO are defined as ports 0-3 on the Digital I/O module.

Procedure

1. Connect the ribbon cable to connector J1 and/or J2 on the Digital I/O module.
2. Connect the wires on the ribbon cable to the peripheral as described in Table 2-1 for the GPIO interface.

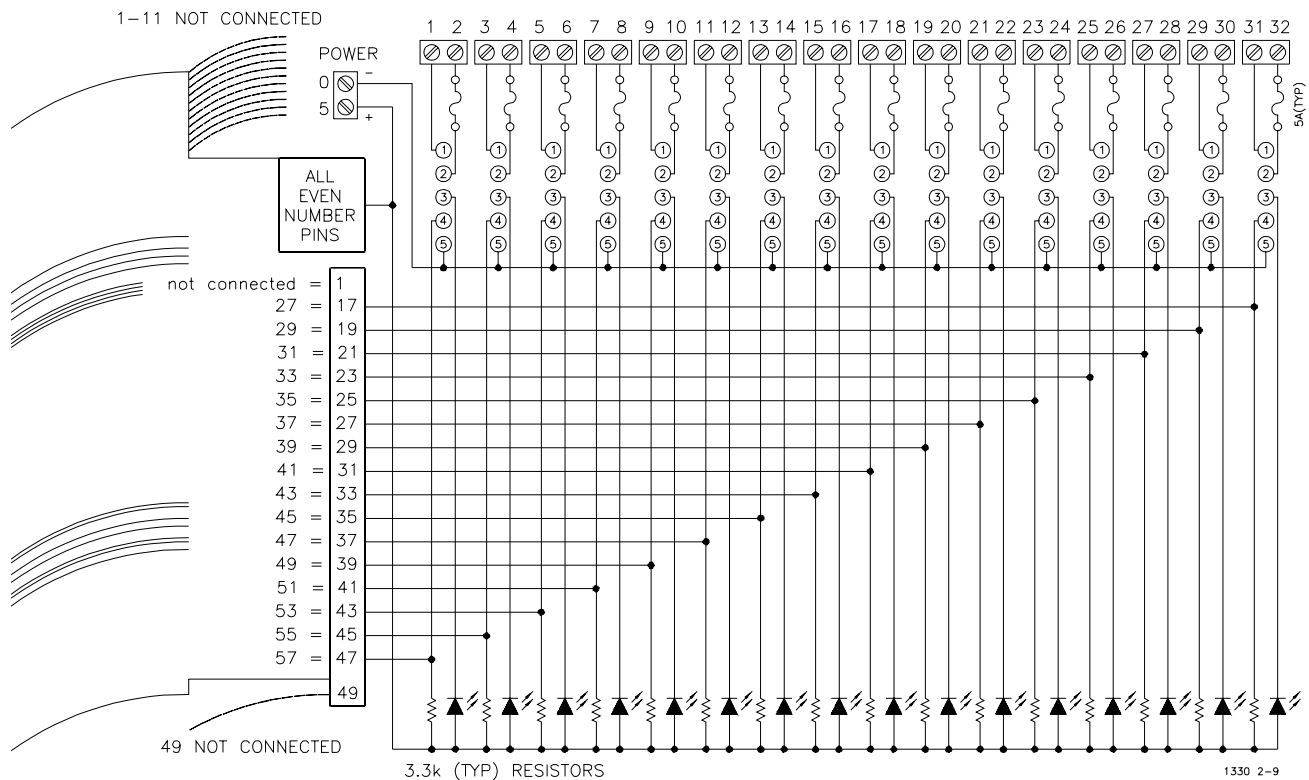

Figure 2-9. Typical Isolated Peripheral Hookup

Table 2-1. Digital I/O Pinout to GPIO Pinout

	Port 0 Digital I/O	GPIO		Port 1 Digital I/O	GPIO
Connector	J1	J2	Connector	J1	J2
Name	Pin #	Pin#	Name	Pin#	Pin#
D00	43	33	D10	27	4
D01	45	15	D11	29	22
D02	47	34	D12	31	3
D03	49	16	D13	33	21
D04	51	35	D14	35	2
D05	53	17	D15	37	20
D06	55	36	D16	39	1
D07	57	18	D17	41	19
RES0	5	12	RES1	3	29
STS0	9	26	STS1	7	8
PIR0	13	9	PIR1	11	25
FLG0	17	27	FLG1	15	7
CTL0	21	13	CTL1	19	30
I/O0	25	31	I/O1	23	11
	Port 2 Digital I/O	GPIO		Port 3 Digital I/O	GPIO
Connector	J2	J1	Connector	J2	J1
Name	Pin #	Pin#	Name	Pin#	Pin#
D20	43	33	D30	27	4
D21	45	15	D31	29	22
D22	47	34	D32	31	3
D23	49	16	D33	33	21
D24	51	35	D34	35	2
D25	53	17	D35	37	20
D26	55	36	D36	39	1
D27	57	18	D37	41	19
RES2	5	12	RES3	3	29
STS2	9	26	STS3	7	8
PIR2	13	9	PIR3	11	25
FLG2	17	27	FLG3	15	7
CTL2	21	13	CTL3	19	30
I/O2	25	31	I/O3	23	11
<p>For the Digital I/O connectors, all even numbered pins are ground. For the GPIO connector, pins 5, 6, 10, 14, 23, 24, 28 and 32 are ground.</p>					

Using with External Pull-ups

The Digital I/O module data lines can be used in an open collector configuration. Connections for open collector require the use of external power supplies and pull-up resistors. The internal pull-up mode of the Digital I/O module should be disabled for open collector output. Figure 2-10 shows a single data line connection. The value of the pull-up resistor is calculated as follows:

$$V_{cc} = 5.0 \text{ Vdc}$$

$$I_{max} = I_{out_Low} \times \text{safety_factor} = 48\text{mA} \times 0.52 = 25\text{mA}$$

$$R = \frac{V_{cc}}{I_{max}} = \frac{5}{0.025} = 200\Omega$$

The value of TTL high with the 200 Ω pull-up resistor is calculated as follows:

$$V_{High} = V_{cc} \times \frac{6200}{6200 + 200} = 4.84\text{Vdc}$$

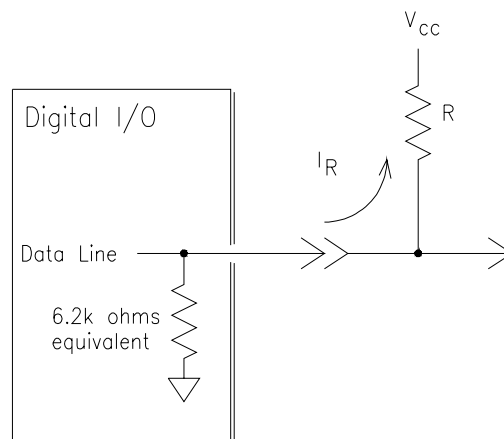

Figure 2-10. Typical Open Collector Data Line

Typical Connection

Figure 2-11 shows a typical driver/receiver connection for data transfer. The FLG, PIR, and STS lines have a discrete resistive pull-up network. The data lines do not have a discrete resistive pull-up, but can use an internal pull-up in the 75ALS160. The I/O, CTL, and RES lines are open collector, and require external pull-up to logic high.

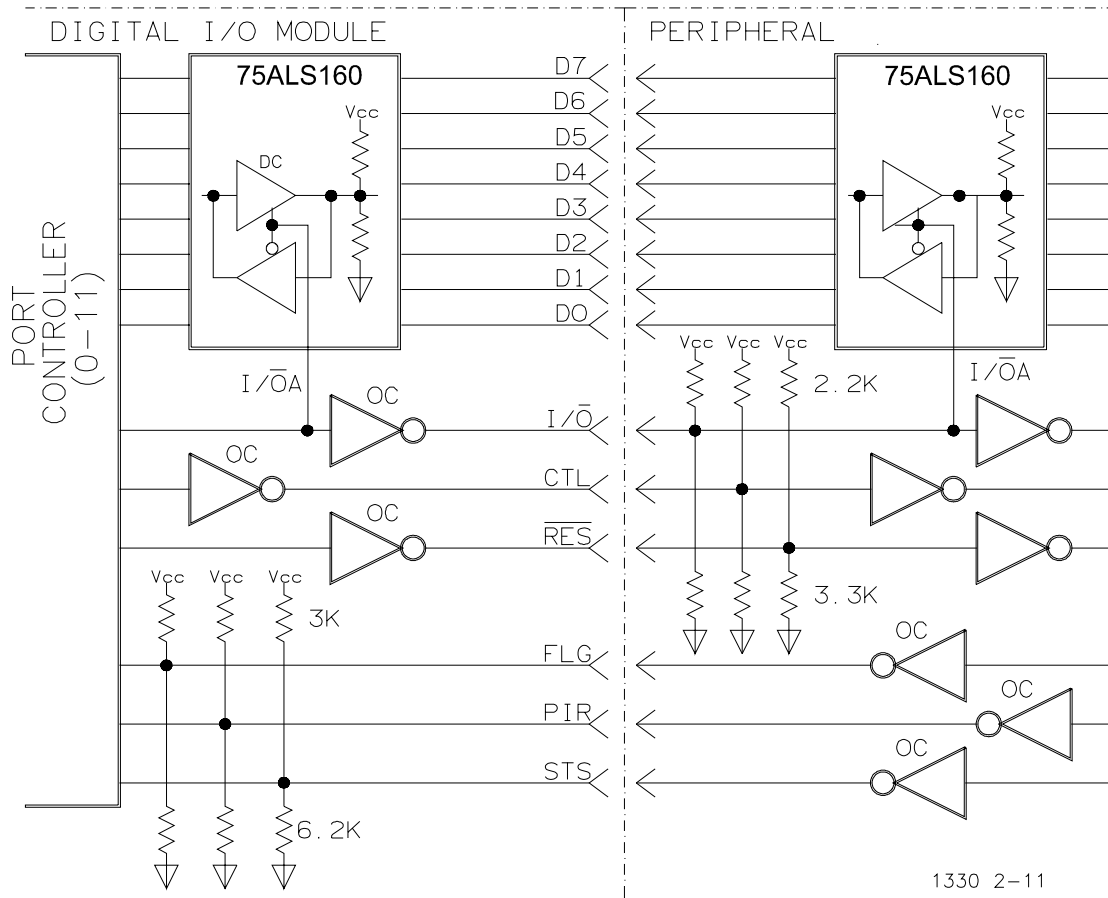

Figure 2-11. Typical Driver/Receiver Connections

Notes:

Using the HP E1330B Digital I/O Module

Using This Chapter

This chapter is divided into eight sections about transferring data to and from the Digital I/O Module and a peripheral:

- Addressing the Module Page 31
- Operation Overview Page 32
- Default and Reset States Page 33
- Setting the Polarity Page 33
- Setting the Handshake Mode Page 34
- Inputting Data Bytes and Bits Page 35
- Outputting Data Bytes and Bits Page 36
- Multiple Port Operations Page 37
- Using Trace Memory Page 38

Addressing the Module

The examples shown in this chapter use the default addresses for the interface, Command module, and Digital I/O module. The address uses both HP-IB primary and secondary addresses. The default address is:

7	0 9	1 8
HP-IB Primary Address		HP-IB Secondary Address
Interface Select Code	Command module HP-IB Address	Digital I/O module address $\left(\frac{LADDR}{8}\right)$

To establish these defaults as an I/O path in HP BASIC, the program examples use this code:

```
10 ASSIGN @Dio TO 70918
```

Each Digital I/O module in a system must have a different logical address. Additionally, no two instruments in the same system can have the same logical address. Setting the logical address is described in Chapter 2 — “Configuring the HPE1330B Digital I/O Module”.

Operation Overview

The following steps illustrate general operation of the Digital I/O module.

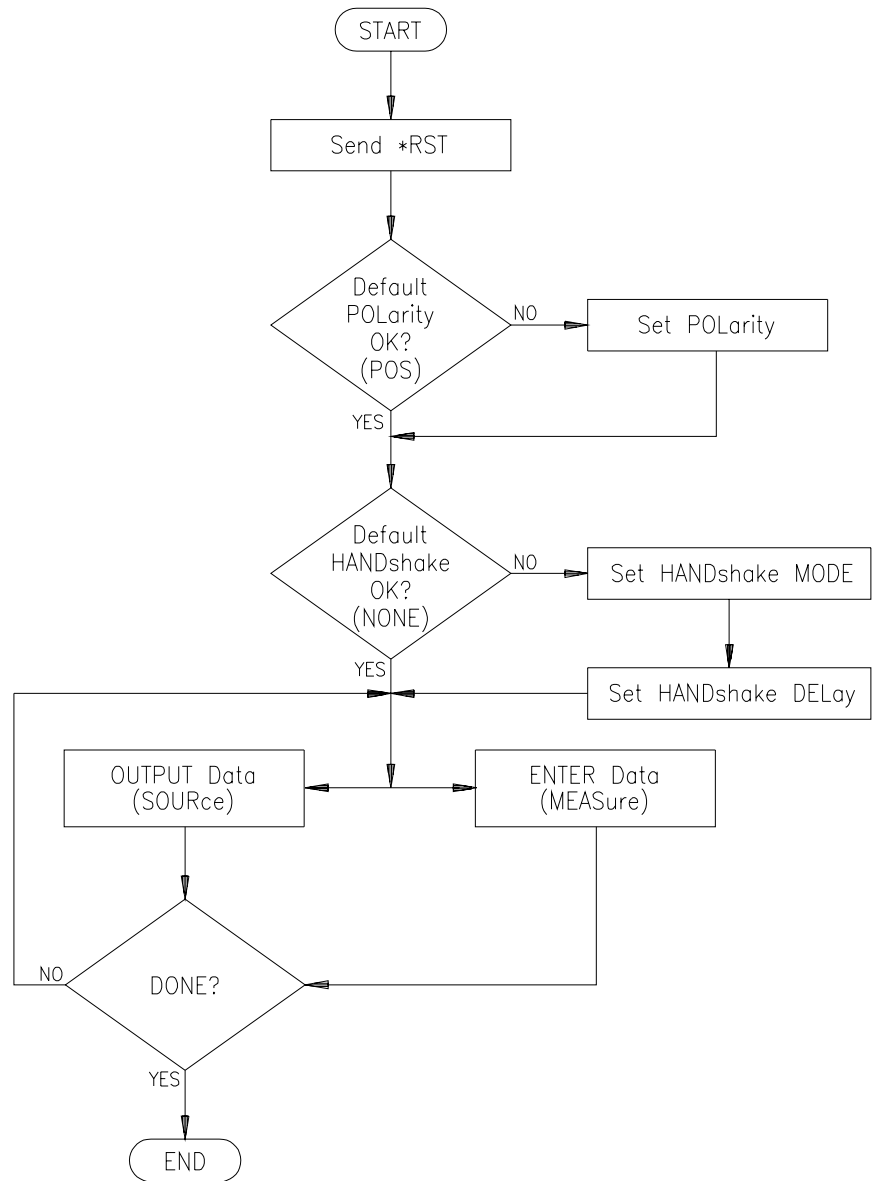

Figure 3-1. HP E1330B General Operation

Default and Reset States

At initial power-on and following the *RST command, the Digital I/O module is set to the following states:

CTL line:	0 = TTL Low
I/O line:	TRUE = input = TTL High
Data, FLG, and CTL line Polarity:	POSitive
Handshake mode:	NONE

Setting the Polarity

The logical true level of the control (CTL) line, the flag (FLG) line, and the data lines of each port can be set to either TTL high (> 2.5V) or TTL Low (< 1.4V) levels. SCPI commands use the **POLarity** keyword as:

[SOURCE:]DIGital:CONTROLn:POLarity <POSitive or NEGative>
to set the control line's (CTL) polarity on port *n*.

[SOURCE:]DIGital:FLAGn:POLarity <POSitive or NEGative>
to set the flag line's (FLG) polarity on port *n*.

[SOURCE:]DIGital:DATA n:POLarity <POSitive or NEGative>
to set the data line's polarity on port *n*.

Example

```
10 ASSIGN @Dio TO 70918
20 DIM Pol$ [3]
30 Pol$ = "POS"
40 OUTPUT @Dio; "DIG:DATA1:POL "&Pol$
50 END
```

This program sets the polarity to positive on port 1 data lines. A TTL high will be input as a 1, or a bit set to 1 will output a TTL High level.

The *RST (reset) condition is positive polarity for control (CTL), flag (FLG), and data lines on all ports.

Setting the Handshake Mode

Handshaking ensures correct transfer of data between devices. You must set both the mode and the timing to establish correct handshaking. Most handshake modes use the FLG and CTL lines to control the data transfer. SCPI commands support the following modes of handshaking:

- LEADing Edge
- TRAILing Edge
- PULSe
- PARTial
- STRobe
- NONE

These SCPI commands set the type of handshake mode used:

```
[SOURce:]DIGital:DATAn[:type]:HANDshake[:MODE] <mode>
```

```
[SOURce:]DIGital:HANDshaken[:MODE] <mode>
```

Handshake Timing

Some handshake modes require that a timing value be set. Primarily, the timing applies to only output functions (the exception is STRobe Input handshaking mode). These SCPI commands set the timing of the handshake (where timing applies):

```
[SOURce:]DIGital:DATAn[:type]:HANDshake:DELay <time>
```

```
[SOURce:]DIGital:HANDshakenDELay <time>
```

Example

```
10 ASSIGN @Dio TO 70918
20 DIM Hand$ [4]
30 Hand$ = "LEAD"
40 Delay = 0.015
50 OUTPUT @Dio;"DIG:DATA0:BYTE:HAND "&Hand$
60 OUTPUT@Dio;"DIG:DATA0:BYTE:HAND:DEL ";Delay
70 END
```

Sets the 8-bit port 0 handshake mode to the LEADing Edge handshake mode and sets the output timing handshake delay to 0.015 seconds.

Detailed descriptions of the handshake modes, timing diagrams, and the use of the FLG and CTL lines are given in Chapter 4 —“Understanding the HP E1330B Digital I/O Module”.

Inputting Data Bytes and Bits

Data input is performed using commands in the SCPI **MEASure:DIGital:DATA*n*** subsystem. The returned value of an input will depend upon the POLarity programmed for the port.

Both Input and Output operations will attempt to complete the handshake mode set for the port and may "hang" if required handshake operations are not completed. To unhang a hung transfer, issue a IEEE 488 selected device clear. In HP BASIC this is CLEAR 70918.

Input

Input operations can involve single bits, 8-bit bytes, or multiple bytes. Single bit operations always return a value of 1 or 0. Byte or multiple byte inputs always return values in decimal format.

```
Example 10 ASSIGN @Dio TO 70918           !Establish I/O path to module.
          20 INTEGER Bits, Bytes, Ready
          30 OUTPUT @Dio;"*RST;*OPC?"    !Reset the module to establish
                                           defaults.
          40 ENTER @Dio;Ready           !Wait for completion.
          50 OUTPUT @Dio;"MEAS:DIG:DATA0:BIT7?" !Input a bit on port 0.
          60 ENTER @Dio;Bits
          70 OUTPUT @Dio;"MEAS:DIG:DATA1?" !Input a byte on port 1.
          80 ENTER @Dio;Bytes
          90 DISP "Port 0, Bit 7 is "&Bits !Show the results.
          100 DISP "Port 1 byte is "&Bytes
          110 END
```

This example first sets the module to the default state (positive polarity and no handshake). The state of data line 7 (Bit 7) of port 0 is read. A byte is input from port 1. The displayed state of the bit input will be either 0 or 1, depending upon the electrical state of port 0 data line 7. The displayed value of the byte input will range from 0 (all port 1 data lines low) to 255 (all port 1 data lines high).

Note Following a *RST command, the port data lines will be configured as inputs, with the ports terminating resistors pulling them high. Bits will be read as a 1 and a byte as 255.

Outputting Data Bytes and Bits

Data output is performed using the commands in SCPI [SOURCE:]DIGital:DATA*n* subsystem. The TTL levels of an output will depend upon the POLarity programmed for the port.

Both Input and Output operations will attempt to complete the handshake mode set for the port and may "hang" if required handshake operations are not completed. To unhang a hung transfer, issue a IEEE 488selected device clear. In HP BASIC this is CLEAR 70918.

Output

Output operations can involve single bits, 8-bit bytes, or multiple bytes. Single bit output operations always expect a value of 0 or 1. Byte or multiple byte output operations can accept numbers in decimal, hexadecimal, octal, or binary formats. The choice of output format is indicated by a special character (#) in the value to be output. If the # character is not used, the output value is assumed to be in decimal format.

```
Example 10 ASSIGN @Dio TO 70918           !Establish I/O path to module.
        20 INTEGER Bits, Bytes, Ready
        30 Bits= 1
        40 Bytes = 255
        50 OUTPUT @Dio;"*RST;*OPC?"   !Reset the module to establish
                                         defaults.
        60 ENTER @Dio;Ready           !Wait for completion.
        70 OUTPUT@Dio;"DIG:DATA0:BIT5 "&VAL$(Bits)&";*OPC?"
                                         !Set port 0 bit 5 true.
        80 ENTER @Dio;Ready           !Wait for completion.
        90 OUTPUT@Dio;"DIG:DATA1 "&VAL$(Bytes)&";*OPC?"
                                         !Output a byte on port 1.
        100 ENTER @Dio;Ready          !Wait for completion.
        110 END
```

This example sets bit 5 on port 0 to a logical true value (with the default polarity established, the data line is set to TTL high). The example then sets all the data lines on port 1 to TTL high. Port 0, bit 5 and port 1 data lines will remain in the TTL high condition until another output command or input command at the same port is received.

Multiple Port Operations

The Digital I/O module supports multiple port operations using a single SCPI command. Multiple port operations are shown in the SCPI command syntax as the optional keyword **[:type]**. For example, this SCPI command syntax initiates a handshake and returns a value:

MEAS:DIG:DATA n [:type]?

The optional keyword **[:type]** is replaced by one of the following keywords:

- :BYTE** This keyword, or no keyword (default), is used for 8-bit port operations.
- :WORD** This keyword is used to combine 2 adjacent ports for 16-bit port operations.
- :LWORD** This keyword is used to combine all 4 ports for 32-bit operations.

Example

```
10 ASSIGN @Dio TO 70918           !Establish I/O path to module.
20 DIM Pat_1$[8], Pat_2$[8], Hand$[4]
30 Pat_1$="AAAAAAAA"             !Alternating 1 and 0.
40 Pat_2$ = "55555555"           !Alternating 0 and 1.
50 Hand$ = "LEAD"
60 OUTPUT @Dio;"*RST;*OPC?"      !Reset the module to establish
                                !defaults.
70 ENTER @Dio;Ready              !Wait for completion.
80 OUTPUT@Dio;"DIG:DATA0:LWORD:HAND "&Hand$&";*OPC?"
                                !Set LEADing handshake for 32
                                !bit operations.
90 ENTER @Dio;Ready              !Wait for completion.
100 OUTPUT@Dio;"DIG:DATA0:LWORD:HAND:DEL .015;*OPC?"
                                !Set handshake delay time.
110 ENTER @Dio;Ready             !Wait for completion.
120 OUTPUT@Dio;"DIG:DATA0:LWORD #H"&Pat_1$&";*OPC?"
                                !Set 32 bits, use handshake,
                                !alternating 1 and 0.
130 ENTER @Dio;Ready             !Wait for completion.
140 OUTPUT@Dio;"DIG:DATA0:LWORD #H"&Pat_2$&";*OPC?"
                                !Set 32 bits, use handshake,
                                !alternating 0 and 1.
150 ENTER @Dio;Ready             !Wait for completion.
160 END
```

This example combines all four ports for handshaking and output operations. The handshake mode is set to LEADing. The output data is given in hexadecimal as specified by the **#H** characters. When using multiple port handshaking, use the highest numbered port CTL line to ensure a correct handshake.

Using Trace Memory

Trace memory can speed input and output operations and free your system controller during multiple byte input or output operations. A portion of system memory is set aside and data is read or written as blocks. Trace memory allows the fastest operation of the Digital I/O module. The rate of transfer of each block of data is determined by the handshake speed of the Digital I/O module and the peripheral.

Note Byte swapping may occur when using the **:TRACe** commands. If you are using a Motorola processor, the bytes are written or read to memory with the lowest port receiving the least significant byte (the case when directly addressing the port through SCPI commands). An Intel processor, however, when used with the **:TRACe** commands will swap the order of the bytes. The bytes are written or read from memory with the lowest port receiving the most significant byte and the highest port the least significant byte.

Trace Memory Example 1

This example writes 20 bytes as 10 WORDS at ports 0 and 1.

```
10 RE-SAVE "Trace_1"
20 ASSIGN @ Dio TO 70918
30 INTEGER A(1:10) ,Ready
40 DATA 65,66,67,68,69,70,71,72,73,74 !A, B, C, D, E, F, G, H, I, J.
50 READ A(*)
60 OUTPUT @Dio;"*RST;*OPC?"
70 ENTER @Dio;Ready !Wait for completion.
80 OUTPUT@Dio;"SOUR:DIG:TRAC:DEF alpha,100;*OPC?"
!Define memory name alpha.
90 ENTER @Dio;Ready !Wait for completion.
100 OUTPUT @Dio USING"K,10(W)";"SOUR:DIG:TRAC alpha,#220";A(*)
!Fill memory alpha with 20
bytes.
110 OUTPUT@Dio;"SOUR:DIG:DATA0:WORD:TRAC alpha;*OPC?"
!Output the 20 bytes.
120 ENTER @Dio;Ready !Wait for completion.
130 OUTPUT @Dio;"SOUR:DIG:TRAC:DEL alpha;*OPC?"
!Delete memory alpha.
140 ENTER @Dio;Ready !Wait for completion.
150 END
```

Trace Memory Example 2

This example writes 20 bytes as 10 WORDS at ports 0 and 1 as in the first example, it uses an external VME memory board.

```
10 RE-SAVE "Trace_2"
20 ASSIGN @ Dio TO 70918
30 INTEGER A(1:10) ,Ready
40 DATA 65,66,67,68,69,70,71,72,73,74 !A, B, C, D, E, F, G, H, I, J.
50 READ A(*)
60 OUTPUT @Dio;"*RST;*OPC?"
70 ENTER @Dio;Ready !Wait for completion.
80 OUTPUT @Dio;"MEM:VME:ADDR #H200000"
!Define memory location.
90 OUTPUT @Dio;"MEM:VME:SIZE 100"!Reserve 100 bytes.
100 OUTPUT @Dio;"MEM:VME:STAT ON"!Enable memory.
110 OUTPUT@Dio;"SOUR:DIG:TRAC:DEF alpha,100;*OPC?"
!Define memory name alpha.
120 ENTER @Dio;Ready !Wait for completion.
130 OUTPUT @Dio USING"K,10(W)";"SOUR:DIG:TRAC alpha,#220";A(*)
!Fill memory alpha with 20
bytes.
140 OUTPUT@Dio;"SOUR:DIG:DATA0:WORD:TRAC alpha;*OPC?"
!Output the 20 bytes.
150 ENTER @Dio;Ready !Wait for completion.
160 OUTPUT@DIO;"SOUR:DIG:TRAC:DEL alpha,*OPC?"
!Delete memory alpha.
170 ENTER @Dio;Ready !Wait for completion.
180 END
```

Trace Memory Example 3

This example reads 40 WORDS from ports 0 and 1.

```
10 RE-SAVE "Trace_3"
20 ASSIGN @ Dio TO 70918
30 DIM Head$(4)
40 INTEGER A(1:20) ,Ready
50 OUTPUT @Dio;"*RST;*OPC?"
60 ENTER @Dio;Ready !Wait for completion.
70 OUTPUT@Dio;"SOUR:DIG:TRAC:DEF alpha,80;*OPC?"
!Define memory name alpha.
80 ENTER @Dio;Ready !Wait for completion.
90 OUTPUT@Dio;"MEAS:DIG:DATA0:WORD:TRAC alpha;*OPC?"
!Output 80 bytes.
100 ENTER @Dio;Ready !Wait for completion.
110 OUTPUT @Dio;"SOUR:DIG:TRAC:DATA? alpha"
!Request the data.
120 ENTER @Dio USING "4A,40(W)";Head$;A(*)
130 OUTPUT @Dio;"SOUR:DIG:TRAC:DEL alpha;*OPC?"
!Remove memory block.
140 ENTER@Dio;Ready !Wait for completion.
150 END
```

Notes:

Chapter 4

Understanding the HP E1330B Digital I/O Module

Using This Chapter

This chapter provides explanations of the signal lines, handshake modes, and port combining for the Digital I/O Module. This chapter has the following topics.

- Port Description Page 41
- Default and Reset States Page 43
- Setting the Polarity Page 43
- Using the Handshake Modes. Page 44
- Inputting Data Bytes and Bits Page 50
- Outputting Data Bytes and Bits Page 51
- Multiple Port Operations. Page 53

Port Description

Each of the Digital I/O module ports has 8 data lines and 6 control lines. Not all these lines are required for every application. A simplified diagram of a port is shown in Figure 1-1. The following subsections describe the use of these lines.

Data Lines

Each port has 8 data lines, numbered from 0 to 7. The data lines can be set as an 8-bit group, as part of a larger group, or individually using SCPI commands.

The logical TRUE condition of the data lines can be controlled with SCPI commands. Positive polarity is the default. The following table shows the effect of changing the polarity with Input and Output operations for each data line.

	Input Operations	Output Operations
POSitive Polarity	TTL High = 1	1 = TTL High
	TTL Low = 0	0 = TTL Low
NEGative Polarity	TTL High = 0	0 = TTL High
	TTL Low = 1	1 = TTL Low

The FLG Line (Input)

Each port has a flag (FLG) line. A flag line is an input line from a peripheral and has two states: READY and BUSY. A flag line is normally used in conjunction with the corresponding control line (CTL) to establish a handshake between a peripheral and the Digital I/O Module. SCPI commands that define handshake modes typically use the FLG and CTL lines. The state of the FLG line can also be read with a SCPI command to implement custom handshakes. Positive polarity is the default. The following shows the effect of changing the polarity of the FLG line.

POSitive Polarity	TTL High = BUSY = 1 TTL Low = READY = 0
NEGative Polarity	TTL High = READY = 0 TTL Low = BUSY = 1

The CTL Line (Output)

Each port has a control line (CTL). A control line is an open collector output line from the Digital I/O module to the peripheral and has two states: TRUE and FALSE. A control line is normally used in conjunction with the corresponding flag line on the same port to establish a handshake between a peripheral and the Digital I/O Module. SCPI commands that define handshake modes typically use the FLG and CTL lines. The state of the CTL line can be read and set with SCPI commands to implement custom handshakes. Positive polarity is the default. The following shows the effect of changing the polarity of the CTL line.

POSitive Polarity	TTL High = TRUE = ON = 1 TTL Low = FALSE = OFF = 0
NEGative Polarity	TTL High = FALSE = OFF = 0 TTL Low = TRUE = ON = 1

The I/O Line (Output)

Each port has an open collector I/O line which is output from the Digital I/O module to the peripheral and has two states: TRUE or FALSE. The state of the I/O line is not directly programmable.

When the I/O line is: TTL High = TRUE = 1 = Input

The data transceiver of that port is enabled for input. The peripheral may respond to the signal by enabling itself to send data.

When the I/O line is: TTL Low = FALSE = 0 = Output

The data transceiver of that port is enabled for output. The peripheral should respond to the signal by enabling itself to receive data.

Caution To prevent damage to the Digital I/O module, when the I/O line is set for Output (TTL Low), the peripheral **MUST NOT** attempt to source on any data lines.

The STS Line Each port has a status line labeled STS. The STS line is an input line to the Digital I/O module. The use of the STS line is only at the register level, and is not supported by SCPI commands. Refer to Appendix B for more information about this line.

The PIR Line Each port has a peripheral interrupt request line labeled PIR. The PIR line is an input line to the Digital I/O module. The use of the PIR line is only at the register level, and is not supported by SCPI commands. Refer to Appendix B for more information about this line.

The $\overline{\text{RES}}$ Line Each port has a reset line labeled $\overline{\text{RES}}$. The $\overline{\text{RES}}$ line is an open collector output line to the peripheral. Control of the $\overline{\text{RES}}$ line is only at the register level and is not supported by SCPI commands. Refer to Appendix B for more information about this line.

Default and Reset States

At initial power-on and following the *RST command, the Digital I/O module is set to the following states:

CTL line:	0 = TTL Low
I/O line:	TRUE = input = TTL High
Data, FLG, and CTL line Polarity:	POSitive
Handshake mode:	NONE

Setting the Polarity

The logical true level of the control (CTL) line, the flag (FLG) line, and the data lines of each port can be set to either TTL high (>2.5V) or TTL Low (<1.4V) levels. SCPI commands use the POLarity keyword as:

[SOURCE:]DIGital:CONTROLn:POLarity <POSitive or NEGative>
to set the control line's (CTL) polarity on port *n*.

[SOURCE:]DIGital:FLAGn:POLarity <POSitive or NEGative>
to set the flag line's (FLG) polarity on port *n*.

[SOURCE:]DIGital:DATAn:POLarity <POSitive or NEGative>
to set the data lines polarity on port *n*.

Example DIG:DATA1:POL POS

Sets the polarity to positive on port 1 data lines, a TTL high will be input as a 1, or a bit set to 1 will output a TTL High level.

The *RST (reset) condition is positive polarity for control (CTL), flag (FLG), and data lines on all ports.

Using the Handshake Modes

Handshaking ensures correct transfer of data between devices. You must set both the mode and the timing to establish correct handshaking. SCPI commands support the following modes of handshaking:

- LEADing Edge
- TRAIling Edge
- PULSe
- PARTial
- STRobe
- NONE

These SCPI commands set the type of handshake mode used:

```
[SOURce:]DIGital:DATAn[:type]:HANDshake[:MODE] <mode>
```

```
[SOURce:]DIGital:HANDshaken[:MODE] <mode>
```

These SCPI commands set the timing of the handshake (where timing applies):

```
[SOURce:]DIGital:DATAn[:type]:HANDshake:DELay <time>
```

```
[SOURce:]DIGital:HANDshaken:DELay <time>
```

Handshake Modes

The operation of each handshake mode for input or output operations is described in the following subsections. In these discussions, only the FLG, CTL, and DATA lines are included. Other port control lines, controlled only through register access, are described in Appendix B of this manual.

LEADing Edge

The LEADing Edge handshake makes use of both the CTL and FLG lines. The input and output operations are described below.

INPUT		OUTPUT	
1	The Digital I/O module senses the FLG line and waits for READY.	1	The Digital I/O module checks the state of the FLG line (must be READY).
2	The Digital I/O module sets the I/O line HIGH.	2	The Digital I/O module sets the I/O line LOW.
3	The Digital I/O module sets CTL TRUE.	3	The Digital I/O module places the data on the data lines.
4	The peripheral senses the CTL line and places data on the data lines.	4	After waiting the programmed delay time, T_d , the Digital I/O module sets CTL to TRUE.
5	The peripheral sets the FLG line to BUSY indicating data is valid.	5	The peripheral senses the CTL line and sets the FLG line to BUSY while it latches the data.
6	The Digital I/O module senses the FLG line and latches the data.	6	When the Digital I/O module senses the FLG line in the BUSY state, it sets the CTL line to FALSE and monitors the FLG line.
7	The Digital I/O module returns CTL to FALSE.	7	When the peripheral returns the FLG line to READY (indicating it has latched the data) the next handshake can begin.
8	The peripheral senses the CTL line and returns the FLG line to READY.		

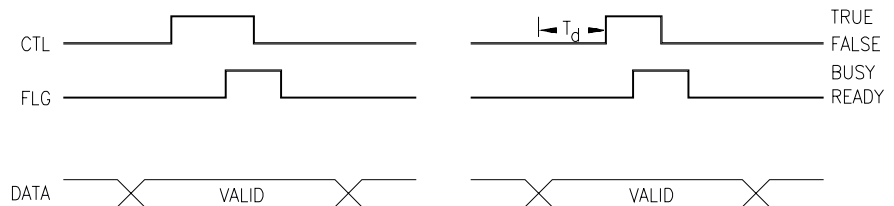

TRAILING Edge

The TRAILING Edge handshake makes use of both the CTL and FLG lines. The input and output operations are described below.

INPUT		OUTPUT	
1	The Digital I/O module senses the FLG line and waits for READY.	1	The Digital I/O module checks the state of the FLG line (must be READY).
2	The Digital I/O module sets the I/O line HIGH.	2	The Digital I/O module sets the I/O line LOW.
3	The Digital I/O module sets CTL TRUE.	3	The Digital I/O module places the data on the data lines.
4	The peripheral senses the CTL line and sets the FLG line to BUSY.	4	After waiting the programmed delay time, T_d , the Digital I/O module sets CTL to TRUE.
5	The Digital I/O module senses the FLG BUSY and sets the CTL line FALSE.	5	The peripheral senses the CTL line and sets the FLG line to BUSY while it latches the data.
6	The peripheral senses the CTL line change and places data on the data lines.	6	The peripheral returns the FLG line to READY indicating the end of data transfer.
7	The peripheral indicates the data is valid by returning the FLG line to READY.	7	The Digital I/O module senses the FLG line in the READY state and returns CTL to FALSE.
8	The Digital I/O module senses the FLG READY and latches the data.		

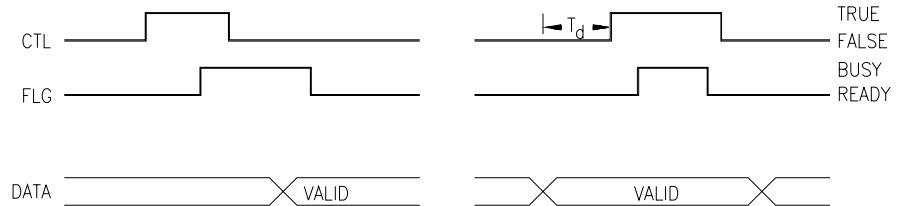

PULSe The PULSe handshake makes use of both the CTL and FLG lines. The input and output operations are described below.

INPUT		OUTPUT	
1	The Digital I/O module senses the FLG line and waits for READY.	1	The Digital I/O module checks the state of the FLG line (must be READY).
2	The Digital I/O module sets the I/O line HIGH.	2	The Digital I/O module sets the I/O line LOW.
3	The Digital I/O module sets CTL TRUE.	3	The Digital I/O module places the data on the data lines.
4	The peripheral senses the CTL line and sets the FLG line to BUSY.	4	After waiting the programmed delay time, T_d , the Digital I/O module sets CTL to TRUE.
5	The peripheral places the data on the data lines and indicates valid data by setting the FLG line to READY.	5	The Digital I/O module then waits another delay time, T_d , and sets the CTL line to FALSE.
6	The Digital I/O module senses the FLG READY, returns CTL to FALSE, and latches the input data.	6	The peripheral senses the CTL line change, sets the FLG line to BUSY and latches the data.
		7	When the data is entered, the peripheral returns the FLG line to READY.

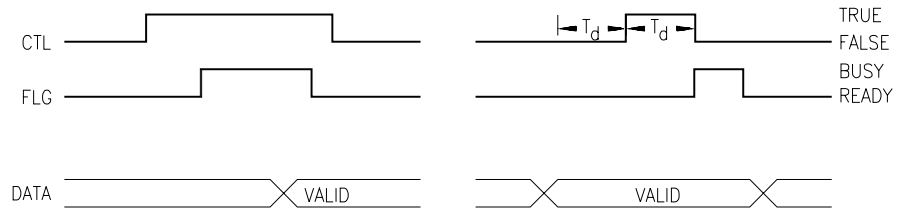

PARTial The PARTial handshake makes use of both the CTL and FLG lines. The input and output operations are described below.

INPUT		OUTPUT	
1	The Digital I/O module sets the I/O line HIGH.	1	The Digital I/O module sets the I/O line LOW.
2	The Digital I/O module sets CTL TRUE.	2	The Digital I/O module places the data on the data lines.
3	The peripheral senses the CTL line and sets the data lines.	3	After waiting the programmed delay time, T_d , the Digital I/O module sets CTL to TRUE.
4	The peripheral holds the FLG line READY for at least 250 nsecs and then sets the FLG line BUSY to indicate the data is valid.	4	The peripheral senses the CTL line change, sets the FLG line to READY for a minimum of 250 nsecs, latches the data, and sets the FLG line to BUSY.
5	The Digital I/O module senses the FLG line change to BUSY and latches the data.	5	The Digital I/O module senses the change of the FLG line and sets CTL to FALSE.
6	The Digital I/O module then sets the CTL line FALSE.		

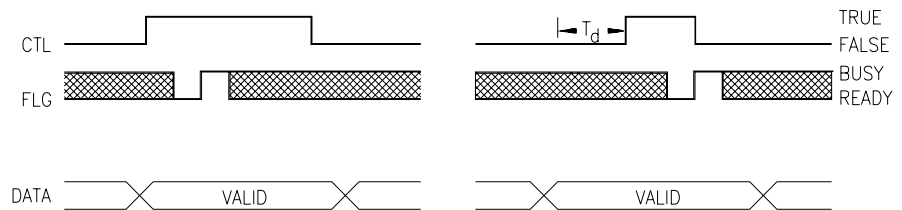

STRobe The STRobe handshake makes use the CTL line, but not the FLG line. The input and output operations are described below.

INPUT		OUTPUT	
1	The Digital I/O module sets the I/O line HIGH.	1	The Digital I/O module sets the I/O line LOW.
2	The Digital I/O module sets CTL TRUE.	2	The Digital I/O module places the data on the data lines.
3	The peripheral senses the CTL line and sets the data lines.	3	After waiting the programmed delay time, T_d , the Digital I/O module sets CTL to TRUE.
4	The Digital I/O module waits the programmed time delay, T_d , after setting CTL TRUE and then latches the data.	4	The peripheral senses the CTL line and latches the data.
5	The Digital I/O module then returns CTL to FALSE.	5	After waiting the programmed delay time, T_d , the Digital I/O module sets CTL to FALSE.

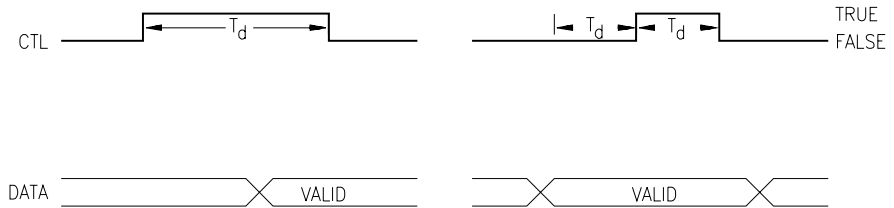

NONE When handshake is set to NONE, no control or flag lines are used. The Digital I/O module will input data or output data when programmed. The I/O line is set for output (LOW) before data is output. Data lines programmed for output will remain as output until another command is received.

Handshake NONE can be combined with the SCPI commands **MEASure:DIgital:FLAGn** and **[SOURCE:]DIgital:CONTRoln** to create custom handshakes.

Handshake Timing

Handshake timing is set through the SCPI commands **[SOURCE:]DIgital:DATA n [type]:HANDshake:DELay <time>** or **[SOURCE:]DIgital:HANDshakenDELay <time>**. Handshake timing is generally used for data output operations. Timing for data input affects only STRobe handshake modes.

Inputting Data Bytes and Bits

Data input is performed using commands in the SCPI **MEASure:DIGital:DATA n** subsystem. The returned value of an input will depend upon the POLarity programmed for the port.

Input operations can involve single bits, 8-bit bytes, or multiple bytes. Single bit input operations always return a decimal value of 0 or 1. Byte or multiple byte input operations always return numbers in decimal format.

Both Input and Output operations will attempt to complete the handshake mode set for the port and may "hang" if required handshake operations are not completed. To unhang a hung transfer issue a IEEE 488 selected device clear. In HP BASIC this is CLEAR 70918.

Bit Input

The SCPI command for inputting the state of a single bit on a data port is:

MEASure:DIGital:DATA n [:type]:BIT m

This command instructs the Digital I/O module to return a value of either 0 or 1, indicating the condition of bit m on port n , following completion of the input handshake. The value returned depends upon the programmed state of the port POLarity. In the default state (POSitive polarity) a TTL high on the data line specified by m will return a 1. For example, the following HP BASIC program code will request and display the state of data line 3 (bit-3) on port 4.

```
120 OUTPUT @Dio;"MEAS:DIG:DATA4:BIT3?"
130 ENTER @Dio;Bits
140 DISP "State of bit 3 on port 4" &Bits
```

Bit numbers range from 0 to 7 for single port operations. For multiple port operations, bit numbers can range from 0 to 31. The section "Multiple Port Operations" beginning on page 53 describes bit numbering for multiple port operations. For a single port, the data line numbers and bit numbers correspond:

D_{n-7}	D_{n-6}	D_{n-5}	D_{n-4}	D_{n-3}	D_{n-2}	D_{n-1}	D_{n-0}
Bit 7	Bit 6	Bit 5	Bit 4	Bit 3	Bit 2	Bit 1	Bit 0

In this manual the physical data lines are indicated as D_{n-1} . The n should be replaced with the port number for the input operation. For example, bit 3 of port 2 affects the state of data line D_{2-3} .

Byte Input

The SCPI command requesting an 8-bit byte from a data port is:

MEASure:DIGital:DATA n [:BYTE][:VALue]?

This command instructs the Digital I/O module to return a decimal value between 0 and 255, indicating the condition of the data lines on port n , following completion of the input handshake. The value returned depends upon the programmed state of the port POLarity. In the default state

(POSitive polarity) if all data lines are at a TTL low level, the returned value will be 0; if all lines are at a TTL high level, the returned value will be 255. For example, the following HP BASIC program code will request and display the decimal value of the data lines on port 2.

```

120 OUTPUT @Dio;"MEAS:DIG:DATA2?"
130 ENTER @Dio;Result
140 DISP "Decimal value of port 2 data lines ";Result

```

Port numbers range from 0 to 3 for single port operations. The section “Multiple Port Operations” beginning on page 53 describes port numbering for multiple port operations. For a single port, the returned decimal value will have the following correspondence to the port data lines:

D_{n-7}	D_{n-6}	D_{n-5}	D_{n-4}	D_{n-3}	D_{n-2}	D_{n-1}	D_{n-0}
Bit 7	Bit 6	Bit 5	Bit 4	Bit 3	Bit 2	Bit 1	Bit 0
MSB							LSB

Outputting Data Bytes and Bits

Data output is performed using the commands in SCPI **[SOURCE:]DIGital:DATA n** subsystem. The TTL levels of an output will depend upon the POLarity programmed for the port.

Output operations can involve single bits, 8-bit bytes, or multiple bytes. Single bit output operations always expect a value of 0 or 1. Byte or multiple byte output operations can accept numbers in decimal, hexadecimal, octal, or binary formats.

Both Input and Output operations will attempt to complete the handshake mode set for the port and may "hang" if required handshake operations are not completed. To unhang a hung transfer issue a IEEE 488 selected device clear. In HP BASIC this is CLEAR 70918.

Bit Output

The SCPI command for setting the state of a single bit on a data port is:

```
[SOURCE:]DIGital:DATA $n$ [:type]:BIT $m$  <value>
```

This command instructs the Digital I/O module to set bit m on port n to $\langle value \rangle$, using the output handshake. The actual TTL level set on the corresponding data line depends upon the programmed state of the port polarity. If $\langle value \rangle$ is 1 and the default polarity (POSitive polarity) is used, the data line corresponding to bit m will be set to a TTL high level. For example, the following HP BASIC program code will set the state of data line 2 (bit-2) on port 3 to a value of 1.

```
120 OUTPUT @Dio;"DIG:DATA3:BIT2 1"
```

Bit numbers range from 0 to 7 for single port operations. For multiple port operations, bit numbers can range from 0 to 31. The section “Multiple Port Operations” beginning on page 53 describes bit numbering for multiple port

operations. For a single port, the data lines number and bit numbers are:

Dn-7	Dn-6	Dn-5	Dn-4	Dn-3	Dn-2	Dn-1	Dn-0
Bit 7	Bit 6	Bit 5	Bit 4	Bit 3	Bit 2	Bit 1	Bit 0

In this manual the physical data lines are indicated as Dn-1. The *n* should be replaced with the port number for the input operation. For example, bit 3 of port 2 affects the state of data line D2-3.

Byte Output

The SCPI command syntax to send an 8-bit byte to a data port is:

[SOURCE:]DIGital:DATA*n*[:BYTE][:VALue] [<base>]<value>

This command instructs the Digital I/O module to set the port *n* data lines to <value> using the output handshake. The optional parameter <base> defines the numbering system to use to implement <value> on the data lines. There are four values allowed for <base>:

no parameter	decimal format
#H	hexadecimal format
#Q	octal format
#B	binary format

The TTL levels set on the data lines depends upon the programmed port polarity. In the default state (POSitive polarity) a TTL high level will be set for any bit set to 1. For example, the following four HP BASIC program lines all perform the same function and set the same data lines on port 3:

```
120 OUTPUT @Dio;"DIG:DATA3 170"
120 OUTPUT @Dio;"DIG:DATA3 #HAA"
120 OUTPUT @Dio;"DIG:DATA3 #Q252"
120 OUTPUT @Dio;"DIG:DATA3 #B10101010"
```

If port 3 is in the default POSitive polarity mode, the TTL levels set on the data lines by any of the program lines above will be:

TTL level	High	Low	High	Low	High	Low	High	Low
Data line	D3-7	D3-6	D3-5	D3-4	D3-3	D3-2	D3-1	D3-0

Port numbers range from 0 to 3 for single port operations. The section "Multiple Port Operations" beginning on page 53 describes port numbering and byte order for multiple port operations. For single port operations, the most significant bit is bit 7. The table below shows the bit numbers and data lines.

Dn-7	Dn-6	Dn-5	Dn-4	Dn-3	Dn-2	Dn-1	Dn-0
Bit 7	Bit 6	Bit 5	Bit 4	Bit 3	Bit 2	Bit 1	Bit 0
MSB							LSB

Multiple Port Operations

The Digital I/O module supports multiple port operations. You can combine operations using 2 or 4 ports with a single SCPI command. Multiple port operations are shown in the SCPI command syntax as the optional keyword **[*:type*]**. For example, this SCPI command syntax initiates a handshake and returns a value:

MEAS:DIG:DATA n [:*type*]?

The optional keyword **[*:type*]** is replaced by one of the following keywords:

- :BYTE** This keyword, or no keyword (default), is used for 8-bit port operations.
- :WORD** This keyword is used to combine 2 adjacent ports for 16-bit port operations.
- :LWORD** This keyword is used to combine all 4 ports for 32-bit operations.

The SCPI keyword **:DATA n** specifies the port to be used for operations by replacing n with the port number. Multiple port operations have fixed values allowed for n . For all operations, if n is omitted, port 0 is assumed. The values allowed for n are:

<u>Operation</u>	<u>Values of n</u>
:BYTE	0, 1, 2, or 3
:WORD	0 or 2
:LWORD	0

For example, the following HP BASIC program code will obtain a decimal value of the state of the 32 data lines contained in physical ports 0, 1, 2 and 3.

```
120 OUTPUT @Dio;"MEAS:DIG:DATA0:LWORD?"
130 ENTER @Dio;Result
140 DISP "32 bit longword at port 4 ";Result
```

Multiple Port Handshaking

The SCPI command syntax to establish a multiple port handshake and set handshake timing is:

[SOURCE:]DIGital:DATA n [:*type*]:HANDshake[:MODE] <*mode*>

[SOURCE:]DIGital:DATA n [:*type*]:HANDshake:DELay <*time*>

The optional keyword **[*:type*]**, parameter **DATA n** , handshake **<*mode*>**, and handshake delay **<*time*>**, are all described earlier in this chapter. See the sections “Handshake Modes”, “Handshake Timing”, and the introduction to “Multiple Port Operations” for explanations of these keywords and parameters.

Multiple port handshaking has the following two abnormalities regarding the CTL and FLG control lines:

- **Input or Output handshaking using the CTL line.** The CTL line is set TRUE or FALSE sequentially on all ports involved in the operation, from the lowest numbered port to the highest numbered port. A slight time delay exists between each port setting the CTL line TRUE or FALSE. When using handshaking on multiple port operations, use the highest numbered port CTL line to ensure correct data transfer.
- **Input or Output handshaking using the FLG line.** A change in the state of any FLG line on any combined port continues the handshake operation for all the combined ports. FLG lines can also be electrically combined through a jumper setting (see Chapter 2).

Multiple Port Input/Output

Data input is performed using commands in the SCPI **MEASure:DIgital:DATA*n*** subsystem. Data output is performed using the commands in SCPI **[SOURce:]DIgital:DATA*n*** subsystem.

The returned value of an input, or the TTL levels of an output, will depend upon the POLarity programmed.

Both Input and Output operations will attempt to complete the handshake mode set and may "hang" if required handshake operations are not completed.

The sections "Byte Input" and "Byte Output", earlier in this chapter, describe operations that also apply to multiple port commands. The values used for input and output operations depend upon the **[:type]** used in the command. Values for multiple port output operations are given below.

	Input Operations		Output Operations	
	Format	Range	Format	Range
BYTE	Decimal	0 to 255	Decimal #H #Q #B	-128 to 255 00 to FF 000 to 377 8-bits
WORD	Decimal	-32768 to 32767	Decimal #H #Q #B	-32768 to 32767 0000 to FFFF 00000 to 177777 16-bits
LWORD	Decimal	-2147483648 to 2147483647	Decimal #H #Q #B	-2147483648 to 2147483647 00000000 to FFFFFFFF 0 to 3777777777 32-bits

Table 4-1 shows allowable port combinations for each value of **[:type]**.

You can combine multiple port operations on the same Digital I/O module. For example, you could define two independent 16-bit ports at port 0 and port 2.

Table 4-1. Port Combinations for [:type] Values

8-bit (BYTE) operations				
Port #	0	1	2	3
Bit Designations	7–0	7–0	7–0	7–0
Data Lines	D0_7–D0_0	D1_7–D1_0	D2_7–D_0	D3_7–D3_0
Parameters	<value>	<value>	<value>	<value>
16-bit (WORD) operations				
Port #	0		2	
Bit Designations	15–8	7–0	15–8	7–0
Data Lines	D0_7–D0_0	D1_7–D1_0	D2_7–D_0	D3_7–D3_0
Parameters	<value>		<value>	
32-bit (LWORD) operations				
Port #	0			
Bit Designations	31–24	23–16	15–8	7–0
Data Lines	D0_7–D0_0	D1_7–D1_0	D2_7–D_0	D3_7–D3_0
Parameters	<value>			

Notes:

Chapter 5

HP E1330B Digital I/O Module Command Reference

Using This Chapter

This chapter describes Standard Commands for Programmable Instrumentation (SCPI) and summarizes IEEE 488.2 Common (*) Commands applicable to the Digital I/O Module.

- Command Types Page 57
- SCPI Command Reference Page 60
- IEEE 488.2 Common Commands Page 98
- Command Quick Reference Page 99

Command Types

Commands are separated into two types: IEEE 488.2 Common Commands and SCPI Commands.

Common Command Format

The IEEE 488.2 standard defines the Common Commands that perform functions like reset, self-test, status byte query, etc. Common Commands are four or five characters in length, always begin with the asterisk character (*), and may include one or more parameters. The command keyword is separated from the first parameter by a space character. Some examples of Common Commands are shown below:

*RST *ESR 32 *STB?

SCPI Command Format

SCPI commands perform functions like closing switches, making measurements, querying instrument states, or retrieving data. A subsystem command structure is a hierarchical structure that usually consists of a top level (or root) command, one or more lower level commands, and their parameters. The following example shows part of a typical subsystem:

```
[SOURce:]
  DIGital
    :DATA $n$ 
      [:VALue]?
      :BIT $m$ ?
```

[SOURce:] is the root command, DIGital is a second level command, :DATA n is a third level command (where n is the port number 0–3), and [:VALue] and :BIT m are fourth level commands (where m is the queried bit location).

Command Separator

A colon (:) always separates one command from the next lower level command. This is illustrated as follows:

```
MEASure:DIGital:DATAn:VALue?
```

Colons separate the root command from the second level (MEASure:DIGital) and the second from third level (DIGital:DATA*n*), and so forth.

Abbreviated Commands

The command syntax shows most commands as a mixture of upper and lower case letters. The upper case letters indicate the abbreviated spelling for the command. For shorter program lines, send the abbreviated form. For better program readability, you may send the entire command. The instrument will accept either the abbreviated form or the entire command.

For example, if the command syntax shows MEASure, then MEAS and MEASURE are both acceptable forms. Other forms of MEASure, such as MEASU or MEASUR will generate an error. You may use upper or lower case letters. Therefore, MEASURE, measure, and MēAsUrE are all acceptable.

Command keywords can be entered in their full form, as shown above, or can be entered in their short form. In this manual, the entry required in short form commands is always capitalized. The short form is generally used for examples in this manual.

Implied Commands

Implied commands are those which appear in square brackets ([]) in the command syntax. (Note that the brackets are not part of the command and are not sent to the instrument.) Suppose you send a second level command but do not send the preceding implied command. In this case, the instrument assumes you intend to use the implied command and it responds as if you had sent it. Examine this excerpt from the [SOURce:] subsystem shown below:

```
[SOURce:]  
  DIGital  
    :DATAn  
      [:VALue] <parameter>  
      :BITm <parameter>
```

Both the root command [SOURce:], and forth level command [:VALue], are implied commands. To set the instrument to output a logical 1 to bit 0 of port 3, you may send either:

```
SOURce:DIGital:DATA3:BIT0 1    or    DIGital:DATA3:BIT0 1
```

Note

You must include a space between the keywords and any parameters.

Parameters **Parameter Types.** The following table contains explanations and examples of parameter types you might see later in this chapter.

Parameter Type	Explanations and Examples
Numeric	Accepts all commonly used decimal representations of numbers including optional signs, decimal points, and scientific notation. 123, 123E2, -123, -1.23E2, .123, 1.23E-2, 1.23000E-01. Special cases include MIN, MAX, and DEF. MIN selects minimum value available, MAX selects maximum value available, and DEF selects default or reset value.
Boolean	Represents a single binary condition that is either true or false. 1 or ON; 0 or OFF.
Discrete	Selects from a finite number of values. These parameters use mnemonics to represent each valid setting. An example is the DIGital:CONTRoln:POLarity < <i>polarity</i> > command where <i>polarity</i> can be either POS or NEG.

Optional Parameters. Parameters shown within square brackets ([]) are optional parameters. (Note that the brackets are not part of the command and are not sent to the instrument.) If you do not specify a value for an optional parameter, the instrument chooses a default value. For example, consider the DISPLAY:MONitor:PORT? [<MIN|MAX|DEF>] command. If you send the command without specifying a parameter, the command returns the state of the port last addressed. If you send the MIN parameter or the DEF parameter, the command returns 0. If you send the MAX parameter, the command returns 3. Be sure to place a space between the command and the parameter.

Keyword Substitutions

Some commands indicate a keyword substitution by showing the keyword bold type with an all lower case keyword. For example, in the SCPI command MEASure:DIGital:DATA*n*[:**type**] the keyword [**type**] should be replaced by one of these parameters:

:BYTE
:WORD
:LWORD

Linking Commands

Linking IEEE 488.2 Common Commands with SCPI Commands.

Use a semicolon between the commands. For example:

*RST;DIG:CONT2 1 *or* DIG:CONT2:POL POS;*OPC?

Linking Multiple SCPI Commands.

Use both a semicolon and a colon between the commands. For example:

DIG:DATA2:POL NEG;;DIG:DATA2:BIT3 1

SCPI Command Reference

This section describes the Standard Commands for Programmable Instruments (SCPI) commands for the Digital I/O Module. Commands are listed alphabetically by subsystem and within each subsystem.

The DISPlay subsystem turns on the Monitor mode. Monitor mode enables the HP E1301 Mainframe display, or an external terminal connected to either a B-size or a C-size mainframe. Parameters related to the state of the data and control lines are shown. Refer to the appropriate *Command Module User's Guide* (HP E1405/E1406) for supported terminal types. The parameters displayed are:

- port number
- polarity
- handshake mode
- state of the control line
- state of the flag line
- values on the data lines in both decimal and hexadecimal

Syntax

```
DISPlay
:MONitor
:PORT <port>[AUTO|MIN|MAX|DEF]
:PORT? [<MAX|MIN|DEF>]
[:STATe] <mode>
[:STATe]?
```

:MONitor:PORT

DISPlay:MONitor:PORT <port>[AUTO|MIN|MAX|DEF] sets the displayed port number.

Parameters

Parameter Name	Parameter Type	Range of Values	Default
<port>	Numeric or Discrete	none, 0 through 3 MIN, MAX, AUTO, DEF	AUTO

Comments

- In the **AUTO** mode of operation, the display shows the state of the port last programmed. **MIN** sets port 0. **MAX** sets port 3. No parameter or **DEF** sets the **AUTO** mode of operation.
- **Related Commands:** DISPlay:MONitor[:STATe], DISPlay:MONitor:PORT?
- ***RST Condition:** DISPlay:MONitor:PORT AUTO

Example **DISP:MON:PORT 3** sets the port to be monitored to 3.

:MONitor:PORT?

DISPlay:MONitor:PORT? [<MAX|MIN|DEF>], with no parameter, returns a decimal number indicating the port being monitored. If **AUTO** was selected as the port parameter in the **DISP:MON:PORT AUTO** command, the query returns a **-1**. If **DEF** is specified, the query always returns **-1**. If **MAX** is specified, the query returns the maximum port (always **3**). If **MIN** is specified, the query returns the minimum port (always **0**).

Parameters

Parameter Name	Parameter Type	Range of Values	Default
MAX MIN DEF	Optional or Discrete	None MAX, MIN, or DEF	None

Comments

- **Related Commands:** DISPlay:MONitor:PORT, DISPlay:MONitor[:STATe]
- ***RST Condition:** Not applicable.

Example **DISP:MON:PORT?** identifies the port being monitored.

:MONitor[:STATe]

DISPlay:MONitor[:STATe] <mode> turns the monitor mode ON or OFF.

Parameters

Parameter Name	Parameter Type	Range of Values	Default
<mode>	Boolean	0 1 ON OFF	0 OFF

Comments

- **DISPlay:MONitor ON** or **DISPlay:MONitor 1** enables the terminal display of port parameters. The parameters are updated to the terminal following each new command accessing a port. **DISPlay:MONitor OFF** or **DISPlay:MONitor 0** turns the monitor mode OFF.
- A keyboard entry at the terminal will set **DISP:MON OFF**.
- This command does not perform an actual readback of the port data lines. It returns the last programmed state of the data lines.
- **Related Commands:** DISPlay:MONitor:PORT, DISPlay:MONitor:PORT?
- ***RST Condition:** DISPlay:MONitor[:STATe] OFF|0

Example **DISP:MON ON** displays the state of the last port programmed.

:MONitor[:STATE]?

DISPlay:MONitor[:STATE]? returns a number indicating whether the monitor mode is enabled or disabled: **1** = ON, **0** = OFF.

Parameters None.

The MEASure subsystem defines the command set for the Digital I/O Module input statements.

Syntax

```

MEASure
  :DIGital
    :DATAn
      [:BYTE]
        :BITm?
        :TRACe <name>
        [:VALue]?
    :LWORD
      :BITm?
      :TRACe <name>
      [:VALue]?
    :WORD
      :BITm?
      :TRACe <name>
      [:VALue]?
  :FLAGn?
  
```

:DIGital:DATA*n*[:type]:BIT*m*?

MEASure:DIGital:DATA*n*:BYTE:BIT*m*? reads the state on bit *m* of 8-bit port *n* after the completion of the handshake.

MEASure:DIGital:DATA*n*:WORD:BIT*m*? reads the state on bit *m* of 16-bit port *n* after the completion of the handshake.

MEASure:DIGital:DATA*n*:LWORD:BIT*m*? reads the state on bit *m* of the 32-bit port *n* after the completion of the handshake.

Parameters

Parameter Name	Parameter Type	Range of Values	Default
DATA <i>n</i>	Numeric	BYTE	none, 0, 1, 2, or 3
		WORD	none, 0 or 2
		LWORD	none or 0
BIT <i>m</i>	Numeric	BYTE	0–7
		WORD	0–15
		LWORD	0–31

Comments

- Input data is always assumed to be in binary format, since only a single bit of data is being read. The command returns either a 0 or 1.
- The keyword **:LW32** may be used instead of **:LWORD** when using the downloaded version of the SCPI driver.
- **:DATA*n*** is the keyword used for commands relating to the data at port *n*. The port number *n* must be the last character of the keyword without spaces.

- If *n* is omitted, bit 0 is used.
- **:BIT*m*** is the keyword that specifies the bit read by this command. Like the **:DATA*n*** keyword, no space can be between the keyword **:BIT** and the bit number *m* parameter.
- **Related Commands:** [SOURce:]DIGital:DATA*n*:POLarity
- ***RST Condition:** Set to input on all ports.

Example MEAS:DIG:DATA2:BIT4? reads port 2, bit 4 (data line D2–4).

:DIGital:DATA*n*[:type]:TRACe

MEASure:DIGital:DATA*n*[:BYTE]:TRACe <name> reads 8-bit port *n* after the completion of the handshake and stores the data block in <name>.

MEASure:DIGital:DATA*n*:WORD:TRACe <name> reads 16-bit port *n* after the completion of the handshake and stores the data block in <name>.

MEASure:DIGital:DATA*n*:LWORD:TRACe <name> reads the 32-bit port *n* after the completion of the handshake and stores the data block in <name>.

Parameters

Parameter Name	Parameter Type	Range of Values	Default
DATA <i>n</i>	Numeric	BYTE none, 0, 1, 2, or 3 WORD none, 0 or 2 LWORD none or 0	0
<name>	String	previously defined block name (max 12 characters)	None

Comments

- **:TRACe <name>** is the keyword (maximum 12 characters) that specifies the block where the data should be stored. This block must have been previously defined by the [SOURce:]DIGital:TRACe:DEFine command.
- This command will completely fill the named block. The defined block size sets the amount of data read. The block size must be an integer multiple of the **[:type]** keyword used in this command. For example, valid block sizes for **:LWORD** are 4, 8, 12, 16, etc.
- Input data is returned in decimal format. Other formats are not supported for input, however, data output may be in binary, octal, decimal or hexadecimal.
- The keyword **:LW32** may be used instead of **:LWORD** when using the download version of the SCPI driver.
- **:DATA*n*** is the keyword used for commands relating to the data at port *n*. The port number *n* must be the last character of the keyword without spaces.
- **Related Commands:** MEASure:DIGital:DATA*n*[:VALue]?, [SOURce:]DIGital:TRACe:DEFine
- ***RST Condition:** Set to input on all ports.

Example MEAS:DIG:DATA0:WORD:TRACe *first_block* reads 16-bit data from port 0 and stores it in the predefined user memory location *first_block*.

:DIGital:DATA n [:type][:VALue]?

MEASure:DIGital:DATA n [:BYTE][:VALue]? reads one byte from 8-bit port n after the completion of the handshake and returns a decimal number between 0 and 255.

MEASure:DIGital:DATA n :WORD[:VALue]? reads 2 bytes (one word) from 16-bit port n after the completion of the handshake and returns a decimal number between -32768 and 32767.

MEASure:DIGital:DATA n :LWORD[:VALue]? reads 4 bytes (one long word) from the 32-bit port n after the completion of the handshake and returns a decimal number between -2^{31} and $(2^{31}-1)$.

Parameters

Parameter Name	Parameter Type	Range of Values	Default
DATA n	Numeric	BYTE none, 0, 1, 2, or 3 WORD none, 0 or 2 LWORD none or 0	0

Comments

- Input data from the Digital I/O is returned in decimal format. Other formats are not supported for input, however, data output to the Digital I/O may be in binary, octal, decimal, or hexadecimal.
- The keyword **:LW32** may be used instead of **:LWORD** when using the downloaded version of the SCPI driver.
- Chapter 4 - “Understanding the HP E1330B Digital I/O Module” describes the byte order of multiple byte reads.
- **:DATA n** is the keyword used for commands relating to the data at port n . The port number n must be the last character of the keyword without spaces.
- If n is omitted, port 0 is used.
- **Related Commands:** [SOURce:]DIGital:DATA n [:type][:VALue], MEASure:DIGital:DATA n [:type]:BIT m ?
- ***RST Condition:** Set to input positive true on all ports.

Examples

MEAS:DIG:DATA1? reads 8-bit port 1 data. If all data lines are set to 1, this command returns the value **255**.

MEAS:DIG:DATA0:LWORD? reads 32-bit port 0 data. If all data lines are set to 1, this command returns the value **-1**.

:DIGital:FLAG*n*?

MEASure:DIGital:FLAG*n*? reads the status of the flag line on port *n* and returns a 0 or 1 to show whether a peripheral has set the flag line to READY or BUSY.

Parameters

Parameter Name	Parameter Type	Range of Values	Default
FLAG <i>n</i>	Numeric	none, 0, 1, 2, or 3	0

Comments

- **MEASure:DIGital:FLAG*n*?** is used to implement custom handshakes. The handshake mode must be set to **NONE** to use these commands.
- **:FLAG*n*** is the keyword used for commands relating to the flag line at port *n*. The port number *n* must be the last character of the keyword without spaces.
- If *n* is omitted, **FLAG0** is used.
- **MEASure:DIGital:FLAG*n*?** may be affected by the condition of the flag combining jumpers. Refer to Chapter 2 for additional information.
- **Related Commands:** [SOURce:]DIGital:CONTRol*n*:POLarity?, [SOURce:]DIGital:CONTRol*n*[:VALue], [SOURce:]DIGital:FLAG*n*:POLarity, [SOURce:]DIGital:FLAG*n*:POLarity?

Example **MEAS:DIG:FLAG1?** reads the port 1 flag line.

MEMory Subsystem

The MEMory subsystem defines the command set for enabling the use of external VME memory for storing traces and macros. The addressable range is #H200000 through #HDFFFF8 in A24 space.

Syntax

```
MEMory
:DElete
:MACRo <name>
:VME
:ADDReSS [<base>]<address>
:ADDReSS? [MIN|MAX]
:SIze [<base>]<size>
:SIze? [MIN|MAX]
:STATe <state>
:STATe?
```

:DElete:MACRo

MEMory:DElete:MACRo <name> deletes a single macro previously recorded using the ***DMC** common command.

Parameters

Parameter Name	Parameter Type	Range of Values	Default
<name>	String	Previously defined block name (maximum 12 characters)	None

Comments

- *name* must have been previously defined by a ***DMC** (Define Macro) common command.
- The maximum length for *name* is 12 characters.
- This command purges a single, specific macro; the ***PMC** common command purges all macros.

Example **MEM:DEL:MACR test_macro** deletes macro named *test_macro* previously defined using the ***DMC** common command.

:VME:ADDRess

MEMory:VME:ADDRess [*<base>*]*<address>* establishes the address of add-on VME memory in the system which can then be used to store block data in commands with the **:TRACe** keyword.

Parameters

Parameter Name	Parameter Type	Range of Values	Default
<i><base></i>	Discrete	none, #H, #Q, or #B	Decimal
<i><address></i>	Numeric or Discrete	200000 ₁₆ –DFFFF8 ₁₆ MIN or MAX	None

Comments

- **base** specifies the numeric format as decimal, hexadecimal, octal, or binary. IEEE-488.2 specifies the following values for this parameter:
 - Decimal = no parameter
 - Hexadecimal = #H
 - Octal = #Q
 - Binary = #B
- Valid values for **base** and **address** are #H200000 (2,097,152 decimal) through #HDFFFF8 (14,680,056 decimal).
- For this memory to actually be used it must also have a defined length and have been turned ON using the **MEMory:VME:STATe** command.
- **Related Commands:** [SOURce:]DIGital:TRACe:DEFine, MEMory:VME:ADDRess?, MEMory:VME:SIZE, MEMory:VME:STATe
- ***RST Condition:** #H200000

Example **MEM:VME:ADDR #H200000** sets the starting VME address to 200000₁₆.

:VME:ADDRess?

MEMory:VME:ADDRess? [*<MIN|MAX>*] queries for the current VME memory address. The optional parameter lets you query for the fixed minimum or maximum address.

Parameters

Parameter Name	Parameter Type	Range of Values	Default
MIN MAX	Discrete	none, MIN, or MAX	None

Comments

- This command always returns the address in decimal format.
- The address returned using **MIN** is always **2,097,152**.
- The address returned using **MAX** is always **14,680,056**.
- **Related Commands:** MEMory:VME:ADDRess, MEMory:VME:SIZE?, MEMory:VME:STATe?

:VME:SIZE

MEMory:VME:SIZE [*base*]*size* sets the size, in bytes, of the external memory.

Parameters

Parameter Name	Parameter Type	Range of Values	Default
<i>base</i>	Discrete	none, #H, #Q, or #B	Decimal
<i>size</i>	Numeric or Discrete	000000 ₁₆ - C00000 ₁₆ or MIN or MAX	None None

Comments

- Address plus *size* must not exceed #HE00000.
- *base* specifies the numeric format as decimal, hexadecimal, octal, or binary. IEEE-488.2 specifies the following values for this parameter:
 - Decimal = no parameter
 - Hexadecimal = #H
 - Octal = #Q
 - Binary = #B
- **Related Commands:** MEMory:VME:ADDRess?, MEMory:VME:SIZE?, MEMory:VME:STATe?
- ***RST Condition:** #H000000.

:VME:SIZE?

MEMory:VME:SIZE? [<MIN|MAX>] queries for the current VME memory size. The optional parameter lets you query for the fixed maximum or minimum VME memory size.

Parameters

Parameter Name	Parameter Type	Range of Values	Default
MIN MAX	Discrete	none, MIN, or MAX	None

Comments

- This command always returns the memory size in decimal format.
- The size returned using **MIN** is always **0**.
- The size returned using **MAX** is always **12582912**.
- **Related Commands:** MEMory:VME:ADDRess?, MEMory:VME:SIZE, MEMory:VME:STATe?

:VME:STATe

MEMory:VME:STATe <state> enables/disables the use of VME memory for storage.

Parameters

Parameter Name	Parameter Type	Range of Values	Default Value
<state>	Boolean	0 1 ON OFF	0 OFF

Comments

- **Related Commands:** [SOURCE:]DIGital:TRACe:DEFine, [SOURCE:]DIGital:TRACe[:DATA], MEMory:VME:ADDRESS, MEMory:VME:SIZE
- ***RST Condition:** Set to OFF.

Example **MEM:VME:STAT ON** enables access to the VME memory.

:VME:STATe?

MEMory:VME:STATe? queries the state of the external memory.

Parameters None.

Comments This command returns **0** or **1**, indicating external memory is OFF or ON.

Related Commands: MEMory:VME:ADDRESS?, MEMory:VME:SIZE?

[SOURce:] Subsystem

The [SOURce:] subsystem defines the command set for the Digital I/O module output statements. It also defines the state and polarity of the control line (CTL), the polarity of the flag line (FLG), the handshaking mode, and handshake delay for both data input and output. The root command, [SOURce:], is optional.

```
[SOURce:]
  DIGital
    :CONTRoln
      :POLarity <POS|NEG>
      :POLarity?
      [:VALue] <0|1 or ON|OFF>
      [:VALue]?
    :DATAn
      [:BYTE]
        :BITm <0|1>
        :BITm?
        :HANDshake
          :DELay <time>
          :DELay?
          [:MODE] <NONE|LEADing|TRAILing
            |PULSe|PARTial|STRobe>
          [:MODE]?
        :POLarity <POS|NEG>
        :POLarity?
        :TRACe <name>
        [:VALue] [<base>]<value>
        [:VALue]?
      :LWORD
        :BITm <0|1>
        :BITm?
        :HANDshake
          :DELay <time>
          :DELay?
          [:MODE] <NONE|LEADing|TRAILing
            |PULSe|PARTial|STRobe>
          [:MODE]?
        :POLarity <POS|NEG>
        :POLarity?
        :TRACe <name>
        [:VALue] [<base>]<value>
        [:VALue]?
```

```

[SOURce:]
  DIgital
    :DATAn
      :WORD
        :BITm <0|1>
        :BITm?
        :HANDshake
          :DELay <time>
          :DELay?
          [:MODE] <NONE|LEADing|TRAILing
            |PULSe|PARTial|STRobe>
          [:MODE]?
        :POLarity <POS|NEG>
        :POLarity?
        :TRACe <name>
        [:VALue] [<base>]<value>
        [:VALue]?
      :FLAGn
        :POLarity <POS|NEG>
        :POLarity?
      :HANDshaken
        :DELay <time>
        :DELay?
        [:MODE] <NONE|LEADing|TRAILing
          |PULSe|PARTial|STRobe>
        [:MODE]?
      :ION?
      :TRACe
        :CATalog?
        [:DATA] <name>,<block_data>
        [:DATA]? <name>
        :DEFine <name>,<size>,<[fill]>]
        :DEFine? <name>
        :DELete
          :ALL
          [:NAME] <name>

```

DIGital:CONTRol*n*:POLarity

[SOURce:]DIGital:CONTRol*n*:POLarity <*polarity*> sets the CTL line voltage level for logical true in port *n* to either TTL high for **POSitive** polarity or TTL low for **NEGative** polarity.

Parameters

Parameter Name	Parameter Type	Range of Values	Default
CONTRol <i>n</i>	Numeric	none, 0, 1, 2, or 3	0
< <i>polarity</i> >	Discrete	POSitive or NEGative	None

Comments

- Control lines are always accessed by their 8-bit port number.
- **:CONTRol*n*** is the keyword used for commands relating to the control (CTL) line at port *n*. The port number *n* must be the last character of the keyword without spaces.
- If *n* is omitted, port 0 is used.
- The control line is used with the flag line to handshake data to and from peripherals.
- **Related Commands:** [SOURce:]DIGital:CONTRol*n*:POLarity?, [SOURce:]DIGital:CONTRol*n*:VALue], [SOURce:]DIGital:FLAG*n*:POLarity, [SOURce:]DIGital:FLAG*n*:POLarity?
- ***RST Condition:** POLarity = POSitive.

Example DIG:CONT0:POL POS sets logical true to TTL high on port 0 control line.

DIGital:CONTRol*n*:POLarity?

[SOURce:]DIGital:CONTRol*n*:POLarity? returns a three character string, either POS or NEG, indicating the logical true condition of the control (CTL) line at port *n*.

Parameters

Parameter Name	Parameter Type	Range of Values	Default
CONTRol <i>n</i>	Numeric	none, 0, 1, 2, or 3	0

Comments

- **:CONTRol*n*** is the keyword used for commands relating to the control (CTL) line at port *n*. The port number *n* must be the last character of the keyword without spaces.
- If *n* is omitted, port 0 is used.

Example DIG:CONT0:POL? queries the state of the logical true condition on port 0.

DIGital:CONTRol*n*[:VALue]

[SOURCE:]DIGital:CONTRol*n*[:VALue] <value> sets or clears the control line on the selected port *n*.

Parameters

Parameter Name	Parameter Type	Range of Values	Default
CONTRol <i>n</i>	Numeric	none, 0, 1, 2, or 3	0
<value>	Boolean	0 or 1, OFF or ON	None

Comments

- This command is used to create custom handshakes when the **HANDshake** is set to **NONE**.
- **:CONTRol*n*** is the keyword used for commands relating to the control (CTL) line at port *n*. The port number *n* must be the last character of the keyword without spaces.
- The control line is used with the flag line to handshake data to and from peripherals.
- **Related Commands:** [SOURCE:]DIGital:CONTRol*n*:POLarity, [SOURCE:]DIGital:CONTRol*n*:POLarity?, [SOURCE:]DIGital:FLAG*n*:POLarity, [SOURCE:]DIGital:FLAG*n*:POLarity?
- ***RST Condition:** Clears the control line; i.e., sets the control line to logical 0.

Example DIG:CONT2 1 sets the 8-bit port 2 control line true.

DIGital:CONTRol*n*[:VALue]?

[SOURCE:]DIGital:CONTRol*n*[:VALue]? reads the state of the control line on port *n* and returns a 0 or 1, indicating the logical condition of the CTL line.

Parameters

Parameter Name	Parameter Type	Range of Values	Default
CONTRol <i>n</i>	Numeric	none, 0, 1, 2, or 3	0

Comments

- This command is only available when using the downloaded SCPI driver.
- This command is used to create custom handshakes when the **HANDshake** is set to **NONE**.
- The condition of the CTL line returned by this command is the logical true value set by the **DIGital:CONTRol*n*:POLarity** command.

Example DIG:CONT2? returns the current state of the 8-bit port 2 control line.

DIGital:DATA n [:type]:BIT m

[SOURce:]DIGital:DATA n [:BYTE]:BIT m <value> sets bit m on 8-bit port n .

[SOURce:]DIGital:DATA n :WORD:BIT m <value> sets bit m on 16-bit port n .

[SOURce:]DIGital:DATA n :LWORD:BIT m <value> sets bit m on 32-bit port n .

Parameters

Parameter Name	Parameter Type	Range of Values	Default
DATA n	Numeric	BYTE none, 0, 1, 2, or 3 WORD none, 0 or 2 LWORD none or 0	0
BIT m	Numeric	BYTE 0–7 WORD 0–15 LWORD 0–31	0
<value>	Numeric	0 or 1	None

Comments

- **:DATA n** and **:BIT m** are the keywords used to write data to port n and bit m . The port number n and bit number m must be the last character of the keyword without spaces.
- For 16-bit operations using **:WORD**, n must be 0 or 2.
- For 32-bit operations using **:LWORD**, n must be 0.
- The keyword **:LW32** may be used instead of **:LWORD** when using the download version of the SCPI driver.
- **Related Commands:** [SOURce:]DIGital:DATA n :POLarity, [SOURce:]DIGital:DATA n :VALue]
- ***RST Condition:** All ports are set for data input.

Example DIG:DATA3:BIT4 1 sets bit 4 (the 5th bit) of port 3 to logical 1.

DIGital:DATA n [:type]:BIT m ?

[SOURCE:]DIGital:DATA n [:BYTE]:BIT m ? returns a **0** or **1** indicating the current programmed state of bit m on 8-bit port n .

[SOURCE:]DIGital:DATA n :WORD:BIT m ? returns a **0** or **1** indicating the current programmed state of bit m on 16-bit port n .

[SOURCE:]DIGital:DATA n :LWORD:BIT m ? returns a **0** or **1** indicating the current programmed state of bit m on 32-bit port n .

Parameters

Parameter Name	Parameter Type	Range of Values	Default
DATA n	Numeric	BYTE none, 0, 1, 2, or 3 WORD none, 0 or 2 LWORD none or 0	0
BIT m	Numeric	BYTE 0–7 WORD 0–15 LWORD 0–31	0

Comments

- This command is only available when using the downloaded SCPI driver.
- This command performs a readback of the data line register, not the actual condition of the data lines.
- The keyword **:LW32** may be used instead of **:LWORD** when using the download version of the SCPI driver.
- **:DATA n** and **:BIT m** are the keywords used to write data to port n and bit m . The port number n and bit number m must be the last character of the keyword without spaces.
- For 16-bit operations using **:WORD**, n must be 0 or 2.
- For 32-bit operations using **:LWORD**, n must be 0.
- **Related Commands:** [SOURCE:]DIGital:DATA n :POLarity, [SOURCE:]DIGital:DATA n [:VALue]

Example **DIG:DATA3:BIT4:VAL?** returns a **0** or **1** indicating the last programmed state of bit 4 on port 3.

DIGital:DATA n [:type]:HANDshake:DELay

[SOURCE:]DIGital:DATA n [:BYTE]:HANDshake:DELay *<time>* sets the delay between data output and control line for data output at 8-bit port n .

[SOURCE:]DIGital:DATA n :WORD:HANDshake:DELay *<time>* sets the delay between data output and control line for data output at 16-bit port n .

[SOURCE:]DIGital:DATA n :LWORD:HANDshake:DELay *<time>* sets the delay between data output and the control line for data output at 32-bit port n .

Parameters

Parameter Name	Parameter Type	Range of Values	Default
DATA n	Numeric	BYTE none, 0, 1, 2, or 3 WORD none, 0 or 2 LWORD none or 0	0
<i><time></i>	Numeric	2 μ s to 15 μ s 20 μ s to 150 μ s 200 μ s to 1.5 ms 2ms to 15ms	None
	Discrete	MIN MAX DEF	

Comments

- This command is related to the handshake mode in use. Chapter 3 describes the handshake modes and timing.
- This command sets strobe pulse width for input and output STrobe handshakes.
- The delay time must be set to the same value on all ports used in a multiple port operation.
- **MAX** sets a 15 ms delay. **DEF** sets 2 μ s delay. **MIN** sets 0.0 delay and is illegal for PULse or STRobe handshake modes.
- **DIGital:DATA n :HANDshake[:MODE] NONE** command ignores any programmed delay time. For all other modes of handshaking, 2 μ s is the minimum recommended.
- Specific bands of delay settings are NOT allowed. These are:

0 μ s > <i><time></i> <2 μ s	150 μ s > <i><time></i> <200 μ s
15 μ s > <i><time></i> <20 μ s	1.5ms > <i><time></i> <2.0ms

 The controller uses a rounded-up value for *<time>* if these values are specified.
- The keyword **:LW32** may be used instead of **:LWORD** when using the download version of the SCPI driver.
- **DIGital:DATA n [:type]:HANDshake** is the sequence used for commands relating to data handshaking at ports defined by n . The port number n must be the last character of the keyword without spaces.
- **Related Commands:** [SOURCE:]DIGital:CONTRol n :POLarity, [SOURCE:]DIGital:CONTRol n :VALue, [SOURCE:]DIGital:FLAG n :POLarity, [SOURCE:]DIGital:HANDshaken n :MODE]
- ***RST Condition:** Delay is set to 2 μ s.

Example DIG:HAND3:DEL .005 sets the delay between the data output and the assertion of the control line to true on 8-bit port 3 to 5ms.

DIGital:DATA n [:type]:HANDshake:DELay?

[SOURce:]DIGital:DATA n [:BYTE]:HANDshake:DELay? queries for the delay time between data output and the control line for data output at 8-bit port n and returns a decimal number between 0 and .015.

[SOURce:]DIGital:DATA n :WORD:HANDshake:DELay? queries for the delay time between data output and the control line for data output at 16-bit port n and returns a decimal number between 0 and .015.

[SOURce:]DIGital:DATA n :LWORD:HANDshake:DELay? queries for the delay time between data output and the control line for data output at 32-bit port n and returns a decimal number between 0 and .015.

Parameters

Parameter Name	Parameter Type	Range of Values	Default
DATA n	Numeric	BYTE none, 0, 1, 2, or 3 WORD none, 0 or 2 LWORD none or 0	0
MIN MAX DEF	Discrete	None or MIN MAX DEF	None

Comments

- The delay time must be set to the same value on all ports used in a multiple port operation.
- The keyword **:LW32** may be used instead of **:LWORD** when using the download version of the SCPI driver.
- **DIG:DATA n [:type]:HANDshake** is the sequence used for commands relating to data handshaking at ports defined by n . The port number n must be the last character of the keyword without spaces.
- **MIN** or **DEF** returns 0.000002. **MAX** returns 0.015.

DIGital:DATA n [:type]:HANDshake[:MODE]

[SOURCE:]DIGital:DATA n [:BYTE]:HANDshake[:MODE] *<mode>* selects the type of handshake and defines the timing relationship between the control (CTL) line, the flag (FLG) line, and when data is transferred in either direction between the Digital I/O Module and a peripheral on the 8-bit port n .

[SOURCE:]DIGital:DATA n :WORD:HANDshake[:MODE] *<mode>* selects the handshake mode used on the 16-bit port n .

[SOURCE:]DIGital:DATA n :LWORD:HANDshake[:MODE] *<mode>* selects the handshake mode used on the 32-bit port n .

Parameters

Parameter Name	Parameter Type	Range of Values	Default
DATA n	Numeric	BYTE none, 0, 1, 2, or 3 WORD none, 0 or 2 LWORD none or 0	0
<i><mode></i>	Discrete	NONE, LEADing, TRAILing, PULse, PARTial, or STRobe	NONE

- Handshake modes are described in Chapter 3.
- The handshake *mode* must be the same on all ports used in a multiple port operation.
- The keyword **:LW32** may be used instead of **:LWORD** when using the downloaded version of the SCPI driver.
- **DIGital:DATA n [:type]HANDshake** is the sequence used for commands relating to data handshaking at port n . The port number n must be the last character of the keyword without spaces.
- **NONE** deletes all automatic data handshaking between the Digital I/O module and the peripheral. For custom handshaking, the control and the flag lines are controlled by the [SOURCE:]DIGital:CONTRol n and MEASure:DIGital:FLAG n commands.
- **Related Commands:** [SOURCE:]DIGital:CONTRol n :POLarity, [SOURCE:]DIGital:CONTRol n :VALue], [SOURCE:]DIGital:FLAG n :POLarity, [SOURCE:]DIGital:HANDshake n :DELay
- ***RST Condition:** Mode is NONE on all ports.

Example DIG:DATA3:HAND LEAD sets the handshake mode to LEADing on 8-bit port 3.

DIGital:DATA n [:type]:HANDshake[:MODE]?

[SOURCE:]DIGital:DATA n [:BYTE]:HANDshake[:MODE]? returns a string indicating the type of handshake set on the 8-bit port n .

[SOURCE:]DIGital:DATA n :WORD:HANDshake[:MODE]? returns a string indicating the type of handshake set on the 16-bit port n .

[SOURCE:]DIGital:DATA n :LWORD:HANDshake[:MODE]? returns a string indicating the type of handshake set on the 32-bit port n .

Parameters

Parameter Name	Parameter Type	Range of Values	Default
DATA n	Numeric	BYTE none, 0, 1, 2, or 3 WORD none, 0 or 2 LWORD none or 0	0

Comments

- The keyword **:LW32** may be used instead of **:LWORD** when using the download version of the SCPI driver.
- The handshake *mode* must be the same on all ports used in a multiple port operation.
- This command will return one of the following strings:
 - NONE
 - LEAD
 - TRA
 - PULS
 - PART
 - STR
- **:DATA n [:type]HANDshake?** is the sequence used for commands relating to data handshaking at port n . The port number n must be the last character of the keyword without spaces.
- **Related Commands:** [SOURCE:]DIGital:CONTRol n :POLarity, [SOURCE:]DIGital:CONTRol n :VALue], [SOURCE:]DIGital:FLAG n :POLarity, [SOURCE:]DIGital:HANDshake n :DELay
- ***RST Condition:** Mode is NONE on all ports.

Example DIG:DATA3:HAND? returns the handshake mode set on port 3.

DIGital:DATA n [:type]:POLarity

[SOURCE:]DIGital:DATA n [:BYTE]:POLarity <*polarity*> sets the data line voltage level for logical true in the 8-bit port n to either TTL high for **POSitive** polarity or TTL low for **NEGative** polarity.

[SOURCE:]DIGital:DATA n :WORD:POLarity <*polarity*> sets the data line voltage level for logical true in the 16-bit port n to either TTL high for **POSitive** polarity or TTL low for **NEGative** polarity.

[SOURCE:]DIGital:DATA n :LWORD:POLarity <*polarity*> sets the data line voltage level for logical true in the 32-bit port n to either TTL high for **POSitive** polarity or TTL low for **NEGative** polarity.

Parameters

Parameter Name	Parameter Type	Range of Values	Default
DATA n	Numeric	BYTE none, 0, 1, 2, or 3 WORD none, 0 or 2 LWORD none or 0	0
< <i>polarity</i> >	Discrete	POSitive or NEGative	None

Comments

- **:DATA n** is the keyword used for commands relating to the data lines at port n . The port number n must be the last character of the keyword without spaces.
- **Related Commands:** [SOURCE:]DIGital:DATA n :BIT m , [SOURCE:]DIGital:DATA n :POLarity?, [SOURCE:]DIGital:DATA n [:VALue]
- ***RST Condition:** POLarity = POSitive

Example DIG:DATA0:POL POS sets logical true to TTL high on 8-bit port 0 data lines.

DIGital:DATA n [:type]:POLarity?

[SOURCE:]DIGital:DATA n [:BYTE]:POLarity? returns a string, either **POS** or **NEG**, indicating the logical true condition of the data lines of 8-bit port n .

[SOURCE:]DIGital:DATA n :WORD:POLarity? returns a string, either **POS** or **NEG**, indicating the logical true condition of the data lines of 16-bit port n .

[SOURCE:]DIGital:DATA n :LWORD:POLarity? returns a string, either **POS** or **NEG**, indicating the logical true condition of the data lines of 32-bit port n .

Parameters

Parameter Name	Parameter Type	Range of Values	Default
DATA n	Numeric	BYTE none, 0, 1, 2, or 3 WORD none, 0 or 2 LWORD none or 0	0

Example DIG:DATA0:POL? returns the state of the logical true condition on port 0 as either **POS** or **NEG**.

DIGital:DATA n [:type]:TRACe

[SOURce:]DIGital:DATA n [:BYTE]:TRACe *<name>* writes the named block of data to 8-bit port n whenever the port is ready to start a new handshake.

[SOURce:]DIGital:DATA n :WORD:TRACe *<name>* writes the named block of data to 16-bit port n whenever the port is ready start a new handshake.

[SOURce:]DIGital:DATA n :LWORD:TRACe *<name>* writes the named block of data to 32-bit port n whenever the port is ready to start a new handshake.

Parameters

Parameter Name	Parameter Type	Range of Values	Default
DATA n	Numeric	BYTE none, 0, 1, 2, or 3 WORD none, 0 or 2 LWORD none or 0	0
<i><name></i>	String	Name of user memory block (maximum 12 characters)	None

Comments

- The keyword **:LW32** may be used instead of **:LWORD** when using the download version of the SCPI driver.
- **:DATA n** and **:TRACe** are the keywords used to write data to port n from block *name*. The port number n must be the last character of the keyword without spaces.
- **Related Commands:** [SOURce:]DIGital:DATA n :POLarity, [SOURce:]DIGital:DATA n [:VALue]
- ***RST Condition:** All ports are set for data input.

Example DIG:DATA2:TRAC:WORD *first_block* writes data from the user memory block *first_block* to 16-bit port 2.

DIGital:DATA n [:type][:VALue]

[SOURce:]DIGital:DATA n [:BYTE][:VALue] [\langle base \rangle] \langle value \rangle writes data to 8-bit port n . Values can be binary, octal, decimal, or hexadecimal.

[SOURce:]DIGital:DATA n :WORD[:VALue] [\langle base \rangle] \langle value \rangle writes data to 16-bit port n . Values can be binary, octal, decimal, or hexadecimal.

[SOURce:]DIGital:DATA n :LWORD[:VALue] [\langle base \rangle] \langle value \rangle writes data to 32-bit port n . Values can be binary, octal, decimal, or hexadecimal.

Parameters

Parameter Name	Parameter Type	Range of Values	Default
DATA n	Numeric	BYTE none, 0, 1, 2, or 3 WORD none, 0 or 2 LWORD none or 0	0
\langle base \rangle	Discrete	None, #H, #Q, or #B	Decimal
\langle value \rangle	Numeric	BYTE -2^7 to (2^8-1) WORD -2^{15} to $(2^{16}-1)$ LWORD -2^{31} to $(2^{31}-1)$	None

Comments

- The keyword **:LW32** may be used instead of **:LWORD** when using the download version of the SCPI driver.
- **base** specifies the numeric format as decimal, hexadecimal, octal, or binary. IEEE-488.2 specifies the following values for this parameter:
 - Decimal = no parameter
 - Hexadecimal = #H
 - Octal = #Q
 - Binary = #B
- **:DATA n** is the keyword used for commands relating to data output at port n . The port number n must be the last character of the keyword without spaces.
- **Related Commands:** [SOURce:]DIGital:DATA n :BIT m , [SOURce:]DIGital:DATA n :POLarity
- ***RST Condition:** All ports are set for data input.

Examples **DIG:DATA3 27** writes the binary equivalent of the decimal number 27 (00011011) to 8-bit port 3.

DIG:DATA3 #B00011011 writes the same byte of data as in the example above to port 3, but in binary format.

DIGital:DATA n [:type][:VALue]?

[SOURce:]DIGital:DATA n [:BYTE][:VALue]? returns the programmed state of 8-bit port n as a decimal number between 0 and 255.

[SOURce:]DIGital:DATA n :WORD[:VALue]? returns the programmed state of 16-bit port n as a decimal number between -32768 and 32767.

[SOURce:]DIGital:DATA n :LWORD[:VALue]? returns the programmed state of 32-bit port n as a decimal number between -2^{31} and $(2^{31} - 1)$.

Parameters

Parameter Name	Parameter Type	Range of Values	Default
DATA n	Numeric	BYTE none, 0, 1, 2, or 3 WORD none, 0 or 2 LWORD none or 0	0

Comments

- This command is only available when using the downloaded SCPI driver.
- The keyword **:LW32** may be used instead of **:LWORD** when using the download version of the SCPI driver.
- This command returns the programmed state of the data lines, not the actual state of the data lines.
- **:DATA n** is the keyword used for commands relating to data output at port n . The port number n must be the last character of the keyword without spaces.
- **Related Commands:** [SOURce:]DIGital:DATA n :BIT m , [SOURce:]DIGital:DATA n :POLarity
- ***RST Condition:** All ports are set for data input.

Example **DIG:DATA3?** returns the decimal equivalent of the data lines on 8-bit port 3.

DIGital:FLAG n :POLarity

[SOURCE:]DIGital:FLAG n :POLarity <*polarity*> sets the voltage level for logical true to either TTL high, **POSitive**, or TTL low, **NEGative** on the FLG handshake line.

Parameters

Parameter Name	Parameter Type	Range of Values	Default
FLAG n	Numeric	none, 0, 1, 2, or 3	0
< <i>polarity</i> >	Discrete	POSitive or NEGative	None

Comments

- **:FLAG n** is the keyword used for commands relating to the flag line at port n . The port number n must be the last character of the keyword without spaces.
- **Related Commands:** [SOURCE:]DIGital:CONTRol n :POLarity, [SOURCE:]DIGital:CONTRol n :POLarity?, [SOURCE:]DIGital:FLAG n :POLarity?
- ***RST Condition:** POLarity = POSitive

Example DIG:FLAG0:POL POS sets logical true to TTL high on the port 0 flag line.

DIGital:FLAG n :POLarity?

[SOURCE:]DIGital:FLAG n :POLarity? returns a string, either **POS** or **NEG**, indicating the logical true condition of the flag (FLG) line.

Parameters

Parameter Name	Parameter Type	Range of Values	Default
FLAG n	Numeric	none, 0, 1, 2, or 3	0

Example SOURCE:DIGITAL:FLAG0:POLARITY? uses long commands to query the state of the logical true condition on port 0.

DIG:FLAG0:POL? performs the same function as the example above with short commands.

DIGital:HANDshaken:DElay

[SOURCE:]DIGital:HANDshaken:DElay *<time>* sets the time between data valid and the assertion of the control line to TRUE for port *n*. This form of the command operates on 8-bit ports only.

Parameters

Parameter Name	Parameter Type	Range of Values	Default
HANDshaken	Numeric	None, 0, 1, 2, or 3	None
<i><time></i>	Numeric	2µs to 15µs 20µs to 150µs 200µs to 1.5ms 2ms to 15ms	None
	Discrete	MIN MAX DEF	

Comments

- **:HANDshaken** is the keyword used for commands relating to data handshaking at port *n*. The port number *n* must be the last character of the keyword without spaces.
- This command sets the strobe pulse width for both input and output STrobe handshakes.
- The delay time must be set to the same value on all ports used in a multiple port operation.
- **MAX** sets a 15 ms delay. **DEF** sets 2µs delay. **MIN** sets a delay of 0, and is illegal for PULse and STrobe handshakes.
- **DIGital:HANDshaken NONE** command sets the delay to 0. For all other modes of handshaking, 2µs is the minimum.
- Specific bands of delay settings are NOT allowed. These are:

0µs > <i><time></i> <2µs	150µs > <i><time></i> <200µs
15µs > <i><time></i> <20µs	1.5ms > <i><time></i> <2.0ms

 The controller uses a rounded-up value for *<time>* if these values are specified.
- **Related Commands:** [SOURCE:]DIGital:CONTRoln:POLarity, [SOURCE:]DIGital:CONTRoln:VALue], [SOURCE:]DIGital:FLAGn:POLarity, [SOURCE:]DIGital:HANDshaken[:MODE]
- ***RST Condition:** Delay is set to 2 µs.

Example DIG:HAND3:DEL .005 sets the delay between the data output and the assertion of the control line to true on 8-bit port 3 to 5 ms.

DIGital:HANDshaken:DELAy?

[SOURCE:]DIGital:HANDshaken:DELAy? queries for the time between data valid and the assertion of the control line to TRUE. This command operates on 8-bit ports and returns a decimal value between 0 and 0.015.

Parameters

Parameter Name	Parameter Type	Range of Values	Default
HANDshaken	Numeric	None, 0, 1, 2, or 3	0
MIN MAX DEF	Discrete	None or MIN MAX DEF	None

Comments

- The delay time must be set to the same value on all ports used in a multiple port operation.
- :HANDshaken is the keyword used for commands relating to data handshaking at 8-bit port *n*. The port number *n* must be the last character of the keyword without spaces.
- MIN or DEF returns 0.000002. MAX returns 0.015.

Example DIG:HAND0:DEL? queries the delay time between data valid and the assertion of the control line to TRUE on 8-bit port 0.

DIGital:HANDshaken[:MODE]

[SOURCE:]DIGital:HANDshaken[:MODE] <mode> selects the type of handshake mode to use to transfer data in either direction between the Digital I/O module and a peripheral on 8-bit port *n*. Handshakes are initiated by execution of a DIGital:DATA*n* or MEASure:DIGital:DATA*n*? command. This form of the HANDshake command operates only on 8-bit ports.

Parameters

Parameter Name	Parameter Type	Range of Values	Default
HANDshaken	Numeric	None, 0, 1, 2, or 3	0
<mode>	Discrete	NONE, LEADing, TRAILing, PULSe, PARTial, or STRobe	NONE

Comments

- :HANDshaken is the keyword used for commands relating to data handshaking at port *n*. The 8-bit port number *n* must be the last character of the keyword without spaces.
- NONE deletes all automatic data handshaking between the Digital I/O Module and peripheral. For custom handshaking, the control and flag lines are controlled by the DIGital:CONTRol*n* and DIGital:FLAG*n* commands.
- **Related Commands:** [SOURCE:]DIGital:HANDshaken:DELAy, [SOURCE:]DIGital:CONTRol*n*:POLarity
- ***RST Condition:** Mode is NONE on all ports.

Example DIG:HAND3 LEAD sets the handshake mode to LEADing on 8-bit port 3.

DIGital:HANDshaken[:MODE]?

[SOURCE:]DIGital:HANDshaken[:MODE]? returns a string indicating the current handshake mode of 8-bit port *n*. This form of the **HANDshake** command operates only on 8-bit ports.

Parameters

Parameter Name	Parameter Type	Range of Values	Default
HANDshaken	Numeric	None, 0, 1, 2, or 3	0

Comments

- This command will return one of the following strings:

NONE
LEAD
TRA
PULS
PART
STR

- **:HANDshaken** is the keyword used for commands relating to data handshaking at port *n*. The port number *n* must be the last character of the keyword without spaces.

DIGital:IO*n*?

[SOURCE:]DIGital:IO*n*? returns a 0 or 1 indicating the current condition of the I/\bar{O} line on port *n*.

Parameters

Parameter Name	Parameter Type	Range of Values	Default
IO <i>n</i>	Numeric	None, 0, 1, 2, or 3	0

Comments

- This command is only available when using the downloaded SCPI driver.
- The I/\bar{O} line's polarity is fixed and is as follows:
 - When Digital I/O module is programmed to output data, the I/\bar{O} line is set low.
 - When Digital I/O module is programmed to input data, the I/\bar{O} line is set high.
- **:IO*n*** is the keyword used for commands relating to the I/\bar{O} line at port *n*. The port number *n* must be the last character of the keyword without spaces.

DIGital:TRACe:CATalog?

[SOURCE:]DIGital:TRACe:CATalog? lists the currently available data blocks.

Parameters None.

Comments

- This command catalogs all blocks in VME memory and all blocks in the mainframe system memory.
- The command returns a string.

Example DIG:TRAC:CAT? would return this string if both alpha and beta had been previously defined; "alpha","beta".

DIGital:TRACe[:DATA]

[SOURCE:]DIGital:TRACe[:DATA] <name>,<block_data> writes a block of data to a previously defined user memory block.

Parameters

Parameter Name	Parameter Type	Range of Values	Default
<name>	String	Name of user memory block (maximum 12 characters)	None
<block_data>	Numeric/String	Numeric header and ASCII block data	None

Comments

- <name> must have been previously defined by a DIGital:TRACe:DEFine command.
- The maximum length for <name> is 12 characters.
- <block_data> is of the form <#digits><length><block> where:
<#digits> tells how many digits are used to define <length>;
<length> tells how many bytes are to be transferred in <block>;
<block> contains the actual data to transfer.

Example DIG:TRAC:DATA first_block,#210ABCDEFGHJIJ sends the data "ABCDEFGHJIJ" to the user memory block *first_block*. Since the ASCII character A has a decimal value of 65, the equivalent of 65 is stored in the first byte of *first_block* (and so on).

DIGital:TRACe[:DATA]?

[SOURCE:]DIGital:TRACe[:DATA]? *<name>* reads a block of data from a previously defined user memory block.

Parameters

Parameter Name	Parameter Type	Range of Values	Default
<i><name></i>	String	Name of user memory block (maximum 12 characters)	None

Comments

- *name* must have been previously defined by a **DIGital:TRACe:DEFine** command.
- The maximum length for *name* is 12 characters.

Example **DIG:TRACe? first_block** reads data from a block named *first_block*. If the previous command example is sent, this command will return the string **#210ABCDEFGH IJ**.

DIGital:TRACe:DEFine

[SOURCE:]DIGital:TRACe:DEFine *<name>*,*<size>*,[*<fill>*] defines a block of data as a user memory block, names the block for future reference, and fills the block with the last parameter. If the last parameter is absent, the block is filled with zeros.

Parameters

Parameter Name	Parameter Type	Range of Values	Default
<i><name></i>	String	Name of user memory block (maximum 12 characters)	None
<i><size></i>	Numeric	Up to 12 Mbytes (depending on memory installed)	None
<i><fill></i>	Numeric	0–255	0

Comments

- The firmware can handle blocks with a total memory space of up to 12 Mbytes of memory space. The actual amount available depends on the memory installed.
- If the **MEMory:VME:STATe ON** command has been used, this command will create blocks in the external add-on memory. If the **MEMory:VME:STATe OFF** command has been used, this command will create blocks in the system memory.

Example **DIG:TRAC:DEF first_block, 256** defines a 256 byte user memory block named *first_block* and fills each byte with a zero.

DIGital:TRACe:DEFine?

[SOURce:]DIGital:TRACe:DEFine? *<name>* returns the size of a previously defined user memory block in bytes. The command returns a decimal number in the range of 0 to 12,582,912.

Parameters

Parameter Name	Parameter Type	Range of Values	Default
<i><name></i>	String	Name of user memory block (maximum 12 characters)	None

Comments

- *<name>* must have been previously defined by a **DIGital:TRACe:DEFine** command. The maximum length for *<name>* is 12 characters.

DIGital:TRACe:DELeTe:ALL

[SOURce:]DIGital:TRACe:DELeTe:ALL deletes all previously defined user memory data blocks.

Parameters None.

DIGital:TRACe:DELeTe[:NAME]

[SOURce:]DIGital:TRACe:DELeTe[:NAME] *<name>* deletes a previously defined user memory data block.

Parameters

Parameter Name	Parameter Type	Range of Values	Default
<i><name></i>	String	Name of user memory block (maximum 12 characters)	None

Comments

<name> must have been previously defined by a **DIGital:TRACe:DEFine** command. The maximum length for *<name>* is 12 characters.

Example **DIG:TRACe:DEL first_block** deletes a user memory block named *first_block*.

STATUS Subsystem

The STATUS subsystem controls the SCPI-defined Operation and Questionable Signal Status Registers and the Standard Event Registers. Each is comprised of a Condition Register, an Event Register, an enable mask, and transition filters.

Each Status Register works as follows: when a condition occurs, the appropriate bit in the Condition Register is set or cleared. If the corresponding transition filter is enabled for that bit, the same bit is set in the associated Event Register. The contents of the Event Register and the enable mask are logically ANDed bit-for-bit; if any bit of the result is set, the summary bit for that register is set in the status byte. The status byte summary bit for the Operation Status Register is bit 7; for the Questionable Signal Status Register, bit 3; and for the Standard Event Register, bit 5.

Syntax STATUS
 :OPERation
 :CONDition?
 :ENABle
 :ENABle?
 [:EVENT]?
 :PRESet
 :QUEStionable
 :CONDition?
 :ENABle
 :ENABle?
 [:EVENT]?

Note This subsystem is provided for compatibility. The Digital I/O module does not use the Operation Status or Questionable Status Registers.

:OPERation:CONDition?

STATus:OPERation:CONDition? returns the contents of the Operation Status Condition Register. Reading the register does not affect its contents. This command does not affect the HP E1330 Digital I/O module.

:OPERation:ENABle

STATus:OPERation:ENABle *<mask>* specifies which bits of the associated Event Register are included in its summary bit. The summary bit is the bit-for-bit logical AND of the Event Register and the unmasked bit(s). This command does not affect the HP E1330 Digital I/O module.

Parameters

Parameter Name	Parameter Type	Range of Values	Default
<i><mask></i>	Numeric or non-decimal numeric	0 through +32767	None

The non-decimal numeric forms are the #H, #Q, or #B formats specified by IEEE-488.2.

:OPERation:ENABle?

STATus:OPERation:ENABle? returns the mask set for the Operation Status Register. This command does not affect the HP E1330 Digital I/O module.

:OPERation[:EVENT]?

STATus:OPERation[:EVENT]? returns the contents of the Operation Event Status Register. Reading the register clears all bits in the register. This command does not affect the HP E1330 Digital I/O module.

:PRESet

STATus:PRESet clears both the Operation Status Enable and Questionable Status Enable Registers. This command does not affect the HP E1330 Digital I/O module.

:QUESTionable:CONDition?

STATus:QUESTionable:CONDition? returns the contents of the Questionable Status Condition Register. Reading the register does not affect its contents. This command does not affect the HP E1330 Digital I/O module.

:QUESTionable:ENABle

STATus:QUESTionable:ENABle <mask> specifies which bits of the associated Event Register are included in its summary bit. The summary bit is the bit-for-bit logical AND of the Event Register and the unmasked bit(s). This command does not affect the HP E1330 Digital I/O module.

Parameters

Parameter Name	Parameter Type	Range of Values	Default
<mask>	Numeric or non-decimal numeric	0 through +32767	None

The non-decimal numeric forms are the #H, #Q, or #B formats specified by IEEE-488.2.

:QUESTionable:ENABle?

STATus:QUESTionable:ENABle? returns the mask set for the Questionable Status Register. This command does not affect the HP E1330 Digital I/O module.

:QUESTionable[:EVENT]?

STATus:QUESTionable[:EVENT]? returns the contents of the Questionable Status Event Register. Reading the register clears all bits in the register. This command does not affect the HP E1330 Digital I/O module.

SYSTEM Subsystem

The SYSTEM subsystem returns information about the module.

Syntax SYSTEM
 :CDEscription? <number>
 :CTYPE? <number>
 :ERRor?
 :VERsion?

:CDEscription?

SYSTEM:CDEscription? <number> returns the module description.

Parameters

Parameter Name	Parameter Type	Range of Values	Default
<number>	Numeric	1	None

Comments

- This command is only available when using the downloaded SCPI driver.
- <number> is the instrument number. Because each Digital I/O module is a single instrument, <number> is always 1.
- The command returns the following string:

Quad 8-bit Digital I/O

:CTYPE?

SYSTEM:CTYPE? <number> returns the module number and manufacturer.

Parameters

Parameter Name	Parameter Type	Range of Values	Default
<number>	Numeric	0 to 99	None

Comments

- This command is only available when using the downloaded SCPI driver.
- The command returns the following string (revision number may vary and the serial number is always set to 0):

HEWLETT-PACKARD, E1330B, 0, A.05.00

:ERRor?

SYSTem:ERRor? queries the Error Register for the error value and returns a string error message to identify the error type. The errors are held in an error buffer and read in a First-In-First-Out manner by this command.

- Comments**
- Returns the error number and error string. If no errors are in the error buffer, returns: **+0, "No error"**.
 - **Related Commands:** *ERR
 - ***RST Condition:** None.

Example **SYST:ERR?** queries the mainframe for errors.

:VERSion?

SYSTem:VERSion? returns the SCPI version to which this instrument complies.

Comments Returns a decimal value in the form:

YYYY .R

where YYYY is the year, and R is the revision number within that year.

IEEE 488.2 Common Commands

The following table lists the IEEE 488.2 Common (*) Commands that can be executed by the HP E1330B Digital I/O Module. For more information on Common Commands, refer to ANSI/IEEE Standard 488.2-1987.

Note These commands apply to many instruments and are not documented in detail here. See ANSI/IEEE Standard 488.2-1987 for more information.

*IDN?	Identification query	Returns identification string of the Digital I/O Module.
*RST	Reset	Sets all ports to input mode, handshake NONE, and polarity POS.
*TST?	Self-Test Query	Always returns 0.
*OPC	Operation Complete	Sets the request for OPC flag when all pending operations have been completed. Also sets the OPC bit in the Standard Event Register.
*OPC?	Operation Complete Query	Returns a 1 to the output queue when all pending operations are complete.
*WAI	Wait to Continue	Halts execution of commands and queries until the "No Operation Pending" message is true.
*CLS	Clear status	Clears all Event Registers, the Request for OPC flag, and all queues (except output queue).
*ESE<mask>	Event status enable	Sets the bits in the Event Status Enable Register.
*ESE?	Event status enable query	Queries the Event Status Enable Register.
*ESR?	Event status register query	Queries and clears the contents of the Standard Event Status Register.
*SRE<mask>	Service request enable	Sets the Service Request Enable Register bits, and corresponding Serial Poll Status Byte Register bits, to generate a service request.
*SRE?	Service request enable query	Queries the contents of the Service Request Enable Register.
*STB?	Read status byte query	Queries the contents of the Status Byte Register.
*TRG	Trigger	
*RCL<n>	Recall saved state	Recalls stored module configuration in the memory location set by <n>.
*SAV<n>	Save state	Stores the module configuration in the memory location set by <n>.
*EMC <n>	Enable macro	Enable execution of macro <n>.
*EMC? <n>	Enable macro query	Queries execution state of macro <n>.
*RMC	Remove macros	Removes all macros.
*LMC	List macros	Lists macros by name.
*DMC	Define macro	Defines a macro.
*GMC	Menu query	Get results of menu query.
*PMC	Purge macros	Purges all system macros.

Command Quick Reference

The following tables summarize SCPI Commands for the HP E1330B Digital I/O module.

Command	Description
DISPlay: MONitor:PORT <port>[AUTO MIN MAX DEF] MONitor:PORT? [<MAX MIN DEF>] MONitor[:STATe] <mode> MONitor[:STATe]?	Sets the displayed monitor port number. Returns the monitored port number. Turns the monitor mode of the display ON or OFF. Returns the state of the monitor mode.
MEASure: DIGital:DATA <i>n</i> [:type]:BIT <i>m</i> ? DIGital:DATA <i>n</i> [:type]:TRACe <name> DIGital:DATA <i>n</i> [:type][:VALue]? DIGital:FLAG <i>n</i> ?	Reads the state on bit <i>m</i> on port <i>n</i> after completion of handshake. Reads port <i>n</i> after completion of handshake and stores block. Reads bytes from port <i>n</i> after completion of handshake. Assumes decimal format of input data. Reads the port <i>n</i> FLAG line. Returns 0 or 1. Used to implement custom handshakes.
MEMory: DELeTe:MACRo <name> VME:ADDRess [<base>]<address> VME:ADDRess? [<MIN MAX>] VME:SIZE [<base>]<size> VME:SIZE? [<MIN MAX>] VME:STATe <state> VME:STATe?	Deletes a macro. Sets the address for add-on VME system memory. Returns the current add-on VME memory address. Sets the size of the add-on VME memory. Returns the current size of the add-on VME memory. Sets the state (ON or OFF) of the assigned VME memory. When this is OFF, all memory commands refer to the base system memory. Returns the current state (0 or 1) of the add-on VME memory.

Command	Description
[SOURce:] DIGital:CONTRol <i>n</i> :POLarity <POS NEG>	Sets logical true level of control line on port <i>n</i> .
DIGital:CONTRol <i>n</i> :POLarity?	Returns current logical true polarity of port <i>n</i> .
DIGital:CONTRol <i>n</i> [:VALue] <0 1 or ON OFF>	Sets or clears control line on port <i>n</i> . Command used to create custom handshakes when HANDshake is set to NONE.
DIGital:CONTRol <i>n</i> [:VALue]?	Returns the current state of the control line on port <i>n</i> (downloaded SCPI driver only).
DIGital:DATA <i>n</i> [:type]:BIT <i>m</i> <0 1>	Sets bit <i>m</i> on port <i>n</i> .
DIGital:DATA <i>n</i> [:type]:BIT <i>m</i> ?	Returns the programmed state of bit <i>m</i> on the port <i>n</i> (downloaded SCPI driver only).
DIGital:DATA <i>n</i> [:type]:HANDshake:DELay < <i>time</i> >	Sets delay between data output and assertion of control line for data output on port <i>n</i> . Also sets strobe pulse for both output and input STRobe handshake.
DIGital:DATA <i>n</i> [:type]:HANDshake:DELay?	Returns the time between data valid and assertion of control line to TRUE.
DIGital:DATA <i>n</i> [:type]:HANDshake[:MODE] <NONE LEADing TRAILing PULSe PARTial STRobe>	Selects type of handshake to transfer data between port <i>n</i> and peripheral. Handshakes are initiated by execution of DIG:DATA <i>n</i> or MEAS:DIG:DATA <i>n</i> ? commands.
DIGital:DATA <i>n</i> [:type]:HANDshake[:MODE]?	Returns the current handshake mode set on port <i>n</i> .
DIGital:DATA <i>n</i> [:type]:POLarity <POS NEG>	Sets logical true level of the data lines on port <i>n</i> .
DIGital:DATA <i>n</i> [:type]:POLarity?	Returns the logical true level set for the data lines on port <i>n</i> .
DIGital:DATA <i>n</i> [:type]:TRACe < <i>name</i> >	Writes the named block of data to the port <i>n</i> .
DIGital:DATA <i>n</i> [:type][:VALue][< <i>base</i> >]< <i>value</i> >	Writes the value, in the specified base, to port <i>n</i> .
DIGital:DATA <i>n</i> [:type][:VALue]?	Returns a decimal value indicating the programmed state of the data lines on the port <i>n</i> (downloaded SCPI driver only).
DIGital:FLAG <i>n</i> :POLarity <POS NEG>	Sets logical true level of the flag line on port <i>n</i> .
DIGital:FLAG <i>n</i> :POLarity?	Returns the logical true level set for the flag line on port <i>n</i> .
DIGital:HANDshake <i>n</i> :DELay < <i>time</i> >	Sets delay between data valid and assertion of control line for data output on 8-bit port <i>n</i> . Also sets strobe pulse for both output and input STRobe handshake.
DIGital:HANDshake <i>n</i> :DELay?	Returns the time between data valid and assertion of control line to TRUE on 8-bit port <i>n</i> .
DIGital:HANDshake <i>n</i> [:MODE] <NONE LEADing TRAILing PULSe PARTial STRobe>	Selects type of handshake to transfer data between 8-bit port <i>n</i> and peripheral. Handshakes are initiated by execution of DIG:DATA <i>n</i> or MEAS:DIG:DATA <i>n</i> ? commands.
DIGital:HANDshake <i>n</i> [:MODE]?	Returns the current handshake mode set on 8-bit port <i>n</i> .

Command	Description
[SOURCE:] DIGital:IO <i>n</i> ? <i>(continued)</i> DIGital:TRAcE:CATalog? DIGital:TRAcE[:DATA] < <i>name</i> >,< <i>block_data</i> > DIGital:TRAcE[:DATA]? < <i>name</i> > DIGital:TRAcE:DEFine < <i>name</i> >,< <i>size</i> >,<[<i>fill</i>]> DIGital:TRAcE:DEFine? < <i>name</i> > DIGital:TRAcE:DELete:ALL DIGital:TRAcE:DELete[:NAME] < <i>name</i> >	Returns the current state of the I/O control line on port <i>n</i> (downloaded SCPI driver only). Returns the currently defined memory blocks. Writes a block of data to <i>name</i> . Reads a block of data from <i>name</i> . Defines <i>name</i> , <i>size</i> , and initial <i>fill</i> for a memory block. Returns the size, in bytes, of the named memory block. Deletes all memory blocks. Deletes the named memory block.
STATus: OPERation:CONDition? OPERation:ENABLE < <i>mask</i> > OPERation:ENABLE? OPERation[:EVENT]? PRESet QUESTionable:CONDition? QUESTionable:ENABLE < <i>mask</i> > QUESTionable:ENABLE? QUESTionable[:EVENT]?	Returns contents of Condition Register. Sets <i>mask</i> for Enable Register. Returns <i>mask</i> set in Enable Register. Returns the contents of the Event Register. Clears Enable Registers. Returns contents of Condition Register. Sets <i>mask</i> for Enable Register. Returns <i>mask</i> set in Enable Register. Returns the content of the Event Register.
NOTE: The STATus subsystem is provided for compatibility only. The Digital I/O module does not use the Operation Status or Questionable Status Registers. SYSTem: CDEscription? < <i>number</i> > CTYPE? < <i>number</i> > ERRor? VERsion?	Returns a string description of the module (download SCPI driver only). Returns a string of the module number (download SCPI driver only). Returns the contents of the system Error Register. Returns the SCPI version to which this instrument complies.

Notes:

Appendix A

HP E1330B Digital I/O Specifications

Logic Levels:

TTL Compatible, 5V max

Data Lines:

Iout (High): -5.2 mA

@ Vout (High): 2.5 V

(Pull-up Enabled)

Iout (Low): 48 mA

@ Vout (Low): 0.5 V

Vin (High): >2.0 V; <5.0 V

Vin (Low): <0.8 V

Iin (High): <2.5 mA @ 2.5 V

Iin (Low): <-3.2 mA @ 0.4 V

Handshake Lines:

Iout (High): 250 μ A

@ Vout (High): 5 V

Iout (Low): 40 mA

@ Vout (Low): 0.7 V

Iout (Low): 16 mA

@ Vout (Low): 0.4 V

Vin (High): >2.0 V

Vin (Low): <0.8 V

Iin (Low): <1.75 mA

Module Size/Device Type:

B, register-based

Connectors Used:

P1

Number of Slots:

1

VXibus Interface Capability:

Slave, interrupter, A16, D16, D08EO

Interrupt Level:

1-7, selectable

Typical Data Line Current vs Data Line Voltage:

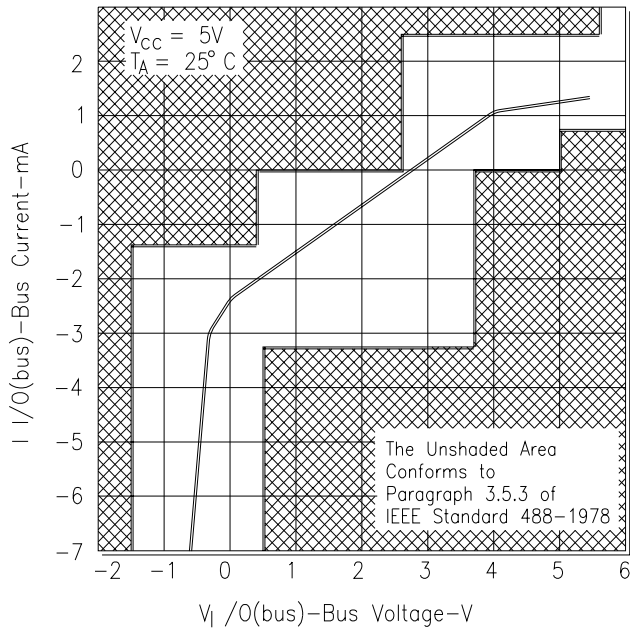

Power Requirements:

Voltage: +5 V

Peak module current, IPM (A): 0.50

Dynamic module current, IDM (A): 0.01

Watts/Slot:

2.5

Cooling/Slot:

0.04 mm H²O @ 0.21 liter/sec

Humidity:

65%, 0° to 40°C

Operating Temperature:

0° to 55°C

Storage Temperature:

-40° to 75°C

EMC, RFI, Safety:

meets FTZ 1046/1984, CSA 556B, IEC 348, UL 1244

Net Weight (kg):

1.0

Appendix B

HP E1330B Digital I/O Module Register Information

Using This Appendix

The contents of this appendix are:

- Addressing the Registers Page 105
- Reset and Registers Page 109
- Register Definitions Page 109
- Register Descriptions Page 111
- A Register-Based Output Algorithm Page 119
- A Register-Based Input Algorithm Page 120
- Programming Examples Page 121

Note Do not mix register programming and SCPI command programming.

Addressing the Registers

To access a specific register for either read or write operations, the address of the register must be used. Register addresses for the plug-in modules are found in an address space known as VXI A16. The exact location of A16 within a VXIbus master's memory map depends on the design of the VXIbus master you are using; for the HP E1300/1301 Mainframe and HP E1405/E1406 Command Module, the A16 space location starts at $1F0000_{16}$.

The A16 space is further divided so that the modules are addressed only at locations above $1FC000_{16}$ within A16. Further, every module is allocated 64 register addresses (40_{16}). The address of a module is determined by its logical address (set by the address switches on the module) times 64 (40_{16}). In the case of the Digital I/O module, the factory setting is 144 or 90_{16} , so the addresses start at $1FE400_{16}$.

Register addresses for register-based devices are located in the upper 25% of VXI A16 address space. Every VXI device (up to 256) is allocated a 64 byte block of addresses. Figure B-1 shows the register address location within A16. Figure B-2 shows the location of A16 address space in the HP E1405/06 Command Module.

The Base Address

When you are reading or writing to a module register, a hexadecimal or decimal register address is specified. This address consists of a base address plus a register offset. The base address used in register-based programming depends on whether the A16 address space is outside or inside the HP E1405/06 Command Module.

A16 Address Space Outside the Command Module

When the HP E1405/06 Command Module is not part of your VXIbus system (Figure B-1), the HP E1330's base address is computed as:¹

$$A16base + C000_{16} + (LADDR * 40)_{16}$$

or (decimal)

$$A16base + 49,152 + (LADDR * 64)$$

where $C000_{16}$ (49,152) is the starting location of the register addresses, LADDR is the module's logical address, and 64 is the number of address bytes per VXI device. For example, the HP E1330's factory set logical address is 144 (90_{16}), therefore it will have a base address of:

$$A16base + C000_{16} + (90 * 40)_{16} = C000_{16} + 2400_{16} = \mathbf{E400_{16}}$$

or (decimal)

$$A16base + 49,152 + (144 * 64) = 49,152 + 9216 = \mathbf{58368}$$

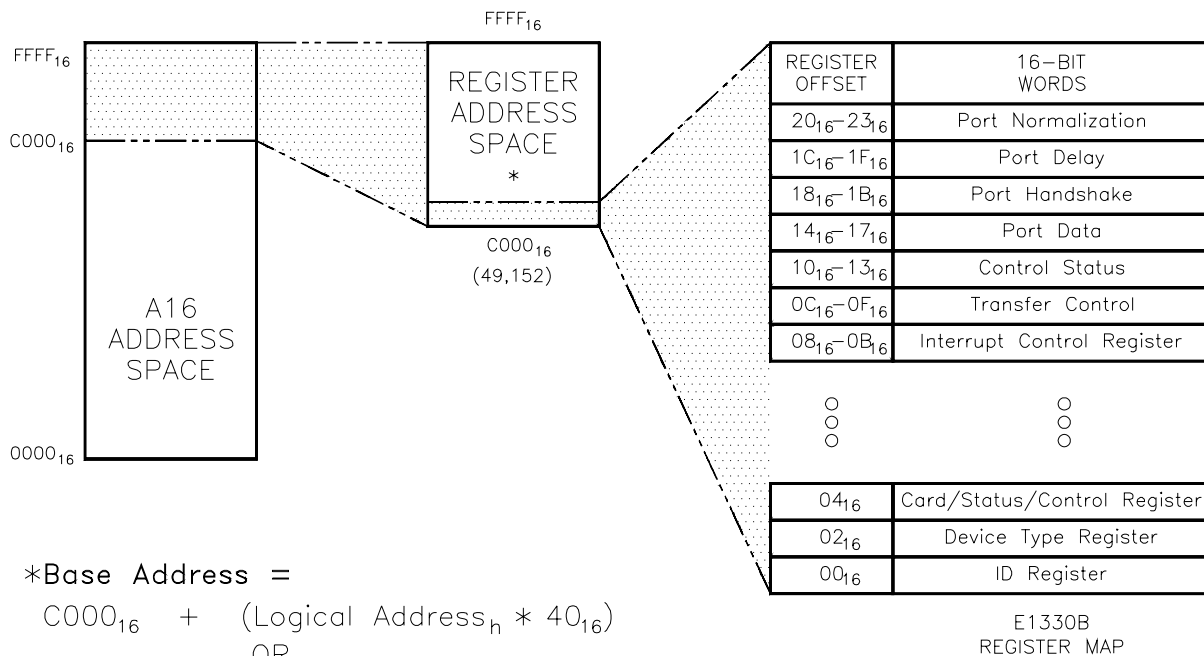

*Base Address =

$$C000_{16} + (\text{Logical Address}_h * 40)_{16}$$

OR

$$49,152 + (\text{Logical Address} * 64)_{10}$$

Register Address =

$$\text{Base Address} + \text{Register Offset}$$

E1330A FIG APPB-1

Figure B-1. Register Address Location Within A16

1.The '16' at the end of the address indicates a hexadecimal base number.

A16 Address Space Inside the Command Module or Mainframe

When the A16 address space is inside the HP E1405/06 Command Module (Figure B-2), the module's base address is computed as:

$$1FC000_{16} + (LADDR * 40)_{16}$$

or

$$2,080,768 + (LADDR * 64)$$

where $1FC000_{16}$ (2,080,768) is the starting location of the VXI A16 addresses, LADDR is the module's logical address, and 64 is the number of address bytes per register-based device. Again, the HP E1330's factory set logical address is 144. If this address is not changed, the module will have a base address of:

$$1FC000_{16} + (90 * 40)_{16} = 1FC000_{16} + 2400_{16} = \mathbf{1FE400_{16}}$$

or

$$2,080,768 + (144 * 64) = 2,080,768 + 9216 = \mathbf{2,089,984}$$

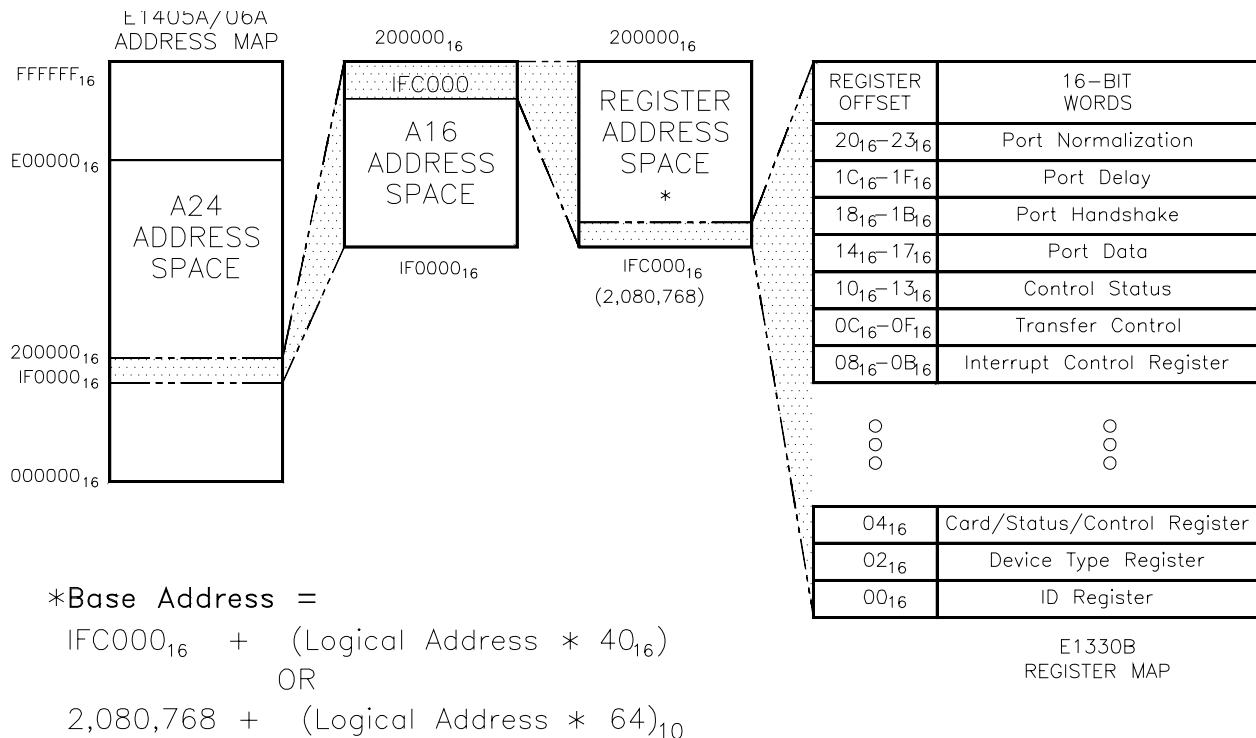

Register Address =
 Base Address + Register Offset

E1330A FIG APPB-2

Figure B-2. A16 Address Space in the HP E1405/06A

Register Offset

The register offset is the register's location in the block of 64 address bytes that belong to the module. For example, the module's Status/Control Register has an offset of 04_{16} . When you write a command to this register, the offset is added to the base address to form the register address:

$$E400_{16} + 04_{16} = \mathbf{E404_{16}} \quad 1FE400_{16} + 04_{16} = \mathbf{1FE404_{16}}$$

or

$$58,368 + 4 = \mathbf{58,372} \quad 2,089,984 + 4 = \mathbf{2,089,988}$$

Table B-1 shows the general programming method for accessing the HP E1330 registers using different computers.

Table B-1. General Register-Based Programming Method

System	Typical Commands	Base Address
HP E1300/E1301 IBASIC (Absolute Addressing) Select Code 8	READIO -9826, Base_addr + offset WRITEIO -9826, Base_addr + offset; data (positive select code = byte read or write negative select code = word read or write) READIO 8, Base_addr + reg number WRITEIO 8, Base_addr + reg number; data	Base_addr = $1fc000_{16} + (LADDR * 40)_{16}$ or = $2,080,768 + (LADDR * 64)$ offset = register number Base_addr = $LADDR * 256$ reg number = offset
External Computer (over HP-IB to HP E1300/E1301 Mainframe or HP E1405/06 Command Module)	VXI:READ? logical_address, offset VXI:WRITE logical_address, offset, data DIAG:PEEK? (Base_addr + offset, width) DIAG:POKE (Base_addr + offset, width, data) When using DIAG:PEEK? and DIAG:POKE, the width must be either 8 or 16.	Module Logical Address setting (LADDR) offset = register number Base_addr = $1FC000_{16} + (LADDR * 40)_{16}$ or = $2,080,768 + (LADDR * 64)$ offset = register number
V/360 Embedded Computer (C-Size system)	READIO -16, Base_addr + offset WRITEIO -16, Base_addr + offset; data (positive select code = byte read or write negative select code = word read or write)	Base_addr = $C000_{16} + (LADDR * 40)_{16}$ or = $49,152 + (LADDR * 64)$ offset = register number
SICL	IWPOKE(Base_addr+offset,data) IWPEEK(Base_addr+offset)	imap(id,I_MAP_VXIDEV,O,0,NULL)
LADDR = HP E1330 Logical Address = $\frac{144}{8} = 18$		

Reset and Registers

When the Digital I/O module undergoes a power on or *RST in SCPI, the bits of the registers are put into the following states:

- The identification bytes at address 00 through 03, the Manufacturer ID and Device ID, remain unaffected.
- The I/O bits (bit 6 of the Port Control/Status Registers (0-3)) are set to "1", enabling all four ports for input.
- The port delay register is set to 2μs.
- The port handshake register is set to interrupt driver.
- All other bits of all registers are set to "0".

Register Definitions

You can program the HP E1330A/B Quad 8-bit Digital I/O module using its hardware registers. *The procedures for reading or writing to a register depend on your operating system and programming language.* Whatever the access method, you will need to identify each register with its address. These addresses are given in Table B-2.

Table B-2. Register Map

Register Name	Address			
Manufacturer ID (MSB)	00 ₁₆			
Manufacturer ID (LSB)	01 ₁₆			
Device ID (MSB)	02 ₁₆			
Device ID (LSB)	03 ₁₆			
Card /Status/Control (MSB)	04 ₁₆			
Card/Status/Control (LSB)	05 ₁₆			
Register Name	Address			
	Port 0	Port 1	Port 2	Port 3
Port Interrupt Control	08 ₁₆	09 ₁₆	0A ₁₆	0B ₁₆
Port Transfer Control	0C ₁₆	0D ₁₆	0E ₁₆	0F ₁₆
Port Control/Status	10 ₁₆	11 ₁₆	12 ₁₆	13 ₁₆
Port Data	14 ₁₆	15 ₁₆	16 ₁₆	17 ₁₆
Port Handshake	18 ₁₆	19 ₁₆	1A ₁₆	1B ₁₆
Port Delay	1C ₁₆	1D ₁₆	1E ₁₆	1F ₁₆
Port Normalization	20 ₁₆	21 ₁₆	22 ₁₆	23 ₁₆

The module is a register-based slave/interrupter device, supporting VME D16, D8(O), and D8(OE) transfers. The interrupt protocol supported is “release on interrupt acknowledge” – an interrupt is cleared by a VXIbus interrupt acknowledge cycle.

WARNING Registers have been documented as 8 bit bytes. If you access them using 16 bit transfers from a Motorola CPU, the high and low byte will be swapped. The HP E1300/01 Mainframe and HP E1405/06 Command Modules use Motorola CPUs. Motorola CPUs place the highest weighted byte in the lower memory location and the lower weighted byte in the higher memory address; Intel processors do just the opposite. VXI registers are memory mapped, thus you will see this Motorola/Intel byte swap difference when doing register programming.

Register Descriptions

The following pages detail register descriptions of the Digital I/O module.

Manufacturer Identification Register

The Manufacturer Identification Register is a read-only register at address 00_{16} (Most Significant Byte (MSB)) and 01_{16} (Least Significant Byte (LSB)). Reading this register returns the Hewlett-Packard identification, $FFFF_{16}$.

Device Identification Register

The Device Identification Register is a read-only register accessed at address 02_{16} . Reading this register returns the Digital I/O module identification of 50_{16} for the HP E1330A or 51_{16} for the HP E1330B. Reading address 03_{16} always returns FF_{16} .

Card Status/Control Register

The Card Status/Control Register is a read/write register accessed at address 04_{16} and 05_{16} . The following table shows the register bit patterns.

Address base+ 04_{16}								Address base+ 05_{16}							
15	14	13	12	11	10	9	8	7	6	5	4	3	2	1	0
1	1	1	1	I2	I3	I0	I1	1	IEN	1	1	1	1	1	SR

SR (soft reset) Writing a "1" and then a "0" to this bit resets all Digital I/O module components. SR disables all output ports (all ports become input ports) and sets all other registers to default values. Reads and writes to the other module registers will not transfer valid data when SR is asserted. This bit is cleared by a hard reset.

IEN (Main Interrupt Enable) Writing a "1" to this bit allows interrupts from port controller ICs to assert interrupt on the VXIbus. Writing a "0" masks these interrupts. This bit is cleared by a hard reset, but not by a soft reset.

Caution **A potential race condition exists when clearing this bit or masking interrupts by means of register 08_{16} through $0B_{16}$. If an interrupt occurs just before interrupts are masked, it could be asserted on the VXIbus but not acknowledged by the Digital I/O module. Use care in disabling interrupts once they have been enabled.**

I(0-3) Interrupt Flags for ports (0-3) (0 = interrupt). The MSB of this register is the module's interrupt response vector. It is asserted on the VXIbus during an interrupt acknowledge cycle.

Port Interrupt Control Register

The Port Interrupt Control Register is a read/write register and functions as the interrupt register for the port. This register shows the interrupt enable status, the level of interrupt that can signal the controller (always set to 0), and whether an interrupt is pending.

Port Address (0-3) base+08 ₁₆ , base+09 ₁₆ , base+0A ₁₆ , base+0B ₁₆							
7	6	5	4	3	2	1	0
PIEN	IP	IL1	IL0	—	—	—	—

Bits (0-3) Are unused.

IL0 and IL1 (Interrupt Level) Both bits *must* be left at 0 to initialize the Digital I/O module for interrupt operation.

IP (Interrupt Pending) When equal to "1", indicates an interrupt is pending. This is a read/write bit. You can force a hardware interrupt by setting this bit to "1" if PIEN is set to "1" and IEN is set to "1" in the Status/Control Register.

PIEN (Port Interrupt Enable) When set to "1", enables interrupt. Pending or forced interrupts are ignored if set to "0".

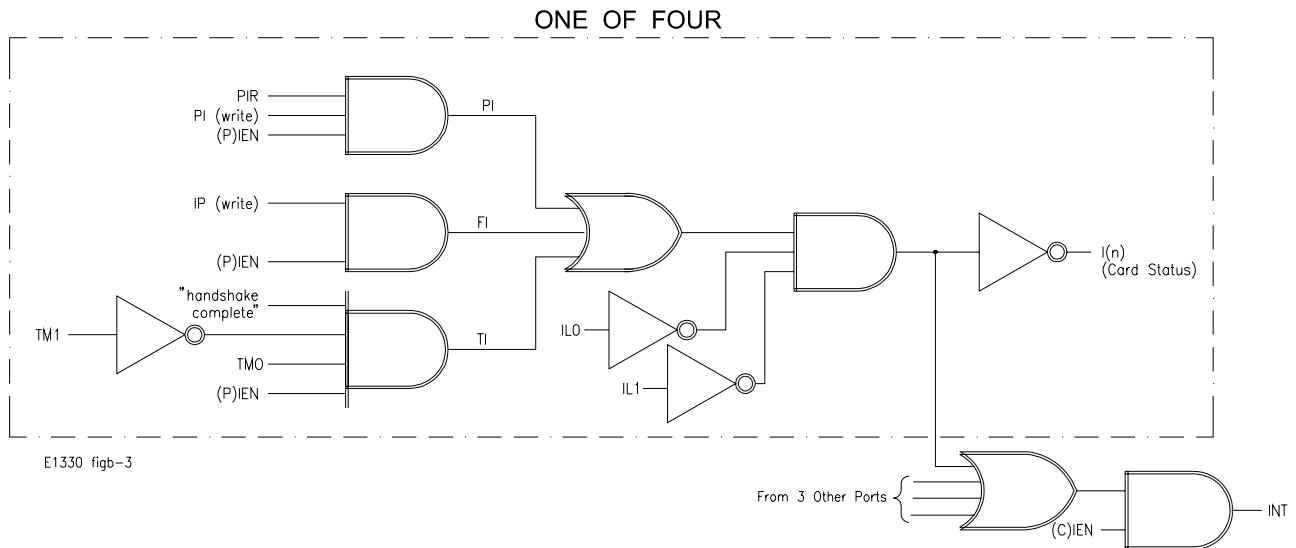

Figure B-3. Interrupt Line Logic Diagram

Port Transfer Control Register

The Port Transfer Control Register controls transfers between the mainframe and port, identifies port interrupts, and identifies forced interrupts from the controller.

Port Address (0–3) base+0C ₁₆ , base+0D ₁₆ , base+0E ₁₆ , base+0F ₁₆							
7	6	5	4	3	2	1	0
PI	FI	TI	—	—	—	HE	DRR

- DRR (Data Register Ready)** Is a read-only bit. When set to "1", it indicates either that the Port Data Register contains valid data for the mainframe to read, or that the Port Data Register is ready for the mainframe to write a byte of data to it. When the Port Data Register is read, DRR is set to "0".
- HE (Handshake Enable)** When set to "1", enables handshaking for the port. You can read from or write to this bit. When the registers have been initialized, you can set this bit to "1" to enable handshaking if you are using the port handshake lines to transfer data.
- Bits 2 - 4** Are not used.
- TI (Transfer Interrupt)** Is a read-only bit. When set to "1", indicates a port transfer has occurred. A port transfer interrupt, if enabled, occurs on a "port data register ready" condition (when bit 0 of this register is set to "1"). To enable port transfer interrupts, specify the "interrupt driven" transfer mode of port (refer to Port Handshake Register) and set the "interrupt enable" bit (bit 7 of Interrupt Control Register) equal to "1". When the Port Data Register is read, TI is set to "0".
- FI (Forced Interrupt)** Is a read-only bit. When set to "1", indicates that a forced interrupt (from the mainframe) has occurred. To force an interrupt, write a "1" to bit 6 and bit 7 of the Port Interrupt Control Register and bit 6 of the Status/Control Register.
- PI (Peripheral Interrupt)** Bit 7 is a read/write bit. Writing a "1" to bit 7 enables port peripheral interrupts. Writing a "0" disables port peripheral interrupts. When reading bit 7, a "1" indicates a port interrupt has occurred. To clear PI you must write a "0" to PI. Writing a "0" then a "1" to PI is the correct procedure to clear one interrupt and re-enable for a second one.

Note Port peripheral interrupts are caused by a transition in the PIR line. If bit 4 of the Port Normalization Register is "0", a rising-edge (low to high) transition caused the interrupt. If bit 4 is set to "1", a falling-edge (high to low) transition caused the interrupt. Refer to the Port Normalization Register for more information.

Port Control/ Status Register

The Port Control/Status Register shows the status of STS, PIR, and FLG lines. It also directly controls the \overline{RES} , I/\overline{O} and CTL lines.

Port Address (0–3) base+10 ₁₆ , base+11 ₁₆ , base+12 ₁₆ , base+13 ₁₆							
7	6	5	4	3	2	1	0
CTL	I/\overline{O}	RES	FLG	—	—	PIR	STS

STS Bit 0 is read-only bit. Read this bit to find the status of the STS line, which is an input from the peripheral for the port. A "1" shows that the line is BUSY; a "0", shows that the line is READY.

PIR Bit 1 is a read-only bit. This bit shows the *normalized* state of the PIR line, which is an input line from the peripheral:

- If positive-true logic is in use (bit 4 of the Port Normalization Register is equal to "0"), bit 1 is equal to 0 if the line is low; "1" if the line is high.
- If the PIR line is inverted (bit 4 of the Port Normalization Register is equal to "1"), bit 1 is equal to "0" if the line is high; "1" if the line is low.

If peripheral interrupts are not enabled, you can use the PIR line as a secondary status line. Just read bit 1 to monitor the state of the line.

If peripheral interrupts are enabled, you can still monitor the status of the PIR line by reading bit 1. However, the current status of the PIR line does not indicate whether a peripheral interrupt has occurred. Port peripheral interrupts are caused by transitions in the state of the PIR line. Read bit 7 of the Port Transfer Control Register to determine whether a port peripheral interrupt has occurred.

Bits 2 and 3 Are not used.

FLG This is a read-only bit. Read this bit to find the *normalized* status of the FLG line. A "1" shows that the line is BUSY; a "0" shows that the line is READY. This bit shows the logical state (BUSY or READY) of the FLG line, regardless of the logic sense.

\overline{RES} This is a read/write bit. Reading this bit shows the current state of the \overline{RES} line which is an output line to the peripheral. A "1" shows that the line is high; a "0" shows that the line is low. Bit 5 is initially set to "0" by a hardware reset of the interface. This causes the \overline{RES} line to go low, resetting the peripheral, if the peripheral implements the reset feature. You can control the logical state of the \overline{RES} line by writing to this bit. Set bit 5 equal to "1" to change \overline{RES} to the high state. The peripheral will then operate normally. To reset the peripheral, clear bit 5 to "0", putting \overline{RES} in the low state.

I/O This is a read/write bit. Read this bit to find the current status of the I/O line, which is an output line to the peripheral, and the port data transceiver. If bit 6 is equal to "0", the line is FALSE and the transceiver is enabled for output. If bit 6 is equal to "1", the line is TRUE and the transceiver is enabled for input. *This bit is equal to "1" (input) after a hardware reset.* You can select input or output by changing this bit.

Note If you are using the port handshake lines to control transfers, use the I/O line to control the direction of data transfer to your peripheral. Make sure that the peripheral is always enabled to send data during input transfers and to receive data during output transfers.

CTL This is a read/write bit. Read this bit to find the current state of the CTL line. A "1" shows the line is TRUE; a "0" shows the line is FALSE (the bit is not normalized). When handshaking is enabled (bit 1 of the Port Transfer Control Register is set), the CTL line is controlled by the port controller. To prevent incorrect handshaking due to interaction with other lines, before enabling handshaking, set the control line to FALSE.

Port Data Register

The Port Data Register is a read/write register. It is used for both output and input. Its operation depends on the state of the I/O.

Port Address (0-3) base+14 ₁₆ , base+15 ₁₆ , base+16 ₁₆ , base+17 ₁₆							
7	6	5	4	3	2	1	0
D7	D6	D5	D4	D3	D2	D1	D0

- If I/O is set for output (bit 6, Port Transfer Control Register = "0"), data written to the Port Data Register is latched and remains until new data is written. The current data in the Port Data Register drives the port data bus. If you read Port Data Register, the value read is the value last written to the register.
- If I/O is set for input (bit 6, Port Transfer Control Register = "1"), the data read from the Port Data Register is the data transmitted by the peripheral on the port data bus. If you write to the Port Data Register, the data is latched for output, but the data lines are not affected until I/O is again set for output.
- When the Port Data Register is read, the following bits are set to "0" on the Port Transfer Control Register: DRR (bit 0), TI (bit 5), and PI (bit 7).

Bits 0-7 Bits 0-7 of the Port Data Register correspond to data lines D(0-7) where bit 7 is the most significant bit.

Port Handshake Register

The Port Handshake Register determines the type of handshake protocol used for the port data transfers and how the data is transferred from the Digital I/O module to the mainframe on the VXibus.

Port Address (0-3) base+18 ₁₆ , base+19 ₁₆ , base+1A ₁₆ , base+1B ₁₆							
7	6	5	4	3	2	1	0
HT2	HT1	HT0	EI	—	—	TM1	TM0

TM(0,1) (Transfer Mode) These bits control the transfer mode for the port between the Digital I/O module and the VXibus as shown in Table B-3.

Table B-3. Transfer Mode

Transfer Mode	TM1 Bit 1	TM0 Bit 0
Flag Driven	0	0
Interrupt Driven	0	1
Fast Handshake	1	0

The three transfer modes are used to transfer data between the VXibus and the Digital I/O module:

- Flag Driven – the mainframe polls the Data Register Ready bit (bit 0, Port Transfer Control Register). When this bit is set, it reads data from the Port Data Register or writes data to the Port Data Register.
- Interrupt Driven – the peripheral sets bit 1 of the Port Status/Control Register and the Digital I/O module interrupts the VXibus for data transfer with the mainframe.
- Fast Handshake – the peripheral talks directly with the VXibus's Data Acknowledge Line to transfer data between the Port Data Registers and the VXibus.

Bits 2 and 3 Are not used.

EI (Enable Inhibit) This bit, if set to "1", enables the STS line to inhibit a transfer cycle during a transfer. If bit 4 is set, the transfer is inhibited when the peripheral puts STS in the BUSY state and resumes when STS returns to the READY state.

HT(5-7) (Handshake Type) These bits determine the type of handshake for port input and output transfers as shown in Table B-4.

Table B-4. Handshake Type

Output/Input Transfer	Bit 7	Bit 6	Bit 5
No Handshake (NONE)	0	0	0
LEADing Edge	0	0	1
TRAIling Edge	0	1	0
PULSe	0	1	1
PARTial	1	0	0
STRobe	1	0	1

Port Delay Register

The Port Delay Register sets the delay time, T_d . Delay time is the time between data valid and setting the control (CTL) line TRUE. It is used with several handshake modes. You can also read this register to find the current delay time.

Port Address (0–3) $\text{base}+1\text{C}_{16}$, $\text{base}+1\text{D}_{16}$, $\text{base}+1\text{E}_{16}$, $\text{base}+1\text{F}_{16}$							
7	6	5	4	3	2	1	0
DF7	DF6	DF5	DF4	—	—	RM1	RM0

RM(0,1) (Range Multiplier)

You can specify the range of delay time, T_d , by selecting the one of the range multipliers in Table B-5.

Table B-5. Range Multipliers

Range Multiplier	RM1 Bit 1	RM0 Bit 0
1 ms	0	0
100 μ s	0	1
10 μ s	1	0
1 μ s	1	1

Bits 2 and 3 Are not used.

DF(4-7) (Delay Factor)

Regardless of the range multiplier you select, you can specify a delay factor in the range of 0 through 15 (decimal equivalent of the binary value) by setting these bits (0 specifies no delay time). For all output handshake types, the delay period T_d is equal to the range multiplier times the delay factor specified by bits 4–7. For example, if you write the value "00010000" to register 5, the multiplier is 1 ms and the delay factor is 1. If you write "11110010" to register 5, then the multiplier is 10 μ s and the delay factor is 15; hence, the delay factor is 150 μ s. The actual delay for a given transfer may be one count longer due to uncertainty in recognizing a transition of a handshake signal.

Note If you are using the output STRobe or PULSe handshake, you can specify delay factors in the range 2 through 15, or you can specify 0 (no delay period). Thus, you can specify T_d values from 2 to 15 μ s, from 20 to 150 μ s, and so forth for these handshakes.

If you are using the input STRobe handshake, the delay factor specified by bits 4 through 7 is reduced by one, then multiplied by the range multiplier. For example, the register value "00100000" for an input STRobe handshake specifies $T_d = 1$ ms. (The multiplier is 1 ms and the delay factor is 2-1= 1.) On the other hand, the value "11110010" specifies $T_d = 140\mu$ s. (The multiplier is 10 μ s and the delay factor is 15-1=14.)

The input STRobe handshake is the only *input* handshake that uses a delay period. For the other input handshakes, the value in this register has no effect.

Port Normalization Register

The Port Normalization Register allows you to normalize the port handshake and data lines to the correct logic sense for your peripheral. Positive true logic is the default. You can invert a line by setting the appropriate bit equal to "1".

Port Address (0-3) base+20 ₁₆ , base+21 ₁₆ , base+22 ₁₆ , base+23 ₁₆							
7	6	5	4	3	2	1	0
ID	ICTL	IFLG	IPIR	—	—	—	—

Bits 0-3 Are not used.

IPIR (Invert PIR) This bit specifies the logic sense of a peripheral interrupt request. If bit 4="0", a rising-edge (low to high) transition of the PIR line triggers an interrupt. If bit 4="1", a falling-edge (high to low) transition of the PIR line triggers an interrupt. In either case, no interrupt occurs unless peripheral interrupts are enabled.

IFLG (Invert FLG) This bit specifies the logic sense of the FLG line.
If bit 5="0", then positive-true logic is used: HIGH=BUSY, LOW=READY.
If bit 5="1", then negative-true logic is used: LOW=BUSY, HIGH=READY.

ICTL (Invert CTL) This bit specifies the logic sense of the CTL line.
If bit 6="0", then positive-true logic is used: HIGH=TRUE, LOW=FALSE.
If bit 6="1", then negative-true logic is used: LOW=TRUE, HIGH=FALSE.

ID (Invert DATA) This bit specifies the logic sense of the port data lines.
If bit 7="0", then positive-true logic is used: HIGH=TRUE, LOW=FALSE.
If bit 7="1", then negative-true logic is used: LOW=TRUE, HIGH=FALSE.

A Register-Based Output Algorithm

The following algorithm describes the procedure you would use to program the registers to transmit a byte of data to a peripheral. The algorithm follows a flag-driven output procedure initiated by the computer. The computer polls the Digital I/O module to see if the data has been accepted by the peripheral by checking the Port Transfer/Control Register, bit 0 (referred to as the acknowledge flag - hence, the name of flag-driven). Once the flag is TRUE the computer can output new data to the port. The actual path followed by the peripheral and the Digital I/O module to set this bit is controlled by the handshake mode you select.

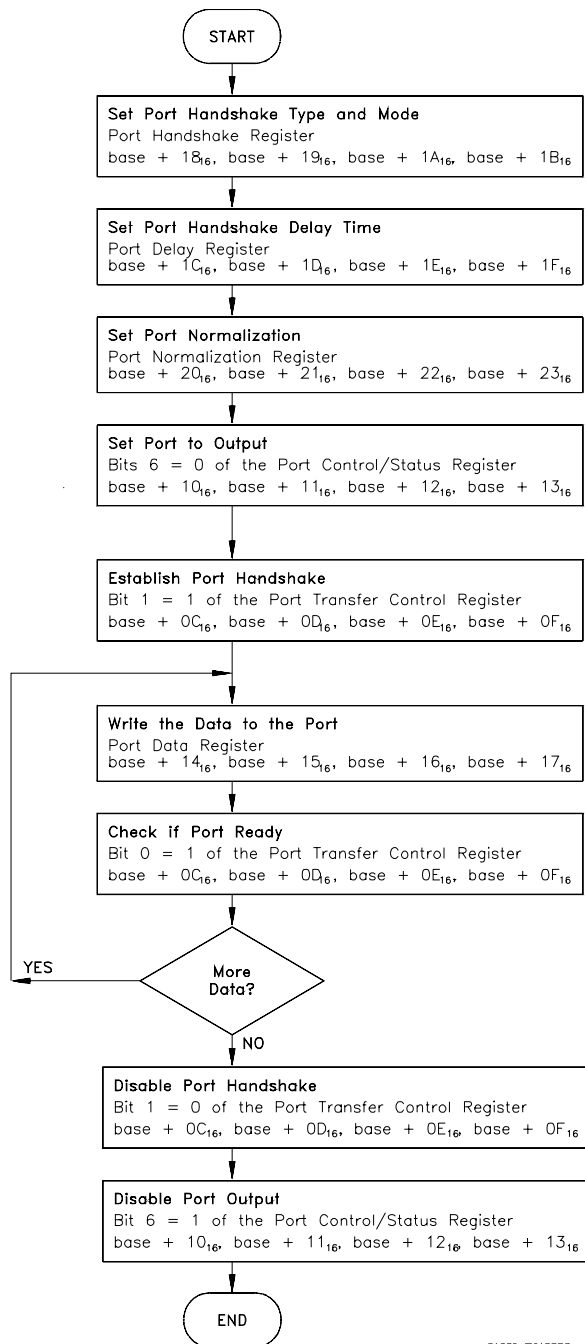

E1330 FIGAPPB3

A Register-Based Input Algorithm

The following algorithm describes the procedure you use to program the registers to read a byte of data from a peripheral. The algorithm follows a flag-driven input procedure initiated by the computer. The computer polls the Digital I/O module to see if the data has been transmitted by the peripheral by checking the Port Transfer/Control Register, bit 0 (referred to as the acknowledge flag - hence, the name flag-driven). Once the flag is TRUE the computer can read new data from the port. The actual path followed by the peripheral and the Digital I/O module to set this bit is controlled by the handshake mode you select.

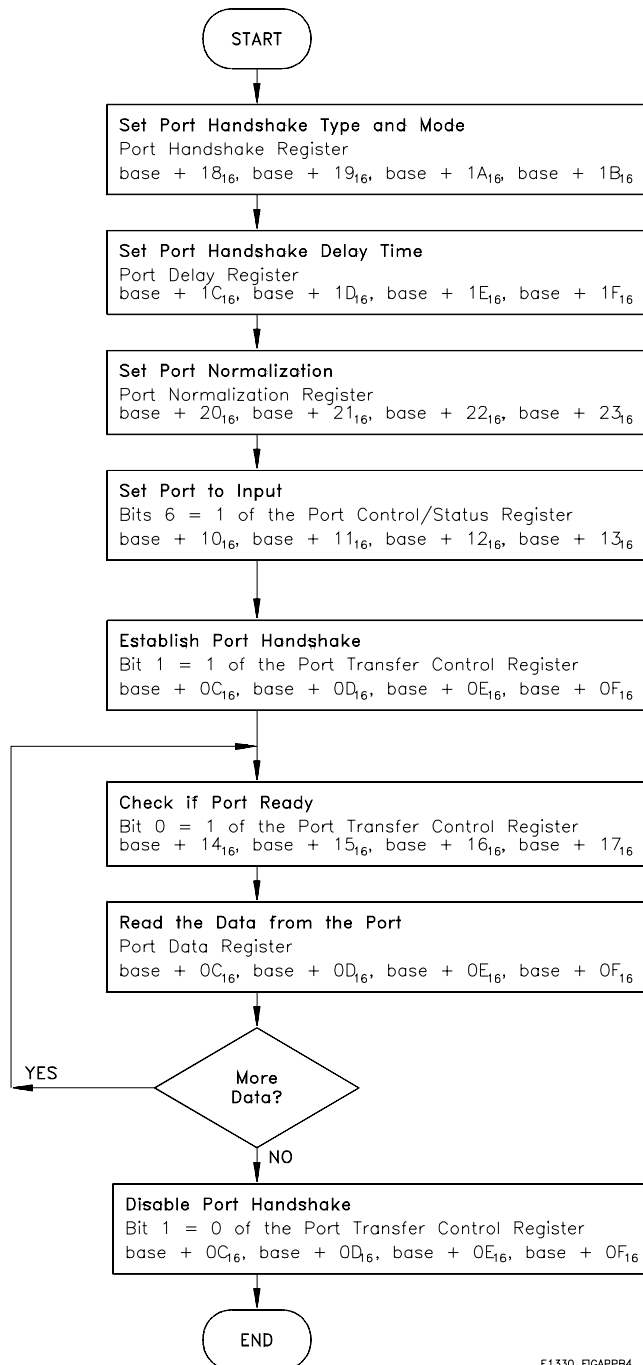

E1330 FIGAPPB4

Programming Examples

The examples in this section demonstrate how to program the module at the register level. The programs follow the execution and timing models covered in the previous section. The examples in this section include:

- Resetting the Module
- Reading the ID, Device Type, and Status Registers
- Writing an 8-bit Byte
- Writing a 16-bit Word
- Reading an 8-bit Byte
- Reading a 16-bit word
- Debugging Register Based Programs
- Using an Embedded Computer

System Configuration

The following example programs were developed with the module at logical address 144. The HP BASIC/UX programs were developed using the HP E1300 Mainframe Series B HP BASIC language. The C language programs were developed on an HP Vectra PC (IBM PC compatible) using Borland's Turbo C++® programming language.¹

1. Borland Intl., Inc.

Resetting the Module

The following program resets the HP E1330 Digital I/O module (Bit 6 of the Port Control/Status Register set to "1" then to "0"). Reset enables all four ports for input, all other bits of other registers set to "0" HP IBASIC Version.

HP IBASIC Version

```
10 Base_addr = DVAL("1FE400",16)      !Logical Address 144.
20 Reg_addr = 04                       !Offset for Status Control Register.
30 !Write a 0 then a 1 to bit 0 of status register.
40 WRITEIO -9826, Base_addr + Reg_addr; 1
50 WRITEIO -9826, Base_addr + Reg_addr; 0
60 END
```

C Version

```
#include <stdio.h>
#include <chplib.h>

#define LOG_ADDR 144
#define BASE_ADDR (long) ((0x1FC000) + (64 * LOG_ADDR))

main ()
{
    int          reg_addr;
    float        send_data[3];
    char         state[2] = {13,10};
    send_data[0] = BASE_ADDR + reg_addr;
    send_data[1] = 16;
    send_data[2] = 1;

    IOEOI (7L, 0); IOEOL (7L, " ",0);
    IOOUTPUTS (70900L, "DIAG:POKE ",10);
    IOEOI (7L, 1); IOEOL (7L, " ",state,0);
    IOOUTPUTA (70900L, send_data, 3);
    send_data[2] = 0;
    IOEOI (7L, 0); IOEOL (7L, " ",0);
    IOOUTPUTS (70900L, "DIAG:POKE ",10);
    IOEOI (7L, 1); IOEOL (7L, " ",state,0);
    IOOUTPUTA (70900L, send_data, 3);
    return 0;
}
```

Reading the ID, Device Type, and Status Registers

The following examples read the module ID, DEVICE ID, and STATUS registers from the module.

HP IBASIC Version

```
10 !*****
20 !***** READREG *****
30 !*****
40 !OPTION BASE 0 is default
50 !Set up arrays to store register names and addresses
60 DIM Reg_name$(0:2)[32], Reg_addr(0:2)
70 !
80 !Read register names and addresses into the arrays
90 READ Reg_name$(*)
100 READ Reg_addr(*)
110 !
120 !Set base Address variable
130 Base_addr = DVAL ("1FE400",16)
140 !
150 !Map the A16 address space
160 !
170 !CONTROL 16,25;2 ! used only with V360 Controller
180 !Call the subprogram Read_regs
190 Read_regs(Base_addr, Reg_name$(*),Reg_addr(*)
200 !
210 DATA Identification Register, Device Register, Status Register
220 DATA 00, 02, 04
230 END
```

This subprogram steps through a loop that reads each register and prints its contents

```
320 SUB Read_regs(Base_addr, Reg_name$(*),Reg_addr(*)
330 FOR Number = 0 to 2
340 Register = READIO(-9826,Base_addr + Reg_addr(number))
350 PRINT Reg_name$(number);" = "; IVAL$(Register, 16)
360 NEXT Number
370 SUBEND
```

This program returns:

Identification Register = FFFF

Device Register = FF50

Status Register = (dependent on current status, default is FFBE)

C Version

```
#include <stdio.h>
#include <chplib.h>
#include <cfunc.h>

#define LOG_ADDR 144
#define BASE_ADDR (long) ((0x1FC000) + (64 * LOG_ADDR))
main()
{
    int      reg_addr;
    float    send_data[3], read;
    char     state[2] = {13,10};

    send_data[1] = 16;
    send_data[2] = 0;
    send_data[0] = BASE_ADDR + 0;

    IOEOI (7L, 0); IOEOL (7L, " ", 0);
    IOOUTPUTS (70900L, "DIAG:PEEK? ", 11);

    IOEOI (7L, 1); IOEOL (7L, state, 2);
    IOOUTPUTA (70900L, send_data, 2);

    IOENTER(70900L, &read);
    printf("/nIdentification Register = %0x",read);

    send_data[0] = BASE_ADDR + 2;

    IOEOI (7L, 0); IOEOL (7L, " ", 0);
    IOOUTPUTS (70900L, "DIAG:PEEK? ", 11);
    IOEOI (7L, 1); IOEOL (7L, state, 2);
    IOOUTPUTA (70900L, send_data, 2);
    IOENTER(70900L, &read);
    printf("/nDevice Register = %0x",read);

    send_data[0] = BASE_ADDR + 4;

    IOEOI (7L, 0); IOEOL (7L, " ", 0);
    IOOUTPUTS (70900L, "DIAG:PEEK? ", 11);
    IOEOI (7L, 1); IOEOL (7L, state, 2);
    IOOUTPUTA (70900L, send_data, 2);

    IOENTER(70900L, &read);
    printf("/nStatus Register = %0x",read);
    return 0;
}
```

Writing an 8-Bit Byte

Using the output algorithm described earlier, the following programs describe how to output an 8-bit byte to your peripheral device. The program use a leading edge handshake and flag-driven data transfer to send data (decimal value 255) from Port 1.

HP IBASIC Version

```
10 Base_addr = DVAL("1FE400",16)
20 !Logical Address 144.
30 WRITEIO 9826,Base_Addr+DVAL("19",16);32
40 !Sets Port 1 Handshake Register to leading edge handshake and flag
50 !driven transfer.
60 WRITEIO 9826,Base_Addr+DVAL("1D",16);00
70 !Sets Port 1 Delay Register to 0.
80 WRITEIO 9826,Base_Addr+DVAL("21",16);00
90 !Sets Port 1 Normalization Register (polarity) to positive-true (High = true).
100 WRITEIO 9826,Base_Addr+DVAL("11",16);0
110 !Sets Port 1 Status Control bit 6 to enable output.
120 WRITEIO 9826,Base_Addr+DVAL("0D",16);2
130 !Sets Port 1 Transfer Control Register bit 1 to Enable Handshake.
140 WRITEIO 9826,Base_Addr+DVAL("15",16);255
150 !Sets Port 1 Data Register to the value to output.
160 REPEAT
170 UNTIL BIT(READIO ( 9826,Base_addr+DVAL("0D",16)),1)
180 !If more data to send, repeat lines 140 - 170.
190 WRITEIO 9826,Base_Addr+DVAL("0D",16);0
200 !Clears Port 1 Transfer Control Register bit 1 to Disable Handshake.
210 END
```

C Version

```
/* writing an 8-bit byte */
#include <stdio.h>
#include <chplib.h>
#define LOG_ADDR 144
#define BASE_ADDR (long) ((0x1FC000) + (64 * LOG_ADDR))
void send_info(char state[], float send_data[]);
main ()
{
    float    send_data[3], read;
    char     state[2] = {13,10};
    int      handshak_reg, delay_reg, normiz_reg,
            statuscont_reg, transfercont_reg, data_reg;
    handshak_reg = 0x19;
    delay_reg = 0x1D;
    normiz_reg = 0x21;
    statuscont_reg = 0x11;
    transfercont_reg = 0x0D;
    data_reg = 0x15;
    send_data[1] = 16;
    send_data[0] = BASE_ADDR + handshak_reg;
    send_data[2] = 32;
    send_info(state, send_data);
    send_data[0] = BASE_ADDR + delay_reg;
    send_data[2] = 00;
    send_info(state, send_data);
    send_data[0] = BASE_ADDR + normiz_reg;
    send_data[2] = 00;
    send_info(state, send_data);
    send_data[0] = BASE_ADDR + statuscont_reg;
    send_data[2] = 00;
    send_info(state, send_data);
    send_data[0] = BASE_ADDR + transfercont_reg;
    send_data[2] = 2;
    send_info(state, send_data);
    send_data[0] = BASE_ADDR + data_reg;
    send_data[2] = 255;
    send_info(state, send_data);
    return 0;
}
void send_info(char state[], float send_data[]
{
    IOEOI (7L, 0);IOEOL (7L, " ", 0);
    IOOUTPUTS (70900L, "DIAG:POKE ", 10);
    IOEOI (7L, 1);IOEOL (7L, state, 0);
    IOOUTPUTA (70900L, send_data, 3);
}
```

Writing a 16-Bit Word

Similar to the last program example, this program outputs a 16-bit word to your peripheral device. To write a 16-bit word, two consecutive ports are required (i.e. ports 0 and 1, 1 and 2, 2 and 3, or 3 and 4). Both ports must be configured exactly the same. Configure consecutive port registers by addressing the lower port's register and sending a 16-bit word. Handshaking is accomplished using the lower port's handshake lines.

HP BASIC Version

```
10 Base_addr = DVAL("1FE400",16)
20 !Logical Address 144.
30 WRITEIO -9826,Base_Addr+DVAL("18",16);DVAL("3232",16)
40 !Sets Ports 0 & 1 Handshake Register to leading edge handshake
50 !and flag driven transfer.
60 WRITEIO -9826,Base_Addr+DVAL("1C",16);DVAL("0000",16)
70 !Sets Ports 0 & 1 Delay Register to 0.
80 WRITEIO -9826,Base_Addr+DVAL("20",16);DVAL("0000",16)
90 !Sets Ports 0 & 1 Normalization Register (polarity) to positive-true
100 !(High = true).
110 WRITEIO -9826,Base_Addr+DVAL("10",16);DVAL("0000",16)
120 !Sets Ports 0 & 1 Status Control bit 6 to enable output.
130 WRITEIO -9826,Base_Addr+DVAL("0C",16);DVAL("0202",16)
140 !Sets Ports 0 & 1 Transfer Control Register bit 1 to Enable Handshake.
150 WRITEIO -9826,Base_Addr+DVAL("14",16);512
160 !Sets Ports 0 & 1 Data Register to the value to output.
170 REPEAT
180 UNTIL BIT(READIO ( 9826,Base_addr+DVAL("0C",16)),1)
190 !If more data to send, repeat lines 150 - 180.
200 WRITEIO 9826,Base_Addr+DVAL("0C",16);DVAL("0000",16)
210 !Clears Ports 0 & 1 Transfer Control Register bit 1 to Disable Handshake.
220 END
```

C Version

The C program is similar to that shown for writing an 8-bit byte except the data sent to the registers must be 16 bits.

Reading an 8-Bit Byte

Using the input algorithm described earlier, the following programs describe how to input an 8-bit byte from your peripheral device. The program use a leading edge handshake and flag-driven data transfer.

HP BASIC Version

```
10 Base_addr = DVAL("1FE400",16)
20 !Logical Address 144.
30 WRITEIO 9826,Base_Addr+DVAL("19",16);32
40 !Set Port 1 Handshake Register to leading edge handshake and flag
50 !driven transfer.
60 WRITEIO 9826,Base_Addr+DVAL("1D",16);00
70 !Set Port 1 Delay Register to 0.
80 WRITEIO 9826,Base_Addr+DVAL("21",16);00
90 !Set Port 1 Normalization Register (polarity) to positive-true
100 !(High = true).
110 WRITEIO 9826,Base_Addr+DVAL("11",16);64
120 !Set Port 1 Status Control bit 6 to enable output.
130 WRITEIO 9826,Base_Addr+DVAL("0D",16);2
140 !Set Port 1 Transfer Control Register bit 1 to Enable Handshake.
150 A = READIO (9826,Base_addr+DVAL("15",16))
160 Print A
170 !If more data to send, repeat lines 150 - 160.
180 WRITEIO 9826,Base_Addr+DVAL("0D",16);0
190 !Clear Port 1 Transfer Control Register bit 1 to Disable Handshake.
200 END
```

C Version /* reading an 8-bit byte */

```
#include <stdio.h>
#include <chplib.h>
#define LOG_ADDR 144
#define BASE_ADDR (long) ((0x1FC000) + (64 * LOG_ADDR))
void send_info(char state[], float send_data[]);
main ()
{
    float    send_data[3], read;
    char     state[2] = {13,10};
    int      handshak_reg, delay_reg, normiz_reg,
            statuscont_reg, transfercont_reg, data_reg;
    handshak_reg = 0x19;
    delay_reg = 0x1D;
    normiz_reg = 0x21;
    statuscont_reg = 0x11;
    transfercont_reg = 0x0D;
    data_reg = 0x15;
    send_data[1] = 16;
    send_data[0] = BASE_ADDR + handshak_reg;
    send_data[2] = 32;
    send_info(state, send_data);
    send_data[0] = BASE_ADDR + delay_reg;
    send_data[2] = 00;
    send_info(state, send_data);
    send_data[0] = BASE_ADDR + normiz_reg;
    send_data[2] = 00;
    send_info(state, send_data);
    send_data[0] = BASE_ADDR + statuscont_reg;
    send_data[2] = 00;
    send_info(state, send_data);
    send_data[0] = BASE_ADDR + transfercont_reg;
    send_data[2] = 2;
    send_info(state, send_data);
    send_data[0] = BASE_ADDR + data_reg;
    IOEOI (7L, 0); IOEOL (7L, " ",0);
    IOOUTPUTS (70900L, "DIAG:PEEK? ", 11);
    IOEOI (7L, 1); IOEOL (7L, state, 2);
    IOOUTPUTA (70900L, send_data, 2);
    IOENTER (70900L, &read);
    printf("\nData read from module = %X", (int)read);
    send_data[0] = BASE_ADDR + transfercont_reg;
    send_data[2] = 0;
    send_info(state, send_data);
return 0;
}
void send_info(char state[], float send_data[])
{
```

```

IOEOI (7L, 0); IOEOL (7L, " ", 0);
IOOUTPUTS (70900L, "DIAG:POKE ", 10);
IOEOI (7L, 1); IOEOL (7L, state, 0);
IOOUTPUTA (70900L, send_data, 3);
}

```

Reading a 16-Bit Word

To read a 16-bit word, two consecutive ports are required (i.e. ports 0 and 1, 1 and 2, 2 and 3, or 3 and 4). Both ports must be configured exactly the same. Configuring consecutive port registers by addressing the lower port's register and sending a 16-bit word. Handshaking is accomplished using the lower port's handshake lines.

Debugging Basic Register-Based Programs

Register-based programming may at times be difficult but this difficulty can be greatly minimized by having a little helpful code to ease the debugging task.

In order to do rapid debugging you need to be able to see program flow, program variables, and instrument errors. A good ERROR and TIME OUT handling shell is an essential part of this.

The main line of program PIR_INT (lines 10-240) act as a shell that prevents your BASIC program from ever hanging up due to an I/O that is not proceeding. It will identify the LINE NUMBER of lines that have RUN TIME ERRORS or that have TIMED OUT. The shell will then call the subprogram E13xx_errors which will query instruments for errors. Often time outs are caused by doing an ENTER after having sent incorrect commands to instruments.

Since the shell prevents I/O hang ups, BASIC's PAUSE, STEP, and CONT may now be used effectively to debug programs. When a program does not seem to be proceeding correctly, use PAUSE then STEP to trace the flow, type variable names to see their value when PAUSED, and finally use CONT to proceed at full speed.

The main line of this program is the error handler. It will catch all TIME OUTS and ERRORS that are not caught by lower level contexts. Five softkeys are defined:

```

QUIT& ?   will check for instrument errors and then stop.
END!      will end the program immediately with no error checking.
Reg_dump  will print the contents of all HP E1330 registers.
Res0_0    will drive line sts0 to a logic zero.
Res0_1    will drive line sts0 to a logic one.

```

In order for this shell to catch errors and time outs, all application codes must start in the Subprogram Main (lines 390-680). The subprogram *Reg_dump* (lines 760-910) will read all registers on the HP E1330 and display them in both decimal and hex format. When developing a program you may temporarily place calls to *Reg_dump* in your program. This will allow you to see what the registers contain and accelerate your understanding of them. The subprogram *Reg_dump* has also been assigned to a softkey so you may see the registers at any time.

The subprogram *Res0_0* and *Res0_1* are used to provide stimulus. These routines may be embedded in lines of code or the softkeys that have been assigned to them may be used to provide a testing stimulus. The important thing to make note of is the way that a testing stimulus has been made very visible, which will ease the testing and debugging of programs.

PIR Interrupts on the HP E1330

When debugging, it is often necessary to go between editing and running of the program. To accelerate this activity it is very helpful to assign a line label to the first line of a subprogram that is the same as the subprogram name. This makes it possible to start editing by typing `EDIT <subprogram>`.

This example demonstrates how to use the four PIR interrupt lines that exist on the HP E1330A/B digital I/O module. This example produces true interrupts from these lines. Register programming must be used to access this capability as the HP E1330 SCPI driver does not use these lines.

The routines have been written in a style so it is easy to go between the HP E1330 register documentation and the code.

i.e. `OUTPUT@Sys;"DIAG:POKE"&VAL$(Base+(DVAL("10",16))) &"",8,64"`.

This code means output write to register 10 (hex), a 8 bit byte of value 64.

MAIN The MAIN line code 10-240 provides a error handling shell.

E13xx_errors Checks for any errors in all instruments.

Reset_dig Resets the E1330 using the *RST command.

The following subprograms do register programming to the HP E1330:

Reg_dump Prints the full register contents for debugging.

Enable_pir0 Enables pir0 to produce a interrupt.

Enable_pir1 Enables pir1 to produce a interrupt.

Enable_pir2 Enables pir2 to produce a interrupt.

Enable_pir3 Enables pir3 to produce a interrupt.

Enable_int A second level enable that allows PIR0-3 to reach the backplane.

Res0_0 Drives Res0 (pin 9) to 0 !Used as a testing signal source.

Res0_1 Drives Res0 (pin 9) to 1 if pull-up is connected.

The following subprograms were added to show how to handle interrupts:

Main (lines 390-680) Initializes the HP E1330 and sets up for interrupts.

Intr_ser (lines 930-1250) Provides on going servicing of PIR interrupts by determining which PIR occurred and then re-enables.

Since interrupts are events that get latched, once they have occurred most all features in the interrupt path must be re-enabled in order to prepare for another event. Re-enabling may require either a read or a write to each element in the interrupt path. To properly service a interrupt the Subprogram *Intr_ser* does the following:

1. Re-enables the HP E1330 hardware to pull a backplane interrupt.i.e.
 - 1070 `Enable_pir0`
 - 1110 `Enable_pir1`
 - 1150 `Enable_pir2`
 - 1190 `Enable_pir3`
 - 1210 `Enable_int`

2. Re-enables the System Instrument features that catch the backplane interrupt and pull the bus SRQ. i.e.

```

960 A=SPOLL(@Sys)
980 OUTPUT @Sys;"STAT:OPER:EVEN?"
990 ENTER @Sys;Stat_oper
1010 OUTPUT @Sys;"DIAG:INT:RESP?"
1020 ENTER @Sys;Int_ack
1220 OUTPUT @Sys;"DIAG:INT:SETUP2 ON;
      :DIAG:INT:ACT ON"

```
3. Re-enable the BASIC Language interrupt features that catch the bus SRQ. i.e.

```

1240 ENABLE INTR 7;2

```

This program has been written to run on an external computer connected via HP-IB to the HP E1300/01. All programming of the HP E1330 including catching interrupts is handled by the system instrument in the HP E1300/01. Firmware revision A.07 or later is required.

The two IRQ jumpers on the HP E1330 have been moved from the normal IRQ1 position to the IRQ2 position (you must move both of them!). This is necessary so the system instrument can catch interrupts instead of the operating system, which handles all interrupts on IRQ1. Once these jumpers are moved, only register programming is usually possible.

To produce a signal that can be wired to the PIR lines, two register routines *Res0_0*, and *Res0_1* were created and are called by pressing the defined Softkeys labeled Res0_0 and Res0_1. *Res0_0* drives the Res0 line to 0 and *Res0_1* drives the Res0 line high. A pull-up must also be attached to Res0 as it is an open collector device. In order to test the PIR interrupts you connect a wire from Res0 (pin 9) to one or more PIR inputs. Then, by pressing the softkeys Res0_0 followed by Res0_1, you will produce the required signal.

```

10 !re-save "PIR_INT"
20 !This main line code is reserved as a error handling shell.
30 !All application code must be at lower level context.
40 ASSIGN @Sys TO 70900           !Define I/O paths.
50 ASSIGN @Dig TO 70918
60 COM /Instr/ @Sys,@Dig
70 COM /Register/ Logical_address
80 ON KEY 1 LABEL "QUIT& ?" RECOVER Quit
                                !Key to quit and check for errors.
90 ON KEY 2 LABEL "END!" RECOVER End
                                !Key to END now, no error check.
100 ON KEY 3 LABEL "REG_DUMP" CALL Reg_dump
                                !Key to see E1330 registers.
110 ON KEY 5 LABEL "STSO=1" CALL Res0_1
                                !Key to drive line STSO to 1
120 ON KEY 6 LABEL "STSO=0" CALL Res0_0
                                !Key to drive line STSO to 0.
130 ON TIMEOUT 7,3 GOTO End      !Turn TIMEOUTS to errors--this branch
                                never taken.
140 ON ERROR RECOVER Kaboom      !This handles timeouts and errors not
                                handled at lower level contexts.

```

```

150 !
160 Main                                     !Put application code in this sub.
170 Quit:PRINT "Checking for E13xx Errors at the end of the program"
180 E13xx_errors
190 GOTO End
200 Kaboom:PRINT ""
210 PRINT ERRM$
220 PRINT "Checking for E13xx Errors as a BASIC Error has occurred"
230 E13xx_errors
240 End:END
250 !
260 SUB E13xx_errors                          !This sub reads all errors from E13xx
                                              instruments.

270 COM /Instr/ @Sys,@Dig
280 DIM A$[128]
290 ABORT 7                                  !Free bus handshakes.
300 !
310 CLEAR @Sys                              !Terminate instrument activity & clear
                                              I/O buffers.

320 REPEAT
330   OUTPUT @Sys;"SYST:ERR?"
340   ENTER @Sys;A,A$
350   PRINT "SYSTEM ERROR ";A$
360   UNTIL A=0
370 SUBEND
380 !
390 Main:SUB Main                            !This subroutine is treated as the main
                                              line

400 COM /Instr/ @Sys,@Dig
410 COM /Register/ Logical_address
420 !Put application code here
430 CLEAR @Sys
440 OUTPUT @Sys;"*RST;*CLS;*OPC?"
450 ENTER @Sys;A
460 Logical_address=144                     !E1330 LOGICAL ADDRESS.
470 CALL Reset_dig                          !Reset the E1330.
480 !
490 !Now setup the system instrument to catch backplane interrupt on IRQ2.
500 OUTPUT @Sys;"STATUS:OPER:ENAB 256;*SRE 128"
                                           !SRQ on backplane INT.
510 OUTPUT @Sys;"DIAG:INT:SETUP2 ON"
                                           !System instrument to catch IRQ2.

520 OUTPUT @Sys;"DIAG:INT:ACT ON;*OPC?"
530 ENTER @Sys;A
540 !
550 !Enable the E1330 to produce PIR interrupts.
560 Enable_pir0
570 Enable_pir1
580 Enable_pir2
590 Enable_pir3
600 Enable_int
610 ON INTR 7,2 CALL Intr_ser
620 ENABLE INTR 7;2
630 !This is just a wait loop.
640 LOOP
650 PRINT TIMEDATE
660 WAIT .5

```

```

670 END LOOP
680 Main_:SUBEND
690 !
700 SUB Reset_dig
710 COM /Register/ Logical_address
720 COM /Instr/ @Sys,@Dig
730 OUTPUT @Dig;"*RST;*OPC?" !May use SCPI as reset does not use
interrups as the IRQ2 jumper is being
used.

740 ENTER @Dig;A
750 SUBEND
760 Reg_dump:SUB Reg_dump
770 !This queries all E1330 registers to help debugging.
780 COM /Instr/ @Sys,@Dig
790 COM /Register/ Logical_address
800 INTEGER Query,Reg
810 Base=2031616+49152+(Logical_address*64)
820 FOR Reg=0 TO 35
830 OUTPUT @Sys;"DIAG:PEEK? "&VAL$(Base+Reg)&","8"
!Do 8 Bit reads.

840 ENTER @Sys;Query
850 Query=BINAND(Query,255)
860 Hquery$=IVAL$(Query,16)
870 Bquery$=IVAL$(Query,2)
880 Hreg$=IVAL$(Reg,16)
890 PRINT "REGISTER--#D";Reg;" #H";Hreg$[3,4];
"VALUE--#D";Query;" #H";Hquery$[3,4];" #B";Bquery$[9,16]
900 NEXT Reg
910 Reg_dump_:SUBEND

920 !
930 Int_ser:SUB Intr_ser !This is the interrupt service routine.
940 COM /Instr/ @Sys,@Dig
950 PRINT "got a interrupt"
960 A=SPOLL(@Sys) !Must serial poll to clear status byte.
970 PRINT "SERIAL POLL VALUE ";A
980 OUTPUT @Sys;"STAT:OPER:EVENT?"!Must read Operation Status register
990 ENTER @Sys;Stat_oper
1000 PRINT "STATUS:OPERATION:EVENT ";Stat_oper
1010 OUTPUT @Sys;"DIAG:INT:RESP?"
1020 ENTER @Sys;Int_ack !Must enter Interrupt Acknowledge
query.
1030 PRINT "INTERRUPT ACKNOWLEDGE ";Int_ack;DVAL$(Int_ack,2);
" = LADD ";BINAND(Int_ack,255)
!Determine which PIR interrupt
occurred & re-enable it.

1040 !
1050 IF BIT(Int_ack,9)=0 THEN
1060 PRINT "PIR0 OCCURRED"
1070 Enable_pir0
1080 END IF
1090 IF BIT(Int_ack,8)=0 THEN
1100 PRINT "PIR1 OCCURRED"
1110 Enable_pir1
1120 END IF
1130 IF BIT(Int_ack,11)=0 THEN
1140 PRINT "PIR2 OCCURRED"

```



```

1150 Enable_pir2
1160 END IF
1170 IF BIT(Int_ack,10)=0 THEN
1180 PRINT "PIR3 OCCURRED"
1190 Enable_pir3
1200 END IF
1210 Enable_int
1220 OUTPUT @Sys;"DIAG:INT:SETUP2 ON;;DIAG:INT:ACT ON;*OPC?"
1230 ENTER @Sys;A
1240 ENABLE INTR 7;2
1250 Int_ser_:SUBEND
1260 !
1270 Res0_1:SUB Res0_1                                     !Subprogram to drive line RES0 (PIN 5)
                                                         to 1.
1280 !                                                     !Must have a pullup on RES0 as it is
                                                         open collector.

1290 COM /Instr/ @Sys,@Dig
1300 COM /Register/ Logical_address
1310 Base=2031616+49152+(Logical_address*64)
1320 OUTPUT @Sys;"DIAG:POKE "&VAL$(Base+(DVAL("10",16)))&",&8,96"
1330 PRINT "RES0 DRIVEN TO 1"
1340 Res0_1_:SUBEND
1350 !
1360 Res0_0:SUB Res0_0                                     !Subprogram to drive line RES0 (PIN 5)
                                                         to 0.

1370 COM /Instr/ @Sys,@Dig
1380 COM /Register/ Logical_address
1390 Base=2031616+49152+(Logical_address*64)
1400 OUTPUT @Sys;"DIAG:POKE "&VAL$(Base+(DVAL("10",16)))&",&8,64"
1410 PRINT "STS0 DRIVEN TO 0"
1420 Res0_0_:SUBEND
1430 !
1440 Enable_pir0:SUB Enable_pir0
1450 COM /Instr/ @Sys,@Dig
1460 COM /Register/ Logical_address
1470 Base=2031616+49152+(Logical_address*64)
1480 OUTPUT @Sys;"DIAG:POKE "&VAL$(Base+(DVAL("0C",16)))&",&8,0"
                                                         !PI=0
1490 OUTPUT @Sys;"DIAG:POKE "&VAL$(Base+(DVAL("08",16)))&",&8,128"
                                                         !PIEN=1
1500 OUTPUT @Sys;"DIAG:POKE "&VAL$(Base+(DVAL("0C",16)))&",&8,128"
                                                         !PI=1

1510 Enable_pir0_:SUBEND
1520 !
1530 Enable_pir1:SUB Enable_pir1
1540 COM /Instr/ @Sys,@Dig
1550 COM /Register/ Logical_address
1560 Base=2031616+49152+(Logical_address*64)
1570 OUTPUT @Sys;"DIAG:POKE "&VAL$(Base+(DVAL("0D",16)))&",&8,0"
                                                         !PI=0
1580 OUTPUT @Sys;"DIAG:POKE "&VAL$(Base+(DVAL("09",16)))&",&8,128"
                                                         !PIEN=1
1590 OUTPUT @Sys;"DIAG:POKE "&VAL$(Base+(DVAL("0D",16)))&",&8,128"
                                                         !PI=1

1600 Enable_pir1_:SUBEND
1610 !
1620 Enable_pir2:SUB Enable_pir2

```

```

1630 COM /Instr/ @Sys,@Dig
1640 COM /Register/ Logical_address
1650 Base=2031616+49152+(Logical_address*64)
1660 OUTPUT @Sys;"DIAG:POKE "&VAL$(Base+(DVAL("0E",16)))&",&8,0"
!PI=0
1670 OUTPUT @Sys;"DIAG:POKE "&VAL$(Base+(DVAL("0A",16)))&",&8,128"
!PIEN=1
1680 OUTPUT @Sys;"DIAG:POKE "&VAL$(Base+(DVAL("0E",16)))&",&8,128"
!PI=1

1690 Enable_pir2_:SUBEND
1700 !
1710 Enable_pir3:SUB Enable_pir3
1720 COM /Instr/ @Sys,@Dig
1730 COM /Register/ Logical_address
1740 Base=2031616+49152+(Logical_address*64)
1750 OUTPUT @Sys;"DIAG:POKE "&VAL$(Base+(DVAL("0F",16)))&",&8,0"
!PI=0
1760 OUTPUT @Sys;"DIAG:POKE "&VAL$(Base+(DVAL("0B",16)))&",&8,128"
!PIEN=1
1770 OUTPUT @Sys;"DIAG:POKE "&VAL$(Base+(DVAL("0F",16)))&",&8,128"
!PI=1

1780 Enable_pir3_:SUBEND
1790 Enable_int:SUB Enable_int !Enables PIRO-3 INT to reach the
backplane.

1800 COM /Instr/ @Sys,@Dig
1810 COM /Register/ Logical_address
1820 Base=2031616+49152+(Logical_address*64)
1830 OUTPUT @Sys;"DIAG:POKE "&VAL$(Base+(DVAL("05",16)))&",&8,64"
!PIEN=1

1840 Enable_pir3_:SUBEND

```

HP E1330B Non-data Line I/O

The HP E1330 has several signal lines other than the data lines which can be individually controlled. These lines are the FLG, CTL, STS, \overline{RES} , and PIR lines. The following BASIC language program demonstrates how to control these lines.

FLG0–FLG3 are input lines (input from the peripheral to the HP E1330 module) that can be used as individual input lines when not used as handshake lines. The subroutine *Ctl_flg_io* demonstrates using SCPI commands to control these lines.

CTL0–CTL3 are output lines (output from the HP E1330 module to your peripheral) which can be controlled individually when not used as handshaking lines. Subroutine *Ctl_flg_io* demonstrates driving these lines using SCPI programming commands.

STS0–STS3 are input lines that can be controlled using register based programming. Subroutine *Res_sts_io* demonstrates using register based programming of these lines.

$\overline{RES0}$ – $\overline{RES3}$ are output lines that can be controlled using register based programming. Subroutines *Res_sts_io*, *Res_pir_io*, and *Res_pi_io* demonstrate register programming.

PIR0–PIR3 are input lines. Subroutine *Res_pir_io* demonstrates directly reading these input lines. Subroutine *Res_pi_io* demonstrates reading a latched version of these inputs.

```

10 !re-save "DIG_NDL".
20 !Program to demonstrate the non-data lines—FLAG/CONTROL,RES/STS, PIR.
30 !This main line code is reserved as a error handling shell.
40 !All application code must be at lower level context.
50 ASSIGN @Sys TO 70900           !Define I/O paths.
60 ASSIGN @Dvm TO 70903
70 ASSIGN @Dig TO 70910
80 COM @Sys,@Dvm,@Dig
90 ON TIMEOUT 7,3 GOTO End       !Turn TIMEOUTS to errors—this
                                  branch never taken.

100 ON ERROR RECOVER Kaboom      !This handles timeouts and errors not
                                  handled.

110 !at lower level contexts.
120 Main                          !Put application code in this sub.
121 PRINT ""
130 E13xx_errors
140 GOTO End
150 Kaboom:PRINT ""
160 PRINT ERRM$
170 PRINT "HERE IS THE E13XX ERROR STATUS"
180 E13xx_errors
190 End:END
200 !
210 SUB E13xx_errors              !This sub reads all errors from E13xx
                                  instruments.

220 COM @Sys,@Dvm,@Dig
230 DIM A$[128]
240 ABORT 7
250 CLEAR @DVM
260 REPEAT
270 OUTPUT @Dvm;"SYST:ERR?"
280 ENTER @Dvm;A,A$
290 PRINT "DVM ERROR ";A$
300 UNTIL A=0
310 !
320 CLEAR @Sys
330 REPEAT
340 OUTPUT @Sys;"SYST:ERR?"
350 ENTER @Sys;A,A$
360 PRINT "SYSTEM ERROR ";A$
370 ! UNTIL A=0
390 CLEAR @Dig
400 REPEAT
410 OUTPUT @Dig;"SYST:ERR?"
420 ENTER @Dig;A,A$
430 PRINT "DIG I/O ERROR ";A$
440 UNTIL A=0
450 SUBEND
460 !
470 SUB Main                      !This subroutine is treated as the main line.
480 COM @Sys,@Dvm,@Dig
490 Cnt_flg_io                    !Demonstrate driving CONTROL0,
                                  receiving FLAG0.

500 Res_sts_io                    !Demonstrate driving RES0, receiving STS0.
510 Res_pir_io                    !Demonstrate driving RES0, receiving PIR0.
520 Res_pi_io                     !Demonstrate driving RES0, receiving PIO.
530 !Put Application code here.

```

```

540 SUBEND
550 !
560 SUB Cnt_flg_io                                !Demonstrates driving CONTROL0 then
                                                receiving FLAG 0.
570 COM @Sys,@Dvm,@Dig                          !Connect CONTROL 0 to FLAG 0.
580 PRINT ""
590 PRINT "SUBPROGRAM Cnt_flg_io"
600 OUTPUT @Dig;"*RST"                          !RESET to power on state.
610 OUTPUT @Dig;"SOUR:DIG:CONT0:VAL 0"
                                                !Drive CONTROL 0 to 0.
620 OUTPUT @Dig;"MEAS:DIG:FLAG0"               !Read FLAG 0.
630 ENTER @Dig;A
640 PRINT "CONTROL0 DRIVEN TO 0 AND FLAG0 RECEIVED AS ";A
650 OUTPUT @Dig;"SOUR:DIG:CONT0:VAL 1"
                                                !Drive CONTROL 0 to 1.
660 OUTPUT @Dig;"MEAS:DIG:FLAG0"               !Read FLAG 0.
670 ENTER @Dig;A
680 PRINT "CONTROL0 DRIVEN TO A 1 AND FLAG0 RECEIVED AS A ";A
690 PRINT ""
700 SUBEND
710 SUB Res_sts_io                                !Demonstrates driving RES0 then
                                                receiving STS0.
720 !Connect RES0 to STS0.
730 !Use register programming to use RES0 & STS0.
740 COM @Sys,@Dvm,@Dig
750 PRINT ""
760 PRINT "SUBPROGRAM Res_sts_io"
770 OUTPUT @Dig;"*RST"                          !RESET to power on state.
780 Ladd=80
790 !Base=Start of A16+Offset to VXI Reg+Offset to card Reg.
800 Base=2031616+49152+(Ladd*64)
810 OUTPUT @Sys;"DIAG:POKE "&VAL$(Base+(DVAL("10",16))) &" ,8,64 "
                                                !Drive RES0 to 0.
820 OUTPUT @Sys;"DIAG:PEEK? "&VAL$(Base+(DVAL("10",16))) &" ,8"
                                                !Read REG B+10H
830 ENTER @Sys;A
840 Bit0=BIT(A,0)
850 PRINT "RES0 DRIVEN TO 0, STS0 RECEIVED AS ";Bit0
860 OUTPUT @Sys;"DIAG:POKE "&VAL$(Base+(DVAL("10",16))) &" ,8,96"
                                                !Drive RES0 to 1.
870 OUTPUT @Sys;"DIAG;PEEK? "&VAL$(Base+(DVAL("10",16))) &" ,8"
                                                !Read REG B+10H.
880 ENTER @Sys;A
890 Bit0=BIT(A,0)
900 PRINT "RES0 DRIVEN TO 1, STS0 RECEIVED AS ";Bit0
910 SUBEND
920 SUB Res_pir_io                                !Demonstrates driving RES0 then
                                                receiving PIR0.
930 !Connect RES0 to PIR0.
940 !Use register programming to use RES0 & PIR0.
950 COM @Sys,@Dvm,@Dig
960 PRINT ""
970 PRINT "SUBPROGRAM Res_pir_io"
980 OUTPUT @Dig;"*RST"                          !RESET to power on state.
990 Ladd=80
1000 !Base=Start of A16+Offset to VXI Reg+Offset to card Reg.
1010 Base=2031616+49152+(Ladd*64)

```

```

1020 OUTPUT @Sys;"DIAG:POKE "&VAL$(Base+(DVAL("10",16))) &" ,8,64"
      !Drive RES0 to 0.
1030 OUTPUT @Sys;"DIAG:PEEK? "&VAL$(Base+(DVAL("10",16))) &" ,8"
      !Read REG B+10H.
1040 ENTER @Sys;A
1050 Bit1=BIT(A,1)
1060 PRINT "RES0 DRIVEN TO 0, PIR0 RECEIVED AS ";Bit1
1070 OUTPUT @Sys;"DIAG:POKE "&VAL$(Base+(DVAL("10",16))) &" ,8,96"
      !Drive RES0 to 1.
1080 OUTPUT @Sys;"DIAG:PEEK? "&VAL$(Base+(DVAL("10",16))) &" ,8"
      !Read REG B+10H.
1090 ENTER @Sys;A
1100 Bit1=BIT(A,1)
1110 PRINT "RES0 DRIVEN TO 1, PIR0 RECEIVED AS ";Bit1
1120 SUBEND
1130 !
1140 SUB Res_pi_io
      !Demonstrates driving RES0 then
      receiving PI.
1150 !LATCHED PIR0.
1160 !Connect RES0 to PIR0.
1170 !Use register programming to use RES0 & PIR0.
1180 COM @Sys,@Dvm,@Dig
1190 PRINT ""
1200 PRINT "SUBPROGRAM Res_pi_io"
1210 OUTPUT @Dig;"*RST"
      !RESET to power on state.
1220 Ladd=80
1230 !Base=Start of A16+Offset to VXI Reg+Offset to card Reg.
1240 Base=2031616+49152+(Ladd*64)
1270 OUTPUT @Sys;"DIAG:POKE "&VAL$(Base+(DVAL("08",16))) &" ,8,131"
      !Set PIEN=1.
1280 OUTPUT @Sys;"DIAG:POKE "&VAL$(Base+(DVAL("0C",16))) &" ,8,128"
      !Set PI=1.
1290 OUTPUT @Sys;"DIAG:POKE "&VAL$(Base+(DVAL("10",16))) &" ,8,64"
      !Drive RES0 to 0.
1300 OUTPUT @Sys;"DIAG:PEEK? "&VAL$(Base+(DVAL("10",16))) &" ,8"
      !Read REG B+10H.
1310 ENTER @Sys;A
1320 Bit1=BIT(A,1)
1330 PRINT "RES0 DRIVEN TO 0, PIR0 RECEIVED AS ";Bit1
1340 OUTPUT @Sys;"DIAG:PEEK? "&VAL$(Base+(DVAL("0C",16))) &" ,8"
      !Read PI.
1350 ENTER @Sys;A
1360 Bit7=BIT(A,7)
1370 PRINT "PERIPHERAL INTERRUPT = ";Bit7
1380 OUTPUT @Sys;"DIAG:POKE "@VAL$(Base+(DVAL("10",16))) &" ,8,96"
      !Drive RES0 to 1.
1390 OUTPUT @Sys;"DIAG:PEEK? "&VAL$(Base+(DVAL("10",16))) &" ,8"
      !Read REG B+10H.
1400 ENTER @Sys;A
1410 Bit1=BIT(A,1)
1420 PRINT "RES0 DRIVEN TO 1, PIR0 RECEIVED AS ";Bit1
1430 OUTPUT @Sys;"DIAG:PEEK? "&VAL$(Base+(DVAL("0C",16))) &" ,8"
      !Read PI.
1440 ENTER @Sys;A
1450 Bit7=BIT(A,7)
1460 PRINT "PERIPHERAL INTERRUPT = ";BIT7
1470 SUBEND

```

Embedded Computer Example

The following example was developed with the module at logical address 144. The C language programs were developed on an HP V382 using ANSI C programming language and SICL (Standard Instrument Control Library).

```
/* C register programming example */
```

```
#include <stdio.h>
#include <stdlib.h>
#include <sicl.h>
```

```
/* Setup the registers and offsets */
```

```
#define mfr_id      0x00
#define dev_id     0x02
#define card_stat  0x04
#define port_xfr_0 0x0C
#define port_xfr_1 0x0D
#define port_xfr_2 0x0E
#define port_xfr_3 0x0F
#define port_ctl_0 0x10
#define port_ctl_1 0x11
#define port_ctl_2 0x12
#define port_ctl_3 0x13
#define port_data_0 0x14
#define port_data_1 0x15
#define port_data_2 0x16
#define port_data_3 0x17
#define port_hand_0 0x18
#define port_hand_1 0x19
#define port_hand_2 0x1A
#define port_hand_3 0x1B
#define port_del_0  0x1C
#define port_del_1  0x1D
#define port_del_2  0x1E
#define port_del_3  0x1F
#define port_norm_0 0x20
#define port_norm_1 0x21
#define port_norm_2 0x22
#define port_norm_3 0x23
```

```
/* set up bytes to output */
```

```
#define pattern_10xAA
#define pattern_20x55
```

```
/* function to test the data register ready bit of the port transfer control register */
```

```
int test_drr (int reg_addr){
    int test_1;
    unsigned char reg_byte;
    reg_byte = ibpeek (reg_addr);
    reg_byte = reg_byte << 7;
    if (reg_byte = 0x80)
```

```

        test_1 = 0; /* port is ready */
    else
        test_1 = 1; /* port not ready */
    return test_1; }

main () {

    INST id;
    unsigned short data_word;
    unsigned char data_byte;
    int reg_num;
    char *base_addr;
    int errnum;

    /* open a path to digital I/O module */

    id = iopen("vxi,144");
    if (id == 0){
        errnum = igeterrno();
        printf ("iopen failed: error = %d,%s\n\n",errnum,igeterrstr(errnum));
        exit (-1); }

    /* get base address */

    base_addr = imap(id,I_MAP_VXIDEV,0,0,NULL);
    if (base_addr == NULL){
        errnum = igeterrno();
        printf("imap failure: error = %d,%s\n",errnum,igeterrstr(errnum));
        exit (-1); }

    /* perform a soft reset */

    iwpoke((base_addr + card_stat),0xFCBF);
    iwpoke((base_addr + card_stat),0xFCBE);

    /* read MFR and device ID registers */

    data_word = iwpeek (base_addr + mfr_id);
    printf("MFR ID value = %04X\n",data_word);
    data_word = iwpeek (base_addr + dev_id);
    printf("Dev ID value = %04X\n",data_word);

    /* output data bytes to ports 0 and 3, no handshake */

    /* port 0 */
    ibpoke((base_addr + port_hand_0),0x00);
    ibpoke((base_addr + port_del_0),0x00);
    ibpoke((base_addr + port_norm_0),0x00);
    ibpoke((base_addr + port_ctl_0),0x00);
    ibpoke((base_addr + port_xfr_0),0x00);
    ibpoke((base_addr + port_data_0),pattern_1);

```

```

/* port 3 */
ibpoke((base_addr + port_hand_1),0x00);
ibpoke((base_addr + port_del_1),0x00);
ibpoke((base_addr + port_norm_1),0x00);
ibpoke((base_addr + port_ctl_1),0x00);
ibpoke((base_addr + port_xfr_1),0x00);
ibpoke((base_addr + port_data_1),pattern_2);

/* return ports back to input state */
ibpoke((base_addr + port_ctl_0),0x40);
ibpoke((base_addr + port_xfr_0),0x00);
ibpoke((base_addr + port_ctl_1),0x40);
ibpoke((base_addr + port_xfr_0),0x00);

/* input a data byte at port 2, no handshake */

ibpoke((base_addr + port_hand_2),0x00);
ibpoke((base_addr + port_del_2),0x00);
ibpoke((base_addr + port_norm_2),0x00);
ibpoke((base_addr + port_ctl_2),0x40);
ibpoke((base_addr + port_xfr_2),0x00);
data_byte = ibpeek(base_addr + port_data_2);
printf("port data register value = %02X\n",data_byte);

/* input a data byte at port 1, leading edge handshake */

ibpoke((base_addr + port_hand_1),0x20);
ibpoke((base_addr + port_del_1),0xF2);
ibpoke((base_addr + port_norm_1),0x00);
ibpoke((base_addr + port_ctl_1),0x40);
ibpoke((base_addr + port_xfr_1),0x02);
count = 0;
while (test_drr(base_addr + port_xfr_1)){
    count = count++;
    if (count == 100) {
        printf("DRR bit not ready ");
        exit (-1); }
    }
data_byte = ibpeek(base_addr + port_data_1);
printf("port data register value = %02X\n",data_byte);
/* disable port handshake */
ibpoke((base_addr + port_xfr_2),0x00);
ibpoke((base_addr + port_xfr_1),0x00);
return 0; }

```

Appendix C

Error Messages

Code	Message	Cause
-101	Invalid character	Unrecognized character in specified parameter.
-102	Syntax Error	Command is missing a space or comma between parameters.
-103	Invalid separator	Command parameters are not separated by a comma.
-104	Data Type Error	The wrong data type (i.e. number, character, string, expression) was used when specifying a parameter.
-108	Parameter not allowed	Parameter specified in a command where none is allowed.
-109	Missing parameter	No parameter specified when required.
-113	Undefined header	Command header was incorrectly specified.
-124	Too many digits	>257 digits were specified for a parameter.
-128	Numeric data not allowed	A number was specified for a parameter when a letter is required.
-131	Invalid suffix	Parameter suffix incorrectly specified.
-138	Suffix not allowed	Parameter suffix is specified when one is not allowed.
-141	Invalid character data	The parameter type specified is not allowed.
-161	Invalid block data	Mismatch between character count in header and actual number of characters.
-178	Expression data not allowed	A parameter is enclosed in parenthesis.
-221	Settings conflict	Digital I/O command settings are in conflict (e.g., control asserted when in a handshake mode other than NONE).
-222	Data out of range	Value specified is out of the legal range for parameter.
-224	Illegal Parameter Value	Inconsistent parameter value or block not found.
-240	Hardware Error	Hardware error detected during power-on cycle. Return Digital I/O Module to Hewlett-Packard for repair.
-410	Query Interrupted	Data is not read from the output buffer before another command is issued.
-420	Query unterminated	Command which generates data not able to finish executing due to a Digital I/O Module configuration error.
-430	Query deadlocked	Command execution cannot continue since the mainframe's command input and data buffers are full. Clearing the instrument restores control.
+1000	Out of memory	No memory available.
+2006	Undefined command	Command not recognized by this instrument.
+2025	Invalid port number for access TYPE	The port number specified is not valid for the [:type] set.
+2026	Port number out of range	The port number specified is out of the legal range of port numbers.
+2027	Invalid bit number for access TYPE	The bit number specified is not valid for the port [:type] set.
+2028	LW64 & LW96 not supported by this card	Attempt to replace [:type] with either LW64 or LW96 keywords.
+2029	Duplicate memory block name	The memory block name specified already exists.
+2030	Invalid number of bytes for TRACE access TYPE	The number of bytes specified in a trace does not match the [:type] set.

Notes:

Symbols

- *CLS, 98
- *DMC, 68, 98
- *EMC, 98
- *EMC?, 98
- *ESE, 98
- *ESE?, 98
- *ESR?, 98
- *GMC, 98
- *IDN, 98
- *LMC, 98
- *OPC, 98
- *OPC?, 98
- *PMC, 68, 98
- *RCL, 98
- *RMC, 98
- *RST, 33, 43, 98
- *SAV, 98
- *SRE, 98
- *SRE?, 98
- *STB?, 98
- *TRG, 98
- *TST?, 98
- *WAI, 98

A

- A16 Address Space, 105–107
 - inside the command module, 107
 - inside the mainframe, 107
 - outside the command module, 106–107
- A24 Address Space, 68
- Abbreviated Commands, 58
- Address
 - base, 106–107
 - HP-IB, 31
 - LADDR, 18, 31
 - logical switch, 18, 31
 - module, 31
 - primary, 31
 - registers, 105–110
 - secondary, 31

Address (*continued*)

- space defined, 68, 105
- switch, setting, 18, 31
- VME memory, 69

Algorithm

- input register-based, 120
- output register-based, 119

B

Base Address, 106–107

Binary Format, 52, 54

BIT

- input, 35, 50
- numbers, 50–51, 54
- output, 36, 51
- querying, 77
- specifying, 50–51, 76
- summary bit, 93–95

Boolean Command Parameters, 59

BYTE

- bit designations, 12
- bit numbering, 50, 52, 54
- data lines used, 51, 54
- input, 35, 50
- keyword described, 37, 53, 64–66, 76–85
- least significant bit, 52
- most significant bit, 52
- output, 36, 51–52
- range of values, 54
- reading an 8-bit, 128–129
- status byte, 93
- writing an 8-bit, 125–126

C

C Program Examples

- reading
 - an 8-bit byte, 129
 - registers, 124
- resetting the module, 122
- using an embedded computer, 140
- writing
 - a 16-bit word, 127
 - an 8-bit byte, 126

Cables

- digital I/O, connecting, 24
- ribbon cable
 - data line location, 24
 - ordering, 12

Card Edge Connector, 25

Card Status/Control Register, 111

*CLS, 98

Combining Flag Lines, 21

Command Parameters, rules for use, 14, 59

Command Reference, 57–101

- abbreviated commands, 58
- command
 - quick reference, 99–101
 - separator, 58
 - types, 57
- common command format, 57
- DISPlay subsystem, 61–63
- IEEE 488.2 common commands, 98
- implied commands, 58
- keyword substitutions, 59
- linking commands, 59
- MEASure subsystem, 64–67
- MEMory subsystem, 68–71
- parameters, 59
- SCPI command format, 57–59
- SOURce subsystem, 72–92
- STATus subsystem, 93–95
- SYSTEM subsystem, 96–97

Commands

- abbreviated, 58
- IEEE 488.2, 57, 98
- implied, 14, 58
- keyword substitutions, 59
- linking, 59
- optional, 14, 58
- optional parameters, 14, 59
- parameters, 59
- quick reference, 99–101
- SCPI, 57, 99–101
 - format, 14, 57–59

Commands (*continued*)

- separator, 58
- types, 57

Common (*) Commands, 57, 98

- *CLS, 98
- *DMC, 68, 98
- *EMC, 98
- *EMC?, 98
- *ESE, 98
- *ESE?, 98
- *ESR?, 98
- *GMC, 98
- *IDN?, 98
- *LMC, 98
- *OPC, 98
- *OPC?, 98
- *PMC, 68, 98
- *RCL, 98
- *RMC, 98
- *RST, 33, 43, 98
- *SAV, 98
- *SRE, 98
- *SRE?, 98
- *STB?, 98
- *TRG, 98
- *TST?, 98
- *WAI, 98
- format, 57
- listing, 98

Condition Register, 93–95

Configuring

- for open collector, 28
- for VXIbus, 18, 20
- isolated digital I/O, 25
- system, 121
- the HP E1330B, 17–29

Connecting

- computers to peripherals, 26–27
- digital I/O cables, 24
- GPIO peripheral, 26–27
- ribbon cables, 25

Connections

- GPIO, 26–27
- open collector, 28
- to peripheral, 22–23
- typical, 29

Connectors

- card edge connector, 25
- header connector, 25
- pin assignments, 22–24
- ribbon cable, 24–25

C (continued)

Control Lines

CTL, 12, 21–22, 42, 115, 136
FLG, 12, 16, 21–22, 42, 114, 136
I/O, 12, 22, 42, 89, 115
PIR, 12, 22, 43, 114, 136
polarity, 33, 43, 74
RES, 12, 22, 43, 114, 136
setting value, 75
specify logic sense, 118
STS, 12, 22, 43, 114, 136

CTL Control Line, 12, 21–22

clearing value, 75
controlling, 114
default/reset state, 33, 43
description, 42
for handshaking, 21
input/output handshaking, 54
invert CTL, 118
operation, 42
operation of, 115
polarity, 33, 43
setting
 polarity, 33, 42–43, 74
 value, 75
status, 115
using as output lines, 136

D

Data

input, 54
 from multiple ports, 54
output, 54
 to multiple ports, 54

Data Bits

inputting, 35, 50
outputting, 36, 51
querying, 77
specifying, 15, 76

Data Bytes

inputting, 35, 50
outputting, 36, 51–52

Data Lines

data bits, 15
default/reset state, 33, 43
description, 41
invert DATA, 118
mapping, 12
numbers, 50–51, 54
open collector, 28–29
polarity, 33, 41, 43, 82

Data Lines (continued)

ports, 41
pull-up, 19, 28
setting polarity, 82
specify logic sense, 118
termination, 19
TTL levels, 52

Debugging Programs, 130

Decimal Format, 52

Default and Reset States, 33, 43

Deleting

automatic data handshaking, 88
macros, 68
memory data blocks, 92

Device Identification Register, 111

DIAG:PEEK?, 108

DIAG:POKE, 108

Disable VME Memory, 71

Discrete Command Parameters, 59

DISPlay Subsystem, 61–63

DISPlay:MONitor:PORT, 61

DISPlay:MONitor:PORT?, 62

DISPlay:MONitor[:STATe], 62

DISPlay:MONitor[:STATe]?, 63

*DMC, 68, 98

Drivers

downloading SCPI, 13
SCPI, 13
typical connection, 29

E

Embedded Computer Example, 140

*EMC, 98

*EMC?, 98

Enable

inhibit, 116
mask, 93
VME memory, 71

Error

messages and numbers, 143
query for, 97
register, 97

*ESE, 98

*ESE?, 98

*ESR?, 98

Event Register, 93–95

Example Programs (VXIplug&play)

See online help

External

pull-up, 28–29
VME memory, 70

F

- Flag Control Line
 - See FLG Control Line
- Flag Line
 - polarity, 86
 - query status, 67
 - specify logic sense, 118
- FLG Control Line, 12, 22
 - combining, 21
 - description, 42
 - factory setting, 21
 - input/output handshaking, 54
 - invert FLG, 118
 - operation, 42
 - operation of, 114
 - polarity, 33, 43, 86
 - setting polarity, 16, 33, 42–43, 86
 - status, 114
 - using as input lines, 136
- Format
 - common commands, 57
 - output, 52
 - SCPI commands, 57–59
- Function Reference (VXIplug&play)
 - See online help

G

- Getting Started, 11–14, 16
- *GMC, 98
- GPIO Interface, 26–27
 - connecting, 26

H

- Handshake
 - default/reset mode, 33
 - delay, 34, 49, 78–79, 87–88
 - flag combining, 21
 - LEADing edge mode, 34, 44–45, 80–81, 88–89, 117
 - multiple ports, 53
 - NONE mode, 34, 44, 49, 80–81, 88–89, 117
 - PARTial mode, 34, 44, 48, 80–81, 88–89, 117
 - PULSe mode, 34, 44, 47, 78, 80–81, 87–89, 117
 - querying mode, 81, 89
 - setting mode, 34, 44–49, 80, 88
 - STRobe mode, 34, 44, 49, 78, 80–81, 87–89, 117
 - timing, 34, 44, 49, 78–79, 87–88
 - TRAILing edge mode, 34, 44, 46, 80–81, 88–89, 117
 - types of, 116

- Handshake (*continued*)
 - using CTL line, 54
 - using FLG line, 54, 86
 - with peripheral, 21, 80, 88
- Header Connector, 25
- Hexadecimal Format, 52, 54
- HP IBASIC Examples
 - reading
 - an 8-bit byte, 128
 - registers, 123
 - resetting the module, 122
 - using
 - non-data I/O lines, 136
 - PIR interrupt lines, 132
 - writing
 - a 16-bit word, 127
 - an 8-bit byte, 125
- HP-IB
 - description of, 16
 - primary and secondary address, 31

I

- I/O Control Line, 12, 22
 - controlling, 114
 - default/reset state, 33, 43
 - description, 42
 - operation, 42
 - operation of, 115
 - query condition of, 89
 - status, 115
- *IDN, 98
- IEEE-488.2 Common Commands
 - Common (*) Commands, 98
- Implied Commands, 14, 58
- Initial Operation, 16
- Input
 - byte, 35, 50
 - changing polarity, 41
 - data
 - bits, 35, 50
 - bytes, 35, 50
 - from multiple ports, 54
 - format, 54
 - range of values, 54
 - register-based algorithm, 120
- Input/Output Control Line
 - See I/O Control Line
- Interface
 - GPIO, 26–27
 - select code, 31
 - standard parallel, 26–27

I (continued)

Internal Pull-up, 19, 29

Interrupts

- disable, 20
- flags, 111
- line, 20
- peripheral, 114
- PIR control line, 131
- setting priority, 20
- VXIbus, 20, 110

J

Jumpers

- flag combining, 67
- hardware configuration, 12
- interrupt line, 20, 132
- JM15 and JM16, 20
- pull-up enable, 19

K

Keyword

- rules for use, 58
- substitutions, 59

L

LADDR, 18, 31

LEADing Edge Handshake Mode, 34, 44–45, 80–81, 88–89, 117

Linking Commands, 59

*LMC, 98

Logical Address, 18, 31

- changing, 18, 31
- factory setting, 18, 31, 107
- switch, setting, 18, 31

LWORD

- bit
 - designations, 12
 - numbering, 54
- data lines used, 54
- keyword described, 37, 53, 64–66, 76–85

M

Macro, deleting, 68

Manufacturer ID Register, 111

MEASure Subsystem, 64–67

MEASure:DIGital:DATA*n*

- [:BYTE]BIT*m*?, 64
- [:BYTE]TRACe, 65
- [:BYTE][:VALue]?, 66
- :LWORD:BIT*m*?, 64
- :LWORD:TRACe, 65
- :LWORD[:VALue]?, 66
- [:type]BIT*m*?, 15, 64
- [:type]TRACe, 65
- [:type][:VALue]?, 37, 50, 53, 66
- :WORD:BIT*m*?, 64
- :WORD:TRACe, 65
- :WORD[:VALue]?, 66

MEASure:DIGital:FLAG*n*?, 67

Memory

- add-on VME, 69
- catalog mainframe system, 90
- catalog VME blocks, 90
- define user block, 91
- delete blocks from, 92
- disable/enable VME, 71
- external VME, 68–71
- query block size, 92
- query VME size, 70
- read data from block, 91
- setting VME size, 70
- using trace, 38–39, 83
- write data to block, 90

MEMory Subsystem, 68–71

MEMory:DELeTe:MACRo, 68

MEMory:VME:ADDRess, 69

MEMory:VME:ADDRess?, 69

MEMory:VME:SIZE, 70

MEMory:VME:SIZE?, 70

MEMory:VME:STATe, 71

MEMory:VME:STATe?, 71

Module

- base address, 106–107
- configuring the, 17–29
- description, 96
- manufacturer, 96
- number, 96
- register information, 105–142
- resetting, 122
- specifications, 103–104
- understanding the, 41–54
- using the, 31–39

M (continued)

Multiple

port

- handshaking, 53
- input/output, 54
- operations, 37, 53

ports

- single handshake line, 21
- specifying, 15, 37, 53

SCPI commands, linking, 59

N

Non-Data Line I/O, 136

NONE Handshake Mode, 34, 44, 49, 80–81, 88–89, 117

Numeric Command Parameters, 59

O

Octal Format, 52, 54

*OPC, 98

*OPC?, 98

Open Collector

- configuration, 28–29
- data lines, 29

Operation

- flowchart, 32
- overview, 32

Operation Event Status Register, 94

Operation Status

- condition register, 94
- enable register, 94
- event register, 94
- register, 93
- query mask set, 94

Optional

- command parameters, 14, 59
- commands, 14, 58

Opto 22 Mounting Rack, 25

Output

- bit, 36, 51
- byte, 36, 51–52
- changing polarity, 41
- data
 - bits, 36, 51
 - bytes, 36, 51–52
 - to multiple ports, 54
- format, 52, 54
- range of values, 54
- register-based algorithm, 119
- using open collector, 28

P

Parameters, 59

PARTial Handshake Mode, 34, 44, 48, 80–81, 88–89, 117

Peripheral

connecting to computers, 26–27

GPIO, connecting to, 26–27

handshake, 21, 80, 88

interrupt, 22

bus, 20

interrupts, 114

pinout, 22–23

reset, 22

Peripheral Control Line

See PIR Control Line

Pinouts

connectors, 24

peripheral, 22–23

PIR Control Line, 12, 22

description, 43

interrupts, 131

operation, 43

operation of, 114

status, 114

using as input lines, 136

Plug&Play

See online help

*PMC, 68, 98

Polarity

changing, 41–42

CTL line, 33, 42–43, 74

data lines, 82

default/reset state, 33, 43

FLG line, 33, 42–43, 86

setting, 33, 41, 43, 74, 82

Ports

bit designations, 12

combining, 21

control (CTL) line, 42

control/status register, 114

data lines, 15, 41

data register, 115

delay register, 117

description, 12, 41–43

flag (FLG) line, 42

flag line, 21, 86

handshake register, 116

input/output (I/O) line, 42

interrupt control register, 112

multiple port handshaking, 53

normalization register, 118

P *(continued)*

Ports *(continued)*

- peripheral interrupt request (PIR) line, 43
- reset ($\overline{\text{RES}}$) line, 43
- specifying, 14
- specifying multiple, 15, 37, 53
- status (STS) line, 43
- transfer control register, 113
- transfer mode, 116
- type combinations allowed, 55
- writing data to, 83–84

Primary Address, 31

Program Examples

- combine all 4 ports, 37
- input data bits and bytes, 35
- output data bits and bytes, 36
- reading
 - an 8-bit byte, 128–129
 - registers, 123–124
- register access, 121
- resetting the module, 122
- set the handshake mode, 34
- system configuration, 121
- trace memory, 38–39
- using
 - non-data I/O lines, 136
 - PIR interrupt lines, 132
- verify initial operation, 16
- writing
 - a 16-bit word, 127
 - an 8-bit byte, 125–126

Programming

- debugging register-based, 130
- the Digital I/O module, 13–15
- using SCPI, 13–15

Pull-up

- calculating resistor value, 28
- discrete resistive, 29
- enable jumpers, 19
- external, 28–29
- internal, 19, 29
- resistor, 19, 28

PULSe Handshake Mode, 34, 44, 47, 78, 80–81, 87–89, 117

Q

Query

- data
 - bits, 77
 - blocks available, 90
 - lines polarity, 82
 - error register, 97
 - external memory state, 71
 - flag line
 - polarity, 86
 - status, 67
 - handshake
 - delay time, 79, 88
 - mode, 81, 89
 - I/\overline{O} control line, 89
 - memory block size, 92
 - module description, 96
 - monitor mode state, 63
 - operation
 - event status register, 94
 - status condition register, 94
 - questionable status
 - condition register, 95
 - event register, 95
 - register, 95
 - SCPI version, 97
 - VME memory
 - address, 69
 - size, 70
- ### Questionable Status
- condition register, 95
 - enable register, 94
 - event register, 95
 - register, 93
 - query mask set, 95

R

Range Multipliers, 117

*RCL, 98

Reading

- a 16-bit word, 130
- an 8-bit byte, 128–129
- data from memory block, 91
- operation
 - event status register, 94
 - status condition register, 94
- questionable status
 - condition register, 95
 - event register, 95
- registers, 123–124

R (continued)

Register-Based

- debugging programs, 130
- input algorithm, 120
- output algorithm, 119
- programming examples, 121

Registers

- addressing, 105–110
 - base address, 106–107
 - card status/control, 111
 - condition register, 93–95
 - definitions, 109–110
 - descriptions, 111–118
 - Device Identification Register, 111
 - event register, 93–95
 - information, 105–142
 - manufacturer ID, 111
 - map, 109–110
 - offset, 108
 - operation event status, 94
 - operation status
 - condition register, 94
 - enable register, 94
 - event register, 94
 - register, 93–94
 - port
 - control/status, 114
 - data, 115
 - delay, 117
 - handshake, 116
 - interrupt control, 112
 - normalization, 118
 - transfer control, 113
 - questionable status
 - condition register, 95
 - enable register, 94
 - event register, 95
 - register, 93, 95
 - reading, 123–124
 - reset states, 109
 - standard event register, 93
 - status register, 93
- RES** Control Line, 12, 22
- controlling, 114
 - description, 43
 - operation, 43
 - operation of, 114
 - status, 114
 - using as output lines, 136
- Reset Control Line
- See RES* Control Line

Reset States, 33, 43, 109

Resetting Module, 122

Ribbon Cable

- connecting, 25
- pins, 24–25
- replacement, 12

*RMC, 98

*RST, 33, 43, 98

S

*SAV, 98

SCPI

- drivers, downloading, 13
- status registers, 93
- version query, 97

SCPI Commands, 57, 99–101

- abbreviated, 58
- abbreviated commands, 58
- command separator, 58
- DISPlay subsystem, 61–63
- format used, 14, 57–59
- handshake modes, 34, 44
- implied, 14, 58
- implied commands, 58–59
- linking, 59
- long form, 14, 58
- MEASure subsystem, 64–67
- MEMory subsystem, 68–71
- multiple port operations, 37, 53
- optional, 14, 58
- optional parameters, 14, 59
- parameters, 14, 59
- quick reference, 99–101
- reference, 60
- short form, 14, 58
- [SOURce:] subsystem, 72–92
- specifying, 14
- STATus subsystem, 93–95
- SYSTEM subsystem, 96–97
- [:type] keyword substitutions, 37, 53, 59, 64–66, 76–85

Secondary Address, 31

Select Code Interface, 31

Selecting Interrupt Line, 20

Setting

- address switch, 18, 31
- CTL line
 - polarity, 33, 42–43, 74
 - value, 75
- data lines polarity, 82
- FLG line polarity, 33, 42–43, 86

S (continued)

Setting (continued)

- handshake mode, 34, 44–49, 80, 88
- interrupt line, 20
- polarity, 33, 41, 43, 74, 82
- VME external memory, 70

Soft [SOURCE:]Front Panel (VXI*plug&play*)
See online help

SOURCE Subsystem, 72–92

[SOURCE:]DIGital:CONTRoln

- :POLarity, 33, 43, 74
- :POLarity?, 74
- [:VALue], 75
- [:VALue]?, 75

[SOURCE:]DIGital:DATA n

- [:BYTE]BITm, 76
- [:BYTE]BITm?, 77
- [:BYTE]HANDshake:DELay, 78
- [:BYTE]HANDshake:DELay?, 79
- [:BYTE]HANDshake[:MODE], 80
- [:BYTE]HANDshake[:MODE]?, 81
- [:BYTE]POLarity, 82
- [:BYTE]POLarity?, 82
- [:BYTE]TRACe, 83
- [:BYTE][:BYTE][:VALue], 84
- [:BYTE][:type][:VALue]?, 85
- :LWORD:BITm, 76
- :LWORD:BITm?, 77
- :LWORD:HANDshake:DELay, 78
- :LWORD:HANDshake:DELay?, 79
- :LWORD:HANDshake[:MODE], 80
- :LWORD:HANDshake[:MODE]?, 81
- :LWORD:POLarity, 82
- :LWORD:POLarity?, 82
- :LWORD:TRACe, 83
- :LWORD[:VALue], 84
- :LWORD[:VALue]?, 85
- :POLarity, 33, 43
- [:type]BITm, 50–51, 76
- [:type]BITm?, 77
- [:type]HANDshake:DELay, 34, 44, 49, 53, 78
- [:type]HANDshake:DELay?, 79
- [:type]HANDshake[:MODE], 34, 44, 53, 80
- [:type]HANDshake[:MODE]?, 81
- [:type]POLarity, 82
- [:type]POLarity?, 82
- [:type]TRACe, 83
- [:type][:VALue], 14, 52, 84
- [:type][:VALue]?, 85

[SOURCE:]DIGital:DATA n (continued)

- :WORD:BITm, 76
- :WORD:BITm?, 77
- :WORD:HANDshake:DELay, 78
- :WORD:HANDshake:DELay?, 79
- :WORD:HANDshake[:MODE], 80
- :WORD:HANDshake[:MODE]?, 81
- :WORD:POLarity, 82
- :WORD:POLarity?, 82
- :WORD:TRACe, 83
- :WORD[:VALue], 84
- :WORD[:VALue]?, 85

[SOURCE:]DIGital:FLAG n

- :POLarity, 33, 43, 86
- :POLarity?, 86

[SOURCE:]DIGital:HANDshaken

- :DELay, 34, 44, 49, 87
- :DELay?, 88
- [:MODE], 34, 44, 88
- [:MODE]?, 89

[SOURCE:]DIGital:ION?, 89

[SOURCE:][:BYTE]DIGital:TRACe

- :CATalog?, 90
- [:DATA], 90
- [:DATA]?, 91
- :DEFine, 91
- :DEFine?, 92
- :DELete:ALL, 92
- :DELete[:NAME], 92

Specifications, 103–104

Specifying

- bits for input, 50
- bits for output, 51
- bytes for input, 50
- data bits, 15, 76
- multiple ports, 15, 37, 53
- ports, 14
- SCPI commands, 14

*SRE, 98

*SRE?, 98

Standard Commands for Programmable Instruments
See SCPI Commands

Standard Event Register, 93

Status Byte, 93

Status Control Line
See STS Control Line

Status Register, 93

STATus Subsystem, 93–95

STATus:OPERation:CONDition?, 94

STATus:OPERation:ENABle, 94

STATus:OPERation:ENABle?, 94

STATus:OPERation[:EVENT]?, 94

S (continued)

STATus:PRESet, 94
STATus:QUESTionable:CONDition?, 95
STATus:QUESTionable:ENABLE, 95
STATus:QUESTionable:ENABLE?, 95
STATus:QUESTionable[:EVENT]?, 95
*STB?, 98
STRobe Handshake Mode, 34, 44, 49, 78, 80–81, 87–89, 117
STS Control Line, 12, 22
 description, 43
 operation, 43
 operation of, 114
 status, 114
 using as input lines, 136
Summary Bit, 93–95
Switches
 flag combining, 21
 logical address, 18, 31
System Configuration, 121
SYSTEM Subsystem, 96–97
SYSTEM:CDEscription?, 96
SYSTEM:CTYPE?, 96
SYSTEM:ERRor?, 97
SYSTEM:VERSion?, 97

T

Technical Description, 11–12
Trace Memory, using, 38–39, 83
TRailing Edge Handshake Mode, 34, 44, 46, 80–81, 88–89, 117
Transfer Mode, 116
Transition Filters, 93
*TRG, 98
*TST?, 98
[:type]
 keyword
 described, 37, 53
 substitutions, 37, 53, 59, 64–66, 76–85
 port combinations allowed, 55
Typical Driver/Receiver Connection, 29

U

Understanding the HP E1330B, 41–54
Using
 external pull-ups, 28
 handshake mode, 44–49, 80–81, 88
 the HP E1330B, 31–39
 trace memory, 38–39, 83

V

VMEbus, 11, 68
 add-on VME memory, 69
 catalog memory, 90
 external memory, 68–71
 size, 70
 query memory address, 69
VXIbus
 A16 address space, 105–107
 data acknowledge line, 116
 interrupt level, 11
 interrupts, 20, 110
 transferring data, 116
VXI*plug&play*
 See online help

W

*WAI, 98
WORD
 bit
 designations, 12
 numbering, 54
 data lines used, 54
 keyword described, 37, 53, 64–66, 76–85
 reading a 16-bit, 130
 writing a 16-bit, 127
Writing
 a 16-bit word, 127
 an 8-bit byte, 125–126
 data
 to memory block, 90
 to ports, 83–84