



HP 75000 SERIES B

Mainframes
HP E1300A and E1301A

User's Manual



Copyright © Hewlett-Packard Company, 1989, 1990, 1991

Manual Part Number: E1300-90005
Microfiche Part Number: E1300-99005

Printed: November 1991
Printed in U.S.A.

Edition 3
E 1191

CERTIFICATION

Hewlett-Packard Company certifies that this product met its published specifications at the time of shipment from the factory. Hewlett-Packard further certifies that its calibration measurements are traceable to the United States National Institute of Standards and Technology (formerly National Bureau of Standards), to the extent allowed by that organization's calibration facility, and to the calibration facilities of other International Standards Organization members.

WARRANTY

This Hewlett-Packard product is warranted against defects in materials and workmanship for a period of three years from date of shipment. Duration and conditions of warranty for this product may be superseded when the product is integrated into (becomes a part of) other HP products. During the warranty period, Hewlett-Packard Company will, at its option, either repair or replace products which prove to be defective.

For warranty service or repair, this product must be returned to a service facility designated by Hewlett-Packard (HP). Buyer shall prepay shipping charges to HP and HP shall pay shipping charges to return the product to Buyer. However, Buyer shall pay all shipping charges, duties, and taxes for products returned to HP from another country.

HP warrants that its software and firmware designated by HP for use with a product will execute its programming instructions when properly installed on that product. HP does not warrant that the operation of the product, or software, or firmware will be uninterrupted or error free.

LIMITATION OF WARRANTY

The foregoing warranty shall not apply to defects resulting from improper or inadequate maintenance by Buyer, Buyer-supplied products or interfacing, unauthorized modification or misuse, operation outside of the environmental specifications for the product, or improper site preparation or maintenance.

The design and implementation of any circuit on this product is the sole responsibility of the Buyer. HP does not warrant the Buyer's circuitry or malfunctions of HP products that result from the Buyer's circuitry. In addition, HP does not warrant any damage that occurs as a result of the Buyer's circuit or any defects that result from Buyer-supplied products.

NO OTHER WARRANTY IS EXPRESSED OR IMPLIED. HP SPECIFICALLY DISCLAIMS THE IMPLIED WARRANTIES OF MERCHANTABILITY AND FITNESS FOR A PARTICULAR PURPOSE.

EXCLUSIVE REMEDIES

THE REMEDIES PROVIDED HEREIN ARE BUYER'S SOLE AND EXCLUSIVE REMEDIES. HP SHALL NOT BE LIABLE FOR ANY DIRECT, INDIRECT, SPECIAL, INCIDENTAL, OR CONSEQUENTIAL DAMAGES, WHETHER BASED ON CONTRACT, TORT, OR ANY OTHER LEGAL THEORY.

NOTICE

The information contained in this document is subject to change without notice. HEWLETT-PACKARD (HP) MAKES NO WARRANTY OF ANY KIND WITH REGARD TO THIS MATERIAL, INCLUDING, BUT NOT LIMITED TO, THE IMPLIED WARRANTIES OF MERCHANTABILITY AND FITNESS FOR A PARTICULAR PURPOSE. HP shall not be liable for errors contained herein or for incidental or consequential damages in connection with the furnishing, performance or use of this material. This document contains proprietary information which is protected by copyright. All rights are reserved. No part of this document may be photocopied, reproduced, or translated to another language without the prior written consent of Hewlett-Packard Company. HP assumes no responsibility for the use or reliability of its software on equipment that is not furnished by HP.

Restricted Rights Legend

Use, duplication, or disclosure by the Government is subject to restrictions as set forth in subdivision (b)(3)(ii) of the Rights in Technical Data and Computer Software clause at 52.227-7013. Hewlett-Packard Company; 3000 Hanover Street; Palo Alto, California 94304

Herstellerbescheinigung

Hiermit wird bescheinigt, dass dieses Gerät/System HP E1300A/E1301A in Übereinstimmung mit den Bestimmungen von Postverfügung 1046/84 funktentstört ist. Der Deutschen Bundespost wurde das Inverkehrbringen dieses Gerätes/Systems angezeigt und die Berechtigung zur Überprüfung der Serie auf Einhaltung der Bestimmungen eingeräumt.

Zusatzinformation für Mess- und Testgeräte:

Werden Mess- und Testgeräte mit ungeschirmten Kabeln und/oder in offenen Messaufbauten verwendet, so ist vom Betreiber sicherzustellen, dass die Funk-Entstörbestimmungen unter Betriebsbedingungen an seiner Grundstücksgrenze eingehalten werden.

Manufacturer's Declaration

This is to certify that the equipment HP E1300A/E1301A meets the radio frequency interference requirements of Directive FTZ 1046/84. The German Bundespost has been notified that this equipment was put into circulation and has been granted the right to check the product type for compliance with these requirements.

Additional Information for Test and Measurement Equipment:

If test and measurement equipment is operated with unshielded cables and/or used for measurements on open set-ups, the user has to assure that under operating conditions the Radio Interference Limits are still met at the border of the user's premises.

Printing History

The Printing History shown below lists all Editions and Updates of this manual and the printing date(s). The first printing of the manual is Edition 1. The Edition number increments by 1 whenever the manual is revised. Updates, which are issued between Editions, contain replacement pages to correct the current Edition of the manual. Updates are numbered sequentially starting with Update 1. When a new Edition is created, it contains all the Update information for the previous Edition. Each new Edition or Update also includes a revised copy of this printing history page. Many product updates or revisions do not require manual changes and, conversely, manual corrections may be done without accompanying product changes. Therefore, do not expect a one-to-one correspondence between product updates and manual updates.

Edition 1 (Part Number E1300-90001) September 1989
Edition 2 (Part Number E1300-90002) September 1990
Edition 3 (Part Number E1300-90005) November 1991

Trademark Information

Microsoft® and MS-DOS® are U.S. registered trademarks of Microsoft Corporation.
IBM® and PC-DOS® are U.S. registered trademarks of International Business Machines Corporation.
DEC®, VT100®, and VT220® are registered trademarks of Digital Equipment Corporation.
WYSE® is a registered trademark of Wyse Technology
WY-30™ is a trademark of Wyse Technology
Macintosh® is a registered trademark of Apple Computer Inc.

Safety Symbols



Instruction manual symbol affixed to product. Indicates that the user must refer to the manual for specific Warning or Caution information to avoid personal injury or damage to the product.



Indicates the field wiring terminal that must be connected to earth ground before operating the equipment to protect against electrical shock in case of fault.



Frame or chassis ground terminal typically connects to the equipment's metal frame.



Alternating current (AC).



Direct current (DC).



Indicates hazardous voltages.

WARNING

Calls attention to a procedure, practice, or condition that could cause bodily injury or death.

CAUTION

Calls attention to a procedure, practice, or condition that could possibly cause

damage to equipment or permanent loss of data.

WARNINGS

The following general safety precautions must be observed during all phases of operation, service, and repair of this product. Failure to comply with these precautions or with specific warnings elsewhere in this manual violates safety standards of design, manufacture, and intended use of the product. Hewlett-Packard Company assumes no liability for the customer's failure to comply with these requirements.

Ground the equipment: For Safety Class 1 equipment (equipment having a protective earth terminal), an uninterruptible safety earth ground must be provided from the mains power source to the product input wiring terminals or supplied power cable.

DO NOT operate the product in an explosive atmosphere or in the presence of flammable gases or fumes.

For continued protection against fire, replace the line fuse(s) only with fuse(s) of the same voltage and current rating and type. DO NOT use repaired fuses or short-circuited fuseholders.

Keep away from live circuits: Operating personnel must not remove equipment covers or shields. Procedures involving the removal of covers or shields are for use by service-trained personnel only. Under certain conditions, dangerous voltages may exist even with the equipment switched off. To avoid dangerous electrical shock, DO NOT perform procedures involving cover or shield removal unless you are qualified to do so.

DO NOT operate damaged equipment: Whenever it is possible that the safety protection features built into this product have been impaired, either through physical damage, excessive moisture, or any other reason, REMOVE POWER and do not use the product until safe operation can be verified by service-trained personnel. If necessary, return the product to a Hewlett-Packard Sales and Service Office for service and repair to ensure that safety features are maintained.

DO NOT service or adjust alone: Do not attempt internal service or adjustment unless another person, capable of rendering first aid and resuscitation, is present.

HP 75000 Series B Documentation

Manual Descriptions

Installation and Getting Started Guide. Contains step-by-step instructions for all aspects of plug-in module and mainframe installation. This guide also contains introductory programming information and examples.

HP E1300A/E1301A Mainframe User's Manual. Contains programming information for the mainframe, front panel operation information (for the HP E1301A mainframe), and general programming information for instruments installed in the mainframe.

Plug-In Module User's Manuals. Contains plug-in module programming and configuration information. These manuals contains examples for the most-used module functions, and a complete TMSL command reference for the plug-in module.

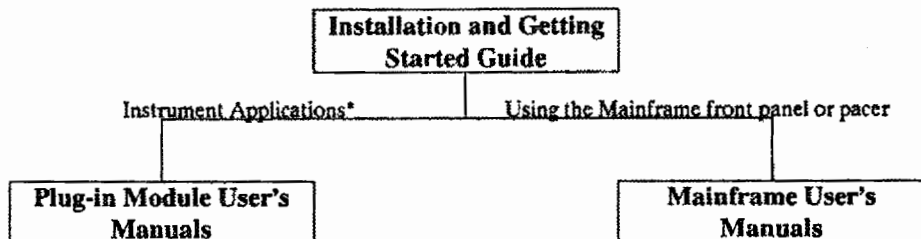

* For Scanning Voltmeter Applications, refer to the HP E1326A/E1411A 5 1/2 Digit Multimeter User's Manual.

Suggested Sequence for Using the Manuals

Related Documents

HP Instrument BASIC User's Handbook. Includes three books: *HP Instrument BASIC Programming Techniques*, *HP Instrument BASIC Interfacing Techniques*, and *HP Instrument BASIC Language Reference*.

Using HP Instrument BASIC with the E1405. Contains information on the version of HP Instrument Basic which can be installed in ROM in your E1405B Command Module.

Beginner's Guide to SCPI. Explains the fundamentals of programming instruments with Standard Commands for Programmable Instruments (SCPI). We recommend this guide to anyone who is programming with TMSL for the first time.

Tutorial Description of the Hewlett-Packard Interface Bus. Describes the technical fundamentals of the Hewlett-Packard Interface Bus (HP-IB). This book also includes general information on IEEE 488.2 Common Commands. We recommend this book to anyone who is programming with IEEE 488.2 for the first time.

IEEE Standard 488.2-1987, IEEE Standard Codes, Formats, Protocols, and Common Commands. Describes the underlying message formats and data types used in TMSL and defines Common Commands. You may find this document useful if you need to know the precise definition of certain message formats, data types, or Common Commands. Available from: The Institute of Electrical and Electronic Engineers, Inc.; 345 East 47th Street; New York, NY 10017; USA

VXIbus System Specifications. Hewlett-Packard part number E1400-90006.

The VMEbus Specification. Available from: VMEbus International Trade Association; 10229 N. Scottsdale Road, Suite E; Scottsdale, AZ 85253; U.S.A.

About this Manual

Manual Content

- This manual shows how to use the HP E1300/E1301 Mainframe and how to operate and program instruments within the mainframe using SCPI (Standard Commands for Programmable Instruments) commands and IEEE 488.2 Common Commands. For installation and configuration information refer to the "HP 75000 Series B Installation and Getting Started Guide".
- Chapter 1: Getting Started** This chapter contains a mainframe description, discusses the instrument concept, and contains introductory programming examples.
- Chapter 2: Using the Front Panel** This chapter describes how to use the HP E1301A mainframe's front panel keyboard and display to operate instruments in the mainframe.
- Chapter 3: Using the Display Terminal Interface** This chapter describes how to use a display terminal to operate instruments in the mainframe.
- Chapter 4: Using the Mainframe** This chapter shows how to use the mainframe's Pacer, how to change the primary HP-IB address, and how to synchronize internal and external instruments using the mainframe's Trigger In and Event Out ports.
- Chapter 5: Downloading Device Drivers** This chapter contains information on downloading device drivers into non-volatile memory using both HP-IB and RS-232 connections.
- Chapter 6: Controlling Instruments using HP-IB** This chapter shows some general concepts for operating instruments in the mainframe using IEEE 488.2 Common Commands and the HP-IB interface.
- Chapter 7: Command Reference** The command reference contains a detailed description of each System Instrument command. It includes information on the choice of settings and examples showing the context in which the command is used. It also contains command references for the supported IEEE 488.2 Common Commands and IEEE 488.1 HP-IB Messages.
- Appendix A: Specification** This appendix contains a list of the Mainframe's operating specifications.
- Appendix B: Error Messages** This appendix lists SCPI error codes and messages for the System Instrument, and possible causes.
- Appendix C: Connecting & Configuring a Terminal** This appendix shows how to set-up a terminal for use with the Display Terminal Interface described in Chapter 3.
- Appendix D: Using the D.C. Power Option** This chapter shows you how to connect and operate the optional D.C. Power module (E1300A Option 008).
- Appendix E: Sending Binary Data Over RS-232** This Appendix contains information on transferring binary files over an RS-232 interface. It includes information on how these files are coded for transmission.

Table of Contents

1. Getting Started

Using This Chapter	1-1
Mainframe Description	1-1
Optional Mainframe Memory	1-1
Instrument Definition	1-3
Instrument Logical Addresses	1-4
Instrument Secondary Addresses	1-4
Unassigned Modules	1-4
Introductory Programming Examples	1-4

2. Using the Front Panel

Using this Chapter	2-1
Front Panel Features	2-1
Using Menus	2-2
A 60-Second Menu Tutorial	2-2
Using the System Instrument Menu	2-3
Using the Other Instrument Menus	2-5
Monitor Mode	2-8
Executing Commands	2-9
Editing	2-9
Key Descriptions	2-10
Menu Keys	2-10
Display Control & Editing Keys	2-10
Instrument Control Keys	2-11
Other Keys	2-11
In Case of Difficulty	2-12
Instrument Menus	2-13

3. Using the Display Terminal Interface

Using this Chapter	3-1
Terminal Interface Features	3-2
Using Menus	3-3
A 60-Second Menu Tutorial	3-3
Using the System Instrument Menu	3-5
Using the Other Instrument Menus	3-8
3-11	
Monitor Mode	3-11
Executing Commands	3-13
Editing	3-13
General Key Descriptions	3-14
Menu and Menu Control Keys	3-14
Editing Keys	3-14
Instrument Control Keys	3-15
Other Keys	3-15

Using Supported Terminals	3-16
The Supported Terminals	3-16
Using the HP 700/22	3-17
Using the WYSE® WY-30ce	3-19
Using Other Terminals	3-19
What "Not Supported" Means	3-20
Testing Terminals for Compatibility	3-20
Using a Terminal Without Menus	3-21
In Case of Difficulty	3-23
Instrument Menus	3-25

4. Using the Mainframe

Using this Chapter	4-1
Using the Pacer	4-1
Changing the Primary HP-IB Address	4-3
Synchronizing Internal and External Instruments	4-3
Mainframe Data Memory	4-6
Using Mainframe Data Memory	4-6
Non-Volatile User Memory	4-7
Allocating a User Memory Segment	4-7
Locating the NRAM segment	4-7
Using :DOWNload and :UPload? to Access Data	4-9
Data Formats for :DOWNload	4-9

5. Downloading Device Drivers

About this Chapter	5-1
What You Will Need	5-1
Memory Configuration	5-3
Download Program Configuration	5-4
Editing the Configuration File	5-4
Downloading Drivers in MS-DOS Systems	5-6
Downloading Drivers in HP-IB Systems with IBASIC	5-7
Downloading Drivers in HP-IB Systems with HP BASIC	5-8
Downloading Multiple Drivers	5-9
Checking Driver Status	5-9
Manually Downloading a Driverdown manual	5-10
Preparing Memory for Manual Downloading	5-10
Manually Downloading Over HP-IB	5-11
Manually Downloading Over RS-232	5-11

6. Controlling Instruments Using HP-IB

About this Chapter	6-1
Programming Hints	6-1
Status System Structure	6-2
The Status Byte Register	6-3
Reading the Status Byte Register	6-4
Service Request Enable Register	6-5

The Service Request Bit	6-5
Clearing the Service Request Enable Register	6-5
Standard Event Status Register	6-6
Unmasking Standard Event Status Bits	6-6
Reading the Standard Event Status Enable Register Mask	6-7
Reading the Standard Event Status Register	6-7
Operation Status Group	6-7
Reading the Condition Register	6-8
Unmasking the Operation Event Register Bits	6-8
Clearing the Operation Event Register Bits	6-9
Using the Operation Status Group Registers	6-9
Clearing Status	6-10
Interrupting an External Computer	6-10
Synchronizing an External Computer and Instruments	6-12

7. System Instrument Command Reference

About This Chapter	7-1
Command Types	7-1
Common Command Format	7-1
SCPI Command Format	7-1
Linking Commands	7-3
SCPI Command Reference	7-4
ABORt	7-4
DIAGnostic	7-5
INITiate	7-29
[SOURce]	7-30
STATus	7-32
SYSTem	7-35
TRIGger	7-51
VXI 7-54	
Common Command Reference	7-65
*CLS	7-66
*DMC < name_string >, < command_block >	7-66
*EMC < enable >	7-66
*EMC?	7-66
*ESE < mask >	7-66
*ESE?	7-67
*ESR?	7-67
*GMC? < name_string >	7-67
*IDN?	7-68
*LMC?	7-68
*LRN?	7-68
*OPC	7-69
*OPC?	7-69
*PMC	7-69
*PSC < flag >	7-69
*PSC?	7-69
*RCL < state number >	7-70
*RMC < name_string >	7-70
*RST	7-70
*SAV < state number >	7-70

*SRE <mask >	7-70
*SRE?	7-71
*STB?	7-71
*TRG	7-71
*TST?	7-71
*WAI	7-71
HP-IB Message Reference	7-72
Go To Local (GTL)	7-72
Group Execute Trigger (GET)	7-72
Interface Clear (IFC)	7-72
Device Clear (DCL) or Selected Device Clear (SDC)	7-73
Local Lockout (LLO)	7-73
Remote	7-74
Serial Poll (SPOLL)	7-74
Command Quick Reference	7-75

A. Specifications

Mainframe Specifications	A-1
Pacer(50% duty cycle):	A-1
Real-time Clock:	A-1
Trigger Input:	A-1
Non-volatile added memory storage lifetime:	A-1
Slots:	A-1
EMC, RFI, Safety:	A-1
Size:	A-2
Weight:	A-2
Power:	A-2
Cooling:	A-2
Humidity:	A-2
Operating temperature:	A-2
Storage temperature:	A-2
SCPI Conformance Information	A-3
Switchbox Configuration	A-3
Multimeter Commands	A-4
Counter Commands	A-6
D/A Converter Commands	A-8
Digital I/O Commands	A-9
System Instrument Commands	A-10

B. Error Messages

Using This Appendix	B-1
Reading an Instrument's Error Queue	B-1
Error Types	B-2
Command Errors	B-2
Execution Errors	B-2
Device-Specific Errors	B-2
Query Errors	B-2
Start-up Error Messages	B-5

C. Connecting and Configuring a Display Terminal	
Using this Appendix	C-1
Overview	C-1
Connecting a Terminal to the Mainframe	C-1
Configuring a Terminal for the Mainframe	C-3
Starting with Default Mainframe Settings	C-3
Restoring the Default Configuration	C-3
Configuring the Terminal	C-3
Trying it	C-4
Configuring the Mainframe with Menus	C-4
D. Using The DC Power Option	
Chapter Contents and Purpose	D-1
DC Power Option Description	D-1
Connecting the Battery to the DC Power Option	D-2
DC Power Option Operation	D-2
Powerdown Operation	D-2
DC Power Option Trickle Charge Currents	D-3
DC Power Option Specifications	D-3
Selecting the Trickle Charge Current and Latched Switches	D-4
E. Sending Binary Data Over RS-232	
About this Appendix	E-1
Formatting Binary Data for RS-232 Transmission	E-1
Sending Binary Data Over RS-232	E-2
Setting Up the Mainframe	E-2

Getting Started

Using This Chapter

This chapter describes the HP E1300A/E1301A Mainframe, defines the instrument concept, and explains how plug-in modules are designated as instruments in the mainframe. This chapter also contains introductory programming examples showing how to read and set the mainframe's clock and calendar. This chapter contains the following sections:

- Mainframe Description 1-1
- Instrument Definition 1-3
- Introductory Programming Examples 1-4

Mainframe Description

The HP E1301A mainframe contains a front panel keyboard and display; the HP E1300A has no keyboard or display. Otherwise, there is no conceptual difference between the two mainframes. Both models provide a terminal based user interface (Display Terminal Interface) through the built-in, or optional plug-in serial interfaces. The front panel keyboard and display are discussed in Chapter 2 of this manual. The Display Terminal Interface is discussed in Chapter 3.

The mainframe handles such high level operations as language translation of IEEE-488.2 Common Commands and SCPI (Standard Commands for Programmable Instruments) commands; module-to-module synchronization; and memory management. When installed in the mainframe, SCPI-compatible register-based plug-in modules behave as independent instruments operating under control of SCPI commands and Common Commands. Plug-in modules that are not SCPI-compatible must be programmed at a register level (see the VXI:REG:WRITE and VXI:REG:READ? commands in Chapter 5 of this manual for more information). Figure 1-2 shows the HP E1300A/E1301A Mainframe's A- and B-size plug-in module slots, HP-IB* connector, RS-232 port, and input/output ports.

Optional Mainframe Memory

The mainframe comes from the factory with 256 kBytes of non-volatile memory (RAM) for reading storage. You can install up to 2 MBytes of optional RAM. The HP E1320A provides 500 kBytes while the HP E1321A provides 1 MByte of memory. Optional RAM replaces the standard memory and is *not* in addition to it (e.g. the mainframe with an optional 1 Mbyte module has 1Mbyte available).

* HP-IB is Hewlett-Packard's implementation of IEEE Std 488.1-1978.

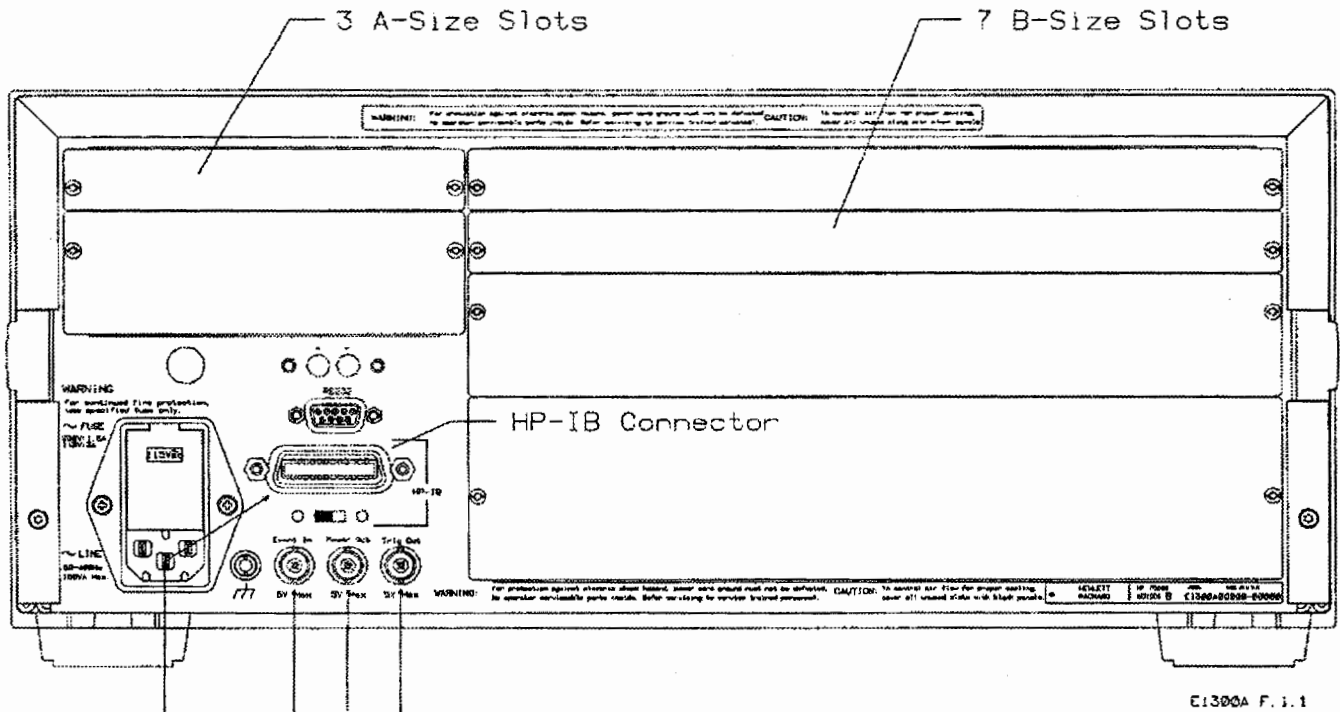

Trig Out: Allows an instrument to output a negative-going pulse to indicate the occurrence of some event such as closing a channel on a Switchbox Instrument. The signal levels are standard TTL (0V to 5V). This pulse can be used to synchronize external equipment to the instrument (see Chapter 5 for examples). You direct the pulse from the appropriate instrument to the Trig Out port using the `OUTP:STAT ON` command.

Pacer Out: Allows you to output a square wave signal to trigger or pace external equipment such as scanners or voltmeters. You can control the period of the square wave signal and the number of periods output. The signal levels are standard TTL (0V to 5V). Refer to Chapters 4 and 5 for more information on the Pacer.

Event In: Allows an instrument to be armed or triggered from an external negative-going signal. The signal levels are standard TTL (0V to 5V). Use an instrument's `ARM:SOUR:EXT` command or the `TRIG:SOUR:EXT` command to direct the Event In port to that instrument.

RS-232: Serial interface provides a user interface using a terminal or a computer running terminal emulator software. The user interface provides the functionality of the HP E1301's keyboard and display. If present, the optional IBASIC interpreter can be configured to control the RS-232 port.

Figure 1-1. Mainframe Features

Instrument Definition

SCPI-compatible plug-in modules installed in the mainframe are treated as independent instruments each having a unique secondary HP-IB address. As shown in Figure 1-3, each instrument is assigned a dedicated error queue, input and output buffers, status registers and, if applicable, dedicated mainframe memory space for readings or data. An instrument may be composed of a single plug-in module (such as a counter) or multiple plug-in modules (for a Switchbox or Scanning Voltmeter Instrument). In addition, the mainframe contains a built-in instrument called the System Instrument which has a Pacer for timing external devices. The System Instrument also can control the built-in RS-232, as well as up to seven optional HP E1324A plug-in serial interfaces.

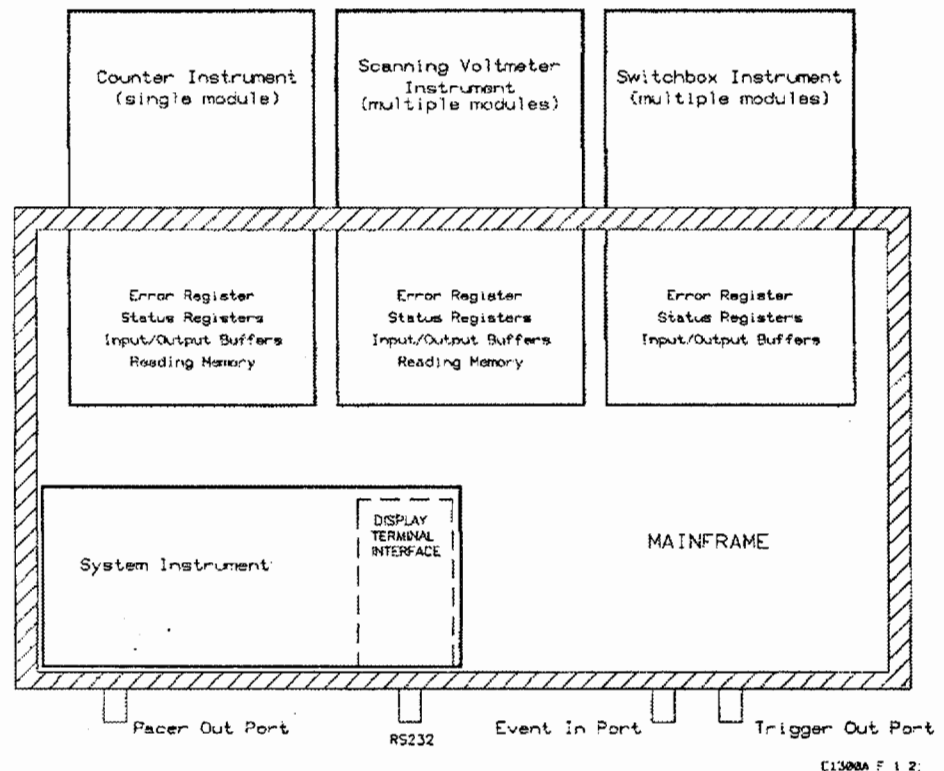

Figure 1-2. Instrument Concept

Instrument Logical Addresses

Instruments are identified by a logical address which directly relates to its HP-IB secondary address. Instruments come from the factory with a preset logical address. You can change the factory setting during installation (see the "HP 75000 Series B Installation and Getting Started Guide" for instructions).

A single-module instrument must have its logical address set to an integer multiple of 8 (0, 8, 16, 24, ... 240). In a multiple-module instrument, only one of the modules has a logical address that is an integer multiple of 8. The other modules in the multiple-module instrument must have consecutive logical addresses. For example, in a Scanning Voltmeter, if the voltmeter module has a logical address of 16, the other modules in that instrument must have logical addresses of 17, 18, 19 and so on. The same applies to the System Instrument whose logical address is fixed at 0. An HP E1324A plug-in serial interface controlled by the System Instrument would be set to logical address 1. A second HP E1324A would be set to logical address 2 and so on.

Instrument Secondary Addresses

An instrument's HP-IB secondary address is simply the logical address divided by 8 (for a multiple-module instrument, the lowest logical address divided by 8). For example, an instrument with a logical address of 16 has a secondary address of 02. The secondary address allows access to a particular instrument when programming via HP-IB. (The System Instrument's secondary address is 00 and is the only address that cannot be changed).

Unassigned Modules

An unassigned module in an HP E1300A/E1301A Mainframe is one that does not have a logical address that is a multiple of 8 (8, 16, 24...240) and is not part of a Scanning Voltmeter or Switchbox configuration. You can only program these modules at the register level using the VXI:WRITE and VXI:READ? commands (see Chapter 5 of this manual for more information on these commands).

Introductory Programming Examples

This section shows how to send SCPI and Common Commands to the mainframe's System Instrument and how to read data back. The following assumes that you send the commands or read the data over HP-IB. To send SCPI commands or to read data, specify the:

- Computer's HP-IB interface address
- Mainframe's HP-IB primary address
- Instrument's HP-IB secondary address.
- SCPI command string or Common Command

For instruments in the mainframe, the primary address is the same as the mainframe address (i.e., the factory setting is 09). The instrument's secondary address is simply the logical address divided by 8 (e.g., logical addresses of 8, 16, 24, or 32, result in secondary addresses of 01, 02, 03, or 04, respectively).

Example: Reading the Time

This program reads and prints the time from the System Instrument's internal clock. The computer used in the example is an HP Series 200/300 computer with HP BASIC as the program language. The computer interfaces to the mainframe using the Hewlett-Packard Interface Bus (HP-IB). The HP-IB interface select code is 7, the HP-IB primary address is 09, and the HP-IB secondary address is 00 (System Instrument). Resulting in a combined address of 70900.

10 OUTPUT 70900;"*RST"	<i>Reset System Instrument using Common Command</i>
20 OUTPUT 70900;"SYST:TIME?"	<i>Send SCPI query command to return time</i>
30 ENTER 70900; H,M,S	<i>Place hour in H, minutes in M, seconds in S</i>
40 PRINT H,M,S	<i>Print time</i>
50 END	

Typical response: +16, +15, +30 (4:15:30 PM)

Example: Setting the Time

Set the clock using the 24 hour *hour,minute,second* format. Execute the following line to set the time to 14,00,00 (i.e., 2:00:00 PM).

```
SYST:TIME 14,00,00
```

Example: Reading the Date

This program reads and prints the date stored in the mainframe's internal calendar.

10 OUTPUT 70900;"SYST:DATE?"	<i>Send SCPI query command to return date</i>
20 ENTER 70900; Y,M,D	<i>Place year in Y, month in M, day in D</i>
30 PRINT Y,M,D	<i>Print date</i>
40 END	

Typical response: +1989, +9, +16 (September 16, 1989)

Example: Setting the Date

Set the date using the *YYYY,MM,DD* format. Executing the following line sets the date to 1990,1,13 (January 13, 1990).

```
SYST:DATE 1990,1,13
```

Using the Front Panel

Using this Chapter

This chapter shows you how to use the HP E1301A Mainframe's front panel keyboard and display to operate instruments in the mainframe. It contains the following sections:

- Front Panel Features 2-1
- Using Menus 2-2
- Executing Commands 2-9
- Key Descriptions 2-10
- In Case of Difficulty 2-12
- Instrument Menus 2-13

Front Panel Features

Figure 2-1 shows the front panel's QWERTY keyboard and the dedicated key groupings. The tutorials in this chapter show how to use most of the dedicated keys. See "Key Descriptions" near the end of this chapter for a complete description of each dedicated key.

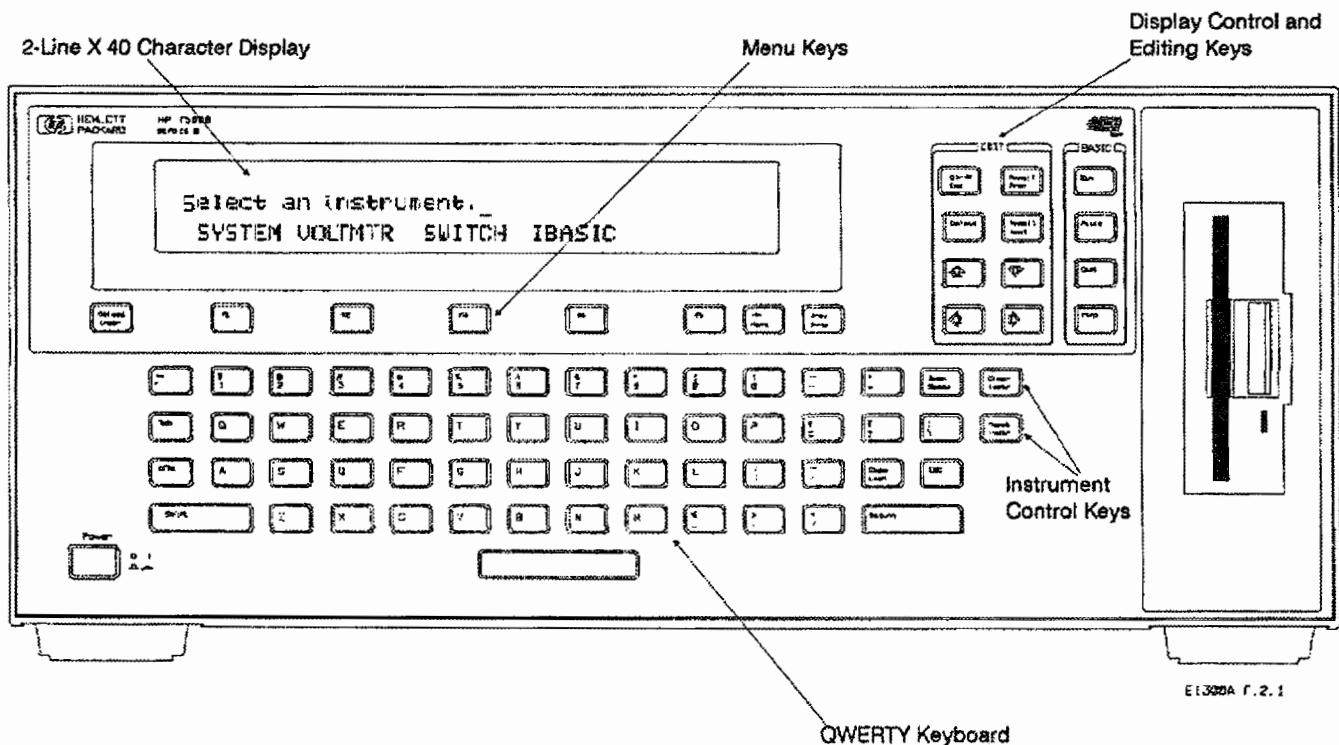
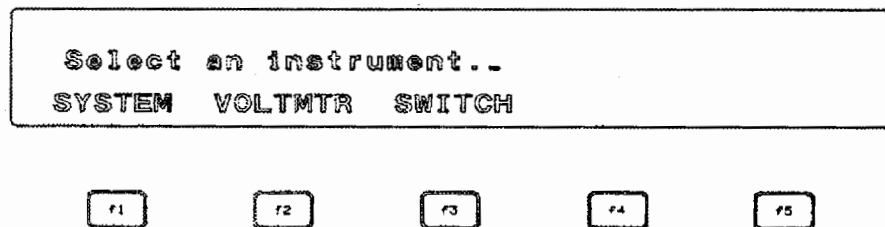

Figure 2-1. Front Panel Features

Using Menus

You can access a System Instrument menu and a variety of other instrument menus (depending on installed instruments) from the front panel. These menus incorporate the most used functions but do not provide access to all of the instrument commands. If a particular function is not available from a menu, you can type the corresponding command string and execute it from the front panel. See "Executing Commands" later in this chapter for more information.

When you select an instrument, you are assigning the keyboard and display to that instrument. This means that any menu operations, commands executed or recalled, errors displayed, etc. pertain only to that instrument. Front panel operation of an instrument is independent from other instruments and independent from the remote operation of the instrument. To operate another instrument from the front panel, you must select that instrument.



Note: Typical instruments shown. Actual choices depend on installed instruments

C1200.01 F.2.2

Figure 2-2. Select an Instrument Menu

A 60-Second Menu Tutorial

Following the power-on sequence or a system reset the display shows the *Select an instrument* menu (see Figure 2-2) which lets you select one of the instruments listed.

The menu keys are located directly below the display. To select a displayed menu choice, press the function key (f1 - f5) directly below the choice. This chapter shows key labels in bold text.

- When there are more than five menu choices, an arrow appears on the right side of the display. Press **More** to display the next group of choices. By repeatedly pressing **More** you can display all groups of choices. After you have displayed all groups of choices, pressing **More** again returns to the first group of choices.
- When the display is requesting information (input prompt) such as *Enter the device's logical address*, just type the information and press **Return**.

If you press the wrong menu key and do not want to enter the requested information, you can escape the input prompt and stay at the same menu level by pressing **ESC** or **Prev Menu**.

If you make an incorrect entry in response to an input prompt, the top line of the display will show an error message. When this happens, just select that menu choice again (f1 - f5 keys), re-type the correct information, and press **Return**.

- Press **Prev Menu** to return to the previous menu within an instrument menu or escape from an input prompt. Press **Select Instr** to return to the *Select an Instrument* menu. Note that when you leave an instrument and return later, you return to the same menu location you were when you left. In addition, any other displayed information (instrument responses or commands being entered) will also be displayed when you return.
- In addition to the menu keys, **Clear Instr** and **Reset Instr** are helpful when operating an instrument. **Clear Instr** clears the instrument's front panel input and output buffers (remote buffers are not cleared) and returns to the top level of the instrument menu. Press **Clear Instr** whenever an instrument is busy, is not responding to front panel control, or to abort a command being entered from the front panel. **Reset Instr** clears all front panel and remote input and output buffers and resets the instrument.

Using the System Instrument Menu

The System Instrument menu allows you to:

- Set or read the system HP-IB address
- Reset (reboot) the mainframe
- Display the logical addresses of installed instruments
- Display information about installed instruments

How to Set or Read the System HP-IB Address

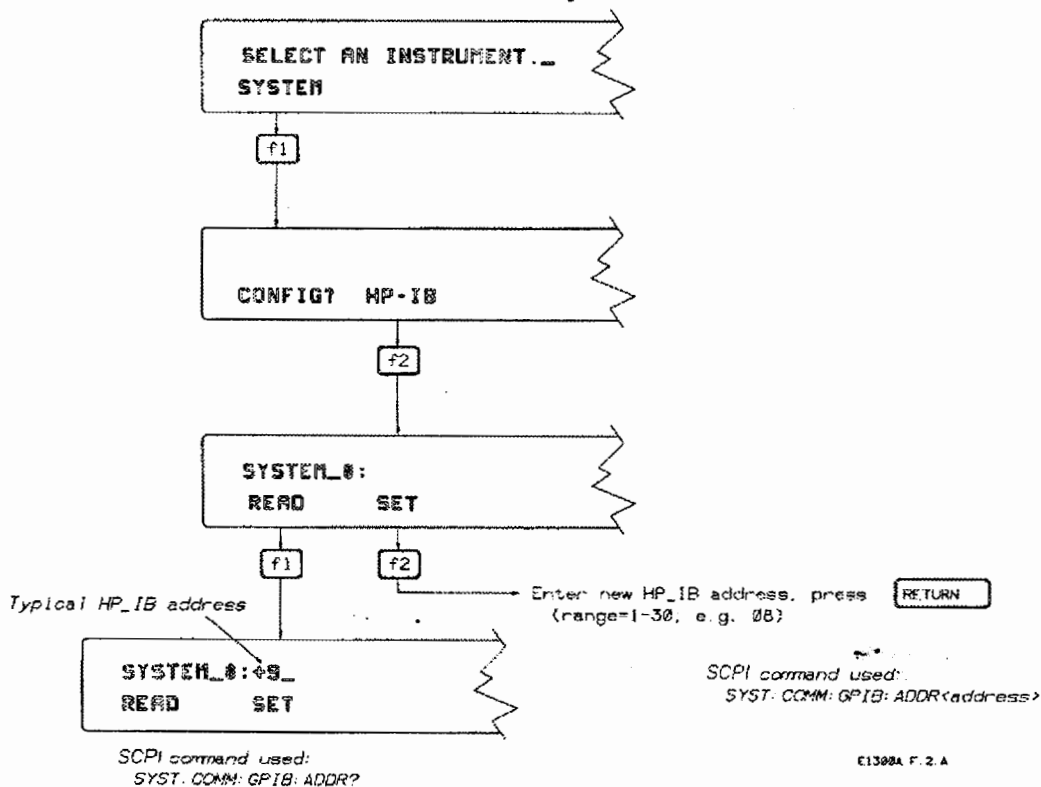

How to Reset the System

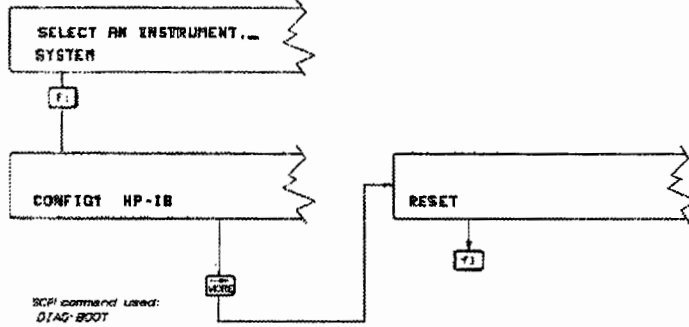

Note: The RESET menu selection is equivalent to the DIAG:BOOT command which has the same effect as cycling power to the mainframe. Pressing Reset Instr from the System Instrument menu is equivalent to executing the *RST command which resets the System Instrument.

How to Display Logical Addresses or Instrument Information

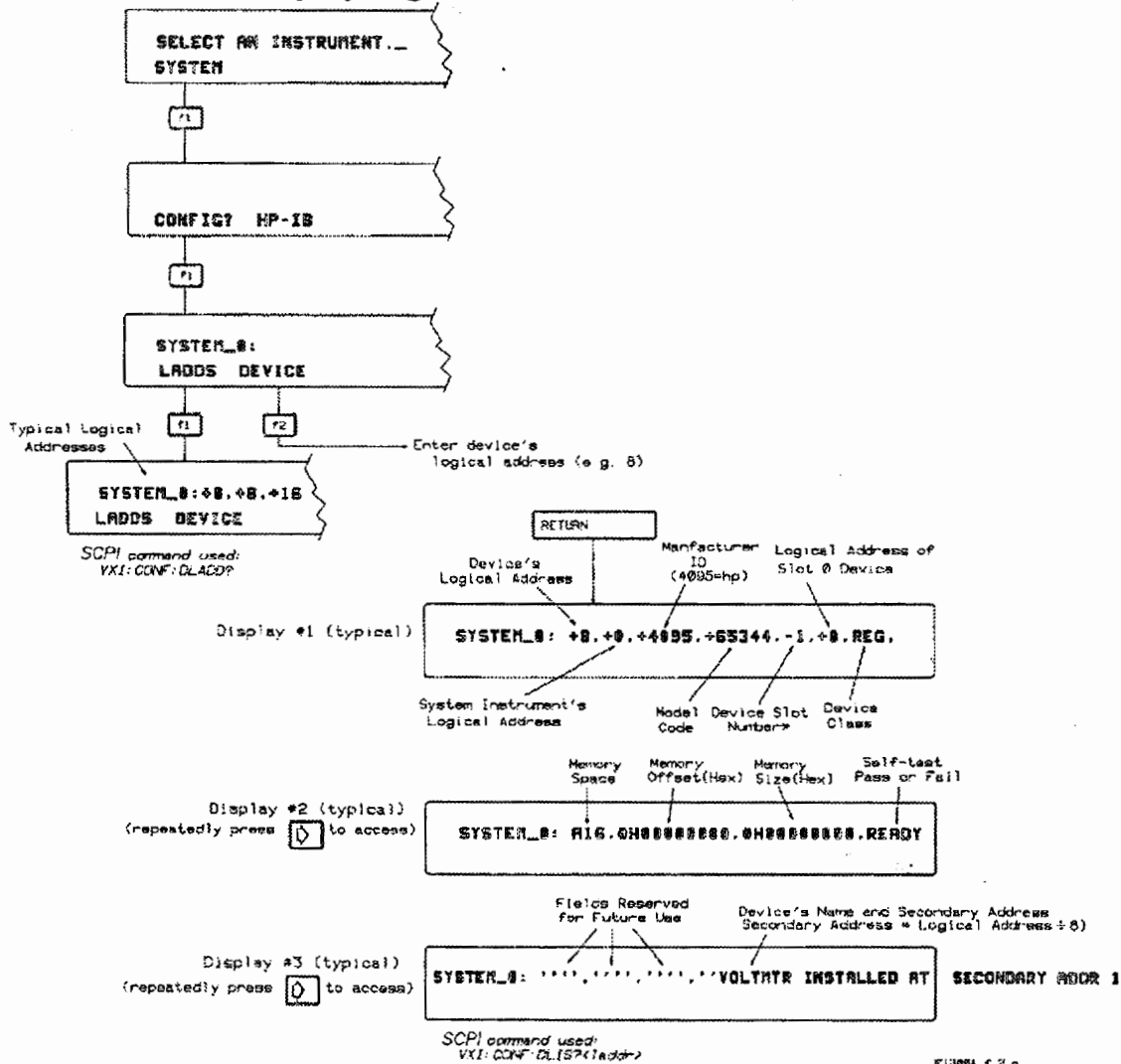

Using the Other Instrument Menus

The instrument menus allow you to access the most-used instrument functions or to monitor an instrument (monitor mode) while it is being controlled from remote. We'll use the Switchbox menu to show you how to use the instrument menus. Menus are available for many but not all instruments. See "Instrument Menus", later in this chapter, for more information on a particular instrument's menu. The Switchbox menu allows you to:

- Open and Close Channels
- Scan Channels
- Display Module Type and Description
- Monitor a Switchbox
- Reset a selected switch module

Selecting the Switchbox

To select the Switchbox, press the function key (f1 - f5) directly below the word SWITCH in the "Select an instrument" menu. (If the "Select an instrument" menu is not being displayed press **Select Instr.**)

Note

After you press the function key below the word SWITCH, the top line of the display may show: "Select SWITCH at logical address: _" while the bottom line of the display lists two or more logical addresses. This means more than one Switchbox is installed in the mainframe. To select one of the Switchboxes, press the function key directly below the corresponding logical address.

The charts on the following pages show how to use the Switchbox menu. Keep the following points in mind when using the menu:

- The card number identifies a module within the Switchbox. The module with the lowest logical address is always card number 01. The module with the next successive logical address is card number 02 and so on.
- The @ character is required preceding a channel list when executing a Switchbox command from the front panel or remote. When entering a channel list in response to a menu prompt however, do not precede it with the @ character. Doing so causes a syntax error.

How to Open/Close Channels

Switchbox instrument at log:cal address 16
(Secondary address = 02)

SWITCH_16: _
MONITOR OPEN CLOSE SCAN CARD →

f1 f2 f3 f4 f5

SWITCH_16: ENTER CHANNEL LIST
_

ENTER CHANNEL LIST AND PRESS Return
(e.g., 102 for channel 02 on card #1)

SCPI command used:
OPEN <channel_list>

SWITCH_16: ENTER CHANNEL LIST
_

ENTER CHANNEL LIST AND PRESS Return
(e.g., 102 for channel 02 on card #1)

SCPI command used:
CLOSE <channel_list>

51398-F-3-E

How to Scan Channels

SWITCH_16: _
MONITOR OPEN CLOSE SCAN CARD →

f1 f2 f3 f4 f5

SWITCH_16: _
SET_UP STEP

f1 f2 f3 f4 f5

SWITCH_16: ENTER CHANNEL LIST
_

ENTER CHANNEL LIST AND PRESS Return
(e.g., 100:115 to scan channels 00 to 15 on card #1)

SCPI commands used:
TRIG: SOUR HOLD
SCAN<channel_list>
INIT

PRESS f2 TO ADVANCE TO NEXT CHANNEL
(i.e., trigger the instrument)

SCPI command used:
TRIG

How to Display Monitor Type, Description, or Reset Module

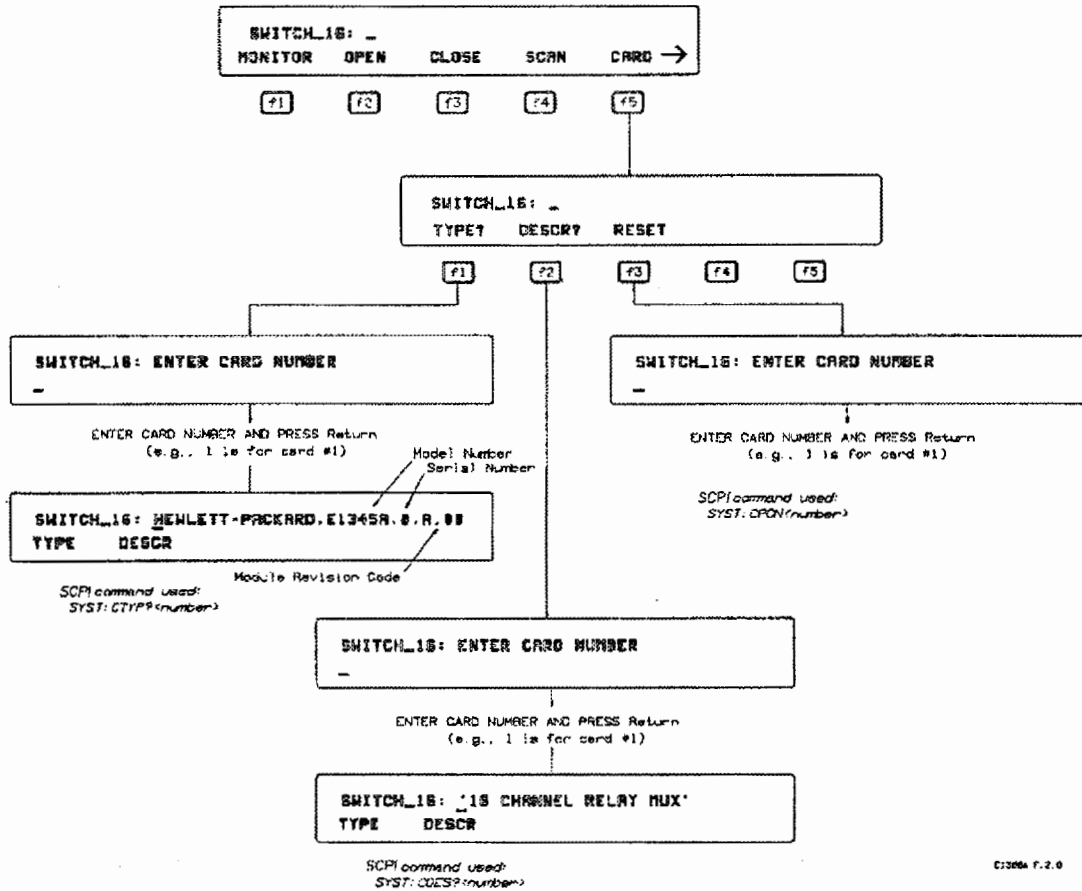

How to Select Monitor Mode

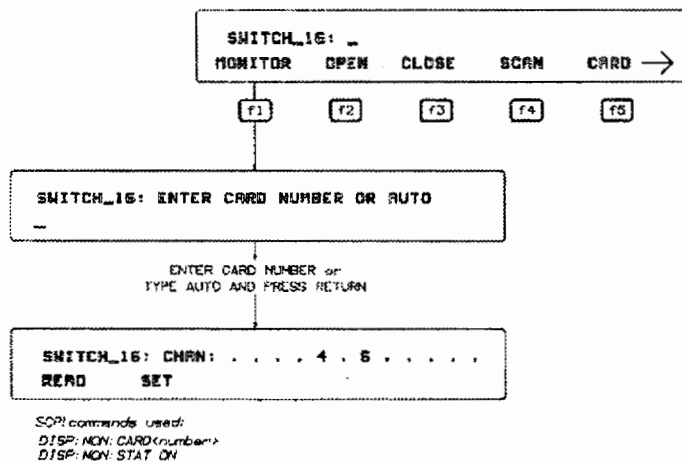

Monitor Mode

Monitor mode displays the status of an instrument while it is being controlled from remote. Monitor mode is useful for debugging programs. You can place an instrument in monitor mode using front panel menus, or by executing the `DISP:MON:STAT ON` command from the front panel or by remote. (Executing the remote `DISP:MON:STAT ON` command is the only way to assign the display/keyboard to an instrument from remote.) Pressing most front panel keys will automatically exit monitor mode and return to the instrument menu. However, you can use the left and right arrow keys in monitor mode to view long displays.

Note

Enabling monitor mode slows instrument operations. If the timing or speed of instrument operations is critical (such as making multimeter readings at a precise time interval), you should not use monitor mode.

Table 2-8 shows the status annunciators that may appear in the bottom line of the display in monitor mode. Some instruments also have device-specific annunciators (see the plug-in module manual for more information).

Table 2-1. Monitor Mode Display Annunciators

Annunciator	Description
mon	The instrument is in monitor mode
bsy	The instrument is executing a command
err	An error has occurred (see "Reading Error Messages" below)
srq	A service request has occurred

Reading Error Messages

Whenever the display is showing the *err* annunciator, an error has occurred for the instrument being monitored. You can read the error message, although doing so cancels monitor mode. To read an error message, press the following keys:



The error message will be displayed in the top line of the display. To see if another error was logged, repeat the above keystrokes or press:

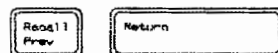

After you have read all the error messages, executing the `SYST:ERR?` command causes the display to show: `+0 No error`. After reading the error message(s), press `f1` to return to monitor mode.

Executing Commands

From the front panel, you can type and execute IEEE 488.2 Common Commands and SCPI Commands for the instrument presently selected by the *Select an instrument* menu. (However, you cannot execute a command when the display is requesting that you input information.) This is particularly useful for accessing functions not available in an instrument's menu. For example, the System Instrument contains a Pacer that can be programmed to output a square wave signal on the mainframe's Pacer Out port. From the System Instrument menu, you can program the Pacer to output 10 square wave cycles with a period of 1 second each by typing the following commands and pressing **Return** after each command (see Chapter 3 for more information on the Pacer).

```
SOUR:PULS:COUN 10
SOUR:PULS:PER 1
INIT:IMM
TRIG:SOUR IMM
```

As another example, after selecting the Switchbox, suppose you must set up and execute a scan list with automatic advance (automatic advance is not available from the menu). You can do this by typing the following command string and pressing **Return** (notice that by linking the commands together with a semicolon and colon you need press **Return** only once).

```
TRIG:SOUR IMM;;SCAN (@100:105)::INIT
```

Editing

The display editing keys (shown on the following page) allow you to edit user-entered data or commands. When editing, the display is in insert mode. That is, typed characters will be inserted into the string at the present cursor position.

Key Descriptions

This section explains the function of each of the front panel's dedicated keys. If a key is not functional in a particular situation, pressing that key does nothing except to cause a beep. Users of the optional IBASIC interpreter should refer to their IBASIC manual set for additional editing functions.

Menu Keys



Selects the menu choice displayed directly above each key.



Returns to the *Select an instrument* menu.



Returns to the previous menu level within an instrument menu or escapes from an input prompt. When you reach the top of an instrument's menu, pressing **Prev Menu** does nothing except to cause a beep.



The display can show a maximum of five menu choices at a time. When there are more than five menu choices, an arrow appears on the right side of the display. Press **More** to display the next group of choices. By repeatedly pressing **More** you can display all groups of choices. After you have displayed all groups of choices, pressing **More** again returns to the first group of choices.



Recalls the last command entered from the front panel. After recalling a command, it can be edited or re-executed. You can recall from a stack of previously executed commands by repeatedly pressing **Recall Prev**. When you reach the bottom of the stack (the last line in the buffer), pressing **Recall Prev** does nothing except to cause a beep. Pressing **Shift** with **Recall Prev** recalls the last SCPI command generated by a menu operation. For example, reading the time using the menus (SYSTEM, TIME, READ) generates and executes the SCPI command SYST:TIME?. A recalled command can be executed by pressing the **Return** key. You can also edit a recalled command before you execute it.



Accesses commands in the opposite order to that of **Recall Prev**. Pressing **Recall Next** does nothing until you have pressed **Recall Prev** at least twice.



Performs the same function as **Prev Menu**.

Display Control & Editing Keys



(Right arrow key.) Moves the cursor one character space to the right while leaving characters intact. Use the right arrow key to scroll displays that are longer than the display size. Pressing **Shift** followed by the right arrow key moves the cursor to the end of the line. Pressing **CTRL** followed by the right arrow key moves the cursor 4 character spaces to the right.



(Left arrow key.) Moves the cursor one character space to the left while leaving characters intact. Use the left and right arrow keys to scroll displays that are longer than the display size. Pressing **Shift** followed by the left arrow key moves

the cursor to the beginning of the line. Pressing **CTRL** followed by the left arrow key moves the cursor 4 character spaces to the left.



Erases the character at the present cursor position (for user-entered data only).



Erases the character to the left of the cursor (for user-entered data only).



(Clear-to-end key.) Erases all characters from the present cursor position to the end of the input line (for user-entered data only). Pressing **Shift** followed by the clear-to-end key erases the entire line and moves the cursor to the beginning of the line.

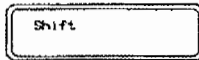

Selects the upper-case alphabetic characters or the character shown on the top half of a key. You can either hold down **Shift** while pressing another key or press and release **Shift** and then press another key.



Sets all alphabetic keys to uppercase (capitals); does not affect the other keys. To return to lowercase, press **Caps Lock** again.

Instrument Control Keys



Resets only the selected instrument (equivalent of executing ***RST**). **Reset Instr** also clears the instrument's front panel and remote input and output buffers. **Reset Instr** is the only front panel key that can affect an instrument being operated from remote.



Clears the front panel input and output buffers (remote buffers are not cleared) of the selected instrument and returns to the top level of the instrument menu. Press **Clear Instr** whenever an instrument is busy, is not responding to front panel control, or to abort a command being entered from the front panel.

Other Keys

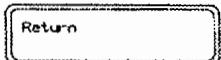

End of line. Enters your responses to menu prompts. Executes commands entered from the front panel keyboard.



Selects alternate key definitions. You can either hold down **CTRL** while pressing another key or press and release **CTRL** and then press another key. These **CTRL** key sequences provide short-cuts for some menu key sequences as well as additional functions not directly available from dedicated front panel keys. For a complete list of all **CTRL** key sequences see table 3-3 in the next chapter.

In Case of Difficulty

Problem:	Problem Cause/Solution:
<p>Error -113 undefined header error occurs after entering data in response to a menu prompt.</p>	<p>For some commands used by the menus, the data entered is appended to a command header. For example, if you enter "1" as the port number for a digital I/O module, the command used is DIG:HAND1:MODE NONE where HAND1 indicates the port number. If your entry was invalid or incorrect, error -113 occurs.</p>
<p>Following the power-on sequence or system reset the display shows:</p> <p>Configuration errors. Select SYSTEM Press any key to continue_</p>	<p>An unassigned device (incorrect logical address) was detected, or the contents of non-volatile memory may have been lost. If you cycle power or perform system reset, the display will show the logical address of the unassigned device. You can also check the logical addresses using the CONFIG? -- LADDS branch of the System Instrument menu. Refer to Chapter 1 of this manual for a discussion of logical addresses and unassigned devices.</p>
<p>The display shows: "instrument in local lockout". Menus seem to work but nothing happens when I reach the bottom level or try to execute a command.</p>	<p>The front panel has been locked-out (HP-IB local lockout). You can re-enable menu operation by cancelling local lockout (from remote) or by cycling mainframe power.</p>
<p>Display cannot be removed from monitor mode.</p>	<p>Monitor mode was entered from remote (DISP:MON:STAT ON command) and the front panel has also been locked out (HP-IB local lockout). Either cancel the local lockout or execute DISP:MON:STAT OFF (from remote).</p>
<p>Display shows:</p> <p>Can not connect to instrument Press any key to continue_</p>	<p>A hardware or software problem has occurred in the instrument preventing it from responding to front panel control.</p>
<p>After selecting an instrument the display shows:</p> <p>busy.</p>	<p>The instrument is busy performing an operation. Press Clear Instr to abort the instrument operations and allow the front panel to access the instrument.</p>
<p>Display shows:</p> <p>Instrument in use by another display. Press any key to continue_</p>	<p>The instrument has already been selected from the Display Terminal Interface. An instrument can only be "attached" to one display at a time. At the terminal, return to the "Select instrument" menu. The instrument can now be selected from the Front Panel.</p>

Instrument Menus

This section contains charts showing the structure and content for all front panel instrument menus. Also shown in the charts are the SCPI or Common Commands used and descriptions of menu-controlled instrument operations.

This section contains the following charts:

- System Instrument Menu 2-14
- Switchbox Menu 2-16
- Scanning Voltmeter Menu 2-18
- HP E1326A 5 1/2 Digit Multimeter Menu 2-20
- HP E1328A 4-Channel D/A Converter Menu 2-21
- HP E1330A Quad 8-Bit Digital I/O Menu 2-22
- HP E1332A 4-Channel Counter/Totalizer Menu 2-24
- HP E1333A 3-Channel Universal Counter Menu 2-26

System Instrument Menu

Menu Levels and Content

Level 1	Level 2	Level 3	Level 4	Level 5	Level 6	User Entry	Command(s) Used	Description
SYSTEM	CONFIG?	LADDRS					VXL:CONF:DLADD?	Displays logical addresses of mainframe instruments
		DEVICE				logical address	VXL:CONF:DLIS? <log_addr>	Displays information about the device at the specified logical address. (Refer to the Command Reference for details)
	HP-IB	READ				HP-IB address	SYST:COMM:CFIB:ADDR?	Displays HP-IB address
		SET				card number	SYST:COMM:CFIB:ADDR <address>	Read current baud rate
	RS232	BAUD				card number	SYST:COMM:SER[n]:BAUD?	Sets the serial interface baud rate to 300
		READ				card number	SYST:COMM:SER[n]:BAUD 300	Sets the serial interface baud rate to 1200
		SET				card number	SYST:COMM:SER[n]:BAUD 1200	Sets the serial interface baud rate to 2400
						card number	SYST:COMM:SER[n]:BAUD 2400	Sets the serial interface baud rate to 9600
						card number	SYST:COMM:SER[n]:BAUD 9600	Sets the serial interface baud rate to 19200
						card number	SYST:COMM:SER[n]:BAUD 19200	Read current parity type
		PARITY				card number	SYST:COMM:SER[n]:PAR?	Sets the serial interface parity to even
		READ				card number	SYST:COMM:SER[n]:PAR EVEN	Sets the serial interface parity to odd
		SET				card number	SYST:COMM:SER[n]:PAR ODD	Sets the serial interface parity to one
						card number	SYST:COMM:SER[n]:PAR ONE	Sets the serial interface parity to zero
						card number	SYST:COMM:SER[n]:PAR ZERO	Sets the serial interface parity to none
						card number	SYST:COMM:SER[n]:PAR NONE	Read current data bit width
		BITS				card number	SYST:COMM:SER[n]:BITS?	Sets the data width to 7 bits
		READ				card number	SYST:COMM:SER[n]:BITS 7	Sets the data width to 8 bits
		SET				card number	SYST:COMM:SER[n]:BITS 8	Read current pacing type
						card number	SYST:COMM:SER[n]:PACE?	Enables XON/XOFF software handshaking
		PACE				card number	SYST:COMM:SER[n]:PACE XON	Disables XON/XOFF software handshaking
		READ				card number	SYST:COMM:SER[n]:PACE XON	
		SET				card number	SYST:COMM:SER[n]:PACE NONE	
						card number		

(continued on following page)

System Instrument Menu

Menu Levels and Content

Level 1	Level 2	Level 3	Level 4	Level 5	Level 6	User Entry	Command(s) Used	Description
(continued from previous page)		CONTROL	DTR	READ		card number	SYST:COMM:SERQ[n]:CONV:DTR?	Read current setting for DTR line
				SET	ON	card number	SYST:COMM:SERQ[n]:CONV:DTR ON	Set DTR line to static +V
					OFF	card number	SYST:COMM:SERQ[n]:CONV:DTR OFF	Set DTR line to static -V
					IBFULL	card number	SYST:COMM:SERQ[n]:CONV:DTR IBF	Set DTR for hardware handshaking
					STANDARD	card number	SYST:COMM:SERQ[n]:CONV:DTR STAN	DTR operates to RS-232 standard
		KIS	READ			card number	SYST:COMM:SERQ[n]:CONV:KIS?	Read current setting for KIS line
				SET	ON	card number	SYST:COMM:SERQ[n]:CONV:KIS ON	Set KIS line to static +V
					OFF	card number	SYST:COMM:SERQ[n]:CONV:KIS OFF	Set KIS line to static -V
					IBFULL	card number	SYST:COMM:SERQ[n]:CONV:KIS IBF	Set RTS for hardware handshaking
					STANDARD	card number	SYST:COMM:SERQ[n]:CONV:KIS STAN	KIS operates to RS-232 standard
		STORE				card number	DIAG:COMM:SERQ[n]:STORE	Store current serial communications settings into non-volatile storage.
	DEBUG	READ				laddr, reg_num	VXI:READ? <laddr>, <reg>	Read register in A16 address space.
		WRITE				laddr, reg_num, data	VXI:WRIT <laddr>, <reg>, <data>	Write data to register in A16 address space.
	TIME	READ				time	SYST:TIME?	Read the current system clock
		SET					SYST:TIME <time>	Set the system clock
	DATE	READ				date	SYST:DATE?	Read the current system calendar
		SET					SYST:DATE <date>	Set the system calendar
	RESET						DIAG:BOOT	Resets mainframe using the configuration stored in non-volatile memory

Switchbox Menu

Menu Levels and Content

Level 1	Level 2	Level 3	User Entry	Command(s) Used	Description	
SWITCH	MONITOR		card number † or AUTO	DISP:MON: CARD <card_number>;STAT ON	Monitor instrument operations	
		OPEN	channel list †	OPEN (@channel_list)	Open channel(s)	
		CLOSE	channel list †	CLOSE (@channel_list)	Close channel(s)	
	SCAN	SET_UP	channel list †	TRIG:SOUR HOLD;SCAN <channel_list>;INIT		Set up channels to scan
		STEP	channel list †	TRIG		Step to next channel in scan list
		TYPE?	card number †	SYSTEM:TYPE? <card_number>		Display module ID information
	CARD	DESCR?	card number †	SYSTEM:DESCR? <card_number>		Display module description
		RESET	card number †	SYSTEM:CPON <card_number>		Return module to power-on state
		TEST	card number †	*TSI?		Runs self-test, displays results (+0 =pass; any other number=fail)

† Channel lists are of the form "ccnn" (single channel), "ccnn,ccnn" (two or more channels) or "ccnn:ccnn" (range of channels); where "cc" is the card number and "nn" is the channel number. For example, to access channel 2 on card number 1 specify 102.

‡ The card number identifies a module within the Switchbox. The switch module with the lowest logical address is always card number 01. The switch module with the next successive logical address is card number 02 and so on.

Notes

Scanning Voltmeter Menu

Menu Levels and Content

Level 1 Level 2 Level 3 Level 4

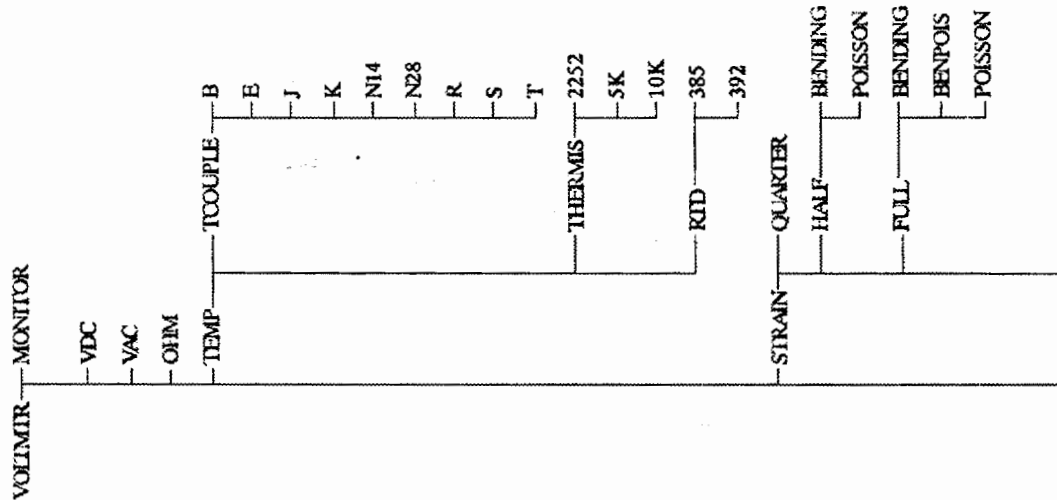

User Entry	Command(s) Used	Description
channel list † or 0 for auto	DISP:MON:CHAN <channel_list> >STAT ON	Monitor instrument operations
channel list †	MEAS:VOLT:DC? <channel_list>	Measure DC voltage on each channel
channel list †	MEAS:VOLT:AC? <channel_list>	Measure AC voltage on each channel
channel list †	MEAS:RES? <channel_list>	Measure 2-wire resistance on each channel
channel list †	MEAS:TEMP? TC,B <channel_list>	Measure °C of B thermocouple on each channel
channel list †	MEAS:TEMP? TC,E <channel_list>	Measure °C of E thermocouple on each channel
channel list †	MEAS:TEMP? TC,J <channel_list>	Measure °C of J thermocouple on each channel
channel list †	MEAS:TEMP? TC,K <channel_list>	Measure °C of K thermocouple on each channel
channel list †	MEAS:TEMP? TC,N14 <channel_list>	Measure °C of N14 thermocouple on each channel
channel list †	MEAS:TEMP? TC,N28 <channel_list>	Measure °C of N28 thermocouple on each channel
channel list †	MEAS:TEMP? TC,R <channel_list>	Measure °C of R thermocouple on each channel
channel list †	MEAS:TEMP? TC,S <channel_list>	Measure °C of S thermocouple on each channel
channel list †	MEAS:TEMP? TC,T <channel_list>	Measure °C of T thermocouple on each channel
channel list †	MEAS:TEMP? THER,2252, <channel_list>	Measure °C of 2252 Ω thermistor on each channel
channel list †	MEAS:TEMP? THER,5000, <channel_list>	Measure °C of 5k Ω thermistor on each channel
channel list †	MEAS:TEMP? THER,10000, <channel_list>	Measure °C of 10k Ω thermistor on each channel
channel list †	MEAS:TEMP? KID,85, <channel_list>	Measure °C of 385 KID on each channel (4-wire)
channel list †	MEAS:TEMP? KID,92, <channel_list>	Measure °C of 392 KID on each channel (4-wire)
channel list †	MEAS:STR:QUART? <channel_list>	Measure strain with quarter bridge
channel list †	MEAS:STR:HALF? <channel_list>	Measure strain with bending half bridge
channel list †	MEAS:STR:HPO? <channel_list>	Measure strain with Poisson half bridge
channel list †	MEAS:STR:FREN? <channel_list>	Measure strain with bending full bridge
channel list †	MEAS:STR:FBP? <channel_list>	Measure strain with Bending Poisson full bridge
channel list †	MEAS:STR:FPO? <channel_list>	Measure strain with Poisson full bridge

(continued on following page)

Scanning Voltmeter Menu

Menu Levels and Content

Level 1	Level 2	Level 3	Level 4	User Entry	Command(s) Used	Description
(continued from previous page)		UNSTRN		channel list †	MEAS:STR:UNST? <channel_list>	Measure bridge unstrained
		DIAG	COMPRES	channel list †	MEAS:STR:QCOM? <channel_list>	Compression shunt diagnostic
			TENSION	channel list †	MEAS:STR:QIEN? <channel_list>	Tension shunt diagnostic
	CARD	TYPE?		card number ‡	SYST:CTYP? <card_number>	Displays module ID information
		DESCR?		card number ‡	SYST:CDIS? <card_number>	Displays module description
					*TST?	Runs self-test, displays results (+0 =pass; any other number=fail)

† Channel lists are of the form "ccnn" (single channel), "ccnn,ccnn" (two or more channels) or "ccnn:ccnn" (range of channels); where "cc" is the card number and "nn" is the channel number. For example, to access channel 2 on card number 1 specify 102.

‡ The card number identifies a module within the Switchbox. The switch module with the lowest logical address is always card number 01. The switch module with the next successive logical address is card number 02 and so on.

HP E1326B/E1411B 5 1/2 Digit Multimeter (Standalone) Menu

Menu Levels and Content

Level 1	Level 2	Level 3	Level 4	User Entry	Command(s) Used	Description
VOLTMTR	MONITOR				DISP:MON:STAT ON	Display instrument operations
	VDC				MEAS:VOLT:DC?	Measure DC volts
	VAC				MEAS:VOLT:AC?	Measure AC volts
	OHM				MEAS:FRES?	Measure 4-wire ohms
	TEMP	HERMIS	2252		MEAS:TEMP? FTH,2252	Measure °C of 2252Ω thermistor (4-wire measurement)
			5K		MEAS:TEMP? FTH,5000	Measure °C of 5kΩ thermistor (4-wire measurement)
			10K		MEAS:TEMP? FTH,10000	Measure °C of 10kΩ thermistor (4-wire measurement)
		RID	385		MEAS:TEMP FKID,85?	Measure °C of 100Ω RID with alpha = 385 (4-wire measurement)
			392		MEAS:TEMP FKID,92?	Measure °C of 100Ω RID with alpha = 392 (4-wire measurement)
					*TST?	Run self-test, display results (0 =pass; any other number =fail)

† Channel lists are of the form "ccnn" (single channel), "ccnn,ccnn" (two or more channels) or "ccnn:ccnn" (range of channels); where "cc" is the card number and "nn" is the channel number. For example, to access channel 2 on card number 1 specify 102.

‡ The card number identifies a module within the Switchbox. The switch module with the lowest logical address is always card number 01. The switch module with the next successive logical address is card number 02 and so on.

HP E1328A 4-Channel D/A Converter Menu

Menu Levels and Content

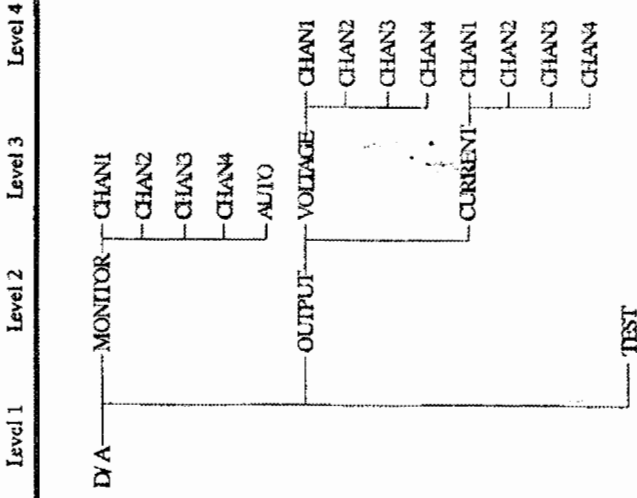

Level 1	Level 2	Level 3	Level 4	User Entry	Command(s) Used	Description
D/A	MONITOR	CHAN1			DISP:MON:CHAN 1;STAT ON	Monitor instrument operations on channel 1
		CHAN2			DISP:MON:CHAN 2;STAT ON	Monitor instrument operations on channel 2
		CHAN3			DISP:MON:CHAN 3;STAT ON	Monitor instrument operations on channel 3
		CHAN4			DISP:MON:CHAN 4;STAT ON	Monitor instrument operations on channel 4
		AUTO			DISP:MON:CHAN AUTO;STAT ON	Monitor instrument operations on active channel
	OUTPUT	VOLTAGE		voltage †	VOLT1 <voltage >	Output voltage on channel 1
				voltage †	VOLT2 <voltage >	Output voltage on channel 2
				voltage †	VOLT3 <voltage >	Output voltage on channel 3
				voltage †	VOLT4 <voltage >	Output voltage on channel 4
		CURRENT		current ‡	CURR1 <current >	Output current on channel 1
				current ‡	CURR2 <current >	Output current on channel 2
				current ‡	CURR3 <current >	Output current on channel 3
				current ‡	CURR4 <current >	Output current on channel 4
					*TST?	Run self-test, display results (+0 =pass; any other number =fail)

†Enter voltage values in volts. Typical examples are: +3.5, -2, +500E-3.
 ‡Enter current values in amps. Typical examples are: .05, +200E-3.

HP E1330A Quad 8-Bit Digital Input/Output Menu

Menu Levels and Content

Level 1	Level 2	Level 3	Level 4	User Entry	Command(s) Used	Description	
DIG_I/O	MONITOR	PORT0			DISP:MON:CHAN 0;STAT ON	Monitor instrument operations on port 0	
		PORT1			DISP:MON:CHAN 1;STAT ON	Monitor instrument operations on port 1	
		PORT2			DISP:MON:CHAN 2;STAT ON	Monitor instrument operations on port 2	
		PORT3			DISP:MON:CHAN 3;STAT ON	Monitor instrument operations on port 3	
	READ	AUTO			DISP:MON:CHAN AUTO;STAT ON	Monitor instrument operations on any active port	
		R_BYTE	PORT0			DIG:HAND0:MODE NONE;MEAS:DIG:DATA0?	Reads port 0 after handshake
			PORT1			DIG:HAND1:MODE NONE;MEAS:DIG:DATA1?	Reads port 1 after handshake
			PORT2			DIG:HAND2:MODE NONE;MEAS:DIG:DATA2?	Reads port 2 after handshake
	PORT3				DIG:HAND3:MODE NONE;MEAS:DIG:DATA3?	Reads port 3 after handshake	
	R_BIT	PORT0		bit (0-7)	DIG:HAND0:MODE NONE;MEAS:DIG:DATA0:BITm?	Reads bit m on port 0 after handshake	
		PORT1		bit (0-7)	DIG:HAND1:MODE NONE;MEAS:DIG:DATA1:BITm?	Reads bit m on port 1 after handshake	
		PORT2		bit (0-7)	DIG:HAND2:MODE NONE;MEAS:DIG:DATA2:BITm?	Reads bit m on port 2 after handshake	
		PORT3		bit (0-7)	DIG:HAND3:MODE NONE;MEAS:DIG:DATA3:BITm?	Reads bit m on port 3 after handshake	
	WRITE	W_BYTE	PORT0	data (0-255)	DIG:HAND0:MODE NONE;DIG:DATA0 <data >	Writes data to port 0	
			PORT1	data (0-255)	DIG:HAND1:MODE NONE;DIG:DATA1 <data >	Writes data to port 1	
			PORT2	data (0-255)	DIG:HAND2:MODE NONE;DIG:DATA2 <data >	Writes data to port 2	
PORT3			data (0-255)	DIG:HAND3:MODE NONE;DIG:DATA3 <data >	Writes data to port 3		
W_BIT	PORT0	bit (0-7), value (0,1)	DIG:HAND0:MODE NONE;DIG:DATA0:BITm <value >	Writes data to bit m on port 0			
	PORT1	bit (0-7), value (0,1)	DIG:HAND1:MODE NONE;DIG:DATA1:BITm <value >	Writes data to bit m on port 1			
	PORT2	bit (0-7), value (0,1)	DIG:HAND2:MODE NONE;DIG:DATA2:BITm <value >	Writes data to bit m on port 2			
	PORT3	bit (0-7), value (0,1)	DIG:HAND3:MODE NONE;DIG:DATA3:BITm <value >	Writes data to bit m on port 3			

Notes

HP E1332A 4-Channel Counter/Totalizer Menu

Menu Levels and Content

Level 1	Level 2	Level 3	Level 4	Level 5	User Entry	Command(s) Used	Description
COUNTER	MONITOR	CHAN1				DISP:MON:CHAN 1;STAT ON	Monitor instrument operations on channel 1
		CHAN2				DISP:MON:CHAN 2;STAT ON	Monitor instrument operations on channel 2
	INPUT	CHAN3				DISP:MON:CHAN 3;STAT ON	Monitor instrument operations on channel 3
		CHAN4				DISP:MON:CHAN 4;STAT ON	Monitor instrument operations on channel 4
		ALTO				DISP:MON:CHAN AUTO;STAT ON	Monitor instrument operations on active channel
		LEVEL	CHAN1&2		voltage †	SENS1:EVEN:LEV <value >	Set level trigger voltage for channels 1 & 2
			CHAN3&4		voltage †	SENS3:EVEN:LEV <value >	Set level trigger voltage for channels 3 & 4
		SLOPE	CHAN1	POS		SENS1:EVEN:SLOP POS	Positive level trigger slope for channel 1
				NEG		SENS1:EVEN:SLOP NEG	Negative level trigger slope for channel 1
			CHAN2	POS		SENS2:EVEN:SLOP POS	Positive level trigger slope for channel 2
				NEG		SENS2:EVEN:SLOP NEG	Negative level trigger slope for channel 2
			CHAN3	POS		SENS3:EVEN:SLOP POS	Positive level trigger slope for channel 3
				NEG		SENS3:EVEN:SLOP NEG	Negative level trigger slope for channel 3
			CHAN4	POS		SENS4:EVEN:SLOP POS	Positive level trigger slope for channel 4
				NEG		SENS4:EVEN:SLOP NEG	Negative level trigger slope for channel 4
		ISOLATE	ON			INP:ISOL ON	Input isolation on
			OFF			INP:ISOL OFF	Input isolation off
		FILTER	ON			INP:FLT ON	Input filter on
			OFF			INP:FLT OFF	Input filter off
			FREQ		frequency ‡	INP:FLT:FREQ <value >	Set input filter frequency
	FREQ	CHAN1				TRIG:SOUR IMM4;MEAS1:FREQ?	Frequency measurement on channel 1
		CHAN3				TRIG:SOUR IMM4;MEAS3:FREQ?	Frequency measurement on channel 3
	PERIOD	CHAN1				TRIG:SOUR IMM4;MEAS1:PER?	Period measurement on channel 1
		CHAN3				TRIG:SOUR IMM4;MEAS3:PER?	Period measurement on channel 3

(continued on following page)

HP E1332A 4-Channel Counter/Totalizer Menu

Menu Levels and Content

Level 1	Level 2	Level 3	Level 4	Level 5	User Entry	Command(s) Used	Description	
(continued from previous page)	---TIMENT	---CHAN1	---CHAN3	---START	---READ	TRIG:SOUR IMM4; MEAS1:INT?	Time interval measurement on channel 1	
							TRIG:SOUR IMM4; MEAS3:INT?	Time interval measurement on channel 3
		---POS_PW	---CHAN2	---CHAN4	---START	---READ	TRIG:SOUR IMM4; MEAS2:PWID?	Positive pulse width measurement on channel 2
								TRIG:SOUR IMM4; MEAS4:PWID?
	---NEG_PW	---CHAN2	---CHAN4	---START	---READ	TRIG:SOUR IMM4; MEAS2:NWID?	Negative pulse width measurement on channel 2	
							TRIG:SOUR IMM4; MEAS4:NWID?	Negative pulse width measurement on channel 4
	---UDCOUNT	---CHAN1	---CHAN3	---START	---READ	FEIC1?	Up/down count, subtract ch. 2 count from ch. 1 count	
							TRIG:SOUR IMM4; CONF1:UDC;INT1	Get up/down count from channels 1 & 2
		---TOTALIZ	---CHAN2	---CHAN4	---START	---READ	FEIC3?	Up/down count, subtract ch. 4 count from ch. 3 count
								TRIG:SOUR IMM4; CONF3:UDC;INT3
	---TEST	---CHAN1	---CHAN3	---START	---READ	TRIG:SOUR IMM4; CONF1:TOT;INT1	Totalize on channel 1	
							FEIC1?	Get totalize count on channel 1
		---TOTALIZ	---CHAN2	---CHAN4	---START	---READ	TRIG:SOUR IMM4; CONF2:TOT;INT2	Totalize on channel 2
								FEIC2?
	---TOTALIZ	---CHAN3	---CHAN4	---START	---READ	TRIG:SOUR IMM4; CONF3:TOT;INT3	Totalize on channel 3	
							FEIC3?	Get totalize count on channel 3
---TOTALIZ	---CHAN4	---CHAN4	---START	---READ	TRIG:SOUR IMM4; CONF4:TOT;INT4	Totalize on channel 4		
						FEIC4?	Get totalize count on channel 4	
					*TST?	Run self-test, display results (+0=pass; any other number=fail)		

†Enter voltage values in volts. Typical examples are: +3.5, -2, +500E-3.

#Enter frequency value in hertz. Typical examples are: 60, 120, 1EB.

HP E1333A 3-Channel Universal Counter

Menu

Menu Levels and Content

Level 1	Level 2	Level 3	Level 4	Level 5	User Entry	Command(s) Used	Description
COUNTER	MONITOR	CHAN1				DISP:MON:CHAN 1;STAT ON	Monitor instrument operations on channel 1
		CHAN2				DISP:MON:CHAN 2;STAT ON	Monitor instrument operations on channel 2
	INPUT	CHAN3				DISP:MON:CHAN 3;STAT ON	Monitor instrument operation on channel 3
		AUTO				DISP:MON:CHAN AUTO;STAT ON	Monitor instrument operations on active channel
		LEVEL	CHAN1		voltage ↑	SENS1:EVEN:LEV <value >	Set trigger level voltage for channel 1
			CHAN2		voltage ↑	SENS2:EVEN:LEV <value >	Set trigger level voltage for channel 2
		SLOPE	CHAN1	POS		SENS1:EVEN:SLOP POS	Positive trigger slope for channel 1
				NEG		SENS1:EVEN:SLOP NEG	Negative trigger slope for channel 1
			CHAN2	POS		SENS2:EVEN:SLOP POS	Positive trigger slope for channel 2
				NEG		SENS2:EVEN:SLOP NEG	Negative trigger slope for channel 2
		COUPLE	AC			INP:COUP AC	AC-coupled input (channels 1 & 2 only)
			DC			INP:COUP DC	DC-coupled input (channels 1 & 2)
		IMPED	50_OHM			INP:IMP 50	50Ω input resistance (channels 1 & 2 only)
			1_MOHM			INP:IMP 1e6	1MΩ input resistance (channels 1 & 2 only)
		ATTEN	0dB			INP:ATT 0	No input attenuation (channels 1 & 2 only)
			20dB			INP:ATT 20	20dB input attenuation (channels 1 & 2 only)
		FILTER	ON			INP:FLT ON	Input filter on (channels 1 & 2 only)
			OFF			INP:FLT OFF	Input filter off (channels 1 & 2 only)
		FREQ	CHAN1			TRIG:SOUR IMM::MEAS1:FREQ?	Frequency measurement on channel 1
			CHAN2			TRIG:SOUR IMM::MEAS2:FREQ?	Frequency measurement on channel 2
			CHAN3			TRIG:SOUR IMM::MEAS3:FREQ?	Frequency measurement on channel 3
		PERIOD	CHAN1			TRIG:SOUR IMM::MEAS1:PER?	Period measurement on channel 1
			CHAN2			TRIG:SOUR IMM::MEAS2:PER?	Period measurement on channel 2

(continued on following page)

HP E1333A 3-Channel Universal Counter Menu

Menu Levels and Content

Level 1	Level 2	Level 3	Level 4	Level 5	User Entry	Command(s) Used	Description
(continued from previous page)	TIMEINT	CHAN1	-----			TRIG:SOUR IMM;:MEAS1:INT?	Time interval measurement on channel 1
			-----			TRIG:SOUR IMM;:MEAS2:INT?	Time interval measurement on channel 2
	POS_PW	CHAN1	-----			TRIG:SOUR IMM;:MEAS1:PWID?	Positive pulse width measurement on channel 1
			-----			TRIG:SOUR IMM;:MEAS2:PWID?	Positive pulse width measurement on channel 2
	NEG_PW	CHAN1	-----			TRIG:SOUR IMM;:MEAS1:NWID?	Negative pulse width measurement on channel 1
			-----			TRIG:SOUR IMM;:MEAS2:NWID?	Negative pulse width measurement on channel 2
	RATIO	CHAN1	-----			TRIG:SOUR IMM;:MEAS1:RAT?	Ratio of channel 1/channel 2
			-----			TRIG:SOUR IMM;:MEAS2:RAT?	Ratio of channel 2/channel 1
	TOTALIZ	CHAN1	-----			TRIG:SOUR IMM;:CONF1:TOT;:INT1	Totalize on channel 1
			-----			FEIC1?	Display totalize count
	TEST	CHAN2	-----			TRIG:SOUR IMM;:CONF2:TOT;:INT2	Totalize on channel 2
			-----			FEIC2?	Display totalize count
					*TST?	Run self-test, display results (+0=pass; any other number=fail)	

†Enter voltage values in volts. Typical examples are: +3.5, -2, +500E-3.

Notes

Using the Display Terminal Interface

Using this Chapter

This chapter shows you how to use the HP E1300A and HP E1301A Mainframes' Display Terminal Interface (terminal interface) to operate instruments in the mainframe. The terminal interface uses the built-in RS-232 and/or the optional HP E1324A Datacomm Module to provide all of the features of the HP E1301A's front panel, plus comfortable keyboard position and full screen display. It contains the following sections:

- Terminal Interface Features 3-2
- Using Menus 3-3
- Executing Commands 3-13
- General Key Descriptions 3-14
- Using Supported Terminals 3-16
- Using Other Terminals 3-19
- In Case of Difficulty 3-23
- Instrument Menus 3-25

Note

This chapter discusses *using* the display terminal interface. It assumes that you have already connected your terminal and configured it to communicate with your mainframe. For information on connecting and configuring your terminal, refer to Appendix C in this manual.

Terminal Interface Features

Figure 3-2 shows a typical terminal interface display with its function labels across the bottom of the screen. The first five function keys (F1 through F5) select instrument menu choices. Function keys F6 through F8 provide menu control and access to utility functions. The tutorials in this chapter show how to use most of the menu control and utility function keys. See "General Key Descriptions" near the end of this chapter for a complete description of each of these key functions.

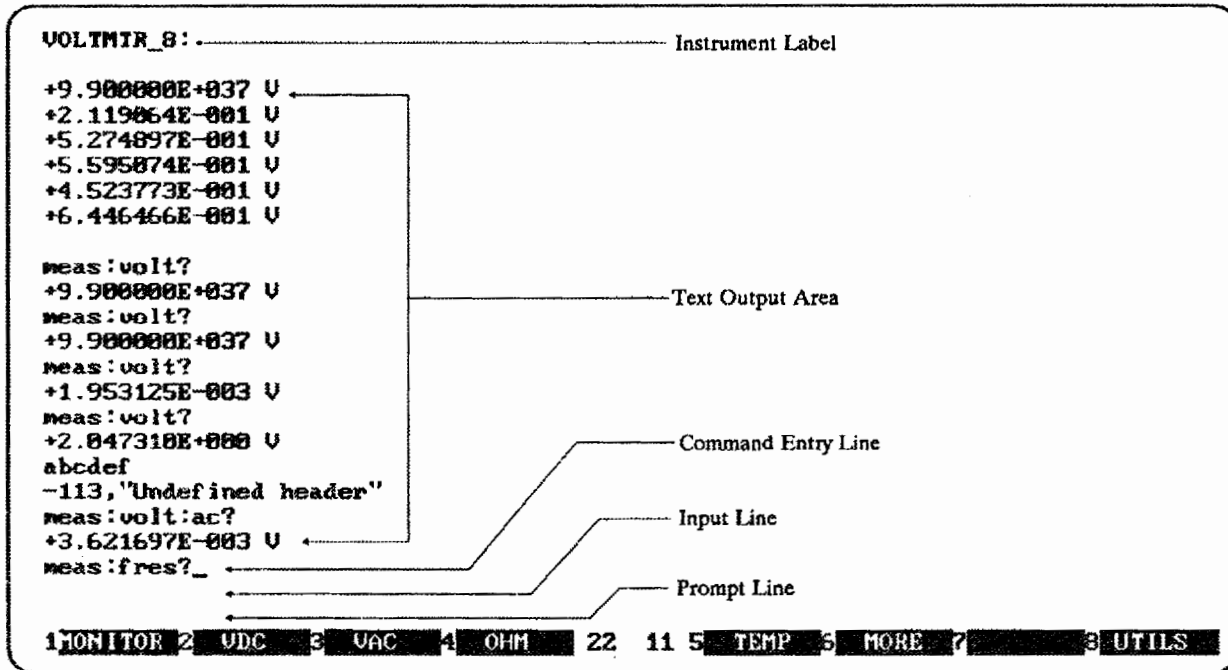

- Notes:
1. Example screens are from HP AdvanceLink terminal emulator.
 2. Later screen examples are shown compressed (only 4 lines tall) and may show only part of the screen width.

Figure 3-1. Typical Terminal Interface Display

Using Menus

A System Instrument menu and a variety of other instrument menus (depending on installed instruments) are available from the terminal interface. These menus incorporate the most used functions but do not provide access to the complete functionality of an instrument. If a particular function is not available from a menu, you can type the corresponding Common Command or SCPI command string and execute it from the terminal interface. See "Executing Commands" later in this chapter for more information.

When you select an instrument, you are assigning the terminal interface to that instrument. This means that any menu operations, commands executed or recalled, errors displayed, etc. pertain only to that instrument. Terminal interface operation of an instrument is independent from other instruments and independent from the remote operation of the instrument. To operate another instrument from the terminal interface, you must select that instrument.

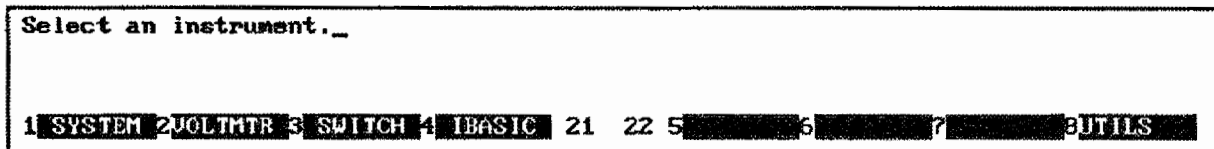

Note: Typical instruments shown. Actual choices depend on installed instrument

Figure 3-2. "Select an instrument" Menu

A 60-Second Menu Tutorial

Following the power-on sequence or a system reset, the screen shows the *Select an instrument* menu (see Figure 3-2). This menu allows you to select one of the instruments listed.

The menu select and menu control function keys (usually labeled **f1** - **f8** on their key caps) are defined by eight function labels located across the bottom of the terminal screen. Once you learn how these keys operate, using the menus is easy (key labels are shown in bold text in this chapter):

To select a displayed menu choice, press the function key (**f1** - **f5**) which corresponds to the function key label.

- When there are more than five menu choices, function key **f6** becomes labeled **MORE**. Press **MORE** to display the next group of choices. By repeatedly pressing **MORE** you can display all groups of choices. After you have displayed all groups of choices, pressing **MORE** again returns to the first group of choices.
- Whenever the screen is requesting information (input prompt) such as *Enter the device's logical address*, just type the information and press **Return** (may be **Enter** on a terminal emulator).

If you pressed the wrong menu key and do not want to enter the requested information, you can escape the input prompt and stay at the same menu level by pressing **ESC** or **PRV_MENU**.

If you make an incorrect entry in response to an input prompt, the bottom line of the Text Output Area will show an error message. When this happens, just select that menu choice again (f1 - f5 keys), re-type the correct information, and press **Return**.

- Press **PRV_MENU** or **ESC** to return to the previous menu within an instrument menu or escape from an input prompt. Press **SEL_INST** to return to the *Select an Instrument* menu (see next item). Note that when you leave an instrument and return later, you return to the same menu location you were when you left. In addition, any information below the Text Output Area will also be re-displayed when you return.
- In addition to the instrument menu keys, **CLR_INST**, **RST_INST** and **SEL_INST** are helpful when operating instruments. These and other utility keys are accessed by pressing the **UTILS** key. See "Executing Commands" for information on the **RCL_....** keys in this menu.

CLR_INST clears the instrument's terminal interface input and output buffers (remote buffers are not cleared) and returns to the top level of the instrument menu. Press **CLR_INST** whenever an instrument is busy, is not responding to terminal interface control, or to abort a command being entered from the terminal interface.

RST_INST clears all terminal interface and remote input and output buffers and resets the instrument.

SEL_INST returns you to the *Select an Instrument* menu. Note that

SEL_INST is the key "under" the **UTILS** key. You can easily return to the *Select an Instrument* menu by pressing **f8** twice.

How to Access the Utility Keys

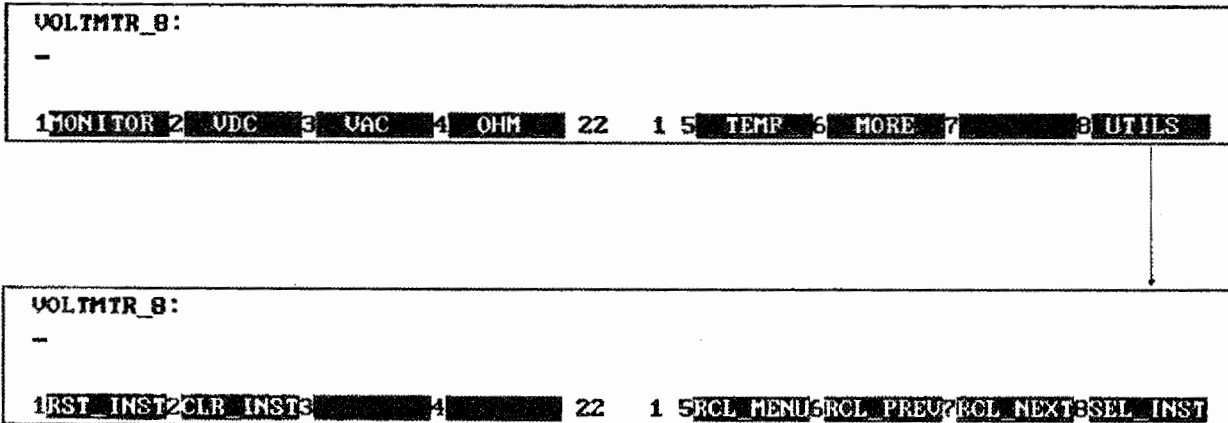

Using the System Instrument Menu

The System Instrument menu allows you to:

- Set or read the system HP-IB address
- Reset (reboot) the mainframe
- Display the logical addresses of installed instruments
- Display information about installed instruments

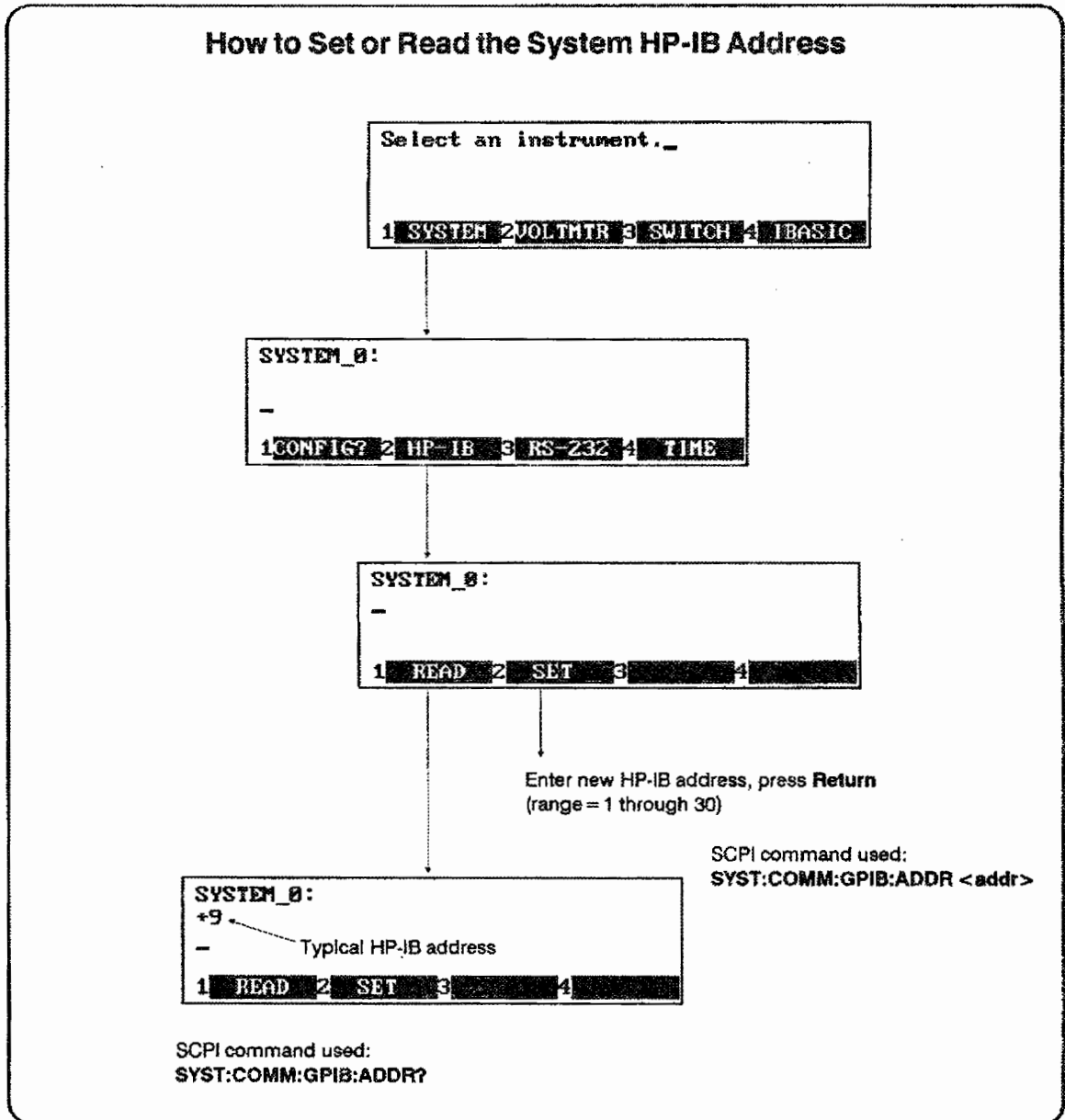

How to Reset the System

Select an instrument._

1 SYSTEM 2 VOLTMR 3 SWITCH 4 IBASIC 21 22 5 6 7 UTILS

SYSTEM_0:

-

1 CONFIG? 2 HP-IB 3 RS-232 4 TIME 23 1 5 DATE 6 MORE 7 8 UTILS

SYSTEM_0:

Press f1 to Reset

-

1 RESET 2 3 4 23 1 5 6 MORE 7 8 UTILS

Note: The RESET menu selection is equivalent to executing the DIAG:BOOT command which has the same effect as cycling the mainframe's power. Pressing RST_INST from the System Instrument menu is the equivalent to sending the *RST command to the System Instrument.

How to Display Logical Addresses and Instrument Information

Select an instrument. _

1 SYSTEM 2 VOLTMR 3 SWITCH 4 IBASIC

SYSTEM_0:

-

1 CONFIG? 2 HP-IB 3 RS-232 4 TIME

SYSTEM_0:

-

1 LADDS 2 DEVICE 3 4

Enter device's logical address and press **Return** for individual instrument information, or just enter one space and **Return**, for information on all instruments.

(In this case, 8 was entered)

SYSTEM_0:

+8, +8, +32, +240

1 LADDS 2 DEVICE 3 4

Logical address of selected device

Instrument name

SYSTEM_0:

+8, +8, +4895, +65344, -1, +0, REG, A16, #H00000000, #H00000000, READY, "", "", "", "VOLTMR
INSTALLED AT SECONDARY ADDR 1"

1 LADDS 2 DEVICE 3 4 24 1 5 6 7 PRU MENUS UTILS

HP-IB secondary address

Note: For a description of each field of the Instrument information, see
VXI:CONF:DLIS? in the SCPI Command Reference section.

Using the Other Instrument Menus

The instrument menus allow you to access the most-used instrument functions or to monitor an instrument (monitor mode) while it is being controlled from remote. We'll use the Switchbox menu to show you how to use the instrument menus. Menus are available for many but not all instruments. See "Instrument Menus", later in this chapter, for more information on a particular instrument's menu. The Switchbox menu allows you to:

- Open and Close Channels
- Scan Channels
- Display Module Type and Description
- Monitor a Switchbox
- Reset a selected switch module

Selecting the Switchbox

To select the Switchbox, press the function key (f1 - f5) corresponds to the label **SWITCH** in the "Select an instrument" menu. (If the "Select an instrument" menu is not being displayed press **UTILS** then **SEL_INST.**)

Note

After you press the function key for **SWITCH**, the screen may show: "*Select SWITCH at logical address: _*" while the screen labels show two or more logical addresses. This means more than one Switchbox is installed in the mainframe. To select one of the Switchboxes, press the function key for the logical address key label.

The charts on the following pages show how to use the Switchbox menu. Keep the following points in mind when using the menu:

- The card number identifies a module within the Switchbox. The module with the lowest logical address is always card number 01. The module with the next successive logical address is card number 02 and so on.
- The @ character is required preceding a channel list when executing a Switchbox command from the terminal interface or remote. When entering a channel list in response to a menu prompt however, do not precede it with the @ character. Doing so causes a syntax error.

How to Open/Close Channels

Switchbox instrument at logical address 32
(secondary address = 04)

```
SWITCH_32:  
-  
1 MONITOR 2 OPEN 3 CLOSE 4 SCAN
```

```
SWITCH_32:  
Enter channel list  
1 2 3 4
```

SCPI command used:
OPEN <channel_list>

Enter Channel List and press Return
(e.g., 102 for channel 2 on card #1)

```
SWITCH_32:  
Enter channel list  
1 2 3 4
```

SCPI command used:
CLOSE <channel_list>

How to Scan Channels

```
SWITCH_32:  
-  
1 MONITOR 2 OPEN 3 CLOSE 4 SCAN
```

```
SWITCH_32:  
-  
1 SET UP 2 STEP 3 4
```

Press **f2** to advance to the next channel in
the Scan List (i.e. to trigger the instrument.)

```
SWITCH_32:  
Enter channel list  
1 2 3 4
```

Enter Channel List and press Return
(e.g., 100:115 to scan channels 00 to 15 on card #1)

How to Display Module Type , Description, or Reset Module

```
SWITCH_32:
-
1 MONITOR 2 OPEN 3 CLOSE 4 SCAN 23 1 5 CARD 6
```

```
SWITCH_32:
-
1 TYPE? 2 DESCR? 3 RESET 4
```

```
SWITCH_32:
Enter card number
1 2 3 4
```

Enter Card Number and press Return

```
SWITCH_32:
HEWLETT-PACKARD,E1345A,0,A.03.00
1 TYPE? 2 DESCR? 3 RESET 4
```

SCPI command used:
SYST:CTYP? <card_number>

```
SWITCH_32:
Enter card number
1 2 3 4
```

Enter Card Number and press Return

SCPI command used:
SYST:CPON <card_number>

```
SWITCH_32:
Enter card number
1 2 3 4
```

Enter Card Number and press Return

```
SWITCH_32:
"16 Channel Relay Mux"
1 TYPE? 2 DESCR? 3 RESET 4
```

SCPI command used:
SYST:CDES? <card_number>

How to Select Monitor Mode

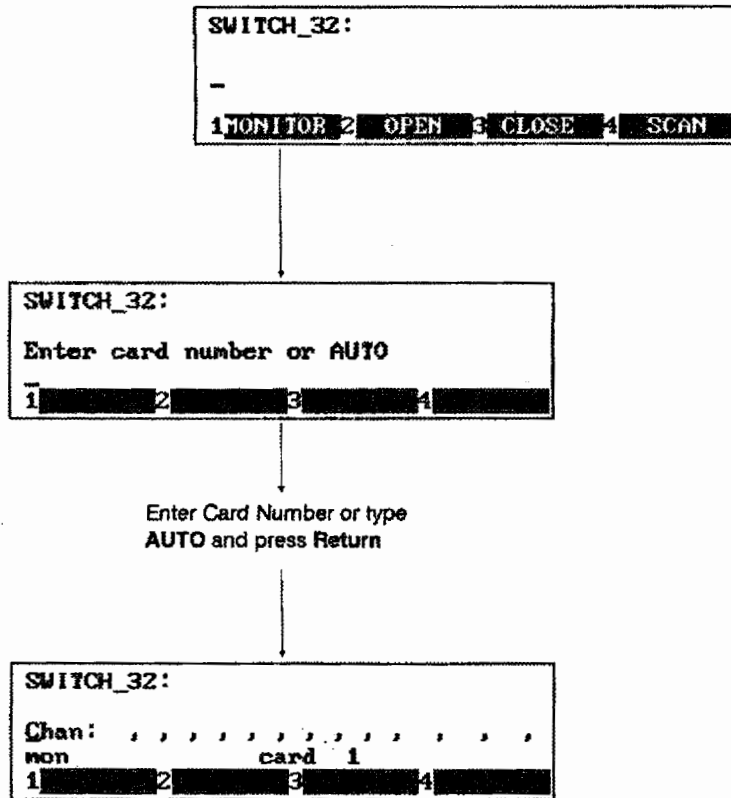

SCPI commands used:
DISP:MON:CARD <card_number>
DISP:MON:STAT ON

Monitor Mode

Monitor mode displays the status of an instrument while it is being controlled from remote. Monitor mode is useful for debugging programs. You can place an instrument in monitor mode using terminal interface menus, or by executing the DISP:MON:STAT ON command from the terminal interface. Pressing most terminal interface keys will automatically exit monitor mode and return to the instrument menu. However, you can use the left and right arrow keys in monitor mode to view long displays.

Note

Enabling monitor mode slows instrument operations. If the timing or speed of instrument operations is critical (such as making multimeter readings at a precise time interval), you should not use monitor mode.

Table 3-1 shows the status annunciators that may appear in the bottom line of the screen in monitor mode. Some instruments also have device-specific annunciators (see the plug-in module manual for more information).

Table 3-1. Monitor Mode Display Annunciators

Annunciator	Description
mon	The instrument is in monitor mode
bsy	The instrument is executing a command
err	An error has occurred (see "Reading Error Messages" below)
srq	A service request has occurred

Reading Error Messages

Whenever the screen is showing the *err* annunciator, an error has occurred for the instrument being monitored. You can read the error message, although doing so cancels monitor mode. To read an error message, type the following SCPI command (followed by the **Return** key):

SYST:ERR?

The error message will be displayed in the bottom line of the Text Output Area. To see if another error was logged, repeat the above command by pressing **UTILS**, **RCL_PREV**, then **Return**.

After you have read all the error messages, executing the **SYST:ERR?** command causes the screen to show: *+0 No error*. After reading the error message(s), press **fi** to return to monitor mode.

Executing Commands

From the terminal interface, you can type and execute IEEE 488.2 Common Commands and SCPI Commands for the instrument presently selected by the *Select an instrument* menu. (However, you cannot execute a command when the screen is requesting that you input information.) This is particularly useful for accessing functions not available in an instrument's menu. For example, the System Instrument contains a Pacer that can be programmed to output a square wave signal on the mainframe's Pacer Out port. From the System Instrument menu, you can program the Pacer to output 10 square wave cycles with a period of 1 second each by typing the following commands and pressing **Return** after each command (see Chapter 3 for more information on the Pacer).

```
SOUR:PULS:COUN 10
SOUR:PULS:PER 1
TRIG:SOUR IMM
INIT:IMM
```

As another example, after selecting the Switchbox, suppose you must set up and execute a scan list with automatic advance (automatic advance is not available from the menu). You can do this by typing the following command string and pressing **Return** (notice that by linking the commands together with a semicolon and colon you need press **Return** only once).

```
TRIG:SOUR IMM::SCAN (@100:105)::INIT
```

Editing

The screen editing keys (shown on the following page) allow you to edit user-entered data or commands. When editing, the screen is in insert mode. That is, typed characters will be inserted into the string at the present cursor position.







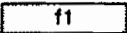
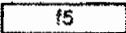
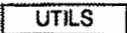
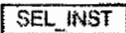

Note

The key labels shown are found on all HP terminals (except HP terminals supporting ANSI terminal protocol). See "Using Supported Terminals" for equivalent key functions on your terminal.

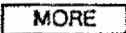
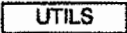
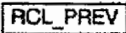

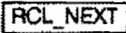
General Key Descriptions

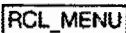
This section explains the function of each of the terminal interface's menu, menu control, and editing keys. If a key is not functional in a particular situation, pressing that key does nothing except to cause a beep.

Menu and Menu Control Keys

-  through  Label menu choices for corresponding function keys.
-  →  Returns to the *Select an instrument* menu.
-  Returns to the previous menu level within an instrument menu or escapes from an input prompt. When you reach the top of an instrument's menu, the **PRV_MENU** label disappears.
-  The screen can show a maximum of five menu choices at a time. When there are more than five menu choices, function key **f6** becomes labeled **MORE**. Press **MORE** to display the next group of choices. By repeatedly pressing **MORE** you can display all groups of choices. After you have displayed all groups of choices, pressing **MORE** again returns to the first group of choices.
-  →  Recalls the last command entered from the terminal interface. After recalling a command, it can be edited or re-executed. You can recall from a stack of previously executed commands by repeatedly pressing **RCL_PREV**. When you reach the bottom of the stack (the last line in the buffer), pressing **RCL_PREV** does nothing except to cause a beep.
-  →  Accesses commands in the opposite order to that of **RCL_PREV**. Pressing **RCL_NEXT** does nothing until you have pressed **RCL_PREV** at least twice.
-  →  Recalls the last SCPI command generated by a menu operation. For example, reading the time using the menus (**SYSTEM**, **TIME**, **READ**) generates and executes the SCPI command **SYST:TIME?**. A recalled command can be executed by pressing the **Return** key. You can also edit a recalled command before you execute it.
-  Performs the same function as **PRV_MENU**.

Editing Keys

-  (Right arrow key.) Moves the cursor one character space to the right while leaving characters intact.
-  (Left arrow key.) Moves the cursor one character space to the left while leaving characters intact.
-  Erases the character at the present cursor position (for user-entered data only).



Erases the character to the left of the cursor (for user-entered data only).



(Clear-to-end key.) Erases all characters from the present cursor position to the end of the input line (for user-entered data only).

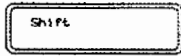

Selects the upper-case alphabetic characters or the character shown on the top half of a key.



Sets all alphabetic keys to uppercase (capitals); does not affect the other keys. To return to lowercase, press **Caps Lock** again.

Instrument Control Keys



Resets only the selected instrument (equivalent of executing *RST). **RST_INST** also clears the instrument's terminal interface and remote input and output buffers. **RST_INST** is the only terminal interface key that can affect an instrument being operated from remote.

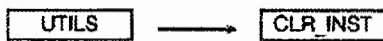

Clears the terminal interface input and output buffers (remote buffers are not cleared) of the selected instrument and returns to the top level of the instrument menu. Press **CLR_INST** whenever an instrument is busy, is not responding to terminal interface control, or to abort a command being entered from the terminal interface.

Other Keys

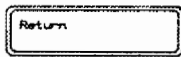

End of line. Enters your responses to menu prompts. Executes commands entered from the terminal keyboard (may be labeled Enter on your terminal emulator):



Selects alternate key definitions. These **CTRL** key sequences provide short-cuts to some of the menu sequences and also provide some functions not directly available from dedicated terminal keys. Some alternate key definitions are:

- CTRL R** = Instrument Reset
- CTRL C** = Clear Instrument
- CTRL D** = *Select an instrument* menu.

For a complete list of all **CTRL** Sequences, see Table 3-3 in this chapter. Users of the optional IBASIC interpreter should refer to their IBASIC manual set for additional editing functions.

Using Supported Terminals

The Display Terminal Interface supports several popular terminal brands and models. This chapter will show you how to access all of the terminal interface functions described previously using your supported terminal.

The Supported Terminals

The following list names the supported terminals and shows where to go for more information. If your terminal isn't named in this list, see "Using Other Terminals" in the next section.

- HP 700/92 Menu tutorial
- HP 700/94 Menu tutorial
- HP 700/22 See page 3-17
- HP 700/43 and WYSE WY-30™ See page 3-19

The keyboard guides provided for the listed terminals may be removed or copied, and placed near your keyboard while you go through the menu tutorial sections.

Using the HP 700/22

The HP 700/22 terminal emulates the DEC® VT100® or VT220® terminals. Some functions of the Display Terminal Interface have been mapped into keys with other labels. A keyboard map is provided for each of the emulation models. Use these keyboard maps to help locate the terminal interface functions.

VT100® Key Map

The symbols shown in the upper left corner of key each are now mapped with the function labeled in the center of each key.

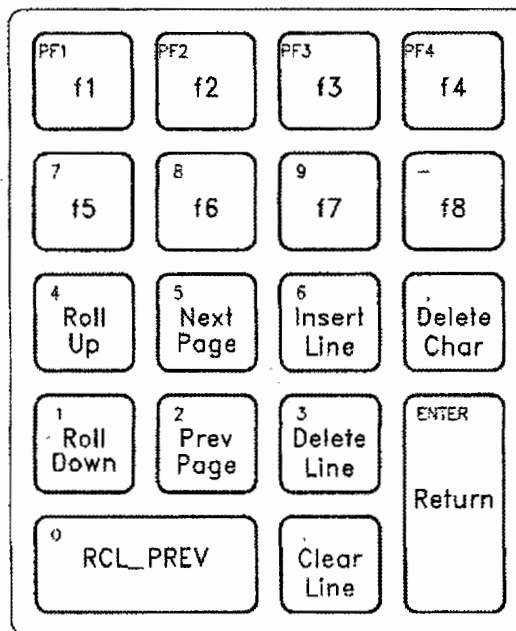

E1405-DL VT100

Selecting VT100® Mode

To use the HP 700/22 in VT100® mode, press the Set-Up key and set the following configuration:

Fields	Value
Terminal Mode	EM100, 7 bit Ctrls
Columns	80
EM100 ID	EM100
Inhibit Auto Wrap	YES

VT220® Key Map The function keys that are normally labeled **f6** through **f14** are now labeled:

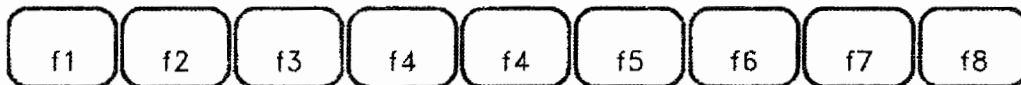

Note

Because the HP 700/22 keyboard has nine function keys in the center of the keyboard, f4 is mapped twice

The symbols shown in the upper left corner of key each are now mapped with the function labeled in the center of each key.

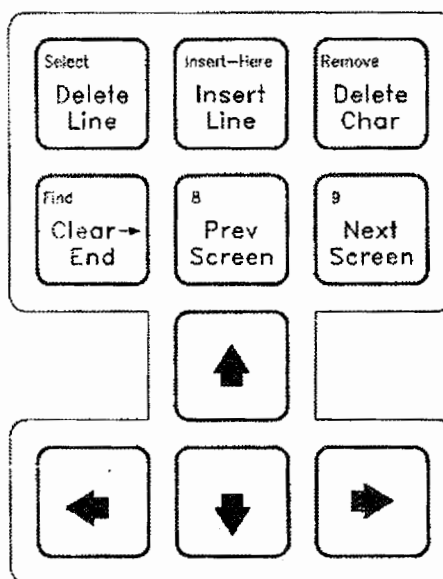

E1405-DL VT220

Selecting VT220® Mode

To use the HP 700/22 in VT220® mode, press the **Set-Up** key and set the following configuration:

Fields	Value
Terminal Mode	EM200, 7 bit Ctrls
Columns	80
EM100 ID	EM220
Inhibit Auto Wrap	YES

Using the WYSE[®] WY-30[™]

With the WYSE[®] WY-30[™] terminal, some functions of the Display Terminal Interface have been assigned to keys with other labels. Use this keyboard map to help locate these functions.

The symbols shown in the upper left corner of key each are now mapped with the function labeled in the center of each key.

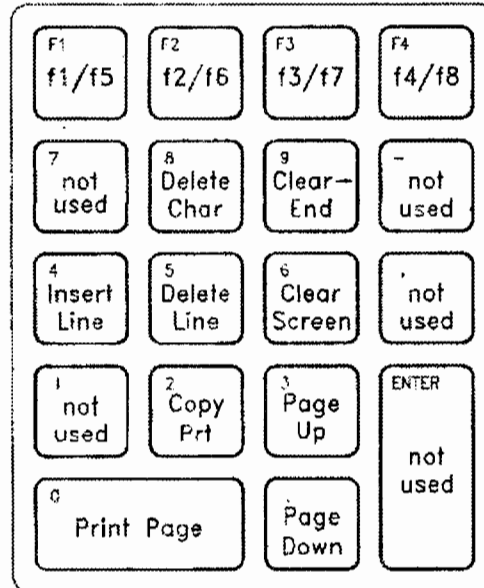

E1405-DL WY30

Where two function key labels are shown, the one following the "/" character is accessed by pressing and holding the CTRL key while pressing the desired function key (e.g. to access the f6 function, press CTRL-f2/f6).

Using Other Terminals

This section discusses using terminals which are not on the Supported Terminals list. Primarily this section is to help you use terminals which do not provide programmable soft keys (function keys). Without this capability, a terminal can not access the Display Terminal Interface's menus. Instead, the terminal interface provides a set of Terminal Interface Commands which allow you to select instruments by name or logical address. Once selected, you can type Common Commands or SCPI commands to the instrument. In addition, keyboard accessible control codes provide display control for terminals which may not have keys dedicated to those functions.

What "Not Supported" Means

Strictly speaking, a terminal is not supported if it has not been rigorously tested with the Display Terminal Interface. There are several HP terminals which may be compatible with the terminal interface. Terminals such as the DEC® VT100®, DEC® VT220®, and WYSE® WY-50™, or emulations of these may also work properly with the terminal interface. If you have one of these terminals, try it. Here is a list of terminals you should try.

HP 2392A
HP 2394A
DEC® VT100®
DEC® VT220®
WYSE® WY-50™
HP AdvanceLink terminal emulation software (configure as HP 2392A)

Testing Terminals for Compatibility

Here is how you test an unsupported terminal for compatibility with the Display Terminal Interface:

1. Connect your terminal and configure its communication parameters to match the mainframe's serial interface (see Appendix C)
2. With your terminal turned on and set to "remote mode", turn on the mainframe. After the mainframe power-on self-test, the display interface sends sequences of characters to your terminal which should cause it to return its identification. If the terminal ID matches one in a list kept by the terminal interface, it will send character sequences to program the function keys and their labels.
3. If you now see the "Select an instrument" prompt *and* the "Select an instrument" menu labels, your terminal is ready to try. Go to the beginning of this chapter and try the menus.
4. If you see only the "Select an instrument" prompt without the "Select an instrument" menu labels, your terminal did not return a recognized ID. To set the terminal type manually, type the Terminal Interface Command:

ST HP (followed by **Return** for HP terminals)
or
ST VT100 (followed by **Return** for VT100® emulators)
or
ST VT220 (followed by **Return** for VT220® emulators)
or
ST WYSE30 (followed by **Return** for WY-30® emulators)
or
ST WYSE50 (followed by **Return** for WY-50™ emulators)

NOTE

You can type "ST" without arguments at the "Select an Instrument" menu. The display terminal will attempt to identify the terminal that is connected. This is particularly useful if you are hooking a terminal to a system which already has power, since you do not need to cycle power and wait for the system to reboot.

If you now see the "Select an instrument" menu labels:

Go to the beginning of this chapter and try the menus.

or

Turn the mainframe off and then on again.

Using a Terminal Without Menus

You can still control instruments installed in your mainframe without using the terminal interface menus. In this case you will send Common Commands and SCPI commands to your instruments by typing them on your terminal keyboard, or through a computer interface.

Selecting Instruments

To send commands to, and receive responses from an instrument, you must first select that instrument. Two commands are provided to select instruments. They are; SI (Select Instrument), and SA (Select Address). These commands only work from the "Select an instrument" prompt. The commands can be typed in upper case or lower case.

SI SI selects an instrument by its name, exactly as it would appear in the "Select an instrument" menu (see Table 3-2). If your mainframe has more than one instrument with the same name, follow the name with a comma (,) and the desired instrument's logical address. Here are some examples of SI commands:

`si voltmtr` (selects a voltmeter instrument)

`si switch` (selects a switchbox instrument)

`SI SWITCH` (same as above)

`si switch,16` (selects switchbox at logical address 16)

Table 3-2. Instrument Names for the SI Command

Menu Name	Instrument
SYSTEM	The System Instrument (built-in to the mainframe)
VOLTMTR	HP E1326A Standalone, or HP E1326A Scanning Voltmeter Modules
SWITCH	Switchbox composed of one or more HP Multiplexer Modules
DIG_I/O	HP E1330A Quad 8-Bit Digital Input/Output Module
IBASIC	Optional IBASIC interpreter
COUNTER	HP E1332A 4-Channel Counter/Totalizer, or HP E1333A Universal Counter Modules
D/A	HP E1328A Digital to Analog Converter Module

SA SA selects an instrument by its logical address. For multiple module instruments, use the logical address of the first module in the instrument. For example; SA 8 selects the instrument at logical address 8. When you have selected an instrument, the terminal interface will respond with an instrument prompt which is the instrument's menu name followed by its logical address (e.g. VOLTMTR_8).

To get a list of the logical addresses used in your mainframe, send the SCPI command `VXI:CONF:DLAD?` to the System Instrument. Then to determine what instrument is at each logical address, send the command `VXI:CONF:DLIS? n` for each logical address in the list (where `n` is a logical address).

Returning to the "Select an Instrument" Prompt

To return to the "Select an instrument" prompt, press and hold the **CTRL** key then press **D**.

Control Sequences for Terminal Interface Functions

The terminal interface provides the keyboard control sequences listed in Table 3-3. These can be thought of as keyboard short-cuts for compatible terminals (those which provide menu capability). Only those functions in the table which are shaded, operate for "UNKNOWN" terminal types (those which do not support menus). An "UNKNOWN" terminal type has very limited editing capability. It will not support the EDIT mode for the optional IBASIC interpreter. In the following table, † = IBASIC only, ‡ = Front Panel only.

Table 3-3. Control Sequence Functions

Del char	Delete character at the cursor position	CTRL-X
Clr →end	Clears line from cursor position to end of line	CTRL-L
Clear line	Clears line regardless of cursor position	CTRL-U
Insert line †	Inserts a blank line at the cursor position	CTRL-O
Delete line † ‡	Deletes the line at the current cursor position	CTRL-DEL
End of line	Move cursor to the end of current line	CTRL-Z
Start of line	Move cursor to the beginning of current line	CTRL-A
Return	Terminates user entry	CTRL-M
RCL_MENU	Recalls the last command executed via the menu keys	CTRL-W
RCL_PREV	Recalls the last several commands executed via user input	CTRL-F
RCL_NEXT	After RCL_PREV, RCL_NEXT may be used to move forward through the recalled commands	CTRL-B
SEL_INST	Return to "Select an instrument" menu	CTRL-D
CLR_INST	Clear instrument's input and output buffers	CTRL-C
RST_INST	Like CLR_INST plus clears	CTRL-R

In Case of Difficulty

Problem:	Problem Cause/Solution:
<p>Error -113 undefined header error occurs after entering data in response to a menu prompt.</p>	<p>For some commands used by the menus, the data entered is appended to a command header. For example, if you enter "1" as the port number for a digital I/O module, the command used is DIG:HAND1:MODE NONE where HAND1 indicates the port number. If your entry was invalid or incorrect, error -113 occurs.</p>
<p>Following the power-on sequence or system reset the display shows:</p> <p>Configuration errors. Select SYSTEM Press any key to continue_</p>	<p>An unassigned device (incorrect logical address) was detected, or the contents of non-volatile memory may have been lost. If you cycle power or perform system reset, the display will show the logical address of the unassigned device. You can also check the logical addresses using the CONFIG? -- LADDS branch of the System Instrument menu. Refer to Chapter 1 of this manual for a discussion of logical addresses and unassigned devices.</p>
<p>The display shows: "instrument in local lockout". Menus seem to work but nothing happens when I reach the bottom level or try to execute a command.</p>	<p>The terminal interface has been locked-out (HP-IB local lockout). You can re-enable menu operation by cancelling local lockout (from remote) or by cycling mainframe power.</p>
<p>Display cannot be removed from monitor mode.</p>	<p>Monitor mode was entered from remote (DISP:MON:STAT ON command) and the terminal interface has also been locked out (HP-IB local lockout). Either cancel the local lockout or execute DISP:MON:STAT OFF (from remote).</p>
<p>Display shows:</p> <p>Can not connect to instrument Press any key to continue_</p>	<p>A hardware or software problem has occurred in the instrument preventing it from responding to terminal interface control.</p>
<p>After selecting an instrument the display shows:</p> <p>"busy".</p>	<p>The instrument is busy performing an operation. Press Clear Instr to abort the instrument operations and allow the terminal interface to access the instrument.</p>
<p>Display shows:</p> <p>Instrument in use by another display. Press any key to continue_</p>	<p>The instrument has already been selected from the Front Panel. An instrument can only be "attached" to one display at a time. At the Front Panel, press Select Instr. The instrument can now be selected from the terminal interface.</p>

Notes

Instrument Menus

This section contains charts showing the structure and content for all terminal interface instrument menus. Also shown in the charts are the SCPI or Common Commands used and descriptions of menu-controlled instrument operations.

This section contains the following charts:

- System Instrument Menu 3-26
- Switchbox Menu 3-28
- Scanning Voltmeter Menu 3-30
- HP E1326A 5 1/2 Digit Multimeter Menu 3-32
- HP E1328A 4-Channel D/A Converter Menu 3-33
- HP E1330A Quad 8-Bit Digital I/O Menu 3-34
- HP E1332A 4-Channel Counter/Totalizer Menu 3-36
- HP E1333A 3-Channel Universal Counter Menu 3-38

System Instrument Menu

Menu Levels and Content

Level 1	Level 2	Level 3	Level 4	Level 5	Level 6	User Entry	Command(s) Used	Description
SYSTEM	CONFIG?	LADDS					VXI:CONF:DLAD?	Displays logical addresses of mainframe instruments
		DEVICE				logical address	VXI:CONF:DLIS? <log_addr>	Displays information about the device at the specified logical address. (Refer to the Command Reference for details)
	HP-IB	READ				HP-IB address	SYST:COMM:CFIB:ADDR?	Displays HP-IB address
		SET				card number	SYST:COMM:CFIB:ADDR <address>	
	RS232	BAUD				card number	SYST:COMM:SER[n]:BAUD?	Read current baud rate
		READ				card number	SYST:COMM:SER[n]:BAUD 300	Sets the serial interface baud rate to 300
		SET				card number	SYST:COMM:SER[n]:BAUD 1200	Sets the serial interface baud rate to 1200
						card number	SYST:COMM:SER[n]:BAUD 2400	Sets the serial interface baud rate to 2400
						card number	SYST:COMM:SER[n]:BAUD 9600	Sets the serial interface baud rate to 9600
						card number	SYST:COMM:SER[n]:BAUD 19200	Sets the serial interface baud rate to 19200
						card number	SYST:COMM:SER[n]:PAR?	Read current parity type
		PARITY				card number	SYST:COMM:SER[n]:PAR EVEN	Sets the serial interface parity to even
		READ				card number	SYST:COMM:SER[n]:PAR ODD	Sets the serial interface parity to odd
		SET				card number	SYST:COMM:SER[n]:PAR ONE	Sets the serial interface parity to one
						card number	SYST:COMM:SER[n]:PAR ZERO	Sets the serial interface parity to zero
						card number	SYST:COMM:SER[n]:PAR NONE	Sets the serial interface parity to none
						card number	SYST:COMM:SER[n]:BITS?	Read current data bit width
		BITS				card number	SYST:COMM:SER[n]:BITS 7	Sets the data width to 7 bits
		READ				card number	SYST:COMM:SER[n]:BITS 8	Sets the data width to 8 bits
		SET				card number	SYST:COMM:SER[n]:PACE?	Read current pacing type
						card number	SYST:COMM:SER[n]:PACE XON	Enables XON/XOFF software handshaking
		PACE				card number	SYST:COMM:SER[n]:PACE NONE	Disables XON/XOFF software handshaking
		READ				card number		
		SET				card number		

(continued on following page)

System Instrument Menu

Menu Levels and Content

Level 1	Level 2	Level 3	Level 4	Level 5	Level 6	User Entry	Command(s) Used	Description
	(continued from previous page)							
		CONTROL	DIR	READ		card number	SYSTEM:COMM:SERQ[n]:CONV:DTR?	Read current setting for DTR line
				SET	ON	card number	SYSTEM:COMM:SERQ[n]:CONV:DTR ON	Set DTR line to static +V
					OFF	card number	SYSTEM:COMM:SERQ[n]:CONV:DTR OFF	Set DTR line to static -V
					IBFULL	card number	SYSTEM:COMM:SERQ[n]:CONV:DTR IBF	Set DTR for hardware handshaking
					STANDARD	card number	SYSTEM:COMM:SERQ[n]:CONV:DTR STAN	DTR operates to RS-232 standard
			KIS	READ		card number	SYSTEM:COMM:SERQ[n]:CONV:KIS?	Read current setting for KIS line
				SET	ON	card number	SYSTEM:COMM:SERQ[n]:CONV:KIS ON	Set KIS line to static +V
					OFF	card number	SYSTEM:COMM:SERQ[n]:CONV:KIS OFF	Set KIS line to static -V
					IBFULL	card number	SYSTEM:COMM:SERQ[n]:CONV:KIS IBF	Set KIS for hardware handshaking
					STANDARD	card number	SYSTEM:COMM:SERQ[n]:CONV:KIS STAN	KIS operates to RS-232 standard
						card number	DIAG:COMM:SERQ[n]:STORE	Store current serial communications settings into non-volatile storage.
						laddr, reg_num	VXI:READ? <laddr>, <reg>	Read register in A16 address space.
						laddr, reg_num, data	VXI:WRIT <laddr>, <reg>, <data>	Write data to register in A16 address space.
						time	SYSTEM:TIME?	Read the current system clock
						time	SYSTEM:TIME <time>	Set the system clock
						date	SYSTEM:DATE?	Read the current system calendar
						date	SYSTEM:DATE <date>	Set the system calendar
							DIAG:BOOT	Resets mainframe using the configuration stored in non-volatile memory

Switchbox Menu

Menu Levels and Content

Level 1	Level 2	Level 3	User Entry	Command(s) Used	Description
SWITCH	MONITOR		card number † or AUDIO	DISP:MON:CARD <card_number> ;STAT ON	Monitor instrument operations
	OPEN		channel list †	OPEN (@channel_list)	Open channel(s)
	CLOSE		channel list †	CLOS (@channel_list)	Close channel(s)
	SCAN	SET_UP	channel list †	TRIG:SOUR:HOLD;SCAN <channel_list>;:INIT	Set up channels to scan
		STEP	channel list †	TRIG	Step to next channel in scan list
	CARD	TYPE?	card number †	SYST:CTYP? <card_number>	Display module ID information
		DESCR?	card number †	SYST:CDIS? <card_number>	Display module description
		RESET	card number †	SYST:CFON <card_number>	Return module to power-on state
	TEST			*:IST?	Runs self-test, displays results (+0 =pass; any other number =fail)

† Channel lists are of the form "ccnn" (single channel), "ccnn:ccnn" (two or more channels) or "ccnn:ccnn" (range of channels); where "cc" is the card number and "nn" is the channel number. For example, to access channel 2 on card number 1 specify 102.

‡ The card number identifies a module within the Switchbox. The switch module with the lowest logical address is always card number 01. The switch module with the next successive logical address is card number 02 and so on.

Notes

Scanning Voltmeter Menu

Menu Levels and Content

Level 1	Level 2	Level 3	Level 4	User Entry	Command(s) Used	Description
VOITMTR	MONITOR			channel list † or 0 for auto	DISP:MON:CHAN <channel_list>;STAT ON	Monitor instrument operations
	VDC			channel list †	MEAS:VOLT:DC? <channel_list>	Measure DC voltage on each channel
	VAC			channel list †	MEAS:VOLT:AC? <channel_list>	Measure AC voltage on each channel
	OHM			channel list †	MEAS:RES? <channel_list>	Measure 2-wire resistance on each channel
	TEMP	TCOUPLE	B	channel list †	MEAS:TEMP? TC,B, <channel_list>	Measure °C of B thermocouple on each channel
			E	channel list †	MEAS:TEMP? TC,E, <channel_list>	Measure °C of E thermocouple on each channel
			J	channel list †	MEAS:TEMP? TC,J, <channel_list>	Measure °C of J thermocouple on each channel
			K	channel list †	MEAS:TEMP? TC,K, <channel_list>	Measure °C of K thermocouple on each channel
			N14	channel list †	MEAS:TEMP? TC,N14, <channel_list>	Measure °C of N14 thermocouple on each channel
			N28	channel list †	MEAS:TEMP? TC,N28, <channel_list>	Measure °C of N28 thermocouple on each channel
			R	channel list †	MEAS:TEMP? TC,R, <channel_list>	Measure °C of R thermocouple on each channel
			S	channel list †	MEAS:TEMP? TC,S, <channel_list>	Measure °C of S thermocouple on each channel
			T	channel list †	MEAS:TEMP? TC,T, <channel_list>	Measure °C of T thermocouple on each channel
			THERMIS	channel list †	MEAS:TEMP? THER,2252, <channel_list>	Measure °C of 2252 Ω thermistor on each channel
			5K	channel list †	MEAS:TEMP? THER,5000, <channel_list>	Measure °C of 5k Ω thermistor on each channel
			10K	channel list †	MEAS:TEMP? THER,10000, <channel_list>	Measure °C of 10k Ω thermistor on each channel
			R1D	channel list †	MEAS:TEMP? R1D,85, <channel_list>	Measure °C of 385 R1D on each channel (4-wire)
			392	channel list †	MEAS:TEMP? R1D,92, <channel_list>	Measure °C of 392 R1D on each channel (4-wire)
	STRAIN	QUARTER		channel list †	MEAS:STR:QUAR? <channel_list>	Measure strain with quarter bridge
		HALF	BENDING	channel list †	MEAS:STR:HBEN? <channel_list>	Measure strain with bending half bridge
			POISSON	channel list †	MEAS:STR:HPO? <channel_list>	Measure strain with Poisson half bridge
		FULL	BENDING	channel list †	MEAS:STR:FBEN? <channel_list>	Measure strain with bending full bridge
			BENPOIS	channel list †	MEAS:STR:FBP? <channel_list>	Measure strain with Bending Poisson full bridge
			POISSON	channel list †	MEAS:STR:FPO? <channel_list>	Measure strain with Poisson full bridge

(continued on following page)

Scanning Voltmeter Menu

Menu Levels and Content

Level 1	Level 2	Level 3	Level 4	User Entry	Command(s) Used	Description
(continued from previous page)						
		UNSTRN		channel list †	MEAS:STR:UNST? <channel_list >	Measure bridge unstrained
		DIAG	COMPRES	channel list †	MEAS:STR:QCOM? <channel_list >	Compression shunt diagnostic
			TENSION	channel list †	MEAS:STR:QIEN? <channel_list >	Tension shunt diagnostic
		CARD	TYPE?	card number ‡	SYST:CTYP? <card_number >	Displays module ID information
			DESCR?	card number ‡	SYST:ODES? <card_number >	Displays module description
			TEST		*TST?	Runs self-test, displays results (+0 =pass; any other number =fail)

† Channel lists are of the form "ccnn" (single channel), "ccnn,ccnn" (two or more channels) or "ccnn:ccnn" (range of channels); where "cc" is the card number and "nn" is the channel number. For example, to access channel 2 on card number 1 specify 102.

‡ The card number identifies a module within the Switchbox. The switch module with the lowest logical address is always card number 01. The switch module with the next successive logical address is card number 02 and so on.

HP E1326B/E1411B 5 1/2 Digit Multimeter (Standalone) Menu

Menu Levels and Content

Level 1	Level 2	Level 3	Level 4	User Entry	Command(s) Used	Description	
VOLT/MR	MONITOR	-	VDC		DISP: MON: STAT ON	Display instrument operations	
			VAC		MEAS: VOLT: DC?	Measure DC volts	
			OHM		MEAS: VOLT: AC?	Measure AC volts	
			TEMP		MEAS: PRIS?	Measure 4-wire ohms	
				THERMIS	2252	MEAS: TEMP? FTH, 2252	Measure °C of 2252Ω thermistor (4-wire measurement)
					5K	MEAS: TEMP? FTH, 5000	Measure °C of 5kΩ thermistor (4-wire measurement)
					10K	MEAS: TEMP? FTH, 10000	Measure °C of 10kΩ thermistor (4-wire measurement)
					385	MEAS: TEMP FRID, 85?	Measure °C of 100Ω RTD with alpha = 385 (4-wire measurement)
					392	MEAS: TEMP FRID, 92?	Measure °C of 100Ω RTD with alpha = 392 (4-wire measurement)
						*IST?	Run self-test, display results (0 = pass; any other number = fail)
						TEST	

† Channel lists are of the form "ccnn" (single channel), "ccnn,ccnn" (two or more channels) or "ccnn:ccnn" (range of channels); where "cc" is the card number and "nn" is the channel number. For example, to access channel 2 on card number 1 specify 102.

‡ The card number identifies a module within the Switchbox. The switch module with the lowest logical address is always card number 01. The switch module with the next successive logical address is card number 02 and so on.

HP E1328A 4-Channel D/A Converter Menu

Menu Levels and Content

Level 1	Level 2	Level 3	Level 4	User Entry	Command(s) Used	Description
D/A	MONITOR	CHAN1			DISP:MON:CHAN 1;STAT ON	Monitor instrument operations on channel 1
		CHAN2			DISP:MON:CHAN 2;STAT ON	Monitor instrument operations on channel 2
		CHAN3			DISP:MON:CHAN 3;STAT ON	Monitor instrument operations on channel 3
		CHAN4			DISP:MON:CHAN 4;STAT ON	Monitor instrument operations on channel 4
		AUTO			DISP:MON:CHAN AUTO;STAT ON	Monitor instrument operations on active channel
	OUTPUT	VOLTAGE	CHAN1	voltage †	VOLT1 <voltage >	Output voltage on channel 1
			CHAN2	voltage †	VOLT2 <voltage >	Output voltage on channel 2
			CHAN3	voltage †	VOLT3 <voltage >	Output voltage on channel 3
			CHAN4	voltage †	VOLT4 <voltage >	Output voltage on channel 4
	CURRENT	CHAN1		current ‡	CURR1 <current >	Output current on channel 1
			CHAN2		current ‡	CURR2 <current >
			CHAN3	current ‡	CURR3 <current >	Output current on channel 3
			CHAN4	current ‡	CURR4 <current >	Output current on channel 4
					*TEST?	Run self-test, display results (+0 = pass; any other number = fail)

†Enter voltage values in volts. Typical examples are: +3.5, -2, +500E-3.

‡Enter current values in amps. Typical examples are: .05, +200E-3.

HP E1330A Quad 8-Bit Digital Input/Output Menu

Menu Levels and Content

Level 1	Level 2	Level 3	Level 4	User Entry	Command(s) Used	Description
DIG_I/O	MONITOR	PORT0	PORT0		DISP: MON: CHAN 0: STAT ON	Monitor instrument operations on port 0
			PORT1		DISP: MON: CHAN 1: STAT ON	Monitor instrument operations on port 1
			PORT2		DISP: MON: CHAN 2: STAT ON	Monitor instrument operations on port 2
			PORT3		DISP: MON: CHAN 3: STAT ON	Monitor instrument operations on port 3
			AUTO		DISP: MON: CHAN AUTO: STAT ON	Monitor instrument operations on any active port
	READ	R_BYTE	PORT0		DIG: HAND0: MODE NONE; MEAS: DIG: DATA0?	Reads port 0 after handshake
			PORT1		DIG: HAND1: MODE NONE; MEAS: DIG: DATA1?	Reads port 1 after handshake
			PORT2		DIG: HAND2: MODE NONE; MEAS: DIG: DATA2?	Reads port 2 after handshake
			PORT3		DIG: HAND3: MODE NONE; MEAS: DIG: DATA3?	Reads port 3 after handshake
			PORT0	bit (0-7)	DIG: HAND0: MODE NONE; MEAS: DIG: DATA0: BITm?	Reads bit m on port 0 after handshake
			PORT1	bit (0-7)	DIG: HAND1: MODE NONE; MEAS: DIG: DATA1: BITm?	Reads bit m on port 1 after handshake
	WRITE	W_BYTE	PORT0		DIG: HAND2: MODE NONE; MEAS: DIG: DATA2: BITm?	Reads bit m on port 2 after handshake
			PORT1		DIG: HAND3: MODE NONE; MEAS: DIG: DATA3: BITm?	Reads bit m on port 3 after handshake
			PORT0	data (0-255)	DIG: HAND0: MODE NONE; MEAS: DIG: DATA0 <data >	Writes data to port 0
			PORT1	data (0-255)	DIG: HAND1: MODE NONE; MEAS: DIG: DATA1 <data >	Writes data to port 1
PORT2			data (0-255)	DIG: HAND2: MODE NONE; MEAS: DIG: DATA2 <data >	Writes data to port 2	
PORT3			data (0-255)	DIG: HAND3: MODE NONE; MEAS: DIG: DATA3 <data >	Writes data to port 3	
	W_BIT	PORT0	bit (0-7), value (0,1)	DIG: HAND0: MODE NONE; MEAS: DIG: DATA0: BITm <value >	Writes data to bit m on port 0	
		PORT1	bit (0-7), value (0,1)	DIG: HAND1: MODE NONE; MEAS: DIG: DATA1: BITm <value >	Writes data to bit m on port 1	
		PORT2	bit (0-7), value (0,1)	DIG: HAND2: MODE NONE; MEAS: DIG: DATA2: BITm <value >	Writes data to bit m on port 2	
			PORT3	bit (0-7), value (0,1)	DIG: HAND3: MODE NONE; MEAS: DIG: DATA3: BITm <value >	Writes data to bit m on port 3

Notes

HP E1332A 4-Channel Counter/Totalizer Menu

Menu Levels and Content

Level 1	Level 2	Level 3	Level 4	Level 5	User Entry	Command(s) Used	Description
COUNTER	MONITOR	CHAN1				DISP:MON:CHAN 1;STAT ON	Monitor instrument operations on channel 1
		CHAN2				DISP:MON:CHAN 2;STAT ON	Monitor instrument operations on channel 2
	INPUT	CHAN3				DISP:MON:CHAN 3;STAT ON	Monitor instrument operations on channel 3
		CHAN4				DISP:MON:CHAN 4;STAT ON	Monitor instrument operations on channel 4
		AUTO				DISP:MON:CHAN AUTO;STAT ON	Monitor instrument operations on active channel
		LEVEL	CHAN1 & 2		voltage †	SENS1:EVEN:LEV <value >	Set level trigger voltage for channels 1 & 2
			CHAN3 & 4		voltage †	SENS3:EVEN:LEV <value >	Set level trigger voltage for channels 3 & 4
		SLOPE	CHAN1	POS		SENS1:EVEN:SLOP POS	Positive level trigger slope for channel 1
				NEG		SENS1:EVEN:SLOP NEG	Negative level trigger slope for channel 1
			CHAN2	POS		SENS2:EVEN:SLOP POS	Positive level trigger slope for channel 2
				NEG		SENS2:EVEN:SLOP NEG	Negative level trigger slope for channel 2
			CHAN3	POS		SENS3:EVEN:SLOP POS	Positive level trigger slope for channel 3
				NEG		SENS3:EVEN:SLOP NEG	Negative level trigger slope for channel 3
			CHAN4	POS		SENS4:EVEN:SLOP POS	Positive level trigger slope for channel 4
				NEG		SENS4:EVEN:SLOP NEG	Negative level trigger slope for channel 4
		ISOLATE	ON			INP:ISOL ON	Input isolation on
			OFF			INP:ISOL OFF	Input isolation off
		FILTER	ON			INP:FILT ON	Input filter on
			OFF			INP:FILT OFF	Input filter off
			FREQ		frequency ‡	INP:FILT:FREQ <value >	Set input filter frequency
	FREQ		CHAN1			TRIG:SOUR IMM::MEAS1:FREQ?	Frequency measurement on channel 1
			CHAN3			TRIG:SOUR IMM::MEAS3:FREQ?	Frequency measurement on channel 3
	PERIOD		CHAN1			TRIG:SOUR IMM::MEAS1:PER?	Period measurement on channel 1
			CHAN3			TRIG:SOUR IMM::MEAS3:PER?	Period measurement on channel 3

(continued on following page)

HP E1332A 4-Channel Counter/Totalizer Menu

Menu Levels and Content

Level 1	Level 2	Level 3	Level 4	Level 5	User Entry	Command(s) Used	Description
(continued from previous page)	TIMEINT	CHAN1	START	READ		TRIG:SOUR IMM::MEAS1:INIT?	Time interval measurement on channel 1
						TRIG:SOUR IMM::MEAS3:INIT?	Time interval measurement on channel 3
	POS_PW	CHAN2	START	READ		TRIG:SOUR IMM::MEAS2:PWID?	Positive pulse width measurement on channel 2
						TRIG:SOUR IMM::MEAS4:PWID?	Positive pulse width measurement on channel 4
	NEG_PW	CHAN2	START	READ		TRIG:SOUR IMM::MEAS2:NWID?	Negative pulse width measurement on channel 2
						TRIG:SOUR IMM::MEAS4:NWID?	Negative pulse width measurement on channel 4
	UDCOUNT	CHAN1	START	READ		TRIG:SOUR IMM::CONF1:UDC:INIT?	Up/down count, subtract ch. 2 count from ch. 1 count
						FEIC1?	Get up/down count from channels 1 & 2
	TOTALIZ	CHAN3	START	READ		TRIG:SOUR IMM::CONF3:UDC:INIT?	Up/down count, subtract ch. 4 count from ch. 3 count
						FEIC3?	Get up/down count from channels 3 & 4
	TOTALIZ	CHAN1	START	READ		TRIG:SOUR IMM::CONF1:TOT:INIT?	Totalize on channel 1
						FEIC1?	Get totalize count on channel 1
	TOTALIZ	CHAN2	START	READ		TRIG:SOUR IMM::CONF2:TOT:INIT?	Totalize on channel 2
						FEIC2?	Get totalize count on channel 2
TOTALIZ	CHAN3	START	READ		TRIG:SOUR IMM::CONF3:TOT:INIT?	Totalize on channel 3	
					FEIC3?	Get totalize count on channel 3	
TOTALIZ	CHAN4	START	READ		TRIG:SOUR IMM::CONF4:TOT:INIT?	Totalize on channel 4	
					FEIC4?	Get totalize count on channel 4	
TTEST						*TST?	Run self-test, display results (+0=pass; any other number=fail)

†Enter voltage values in volts. Typical examples are: +3.5, -2, +500E3.

‡Enter frequency value in hertz. Typical examples are: 60, 120, 1E3.

HP E1333A 3-Channel Universal Counter Menu

Menu Levels and Content

Level 1	Level 2	Level 3	Level 4	Level 5	User Entry	Command(s) Used	Description	
COUNTER	MONITOR	CHAN1					DISP:MON:CHAN 1;STAT ON	Monitor instrument operations on channel 1
		CHAN2					DISP:MON:CHAN 2;STAT ON	Monitor instrument operations on channel 2
		CHAN3					DISP:MON:CHAN 3;STAT ON	Monitor instrument operation on channel 3
		AUTO					DISP:MON:CHAN AUTO;STAT ON	Monitor instrument operations on active channel
	INPUT	LEVEL	CHAN1			voltage †	SENS1:EVEN:LEV <value >	Set trigger level voltage for channel 1
			CHAN2			voltage †	SENS2:EVEN:LEV <value >	Set trigger level voltage for channel 2
		SLOPE	CHAN1	POS			SENS1:EVEN:SLOP POS	Positive trigger slope for channel 1
			CHAN1	NEG			SENS1:EVEN:SLOP NEG	Negative trigger slope for channel 1
			CHAN2	POS			SENS2:EVEN:SLOP POS	Positive trigger slope for channel 2
			CHAN2	NEG			SENS2:EVEN:SLOP NEG	Negative trigger slope for channel 2
	COUPLE	AC				INP:COUP AC	AC-coupled input (channels 1 & 2 only)	
		DC				INP:COUP DC	DC-coupled input (channels 1&2)	
	IMPED	50_OHM				INP:IMP 50	50Ω input resistance (channels 1 & 2 only)	
		1_MOHM				INP:IMP 1e6	1MΩ input resistance (channels 1 & 2 only)	
	ATTEN	0dB				INP:ATT 0	No input attenuation (channels 1 & 2 only)	
20dB					INP:ATT 20	20dB input attenuation (channels 1 & 2 only)		
FILTER	ON				INP:FLT ON	Input filter on (channels 1 & 2 only)		
	OFF				INP:FLT OFF	Input filter off (channels 1 & 2 only)		
FREQ	CHAN1	CHAN1				TRIG:SOUR IMM;MEAS1:FREQ?	Frequency measurement on channel 1	
		CHAN2				TRIG:SOUR IMM;MEAS2:FREQ?	Frequency measurement on channel 2	
		CHAN3				TRIG:SOUR IMM;MEAS3:FREQ?	Frequency measurement on channel 3	
PERIOD	CHAN1	CHAN1				TRIG:SOUR IMM;MEAS1:PER?	Period measurement on channel 1	
		CHAN2				TRIG:SOUR IMM;MEAS2:PER?	Period measurement on channel 2	

(continued on following page)

HP E1333A 3-Channel Universal Counter Menu

Menu Levels and Content

Level 1	Level 2	Level 3	Level 4	Level 5	User Entry	Command(s) Used	Description
(continued from previous page)							
	TIMEINT	CHAN1				TRIG:SOUR IMM::MEAS1:TINT?	Time interval measurement on channel 1
		CHAN2				TRIG:SOUR IMM::MEAS2:TINT?	Time interval measurement on channel 2
	POS_PW	CHAN1				TRIG:SOUR IMM::MEAS1:PWID?	Positive pulse width measurement on channel 1
		CHAN2				TRIG:SOUR IMM::MEAS2:PWID?	Positive pulse width measurement on channel 2
	NEG_PW	CHAN1				TRIG:SOUR IMM::MEAS1:NWID?	Negative pulse width measurement on channel 1
		CHAN2				TRIG:SOUR IMM::MEAS2:NWID?	Negative pulse width measurement on channel 2
	RATIO	CHAN1				TRIG:SOUR IMM::MEAS1:RAT?	Ratio of channel 1/channel 2
		CHAN2				TRIG:SOUR IMM::MEAS2:RAT?	Ratio of channel 2/channel 1
	TOTALIZ	CHAN1	START			TRIG:SOUR IMM::CONF1:TOT::INIT1	Totalize on channel 1
			READ			FEIC1?	Display totalize count
		CHAN2	START			TRIG:SOUR IMM::CONF2:TOT::INIT2	Totalize on channel 2
			READ			FEIC2?	Display totalize count
	TEST					*TST?	Run self-test, display results (+0 =pass; any other number=fail)

†Enter voltage values in volts. Typical examples are: +3.5, -2, +500E-3.

Notes

Using the Mainframe

Using this Chapter

This chapter shows how to use the mainframe's Pacer function, how to change the primary HP-IB address, and how to synchronize internal and external instruments using the mainframe's Event In and Trigger Out ports. This chapter also discusses how mainframe memory is used by installed instruments. Where possible, examples show only the command string sent to the instrument (no information about a computer language or interface is shown). Examples that require showing a computer language are written for HP 9000 Series 200/300 Computers using HP BASIC language and the HP-IB interface. This chapter contains the following sections:

- Using the Pacer 4-1
- Changing the Primary HP-IB Address 4-3
- Synchronizing Internal and External Instruments 4-3
- Mainframe Data Memory 4-6

Using the Pacer

The Pacer generates a square wave signal on the mainframe's rear panel Pacer Out connector. The signal levels are standard TTL levels (0V to 5V). The Pacer signal can be used to trigger or pace external equipment such as scanners or voltmeters. Figure 4-1 shows a single cycle of the Pacer output with a specified period of 1 second.

The following SCPI commands control the Pacer:

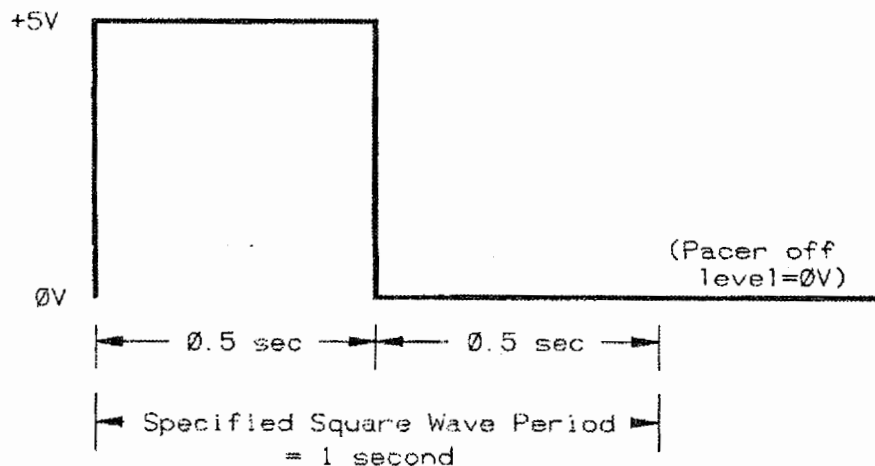

Figure 4-1. Pacer Out Square Wave

E1300A F. 3.1

- SOUR:PULS:COUN sets the number of Pacer cycles. Specify from 1 to 8388607 cycles or specify INF for a continuous output.
- SOUR:PULS:PER sets the period of each Pacer cycle. You can specify periods from 500ns to 8.3 seconds.
- TRIG:SOUR sets the trigger source. The Pacer signal is output whenever the trigger event occurs (specified by the TRIG:SOUR command) and the INIT:IMM command has been executed.

Example: Pacing an External Scanner This example paces an external scanner connected to the mainframe's Pacer Out port. Each negative-going transition of the square wave advances to the next channel in the scanner's channel list. In this example, the Pacer outputs 10 periods of 1 second each.

ABORT	<i>Set Pacer trigger system to Idle State</i>
SOUR:PULS:COUN 10	<i>Configure Pacer for 10 cycles</i>
SOUR:PULS:PER 1	<i>Square wave period = 1 second</i>
TRIG:SOUR IMM	<i>Trigger Pacer (when INIT is executed)</i>
INIT:IMM	<i>Place Pacer in Wait for Trigger State</i>

Example: Continuous Pacer Out Signal This example generates a continuous signal with a period of 250ms. The signal will begin when the trigger event (EXT) occurs (a negative-going transition on the mainframe's Event In connector).

ABORT	<i>Set Pacer trigger system to Idle State</i>
SOUR:PULS:COUN INF	<i>Configure Pacer for continuous output</i>
SOUR:PULS:PER 250E-3	<i>Square wave period = 250 milliseconds</i>
TRIG:SOUR EXT	<i>Trigger Pacer on external signal</i>
INIT:IMM	<i>Place Pacer in Wait for Trigger State</i>

Pacer Trigger States

Figure 4-2 shows that the Pacer's trigger system has an Idle State, a Wait for Trigger State, and a Pacer Action State. When you apply power, reset the system, or execute the ABORT command, the trigger system goes to the Idle State. You can configure the Pacer (SOURCE subsystem) and specify the trigger source (TRIG:SOUR command) while in the Idle State. Executing the INIT:IMM command places the Pacer in the Wait for Trigger State. Now when the trigger event occurs, the Pacer will move to the Pacer Action State and begin outputting the specified number of square wave cycles. Once the Pacer has begun outputting, the trigger system returns to the Idle State.

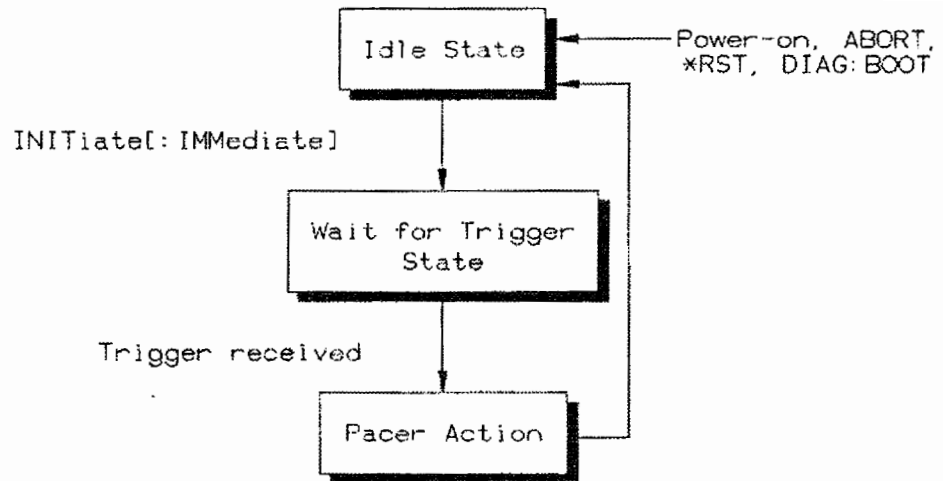

E1320A F.3.2

Figure 4-2. Pacer Trigger States

Changing the Primary HP-IB Address

You can set the mainframe's primary HP-IB address to any integer value between 0 and 30. The address is set to 9 at the factory. (See Chapter 2 for instructions on setting/reading the HP-IB address from the front panel.) The following command sets the mainframe's primary HP-IB address to 12.

```
SYST:COMM:GPIB:ADDR 12
```

Synchronizing Internal and External Instruments

The mainframe's Trig Out and Event In ports allow you to synchronize external equipment to instruments operating within the mainframe. The Trig Out port allows an instrument in the mainframe to output a negative-going pulse to indicate the occurrence of some event such as a multiplexer channel closure. The signal levels are standard TTL (0V to 5V). You direct the pulse from the appropriate instrument to the Trig Out port by sending the `OUTP:STAT ON` command to that instrument.

The Event In port allows an instrument in the mainframe to be armed or triggered from an external negative-going signal. The signal levels are standard TTL (0V to 5V). Send the `ARM:SOUR:EXT` command or the `TRIG:SOUR:EXT` command to an instrument to direct the signal on the Event In port to that instrument.

The following examples use an external HP 3457A Multimeter and an internal HP E1345A 16-Channel Multiplexer to demonstrate the use of the Trig Out and Event In ports.

Example: Synchronizing an Internal Instrument to an External Instrument

This example uses the mainframe's Trig Out and Event In ports to synchronize an external multimeter to a multiplexer installed in the mainframe. Connections are shown in Figure 4-3. The multimeter's Voltmeter Complete port outputs a pulse whenever the multimeter has finished a reading. The multimeter's External Trigger port allows the multimeter to be triggered by a negative going TTL pulse. Since the synchronization is independent of the HP-IB bus and the computer, readings must be stored in the multimeter's reading memory. The sequence of operation is:

1. INIT (line 50) closes channel number 100.
2. The channel closure causes a pulse on Trig Out which triggers the multimeter to take a reading.
3. When the reading is complete it is stored in multimeter memory and the multimeter outputs a pulse on its Voltmeter Complete port. This signals the multiplexer to advance to the next channel in the scan list.
4. Steps 2 and 3 are repeated until all channels have been scanned and readings taken.

10 OUTPUT 722;"TRIG EXT;DCV;MEM FIFO"

Set multimeter to external trigger, DC volts, enable reading memory

20 OUTPUT 70914;"OUTP ON"

Enable Trig Out port

30 OUTPUT 70914;"TRIG:SOUR EXT"

Set multiplexer to advance scan on external signal

40 OUTPUT 70914;"SCAN (@100:115)"

Specify scan list (channels 100 to 115)

50 OUTPUT 70914;"INIT"

Close first channel (starts scanning cycle)

60 END

Example: Synchronizing Internal/External Instruments and the Computer This example uses the mainframe's Trig Out port to synchronize an external

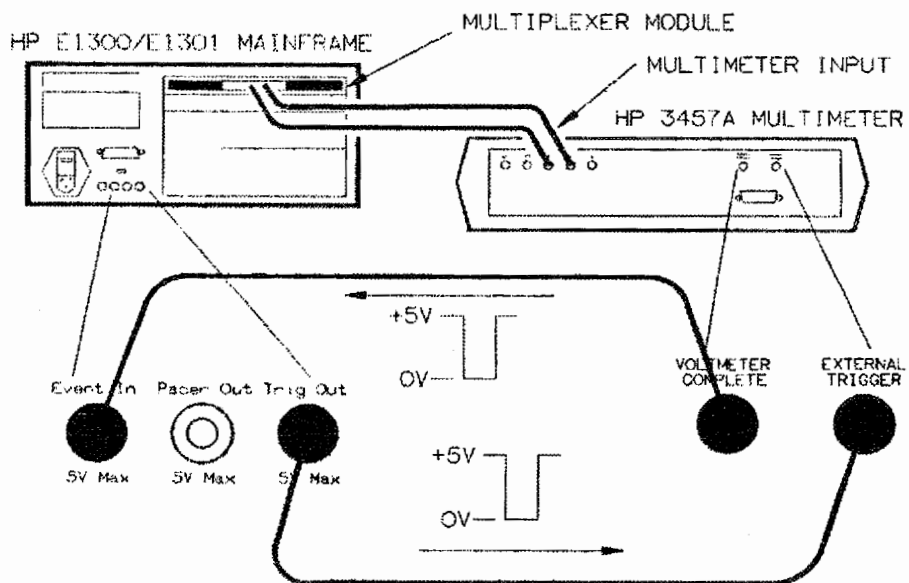

E1302A F. 3. 3

Figure 4-3. Synchronizing Internal/External Instruments

multimeter to an internal multiplexer. Connections are shown in Figure 4-4. This method synchronizes the computer to the instruments and relies on the computer to enter each reading and advance to the next channel in the scan list. The sequence of operation is:

1. INIT (line 50) closes channel number 100.
2. The channel closure causes a pulse on Trig Out which triggers the multimeter to take a reading.
3. When the reading is complete it is sent to the computer (lines 60 to 80).
4. The computer sends Group Execute Trigger to the multiplexer (line 90); this advances to the next channel in the scan list.
5. Steps 2 through 4 are repeated until all channels have been scanned and readings taken.

```

10 OUTPUT 722;"TRIG EXT;DCV"
    Set multimeter to external trigger, DC voltage measurements
20 OUTPUT 70914;"OUTP ON"      Enable Trig Out port
30 OUTPUT 70914;"TRIG:SOUR BUS"
    Set multiplexer to advance scan on Group Execute Trigger or
    *TRG
40 OUTPUT 70914;"SCAN (@100:115)" Specify scan list (channels 100
    to 115)
50 OUTPUT 70914;"INIT"        Close first channel (starts
    scanning cycle)
60 FOR I=1 TO 16              Loop through following lines
    16 times
70 ENTER 722;A                Enter reading (computer waits
    until reading taken & received)
80 PRINT A                    Print reading
90 TRIGGER 70914              Trigger multiplexer; advances
    to next channel
100 NEXT I
110 END

```

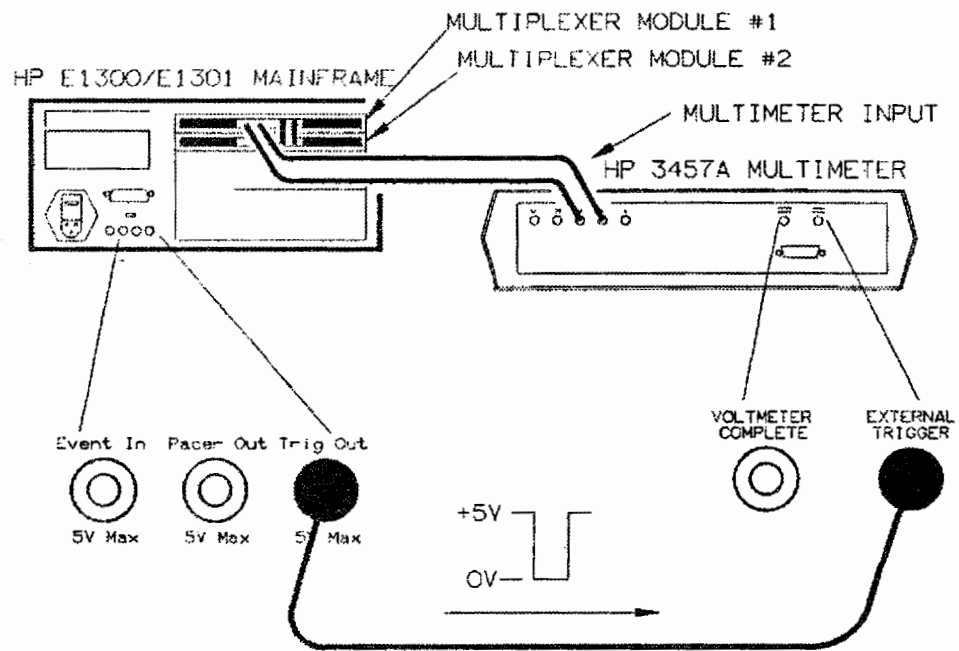



Figure 4-4. Synchronizing Internal/External Instruments and Computer 75K16 F. 3. 5

Mainframe Data Memory

When power is applied or the system rebooted (DIAG:BOOT command), mainframe memory is automatically configured to provide a predefined amount of memory for any installed instruments that require memory space. For example, each multimeter instrument within the mainframe is allocated enough memory to store 100 readings.

Mainframe memory is also automatically re-allocated upon demand while programming. For example, if greater than 100 readings are requested for a multimeter, the mainframe computes the amount of memory required for these extra readings. If enough memory space is available, an additional amount is allocated to the multimeter and the readings are stored. If enough memory is not available, an error message occurs and the command is aborted. The memory allocated to an instrument above the initial power-on amount remains dedicated to that instrument until that instrument is reset (*RST command) or until power is cycled. Once de-allocated, the memory is available to other instruments.

Using Mainframe Data Memory

Commands that generate data and do not have a question mark (?) in their syntax store the data in mainframe memory. Faster instrument reading rates are possible when using reading memory versus sending data directly to an external computer. Storing readings in memory can also help to ensure that the period between paced readings is maintained at a constant value. When instrument data is stored in memory, it overwrites any data previously stored by that instrument. You can retrieve data stored in mainframe memory using the FETCh? command.

Example: Storing and Retrieving Data From Mainframe Memory. This example shows how to use mainframe memory to store 15 readings made using an HP E1326A Multimeter. After the readings are stored, they are retrieved by the computer and displayed.

10 REAL OHM_RGS(1:15)	<i>Create computer array for 15 readings</i>
20 OUTPUT 70903;"CONF:FRES (@105:109)"	<i>Configure multimeter for 4-wire resistance, scan channels 105 - 109</i>
30 OUTPUT 70903;"RES:OCOM ON"	<i>Enable offset compensation</i>
40 OUTPUT 70903;"TRIG:COUN 3"	<i>Cycle through scan list 3 times</i>
50 OUTPUT 70903;"INIT"	<i>Trigger multimeter, store the readings in mainframe memory</i>
60 OUTPUT 70903;"FETCH?"	<i>Get readings from mainframe memory</i>
70 ENTER 70903;OHM_RGS(*)	<i>Enter readings into computer</i>
80 PRINT OHM_RGS (*)	<i>Display readings on computer</i>
90 END	

Non-Volatile User Memory

The System Instrument provides a way to allocate a segment of its non-volatile memory for storage and retrieval of user data. The structure and content of the data you store in this memory segment is up to you. The commands provided for data access merely store or retrieve a specified number of bytes. Commands for allocating and accessing the memory segment are implemented by the System Instrument (logical address, and HP-IB secondary address 0).

Allocating a User Memory Segment

The SCPI command `DIAGnostic:NRAM:CREate <size >` is used to allocate a segment of User non-volatile RAM. The amount of memory allocated is controlled by the *size* parameter. The `DIAG:NRAM:CRE` command informs the system of your request for a User RAM segment. The segment is not allocated until the system is reset (`DIAG:BOOT` command, or `RESET` from the front panel). Once the NRAM segment is allocated, you can consider it part of your System Instrument's configuration. It will remain through power interruptions and system resets. Only the `DIAG:BOOT:COLD`, or `DIAG:NRAM:CRE 0` commands can de-allocate the NRAM segment.

Note: IBASIC Users

Allocating an NRAM segment will de-allocate a previously allocated RDISK segment. To include both types; allocate them both before a reset, or allocate the NRAM segment, reset the system, then allocate the RDISK segment and again reset the system.

Locating the NRAM segment

Since the system decides where in memory to locate the NRAM segment, you must execute the `DIAG:NRAM:ADDRess?` query to determine its starting

address. You will then know the starting address , and (from the ...NRAM:CRE <size> command) the length of the NRAM segment.

Example: Allocating an NRAM segment and locating it. This example shows how to allocate a small 128 byte NRAM segment. In addition, it shows how to determine the starting address of that segment.

```
      define variables
10  REAL Addr,Size
      128 byte NRAM segment
20  OUTPUT 70900;"DIAG:NRAM:CRE 128"
      reset the system
30  OUTPUT 70900;"DIAG:BOOT"
      allow time for reset to begin
40  WAIT 5
      wait for self-test to complete
50  ON TIMEOUT 7,.1 GOTO Complete
60 Complete:B = SPOLL(70900)
      query starting addr
70  OUTPUT 70900;"DIAG:NRAM:ADDR?"
      enter starting addr
80  ENTER 70900;Addr
      print it
90  PRINT USING "31X,""Addr = "" ,8D";Addr
```

Using :DOWNload and :UPload? to Access Data

The command `DIAG:DOWNload <address>, <data_block>` is used to store data into the NRAM segment. The command `DIAG:UPload? <address>, <byte_count>` is used to retrieve data from the NRAM segment. The *address* parameter in ...DOWNload and ...UPload? can specify any address within the capability of the System Instrument's control processor. The system does not restrict you from storing or retrieving data which is outside of the NRAM segment.

Caution

This capability to store (DOWNload) data to any location in mainframe memory means that you could inadvertently change the contents of memory being used by the mainframe control processor. This will occur if:

- you specify a starting address for DOWNload which is outside the NRAM segment
- you specify a starting address for DOWNload which is inside the NRAM segment, but the data block you send extends past the end of the NRAM segment.

If either of these occur, operation of the mainframe will be disrupted. To restore operation:

1. turn the mainframe off and then back on.
2. while the mainframe is "Testing ROM", press the **Reset Instr** button on the front panel or, for terminal users, press the CTRL and R keys.

This operation is the same as executing `DIAG:BOOT:COLD`

Data Formats for :DOWNload

Data stored into NRAM using :DOWNload can be sent in either Definite, or Indefinite Length Arbitrary Block Program Data formats (see Parameter Types in the beginning of Chapter 5). The *Definite Length* block format is recommended since the format includes a data length count which positively terminates the :DOWNload command when that count is reached. If the *Indefinite Length* format's termination sequence (< newline > with END) is not received correctly, commands sent after the :DOWNload command will be interpreted as more data and sent to memory, possibly overwriting system memory and disrupting mainframe operation.

The following example program will use the small NRAM segment created in the previous example. It will show how to store and retrieve:

- 64 ASCII characters
- thirty-two, 8 bit data bytes
- sixteen, 16 bit data words

Example: Storing and Retrieving data using DOWNload and UPLoad.

```
      define variables for DOWNload and UPLoad
90 DIM Chars${64},Chars_back${80}
100 INTEGER Words(1:16),Bytes(1:32),Words_back(1:16),
    Bytes_back(1:32)
      create string of characters
110 Chars$ = "1234567890123456789012345678901234567890
    123456789012345678901234"
      create array of 16 bit data words
120 FOR I = 1 TO 16
130   Words(I) = 32700 + I
140 NEXT I
      create array of 8 bit data bytes
150 FOR I = 1 TO 32
160   Bytes(I) = 63 + I
170 NEXT I
      DOWNload 16 words to NRAM segment
180 OUTPUT 70900 USING ""DIAG:DOWN "" ,8D,"" ,#232"" ,16(W)";
    Addr + 96,Words(*)
      DOWNload 32 bytes to NRAM segment
190 OUTPUT 70900 USING ""DIAG:DOWN "" ,8D,"" ,#232"" ,32(B)";
    Addr + 64,Bytes(*)
      Download 64 characters to NRAM segment
200 OUTPUT 70900 USING ""DIAG:DOWN "" ,8D,"" ,#264"" ,64A";
    Addr,Chars$

      UPLoad 64 characters from NRAM segment
210 OUTPUT 70900 USING ""DIAG:UPL? "" ,8D,"" ,64"" ;Addr
220 ENTER 70900 USING "4X,64A";Chars_back$
230 PRINT TAB(5);Chars_back$

      UPLoad 32 data bytes from NRAM segment
240 OUTPUT 70900 USING ""DIAG:UPL? "" ,8D,"" ,32"" ;Addr + 64
250 ENTER 70900 USING "4X,32(B)";Bytes_back(*)
260 PRINT Bytes_back(*)

      UPLoad 16 data words from NRAM segment
270 OUTPUT 70900 USING ""DIAG:UPL? "" ,8D,"" ,32"" ;Addr + 96
280 ENTER 70900 USING "4X,16(W)";Words_back(*)
290 PRINT Words_back(*)
300 END
```

Downloading Device Drivers

About this Chapter

This chapter describes the procedure for using downloadable device drivers with the E1405 Command Module. This functionality was added so that SCPI capability for new register based devices could be added to the Command Module without having to update an internal set of ROMs. This chapter contains the following sections:

- About this Chapter 5-1
- What You Will Need 5-1
- Memory Configuration 5-3
- Download Program Configuration 5-4
- Downloading Drivers in MS-DOS systems 5-6
- Downloading Drivers in HP IBASIC Systems 5-7
- Downloading Drivers from Other HP BASIC Systems 5-8
- Downloading Multiple Drivers 5-9
- Checking Driver Status 5-9
- Manually Downloading Drivers 5-10

What You Will Need

The downloadable device drivers and the software necessary to download the drivers into HP mainframes are provided on 3.5" floppy disks which ship with the device driver manual. Disks are provided in both LIF and DOS format for your convenience. Drivers and appropriate downloading software are provided for use in MS-DOS systems downloading over an RS-232 link and for use in systems using HP BASIC or HP IBASIC (Instrument BASIC) and downloading over an HP-IB (IEEE 488.2) link. The procedures for both types of downloaders are detailed later in this chapter.

Figure 5-1 shows the files and documents that will be needed for each type of download supported.

For RS-232 downloads you will need appropriate cables to connect your computer to the Command Module. If your computer has a 25 pin serial output connector, you can use an HP 24542G cable to make the connection. If your computer has a 9 pin serial output connector, you can use an HP 24542M and an HP 24542H cable (connected end to end) to make the connection.

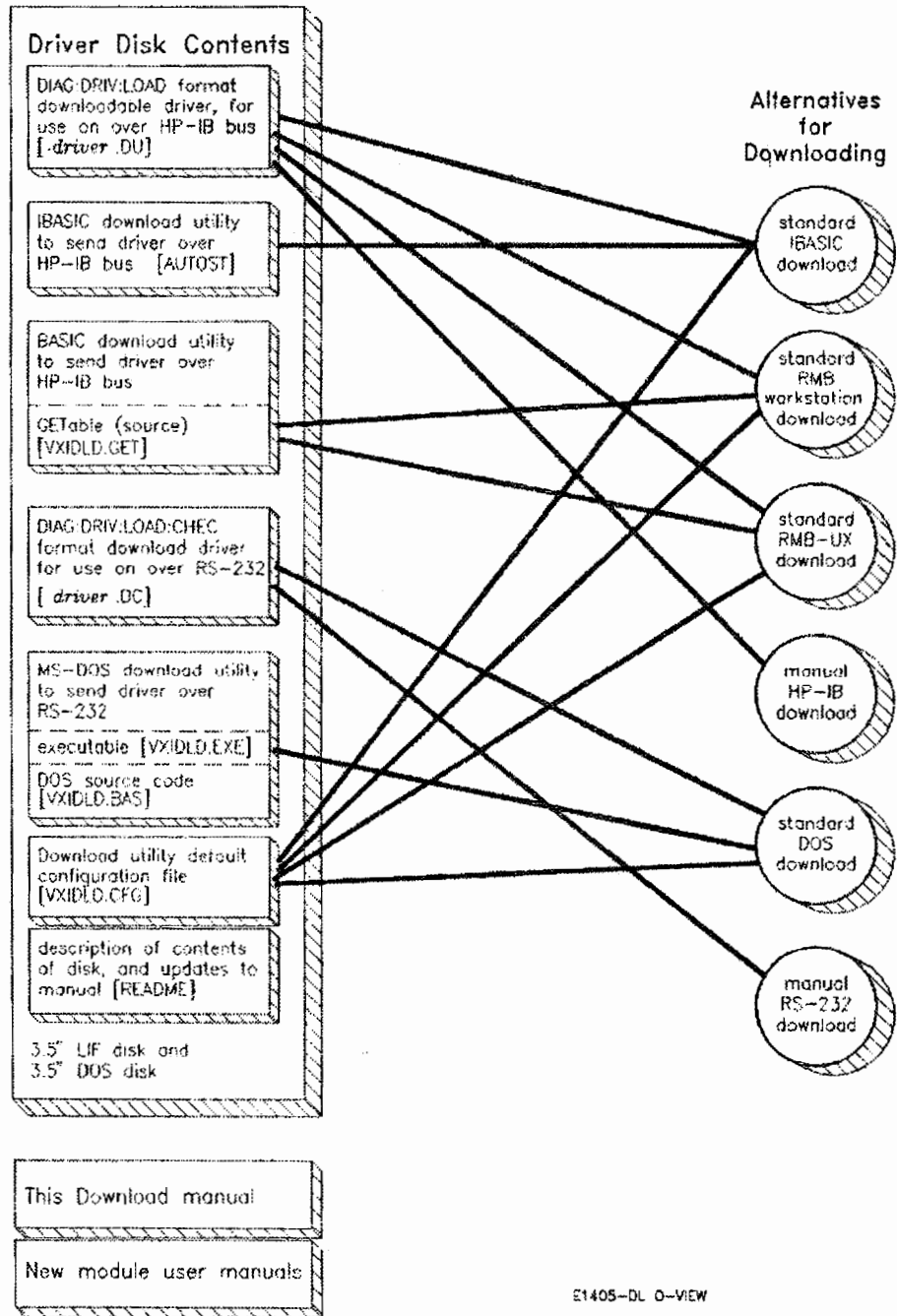

~ Figure 5-1. Driver and Documentation Usage

Memory Configuration

Before attempting to download any device drivers you should understand how memory is affected when you specify a size for one or more types of RAM. There are three types of RAM that you can allocate in the mainframe:

- RAM disk (RDISK)
- Non-volatile RAM (NRAM)
- Driver RAM (DRAM)

Figure 5-2 shows the positioning of these areas in memory. User Non-volatile RAM and RAM Disk both occupy higher memory addresses than the Driver RAM. Because the actual size of these three areas is variable, they do not have a fixed starting position. At creation time, the lowest unused memory address becomes the starting address for the requested type of RAM. Memory areas set at higher addresses can be created without affecting any previously created lower memory areas, but creating a new memory area causes any areas *above it* to be removed.

NOTE

If you wish to use RDISK or NRAM, you can modify the configuration file so that the download program sets up the required memory segments.

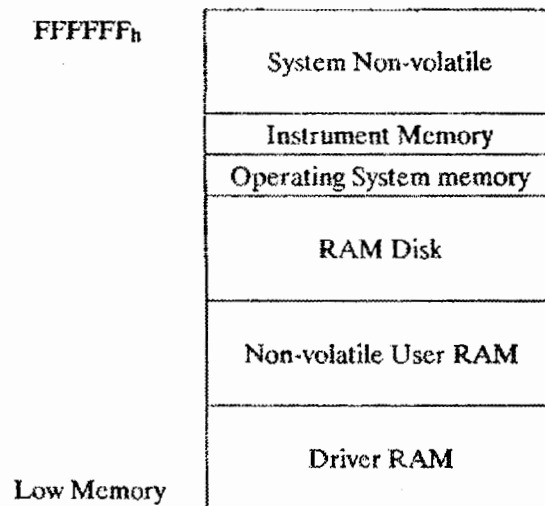

The Low Address depends on the amount of memory installed. It is equal to the highest address plus 1 (1000000_h) minus the size of memory installed. The boot time messages will tell you how much RAM you have installed in your system. In a system with 512Kbytes of memory the Low Address is low address = 1000000_h - 80000_h = F80000_h, or 16,252,928 decimal.

Figure 5-2. Positioning of Allocatable RAM

Example *If you create a RAM Disk area without creating any User Non-volatile RAM or Driver RAM, the starting address for the RAM Disk will be at the lowest address (F80000_h for a command module with 512Kbytes of memory). If you now create a Driver RAM area, the RAM Disk area will be removed since the new area has to be at a lower address than the RAM Disk area.*

Download Program Configuration

If you will not be using the default configurations for downloading, you will need to edit the configuration file to match your system configuration. If the default values shown below are correct for your setup, you can proceed to the appropriate downloading instructions.

The configuration defaults for MS-DOS systems are:

- Download program searches for drivers in current directory.
- Execution Log is OFF (log to screen only).
- All drivers in current directory will be downloaded.
- COM1 is used for output.
- Baud rate is 9600.
- 1 stop bit is used
- NRAM size is zero.
- RDISK size is zero.

The configuration defaults for HP-IB systems are:

- Download program searches for drivers in current directory.
- Execution Log is OFF (log to screen only).
- All drivers in current directory will be downloaded.
- 80900 is used for the interface address when running from IBASIC. 70900 is used as the interface address when running in any HP BASIC environment other than IBASIC.
- NRAM size is zero.
- RDISK size is zero.

Editing the Configuration File

The configuration file (VXIDLD.CFG or VXIDLD_CFG) on your driver distribution disk is shipped with all entries commented out. In this state, the download programs will use the default values shown above. To activate or change an entry, you must edit the file manually. The file is set up so that it can be edited either by a standard text editor or word processor, or with a Basic language editor. Comments and instructions are included in the file.

- The beginning of the useful information on each line is the part following "linenumber REM" (the "linenumber REM" is ignored).
- All lines beginning with "#" are comments.
- Lines that start with "##" are intended to remain comments.
- Lines that start with "# " are example lines that you may wish to activate and/or modify. These are the actual configuration statements.
- Setting labels are not case sensitive, and should be separated from the associated value by an equal sign ("=").
- Unrecognized settings are ignored.
- If you activate more than one line for a setting that can take only one value, the first value found for the setting will be used.

DIRECTORY = specifies the directory where you store your drivers and where the driver programs will log information about their progress. The default is the current directory. The directory specified must be writeable if you are doing downloads using IBASIC or logging progress.

EXECUTION LOG = specifies the place to log information about the program's progress. The default location for this function is the screen. If you

specify a file name here, the driver downloader will log to the screen and to the specified file.

DRIVER FILE = specifies the driver file or files to download. The default is to download all device driver files found in the directory specified by **DIRECTORY** = . If the driver downloader finds one line in this format, it will assume that you are specifying entries and will only download the listed entries. This configuration item can have multiple lines.

ADDRESS = specifies the I/O interface that you will be using. The default interface address when running in IBASIC over HP-IB is 80900. The default address when running over HP-IB in any other HP BASIC environment is 70900. The default address when running in DOS is 1 (for COM1:).

The communication interface you will be using when running from any of Hewlett-Packard's BASIC environments is the "HP-IB" interface (also known as IEEE 488.1). Selection of a specific HP-IB interface consists of an address in the form "sspp00" where:

- ss is the select code of the HP-IB interface card.
- pp is the primary HP-IB address used for the VXI mainframe.
- 00 is the secondary HP-IB address used for the SYSTEM instrument.

The communication interface you will be using when running from DOS is the "RS-232" interface. When Using the RS-232 interface the serial cable must be connected to either the built-in RS-232 connection of the VXI mainframe or an RS-232 module (HP E1324A) that is set to interrupt at the default interrupt level (level 1). Selection of the address for the RS-232 interface consists of an address that is 1 for COM1 or 2 for COM2:.

BAUD = specifies the baud rate of the transmission if you are using RS-232. The default is 9600 (which is also the default for the VXI mainframe after a DIAG:BOOT:COLD command). Allowed values are 300, 1200, 2400, 4800, 7200, or 9600 (19,200 is not supported by DOS).

STOP BITS = specifies the number of stop bits per byte if you are using RS-232. The default is 1 (which is also the default for the VXI mainframe after a DIAG:BOOT:COLD command). Allowed values are 1 or 2.

NRAM = specifies the size in bytes of the non-volatile user RAM area you wish to set up. The default value is zero bytes. You may change this value later independent of the downloaded drivers, but changing it will always affect any RAM disk (RDISK) you have specified.

RDISK = specifies the size in bytes of the RAM disk segment you wish to set up. The default value is zero bytes. You can change this value later without affecting either the downloaded device drivers or the user non-volatile RAM (NRAM).

Downloading Drivers in MS-DOS Systems

The device driver download program VXIDLD.EXE provided on the disk with the driver files for use with an RS-232 interface must be run from MS-DOS. It will set up the the required device driver memory and any other memory partitions defined in the configuration file, reboot the system, and download the device driver. If there are device drivers present, or you already have memory allocated for NRAM (User Non-volatile RAM) or RDISK (RAM Disk), a warning will be issued and the downloading process aborted. You must first clear any existing drivers from the system, and then download all of the required drivers together. You may redefine any NRAM or RDISK areas after downloading the device drivers.

1. Make sure that your computer can talk to the E1405 Command Module. If you have changed the communications protocol for the Command Module or mainframe, you must change them back to 9600 BAUD, 8 data bits, 1 stop bit, and no parity before this download will work correctly.

These are the defaults after cold boot. If necessary, you can change the baud rate and number of stop bits in the configuration file, but since the special formatting required for downloading over RS-232 requires all 8 data bits in each byte, you must make sure that the data bits are set to 8 and parity checking is OFF. The download program handles its own pacing, so the setting for pacing does not matter.

2. Put the floppy disk into an appropriate drive.
3. Make sure that the floppy disk is your current drive (for example, type "A:" and press ENTER).
4. Execute the device downloader program (type "VXIDLD" and press ENTER).
5. The downloader program will check to make sure that there are no device drivers already loaded, and no memory has been allocated for NRAM or RDISK. If either condition exists, the program will issue a warning and abort. If not, it will create the required RAM partitions, reboot the system, and download the device driver on the supplied disk.

Any errors encountered while downloading will be reported.

6. The download program will check to make sure that the driver has been downloaded and is in memory.

WARNING

Terminate and Stay Resident programs in your MS-DOS system may interfere with the timing of RS-232 transfers and cause errors in the downloading. If you encounter errors indicating that the download program did not receive back what it expected, and the driver is not loaded, remove all of your TSRs from memory and try the download procedure again.

Downloading Drivers in HP-IB Systems with IBASIC

The device driver download program AUTOST provided on the disk with the driver files for use with HP-IB must be run from HP IBASIC (Instrument Basic). It will set up the the required device driver memory and any other memory partitions defined in the configuration file, reboot the system, and download the device driver. This program will issue a warning and abort if any errors are encountered. If there are device drivers present, or if you already have memory allocated for NRAM (User Non-volatile RAM) or RDISK (RAM Disk), you must first clear any existing drivers from the system, and then download all of the required drivers together. You may redefine any NRAM or RDISK areas after downloading the device drivers.

NOTE

If you wish to see the messages that the download program generates, you need to have a terminal connected to the IBASIC display port. If you have not changed this from its default value of NONE, messages are sent to the built-in RS-232 port.

1. Make sure that your Command Module (E1405) is set to System Controller mode.
2. Put the floppy disk into an appropriate drive.
3. Make sure that the floppy disk is your current drive (for example, type 'MSI";,700,1" and press ENTER).
4. Load the device download program into IBASIC (type 'GET "AUTOST"' and press ENTER) and run the program (type "RUN" and press ENTER).
5. The download program will check to make sure that there are no device drivers already loaded, and no memory has been allocated for NRAM or RDISK. If either condition exists, the program will issue a warning and abort. If not, it will create the required RAM partitions, reboot the system, and download the device driver on the supplied disk.

Any errors encountered while downloading will be reported and will cause the program to abort.
6. The download program will check to make sure that the driver has been downloaded and is in memory.

NOTE

If you are using IBASIC but controlling the system over the HP-IB, you must put all commands in quotes and prefix them with "PROG:EXEC". A typical command would be:

```
PROG:EXEC 'MSI ";,700,1"
```

Downloading Drivers in HP-IB Systems with HP BASIC

The device driver download program VXIDLD_GET provided on the disk with the driver files for use with HP-IB must be run from an HP BASIC other than IBASIC. It will set up the the required device driver memory and any other memory partitions defined in the configuration file, reboot the system, and download the device driver. If there are device drivers present, or you already have memory allocated for NRAM (User Non-volatile RAM) or RDISK (RAM Disk), a warning will be issued and the downloading process aborted. You must first clear any existing drivers from the system, and then download all of the required drivers together. You may redefine any NRAM or RDISK areas after downloading the device drivers.

1. Make sure that your Command Module (E1405) *is not* set to System Controller mode.
2. Put the floppy disk into an appropriate drive.
3. Make sure that the floppy disk is your current drive (for example, type 'MSI ":,700,1"' and press ENTER).
4. Load the device download program into BASIC (type 'GET "VXIDLD_GET"' and press ENTER) and run the program (type "RUN" and press ENTER).
5. The download program will check to make sure that there are no device drivers already loaded, and no memory has been allocated for NRAM or RDISK. If not, it will create the required RAM partitions, reboot the system, and download the device driver on the supplied disk.

Any errors encountered while downloading will be reported and will cause the program to abort.
6. The download program will check to make sure that the device driver was successfully downloaded.

Downloading Multiple Drivers

The driver downloader software automatically checks for the existence of other drivers when it is run. If there are device drivers present, it will abort the process and inform you that you must first clear the other device drivers out of the mainframe and then download all of the required drivers at once. The easiest way to accomplish this is to place copies of all of the device drivers into a single directory on your hard disk along with the downloader, or onto the same floppy disk. The download program will look in its own directory first, and download any device drivers it finds.

1. Move all of your device drivers into a single directory with the downloaders.
2. Clear the DRAM memory in the mainframe (send "DIAG:DRAM:CRE 0" and "DIAG:BOOT" to the System Instrument).
3. Execute or load and run the appropriate device driver software, as described above.

All device drivers in the directory or on the same floppy disk as the driver downloader will be downloaded automatically after the system checks to make sure that there are no other device drivers already loaded. You can change several aspects of the downloading procedure by editing the configuration file .

Checking Driver Status

Once your drivers are downloaded, you can use the System Instrument command `DIAG:DRIV:LIST?` to check their status. In the format shown, this command lists all types of drivers. You can specify the *type* (ALL, RAM or ROM) by using `DIAG:DRIV:LIST:type?`

NOTE:

- `DIAG:DRIV:LIST?` lists all drivers in the system.
- `DIAG:DRIV:LIST:RAM?` lists all drivers found in the RAM driver table DRAM. These are the drivers which you just downloaded into the system.
- `DIAG:DRIV:LIST:ROM?` lists all drivers found in the ROM driver table. These drivers are always present in the system. If one of these is meant for an instrument which also has a driver in RAM, the driver in RAM will be used by the system.

Manually Downloading a Driverdown manual

Download programs are supplied for use with the system setups described earlier in this chapter. If you have a system setup that does not allow the use of one of the supplied download programs (for instance, if you are using a Macintosh® computer), you will need to manually download the driver. The details of this process will be different for different system setups, but the basic procedures are outlined below.

Preparing Memory for Manual Downloading

Before you can manually download any drivers using either RS-232 or HP-IB, you must define the DRAM (Driver RAM) into which the drivers will be transferred. DRAM memory is non-volatile.

1. Calculate the required total DRAM size. This is the total amount of memory required by the mainframe for all of the device drivers you are going to download.

Typical driver size will range from 40Kbytes to 100Kbytes. If you are in doubt about the amount of memory needed for downloading your device drivers, use the size of the HP-IB driver file (ends in "DU") on the driver disks. Remember that you must add the amount of memory necessary for all of the device drivers you plan to download. You can see how much RAM is available by using the DIAG:DRAM:CRE? MAX, DEF query.

NOTE

Each driver will need additional system RAM at run time. Although this is not part of the RAM necessary for the DRAM calculations, you should make sure that you have enough DRAM to download the drivers, and enough system RAM left after downloading to run the drivers. Most drivers will need less than 15Kbytes of additional RAM (per driver) at run time. If IBASIC is in the system, it will take at least 150Kbytes to 200Kbytes of system RAM in addition to the RAM used by the device drivers.

-
2. Create the appropriate DRAM partition using the DIAG:DRAM:CRE command. Unless you have more than eight drivers to download, you do not need to specify the second parameter.

WARNING

Creating this memory partition will delete any NRAM or RDISK partitions that you have defined, and any data in NRAM or RDISK memory. You must redefine any such memory blocks after you have defined the Driver RAM.

-
3. Reboot the system

Manually Downloading Over HP-IB

Manually downloading a driver over HP-IB is fairly straightforward. This discussion assumes that the downloadable device driver has been supplied by Hewlett-Packard. Drivers supplied by HP are formatted so that you just need to transfer the driver to command module memory. You must also have the driver on media that is accessible to the host computer that will be controlling the download.

You should send a *RST command and a *CLS command to the SYSTEM instrument to put it in a known state before beginning your download.

On most computers, a program will be required for the actual download process. Since the driver file contains the System Instrument command to start the downloading and the actual data to download, this program just needs to transfer the bytes in the driver file to the System Instrument, one byte at a time.

This file contains the SCPI command DIAG:DRIV:LOAD followed by the IEEE 488.2 arbitrary definite block header, and then the actual driver. The definite block starts with the # character, followed by a single digit that shows how many digits are in the length field, followed in turn by the length field. For instance, a block that is 1000 bytes long would have a block header of #800001000.

When your transfer program is complete you should send the SCPI query SYST:ERR? to make sure that there were no errors during the download, and reboot the system (send DIAG:BOOT). You can make sure that all of your drivers have been properly loaded into Driver RAM by sending the SCPI command DIAG:DRIV:LIST:RAM?

Manually Downloading Over RS-232

Manually downloading a driver over RS-232 is similar in concept to downloading over HP-IB. Drivers supplied by HP are formatted so that you just need to transfer them to command module memory. You must also have the driver on media that is accessible to the host computer that will be controlling the download.

However, the RS-232 interface of the E1405 uses special control characters (e.g., <CTRL-C> to implement the equivalent of the HP-IB "device clear" function) that would cause havoc in the download process if sent as part of the driver. The driver file on the distribution disk that ends in "DC" is specially formatted for RS-232 downloading to avoid this problem (see Appendix E "Formatting Binary Data for RS-232" for more information on the data format of these files).

Transmission Format

You need to make sure that the transmission format of your computer matches the format used at the System Instrument. The default configuration for the System Instrument after a DIAG:BOOT:COLD command has been issued is

- 9600 BAUD
- 8 data bits
- 1 stop bit
- Parity checking is OFF
- XON/XOFF pacing

If you are going to use any other setting, you must set up the appropriate settings in the System Instrument using the following commands

COMM:SER[n]:REC:BAUD <rate>	<i>sets BAUD rate</i>
COMM:SER[n]:REC:SBITS <bits>	<i>sets number of stop bits</i>
DIAG:COMM STOR	<i>saves settings so they will be kept through a reboot.</i>

NOTE

Because the special formatting for binary files uses all 8 bits, the number of data bits must be set to 8 and parity checking must remain OFF for the driver files to transfer properly.

Pacing the Data

Since the RS-232 interface is asynchronous, it is possible for the computer that is doing the download to overrun the System Instrument. This would cause part of the driver to be lost. To prevent this from happening, you should enable hardware handshake (either RTS or DTR) or software handshake (XON/XOFF).

The default configuration for the E1405 Command Module is for software handshake enabled and hardware handshake disabled. To make sure that software handshake is enabled for the command module use the SYST:COMM:SER:PACE? query. To set up software handshake you can use the following commands:

SYST:COMM:SER:PACE:THR:STOP? MAX

to find the maximum number of characters to fill the input buffer.

SYST:COMM:SER:PACE:THR:STOP <max-20>

to set the threshold for stopping data to the maximum size of the input buffer minus 20 characters.

SYST:COMM:SER:PACE:THR:STAR 0

to set the start buffer level to zero. This makes sure that the input buffer is completely flushed whenever transmissions are stopped.

SYST:COMM:SER:PACE:XON

to enable the software handshake protocol.

The start threshold is not critical as long as it is less than the stop threshold. The stop threshold must be set low enough to handle the maximum number of characters that are likely to be received at the System Instrument after it sends the XOFF signal.

Hardware handshake can be set up to use either the DTR (Data Terminal Ready) line or the RTS (Ready to Send) line. These modes can be set with the SYST:COMM:SER:CONT:DTR IBFULL command (to set for DTR) or SYST:COMM:SER:CONT:RTS IBFULL command (to set for RTS). You may wish to turn software handshake OFF using the SYST:COMM:SER:PACE NONE command, though the system will operate with both protocols enabled. When the input buffer of the System Instrument is not full (number of characters in the input buffer is less than the high threshold), the specified hardware line will be asserted. When either hardware

handshake mode is enabled, the System Instrument will not transmit characters when either the CTS (Clear to Send) or the DSR (Data Set Ready) lines are not asserted. This acts to pace the System Instrument output.

NOTE

The E1405 Command Module RS-232 interface is implemented as a DTE (Data Terminating Equipment). Since most computer RS-232 interfaces are also implemented as DTEs, a cable that does line swapping (null modem cable) is usually used to connect the computer to the instrument. This cable typically swaps the receive and transmit lines. It will usually connect the DTR line of one interface to the CTS and DSR lines of the other. It will connect the RTS line of one interface to the DCD (Data Carrier Detect) line of the other.

CAUTION

The RS-232 interface of the E1405 Command Module will echo any characters received with an ASCII value greater than 32 and less than 128. Carriage returns are echoed as carriage return/linefeed. When transferring the driver file, these echoes can fill up the RS-232 receive buffer of your computer if they are not read. If receive pacing is enabled for your computer this could cause the computer to send the "Stop Transmitting" signal to the System Instrument, which could block the remaining downloaded bytes or other commands sent after the download. Since the driver file contains command strings and many carriage returns that will be echoed by the system, your program should read the returning echo characters from the RS-232 line. This will also let you determine if there are any error messages coming back.

Transmitting Using a COPY Command

On some computers it is possible to use an RS-232 or HP-IB port and the copy command to transfer the device driver. Hardware or software handshake must be used by the copy command on the computer doing the downloading, and the same handshake mode must be enabled on the System Instrument.

1. Set the required handshake mode and data format (e.g., on DOS systems use the MODE command).
2. Type "COPY *filename port*" to transfer the file through the RS-232 port to the System Instrument (e.g., on a DOS system you might use "COPY /B *filename.DC COM1:*"). This command may be slightly different depending on the type of computer being used.

NOTE

Since errors are echoed immediately, this method of transfer has no means of trapping errors.

Transmitting Using a CAT Command

On HP-UX systems you can use the *cat* command to transfer the device driver. The appropriate device file must exist. All shell commands are assumed to be executed from either the */bin/sh* or */bin/ksh* shell.

1. Start a process that opens the device file to be used. This process should keep the device file open long enough for the transfer to begin. This step is done so that the following command to set the device file configurations will remain in effect for the transfer. A command that will do this is:

```
(cat < device file > /dev/null; sleep 1000) &
```

2. Set the required configuration of the device file using the *stty* command. The following command will set the device file to work with the default System Instrument configuration.

```
stty -opost 9600 ixon -ixoff cs8 -cstopb ignpar < device file
```

3. Transfer the file to the System instrument with the *cat* command.

```
cat filename > device file
```

Transmitting Using Custom Software

If the *COPY* command on your computer cannot directly implement handshaking, or if you wish to trap errors and abort or otherwise modify the transmission process, you must use a program to handle the download process.

This procedure assumes that your computer has some means of looking at data being echoed from the System Instrument, and can check for a return character without having to have a character returned. Since the actual driver file bytes sent over the RS-232 interface are not echoed, the lack of ability to do this would put the system into an infinite wait at the first byte that was not echoed.

1. Set up the appropriate handshake mode and data format on your system, and the matching handshake mode in the System Instrument.
2. Transfer the driver file over the RS-232 interface using a program that follows the outline in figure 5-3.

Check Driver Status

Make sure that the drivers were properly downloaded by checking their status using the *DIAG:DRIV:LIST:RAM?* command. This will give you a list of all the drivers currently found in DRAM.

Controlling Instruments Using HP-IB

About this Chapter

This chapter shows how to control instruments in the mainframe from an external computer using IEEE 488.2 Common Commands and the HP-IB interface. This includes how to monitor instrument status, interrupt the computer, and synchronize one or more instruments to an external computer.

Command references for the supported IEEE 488.2 Common Commands and IEEE 488.2 HP-IB Messages are located near the end of this chapter. This chapter contains the following sections:

- Programming Hints 6-1
- Instrument Status 6-2
- Clearing Status 6-10
- Interrupting the External Computer 6-10
- Synchronizing an External Computer and Instruments 6-12

Note

Examples that require showing a computer language are written for HP 9000 Series 200/300 Computers using HP BASIC language.

Programming Hints

- Only one instrument in the mainframe can be the addressed listener (i.e., receiving commands) on the HP-IB at any one time.
- After executing a query command (any command that generates data), do not attempt to execute another command until you have read the data generated by the query command. Doing so causes the -410: Query INTERRUPTED error. You can however, send a command following a query command if they are combined in the same command string (joined by semicolon and colon).
- Instruments in the mainframe have 128 character input buffers. Do not send a command string containing a query command that is longer than 128 characters. Doing so may cause a deadlock situation which can only be resolved by setting a timeout on the computer's enter statements and then reading the error(s) after the timeout occurs.

Status System Structure

The instrument status structure monitors important events for an instrument such as when an error occurs or when a reading is available. All instruments have the following status groups and registers within those groups:

- Status Byte Status Group
 - status byte register
 - service request enable register
- Standard Event Status Group
 - standard event status register
 - standard event status enable register
- Operation Status Group
 - condition register
 - event register
 - enable register
- Questionable Data Status Group
 - condition register
 - event register
 - enable register

You read and configure the registers in the Status Byte and Standard Event groups using Common Commands. These are the most commonly used instrument registers. The registers in the Standard Operation Status group and Questionable Data status group are configured using the commands in the STATUS subsystem.

NOTE

The Status Byte, Standard Event, and Operation Status groups are the only groups covered in this chapter. The Questionable Data status group is supported by the system instrument (Command Module) but is not used by the system instrument. Commands affecting this status group (Chapter 5) are accepted but have no effect.

Refer to the STATUS subsystem in the Command Reference of the individual plug-in module manuals to determine how a module uses the Operation Status group and Questionable Data status groups. If the STAT:OPER or STAT:QUES commands are not documented in the plug-in module manual, that module does not use the registers.

The Status Byte Register

As shown in Figure 4-1, the Status Byte register is the highest-level register in the status structure. This register contains bits which summarize information from the other status groups.

NOTE

The bits in the other status group registers must be specifically enabled to be reported in the Status Byte register. Refer to "Unmasking Standard Event Status Bits" (later in this chapter) for more information.

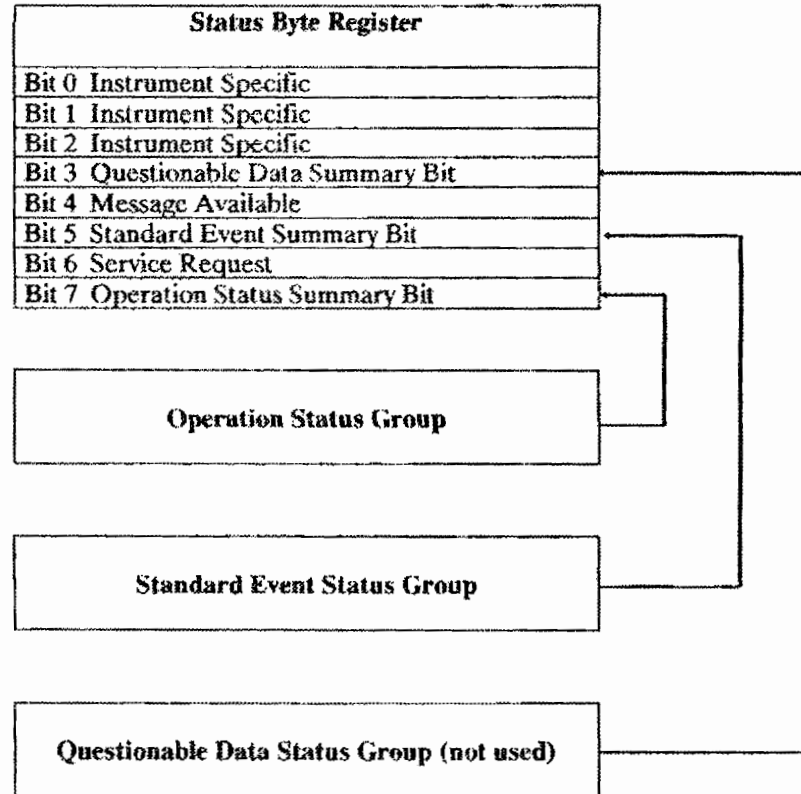

Figure 6-1. Status Structure

Table 4-1 shows each of the Status Byte register bits and describes the event that will set each bit.

Table 4-1. Status Byte Register

Bit Number	Decimal Weight	Description
0	1	Instrument Specific (not used by most instruments)
1	2	Instrument Specific (not used by most instruments)
2	4	Instrument Specific (not used by most instruments)
3	8	Questionable Data Status Group Summary Bit. One or more events in the Questionable Data Status group have occurred and set bit(s) in those registers.
4	16	Message Available. The instrument's output queue contains information. This bit can be used to synchronize data exchange with an external computer. For example, you can send a query command to the instrument and then wait for this bit to be set. The HP-IB is then available for other use while the program is waiting for the instrument to respond.
5	32	Standard Event Status Group Summary Bit. One or more enabled events in the Standard Event Status Register have occurred and set bit(s) in that register.
6	64	Service Request--Service is requested by the instrument and the HP-IB SRO line is set true. This bit will be set when any other bit of the Status Byte Register is set and has been enable to assert SRO by the *SRE command.
7	128	Operation Status Group Summary Bit. One or more events in the Operation Status Group have occurred and set bit(s) in those registers.

Reading the Status Byte Register

You can read the Status Byte register using either the *STB? command or an HP-IB serial poll. Both methods return the decimal weighted sum of all set bits in the register. The difference between the two methods is that *STB? does not clear bit 6 (Service Request); serial poll does clear bit 6. No other status register bits are cleared by either method with the exception of the Message Available bit (bit 4) which may be cleared as a result of reading the response to *STB?. In addition, using an HP-IB serial poll lets you read the status byte without interrupting the instrument parser. The *STB? method requires the instrument to process the command. This can generate interrupt query errors if the instrument is executing another query.

The following program uses the *STB? command to read the contents of the system instrument's (Command Module's) Status Byte register.

```

10 OUTPUT 70900; "*STB?"           Read Status Byte Register
20 ENTER 70900; A                  Enter weighted sum
30 PRINT A                          Print weighted sum
40 END

```

For example, assume bit 3 (weight = 8) and bit 7 (weight = 128) are set. The above program returns the sum of the two weights (136).

The following program reads the system instrument's Status Byte register using the HP-IB Serial Poll command.

```
10 P = SPOLL(70900)           Read Status Byte Register using  
                               Serial Poll, place weighted sum  
                               in P  
20 PRINT P                   Print weighted sum  
30 END
```

Service Request Enable Register

The Service Request Enable register is used to "unmask" bits in the Status Byte register. When an unmasked Status Byte register bit is set to '1', a service request is sent to the computer over HP-IB.

The command used to unmask Status Byte register bits is:

```
*SRE <mask >
```

where <mask> is the decimal weight of the bit to be unmasked, or is the sum of the decimal weights if multiple bits are to be unmasked. For example, executing:

```
*SRE 16
```

unmasks the *message available* (MAV) bit in the Status Byte register. Sending:

```
*SRE 48
```

unmasks the *message available* (MAV) and *event status bit* (ESB).

You can determine which bits in the Status Byte register are unmasked by sending the command:

```
*SRE?
```

This command returns the decimal weighted sum of all unmasked bits.

The Service Request Bit

Note that the Service Request bit (bit 6) in the Status Byte register does not have a mask. Bit 6 is set any time another Status Byte register bit is set. If the other bit which is set is unmasked, a service request is generated.

Clearing the Service Request Enable Register

The Service Request Enable register mask is cleared (each bit masked except bit 6) by sending the command:

```
*SRE 0
```

If *PSC 1 has been executed, the Service Request Enable register mask is cleared when power is cycled. If *PSC 0 has been executed, the mask is unchanged when power is cycled. (*PSC? queries the setting.)

Standard Event Status Register

The Standard Event Status Register in the Standard Event status group monitors the instrument status events shown in Table 4-2. When one of these events occurs, it sets a corresponding bit in the Standard Event Status Register.

NOTE

The Standard Event Status Register bits are not reported in the Status Byte Register unless unmasked by the Standard Event Status Enable Register. Refer to the section "Unmasking Standard Event Status Bits" for more information.

Table 4-2. Standard Event Status Register

Bit Number	Decimal Weight	Description
0	1	Operation Complete. The instrument has completed all pending operations. This bit is set in response to the *OPC command.
1	2	Request Control. An instrument is requesting permission to become the active HP-IB controller.
2	4	Query Error. A problem has occurred in the instrument's output queue.
3	8	Device Dependent Error. An instrument operation did not complete possibly because of an abnormal hardware or firmware condition (overload occurred, self-test failure, loss of calibration or configuration memory, etc.)
4	16	Execution Error. The instrument cannot do the operation(s) requested by a command.
5	32	Command Error. The instrument cannot understand or execute the command.
6	64	User Request. The instrument is under local (front panel) control.
7	128	Power-On. Power has been applied to the instrument. You must execute the *PSC 0 command to the System Instrument to allow this bit to remain enabled when power is cycled. See the *PSC command later in this chapter for an example.
8-15		Reserved for future use (always return zero).

Unmasking Standard Event Status Bits

To allow any of the Standard Event Status register bits to set bit 5 (ESB) of the Status Byte register, you must first unmask the bit(s) using the Standard Event Status Enable register with the command:

*ESE

For example, suppose your application requires an interrupt whenever any type of error occurs. The error related bits in the Standard Event Status register are bits 2 through 5. The sum of the decimal weights of these bits is 60. You can enable any one of these bits to set bit 5 in the Status Byte Register by sending:

*ESE 60

If you want to generate a service request following any one of these errors, you can do so by unmasking bit 5 (ESB) in the Status Byte register:

*SRE 32

*ESE 60

Now, whenever an error occurs, it will set one of the bits 2 - 5 in the Standard Event Status register which will set bit 5 in the Status Byte register. Since bit 5 is

unmasked, an HP-IB service request (SRQ) will be generated. ("Interrupting the External Computer", later in this chapter contains an example program which demonstrates this sequence).

Note that the Standard Event Status Register bits that are not unmasked still respond to their corresponding conditions. They do not, however, set bit 5 in the Status Byte Register.

Reading the Standard Event Status Enable Register Mask

You can determine which bits in the Standard Event Status register are unmasked with the command:

*ESE?

This command returns the decimal weighted sum of all unmasked bits.

The Standard Event Status Enable register is cleared (all bits masked) by sending the command:

*ESE 0

Reading the Standard Event Status Register

You can determine which bits in the Standard Event Status register are set using the command:

*ESR?

This command returns the decimal weighted sum of all set bits. *ESR? clears the register. *CLS also clears the register.

Both of these commands return the decimal weighted sum of all set or enabled bits.

Operation Status Group

The registers in the Standard Operation Status Group provide information about the state of measurement functions within an instrument. These functions are represented by bits in the Condition register which is described in Table 4-3.

The System Instrument (Command Module) only uses bit 8 in the Condition register. Bit 8 (when set) indicates that an interrupt set up by the DIAGnostic:INTerrupt commands has occurred and has been acknowledged.

NOTE

The registers in the Operation Status Group and the DIAGnostic:INTerrupt commands are only used when, for a specific VXIbus interrupt line, it is necessary to replace the operating system's interrupt service routine with the System Instrument's service routine. Hewlett-Packard VXIbus devices used with the Command Module use the operating system service routine. The VXIbus interrupt line that is used by these devices (primarily line 1), should not be used with the DIAGnostic:INTerrupt commands.

The DIAGnostic:INTerrupt commands are covered in Chapter 5.

Table 4-3. Operation Status Group - Condition Register

Bit Number	Decimal Weight	Description
0	1	Calibrating
1	2	Settling
2	4	Ranging
3	8	Sweeping
4	16	Measuring
5	32	Waiting for TRG
6	64	Waiting for ARM
7	128	Correcting
8	256	Interrupt acknowledged (System Instrument)
9-12		Instrument Dependent
13-14		Reserved
15		Always zero

Reading the Condition Register

When an event monitored by the Condition register has occurred or is occurring, a corresponding bit in the register is set. The bit which is set can be determined with the command:

STATUS:OPERation:CONDition?

The data which is returned is the decimal weighted sum of the set bit. Since bit 8 is the only bit used by system instrument, 256 is returned if the bit is set.

Bit 8 in the Condition register is cleared with the command:

DIAGnostic:INTerrupt:RESPonse?

Unmasking the Operation Event Register Bits

When a condition monitored by the condition register occurs, a corresponding bit in the Operation Status Group Event register is automatically set. In order for this condition to generate a service request, the bit in the Event register must be unmasked using the Operation Status Group Enable register. This is done using the command:

STATUS:OPERation:ENABle < event >

where *event* is the decimal weight of the bit to be unmasked. Since the system instrument only uses bit 8, the only useful value of *event* is 256.

When bit 8 is set and is unmasked, it sets bit 7 in the Status Byte register in the Status Byte Group.

Bits in the Operation Status Group Event register which are unmasked can be determined with the command:

STATUS:OPERation:ENABle?

The command returns the decimal weighted sum of the unmasked bit(s).

Bits in the Operation Status Group Event register which are set can be determined with the command:

```
STATUS:OPERation:EVENT?
```

This command returns the decimal weighted sum of the set bit(s).

Clearing the Operation Event Register Bits

Bits in the Operation Status Group Event register are cleared with the command:

```
STATUS:OPERation:EVENT?
```

or the bits can be cleared with the command:

```
*CLS
```

The Operation Status Group Enable register is cleared (all bits masked) by sending the command:

```
STATUS:OPERation:ENABLE 0
```

Using the Operation Status Group Registers

The following example shows the sequence of commands used to setup and respond to an interrupt using the system instrument interrupt servicing routine.

NOTE

An interrupt handler must be assigned to handle the interrupt on the VXIbus backplane interrupt line specified. See "Interrupt Line Allocation" in Chapter 2 for more information.

```
!Call computer subprogram Intr_resp when a service request  
! is received due to an interrupt on a VXIbus backplane  
! interrupt line.
```

```
ON INTR 7 CALL Intr_resp
```

```
ENABLE INTR 7;2
```

```
!Unmask bit 7 in the Status Byte register so that a service  
! request (SRQ) will occur when an interrupt occurs.  
!Unmask bit 8 in the Operation Status Group Enable register  
!so that when the interrupt occurs it will set bit 7 in the  
!Status Byte register.
```

```
OUTPUT 70900; "**SRE 128"
```

```
OUTPUT 70900; "STAT:OPER:ENAB 256"
```

```
!Set up interrupt line 5 and enable interrupt response data  
!to be generated.
```

```
OUTPUT 70900; "DIAG:INT:SETUP5 ON"
```

```
OUTPUT 70900; "DIAG:INT:ACT ON"
```

```
.  
.  
(Program which executes until interrupt occurs)  
.  
.
```

```
!Computer service request routine which does an SPOLL  
!to determine the cause of the interrupt, then reads  
!(and clears) the Operation Event register to determine which  
!event occurred, and then reads the interrupt acknowledge  
!response (which also clears condition register bit 8).
```

```
SUB Intr_resp
  B = SPOLL(70900)
  OUTPUT 70900; "STAT:OPER:EVENT?"
  ENTER 70900; E
  OUTPUT 70900; "DIAG:INTR:RESP?"
  ENTER 70900; R
.
.
.
SUBEND
```

Clearing Status

The *CLS command clears all status registers (Standard Event Status Register, Standard Operation Status Event Register, Questionable Data Status Event Register) and the error queue for an instrument. This clears the corresponding summary bits (bits 3, 5, & 7) and the instrument-specific bits (bits 0, 1, & 2) in the Status Byte Register. *CLS does not affect which bits are enabled to be reflected in the Status Byte Register or enabled to assert SRQ.

Interrupting an External Computer

When a bit in the status byte register is set and has been enabled to assert SRQ (*SRE command), the instrument sets the HP-IB SRQ line true. Interrupts can be used to alert an external computer to suspend its present operation and find out what service the instrument requires. (Refer to your computer/language manuals for information on how to program the computer to respond to the interrupt.)

To allow any of the status byte register bits to set the SRQ line true, you must first enable the bit(s) with the *SRE command. For example, suppose your application requires an interrupt whenever a message is available in the instrument's output queue (status byte register bit 4). The decimal weight of this bit is 16. You can enable bit 4 to assert SRQ by sending:

```
*SRE 16
```

NOTE

You can determine which bits are enabled in the Status Register using *SRE?. This command returns the decimal weighted sum of all enabled bits.

Example: Interrupting when an Error Occurs

This program shows how to interrupt an external computer whenever an error occurs for the instrument being programmed which, in this example, is a multimeter at secondary address 03.

```
10 OPTION BASE 1                                !Array numbering starts with 1
20 ON INTR 7 CALL Errmsg
   !When SRQ occurs on interface 7, call subprogram
30 ENABLE INTR 7;2
   !Enable SRQ interrupt, interface 7
40 OUTPUT 70903;"*SRE 32"
   !Enable bit 5 (Standard Event Status Bit) in Status Byte Register
50 OUTPUT 70903;"*ESE 60"
   !Enable error bits (bits 2-5) in Standard Event Status Register to be reflected
   ! in Status Byte Register
60 OUTPUT 70903;"MEAS:TEMP? TC,T,@104"
   !Measure temperature with voltmeter
70 WAIT 2
80 ENTER 70903;Tmp_rdg                            !Enter temperature reading
90 PRINT Tmp_rdg                                  !Print temperature reading
100 END
110 SUB Errmsg
120 DIM Message$(256)                             !Create array for error message
130 CLEAR 70903                                   !Clear multimeter
140 B = SPOLL(70903)
   !Serial poll multimeter (clears SRQ)
150 REPEAT
   !Repeat next 3 lines until error number = 0
160 OUTPUT 70903;"SYST:ERR?"                      !Read error from queue
170 ENTER 70903;Code,Message$                    !Enter error number & message
180 PRINT Code,Message$                          !Print error number & message
190 UNTIL Code=0
200 OUTPUT 70903;"*CLS"                           !Clear status structures
210 STOP
220 SUBEND
```

Synchronizing an External Computer and Instruments

The *OPC? and *OPC commands (operation complete commands) allow you to maintain synchronization between an external computer and an instrument. The *OPC? query places an ASCII character 1 into the instrument's output queue when all pending instrument operations are finished. By requiring the computer to read this response before continuing program execution, you can ensure synchronization between one or more instruments and an external computer.

The *OPC command sets bit 0 (Operation Complete Message) in the Standard Event Status Register when all pending instrument operations are finished. By enabling this bit to be reflected in the Status Byte Register, you can ensure synchronization using the HP-IB serial poll function.

Example: Synchronizing an External Computer and Two Instruments using the OPC? query.

This example uses a D to A Converter module (DAC) at secondary address 09 and a Scanning Voltmeter at secondary address 03. The application requires the DAC to output a voltage to a device under test. After the voltage is applied, the voltmeter measures the response from the device under test. The *OPC? command ensures that the voltage measurement will be made only after the voltage is applied by the DAC.

```
10 OUTPUT 70909;"SOUR:VOLT1 5;*OPC?"  
    !Configure DAC to output 5 volts on channel 1; place 1 in  
    output  
    !queue when done  
20 ENTER 70909;A  
    !Wait for *OPC? response  
30 OUTPUT 70903;"MEAS:VOLT:DC? (@104)"  
    !Measure DC voltage on device under test  
40 ENTER 70903;A  
    !Enter voltage reading  
50 PRINT A  
    !Print reading  
60 END
```

Example: Synchronizing an External Computer and Two Instruments using the *OPC command.

This example uses the *OPC command and serial poll to synchronize an external computer and two instruments (DAC at secondary address 09; Scanning Voltmeter at secondary address 03). The advantage to using this method over *OPC? query method is that the computer can do other operations while it is waiting for the instrument(s) to complete operations. When using this method, the Operation Complete bit (bit 0) must be the only enabled bit in the Standard Event Status Register (*ESE 1 command). If other bits (such as error bits) are enabled, you must make sure that bit 0 causes the interrupt.

```
10 OUTPUT 70909;"*CLS"  
    !Clear all status structures on instrument at secondary address  
    09  
20 OUTPUT 70909;"*ESE 1"  
    !Enable Operation Complete to be reflected in bit 5 of the  
    Status Byte Register  
30 OUTPUT 70909;"SOUR:VOLT1 5;*OPC"  
    !Configure instrument #1, set Operation Complete bit when  
    done  
40 WHILE NOT BIT(S POLL(70909),5)  
    !While waiting for bit 5 in instrument's Status Byte Register to  
    be set,  
    !computer can do other operations  
50 !(Computer does other operations here)  
60 END WHILE  
70 OUTPUT 70903;"MEAS:VOLT:DC? (@104)"  
    !Measure DC voltage using instrument #2  
80 END
```

System Instrument Command Reference

About This Chapter

This chapter describes the **Standard Commands for Programmable Instruments (SCPI)** command set and the **IEEE 488.2 Common Commands** for the System Instrument. The System Instrument is part of the HP E1300/E1301 Mainframe's internal control processor and is therefore always present in a Mainframe. This chapter contains the following sections:

- Command Types 7-1
- SCPI Command Reference 7-4
- Common Command Reference 7-65
- HP-IB Message Reference 7-72
- Command Quick Reference 7-75

Command Types

Commands are separated into two types: IEEE 488.2 Common Commands and SCPI Commands.

Common Command Format

The IEEE 488.2 standard defines the Common commands that perform functions like reset, self-test, status byte query, etc. Common commands are four or five characters in length, always begin with the asterisk character (*), and may include one or more parameters. The command keyword is separated from the first parameter by a space character. Some examples of Common commands are shown below:

```
*RST, *ESE <mask>, *STB?
```

SCPI Command Format

The SCPI commands perform functions like closing switches, making measurements, and querying instrument states or retrieving data. A subsystem command structure is a hierarchical structure that usually consists of a top level (or root) command, one or more lower level commands, and their parameters. The following example shows part of a typical subsystem:

```
[ROUTE:]
  CLOSe <channel_list>
  SCAN <channel_list>
  :MODE?
```

ROUTE: is the root command, CLOSe and SCAN are second level commands with parameters, and :MODE? is a third level command.

Command Separator A colon (:) always separates one command from the next lower level command as shown below:

ROUTe:SCAN:MODE?

Colons separate the root command from the second level command (ROUTe:SCAN) and the second level from the third level (SCAN:MODE?).

Abbreviated Commands The command syntax shows most commands as a mixture of upper and lower case letters. The upper case letters indicate the abbreviated spelling for the command. For shorter program lines, send the abbreviated form. For better program readability, you may send the entire command. The instrument will accept either the abbreviated form or the entire command.

For example, if the command syntax shows MEASure, then MEAS and MEASURE are both acceptable forms. Other forms of MEASure, such as MEASU or MEASUR will generate an error. You may use upper or lower case letters. Therefore, MEASURE, measure, and MeAsUrE are all acceptable.

Implied Commands Implied commands appear in square brackets ([]) in the command syntax. (The brackets are not part of the command, and are not sent to the instrument.) Suppose you send a second level command but do not send the preceding implied command. In this case, the instrument assumes you intend to use the implied command and it responds as if you had sent it. Examine the SOURCE subsystem shown below:

```
[SOURCE:]
  PULSe
    :COUNT
    :COUNT?
    :PERIOD
    :PERIOD?
```

The root command SOURCE: is an implied command. To set the instrument's pulse count to 25, you can send either of the following command statements:

SOUR:PULS:COUN 25 or PULS:COUN 25

Variable Command Syntax Some commands have what appears to be a variable syntax. For example:

DIAG:INT:SETUp[n]? and SYST:COMM:SERial[n]:BAUD?

In these commands, the "n" is replaced by a number. No space is left between the command and the number because the number is not a parameter. The number is part of the command syntax. The purpose of this notation is to save a great deal of space in the command reference. In the case of ...SETUp[n], n could range from 1 through 7. In ...SERial[n]..., n can be from 0 through 7. You can send the command without the [n] and a default value will be used by the instrument. Some examples:

DIAG:INT:SETUP2?, DIAG:INT:PRI2 5, SYST:COMM:SER1:BAUD 9600

Parameters **Parameter Types.** The following list contains explanations and examples of parameter types you will see later in this chapter.

- **Numeric Parameters** are commonly used decimal representations of numbers including optional signs, decimal points, and scientific notation

(e.g., 123, 123E2, -123, -1.23E2, .123, 1.23E-2, 1.23000E-01). Special cases include MIN, MAX, and INFINITY. The Comments section within the Command Reference will state whether a numeric parameter can also be specified in hex, octal, and/or binary. #H7B, #Q173, #B1111011

- **Boolean parameters** represent a single binary condition that is either true or false (e.g., ON, OFF, 1, 0). Any non-zero value is considered true.

Discrete parameters select from a finite number of values. These parameters use mnemonics to represent each valid setting. An example is the TRIGGER:SOURCE <source> command where *source* can be BUS, EXT, HOLD, or IMM.

- **Arbitrary Block Program Data parameters** are used to transfer blocks of data in the form of bytes. The block of data bytes is preceded by a preamble which indicates either 1) the number of data bytes which follow, or 2) that the following data block will be terminated upon receipt of a New Line message with the EOI signal true. The syntax is:

Definite Length Block

< non-zero digit > < digit(s) > < data byte(s) >

Where the value of < non-zero digit > equals the number of < digit(s) >. The value of < digit(s) > taken as a decimal integer indicates the number of < data byte(s) > in the block.

Indefinite Length Block

#0 < data byte(s) > < NL ^ END >

Examples of sending 4 data bytes:

```
#14 < byte > < byte > < byte > < byte >
#3004 < byte > < byte > < byte > < byte >
#0 < byte > < byte > < byte > < byte > < NL ^ END >
```

Optional Parameters. Parameters shown within square brackets ([]) are optional parameters. (Note that the brackets are not part of the command, and are not sent to the instrument.) If you do not specify a value for an optional parameter, the instrument chooses a default value. For example, consider the ARM:COUNT? [< MIN | MAX >] command. If you send the command without specifying a parameter, the present ARM:COUNT value is returned. If you send the MIN parameter, the command returns the minimum count available. If you send the MAX parameter, the command returns the maximum count available. Be sure to place a space between the command and the parameter.

Linking Commands

Linking IEEE 488.2 Common Commands with SCPI Commands. Use a semicolon between the commands. For example:

```
*RST;OUTP ON or TRIG:SOUR HOLD;*TRG
```

Linking Multiple SCPI commands. Use both a semicolon and a colon between the commands. For example:

```
ARM:COUN 1;;TRIG:SOUR EXT
```

SCPI Command Reference

This section describes the SCPI commands for the System Instrument. Commands are listed alphabetically by subsystem and also within each subsystem. A command guide is printed in the top margin of each page. The guide indicates the first command listed on that page.

ABORT

The ABORT subsystem is a part of the System Instrument's trigger system. ABORT resets the trigger system from its Wait For Trigger state to its Idle state and aborts any pacer pulse train in progress. ABORT performs the opposite function of the INITiate:IMMediate command. INITiate enables the trigger system, while ABORT disables it.

Subsystem Syntax ABORT

- Comments**
- ABORT does not affect any other settings of the trigger system. When the INITiate command is sent, the trigger system will respond just as it did before the ABORT command was sent.
 - **Related Commands:** INITiate, TRIGger
 - ***RST Condition:** ABORT

Example **Stopping Pacer pulses with ABORT**

TRIG:SOUR HOLD

trigger source is TRIG command

SOUR:PULS:COUN 1E3

output 1000 Pacer pulses

SOUR:PULS:PER .1 S

pulse period set to .1 second

INIT

go to Wait For Trigger state

TRIG

trigger the Pacer to output pulses

ABORT

go to Trigger-Idle state and stop Pacer pulses

DIAGnostic

The DIAGnostic subsystem allows control over the System Instrument's internal processor system (:BOOT, and :INTerrupt), the allocation and contents of User RAM, and, disc volume RAM (:NRAM, and :RDISK), and allocation of the built-in serial interface (:COMM:SER:OWNer).

Subsystem Syntax DIAGnostic

```

:BOOT
  :COLD
  [:WARM]
:COMMunicate
  :SERial[0]
    [:OWNer] [SYSTem|IBASic|NONE]
    [:OWNer]?
  :SERial[n]
  :STORe
:DOWNload
  :CHECKed
    [:MADDress] < address > , < data >
    :SADDress < address > , < data >
    [:MADDress] < address > , < data >
    :SADDress < address > , < data >
:DRAM
  :AVAlable?
  :CREate < size > < num_drivers >
  :CREate? < MIN|MAX > , < MIN|MAX|DEF >
:DRIVER
  :LOAD < driver_block >
  :CHECKed < driver_block >
  :LIST
    :ALL?
    :RAM?
    :ROM?
:INTerrupt
  :ACTivate [ON|OFF|1|0]
  :SETup[n] [ON|OFF|1|0]
  :SETUP[n]?
  :PRiority[n] [ < priority > |MIN|MAX|DEF]
  :PRiority[n]? [MIN|MAX|DEF]
  :RESPonse?
:NRAM
  :ADDRess?
  :CREate < size > |MIN|MAX
  :CREate? [MAX|MIN]
:PEEK? < address > , < width >
:POKE < address > , < width > , < data >
:RDISK
  :ADDRess?
  :CREate < size > |MIN|MAX
  :CREate? [MIN|MAX]
:UPLoad
  [:MADDress]? < address > , < byte_count >
  SADDress? < address > , < byte_count >

```

:BOOT:COLD **DIAGnostic:BOOT:COLD** causes the System Instrument to restart (re-boot). Configurations stored in non-volatile memory and RS-232 configurations are reset to their default states:

- DRAM, NRAM, and RDISk memory segments are cleared
- Serial Interface parameters set to:
 - BAUD 9600
 - BITS 8
 - PARity NONE
 - SBITs 1
 - DTR ON
 - RTS ON
 - PACE XON
- Serial 0 Owner = system

NOTE

Resetting the serial interface parameters takes about 0.01 seconds for the built-in serial port and 0.75 seconds per serial plug-in card. While this is taking place the System Instrument will still respond to serial polls. If you are using a serial poll to determine when the cold boot cycle is complete, you should insert a delay of 1 second per plug-in serial card (E1324) before polling the system instrument. This will prevent incorrectly determining that the system instrument has completed its boot cycle.

- Comments**
- The System Instrument goes through its power-up self tests.
 - **Related Commands:** DIAG:BOOT:WARM

Example Re-booting the System Instrument (cold)

DIAG:BOOT:COLD *force boot*

:BOOT[:WARM]

DIAGnostic:BOOT[:WARM] causes the System Instrument to restart (re-boot) using the current configuration stored in non-volatile memory. The effect is the same as cycling power.

Comments

- The System Instrument goes through its power-up self tests.
- The non-volatile system state is used for configuration wherever applicable.
- **Related Commands:** DIAG:BOOT:COLD

Example

Booting the System Instrument (warm)

DIAG:BOOT:WARM *force boot*

**:COMMunicate
:SERial[0][:OWNer]**

DIAGnostic:COMMunicate:SERial[0][:OWNer] <owner > Allocates the built-in serial interface to the System Instrument, the optional IBASIC interpreter, or to neither.

Parameters

Parameter Name	Parameter Type	Range of Values	Default Units
<i>owner</i>	discrete	SYSTEM IBASIC NONE	none

Comments

- While the serial interface is allocated to the Command Module (SYSTEM), it can function as the mainframe user interface when connected to a terminal or computer running terminal emulation software.
- When the built-in serial interface is allocated to IBASIC, it is controlled only by IBASIC. The serial interface is given a select code of 9, and any RS-232 device connected to the (Command Module) RS-232 port is programmed accordingly.
- If the built-in serial interface is not needed, specifying NONE will release memory for use by other instruments.
- Once the new serial interface owner has been specified (DIAG:COMM:SER:OWN), the change will not take effect until you re-boot (warm) the system.
- **Related Commands:** DIAGnostic:COMMunicate:SERial[:OWNer]

Example

Give the serial interface to IBASIC.

DIAG:COMM:SER IBAS *Note; :OWNer is implied*
DIAG:BOOT:WARM *Complete the allocation*

DIAGnostic:COMMunicate :SERial[0][:OWNer]?

:COMMunicate :SERial[0][:OWNer]?

DIAGnostic:COMMunicate:SERial[0][:OWNer]? Returns the current "owner" of the built-in serial interface. The values returned will be; "SYST", "IBAS", or "NONE".

Comments ● **Related Commands:** DIAGnostic:SERial[:OWNer]

Example Determine which instrument has the serial interface.

DIAG:COMM:SER?

enter statement

*Note; :OWNer is implied
statement returns the string
SYST, IBAS, or NONE*

:COMMunicate :SERial[n]:STORE

DIAGnostic:COMMunicate:SERial[n]:STORE Stores the serial communications parameters (e.g. BAUD, BITS, PARity etc.) into non-volatile storage for the serial interface specified by [n] in SERial[n].

- Comments**
- Until ...STORE is executed, communication parameter values are stored in *volatile* memory, and a power failure will cause the settings to be lost.
 - DIAG:COMM:SER(1-7):STOR causes an HP E1324A (B-size RS-232 card) to store its settings in an on-board EEROM. This EEROM write cycle takes nearly one second to complete. Wait for this operation to complete before attempting to use that serial interface.
 - The HP E1324A's EEROM used to store its serial communication settings has a finite lifetime of approximately ten thousand write cycles. Even if your application program sent the ...STORE command once every day, the lifetime of the EEROM would still be over 27 years. Be careful that your application program sends the ...STORE command to an HP E1324A no more often than is necessary.
 - **Related Commands:** all SYST:COMM:SER[n]... commands

Example Store the serial communications settings in the third HP E1324A.

DIAG:COMM:SER3:STOR

**:DOWNload:CHECked
[:MADdress]**

DIAGnostic:CHECked:DOWNload[:MADdress] < address>, < data> writes *data* into a non-volatile User RAM segment starting at *address* using error correction. The User RAM segment is allocated by the DIAG:NRAM:CREate or DIAG:DRAM:CREate command.

Parameters

Parameter Name	Parameter Type	Range of Values	Default Units
<i>address</i>	numeric	0 to 16,777,215 (#HFFFFFFE)	none
<i>data</i>	arbitrary block program data	See "Parameter Types", in the beginning of this chapter	none

Comments

- This command is typically used to send a block of data to a block of user RAM. It is the only way to send binary data to multiple addresses over a serial (RS232C) line.
- **CAUTION:** Be certain that *all* of the data you download will be contained entirely within the allocated NRAM segment. Writing data outside of the NRAM segment will disrupt the operation of the Command Module. Most computers terminate an OUTPUT, PRINT, or WRITE statement with a carriage return or carriage return and line feed. These End-Of-Line characters must be either accounted for (NRAM segment sized to accommodate them), or suppressed using an appropriate IMAGE or FORMAT statement. Some helpful methods:
 - Size the NRAM segment a little larger than the expected data block
 - Control the End-Of-Line characters with format statements.
 - Use the *Definite Length Arbitrary Block Program Data* format (see example) to send your data rather than the *Indefinite Length Arbitrary Block Program Data* format.
- *Address* may be specified in decimal, hex (#H), octal (#Q), or binary (#B) formats. DOWNload is done by word (16 bit) access so *address* must be even.
- Be certain that *address* specifies a location within the User RAM segment allocated using DIAG:NRAM:CREate if you are downloading a configuration table. DIAG:DOWNload can change the contents of System RAM causing unpredictable results.
- This command can also be used to write data to a device with registers in the A16 address space. See :DOWNload:SADdress.
- **Related Commands:** DIAG:NRAM:CREate, DIAG:NRAM:ADDRes?, DIAG:UPLoad?, VXI:CONF:CTABLE, VXI:CONF:DCTable, VXI:CONF:ITABLE, VXI:CONF:MTABLE

DIAGnostic:DOWNload:CHECKed [:MADDRESS]

Byte Format Each byte sent with this command is expected to be in the following format:

Bit #	7	6	5	4	3	2	1	0
	<i>Control Bit</i>	<i>Check Bits</i>			<i>Data Bits</i>			

- *Control Bit* is used to indicate the serial driver information such as clear, reset, or end of transmission. This bit is ignored by the regular 488.2 driver. The control bit should be one for regular data.
- *Check Bits* are used to detect and correct a single bit error. The control bit is not included in the check. The check bits are a Hamming single bit error correction code, as specified by the following table:

Data Value	Check Bits
0	0
1	7
2	6
3	1
4	5
5	2
6	3
7	4
8	3
9	4
10	5
11	2
12	6
13	1
14	0
15	7

- *Data bits* are the actual data being transferred (four bits at a time). Each word to be written requires four data bytes for transmission. The significance of the data is dependant on the order received. The first data byte received contains the most significant nibble of the 16 bit word to be written (bits 15-12). The next data byte received contains the least significant nibble of the most significant byte of the word (bits 11-8). The third data byte received contains the most significant nibble of the least significant byte of the word (bits 7-4). The fourth data byte received contains the least significant nibble of the least significant byte of the word to be written (bits 3-0). Once all four bytes have been received the word will be written.

**:DOWNload:CHECKed
:SADDRESS**

DIAGnostic:CHECKed:DOWNload:SADDRESS < address> , < data> writes *data* to non-volatile User RAM at a single address specified by *address* using error correction. It can also write to devices with registers in the A16 address space.

Parameters

Parameter Name	Parameter Type	Range of Values	Default Units
<i>address</i>	numeric	0 to 16,777,215 (#HFFFFFFE)	none
<i>data</i>	arbitrary block program data	See "Parameter Types", in the beginning of this chapter	none

Comments

- This command is typically used to send data to a device which accepts data at a single address. It is the only way to send binary data to single addresses over a serial (RS232C) line.
- Most computers terminate an OUTPUT, PRINT, or WRITE statement with a carriage return or carriage return and line feed. These End-Of-Line characters must be either accounted for (NVRAM segment sized to accommodate them), or suppressed using an appropriate IMAGE or FORMAT statement. Some helpful methods:
 - Control the End-Of-Line characters with format statements.
 - Use the *Definite Length Arbitrary Block Program Data* format (see example) to send your data rather than the *Indefinite Length Arbitrary Block Program Data* format.
- A register address in A16 address space can be determined by:

$$1FC00_{16} + (LADDR * 64) + register_number$$
 where $1FC00_{16}$ is the base address in the System Instrument A16 space, LADDR is the device logical address, 64 is the number of address bytes per device, and register_number is the register to which the data is written.

If the device is an A24 device, the address can be determined using the VXI:CONF:DLIST command to find the base address in A24, and then adding the register_number to that value. A24 memory between address 200000_{16} and address $E00000_{16}$ is directly addressable by the Controller.
- *Address* may be specified in decimal, hex (#H), octal (#Q), or binary (#B) formats. DOWNload is done by word (16 bit) access so *address* must be even.
- **Related Commands:** DIAG:UPLoad:SADDRESS?

DIAGnostic:DOWNload:CHECKed :SADDRESS

Byte Format Each byte sent with this command is expected to be in the following format:

Bit #	7	6	5	4	3	2	1	0
	<i>Control Bit</i>			<i>Check Bits</i>			<i>Data Bits</i>	

- *Control Bit* is used to indicate the serial driver information such as clear, reset, or end of transmission. This bit is ignored by the regular 488.2 driver. The control bit should be one for regular data.
- *Check Bits* are used to detect and correct a single bit error. The control bit is not included in the check. The check bits are a Hamming single bit error correction code, as specified by the following table:

Data Value	Check Bits
0	0
1	7
2	6
3	1
4	5
5	2
6	3
7	4
8	3
9	4
10	5
11	2
12	6
13	1
14	0
15	7

- *Data bits* are the actual data being transferred (four bits at a time). Each word to be written requires four data bytes for transmission. The significance of the data is dependant on the order received. The first data byte received contains the most significant nibble of the 16 bit word to be written (bits 15-12). The next data byte received contains the least significant nibble of the most significant byte of the word (bits 11-8). The third data byte received contains the most significant nibble of the least significant byte of the word (bits 7-4). The fourth data byte received contains the least significant nibble of the least significant byte of the word to be written (bits 3-0). Once all four bytes have been received the word will be written.

**:DOWNload
[:MADDRESS]**

DIAGnostic:DOWNload[:MADDRESS] < address>, < data> writes *data* into a non-volatile User RAM segment starting at *address*. The User RAM segment is allocated by the DIAG:NRAM:CREate command.

Parameters

Parameter Name	Parameter Type	Range of Values	Default Units
<i>address</i>	numeric	0 to 16,777,215 (#HFFFFFFE)	none
<i>data</i>	arbitrary block program data	See "Parameter Types", in the beginning of this chapter	none

Comments

- **CAUTION:** Be certain that *all* of the data you download will be contained entirely within the allocated NRAM segment. Writing data outside of the NRAM segment will disrupt the operation of the Command Module. Most computers terminate an OUTPUT, PRINT, or WRITE statement with a carriage return or carriage return and line feed. These End-Of-Line characters must be either accounted for (NRAM segment sized to accommodate them), or suppressed using an appropriate IMAGE or FORMAT statement. Some helpful methods:
 - Size the NRAM segment a little larger than the expected data block
 - Control the End-Of-Line characters with format statements.
 - Use the *Definite Length Arbitrary Block Program Data* format (see example) to send your data rather than the *Indefinite Length Arbitrary Block Program Data* format.
- This command is generally used to download data into User Configuration Tables. These tables allow the user to control the system's dynamic configuration DOWNload uses word writes.
- *Address* may be specified in decimal, hex (#H), octal (#O), or binary (#B) formats. DOWNload is done by word (16 bit) access so *address* must be even.
- Be certain that *address* specifies a location within the User RAM segment allocated using DIAG:NRAM:CREate if you are downloading a configuration table. DIAG:DOWNload can change the contents of System RAM causing unpredictable results.
- This command can also be used to write data to a device with registers in the A16 address space. See :DOWNload:SADDRESS.
- **Related Commands:** DIAG:NRAM:CREate, DIAG:NRAM:ADDRESS?, DIAG:UPLoad?, VXI:CONF:CTABLE, VXI:CONF:DCTable, VXI:CONF:ITABLE, VXI:CONF:MTABLE

DIAGnostic:DOWNload:SADdress

Example Loading Dynamic Configuration information into an allocated RAM segment.

```

DIAG:NRAM:CRE 6           Allocate a segment of user
                           RAM
DIAG:BOOT:WARM           Re-boot system to complete
                           allocation
DIAG:NRAM:ADDR?         query starting address
- enter value to variable X get starting address into X
DIAG:DOWN < value of X >,table data download table data
VXI:CONF:DCTAB < value of X > link configuration table to
                           configuration algorithm
DIAG:BOOT:WARM           Re-boot to set new
                           configuration
    
```

:DOWNload:SADdress

DIAGnostic:DOWNload:SADdress < address >, < data > writes *data* to non-volatile User RAM at a single address specified by *address*, and writes data to devices with registers in A16 address space.

Parameters

Parameter Name	Parameter Type	Range of Values	Default Units
<i>address</i>	numeric	0 to 16,777,215 (#HFFFFFFE)	none
<i>data</i>	arbitrary block program data	See "Parameter Types", in the beginning of this chapter	none

Comments

- Most computers terminate an OUTPUT, PRINT, or WRITE statement with a carriage return or carriage return and line feed. These End-Of-Line characters must be accounted for or suppressed using an appropriate IMAGE or FORMAT statement. Some helpful methods:
 - Control the End-Of-Line characters with format statements.
 - Use the *Definite Length Arbitrary Block Program Data* format to send your data rather than the *Indefinite Length Arbitrary Block Program Data* format.
- A register address in A16 address space can be determined by:

$$1FC000_{16} + (LADDR * 64) + register_number$$
 where $1FC000_{16}$ is the base address in the System Instrument A16 address space, LADDR is the device logical address, 64 is the number of address bytes per device, and register_number is the register to which the data is written.

If the device is an A24 device, the address can be determined using the VXI:CONF:DLIST command to find the base address in A24, and then adding the register_number to that value. A24 memory between address 200000_{16} and address $E00000_{16}$ is directly addressable by the Controller.
- *Address* may be specified in decimal, hex (#H), octal (#O), or binary (#B) formats. DOWNload is done by word (16 bit) access so *address* must be even.
- **Related Commands:** DIAG:UPLoad:SADdress?

Example Downloading Data to a Single Address Location

This program downloads an array with the data 1, 2, 3, 4, 5 to register 32 on a device with logical address 40 in VXIbus A16 address space.

```

DIM Dnld_data(1:5)           Dimension controller array
DATA 1,2,3,4,5
READ Dnld_data(*)          Load data into controller array
"DIAG:DOWN:SADD #H1FCA20,#210";
    This line is sent without termination.
Send Dnld_data as 16-bit words Terminate after last word with
EOI or LF and EOI
    
```

:DRAM:AVailable? DIAGnostic:DRAM:AVailable? Returns the amount of RAM remaining (available) in the DRAM (Driver RAM) segment, which is the amount of RAM in the segment minus any previously loaded drivers.

- Comments**
- DIAG:DRAM:CREate does not allocate the RAM segment until after a subsequent re-boot.
 - **Related Commands:** DIAG:DRAM:CREate, DIAG:DRIVER:LOAD, DIAG:DRIVER:LIST?

Example Determine amount of space left for drivers in the DRAM segment.

```

DIAG:DRAM:AVA?
enter statement           statement returns available
DRAM in bytes.
    
```

:DRAM:CREate

DIAGnostic:DRAM:CREate <size> <num_drivers> creates a non-volatile RAM area for loading instrument drivers. DIAGnostic:DRAM:CREate 0 removes the RAM segment when the system is re-booted.

Parameters

Parameter Name	Parameter Type	Range of Values	Default Units
<i>size</i>	numeric	0 to available RAM or MIN MAX	none
<i>num_drivers</i>	numeric	0 to available RAM or MIN MAX DEF	8

Comments

- *size* is the number of bytes to be allocated to DRAM use. A *size* of zero will remove the DRAM segment.
- *num_drivers* is the maximum number of drivers to be loaded.
- The DRAM segment will be created only after the System Instrument has been re-booted (cycle power or execute DIAG:BOOT).
- Based on the *size* specified, DIAG:DRAM:CRE rounds the *size* up to an even value.
- DRAM will de-allocate previously allocated NRAM and RDISK segments.
- Using all of the available RAM (MAX) for the DRAM segment will limit some functions such as IBASIC program space, instrument reading storage space, and full functionality of the Display Terminal Interface.
- Use DIAG:DRIVER:LOAD... and, DIAG:DRIVER:LIST...? to load and manage DRAM.
- **Related Commands:**DIAG:DRAM:AVAILable?, DIAG:DRIVER:LOAD..., DIALG:DRIVER:LIST...?.

Example

Allocate a 15 Kbyte non-volatile Driver Ram segment.

DIAG:DRAM:CREate 15360

allocate 15 Kbyte segment of Driver Ram.

:DRAM:CREate?

DIAGnostic:DRAM:CREate? [<MIN|MAX>, <MIN|MAX|DEF>] returns the size (in bytes) of a previously created non-volatile RAM area for loading instrument drivers, and the number of drivers currently loaded.

- *size* is the number of bytes currently allocated to DRAM use.
- *num_drivers* is the number of drivers currently loaded.

:DRIVER:LOAD
 < driver_block >

DIAGnostic:DRIVER:LOAD < driver_block > loads the instrument driver contained in the driver_block into a previously created DRAM segment.

Parameters

Parameter Name	Parameter Type	Range of Values	Default Units
driver_block	arbitrary block program data	See "Parameter Types" at the beginning of this chapter.	none

Comments

- driver_block is the actual binary driver data to be transferred.
- **Related Commands:**DIAG:DRAM:AVailable?, DIAG:DRAM:CREate, DIAG:DRIVER:LIST...?.

Example

Download a driver block.

DIAG:DRIV:LOAD

downloads the driver < driver_block > to DRAM memory.

**:DRIVER :LOAD:
 CHECKed**
 < driver_block >

DIAGnostic:DRIVER:LOAD:CHECKed < driver_block > loads the instrument driver contained in the driver_block into a previously created DRAM segment. The driver_block is formatted in the same data byte format used by DOWNload:CHECKed.

Parameters

Parameter Name	Parameter Type	Range of Values	Default Units
driver_block	arbitrary block program data	See "Parameter Types" at the beginning of this chapter.	none

Comments

- driver_block is the actual binary driver data to be transferred.
- This is the only way to download a device driver over a serial (RS232C) line.
- **Related Commands:**DIAG:DRAM:AVailable?, DIAG:DRAM:CREate, DIAG:DRIVER:LIST...?.

Example

Download the driver named DIGITAL.DC.

DIAG:DRIVER:LOAD:CHEC

downloads the driver < driver_block > to DRAM memory.

DIAGnostic:DRIVER :LIST[:type]?

:DRIVER :LIST[:type]?

DIAGnostic:DRIVER:LIST[:type]? lists all drivers from the specified table found on the system. If no parameter is specified, all driver tables are searched and the data from each driver table is separated from the others by a semicolon.

Parameters

Parameter Name	Parameter Type	Range of Values	Default Units
<i>type</i>	discrete	ALL RAM ROM	ALL

For each driver listed, the following items are returned:

NAME, IDN_MODEL, REV_CODE, TABLE

Parameter	Description
<i>NAME</i>	The instrument name. This is the same label that appears on the instrument selection menu.
<i>IDN_MODEL</i>	The model name. This is the same model name as used in the response to the *IDN? command.
<i>REV_CODE</i>	The revision code. It is in the form A.nn.nn where A as an alpha character
<i>TABLE</i>	The name of the table the driver was found in. This will be RAM or ROM.

Comments

- DIAGnostic:DRIVER:LIST? lists all drivers found in the system.
- DIAGnostic:DRIVER:LIST:RAM? lists all drivers found in the RAM driver table DRAM.
- DIAGnostic:DRIVER:LIST:ROM? lists all drivers found in the ROM driver table.
- Related Commands:DIAG:DRAM:AVAILABLE?, DIAG:DRAM:CREATE, DIAG:DRIVER:LOAD...

Example List all drivers in the system.

DIAG:DRIV:LIST? *lists all drivers currently loaded.*

Example List all drivers in ROM.

DIAG:DRIV:LIST:ROM? *lists all of the drivers currently loaded in ROM.*

:INTerrupt:ACTivate

DIAGnostic:INTerrupt:ACTivate < mode> enables an interrupt on the VXI backplane interrupt line specified by DIAG:INT:SET[n] to be acknowledged.

Parameters

Parameter Name	Parameter Type	Range of Values	Default Units
<i>mode</i>	boolean	0 1 OFF ON	none

Comments

- When an interrupt occurs and has been acknowledged, the response is read with the DIAGnostic:INTerrupt:RESPonse? command.
- If an interrupt occurs on a VXIbus backplane interrupt line and the interrupt acknowledgement has not been enabled, there is no interrupt acknowledgement response. The interrupt will be held off until the interrupt acknowledge is enabled by either the DIAG:INT:ACT command or DIAG:INT:RESP? command.
- ON or 1 enable interrupt acknowledgement. OFF or 0 disables interrupt acknowledgement.
- Bit 8 in the Operation Status register can be used to indicate when an interrupt has been acknowledged. See chapter 6 for more details about this register.
- Interrupt acknowledgement must be re-enabled every time an interrupt is acknowledged
- **Related Commands:** DIAG:INT:PRIority[n], DIAG:INT:RESP?, DIAG:INT:SET[n]
- ***RST Condition:** DIAG:INT:ACTivate OFF (for all lines)

Example Enable an Interrupt Acknowledgement on Line 2.

```
DIAG:INT:SET2           Set up interrupt line 2
DIAG:INT:ACT ON        Enable interrupt to be
                        acknowledged
```

:INTerrupt:SETup[n]

DIAGnostic:INTerrupt:SETup[n] < mode> specifies that an interrupt on VXI backplane interrupt line [n] will be serviced by the System Instrument service routine (DIAGnostic:INTerrupt commands) rather than the operating system service routine.

Parameters

Parameter Name	Parameter Type	Range of Values	Default Units
<i>mode</i>	boolean	0 1 OFF ON	none

Comments

- ...SETup1 through ...SETup7 specify the VXI interrupt lines 1 through 7.
- Sending SETup without an [n] value specifies VXI interrupt line 1.

DIAGnostic:INTerrupt:SETup[n]?

- ON or 1 specify that interrupt handling is to be set up for the specified interrupt line. OFF or 0 indicate that interrupt handling of the specified line is to be done by the operating system.
- **Related Commands:** DIAG:INT:ACT, DIAG:INT:PRiority[n], DIAG:INT:RESP?
- ***RST Condition:** DIAG:INT:SETup[n] OFF (for all lines)

Example Setup and wait for VXI interrupt response on line 2.

DIAG:INT:PRI2 5	<i>set priority to 5 on line 2</i>
DIAG:INT:SETUP2 ON	<i>handle interrupt on line 2</i>
.	<i>code which will</i>
.	<i>initiate an action</i>
.	<i>resulting in an interrupt</i>
DIAG:INT:RESP?	<i>Read the acknowledge response</i>

:INTerrupt:SETup[n]?

DIAGnostic:INTerrupt:SETup[n]? Returns the current state set by DIAG:INT:SETUP[n] <mode>, for the VXI interrupt line specified by [n] in ...SETup[n]?

Comments

- ...SETup1? through ...SETup7? specify the VXI interrupt lines 1 through 7.
- Sending SETUP? without an [n] value specifies VXI interrupt line 1.
- If 1 is returned, interrupt handling is set up for the specified interrupt line using the System Instrument (DIAGnostic:INTerrupt commands). If 0 is returned, interrupt handling is done by the operating system.
- **Related Commands:** DIAG:INT:SETup[n], DIAG:INT:PRiority[n], DIAG:INT:ACT, DIAG:INT:RESP?

Example Determine interrupt setup for line 4.

DIAG:INT:SETUP4?	
enter statement	<i>statement returns 0 or 1</i>

:INTerrupt:PRiority[n]

DIAGnostic:INTerrupt:PRiority[n] [<level>] gives a priority level to the VXI interrupt line specified by [n] in ...PRiority[n].

Parameters

Parameter Name	Parameter Type	Range of Values	Default Units
<i>level</i>	numeric	1 through 7 MIN MAX DEF	none

Comments

- The priority of an interrupt line determines which line will be acknowledged first in the event that more than one line is interrupting.
- For *level*, lower values have lower priority (level 1 is lower priority than level 2).
- No parameter, or DEF (default) sets priority to 1.
- ...PRiority1 through ...PRiority7 specify the VXI interrupt lines 1 through 7.
- Sending PRiority without an [n] value specifies VXI interrupt line 1.
- This command has no effect if only one interrupt is to be set up.
- **Related Commands:** DIAG:INT:ACT, DIAG:INT:SETup[n], DIAG:INT:RESP?

Example Setup, set a priority, and wait for VXI interrupt response on line 2.

```
DIAG:INT:PRI2 5           handle interrupt on line 2
DIAG:INT:PRI2 5           set priority to 5 on line 2
.                          code which will
.                          initiate an action
.                          resulting in an interrupt
DIAG:INT:RESP?           Read the acknowledge response
```

:INTerrupt:PRiority[n]?

DIAGnostic:INTerrupt:PRiority[n]? Returns the current priority level set for the VXI interrupt line specified by [n] in ...PRiority[n]?

Comments

- ...PRiority?1 through ...PRiority?7 specify the VXI interrupt lines 1 through 7.
- Sending PRiority? without an [n] value specifies VXI interrupt line 1.
- **Related Commands:** DIAG:INT:PRiority[n], DIAG:INT:SETup[n], DIAG:INT:RESP?

Example Determine interrupt priority for line 4.

```
DIAG:INT:PRI4?
enter statement           statement returns 1 through 7
```

:INTerrupt:RESPonse?

DIAGnostic:INTerrupt:RESPonse? Returns the interrupt acknowledge response (STATUS/ID word) from the highest priority VXI interrupt line.

Comments

- The value returned is the response from the interrupt acknowledge cycle (STATUS/ID word) of a device interrupting on one of the interrupt lines set up with the DIAG:INT:SET[n] command.
- Bits 0 through 7 of the STATUS/ID word are the interrupting device's logical address. Bits 8 through 15 are Cause/Status bits. Bits 16 through 31 (D32 Extension) are not read by the System Instrument.
- If only bits 0 through 7 are used by the device (bits 8 - 15 are FF), the logical address can be determined by adding 256 to the value returned by DIAG:INT:RESP?. If bits 0 - 15 are used, the logical address is determined by adding 65536 to the value returned (if the number returned is negative).
- Only the interrupt lines previously configured with the DIAG:INT:SET[n] commands generate responses for this command.
- If there are interrupts on multiple lines when this command is received, or when the acknowledgement was enabled with DIAG:INT:ACT, the response data returned will be from the line with the highest priority set using the DIAG:INT:PRI [n] command.
- If interrupt acknowledge has not been enabled with DIAG:INT:ACT, then it will be enabled by DIAG:INT:RESP?. System Instrument execution is halted until the interrupt acknowledgement response is received.
- DIAG:INT:WAIT? can also be used to wait for the interrupt response.
- **Related Commands:** DIAG:INT:ACT, DIAG:INT:SETup[n], DIAG:INT:PRIOriety[n]

Example Setup and wait for VXI interrupt response on line 2.

DIAG:INT:PRI2 5	<i>set priority to 5 on line 2</i>
DIAG:INT:SETUP2 ON	<i>handle interrupt on line 2</i>
.	<i>code which will</i>
.	<i>initiate an action</i>
.	<i>resulting in an interrupt</i>
DIAG:INT:RESP?	<i>read the acknowledge response</i>

:NRAM:ADDRess?

DIAGnostic:NRAM:ADDRess? Returns the starting address of the non-volatile User RAM segment allocated using DIAG:NRAM:CREate.

Comments

- DIAG:NRAM:CREate does not allocate the RAM segment until after a subsequent re-boot. To get accurate results, execute DIAG:NRAM:ADDRess? after the re-boot.
- **Related Commands:** DIAG:NRAM:CREate, DIAG:NRAM:CREate?, DIAG:DOWNload, DIAG:UPload?

Example

Determine address of the most recently created User RAM segment

DIAG:NRAM:ADDR?

enter statement

statement returns decimal numeric address

:NRAM:CREate

DIAGnostic:NRAM:CREate < size > allocates a segment of non-volatile User RAM for a user-defined table.

Parameters

Parameter Name	Parameter Type	Range of Values	Default Units
size	numeric	0 to available RAM or MIN MAX	none

Comments

- The RAM segment will be created only after the System Instrument has been re-booted (cycle power or execute DIAG:BOOT).
- Based on the *size* specified, DIAG:NRAM:CRE rounds the *size* up to an even value.
- NRAM will de-allocate a previously allocated RDISK segment.
- Using all of the available RAM (MAX) for the NRAM segment will limit some functions such as IBASIC program space, instrument reading storage space, and full functionality of the Display Terminal Interface.
- Use DIAG:NRAM:ADDR? to determine the starting address of the RAM segment.
- Use DIAG:DOWNload, DIAG:UPload?, DIAG:PEEK, or DIAG:POKE to store and retrieve information in the non-volatile RAM segment.
- Use DIAG:NRAM:CRE? MAX to find maximum available segment size.
- **Related Commands:** DIAG:NRAM:CREate?, DIAG:NRAM:ADDRess?, DIAG:DOWNload, DIAG:UPload?

Example

Allocate a 15 Kbyte User Non-volatile Ram segment.

DIAG:NRAM:CREate 15360

allocate 15 Kbyte segment of User Ram.

:NRAM:CREate? **DIAGnostic:NRAM:CREate?** [**MIN** | **MAX**] Returns the current or allowable (**MIN** | **MAX**) size of the User non-volatile RAM segment.

- Comments**
- **DIAG:NRAM:CRE** does not allocate driver RAM until a subsequent re-boot. To get accurate results, execute **DIAG:NRAM:CRE?** after the re-boot.
 - **Related Commands:** **DIAG:NRAM:ADDRess?**, **DIAG:NRAM:CREate**

Example Check the size of the User RAM segment.

DIAG:NRAM:CREate?
 enter statement *statement enters size in bytes*

:PEEK? **DIAGnostic:PEEK?** <address> , <width> reads the data (number of bits given by *width*) starting at *address*.

Parameters

Parameter Name	Parameter Type	Range of Values	Default Units
<i>address</i>	numeric	0 to 16,777,215 (#HFFFFFF)	none
<i>width</i>	numeric	8 16 32	none

- Comments**
- *Address* specifies a location within the range of the control processor's addressing capability.
 - *Address* may be specified in decimal, hex (#H), octal (#O), or binary (#B) formats.
 - **Related Commands:** **DIAG:POKE**

Example Read byte from User non-volatile RAM

DIAG:PEEK? 16252928,8 *ask for byte*
 enter statement *return value of byte*

:POKE **DIAGnostic:POKE** <address>, <width>, <data> writes *data* (number of bits given by *width*) starting at *address*.

Parameters

Parameter Name	Parameter Type	Range of Values	Default Units
<i>address</i>	numeric	0 to 16,777,215 (#FFFFFF)	none
<i>width</i>	numeric	8 16 32	none
<i>data</i>	numeric	8 to 32 bit integer	none

Comments

- *Address* specifies a location within the range of the control processor's addressing capability.
- *Address* and *data* may be specified in decimal, hex (#H), octal (#O), or binary (#B) formats.
- **CAUTION:** DIAG:POKE can change the contents of any address in RAM. Changing the contents of RAM used by the Command Module's control processor can cause unpredictable results.
- **Related Commands:** DIAG:PEEK?

Example

Store byte in User non-volatile RAM
DIAG:POKE 16252928,8,255

:RDISk:ADdRes?

DIAGnostic:RDISk:ADdRes? Returns the starting address of the RAM disc volume previously defined with the DIAG:RDISk:CREate command. The RAM disc volume is defined for use only by the IBASIC option.

Comments

- DIAG:RDISk:CREate does not allocate the RAM volume segment until after a subsequent re-boot. To get accurate results, execute DIAG:RDISk:ADdRes? after the re-boot.
- **Related Commands:** DIAG:RDISk:CREate, DIAG:RDISk:CREate?

Example

Return the starting address of the IBASIC RAM volume.

DIAG:RDIS:ADDR?
 enter statement

*statement returns decimal
 numeric address*

:RDISk:CREate **DIAGnostic:RDISk:CREate < size>** Allocates memory for a RAM disc volume. The RAM disc volume is defined for use only by the IBASIC option.

Parameters

Parameter Name	Parameter Type	Range of Values	Default Units
<i>size</i>	numeric	0 to available RAM or MIN MAX	none

Comments

- The RAM disc segment will only be created after the System Instrument has been re-booted (cycle power or execute DIAG:BOOT).
- Based on the *size* specified, DIAG:RDIS:CRE rounds the *size* up to an even value.
- Using all of the available RAM (MAX) for the disc volume segment will limit some functions such as IBASIC program space, instrument reading storage space, and full functionality of the Display Terminal Interface.
- **Related Commands:** DIAG:RDISk:ADDress?, DIAG:RDISk:CREate?

Example Allocate a 64 Kbyte segment for the IBASIC option's RAM volume.

DIAG:RDIS:CRE 65536

:RDISk:CREate? **DIAGnostic:RDISk:CREate? [MIN | MAX]** Returns the current or allowable (MIN | MAX) size of the RAM disc volume segment.

Comments

- DIAG:RDIS:CRE does not allocate driver RAM until a subsequent re-boot. To get accurate results, execute DIAG:RDIS:CRE? after the re-boot.
- **Related Commands:** DIAG:RDISk:CREate, DIAG:RDISk:ADDR?

Example Return the size of the current RAM disc volume.

DIAG:RDIS:CRE?

enter statement

returns numeric size

:UPLoad[:MADdress]?

DIAGnostic:UPLoad[:MADdress]? < address> , < byte_count> Returns the number of bytes specified by *byte_count*, starting at *address*.

Parameters

Parameter Name	Parameter Type	Range of Values	Default Units
<i>address</i>	numeric	0 to 16,777,215 (#HFFFFFFE)	none
<i>byte_count</i>	numeric	0 to (999,999,998)	none

Comments

- *Address* may be specified in decimal, hex (#H), octal (#Q), or binary (#B) formats.
- UPLoad is done by word (16 bit) access so *address* and *byte_count* must be even.
- Data is returned in the Definite Block Response Data format:

< non-zero digit > < digit(s) > < data byte(s) >

Where the value of < non-zero digit > equals the number of < digit(s) >. The value of < digit(s) > taken as a decimal integer indicates the number of < data byte(s) > to expect in the block.
- This command can also be used to retrieve data from a device with registers in A16 address space. See DIAG:UPload:SADdress?
- **Related Commands:** DIAG:NRAM:ADdress?, DIAG:NRAM:CREate, DIAG:DOWNload

Example Upload data stored on non-volatile User RAM.

```

DIM HEADERS$[6],DATA(1024)
    6 chars for "#41024" header
    1024 chars for data bytes
DIAG:NRAM:ADDR?
    get starting address of NRAM
enter ADD
    address into ADD
OUTPUT "DIAG:UPL? < value of ADD > ,1024"
    request 1 Kbyte from address in ADD
enter HEADERS$
    strip "#41024" from data
enter DATA
    get 1024 data bytes into string; use enter format so statement
    won't terminate on CRs or LFs etc. Line Feed (LF) and EOI
    follow the last character retrieved.
    
```

:UPload:SADdress?

DIAGnostic:UPload:SADdress? < address> , < byte_count> Returns the number of bytes specified by *byte_count*, at *address*.

Parameters

Parameter Name	Parameter Type	Range of Values	Default Units
<i>address</i>	numeric	0 to 16,777,215 (#HFFFFFFE)	none
<i>byte_count</i>	numeric	0 to (999,999,998)	none

Comments

- *Address* may be specified in decimal, hex (#H), octal (#O), or binary (#B) formats.
- UPLoad is done by word (16 bit) access so *address* and *byte_count* must be even.
- The register address in A16 address space can be determined by:
 $1FC000_{16} + (LADDR * 64) + register_number$
 where $1FC000_{16}$ is the base address in the VXIbus A16 address space, *LADDR* is the device logical address, 64 is the number of address bytes per device, and *register_number* is the register from which data is retrieved.

 If the device is an A24 device, the address can be determined using the VXI:CONF:DLIST command to find the base address in A24, and then adding the *register_number* to that value. A24 memory between address 2000000_{16} and address $E0000_{16}$ is directly accessible by the Controller.
- Data is returned in the Definite Block Response Data format:
 $\# < non\text{-}zero\ digit > < digit(s) > < data\ byte(s) >$
 Where the value of < non-zero digit > equals the number of < digit(s) > . The value of < digit(s) > taken as a decimal integer indicates the number of < data byte(s) > to expect in the block.
- **Related Commands:** DIAG:DOWNload:SADdress

Example Upload data stored in non-volatile User RAM.

This program reads 1024 data bytes from register 32 on a device with logical address 40 in Command Module A16 address space.

```

DIM HEADER$(6),DATA(1024)
    6 chars for "#41024" header
    1024 chars for data bytes
OUTPUT "DIAG:UPL:SADD? #H1FCA20,1024"
    request 1 Kbyte from device
    register 32
enter HEADER$
    strip "#41024" from data
enter DATA
    get 1024 data bytes into string; use enter format so statement
    won't terminate on CRs or LFs etc. Line Feed (LF) and EOI
    follow the last character retrieved.
    
```

INITiate

The INITiate command subsystem controls the initiation of the trigger system for one or more trigger cycles. INITiate enables while ABORt disables the trigger system. The TRIGger command subsystem controls the behavior of the trigger system while it is enabled.

Subsystem Syntax INITiate
 [:IMMediate]

[:IMMediate] INITiate:IMMediate changes the trigger system from the Idle state to the Wait For Trigger state.

- Comments**
- If TRIGger:SOURce is IMMEDIATE, the Pacer starts. If TRIG:SOURce is BUS, EXT, or HOLD, the Pacer will start when that trigger condition is satisfied.
 - Sending the ABORt command will reset the trigger system back to its Idle state and terminate any pacer pulse train in progress.
 - Sending INIT while the system is still in the Wait for Trigger state (already INITiated) will cause an error -213, "Init ignored".
 - **Related Commands:** ABORt, TRIGger
 - ***RST Condition:** Trigger system is in the Idle state.

Example Initiating the trigger system (Wait For Trigger state).

TRIG:SOUR HOLD	<i>trigger source is TRIG command</i>
SOUR:PULS:COUN 1E3	<i>output 1000 Pacer pulses</i>
SOUR:PULS:PER .1 S	<i>pulse period set to .1 second</i>
INIT	<i>go to Wait For Trigger state</i>
TRIG	<i>trigger the Pacer to output pulses</i>
.	
.	
INIT	<i>must re-initiate system before each trigger cycle</i>
TRIG	
.	
.	

[SOURCE]:PULSE:COUNT

[SOURCE]

The System Instrument contains a Pacer which produces TTL level pulses. The SOURCE command subsystem controls the number and period of these pulses. The output of the Pacer is available at the rear-panel BNC connector labeled "Pacer Out".

Subsystem Syntax [SOURCE]
:PULSe
:COUNT <count>
:COUNT? [MIN | MAX]
:PERiod <period>
:PERiod? [MIN | MAX]

:PULSE:COUNT SOURCE:PULSE:COUNT <count> sets the number of Pacer pulses that are generated when the trigger condition is satisfied.

Parameters

Parameter Name	Parameter Type	Range of Values	Default Units
count	numeric	1 to 8,388,607 9.9E37 INFINITY MIN MAX	none

Comments

- When count is set to INFINITY or 9.9E37, pulses are continuous.
- **Related Commands:** ABORT, INIT, TRIG
- ***RST Condition:** SOUR:COUN 1

Example Setting the Pacer pulse count.

TRIG:SOUR HOLD

trigger source is TRIG command

SOUR:PULS:COUN 1E3

output 1000 Pacer pulses

SOUR:PULS:PER .1 S

pulse period set to .1 second

INIT

go to Wait For Trigger state

TRIG

trigger the Pacer to output pulses

:PULSE:COUNT? SOURCE:PULSE:COUNT? [MIN | MAX] returns:

- The current count if no parameter is sent.
- The maximum allowable count if MAX is sent.
- The minimum allowable count if MIN is sent.

Example Querying the pulse count.

SOUR:PULS:COUN 1E3

output 1000 Pacer pulses

SOUR:PULS:COUN?

query system for pulse count

retrieve value

:PULSe:PERiod

SOURce:PULSe:PERiod < period > sets the period of the pulse(s) to be generated by the Pacer.

Parameters

Parameter Name	Parameter Type	Range of Values	Default Units
<i>pweiod</i>	numeric	500E-9 to 8.388607 or MIN MAX	second

Comments

- The resolution of *period* is 500E-9 seconds.
- The Pacer waveform is a square wave with the output high for the first half of the period, and low for the final half.
- **Related Commands:** SOUR:PULS:COUN, ABORT, INIT, TRIG
- ***RST Condition:** SOUR:PULS:PER 1E-6

Example Setting the Pacer pulse period.

TRIG:SOUR HOLD

trigger source is TRIG command

SOUR:PULS:COUN 1E3

output 1000 Pacer pulses

SOUR:PULS:PER .1 S

pulse period set to .1 second

INIT

go to Wait For Trigger state

TRIG

trigger the Pacer to output pulses

:PULSe:PERiod?

SOURce:PULSe:PERiod? [MIN | MAX] returns :

- The current period if no parameter is sent.
- The maximum allowable period if MAX is sent.
- The minimum allowable period if MIN is sent.

Example Querying the Pacer pulse period.

SOUR:PULS:PER?

ask for pulse period

enter statement

statement to enter value of period

STATus :OPERation :CONDition?

STATus

The STATus subsystem commands access the condition, event, and enable registers in the Operation Status group and the Questionable Data group.

Subsystem Syntax STATus
 :OPERation
 :CONDition?
 :ENABle <event >
 :ENABle?
 [:EVENT]?
 :PRESet
 :QUEStionable
 :CONDition?
 :ENABle <event >
 :ENABle?
 [:EVENT]?

:OPERation :CONDition? STATus:OPER:COND? returns the state of the condition register in the Operation Status group. The state represents conditions which are part of an instrument's operation.

- Comments**
- Bit 8 in the register is used by the System Instrument (Command Module) to indicate when an interrupt set up by the DIAG:INTerrupt commands has been acknowledged.
 - Reading the condition register does not change the setting of bit 8. Bit 8 is cleared by the DIAG:INT:RESP? command.
 - **Related Commands:** STAT:OPER:ENABle, STAT:OPER:EVENT?

Example Reading the contents of the condition register

```
STAT:OPER:COND?           query register
enter statement
```

:OPERation:ENABle <event > STATus:OPER:ENABle <event > sets an enable mask to allow events monitored by the condition register and recorded in the event register, to send a summary bit to the Status Byte register (bit 7).

Parameters

Parameter Name	Parameter Type	Range of Values	Default Units
event	numeric	256	none

- Comments**
- Bit 8 in the condition register is used by the system instrument (Command Module) to indicate when an interrupt set up by the DIAG:INTerrupt commands has been acknowledged.

STATUS :OPERation:ENABLE?

- Bit 8 is the only bit used in the condition register (by the System Instrument), therefore, it is the only bit which needs to be unmasked in the event register. Specifying the "bit weight" for the event unmask the bit. The bit weight is 256 and can be specified in decimal, hexadecimal (#H), Octal (#Q) or binary (#B).
- When the summary bit is sent, it sets bit 7 in the Status Byte register.
- **Related Commands:** STAT:OPER:ENABLE?

Example Unmasking bit 8 in the Event Register

STAT:OPER:ENAB 256 *unmask bit 8*

:OPERation:ENABLE?

STATUS:OPER:ENABLE? returns which bits in the event register (standard operation status group) are unmasked.

Comments

- Bit 8 in the condition register is used by the system instrument (Command Module) to indicate when an interrupt set up by the DIAG:INTerrupt commands has been acknowledged.
- Bit 8 in the event register generally is the only bit which will be unmasked. If this bit is unmasked when STAT:OPER:ENAB? is sent, 256 is returned.
- Reading the event register mask does not change the mask setting (STAT:OPER:ENAB <event >).
- **Related Commands:** STAT:OPER:ENABLE

Example Reading the Event Register Mask

STAT:OPER:ENAB? *query register mask*
enter statement

:OPERation[:EVENT]?

STATUS:OPER:EVENT? returns which bits in the event register (standard operation status group) are set. The event register indicates when there has been a positive transition in the condition register.

Comments

- Bit 8 in the condition register is used by the system instrument (Command Module) to indicate when an interrupt set up by the DIAG:INTerrupt commands has been acknowledged.
- Bit 8 in the event register generally is the only bit which is used. If this bit is set when STAT:OPER:EVENT? is sent, 256 is returned.
- Reading the event register clears the contents of the register. If the event register is to be used to generate a service request (SRQ), you should clear the register before enabling the SRQ (*SRE). This prevents an SRQ from occurring due to a previous event.
- **Related Commands:** STAT:OPER:ENABLE, STAT:OPER:ENABLE?

STATus :PRESet

Example **Reading the Event Register**

STAT:OPER:EVEN?
enter statement

query if bit(s) is set

:PRESet STATus:PRESet sets each bit in the enable register (standard operation status group) to '0'.

Example **Presetting the Enable Register**

STAT:PRES

preset enable register

:QUESTionable The STATus:QUESTionable commands are supported by the system instrument, however, they are not used by the System Instrument. Queries of the Questionable Data condition and event registers will always return +0.

SYSTEM

The SYSTEM command subsystem for the System Instrument provides for:

- Configuration of the RS-232 interface
- Control and access of the System Instrument's real time clock/calendar (SYST:TIME, SYST:TIME?, SYST:DATE, SYST:DATE?).
- Access to the System Instrument's error queue (SYST:ERR?).
- Configuring the communication ports (HP-IB and serial).

Subsystem Syntax

```

SYSTem
:BEEPer
    [:IMMediate]
:COMMunicate
:GPIB
    :ADDRes <address> [MIN|MAX]
    :ADDRes? [MIN|MAX]
:SERial[n]
:CONTRol
    :DTR ON | OFF | STANdard | IBFull
    :DTR?
    :RTS ON | OFF | STANdard | IBFull
    :RTS?
[:RECEive]
    :BAUD <baud_rate> | MIN | MAX
    :BAUD? [MIN | MAX]
    :BITS 7 | 8 | MIN | MAX
    :BITS? [MIN | MAX]
    :PACE
        [:PROTocol] XON | NONE
        [:PROTocol]?
        :THReshold
            :START <characters> | MIN | MAX
            :START? [MIN | MAX]
            :STOP <characters> | MIN | MAX
            :STOP? [MIN | MAX]
:PARity
    :CHECK 1 | 0 | ON | OFF
    :CHECK?
    [:TYPE] EVEN | ODD | ZERO | ONE | NONE
    [:TYPE]?
    :SBITs 1 | 2 | MIN | MAX
    :SBITs? [MIN | MAX]
:TRANsmit
    :AUTO 1 | 0 | ON | OFF
    :AUTO?
    :PACE
        [:PROTocol] XON | NONE
        [:PROTocol]?
:DATE <year>, <month>, <day>
:DATE? [MIN|MAX,MIN|MAX,MIN|MAX]
:ERRor?
:TIME <hour>, <minute>, <second>
:TIME? [MIN | MAX,MIN | MAX,MIN | MAX]
:VERSion?

```

:BEEPer[:IMMediate] SYSTem:BEEPer:IMMediate causes the system beeper to sound momentarily.

Example Sound the Beeper

SYST:BEEP:IMM

**:COMMunicate
:GPIB:ADDRess**

SYSTem:COMMunicate:GPIB:ADDRess <address> sets the primary address of the Instrument's HP-IB port.

Parameters

Parameter Name	Parameter Type	Range of Values	Default Units
<i>address</i>	numeric	must round to 0 to 30	none

Comments

- The value of <address> is effective after the System Instrument has received a <new line> following the SYST:COMM:GPIB:ADDR command. <new line> can be a line-feed or END (EOI signal).
- **Related Commands:** SYST:COMM:GPIB:ADDR?, DIAG:BOOT:COLD
- ***RST Condition:** *RST does not change the System Instrument's primary HP-IB address.

Example

Set the HP-IB port's primary address

SYST:COMM:GPIB:ADDR 9 *sets the primary address to 9*

**:COMMunicate
:GPIB:ADDRess?**

SYSTem:COMMunicate:GPIB:ADDRess? returns the Command Module primary HP-IB address.

Example

Read the Primary HP-IB Address.

SYST:COMM:GPIB:ADDR? *Read the HP-IB address*
 enter statement *Enter the HP-IB address*

**:COMMunicate
:SERial[n]: ...**

The SYSTem:COMMunicate:SERial[n]: ... commands set and/or modify the configuration of the serial interface(s) that are under control of the System Instrument. The interface to be affected by the command is specified by a number (zero through seven) which replaces the [n] in the :SERial[n] command. The number is the interface's **card number**. Card number zero specifies the E1300/E1301 mainframe's built-in interface while one through seven specify one of up to seven E1324 B-size plug-in serial interface modules. The serial interface installed at logical address 1 becomes card number 1, the serial interface installed at the next sequential logical address becomes card number 2 and so on. The logical addresses used by plug-in serial interfaces must start at 1 and be contiguous (no unused logical addresses).

Comments

- Serial communication commands take effect *after* the end of the program message containing the command.
- Serial communication settings for the built-in RS-232 interface can be stored in its non-volatile RAM **only** after the DIAG:COMM:SER[n]:STORE command is executed. These settings are used at power-up and DIAG:BOOT[:WARM].

SYSTEM:COMMunicate:SERial[n]:CONTrol:DTR

- Serial communication settings for the HP E1324A Datacomm interface can be stored in its on-board non-volatile EEROM only after the DIAG:COMM:SER[n]:STORE command is executed. These settings are used at power-up and DIAG:BOOT[:WARM].
- DIAG:BOOT:COLD will set the serial communication parameters to the following defaults:
 - BAUD 9600
 - BITS 8
 - PARity NONE
 - SBITs 1
 - DTR ON
 - RTS ON
 - PACE XON

Example Setting baud rate for plug-in card 2.

SYST:COMM:SER2:BAUD 9600 (must be a card number 1 also)

**:COMMunicate
:SERial[n]:CONTrol
:DTR**

SYSTEM:COMMunicate:SERial[n]:CONTrol:DTR < dtr_cntrl > controls the behavior of the Data Terminal Ready output line. DTR can be set to a static state (ON | OFF), can operate as a modem control line (STANDARD), or can be used as a hardware handshake line (IBFull).

Parameters

Parameter Name	Parameter Type	Range of Values	Default Units
dtr_cntrl	discrete	ON OFF STANDARD IBFull	none

Comments

- The following table defines each value of dtr_cntrl:

Value	Definition
ON	DTR line is asserted
OFF	DTR Line is unasserted
STANDARD	DTR will be asserted when the serial interface is ready to send output data. Data will be sent if the connected device asserts DSR and CTS.
IBFull	While the input buffer is not yet at the :STOP threshold, DTR is asserted. When the input buffer reaches the :STOP threshold, DTR will be unasserted.

- DIAG:BOOT:COLD will set ...DTR to ON.
- **Related Commands:** SYST:COMM:SER[n]:CONT:RTS, SYST:COMM:SER[n]:PACE:THR:START, SYST:COMM:SER[n]:PACE:THR:STOP
- ***RST Condition:** No change

Example Asserting the DTR line.

SYST:COMM:SER0:CONT:DTR ON

SYSTem:COMMunicate :SERial[n] :CONTrol :DTR?

**:COMMunicate
:SERial[n] :CONTrol
:DTR?**

SYSTem:COMMunicate:SERial[n]:CONTrol:DTR? returns the current setting for DTR line control.

Example Checking the setting of DTR control.

SYST:COMM:SER0:CONT:DTR?

enter statement

statement enters the string "ON", "OFF", "STAN", or "IBF"

**:COMMunicate
:SERial[n] :CONTrol
:RTS**

SYSTem:COMMunicate:SERial[n]:CONTrol:RTS < Rts_cntrl> controls the behavior of the Request To Send output line. RTS can be set to a static state (ON | OFF), can operate as a modem control line (STANDARD), or can be used as a hardware handshake line (IBFull).

Parameters

Parameter Name	Parameter Type	Range of Values	Default Units
<i>rts_cntrl</i>	discrete	ON OFF STANDARD IBFull	none

Comments

- The following table defines each value of *rts_cntrl*:

Value	Definition
ON	RTS line is asserted
OFF	RTS Line is unasserted
STANDARD	RTS will be asserted when the serial interface is ready to send <i>output</i> data. Data will be sent if the connected device asserts CTS and DSR.
IBFull	While the input buffer is not yet at the :STOP threshold, RTS is asserted. When the input buffer reaches the :STOP threshold, RTS will be unasserted.

- DIAG:BOOT:COLD will set ...RTS to ON.
- **Related Commands:** SYST:COMM:SER[n]:CONT:DTR, SYST:COMM:SER[n]:PACE:THR:START, SYST:COMM:SER[n]:PACE:THR:STOP
- ***RST Condition:** No change

Example Unasserting the RTS line.

SYST:COMM:SER0:CONT:RTS OFF

**:COMMunicate
:SERial[n] :CONTrol
:RTS?**

SYSTem:COMMunicate:SERial[n]:CONTrol:RTS? returns the current setting for RTS line control.

Example Checking the setting of RTS control.

SYST:COMM:SER0:CONT:RTS?

enter statement

statement enters the string "ON", "OFF", "STAN", or "IBF"

**:COMMunicate
:SERial[n] [:RECeive]
:BAUD**

SYSTem:COMMunicate:SERial[n][:RECeive]:BAUD <baud_rate> Sets the baud rate for the serial port.

Parameters

Parameter Name	Parameter Type	Range of Values	Default Units
<i>baud</i>	numeric	300 1200 2400 4800 9600 19200 MIN MAX	none

Comments

- Attempting to set *baud* to other than those values shown will result in an error -222.
- DIAG:BOOT:COLD will set ...BAUD to 9600.
- *RST condition: No change.

Example Setting the baud rate to 1200.

SYST:COMM:SER0:BAUD 1200

**:COMMunicate
:SERial[n] [:RECeive]
:BAUD?**

SYSTem:COMMunicate:SERial[n][:RECeive]:BAUD? [MIN | MAX] returns:

- The current baud rate setting if no parameter is sent.
- The maximum allowable setting if MAX is sent.
- The minimum allowable setting if MIN is sent.

Example Querying the current baud rate.

SYST:COMM:SER0:BAUD?

enter statement

statement enters a numeric value

SYSTem:COMMunicate :SERial[n] [:RECEive] :BITS

**:COMMunicate
:SERial[n] [:RECEive]
:BITS**

SYSTem:COMMunicate:SERial[n] [:RECEive]:BITS < bits> Sets the number of bits to be used to transmit and receive data.

Parameters

Parameter Name	Parameter Type	Range of Values	Default Units
<i>bits</i>	numeric	7 8 MIN MAX	none

Comments

- Attempting to set *bits* to other than those values shown will result in an error -222.
- While this command operates independently of either the ...PARity:TYPE or ...SBITs commands, there are two combinations which are disallowed because of their data frame bit width. The following table shows the possible combinations:

...BITS	...PARity:TYPE	...SBITs	Frame Bits
7	NONE	1	9 - disallowed
7	NONE	2	10
7	Yes	1	10
7	Yes	2	11
8	NONE	1	10
8	NONE	2	11
8	Yes	1	11
8	Yes	2	12 - disallowed

- DIAG:BOOT:COLD will set ...BITS to 8.
- Related Commands: SYST:COMM:SER[n]:PARity
- *RST Condition: No change

Example Configuring data width to 7 bits.

SYST:COMM:SER0:BITS 7

**:COMMunicate
:SERial[n] [:RECEive]
:BITS?**

SYSTem:COMMunicate:SERial[n] [:RECEive]:BITS? [MIN | MAX] returns:

- The current data width if no parameter is sent.
- The maximum allowable setting if MAX is sent.
- The minimum allowable setting if MIN is sent.

Example Querying the current data width.

SYST:COMM:SER0:BITS?

enter statement

statement enters 7 or 8

SYSTem :COMMunicate :SERial[n] [:RECeive] :PACE [:PROTOcol]

**:COMMunicate
:SERial[n] [:RECeive]
:PACE [:PROTOcol]**

SYSTem:COMMunicate:SERial[n] [:RECeive]:PACE[:PROTOcol]
 < *protocol* > enables or disables receive pacing (XON/XOFF) protocol.

Parameters

Parameter Name	Parameter Type	Range of Values	Default Units
<i>protocol</i>	discrete	XON NONE	none

Comments

- While ...PROT is XON, the serial interface will send XOFF when the buffer reaches the ...STOP threshold, and XON when the buffer reaches the ...START threshold.
- For an HP E1324A, AUTO is always ON. In this case ...[:RECeive]:PACE will also set ...TRAN:PACE
- The XON character is control Q (ASCII 17₁₀, 11₁₆), The XOFF character is control S (ASCII 19₁₀, 13₁₆).
- DIAG:BOOT:COLD will set ...PACE to XON.
- **Related Commands:** ...PROTOcol:THReshold:START, ...PROTOcol:THReshold:STOP, ...TRAN:AUTO
- ***RST Condition:** No change

Example

Enabling XON/XOFF handshaking.

SYST:COMM:SER0:PACE:PROT XON

**:COMMunicate
:SERial[n] [:RECeive]
:PACE [:PROTOcol]?**

SYSTem:COMMunicate:SERial[n] [:RECeive]:PACE[:PROTOcol]? returns the current receive pacing protocol.

Example

See if XON/XOFF protocol is enabled.

SYST:COMM:SER0:PACE:PROT?

enter statement

statement enters the string "XON" or "NONE"

SYSTem:COMMunicate :SERial[n] [:RECeive] :PACE :THReshold :STARt

**:COMMunicate
:SERial[n] [:RECeive]
:PACE :THReshold
:STARt**

SYSTem:COMMunicate:SERial[n] [:RECeive]:PACE:THReshold:STARt <char_count> configures the input buffer level at which the specified interface may send the XON character (ASCII 11₁₆), assert the DTR line, and/or assert the RTS line.

Parameters

Parameter Name	Parameter Type	Range of Values	Default Units
<i>char_count</i>	numeric	1 through 99 for built-in 1 through 8191 for HP E1324A	none

Comments

- To determine the size of the input buffer of the serial interface you are using, send **SYST:COMM:SER[n]:PACE:THR:STARt? MAX**. The returned value will be the buffer size less one.
- ...STARt must be set to less than ...STOP.
- The ...THR:STAR command has no effect unless ...PACE:PROT XON, ...CONT:DTR IBF, or ...CONT:DTR IBF has been sent.
- **Related Commands:** ...PACE:PROT XON | NONE, ...CONT:DTR, ...CONT:RTS
- ***RST Condition:** No change

Example

Set interface to send XON when input buffer contains 10 characters.

```
SYST:COMM:SER0:PACE:PROT XON
SYST:COMM:SER0:PACE:THR:STAR 10
```

**:COMMunicate
:SERial[n] [:RECeive]
:PACE :THReshold
:STARt?**

SYSTem:COMMunicate:SERial[n] [:RECeive]:PACE:THReshold:STARt? [MIN | MAX] returns:

- The current start threshold if no parameter is sent.
- The maximum allowable setting if MAX is sent.
- The minimum allowable setting if MIN is sent.

Comments

- To determine the size of the input buffer of the serial interface you are using, send **SYST:COMM:SER[n]:PACE:THR:STARt? MAX**. The returned value will be the buffer size.

Example

Return current start threshold

```
SYST:COMM:SER0:PACE:THR:STAR? query for threshold value
enter statement statement enters a numeric value
```

SYSTem :COMMunicate :SERial[n] [:RECeive] :PACE :THReshold :STOP

**:COMMunicate
:SERial[n] [:RECeive]
:PACE :THReshold
:STOP**

SYSTem:COMMunicate:SERial[n] [:RECeive]:PACE:THReshold:STOP
< char_count > configures the input buffer level at which the specified interface may send the XOFF character (ASCII 13₁₆), de-assert the DTR line, and/or de-assert the RTS line.

Parameters

Parameter Name	Parameter Type	Range of Values	Default Units
char_count	numeric	1 through 99 for built-in 1 through 8191 for HP E1324A	none

Comments

- To determine the size of the input buffer of the serial interface you are using, send **SYST:COMM:SER[n]:PACE:THR:STOP? MAX**. The returned value will be the buffer size.
- ...STOP must be set to greater than ...START.
- The ...THR:STOP command has no effect unless ...PACE:PROT XON, ...CONT:DTR IBF, or ...CONT:DTR IBF has been sent.
- **Related Commands:** ...PACE:PROT XON | NONE, ...CONT:DTR, ...CONT:RTS
- ***RST Condition:** No change

Example

Set interface to send XOFF when input buffer contains 80 characters.
SYST:COMM:SER0:PACE:THR:STOP 80

**:COMMunicate
:SERial[n] [:RECeive]
:PACE :THReshold
:STOP?**

SYSTem:COMMunicate:SERial[n] [:RECeive]:PACE:THReshold:STOP?
[MIN | MAX] returns:

- The current stop threshold if no parameter is sent.
- The maximum allowable setting if MAX is sent.
- The minimum allowable setting if MIN is sent.

Comments

- To determine the size of the input buffer of the serial interface you are using, send **SYST:COMM:SER[n]:PACE:THR:STOP? MAX**. The returned value will be the buffer size.

Example

Return current stop threshold

SYST:COMM:SER0:PACE:THR:STOP? *query for threshold*
enter statement *statement enters a numeric value*

SYSTem:COMMunicate :SERial[n] [:RECeive] :PARity :CHECK

**:COMMunicate
:SERial[n] [:RECeive]
:PARity :CHECK**

SYSTem:COMMunicate:SERial[n][:RECeive]:PARity:CHECK < check_cntrl> controls whether or not the parity bit in received serial data frames will be considered significant.

Parameters

Parameter Name	Parameter Type	Range of Values	Default Units
<i>check_cntrl</i>	boolean	0 1 OFF ON	none

Comments

- When *check_cntrl* is set to 0 or OFF, received data is not checked for correct parity. Transmitted data still includes the type of parity configured with ...PARity:TYPE.
- DIAG:BOOT:COLD will set ...CHECK to OFF.
- **Related Commands:** SYST:COMM:SER[n]:PARity:TYPE
- ***RST Condition:** No change

Example

Set parity check to ON
SYST:COMM:SER0:PAR:CHEC ON

**:COMMunicate
:SERial[n] [:RECeive]
:PARity :CHECK?**

SYSTem:COMMunicate:SERial[n][:RECeive]:PARity:CHECK? returns the state of parity checking.

Example

Is parity checking on or off?
SYST:COMM:SER0:PAR:CHEC?
enter statement *statement enters 0 or 1*

**:COMMunicate:
SERial[n] [:RECeive]
:PARity [:TYPE]**

SYSTem:COMMunicate:SERial[n][:RECeive]:PARity[:TYPE] < type> Configures the type of parity to be checked for received data, and generated for transmitted data.

Parameters

Parameter Name	Parameter Type	Range of Values	Default Units
<i>type</i>	discrete	EVEN ODD ZERO ONE NONE	none

Comments

- Attempting to set *type* to other than those values shown will result in an error -222.

SYSTem :COMMunicate: SERIAL[n] [:RECEive] :PARity [:TYPE]

- The following table defines each value of *type*:

Value	Definition
EVEN	If ...PARity:CHECK is ON, the received parity bit must maintain even parity. The transmitted parity bit will maintain even parity.
ODD	If ...PARity:CHECK is ON, the received parity bit must maintain odd parity. The transmitted parity bit will maintain odd parity.
ZERO	If ...PARity:CHECK is ON, the received parity bit must be a zero. The transmitted parity bit will be a zero.
ONE	If ...PARity:CHECK is ON, the received parity bit must be a logic one. The transmitted parity bit will be a logic one.
NONE	A parity bit must not be received in the serial data frame. No parity bit will be transmitted.

- While this command operates independently of either the ...BITS or ...SBITs commands, there are two combinations which are disallowed because of their data frame bit width. The following table shows the possible combinations:

...BITS	...PARity:TYPE	...SBITs	Frame Bits
7	NONE	1	9 - disallowed
7	NONE	2	10
7	Yes	1	10
7	Yes	2	11
8	NONE	1	10
8	NONE	2	11
8	Yes	1	11
8	Yes	2	12 - disallowed

- Received parity will not be checked unless ...PAR:CHEC ON is has been sent. Transmitted data will include the specified parity whether ...PAR:CHEC is ON or OFF.
- DIAG:BOOT:COLD will set ...PARity to NONE.
- **Related Commands:** ...PAR:CHEC 1 | 0 | ON | OFF, ...SER[n]:BITS 7 | 8, ...SER[n]:SBITs 1 | 2
- ***RST Condition:** No change

Example Set parity check/generation to ODD.

```

SYST:COMM:SER0:PAR ODD           Set parity type
SYST:COMM:SER0:PAR:CHEC ON       Enable parity check/gen.

```

SYSTem:COMMunicate :SERial[n] [:RECEive] :PARity [:TYPE]?

**:COMMunicate
:SERial[n] [:RECEive]
:PARity [:TYPE]?**

SYSTem:COMMunicate:SERial[n] [:RECEive]:PARity[:TYPE]? returns the type of parity checked and generated.

Example What type of parity checking is set?

SYST:COMM:SER0:PAR?
enter statement

*ask for parity type
returns the string EVEN, ODD,
ZERO, ONE, or NONE*

**:COMMunicate
:SERial[n] [:RECEive]
:SBITS**

SYSTem:COMMunicate:SERial[n] [:RECEive]:SBITS <sbits> Sets the number of stop bits to be used to transmit and receive data.

Parameters

Parameter Name	Parameter Type	Range of Values	Default Units
<i>sbits</i>	numeric	1 2 MIN MAX	none

Comments

- Attempting to set *sbits* to other than those values shown will result in an error -222.
- While this command operates independently of either the ...BITS or ...PARity:TYPE commands, there are two combinations which are disallowed because of their data frame bit width. The following table shows the possible combinations:

...BITS	...PARity:TYPE	...SBITS	Frame Bits
7	NONE	1	9 - disallowed
7	NONE	2	10
7	Yes	1	10
7	Yes	2	11
8	NONE	1	10
8	NONE	2	11
8	Yes	1	11
8	Yes	2	12 - disallowed

- DIAG:BOOT:COLD will set ...SBITS to 1.
- **Related Commands:** SYST:COMM:SER[n]:BAUD
- ***RST Condition:** No change

Example Configuring for 2 stop bits.

SYST:COMM:SER0:SBITS 2

SYSTem :COMMunicate :SERial[n] [:RECEive] :SBITs?

**:COMMunicate
:SERial[n] [:RECEive]
:SBITs?**

SYSTem:COMMunicate:SERial[n][:RECEive]:SBITs? [MIN | MAX] returns:

- The current stop bit setting if no parameter is sent.
- The maximum allowable setting if MAX is sent.
- The minimum allowable setting if MIN is sent.

Example Querying the current stop bit configuration.

SYST:COMM:SER0:SBITs? *:REC is implied*
enter statement *statement enters 1 or 2*

**:COMMunicate
:SERial[n] :TRANsmitt
:AUTO**

SYSTem:COMMunicate:SERial[n]:TRANsmitt:AUTO <auto_cntr> when ON, sets the transmit pacing mode to be the same as that set for receive pacing. When OFF, the transmit pacing mode may be set independently of the receive pacing mode.

Parameters

Parameter Name	Parameter Type	Range of Values	Default Units
<i>auto_cntrl</i>	boolean	0 1 OFF ON	none

Comments

- For an HP E1324A, AUTO is always ON. Trying to set OFF or 0 will generate an error.
- DIAG:BOOT:COLD will set ...AUTO to ON.
- **Related Commands:** SYST:COMM:SER[n]:REC:PACE:PROT, SYST:COMM:SER[n]:TRAN:PACE:PROT
- ***RST Condition:** ...TRAN:AUTO ON

Example Link transmit pacing with receive pacing

SYST:COMM:SER0:TRAN:AUTO ON

**:COMMunicate
:SERial[n] :TRANsmitt
:AUTO?**

SYSTem:COMMunicate:SERial[n]:TRANsmitt:AUTO? returns the current state of receive to transmit pacing linkage.

Comments

- For an HP E1324A, AUTO is always ON. In this case ...AUTO? will always return a 1.

Example Is AUTO ON or OFF?

SYST:COMM:SER0:TRAN:AUTO?
enter statement *statement enters the number 1 or 0*

SYSTem:COMMunicate :SERial[n]:TRANsmit :PACE [:PROTOcol]

**:COMMunicate
:SERial[n]:TRANsmit
:PACE [:PROTOcol]**

SYSTem:COMMunicate:SERial[n]:TRANsmit:PACE[:PROTOcol]
 <protocol> enables or disables the transmit pacing (XON/XOFF) protocol.

Parameters

Parameter Name	Parameter Type	Range of Values	Default Units
<i>protocol</i>	discrete	XON NONE	none

Comments

- For an HP E1324A, AUTO is always ON. In this case ...TRAN:PACE will also set ...[RECEive]:PACE
- Receipt of an XOFF character (ASCII 19₁₀, 13₁₆) will hold off transmission of data until an XON character (ASCII 17₁₀, 11₁₆) is received.
- DIAG:BOOT:COLD will set ...PACE to XON.
- **Related Commands:** SYST:COMM:SER[n]:TRAN:AUTO
- ***RST Condition:** No change

Example

Set XON/XOFF transmit pacing
SYST:COMM:SER0:TRAN:PACE:PROT XON

**:COMMunicate
:SERial[n] :TRANsmit
:PACE [:PROTOcol]?**

SYSTem:COMMunicate:SERial[n]:TRANsmit:PACE[:PROTOcol]? returns the current transmit pacing protocol.

Example

Check transmit pacing protocol
SYST:COMM:SER0:TRAN:PACE:PROT?
 enter statement *statement enters the string "XON" or "NONE"*

:DATE

SYSTem:DATE <year> ,< month> ,< day> sets the E1300/E1301 mainframe's internal calendar.

Parameters

Parameter Name	Parameter Type	Range of Values	Default Units
<i>year</i>	numeric	must round to 1980 to 2079	none
<i>month</i>	numeric	must round to 1 to 12	none
<i>day</i>	numeric	must round to 1 through last day of month	none

Comments

- The upper limit on the day parameter is dependent on the month parameter and may be dependent on the year parameter in the case of a leap year.

SYSTem :DATE?

- **Related Commands:** SYST:TIME, SYST:TIME?, SYST:DATE?
- ***RST Condition:** *RST does not change the setting of the calendar.

Example Setting the system Date

```
SYST:DATE 1991,09,08          set SEP 8, 1991
```

:DATE? SYSTem:DATE? [MIN|MAX,MIN|MAX,MIN|MAX] returns:

- **When no parameter is sent:** the current system date in the form +YYYY, +MM, +DD, where YYYY can be the year 1980 through 2079, MM can be the month 1 through 12, and DD can be the day 1 through 31.
- **When parameters are sent:** the minimum or maximum allowable values for each of the three parameters. The parameter count must be three.

Example Querying the system date

```
SYST:DATE?                   ask for current date
input values of year,month,day read back date
```

:ERRor? SYSTem:ERR? queries the system's error queue. The response format is: <error number>,"<error description string>".

Comments

- As system errors are detected, they are placed in the System Instrument error queue. The error queue is first in, first out. This means that if several error messages are waiting in the queue, each SYST:ERR? query will return the oldest error message, and that message will be deleted from the queue.
- If the error queue fills to 30 entries, the last error in the queue is replaced with error -350,"Too may errors". No further errors are accepted by the queue until space becomes available using SYST:ERR?, or the queue is cleared using *CLS.
- The SYST:ERR? command can be used to determine if any configuration errors occurred during the power-on sequence.
- When SYST:ERR? is sent while the error queue is empty, the System Instrument responds with +0,"No error".
- **Related Commands:** *ESE, *ESR?, *SRE
- ***RST Condition:** Error queue is cleared

Example Read all error messages from, and empty the error queue.

```
loop statement                loop to read all errors
SYST:ERR?                    ask for error message
enter statement               input the error (a number), and
                               error message (a string)
until statement              until error number is 0
```

:TIME SYSTem:TIME <hour> , <minute> , <second> sets the E1300/E1301 mainframe's internal clock.

Parameters

Parameter Name	Parameter Type	Range of Values	Default Units
<i>hour</i>	numeric	must round to 0 to 23	none
<i>minute</i>	numeric	must round to 0 to 59	none
<i>second</i>	numeric	must round to 0 to 60	none

Comments

- **Related Commands:** SYST:DATE, SYST:DATE?, SYST:TIME?
- ***RST Condition:** *RST does not change the Command Module's real time clock.

Example Setting the system time

SYST:TIME 14,30,20 *set 2:30:20 PM*

:TIME? SYSTem:TIME? [MAX|MIN,MAX|MIN,MAX|MIN] returns:

- **When no parameter is sent;** the current system time in the form + HH, + MM, + SS, where HH can be 0 through 23 hours, MM can be 0 through 59 minutes, and SS can be 0 through 60 seconds.
- **When parameters are sent;** the minimum or maximum allowable values for each of the three parameters. The parameter count must be three.

Example Querying the system time

SYST:TIME? *ask for current time*
 input values of hour,min,sec *read back time*

:VERSION? SYSTem:VERSION? Returns the SCPI version for which this instrument complies.

Comments

- The returned information is in the format: YYYY.R; where YYYY is the year, and R is the revision number within that year.
- **Related Commands:** *IDN?

Example Determine compliance version for this instrument.

SYST:VERS?
 enter statement *Statement enters 1990.0*

TRIGger

The TRIGger command subsystem controls the behavior of the trigger system once it is initiated (see INITiate command subsystem). The trigger command subsystem controls:

- The delay between trigger and first Pacer pulse (TRIG:DElay)
- An immediate software trigger (TRIG:IMM)
- The source of the trigger (TRIG:SOUR BUS|EXT|HOLD|IMM)

Subsystem Syntax TRIGger
 :DElay <delay>
 :DElay? [MIN | MAX]
 [:IMMEDIATE]
 :SLOPe <slope>
 :SLOPe?
 :SOURce BUS | EXT | HOLD | IMM
 :SOURce?

:DElay TRIGger:DElay <delay> sets the delay between receipt of trigger and first Pacer pulse.

Parameters

Parameter Name	Parameter Type	Range of Values	Default Units
<i>delay</i>	numeric	250E-9s to 4.19430375s or MIN MAX	second

Comments

- The resolution for *delay* is 250E-9 seconds.
- **Related Commands:** ABORt, INITiate
- ***RST Condition:** TRIG:DElay 2.5E-9

Example Setting delay between trigger and Pacer output.

```
TRIG:SOUR HOLD           trigger is TRIG command
SOUR:PULS:COUN 100       set Pacer to output 100 pulses
SOUR:PULS:PER .1 S      pulse period set to .1 second
TRIG:DElay .75 S        start Pacer .75 sec after trigger
INIT                     go to Wait For Trigger state
TRIG                     trigger Pacer to output pulses
```

:DElay? TRIGger:DElay? [MIN | MAX] returns:

- The current delay if no parameter is sent.
- The maximum allowable delay if MAX is sent.
- The minimum allowable delay if MIN is sent.

Example Querying the trigger delay setting.

```
TRIG:DEL .75 S           start Pacer .75 sec after trigger
TRIG:DEL?               command System Instrument
                        to send TRIG:DEL value.
enter statement         input value of trigger delay
```

TRIGger[:IMMediate]

[:IMMediate] TRIGger:IMMediate will cause a trigger cycle to occur immediately, provided that the trigger system has been initiated (INITiate).

- Comments**
- **Related Commands:** ABORT, INITiate
 - ***RST Condition:** This command is an event and has no *RST condition.

Example Triggering the Pacer.

TRIG:SOUR HOLD	<i>trigger source is TRIG command</i>
SOUR:PULS:COUN 1E3	<i>output 1000 Pacer pulses</i>
SOUR:PULS:PER .1 S	<i>pulse period set to .1 second</i>
TRIG:DELAY .75 S	<i>start Pacer .75 sec after trigger</i>
INIT	<i>go to Wait For Trigger state</i>
TRIG	<i>trigger Pacer to output pulses.</i>

:SLOPe TRIGger:SLOPe < slope > is for SCPI compatibility. The mainframe's "Event In" signal only triggers on a negative going edge.

Parameters

Parameter Name	Parameter Type	Range of Values	Default Units
<i>slope</i>	discrete	NEGative	none

- Comments**
- Trying to set ...SLOPe to other than NEG will generate an error.
 - **Related Commands:** ABORT, INITiate,

:SLOPe? TRIGger:SLOPe? returns the current trigger slope setting. Since the mainframe's "Event In" signal only triggers on a negative going edge, TRIG:SLOP? will always return "NEG".

:SOURce TRIGger:SOURce < trig_source > configures the trigger system to respond to the specified source.

Parameters

Parameter Name	Parameter Type	Range of Values	Default Units
<i>trig_source</i>	character	BUS EXT HOLD IMM	none

Comments

- The following table explains the possible choices.

Parameter Value	Source of Trigger
BUS	Group Execute Trigger (GET) bus command, *TRG common command, or TRIGger command.
EXTernal	"Event In" signal at rear panel BNC connector, or TRIGger command.
HOLD	Only the TRIGger command will cause trigger.
IMMEDIATE	The trigger signal is always true (continuous triggering).

- While an instrument which uses the "Event In" signal has EXT set, no other instrument which uses the "Event In" signal may set EXT, or an error 1500 "External trigger source already allocated" will result.
- While TRIG:SOUR is IMM, you need only INITiate the trigger system to start the Pacer.
- **Related Commands:** ABORt, INITiate, *TRG
- ***RST Condition:** TRIG:SOUR IMM

Example Specifying the Trigger Source.

TRIG:SOUR HOLD	<i>trigger source is TRIG command</i>
SOUR:PULS:COUN 1E3	<i>output 1000 Pacer pulses</i>
SOUR:PULS:PER .1 S	<i>pulse period set to .1 second</i>
TRIG:DELAY .75 S	<i>start Pacer .75 sec after trigger</i>
INIT	<i>go to Wait For Trigger state</i>
TRIG	<i>trigger the Pacer to output pulses.</i>

:SOURce? TRIGger:SOURce? returns the current trigger source configuration. Response data can be one of; BUS, EXT, HOLD, or IMM. See the TRIG:SOUR command for more response data information.

Example Querying the Trigger Source.

TRIG:SOUR HOLD	<i>trigger source is TRIG command</i>
TRIG:SOUR?	<i>ask System Instrument to return trigger source configuration</i>
enter statement	<i>input selection of trigger source</i>

VXI:CONFigure :DLADdress?

VXI

The VXI command subsystem provides for:

- Determining the number, type, and logical address of the devices (instruments) installed in the E1300/E1301 mainframe.
- Direct access to VXIbus A16 registers within devices installed in the Mainframe.

Subsystem Syntax VXI

```
:CONFigure
:DeviceLADd?
:DeviceLIST?
:DeviceNUMBER?
:HEIRarchy
:ALL?
:INFormation?
:ALL?
:LADdress?
:NUMBER?
:READ? <logical_addr>,<register_num>
:REGister
:READ? <numeric_value>|<register_name>
:WRITE <numeric_value>|<register_name>
:RESet?
:SElect <numeric_value>
:WRITE <logical_addr>,<register_num>,<data>
```

:CONFigure :DLADdress?

VXI:CONF:DLAD? returns a comma separated decimal numeric list of device logical addresses currently installed in the mainframe. If the Command Module is not the resource manager, it only returns the logical addresses of the devices in its servant area.

Comments

- Use the VXI:CONF:DNUM? command to determine the number of values which will be returned by VXI:CONF:DLAD?.
- Use each of the logical addresses returned by VXI:CONF:DLAD? with VXI:CONF:DLIS? to determine the types of devices installed.
- VXI:CONF:DEVICELAD? is also accepted.
- This command has been retained for compatibility with existing programs. For new programs you should use the VXI:CONF:LADD? command.
- **Related Commands:** VXI:CONF:DLIS?, VXI:CONF:DNUM?, VXI:CONF:LADD?

Example Determining the device addresses within the system

```
VXI:CONF:DLAD?          query for list of addresses.
enter statement         list of addresses.
```

:CONFigure:DLIST? VXI:CONF:DLIS? [<logical_addr>] returns information about the device specified by *logical_addr*. Response data is in the form:

n1, n2, n3, n4, n5, n6, c1, c2, c3, c4, c5, s1, s2, s3, s4

Where the fields above are defined as:

- n fields Indicate numeric data response fields.
- c fields Indicate character data response fields.
- s fields Indicate string data response fields.
- n1** **Device's Logical Address.** A number from 0 to 255.
- n2** **Commander's Logical Address.** A number from -1 to 255; -1 means this device has no commander.
- n3** **Manufacturer's ID.** A number from 0 to 4095.
- n4** **Model Code.** A number from 0 to 65535, chosen by the manufacturer to signify the model of this device.
- n5** **Slot Number.** A number between -1 and the number of slots in this mainframe; -1 indicates that the slot associated with this device is unknown. This is always -1 for B size mainframes.
- n6** **Slot 0 Logical Address.** A number from 0 to 255.
- c1** **Device Class.** 3 data characters; EXT|HYB|MEM|MSG|REG|VME. EXT = Extended device, HYB = hybrid device (e.g. IBASIC), MEM = memory device, MSG = Message-based device, REG = Register-based device, VME = VME device
- c2** **Memory Space.** Up to 4 data characters; A16|A24|A32|NONE|RES. A16 = A16 addressing mode, A24 = A24 addressing mode, A32 = A32 addressing mode, NONE = no addressing mode, RES = reserved.
- c3** **Memory Offset.** 10 data characters which define the base address of the A24 or A32 address space on the device. This value is expressed in hex format (first two characters are #H).
- c4** **Memory Size.** 10 data characters which define the size of the A24 or A32 address space in bytes. This value is expressed in hex format (first two characters are #H).
- c5** **Pass/Failed.** Up to 5 data characters which define the status of the device; FAIL|IFAIL|PASS|READY. FAIL = failed self-test, IFAIL = configuration register initialization fails, PASS = self-test passed, READY = ready to receive commands
- s1** **Extended Field 1.** Not currently used; returns ""
- s2** **Extended Field 2.** Not currently used; returns ""
- s3** **Extended Field 3.** Not currently used; returns ""
- s4** **Manufacturer's Specific Comments.** Up to 80 character string contains manufacturer specific data in string response data format. This field is sent with a 488.2 string response data format, and will contain the instrument name and its IEEE 488.1 secondary address unless a start-up error is detected. In that case, this field will contain one or more error codes in the form "CNFG ERROR: n, m, ...,z". See Appendix B, Table B-3 for a complete list of these codes.

VXI:CONFigure :DNUMber?

Parameters

Parameter Name	Parameter Type	Range of Values	Default Units
<i>logical_addr</i>	numeric	0-255 (or nothing)	none

Comments

- When *logical_addr* is not specified, VXI:CONF:DLIS? returns information for each of the devices installed, separated by semicolons. If the Command Module is not the resource manager, it returns information on only the devices in its servant area.
- Cards which are part of a combined instrument such as a switchbox or scanning voltmeter always return the same manufacturer's comments as the first card in the instrument. Information in the other fields correspond to the card for which the Logical Address was specified.
- This command has been retained for compatibility with existing programs. For new programs you should use the VXI:CONF:INF? command.
- **Related Commands:** VXI:CONF:DLAD?, VXI:CONF:DNUM?, VXI:CONF:INF?, CONF:HEIR?

Example Querying the device list for the System Instrument

```
dimension string[1000]           string size large in case of
                                  multiple device list
VXI:CONF:DLIS? 0                 Ask for the device list for the
                                  System Instrument
enter string                       enter return data into string
```

Example response data (no error): +0, -1, +4095, +1301, +0, +0, HYB, NONE, #H00000000, #H00000000, READY, "", "", "", "SYSTEM INSTALLED AT SECONDARY ADDR 0"

Example response data (with error): +255, +0, +4095, +65380, -1, +0, REG, A16, #H00000000, #H00000000, READY, "", "", "", "CNFG ERROR: 11"

:CONFigure :DNUMber?

VXI:CONF:DNUM? returns the number of devices installed in the mainframe (including the System Instrument itself). If the Command Module is not the resource manager, it returns the number of devices in its servant area.

Comments

- Use the VXI:CONF:DNUM? command to determine the number of values which will be returned by VXI:CONF:DLAD?.
- This command has been retained for compatibility with existing programs. For new programs you should use VXI:CONF:NUMB?.
- **Related Commands:** VXI:CONF:DLAD?, VXI:CONF:DLIS?

Example Determining the number of devices within the system

```
VXI:CONF:DNUM?                   query the number of devices
enter statement                   input number of devices
```

**:CONFigure
:HIERarchy?**

VXI:CONF:HIER? Returns current hierarchy configuration information about the selected logical address. The individual fields of the response are comma separated. If the information about the selected logical address is not available from the destination device (i.e., the requested device is not in the mainframe) then Error -224 ("parameter error") will be set and no response data will be sent.

NOTE

This command is included in the E1300/E1301 because it is a required SCPI command. Since there are no message based devices in the E1300/E1301, most of these fields will be null valued for the E1300/E1301.

Comments

- This command returns the following values:

Logical address: an integer between -1 and 255 inclusive. -1 indicates that the device has no logical address.

Commander's logical address: an integer between -1 and 255 inclusive. -1 indicates that the device has no commander or that the commander is unknown. This value is always 0 for the E1300/E1301.

Interrupt handlers: a comma separated list of seven integers between 0 and 7 inclusive. Interrupt lines 1–7 are mapped to the individual return values. 0 is used to indicate that the particular interrupt handler is not configured. A set of return values of 0,0,0,5,2,0,6 would indicate that:

- handler 4 is configured to handle interrupts on line 5
- handler 5 is configured to handle interrupts on line 2
- handler 7 is configured to handle interrupts on line 6
- handlers 1, 2, 3, and 6 are not configured

Interrupters: a comma separated list of seven integers between 0 and 7 inclusive. Interrupt lines 1–7 are mapped to the individual return values. 0 is used to indicate that the particular interrupter is not configured. A set of return values of 0,0,0,5,2,0,6 would indicate that:

- interrupter 4 is configured to handle interrupts on line 5
- interrupter 5 is configured to handle interrupts on line 2
- interrupter 7 is configured to handle interrupts on line 6
- interrupters 1, 2, 3, and 6 are not configured

Pass/Failed: an integer which contains the pass/fail status of the specified device encoded as follows:

0 = FAIL, 1 = IFAIL, 2 = PASS, 3 = READY

Manufacturer's Specific Comments. Up to 80 character string contains manufacturer specific data in string response data format. This field is sent with a 488.2 string response data format, and will contain the instrument name and its IEEE 488.1 secondary address unless a start-up error is detected. In that case, this field will contain one or more error codes in the form "CNFG ERROR: n, m, ...,z". See Appendix B, Table B-3 for a complete list of these codes.

VXI:CONFigure :HIERarchy:ALL?

- Cards which are part of a combined instrument such as a switchbox or scanning voltmeter always return the same manufacturer's comments as the first card in the instrument. Information in the other fields correspond to the card for which the Logical Address was specified.
- **Related Commands:** VXI:SEL, VXI:CONF:HEIR:ALL?, VXI:CONF:LADD?

:CONFigure :HIERarchy:ALL?

VXI:CONF:HIER:ALL? Returns the configuration information about all logical addresses in the E1300/E1301 mainframe. The information is returned in the order specified in the response to VXI:CONF:LADD?. The information about multiple logical addresses will be semicolon separated and follow the IEEE 488.2 response message format. Individual fields of the output are comma separated.

NOTE

This command is included in the E1300/E1301 because it is a required SCPI command. Since there are no message based devices in the E1300/E1301, most of these fields will be null valued for this E1300/E1301.

Comments

- **Related Commands:** VXI:CONF:HEIR?, VXI:SEL, VXI:CONF:LADD?

:CONFigure :INFormation?

VXI:CONF:INF? Returns the static information about the selected logical address (see VXI:SELEct). The individual fields of the response are comma separated. If the information about the selected logical address is not available from the destination device (i.e., the requested device is not in the mainframe) then Error -224 ("parameter error") will be set and no response data will be sent. The command returns the following values:

- **Logical address:** an integer between -1 and 255 inclusive. -1 indicates that the device has no logical address.
- **Manufacturer ID:** an integer between -1 and 4095 inclusive. -1 indicates that the device has no Manufacturer ID.
- **Model code:** an integer between -1 and 65535 inclusive. -1 indicates that the device has no model code.
- **Device class:** an integer between 0 and 5 inclusive. 0 = VXIbus memory device, 1 = VXIbus extended device, 2 = VXIbus message based device, 3 = VXIbus register based device, 4 = Hybrid device, 5 = Non-VXIbus device.
- **Address space:** an integer between 0 and 15 inclusive, which is the sum of the binary weighted codes of the address space(s) occupied by the device. 1 = The device has A16 registers, 2 = The device has A24 registers, 4 = The device has A32 registers, 8 = The device has A64 registers.
- **A16 memory offset:** an integer between -1 and 65535 inclusive. Indicates the base address for any A16 registers (other than the VXIbus defined

VXI :CONFigure :INFormation?

registers) which are present on the device. -1 indicates that the device has no A16 memory.

- **A24 memory offset:** an integer between -1 and 16777215 inclusive. Indicates the base address for any A24 registers which are present on the device. -1 indicates that the device has no A24 memory.
- **A32 memory offset:** an integer between -1 and 4294967295 inclusive. Indicates the base address for any A32 registers which are present on the device. -1 indicates that the device has no A32 memory.
- **A16 memory size:** an integer between -1 and 65535 inclusive. Indicates the the number of bytes reserved for any A16 registers (other than the VXIbus defined registers) which are present on the device. -1 indicates that the device has no A16 memory.
- **A24 memory size:** an integer between -1 and 16777215 inclusive. Indicates the number of bytes reserved for any A24 registers which are present on the device. -1 indicates that the device has no A24 memory.
- **A32 memory seze:** an integer between -1 and 4294967295 inclusive. Indicates the number of bytes reserved for any A32 registers which are present on the device. -1 indicates that the device has no A32 memory.
- **Slot number:** an integer between -1 and the number of slots which exist in the cage. -1 indicates that the slot which contains this device is unknown.
- **Slot 0 logical address:** an integer between -1 and 255 inclusive. -1 indicates that the Slot 0 device associated with this device is unknown.
- **Subclass:** an integer representing the contents of the subclass register. -1 indicates that the subclass register is not defined for this device.
- **Attribute:** an integer representing the contents of the attribute register. -1 indicates that the attribute register is not defined for this device.
- **Manufacturer's Specific Comments.** Up to 80 character string contains manufacturer specific data in string response data format. This field is sent with a 488.2 string response data format, and will contain the instrument name and its IEEE 488.1 secondary address unless a start-up error is detected. In that case, this field will contain one or more error codes in the form "CNFG ERROR: n, m, ...,z". See Appendix B, Table B-3 for a complete list of these codes.

Comments

- **Related Commands:** VXI:SEL, VXI:CONF:INF:ALL?, VXI:CONF:LADD?

Example Query information on logical address 0.

VXI:SEL 0	<i>select the logical address</i>
VXI:CONF:INF?	<i>ask for data</i>
enter statement	<i>return data</i>

VXI:CONFigure :INFormation:ALL?

:CONFigure :INFormation:ALL?

VXI:CONF:INF:ALL? Returns the static information about all logical addresses. The information is returned in the order specified in the response to **VXI:CONF:LADD?**. The information about multiple logical addresses will be semicolon separated and follow the IEEE 488.2 response message format. Individual fields of the output are comma separated.

Comments

- **Related Commands:** VXI:SEL, VXI:CONF:INF?, VXI:CONF:LADD?

:CONFigure :LADdress?

VXI:CONF:LADD? Returns a comma separated list of logical addresses of devices in the mainframe. This is an integer between 1 and 256 inclusive. The logical address of the device responding to the command will be the first entry in the list.

Comments

- **Related Commands:** VXI:CONF:NUMB?

:CONFigure :NUMBer?

VXI:CONF:NUMB? Returns the number of devices in the system. This is an integer between 1 and 256 inclusive.

Comments

- **Related Commands:** VXI:CONF:LADD?

:READ?

VXI:READ? <logical_addr>, <register_addr> allows access to the entire 64 byte A16 register address space for the device specified by *logical_addr*. Since the VXIbus system is byte-addressed, while the registers are 16 bits wide, registers are specified by even addresses only. This method of identifying registers follows the VXIbus standard format.

Parameters

Parameter Name	Parameter Type	Range of Values	Default Units
<i>logical_addr</i>	decimal numeric	must round to 0 through 255	none
<i>register_addr</i>	numeric	must round to an even value from 0 through 62 (3E ₁₆)	none

Comments

- Specifying an odd register address will cause an error 2003, "Invalid word address".
- Specifying a logical address not currently in the system will cause an error 2005, "No card at logical address".
- *Logical_addr* must be specified in decimal. *Register_addr* may be specified in decimal, hex (#H), octal (#Q), or binary (#B).
- This command has been retained for compatibility with existing programs. For new programs you should use the **VXI:REG:READ?** command.
- Accesses are 16-bit non-privileged data accesses.

- **Related Commands:** VXI:WRITE, VXI:REG:READ?

Example Read from one of a device's configuration registers

VXI:READ? 8,0 *read ID register on device at Logical Address 8*
 enter statement *enter value from device register*

:REGister:READ?

VXI:REG:READ? <register> returns the contents of the specified 16 bit register at the selected logical address as an integer (see VXI:SElect). The register is specified as the byte address of the desired register or optionally as the register name.

Parameters

Parameter Name	Parameter Type	Range of Values	Default Units
<i>register</i>	numeric	even numbers from 0 to 62 or register name (see below)	none

Comments

- The register parameter can be all even numbers from 0 to 62 inclusive (as a <numeric_value>) or the following (optional) words:
 A24Low: A24 Pointer Low register (18)
 A24High: A24 Pointer High register (16)
 A32Low: A32 Pointer Low register (22)
 A32High: A32 Pointer High register (20)
 ATTRibute: Attribute register (8)
 DHIGH: Data High register (12)
 DLOW: Data Low register (14)
 DTYPE: Device Type register (2)
 ICONtrol: Interrupt control register (28)
 ID: ID register (0)
 IStatus: Interrupt Status register (26)
 MODid: MODID register (8)
 OFFSet: Offset register (6)
 PROTocol: Protocol register (8)
 RESPonse: Response register (10)
 SNHigh: Serial Number High register (10)
 SNLow: Serial Number Low register (12)
 STATus: Status register (4)
 SUBClass: Subclass register (30)
 VNUMBER: Version Number register (14)
- **Related Commands:** VXI:SEL, VXI:REG:WRIT

Example Read from a register on the currently selected device

VXI:READ? CONT *Read from the control register of the currently selected device*

:REGister:WRITE

VXI:REG:WRITE? <register> , <data> writes to the specified 16 bit register at the selected logical address (see VXI:SElect). The data is a 16 bit value specified as a numeric value in the range of -32768 to 32767 or 0 to 65535. The register is specified as the byte address of the desired register or optionally as the register name.

Parameters

Parameter Name	Parameter Type	Range of Values	Default Units
<i>register</i>	numeric	even numbers from 0 to 62 or register name (see below)	none
<i>data</i>	numeric	-32768 to 65535	none

Comments

- The register parameter can be all even numbers from 0 to 62 inclusive (as a <numeric_value>) or the following (optional) words:
 CONTROL: Control Register (4)
 DEXTended: Data Extended register (10)
 DHIGH: Data High register (12)
 DLOW: Data Low register (14)
 ICONtrol: Interrupt Control register (28)
 MODId: MODID register (8)
 LADDress: Logical Address register (0)
 OFFSet: Offset register (6)
 SIGNal: Signal register (8)
- **Related Commands:** VXI:SEL, VXI:REG:READ?

Example

Write to a register on the currently selected device

VXI:REG:WRIT? DHIG,64

writes "64" to the Data High register

Reset?

VXI:RESET? resets the selected logical address. SYSFAIL generation is inhibited while the device is in the self test state. The command waits for 5 seconds or until the selected device has indicated passed (whichever occurs first). If the device passes its self test SYSFAIL generation is re-enabled. If the device fails its self test SYSFAIL generation remains inhibited. The return value from this command is the state of the selected device after it has been reset. The command returns an integer encoded as followed.

- 0 = FAIL
- 2 = PASS
- 3 = READY

The state of the A24/A32 enable bit is not altered by this command

Comments

- **Related Commands:** VXI:SEL

:SElect VXI:SElect <logical_addr> specifies the logical address which is to be used by many subsequent commands in the VXI subsystem.

Parameters

Parameter Name	Parameter Type	Range of Values	Default Units
<i>logical_addr</i>	numeric	0 through 255	none

Comments

- The *RST default value for *logical_addr* is that no logical address is selected (i.e., -1). All other commands which require a logical address to be selected will respond with Error -221 ("settings conflict") if no logical address is selected.
- When a command encounters an Error -240 ("Hardware Error") the equivalent of a *RST is executed. This will cause the selected logical address to be set to -1.
- **Related Commands:** VXI:CONF:LADD?

Example Select a logical address

VXI:SEL 64

sets the logical address to be used by subsequent VXI subsystem commands to 64.

:SElect? VXI:SElect? returns the logical address which will be used by many subsequent commands in the VXI subsystem. If no logical address has been selected, this query will return -1.

:WRITE **VXI:WRITE** <logical_addr> , <register_addr> , <data> allows access to the entire 64 byte A16 register address space for the device specified by *logical_addr*. Since the VXIbus system is byte-addressed, while the registers are 16 bits wide, registers are specified by even addresses only. This method of identifying registers follows the VXIbus standard format.

Parameters

Parameter Name	Parameter Type	Range of Values	Default Units
<i>logical_addr</i>	decimal numeric	Must round to 0 through 255	none
<i>register_addr</i>	numeric	must round to an even value from 0 through 62 (3E _h)	none
<i>data</i>	numeric	must round to -32768 to 32767 (0 to FFFF _h)	none

Comments

- Specifying an odd register address will cause an error 2003, "Invalid word address".
- Specifying a logical address not currently in use in the system will cause an error 2005, "No card at logical address".
- *Logical_addr* must be specified in decimal. *Register_addr* and *data* may be specified in decimal, hex (#H), octal (#Q), or binary (#B).
- This command has been retained for compatibility with existing programs. For new programs you should use the VXI:REG:WRIT command.
- Accesses are 16-bit non-privileged data accesses.
- **Related Commands:** VXI:READ?, VXI:REG:WRIT

Example Write a value into a device's device dependent register.

VXI:WRIT 8,24,#H4200

write hex 4200 (16,896 decimal) to register 24 of device at Logical Address 8

Common Command Reference

This section describes the IEEE-488.2 Common Commands that can be used to program instruments in the mainframe. Commands are listed by command groups in the summary table below, and alphabetically in the rest of this section. Examples are shown when the command has parameters or returns a response; otherwise the command string is as shown in the headings in this section. For additional information on any Common Commands, refer to the *IEEE Standard 488.2-1987* (see "Related Documentation" in the front of this manual for more information on this standard).

IEEE 488.2 Common Commands Functional Groupings		
Category	Command	Title
General	*IDN	Identification Query
	*RST	Reset Command
	*TST?	Self-Test Query
Instrument Status	*CLS	Clear Status Command
	*ESE <mask>	Standard Event Status Enable Command
	*ESE?	Standard Event Status Enable Query
	*ESR?	Standard Event Status Register Query
	*PSC	Power-On Status Clear Command
	*PSC?	Power-On Status Clear Query
	*SRE <mask>	Service Request Enable Command
	*SRE?	Service Request Enable Query
	*STB?	Status Byte Query
Macros	*DMC <name>, <cmds>	Define Macro Command
	*EMC <state>	Enable Macros Command
	*EMC?	Enable Macros Query
	*GMC? <name>	Get Macro Query
	*LMC?	Learn Macro Query
	*PMC	Purge all Macros Command
	*RMC <name>	Remove individual Macro Command
Synchronization	*OPC	Operation Complete Command
	*OPC?	Operation Complete Query
	*WAI	Wait-to-Continue Command
		Wait-to-Continue Query

***CLS** Clear Status Command. The *CLS command clears all status registers (Standard Event Status Register, Standard Operation Event Status Register, Questionable Data Event Register) and the error queue for an instrument. This clears the corresponding summary bits (bits 3, 5, & 7) and the instrument-specific bits (bits 0, 1, & 2) in the Status Byte Register. *CLS does not affect the enabling of bits in any of the status registers (Status Byte Register, Standard Event Status Register, Standard Operation Event Status Register, or Questionable Data Event Status Register). (The SCPI command STATus:PRESet *does* clear the Standard Operation Status Enable and Questionable Status Enable registers.) *CLS disables the Operation Complete function (*OPC command) and the Operation Complete Query function (*OPC? command).

***DMC <name_string> ,** Define Macro Command. Assigns one, or a sequence of commands to a macro
<command_block> name.

The command sequence may be composed of SCPI and/or Common commands.

The name given to the macro may be the same as a SCPI command, but may not be the same as a Common command. When a SCPI named macro is executed, the macro rather than the SCPI command is executed. To regain the function of the SCPI command, execute the *EMC 0 command.

Example

Create a macro to return the System Instrument's Device list.
OUTPUT 70900;"*DMC 'LIST',#0VXI:CONF:DLIS?"

Note that the name LIST is in quotes. The second parameter type is *arbitrary block program data*. The characters that define a command message are prefixed by the characters #0 (pound zero). For a more information on this parameter type, see Parameter Types in the first part of this chapter.

***EMC <enable>** Enable Macros Command. When *enable* is non-zero, macros are enabled. When *enable* is zero, macros are disabled.

***EMC?** Enable Macros Query. Returns either 1 (macros are enabled), or 0 (macros are disabled) for the selected instrument.

***ESE <mask>** Standard Event Status Enable Register Command. Enables one or more events in the Standard Event Status Register to be reported in bit 5 (the Standard Event Status Summary Bit) of the Status Byte Register. You enable an event by specifying its decimal weight for *<mask>*. To enable more than one event, specify the sum of the decimal weights. Refer to "Standard Event Status Register" earlier in this chapter for a table showing the contents of the Standard Event Status Register.

Example

OUTPUT 70900;"*ESE 60"

*Enables bits 2, 3, 4, & 5.
Respective weights are 4 + 8
+ 16 + 32 = 60*

***ESE?** Standard Event Status Enable Query. Returns the weighted sum of all enabled (unmasked) bits in the Standard Event Status Register.

Example	10 OUTPUT 70900;"*ESE?" 20 ENTER 70900;A 30 PRINT A 40 END	<i>Sends status enable query</i> <i>Places response in variable</i> <i>Prints response</i>
----------------	---	--

***ESR?** Standard Event Status Register Query. Returns the weighted sum of all set bits in the Standard Event Status Register. After reading the register, *ESR? clears the register. The events recorded in the Standard Event Status Register are independent of whether or not those events are enabled with the *ESE command.

Example	10 OUTPUT 70900;"*ESR?" 20 ENTER 70900;A 30 PRINT A 40 END	<i>Sends Standard Event Status Register query</i> <i>Places response in variable</i> <i>Prints response</i>
----------------	---	---

***GMC? < name_string >** Get Macro Query. Returns *arbitrary block response data* which contains the command or command sequence defined by *name_string*. The command sequence will be prefixed with characters which indicate the number of characters that follow the prefix.

Example	10 OUTPUT 70900;"*GMC? 'LIST'" 20 ENTER 70900;Cmds\$ 30 PRINT Cmds\$ 40 END	<i>ask for definition of macro from *DMC example</i> <i>enter into Cmds\$ the definition of the macro "LIST"</i> <i>Cmds\$ = #214VXI:CONF:DLIS?</i>
----------------	--	---

In this case, the prefix consists of "#214". The 2 says to expect two character-counting digits. The 14 says that 14 characters of data follow. Had the returned macro been shorter, such as #15*EMC?, we would read this as 1 counting digit indicating 5 data characters.

***IDN?** Identity. Returns the device identity. The response consists of the following four fields (fields are separated by commas):

- Manufacturer
- Model Number
- Serial Number (returns 0 if not available)
- Firmware Revision (returns 0 if not available)

The *IDN? command returns the following command string for the E1301A:

```
HEWLETT-PACKARD,E1301A,0,A,07.00
```

This command will return the following string for the E1300A:

```
HEWLETT-PACKARD,E1300A,0,A,07.00
```

NOTE

The revision will vary with the revision of the ROM installed in the system. This is the only indication of which version of ROM is in the box. The major number (01 in the examples) indicates whether there have been functional changes made in this ROM. The minor number (00 in the examples) indicates whether only bug fixes and minor changes were made.

Example Get the ID fields from the system and print them.

```
10 DIM A${50} Dimension array for ID fields
20 OUTPUT 70900;"*IDN?" Queries identity
30 ENTER 70900;A$ Places ID fields in array
40 PRINT A$ Print ID fields
50 END
```

***LMC?** Learn Macros Query. Returns a quoted string *name* for each currently defined macro. If more than one macro is defined, the quoted strings are separated by commas (.). If no macro is defined, then a quoted null string ("") is returned.

***LRN?** Learn query command. *LRN? causes the instrument to respond with a string of SCPI commands which define the instrument's current state. Your application program can enter the *LRN? response data into a string variable, later to be sent back to the instrument to restore that configuration.

Example response from an HP E1326B voltmeter in the power-on state:

```
*RST;:CAL:ZERO:AUTO 1;:CAL:LFR +60; VAL +0.00000000E+000;
:DISP:MON:STAT 0; CHAN (@0); :FORM ASC, +7; :FUNC "VOLT";
:MEM:VME:ADDR +2097152; SIZE +0; STAT 0; :RES:APER
+1.666667E-002; OCOM 0; RANG +1.638400E+004; RANG:AUTO
1;:VOLT:APER +1.666667E-002; RANG +8.000000E+000; RANG:AUTO
1;:TRIG:COUN +1; DEL +0.00000000E+000; DEL:AUTO 1; :TRIG:SOUR
IMM; :SAMP:COUN +1; SOUR IMM;TIM +5.000000E-002 S
```

NOTE

The System Instrument no longer implements the *LRN? command. Attempting to have the System Instrument execute this command will generate an error -113 "Undefined header".

***OPC** Operation Complete. Causes an instrument to set bit 0 (Operation Complete Message) in the Standard Event Status Register when all pending operations have been completed. By enabling this bit to be reflected in the Status Byte Register (*ESE 1 command), you can ensure synchronization between the instrument and an external computer or between multiple instruments. (Refer to "Synchronizing an External Computer and Instruments" earlier in this chapter for an example).

***OPC?** Operation Complete Query. Causes an instrument to place an ASCII 1 into the instrument's output queue when all pending instrument operations are finished. By requiring the computer to read this response before continuing program execution, you can ensure synchronization between one or more instruments and the computer. (Refer to "Synchronizing an External Computer and Instruments" earlier in this chapter for an example).

***PMC** Purge Macros Command. Purges all currently defined macros in the selected instrument.

***PSC <flag>** Power-on Status Clear Command. Controls the automatic power-on clearing of the Service Request Enable register and Standard Event Status Enable register. Executing *PSC 1 disables any previously enabled bits at power-on, preventing the System Instrument from requesting service when power is cycled. Executing *PSC 0 causes any previously enabled bits to remain enabled at power-on which allows the System Instrument to request service (if it has been enabled - *SRE) when power is cycled. The value of *flag* is stored in non-volatile memory.

Example This example configures the System Instrument to request service from the external computer whenever power is cycled.

Status Byte register and Standard Event Status register bits remain enabled (unmasked) after cycling power

```
10 OUTPUT 70900;""*PSC 0"
```

Enable bit 5 (Standard Event Status Register Summary Bit) in the Status Byte Register

```
20 OUTPUT 70900;""*SRE 32"
```

Enable bit 7 (Power-on bit) in the Standard Event Status Register to be reflected as bit 5 in the Status Byte Register

```
30 OUTPUT 70900;""*ESE 128"
```

***PSC?** Power-on status clear query. Returns a response indicating whether an instrument's Status Byte Register and Standard Event Status Register bits remain enabled or become disabled at power-on. A "1" means the bits are disabled at power-on; a "0" means the bits remain enabled at power-on.

***RCL <state number>** Recall stored state. Recalls a stored state from memory and configures the instrument to that state. States are stored using the *SAV command.

Example OUTPUT 70900;"*RCL 4" *Recalls instrument state number 4*

***RMC <name_string>** Remove Individual Macro Command. Purges an individual macro identified by the *name_string* parameter.

Example output 70900;"*RMC 'LIST'" *remove macro command from *DMC example*

NOTE: At printing time, *RMC is a command proposed for a revision and re-designation of ANSI/IEEE Std 488.2-1987.

***RST** Reset. Resets an instrument as follows:

- Sets the instrument to a known state (usually the power-on state)
- Aborts all pending operations
- Disables the *OPC and *OPC? modes.

*RST does not affect:

- The state of the HP-IB interface
- The HP-IB address
- The output queue
- The Service Request Enable Register
- The Standard Event Status Enable Register
- The power-on flag
- Calibration data
- Protected user data

***SAV <state number>** Store state. Stores an instrument's present state in a numbered memory location (<state number> parameter). State numbers can range from 0 to 9.

Example OUTPUT 70900;"*SAV 4" *Saves present instrument state as state number 4*

***SRE <mask>** Service Request Enable. When a service request event occurs, it sets a corresponding bit in the Status Byte Register (this happens whether or not the event has been enabled (unmasked) by *SRE). The *SRE command allows you to identify which of these events will assert an HP-IB service request (SRQ). When an event is enabled by *SRE and that event occurs, it sets a bit in the Status Byte Register and issues an SRQ to the computer (sets the HP-IB SRQ line true). You enable an event by specifying its decimal weight for <mask>. To enable more than one event, specify the sum of the decimal weights. Refer to "The Status Byte Register" earlier in this chapter for a table showing the contents of the Status Byte Register.

Example OUTPUT 70900;"*SRE 160" *Enables bits 5 & 7. Respective weights are 32 + 128 = 160*

***SRE?** Status Register Enable Query. Returns the weighted sum of all enabled (unmasked) events (those enabled to assert SRQ) in the Status Byte Register.

Example 10 OUTPUT 70900;"*SRE?" *Sends Status Register Enable query*
 20 ENTER 70900;A *Places response in variable*
 30 PRINT A *Prints response*
 40 END

***STB?** Status Byte Register Query. Returns the weighted sum of all set bits in the Status Byte Register. Refer to "The Status Byte Register" earlier in this chapter for a table showing the contents of the Status Byte Register.

Comments You can read the Status Byte Register using either the *STB? command or an HP-IB serial poll (IEEE 488.1 message). Both methods return the weighted sum of all set bits in the register. The difference between the two methods is that *STB? does not clear bit 6 (Service Request); serial poll does clear bit 6. No other status byte register bits are cleared by either method with the exception of the Message Available bit (bit 4) which may be cleared as a result of reading the response to *STB?.

Example 10 OUTPUT 70900;"*STB?" *Sends Status Byte Register query*
 20 ENTER 70900;A *Places response in variable*
 30 PRINT A *Prints response*
 40 END

***TRG** Trigger. Triggers an instrument when the trigger source is set to bus (TRIG:SOUR BUS command) and the instrument is in the Wait for Trigger state.

***TST?** Self-Test. Causes an instrument to execute an internal self-test and returns a response showing the results of the self-test. A zero response indicates that self-test passed. A value other than zero indicates a self-test failure or error.

Example 10 OUTPUT 70900;"*TST?" *Execute self-test, return response*
 20 ENTER 70900;A *Places self-test response in variable*
 30 PRINT A *Prints response*
 40 END

***WAI** Wait-to-continue. Prevents an instrument from executing another command until the operation caused by the previous command is finished (sequential operation). Since all instruments normally perform sequential operations, executing the *WAI command causes no change to the instrument's operation.

HP-IB Message Reference

This section describes IEEE-488.1 defined messages and their affect on instruments installed in the mainframe. The examples shown are specifically for HP 9000 Series 200/300 computers using BASIC language. Any IEEE-488 controller can send these messages; however, the syntax may be different from that shown here.

Go To Local (GTL) Places an instrument in local state.

Comments ● Refer to the Local Lockout message, later in this chapter, for information on how GTL affects front panel lockout.

Examples

LOCAL 7	<i>Sets HP-IB remote enable line false (all instruments go to local). (You must now execute REMOTE 7 to return to remote mode).</i>
LOCAL 70900	<i>Issues HP-IB GTL to System Instrument. (The instrument will return to remote mode when it is listen addressed.)</i>

Group Execute Trigger (GET) Executing a group execute trigger will trigger an instrument assuming the following conditions are true:

- The instrument's trigger source is set to Bus (TRIG:SOUR BUS command), and:
- The instrument is in the Wait For Trigger state, and:
- The instrument is addressed to listen (can be done by sending any command, the REMOTE 709ss (ss = secondary address) command, or with the LISTEN command).

Comments ● For instruments in an HP E1300A/E1301A Mainframe, only one instrument at a time can be programmed to respond to GET. This is because only one instrument can be addressed to listen at any one time.

Example

10 OUTPUT 70900;"TRIG:SOUR BUS"	<i>Sets trigger source to bus</i>
20 OUTPUT 70900;"INIT:IMM"	<i>Places System Instrument's Pacer in Wait For Trigger state</i>
30 TRIGGER 70900	<i>Triggers Pacer</i>
40 END	

Interface Clear (IFC) Unaddresses all instruments in the mainframe and breaks any bus handshaking in progress.

Example ABORT 7

Device Clear (DCL) or Selected Device Clear (SDC)

DCL clears all instruments in the mainframe. SDC clears a specific instrument. The purpose of DCL or SDC is to prepare one or more instruments to receive and execute commands (usually *RST). DCL or SDC do the following to each instrument:

- Clear the input buffer and output queue.
- Reset the command parser.
- Disable any operation that would prevent *RST from being executed.
- Disable the Operation Complete and Operation Complete Query modes.

DCL or SDC do not affect:

- Any settings or stored data in the instrument (except the Operation Complete and Operation Complete Query modes)
- Front panel operation
- Any instrument operation in progress (except as stated above)
- The status byte (except for clearing the Message Available bit as a result of clearing the output queue).

Examples

CLEAR 7

Clears all instruments

CLEAR 70900

Clears the System Instrument

Local Lockout (LLO)

When an instrument is in remote mode, Local Lockout prevents an instrument from being operated from the mainframe's front panel.

Comments

- Certain front panel operations such as menu control and display scrolling are still active in Local Lockout mode.
- If the instrument is in the local state when you send LOCAL LOCKOUT, it remains in local. If the instrument is in the remote state when you send LOCAL LOCKOUT, front panel control is disabled immediately for that instrument.
- After executing LOCAL LOCKOUT, you can enable the keyboard by sending the LOCAL 7 command or by cycling power. The LOCAL 709ss (ss = secondary address) command enables the front panel for that instrument but a subsequent remote command disables it. Sending the LOCAL 7 command removes lockout for all instruments and places them in the local state.

Examples

10 REMOTE 70900

Sets the System Instrument remote state

20 LOCAL LOCKOUT 7

Disables front panel control for the System Instrument and all other instruments that were in the remote state.

30 END

Remote Sets the HP-IB remote enable line (REN) true which places an instrument in the remote state.

- Comments**
- The REMOTE 709ss (ss = secondary address) command places the instrument in the remote state. The REMOTE 7 command, does not, by itself, place the instrument in the remote state. After sending the REMOTE 7 command, the instrument will only go into the remote state when it receives its listen address.
 - In most cases, you will only need the REMOTE command after using the LOCAL command. REMOTE is independent of any other HP-IB activity and toggles a single bus line called REN. Most controllers set the REN line true when power is applied or when reset.

Examples

REMOTE 7	<i>Sets HP-IB REN line true</i>
REMOTE 70900	<i>Sets REN line true and addresses System Instrument</i>

Serial Poll (SPOLL) The SPOLL command, like the *STB? Common Command, returns the weighted sum of all set bits in an instrument's Status Register (status byte). Refer to "The Status Register" earlier in this chapter for a table showing the contents of the Status Register.

- Comments**
- The SPOLL command differs from the *STB? command in that SPOLL clears bit 6 (RQS). Executing *STB? does not clear bit 6.

Examples

10 P = SPOLL (70900)	<i>Sends Serial Poll, places response into P</i>
20 DISP P	<i>Displays response</i>
30 END	

Command Quick Reference

The following tables summarize SCPI and IEEE 488.2 Common (*) commands for the HP E1300/E1031 Mainframe System Instrument.

SCPI Commands Quick Reference	
Command	Description
ABOR: [IMMediate]	Abort Pacer output.
DIAGnostic :BOOT :COLD [:WARM]	Restarts System processor, clears stored configurations. Same as cycling power.
:COMMunicate :SERial[0] [:OWNer] [SYSTem IBASic NONE] [:OWNer]? :SERial[n] :STORe	Allocates the built-in serial interface. Returns SYST, IBAS, or NONE. Stores serial communication parameters into non-volatile storage.
:DOWNload :CHECKed [:MADDRESS]	Write data to non-volatile user RAM starting at the specified address using error correction.
:SADDRESS [:MADDRESS] < address >, < data >	Write data to non-volatile user RAM at the specified address using error correction.
:SADDRESS < address >, < data >	Write data to non-volatile user RAM starting at the specified address.
:DRAM :AVailable?	Returns the amount of RAM remaining in the DRAM (Driver RAM) segment.
:CREate < size >, < num_drivers >	Creates a non-volatile RAM area for loading instrument drivers.
:DRIVER :LOAD < driver_block >	Loads the instrument driver contained in the specified driver_block into a previously created DRAM segment.
:LOAD :CHECKed	Loads the instrument driver contained in the specified driver_block into a previously created DRAM segment using error correction.
:LIST [:ALL] :RAM :ROM	Lists all drivers from all driver tables (RAM and ROM) Lists all drivers found in the RAM driver table. Lists all drivers found in the ROM driver table.
:INTerrupt :ACTivate [ON OFF 1 0] :SETup[n] [ON OFF 0 1]	Enable VXIbus interrupt acknowledgement. Enables or disables System Instrument control of VXI interrupt line [n].
:SETup[n]?	Returns current state of SETup[n].
:PRiority[n] [< priority > MIN MAX DEF]	Specifies the priority level of VXI interrupt line [n].
:PRiority[n]? [MIN MAX DEF]	Returns priority level of VXI interrupt line [n].
:RESPonse?	Returns response from the highest priority interrupt line.

SCPI Commands Quick Reference

Command	Description
<p>:NRAM :ADDRESS? :CREate < size> MIN MAX :CREate? [MIN MAX] :PEEK? < address> MIN MAX,< width> :POKE < address> MIN MAX,< width>,< data> :RDISk :ADDRESS? :CREate < size> MIN MAX :CREate? [MIN MAX] :UPIload [:MADDRESS]? < address>,< byte_count> :SADDRESS? < address>,< byte_count></p>	<p>Returns starting address of the User non-volatile RAM. Creates a User non-volatile RAM segment. Returns the current or allowable size of User NVRAM. Returns an 8, 16, or 32 bit value from memory. Stores an 8, 16, or 32 bit value to RAM. Returns the starting address of an IBASIC RAM volume. Allocates RAM for an IBASIC RAM volume. Returns the current or allowable size of the RAM vol. Returns data from non-volatile user RAM starting at address. Returns data from non-volatile user RAM at address.</p>
<p>INITiate [:Immediate]</p>	<p>Enables trigger system to start Pacer.</p>
<p>[SOURce] :PULSe COUNT < numeric value > COUNT? [MIN MAX] :PERiod < numeric value :PERiod? [MIN MAX]</p>	<p>Sets number of Pacer pulses per trigger. Returns current count, or MIN MAX allowed value. Sets Pacer pulse period in seconds. Returns the current or allowable period value.</p>
<p>STATus :OPERation :CONDition? :ENABle 256 :ENABle? [:EVENt]? :PRESet :QUESTionable :CONDition? :ENABle < mask> :ENABle? [:EVENt]?</p>	<p>Returns the state of the condition register. Set Standard Operation Enable Register mask. Returns value of enable mask. Returns value of the bit set in the Event register (Standard Operation Status Group). Presets status registers Always returns +0. Set Questionable Status Register enable mask. Returns value of enable mask. Always returns +0.</p>

SCPI Commands Quick Reference

Command	Description
SYSTEM :BEEPer [IMMediate] :COMMunicate :GPIB :ADDResS :ADDResS? :SERial[n] :CONTRol :DTR ON OFF STANdard IBFull :DTR? :RTS ON OFF STANdard IBFull :RTS? [;RECEive] :BAUD < baud_rate> MIN MAX :BAUD? [MIN MAX] :BITS 7 8 MIN MAX :BITS? [MIN MAX] :PACE [:PROTOcol] XON NONE [:PROTOcol]? :THREshold :STARt < char_count> :STARt? [MIN MAX] :STOP < char_count> :STOP? [MIN MAX] :PARity :CHECK 1 0 ON OFF :CHECK? [:TYPE] EVEN ODD ZERO ONE NONE [:TYPE]? :SBITs 1 2 MIN MAX :SBITs? MIN MAX :TRANsmit :AUTO 1 0 ON OFF :AUTO? :PACE [:PROTOcol] XON NONE [:PROTOcol]? :DATE < year>,< month>,< day> :DATE? [MIN MAX,MIN MAX,MIN MAX] :ERRor? :TIME < hour>,< minute>,< second> :TIME? [MIN MAX,MIN MAX,MIN MAX] :VERSion?	<p>Sound beeper (fixed duration and tone).</p> <p>Sets the primary address of the communications port. Returns GPIB address or min max allowed value.</p> <p>Sets mode for modem control line DTR. Returns current mode of DTR line.</p> <p>Sets mode for modem control line RTS. Returns current mode of RTS line.</p> <p>Sets transmit and receive baud rate of serial interface. Returns the current or allowable baud setting.</p> <p>Sets the number of data bits in the serial data frame. Returns the current or allowable BITS setting.</p> <p>Sets the receive pacing protocol to XON/XOFF or none. Returns the state of receive pacing protocol.</p> <p>Sets the input buffer start threshold for input pacing. Returns current or allowable STARt threshold level.</p> <p>Sets the input buffer stop threshold for input pacing. Returns the current or allowable STOP threshold level.</p> <p>Enables/disables receive parity checking. Returns the current state of receive parity checking. Sets the type of receive and transmit parity. Returns the current parity type setting.</p> <p>Sets the number of stop bits for receive and transmit. Returns the number of stop bits set.</p> <p>Note: HP E1324A is always ...TRAN:AUTO ON Links/unlinks the transmit and receive pacing protocol. Returns the current transmit/receive pacing linkage.</p> <p>Sets the transmit pacing protocol to XON/XOFF or none. Returns the state of transmit pacing protocol.</p> <p>Sets system calendar. Returns current date or min max allowable values.</p> <p>Returns oldest error message in Error Queue.</p> <p>Sets the system clock. Returns current time or min max allowable values.</p> <p>Returns SCPI version for which this instrument complies.</p>

SCPI Commands Quick Reference

Command	Description
<p>TRIGger</p> <p>:DElay < numeric value ></p> <p>:DElay? [MIN MAX]</p> <p>[IMMediate]</p> <p>:SLOPe [NEGATIVE]</p> <p>:SLOPe?</p> <p>:SOURce EXTernal IMMediate BUS HOLD</p> <p>:SOURce?</p>	<p>Sets delay between trigger and first Pacer pulse.</p> <p>Returns current trigger delay or MIN MAX allowable value.</p> <p>Sets trigger source for timer/pacer.</p> <p>For compatibility only. Accepts only NEGATIVE.</p> <p>Returns the string NEG.</p> <p>Trigger source is GET or *TRIG.</p> <p>Returns current trigger source.</p>
<p>VXI</p> <p>:CONFigure</p> <p>:DeviceLADd?</p> <p>:DeviceLIST?</p> <p>:DeviceNUMber?</p> <p>:INFormation</p> <p>:ALL?</p> <p>:HIERarchy</p> <p>:ALL?</p> <p>:NUMber?</p> <p>:LADdress?</p> <p>:READ? <logical_addr>, <register_num></p> <p>:REGister</p> <p>:READ? < numeric_value < reg_name ></p> <p>:WRITe < numeric_value < reg_name >, < data ></p> <p>:RESet?</p> <p>:SElect < numeric_value ></p> <p>:WRITe < logical_addr >, < register_num >, < data ></p>	<p>Returns a list of the logical addresses in the system.</p> <p>Returns information about one or all installed devices.</p> <p>Returns the number of installed devices.</p> <p>Gets the static information about the selected logical address (see VXI:SElect).</p> <p>Gets the static information about all logical addresses.</p> <p>Gets the current hierarchy configuration data for the selected logical address (see VXI:SElect)</p> <p>Gets the current hierarchy configuration data for all logical addresses.</p> <p>Gets the number of devices in the system when issued to a Resource Manager.</p> <p>Gets a comma separated list of all logical addresses of devices in the system when issued to a Resource Manager.</p> <p>Read the contents of the device register at register_num.</p> <p>Returns the contents of the specified 16 bit register at the selected logical address (see VXI:SElect).</p> <p>Writes to the specified 16 bit register at the selected logical address (see VXI:SElect).</p> <p>Resets the device at the selected logical address (see VXI:SElect).</p> <p>Specifies the logical address to be used by all subsequent commands in the VXI subsystem.</p> <p>Write data to the device register at logical_addr.</p>

IEEE 488.2 Command Commands Quick Reference

Category	Command	Title
General	*IDN?	Identification Query
	*RST	Reset Command
	*TST?	Self Test Query
Instrument Status	*CLS	Clear Status Command
	*ESE <mask>	Standard Event Status Enable Register Command
	*ESE?	Standard Event Status Enable Query
	*ESR?	Standard Event Status Register Query
	*PSC <flag>	Power-on Status Clear Command
	*PSC?	Power-on Status Clear Query
	*SRE <mask>	Service Request Enable Command
	*SRE?	Service Request Enable Query
	*SIB?	Status Byte Register Query
Macros	*DMC <name>,<cmd_data>	Define Macro Command
	*EMC <enable>	Enable Macro Command
	*EMC?	Enable Macro Query
	*GMC? <name>	Get Macro Query
	*LMC?	Learn Macro Query
	*PMC	Purge all Macros Command
	*RMC <name>	Remove individual Macro Command
Synchronization	*OPC	Operation Complete Command
	*OPC?	Operation Complete Query
	*WAI	Wait-to-Continue Command

Specifications

Mainframe Specifications

Pacer(50% duty cycle): Programmable intervals: 500 nsec to 8.389 sec with 500 nsec resolution.
Accuracy:
First pulse after trigger: 0.01% of programmed time + 600 to 850 nsec.
Additional pulses: 0.01% of programmed time \pm 50 nsec.
Number of pulses: 1 through 8388607 or continuous.
Drive capability:
 $V_{LO} \leq 0.75 \text{ V @ } 4 \text{ mA}$
 $V_{HI} \geq 3.4 \text{ V @ } -4 \text{ mA}$
Rise Time/Fall Time: 320 nsec/90 nsec.

Real-time Clock: Accuracy: 0.01% of elapsed time since last sset \pm 1 sec @ 25° C.
Temperature variation: \pm 0.01% of elapsed time since last set, over full temperature range.
Resolution: 1 sec.
Non-volatile lifetime: 60 days without additional RAM.
Battery life: 1 year typical, NiCd battery.

Trigger Input: TTL compatible, minimum pulse width 300 nsec.

Non-volatile added memory storage lifetime: Non-volatile added storage is backed up by NiCd battery. The table below shows minimum and typical lifetimes, which vary according to the amount of memory installed.

RAM (MBytes)	MIN Lifetime (hours)	Typical lifetime (days)
0.5	240	320
1.0	130	180
1.5	90	120
2.0	72	90

Slots: 7 B-size and 3 A-size

EMC, RFI, Safety: Meets FTZ 1046/1984, CSA 556B, IEC 348, UL 1244.

Size:

	inches	mm
Height without feet	6.97	177
Height with feet	7.44	189
Width	16.75	426
Depth	20.1	510
Depth with terminal blocks	22.38	569

Weight:

	E1300A	E1301A
Net	7.4 kg	7.8 kg
Max per modules	1.3 kg	1.3 kg

Power: Line voltage: 115 or 230 Vac @ 50 to 400 Hz
 Fused at: 3 A @ 115 Vac
 1.5 A @ 230 Vac
 Consumption: E1300A (empty) 27 W, 52 VA
 E1301A (empty) 31 W, 57 VA

Any combination of HP Series B modules can be powered and cooled by the HP 75000 Series B mainframe. Configuration using non-HP modules (e.g., VME modules) should be checked to assure the power consumption does not exceed 12.25 A on +5 V, 4.65 A on +12 V, and 0.95 A on -12 V supplies. The HP 75000 Series B mainframe will provide ample cooling for configurations that stay within these limits.

Cooling: 80 Watts total

Note: HP Series B mainframes provide VXIbus connector P1. Modules may not be masters or use more than 10 Watts.

Humidity: 65% 0° to 40° C

Operating temperature: 0° to 55° C

Storage temperature: -40° to 75° C

SCPI Conformance Information

The HP E1300/1301A conforms to SCPI-1990.0

In documentation produced prior to June 1990, these SCPI commands are labeled as TMSL commands.

The following tables list all the SCPI conforming, approved, and non-SCPI commands that the HP E1300/1301A can execute. Individual commands may not execute without having the proper plug-in module installed in the HP E1300/1301A. Each plug-in module manual describes the commands that apply to that module.

Switchbox Configuration

The following plug-in modules can be configured as switchbox modules. Refer to the individual plug-in User's Manual for configuration information.

HP E1345A	HP E1353A	HP E1366A
HP E1346A	HP E1357A	HP E1367A
HP E1347A	HP E1358A	HP E1368A
HP E1351A	HP E1361A	HP E1369A
HP E1352A	HP E1364A	HP E1370A

Table A-1. Switchbox SCPI-1990.0 Confirmed Commands

ABORt	STATus
	:QUEStionable
ARM	:CONDition?
:COUNt	[:EVENT]?
	:ENABle
INITiate	:ENABle?
[:IMMediate]	:OPERation
:CONTinuous	:CONDition?
	[:EVENT]?
OUTPut	:ENABle
:ECLTrg	:ENABle?
[:STATe]	:PRESet
:TTLTrg	
[:STATe]	SYSTem
	:ERRor?
[ROUTe]	:CPON
:OPEN	:CTYPe?
:OPEN?	:VERsion?
:CLOSE	
:CLOSE?	TRIGger
:SCAN	[:IMMediate]
	:SOURce
	:SLOPe

Table A-2. Switchbox Non-SCPI Commands

DISPlay	[ROUTe]
:MONitor	:SCAN
[:STATe]	[:LIST]
:CARD	:MODE
	:PORT
SYSTem	:SETTing
:CDEscription?	[:TIME]
	:TIME?

Multimeter Commands

The following tables apply to the HP E1326A and E1326B.

Table A-3. Multimeter SCPI-1990.0 Confirmed Commands

ABORt	[SENSe]
	:FUNction
CALibration	:FUNction?
:ZERo	:RESistance
:AUTo	:APERture
:AUTo?	:APERture?
:VALue	:RANGe
	:AUTo
CONFigure	:AUTo?
:FREStance	:RANGe?
:RESistance	:RESolution
:TEMPerature	:RESolution?
:VOLtage	:VOLtage
:AC	:AC
[:DC]	:RANGe
	:RANGe?
CONFigure?	[:DC]
	:RANGe
FETCh?	:AUTo
	:AUTo?
FORMat	:RANGe?
[:DATA]	:RESolution
	:RESolution?
INITiate	
[:IMMediate]	STATus
	:QUESTionable
MEASure	:CONDition?
:FREStance?	[:EVENT]?
:RESistance?	:ENABle
:TEMPerature?	:ENABle?
:VOLtage	:OPERation
:AC?	CONDition?
[:DC]?	[:EVENT]?
	:ENABle
	:ENABle?
READ?	:PREset
	SYSTEM
	:ERRor?
	:CTYPe?
	:VERsion?
	TRIGger
	:COUNt
	:COUNt?
	:DELay?
	:AUTo
	:AUTo?
	:DELay?
	[:IMMediate]
	:SOURce
	:SOURce?

Table A-4. Multimeter SCPI Approved (not confirmed) Commands

[SENSe]
:RESistance
:NPLC
:NPLC?
:VOLtage
:NPLC
:NPLC?

Table A-5. Multimeter Non-SCPI Commands

CALibration	MEMory
:LFRequency	:VME
:LFRequency?	:ADDRess
:STRain	:ADDRess?
	:SIZE
CONFigure	:SIZE?
:STRain	:STATe
:QUARter	:STATe?
:HBENding	
:HPOisson	[ROUTe]
:FBENding	:FUNCTion
:FPOisson	
:FBPOisson	SAMPle
:QTENsion	:COUNT
:QCOMpression	:COUNT?
:UNSTrained	:SOURce
	:SOURce?
DISPlay	:TIMER
:MONitor	:TIMER?
:CHANnel	
:CHANnel?	[SENSe]
[:STATe]	:RESsitance
[:STATe]?	:OCOMPensated
	:OCOMPensated?
MEASure	:STRain
:STRain	:GFACTor
:QUARter?	:POISSon
:HBENding?	:UNSTrained
:HPOisson?	
:FBENding?	SYSTEM
:FPOisson?	:CDEscription
:FBPOisson?	
:QTENsion?	
:QCOMpression?	
:UNSTrained?	

Counter Commands

The following tables apply to the HP E1332A 4 Channel Counter/Totalizer and the HP E1333A 3 Channel Universal Counter.

Table A-6. HP E1332A SCPI-1990.0 Confirmed Commands

ABORt	READ?
CONFigure	[SENSe]
:FREQuency	:FUNctIon
:PERiod	:FREQuency
:PWIDth	:PERiod
:NWIDth	:FREQuency
CONFigure?	:APERture
FEICh?	:APERture?
FORMat	STATUS
[:DATA]	:QUEStionable
INTIate	[:EVENt]?
[:IMMediate]	:CONDition?
INPut	:ENABle
:FILTer	:ENABle?
[:LPASs]	:OPERation
[:STATe]	[:EVENt]?
[:STATe]?	:CONDition?
:FREQuency	:ENABle
:FREQuency?	:ENABle?
MEASure	:PRIsset
:FREQuency?	SYSTEM
:PERiod?	:ERRor?
:PWIDth?	:VERSIon?
:NWIDth	TRIGger
	[:IMMediate]
	:SOURCe
	:SOURCe?

Table A-7. HP E1332A Non-SCPI Commands

CONP[< channel >]	[SENSe[< channel >]]
:TOTalize	:PERiod
:TINTerval	:NPERiods
:UDCount	:NPERiods?
DISPlay	:TOTalize
:MONitor	:GATE
:CHANnel	[:STATe]
:CHANnel?	[:STATe]?
[:STATe]	:POLarity
[:STATe]?	:POLarity?
INPut	:EVENt
:ISOLate	:LEVel
:ISOLate?	:LEVel?
MEASure[< channel >]	:SLOPe
:TINTerval? >	:SLOPe?

Table A-8. HP E1333A SCPI-1990.0 Confirmed Commands

ABORt	READ?
FETCh?	[SENSe]
	:FUNction
CONFigure	:FREQuency
:FREQuency	:PERiod
:PERiod	:FREQuency
:PWIDth	:APERture
:NWIDth	:APERture?
CONFigure?	STATus
FORMat	:QUESTionable
[:DATA]	: [EVENT]?
	:CONDition?
	:ENABle
	:ENABle?
INITiate	:OPERation
[:IMMediate]	: [EVENT]?
	:CONDition?
	:ENABle
	:ENABle?
INPut	:PREset
:ATTenuation	
:ATTenuation?	
:COUPling	
:COUPling?	
:FILTer	
[:LPASs]	
[:STATe]	
[:STATe]?	
:IMPedance	
:IMPedance?	
MEASure	
:FREQuency?	
:PERiod?	
:PWIDth?	
:NWIDth?	
	SYSTEM
	:ERRor?
	:VERsion?
	TRIGger
	[:IMMediate]
	:SOURCe
	:SOURCe?

Table A-9. HP E1333A Non-SCPI Commands

CONF[< channel >]	[SENSe[< channel >]]
:TOTalize	:PERiod
:TINTerval	:NPERiods
:RATio	:NPERiods?
	:RATio
DISPlay	:NPERiods
:MONitor	:NPERiods?
:CHANnel	:TINTerval
:CHANnel?	:NPERiods
[:STATe]	:NPERiods?
[:STATe]?	:EVENT
MEASure[< channel >]	:LEVel
:TINTerval?	:LEVel?
:RATio?	:SLOPe
	:SLOPe?

D/A Converter Commands

The following tables apply to the HP E1328A 4 Channel D/A Converter.

Table A-10. HP E1328A SCPI-1990.0 Confirmed Commands

CALibration	STATus
:STATe	:QUESTIONable
:STATe?	:CONDition?
	[:EVENT]?
SYSTem	:ENABle
:ERRor?	:ENABle?
:VERSion?	:OPERation
	:CONDition?
	[:EVENT]?
	:ENABle
	:ENABle?

Table A-11. HP E1328A Non-SCPI Commands

CALibration	SOURce
:VOLTag	:VOLTag < channel >
:CURRent	:VOLTag < channel > ?
	:CURRent < channel >
DISPlay	:CURRent < channel > ?
:MONitor	:FUNction < channel > ?
:CHANnel	
:CHANnel?	
[:STATe]	
:STRing?	

Digital I/O Commands The following tables apply to the HP E1330A Quad 8-bit Digital I/O Module.

Table A-12. HP E1330A SCPI-1990.0 Confirmed Commands

STATus :QUEStionable :CONDition? [:EVENT]? :ENABle :ENABle? :OPERation :CONDition? [:EVENT]? :ENABle :ENABle? :PREset	SYSTem :ERRor? :VERSIon?
---	---------------------------------------

Table A-13. HP E1330A Non-SCPI Commands

DISPlay :MONitor [:STATe] :PORT :PORT? :STRing? MEASure :DIGital :DATA < port > ? :BIT < number > ? :BLOCK? :FLAG < port > ? MEMory :DELete MACRO :VME :ADDRes :ADDRes? :SIZE :SIZE? :STATe :STATe?	[SOURce] :DIGital :TRACe :CATalog [:DATA] [:DATA]? :DEFine :DELete :CONTrol < port > :POLarity :POLarity? [:VALue] :DATA < port > [:VALue] :BIT < number > :TRACe :HANDshake :DELay [:MODE] [:MODE]? :POLarity :POLarity? :FLAG < port > :POLarity :POLarity? :HANDshake < port > :DELay [:MODE] [:MODE]?
---	--

**System Instrument
Commands**

Table A-14. System Instrument SCPI-1990.0 Confirmed Commands

ABORt	SYSTem
INITiate	:BEEPer
[:IMMediate]	[:IMMediate]
[SOURce]	:COMMunicate
:PULSe	:GPIB
:COUNt	:ADDRess
:COUNt?	:ADDRess?
:PERiod	:SERial
:PERiod?	[:RECeive]
STATus	:BAUD
:QUEStionable	:BAUD?
:CONDition?	:BITS
[:EVENt]?	:BITS?
:ENABle	:PARity
:ENABle?	[:TYPE]
:OPERation	[:TYPE]?
:CONDition?	:CHECK
[:EVENt]?	:CHECK?
:ENABle	:SBITS
:ENABle?	:SBITS?
:PREset	:TRANsmit
TRIGger	:AUTO
[:IMMediate]	:AUTO?
:SOURce	:ERRor?
:SOURce?	:TIMB
:SLOPe	:TIME?
:SLOPe?	:DATE
	:DATE?
	:VERsion?
	VXI
	:CONFIgure
	:DNUMBer?

Table A-15. System Instrument SCPI-1991.0 Confirmed Commands

SYSTem	SYSTem
:COMMunicate	:COMMunicate
:SERial	:SERial
[:RECeive]	:TRANsmit
:PACE	:PACE
[:PROTOcol]	[:PROTOcol]
[:PROTOcol]?	[:PROTOcol]?
:THReshold	:CONTRol
:STARt	:RTS
:STARt?	:RTS?
:STOP	:DTR
:STOP?	:DTR?

Table A-16. System Instrument SCPI-1992.0 Approved Commands

VXI
:SELect
:CONFIgure
:INFormation
:ALL
:HEIRarchy
:ALL
:LADDRess?
:NUMBer?
:REGister
:READ?
:WRITe
:RESet?

Table A-17. System Instrument Non-SCPI Commands

DIAGnostic :AUTstart :AUTostart? :CHECKsum :COMMunicate :SERial [:OWNer] [:OWNer]? :BOOT :COLD [:WARM] :UPLoad? :DOWNload :INTerrupt :ACT :SETup(n) :SETup(n)? :PRiority(n) :PRiority(n)? :WAIT? :JSR :CALL :DRIVER :LOAD :LIST? :DRAM :CREate :CREate? :AVailable? :NRAM :CREate :CREate? :AVailable? :RDISK :CREate :CREate? :ADDRes? :PEEK :POKE	MEMory :DELete :MACRo TRIGger :DELay [:MINimum] [:MINimum]? VXI :CONFigure :DLADdress? :DEVICELADd? :DLIST? :DEVICELIS? :DEVICENUMber? :READ? :WRITE
--	--

Table A-18. Common Commands SCPI-1990.0 Confirmed

*IDN	*RCL
*RST	*SAV
*TST	*TRG
*CLS	*DMC
*ESE	*GMC?
*ESE?	*PMC
*ESR	*LMC?
*SRE	*EMC
*SRE?	*EMC?
*STB	*OPC
*PSC	*OPC?
*PSC?	*WAI

Error Messages

Using This Appendix

This appendix shows how to read an instrument's error queue, discusses the types of command language-related error messages, and provides a table of all of the System Instrument's error messages and their probable causes.

- Reading an Instrument's Error QueueB-1
 - Error TypesB-2
 - Start-up Error MessagesB-5
-

Reading an Instrument's Error Queue

Executing the SYST:ERR? command reads the oldest error message from the instrument's error queue and erases that error from the error queue. The SYST:ERR? command returns response data in the form:

< error number > , < error description string > .

Example error message; -113,"Undefined header"

Positive error numbers are specific to an instrument. Negative error numbers are command language-related and discussed in the next section "Error Messages". Command language-related errors also set a corresponding bit in the Standard Event Status Register (refer to "Instrument Status" in Chapter 4 for more information).

Example: Reading the Error Queue

This program reads all errors (one error at a time, oldest to newest) from the System Instrument's error queue. After reading each error, that error is automatically erased from the queue. When the error queue is empty, this program returns: +0,"No error".

```
10 OPTION BASE 1
20 DIM Message$(256)           Create array for error message
30 REPEAT                     Repeat next 3 lines until error
                               number = 0
40   OUTPUT 70900;"SYST:ERR?"  Read error number & message
50   ENTER 70900,Code,Message$ Enter error number & message
60   PRINT Code,Message$      Print error number & message
70   UNTIL Code = 0
80 END
```

Error Types

Negative error numbers are language-related and categorized as shown below. Positive error numbers are instrument specific and for the System Instrument are summarized in Table B-2. For other instruments, refer to their own user's manual for a description of error messages.

Table B-1. Negative Error Numbers

Error Number	Error Type
-199 to -100	Command Errors
-299 to -200	Execution Errors
-399 to -300	Device-Specific Errors
-499 to -400	Query Errors

Command Errors

A command error means the instrument cannot understand or execute the command. When a command error occurs, it sets the Command Error Bit (bit 5) in the Event Status Register. Command errors can be caused by:

- A syntax error was detected in a received command or message. Possible errors include a data element which violates the instrument's listening formats or is of the wrong type (binary, numeric, etc.) for the instrument.
- An unrecognizable command header was received. Unrecognizable headers include incorrect SCPI headers and incorrect or unimplemented Common Commands.
- A Group Execute Trigger (GET) was entered into the input buffer inside of a Common Command.

Execution Errors

An execution error indicates the instrument is incapable of doing the action or operation requested by a command. When an execution error occurs, it sets the Execution Error Bit (bit 4) in the Event Status Register. Execution errors can be caused by the following:

- A parameter within a command is outside the limits or inconsistent with the capabilities of an instrument.
- A valid command could not be executed because of an instrument failure or other condition.

Device-Specific Errors

A device-specific error indicates an instrument operation did not complete, possibly due to an abnormal hardware or firmware condition (self-test failure, loss of calibration or configuration memory, etc.). When a device-specific error occurs, it sets the Device-Specific Error Bit (bit 3) in the Event Status Register.

Query Errors

A query error indicates a problem has occurred in the instrument's output queue. When a query error occurs, it sets the Query Error Bit (bit 2) in the Event Status Register. Query errors can be caused by the following:

- An attempt was made to read the instrument's output queue when no output was present or pending.
- Data in the instrument's output queue has been lost for some reason.

Table B-2. Error Messages and Causes

Error Messages and Causes		
Code	Message	Cause
-101	Invalid character	Unrecognized character in specified parameter.
-102	Syntax error	Command is missing a space or comma between parameters
-103	Invalid separator	Command parameter is separated by some character other than a comma.
-104	Data type error	The wrong data type (i.e. number, character, string expression) was used when specifying a parameter.
-108	Parameter not allowed	Parameter specified in a command which does not require one.
-109	Missing parameter	No parameter specified in the command in which a parameter is required.
-113	Undefined header	Command header was incorrectly specified.
-123	Numeric overflow	A parameter specifies a value greater than the command allows.
-128	Numeric data not allowed	A number was specified for a parameter when a letter is required.
-131	Invalid suffix	Parameter suffix incorrectly specified (e.g. SSECOND rather than SS or SSEC).
-138	Suffix not allowed	Parameter suffix is specified when one is not allowed.
-141	Invalid character data	The discrete parameter specified is not allowed (e.g. TRIG:SOUR INT - INT is not a choice.)
-178	Expression data not allowed	A parameter other than the channel list is enclosed in parentheses.
-211	Trigger ignored	Trigger occurred while the Pacer is in the idle state, or a trigger occurred from a source other than the specified source.
-222	Data out of range	The parameter value specified is too large or too small.
-224	Illegal parameter value	The numeric value specified is not allowed.
-240	Hardware error	Hardware error detected during power-on cycle. Return multimeter to Hewlett-Packard for repair.
-310	System error	If caused by *DMC, then macro memory is full.
-350	Too many errors	The error queue is full as more than 30 errors have occurred.
-410	Query interrupted	Data is not read from the output buffer before another command is executed.
-420	Query unterminated	Command which generates data not able to finish executing due to a multimeter configuration error.
-430	Query deadlocked	Command execution cannot continue since the mainframe's command input, and data output buffers are full. Clearing the instrument restores control.
1500	External trigger source already allocated	"Event In" signal already allocated to another instrument such as a Switchbox.
2002	Invalid logical address	A value less than 0 or greater than 255 was specified for logical address.
2003	Invalid word address	An odd address was specified for a 16 bit read or write. Always use even addresses for 16 bit (word) accesses.
2005	No card at logical address	A non-existent logical address was specified with the VXI:READ? or VXI:WRITE command.
2101	Failed Device	VXI device failed its self test.
2102	Unable to combine device	Device type can not be combined into an instrument such as a scanning voltmeter or a switchbox.
2103	Config warning, Device driver not found	ID of device does not match list of drivers available. Warning only.
2105	Config error 5, A24 memory overflow	More A24 memory installed in the mainframe than can be configured into the available A24 memory space.
2108	Config error 8, Inaccessible A24 memory	A24 memory device overlaps memory space reserved by the mainframe's operating system.

Error Messages and Causes		
Code	Message	Cause
2110	Config error 10, Insufficient system memory	Too many instruments installed for the amount of RAM installed in the mainframe. Cannot configure instruments. Only the system instrument is started.
2111	Config error 11, Invalid instrument address	A device's logical address is not a multiple of 8 and the device is not part of a combined instrument.
2113	Config error 13, Logical address or LACK switch set wrong	Duplicate logical addresses set or interrupt bypass switches set improperly. Only the system instrument is started.
2129	Config warning, Sysfail detected	A device was asserting SYSFAIL on the backplane during startup.
2130	Config error 30, Pseudo instrument logical address unavailable	A physical device has the same logical address as IBASIC (240)
2131	Config error 32, File system start up failed	Insufficient system resources to allow the IBASIC file system to start.
2145	Config warning, Non-volatile RAM contents lost	NVRAM was corrupted or a cold boot was executed.
2148	Config warning, Driver RAM contents lost	Driver RAM was corrupted or a cold boot was executed.
2202	Unexpected interrupt from non-message based card	A register based card interrupted when an interrupt service routine had not been set up.
2809	Interrupt line has not been set up	A DIAG:INT:ACT or DIAG:INT:RESP command was executed before setting the interrupt with DIAG:INT:SET.

Start-up Error Messages

Start-up errors are most often generated just after the mainframe is powered-up or re-booted (DIAG:BOOT command). If you have an HP E1301A, or an HP E1300A with a terminal connected to the Display Terminal Interface (built-in RS-232 only), you can read these errors on the front panel or terminal. If you have an HP E1300A and no terminal, then you must access this error information by sending the VXI:CONF:DLIS? command over HP-IB. We recommend that users of either model include a routine at the beginning of their application program which checks for start-up errors before the program tries to access individual instruments. See your Installation and Getting Started Guide for an example program.

Table B-3. Start-up Error Messages and Warnings

Start-Up Error Messages and Warnings		
Code	Message	Cause
1	Failed Device	VXI device failed its self test.
2	Unable to combine device	Device type can not be combined into an instrument such as a scanning voltmeter or a switchbox.
3	Config warning, Device driver not found	ID of device does not match list of drivers available. Warning only.
5	Config error 5, A24 memory overflow	More A24 memory installed in the mainframe than can be configured into the available A24 memory space.
8	Config error 8, Inaccessible A24 memory	An A24 memory device overlaps a memory space reserved by the mainframe's operating system.
10	Config error 10, Insufficient system memory	Too many instruments installed for the amount of RAM installed in the mainframe. Cannot configure instruments. Only the system instrument is started.
11	Config error 11, Invalid instrument address	A device's logical address is not a multiple of 8 and the device is not part of a combined instrument.
13	Config error 13, Logical address or JACK switch set wrong	Duplicate logical addresses set or interrupt bypass switches set improperly. Only the system instrument is started.
29	Config warning, Sysfail detected	A device was asserting SYSFAIL on the backplane during startup.
30	Config error 30, Pseudo instrument logical address unavailable	A physical device has the same logical address as IBASIC (240)
31	Config error 32, File system start up failed	Insufficient system resources to allow the IBASIC file system to start.
45	Config warning, Non-volatile RAM contents lost	NVRAM was corrupted or a cold boot was executed.
48	Config warning, Driver RAM contents lost	Driver RAM was corrupted or a cold boot was executed.

Connecting and Configuring a Display Terminal

Using this Appendix

This appendix shows you how to configure the mainframe and a supported terminal to operate with the Display Terminal Interface. Using the Display Terminal Interface is discussed in Chapter 3.

- OverviewC-1
- Connecting a Terminal to the MainframeC-1
- Configuring a Terminal for the MainframeC-3
- Configuring the Mainframe with MenusC-4

Overview

The basic steps to configure a terminal to operate with the mainframe are:

1. Choosing the proper cable to connect the terminal to the mainframe. The cable connects the appropriate data and control signals from the terminal to the mainframe.
2. Configuring the terminal's serial interface parameters to match those of the mainframe. The terminal and mainframe can only communicate with each other when they are using the same data rate, data word width, error checking scheme, and overall data frame width.
3. Using the terminal interface menus to configure mainframe's serial interface parameters. Once the terminal is communicating with the mainframe, the terminal can be used to adjust (if necessary) the mainframe's serial interface parameters for best operation.

Connecting a Terminal to the Mainframe

The easiest way to connect the terminal to the mainframe is by using off-the-shelf cables which have been tested to work with your supported terminal. In the following figures you will find HP cables specified (by part number) for each of the supported terminals. If you plan to have the mainframe far from the terminal, you may need a custom built cable. The equivalent wiring diagram for each cable or cable combination is also provided.

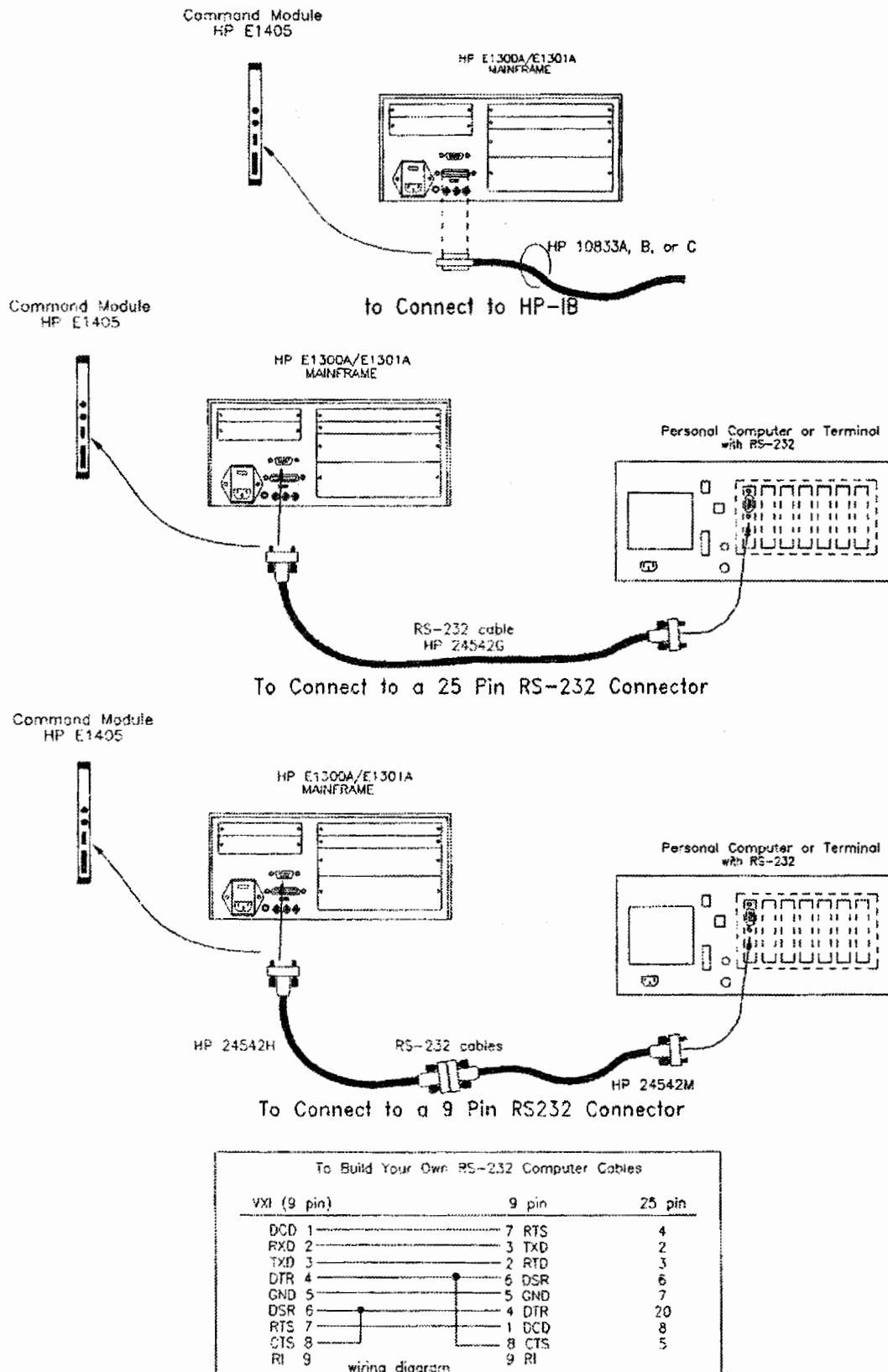

E1445A fig1-1a

Figure C-1 Connecting a Terminal to the Mainframe

C-2 Connecting and Configuring a Display Terminal

Configuring a Terminal for the Mainframe

We'll first set the terminal's serial communication parameters to match the mainframe's default settings. If the mainframe is new and its factory default values are still set, the terminal will be ready to use. If the settings have been changed and you don't know what they are (HP E1300 with no front panel), you will restore them to their default values.

Starting with Default Mainframe Settings

The mainframe leaves the factory with these default serial communication settings:

- Baud rate; 9600
- Data word width; 8 bits
- Parity type; NONE
- Parity checking; OFF
- Number of stop bits; 1
- Pacing; XON (for both receive and transmit)
- DTR and RTS ON (signal level high)

If your mainframe is new, or you know these default settings are still in effect you can go on to "Configuring the Terminal". If you are unsure of the current settings, continue on with the following section "Restoring the Default Configuration".

Restoring the Default Configuration

There is an easy way to restore the factory default settings. While the mainframe is performing its power-up self-test, the built-in serial interface always uses the factory default settings listed above. With your terminal set to the default settings, turn on the mainframe. While the mainframe is "Testing ROM", press and hold the CTRL key and press the R key. The mainframe will reset its stored serial communication settings to the factory default values. It is important that you press CTRL-R *during* the "Testing ROM" portion of the self-test. The terminal should now display "Select an instrument".

Note

Restoring the default serial communication settings also clears both the User and System non-volatile RAM areas.

Configuring the Terminal

Using your terminal owner's manual, set the terminal's communication parameters to the values shown in the list above. For DTR and RTS, set your terminal to DTR or Hardware handshake OFF. In addition, make sure your terminal is configured to "Transmit Functions" or "Transmit Codes". This means that when you press one of the editing keys (e.g. right arrow key) the terminal will send to the mainframe, the code which corresponds to the key. If this not set properly, the cursor will appear to respond to the keys, but the mainframe will not know that you moved the cursor.

Trying it Turn on the mainframe while watching the terminal's display. After the mainframe finishes its self-test, the terminal should display "Select an instrument". If not, the mainframe's communication parameters are not set to the default values. Go back to "Restoring the Default Configuration".

Configuring the Mainframe with Menus

After you have your terminal communicating with your mainframe at the default settings you may want to change to settings which are better for your installation. You can make these changes to the serial interface configuration using the Display Terminal Interface menus. Several of the changes you can make using the menus will cause communication between the terminal and mainframe to be lost. You will have to match each change in the mainframe configuration with a corresponding change in your terminal's configuration. Use the following procedure:

1. Change the mainframe configuration (see the menu example on page C-5).
2. Change the terminal's configuration to match the change from step one. Repeat steps one and two for each desired configuration change.

Any changes you make to the mainframe configuration are only temporary (lost when power is removed) until you put them into non-volatile storage. To store the current configuration, follow the menu example on page C-6.

How to Use the Serial Interface Menus

```

SYSTEM_0:
-
1 CONFIG? 2 HP-IB 3 RS-232 4 TIME 23
    
```

```

SYSTEM_0:
-
1 BAUD 2 PARITY 3 BITS 4 PACE 22 1 CONTROL 5 MOR
    
```

Press READ to find out the current setting

Press SET to change the current setting

```

SYSTEM_0:
-
1 READ 2 SET 3 4 33
    
```

Each SET Menu will have two or more choices

```

SYSTEM_0:
Enter card number
1 2 3
    
```

```

SYSTEM_0:
-
1 300 2 1200 3 2400 4 9600 33 1 5 19200 6
    
```

Enter Card Number press Return (0 for built-in, 1-7 for a plug-in)

```

SYSTEM_0:
+9600
-
1 READ 2 SET 3
    
```

Read the BAUD rate

```

SYSTEM_0:
Enter card number
1 2 3 4 24 1 5 6
    
```

Enter Card Number press Return (0 for built-in, 1-7 for a plug-in)

The setting is now in volatile RAM storage. See the "How to Store Interface Settings" Menu Chart for non-volatile storage which maintains settings through power cycles.

How to Store the Serial Interface Configuration

```
SYSTEM_0:  
-  
1 CONFIG? 2 HP-IB 3 RS-232 4 TIME 23
```

```
SYSTEM_0:  
-  
1 BAUD 2 PARITY 3 BITS 4 PACE 22 1 5 CONTROL 3 MORE 7 PRU_MENU 3 UTILS
```

```
SYSTEM_0:  
-  
1 STORE 2 3 4 22 1 5 3 MORE 7 3 UTILS
```

```
SYSTEM_0:  
Enter card number  
-  
1 2 3 4
```

Enter Card Number press **Return**. Card Number 0 for built-in stores settings into non_volatile RAM. Card Number 1-7 for HP E1324A stores settings into its on-board EEROM)

Using The DC Power Option

Chapter Contents and Purpose

This chapter describes the HP E1300A/E1301A Mainframe DC Power Option (E1300A Option 008; HP Part Number E1300-80008). This chapter contains the following sections:

- DC Power Option Description D-1
- Connecting the Battery to the DC Power Option D-2
- DC Power Option Operation D-2
- Powerdown Operation D-2
- DC Power Option Trickle Charge Currents D-3
- DC Power Option Specifications D-3
- Selecting the Trickle Charge Current/Latched Operation ... D-4

DC Power Option Description

The DC Power Option allows you to operate the mainframe from an externally connected battery without AC power connected. It also operates the mainframe if AC power goes below the operating level. The length of operation using battery power depends on the type of battery used. Transfer from AC to DC or DC to AC is transparent (i.e., bumpless transfer).

When operating with AC power (i.e., normal operation), the DC Power Option provides four selectable trickle charge currents for the externally connected battery (see "DC Power Option Trickle Charge Currents" section below).

The DC Power Option is circuit breaker protected from over-current, over-voltage, and reverse polarity inputs (see Figure 6-1 for circuit breaker location and settings). The circuit breaker is a magnetic breaker that cannot "held set" while faults are present.

Connecting the Battery to the DC Power Option

See Figure D-1 to connect the battery to the DC Power Option. Observe the correct battery polarity when connecting the battery.

Warning



To prevent possible electric shock hazard during battery operation, connect the HP E1300/E1301 Mainframe's chassis terminal to earth ground. If the ac power cord remains connected to the mainframe and is plugged into an ac power receptacle with a reliable earth ground, no additional connection is required.

DC Power Option Operation

Mainframe operation with AC power always takes precedence over DC power operation. With the mainframe at full power load, the power option switches to DC power if the AC power line voltage goes below 90 Vac or 180 Vac. This is for a mainframe power line voltage setting of 115 Vac or 230 Vac, respectively. If there is sufficient AC power to operate the mainframe at a given power load, the power option switches back to AC power operation. With the mainframe at full power load, AC operation starts at 100 V or 200 V, respectively. The above voltage values are lower with lighter mainframe power loads.

Powerdown Operation

The mainframe has two different selectable powerdown operations when operating on DC power: Non Latched or Latched. The factory sets the option to the "Non Latched" operation. Refer to the "Selecting the Trickle Charge Current and Latched Switches" section in this chapter to select the "Latched" operation, if needed. The following explains the two different operations.

1. **Non Latched Operation** - If the DC Power Option detects a low DC voltage (below 10 Vdc), the mainframe turns off. If the DC voltage returns to a normal level (11 Vdc to 30 Vdc), the mainframe turns on again.
2. **Latched Operation** - If the DC Power Option detects a low DC voltage (below 10 Vdc), the mainframe turns off. To turn the mainframe on, set the DC voltage to a normal level (11 Vdc to 30 Vdc) and then cycle the mainframe's power switch off and on.

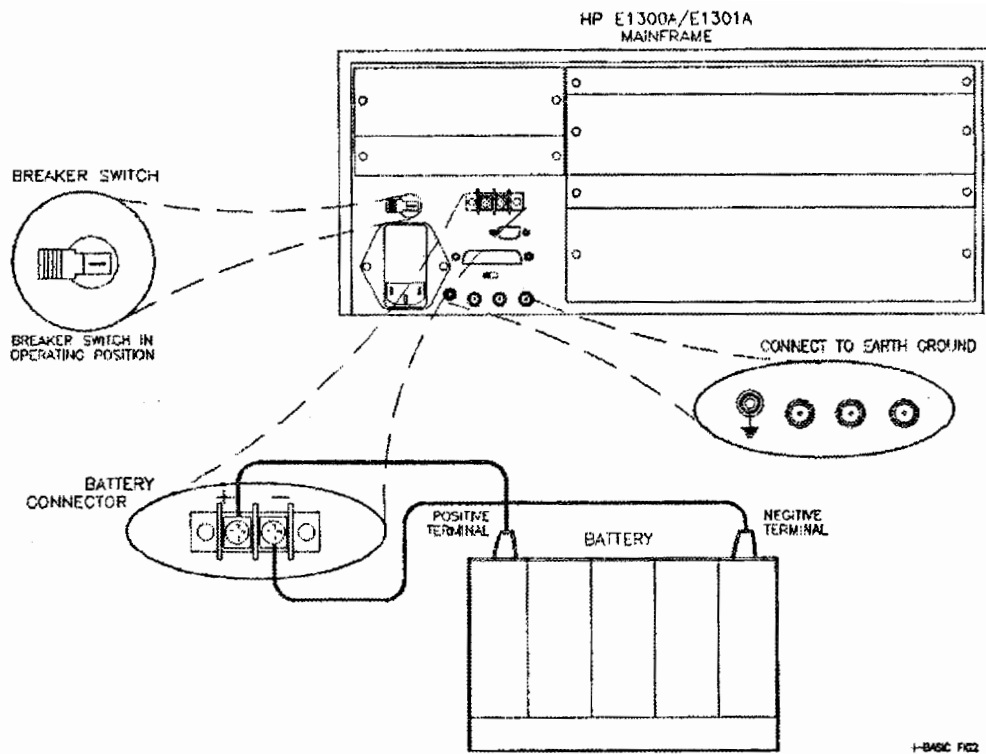

Figure D-1. Connecting the External Battery

DC Power Option Trickle Charge Currents

The trickle charge currents are 0 mA, 50 mA, 100 mA, and 200 mA. The trickle charge keeps the battery from self-discharging when not in use. Refer to the "Selecting the Trickle Charge Current and Latched Switches" section below to select the different trickle charge currents. The factory sets the trickle charge current to 0 mA.

DC Power Option Specifications

DC Voltage Range: Operating 10 Vdc to Overprotection trip (30 Vdc)

DC Current: 20A maximum at approximately 10 Vdc

DC Starting Surge Current: 20A at approximately 12 Vdc for 100 msec (1/2 at 24 Vdc)

AC Voltage Range: same as HP E1300/E1301 Mainframe

Selecting the Trickle Charge Current and Latched Switches

1. Remove handle/rear cover screws and top cover

WARNING

Remove AC power before removing the top cover

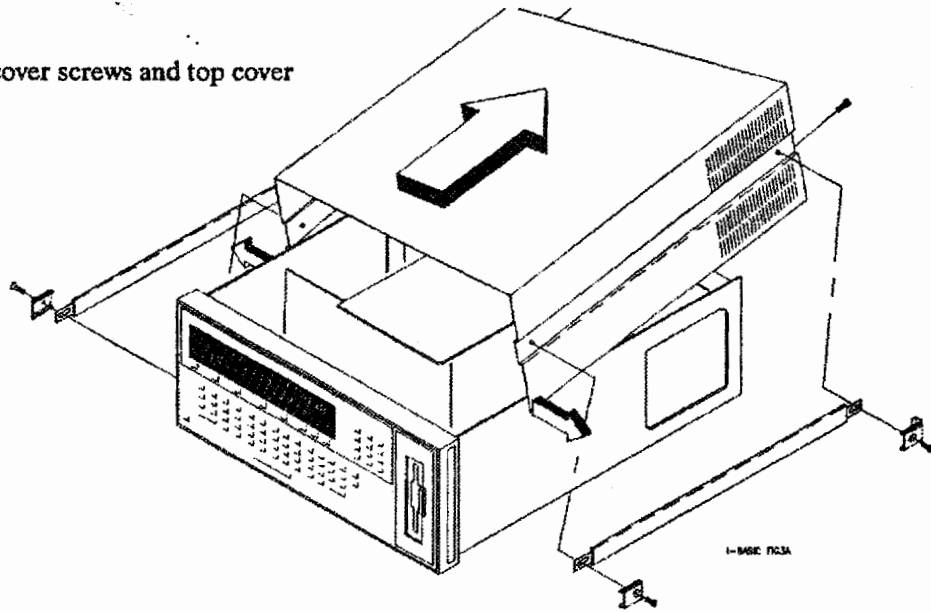

Tools Required

- #1 Pozidriv screwdriver
- #TX10 Torx driver

2. Set the trickle charge/latched switches

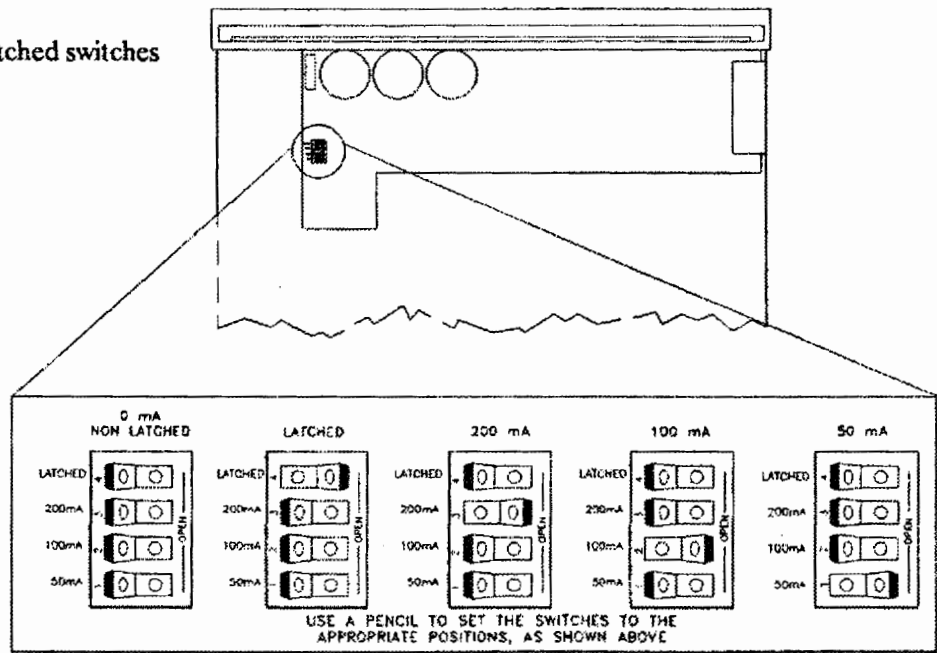

Figure D-2. Selecting Battery Options

Sending Binary Data Over RS-232

About this Appendix

This appendix describes the procedure for sending pure binary data over an RS-232 interface. The formatting described is used in the DIAG:DOWN:CHEC:MADD, DIAG:DOWN:CHEC:SADD, and DIAG:DRIV:LOAD:CHEC commands. this appendix contains the following main sections.

- About this AppendixE-1
- Formatting Binary Data for RS-232 TransmissionE-1
- Sending Binary Data Over RS-232E-2

Formatting Binary Data for RS-232 Transmission

The most straightforward way to send a block of data is to open the data file, read the next byte from the file, and send it to the System Instrument until you reach the end of file. However, binary data cannot be sent to the System Instrument as is. It must be converted into a format that will not conflict with the special characters that the RS-232 interface recognizes. This is done by sending only one half byte (a nibble) at a time. To prevent this nibble from being confused with a special character, bit 7 of the nibble is set to one. This gives all data bytes in the block values greater than 127 so they are not confused with ASCII characters. It also doubles the size of the file to be sent and the transmission time for the file. Since a transmission error that required retransmission of the entire data block would be very time consuming, a 3-bit error code (which allows for correction of single bit errors) is added to the transmission byte. The following format is sent for each nibble:

Bit #	7	6	5	4	3	2	1	0
	<i>1</i>	<i>Correction Code</i>			<i>Data</i>			

The error correction code is based on the nibble of data sent. The easiest way to implement this code is to use table E-1. It is indexed based on the value of the nibble to send out, so there are 16 elements to the table.

Table E-1. Correction Codes for RS-232 Transmission

Data Value	Correction Code	Byte in Hex	Byte in Decimal
0	0	80 _h	128
1	7	F1 _h	241
2	6	E2 _h	226
3	1	93 _h	147
4	5	D4 _h	212
5	2	A5 _h	165
6	3	B6 _h	182
7	4	C7 _h	199
8	3	B8 _h	184
9	4	C9 _h	201
10	5	DA _h	218
11	2	AB _h	171
12	6	EC _h	236
13	1	9D _h	157
14	0	8E _h	142
15	7	FF _h	255

Sending Binary Data Over RS-232

The RS-232 interface differs from the HP-IB interface in that there is no device addressing built into the interface definition. Device addressing must be done on top of the RS-232 functions. This addressing is done through the same mechanism as the terminal-based front panel, and must be done either by the transfer program or manually before starting the transfer program.

Setting Up the Mainframe

There are two commands (SI - Select and Instrument and SA - Select Address) that can be used at the "Select an Instrument" interface. The "Select an Instrument" interface can always be reached by sending the <CTRL-D> character (ASCII 4) over the RS-232 line. Once there, the System Instrument can be reached by sending the command "SI SYSTEM" followed by a carriage return. All output after this command will be directed to/from the System Instrument until another <CTRL-D> is received. The following sequence will make sure that the mainframe is set up and ready.

1. Send <CTRL-D> (ASCII 4) to get to the "Select and Instrument" interface.
2. Send "ST UNKNOWN" and a carriage return to insure that the terminal is set to dumb terminal mode.

- Switchbox, 2-16
- System Instrument, 2-14 - 2-15
- tutorial, 2-2
- Menu (terminal interface)
 - 3-Channel Universal Counter, 3-38 - 3-39
 - 4-Channel Counter/Totalizer, 3-36 - 3-37
 - Quad 8-Bit Digital Input/Output, 3-34
 - 4-Channel D/A Converter, 3-33
 - 5 1/2 Digit Multimeter, 3-32
 - control keys, 3-14
 - instrument, 3-25
 - keys, 3-14
 - Scanning Voltmeter, 3-30 - 3-31
 - Switchbox, 3-28
 - System Instrument, 3-26 - 3-27
 - tutorial, 3-3
- Mode, monitor, 3-11
- Mode, monitor (front panel), 2-8
- Modules, unassigned, 1-4
- Monitor
 - a Switchbox (front panel), 2-5
 - a Switchbox (terminal interface), 3-8
 - mode, 3-11
 - mode (front panel), 2-8
- Multiple device drivers, 5-9

N

- Non-volatile user memory, 4-7
- NRAM, 5-5
 - :ADDRESS?, 7-23
 - :CREATE, 7-23
 - :CREATE?, 7-24
 - address, 4-7
 - allocating a segment, 4-7
 - locating the segment, 4-7
 - user non-volatile memory, 4-7

O

- Open and close channels
 - terminal interface, 3-8
- Open and close channels (front panel), 2-5
- OPERation
 - :CONDition?, 7-32
 - :ENABle, 7-32
 - :ENABle?, 7-33
 - [:EVENT]?, 7-33
 - DC Power Option, D-2
- Optional mainframe memory, 1-1
- Options
 - DC Power, D-1 - D-4
- Other Terminals, non-supported, 3-19

P

- Pacer, using, 4-1
- Pacing data for manual download, 5-12
- PEEK?, 7-24
- POKE, 7-25
- Power Down Operation, D-2
- Powerdown Operation
 - DC Power Option, D-2
- PRESet, 7-34
- Primary HP-IB address, changing, 4-3
- Programming examples, introductory, 1-4
- Programming hints, 6-1
- PULSe
 - :COUNT, 7-30
 - :COUNT?, 7-30
 - :PERiod, 7-31
 - :PERiod?, 7-31

Q

- Quad 8-Bit Digital Input/Output
 - Menu (front panel), 2-22
 - Menu (terminal interface), 3-34
- Query Errors, B-2
- QUESTionable, 7-34
- Quick Reference, Command, 7-75

R

- RDISK, 5-5
 - :ADDRESS?, 7-25
 - :CREATE, 7-26
 - :CREATE?, 7-26
- READ?, 7-60
- Reading
 - error messages (front panel), 2-8
 - error messages (terminal interface), 3-12
 - the Condition register, 6-8
 - the Status Byte register, 6-4
 - the system HP-IB address, 3-5
 - the system HP-IB address (front panel), 2-3
- Reading Instrument's Error Queue, B-1
- Reading the date, 1-5
- Reading the time, 1-5
- Readings
 - retrieving from mainframe memory, 4-7
 - storing in mainframe memory, 4-7
- Reboot the mainframe
 - terminal interface, 3-5
- Reboot the mainframe (front panel), 2-3
- Reference, Common Commands, 7-65
- register
 - :READ?, 7-61
 - :WRITE?, 7-62
 - VX:READ?, 7-60

VXI:WRIT, 7-64
 Register, Status Byte, 6-4
 Remote (HP-IB message), 7-74
 Reset
 (reboot) the mainframe (front panel), 2-3
 (reboot) the mainframe (terminal interface), 3-5
 a switch module (front panel), 2-5
 a switch module (terminal interface), 3-8
 Retrieving data from mainframe memory, 4-7
 Right arrow key
 terminal interface, 3-14
 RS-232 Cable, 5-1

S

SA, terminal interface command, 3-21
 Scan channels
 (front panel), 2-5
 Switchbox, terminal interface, 3-8
 Scanning
 Voltmeter Menu (front panel), 2-18 - 2-19
 Voltmeter Menu (terminal interface), 3-30 - 3-31
 SCPI Commands, 7-1
 Format, 7-1
 Reference, 7-4
 SDC (selected device clear), 7-73
 Secondary addresses, instrument, 1-4
 SElect, 7-63
 Select Address command (terminal interface), 3-21
 Select Instrument command (terminal interface), 3-21
 SElect?, 7-63
 Selected device clear (SDC), 7-73
 Selecting
 instruments, without menus, 3-21
 the Switchbox (front panel), 2-5
 the Switchbox (terminal interface), 3-8
 Selecting the Latched Switches, D-4
 DC Power Option, D-4
 Selecting the Trickle Charge Currents, D-4
 DC Power Option, D-4
 Separator
 Command, 7-2
 Serial poll (SPOLL), 7-74
 Service request
 enable register, 6-5
 Service request enable register, 6-5
 clearing, 6-5
 Set or read the system HP-IB address
 terminal interface, 3-5
 Set or read the system HP-IB address (front panel), 2-3
 Setting the date, 1-5
 Setting the time, 1-5
 Shift key
 terminal interface, 3-15
 Shift key (front panel), 2-11
 SI, terminal interface command, 3-21
 SLOPe, TRIGger:SLOPe, 7-52
 SLOPe?, TRIGger:SLOPe?, 7-52

SOURce subsystem, 7-30 - 7-31
 SOURce, TRIG:SOUR, 7-52
 SOURce?, TRIG:SOUR?, 7-53
 Specifications
 DC Power Option, D-3
 SPOLL (serial poll), 7-74
 ST, terminal interface command, 3-20
 Standard Commands for Programmable Instruments, SCPI, 7-4
 Standard Event Status bits, unmasking, 6-6
 Standard Event Status Register, 6-6
 reading, 6-7
 Standard Event Status Register (table), 6-8
 Standard Operation Status Group
 Condition register, 6-7
 Condition register (table), 6-8
 Status Byte register, 6-3 - 6-4
 Status Byte Register, reading, 6-4
 STATus subsystem, 7-32 - 7-34
 STAT:OPER:COND?, 7-32
 STAT:OPER:ENAB, 7-32
 STAT:OPER:ENAB?, 7-33
 STAT:OPER[:EVEN]?, 7-33
 STAT:PRES, 7-34
 STAT:QUES, 7-34
 Status system structure, 6-2
 Status, clearing, 6-10
 Status, system structure, 6-2
 Storing and retrieving data from mainframe memory, 4-7
 Subsystem
 ABORT, 7-4
 DIAGnostic, 7-5 - 7-28
 INITiate, 7-29
 SOURce, 7-30 - 7-31
 STATus, 7-32 - 7-34
 SYSTem, 7-35 - 7-50
 TRIGger, 7-51 - 7-53
 VXI, 7-54 - 7-64
 Switchbox
 close channels (front panel), 2-5
 close channels (terminal interface), 3-8
 display module type & description (front panel), 2-5
 display module type & description (term. interface), 3-8
 Menu (front panel), 2-16
 Menu (terminal interface), 3-28
 monitoring (front panel), 2-5
 monitoring (terminal interface), 3-8
 open and close channels (front panel), 2-5
 open and close channels (terminal interface), 3-8
 scan channels (front panel), 2-5
 scan channels (terminal interface), 3-8
 selecting (front panel), 2-5
 selecting (terminal interface), 3-8
 Synchronizing
 internal/external instruments, 4-3
 Synchronizing external computer/instruments, 6-12
 Syntax, Variable Command, 7-2
 System Instrument, 7-1

3. Send "SI SYSTEM" and a carriage return to get the attention of the System Instrument.
4. Send <CTRL-C> to clear the system.
5. Send "*RST" and a carriage return to put the System Instrument in a known state.

The program must then send the binary data. This block of data should include the command "DIAG:DOWN:CHEC" followed by the address to download to and an IEEE 488.2 arbitrary block header. This block header can be either definite or indefinite. The advantage of using an indefinite block header is that you do not need to know the length of the data block. The indefinite block header is #0. With the DIAG:DOWN:CHEC command an indefinite block is terminated with the "!" character followed by a carriage return. The "!" character is not considered part of the block. A definite block only requires the ASCII carriage return character as terminator. The definite block starts with #. This is followed by a single digit that shows the number of digits in the length field, which is followed by the actual length of the block, not counting the header. For instance, a block of 1000 bytes would have a definite block header of #41000. Due to the formatting required, the size of the block when using the DIAG:DOWN:CHEC command is twice the length of the data in bytes.

Once the block header has been sent, the actual data is sent. Since the buffer size of the System Instrument RS-232 Interface is limited to 79 bytes, the buffer must be flushed (passed to an instrument parser) before it reaches 79 bytes. This can be done by sending a carriage return. The first carriage return should be included in the binary file after the buffer header. Sending it before this would result in the parser determining that there are not enough parameters and producing an error condition. Once transmission of the actual data begins, a carriage return should be included after every 78 bytes.

NOTE

The carriage returns are not considered part of the block count.

After the last byte of data, there must be a carriage return to terminate the transmission for a definite block or a "!" and carriage return for an indefinite block.

Index

I

- 3-Channel Universal Counter
 - Menu (front panel), 2-26 - 2-27
 - Menu (terminal interface), 3-38 - 3-39
- 4-Channel Counter/Totalizer
 - Menu (front panel), 2-24 - 2-25
 - Menu (terminal interface), 3-36 - 3-37
- 4-Channel D/A Converter
 - Menu (front panel), 2-21
 - Menu (terminal interface), 3-33
- 5 1/2 Digit Multimeter
 - Menu (front panel), 2-20
 - Menu (terminal interface), 3-32
- 60-second menu tutorial
 - front panel, 2-2
 - terminal interface, 3-3
- :DRIVER:LOAD, 7-17
- :DRIVER:LOAD:CHECKed, 7-17

A

- Abbreviated Commands, 7-2
- ABORt subsystem, 7-4
- Allocating a user memory segment, 4-7

B

- Back Space key
 - terminal interface, 3-15
- Back Space key (front panel), 2-11
- BEEPPer:IMMEDIATE, 7-35
- BOOT
 - :COLD, 7-6
 - :WARM, 7-7

C

- Cable
 - RS-232, 5-1
- Caps Lock key
 - terminal interface, 3-15
- Caps Lock key (front panel), 2-11
- Changing the primary HP-IB address, 4-3
- Clear-to-end key
 - terminal interface, 3-15
- Clear-to-end key (front panel), 2-11
- Clearing Standard Operation Event Register Bits, 6-9
- Clearing status, 6-10
- Close channels

- terminal interface, 3-8
- Close channels (front panel), 2-5
- Command
 - Abbreviated, 7-2
 - Implied, 7-2
 - Linking, 7-3
 - Separator, 7-2
 - Types, 7-1
- Command Errors, B-2
- Command Quick Reference, 7-75
- Command Reference, SCPI
 - ABORt subsystem, 7-4
 - Common Commands, 7-65
 - DIAGNOSTIC subsystem, 7-5 - 7-28
 - INITIate subsystem, 7-29
 - INITIate:IMMEDIATE, 7-29
 - SOURce subsystem, 7-30 - 7-31
 - SOURce:PULSe:COUNT, 7-30
 - SOURce:PULSe:COUNT?, 7-30
 - SOURce:PULSe:PERIOD, 7-31
 - SOURce:PULSe:PERIOD?, 7-31
 - STATus subsystem, 7-32 - 7-34
 - SYSTEM subsystem, 7-35 - 7-50
 - SYSTEM:BEEP:IMMEDIATE, 7-35
 - SYSTEM:COMMUNICATE:GPIB:ADDRESS, 7-36
 - TRIGger subsystem, 7-51 - 7-53
 - TRIGger:DELay, 7-51
 - TRIGger:IMMEDIATE, 7-52
 - TRIGger:SLOPe, 7-52
 - TRIGger:SLOPe?, 7-52
 - TRIGger:SOURce, 7-52
 - TRIGger:SOURce?, 7-53
 - VXI subsystem, 7-54 - 7-64
- Commands
 - executing (front panel), 2-9
 - executing (terminal interface), 3-13
 - terminal interface, 3-19
- Common Command Format, 7-1
- Common Command reference, 7-65
- Common Command reference, all instruments
 - *CLS, 7-66
 - *ESE, 7-66
 - *ESE?, 7-67
 - *ESR?, 7-67
 - *IDN?, 7-68
 - *LRN?, 7-68
 - *OPC, 7-69
 - *OPC?, 7-69
 - *PSC, 7-69
 - *PSC?, 7-69
 - *RCL, 7-70
 - *RST, 7-70

- *SAV, 7-70
- *SRE, 7-70
- *SRE?, 7-71
- *STB?, 7-71
- *TRG, 7-71
- *TST?, 7-71
- *WAI, 7-71
- Common Commands functional groupings, 7-65
- COMMunicate:GPIB
 - :ADDReSS, 7-36
 - :ADDReSS?, 7-36
- COMMunicate:SERial[0]
 - :OWNer, 7-7
 - :OWNer?, 7-8
- COMMunicate:SERial[n]
 - :CONTRol:DTR, 7-37
 - :CONTRol:DTR?, 7-38
 - :CONTRol:RTS, 7-38
 - :CONTRol:RTS?, 7-39
 - :RECEive:BAUD, 7-39
 - :RECEive:BAUD?, 7-39
 - :RECEive:BITS, 7-40
 - :RECEive:BITS?, 7-40
 - :RECEive:PACe:PROTOcol, 7-41
 - :RECEive:PACe:PROTOcol?, 7-41
 - :RECEive:PACe:THReShold:STARt, 7-42
 - :RECEive:PACe:THReShold:STARt?, 7-42
 - :RECEive:PACe:THReShold:STOP, 7-43
 - :RECEive:PACe:THReShold:STOP?, 7-43
 - :RECEive:PARity:CHECK, 7-44
 - :RECEive:PARity:CHECK?, 7-44
 - :RECEive:PARity:TYPE, 7-44 - 7-45
 - :RECEive:PARity[:TYPE?], 7-46
 - :RECEive:SBITS, 7-46
 - :RECEive:SBITS?, 7-47
 - :STORE, 7-8
 - :TRANSMit:AUTO, 7-47
 - :TRANSMit:AUTO?, 7-47
 - :TRANSMit:PACe:PROTOcol, 7-48
 - :TRANSMit:PACe:PROTOcol?, 7-48
- COMMunicate:SERial[n] ..., 7-36
- Condition register, reading, 6-8
- CONFigure
 - :DLADdress?, 7-54
 - :DNUMBER?, 7-56
 - :HIERarchy:ALL?, 7-58
 - :HIERarchy?, 7-57
 - :INFORMATION:ALL?, 7-60
 - :INFORMATION?, 7-58 - 7-59
 - :NUMBER?, 7-60
- CONFigure:DLISt?, 7-55
- Configuring a Terminal, C-1 - C-5
- Connecting a terminal, C-1 - C-5
- Connecting Battery to DC Power Option, D-2
- Control keys, menu (terminal interface), 3-14

D

- Data memory, mainframe, 4-6
- DATE, 7-48
 - SYST:DATE, 7-48
 - SYST:DATE?, 7-49
- Date, reading or setting, 1-5
- DATE?, 7-49
- DC Power Option, D-1 - D-4
 - Connecting Battery, D-2
 - Operation, D-2
 - Power Down Operation, D-2
 - Selecting the Latched switches, D-4
 - Trickle Charge Currents, D-3
- DC Power Option Description, D-1
- DC Power Option Operation, D-2
- DC Power Option Specifications, D-3
- DC Power Option Trickle Charge Currents, D-3
 - Selecting, D-4
- DCL (device clear), 7-73
- Definition, instrument, 1-3
- DELay, 7-51
 - TRIG:DELay, 7-51
 - TRIG:DELay?, 7-51
- DELay?, 7-51
- Delete key
 - terminal interface, 3-14
- Delete key (front panel), 2-11
- Description
 - DC Power Option, D-1
- Device clear (DCL), 7-73
- Device Driver
 - manual download over HP-IB, 5-11
 - manual download over RS-232, 5-11
 - preparing memory for download, 5-10
- Device driver RAM, 5-3
- Device Drivers
 - checking status, 5-9
 - Disks, 5-1
 - download program configuration, 5-4
 - downloading in HP-IB systems with HP BASIC, 5-8
 - downloading in HP-IB systems with IBASIC, 5-7
 - downloading in MS-DOS systems, 5-6
 - downloading multiple drivers, 5-9
 - editing the configuration file, 5-4
 - memory configuration, 5-3
- Device-Specific Errors, B-2
- DIAGnostic subsystem, 7-5 - 7-28
 - DIAG:BOOT:COLD, 7-6
 - DIAG:BOOT:WARM, 7-7
 - DIAG:COMM:SER[0]:OWN, 7-7
 - DIAG:COMM:SER[0]:OWN?, 7-8
 - DIAG:COMM:SER[n]:STOR, 7-8
 - DIAG:DOWN:CHec:SADD, 7-11 - 7-12
 - DIAG:DOWN:CHec[:MADD], 7-9 - 7-10
 - DIAG:DOWN:SADD, 7-14
 - DIAG:DOWN[:MADD], 7-13

DIAG:DRAM:AVA?, 7-15
 DIAG:DRAM:CRE, 7-16
 DIAG:DRIVER:LOAD, 7-17
 DIAG:DRIVER:LOAD:CHEC, 7-17
 DIAG:INT:ACT, 7-19
 DIAG:INT:PRI[n], 7-21
 DIAG:INT:PRI[n]?, 7-21
 DIAG:INT:RESP?, 7-22
 DIAG:INT:SET[n], 7-19
 DIAG:INT:SET[n]?, 7-20
 DIAG:NRAM:ADDR?, 7-23
 DIAG:NRAM:CRE, 7-23
 DIAG:NRAM:CRE?, 7-24
 DIAG:PEEK?, 7-24
 DIAG:POKE, 7-25
 DIAG:RDIS:ADD?, 7-25
 DIAG:RDIS:CRE, 7-26
 DIAG:RDIS:CRE?, 7-26
 DIAG:UPL:SADD?, 7-28
 DIAG:UPL[:MADD]?, 7-27
 DRIV:LIST:ROM?, 7-18
 DRIV:LIST?, 7-18
 DIAGnostic:DRIVER:LIST:RAM?, 7-18
 DIAGnostic:DRIVER:LIST:ROM?, 7-18
 DIAGnostic:DRIVER:LIST?, 7-18
 Display

- instrument information (terminal interface), 3-5
- control/editing keys (front panel), 2-10
- instrument information (front panel), 2-3
- instrument logical addresses (front panel), 2-3
- instrument logical addresses (terminal interface), 3-5
- module type & description (front panel), 2-5
- module type & description (term. interface), 3-8

 DOWNload

- :CHECKed:SADDRESS, 7-11 - 7-12
- :CHECKed[:MADDRESS], 7-9 - 7-10
- :SADDRESS, 7-14
- [:MADDRESS], 7-13

 Download program, 5-4
 DOWNload, using, 4-9
 Downloading device drivers

- checking status, 5-9
- hardware handshake, 5-12
- in HP-IB systems with HP BASIC, 5-8
- in HP-IB systems with IBASIC, 5-7
- in MS-DOS systems, 5-6
- manually over HP-IB, 5-11
- manually over RS-232, 5-11
- manually using hardware handshake, 5-13
- manually using software handshake, 5-14
- multiple device drivers, 5-9
- pacing data, 5-12
- preparing memory, 5-10
- software handshake, 5-12

 DRAM, 5-3

- :AVAILable?, 7-15
- :CREate, 7-16
- :CREate?, 7-16

Drivers
 listing, 7-18

E

Editing

- VXIDLD.CFG, 5-4

 Editing keys

- front panel, 2-10

 Editing keys (terminal interface), 3-14
 Editing:the configuration file, 5-4
 Error

- messages, reading, 3-12
- messages, reading (front panel), 2-8
- SYST:ERR?, 7-49

 Error Messages, B-1 - B-6
 Error Queue ,reading, B-1
 Error Types, B-2
 ERRor?, 7-49
 Errors

- Command, B-2
- Device-Specific, B-2
- Execution, B-2
- Query, B-2

 Example

- Storing and retrieving data from mainframe memory, 4-7
- Allocating an NRAM segment, 4-8
- Continuous pacer out signal, 4-2
- interrupting when an error occurs, 6-11
- Pacing an external scanner, 4-2
- reading the date, 1-5
- reading the time, 1-5
- setting the date, 1-5
- setting the time, 1-5
- Synchronizing an internal instrument to an external instrument, 4-4
 - synchronizing computers using *OPC, 6-13
 - synchronizing computers using *OPC?, 6-12
- Synchronizing internal/external instruments and the computer, 4-4
 - Using the Operation Status Group Registers, 6-9
 - Using UPLoad and DOWNload, 4-10

 Example: Reading Error Queue, B-1
 Executing commands (front panel), 2-9
 Executing commands (terminal interface), 3-13
 Execution Errors, B-2
 External computer, interrupting, 6-10
 External computer/instruments, synchronizing, 6-12

F

- Files:VXIDLD.CFG, 5-4
- Format
 - Common Command, 7-1
 - SCPI Command, 7-1
- Front panel
 - features, 2-1
 - menu tutorial, 2-2
 - menus, 2-2

G

- GET (group execute trigger), 7-72
- Go to local (GTL), 7-72
- Group execute trigger (GET), 7-72
- GTL (go to local), 7-72

H

- Hints, programming, 6-1
- How to
 - display instrument information (front panel), 2-3
 - display instrument information (terminal interface), 3-5
 - display instrument ladd (terminal interface), 3-5
 - display instrument ladd(front panel), 2-3
 - reset (reboot) the mainframe (front panel), 2-3
 - reset (reboot) the mainframe (terminal interface), 3-5
 - set or read the system HP-IB address, 3-5
 - set or read the system HP-IB address (front panel), 2-3
- HP-IB message reference, 7-72

I

- IBASIC, Users Note, 4-7
- IFC (interface clear), 7-72
- IMMEDIATE
 - BEEP:IMM, 7-35
 - INIT:IMM, 7-29
 - TRIG:IMM, 7-52
- Implied Commands, 7-2
- In case of difficulty
 - terminal interface, 3-23
- In case of difficulty (front panel), 2-12
- INITiate subsystem, 7-29
- Instrument
 - Control Keys (front panel), 2-11
 - Control Keys (terminal interface), 3-15
 - definition, 1-3
 - logical addresses, 1-4
 - menus (front panel), 2-13
 - menus (terminal interface), 3-25
 - menus, using, 3-8
 - menus, using (front panel), 2-5
- Instrument secondary addresses, 1-4
- Instruments, synchronizing, 4-3

- Interface clear (IFC), 7-72
- Internal/external instruments, synchronizing, 4-3
- INTerrupt
 - :ACTivate, 7-19
 - :PRiority[n], 7-21
 - :PRiority[n]?, 7-21
 - :RESponse?, 7-22
 - :SETup[n], 7-19
 - :SETup[n]?, 7-20
- Interrupting external computer, 6-10
- Introductory programming examples, 1-4

K

- Key descriptions (front panel), 2-10
- Key descriptions, General, 3-14
- Keys
 - editing (terminal interface), 3-14
 - menu (front panel), 2-10
 - menu (terminal interface), 3-14
 - menu control (terminal interface), 3-14

L

- Left arrow key
 - terminal interface, 3-14
- Left arrow key (front panel), 2-10
- Linking Commands, 7-3
- LLO (local lockout), 7-73
- Local lockout (LLO), 7-73
- Logical addresses
 - displaying (front panel), 2-3
 - displaying (terminal interface), 3-5
 - instrument, 1-4

M

- Mainframe
 - data memory, 4-6
 - description, 1-1
 - memory, optional, 1-1
- Mainframe Options
 - DC Power, D-1 - D-4
- Memory
 - device driver RAM, 5-3
- Memory, mainframe, 4-6
- Menu
 - using a terminal without, 3-21
- Menu (front panel)
 - 3-Channel Universal Counter, 2-26 - 2-27
 - 4-Channel Counter/Totalizer, 2-24 - 2-25
 - Quad 8-Bit Digital Input/Output, 2-22
 - 4-Channel D/A Converter, 2-21
 - 5 1/2 Digit Multimeter, 2-20
 - instrument (front panel), 2-13
 - keys, 2-10
 - Scanning Voltmeter, 2-18 - 2-19

- Menu (front panel), 2-14 - 2-15
- Menu (terminal interface), 3-26 - 3-27
- System Instrument menu, 3-5
- System Instrument menu (front panel), 2-3
- SYSTem subsystem, 7-35 - 7-50
 - SYST:COMM:GPIB:ADDR?, 7-36
 - SYST:COMM:SER[n]:REC:PAR:TYPE, 7-44 - 7-45
 - SYST:COMM:SER[n]:CONT:DTR, 7-37
 - SYST:COMM:SER[n]:CONT:DTR?, 7-38
 - SYST:COMM:SER[n]:CONT:RTS?, 7-39
 - SYST:COMM:SER[n]:REC:BAUD, 7-39
 - SYST:COMM:SER[n]:REC:BAUD?, 7-39
 - SYST:COMM:SER[n]:REC:BITS, 7-40
 - SYST:COMM:SER[n]:REC:BITS?, 7-40
 - SYST:COMM:SER[n]:REC:PACE:PROT, 7-41
 - SYST:COMM:SER[n]:REC:PACE:PROT?, 7-41
 - SYST:COMM:SER[n]:REC:PACE:THR:STAR, 7-42
 - SYST:COMM:SER[n]:REC:PACE:THR:STAR?, 7-42
 - SYST:COMM:SER[n]:REC:PACE:THR:STOP, 7-43
 - SYST:COMM:SER[n]:REC:PACE:THR:STOP?, 7-43
 - SYST:COMM:SER[n]:REC:PAR:CHEC, 7-44
 - SYST:COMM:SER[n]:REC:PAR:CHEC?, 7-44
 - SYST:COMM:SER[n]:REC:PAR[:TYPE?], 7-46
 - SYST:COMM:SER[n]:REC:SBIT, 7-46
 - SYST:COMM:SER[n]:REC:SBIT?, 7-47
 - SYST:COMM:SER[n]:TRAN:AUTO, 7-47
 - SYST:COMM:SER[n]:TRAN:AUTO?, 7-47
 - SYST:COMM:SER[n]:TRAN:PACE:PROT, 7-48
 - SYST:COMM:SER[n]:TRAN:PACE:PROT?, 7-48
 - SYST:COMM:SERIAL[n]:CONT:RTS, 7-38
 - SYST:DATE, 7-48
 - SYST:DATE?, 7-49
 - SYST:ERRor?, 7-49
 - SYST:TIME, 7-50
 - SYST:TIME?, 7-50
 - SYST:VERS?, 7-50

T

- Terminal
 - configuring, C-1 - C-5
 - connecting, C-1 - C-5
- Terminal interface
 - commands, 3-19
 - commands, SA, 3-21
 - commands, SI, 3-21
 - commands, ST, 3-20
 - features, 3-2
 - menu tutorial, 3-3
 - menus, 3-3
- TIME, 7-50
 - SYST:TIME, 7-50
 - SYST:TIME?, 7-50
- Time, reading or setting, 1-5
- TIME?, 7-50
- Trickle Charge Currents
 - DC Power Option, D-3
- TRIG:SOURce, 7-52

- TRIG:SOURce?, 7-53
- TRIGger subsystem, 7-51 - 7-53
- trigger system
 - ABORt subsystem, 7-4
 - INITiate subsystem, 7-29
 - TRIGger subsystem, 7-51 - 7-53
- TRIGger:IMMediate, 7-52
- TRIGger:SLOPe, 7-52
- TRIGger:SLOPe?, 7-52

U

- Unassigned modules, 1-4
- Unmasking Standard Event Status bits, 6-6
- Unmasking Standard Operation Event Register Bits, 6-8
- UPLoad
 - :SADDress?, 7-28
 - [:MADDress?], 7-27
- UPLoad, using, 4-9
- User memory, non-volatile, 4-7
- Using
 - :DOWNload and :UPLoad, 4-9
 - a terminal without menus, 3-21
 - instrument menus (front panel), 2-5
 - instrument menus (terminal interface), 3-8
 - menus, 2-2, 3-3
 - Operation Status Group Registers, 6-9
 - Other Terminals, 3-19
 - Supported Terminals, 3-16
 - the Pacer, 4-1

V

- Variable Command Syntax, 7-2
- VERSion?, 7-50
- VXI subsystem, 7-54 - 7-64
 - VXI:CONF:DLAD?, 7-54
 - VXI:CONF:DLIS?, 7-55
 - VXI:CONF:DNUM?, 7-56
 - VXI:CONF:HIER:ALL?, 7-58
 - VXI:CONF:HIER?, 7-57
 - VXI:CONF:INF:ALL?, 7-60
 - VXI:CONF:INF?, 7-58 - 7-59
 - VXI:CONF:NUMB?, 7-60
 - VXI:READ?, 7-60
 - VXI:REG:READ?, 7-61
 - VXI:SEL, 7-63
 - VXI:SEL?, 7-63
 - VXI:WRIT, 7-64
- VXI Subsystem, 7-62
- VXIDL.D.CFG, 5-4

W

- WRITe, 7-64

SALES & SUPPORT OFFICES

Arranged alphabetically by country

1



HEADQUARTERS OFFICES

If there is no sales office listed for your area, contact one of these headquarters offices.

NORTH/CENTRAL AFRICA

Hewlett-Packard S.A.
7, rue du Bois-du-Lan
CH-1217 MEYRIM 1, Switzerland
Tel: (022) 83 12 12
Telex: 27835 hmea
Cable: HEWPACKSA Geneve

ASIA

Hewlett-Packard Asia Ltd.
47/F, 26 Harbour Rd.,
Wanchai, HONG KONG
G.P.O. Box 863, Hong Kong
Tel: 5-8330833
Telex: 76793 HPA HX
Cable: HPASIAL TD

EASTERN EUROPE

Hewlett-Packard Ges.m.b.H.
Lieblgasse 1
P.O.Box 72
A-1222 VIENNA, Austria
Tel: (222) 2500-0
Telex: 1 3 4425 HEPA A

NORTHERN EUROPE

Hewlett-Packard S.A.
V. D. Hooplaan 241
P.O.Box 999
NL-1183 AG AMSTELVEEN
The Netherlands
Tel: 20 547999
Telex: 18 919 hpner

SOUTH EAST EUROPE

Hewlett-Packard S.A.
World Trade Center
110 Avenue Louis Casai
1215 Cointrin, GENEVA, Switzerland
Tel: (022) 98 96 51
Telex: 27225 hpser

EASTERN USA

Hewlett-Packard Co.
4 Choke Cherry Road
ROCKVILLE, MD 20850
Tel: (301) 948-6370

MIDWESTERN USA

Hewlett-Packard Co.
5201 Tollview Drive
ROLLING MEADOWS, IL 60008
Tel: (312) 255-9600

SOUTHERN USA

Hewlett-Packard Co.
2000 South Park Place
ATLANTA, GA 30339
Tel: (404) 955-1500

WESTERN USA

Hewlett-Packard Co.
5161 Lankershim Blvd.
NORTH HOLLYWOOD, CA 91601
Tel: (818) 505-5600

MEDITERRANEAN AND MIDDLE EAST

Hewlett-Packard S.A.
Mediterranean and Middle East
Operations
Atrina Centre
32 Kifissias Ave.
Paradissos-Amarousion, ATHENS
Greece
Tel: 682 88 11
Telex: 21-6588 HPAT GR
Cable: HEWPACKSA Athens

OTHER INTERNATIONAL AREAS

Hewlett-Packard Co.
Intercontinental Headquarters
3495 Deer Creek Road
PALO ALTO, CA 94304
Tel: (415) 857-1501
Telex: 034-8300
Cable: HEWPACK

ARGENTINA

Hewlett-Packard Argentina S.A.
Montaneses 2140/50
1428 BUENOS AIRES
Tel: 781-4059/69
Cable: HEWPACKARG

AUSTRALIA

Hewlett-Packard Australia Ltd.
31-41 Joseph Street
P.O. Box 221
BLACKBURN, Victoria 3130
Tel: 895-2895
Telex: 31-024
Cable: HEWPARD Melbourne

Hewlett-Packard Australia Ltd.
17-23 Talavera Road
P.O. Box 308
NORTH RYDE, N.S.W. 2113
Tel: 886-4444
Telex: 21561
Cable: HEWPARD Sydney

AUSTRIA

Hewlett-Packard Ges.m.b.H.
Lieblgasse 1
P.O. Box 72
A-1222 VIENNA
Tel: (0222) 2500-0
Telex: 134425 HEPA A

BELGIUM

Hewlett-Packard Belgium S.A./N.V.
Blvd de la Woluwe, 100
Woluwe-dal
B-1200 BRUSSELS
Tel: (02) 762-32-00
Telex: 23-494 paloben bru

BRAZIL

Hewlett-Packard do Brasil
I.e.C. Ltda.
Alameda Rio Negro, 750
ALPHAVILLE
06400 Barueri SP
Tel: (011) 421 1311
Telex: (011) 33872 HPBR-BR
Cable: HEWPACK Sao Paulo

Hewlett-Packard do Brasil
I.e.C. Ltda.
Praia de Botafogo 228
6° Andar-conj 614
Edificio Argentina - Ala A
22250 RIO DE JANEIRO, RJ
Tel: (021) 552-6422
Telex: 21905 HPBR-BR
Cable: HEWPACK Rio de Janeiro

CANADA

Hewlett-Packard (Canada) Ltd.
11120-178th Street
EDMONTON, Alberta T5S 1P2
Tel: (403) 486-6666

Hewlett-Packard (Canada) Ltd.
17500 Trans Canada Highway
South Service Road
KIRKLAND, Quebec H9J 2X8
Tel: (514) 697-4232
Telex: 056-21521

Hewlett-Packard (Canada) Ltd.
5877 Goreway Drive
MISSISSAUGA, Ontario L4V 1M8
Tel: (416) 678-9430
Telex: 069-8644

Hewlett-Packard (Canada) Ltd.
2670 Queensview Dr.
OTTAWA, Ontario K2B 8K1
Tel: (613) 820-6483

CHINA, People's Republic of

China Hewlett-Packard Co., Ltd.
P.O. Box 9610, Beijing
4th Floor, 2nd Watch Factory Main
Bldg.
Shuang Yu Shou, Bei San Huan Road
Hai Dian District
BEIJING
Tel: 28-0567
Telex: 22601 CTSHP CN
Cable: 1920 Beijing

DENMARK

Hewlett-Packard A/S
Kongevej 25
DK-3460 BINKERØED
Tel: (02) 81-86-40
Telex: 37408 hpas dk

FINLAND

Hewlett-Packard Oy
Pilepääntie 17
02200 ESPOO
Tel: 00358-0-88721
Telex: 121563 HEWPA SF

FRANCE

Hewlett-Packard France
Chemin des Mouilles
Boite Postale 162
69131 ECULLY Cedex (Lyon)
Tel: (78) 133-81-25
Telex: 310617F

Hewlett-Packard France
Parc d'activités du Bois Briard
Avenue du Lac
91040 EVRY Cedex
Tel: (60) 77-83-83
Telex: 692315F

Hewlett-Packard France
Zone Industrielle de Courtabouef
Avenue des Tropiques
91947 LES ULIS Cedex (Orsay)
Tel: (69) 07-78-25
Telex: 600048F

GERMAN FEDERAL REPUBLIC

Hewlett-Packard GmbH
Vertriebszentrum Mitte
Hewlett-Packard-Strasse
D-6380 BAD HOMBURG
Tel: (06172) 16-0
Fax: (06172) 16-1309

Hewlett-Packard GmbH
Vertriebszentrum Südwest
Schickardstrasse 2
D-7030 BÖBLINGEN
Tel: (07031) 14-0
Fax: (07031) 14-8429

Hewlett-Packard GmbH
Vertriebszentrum Süd
Eschenstrasse 5
D-8028 TAUFKIRCHEN
Tel: (089) 81207-0
Fax: (089) 81207-300

GREECE

Hewlett-Packard A.E.
178, Kifissias Avenue
6th Floor
Halandri-ATHENS
Greece
Tel: 6471543, 6471673, 6472971
Telex: 221 286 HPHLGR

HONG KONG

Hewlett-Packard Hong Kong, Ltd.
G.P.O. Box 785
5th Floor, Sun Hung Kai Centre
30 Harbour Road
HONG KONG
Tel: 5-8323211
Telex: 66678 HEWPA HX
Cable: HEWPACK HONG KONG

ICELAND

Hewlett-Packard Iceland
Hoefdabekka 9
110 REYKJAVIK
Tel: (1) 67 1000

INDIA

Blue Star Ltd.
13 Community Center
New Friends Colony
NEW DELHI 110 065
Tel: 633182, 636674
Telex: 031-611120
Cable: BLUEFROST

INDONESIA

BERCA Indonesia P.T.
P.O.Box 24977/Jkt
Antara Bldg., 11th Floor
Jl. Medan Merdeka Selatan 17
JAKARTA-PUSAT
Tel: 343989
Telex: 46748 BERSAL IA

IRELAND

Hewlett-Packard Ireland Ltd.
82/83 Lower Leeson Street
DUBLIN 2
Tel: 0001 608800
Telex: 30439

ISRAEL

Computation and Measurement
Systems (CMS) Ltd.
11 Masad Street
67060
TEL-AVIV
Tel: 398 398
Telex: 33569 Motil IL

ITALY

Hewlett-Packard Italiana S.p.A.
Via G. di Vittorio 9
I-20063 CERNUSCO SUL
NAVIGLIO
(Milano)
Tel: (02) 923691
Telex: 334632

Hewlett-Packard Italiana S.p.A.
Viale C. Pavese 340
I-00144 ROMA EUR
Tel: (06) 54831
Telex: 610514

JAPAN

Yokogawa-Hewlett-Packard Ltd.
Chuo Bldg.,
4-20 Nishinakajima, 5 Chome
Yodogawa-ku
OSAKA, 532
Tel: (06) 304-6021
Telex: YHPOSA 523-3624
Yokogawa-Hewlett-Packard Ltd.
29-21 Takaido-Higashi, 3 Chome
Suginami-ku TOKYO 168
Tel: (03) 331-6111
Telex: 232-2024 YHPTOK

Yokogawa-Hewlett-Packard Ltd.
Yasuda Seimei Nishiguchi Bldg.
30-4 Tsunuya-cho, 3 Chome
Kanagawa-ku, YOKOHAMA 221
Tel: (045) 312-1252

SALES & SUPPORT OFFICES

Arranged alphabetically by country

KOREA
Samsung Hewlett-Packard Co. Ltd.
Dongbang Yeosu-do Building
12-16th Floors
36-1 Yeosu-do-Dong
Youngdeungpo-Ku
SEOUL
Tel: 784-4686, 794-2866
Telex: 25 186 SAMSAN K

MALAYSIA
Hewlett-Packard Sales (Malaysia)
Sdn. Bhd.
9th Floor
Chung Khaiw Bank Building
46, Jalan Raja Laut
50350 **KUALA LUMPUR**
Tel: 2986555
Telex: 31011 HPSM MA

MEXICO
Hewlett-Packard de Mexico,
S.A. de C.V.
Monte Pelvoux No. 111
Lomas de Chapultepec
11000 **MEXICO, D.F.**
Tel: 5-40-62-28, 72-86, 50-25
Telex: 17-74-507 HEWPACK MEX

NETHERLANDS
Hewlett-Packard Nederland B.V.
Starbaan 16
NL-1187 XR **AMSTELVEEN**
P.O. Box 667
NL-1180 AR **AMSTELVEEN**
Tel: (020) 547-6911
Telex: 13 216 HEPA NL

NORWAY
Hewlett-Packard Norge A/S
Osterndalen 16-18
P.O. Box 34
N-1345 **DESTERAAS**
Tel: 0047/2/24 80 90
Telex: 76621 nprns n

PUERTO RICO
Hewlett-Packard Puerto Rico
101 Muñoz Rivera Av
Esu. Calle Ochoa
HATO REY, Puerto Rico 00918
Tel: (809) 754-7800

SAUDI ARABIA
Modern Electronics Establishment
Hewlett-Packard Division
P.O. Box 1228
Redec Plaza, 6th Floor
JEDDAH
Tel: 544 96 28
Telex: 4027 12 FARNAS SJ
Cable: ELECTA JEDDAH

SINGAPORE
Hewlett-Packard Singapore (Sales)
Pte. Ltd.
#08-00 Inchcape House
450-2 Alexandra Road
Alexandra P.O. Box 58
SINGAPORE, 9115
Tel: 4731788
Telex: 34209 HPSGSO RS
Cable: HEWPACK, Singapore

SOUTH AFRICA
Hewlett-Packard So Africa (Pty.) Ltd.
9 Eastern Service Road
Eastgate Ext. 3
SANDTON 2144
Tel: 802-5111, 802-5125
Telex: 4-20877 SA
Cable: HEWPACK Johannesburg

SPAIN
Hewlett-Packard Española, S.A.
Ctra. de la Coruña, Km. 16, 400
Las Rozas
E-MADRID
Tel: (1) 637.00.11
Telex: 23515 HPE

SWEDEN
Hewlett-Packard Sverige AB
Skalhottsgatan 9, Kista
Box 19
S-16393 **SPÅNGA**
Tel: (08) 750-2000
Telex: (854) 17886
Teletax: (08) 7527781

SWITZERLAND
Hewlett-Packard (Schweiz) AG
7, rue du Bois-du-Lan
Case postale 365
CH-1217 **MEYRIN 1**
Tel: (0041) 22-83-11-11
Telex: 27333 HPAG CH

TAIWAN
Hewlett-Packard Taiwan Ltd.
8th Floor, Hewlett-Packard Building
337 Fu Hsing North Road
TAIPEI
Tel: (02) 712-0404
Telex: 24439 HEWPACK
Cable: HEWPACK Taipei

TURKEY
Teknim Company Ltd.
Iran Caddesi No. 7
Karaklıdere
ANKARA
Tel: 275800
Telex: 42155 TKNM TR

UNITED KINGDOM
ENGLAND
Hewlett-Packard Ltd.
Heathside Park Road
Chesham Heath
STOCKPORT
Cheshire
SK3 0RB
Tel: 061-428-0928
Telex: 668065

Hewlett-Packard Ltd.
King Street Lane
Winnersh, **WOKINGHAM**
Berkshire RG11 5AR
Tel: 0734 784774
Telex: 847178

SCOTLAND
Hewlett-Packard Ltd.
SOUTH QUEENSFERRY
West Lothian, EH30 9TG
Tel: 031 331 1188
Telex: 72682

UNITED STATES
Alabama
Hewlett-Packard Co.
420 Wynn Drive
HUNTSVILLE, AL 35805
Tel: (205) 830-2000

Arizona
Hewlett-Packard Co.
8080 Pointe Parkway West
PHOENIX, AZ 85044
Tel: (602) 273-8000

California
Hewlett-Packard Co.
1421 S. Manhattan Av.
FULLERTON, CA 92831
Tel: (714) 998-8700

Hewlett-Packard Co.
5651 West Manchester Ave.
LOS ANGELES, CA 90045
Tel: (213) 337-8000
Telex: 910-325-6608

Hewlett-Packard Co.
9606 Aero Drive
SAN DIEGO, CA 92123
Tel: (619) 279-3200

Hewlett-Packard Co.
3003 Scott Boulevard
SANTA CLARA, CA 95054
Tel: (408) 988-7000
Telex: 910-338-0586

Colorado
Hewlett-Packard Co.
24 Inverness Place, East
ENGLEWOOD, CO 80112
Tel: (303) 649-5000

Connecticut
Hewlett-Packard Co.
47 Barnes Industrial Road South
WALLINGFORD, CT 06492
Tel: (203) 265-7801

Florida
Hewlett-Packard Co.
2901 N.W. 62nd Street
FORT LAUDERDALE, FL 33309
Tel: (305) 973-2600

Hewlett-Packard Co.
6177 Lake Ellenor Drive
ORLANDO, FL 32809
Tel: (305) 859-2900

Georgia
Hewlett-Packard Co.
2000 South Park Place
ATLANTA, GA 30339
Tel: (404) 955-1500
Telex: 810-766-4890

Illinois
Hewlett-Packard Co.
5201 Tollview Drive
ROLLING MEADOWS, IL 60008
Tel: (312) 255-9800
Telex: 910-887-1066

Indiana
Hewlett-Packard Co.
11911 N. Meridian St.
CARMEL, IN 46032
Tel: (317) 844-4100

Louisiana
Hewlett-Packard Co.
160 James Drive East
ST. ROSE, LA 70087
P.O. Box 1449
KENNER, LA 70063
Tel: (504) 467-4100

Maryland
Hewlett-Packard Co.
3701 Koppers Street
BALTIMORE, MD 21227
Tel: (301) 644-5800
Telex: 710-862-1943

Hewlett-Packard Co.
2 Choke Cherry Road
ROCKVILLE, MD 20850
Tel: (301) 948-6370

Massachusetts
Hewlett-Packard Co.
1775 Minuteman Road
ANDOVER, MA 01810
Tel: (617) 682-1500

Michigan
Hewlett-Packard Co.
39550 Orchard Hill Place Drive
NOVI, MI 48050
Tel: (313) 349-9200

Minnesota
Hewlett-Packard Co.
2025 W. Larpenteur Ave.
ST. PAUL, MN 55113
Tel: (612) 644-1100

Missouri
Hewlett-Packard Co.
1001 E. 101st Terrace Suite 120
KANSAS CITY, MO 64131-3368
Tel: (816) 941-0411

Hewlett-Packard Co.
13001 Hollenberg Drive
BRIDGETON, MO 63044
Tel: (314) 944-5100

New Jersey
Hewlett-Packard Co.
120 W. Century Road
PARAMUS, NJ 07653
Tel: (201) 265-5000

New Mexico
Hewlett-Packard Co.
7801 Jefferson N.E.
ALBUQUERQUE, NM 87109
Tel: (505) 823-6100

New York
Hewlett-Packard Co.
9600 Main Street
CLARENCE, NY 14031
Tel: (716) 759-8621

Hewlett-Packard Co.
7641 Henry Clay Blvd.
LIVERPOOL, NY 13088
Tel: (315) 451-1820

Hewlett-Packard Co.
3 Crossways Park West
WOODBURY, NY 11797
Tel: (516) 682-7800

North Carolina
Hewlett-Packard Co.
5605 Roanne Way
GREENSBORO, NC 27420
Tel: (919) 852-1800

Ohio
Hewlett-Packard Co.
15885 Sprague Road
CLEVELAND, OH 44136
Tel: (216) 243-7300

Hewlett-Packard Co.
9080 Springboro Pike
MIAMSBURG, OH 45342
Tel: (513) 433-2223

Hewlett-Packard Co.
675 Brooksedge Blvd.
WESTERVILLE, OH 43081
Tel: (614) 891-3344

Oklahoma
Hewlett-Packard Co.
3525 N.W. 56th St.
Suite C-100
OKLAHOMA CITY, OK 73112
Tel: (405) 946-9499

Oregon
Hewlett-Packard Co.
9255 S. W. Pioneer Court
WILBONVILLE, OR 97070
Tel: (503) 682-8000

Pennsylvania
Hewlett-Packard Co.
111 Zeta Drive
PITTSBURGH, PA 15238
Tel: (412) 782-0400

Hewlett-Packard Co.
2750 Monroe Boulevard
VALLEY FORGE, PA 19482
Tel: (215) 666-9000

Texas
Hewlett-Packard Co.
1826-P Kramer Lane
AUSTIN, TX 78758
Tel: (512) 835-6771

Hewlett-Packard Co.
10535 Harwin Drive
HOUSTON, TX 77036
Tel: (713) 776-6400

Hewlett-Packard Co.
930 E. Campbell Rd.
RICHARDSON, TX 75081
Tel: (214) 231-6101

Hewlett-Packard Co.
1020 Central Parkway South
SAN ANTONIO, TX 78232
Tel: (512) 494-9336

Utah
Hewlett-Packard Co.
3530 W. 2100 South St.
SALT LAKE CITY, UT 84119
Tel: (801) 974-1700

Virginia
Hewlett-Packard Co.
4305 Cox Road
GLEN ALLEN, VA 23060
Tel: (804) 747-7750

Washington
Hewlett-Packard Co.
15815 S.E. 37th Street
BELLEVUE, WA 98006
Tel: (206) 643-4000

Wisconsin
Hewlett-Packard Co.
275 N. Corporate Dr.
BROOKFIELD, WI 53005
Tel: (414) 794-8800

VENEZUELA
Hewlett-Packard de Venezuela C.A.
3A Transversal Los Ruices Norte
Edificio Segre 2 & 3
Apartado 50933
CARACAS 1050
Tel: (582) 239-4133
Telex: 251046 HEWPACK

YUGOSLAVIA
Do Hermes
General Zdanova 4
YU-11000 BEOGRAD
Tel: (011) 342 641
Telex: 11433