

HP 8981A VECTOR MODULATION ANALYZER

SERIAL NUMBERS

This manual applies directly to instruments with serial numbers prefixed 2805A and above.

For additional important information about serial numbers, see INSTRUMENTS COVERED BY THIS MANUAL in Section 1.



© Copyright HEWLETT-PACKARD COMPANY 1987, 1988
1501 PAGE MILL ROAD, PALO ALTO, CALIFORNIA, U.S.A.

OPERATING MANUAL PART NO. 08981-90006

Edition 1 E1188

HP Binder Part No. 9282-1079

Microfiche Operating Manual Part No. 08981-90007

Service Manual Part No. 08981-90008

Microfiche Service Manual Part No. 08981-90009

TABLE OF CONTENTS

Section 1

GENERAL INFORMATION

Introduction	1-1
Specifications	1-1
Safety Considerations	1-1
Instruments Covered by this Manual	1-3
Manual Modification Package	1-3
Description	1-3
Mechanical Options	1-4
Rack Flange Kit (Option 908)	1-4
Front Handle Kit (Option 907)	1-4
Rack Flange and Front Handle Combination Kit (Option 909)	1-4
Hewlett-Packard Interface Bus	1-4
Accessories Supplied	1-5
Line Power Cable	1-5
75 Ohm BNC Adapters	1-5
Electrical Equipment Available	1-5
High Impedance Probes	1-5
Active Probe Set	1-5
HP-IB Controllers	1-5
Graphics Printer	1-6
Support Kit	1-6
Mechanical Equipment Available	1-6
Chassis Slide Mount Kit	1-6
Chassis Tilt Slide Mount Kit	1-6
Recommended Test Equipment	1-7

Section 2

INSTALLATION

Introduction	2-1
Initial Inspection	2-1
Preparation for Use	2-2
Power Requirements	2-2
Line Voltage and Fuse Selection	2-2
Power Cables	2-3
HP-IB Address Selection and Configuring	2-4
Interconnections	2-6
Impedance Selection	2-6
Mating Connectors	2-9
Operating Environment	2-9
Bench Operation	2-9
Rack Mounting	2-9
Storage and Shipment	2-10
Environment	2-10
Packaging	2-10

Section 3

OPERATION

Introduction	3-1
Panel Features	3-1
Operating Characteristics	3-1
Local Operation	3-1
HP-IB Remote Operation	3-1
Operator's Check	3-1
Operator's Maintenance	3-1
Turn-On	3-3
Turn-On Procedure	3-3
Turn-On Sequence	3-3
Simplified Operation	3-4
Remote Operation, Hewlett-Packard Interface Bus	3-9
HP-IB Compatibility	3-9
Remote Mode	3-12
Local Mode	3-13
Addressing	3-14
Data Messages	3-14
Receiving Data Messages	3-15
Sending the Data Message	3-20
Receiving the Clear Message	3-20
Receiving the Trigger Message	3-21
Receiving the Remote Message	3-21
Receiving the Local Message	3-21
Receiving the Clear Lockout/Set Local Message	3-21
Receiving the Pass Control Message	3-21
Sending the Require Service Message	3-22
Sending the Status Byte Message	3-22
Sending the Status Bit Message	3-22
Receiving the Abort Message	3-23
Programming the Status Register	3-23
General	3-23
Status Register	3-23
Status Register Enable Field	3-25
Bit 1, Overdrive Errors	3-25
Bit 5, Message Available	3-29
Bit 6, Events	3-29
Bit 7, Require Service (RQS)	3-31
Parallel Poll Enable Field	3-33
Operator's Check	3-53
Preliminary Check	3-53
Display Check	3-55
Markers Check	3-57
Demodulator Check	3-59
Autoscope	3-64
Calibration	3-71
Constellation Display	3-74
Data Gathering and HP-IB Transmission	3-77
Delay Selection	3-88
Demodulation	3-91

OPERATION (cont'd)

Demodulator Corrections.....	3-100
Display, General.....	3-112
Error Messages and Recovery.....	3-118
Gain.....	3-161
Gate Configuration.....	3-165
HELP Key.....	3-168
I & Q versus Time Display.....	3-170
I Marker Setup.....	3-174
Input Coupling.....	3-181
Instrument Information.....	3-184
I versus Time Display.....	3-186
KEY Command.....	3-189
Magnitude Marker Setup.....	3-201
Measurement Functions.....	3-209
Menu Softkeys.....	3-216
Offset.....	3-218
Phase Marker Setup.....	3-222
Preset.....	3-228
Printer, Use With.....	3-231
Q Marker Setup.....	3-237
Q Versus Time Display.....	3-244
Save and Recall (Demodulator Corrections).....	3-247
Save and Recall (Instrument State).....	3-251
Special Display.....	3-254
Sweep Selection.....	3-260
Time Base Selection.....	3-263
Time Marker Setup.....	3-266
Trigger Setup.....	3-272
Vector Display.....	3-278

Section 4**PERFORMANCE TESTS**

Introduction.....	4-1
Equipment Required.....	4-1
Performance Test Record.....	4-1
Calibration Cycle.....	4-1
Abbreviated Performance Test.....	4-2
Performance Test Procedures.....	4-2
Abbreviated Performance Test.....	4-3
Turn-On Check.....	4-3
I&Q Bandwidth and Timing Accuracy.....	4-4
DC Vector and Differential Accuracy.....	4-9
RF Input.....	4-12
Demodulated Bandwidth and Timing.....	4-15
Corrected DC Accuracy.....	4-20
Bandwidth Test.....	4-27
DC Vector Accuracy Test.....	4-30
I Versus Q Differential Voltage Accuracy Test.....	4-36
Delta Time Accuracy Test.....	4-39
I Versus Q Timing Accuracy Test.....	4-44

PERFORMANCE TESTS (cont'd)

Minimum Trigger Level Test	4-49
RF Input Frequency Range Test	4-52
Full Scale Input Range Test	4-55
Demodulated I and Q Bandwidth Test	4-58
Demodulated I Versus Q Timing Accuracy Test	4-63
Corrected DC Accuracy Test	4-68

Appendix A

Index	A-1
-------------	-----

Illustrations

Figure	Page
1-1. HP 8981A Vector Modulation Analyzer with Accessories Supplied and Options Available	1-2
1-2. Cabinet Dimensions	1-10
1-3. Low Pass Filter Schematic Diagram	1-16
2-1. Line Voltage and Fuse Selection	2-3
2-2. Power Cable and Line (Mains) Plug Part Numbers	2-4
2-3. Hewlett-Packard Interface Bus Connection	2-8
3-1. Front Panel Features	3-2
3-2. Rear Panel Features	3-2
3-3. Status Register	3-24
3-4. Bit 1, Overdrive Errors	3-25
3-5. Bit 6, Events	3-30
3-6. Status Register Hierarchy Chart	3-32
3-7. Preliminary Check and Display Check Setup	3-53
3-8. Preliminary Check Waveform	3-55
3-9. Display Mode	3-56
3-10. Autoscope	3-56
3-11. Demodulator Check Setup	3-60
3-12. Display Showing A-to-D Counts	3-81
3-13. Typical Vector Modulation Test System	3-91
3-14. Equipment Setup - Internal Demodulator	3-103
3-15. Equipment Setup - External Demodulator	3-103
3-16. Equipment Setup - Internal Demodulator	3-104
3-17. Equipment Setup - External Demodulator	3-105
3-18. Display Formats	3-113
3-19. Display Areas	3-114
3-20. Display with I Limits	3-177
3-21. Display with Magnitude Limits	3-205
3-22. Misaligned Constellation Pattern	3-210
3-23. Display with Phase Angle Limits	3-225
3-24. Typical Display Printout	3-231
3-25. Display with Q Limits	3-240
3-26. Display with Time Window	3-269

Illustrations (cont'd)

Figure	Page
4-1. Bandwidth and Timing Accuracy Test Setup.....	4-5
4-2. DC Vector/Differential Accuracy Test Setup.....	4-9
4-3. RF INPUT Test Setup.....	4-13
4-4. Demodulated Bandwidth/Timing Test Setup.....	4-16
4-5. Corrected dc Accuracy Test Setup.....	4-20
4-6. Bandwidth Test Setup.....	4-28
4-7. DC Vector Accuracy Test Setup.....	4-31
4-8. I vs. Q Differential Accuracy Test Setup.....	4-37
4-9. Delta Time Accuracy Test Setup.....	4-40
4-10. I versus Q Timing Accuracy Test Setup.....	4-45
4-11. Minimum Trigger Level Test Setup.....	4-50
4-12. Input Frequency Range Test Setup.....	4-53
4-13. Full Scale Input Range Test Setup.....	4-56
4-14. Demodulated I and Q Bandwidth Test Setup.....	4-60
4-15. I vs. Q Timing Accuracy Test Setup.....	4-64
4-16. Corrected dc Accuracy Test Setup.....	4-69

Tables

Table	Page
1-1. Specifications.....	1-7
1-2. Supplemental Characteristics.....	1-11
1-3. Recommended Test Equipment.....	1-15
2-1. Allowable HP-IB Addresses.....	2-5
3-1. Operating Characteristics.....	3-4
3-2. Message Reference Table.....	3-10
3-3. Functions Not Directly Programmable via HP-IB.....	3-14
3-4. HP 3709A/B Compatibility Commands.....	3-18
3-5. Status Register Bit Definitions.....	3-24
3-6. Bit 1 Status Register.....	3-26
3-7. Event Status Register.....	3-30
3-8. Summary of Status Register Commands.....	3-34
3-9. HP-IB Code to Parameter Summary, System Level Codes.....	3-35
3-10. HP-IB Code to Parameter Summary, Two-Leveled Subsystem Codes.....	3-38
3-11. Commonly Used Code Conversions.....	3-52
3-12. Main Function Defects.....	3-55
3-13. Listing of Detailed Operating Instructions (Functional).....	3-63
3-14. Trigger Search Sequence.....	3-65
3-15. Data Transmission Formats.....	3-78
3-16. Data Transmission Format, XY Source.....	3-78
3-17. Error Messages.....	3-121
3-18. Front Panel Key to KEY Command Number.....	3-191
3-19. First Level Menu Softkeys to KEY Command Numbers.....	3-192
3-20. Second Level Menu Softkeys to KEY Command Numbers.....	3-195
3-21. Third Level Menu Softkeys to KEY Command Numbers.....	3-197

Tables (cont'd)

Table	Page
3-22. Fourth Level Menu Softkeys to KEY Command Numbers.....	3-198
3-23. Terminator Menus	3-199
3-24. Preset Conditions.....	3-228
3-25. Printer Control Characters.....	3-232
4-1. Abbreviated Performance Test Record.....	4-25
4-2. Performance Test Record	4-77

Safety Considerations

This product and related documentation must be reviewed for familiarization with safety markings and instructions before operation.

This product is a Safety Class I instrument (provided with a protective earth terminal).

Before Applying Power

Verify that the product is set to match the available line voltage and the correct fuse is installed.

Safety Earth Ground

An uninterruptable safety earth ground must be provided from the main power source to the product input wiring terminals, power cord, or supplied power cord set.

Warning



Any interruption of the protective (grounding) conductor (inside or outside the instrument) or disconnecting the protective earth terminal will cause a potential shock hazard that could result in personal injury. (Grounding one conductor of a two conductor outlet is not sufficient protection.) In addition, verify that a common ground exists between the unit under test and this instrument prior to energizing either unit.

Whenever it is likely that the protection has been impaired, the instrument must be made inoperative and be secured against any unintended operation.

If this instrument is to be energized via an autotransformer (for voltage reduction) make sure the common terminal is connected to neutral (that is, the grounded side of the mains supply).

Servicing instructions are for use by service-trained personnel only. To avoid dangerous electric shock, do not perform any servicing unless qualified to do so.

Adjustments described in the manual are performed with power supplied to the instrument while protective covers are removed. Energy available at many points may, if contacted, result in personal injury.

Capacitors inside the instrument may still be charged even if the instrument has been disconnected from its source of supply.

For continued protection against fire hazard, replace the line fuse(s) only with 250V fuse(s) of the same current rating and type (for example, normal blow, time delay, etc.). Do not use repaired fuses or short circuited fuseholders.

Safety Symbols



Instruction manual symbol: The product will be marked with this symbol when it is necessary for the user to refer to the instruction manual (see Table of Contents for page references).



Indicates hazardous voltages.



Indicates earth (ground) terminal.

Warning



The **WARNING** sign denotes a hazard. It calls attention to a procedure, practice, or the like, which, if not correctly performed or adhered to, could result in personal injury. Do not proceed beyond a **WARNING** sign until the indicated conditions are fully understood and met.

Caution



The **CAUTION** sign denotes a hazard. It calls attention to an operating procedure, practice, or the like, which, if not correctly performed or adhered to, could result in damage to or destruction of part or all of the product. Do not proceed beyond a **CAUTION** sign until the indicated conditions are fully understood and met.

CERTIFICATION

Hewlett-Packard Company certifies that this product met its published specifications at the time of shipment from the factory. Hewlett-Packard further certifies that its calibration measurements are traceable to the United States National Bureau of Standards, to the extent allowed by the Bureau's calibration facility, and to the calibration facilities of other International Standards Organization members.

WARRANTY

This Hewlett-Packard instrument product is warranted against defects in material and workmanship for a period of one year from date of shipment. During the warranty period, Hewlett-Packard Company will, at its option, either repair or replace products which prove to be defective.

The cathode-ray tube (CRT) in the instrument and any replacement CRT purchased from HP are also warranted against electrical failure for a period of one year. BROKEN TUBES AND TUBES WITH PHOSPHOR OR MESH BURNS, HOWEVER, ARE NOT INCLUDED UNDER THIS WARRANTY.

For warranty service or repair, this product must be returned to a service facility designated by HP. Buyer shall prepay shipping charges to HP and HP shall pay shipping charges to return the product to Buyer. However, Buyer shall pay all shipping charges, duties, and taxes for products returned to HP from another country.

HP warrants that its software and firmware designated by HP for use with an instrument will execute its programming instructions when properly installed on that instrument. HP does not warrant that the operation of the instrument, or software, or firmware will be uninterrupted or error free.

LIMITATION OF WARRANTY

The foregoing warranty shall not apply to defects resulting from improper or inadequate maintenance by Buyer, Buyer-supplied software or interfacing, unauthorized modification or misuse, operation outside of the environmental specifications for the product, or improper site preparation or maintenance.

NO OTHER WARRANTY IS EXPRESSED OR IMPLIED. HP SPECIFICALLY DISCLAIMS THE IMPLIED WARRANTIES OF MERCHANTABILITY AND FITNESS FOR A PARTICULAR PURPOSE.

EXCLUSIVE REMEDIES

THE REMEDIES PROVIDED HEREIN ARE BUYER'S SOLE AND EXCLUSIVE REMEDIES. HP SHALL NOT BE LIABLE FOR ANY DIRECT, INDIRECT, SPECIAL, INCIDENTAL, OR CONSEQUENTIAL DAMAGES, WHETHER BASED ON CONTRACT, TORT, OR ANY OTHER LEGAL THEORY.

ASSISTANCE

Product maintenance agreements and other customer assistance agreements are available for Hewlett-Packard products.

For any assistance, contact your nearest Hewlett-Packard Sales and Service Office. Addresses are provided at the back of this manual.

HP 8981A

Herstellerbescheinigung

Hiermit wird bescheinigt, dass dieses Gerät/System in Übereinstimmung mit den Bestimmungen von Postverfügung 1046/84 funkenstört ist.

Der Deutschen Bundespost wurde das Inverkehrbringen dieses Gerätes/Systems angezeigt und die Berechtigung zur Überprüfung der Serie auf Einhaltung der Bestimmungen eingeräumt.

Zusatzinformation für Mess- und Testgeräte:

Werden Mess- und Testgeräte mit ungeschirmten Kabeln und/oder in offenen Messaufbauten verwendet, so ist vom Betreiber sicherzustellen, dass die Funk-Entstörbestimmungen unter Betriebsbedingungen an seiner Grundstücksgrenze eingehalten werden.

Manufacturer's Declaration

This is to certify that this product meets the radio frequency interference requirements of Directive FTZ 1046/1984. The German Bundespost has been notified that this equipment was put into circulation and has been granted the right to check the product type for compliance with these requirements.

Note: If test and measurement equipment is operated with unshielded cables and/or used for measurements on open set-ups, the user must ensure that under these operating conditions, the radio frequency interference limits are met at the border of his premises.

1

GENERAL INFORMATION

1-1. Introduction

This manual contains information required to install, operate, and test the Hewlett-Packard 8981A Vector Modulation Analyzer. Figure 1-1 shows the Vector Modulation Analyzer with all of its externally supplied accessories.

The HP 8981A Operating Manual has four sections. The subjects addressed are:

- Section 1, General Information
- Section 2, Installation
- Section 3, Operation
- Section 4, Performance Tests

A copy of the operating information is supplied with the Vector Modulation Analyzer. The Operating Manual should stay with the instrument for use by the operator. Additional copies of the Operating Manual can be ordered separately through your nearest Hewlett-Packard office. The part number is listed on the title page of this manual.

Also listed on the title page of this manual, below the manual part number, is a microfiche part number. This number may be used to order 100 x 150 millimetre (4 x 6 inch) microfilm transparencies of this manual. Each microfiche contains up to 96 photo-duplicates of the manual pages. The microfiche package also includes the latest Manual Modification Package, as well as any pertinent Service Notes.

1-2. Specifications

Instrument specifications are listed in Table 1-1. These specifications are the performance standards or limits against which the instrument may be tested. Supplemental characteristics are listed in Table 1-2. Supplemental characteristics are not warranted specifications, but are typical characteristics included as additional information for the user.

1-3. Safety Considerations

This product is a Safety Class I instrument, that is, one provided with a protective earth terminal. The Vector Modulation Analyzer and all related documentation should be reviewed for familiarization with safety markings and instructions before operation. Refer to the Safety Considerations page found at the beginning of this manual for a summary of the safety information. Safety information for installation, operation, and performance testing is found in appropriate places throughout this manual.

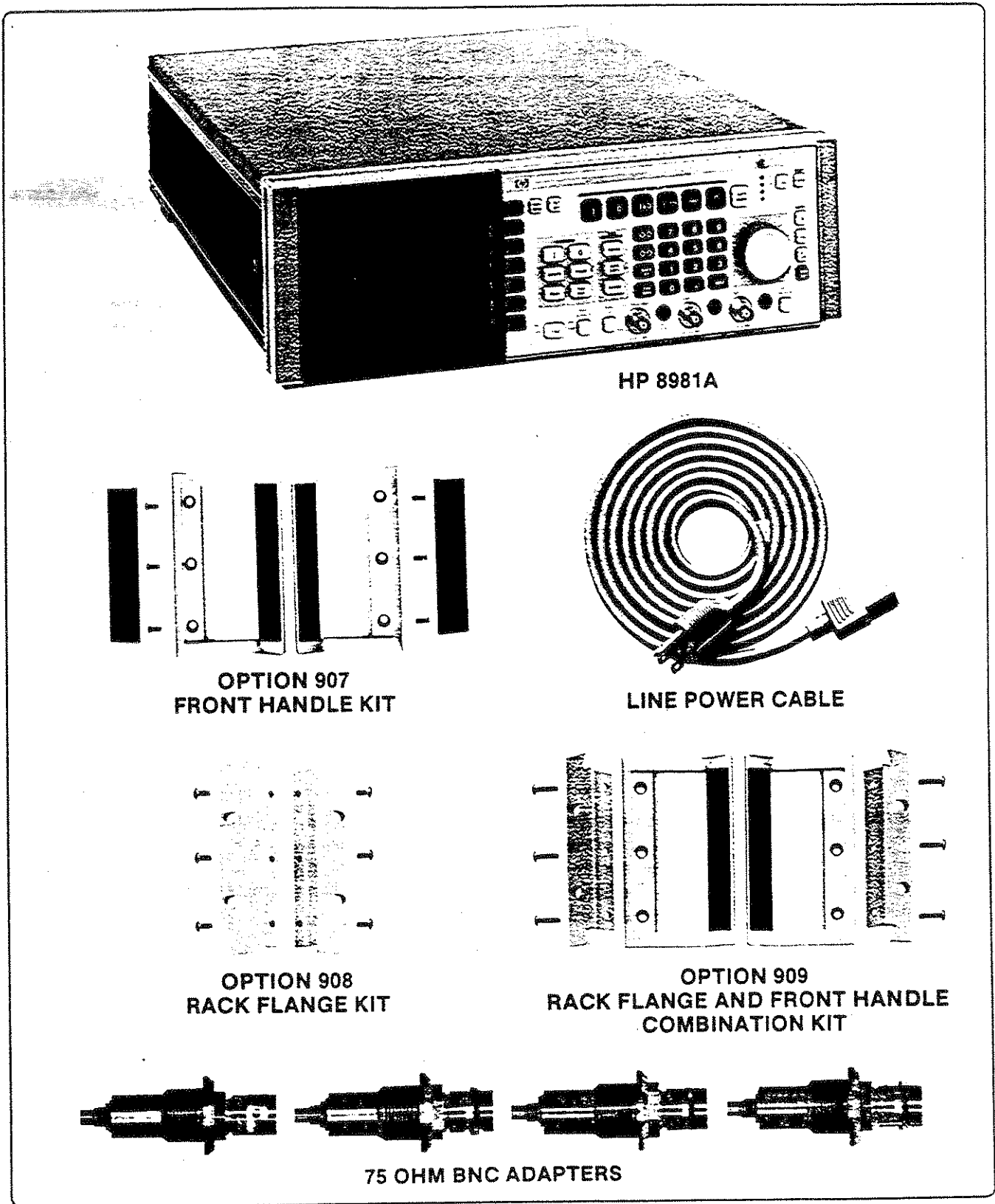

Figure 1-1. HP 8981A Vector Modulation Analyzer with Accessories Supplied and Options Available

1-4. Instruments Covered by this Manual

Attached to the rear panel of the instrument is a serial number tag. The serial number is in the form: 0000A00000. The first four digits and the letter are the serial number prefix. The last five digits are the suffix. The prefix is the same for identical instruments; it changes only when a configuration change is made to the instrument. The suffix however, is assigned sequentially and is different for each instrument. The contents of this manual apply directly to instruments having the serial number prefix(es) listed under SERIAL NUMBERS on the title page.

1-5. Manual Modification Package

An instrument manufactured after the printing of this manual may have a serial number prefix that is not listed on the title page. This unlisted serial number prefix indicates that the instrument is different from those documented in this manual. If manual changes are needed, the manual for this newer instrument is accompanied by a Manual Modification Package. The package contains change pages and instructions that explain how to adapt this manual to the newer instrument.

In addition to change information, the supplement may contain change pages for correcting errors in the manual. To keep the manual as current and as accurate as possible, Hewlett-Packard recommends that you periodically request the latest Manual Modification Package. The package is identified with the manual print date and part number, both of which appear on the manual title page. Complimentary copies of the package are available from Hewlett-Packard.

For information concerning a serial number prefix that is not listed on the title page or in the Manual Modification Package, contact your nearest Hewlett-Packard office.

1-6. Description

The HP 8981A Vector Modulation Analyzer is a wideband modulation test instrument that uses analog sampling oscilloscope technology. The major display modes of the Vector Modulation Analyzer include vector, constellation, and voltage versus time, plus special display modes. Special display modes are useful when aligning symmetrical modulation patterns in digital modulators. An important feature of the instrument is its measurement capability. The instrument has the capability to measure the voltage (or relative position in percent of full scale in DEMOD mode) of the I and Q signals at the time marker instant. The instrument can also measure percent closure, lock (phase) angle error and quadrature error. Refer to the "Measurement Functions" Detailed Operating Instruction for further information.

The Vector Modulation Analyzer can analyze either demodulated I and Q input signals from an external demodulator or a modulated RF signal that is demodulated using the internal demodulator. When using an external

demodulator or the demodulation capability of the Vector Modulation Analyzer, the instrument software contains an algorithm which acts to correct for errors in the demodulator. This allows for a higher degree of accuracy in the displayed signal as well as in measurements made by the instrument.

The HP 8981A has many special features. These special features include AUTO SCOPE, calibrated I, Q, magnitude, phase, and time markers, and a HELP key. In addition, all functions are programmable via HP-IB (HP's implementation of IEEE standard 488) for automatic or semi-automatic measurement applications.

To ensure that the instrument is operating properly, the Vector Modulation Analyzer has a set of power-up diagnostics. Whenever the instrument is turned on, the power-up diagnostics are executed. If a malfunction is detected, an error message will appear on the screen indicating the nature of the fault. All diagnostics are described in the Service section of the Service Manual.

1-7. Mechanical Options

The following options may have been ordered and received with the Vector Modulation Analyzer. If they were not ordered with the original shipment and are now desired, they can be ordered from the nearest Hewlett-Packard office using the part numbers included in each of the following paragraphs.

1-8. Rack Flange Kit (Option 908)

The Vector Modulation Analyzer can be mounted in an instrument rack using the rack flange kit. The Rack Flange Kit part number is 5061-9677.

1-9. Front Handle Kit (Option 907)

Ease of handling is increased with the front panel handles. The handles also provide some protection for the front panel. The Front Handle Kit part number is 5061-9689.

1-10. Rack Flange and Front Handle Combination Kit (Option 909)

This is a unique part which combines both functions. It is not simply a front handle kit and a rack flange kit packaged together. The Rack Flange and Front Handle Combination Kit part number is 5061-9683.

1-11. Hewlett-Packard Interface Bus

The Vector Modulation Analyzer is compatible with HP-IB to the extent indicated by the following codes: SH1, AH1, T5, TE0, L3, LE0, SR1, RL1, PP1, DC1, DT0, C0, and E2. The Vector Modulation Analyzer interfaces with HP-IB via tri-state circuitry. An explanation of the compatibility code can be found in IEEE Standard 488 (1978), "IEEE Standard Digital Interface for Programmable Instrumentation" or the identical ANSI Standard MC1.1. For more detailed information relating to programmable control of the Vector Modulation Analyzer, refer to Remote Operation, Hewlett-Packard Interface Bus in Section 3 of this manual.

1-12. Accessories Supplied

The accessories supplied with the Vector Modulation Analyzer are shown in Figure 1-1.

1-13. Line Power Cable

The line power cable is supplied in several configurations, depending on the destination of the original shipment. Refer to Power Cables in Section 2 of this manual.

1-14. 75 Ohm BNC Adapters

Four 75 Ω BNC adapters are provided with the instrument so that it can be used in a 75 Ω system. The front panel I and Q inputs and EXT TRIG INPUT as well as the rear panel RF IN input can be configured for 75 Ω . If the 75 Ω BNC adapters are lost, they can be ordered separately. The HP Part Number for the replacement adapter is 08980-60063.

1-15. Electrical Equipment Available

1-16. High Impedance Probes

The HP 1124A Active Divider Probe facilitates use of the HP 8981A as a conventional oscilloscope using the front panel I and Q inputs. The probes have 10 M Ω impedance and a bandwidth of 100 MHz. Power to the probes is supplied via the PROBE POWER outputs on the front panel of the instrument. The Active Divider Probe Set can be mounted to the side of the instrument.

1-17. Active Probe Set

The HP 11748A Active Probe Set provides three high impedance active probes in one package. The probes have 1 M Ω , 8 pf loading and 10:1 attenuation. Power to the Active Probe Set is supplied via a PROBE POWER output on the front panel of the Vector Modulation Analyzer.

Note



There are two recommended setup configurations for the HP 8981A with the HP 11748A Active Probe Set (refer to the HP 11748A Operating and Service Manual). Other configurations may cause the HP 8981A to function atypically. Simply turn the line switch OFF and then back ON to restore normal operation.

1-18. HP-IB Controllers

The Vector Modulation Analyzer has an HP-IB interface and can be used with any HP-IB compatible computing controller or computer for automatic systems applications.

1-19. Graphics Printer

A graphics printer can be used with the instrument to obtain hardcopy records of the display. The Vector Modulation Analyzer can be used with the HP 2225A Thinkjet printer or printers meeting the criteria outlined in the PRINTER, USE WITH Detailed Operating Instruction.

1-20. Support Kit

The HP 11739A Support Kit contains a selection of cables, adapters, board extenders, and adjustment tools to aid in servicing the HP 8981A.

1-21. Mechanical Equipment Available

1-22. Chassis Slide Mount Kit

This kit is useful when the Vector Modulation Analyzer is rack mounted. Access to internal circuits and components or the rear panel is possible without removing the instrument from the rack. Order HP part number 1494-0059 for 574 mm (23 inch) fixed slides and part number 1494-0061 for the correct metric adapters for non-HP rack enclosures.

1-23. Chassis Tilt Slide Mount Kit

The chassis tilt slide mount kit is the same as the chassis slide mount kit except it also allows tilting of the instrument up or down 90 degrees. Order HP part number 1494-0063 for 574 mm (23 inch) tilting slides and part number 1494-0061 for the correct metric adapters for non-HP rack enclosures. The HP part number for standard inch rack adapters is 1494-0023.

1-24. Recommended Test Equipment

Table 1-3 lists the test equipment recommended for use in testing, adjusting and servicing the Vector Modulation Analyzer. The Critical Specifications column describes the essential requirements for each piece of test equipment. Other equipment can be substituted if it meets or exceeds these critical specifications.

The Recommended Model column may suggest more than one model. The first model shown is usually the least expensive, single-purpose model. Alternate models are suggested for additional features that would make them a better choice in some applications.

Table 1-1. Specifications

Electrical Characteristics	Performance Limits	Conditions
MODULATED IF INPUT Input Carrier Frequency Range Input Level Range	50 MHz to 200 MHz -5 dBm to -20 dBm	
COHERENT REFERENCE INPUT Input Frequency Range Input Level Range	50 MHz to 200 MHz +10 dBm to -20 dBm	
DEMODULATED I AND Q Baseband Bandwidth with External Filters (3 dB) Corrected Vector DC Accuracy (I, Q) I versus Q Timing Accuracy	>100 MHz <±2% of full scale IF input ±1.5 ns or 1% of full scale, whichever is greater	From 50 to 200 MHz; measured at 70MHz typical elsewhere Delay I=0, Delay Q=0, Delay I&Q=0
I AND Q CHANNEL INPUTS Maximum Input -DC coupled -AC coupled	±5V peak ±25V dc; ±5V peak ac	

Table 1-1. Specifications (Cont.)

Electrical Characteristics	Performance Limits	Conditions
DC Vector Accuracy (1) I versus Q Differential Voltage Accuracy (1) Bandwidth (-3 dB) -DC coupled -AC coupled Input Sensitivity I or Q Offset Range	$\pm 1\%$ of full scale (or 2 mV if greater) $\pm 1\%$ of offset $\pm 1\%$ DC to 350 MHz Approximately 1 kHz to 350 MHz 5.0 mV/div to 1.0V/div ± 10 divisions	Measured at 100 mV full scale deflection; typical at all ranges
TIMING (2) Time per Division Range Delay I&Q Range I Delay, Q Delay Range Delta Time Accuracy I versus Q Timing Accuracy	500 ps/div to 2 ms/div 0 to 100 divisions, 20 ms maximum 0 to 5 divisions $\pm 3\%$ ± 0.5 ns or 1% of full-scale, whichever is greater	$20 \mu\text{s}$ maximum Delta times greater than 6 ns or 2 divisions, whichever is larger; start times greater than 20 ns or 1 division, whichever is larger; both start and stop time on screen Delay I=0, Delay Q=0, Delay I&Q=0
TRIGGERING Maximum External Trigger Input Minimum Signal -Internal -External	± 5 V peak dc + ac, 5 V p-p ac 2 divisions p-p 3 divisions p-p 100 mV p-p into 50 ohms 200 mV p-p into 50 ohms	DC to 80 MHz 80 MHz to 150 MHz DC to 80 MHz 80 MHz to 150 MHz

Table 1-1. Specifications (Cont.)

Electrical Characteristics	Performance Limits	Conditions
GENERAL Operating Temperature Range	0 Degrees C to 55 Degrees C	
Power Requirements -Line Voltage	100, 120, 220, or 240 Vac, +10% to -10%	
-Line Frequency	48 to 66 Hz, single phase	
Power Dissipation	<330 VA	
EMI	MIL-STD-461B	Conducted and radiated interference is within the requirements of CE03, CS01, CS02, RE02, RS01, and RS03 of MIL-STD-461B. Also within the requirements of VDE 0871 and CISPR Publication 11.
Net weight	20.4 kg (45 lbs.)	
Dimensions (3): Full Envelope Height x Width x Depth	146 H x 426 W x 620 mm D (5.75 H x 16.75 W x 24.40 inches D)	

(1) Measurements made with internal A/D converter.

(2) Specified for delay <100 divisions.

(3) For ordering System II cabinet accessories, the module sizes are 5-1/4 H, 1 MW and 23 D.

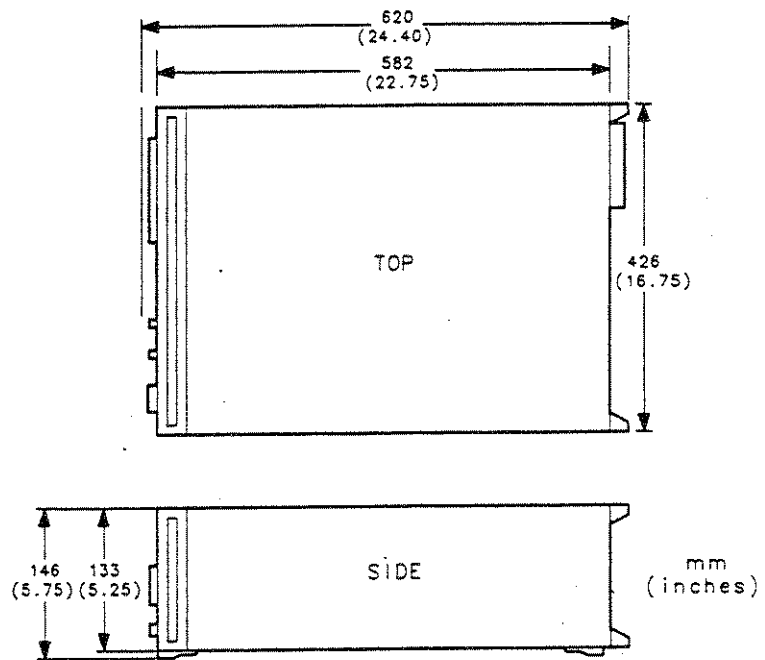

Figure 1-2. Cabinet Dimensions

Table 1-2. Supplemental Characteristics (1)

MODULATED IF INPUT	<p>Input Impedance: 50Ω nominal (75Ω with interchangeable adapter)</p> <p>VSWR (50Ω input): <1.4:1</p> <p>Minimum Input Frequency: 20 MHz</p> <p>AM to AM Conversion (-5 dBm input power): <0.1 dB/dB</p> <p>AM to PM Conversion (-5 dBm input power): <0.5°/dB</p> <p>Signal to Noise Ratio with Internal Filters: >40 dB</p>
COHERENT REFERENCE INPUT	<p>Input Impedance: 50Ω nominal</p> <p>VSWR (50Ω input): <2:1</p> <p>Reference Phase versus Level Sensitivity:</p> <p>70 MHz Coherent Reference Input: <1°/dB</p> <p>140 MHz Coherent Reference Input: <1.6°/dB</p>
DEMODULATED I AND Q	<p>Absolute Level Accuracy: <1.2 dB</p> <p>Baseband Bandwidth with Internal Filters (3 dB): 35 MHz</p> <p>Uncorrected Vector DC Accuracy: $\pm 2.5\%$ of full scale IF input</p> <p>Uncorrected Quadrature Error: $\pm 1^\circ$</p> <p>Uncorrected Residual DC Offsets: $\pm 4\%$ of full scale IF input</p> <p>Uncorrected I/Q Gain Imbalance (DC to 10 kHz): ± 0.25 dB</p> <p>I and Q Amplitude Flatness Matching (DC to 20 MHz with internal filters): ± 0.3 dB</p> <p>I and Q Amplitude Flatness Matching (DC to 20 MHz with internal filters): < 0.2 dB</p> <p>Corrected Quadrature Error: $\pm 0.5^\circ$</p> <p>Corrected Residual DC Offsets: $\pm 1\%$ of full scale IF input</p> <p>Corrected I/Q Gain Imbalance (DC to 10 kHz): ± 0.1 dB</p>

Table 1-2. Supplemental Characteristics (1) (Cont.)

<p>DEMODULATED I AND Q (cont'd)</p>	<p>Crosstalk Between I and Q</p> <p>70 MHz Carrier; 40 MHz IF Bandwidth: <0.6%</p> <p>140 MHz Carrier; 80 MHz IF Bandwidth: <0.6%</p> <p>Corrected Phase Accuracy: $\leq \pm 1.6^\circ$</p> <p>Corrected Magnitude Accuracy: $\leq \pm 0.24$ dB</p>
<p>EXTERNAL FILTER I AND Q PORTS</p>	<p>VSWR (DC to 40 MHz): <1.3:1</p> <p>Impedance: 50Ω nominal</p> <p>Signal Level for -20 dBm Inputs: >50 mV p-p</p> <p>Quadrature Error: $\leq \pm 8^\circ$</p> <p>Residual DC Offsets (at -20 dBm IF input): <20% of full scale IF input</p> <p>I/Q Gain Imbalance (DC to 10 kHz): $\leq \pm 0.5$ dB</p> <p>I and Q Amplitude Flatness (DC to 40 MHz): $\leq \pm 0.3$ dB</p> <p>I and Q Amplitude Flatness Matching (DC to 40 MHz): <0.2 dB</p>
<p>SPURIOUS SIGNALS</p> <p>Internal Filters</p> <p>External Filters</p>	<p>Harmonics of Baseband Tones DC to 10 kHz (<-5 dBm IF input power): <-40 dBc</p> <p>Isolation from Modulated IF Input to I/Q; DC to 50 MHz >24 dB</p> <p>Isolation from Modulated IF Input to I/Q; >50 MHz >60 dB</p> <p>Isolation from Coherent Reference Input to I/Q at -20 dBm IF Input: >40 dB</p> <p>Isolation from Modulated IF Input to External Filter I/Q Outputs: >24 dB</p> <p>Isolation from Coherent Reference Input to External Filter I/Q Outputs at -20 dBm IF Input: >10 dB</p> <p>Isolation from External Filter Output to External Filter Input: >45 dB</p>

Table 1-2. Supplemental Characteristics (1) (Cont.)

<p>I & Q CHANNEL INPUTS</p> <p>DC Display & Marker Accuracy</p> <p>Dynamic Performance</p>	<p>Input Impedance: 50 ohms nominal; 75 ohms nominal with interchangeable adapters (adapters provide a series 25 ohm resistance)</p> <p>Deflection Factor Accuracy: $\pm 2\%$</p> <p>Display Offset Accuracy: $\pm 2\%$ of full scale (or 2 mV if greater) for a zero volt signal with offsets=0.</p> <p>I or Q Vector Accuracy Using the I or Q Marker: $\pm 3\%$ of full scale (or 2 mV if greater) $\pm 1\%$ of offset.</p> <p>I versus Q Differential Voltage Accuracy Using the I and Q Markers: $\pm 2\%$ of full scale.</p> <p>Transition Time: 1.0 ns typical (10% to 90%), for an 80% of full scale step measured at 10 mV/div; typical for all ranges.</p> <p>I-Q Crosstalk: -60 dB or 1% of full scale peak, whichever is greater, from dc to 350 MHz.</p>
<p>TIMING</p>	<p>Time/Division Accuracy: $\pm 3\%$</p> <p>Delay Reference Accuracy (Delay I&Q=0): Internal Trigger Only - Less than 5 ns or 2% of full scale, whichever is greater</p> <p>Delay Accuracy: $\pm 3\%$ + Delay Reference Accuracy</p> <p>Time Base Jitter: 2% of full scale RMS for delays <200 divisions.</p> <p>I versus Q Timing Accuracy: ± 1ns or 2.5% of full scale, whichever is greater; typical for Delay I=0, Delay Q=0, and Delay I&Q=100 divisions.</p>
<p>TRIGGERING</p>	<p>Minimum Signal (pulse width >3 ns):</p> <p>Internal - 20% of full scale p-p</p> <p>External - 200 mV p-p</p> <p>External Trigger ECL Termination: 50 ohms (2) to -2V</p> <p>External Trigger Ground Termination: 50 ohms (2) to ground</p> <p>External Trigger ECL Level: Triggers on ECL threshold</p> <p>External Trigger TTL Level: Triggers on TTL threshold</p>

Table 1-2. Supplemental Characteristics (1) (Cont.)

TRIGGERING (cont'd)	<p>External Trigger VAR Level: Adjustable trigger threshold</p> <p>External Trigger AUTO Level: Continuously adjusted to half way between high and low input levels for frequencies >1 kHz</p> <p>Internal Variable Trigger Range: Anywhere on display</p> <p>Internal Variable Trigger Resolution: 2% of full scale</p> <p>Internal Variable Trigger Accuracy: +/-5% of full scale</p> <p>External Variable Trigger Range: +/-5V</p> <p>External Variable Trigger Resolution: 40 mV</p> <p>External Variable Trigger Accuracy: +/-100 mV</p>
GATE	<p>Gate Operation: Blanks display and disables measurements when high. Works asynchronously with trigger rate.</p> <p>Minimum Gate Pulse Width (ON or OFF): 100 ns</p> <p>Gate Timing: 0 to 5 ns prior to display time instant</p> <p>Gate Input Termination and Trigger Levels: GND termination with TTL trigger level, -2V termination with ECL trigger level, or GND termination with 0V trigger level</p>
DIGITIZING	<p>Resolution: 12 bits</p> <p>Digitizing Rate: 3 kHz maximum</p> <p>Measurement Noise: 4 counts RMS</p>

(1) Supplemental characteristics are intended to provide information useful in applying the instrument by giving typical, but non-warranted performance parameters.

(2) 75 ohms with interchangeable adapters.

Table 1-3. Recommended Test Equipment

Instrument	Critical Specifications	Recommended Model	Use (1)
Coherent Carrier Signal Generator	70 to 200 MHz 0 dBm	HP 8662A	P, C
Digital Voltmeter	-2.5 to +2.5 Vdc 1 mV resolution	HP 3456A HP 3455A HP 3478A	P P P
Frequency Counter	10-400 MHz	HP 5342A HP 5343A	P P
Function Generator	+/-5V DC offset 12.5 kHz - 50 MHz frequency 50 ohm output impedance	HP 8116A	C, P
Low Pass Filter	110 MHz cutoff frequency	See Figure 1-3	P
Network Analyzer	70 MHz polar display CW sweep mode Real/imaginary linear marker readout	HP 3577A	P
Power Meter		HP 436A HP 438A	P P
Power Sensor	10-350 MHz	HP 8482A	P
Signal Generator	10-350 MHz, syn- thesized 1 Hz resolution -10 to +7 dBm Internal ALC Pulse modulation	HP 8340B HP 8662A HP 8341B	P P, C P

(1) C = Operator's Checks; P = Performance Tests.

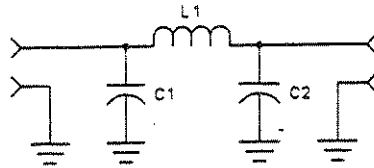

Figure 1-3. Low Pass Filter Schematic Diagram

2

INSTALLATION

2-1. Introduction

This section provides the information needed to install the Vector Modulation Analyzer. Included is information pertinent to initial inspection, power requirements, line voltage selection, power cables, interconnection, environment, instrument mounting, storage, and shipment. In addition, this section contains the procedures for selecting the impedance of the instrument inputs and setting the HP-IB address.

2-2. Initial Inspection

Warning



To avoid hazardous electrical shock, do not turn on the instrument when there are signs of shipping damage to any portion of the outer enclosure (covers, panels, meters).

Inspect the shipping container for damage. If the shipping container or cushioning material is damaged, it should be kept until the contents of the shipment have been checked for completeness and the instrument has been checked mechanically and electrically. The contents of the shipment should be as shown in Figure 1-1. Procedures for checking electrical performance are given in Section 4. If the contents are incomplete, if there is mechanical damage or defect, or if the instrument does not pass the electrical performance tests, notify the nearest Hewlett-Packard office. If the shipping container is damaged, or the cushioning material shows signs of unusual stress, notify the carrier as well as the Hewlett-Packard office. Keep the shipping materials for the carrier's inspection.

2-3. Preparation for Use

Warning



2-4. Power Requirements

To avoid the possibility of hazardous electrical shock, do not operate this instrument at line voltages greater than 126.5 Vac with line frequencies greater than 66 Hz. Leakage currents at these line settings may exceed 3.5 mA.

This is a Safety Class I product (that is, it is provided with a protective earth terminal). An uninterruptible safety earth ground must be provided from the main power source to the product input wiring terminals through the power cable or supplied power cable set. Whenever it is likely that the protection has been impaired, the product must be made inoperative and be secured against any unintended operation.

If this instrument is to be energized via an external autotransformer, make sure the autotransformer's common terminal is connected to neutral (that is, the grounded side of the line (Mains) supply.)

The Vector Modulation Analyzer requires a power source of 100, 120, 220, or 240 Vac, +5% to -10%, 48 to 66 Hz single phase. Power consumption is 320 VA maximum.

2-5. Line Voltage and Fuse Selection

Caution



BEFORE PLUGGING THIS INSTRUMENT into the line (Mains) voltage, be sure the correct voltage and fuse have been selected.

Verify that the line voltage selection card and the fuse are matched to the power source. See Figure 2-1, Line Voltage and Fuse Selection.

Fuses may be ordered using HP part numbers 2110-0055, 4.0A (250V, normal blow) for 100/120 Vac operation and 2110-0002, 2.0A (250V, normal blow) for 220/240 Vac operation.

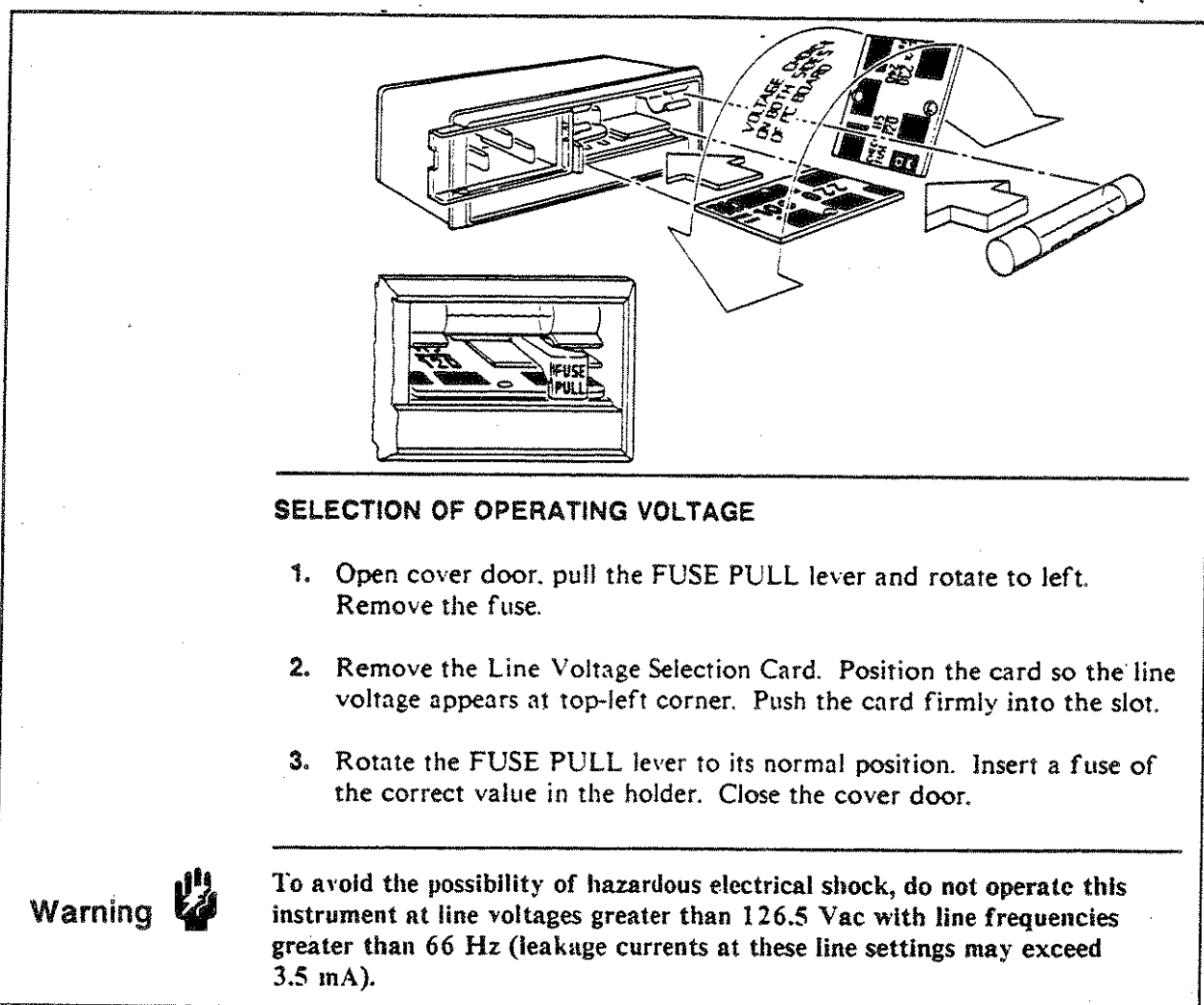

Figure 2-1. Line Voltage and Fuse Selection

2-6. Power Cables

Warning 

BEFORE CONNECTING THIS INSTRUMENT, the protective earth terminals of this instrument must be connected to the protective conductor of the line (Mains) power cable. The line plug shall only be inserted in a socket outlet provided with a protective earth contact. The protective action must not be negated by the use of an extension cord (power cable) without a protective conductor (grounding). Grounding one conductor of a two conductor outlet is not sufficient protection.

This instrument is equipped with a three-wire power cable. When connected to an appropriate ac power receptacle, this cable grounds the instrument cabinet. The type of power cable plug shipped with each instrument depends on the country of destination. See Figure 2-2, Power Cable and Line (Mains) Plug Part Numbers, for the part numbers of these power cables. Cables are available in different lengths and some with right angle plugs to the instrument. Check with your nearest HP service center for descriptions and part numbers for these cables.

<p>220/240V OPERATION</p>  <p>PLUG*: SEV 1011.1959-24507 TYPE 12 CABLE*: HP 8120-2104</p>	<p>220/240V OPERATION</p>  <p>PLUG*: NZSS 198/AS C112 CABLE*: HP 8120-1369</p>	<p>100/120V OPERATION</p>  <p>PLUG*: NEMA 5-15P CABLE*: 8120-1378</p>	<p>220/240V OPERATION</p>  <p>PLUG*: NEMA 6-15P CABLE*: HP 8120-0698</p>
<p>220/240V OPERATION</p>  <p>PLUG*: CEE7-VII CABLE*: HP 8120-1689</p>	<p>220/240V OPERATION</p>  <p>PLUG*: DHCK 107 CABLE*: HP 8120-2956</p>	<p>220/240V OPERATION</p>  <p>PLUG*: BS 1363A CABLE: HP 8120-1351</p>	
<p>*The number shown for the plug is the industry identifier for the plug only. The number shown for the cable is an HP part number for a complete cable including the plug.</p>			

Figure 2-2. Power Cable and Line (Mains) Plug Part Numbers

2-7. HP-IB Address Selection and Configuring

HP-IB Address Selection. The HP-IB address is selectable from the front panel.

When shipped from the factory, the address of the instrument is 09, however, HP-IB addresses from 00 to 30 can be used. A list of allowable addresses is given in Table 2-1:

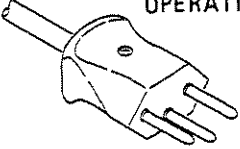
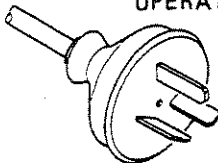
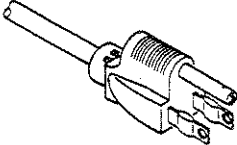
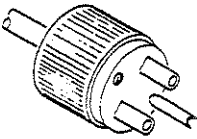
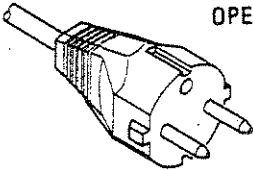
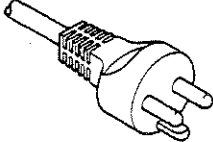
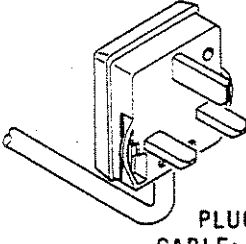
Table 2-1. Allowable HP-IB Addresses

ASCII Address Codes		Decimal Equivalents ¹
LISTEN	TALK	
SP	@	00
!	A	01
"	B	02
-	C	03
\$	D	04
%	E	05
&	F	06
'	G	07
(H	08
)	I	09 ²
*	J	10
+	K	11
,	L	12
.	M	13
:	N	14
/	O	15
0	P	16
1	Q	17
2	R	18
3	S	19
4	T	20
5	U	21 ³
6	V	22
7	W	23
8	X	24
9	Y	25
:	Z	26
;	[27
<	}	28
=]	29
>	^	30

¹ Decimal values are equivalent to the last five bits of both talk and listen addresses.
² Decimal 09 is the factory set HP 8981A address.
³ HP-IB address 21 is usually reserved for the controller.

Use the following procedure to set the HP-IB address:

1. Press the HP-IB key. This activates the HP-IB menu on the display.
2. Press the HP-IB ADDRESS softkey. The words "HP-IB ADDRESS: XX" will appear in the User Interface Area (UIA) with "XX" being the currently selected address.

3. To change the address, use either a function-data-units entry or the step up/step down keys or knob to enter a new address from 00 to 30. The address as displayed in the UIA will change as it is altered.
4. Press the ENTER softkey.

Configuring HP-IB Status. The status of HP-IB can be configured in one of two ways through the menu softkeys. The two choices are explained below:

TALK/LISTEN - Configuring the instrument this way allows it to both transmit and receive data over the HP-IB under the control of an HP-IB controller.

TALK ONLY - This selection sets the instrument to transmit data only.

Use the following procedure to configure HP-IB status:

1. Press the HP-IB key. This activates the HP-IB menu on the display.
2. Press the applicable softkey, either TALK/LISTEN, or TALK ONLY, that identifies the desired configuration of HP-IB status.

2-8. Interconnections

Interconnection data for the Hewlett-Packard Interface Bus is provided in Figure 2-3, Hewlett-Packard Interface Bus Connection.

2-9. Impedance Selection

The INPUT I, INPUT Q, EXT TRIG INPUT, and RF IN connectors of the instrument can be configured for either 50 Ω or 75 Ω impedance. When the instrument is shipped from the factory, these inputs are configured for 50 Ω impedance. The following procedure explains how to configure the inputs for 75 Ω impedance:

Note



The COHERENT CARRIER input on the rear panel has 50 Ω impedance only. It cannot be changed and will not affect measurements in a 75 Ω system.

1. Set the LINE switch on the front panel to OFF ().
2. Using a 7/16" wrench, loosen the 50 Ω BNC adapters from the INPUT I, INPUT Q, EXT TRIG INPUT and RF IN connectors. These adapters are nickel plated. Be careful not to scratch the panel with the wrench when loosening the 50 Ω BNC adapters.

Caution

When removing and inserting the BNC adapters, be careful not to bend the load resistor that is attached to the rear of the adapter body.

3. Unscrew and remove the four 50 Ω BNC adapters by pulling them straight out from the panel.
4. Remove the four 75 Ω BNC adapters from their special adapter holders. The 75 Ω BNC adapters are gold plated.
5. Carefully install the 75 Ω BNC adapters into the INPUT I, INPUT Q, EXT TRIG INPUT, and RF IN connectors on the panels.
6. Slightly torque each of the 75 Ω BNC adapters using the 7/16" wrench. Be careful not to scratch the panel with the wrench when tightening the 75 Ω BNC adapters.
7. Replace the four nickel plated, 50 Ω BNC adapters into their special adapter holders.
8. Set the LINE switch on the front panel to ON ().
9. Press the INST STA key. This activates the instrument state menu on the display.
10. Press the OTHER softkey. This activates the "other" softkey (miscellaneous) menu on the display.
11. Press the IMPEDANCE 50/75 softkey once so that the "75" is highlighted (brighter).

Note

If any of the adapters are lost, they can be ordered separately. The HP Part Number for replacement 50 Ω adapters is 08981-60025 and the HP Part Number for replacement 75 Ω adapters is 08980-60063.

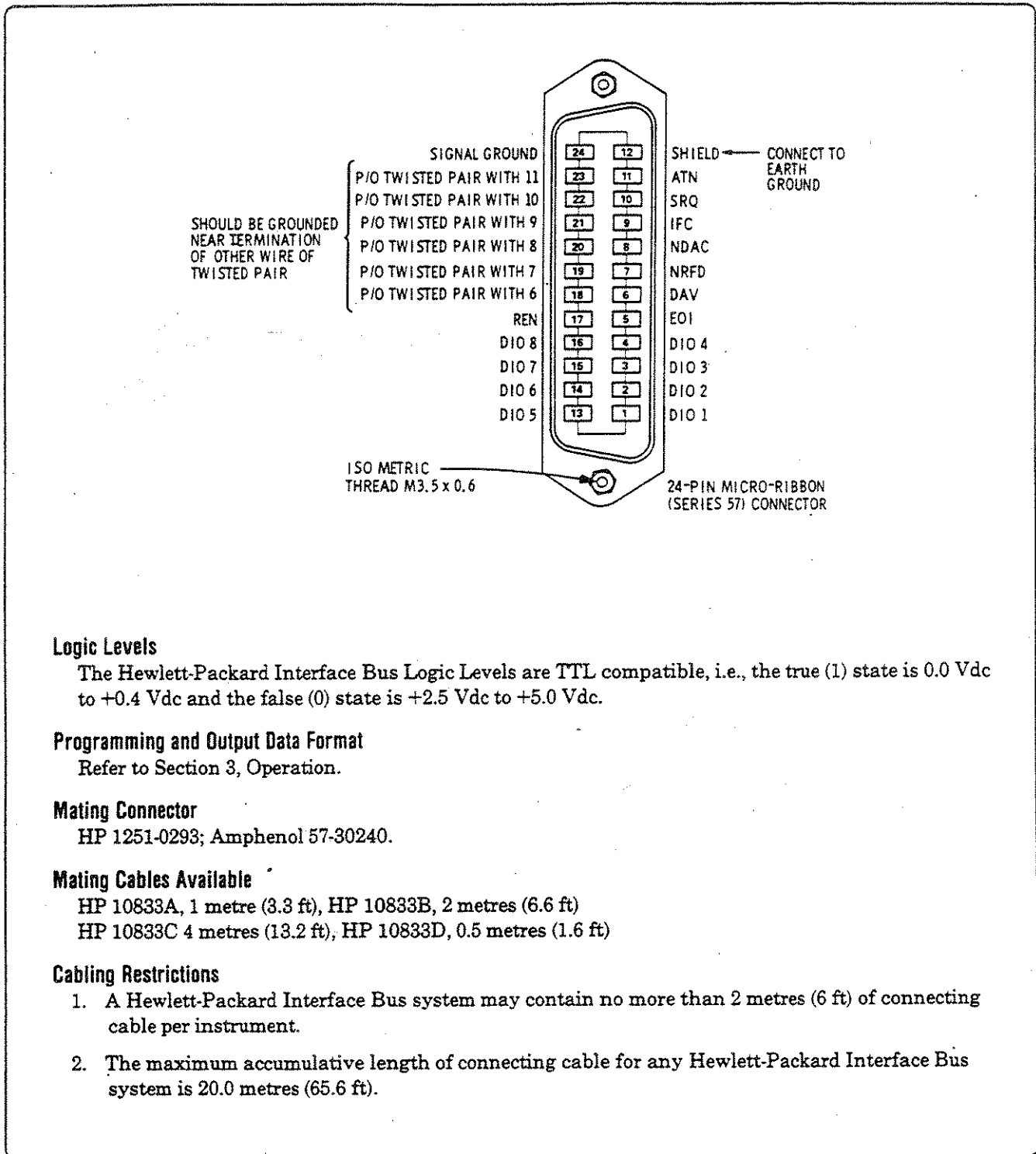

Figure 2-3. Hewlett-Packard Interface Bus Connection

Logic Levels

The Hewlett-Packard Interface Bus Logic Levels are TTL compatible, i.e., the true (1) state is 0.0 Vdc to +0.4 Vdc and the false (0) state is +2.5 Vdc to +5.0 Vdc.

Programming and Output Data Format

Refer to Section 3, Operation.

Mating Connector

HP 1251-0293; Amphenol 57-30240.

Mating Cables Available

HP 10833A, 1 metre (3.3 ft), HP 10833B, 2 metres (6.6 ft)
 HP 10833C 4 metres (13.2 ft), HP 10833D, 0.5 metres (1.6 ft)

Cabling Restrictions

1. A Hewlett-Packard Interface Bus system may contain no more than 2 metres (6 ft) of connecting cable per instrument.
2. The maximum accumulative length of connecting cable for any Hewlett-Packard Interface Bus system is 20.0 metres (65.6 ft).

2-10. Mating Connectors

HP-IB Interface Connector. The HP-IB mating connector is shown in Figure 2-3, Hewlett-Packard Interface Bus Connection. Note that the two securing screws are metric.

Coaxial Connectors. Coaxial mating connectors used with the Vector Modulation Analyzer should be BNC male connectors compatible with US MIL-C-39012.

Probe Connectors. The mating connectors used with the front panel PROBE POWER outputs are female, three pin probe connectors.

2-11. Operating Environment

The operating environment is specified to be within the following limitations:

Temperature	0 °C to +55 °C
Humidity.....	40 °C at <90% relative
Altitude.....	<4600 metres (15 100 feet)

2-12. Bench Operation

The instrument cabinet has plastic feet and fold-away tilt stands for convenience in bench operation. The plastic feet are designed to ensure self-aligning of instruments when stacked. The tilt stands raise the front of the instrument for easier viewing of the front panel.

2-13. Rack Mounting

Warning



The Vector Modulation Analyzer weighs 20.4 kg (45 lb), therefore, care must be exercised when lifting to avoid personal injury. Use equipment slides when rack mounting.

Rack mounting information is provided with the rack mounting kits. If the kits were not ordered with the instrument as options, they may be ordered through the nearest Hewlett-Packard office. Refer to Mechanical Options in Section 1 for information regarding rack mounting kits.

2-14. Storage and Shipment

2-15. Environment

The instrument should be stored in a clean, dry environment. The following environmental limitations apply to both storage and shipment:

Temperature.....-55° C to +75° C
Humidity..... 40° C at <90% relative
Altitude.....<15 000 metres (49 200 feet)

2-16. Packaging

Tagging for Service. If the instrument is being returned to Hewlett-Packard for service, please complete one of the blue repair tags located at the end of this manual and attach it to the instrument.

To minimize repair time, be as specific as possible when describing the failure. Keep the following two items in mind when describing the failure:

1. Describe what makes you think the instrument is failing. An example might be "In step 9 of the Bandwidth performance test, the peaks of the displayed signal fall below the limits represented by the markers when the signal generator is tuned above 300 MHz."
2. If the failure only occurs under certain conditions, explain how to duplicate the failure. An example might be "After pressing the LINE switch three times, the instrument will not power up".

Original Packaging. Containers and materials identical to those used in factory packaging are available through Hewlett-Packard offices. Mark the container "FRAGILE" to encourage careful handling. In any correspondence, refer to the instrument by model number and full serial number.

Other Packaging. The following general instructions should be used for repackaging with commercially available materials.

1. Wrap the instrument in heavy paper or plastic. If shipping to a Hewlett-Packard office or service center, complete one of the blue tags mentioned above and attach it to the instrument.
2. Use a strong shipping container. A double-wall carton made of 2.4 MPa(350 psi) test material is adequate.

3. Use enough shock-absorbing material (75 to 100 mm layer, 3 to 4 inches) around all sides of the instrument to provide a firm cushion and prevent movement in the container. Protect the front panel with an appropriate type of cushioning material to prevent damage during shipment.
4. Seal the shipping container securely.
5. Mark the shipping container "FRAGILE" to encourage careful handling.

9

9

9

3-1. Introduction

This section provides operating information for the Vector Modulation Analyzer. Included in this section are both general and detailed operating instructions, descriptions of the front and rear panels, operator's checks, and operator's maintenance procedures.

3-2. Panel Features

Front and rear panel features are described in figures 3-1 and 3-2.

3-3. Operating Characteristics

Table 3-1 briefly summarizes the major operating characteristics of the Vector Modulation Analyzer. This table is not intended to be a complete listing of all operations and ranges, but gives a general idea of the instrument's capabilities. For more information on the Vector Modulation Analyzer's capabilities, refer to Table 1-1, Specifications, and Table 1-2, Supplemental Characteristics. For information on HP-IB capabilities, refer to Table 3-2, Message Reference Table.

3-4. Local Operation

Information covering front panel operation of the Vector Modulation Analyzer is given in the sections described below. For an overview of instrument operation, begin with Operating Characteristics and Simplified Operation (Operator's Checks can also be used to gain familiarity with the instrument). Once familiar with the general operation of the instrument, refer to the detailed operating instructions as a reference for in-depth operating information.

Turn-On and General Operation. Instructions relating to the Vector Modulation Analyzer turn-on procedure are presented to acquaint the user with the general operation of the instrument.

Simplified Operation. The instructions are designed to quickly acquaint a new user with basic operating procedures and therefore are not an exhaustive listing of all Vector Modulation Analyzer functions. However, a listing of the detailed operating instructions appears at the beginning of the Detailed Operating Instructions portion of this manual to direct the user to the more complete discussion of the topic of interest.

Detailed Operating Instructions. The detailed operating instructions provide the complete operating reference for the Vector Modulation Analyzer user. The instructions are organized alphabetically for easy reference. They are listed by function in Table 3-13.

Operating Information [HELP key]. The front panel HELP key is provided for users who need further information about a particular function. When the HELP function is utilized, a short description explaining the function of the key or softkey in question will appear on the screen. See the HELP KEY Detailed Operating Instruction for further information.

3-5. HP-IB Remote Operation

The Vector Modulation Analyzer is capable of remote operation via the Hewlett-Packard Interface Bus (HP-IB). This section includes discussions on capabilities, addressing, input and output formats, the status byte and service request.

3-6. Operator's Check

The Operator's Check is a procedure designed to verify proper operation of the Vector Modulation Analyzer's main functions. This procedure checks that most front panel controlled functions are being properly executed by the Vector Modulation Analyzer.

3-7. Operator's Maintenance

Warning



For continued protection against fire hazard, replace the line fuse with a 250V fuse of the proper rating only. Do not use repaired fuses or short-circuited fuseholders.

Operator's maintenance consists of replacing blown fuses. The primary power fuse is located within the Line Power Module. Refer to Figure 2-1 for instructions on how to change the fuse.

If the instrument does not operate properly and is being returned to Hewlett-Packard for service, please complete one of the blue tags located at the end of this manual and attach it to the instrument. Refer to Section 2 for packaging instructions.

3-8. Turn-On

Warning



Before the Vector Modulation Analyzer is switched on, all protective earth terminals, extension cords, autotransformers, and devices connected to the instrument should be connected to a protective earth grounded socket. Any interruption of the protective earth grounding will cause a potential shock hazard that could result in personal injury.

Caution



Before the Vector Modulation Analyzer is switched on, it must be set to the same line voltage as the power source or damage to the instrument may result.

3-9. Turn-On Procedure

If the power cable is not plugged in, follow these instructions.

On the rear panel:

1. Check the line voltage selection card for correct voltage selection.
2. Check that the fuse rating is appropriate for the line voltage used (see Figure 2-1). Fuse ratings are printed on the rear panel.
3. Plug in the power cable.

On the front panel, set the LINE switch to ON ().

If the Vector Modulation Analyzer is already plugged in, set the LINE switch to ON ().

3-10. Turn-On Sequence

The Vector Modulation Analyzer performs an internal self test at turn-on. This test takes several seconds during which the display is blanked except for the HP Logo and the message RUNNING POWER-UP SELFTESTS. The selftest tests most of the instrument's control circuitry. All four HP-IB annunciators and the KNOB key indicator light so that they can be visually inspected. If failures are detected during the test, appropriate error messages will appear on the display. If the power-up selftests are successful, the message POWER-UP SELFTEST PASSED will be displayed briefly. After the self test is complete, the instrument is set to the state it was in before being turned off. The firmware copyright statement that appears in the top quarter of the screen will disappear after about twenty seconds.

3-11. Simplified Operation

Table 3-1. Operating Characteristics

Display Modes	I versus time, Q versus time, I&Q versus time, Vector, Constellation, Vector Align, Constellation Align, 3-Dimensional
Maximum I or Q Input -DC coupled -AC coupled	±5V peak ±25 Vdc; ±5V peak AC
Modulated RF Input Range	50 MHz to 200 MHz; -5 dBm to -20 dBm
Coherent Reference Input Range	50 MHz to 200 MHz; +10 dBm to -20 dBm
Input Impedance	50 ohms; 75 ohms with interchangeable BNC adapters (Note - Coherent Carrier and filter connections are 50 ohms only)
Bandwidth (I and Q channels) -DC coupled -AC coupled	DC to 350 MHz approximately 1 kHz to 350 MHz
Bandwidth (demodulator)	35 MHz (internal filters); 100 MHz (external filters)
I or Q Measurement Accuracy	+/-1% of full scale (or 2 mV if greater) +/-1% of offset
Gain Range (I and Q channels)	5 mV/div to 1V/div
Gain Range (internal demodulator)	-5 dBm to -20 dBm (assuming gain correction=0)
Gain Range (external demodulator)	-22 dBm to +24 dBm (assuming gain correction=0)
Horizontal Sensitivity	0.5 ns/div to 2 ms/div
External Trigger Levels	ECL, TTL, Variable, Auto-level
Minimum Trigger Signal -Internal	2 divisions p-p, DC to 80 MHz; 3 divisions p-p, 80 MHz to 150 MHz; 2 divisions p-p, pulse width >3 ns
-External	100 mV p-p into 50 ohms, DC to 80 MHz; 200 mV p-p into 50 ohms, 80 MHz to 150 MHz; 200 mV p-p, pulse width >3 ns

Table 3-1. Operating Characteristics (Cont.)

Maximum External Trigger Input	±5V peak DC+AC; 5V peak-to-peak AC
Gate Operation	Blanks display when high asynchronously with trigger rate. Measurements are disabled when display is blanked.
A/D Resolution	12 bits
Auto Scope	Autorange I and Q channel gain and offset, time base, and triggering. Auto Scoping these parameters can be individually disabled.
Demodulation	Modulated RF signals can be demodulated using the internal demodulator. Instrument has the capability to automatically correct demodulator errors when the internal demodulator is used.
Markers	Calibrated markers for present marker position and delta values. Marker values are shown in the Parameter Data Area when active. Markers provided for I, Q, magnitude, phase and time. When in demodulation mode, I and Q markers are in percent of full scale.

PresetPress: 

This sets the Vector Modulation Analyzer to the conditions listed in the table found in the PRESET Detailed Operating Instruction.

CalibrationPress: 

The instrument will then execute an extensive self-calibration.

Obtaining Basic Display

Use the AUTO SCOPE key to quickly set the Vector Modulation Analyzer for a basic display in any of the display modes.

First, choose the desired display mode by pressing:

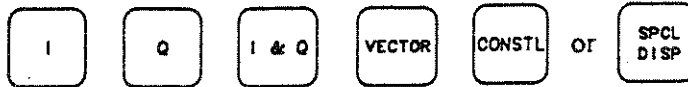

Additional display modes (Vector Align, Constellation Align, and 3-Dimensional) are available under the SPCL DISP key.

then press:

Changing Parameter Values

Value-selectable parameters can be changed either by making a new Function-Data-Units entry, or by using the step up/step down keys or knob.

Function-Data-Units (F-D-U) Entry

Whenever a primary function hardkey or softkey is pressed that requires data entry, the data can be entered using an F-D-U entry. When the "data" portion of the entry is begun, an appropriate units menu is called up. Pressing the units terminator completes the entry. For example, to set the I channel gain to 100 mV/div, the entry sequence is as follows:



To toggle the sign of a parameter, press **CHG SIGN** any time after

the "function" portion of the entry and before the "units" portion of the entry.

Step Up/Step Down Keys

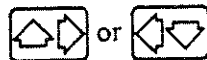

is used to increase or decrease the value of the selected parameter. The increment/decrement values for each parameter can be found in the Detailed Operating Instruction for the function in question.

Knob

Press: **KNOB**

When the indicator inside the KNOB key is lit, the knob is enabled and parameters for the selected function can be changed. Rotating the knob increases or decreases parameter values. The KNOB step values are usually finer than those of the step up/step down keys. The increment/decrement values for each parameter can be found in the Detailed Operating Instruction for the function in question.

Instrument State Save and Recall

Up to eight configurations of the Vector Modulation Analyzer can be stored for recall at a later time. For example, to store the instrument state in register 7, press:

INST STA SAVE **7** ENTER

The register must be a number between 1 and 8, inclusive.

To recall the instrument state from register 7, press:

INST STA RECALL **7** ENTER

Note



Demodulator corrections are not stored during an instrument state store operation. A separate function is available for this. See the "Save and Recall (Demodulator Corrections)" Detailed Operating Instruction for further information.



3-12. Remote Operation, Hewlett-Packard Interface Bus

The Vector Modulation Analyzer can be operated through the Hewlett-Packard Interface Bus (HP-IB). HP-IB is Hewlett-Packard's implementation of IEEE Standard 488 and the identical ANSI Standard MC1.1. Compatibility, programming and data formats are described in the following paragraphs.

Most of the softkey functions and front panel functions are directly programmable via HP-IB. All softkeys and front panel keys except the LINE switch can be accessed remotely using the HP-IB KEY command.

In this manual, program codes are listed in ASCII code. Table 3-11, Commonly Used Code Conversions, includes a listing of ASCII characters and some commonly used equivalent codes. The table is located at the end of this discussion on HP-IB.

For more information about HP-IB, refer to IEEE Standard 488 (or the identical ANSI Standard MC1.1), the Hewlett-Packard Electronic Systems and Instruments catalog, and the booklet, "Tutorial Description of the Hewlett-Packard Interface Bus" (HP part number 5952-0156).

3-13. HP-IB Compatibility

The Vector Modulation Analyzer has a tri-state, TTL, HP-IB interface that can be used with any HP-IB controller or computer for automatic system applications.

The Vector Modulation Analyzer's HP-IB compatibility is described by the twelve HP-IB messages listed in Table 3-2. The most important is the data message, which contains the program codes that set the Vector Modulation Analyzer's mode of operation. The Vector Modulation Analyzer's compatibility with HP-IB is further defined by the following list of interface functions: SH1, AH1, T5, TE0, L3, LE0, SR1, RL1, PP1, DC1, DT0, C0, and E2. A more detailed explanation of these compatibility codes can be found in IEEE Standard 488-1978 and the identical ANSI Standard MC1.1.

Complete HP-IB capability as defined in IEEE Std 488 and ANSI Std MC1.1 is: SH1, AH1, T5, TE0, L3, LE0, DT0, DC1, RL1, C0, SR1, PP1, and E2.

Table 3-2. Message Reference Table

HP-IB message	Applicable	Response	Related Commands and Controls	Interface Functions (1)
Data	Yes	Most Vector Modulation Analyzer functions are bus programmable. Most instrument settings can be read over the HP-IB.		AH1, SH1, T5, TE0, L3, LE0
Trigger	No	The Vector Modulation Analyzer does not have a device trigger capability.	GET	DT0
Clear	Yes	The Vector Modulation Analyzer responds equally to Device Clear (DCL) and Selected Device Clear (SDC) bus commands by canceling any incomplete entries or messages.	DCL,SDC	DC1
Remote	Yes	Remote mode is enabled when the REN bus control line is true. However, remote mode is not entered until the first time the Vector Modulation Analyzer is addressed to listen. The front panel RMT annunciator lights when the Vector Modulation Analyzer is actually in the remote mode.	REN	RL1
Local	Yes	The Vector Modulation Analyzer returns to local mode (front panel control) and responds to the Go To Local (GTL) bus command. When entering the local mode, no instrument settings or functions are changed.	GTL	RL1

Table 3-2. Message Reference Table (Cont.)

HP-IB message	Applicable	Response	Related Commands and Controls	Interface Functions (1)
Local Lockout	Yes	When in remote, all front panel keys, including the LCL key, are disabled.	LLO	RL1
Clear Lockout/ Set Local	Yes	The Vector Modulation Analyzer returns to local (front panel control) and local lockout is cleared when the REN bus control line goes false.	REN	RL1
Pass Control/ Take Control	No	The Vector Modulation Analyzer has no controller capability.		C0
Require Service	Yes	The Vector Modulation Analyzer sets the SRQ bus control line true when one or more of the service request conditions occurs if it has been enabled to send the Require Service message for that condition.	SRQ	SR1
Status Byte	Yes	The Vector Modulation Analyzer responds to a Serial Poll Enable (SPE) bus command by sending an 8-bit status byte when addressed to talk. If the instrument is holding the SRQ control line true (Issuing the Require Service message), bit 7 in the Status Byte and the bit representing the condition causing the Require Service message to be issued will both be true.	SPE, SPD	T5

Table 3-2. Message Reference Table (Cont.)

HP-IB message	Applicable	Response	Related Commands and Controls	Interface Functions (1)
Status Bit	Yes	The Vector Modulation Analyzer responds to a Parallel Poll Enable (PPE) bus command by sending a status bit on an HP-IB data line that has been pre-configured by the controller.	PPE, PPD, PPC, PPU	PP1
Abort	Yes	The Vector Modulation Analyzer stops talking and listening.	IFC	T5, TE0, L3, LE0

(1) Commands, Control Lines, and Interface functions are defined in IEEE Std 488-1978. Knowledge of these may not be necessary if your controller's manual describes programming in terms of the twelve HP-IB messages shown in the left column.

3-14. Remote Mode

Remote Capability. In remote, the Vector Modulation Analyzer can be addressed to talk or listen. When addressed to listen, the Vector Modulation Analyzer responds to the Data, Clear (SDC), and Local messages. When addressed to talk, the Vector Modulation Analyzer can issue the Data and Status Byte messages. Whether addressed or not, the Vector Modulation Analyzer responds to the Clear (DCL), Local Lockout, Clear Lockout/Set Local, and Abort messages. In addition, the Vector Modulation Analyzer may issue the Require Service and Status Bit messages.

Local-to-Remote Mode Changes. The Vector Modulation Analyzer switches to remote operation upon receipt of the Remote message. The Remote message has two parts:

- a. Remote enable bus control line (REN) set true.
- b. Device listen address received (while REN is true).

When the Vector Modulation Analyzer switches to remote, the RMT annunciator on the front panel turns on and the front panel controls are disabled except for LCL and the LINE switch.

3-15. Local Mode

Local Capability. In local, the Vector Modulation Analyzer's front panel controls are fully operational and it will respond to a Remote message. The Vector Modulation Analyzer can send a Require Service message while in the Local mode.

Whether it is addressed or not, it also responds to the Clear, Local Lockout, Clear Lockout/Set Local and Abort messages. Also whether addressed or not, the Vector Modulation Analyzer can issue the Require Service and Status Bit messages. When addressed to talk, the Vector Modulation Analyzer can issue Data messages and the Status Byte message.

Remote-to-Local Mode Changes. The Vector Modulation Analyzer switches to local from remote whenever it receives a Local (GTL), Abort, or Clear Lockout/Set Local message. (The Clear Lockout/Set Local message sets the Remote Enable control line [REN] false.) The Vector Modulation Analyzer can also be switched to local by turning the LINE switch to OFF, and then to ON, or with the LCL key if not in local lockout.

Local Lockout. When a data transmission is interrupted, which can happen by pressing the LCL key to return the Vector Modulation Analyzer to local mode, the data could be lost. This could leave the Vector Modulation Analyzer in an unexpected state. To prevent this, a local lockout is recommended. Local Lockout disables the LCL key and allows return-to-local only under program control.

Note



Return-to-local can also be accomplished by turning the Vector Modulation Analyzer's LINE switch to OFF, then back to ON. This technique, however, has some disadvantages:

- a. It defeats the purpose and advantage of local lockout (that is, the system controller will lose control of a system element).
- b. There are several HP-IB conditions that reset to default states at turn-on.

3-16. Addressing

The Vector Modulation Analyzer's address is set to 09 at the factory. To change the address or determine the present address setting, use the HP-IB ADDRESS softkey function. Refer to the paragraph entitled HP-IB Address Selection and Configuring in Section 2 of this manual.

Any address between 00 and 30 can be assigned to the Vector Modulation Analyzer.

The Vector Modulation Analyzer interprets the byte on the eight HP-IB data lines as an address or a bus command if the bus is in the command mode. The command mode is defined as attention control line (ATN) true and interface clear control line (IFC) false. Whenever the Vector Modulation Analyzer is addressed (whether in local or remote), either the TLK or LSN annunciator on the front panel turns on.

3-17. Data Messages

The Vector Modulation Analyzer communicates on the interface bus primarily with Data messages. Data messages consist of several bytes sent over the bus' data lines when the bus is in the data mode (attention bus control line [ATN] false). Unless it is set to talk only, the Vector Modulation Analyzer receives Data Messages when addressed to listen. The Vector Modulation Analyzer sends Data Messages or the Status Byte message when addressed to talk. Most Vector Modulation Analyzer operations available in local mode can be performed directly in remote mode via Data messages. Those functions not programmable directly via Data messages are shown in Table 3-3.

Table 3-3. Functions Not Directly Programmable via HP-IB ⁽¹⁾

Function	Description
EXTernal INPUT LEVEL CAL	Calibrates the EXT TRIG input.
FOCUS TEST PATTERN	Displays test pattern for focus adjustment.
HELP	Displays information on most keys and softkeys.
HP-IB ADDRESS	Display and enter Vector Modulation Analyzer address.
HP-IB Configuring	Configures HP-IB as TALK ONLY, LISTEN ONLY or TALK/LISTEN.

Table 3-3. Functions Not Directly Programmable via HP-IB ⁽¹⁾ (Cont.)

Function	Description
LINE Switch	Turns instrument ON and OFF.
PREV MENU	Allows user to sequence back through four menus.
PRIMARY TEST PATTERN	Displays test pattern for operation verification of the 1345A display module.
TEXT OFF	Sequentially blanks text, axes, and graticule.
VOLT/DIV I&Q	Sets common gain of I and Q channels.

(1) All menu softkeys and front panel keys with the exception of the LINE switch can be programmed using the HP-IB KEY command. See the KEY COMMAND Detailed Operating Instruction for more information.

3-18. Receiving Data Messages

The Vector Modulation Analyzer responds to Data messages when it is enabled to remote (REN control line true) and addressed to listen. The Vector Modulation Analyzer remains addressed to listen until it receives an Abort message or until its talk address or a universal unlisten command is sent by the controller.

Data Input Format. The Data message string, or program code, consists of a series of ASCII characters. The command set for this instrument can be broken down into two sections. They are system level program codes and two-leveled subsystem program codes.

A typical system level program code can appear either as a system level command by itself or a system level command with an argument. In the following example, "SAV" is the system level command and "5" is the argument:

*SAV 5

A typical two-leveled subsystem program code consists of a subsystem command and a function command. The function command may or may not be followed by an argument. In the following example, "DISP" is the subsystem command, "IMAR" is the function command and "OFF" is the argument:

DISP:IMAR OFF

Table 3-9 lists all of the system level program codes that can be used with the Vector Modulation Analyzer and Table 3-10 lists all of the two-leveled subsystem program codes that can be used. These tables are located at the end of this discussion on HP-IB. In addition, the full program codes for each instrument function can be found in the Detailed Operating Instructions and program codes corresponding to each key or softkey can be found using the front panel HELP function.

The following format guidelines should be observed for all data messages sent to the Vector Modulation Analyzer:

- Always use a semicolon to separate commands, whether they're system level or two-leveled subsystem commands.
- Use a colon following a subsystem command to drop into the function command. In the following example, "CHANI" is the subsystem command and "RANG 5.0" is the function command:

```
CHANI:RANG 5.0
```

- Use a colon preceding a subsystem command to return the interface to system level if multiple subsystems are to be accessed on the same line of code. In the following example, the colon after the "SENS 0.100;" function command returns the interface to the system level from the "CHANI" subsystem. It can then drop into the "TRIG" subsystem:

```
CHANI:SENS 0.100;TRIG:LEV 1.0
```

- A new line of software code always returns the instrument to the system level. Example A and Example B below accomplish the same task, but since three lines are used in Example B, the interface returns to system level after the first line. Therefore, the "CHANI" subsystem must be respecified at the beginning of the following lines:

Example A:

```
CHANI:OFFS 1.0;COUP AC;SENS 0.100
```

Example B:

```
CHANI:OFFS 1.0
CHANI:COUP AC
CHANI:SENS 0.100
```

- Any system level command can be used anywhere in a line of code regardless of hierarchy and will have no effect on hierarchy location. In the following example, the "ERR?" system command is inserted in the command string. After it is read, the "COUP AC"

function command is still interpreted as being under the "CHANI" subsystem without needing to return to that subsystem:

CHANISENS 0.100:ERR?;COUP AC

Programming Numeric Data. When issuing numeric data to the Vector Modulation Analyzer, integer, floating point, or exponential values can be used. Valid characters are 0 through 9, E or e, the plus sign (+), the minus sign (-), and the decimal point (.).

Examples:

Integer (NR1) - 3

Floating Point (NR2) - 3.0

Exponential (NR3) - 3.0E+0

In certain cases, the numeric data can be followed by an optional suffix. The suffix may or may not be preceded by a slash (/). Valid suffixes for the Vector Modulation Analyzer are as follows:

Time

S - seconds
MS - milliseconds
US - microseconds
NS - nanoseconds
PS - picoseconds

Voltage

V - volts
MV - millivolts
UV - microvolts

Thousands (used by MSM, MSMB, and MST commands)

K - decimal (X 1000)

Thousands (used by the PRIN command)

K - binary (X 1024)

Power

DB - decibels
DBM -decibels referenced to 1 mW

Angle

DEG - degrees

Frequency

- HZ - hertz
- KHZ - kilohertz
- MHZ - megahertz
- GHZ - gigahertz

Percent

- PCT - percent

If numeric data is sent to the Vector Modulation Analyzer that contains more precision than the instrument can process, the data is rounded, not truncated.

HP 3709A/B Compatibility. The Vector Modulation Analyzer will respond to certain program codes that have been implemented for the HP 3709A/B Constellation Display. A listing of these program codes is in Table 3-4.

Table 3-4. HP 3709A/B Compatibility Commands

Program Code	Description
DMD:EYI	I Eye display mode
DMD:EYQ	Q Eye display mode
DMD:CON	Constellation display mode
EDG POS	External trigger slope positive
EDG NEG	External trigger slope negative
EPS -1.0 to +1.0	Position of time marker in an eye diagram
GAN 1	Set I and Q channel gain to 100 mv/div (3.98 dBm)
GAN 2	Set I and Q channel gain to 50 mv/div (-2.04 dBm)
GAN 4	Set I and Q channel gain to 25 mv/div (-8.06 dBm)
GND ON	I and Q inputs coupled to ground
GND OFF	I and Q inputs DC coupled

Table 3-4. HP 3709A/B Compatibility Commands (Cont.)

Program Code	Description
IQD OFF	Set I and Q differential delays to zero
MOD NONE	Select 10 x 10 scope format
MOD PRS81	Select 81PRS display format
MOD PRS49	Select 49PRS display format
MOD PRS25	Select 25PRS display format
MOD PRS9	Select 9PRS display format
MOD QAM16	Select 16QAM display format
MOD QAM256	Select 256QAM display format
MOD QAM64	Select 64QAM display format
MOD QPSK	Select QPSK display format
MSM sam	Collect and transmit I and Q coordinate data in numeric A/D form (sam is the number of samples)
MSMB sam	Collect and transmit I and Q coordinate data in block A/D form (sam is the number of samples)
MSR	Perform single constellation analysis measurement and display on front panel only
MST num	Collect statistics for calculation of closure and angle errors
OAN	Output analysis of closure, lock, and quadrature errors
OST	Output statistics on individual constellation clouds in a constellation diagram in ASCII format
OSTB	Output statistics on individual constellation clouds in a constellation diagram in block format
SCL?	Query the scale factor for each channel in Volts per measurement unit ($V/\text{Measurement unit} = 10 \cdot V/\text{Div setting}/1024$)
TMB?	Query whether timebase is greater or less than 20 ns/div (HIGH if greater, LOW if lesser)

3-19. Sending the Data Message

Depending on how HP-IB is configured, the Vector Modulation Analyzer can either talk only or talk and listen both. If set to both talk and listen, the instrument sends Data messages when addressed to talk. The instrument then remains configured to talk until it is unaddressed to talk by the controller. To unaddress the Vector Modulation Analyzer, the controller must send either the instrument's listen address, a new talk address, an Abort message, or a universal untalk command.

Queries. Before the instrument is addressed to talk, the desired output data must be specified with the appropriate input Data message, a query. Otherwise, the instrument cannot complete the bus transaction. Queries are program commands that end with a question mark (?). The Vector Modulation Analyzer responds to a query by outputting a Data message containing the value or state of the associated parameter.

Data Output Format. The Vector Modulation Analyzer outputs data in one of four formats, depending on the query. The four output formats are explained below:

Integer numeric data - The instrument outputs an optional plus sign (+) or minus sign (-), followed by numeric digits. The decimal point (not sent) is assumed to be to the right of the numeric digits.

Exponential numeric data - The instrument outputs floating point numeric data followed by the letter E, a plus or minus sign, and a string of digits representing the exponent value.

Block - The instrument outputs a block of binary data. Refer to the individual Detailed Operating Instructions for the block output formats for specific queries.

ASCII - The instrument outputs a string of ASCII characters. This type of data output is used in cases where the query response is non-numeric. An example would be a response of "CHANI" to indicate Channel I trigger source.

All data output formats are explained in IEEE Std. 488.2, Codes, Formats, Protocols, and Common Commands.

3-20. Receiving the Clear Message

The Vector Modulation Analyzer responds to the Clear message by cancelling any incomplete entries or messages. The message can take two forms: Selected Device Clear which the Vector Modulation Analyzer responds to only when addressed, and Device Clear, which it responds to whether addressed or not.

3-21. Receiving the Trigger Message

The Vector Modulation Analyzer does not respond to the Trigger message.

3-22. Receiving the Remote Message

The Remote message has two parts. First, the remote enable bus control line (REN) is held true; second, the device listen address is sent by the controller. These two actions combine to place the Vector Modulation Analyzer in remote mode. Thus, the Vector Modulation Analyzer is enabled to go into remote when the controller begins the Remote message, but it does not actually switch to remote until addressed to listen the first time. When actually in remote, the Vector Modulation Analyzer's front panel RMT annunciator lights.

3-23. Receiving the Local Message

The Local message is the means by which the controller sends the Go-To-Local (GTL) bus command. If the instrument was in local lockout when the Local message was received, front panel control is returned, but lockout is not cleared. Unless it receives the Clear Lockout/Set Local message, the Vector Modulation Analyzer will return to local lockout the next time it goes to remote. No instrument settings are changed in the transition from remote to local.

When the Vector Modulation Analyzer goes to local mode, the front panel RMT annunciator turns off.

3-24. Receiving the Clear Lockout/Set Local Message

The Clear Lockout/Set Local message is the means by which the controller sets the Remote Enable (REN) bus control line false. The Vector Modulation Analyzer returns to local mode (full front panel control) when it receives the Clear Lockout/Set Local message. When the Vector Modulation Analyzer goes to local mode, the front panel RMT annunciator turns off.

3-25. Receiving the Pass Control Message

The Vector Modulation Analyzer does not respond to the Pass Control message because it does not have controller capability.

3-26. Sending the Require Service Message

The Vector Modulation Analyzer sends the Require Service message by setting the Service Request (SRQ) bus control line true. The instrument can send the Require Service message in either local or remote mode. The Require Service message is cleared when a serial poll is executed by the controller or if a Clear message is received by the Vector Modulation Analyzer. During serial poll, the Require Service message is cleared after the Vector Modulation Analyzer places the Status Byte message on the bus. Refer to Programming the Status Register in this section for a description of the conditions that can be enabled to generate the Require Service message. If no conditions are enabled, the Require Service message is disabled.

When the Vector Modulation Analyzer is sending the Require Service message, the front panel SRQ annunciator lights.

3-27. Sending the Status Byte Message

After receiving a Serial Poll Enable (SPE) bus command and when addressed to talk, the Vector Modulation Analyzer sends the Status Byte message. The Status Byte message consists of one eight bit byte in which the bits are set according to the conditions described in the section entitled Programming the Status Register. (The Status Byte is identical to the Status Register).

Bits in the Status Byte are set according to the instrument state. If a condition occurs that causes one of the bits in the status byte to be set and if its corresponding bit is enabled by the Status Register enable field, the RQS (Require Service) bit is set and the Require Service message is sent.

If the RQS bit is set, indicating that the instrument sent the Require Service message, and a serial poll is executed, the RQS bit will be cleared. All other bits in the status byte remain unchanged. Refer to Programming the Status Register in this section for information on clearing individual bits.

3-28. Sending the Status Bit Message

The Vector Modulation Analyzer sends the Status Bit message (if configured to do so) as part of the interface's response to the Parallel Poll Enable (PPE) bus command. In order for the Vector Modulation Analyzer to respond to a PPE bus command, the controller must assign the Vector Modulation Analyzer a single HP-IB data line on which to respond. The controller also assigns the logic sense of the bit. Both tasks are accomplished by the Parallel Poll Configure (PPC) bus command. The Vector Modulation Analyzer sets its assigned status bit true if one or more of the bits in the Status Register is true and has been enabled. Refer to Programming the Status Register. The Vector Modulation Analyzer can send the Status Bit message without being addressed to talk.

The data line on which the Vector Modulation Analyzer is assigned to respond is cleared by sending the Parallel Poll Unconfigure (PPU) bus command. At turn-on, the data line is unassigned.

3-29. Receiving the Abort Message

The Abort message is the means by which the controller sets the Interface Clear (IFC) bus control line true. When the Abort message is received, the Vector Modulation Analyzer becomes unaddressed and stops talking and listening.

3-30. Programming the Status Register

3-31. General

The Status Register can be programmed to generate a Service Request (SRQ) whenever a predetermined condition occurs.

The Status Register is an 8-bit register that constantly monitors the instrument's status. Each condition is represented by a bit in the Status Register. Each bit in the Status Register has its own requirements for being set true (to a logic 1). These requirements are described in detail in the following pages and summarized in Figure 3-3.

3-32. Status Register

Table 3-5 defines the bits in the Status Register and the conditions that can be programmed to set each bit true.

Figure 3-3 shows the decimal value of each bit in the Status Register.

There are two ways to read the current value of the Status Register:

1. Do a serial poll.
2. Send the Vector Modulation Analyzer the query *STB?.

A serial poll returns the value of the register in a single binary byte. *STB? returns the decimal value of the register in an ASCII string. In both cases, the value of the register is derived by adding together the weighted values of each true bit.

A serial poll clears bit 7 (RQS), if true, but has no effect on other bits in the Status Register. *STB? does not clear any bits in the Status Register.

To clear the BI Event Register, and Event Status Register (that is, set the value of all bits in the registers to 0), send the Vector Modulation Analyzer the command *CLS.

Table 3-5. Status Register Bit Definitions

Bit	Description	Condition That Sets Bit True
8	Always 0	
7	Require Service (RQS)	Status Register bits 1, 5, and/or 6 are true and have been enabled by the Status Register enable field.
6	Events	One or more of the following conditions occurs and has been enabled by the Event Register enable field: Power Fail Command Error Execution Error Device Dependent Error Query Error Operation Complete
5	Message Available	The Vector Modulation Analyzer has received a query and is ready to output data.
4	Always 0	
3	Always 0	
2	Always 0	
1	Overdrive Errors	One or more of the following conditions is true in the Bit 1 Event Register and is enabled by the Bit 1 Event Register enable field: Input I Overdriven Input I Amplifier Overdriven Input Q Overdriven Input Q Amplifier Overdriven

Bit 8	Bit 7	Bit 6	Bit 5	Bit 4	Bit 3	Bit 2	Bit 1
0	Require Service (RQS)	Events	Message Available	0	0	0	Overdrive Errors
Value =128	Value =64	Value =32	Value =16	Value =8	Value =4	Value =2	Value =1

Figure 3-3. Status Register

3-33. Status Register Enable Field

The Status Register enable field defines which bits in the Status Register can generate a Service Request. If no bits are enabled, SRQ cannot be generated

The Status Register enable field is set by sending the Vector Modulation Analyzer the program command *SRE, followed by a number (0 to 255) representing the value of the Status Register bits to be enabled. It is not necessary to enable bit 7 (RQS).

Bits in the Status Register are logically ANDed with the corresponding bits in the enable field. If the resulting value is equal to one, the Vector Modulation Analyzer sets bit 7 in the Status Register true. This sends a Service Request to the system controller.

For example, to enable bits 1 and 6 (overdrive errors and events) to generate a Service Request:

OUTPUT 709;*SRE 33"

3-34. Bit 1, Overdrive Errors

The status of bit 1 in the Status register is determined by the following:

1. Bit 1 Status Register
2. Bit 1 Event Register
3. Bit 1 Falling Edge Register
4. Bit 1 Rising Edge Register
5. Bit 1 Event Register enable Field

Corresponding bits in the above mentioned registers and enable fields refer to the same event. Each bit represents one of the four conditions capable of generating an overdrive error. See Figure 3-4. In addition, the decimal value of each bit is shown. The method by which bits are set is different for each register.

Bit 4	Bit 3	Bit 2	Bit 1
Input I Overdriven	Input I Amplifier Overdriven	Input Q Overdriven	Input Q Amplifier Overdrive
Value=8	Value=4	Value=2	Value=1

Figure 3-4. Bit 1, Overdrive Errors

Bit 1 Status Register. The Bit 1 Status Register is a read-only register. When one or more of the conditions described in Table 3-6 occurs, the appropriate bit is set true. When a bit is set true, note that protective action for that channel has been taken (the input has been switched out). Bits are cleared (set to 0) when the causing condition is removed.

Table 3-6. Bit 1 Status Register

Bit	Description	Condition That Sets Bit True ⁽¹⁾
4	Input I Overdriven	Input signal into I channel exceeds $\pm 5V$ peak, DC coupled or $\pm 25V$ DC; $\pm 5V$ peak ac, ac coupled.
3	Input I Amplifier Overdriven	Signal is applied to I Input that causes the amplifier on the A5/A6 Input Assembly to be overdriven.
2	Input Q Overdriven	Input signal into Q channel exceeds $\pm 5V$ peak, DC coupled or $\pm 25V$ DC; $\pm 5V$ peak ac, ac coupled.
1	Input Q Amplifier Overdriven	Signal is applied to Q Input that causes the amplifier on the A5/A6 Input Assembly to be overdriven.

(1) In internal demodulation mode, there are overdrive limits, but these are not detected.

To read the Bit 1 Status Register, address the Vector Modulation Analyzer to listen and send the program command B1ST?. Then address the Vector Modulation Analyzer to talk. It will return the decimal value of the register. For example:

```
10 OUTPUT 709;"B1ST?"
20 ENTER 709:A
30 PRINT "BIT 1 STATUS REGISTER=";A
40 END
```

If the returned value is 6, the Q input is being overdriven and the I input amplifier is being overdriven.

Bit 1 Event Register. Like the Bit 1 Status Register, the Bit 1 Event Register is a read-only register.

Bits in the Bit 1 Event Register are driven by changes in the Bit 1 Status Register. To set a bit in the Bit 1 Event Register, two things must happen:

1. A bit in the Bit 1 Status Register must change states (that is, changed from true to false or false to true).
2. The corresponding bit in the Bit 1 Event Register has been previously programmed to respond to the false-to-true (rising edge) or true-to-false (falling edge) transition.

Once set, the bits in the Bit 1 Event Register remain set until the register is read. After the register has been read, it is set to 0. Turning the instrument off or sending the program command *CLS also sets the register to 0.

To read the Bit 1 Event Register, address the Vector Modulation Analyzer to listen and send the program command BIET?. Then address the Vector Modulation Analyzer to talk. It returns the value of the register.

There are several differences between the Bit 1 Event Register and the Bit 1 Status Register:

1. The Bit 1 Status Register indicates the instrument's current status, whereas the Bit 1 Event Register indicates a change in status since the last time the register was read.
2. The Bit 1 Status Register is strictly informational, whereas the Bit 1 Event Register can be enabled to drive bit 1 in the Status Register.
3. Conditions in the Bit 1 Event Register are edge sensitive; they must be programmed to respond on the rising edge or falling edge of changes in the Bit 1 Status Register. Conditions in the Bit 1 Status Register are level sensitive; they are true while they are occurring.

Bit 1 Rising and Falling Edge Registers. In order for bits in the Bit 1 Event Register to be set, each bit must be programmed to respond on the rising edge (false-to-true) or falling edge (true-to-false) of changes in the Bit 1 Status Register.

Use program command BIRS followed by a number from 0 to 15 to cause bits in the Bit 1 Event Register to respond on the rising edge transition. The number represents the value of the bits to be set. (See Figure 3-4).

Use the program command BIFL followed by a number from 0 to 15 to cause bits in the Bit 1 Event Register to respond on the falling edge transition in the Bit 1 Status Register.

Program commands BIRS? and BIFL? return the current setting of the Bit 1 Rising Edge and Bit 1 Falling Edge Register.

Bit 1 Event Register Enable Field. In order for a bit in the Bit 1 Event Register to set bit 1 in the Status Register true, it must be enabled by the Bit 1 Event Register enable field.

To set the Bit 1 Event Register enable field, send the program command BIEN followed by a number from 0 to 15. The number represents the value of the bits being enabled. (See Figure 3-4)

Bits in the Bit 1 Event Register are logically ANDed with the corresponding bits in the enable field. If the resultant value is one, bit 1 in the Status Register will be set. If bit 1 in the Status Register enable field is enabled, SRQ will be generated.

Example of Bit 1 Generating a Service Request (SRQ). The following example will show how Bit 1 registers can be programmed generate a Service Request.

At turn-on, all registers and enable fields related to the Service Request are set to 0. In this example, a Service Request will be generated when the Q input is overdriven.

Program the Bit 1 Rising Edge Register so that the Bit 1 Event Register responds on the false-to-true change to the condition "input Q overdriven" in the Bit 1 Status Register. Send the Vector Modulation Analyzer the following command string:

OUTPUT 709;"BIRS 2"

When the "input Q overdriven" condition goes from false to true in the Bit 1 Status Register, bit 2 in the Bit 1 Event Register gets set.

Next, to enable this condition to cause a Service Request:

1. Set the Bit 1 Event Register enable field to allow the "input Q overdriven" condition to set bit 1 in the Status Register true. Send the Vector Modulation Analyzer the following command string:

OUTPUT 709;"BIEN 2"

2. Set the Status Register enable field to allow bit 1 in the Status Register to cause a Service Request. Send the Vector Modulation Analyzer the command string:

OUTPUT 709:"*SRE 1"

The Bit 1 registers and Status Register have now been set up so that an SRQ will be generated when the Q input is overdriven.

If the Q channel input is now overdriven, the second position bit (binary weight of 2) in the Bit 1 Event Register is set true. This bit is ANDed with the second position bit in the Bit 1 Event Register enable field, setting Bit 1 in the Status Register true. Since Bit 1 in the Status Register enable field has been set to one, an SRQ is generated.

Once the SRQ has been generated, the Q input is switched out. To remedy this, the Q input signal must first be reduced and then the Q channel gain must be set again over HP-IB. Setting the gain again clears the overdrive condition.

To determine if the Q input is still being overdriven, read the contents of the Bit 1 Status Register. Send the instrument the query B1ST?. If the Vector Modulation Analyzer returns a value of 2, 3, 6, 7, 10, 11, 14, or 15, the Q input is still being overdriven.

3-35. Bit 5, Message Available

Bit 5 of the Status Register indicates that a message is ready to be read from the Vector Modulation Analyzer. To generate SRQ, bit 5 of the Status Register enable field must be enabled. No other registers are associated with this bit.

3-36. Bit 6, Events

Six conditions are capable of driving bit 6 in the Status Register. These conditions are shown in Figure 3-5.

Event Status Register. The Event Status Register is an 8-bit register that is constantly updated as events occur. Refer to Table 3-7 for a description of conditions that set each bit true.

Bit 8	Bit 7	Bit 6	Bit 5	Bit 4	Bit 3	Bit 2	Bit 1
Power Fail	0	Command Error	Execution Error	Device Dependent Error	Query Error	0	Operation Complete
Value= 128	Value= 64	Value= 32	Value= 16	Value= 8	Value= 4	Value= 2	Value= 1

Figure 3-5. Bit 6, Events

Table 3-7. Event Status Register

Bit	Description	Condition That Sets Bit True
8	Power Fail	Power to the Vector Modulation Analyzer has been interrupted.
7	Always 0	
6	Command Error	Vector Modulation Analyzer receives a command with an invalid format.
5	Execution Error	Vector Modulation Analyzer receives a parameter in an HP-IB command that is out of range.
4	Device Dependent Error	An error has occurred that is neither a Command Error nor an Execution Error.
3	Query Error	Vector Modulation Analyzer has been addressed to talk without first receiving a query.
2	Always 0	
1	Operation Complete	All pending device operations have been completed after the instrument receives the program commands "*OPC" or "*OPC?".

Bits in the Event Status Register are positive edge sensitive; they are set true on the false-to-true transition. Once a bit is set, it remains set until the register is read, the instrument is turned off, or the *CLS program command is received.

To read the Event Status Register, address the Vector Modulation Analyzer to listen and send the command *ESR?. Then address the Vector Modulation Analyzer to talk. The Vector Modulation Analyzer returns the current value of the true bits. The register is then set to zero.

Event Status Register Enable Field. The Event Status Register enable field enables bits in the Event Status Register to drive bit 6 in the Status Register.

To enable bits in the Event Status Register enable field, send the Vector Modulation Analyzer the program command *ESE followed by a number between 0 and 255. The number represents the values of the bits to be enabled. (See Figure 3-5.)

Bits in the Event Status Register are logically ANDed with bits in the Event Status Register enable field. If the resultant value is equal to one, bit 6 in the Status Register is set true.

3-37. Bit 7, Require Service (RQS)

Bit 7 is set when Status Register bits 1, 5, and/or 6 are true and have been enabled by the Status Register enable field. When bit 7 is true, a Service Request is generated and the front panel SRQ annunciator lights.

Figure 3-6 summarizes the hierarchy of registers related to programming the status register.

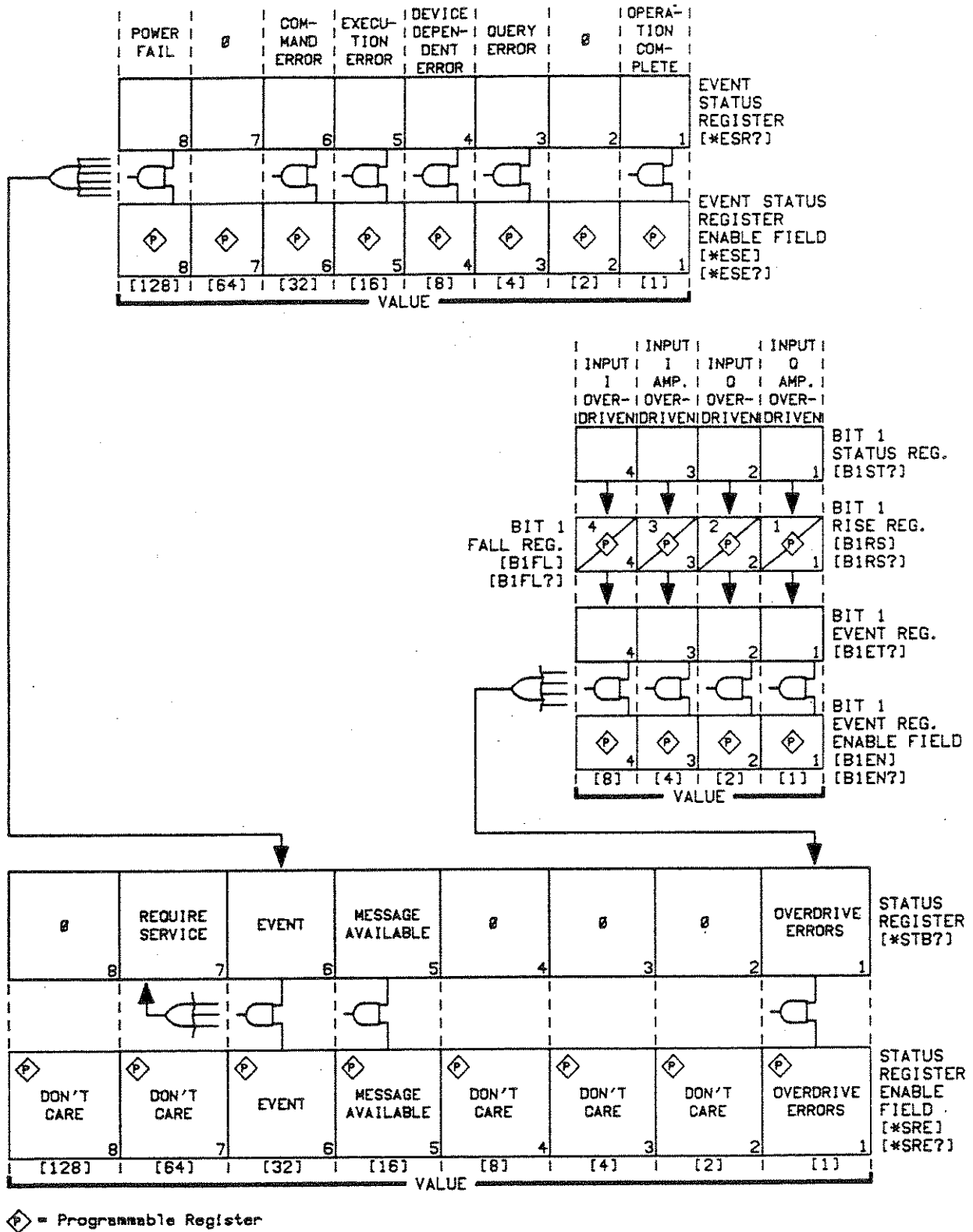

Figure 3-6. Status Register Hierarchy Chart

3-38. Parallel Poll Enable Field

The Vector Modulation Analyzer can be programmed to respond with one bit of status when parallel polled. The Parallel Poll enable field determines what the one bit of status represents. In order for the Vector Modulation Analyzer to respond to a Parallel Poll, it must be configured to do so by the controller. The controller assigns the data line on which the Vector Modulation Analyzer responds (DIO1-DIO8) and the logic sense of the bit (negative-true or positive-true logic).

Bits in the Parallel Poll enable field are identical to the bits in the Status Register. The enable field is set by sending the Vector Modulation Analyzer the command *PRE followed by the value of the bits to be enabled.

The Parallel Poll enable field is logically ANDed with its corresponding bits in the Status Register. How the resultant value is interpreted depends on the previously programmed logic sense of the status bit.

Table 3-8. Summary of Status Register Commands

Command	Description
BIST?	Reads the Bit 1 Status Register.
BIEN	Sets the Bit 1 Event Register enable field. Enables conditions to drive bit 1 of the Status Register.
BIEN?	Reads the current setting of the Bit 1 Event Register enable field.
BIET?	Reads the Bit 1 Event Register, then clears register.
BIFL	Sets the Bit 1 Falling Edge Register.
BIFL?	Reads the current setting of the Bit 1 Falling Edge Register.
BIRS	Sets Bit 1 Rising Edge Register.
BIRS?	Reads the current setting of the Bit 1 Rising Edge Register.
*CLS	Clears the Bit 1 Event Register, the Event Status Register, and the error queue.
*ESE	Sets the Event Status Register enable field.
*ESE?	Reads the current setting of the Event Status Register enable field.
*ESR?	Reads the Event Status Register, then sets the register to zero.
*IST?	Reads current status bit of the instrument (used for Parallel Poll).
*OPC	Sets bit 1 in the Event Status Register true when all pending device operations have been finished.
*OPC?	Always returns a "1" and sets bit 1 in the Event Status Register true when all pending device operations have been finished.
*PRE	Sets Parallel Poll enable field.
*PRE?	Reads the current setting of the Parallel Poll enable field.
*SRE	Sets the Status Register enable field.
*SRE?	Reads the current setting of the Status Register enable field.
*STB?	Reads the Status Register.

Table 3-9. HP-IB Code to Parameter Summary, System Level Codes

Program Code (1)	Parameter	Query
*CAL?	HP 8981A executes self calibration.	
*CLS	Clears Event Status register, the Bit 1 Current Status register, and the error queue.	
*ESE 1	Set "Operation Complete" bit in the Event Enable register.	ESE?
*ESE 4	Set "Query Error" bit in the Event Enable register.	ESE?
*ESE 8	Set "Device Dependent Error" bit in the Event Enable register.	ESE?
*ESE 16	Set "Execution Error" bit in the Event Enable register.	ESE?
*ESE 32	Set "Command Error" bit in the Event Enable register.	ESE?
*ESE 128	Set "Power On" bit in the Event Enable register.	ESE?
*ESR?	Query and clear the Event Status register.	
*IDN?	Query the identification string for the instrument.	
*IST?	Take Parallel Poll.	
*OPC	Set bit 1 in Event Status Register true after all device operations are completed.	
*OPC?	Query the operation complete bit.	
*PRE 1	Set "Overdrive Errors" bit in Parallel Poll Enable register.	PRE?
*PRE 16	Set "Message Available" bit in Parallel Poll Enable register.	PRE?
*PRE 32	Set "Events" bit in Parallel Poll Enable register.	PRE?

Table 3-9. HP-IB Code to Parameter Summary, System Level Codes (Cont.)

Program Code (1)	Parameter	Query
*RCL 1 to 8	Recall instrument state from memory registers 1 through 8.	
*RST	Set instrument to its preset condition.	
*SAV 1 to 8	Save instrument state in a specific memory register. Valid registers are 1 through 8.	
*SRE 1	Set "Overdrive Errors" bit in Service Request Enable register.	SRE?
*SRE 16	Set "Message Available" bit in Service Request Enable register.	SRE?
*SRE 32	Set "Events" bit in Service Request Enable register.	SRE?
*STB?	Read contents of Status Byte register.	
*TST?	Perform self test and report any errors over the bus.	
AUT	Execute Autoscope function.	
BIEN 1	Set "Input Q Amplifier Overdriven" bit in Bit 1 Enable register.	BIEN?
BIEN 2	Set "Input Q Overdriven" bit in Bit 1 Enable register.	BIEN?
BIEN 4	Set "Input I Amplifier Overdriven" bit in Bit 1 Enable register.	BIEN?
BIEN 8	Set "Input I Overdriven" bit in Bit 1 Enable register.	BIEN?
BIET?	Query the Bit 1 Event register.	
BIFL 1	Set "Input Q Amplifier Overdriven" bit in Bit 1 Falling Edge register.	BIFL?
BIFL 2	Set "Input Q Overdriven" bit in Bit 1 Falling Edge register.	BIFL?
BIFL 4	Set "Input I Amplifier Overdriven" bit in Bit 1 Falling Edge register.	BIFL?

Table 3-9. HP-IB Code to Parameter Summary, System Level Codes (Cont.)

Program Code (1)	Parameter	Query
BIFL 8	Set "Input I Overdriven" bit in Bit 1 Falling Edge register.	BIFL?
BIRS 1	Set "Input Q Amplifier Overdriven" bit in Bit 1 Rising Edge register.	BIRS?
BIRS 2	Set "Input Q Overdriven" bit in Bit 1 Rising Edge register.	BIRS?
BIRS 4	Set "Input I Amplifier Overdriven" bit in Bit 1 Rising Edge register.	BIRS?
BIRS 8	Set "Input I Overdriven" bit in Bit 1 Rising Edge register.	BIRS?
BIST?	Query and clear the register containing current status of the overdrive conditions.	
ERR?	Query the next error in the error queue.	
ID?	Query the instrument model number.	
IMP 50	Set impedance of instrument to 50 ohms.	IMP?
IMP 75	Set impedance of instrument to 75 ohms.	IMP?
KEY num	Remotely simulate pressing of any front panel key (except LINE switch). See KEY COMMAND Detailed Operating Instruction for valid key numbers (substituted for "num").	KEY?
PRIN num	Set print points and generate a print output for an external printer. Valid range for "num" is 1 to 999999.	PRIN?
REV?	Query the revision date of the internal firmware.	
RST	Set instrument to its preset condition.	
SER "num"	Store the instrument serial number in internal RAM. Serial Number (num) must be in quotes.	SER?

(1) "num" indicates numeric data is needed.

Table 3-10. HP-IB Code to Parameter Summary
Two-leveled Subsystem Codes

Subsystem Command	Function Command (1)	Parameter	Query
CHANI	COUP AC	Set channel I AC coupling.	COUP?
"	COUP DC	Set channel I DC coupling.	COUP?
"	COUP GRO	Set channel I ground coupling.	COUP?
"	OFFS num	Set channel I voltage offset. Range of values for "num" is -10.00 to 10.00.	OFFS?
"	RANG num	Set full scale voltage range of I channel. Range of values for "num" is -10 to 10.	RANG?
"	SCAL ON	I channel gain and offset autoscope on.	SCAL?
"	SCAL OFF	I channel gain and offset autoscope off.	SCAL?
"	SENS num	Set gain of I channel. Range of values for "num" is -1.0 to 1.0.	SENS?
CHANQ	COUP AC	Set channel Q AC coupling.	COUP?
"	COUP DC	Set channel Q DC coupling.	COUP?
"	COUP GRO	Set channel Q ground coupling.	COUP?
"	OFFS num	Set Q channel voltage offset. Range of values for "num" is -10.00 to 10.00.	OFFS?

Table 3-10. HP-IB Code to Parameter Summary
Two-leveled Subsystem Codes (Cont'd)

Subsystem Command	Function Command (1)	Parameter	Query
CHANQ (cont'd)	RANG num	Set full scale voltage range of Q channel. Range of values for "num" is -10 to 10.	RANG?
	SCAL ON	Q channel gain and offset autoscope on.	SCAL?
	SCAL OFF	Q channel gain and offset autoscope off.	SCAL?
	SENS num	Set gain of Q channel. Range of values for "num" is -1.0 to 1.0.	SENS
CORR	CLR ALL	Clear all demodulator correction storage registers.	
	CLR num	Clear demodulator correction data from an internal register. "num" is the register number to be cleared (from 1 to 6).	
	CLRC	Clear the current demodulator correction data.	
	GAIN num	Set the manual gain correction for a demodulator. "num" is in dB.	GAIN?
	GCOR?	Execute an automatic demodulator correction of gain.	
	IOFF num	Set offset correction of the I demodulator channel. "num" is in volts.	IOFF?

Table 3-10. HP-IB Code to Parameter Summary
Two-leveled Subsystem Codes (Cont'd)

Subsystem Command	Function Command (1)	Parameter	Query
CORR (cont'd)	IQRT num	Set the demodulator IQ gain ratio correction. "num" is in dB.	IQRT?
"	QCOR?	Execute an automatic quadrature, IQ gain ratio, and offset demodulator correction.	
"	QOFF num	Set offset correction of the Q demodulator channel. "num" is in volts.	QOFF?
"	QUAD num	Set quadrature offset adjustment in IQ mode or quadrature offset correction in DEMOD mode. Range for "num" is -20 to 20.	QUAD?
"	RCL num	Recall demodulator correction data from an internal register. "num" is the desired register number from 1 to 6.	
"	RLEV num	Set the RF input level. Used as a reference by the automatic gain correction. "num" is in dBm.	RLEV?
"	SAV num	Save the current demodulator correction data in an internal register. "num" is the register number from 1 to 6.	
"	STAT ON	Enable use of either manual or automatic demodulator correction factors.	STAT?

Table 3-10. HP-IB Code to Parameter Summary
Two-leveled Subsystem Codes (Cont'd)

Subsystem Command	Function Command (1)	Parameter	Query
CORR (cont'd)	STAT OFF	Disable demodulator correction factors.	STAT?
DEM	COUP AC	Set internal demodulator input coupling to AC.	COUP?
"	COUP DC	Set internal demodulator input coupling to DC.	COUP?
"	COUP GRO	Set internal demodulator input coupling to ground.	COUP?
"	EFIL ON	Select use of external filters with internal demodulator.	EFIL?
"	EFIL OFF	Select use of internal filters with internal demodulator.	EFIL?
"	FORM NONE	Select scope format.	FORM?
"	FORM PRS81	Select 81PRS modulation format.	FORM?
"	FORM PRS49	Select 49PRS modulation format.	FORM?
"	FORM PRS25	Select 25PRS modulation format.	FORM?
"	FORM PRS9	Select 9PRS modulation format.	FORM?
"	FORM QAM16	Select 16QAM modulation format.	FORM?
"	FORM QAM256	Select 256QAM modulation format.	FORM?
"	FORM QAM64	Select 64QAM modulation format.	FORM?

Table 3-10. HP-IB Code to Parameter Summary
Two-leveled Subsystem Codes (Cont'd)

Subsystem Command	Function Command (1)	Parameter	Query
DEM (cont'd)	FORM QPSK	Select QPSK modulation format.	FORM?
"	FSCAL num	Set full scale value of the display in demodulation mode. "num" is in dBm.	FSCAL?
"	IOFF num	Set the offset of the I channel in demodulation mode. "num" is in percent of full scale. (2)	IOFF?
"	IQRT num	Set the IQ Ratio of the inputs in demodulation mode. "num" is in dB. (2)	IQRT?
"	MODE DMOD	Set instrument to demodulation mode.	MODE?
"	MODE IQMOD	Set instrument to IQ (oscilloscope) mode.	MODE?
"	PHAS num	Set phase offset. Range for "num" is -360 to 360.	PHAS?
"	QOFF num	Set the offset of the Q channel in demodulation mode. "num" is in percent of full scale.	QOFF?
"	QUAD num	Set quadrature offset for IQ mode or quadrature offset correction for DEMOD mode. Range for "num" is -20 to 20.	QUAD?
"	RFREQ num	Set the current frequency that the instrument is being used at.	RFREQ?
"	RF ON	RF input enabled (signal switched in).	RF?

Table 3-10. HP-IB Code to Parameter Summary
Two-leveled Subsystem Codes (Cont'd)

Subsystem Command	Function Command (1)	Parameter	Query
DEM (con't)	RF OFF	RF input disabled (signal switched out).	RF?
"	RPHAS num	Enter the reference phase for use by the SPHAS? command. "num" is in degrees.	RPHAS?
"	SOUR INT	Select use of internal demodulator.	SOUR?
"	SOUR EXT	Select use of external demodulator.	SOUR?
"	SPHAS?	Set the displayed phase to the coherent reference phase (see RPHAS).	
DISP	ALL ON	Turn analog signal and related text on.	ALL?
"	ALL OFF	Turn analog signal and related text off.	ALL?
"	FORM DUAL	Split screen on.	FORM?
"	FORM SING	Split screen off.	FORM?
"	IMAD ON	Delta I marker on.	IMAD?
"	IMAD OFF	Delta I maker off.	IMAD?
"	IMAR ON	I marker on.	IMAR?
"	IMAR OFF	I marker off.	IMAR?
"	INT 0 to 8	Set signal intensity of analog trace. 0 blanks trace; 1 is dimmest and 8 is brightest.	INT?
"	MMAD ON	Delta magnitude marker on.	MMAD?

Table 3-10. HP-IB Code to Parameter Summary
Two-leveled Subsystem Codes (Cont'd)

Subsystem Command	Function Command (1)	Parameter	Query
DISP (cont'd)	MMAD OFF	Delta magnitude marker off.	MMAD?
"	MMAR ON	Magnitude marker on.	MMAR?
"	MMAR OFF	Magnitude marker off.	MMAR?
"	MODE CHANI	Select I versus time display mode.	MODE?
"	MODE CHANQ	Select Q versus time display mode.	MODE?
"	MODE CHANIQ	Select I&Q versus time display mode.	MODE?
"	MODE CONST	Select constellation display mode.	MODE?
"	MODE VECTOR	Select vector display mode.	MODE?
"	MODE CONALIGN	Select constellation align display mode.	MODE?
"	MODE VECALIGN	Select vector align display mode.	MODE?
"	MODE THREED	Select three dimensional display mode.	MODE?
"	MOFF	Turn all markers off.	
"	PMAD ON	Delta phase marker on.	PMAD?
"	PMAD OFF	Delta phase marker off.	PMAD?
"	PMAR ON	Phase marker on.	PMAR?
"	PMAR OFF	Phase marker off.	PMAR?
"	QMAD ON	Delta Q marker on.	QMAD?

Table 3-10. HP-IB Code to Parameter Summary
Two-leveled Subsystem Codes (Cont'd)

Subsystem Command	Function Command (1)	Parameter	Query
DISP (cont'd)	QMAD OFF	Delta Q marker off.	QMAD?
"	QMAR ON	Q marker on.	QMAR?
"	QMAR OFF	Q marker off.	QMAR?
"	TMAD ON	Delta time marker on.	TMAD?
"	TMAD OFF	Delta time marker off.	TMAD?
"	TMAR ON	Time marker on.	TMAR?
"	TMAR OFF	Time marker off.	TMAR?
MEAS	IDEL num	Turn delta I marker on and set its value. Range for "num" is -40.0 to 40.0.	IDEL?
"	IMAC	Move I marker to center screen.	
"	IMAD ON	Delta I marker on.	IMAD?
"	IMAD OFF	Delta I marker off.	IMAD?
"	IMAV num	Set I marker value. Range for "num" is -20.0 to 20.0.	IMAV?
"	MDEL num	Turn delta magnitude marker on and set its value. Refer to the "Magnitude Marker Setup" Detailed Operating Instruction for range.	MDEL?
"	MMAD ON	Delta magnitude marker on.	MMAD?
"	MMAD OFF	Delta magnitude marker off.	MMAD?

Table 3-10. HP-IB Code to Parameter Summary
Two-leveled Subsystem Codes (Cont'd)

Subsystem Command	Function Command (1)	Parameter	Query
MEAS (cont'd)	MMAF	Set the magnitude marker to full scale.	
"	MMAV num	Set magnitude marker value. Range for "num" is 0.0 to 7.07.	MMAV?
"	PDEL num	Turn delta phase marker on and set its value. Range for "num" is -359.0 to 359.0.	PDEL?
"	PMAD ON	Delta phase marker on.	PMAD?
"	PMAD OFF	Delta phase marker off.	PMAD?
"	PMAV num	Set value of the phase marker. Range for "num" is -359.0 to 359.0.	
"	QDEL num	Turn delta Q marker on and set its value. Range for "num" is -40.0 to 40.0.	QDEL?
"	QMAC	Move Q marker to center screen.	
"	QMAD ON	Delta Q Marker on.	QMAD?
"	QMAD OFF	Delta Q Marker off.	QMAD?
"	QMAV num	Set Q marker value. Range for "num" is -20.0 to 20.0.	QMAV?
"	TDEL num	Turn delta time marker on and set its value. Range for "num" is -20E-3 to 20E-3.	TDEL?
"	TMAC	Move time marker to center screen.	

Table 3-10. HP-IB Code to Parameter Summary
Two-leveled Subsystem Codes (Cont'd)

Subsystem Command	Function Command (1)	Parameter	Query
MEAS (cont'd)	TMAD ON	Delta time marker on.	TMAD?
"	TMAD OFF	Delta time marker off.	TMAD?
"	TMAV num	Set time marker value. Range for "num" is 0.0 to 20E-3.	TMAV?
SERV	CALF?	Queries calibration factors.	
"	DCON num	Modify the setting of the direct control bits. See Service Manual for values for "num".	DCON?
"	FUNC num	Invokes a service function. Refer to the Service Manual for details.	
"	SERR ON	Enables service related error display.	SERR?
"	SERR OFF	Disables service related error display.	SERR?
"	VMET? node	Queries the voltage level at any node that can be accessed by the internal voltmeter. Codes for "node" can be found in the Service Manual.	
TIM	DEL num	Set I&Q (common) delay. Range for "num" is 0 to 20E-3.	DEL?
"	DELI num	Set I channel delay. Range for "num" is 0 to 20E-6.	DELI?

Table 3-10. HP-IB Code to Parameter Summary
Two-leveled Subsystem Codes (Cont'd)

Subsystem Command	Function Command (1)	Parameter	Query
TIM (cont'd)	DELQ num	Set Q channel delay. Range for "num" is 0 to 20E-6.	DELQ?
"	HOLD DITHON	Hold off Dither function on.	HOLD?
"	HOLD DITHOFF	Hold off Dither function off.	HOLD?
"	MODE AUTO	Set auto sweep timing mode.	MODE?
"	MODE FREE	Set free run timing mode.	MODE?
"	MODE TRIG	Set triggered sweep timing mode.	MODE?
"	MSAM MULT	Real time sampling on.	MSAM?
"	MSAM SING	Real time sampling off.	MSAM?
"	RANG num	Set range of time sweep (10 x time/div). Range for "num" is 5E-9 to 20E-3.	RANG?
"	SCAL ON	Enable time base autoscope.	SCAL?
"	SCAL OFF	Disable time base autoscope.	SCAL?
"	SENS num	Set time per division. Range for "num" is 5E-10 to 2E-3.	SENS?
TRIG	COUP AC	EXT TRIG input coupling set to ac.	COUP?
"	COUP DC	EXT TRIG input coupling set to dc.	COUP?

Table 3-10. HP-IB Code to Parameter Summary
Two-leveled Subsystem Codes (Cont'd)

Subsystem Command	Function Command (1)	Parameter	Query
TRIG (cont'd)	ETER ECL	Set voltage termination of EXT TRIG input to ECL.	ETER?
"	ETER GRO	Set voltage termination of EXT TRIG input to ground.	ETER?
"	GATE ECL	Set the threshold level and corresponding termination for rear panel GATE input to ECL.	GATE?
"	GATE TTL	Set the threshold level and corresponding termination for rear panel GATE input to TTL.	GATE?
"	GATE GRO	Set the threshold level and corresponding termination for rear panel GATE input to ground.	GATE?
"	GATE OFF	Disable rear panel GATE input.	GATE?
"	LEV AUTO	Set Auto external trigger level.	LEV?
"	LEV TTL	Set TTL external trigger level.	LEV?
"	LEV ECL	Set ECL external trigger level.	LEV?
"	LEV num	Set variable external trigger level. Range for "num" is -5.0 to 5.0.	LEV?
"	LEV rng	Set variable internal trigger level. Range for "rng" is a voltage between -5V and 5V. (-100 to 100 in DEMOD mode).	LEV?

Table 3-10. HP-IB Code to Parameter Summary
Two-leveled Subsystem Codes (Cont'd)

Subsystem Command	Function Command (1)	Parameter	Query
TRIG (cont'd)	SCAL ON	Enable trigger scan autoscope.	SCAL?
"	SCAL OFF	Disable trigger scan autoscope.	SCAL?
"	SLOP POS	Trigger slope positive.	SLOP?
"	SLOP NEG	Trigger slope negative.	SLOP?
"	SOUR CHANI	Set trigger source to channel I.	SOUR?
"	SOUR CHANQ	Set trigger source to channel Q.	SOUR?
"	SOUR EXT	Set trigger source to external.	SOUR?
"	SOUR LINE	Set trigger source to line.	SOUR?
WAVE	DATA?	Gather and transmit ASCII data.	
"	DATAB?	Gather and transmit block data.	
"	IINC?	Query I channel increment.	
"	IOR?	Query I channel origin.	
"	IREF?	Query I channel reference.	
"	POIN num	Set data points to be sampled. Range for "num" is 1 to 1024.	POIN?
"	QINC?	Query Q channel increment.	

Table 3-10. HP-IB Code to Parameter Summary
Two-levelled Subsystem Codes (Cont'd)

Subsystem Command	Function Command (1)	Parameter	Query
WAVE (cont'd)	QOR?	Query Q channel origin.	
"	QREF?	Query Q channel reference.	
"	SOUR CHANI	Select I channel data source.	SOUR?
"	SOUR CHANQ	Select Q channel data source.	SOUR?
"	SOUR CHANIQ	Select I&Q channel data source.	SOUR?
"	SOUR CONST	Select constellation display data source.	SOUR?
"	SOUR VECTOR	Select vector display data source.	SOUR?
"	SOUR XY	Select XY data source.	SOUR?
"	TINC?	Query time increment.	
"	TOR?	Query time origin.	
"	TREF?	Query time reference.	
"	XINC?	Query X axis increment.	
"	XOR?	Query X axis origin.	
"	XREF?	Query X axis reference.	
"	YINC?	Query Y axis increment.	
"	YOR?	Query Y axis origin.	
"	YREF?	Query Y axis reference.	

(1) "num" indicates numeric data is needed.

(2) These commands are used to adjust the signal relative to the display axes. They are not demodulator corrections.

Table 3-11. Commonly Used Code Conversions

ASCII	Binary	Octal	Decimal	Hexa-decimal
NUL	00 000 000	000	0	00
SOH	00 000 001	001	1	01
STX	00 000 010	002	2	02
ETX	00 000 011	003	3	03
EOT	00 000 100	004	4	04
ENQ	00 000 101	005	5	05
ACK	00 000 110	006	6	06
BEL	00 000 111	007	7	07
BS	00 001 000	010	8	08
HT	00 001 001	011	9	09
LF	00 001 010	012	10	0A
VT	00 001 011	013	11	0B
FF	00 001 100	014	12	0C
CR	00 001 101	015	13	0D
SO	00 001 110	016	14	0E
SI	00 001 111	017	15	0F
DLE	00 010 000	020	16	10
DC1	00 010 001	021	17	11
DC2	00 010 010	022	18	12
DC3	00 010 011	023	19	13
DC4	00 010 100	024	20	14
NAK	00 010 101	025	21	15
SYN	00 010 110	026	22	16
ETB	00 010 111	027	23	17
CAN	00 011 000	030	24	18
EM	00 011 001	031	25	19
SUB	00 011 010	032	26	1A
ESC	00 011 011	033	27	1B
FS	00 011 100	034	28	1C
GS	00 011 101	035	29	1D
RS	00 011 110	036	30	1E
US	00 011 111	037	31	1F
SP	00 100 000	040	32	20
!	00 100 001	041	33	21
"	00 100 010	042	34	22
#	00 100 011	043	35	23
\$	00 100 100	044	36	24
%	00 100 101	045	37	25
&	00 100 110	046	38	26
'	00 100 111	047	39	27
(00 101 000	050	40	28
)	00 101 001	051	41	29
*	00 101 010	052	42	2A
+	00 101 011	053	43	2B
,	00 101 100	054	44	2C
-	00 101 101	055	45	2D
.	00 101 110	056	46	2E
/	00 101 111	057	47	2F
0	00 110 000	060	48	30
1	00 110 001	061	49	31
2	00 110 010	062	50	32
3	00 110 011	063	51	33
4	00 110 100	064	52	34
5	00 110 101	065	53	35
6	00 110 110	066	54	36
7	00 110 111	067	55	37
8	00 111 000	070	56	38
9	00 111 001	071	57	39
:	00 111 010	072	58	3A
;	00 111 011	073	59	3B
<	00 111 100	074	60	3C
=	00 111 101	075	61	3D
>	00 111 110	076	62	3E
?	00 111 111	077	63	3F

ASCII	Binary	Octal	Decimal	Hexa-decimal
@	01 000 000	100	64	40
A	01 000 001	101	65	41
B	01 000 010	102	66	42
C	01 000 011	103	67	43
D	01 000 100	104	68	44
E	01 000 101	105	69	45
F	01 000 110	106	70	46
G	01 000 111	107	71	47
H	01 001 000	110	72	48
I	01 001 001	111	73	49
J	01 001 010	112	74	4A
K	01 001 011	113	75	4B
L	01 001 100	114	76	4C
M	01 001 101	115	77	4D
N	01 001 110	116	78	4E
O	01 001 111	117	79	4F
P	01 010 000	120	80	50
Q	01 010 001	121	81	51
R	01 010 010	122	82	52
S	01 010 011	123	83	53
T	01 010 100	124	84	54
U	01 010 101	125	85	55
V	01 010 110	126	86	56
W	01 010 111	127	87	57
X	01 011 000	130	88	58
Y	01 011 001	131	89	59
Z	01 011 010	132	90	5A
[01 011 011	133	91	5B
\	01 011 100	134	92	5C
]	01 011 101	135	93	5D
^	01 011 110	136	94	5E
_	01 011 111	137	95	5F
`	01 100 000	140	96	60
a	01 100 001	141	97	61
b	01 100 010	142	98	62
c	01 100 011	143	99	63
d	01 100 100	144	100	64
e	01 100 101	145	101	65
f	01 100 110	146	102	66
g	01 100 111	147	103	67
h	01 101 000	150	104	68
i	01 101 001	151	105	69
j	01 101 010	152	106	6A
k	01 101 011	153	107	6B
l	01 101 100	154	108	6C
m	01 101 101	155	109	6D
n	01 101 110	156	110	6E
o	01 101 111	157	111	6F
p	01 110 000	160	112	70
q	01 110 001	161	113	71
r	01 110 010	162	114	72
s	01 110 011	163	115	73
t	01 110 100	164	116	74
u	01 110 101	165	117	75
v	01 110 110	166	118	76
w	01 110 111	167	119	77
x	01 111 000	170	120	78
y	01 111 001	171	121	79
z	01 111 010	172	122	7A
{	01 111 011	173	123	7B
:	01 111 100	174	124	7C
}	01 111 101	175	125	7D
~	01 111 110	176	126	7E
DEL	01 111 111	177	127	7F

3-39. Operator's Check

Note 

If the instrument does not operate properly and is being returned to Hewlett-Packard for service, please complete one of the blue repair tags located at the end of this manual and attach it to the instrument

Describe the problem as accurately as possible to ensure fastest repair. If the failure occurs only under certain conditions, explain what must be done to cause the failure.

Upon receipt of the instrument, or to check the Vector Modulation Analyzer for an indication of normal operation, perform the following operator's check. This procedure can also be used to familiarize the operator with the instrument and provide an understanding of the operating capabilities.

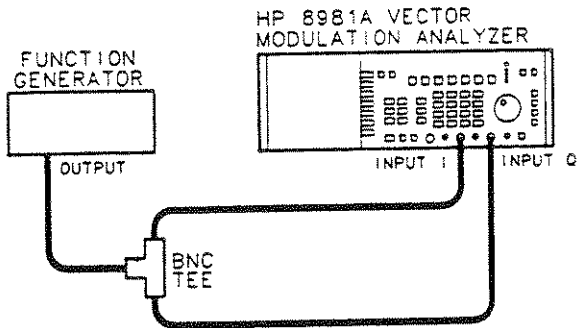



Figure 3-7. Preliminary Check and Display Check Setup

Equipment Needed

Function Generator.....	HP 8116A
Signal Generator.....	HP 8340B
Signal Generator.....	HP 8662A

3-40. Preliminary Check

1. Press the LINE switch to OFF () and then back to ON ().
2. Verify that all four HP-IB annunciators and the KNOB key indicator light.

3. After approximately fifteen seconds, verify that the message POWER-UP SELFTEST PASSED is displayed briefly.
4. Press the CAL key and wait for the instrument to self calibrate. When self calibration is complete, the display will settle.
5. Press the PRESET key.
6. Press the I key in the DISPLAY portion of the front panel.
7. Press the following keys in the order shown. Menu softkeys are shown in brackets:

DEMOM, [MODE IQ/DEMOM] to IQ

TIMING, [DELAY I], 1, [μ s]

GAIN & OFS, [VOLT/DIV I&Q], 1, 6, 5, [mV/DIV]

[OFFSET I], 1, 6, 5, [mV]

TRIG SOURCE, [INT I]

8. Connect the equipment as shown in Figure 3-7 and set the function generator controls as follows:

LINE	ON
MODE	NORM
WAVEFORM	
FRQ	500 kHz
DTY	50%
AMP	1.00 V peak into 50 Ω
OFS	000 mV
AUTO. LIMIT, COMPL. DISABLE	OFF

9. Verify that the waveform on the display appears like the one in Figure 3-8. If the waveform does appear the same, most of the main functions of the instrument are working. Go directly to paragraph 3-41 Display Check.
10. If the waveform differs from that shown in Figure 3-8, use the information in Table 3-12 to help identify which of the main functions are not working correctly.

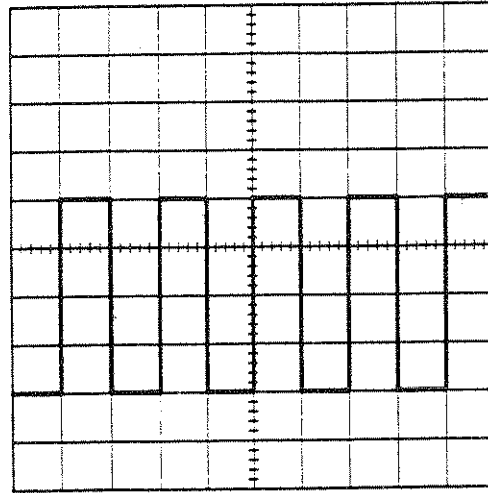

Figure 3-8. Preliminary Check Waveform

Table 3-12. Main Function Defects

Difference in Waveform from Figure 3-8.	Possible Defective Functions
Waveform Appears Garbled	Triggering
Waveform is not four divisions peak to peak	Gain
Waveform is not one quarter above and three quarters below the centerline	Offset
One period of waveform does not cover two divisions	Time Base
Waveform does not begin on the negative edge	Delay

3-41. Display Check

11. Press the following keys in the order shown. Menu softkeys are shown in brackets:

TIMING, [DELAY 1], 0, [ns]

GAIN & OFS, [OFFSET 1], 0, [mV]

12. Press the VECTOR key. Verify that the display appears like the one in Figure 3-9.

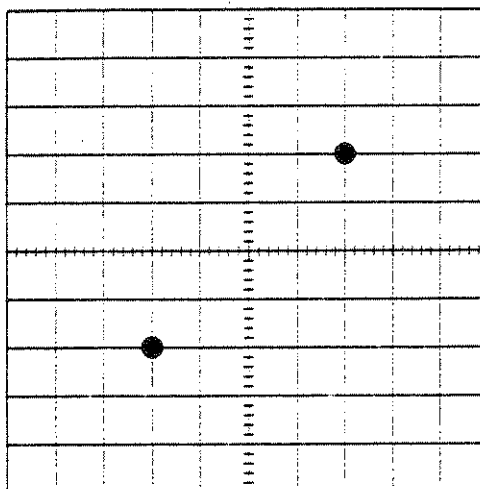

Figure 3-9. Display Mode

13. Press the AUTOSCOPE key. Verify that the display changes so it appears like the one in Figure 3-10.

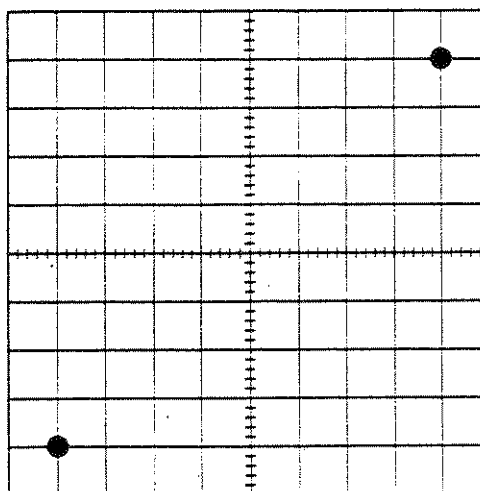

Figure 3-10. Autoscope

14. Turn the function generator OFF and disconnect it from the Vector Modulation Analyzer.

3-42. Markers Check

15. Press the PRESET key.
16. Press the "I" key that is in the MARKERS portion of the front panel and the "I" key that is in the DISPLAY portion of the front panel.
17. Press the following keys in the order shown. Menu softkeys are shown in brackets:

DEMOD, [MODE IQ/DEMOD] to IQ

I marker, [I MARKER VALUE], 1, [V]

The I marker should appear as a horizontal line one division above the centerline of the display.

18. Press the following keys in the order shown. Menu softkeys are shown in brackets:

[DELTA I ON/OFF], 1, [V]

The delta I marker should appear as a horizontal line two divisions above the centerline of the display.

19. Press ALL MKR OFF and verify that both I markers disappear.
20. Press the "Q" key that is in the MARKERS portion of the front panel and the "Q" key that is in the DISPLAY portion of the front panel.
21. Press the following keys in the order shown. Menu softkeys are shown in brackets:

[Q MARKER VALUE], 1, [V]

The Q marker should appear as a horizontal line one division above the centerline of the display.

22. Press the following keys in the order shown. Menu softkeys are shown in brackets:

[DELTA Q ON/OFF], 1, [V]

The delta Q marker should appear as a horizontal line two divisions above the centerline of the display.

23. Press ALL MKR OFF and verify that both Q markers disappear.

24. Press the MAGTD key and the VECTOR key.
25. Press the following keys in the order shown. Menu softkeys are shown in brackets:

[MAGTD MARKER VALUE], 1, [V]

The magnitude marker should appear as a circle that touches all four of the grid lines at the axes that are one division away from the origin.

26. Press the following keys in the order shown. Menu softkeys are shown in brackets:

[DELTA MAGTD ON/OFF], 6, [dB]

The delta magnitude marker should appear as a circle that touches all four of the grid lines at the axes that are two divisions away from the origin.

27. Press ALL MKR OFF and verify that both magnitude markers disappear.
28. Press the PHASE key.

29. Press the following keys in the order shown. Menu softkeys are shown in brackets:

[PHASE MARKER VALUE], 0, [DEG]

The PHASE marker should cause the horizontal axis to appear brighter from the origin to the right border of the screen.

30. Press the following keys in the order shown. Menu softkeys are shown in brackets:

[DELTA PHASE ON/OFF], 9, 0, [DEG]

The delta phase marker should cause the vertical axis to appear brighter from the origin to the upper border of the screen.

31. Press ALL MKR OFF and verify that both phase markers disappear.
32. Press the TIME MKR key and the "I" key that is in the DISPLAY portion of the front panel.

33. Press the following keys in the order shown. Menu softkeys are shown in brackets:

[TIME MARKER VALUE], 1, [μ s]

The time marker should appear as a vertical line that is one division away from the left border of the display.

34. Press the following keys in the order shown. Menu softkeys are shown in brackets:

[DELTA TIME ON/OFF], 1, [μ s]

The delta time marker should appear as a vertical line that is two divisions away from the left border of the display.

35. Press ALL MKR OFF and verify that both time markers disappear.

3-43. Demodulator Check

36. Press the DEMOD key. This activates the demodulation menu on the display
37. Press the MODE IQ/DEMOMOD softkey so that DEMOD is highlighted (brighter). Doing this will cause the DEMOD key menu to change.
38. Press the MORE softkey. This activates the second level "more" menu on the display.
39. Press the DEMOD INT/EXT softkey so that INT is highlighted (brighter).
40. Press the EXIT softkey to return to the DEMOD menu.
41. Press the REF FREQ softkey. Set the reference frequency to 70 MHz.
42. Press the CORRECTION softkey. This activates the demodulator corrections menu on the display.
43. Press the QUAD, IQ & OFFSET CORR softkey.
44. Set up the instrument and other equipment as shown in Figure 3-11.

Caution 

Do not exceed +20 dBm (10 Vdc) continuous power into the RF IN or COHERENT CARRIER inputs on the Vector Modulation Analyzer as damage to the instrument might occur.

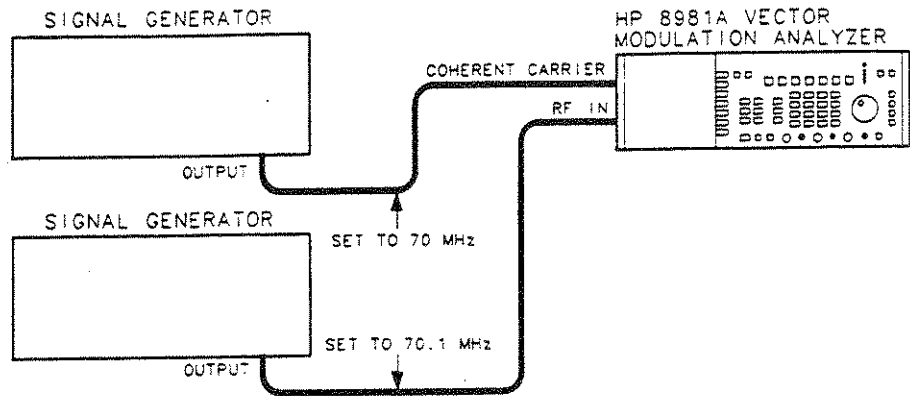

Figure 3-11. Demodulator Check Setup

Note



Set the Vector Modulation Analyzer time base to 1 μ s/div so that only one cycle of the tone frequency (100 kHz) is displayed.

45. Press the START TONE CORRECTION softkey. Some time will elapse before a message appears indicating that the corrections are complete.

Note



If any key is pressed before a correction complete message is displayed, the correction will abort.

46. Verify that the message "DEMOM CORRECTION COMPLETE" appears on the display. If a message is displayed indicating that the correction was incomplete, refer to the Service Manual for troubleshooting. Otherwise, continue with the next step.
47. Once the corrections complete message appears, press the EXIT softkey to return to the corrections menu.
48. Press the DEMOD GAIN CORRECTION softkey.
49. Set the output vernier of the RF IN signal generator to -5 dBm.
50. Press the RF LEVEL softkey. Set the RF level to -5 dBm.
51. Press the START GAIN CORRECTION softkey. Some time will elapse before a message appears indicating that the correction is complete.

Note

If any key is pressed before the correction complete message appears, the correction will abort.

52. Verify that the message "GAIN CORRECTION COMPLETE" appears on the display. If a message is displayed indicating that the gain correction was incomplete, refer to the Service Manual for troubleshooting.

Table 3-13. Listing of Detailed Operating Instructions (Functional)

<p>Advisories Error Messages and Recovery HELP Key Instrument Information</p> <p>Displays Constellation Display Display, General Gate Configuration I&Q Versus Time Display I Versus Time Display Menu Softkeys Q Versus Time Display Special Display Vector Display</p> <p>HP-IB Data Gathering and HP-IB Transmission Printer, Use With</p> <p>Markers I Marker Setup Magnitude Marker Setup Phase Marker Setup Q Marker Setup Time Marker Setup</p>	<p>Measurement Demodulation Demodulator Corrections Measurement Functions</p> <p>Miscellaneous Autoscope Calibration Error Messages and Recovery KEY Command Preset Save and Recall (Demodulator Corrections) Save and Recall (Instrument State)</p> <p>Timing Delay Selection Sweep Selection Time Base Selection</p> <p>Triggering Gate Configuration Trigger Setup</p> <p>Vertical Functions Gain Input Coupling Offset</p>
---	---

This table groups Detailed Operating Instructions according to their function. In this section, Detailed Operating Instructions are in alphabetical order.

Autoscope

Description

The AUTOSCOPE key allows the user to set up the display for optimum viewing of most valid input signals. When this function is activated in I/Q mode, four basic features of the input signal can be automatically adjusted. These four features are I channel gain and offset, Q channel gain and offset, time base, and triggering. The user can control whether or not these features are enabled to be autoscoped through the AUTOSCOPE CONFIG softkey in the INST STA menu. In the DEMOD mode, full scale magnitude, time base, and triggering can be automatically adjusted.

In I/Q mode, phase and quadrature adjust are always set to zero degrees. However, in DEMOD mode, phase and all demodulator corrections are not changed.

I Channel Gain and Offset (I/Q Mode Only)

When this feature has been selected to be autoscoped, two things happen. The I input signal is first offset such that the center of the peak to peak signal is shifted to the center of the screen. After the signal has been centered, the gain is set such that the magnitude is approximately four divisions above and below the center of the screen. If the offset of the signal is large such that the gain can not be set high enough to achieve this result without limiting the offset, the gain will be set at the limit for the amount of offset needed. If the signal is >25 mV or <40 mV p-p, the gain will be set to 5 mV per division. However, if the signal is less than 25 mV, the gain will be set to 1V per division.

Q Channel Gain and Offset (I/Q Mode Only)

When this feature has been selected to be autoscoped, two things happen. The Q input signal is first offset such that the center of the peak to peak signal is shifted to the center of the screen. After the signal has been centered, the gain is set such that the magnitude is approximately four divisions above and below the center of the screen. If the offset of the signal is large such that the gain can not be set high enough to achieve this result without limiting the offset, the gain will be set at the limit for the amount of offset needed. If the signal is >25 mV or <40 mV p-p, the gain will be set to 5 mV per division. However, if the signal is less than 25 mV, the gain will be set to 1V per division.

Full Scale Magnitude (DEMODO Mode Only)

When this feature has been selected to be autoscoped, two things happen. The I and Q channel display offsets are set to zero, and the full scale sensitivity is set so the signal is at full scale. The manual correction factors are not changed. The I/Q Ratio is always set to 0.00 dB when this feature is autoscoped.

Time Base (I/Q and DEMODO Modes)

When this feature has been selected to be autoscoped, the time base is set so that two periods of the trigger signal will fill the screen. In order for this feature to be used, the trigger frequency must be between 100 kHz and 150 MHz. This feature also switches the time sweep to Auto Sweep, and sets all delays (simultaneous and individual) to zero.

Triggering (I/Q and DEMODO Modes)

When this feature has been selected to be autoscoped, the instrument will go through a three step sequence as it searches for a trigger signal. In each step of the sequence, the instrument changes the trigger source, trigger level, and trigger coupling. If a trigger signal is found, the instrument will exit the sequence and use that signal for triggering. The trigger search sequence used by the instrument is outlined in Table 3-14:

Table 3-14. Trigger Search Sequence

STEP	TRIGGER SOURCE	TRIGGER LEVEL	TRIGGER COUPLING
1	EXT	AUTO	
2	INT I	0V	AC
3	INT Q	0V	AC

Procedure

To select the autoscope function, press the AUTOSCOPE key. Use the following procedures to select which of the input signal features will be autoscoped when the AUTOSCOPE key is pressed.

Note



In the following steps, the menu that is displayed is dependent upon whether the mode is set to DEMOD or IQ.

Enabling and Disabling I Channel Gain and Offset Autoscope (I/Q Mode Only)

1. Press the INST STA key. This will activate the instrument state menu on the display.
2. Press the AUTOSCOPE CONFIG softkey. This activates the second level autoscope configure menu on the display.
3. Check the text (AUTO I CHAN ON/OFF) that is adjacent to the menu softkey. Either the "ON" or "OFF" will be highlighted. If the desired autoscope status of the I channel is highlighted, do not press the softkey. If the opposite state is highlighted, press the softkey to toggle the selection. Choose ON to enable and OFF to disable I channel gain and offset autoscope.

Enabling and Disabling Q Channel Gain and Offset Autoscope (I/Q Mode Only)

1. Press the INST STA key. This will activate the instrument state menu on the display.
2. Press the AUTOSCOPE CONFIG softkey. This activates the second level autoscope configure menu on the display.
3. Check the text (AUTO Q CHAN ON/OFF) that is adjacent to the menu softkey. Either the "ON" or "OFF" will be highlighted. If the desired autoscope status of the Q channel is highlighted, do not press the softkey. If the opposite state is highlighted, press the softkey to toggle the selection. Choose ON to enable and OFF to disable Q channel gain and offset autoscope.

Enabling and Disabling Full Scale Magnitude Autoscope (DEMOD Mode Only)

1. Press the INST STA key. This will activate the instrument state menu on the display.
2. Press the AUTOSCOPE CONFIG softkey. This activates the second level autoscope configure menu on the display.

3. Check the text (AUTO MAGTD ON/OFF) that is adjacent to the menu softkey. Either the "ON" or "OFF" will be highlighted. If the desired autoscope status of the full scale magnitude is highlighted, do not press the softkey. If the opposite state is highlighted, press the softkey to toggle the selection. Choose ON to enable and OFF to disable full scale magnitude autoscope.

Enabling and Disabling Time Base Autoscope (I/Q and DEMOD Modes)



1. Press the INST STA key. This will activate the instrument state menu on the display.
2. Press the AUTOSCOPE CONFIG softkey. This activates the second level autoscope configure menu on the display.
3. Check the text (AUTO TIME ON/OFF) that is adjacent to the menu softkey. Either the "ON" or "OFF" will be highlighted. If the desired autoscope status of the time base is highlighted, do not press the softkey. If the opposite state is highlighted, press the softkey to toggle the selection. Choose ON to enable and OFF to disable time base autoscope.

Enabling and Disabling Triggering Autoscope (I/Q and DEMOD Modes)

1. Press the INST STA key. This will activate the instrument state menu on the display.
2. Press the AUTOSCOPE CONFIG softkey. This activates the second level autoscope configure menu on the display.
3. Check the text (TRIGGER SCAN ON/OFF) that is adjacent to the menu softkey. Either the "ON" or "OFF" will be highlighted. If the desired autoscope status of triggering is highlighted, do not press the softkey. If the opposite state is highlighted, press the softkey to toggle the selection. Choose ON to enable and OFF to disable triggering autoscope.

Example

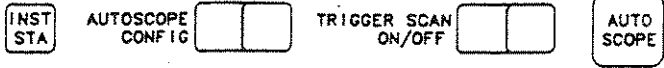
The user wants to autoscale the instrument. Internal Q channel triggering is currently selected and must not change. Assume that all four signal features are currently set up to be autoscaled.

LOCAL (key-strokes)	
 (Program Codes)	TRIG :SCAL OFF AUT:

HP-IB Program Codes

Command Level	Description	Code (1)
System Level Code	Autoscope	AUT AUTOSCALE
Subsystem (SUBS) Codes	I Channel Q Channel Timing Trigger Demodulation	CHANI CHANNEL1 CHANI CH1 CHANQ CHANNEL2 CHAN2 CH2 TIM TIMEBASE TRIG TRIGGER DEM
Function (FNA) Codes	Autoscope Configure Configure Full Scale Magnitude Autoscope	SCAL SCALE MAGTD

(1) If multiple codes appear in this column, the first one listed is the preferred code. Others are given to be compatible with HPOL (Hewlett-Packard Oscilloscope Language).

Parameter	Program Code (SUBS: FNA FNB)
perform an instrument autoscope	AUT
enable I channel gain and offset autoscope (IQ mode only)	CHAN:SCAL ON
disable I channel gain and offset autoscope (IQ mode only)	CHAN:SCAL OFF
enable Q channel gain and offset autoscope (IQ mode only)	CHANQ:SCAL ON
disable Q channel gain and offset autoscope (IQ mode only)	CHANQ:SCAL OFF
enable full scale magnitude autoscope (DEMOD mode only)	DEM:MAGTD ON
disable full scale magnitude autoscope (DEMOD mode only)	DEM:MAGTD OFF
enable time base autoscope	TIM:SCAL ON
disable time base autoscope	TIM:SCAL OFF
enable triggering autoscope	TRIG:SCAL ON
disable triggering autoscope	TRIG:SCAL OFF

Indications

When the AUTOSCOPE key is pressed, the signal is blanked as the autoscope function is carried out. They are set up to the conditions mentioned in the Description portion of this Detailed Operating Instruction. If the I or Q channel gain and offset, full scale magnitude, time base, or triggering autoscope have been disabled via the AUTOSCOPE CONFIG menu, those features of the displayed signal will not change.

After a few seconds, the Autoscope routine will end and the displayed signal will return. The gain and offset or I/Q magnitude, and time base parameters will be set to their new values in the Parameter Data Area.

Comments

Once autoscope has been turned on, the instrument cannot be returned to the original settings simply by pressing the AUTOSCOPE key again. If the user feels that the original settings may be required at a later time, they may be saved in one of the instrument state registers before pressing the AUTOSCOPE key (see the SAVE AND RECALL (INSTRUMENT STATE) Detailed Operating Instruction).

At the end of autoscope, autoscope status messages will appear on the display. These messages and their meanings are as follows

TIME BASE

DONE - Timing autoscope has been successfully completed.

DISABLED - Timing autoscope has been disabled.

UNDER RANGE - The trigger frequency is <100 kHz.

I/Q CHANNEL GAIN AND OFFSET (IQ or External DEMOD Mode)

DONE - I/Q Channel Gain and Offset autoscope successfully completed.

DISABLED - I/Q Channel Gain and Offset autoscope disabled.

GROUNDING - The I and/or Q signal path is grounded.

UNDER RANGE - The input signal amplitude is too small.

OVER RANGE - The input signal amplitude or offset is too large.

MAGNITUDE (Internal DEMOD Mode)

DONE - Magnitude autoscope successfully completed.

DISABLED - Magnitude autoscope disabled.

GROUNDING - The I and Q signal path is grounded.

UNDER RANGE - The input signal magnitude is too small.

OVER RANGE - The input signal magnitude is too large.

TRIGGERING

DONE - Triggering autoscope has been successfully completed.

DISABLED - Triggering autoscope has been disabled.

UNDER RANGE - The trigger frequency is <100 kHz.

Related Sections

Demodulation
Gain
Offset
Save and Recall (Instrument State)
Time Base Selection
Trigger Setup

Calibration

Description

Pressing the front panel CAL key causes the instrument to execute a self-calibration. This function includes a calibration of the analog-to-digital converter, RF attenuators, RF offsets, video gains, video nulls, screen position alignment, internal trigger levels and gains, frequency discriminator, time per division for all ranges, and time delays.

Self-calibration should be done whenever the ambient temperature changes by more than 5° C from the temperature during the last self-calibration or after every 8 hours in a powered-up condition. Perform CAL after the instrument has had a 1/2 hour warm up period.

A separate calibration routine is provided to calibrate the EXT TRIG INPUT (external trigger input).

Procedure

Calibrating the Instrument

To cause the instrument to self-calibrate, press the front panel CAL key. The calibration should take approximately one minute. To abort the calibration routine once it has started, press the LCL key.

Note



Pressing the LCL key or issuing an HP-IB command during calibration returns the instrument to its state prior to pressing CAL and restores its previous calibration factors.

Calibrating the EXT TRIG INPUT

Note



This calibration only needs to be done if external triggering is being used and fine accuracy is needed.

1. Press the INST STA key. This activates the instrument state menu on the display.
2. Press the SERVICE softkey. This activates the second level service menu on the display.

3. If a cable is connected to the EXT TRIG INPUT connector, disconnect it.
4. Press the EXT INPUT LEVEL CAL softkey.
5. The calibration of the EXT TRIG INPUT takes approximately two seconds. Once it is complete, the EXT TRIG INPUT cable can be reconnected.

Example

The user wishes to perform an instrument self-calibration.

LOCAL (key-strokes)	CAL
 (Program Codes)	*CAL?

HP-IB Program Codes

Parameter	Program Code (SUBS: FNA FNB)
initiate instrument self-calibration	*CAL?

Indications

The self-calibration routine takes approximately one minute. When the CAL key is pressed, the display flashes for the first few seconds. After the first few seconds, the display is blanked and the main message "CALIBRATION IN PROGRESS" is displayed in the upper-left corner of the screen. This message remains throughout the remainder of calibration. Other messages are displayed sequentially two lines under the main message to indicate the circuitry that is being calibrated. These messages are listed below in the order in which they appear:

Calibrating Analog to Digital Converter
Calibrating Gain Nulls

- Calibrating RF Offsets
- Calibrating Positions
- Calibrating Offset Gains
- Calibrating Video Gains
- Calibrating I and Q Channel RF Gains
- Calibrating Internal Trigger
- Calibrating Auto Scope
- Calibrating Timing Delays
- Calibrating Timing Ramps
- Calibrating Timing Delays

Relays can be heard switching at various times during calibration.

When calibration is finished, a message is given telling the status of calibration. This message will remain displayed until another key is pressed.

When the EXT INPUT LEVEL CAL softkey is pressed, The display flashes and then is blanked for approximately two seconds as the external trigger input (EXT TRIG INPUT) is calibrated. The message "EXT TRIGGER CAL IN PROCESS" is displayed in the upper-left corner of the screen. When external trigger input calibration is finished, a message is given telling the status of calibration.

Comments

If any calibration-related messages are displayed as a result of calibration, refer to the "Error Messages and Recovery" Detailed Operating Instruction.

There is a brief period during "Calibrating Positions" where the entire display is blanked.

The status messages during some parts of calibration may change in intensity or flicker as a result of the measurements being done.

After 10 minutes of no front panel keystroke activity, the auto intensity shutoff feature will blank the calibration status message.

Related Sections

Error Messages and Recovery

Constellation Display

Description

Pressing the "CONSTL" key sets up a type of display in which the signal displayed corresponds to a continuous display of points occurring at a fixed time after the trigger instant. These points are taken at the time marker instant. The I samples are displayed with respect to the horizontal (X) axis and the Q samples are displayed with respect to the vertical (Y) axis.

Nine display formats are useable in the Constellation display mode. These display formats include a standard 10 x 10 oscilloscope format and eight modulation-specific formats. The eight modulation-specific formats are QPSK, 9PRS, 16QAM, 25PRS, 49PRS, 64QAM, 81PRS, and 256QAM.

When the Constellation display mode is selected, none of the parameters of the previous display are changed.

For more information on displays, see the DISPLAY, GENERAL Detailed Operating Instruction.

Procedure

Selecting the Constellation Display Mode



To set the Vector Modulation Analyzer to the Constellation display mode, press the front panel "CONSTL" key.

Selecting the Display Formats

1. Press the DEMOD key. This activates the demodulator menu on the display.
2. Press the MOD FORMAT softkey. This activates the second level "modulation format" menu on the display.
3. Press the softkey in the MOD FORMAT menu that corresponds to the desired display format. The menu choices are SCOPE FORMAT, QPSK, 9PRS, 16QAM, 64QAM, 256QAM, and MORE. If the MORE softkey is pressed, an additional menu will appear with the choices 25PRS, 49PRS, and 81PRS displayed.

Example

An I&Q versus time display is currently on the screen and the user wants to view the corresponding Constellation display.

LOCAL (key-strokes)	
 (Program Codes)	DISP:MODE CONST

HP-IB Program Codes

Command Level	Description	Code (1)
Subsystem (SUBS) Codes	Display	DISP DISPLAY
	Demodulation	DEM
Function (FNA) Codes (under subsystem DISP)	Display Mode	MODE
Function (FNA) Codes (under subsystem DEM)	Display Format	FORM

(1) If multiple codes appear in this column, the first one listed is the preferred code. Others are given to be compatible with HPOL (Hewlett-Packard Oscilloscope Language).

Parameter	Program Code (SUBS: FNA FNB)
select Constellation display mode	DISP: MODE CONST
select 10 x 10 scope format	DEM: FORM NONE
select QPSK display format	DEM: FORM QPSK
select 9PRS display format	DEM: FORM PRS9
select 16QAM display format	DEM: FORM QAM16
select 25PRS display format	DEM: FORM PRS25
select 49PRS display format	DEM: FORM PRS49
select 64QAM display format	DEM: FORM QAM64
select 81PRS display format	DEM: FORM PRS81
select 256QAM display format	DEM: FORM QAM256

Indications

When the CONSTL key is pressed, all current menus, except for the "special display" and "3D display" menus, remain displayed and active. All data in the User Interface Area and Parameter Data Area remains displayed. The display mode changes to Constellation with the display format at whatever was selected in the DEMOD/MOD FORMAT menu. The words "CONSTELLATION Q vs I" appear in the Display Identification area.

Comments

Pressing the CONSTL key activates the gain and offset menu if the 3D DISPLAY menu was active.

The CONSTL key causes the instrument to display the Q versus I signal at the time marker instant, whether the time marker is on or off.

Related Sections

Display, General
Time Marker Setup

Data Gathering and HP-IB Transmission

Description

General

This Detailed Operating Instruction explains how to use the HP-IB Waveform subsystem commands to gather and transmit waveform data over the HP-IB. It also explains how to calculate actual voltage and time values using the waveform data and information acquired through related query commands.

Explanation of Commands

The Waveform subsystem includes several commands that allow the user to gather, transmit, and interpret waveform data. Several of these commands perform similar functions on different types of data. The following paragraphs give a brief description of these commands:

SOURce Command

The SOUR command is used to set the source that will be used when acquiring waveform data. Except for the case where an XY source is specified, the source selected will change the display to one of the five standard display modes (not including Special Display modes). When the XY source is specified, the display mode is not changed. Data is gathered from whatever display mode is currently active.

POIN Command

The POIN command sets up the number of sample points that will be gathered and transmitted when a WAVE:DATA or DATAB command is received by the Vector Modulation Analyzer. These points are gathered over the time sweep period. The maximum number of points that can be sampled is 1024. When the Constellation display mode has been chosen as the source, all the sample points will be taken at the time marker instant.

Data Commands

When the DATA? or DATAB? commands are sent to the Vector Modulation Analyzer, the instrument starts gathering and transmitting data. If the DATA? command is used, the instrument will transmit data in ASCII character format. If the DATAB? command is used, the instrument will transmit data in block format as defined by IEEE Std. 488.2. Data will be transmitted in several ways depending upon the source selected using the SOUR command. When the XY source is chosen, the display mode is not changed. Table 3-16 shows how the data will be transmitted when the X,Y source is selected.

Table 3-15. Data Transmission Formats

Source	Data Transmission Format (1) (3)
I versus time	$I_1, I_2, I_3, \dots, I_n$
Q versus time	$Q_1, Q_2, Q_3, \dots, Q_n$
I&Q versus time (2)	$I_1, Q_2, I_3, Q_4, \dots, I_{n-1}, Q_n$
Vector	$I_1, Q_1, I_2, Q_2, \dots, I_n, Q_n$
Constellation	$I_1, Q_1, I_2, Q_2, \dots, I_n, Q_n$

- (1) The subscript numbers indicate these samples are taken at the same instant.
- (2) If POIN is an odd number, the last point output will actually be an "I".
- (3) "n" is the number set by the POIN command.

Table 3-16. Data Transmission Format, XY Source

Source	Data Transmission Format (1)
X,Y	$X_1, Y_1, X_2, Y_2, \dots, X_n, Y_n$

- (1) The subscript numbers indicate these samples are taken at the same time instant.

Increment Commands

There are five separate commands that are used to query an increment value between consecutive A/D levels. These commands are listed below with a description of the type of increment that is returned when the command is executed:

IINC? In IQ mode, the instrument returns the I channel volts per A/D count when it receives this query. In DEMOD mode, the instrument returns the I channel percent of full scale per A/D count when it receives the IINC? query.

QINC? In IQ mode, the instrument returns the Q channel volts per A/D count when it receives this query. In DEMOD mode, the instrument returns the Q channel percent of full scale per A/D count when it receives the QINC? query.

XINC? The instrument returns the number of screens per A/D count in the X direction of the display when it receives this command.

YINC? The instrument returns the number of screens per A/D count in the Y direction of the display when it receives this command.

TINC? The instrument returns the time increment between samples when it receives this command.

Origin Commands

There are five separate commands that are used to query a value that corresponds to the center of the display screen. These commands are listed below with a brief description of the type of information that is returned when the command is executed:

IOR? In IQ mode, the instrument returns the voltage value that corresponds to the voltage level at the center of the I axis. This will be zero volts if no I channel offset has been set. If I channel offset is set, IOR will be the offset value. In DEMOD mode, the voltage value returned will always be zero volts.

QOR? In IQ mode, the instrument returns the voltage value that corresponds to the voltage level at the center of the Q axis. This will be zero volts if no Q channel offset has been set. If Q channel offset is set, QOR will be the offset value. In DEMOD mode, the voltage value returned will always be zero volts.

XOR? The instrument returns the X origin value that corresponds to the virtual screen position at the center of the screen. Since the virtual screen goes from 0 to 1.0 in the X direction, the instrument will always return 0.5.

YOR? The instrument returns the Y origin value that corresponds to the virtual screen position at the center of the screen. Since the virtual screen goes from 0 to 1.0 in the Y direction, the instrument will always return 0.5.

TOR? The instrument returns the time origin value. The time origin will be zero if no common (I&Q) delay has been added. If common delay has been added, TOR will be the same as this value. The user must account for any differential delays (DELI or DELQ) as they are not included in TOR.

Reference Commands

There are five separate commands that are used to query the reference value. The five commands are IREF?, QREF?, XREF?, YREF?, and TREF?. The reference value in all cases is the A/D count of the origin given in the corresponding origin command (IOR?, QOR?, XOR?, YOR?, and TOR?).

Interpreting Data

The WAVE:DATA and WAVE:DATAB commands in the HP-IB waveform subsystem are used to cause the instrument to send raw A/D count values of selected points in any display mode. The Increment, Origin, and Reference commands listed above are included to scale the raw A/D counts.

Once all of the data points and scaling information have been acquired from the instrument, the user can mathematically calculate the actual voltage or magnitude, time, or screen position of each individual point.

The general formula for interpreting data is as follows:

$$\text{POINT VALUE} = [(\text{RAW DATA} - \text{REFERENCE}) * \text{INCREMENT}] + \text{ORIGIN}$$

Where POINT VALUE is the voltage or magnitude, time, or screen position of the data point and RAW DATA is any of the data points that are returned when the DATA? or DATAB? command is executed. REFERENCE is the value that is returned when the IREF?, QREF?, XREF?, YREF?, or TREF? command is executed. INCREMENT is the value that is returned when the IINC?, QINC?, XINC?, YINC?, or TINC? command is executed. ORIGIN is the value that is returned when the IOR?, QOR?, XOR?, YOR?, or TOR? command is executed.

The following paragraphs explain use of the formula:

When a given data point is transmitted from the instrument, it simply represents an analog-to-digital (A-to-D) converter count value along a given axis. For the sake of this discussion, let this given point be "Point A". The A-to-D converter has 12 bits of resolution for a range of zero to 4095. Zero is somewhat off the display at the lower-magnitude end of the given axis and 4095 is somewhat off the display at the higher-magnitude end of the given axis. Figure 3-12 illustrates this.

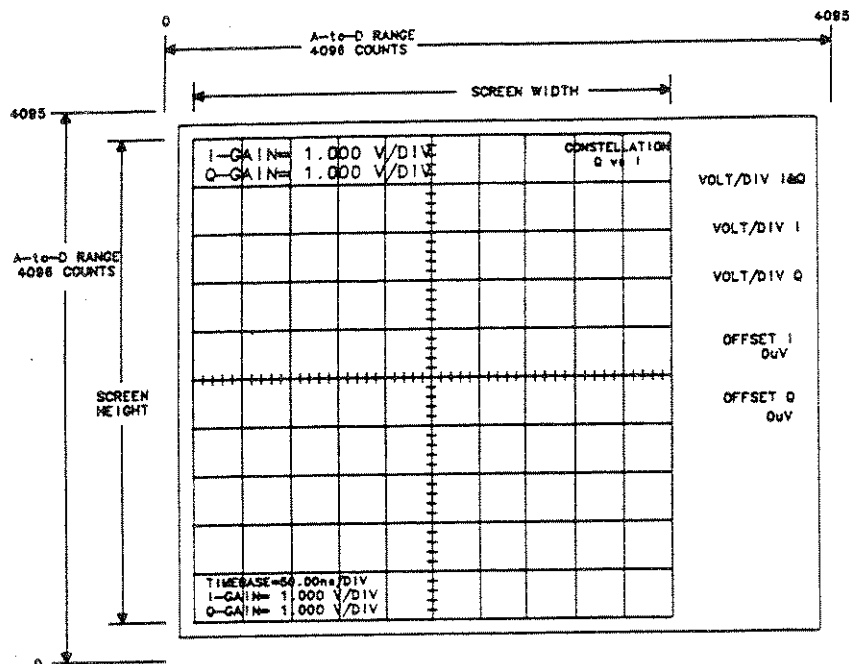

Figure 3-12. Display Showing A-to-D Counts

The A-to-D value (Point A) that is returned by the instrument can be translated to a value, such as volts, time, etc. that is of more use in calculations.

Remembering that the reference value (see "Reference Commands" earlier in this description) is the A-to-D count for the center of the display, we now have a dependable point on the display (the center) to which Point A can be referenced. If this value is subtracted from Point A, the result is the number of counts Point A is from the display center.

The increment (see "Increment Commands" earlier in this description) is some unit value per A-to-D count, whether that unit be volts, percent of full scale, time, or fractions of screen. If, for example, Point A is a sample of a waveform along the I axis, multiplying the value from the above paragraph by the increment value will produce the magnitude in volts that Point A is away from the screen center (assume instrument is in IQ mode). This, however, does not take into account any offset. This is accounted for, however, by adding to the magnitude the value returned when the Origin query is executed. (see "Origin Commands" earlier in this description).

Procedure

Note



The Increment and Origin commands for "I" and "Q" return different values depending upon which mode the instrument is in. The mode should be set before the source is selected if it is not already in the desired mode. See the DEMODULATION Detailed Operating Instruction for HP-IB codes for selecting the instrument mode.

1. Set the source that the data will be gathered from. Use the following command:

WAVE:SOUR source

Where "source" is the appropriate source for the type of data being gathered. All source codes can be found in the PROGRAM CODES section of this Detailed Operating Instruction.

2. Select the number of data points to be sampled. Use the following command:

WAVE:POIN num

Where "num" is the number of data points from 1 to 1024.

3. Cause the instrument to gather and transmit data. To transmit data in arbitrary ASCII character format, use the following command:

WAVE:DATA?

To transmit data in definite length block format, use the following command:

WAVE:DATAB?

The instrument will then transmit data in the following format:

#LXX...XY₁Y₂Y₃...Y_n<LF>

As defined as follows:

L is a digit from 1 to 9 which designates how many of the following digits determine the length of the data to be transmitted.

XX...X is a string of 1 to 9 bytes, as specified by L, which determines how many bytes of block data will be transmitted.

Y₁Y₂Y₃...Y_n is the point data transmitted. (Refer to tables 3-15 and 3-16 for more information).

<LF> is a line feed character.

4. Query the reference. Use the following commands:
WAVE:IREF? - To query the I channel reference value.
WAVE:QREF? - To query the Q channel reference value.
WAVE:XREF? - To query the X axis reference value.
WAVE:YREF? - To query the Y axis reference value.
WAVE:TREF? - To query the Time axis reference value.
5. Query the origin value. Use the following commands:
WAVE:IOR? - To query the I channel origin value.
WAVE:QOR? - To query the Q channel origin value.
WAVE:XOR? - To query the X axis origin value.
WAVE:YOR? - To query the Y axis origin value.
WAVE:TOR? - To query the Time axis origin value.
6. Query the increment value. Use the following commands:
WAVE:IINC? - To query the I channel increment value.
WAVE:QINC? - To query the Q channel increment value.
WAVE:XINC? - To query the X axis increment value.
WAVE:YINC? - To query the Y axis increment value.
WAVE:TINC? - To query the Time axis increment value.
7. Now that all the information and data points have been obtained from the instrument, use the following general equation substituting with the raw data values and other information:

$$\text{POINT VALUE} = [(\text{RAW DATA} - \text{REFERENCE}) * \text{INCREMENT}] + \text{ORIGIN}$$

Example

The following example explains how the user can set up the display, select the points, gather and transmit data, query the reference, origin, and increment values, and use all the collected information to interpret the actual values of the data points. The procedure will be the same for finding voltage or magnitude, time, or fraction of screen values. The difference will be in using the proper Source, Reference, Origin, and Increment commands that are relevant to the type of data being interpreted. The Point and Data commands are the same for all types of data.

In this example, data will be taken from a Vector display with the instrument in IQ mode. Once the data points are collected, they can be analyzed via part of a test program to see if they fall within a voltage range of $\pm 2.5V$ relative to the I axis. The following procedure explains how this is done:

1. Set up the source and select the number of data points to be sampled. The source will be a Vector display and the number of points sampled will be 250.

```
WAVE:SOUR VECTOR  
WAVE:POIN 250
```

2. Gather and transmit data. Data will be transmitted in ASCII character format. Typically, the data would be read into computer memory as part of the test program.

WAVE:DATA?

3. Query the reference, origin, and increment values. Assume no offset has been added to the display.

WAVE:IREF?
WAVE:IOR?
WAVE:IINC?

The values the instrument returns is a reference of 1950 counts, an origin of 0V, and an increment value of 0.0019047 volts/count.

4. Now that all data and other values have been obtained, each data value can be determined using the general formula $POINT\ VALUE = [(RAW\ DATA - REFERENCE) * INCREMENT] + ORIGIN$. For the sake of this example, assume the twenty-seventh data point sampled had a value of 3000. If the voltage of this point were to be calculated, it would be $[(3000 - 1950) * 0.0019047] + 0$ or 2 volts. If the voltage values of all 250 data points are calculated using the formula, the test program can determine if the signal voltage went beyond the $\pm 2.5V$ limit.

HP-IB Program Codes

Command Level	Description	Code (1)
Subsystem (SUBS) Codes	Waveform	WAVE WAV WAVEFORM
Function (FNA) Codes	ASCII Data	DATA?
	Block Data	DATAB?
	I Channel Increment	IINC? IINCREMENT?
	I Channel Origin	IOR? IORIGIN?
	I Channel Reference	IREF? IREFERENCE?

Command Level	Description	Code (1)
Function (FNA) Codes (cont'd)	Points	POIN POINTS PNTS
	Q Channel Increment	QINC? QINCREMENT?
	Q Channel Origin	QOR? QORIGIN?
	Q Channel Reference Source	QREF? QREFERENCE? SOUR SOURCE SRC
	Time Increment	TINC? TINCREMENT?
	Time Origin	TOR? TORIGIN?
	Time Reference	TREF? TREFERENCE?
	X Axis Increment	XINC? XINCREMENT?
	X Axis Origin	XOR? XORIGIN?
	X Axis Reference	XREF? XREFERENCE?
	Y Axis Increment	YINC? YINCREMENT?
	Y Axis Origin	YOR? YORIGIN?
	Y Axis Reference	YREF? YREFERENCE?

(1) If multiple codes appear in this column, the first one listed is the preferred code. Others are given to be compatible with IIPOL (Hewlett-Packard Oscilloscope Language).

Parameter	Program Code (SUBS: FNA FNB)
gather and transmit ASCII data	WAVE:DATA?
gather and transmit block data	WAVE:DATAB?
query I channel increment	WAVE:IINC?
query I channel origin	WAVE:IOR?
query I channel reference	WAVE:IREF?
set data points to be sampled	WAVE:POIN 1 to 1024
query Q channel increment	WAVE:QINC?
query Q channel origin	WAVE:QOR?
query Q channel reference	WAVE:QREF?
select I channel source	WAVESOUR CHANI
select Q channel source	WAVESOUR CHANQ
select I&Q channel source	WAVESOUR CHANIQ
select vector display source	WAVESOUR VECTOR
select constellation display source	WAVESOUR CONST
select XY source	WAVESOUR XY
query time increment	WAVE:TINC?
query time origin	WAVE:TOR?
query time reference	WAVE:TREF?
query X axis increment	WAVE:XINC?
query X axis origin	WAVE:XOR?
query X axis reference	WAVE:XREF?
query Y axis increment	WAVE:YINC?
query Y axis origin	WAVE:YOR?
query Y axis reference	WAVE:YREF?

Indications

When the WAVESOUR command is executed, the display will switch to whatever source was selected if it is not XY.

Related Sections

Constellation Display
Demodulation
I&Q Versus Time Display
I Versus Time Display
Q Versus Time Display
Special Display
Vector Display

Delay Selection

Description

The TIMING key activates a menu that allows the user to insert a delay prior to the start of the time sweep. The delay is defined as the elapsed time from the trigger until the start of the time sweep. Delays can either be added to each channel separately (differential) or simultaneously to both channels. If any simultaneous I and Q delay is added to the time sweep, individual I or Q differential delays will be added to the simultaneous delay.

The differential delay functions are useful for allowing the user to cancel delays caused by cable length differences or to view the states of staggered modulation signals.

Procedure

Setting I and Q Channel Delay Simultaneously

1. Press the TIMING key. This activates the timing menu on the display.
2. Press the DELAY I&Q softkey. Use either a function-data-units entry or the step up/step down keys or knob to set the desired delay. The DELAY I&Q function parameters are as follows:

Range	0 to 1000 divisions, up to a maximum of 20 ms.
Knob Resolution	10% of TIME/DIV setting
Step Up/Down Resolution	100% of TIME/DIV setting

Setting I or Q Channel Delay Independently

1. Press the TIMING key. This activates the timing menu on the display.

- Press either the DELAY I or DELAY Q softkey depending upon what channel needs the time delay. Use either a function-data-units entry or the step up/step down keys or knob to set the desired delay. The function parameters for both the DELAY I and DELAY Q functions are as follows:

Range	0 to 5 divisions, up to a maximum of 20 μ
Knob Resolution	1% of TIME/DIV setting
Step Up/Down Resolution	50% of TIME/DIV setting

Example

The user wants to select an I channel differential delay of 750 ns. The time base is currently set to 200 ns/div.

LOCAL (key-strokes)	
 (Program Codes)	TIM:DEL I 7.5E-7

HP-IB Program Codes

Command Level	Description	Code (1)
Subsystem (SUBS) Codes	Timing	TIM TIMEBASE
Function (FNA) Codes	I and Q Delay	DEL DELAY DLY OFFS OFFSET
	I Delay	DELI

Command Level	Description	Code (1)
Function (FNA) Codes (cont'd)	Q Delay	DELQ

(1) If multiple codes appear in this column, the first one listed is the preferred code. Others are given to be compatible with HPOL (Hewlett-Packard Oscilloscope Language).

Parameter	Program Code (SUBS: FNA FNB)
simultaneous I and Q delay	TIM:DEL 0 to 20E-3 (1)
I delay	TIM:DELI 0 to 20E-6 (2)
Q delay	TIM:DELQ 0 to 20E-6 (2)

(1) "0 to 20E-3" should be replaced with the selected time delay to be added simultaneously to both channels. The delay should be from 0 to 20 ms.

(2) "0 to 20E-6" should be replaced with the selected time delay to be added to the I or Q channels. The delay should be from 0 to 20 μ s.

Indications

When the TIMING key is pressed, the timing menu is activated with the active menu items highlighted (brighter). The delay associated with the active softkey will be shown in the User Interface Area. The delays for DELAY I&Q, DELAY I, and DELAY Q will be shown under their respective menu items. As a delay parameter is changed via either the step up/step down keys or knob, it will be seen changing in the User Interface Area as well as under the active softkey.

Comments

As DELAY I&Q is increased to greater than ten screens, the timing jitter of the whole system will increase. This can be improved somewhat by turning off the Holdoff Dither in the INST STA/OTHER menu.

If the DELAY I&Q is extremely large, small changes in the value displayed in the Parameter Data Area may not be reflected in the displayed signal.

Demodulation

Description

This Detailed Operating Instruction covers using the instrument with either the internal or an external demodulator.

Typical Vector Modulation Test System

A typical vector modulation test system consists of a Device Under Test (DUT), such as a digital radio transmitter, with modulated RF and coherent reference outputs connected to a demodulator. The outputs of the demodulator are connected through low pass filters to the Vector Modulation Analyzer. In order for the information displayed on the Vector Modulation Analyzer to be valid, the demodulator should be perfect, that is, it should not have any errors. The instrument has a means for cancelling out these errors in the input signals so that they are not displayed. These errors and the means for cancelling them are covered in the "Demodulator Corrections" Detailed Operating Instruction.

A typical vector modulation test system might appear as in Figure 3-13.

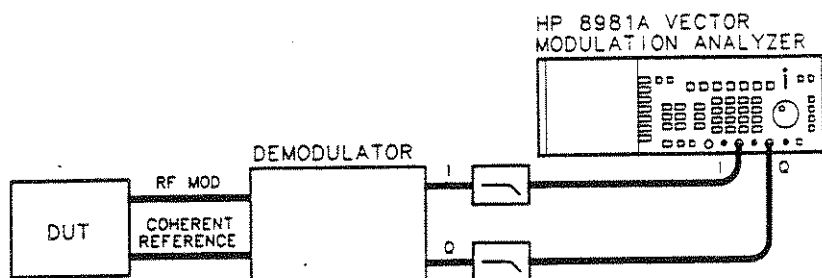

Figure 3-13. Typical Vector Modulation Test System

The HP 8981A can be used as in Figure 3-13 or it can be used with its internal demodulator. In the latter case, the RF Mod. and Coherent Reference outputs of the DUT can be connected directly to the RF IN and COHERENT CARRIER inputs on the back panel of the instrument. The instrument also gives the option of selecting its internal low pass filters or user supplied external low pass filters when the internal demodulator is used.

Phase Offset Error (IQ and DEMOD Modes)

Phase offset error occurs in a vector modulation test system when the coherent reference to the demodulator has some undesirable phase offset relative to the modulated RF input. In the presence of only phase offset error, the demodulated I and Q signals will maintain their 90° relationship to each other but they both will have the same amount of phase offset. When only phase offset error is present, a constellation or vector display will appear rotated about the origin.

The Vector Modulation Analyzer has a phase offset adjustment for manually cancelling this phase offset error so that it does not appear in the display or in measurements.

Set CW Phase to Reference Phase Function

In DEMOD mode, the instrument has a function that calculates a phase correction factor that is added to the RF input signal so that the phase angle between the Coherent Carrier and RF Input always appears to be whatever angle was entered under the REF PHASE softkey.

Quadrature Error (IQ Mode Only)

Quadrature error occurs when the demodulated I and Q signals have a phase relationship that is not exactly 90° apart. When only quadrature error is present, the entire modulation pattern will appear skewed since the I and Q axes are no longer effectively 90° apart.

The Vector Modulation Analyzer has a quadrature adjustment for cancelling this error so that it does not appear in the display or in measurements.

Demodulator Corrections

The "Demodulator Corrections" Detailed Operating Instruction, which includes a group of functions used to correct for imperfections in the input signals, is found elsewhere in this section. These functions are important when using the instrument in demodulation mode.

Modulation Formats

Nine modulation display formats are available. In addition to the standard 10 x 10 oscilloscope format are eight modulation-specific formats. The eight formats are QPSK, 9PRS, 16QAM, 25PRS, 49PRS, 64QAM, 81PRS, and 256QAM. Figure 3-18 in the DISPLAY, GENERAL Detailed Operating Instruction shows each of these formats for Q versus I and voltage versus time.

Procedure

Selecting Demodulation Mode

Note



To use the instrument with an external demodulator and the demodulation correction factors, or to use the internal demodulator, the instrument must be in demodulation mode.

1. Press the DEMOD key. This activates the demodulation menu on the display.
2. Check the text (MODE IQ/DEMOD) that is adjacent to the menu softkey. Either "IQ" or "DEMOD" will be highlighted (brighter). If "DEMOD" is highlighted, do not press the softkey. If "IQ" is highlighted, press the softkey once to select demodulation mode.

Selecting Internal or External Demodulator

1. Press the DEMOD key. This activates the demodulation menu on the display.
2. Press the MORE softkey. This activates the "more" menu on the display.
3. Press the DEMOD INT/EXT softkey so that the desired demodulator selected is highlighted (brighter). Select INT for the internal demodulator and EXT if an external demodulator is used.

Selecting the Low Pass Filters

Note



This function is only valid if the internal demodulator is used. If an external demodulator is used, the rear panel external filter inputs and outputs are not active.

1. Press the DEMOD key. This activates the demodulation menu on the display.
2. Press the MORE softkey. This activates the "more" menu on the display.
3. Check the text (EXT FILTERS ON/OFF) that is adjacent to the menu softkey. Either the "ON" or "OFF" will be highlighted (brighter). If external low pass filters are desired, press the softkey so that "ON" is

highlighted. If the internal low pass filters are desired, press the softkey so that "OFF" is highlighted.

Note



If external low pass filters are chosen, connect a filter between the I EXT FILTER IN and I EXT FILTER OUT connectors and connect another filter between the Q EXT FILTER IN and Q EXT FILTER OUT connectors on the rear panel of the instrument.

Manually Setting the Phase Offset (DEMODO Mode)

1. Press the DEMOD key. This activates the demodulation menu on the display.
2. Press the PHASE ADJ softkey. This activates the phase offset adjustment menu on the display.
3. Press the PHASE OFFSET ADJUST softkey. Use either a function-data-units entry or the step up/step down keys or knob to enter an appropriate amount of phase offset.

Manually Setting the Phase Offset (IQ Mode)

1. Press the DEMOD key. This activates the demodulation menu on the display.
2. Press the PHASE OFFSET ADJUST softkey. Use either a function-data-units entry or the step up/step down keys or knob to enter an appropriate amount of phase offset.

Using the CW PHASE TO REF PHASE Function

1. Determine the desired phase angle between the RF output and the coherent carrier output of the signal source. As an example, the phase angle between the RF output and coherent carrier output of the HP 8780A Vector Signal Generator is 45° for CW.
2. Press the DEMOD key. This activates the demodulation menu on the display.
3. Press the PHASE ADJ softkey. This activates the phase offset adjustment menu on the display.
4. Press the REF PHASE softkey. Use either a function-data-units entry or the step up/step down keys or knob to enter the coherent reference phase.

5. Connect the coherent reference output of the signal source to the COHERENT CARRIER input of the Vector Modulation Analyzer (or the coherent reference input of an external demodulator if one is used). Connect the RF modulation output of the signal source to the RF IN input of the Vector Modulation Analyzer (or the RF mod. input of an external demodulator if one is used).
6. Set the signal source so that the frequency of the coherent reference and the RF modulation output are the same and adjust the Vector Modulation Analyzer so that a dot appears at some angle on the display.
7. Press the SET CW PHASE TO REF PHASE softkey.

Note



The SET CW PHASE TO REF PHASE routine takes several seconds. If any front panel keys are pressed during the routine, the routine will not abort. The key that was pressed will be executed immediately after the routine is finished.

Using the Quadrature Adjust Function (IQ Mode Only)

1. Press the DEMOD key. This activates the demodulation menu on the display.
2. Press the QUADRATURE ADJUST softkey. Use either a function-data-units entry or the step up/step down keys or knob to enter the appropriate amount of quadrature offset.

Turning the RF IN Input ON or OFF

The RF IN input on the rear panel of the instrument can be switched out (turned off) so that offsets can be viewed on the display.

1. Press the DEMOD key on the front panel. This activates the demodulation menu on the display.
2. PRESS the MORE softkey. This activates the "more" menu on the display.
3. Check the text (RF ON/OFF) that is adjacent to the menu softkey. Either the "ON" or "OFF" will be highlighted (brighter). If the RF IN input is to be switched out (turned off), press the softkey so that the "OFF" is highlighted. If the RF IN input is to be switched in (turned on), press the softkey so that the "ON" is highlighted.

Selecting Modulation Format

1. Press the DEMOD key. This activates the demodulator menu on the display.
2. Press the MOD FORMAT softkey. This activates the second level modulation format menu on the display.
3. Press the softkey in the MOD FORMAT menu that corresponds to the desired modulation format. The menu choices are SCOPE FORMAT, QPSK, 9PRS, 16QAM, 64QAM, 256QAM, and MORE. If MORE is pressed, an additional menu will appear with the choices 25PRS, 49PRS, and 81PRS displayed.

Example

A 64QAM modulation pattern is displayed on the Vector Modulation Analyzer. A constellation analysis has determined that the signal has a quadrature error of $+7^\circ$. The user prefers to eliminate this error before using the test setup. Use the following keystroke sequence to do so (NOTE - The instrument is in IQ mode):

LOCAL (key-strokes)	
 (Program Codes)	DEM:FORM QAM64 DEM:QUAD 7

HP-IB Program Codes

Command Level	Description	Code
Subsystem (SUBS) Codes	Demodulation	DEM
Function (FNA) Codes	Modulation Format	FORM
	Phase Adjust	PHAS
	Quadrature Adjust	QUAD
	Instrument Mode	MODE

Command Level	Description	Code
Function (FNA) Codes (cont'd)	Source	SOUR SOURCE SRC
	Filters	EFIL EFILTER EFILT EXTFIL EXTFILT
	Reference Phase	RPHAS
	Set CW Phase to Reference Phase	SPHAS?
	RF Input On/Off	RF

Parameter	Program Code (SUBS: FNA FNB)
select 10x10 oscilloscope format	DEM:FORM NONE
select QPSK modulation format	DEM:FORM QPSK
select 9PRS modulation format	DEM:FORM PRS9
select 16QAM modulation format	DEM:FORM QAM16
select 25PRS modulation format	DEM:FORM PRS25
select 49PRS modulation format	DEM:FORM PRS49
select 64QAM modulation format	DEM:FORM QAM64
select PRS81 modulation format	DEM:FORM PRS81
select 256QAM modulation format	DEM:FORM QAM256
adjust phase offset	DEM:PHAS -360 to 360 (1)
adjust quadrature	DEM:QUAD -20 to 20 (2)

Parameter	Program Code (SUBS: FNA FNB)
set instrument mode to DEMOD	DEM:MODE DMOD
set instrument mode to IQ set demodulator source to internal	DEM:MODE IQMOD DEMSOUR INT
set demodulator source to external	DEMSOUR EXT
select internal filters	DEM:EFIL OFF
select external filters	DEM:EFIL ON
set reference phase	DEM:RPHAS -360 to 360 (3)
set CW phase to reference phase	DEM:SPHAS?
enable RF IN input	DEM:RF ON
disable RF IN input	DEM:RF OFF

- (1) "-360 to 360" should be replaced with a number in degrees that represents the phase error.
 (2) "-20 to 20" should be replaced with a number in degrees that represents the quadrature error.
 (3) "-360 to 360" should be replaced with a number in degrees that represents the coherent reference phase.

Indications

If the instrument mode had been set to IQ, the DEMOD key menu under the MODE IQ/DEMODO softkey will change when it is pressed.

When a modulation format key is pressed, the appropriate modulation format grid will appear on the display if SPLIT SCREEN is OFF. Whether the grid is Q versus I or voltage versus time will depend on the display mode that is active.

When the PHASE OFFSET ADJUST softkey is pressed, the words "PHASE OFS= XX°" will appear in the UIA with XX being the phase offset to hundredths of a degree. As phase offset is changed using either the step up/step down keys or knob, the value will change in the UIA.

When the REF PHASE softkey is pressed, the words "REF PHASE= XX°" will appear in the UIA with XX being the coherent reference phase in hundredths of a degree. As the reference phase parameter is changed using either the step up/step down keys or knob, the value will change in the UIA.

When the CW PHASE TO REF PHASE softkey is pressed, the calculation routine will begin and the message CW PHASE CALCULATION IN PROGRESS will be displayed in the upper portion of the display. After several seconds, the message CW PHASE CALCULATION COMPLETE will appear on the display indicating that the calculation routine is finished. If an incomplete message appears, most likely no input signal was found.

Comments

Before a constellation analysis can be performed, a modulation format grid must be selected.

When a phase offset is entered, it must have the same sign as the error. As an example, if the system has a phase error of $+10^\circ$, the number entered needs to be $+10^\circ$.

When Phase Offset Adjust is added to the display, gains and offsets will be referenced to the new axes as modified by the Phase Offset Adjust.

In internal DEMOD mode, the design of the internal demodulator is such that it can have as much as eight degrees of quadrature error. If a quadrature correction is run, therefore, the correction factor might be as much as eight degrees, leaving twelve degrees of manual quadrature adjustment available. Refer to the "Demodulator Corrections" Detailed Operating Instruction for further information on quadrature correction factor.

Related Sections

Constellation Display
Demodulator Corrections
Display, General
Gain
I&Q Versus Time Display
I Versus Time Display
Measurement Functions
Offset
Q Versus Time Display
Special Display
Vector Display

Demodulator Corrections

Description

When the internal or an external demodulator is used, accuracy of the measurement could be impaired due to certain parameter imperfections in the demodulator. Demodulator circuits do not contain adjustments that can be used to correct these imperfections. The Vector Modulation Analyzer contains a software algorithm that calculates and stores correction factors that correct for the errors of the demodulator before the information is displayed. The algorithm can also be used to correct imperfections in the signal source. This algorithm calculates correction factors for Demodulator Gain, I/Q Gain Ratio, I Offset, Q Offset, and Quadrature Error. The user can also enter manual correction factors for these demodulator parameters. The characteristics of the corrections are explained below.

Note



Pressing the PRESET key turns corrections off but does not alter them.

Note



In the examples in the following paragraphs, assume that only the error being discussed has been introduced into the signals. Other errors in addition to the error being discussed will distort the pattern further.

Gain Correction. A gain error occurs because of the uncertainty of the insertion loss of the demodulator or the magnitude of the source signal. By measuring the actual magnitude of the source signal and entering the value as a reference for the instrument, the algorithm can then correct the instrument so that the displayed magnitude is accurate.

I/Q Gain Ratio Correction. When, as an example, an 8PSK signal is input to a demodulator, the gain ratio of the I and Q signal paths should be such that all eight points are the same distance from the origin when viewed on the display. If the ratio is not ideal, the pattern will appear elliptical instead of circular. An I/Q gain ratio correction will affect the instrument such that the pattern will be circular as shown on the display.

I and Q Offset Corrections. When an 8PSK signal (as an example) is input to a demodulator, no offsets should be introduced by the demodulator into the I and Q outputs. If an offset is introduced into the I or Q signals, the pattern will appear circular but shifted such that the center of the pattern is not at the origin of the display. An I or Q offset correction will affect the instrument such that the center of the pattern is at the origin of the display.

Quadrature Error Correction. When a QPSK pattern (as an example) is viewed on the display and quadrature error is present, the four state pattern will appear skewed (like a parallelogram). This occurs because the demodulator has introduced an error that has caused the phase relationship between the I and Q signals to be something other than 90° . A quadrature error correction will affect the instrument such that the QPSK pattern will appear square on the display with all four points being the same distance from the origin.

The correction factors are calculated at some frequency, which is the frequency of the RF and coherent carrier signals. If the instrument is being used at several frequencies, correction factors for each frequency can be stored in one of six internal storage registers for recall when needed. When the frequency is changed, it is recommended that the proper stored correction factors for that frequency be recalled. Otherwise, the corrections should be performed again. Refer to the "Save and Recall (Demodulator Corrections)" Detailed Operating Instruction for further information.

Procedure

Note



Refer to Table 1-3, Recommended Test Equipment for a listing of equipment recommended for use in these procedures. Any equipment can be used as long as it meets the Critical Specifications listed in the table.

Selecting the Instrument Mode and Demodulator

1. Press the DEMOD key. This activates the demodulation menu on the display
2. Press the MODE IQ/DEMOMOD softkey so that DEMOD is highlighted (brighter) if it is not already highlighted. Doing this will cause the DEMOD key menu to change.
3. Press the MORE softkey. This activates the second level "more" menu on the display.
4. Press the DEMOD INT/EXT softkey so that the desired demodulator selected is highlighted (brighter). Select INT if corrections are for the internal demodulator and EXT if the corrections are for an external demodulator.
5. Press the EXIT softkey to return to the DEMOD menu.

Setting the Reference Frequency

1. Press the REF FREQ softkey. Use either a function-data-units entry or the step up/step down keys or knob to set the frequency of the corrections. The function parameters are as follows:

Range	1 kHz to 100 GHz (external demodulator); 10 MHz to 220 MHz internal demodulator)
Knob Resolution	100 kHz
Step Up/Down Resolution	10 MHz

3. Press the CORRECTION softkey. This activates the demodulator corrections menu on the display.
4. Continue with the following three procedures for performing the desired automatic demodulator corrections.

Performing a Quadrature, IQ Ratio, and Offset Correction - 8PSK Signal

Note



Before an external demodulator correction is performed, the signal should be completely visible on the display to correct for large offsets. Pressing AUTOSCOPE is recommended.

1. Press the QUAD, IQ & OFFSET COR softkey.
2. Set up the instrument and other equipment as shown in Figure 3-14 for the internal demodulator or Figure 3-15 if an external demodulator is used.

Caution



Do not exceed +20 dBm (10 Vdc) continuous power into the RF IN or COHERENT CARRIER inputs on the Vector Modulation Analyzer as damage to the instrument might occur.

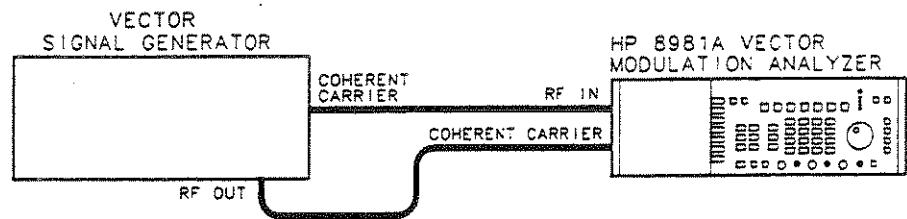

NOTES:

- 1) VECTOR SIGNAL GENERATOR OUTPUT SET TO 8PSK, PSEUDO-RANDOM BIT SEQUENCE.
- 2) COHERENT CARRIER IS CONNECTED TO RF IN TO ELIMINATE ERRORS DUE TO AMPLITUDE CHANGES OF THE RF OUT SIGNAL AS THE PHASE CHANGES.

Figure 3-14. Equipment Setup - Internal Demodulator

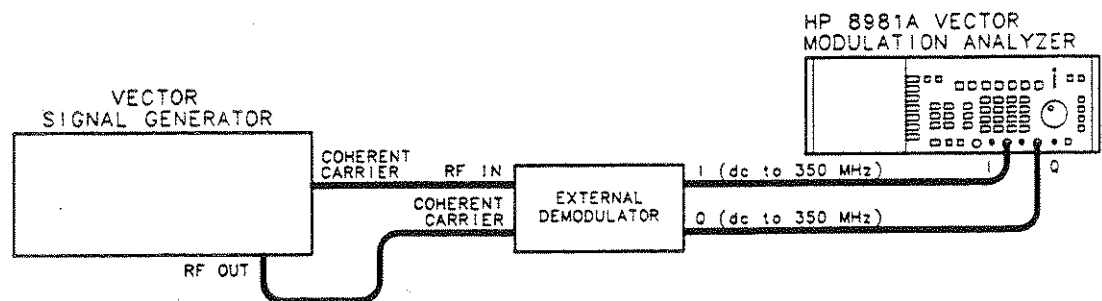

Figure 3-15. Equipment Setup - External Demodulator

3. Press the START 8PSK CORRECTION softkey. Some time will elapse before a message appears indicating that the corrections are complete.
4. Once the corrections complete message appears, press the EXIT softkey to return to the corrections menu.

Note



If any key is pressed before the correction complete message appears, the correction will abort and no change will be made.

Performing a Quadrature, IQ Ratio, and Offset Correction - Tone Signal

Note 

Before an external demodulator correction is performed, the signal should be completely visible on the display to correct for large offsets. Pressing AUTOSCOPE is recommended.

1. Press the QUAD, IQ & OFFSET COR softkey.
2. Set up the instrument and other equipment as shown in Figure 3-16 for the internal demodulator or Figure 3-17 if an external demodulator is used.

Caution 

Do not exceed +20 dBm (10 Vdc) continuous power into the RF IN or COHERENT CARRIER inputs on the Vector Modulation Analyzer as damage to the instrument might occur.

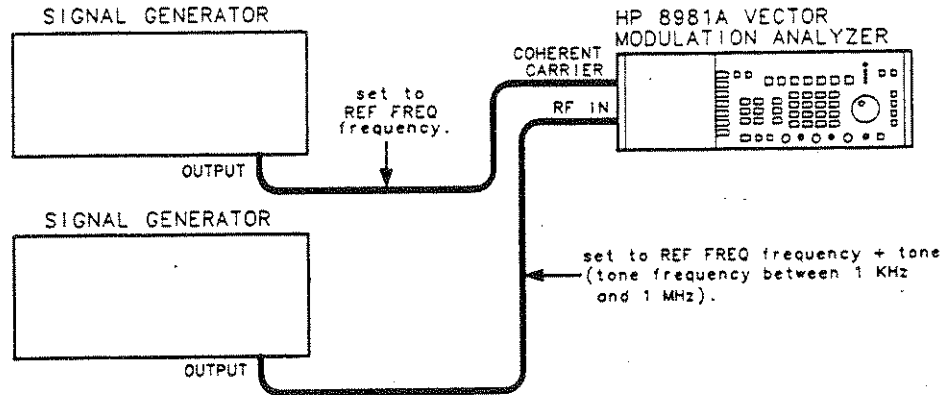

Figure 3-16. Equipment Setup - Internal Demodulator

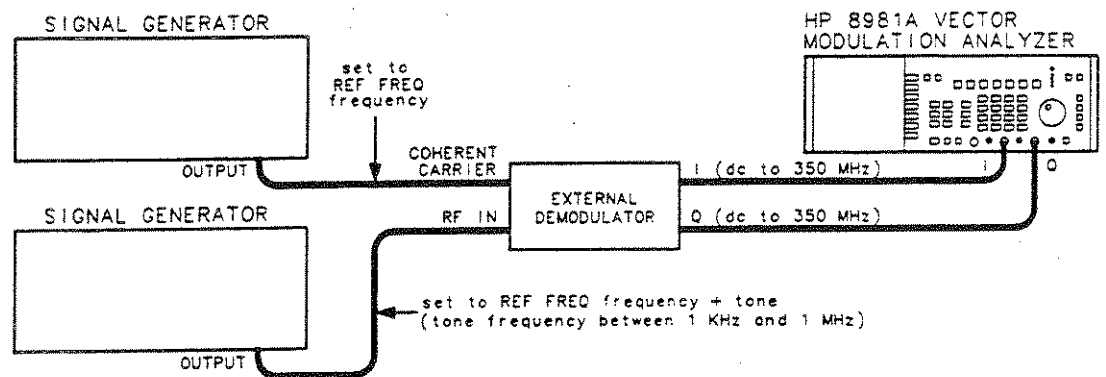

Figure 3-17. Equipment Setup - External Demodulator

3. Press the START TONE CORRECTION softkey. Some time will elapse before a message appears indicating that the corrections are complete.
4. Once the corrections complete message appears, press the EXIT softkey to return to the corrections menu.

Note



If any key is pressed before the correction complete message appears, the correction will abort and no change will be made.

Performing a Demodulator Gain Correction

1. Press the DEMOD GAIN CORRECTION softkey.
2. If absolute power measurements are to be made on the display, measure the level of the RF input signal using a power meter to provide a calibrated reference level.

3. Press the RF LEVEL softkey. Use either a function-data-units entry or the step up/step down keys or knob to enter the RF level obtained in step 2 or from the readout on the signal source if fine accuracy is not needed. The function parameters are as follows:

Range	-99.99 dBm to 99.99 dBm
Knob Resolution	0.1 dB
Step Up/Down Resolution	1.0 dB

Caution 

Although the RF LEVEL function accepts parameter entry between -99 dBm and 99 dBm, the RF IN input can be damaged if the power exceeds +20 dBm (10 Vdc) continuous.

4. For a demodulator gain correction, either a tone signal or an 8PSK signal can be used. The equipment setups from the previous two sections are valid. For 8PSK signal testing, the RF Input and Coherent Carrier signals must be switched from what is shown in the figure.
5. Depending upon whether a tone or 8PSK signal is being used, set up the instrument and other equipment as shown in figures 3-14 or 3-16 for the internal demodulator or Figures 3-15 or 3-17 if an external demodulator is used.

Caution 

Do not exceed +20 dBm (10 Vdc) continuous power into the RF IN or COHERENT CARRIER inputs on the Vector Modulation Analyzer as damage to the instrument might occur.

6. Press the START GAIN CORRECTION softkey. Some time will elapse before a message appears indicating that the correction is complete.
7. Once the correction complete message appears, press the EXIT softkey to return to the corrections menu.

Note 

If any key is pressed before the correction complete message appears, the correction will abort and no change will be made.

Setting Manual Corrections

1. Press the DEMOD key. This activates the Demodulation menu on the display.
2. Press the CORRECTION softkey. This activates the Demodulator Corrections menu on the display.

3. Press the MANUAL CORRECTION softkey. This activates the Manual Corrections menu on the display. Use step 4, 5, 6, 7, or 8 to set the manual correction depending upon which correction is to be set.
4. **Quadrature Correction** - Press the QUAD CORR softkey. Use either a function-data-units entry or the step up/step down keys or knob to enter the desired quadrature correction. The function parameters are as follows:

Range	-20.00 to 20.00°
Knob Resolution	0.01°
Step Up/Down Resolution	0.5°

Note



In internal DEMOD mode, the design of the internal demodulator is such that it can have as much as 8° of quadrature error. If a quadrature correction is run, therefore, the correction factor might be as much as 8°, leaving 12° of manual quadrature adjustment available.

5. **I Offset Correction** - Press the I OFS CORR softkey. Use either a function-data-units entry or the step up/step down keys or knob to enter the desired I offset correction. The function parameters are as follows:

Range	± full scale voltage value
Knob Resolution	0.2% of full scale voltage value
Step Up/Down Resolution	5% of full scale voltage value

6. **Q Offset Correction** - Press the Q OFS CORR softkey. Use either a function-data-units entry or the step up/step down keys or knob to enter the desired Q offset correction. The function parameters are as follows:

Range	± full scale voltage value
Knob Resolution	0.2% of full scale voltage value
Step Up/Down Resolution	5% of full scale voltage value

7. **I/Q Gain Ratio Correction** - Press the I/Q CORR softkey. Use either a function-data-units entry or the step up/step down keys or knob to enter the desired I/Q gain ratio correction. The function parameters are as follows:

Range	0 to ±99.999 dB
Knob Resolution	0.001 dB
Step Up/Down Resolution	0.1 dB

8. **Gain Correction** - Press the GAIN CORR softkey. Use either a

function-data-units entry or the step up/step down keys or knob to enter the desired gain correction. The function parameters are as follows:

Range	0 to ± 50.00 dB
Knob Resolution	0.01 dB
Step Up/Down Resolution	1.00 dB

Clearing Current Corrections

To clear the correction factors currently being used by the instrument (not the correction factors stored in the internal storage registers), press the CLEAR CURR CORRECTIONS softkey in the DEMOD/CORRECTION/MANUAL CORRECTIONS menu.

Example

The user wishes to perform an automatic internal demodulator gain correction at a reference frequency of 80 MHz. The instrument is currently set to IQ mode and the "external demodulator" softkey is active. The RF level of the signal source has been determined to be -10 dBm.

LOCAL (key- strokes)	<div style="display: flex; justify-content: space-between; margin-bottom: 5px;"> DEMOD MODE IQ/DEMOD <input type="text"/> MORE <input type="text"/> DEMOD INT/EXT <input type="text"/> EXIT <input type="text"/> </div> <div style="display: flex; justify-content: space-between; margin-bottom: 5px;"> REF FREQ <input type="text"/> <input type="text" value="8"/> <input type="text" value="0"/> MHZ <input type="text"/> CORRECTION <input type="text"/> </div> <div style="display: flex; justify-content: space-between; margin-bottom: 5px;"> DEMOD GAIN CORRECTION <input type="text"/> RF LEVEL <input type="text"/> <input type="text" value="1"/> <input type="text" value="0"/> CHG SIGN </div> <div style="display: flex; justify-content: space-between;"> dBm <input type="text"/> START GAIN CORRECTION <input type="text"/> </div>
 (Program Codes)	DEM:MODE DMOD; SOUR INT; RFREQ 80MHZ; CORR: RLEV -10DBM; GCOR?

**HP-IB Program
Codes**

Command Level	Description	Code (1)
Subsystem (SUBS) Codes	Corrections	CORR COR
	Demodulation	DEM
Function (FNA) Codes (under subsys- tem CORR)	Quad. IQ, and Offset Correction	GCOR?
	Gain Correction	GCOR?
	RF Level	RLEV
	Quadrature Correction	QUAD
	I Offset Correction	IOFF IOFFS IOFFSET
	Q Offset Correction	QOFF QOFFS QOFFSET
	IQ Ratio Correction	IQRT
	Gain Correction	GAIN
	Clear Current Corrections	CLRC
Corrections State	STAT	
Function (FNA) Codes (under subsystem DEM)	Instrument Mode	MODE
	Reference Frequency	RFREQ
	Source	SOUR SOURCE SRC

(1) If multiple codes appear in this column, the first one listed is the preferred code. Others are given to be compatible with HPOI. (Hewlett-Packard Oscilloscope Language).

Parameter	Program Code (SUBS:FNA FNB)
corrections enabled	CORR:STAT ON
corrections disabled	CORR:STAT OFF
perform automatic quadrature, IQ gain ratio, and offset correction	CORR:QCOR?
perform automatic gain correction	CORR:GCOR?
set the source RF level	CORR:RLEV -99.99 to 99.99 (1)
perform quadrature correction	CORR:QUAD -20.00 to 20.00 (2)
perform I offset correction	CORR:IOFF +FS to -FS (3)
perform Q offset correction	CORR:QOFF +FS to -FS (3)
perform IQ gain ratio correction	CORR:IQRT 0 to ±99.999 (4)
perform gain correction	CORR:GAIN 0 to ±50.00 (5)
clear current corrections	CORR:CLRC
set instrument mode to demodulation	DEM:MODE DMOD
set instrument mode to IQ	DEM:MODE IQMOD
set current reference frequency	DEM:RFREQ num (6)
select internal demodulator	DEMSOUR INT
select external demodulator	DEMSOUR EXT

(1) "-99.99 to 99.99" should be replaced with the RF level of the signal source used in a gain correction. The number is in dBm.

(2) "-20.00 to 20.00" should be replaced with the quadrature error correction. The number is in degrees.

(3) "+FS to -FS" should be replaced with the selected I or Q offset correction in volts. The actual range is dependent upon the full scale magnitude that is set and the parameter cannot be set so that the signal is off the display.

(4) "0 to ±99.999" should be replaced with the IQ gain ratio correction. The number is in dB.

(5) "0 to ±50.00" should be replaced with the demodulator gain correction. The number is in dB.

(6) "num" should be replaced with the reference frequency that the corrections are to be performed at. The actual range for "num" depends upon whether an external or the internal demodulator is used. For the internal demodulator, the range is 10 MHz to 220 MHz and for an external demodulator, the range can be from 1 kHz to 100 GHz.

Indications

When any of the corrections are started, the display will blank or the information displayed will flicker. The message "DEMOD CORRECTION IN PROGRESS" will be displayed near the top of the screen if a quadrature, IQ, and offset correction is being performed. If a demodulator gain correction is being performed, the message "GAIN CORRECTION IN PROGRESS" will be displayed. The automatic correction process might take up to a minute to complete.

If any front panel key is pressed before the appropriate message, either "DEMOD CORRECTION COMPLETE" or "GAIN CORRECTION COMPLETE" is displayed, an error message will be displayed below the center of the display indicating that the correction aborted.

If the correction was unsuccessful, an appropriate "Incomplete" message will be displayed.

Comments

The manual correction menu displays the results of either the entered manual corrections or the automatic corrections under the appropriate softkey item. This menu, therefore, provides a means for the user to view or alter the results of an automatic demodulator correction.

When an automatic demodulator correction is run using an HP 8780A Vector Signal Generator with high power option as the signal source, use a 20 dB attenuator on the coherent reference output. Otherwise, the RF IN input of the Vector Modulation Analyzer could be damaged by the high power of the signal generator.

Related Sections

Demodulation
Save and Recall (Demodulator Corrections)

Display, General

Description

This instruction covers general characteristics of all display modes as well as commands that can be used to control certain aspects of all displays. Automatic intensity shutoff is also explained in the Comments section of this Detailed Operating Instruction.

Display Modes

The Vector Modulation Analyzer has six display modes available. These display modes are listed below:

1. I VERSUS TIME
2. Q VERSUS TIME
3. I&Q VERSUS TIME
4. VECTOR
5. CONSTELLATION
6. SPECIAL DISPLAY

The Special Display mode is further broken down into three more special purpose display modes. These are CONSTELLATION ALIGN, VECTOR ALIGN, and 3-DIMENSIONAL.

Nine display formats are available within each of the display modes with the exception of the 3-Dimensional display mode. In addition to the standard 10 x 10 oscilloscope format are eight modulation-specific formats. These formats are shown in Figure 3-18.

Each display mode is described individually in a separate Detailed Operating Instruction.

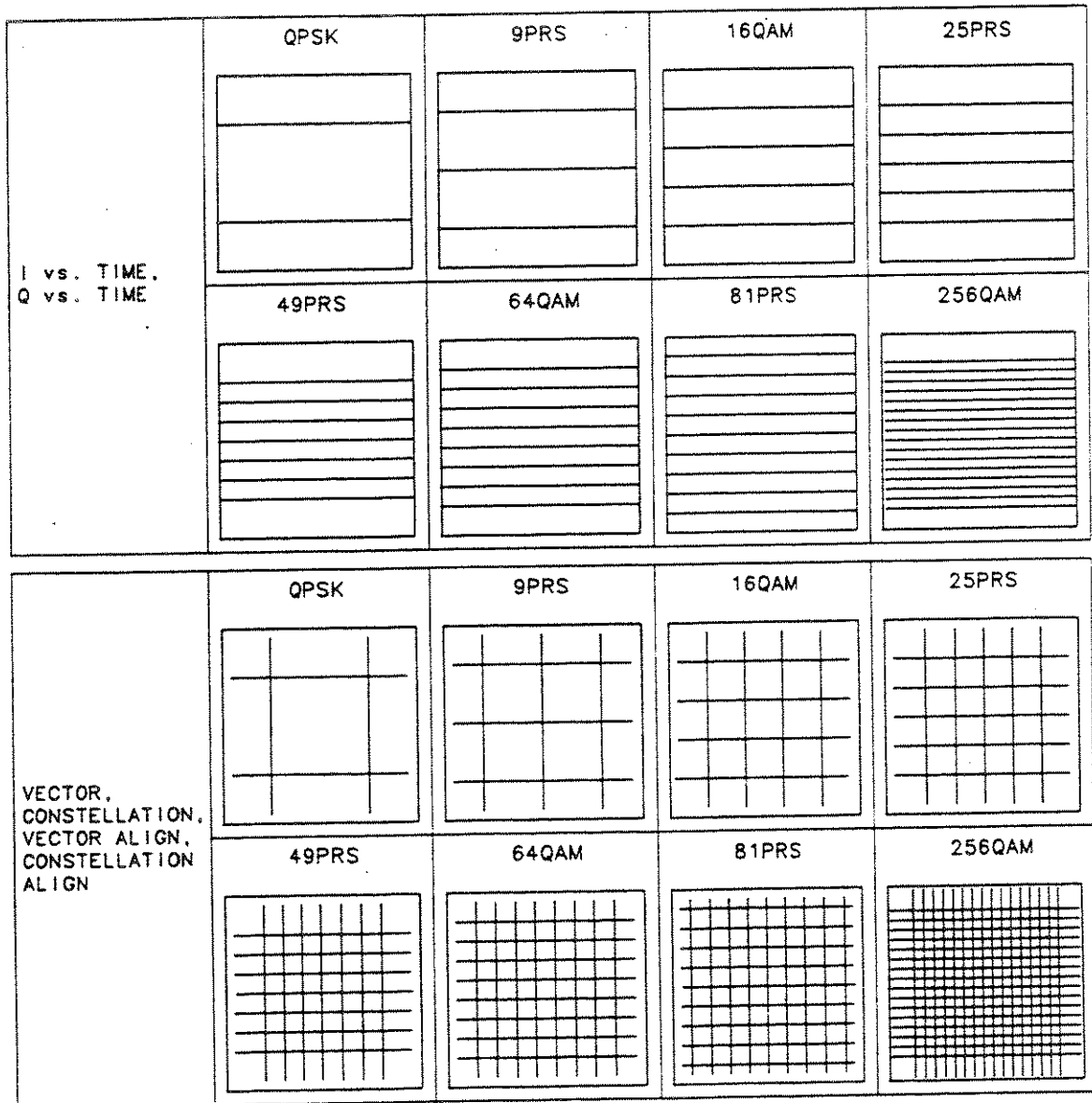

Figure 3-18. Display Formats

Display Areas

The display is divided into several areas where specific types of information can always be found. Figure 3-19 shows the location of these areas and a brief description of each follows.

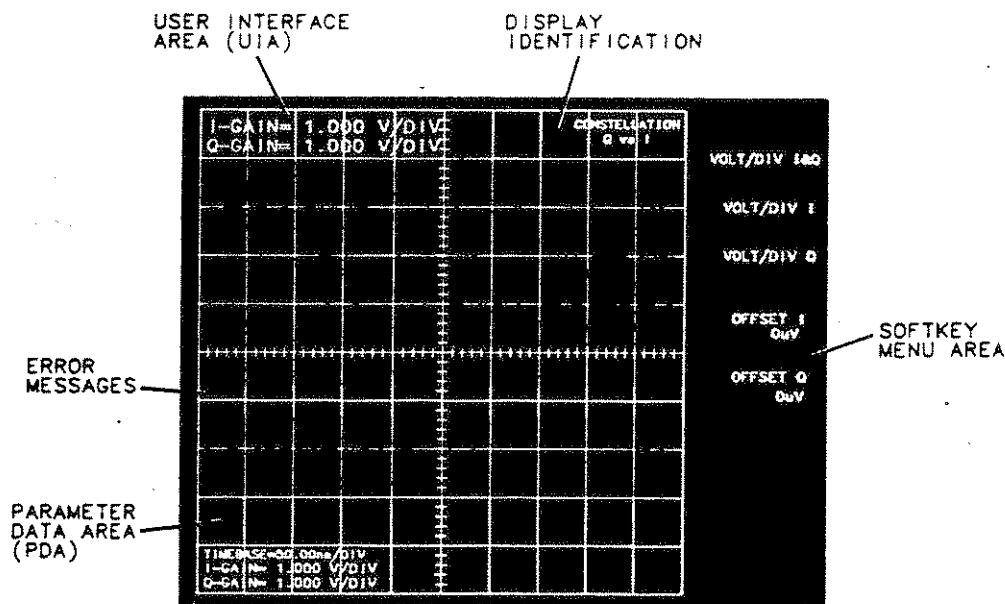

Figure 3-19. Display Areas

User Interface Area (UIA). The parameter that is currently being entered or changed by the user will appear in this area

Display Identification. The currently selected display mode will be shown here.

Softkey Menu Area. The active softkey menu will be displayed here. The text on the display identifies the function of the menu key that is adjacent to it on the front panel.

Parameter Data Area (PDA). Most display parameters that have been entered, such as gain or timebase, will be displayed here.

Error Messages. All error messages and their identification numbers will appear on several lines in this area.

General Display Control Commands

SIGNAL INTENSITY - This function is found in the SPCL DISP menu. It allows the user to adjust the intensity of the signal being displayed. The range is from 0 to 8, with 0 being off (no signal displayed) and 8 being brightest.



Use only as much signal intensity as is necessary for comfortable signal viewing to avoid shortening the life of the display CRT.

ENT OFF - This front panel key removes text from the display in a sequential fashion and disables data entry. Sequential pressing of the ENT OFF key results in the following actions:

First Press. Softkey Menu Area is blanked and menu is disabled. The User Interface Area (UIA) is blanked and the data entry keys are disabled.

Second Press. Parameter Data Area (PDA) is blanked.

Third Press. Display Identification, frame, axes, and graticule are blanked, leaving only the analog signal and HP logo.

Procedure

Adjusting Signal Intensity

1. Press the SPCL DISP key. This will activate the special display menu on the display.
2. Use either a function-data-units entry or the Step Up/Step Down keys or knob to increase or decrease the brightness of the displayed signal.



Use only as much signal intensity as is necessary for comfortable signal viewing to avoid shortening the life of the display CRT.

Using the ENT OFF Feature





Press the ENT OFF key the required amount of times to produce the desired effect on the display. These effects are outlined under the DESCRIPTION portion of this Detailed Operating Instruction. To return full text to the display at any time, press any other key.



When any other key is pressed, that key is immediately executed.

Example

A Constellation pattern is currently on the display. The user needs to set the intensity to its dimmest setting. The display intensity is currently set to its brightest setting.

LOCAL (key- strokes)	 PRESS   SEVEN TIMES TO DECREASE THE INTENSITY FROM "8" TO "1".
 (Program Codes)	DISP:INT 1

**HP-IB Program
Codes**

Command Level	Description	Code (1)
Subsystem (SUBS) Codes	Display	DISP DISPLAY
Function (FNA) Codes	All Intensity	ALL (2) INT

(1) If multiple codes appear in this column, the first one listed is the preferred code. Others are given to be compatible with HPOL (Hewlett-Packard Oscilloscope Language).

(2) There is no HP-IB command that exactly duplicates the front panel ENT OFF key. The "ALL" HP-IB function code is used to blank the entire display, including the analog signal.

Parameter	Program Code (SUBS: FNA FNB)
blank display	DISP: ALL OFF
unblank display	DISP: ALL ON
adjust signal intensity	DISP: INT 0 to 8 (1)

(1) "0 to 8" should be replaced with a whole number from 0 to 8. The number 8 represents the brightest intensity and 1 represents the dimmest intensity of the analog signal. The number 0 blanks the analog signal.

Indications

When the SPCL DISP key is pressed, the SIGNAL INTENSITY softkey will be active and highlighted. The words "SIGNAL INTENSITY= X" will be in the User Interface Area (UIA) with "X" being the currently selected signal intensity. As the signal intensity is changed, the signal intensity number will change in the UIA and the displayed signal will get brighter or dimmer. If a signal intensity number of zero (0) is chosen, the displayed signal will disappear.

When the ENT OFF key is pressed once, all items in the Softkey Menu Area and UIA are blanked. When pressed again, all items in the Parameter Data Area are blanked. When pressed a third time, everything else is blanked except for the displayed signal and HP logo. Pressing the ENT OFF key more than three times will not bring the information back. Pressing any other key, however, will return the full display.

Comments

If no front panel keys are pressed and no HP-IB commands or queries are sent to the instrument for approximately 10 minutes, the analog signal on the display will be blanked and the message "INTENSITY AUTO SHUTOFF OCCURRED PRESS ANY KEY TO ENABLE SIGNAL" will be displayed. This occurs to protect the CRT from being damaged. Pressing any key will return the analog signal to the display. It is suggested that the LCL key be used as it has no effect on the instrument setup.

Related Sections

Constellation Display
Error Messages and Recovery
I&Q Versus Time Display
I Versus Time Display
Menu Softkeys
Q Versus Time Display
Special Display
Vector Display

Error Messages and Recovery

Description

General

Error messages are displayed just below the screen center along with an identification (ID) number whenever some event occurs that inhibits normal operation of the instrument.

The table at the end of this Detailed Operating Instruction lists the ID number and message, a short description, and the recovery sequence for each error.

If the error is service related, a reference to the Service Manual will be provided in place of the recovery sequence.

Note



If the instrument is being returned to Hewlett-Packard for servicing due to recurring error messages, report the error message ID number or numbers on the blue service tag.

Error Messages Read From the Screen.

When an error message is displayed on the screen, it will have an identification (ID) number in parentheses displayed directly below it. As an example, if the user tries to pass a parameter with the HP-IB "KEY" command that is invalid, the following error message and ID number will be displayed as shown:

```
--KEY CODE NOT ASSIGNED--  
(ID # 8501)
```

Table 3-17 lists all of the error messages. The ID number precedes the error message in column one of the table. All errors are listed in numerical order by ID number.

Error Messages Read Via HP-IB

When an error occurs due to an HP-IB related event, an error number for the particular error will be stored in the error queue. The error queue is a buffer that is internal to the Vector Modulation Analyzer. It can contain up to sixteen error numbers. Every time the "ERR?" query is executed, one error number is read from this register. Error numbers are read in a first-in/first-out basis.

If the error queue is empty, the instrument will return a value of 0 (zero). Once the error queue is full (when it receives a 17th error number), the number -32768 is stored in the last location. As error numbers are stored and read from the error queue, this number will move within the queue, but will not actually be read until all other error queue locations have been read. Therefore, reading the number -32768 from the error queue only indicates that the buffer did overflow at some point in time.

In Table 3-17, the ID number that precedes the error message is the same as the error number that is stored in the error queue.

Procedure

Errors on the Screen



Go to Table 3-17 and find the ID number in column one of the table that matches the ID number read from the screen. Scan across the row and perform the recovery sequence shown in column three.

Errors Read Via HP-IB

Go to Table 3-17 and find the ID number in column one of the table that matches the error number read from the error queue. Scan across the row and perform the recovery sequence shown in column three.

Example

To force an error, attempt to set the I channel gain to 100 volts per division. The error message in this case will read "--VALUE OUT OF RANGE -- SET LIMIT" (the instrument is in IQ mode).

LOCAL (key- strokes)	
 (Program Codes)	ERR?

HP-IB Program Code The HP-IB query for reading an error from the error queue is as follows:

ERR?

Comments The "ERR?" HP-IB query will not indicate whether the error was a Command Error, Execution Error, Device Dependent Error, or Query Error as defined by IEEE Std. 488.2. To obtain this information, the contents of the Event Status Register must be read. Refer to the paragraph entitled "Bit 6, Events" in the "Remote Operation, Hewlett-Packard Interface Bus" section of this manual.

Related Sections Bit 6, Events (Remote Operation section of this manual)
 Display, General

Table 3-17. Error Messages

ID Number and Error Message	Description	Recovery Sequence
1 – INSTRUMENT NOT IN HP-IB "TALK ONLY" –	A print was attempted when the Vector Modulation Analyzer was in "Talk/Listen" mode.	Press the front panel "HP-IB" key and then the "Talk Only" softkey before attempting to obtain a printout.
3 – PRINT ABORTED –	If the print function was initiated via the front panel, pressing any key will cause it to abort. If the print function was initiated via HP-IB, it can be aborted locally only by pressing the LCL key. Print can always be aborted by sending the instrument any HP-IB command.	ADVISORY MESSAGE. NO RECOVERY SEQUENCE.
50 – NO LEVEL FOR THIS TRIGGER SOURCE –	Selection of trigger level is invalid when the LINE trigger source is selected.	In order to select a trigger level, the EXT, INT I, or INT Q trigger source must be selected.
51 – KEY IGNORED IN THIS SELECTION –	One of the data entry keys (0 - 9, ., CHG SIGN, BACK SP) was pressed when a valid data entry sequence was not initiated.	Begin a valid data entry sequence by pressing the appropriate function key or softkey (example - VOLT/DIV I&Q) that requires data entry before pressing the data entry keys.
52 – KNOB IGNORED IN THIS SELECTION –	The knob was rotated when a valid data entry sequence was not initiated.	Begin a valid data entry sequence by pressing the appropriate function key or softkey (example - VOLT/DIV I&Q) that requires data entry before rotating the knob.
53 – UP/DOWN ARROW KEYS NOT ACTIVE –	The up/down arrow keys were pressed when a valid data entry sequence was not initiated.	Begin a valid data entry sequence by pressing the appropriate function key or softkey (example - VOLT/DIV I&Q) that requires data entry before pressing the up/down arrow keys.

Table 3-17. Error Messages (Cont.)

ID Number and Error Message	Description	Recovery Sequence
54 – NO ACTIVE PARAMETER –	Data entry was attempted when the active function did not require data entry. (example - A number key was pressed when the Coupling menu was active).	Change the parameter using the appropriate menu item. (example - Press AC, DC, or GND in the Coupling menu, not a number key).
55 – NO ACTIVE MENU –	One of the unmarked, gray keys that are to the right of the display were pressed when no menu was displayed on the screen.	A softkey menu must be displayed next to the unmarked, gray keys in order for them to be active.
56 – LOAD INSTR. DEFAULTS ON USER REQUEST –	The Knob on the front panel was rotated counterclockwise while the instrument was powering up. As a result of this, the instrument has loaded instrument default values from ROM into RAM. Instrument default values set the instrument to the states outlined in the "Preset" Detailed Operating Instruction as well as setting other parameters, such as input impedance and HP-IB address, that normally remain the same once they are initially set.	ADVISORY MESSAGE. NO RECOVERY SEQUENCE.
57 – MEASUREMENT NOT ALLOWED IN 3D –	A measurement (I-Q measurement, internal voltmeter measurement, etc.) was attempted when the three dimensional display mode was selected.	Choose an appropriate alternate display mode (I, Q, Vector, Constellation, Vector Align, or Constellation Align) before attempting a measurement. Refer to the "Special Display" Detailed Operating Instruction for information on selecting Vector Align or Constellation Align display modes.

Table 3-17. Error Messages (Cont.)

ID Number and Error Message	Description	Recovery Sequence
58 – MEASUREMENT TERMINATED NO MEASUREMENT IN THIS DISPLAY MODE –	A measurement (I-Q measurement, internal voltmeter measurement, etc.) was attempted when the three dimensional, Vector Align, or Constellation Align display mode was selected.	Choose an appropriate alternate display mode (I, Q, Vector, or Constellation) before attempting a measurement.
59 – MAG MARKER ANCHOR MUST BE NON ZERO TO CALCULATE DELTA MARKER IN dB –	The magnitude marker was set to zero volts when the delta magnitude marker was turned on.	Set the magnitude marker to a non-zero volt value before turning the delta magnitude marker on. Refer to the "Magnitude Marker Setup" Detailed Operating Instruction for procedures on setting the markers.
60 – MEASUREMENT NOT ALLOWED IN VECTOR ALIGN DISPLAY MODE –	A measurement (I-Q measurement, internal voltmeter measurement, etc.) was attempted when the Vector Align display mode was active. This is not allowed.	Choose an appropriate alternate display mode (I, Q, Constellation, Vector) before attempting a measurement.
61 – MEASUREMENT NOT ALLOWED IN CONSTELLATION ALIGN DISPLAY MODE –	A measurement (I-Q measurement, internal voltmeter measurement, etc.) was attempted when the Constellation Align display mode was active. This is not allowed.	Choose an appropriate alternate display mode (I, Q, Constellation, Vector) before attempting a measurement.
62 – KNOB NOT ENABLED –	Altering parameters with the knob is not valid when this menu is active.	ADVISORY MESSAGE. NO RECOVERY SEQUENCE.
63 – CONSTELLATION ANALYSIS TERMINATED NO CONSTELLATION ANALYSIS IN THIS DISPLAY MODE –	Constellation Analysis was started and then the display mode was changed to something other than "Constellation Q vs I". This is not legal.	Press the CONSTL key or change the display mode to Constellation via HP-IB if in remote and then resume Constellation Analysis.

Table 3-17. Error Messages (Cont.)

ID Number and Error Message	Description	Recovery Sequence
65 – NO HELP ON KEY PRESSED –	An attempt was made to use the HELP function when no HELP information was available for the function in question.	ADVISORY MESSAGE. NO RECOVERY SEQUENCE.
500 - 509 MICROPROCESSOR ERRORS	These errors are microprocessor errors. They indicate that a major problem might exist within the instrument firmware. The operation (function selection, data entry, etc.) that was attempted at the time any of these errors were displayed was not executed.	<p><i>If one or more of these errors keep recurring once the instrument has recovered, troubleshooting and repair of the instrument will be necessary:</i></p> <p>The instrument will try to recover from these errors automatically without losing the current setup. If recovery is successful, the message will disappear after a few seconds and the normal display will return. If recovery is unsuccessful (the error keeps disappearing and returning) use the procedure in the following paragraph.</p> <p>Set the LINE switch to OFF and, while rotating the Knob counterclockwise, set the LINE switch back to ON. Continue rotating the Knob for a few seconds as the instrument is powering up. Message 56 should appear on the display. If this message appears, the instrument has loaded instrument default values from ROM into RAM and it might be necessary to reset certain parameters that otherwise remain the same once they are initially set. If the instrument still has not recovered from the error or message 56 does not appear, go to Troubleshooting in the Service Manual.</p>

Table 3-17. Error Messages (Cont.)

ID Number and Error Message	Description	Recovery Sequence
601 – UNABLE TO COMPLETE REQUESTED FUNCTION PLEASE TRY AGAIN –	This error is an instrument operating system error. The operation (function selection, data entry, etc.) that was attempted at the time the error was displayed was not executed.	Go to the Recovery Sequence for Microprocessor Errors (ID Numbers 500-509).
614 – INSTRUMENT IN REMOTE, KEY IGNORED –	The Vector Modulation Analyzer was in the remote state (under HP-IB control) when a front panel key was pressed.	Either take the instrument out of the remote state (set it to the local state) to use the front panel keys or enable instrument functions and change parameters via HP-IB commands.
619 – NO CAL FACTOR FOUND –	An attempt was made to recall demodulator correction factors from an internal storage register when no correction factors had been previously stored there.	Check to be sure the "recall corrections" register being accessed is the correct one. The reference frequency will appear below a storage register softkey if correction factors have been stored there. Refer to the "Save and Recall (Demodulator Corrections)" Detailed Operating Instruction for further information.
1000 – SHIFT CHAIN HARDWARE FAILURE –	Instrument selftest has determined that one or more of the shift chains in the instrument are failing.	Refer to Troubleshooting in the Service Manual.
1001 – KEYBOARD PROCESSOR FAILURE –	Instrument selftest has determined that the Keyboard Processor circuitry on the Input/Output Assembly is failing.	Refer to Troubleshooting in the Service Manual.
1002 – A/D HARDWARE FAILURE –	Instrument selftest has determined that the Analog to Digital Converter circuitry on the Input/Output Assembly is failing.	Refer to Troubleshooting in the Service Manual.

Table 3-17. Error Messages (Cont.)

ID Number and Error Message	Description	Recovery Sequence
1003 – TIMER HARDWARE FAILURE –	Instrument selftest has determined that the Timer circuit on the Input/Output Assembly is failing.	Refer to Troubleshooting in the Service Manual.
1005 – BATTERY BACKED RAM CORRUPT, POSSIBLE LOW BATTERY LOADING INSTRUMENT DEFAULTS –	Instrument selftest has determined that information in the battery backed RAM might not be valid. The instrument has loaded instrument default values from ROM into RAM in an attempt to recover from this error.	Refer to Troubleshooting in the Service Manual.
1006 – NON VOLATILE RAM HARDWARE FAILURE –	Instrument selftest has determined that battery backed RAM on RAM Assembly is failing.	Refer to Troubleshooting in the Service Manual.
1007 – VOLATILE RAM HARDWARE FAILURE –	Instrument selftest has determined that volatile RAM on RAM Assembly is failing.	Refer to Troubleshooting in the Service Manual.
1008 – ROM HARDWARE FAILURE –	Instrument selftest has determined that the ROM circuitry on the Central Processing Unit Assembly is failing.	Refer to Troubleshooting in the Service Manual.
1010 – CAL FACTORS NOT RELIABLE LOADING DEFAULT CAL FACTORS –	Instrument selftest has determined that the calibration factors that were in battery-backed RAM upon power-down might not have been stored. Factory calibration factors that are in ROM have been loaded into RAM in place of the old calibration factors.	Recalibrate the instrument (press the CAL key).
1011 – INSTRUMENT IN ERROR STATE LOADING INSTRUMENT DEFAULTS –	Upon power-down, the instrument was in an error state. Either no attempt was made to recover or the error condition kept recurring. Upon power-up, instrument default values were loaded from ROM into RAM.	ADVISORY MESSAGE. NO RECOVERY SEQUENCE.

Table 3-17. Error Messages (Cont.)

ID Number and Error Message	Description	Recovery Sequence
1012 – NEW SOFTWARE VERSION DETECTED LOADING INSTRUMENT DEFAULTS –	Upon power up, the selftest routine determined that the instrument firmware (ROMs) had been updated. Default CAL Factors were then loaded from ROM into RAM.	ADVISORY MESSAGE. NO RECOVERY SEQUENCE.
1013 – CAL FACTORS NOT RELIABLE CALIBRATION RECOMMENDED –	Upon power up, the selftest routine discovered that some CAL Factors might not be valid.	Recalibrate the instrument (press the CAL key).
1014 – BATTERY BACKED RAM CORRUPT, POSSIBLE LOW BATTERY –	Instrument selftest has determined that information in Battery Backed RAM might not be valid.	Refer to Troubleshooting in the Service Manual.
1015 – SELFTEST ABORTED –	The instrument selftest routine aborted due to a possible problem with the instrument firmware.	Try to power down the instrument and then power-up. If this error keeps recurring after several attempts to power down/power up, refer to the Service Manual.
1052 – VALUE OUT OF RANGE, VALID RANGE: 0 - 8 –	A direct control chain number entry was attempted that was either negative or greater than eight.	Enter a numerical value that is from zero (0) to eight (8). Refer to Troubleshooting in the Service Manual for further information.
1053 – VALUE OUT OF RANGE – SET LIMIT –	Data entry has been attempted for direct control data that is greater than or less than its acceptable parameter limits. The parameter value has been set to either its upper or lower limit.	Enter a decimal value with a lower limit of zero (0) and an upper limit of (2 to the Nth power)-1 where "N" is the number entered using the NUMBER OF BITS softkey. Refer to Troubleshooting in the Service Manual for further information.
1054 – VALUE OUT OF RANGE – SET LIMIT –	Data entry has been attempted for the delta I marker that is greater than or less than its acceptable parameter limits. The parameter value has been set to either its upper or lower limit.	Enter a value that is between -40.0V and 40.0V. Refer to the "I Marker Setup" Detailed Operating Instruction for further information.

Table 3-17. Error Messages (Cont.)

ID Number and Error Message	Description	Recovery Sequence
1055 – VALUE OUT OF RANGE .. SET LIMIT –	Data entry has been attempted for the delta Q marker that is greater than or less than its acceptable parameter limits. The parameter value has been set to either its upper or lower limit.	Enter a value that is between -40.0V and 40.0V. Refer to the "Q Marker Setup" Detailed Operating Instruction for further information.
1056 – VALUE OUT OF RANGE .. SET LIMIT –	Data entry has been attempted for the delta magnitude marker that is greater than or less than its acceptable parameter limits. The parameter value has been set to either its upper or lower limit.	Enter a value with an upper limit of dB(max) and a lower limit of dB(min) as defined by the following equations. "mval" is the value of the current anchor marker in volts: $\text{dB(max)}=20*\log[(5*\text{sqrt}2)/\text{mval}]$ $\text{dB(min)}=20*\log(.000001/\text{mval})$ Refer to the "Magnitude Marker Setup" Detailed Operating Instruction for further information.
1058 – VALUE OUT OF RANGE .. SET LIMIT –	Data entry has been attempted for the delta time marker that is greater than or less than its acceptable parameter limits. The parameter value has been set to either its upper or lower limit.	Enter a value that is between 0 ns and 20 ms. Refer to the "Time Marker Setup" Detailed Operating Instruction for further information.
1060 – VALUE OUT OF RANGE, VALID RANGE: 0-30 –	An HP-IB address entry was attempted that was either negative or greater than thirty.	Enter an address value that is from zero (0) to thirty (30). Refer to "HP-IB Address Selection and Configuring" in Section 2 of this manual.
1061 – VALUE OUT OF RANGE, VALID RANGE: 0 - 8 –	A Signal Intensity entry was attempted that was either negative or greater than eight.	Enter a numerical value that is from zero (beam off) to eight (beam brightest) for Signal Intensity. Refer to the "Display, General" Detailed Operating Instruction.

Table 3-17. Error Messages (Cont.)

ID Number and Error Message	Description	Recovery Sequence
1062 – VALUE OUT OF RANGE _ SET LIMIT –	Data entry has been attempted for I and Q channel gain that is greater than or less than its acceptable parameter limits. The parameter value has been set to either its upper or lower limit.	Enter a value that is between +/-5 mV/div and +/-1.0V/div. Refer to the "Gain" Detailed Operating Instruction for further information.
1063 – VALUE OUT OF RANGE _ SET LIMIT –	Data entry has been attempted for I channel delay that is greater than or less than its acceptable parameter limits. The parameter value has been set to either its upper or lower limit.	Enter a value that is between 0 ps and 5 times the TIME/DIV setting, up to a maximum of 20 us. Refer to the "Delay Selection" Detailed Operating Instruction for further information.
1064 – VALUE OUT OF RANGE _ SET LIMIT –	Data entry has been attempted for I channel gain that is greater than or less than its acceptable parameter limits. The parameter value has been set to either its upper or lower limit.	Enter a value that is between +/-5 mV/div and +/-1.0V/div. Refer to the "Gain" Detailed Operating Instruction for further information.
1065 – VALUE OUT OF RANGE _ SET LIMIT –	Data entry has been attempted for the I marker value that is greater than or less than its acceptable parameter limits. The parameter value has been set to either its upper or lower limit.	Enter a value that is between -20V and 20V. Refer to the "I Marker Setup" Detailed Operating Instruction for further information.
1066 – VALUE OUT OF RANGE _ SET LIMIT –	Data entry has been attempted for I channel offset that is greater than or less than its acceptable parameter limits. The parameter value has been set to either its upper or lower limit.	Enter a value that is between +10 times the VOLTS/DIV setting and -10 times the VOLTS/DIV setting. Refer to the "Offset" Detailed Operating Instruction for further information.
1067 – VALUE OUT OF RANGE _ SET LIMIT –	Data entry has been attempted for I and Q channel delay that is greater than or less than its acceptable parameter limits. The parameter value has been set to either its upper or lower limit.	Enter a value that is between 0 ps and 1000 times the TIME/DIV setting, up to a maximum of 20 ms. Refer to the "Delay Selection" Detailed Operating Instruction for further information.

Table 3-17. Error Messages (Cont.)

ID Number and Error Message	Description	Recovery Sequence
1068 -- VALUE OUT OF RANGE. VALID RANGE: 0-31 --	A number was entered for number of bits (Direct Control) that was either negative or greater than 31.	Enter a number from zero (0) to 31. Refer to Troubleshooting in the Service Manual for further information.
1070 -- VALUE OUT OF RANGE -- SET LIMIT --	Data entry has been attempted for the Quadrature Adjust function that is greater than or less than its acceptable parameter limits. The parameter value has been set to either its upper or lower limit.	Enter a value that is between -20 degrees and 20 degrees. Refer to the "Demodulation" Detailed Operating Instruction for further information.
1071 -- VALUE OUT OF RANGE -- SET LIMIT --	Data entry has been attempted for Q channel delay that is greater than or less than its acceptable parameter limits. The parameter value has been set to either its upper or lower limit.	Enter a value that is between 0 ps and 5 times the TIME/DIV setting, up to a maximum of 20 us. Refer to the "Delay Selection" Detailed Operating Instruction for further information.
1072 -- VALUE OUT OF RANGE -- SET LIMIT --	Data entry has been attempted for Q channel gain that is greater than or less than its acceptable parameter limits. The parameter value has been set to either its upper or lower limit.	Enter a value that is between +/-5 mV/div and +/-1.0V/div. Refer to the "Gain" Detailed Operating Instruction for further information.
1073 -- VALUE OUT OF RANGE -- SET LIMIT --	Data entry has been attempted for the Q marker value that is greater than or less than its acceptable parameter limits. The parameter value has been set to either its upper or lower limit.	Enter a value that is between -20V and 20V. Refer to the "Q Marker Setup" Detailed Operating Instruction for further information.
1074 -- VALUE OUT OF RANGE -- SET LIMIT --	Data entry has been attempted for Q channel offset that is greater than or less than its acceptable parameter limits. The parameter value has been set to either its upper or lower limit.	Enter a value that is between +10 times the VOLTS/DIV setting and -10 times the VOLTS/DIV setting. Refer to the "Offset" Detailed Operating Instruction for further information.

Table 3-17. Error Messages (Cont.)

ID Number and Error Message	Description	Recovery Sequence
1075 – VALUE OUT OF RANGE – SET LIMIT –	Data entry has been attempted for the magnitude marker value that is greater than or less than its acceptable parameter limits. The parameter value has been set to either its upper or lower limit.	Enter a value that is between 0 and (5 times the square root of two) volts. Refer to the "Magnitude Marker Setup" Detailed Operating Instruction for further information.
1077 – VALUE OUT OF RANGE, VALID RANGE: 0-127 –	A start bit (Direct Control) entry was attempted that was either negative or greater than 127.	Enter a number that is from zero (0) to 127. Refer to Troubleshooting in the Service Manual for further information.
1078 – VALUE OUT OF RANGE, VALID RANGE 1 - 8 –	The storage of an instrument state was attempted in an instrument state register with a value less than one (1) or greater than eight (8).	Enter a storage register number with a value from one to eight. Refer to the "Save and Recall" Detailed Operating Instruction.
1079 – VALUE OUT OF RANGE, VALID RANGE 1 - 8 –	A previously stored instrument state was attempted to be recalled from an instrument state register with a value less than one (1) or greater than eight (8).	Enter a recall register number with a value from one to eight. Refer to the "Save and Recall" Detailed Operating Instruction.
1081 – VALUE OUT OF RANGE – SET LIMIT –	Data entry has been attempted for time-per-division (timebase) that is greater than or less than its acceptable parameter limits. The parameter value has been set to either its upper or lower limit.	Enter a value that is between 500 ps/div and 2 ms/div. Refer to the "Time Base Selection" Detailed Operating Instruction for further information.
1082 – VALUE OUT OF RANGE – SET LIMIT –	Data entry has been attempted for the external trigger level that is greater than or less than its acceptable parameter limits. The parameter value has been set to either its upper or lower limit.	Enter a value that is between -5V and +5V. Refer to the "Trigger Setup" Detailed Operating Instruction for further information.

Table 3-17. Error Messages (Cont.)

ID Number and Error Message	Description	Recovery Sequence
1083 – VALUE OUT OF RANGE – SET LIMIT –	Data entry has been attempted for the internal I channel trigger level that is greater than or less than its acceptable parameter limits. The parameter value has been set to either its upper or lower limit.	<p>Enter a trigger level value that is within the limits as defined by the following formulas:</p> $TLev(DC\ coupled)=+/- (5 * VOLTS/DIV) +/-offset$ $TLev(AC\ coupled)=+/- (5 * VOLTS/DIV)$ <p>Refer to the "Trigger Setup" Detailed Operating Instruction for further information.</p>
1084 – VALUE OUT OF RANGE – SET LIMIT –	Data entry has been attempted for the internal Q channel trigger level that is greater than or less than its acceptable parameter limits. The parameter value has been set to either its upper or lower limit.	<p>Enter a trigger level value that is within the limits as defined by the following formulas:</p> $TLev(DC\ coupled)=+/- (5 * VOLTS/DIV) +/-offset$ $TLev(AC\ coupled)=+/- (5 * VOLTS/DIV)$ <p>Refer to the "Trigger Setup" Detailed Operating Instruction for further information.</p>
1085 – VALUE OUT OF RANGE – SET LIMIT –	Data entry has been attempted for the time marker value that is greater than or less than its acceptable parameter limits. The parameter value has been set to either its upper or lower limit.	Enter a value that is between 0.0 ns and 20 ms. Refer to the "Time Marker Setup" Detailed Operating Instruction for further information.
1089 – VALUE OUT OF RANGE – SET LIMIT –	Data entry has been attempted for print points that is greater than or less than its acceptable parameter limits. The parameter value has been set to either its upper or lower limit.	Enter a value that is between 1 and 999,999. Refer to the "Printer, Use With" Detailed Operating Instruction for further information.

Table 3-17. Error Messages (Cont.)

ID Number and Error Message	Description	Recovery Sequence
1090 – VALUE OUT OF RANGE – SET LIMIT –	Data entry has been attempted for constellation points that is greater than or less than its acceptable parameter limits. The parameter value has been set to either its upper or lower limit.	Enter a value that is between 4 and 99,999. Refer to the "Measurement Functions" Detailed Operating Instruction for further information.
1091 – VALUE OUT OF RANGE – SET LIMIT –	Data entry has been attempted for the reference frequency that is greater than or less than its acceptable parameter limits. The parameter value has been set to either its upper or lower limit.	Enter a reference frequency value that is within the limits as defined below: External Demodulator - 1 kHz to 100 GHz Internal Demodulator - 10 MHz to 220 MHz Refer to the "Demodulator Corrections" Detailed Operating Instruction for further information.
1092 – VALUE OUT OF RANGE – SET LIMIT –	Data entry has been attempted for phase offset adjust that is greater than or less than its acceptable parameter limits. The parameter value has been set to either its upper or lower limit.	Enter a phase offset value that is between -360 degrees and 360 degrees. Refer to the "Demodulation" Detailed Operating Instruction for further information.
1093 – VALUE OUT OF RANGE – SET LIMIT –	Data entry has been attempted for RF Level (used in a demodulator gain correction) that is greater than or less than its acceptable parameter limits. The parameter value has been set to either its upper or lower limit.	Enter an RF level value that is between -99.99 dBm and 99.99 dBm. Refer to the "Demodulator Corrections" Detailed Operating Instruction for further information.
1094 – VALUE OUT OF RANGE – SET LIMIT –	Data entry was attempted for a quadrature correction factor that was greater than or less than its acceptable parameter limits. The parameter value has been set to either its upper or lower limit.	Enter a quadrature correction factor that is between -20.00 degrees and 20.00 degrees. Refer to the "Demodulator Corrections" Detailed Operating Instruction for further information.

Table 3-17. Error Messages (Cont.)

ID Number and Error Message	Description	Recovery Sequence
1095 -- VALUE OUT OF RANGE -- SET LIMIT --	Data entry was attempted for an I offset correction factor that was greater than or less than its acceptable parameter limits. The parameter value has been set to either its upper or lower limit.	Enter an I offset correction factor that is less than two times the positive and negative full scale voltage limits of the current display. Refer to the "Demodulator Corrections" Detailed Operating Instruction for further information.
1096 -- VALUE OUT OF RANGE -- SET LIMIT --	Data entry has been attempted for a Q offset correction factor that is greater than or less than its acceptable parameter limits. The parameter value has been set to either its upper or lower limit.	Enter a value that is less than two times the positive and negative full scale voltage limits of the current display. Refer to the "Demodulator Corrections" Detailed Operating Instruction for further information.
1097 -- VALUE OUT OF RANGE -- SET LIMIT --	Data entry has been attempted for the I/Q gain ratio correction factor that is greater than or less than its acceptable parameter limits. The parameter value has been set to either its upper or lower limit.	Enter a value that is from 0 to +/-99.999 dB. Refer to the "Demodulator Corrections" Detailed Operating Instruction for further information.
1098 -- VALUE OUT OF RANGE -- SET LIMIT --	Data entry has been attempted for the demodulator gain correction factor that is greater than or less than its acceptable parameter limits. The parameter value has been set to either its upper or lower limit.	Enter a value that is from 0 to +/-50.00 dB. Refer to the "Demodulator Corrections" Detailed Operating Instruction for further information.
1099 -- VALUE OUT OF RANGE -- SET LIMIT --	Data entry was attempted for the user I/Q gain ratio setting (not the I/Q gain ratio correction) that is greater than or less than its acceptable parameter limits. The parameter value has been set to either its upper or lower limit.	Enter a value that is from 0 to +/- 40.000 dB. Refer to the "Gain" Detailed Operating Instruction for further information.

Table 3-17. Error Messages (Cont.)

ID Number and Error Message	Description	Recovery Sequence
1100 – VALUE OUT OF RANGE – SET LIMIT –	Data entry was attempted for the full scale magnitude (gain) setting that is greater than or less than its acceptable parameter limits. The parameter value has been set to either its upper or lower limit.	The full scale magnitude limits are not fixed values. The range depends upon the gain of the demodulator being used, the user gain setting, and the gain correction factor. Refer to the "Gain" Detailed Operating Instruction for further information.
1101 – VALUE OUT OF RANGE – SET LIMIT –	Data entry was attempted for the I offset setting in DEMOD mode that is greater than or less than its acceptable parameter limits. The parameter value has been set to either its upper or lower limit.	Enter a value that is between -100% and +100% (of full scale). Refer to the "Offset" Detailed Operating Instruction for further information.
1102 – VALUE OUT OF RANGE – SET LIMIT –	Data entry was attempted for the Q offset setting in DEMOD mode that is greater than or less than its acceptable parameter limits. The parameter value has been set to either its upper or lower limit.	Enter a value that is between -100% and +100% (of full scale). Refer to the "Offset" Detailed Operating Instruction for further information.
1103 – VALUE OUT OF RANGE – SET LIMIT –	Data entry has been attempted for the reference phase setting that is greater than or less than its acceptable parameter limits. The parameter value has been set to either its upper or lower limit.	Enter a value that is between -360.00 and +360.00 degrees. Refer to the "Demodulation" Detailed Operating Instruction for further information.
1104 – VALUE OUT OF RANGE – SET LIMIT –	Data entry has been attempted for the magnitude marker in DEMOD mode that is greater than or less than its acceptable parameter limits. The parameter value has been set to either its upper or lower limit.	Enter a value that is between -200 dBm and 3 dB above the maximum full scale magnitude setting. Refer to the "Magnitude Marker Setup" Detailed Operating Instruction for further information.

Table 3-17. Error Messages (Cont.)

ID Number and Error Message	Description	Recovery Sequence
1105 – VALUE OUT OF RANGE – SET LIMIT –	Data entry has been attempted for the delta magnitude marker in DEMOD mode that is greater than or less than its acceptable parameter limits. The parameter value has been set to either its upper or lower limit.	Enter a value that places the delta magnitude marker within the limits of -200 dBm and the maximum full scale magnitude setting. Refer to the "Magnitude Marker Setup" Detailed Operating Instruction for further information.
1106 – VALUE OUT OF RANGE – SET LIMIT –	Data entry has been attempted for the I marker in DEMOD mode that is greater than or less than its acceptable parameter limits. The parameter value has been set to either its upper or lower limit.	Enter a value that is between +100% and -100% (of full scale). Refer to the "I Marker Setup" Detailed Operating Instruction for further information.
1107 – VALUE OUT OF RANGE – SET LIMIT –	Data entry has been attempted for the delta I marker in DEMOD mode that is greater than or less than its acceptable parameter limits. The parameter value has been set to either its upper or lower limit.	Enter a value that places the delta marker within the display grid. Refer to the "I Marker Setup" Detailed Operating Instruction for further information.
1108 – VALUE OUT OF RANGE – SET LIMIT –	Data entry has been attempted for the Q marker in DEMOD mode that is greater than or less than its acceptable parameter limits. The parameter value has been set to either its upper or lower limit.	Enter a value that is between +100% and -100% (of full scale). Refer to the "Q Marker Setup" Detailed Operating Instruction for further information.
1109 – VALUE OUT OF RANGE – SET LIMIT –	Data entry has been attempted for the delta Q marker in DEMOD mode that is greater than or less than its acceptable parameter limits. The parameter value has been set to either its upper or lower limit.	Enter a value that places the marker within the display grid. Refer to the "Q Marker Setup" Detailed Operating Instruction for further information.

Table 3-17. Error Messages (Cont.)

ID Number and Error Message	Description	Recovery Sequence
1110 – VALUE OUT OF RANGE – SET LIMIT –	Data entry has been attempted for internal I channel trigger level in DEMOD mode that is greater than or less than its acceptable parameter limits. The parameter value has been set to either its upper or lower limit.	Enter a value that is between +100% and -100% (of full scale). Refer to the "Trigger Setup" Detailed Operating Instruction for further information.
1111 – VALUE OUT OF RANGE – SET LIMIT –	Data entry has been attempted for internal Q channel trigger level in DEMOD mode that is greater than or less than its acceptable parameter limits. The parameter value has been set to either its upper or lower limit.	Enter a value that is between +100% and -100% (of full scale). Refer to the "Trigger Setup" Detailed Operating Instruction for further information.
2001 – CONSTL ANALYSIS HALTED: NOT ENOUGH POPULATED STATES –	<p>For any given modulation format, a certain percentage of constellation clouds must be present to perform a Constellation Analysis. As an example, for a 64 QAM modulation format, the maximum number of empty states (States) is defined by the following formula:</p> $\text{States} = (\text{square root of } 64) - 1$	ADVISORY MESSAGE. NO RECOVERY SEQUENCE.
2002 – TOO MANY POINTS PER CONSTL STATE ANALYSIS FAILED –	The Constellation Analysis routine grouped the points into individual constellation clouds before beginning analysis and found too many points per constellation cloud for internal memory to handle. As soon as this condition occurs, analysis will halt.	Enter a lower value for CONSTL POINTS. Also check that the display format being used is correct for the modulation pattern being analyzed. Refer to the "Measurement Functions" Detailed Operating Instruction for further information.
2003 – BAD FORMAT IN INIT STATS ANALYSIS HALTED –	This error should never occur. If it occurs, a problem exists with the instrument firmware.	The instrument will usually recover from this error automatically. If the same error message keeps recurring, refer to the Service Manual for further information.

Table 3-17. Error Messages (Cont.)

ID Number and Error Message	Description	Recovery Sequence
2004 – I SIGNAL OUT OF RANGE –	This error indicates a potential problem with the instrument firmware. The firmware routine that measures I signal voltages is probably malfunctioning.	Try calibrating the instrument (press the CAL key). If the error message recurs, go to the Recovery Sequence for Microprocessor Errors (ID Numbers 500-509).
2005 – Q SIGNAL OUT OF RANGE –	This error indicates a potential problem with the instrument firmware. The firmware routine that measures Q signal voltages is probably malfunctioning.	Try calibrating the instrument (press the CAL key). If the error message recurs, go to the Recovery Sequence for Microprocessor Errors (ID Numbers 500-509).
2006 – ANALYSIS VALUE OVERFLOW ANALYSIS HALTED –	This error indicates a potential problem with the instrument firmware.	Try Constellation Analysis again. If the error message keeps recurring, go to the Recovery Sequence for Microprocessor Errors (ID Numbers 500-509).
2008 – CONSTL ANALYSIS HALTED: INVALID DISPLAY –	A display mode other than CONSTL was selected prior to Constellation Analysis being performed.	Press the CONSTL key and then retry Constellation Analysis. To put the instrument in Constellation display mode via HP-IB, send the command DISP:MODE CONST. Refer to the "Measurement Functions" Detailed Operating Instruction for further information.
2010 – CONSTL ANALYSIS HALTED: NO DEMOD FORMAT SELECTED –	Constellation Analysis cannot be performed when the SCOPE FORMAT display grid is active.	Choose the appropriate modulation format for the type of modulation pattern being analyzed. Refer to the "Demodulation" Detailed Operating Instruction for further information.
2011 – CONSTELLATION ANALYSIS ABORTED –	A single Constellation Analysis was aborted.	ADVISORY MESSAGE. NO RECOVERY SEQUENCE.

Table 3-17. Error Messages (Cont.)

ID Number and Error Message	Description	Recovery Sequence
2012 – EPS OUT OF RANGE - COMMAND IGNORED –	A number was sent with the "EPS num" HP-IB command where "num" was not in the range of -1.0 to +1.0.	Reprogram the "EPS num" command with "num" being a number from -1.0 to +1.0. Refer to Table 3-4 in the "Remote Operation, Hewlett-Packard Interface Bus" section of this manual.
2013 – NO MEASUREMENT DATA AVAILABLE –	The HP-IB command OST, OSTB, or OAN was sent to the Vector Modulation Analyzer requesting Constellation Analysis data before a Constellation Analysis was performed.	Perform a Constellation Analysis before sending the instrument the HP-IB command OST, OSTB, or OAN. Refer to the "Measurement Functions" Detailed Operating Instruction for further information.
2014 – POINTS OUT OF RANGE - COMMAND IGNORED –	The instrument received the HP-IB command "MSM num" or "MST num" where "num" was not within the proper range.	Change the HP-IB command so that "num" is within the following ranges: MSM: 1 to 16383 MST: 4 to 99999
2200 - 2249 – ANALYSIS OPCODE EXECUTION ERROR –	These errors indicate a potential problem with the instrument firmware.	Try calibrating the instrument (press the CAL key). If the error message returns, go to the Recovery Sequence for Microprocessor Errors (ID Numbers 500-509).
3000 – UNKNOWN MEASUREMENT SYSTEM COMMAND –	The instrument received an HP-IB Waveform (WAVE:func) subsystem command and the instrument firmware did not interpret the code correctly.	If the HP-IB mnemonic was programmed correctly and the error keeps recurring, the firmware is probably defective. Go to the Recovery Sequence for Microprocessor Errors (ID Numbers 500-509).

Table 3-17. Error Messages (Cont.)

ID Number and Error Message	Description	Recovery Sequence
3001 – UNKNOWN DISPLAY MODE –	The instrument received the HP-IB command "WAVE:SOUR source" where "source" was not interpreted correctly by the instrument firmware. This error might also occur whenever the display mode is changed and the firmware misinterprets it.	It is possible that the HP-IB misinterpreted a correct mnemonic. If the mnemonic was programmed correctly and the error keeps recurring, go to the Recovery Sequence for Microprocessor Errors (ID Numbers 500-509).
3002 – POINTS OUT OF RANGE - COMMAND IGNORED –	The instrument received the HP-IB command "WAVE:POIN num" where "num" was not in the range of 1 to 1024.	Reprogram the WAVE:POIN command with a number for "num" that is within the range of 1 to 1024. Refer to the "Data Gathering and HP-IB Transmission" Detailed Operating Instruction for further information.
3003 – HINC VALUE OUT OF RANGE –	The CAL Factors for horizontal screen positions are not valid. The value returned by the WAVE:HINC? query is incorrect.	Try calibrating the instrument (press the CAL key). If the error message returns, go to the Recovery Sequence for Microprocessor Errors (ID Numbers 500-509).
3004 – QINC VALUE OUT OF RANGE –	The CAL Factors for vertical screen positions are not valid. The value returned by the WAVE:QINC? query is incorrect.	Try calibrating the instrument (press the CAL key). If the error message returns, go to the Recovery Sequence for Microprocessor Errors (ID Numbers 500-509).
3005 – ERROR IN ADC COUNTS PER X SCREEN –	The CAL Factors for horizontal screen positions are not valid.	Try calibrating the instrument (press the CAL key). If the error message returns, go to the Recovery Sequence for Microprocessor Errors (ID Numbers 500-509).

Table 3-17. Error Messages (Cont.)

ID Number and Error Message	Description	Recovery Sequence
3006 – ERROR IN ADC COUNTS PER Y SCREEN –	The CAL Factors for vertical screen positions are not valid.	Try calibrating the instrument (press the CAL key). If the error message returns, go to the Recovery Sequence for Microprocessor Errors (ID Numbers 500-509).
3007 – MEASUREMENT ABORTED –	A measurement (I-Q Measurement, HP-IB "WAVE:" command, HP 3709A command, etc.) was aborted by the user. Refer to the Detailed Operating Instruction for the particular measurement for further information.	ADVISORY MESSAGE. NO RECOVERY SEQUENCE.
3011 – CANNOT RECOVER OLD DISPLAY MODE AFTER ABORT –	After a print or HP-IB "WAVE:" command was aborted, the instrument was unable to recover the correct display mode. This error indicates a potential problem with the instrument firmware.	The instrument will attempt to recover by choosing a display mode it determines to be correct (which might or might not, in fact, be correct). If the mnemonic was programmed correctly and the error keeps recurring, go to the Recovery Sequence for Microprocessor Errors (ID Numbers 500-509).
3012 – TIME MARKER OUT OF RANGE - MEASURING AT TIME MARKER LIMIT –	An HP-IB measurement or print was attempted at a time marker instant that was out of range. The measurement or print proceeded at the closest limit of the time marker.	The user might want to set the time marker so that it is within range and then make the HP-IB measurement or print again. Refer to the "Time Marker Setup" Detailed Operating Instruction for further information.

Table 3-17. Error Messages (Cont.)

ID Number and Error Message	Description	Recovery Sequence
4000 – DEMOD CORRECTION ABORTED –	An automatic Quadrature, IQ Ratio, and Offset correction has been aborted by pressing any front panel key if the instrument was in local mode. If the instrument was in remote (HP-IB) mode, it was aborted by pressing the LCL key or by sending another HP-IB command.	ADVISORY MESSAGE. NO RECOVERY SEQUENCE.
4001 – SIGNAL LEVEL TOO LOW –	The magnitude of the RF signal is insufficient for the instrument to calculate accurate demodulator correction factors.	Increase the RF signal level so that it spans at least two divisions on the display when the full scale magnitude setting is at its highest sensitivity.
4002 – UNABLE TO CONVERGE TO FIXED CORRECTION VALUES	The instrument can not calculate demodulator correction factors for the input signals that are applied.	Check the input signals to verify that their limits are not being exceeded in any way. Refer to the "Demodulator Corrections" Detailed Operating Instruction for further information.
4003 – CALCULATED QUAD CORRECTION OUT OF RANGE - SETTING TO LIMIT –	The quadrature error correction factor calculated by the instrument is greater than the quadrature error parameter limits. The parameter value has been set to its limit.	The quadrature error in the input signals must be reduced to a value that is within the quadrature error parameter limits. Refer to the "Demodulator Corrections" Detailed Operating Instruction for further information.
4004 – CALCULATED I OFFSET CORRECTION OUT OF RANGE - SETTING TO LIMIT –	The I offset correction factor calculated by the instrument is greater than the I offset parameter limits. The parameter value has been set to either its upper or lower limit.	Increase the full scale magnitude setting to allow a greater I offset parameter range. Refer to the "Gain" and "Demodulator Corrections" Detailed Operating Instructions for further information.

Table 3-17. Error Messages (Cont.)

ID Number and Error Message	Description	Recovery Sequence
4005 – CALCULATED Q OFFSET CORRECTION OUT OF RANGE - SETTING TO LIMIT –	The Q offset correction factor calculated by the instrument is greater than the Q offset parameter limits. The parameter value has been set to either its upper or lower limit.	Increase the full scale magnitude setting to allow a greater Q offset parameter range. Refer to the "Gain" and "Demodulator Corrections" Detailed Operating Instructions for further information.
4006 – CALCULATED IQ RATIO CORRECTION OUT OF RANGE - SETTING TO LIMIT –	The I/Q gain ratio correction factor calculated by the instrument is greater than the I/Q gain ratio parameter limits. The parameter value has been set to its limit.	The I/Q gain ratio error in the input signals must be reduced to a value that is within the I/Q gain ratio parameter limits. Refer to the "Demodulator Corrections" Detailed Operating Instruction for further information.
4050 – GAIN CORRECTION ABORTED –	An automatic demodulator gain correction has been aborted by pressing any front panel key if the instrument was in local mode. If the instrument was in remote (HP-IB) mode, it was aborted by pressing the LCL key.	ADVISORY MESSAGE. NO RECOVERY SEQUENCE.
4051 – CALCULATED GAIN CORRECTION OUT OF RANGE - SETTING TO LIMIT –	The demodulator gain correction factor calculated by the instrument is greater than the demodulator gain parameter limits. The parameter value has been set to its limit.	Verify that the RF LEVEL parameter (in the DEMOD / CORRECTIONS / DEMOD GAIN CORRECTIONS menu) has been properly set. The difference between the RF LEVEL set and the value measured by the instrument must be within the demodulator gain correction limits. Refer to the "Demodulator Corrections" Detailed Operating Instruction for further information.

Table 3-17. Error Messages (Cont.)

ID Number and Error Message	Description	Recovery Sequence
4100 – 8981A SOFTWARE NOT INSTALLED - CANNOT EXECUTE 8981A HP-IB COMMAND –	This error should not occur in the HP 8981A. If the error does occur, it indicates a possible problem with the instrument firmware.	Refer to the Recovery Sequence for Microprocessor Errors (ID Numbers 500 - 509).
4150 – CW PHASE CALCULATION ABORTED –	The HP-IB command DEM:SPHAS? was interrupted.	ADVISORY MESSAGE. NO RECOVERY SEQUENCE.
4176 – SOME FACTORY CORRECTION FACTORS OUTSIDE HARDWARE LIMITS - USING ZERO INSTEAD –	One or more of the correction factors stored in EEPROM exceed the hardware limits of the HP 8981A.	Refer to the Service Manual for further information on fixing this error.
5000 - 5709 <i>CALIBRATION INFORMATION</i>	If a message is generated with an Identification (ID) Number that is within this range, instrument self-calibration has determined that circuitry within the instrument might not be functioning properly.	Recalibrate the instrument (Press the front panel CAL key). If the message keeps recurring, refer to Troubleshooting in the Service Manual for further information.
7016 – AUTO SCOPE TIMEOUT EXPERIENCED –	This error message indicates that a possible problem exists with the firmware Auto Scope routine. If this error occurs, none of the enabled autoscope signal parameters were changed.	Try pressing AUTO SCOPE again. If this error message keeps recurring, a problem exists with the instrument firmware. Refer to Troubleshooting in the Service Manual for further information.

Table 3-17. Error Messages (Cont.)

ID Number and Error Message	Description	Recovery Sequence
<p>7101 - I & Q INPUT OVERDRIVES PRESS ANY KEY TO CLEAR -</p>	<p>The signals into the I and Q input signal paths exceed the Maximum Input specification. When this message appears, the input signals have been switched out.</p>	<p>1. Reduce the signals into the inputs so that they do not exceed these specifications:</p> <p>IQ OR EXT. DEMOD. MODE</p> <p>DC Coupled +/- 5V peak AC Coupled +/- 5V peak ac on +/- 25V dc</p> <p>INTERNAL DEMOD. MODE</p> <p>RF Input - -5 dBm Coherent Reference - +10 dBm</p> <p>2. Press any key to cause the I and Q channels to be switched back in.</p>
<p>7102 - I INPUT OVERDRIVE PRESS ANY KEY TO CLEAR -</p>	<p>The signal into the I input signal path exceeds the Maximum Input specification. When this message appears, the input signal has been switched out.</p>	<p>1. Reduce the signal(s) into the input(s) so that it does not exceed these specifications:</p> <p>IQ OR EXT. DEMOD. MODE</p> <p>DC Coupled +/- 5V peak AC Coupled +/- 5V peak ac on +/- 25V dc</p> <p>INTERNAL DEMOD. MODE</p> <p>RF Input - -5 dBm Coherent Reference - +10 dBm</p> <p>2. Press any key to cause the I channel to be switched back in.</p>

Table 3-17. Error Messages (Cont.)

ID Number and Error Message	Description	Recovery Sequence
<p>7103 – Q INPUT OVERDRIVE PRESS ANY KEY TO CLEAR –</p>	<p>The signal into the Q input signal path exceeds the Maximum Input specification. When this message appears, the input signal has been switched out.</p>	<p>1. Reduce the signal(s) into the input(s) so that it does not exceed these specifications:</p> <p>IQ OR EXT. DEMOD. MODE</p> <p>DC Coupled +/- 5V peak AC Coupled +/-5V peak ac on +/-25V dc</p> <p>INTERNAL DEMOD. MODE</p> <p>RF Input - -5 dBm Coherent Reference - +10 dBm</p> <p>2. Press any key to cause the Q channel to be switched back in.</p>
<p>7104 – I & Q AMPLIFIER OVERDRIVES CHANGE GAIN –</p>	<p>The amplitude of the signals into the Input I and Input Q channels (IQ or external demodulation mode) or RF Input (internal demodulation mode) are too large for the gains that have been set. When this message appears, the input signals have been switched out.</p>	<p>Either step 1a or step 1b can be used to correct the cause of the error. Use step 2 to switch the channels back in.</p> <p>1a. Decrease the input signal amplitudes so that the signals stay on the display.</p> <p>1b. Decrease the I and Q channel gains so that the signals stay on the display.</p> <p>2. Press any key to cause the I and Q channels to be switched back in.</p> <p>Refer to the "Gain" Detailed Operating Instruction for further information.</p>

Table 3-17. Error Messages (Cont.)

ID Number and Error Message	Description	Recovery Sequence
7105 – I AMPLIFIER OVERDRIVE CHANGE GAIN –	The amplitude of the signal into the Input I channel (IQ or external demodulation mode) or RF Input (internal demodulation mode) is too large for the gain that has been set. When this message appears, the input signal has been switched out.	<p>Either step 1a or step 1b can be used to correct the cause of the error. Use step 2 to switch the channel back in.</p> <p>1a. Decrease the input signal amplitude so that the signal stays on the display.</p> <p>1b. Decrease the I channel gain so that the signal stays on the display.</p> <p>2. Press any key to cause the I channel to be switched back in.</p> <p>Refer to the "Gain" Detailed Operating Instruction for further information.</p>
7106 – Q AMPLIFIER OVERDRIVE CHANGE GAIN –	The amplitude of the signal into the Input Q channel (IQ or external demodulation mode) or RF Input (internal demodulation mode) is too large for the gain that has been set. When this message appears, the input signal has been switched out.	<p>Either step 1a or step 1b can be used to correct the cause of the error. Use step 2 to switch the channel back in.</p> <p>1a. Decrease the input signal amplitude so that the signal stays on the display.</p> <p>1b. Decrease the Q channel gain so that the signal stays on the display.</p> <p>2. Press any key to cause the Q channel to be switched back in.</p> <p>Refer to the "Gain" Detailed Operating Instruction for further information.</p>

Table 3-17. Error Messages (Cont.)

ID Number and Error Message	Description	Recovery Sequence
7107 – I INPUT & Q AMP OVERDRIVES PRESS ANY KEY TO CLEAR –	The signal into the I channel input path exceeds the Maximum Input specification and the amplitude of the signal into the Input Q channel (IQ or external demodulation mode) or RF Input (internal demodulation mode) is too large for the gain that has been set. When this message appears, both input signals have been switched out.	Perform the Recovery Sequences for errors 7102 and 7106.
7108 – Q INPUT & I AMP OVERDRIVES PRESS ANY KEY TO CLEAR –	The signal into the Q channel input path exceeds the Maximum Input specification and the amplitude of the signal into the Input I channel (IQ or external demodulation mode) or RF Input (internal demodulation mode) is too large for the gain that has been set. When this message appears, both input signals have been switched out.	Perform the Recovery Sequences for errors 7103 and 7105.
7109 – OVERDRIVE CLEARED BEFORE INTERRUPT SERVICED –	An HP-IB overdrive interrupt was set and when the controller checked for the overdrive condition, it had been cleared.	ADVISORY MESSAGE. NO RECOVERY SEQUENCE.
7110 – OVERDRIVE CLEARED BY RE-TRY (SUSPECT AC COUPLING) –	An overdrive was instantaneously generated and immediately resolved. It is possible that this error was generated when a large DC signal was switched into a channel that was AC coupled, causing a spurious out-of-range AC signal at the input.	ADVISORY MESSAGE. NO RECOVERY SEQUENCE.

Table 3-17. Error Messages (Cont.)

ID Number and Error Message	Description	Recovery Sequence
7111 – 1/2 SECOND TIMER GENERATED OVERDRIVE ERROR –	Two overdrives were detected within a one-half second period.	Perform the Recovery Sequence for error 7101. If that doesn't work, Perform the Recovery Sequence for error 7104. If that doesn't work, preset the instrument (press the PRESET key).
7112 – I CH OVERDRIVE IN CAL MAX ATTEN INSERTED –	An overdrive occurred on the I channel during calibration. The overdrive might have been caused by either the calibration signal or the user input.	Press the PRESET key and, after preset is complete, press the CAL key. If the error message recurs, remove the user input and repeat the procedure in the previous sentence.
7113 – Q CH OVERDRIVE IN CAL MAX ATTEN INSERTED –	An overdrive occurred on the Q channel during calibration. The overdrive might have been caused by either the calibration signal or the user input.	Press the PRESET key and, after preset is complete, press the CAL key. If the error message recurs, remove the user input and repeat the procedure in the previous sentence.
7114 – SOFTWARE DEVELOPMENT ERROR - OVERDRIVE –	This error indicates a possible problem with the instrument firmware. The operation that caused the error was not executed.	Try to preset the instrument (press the PRESET key). If the same error message keeps recurring, a problem exists with the instrument firmware. Refer to the Service Manual for further information.
7115 – OVERDRIVE DURING CALIBRATION –	An overdrive occurred on either the I or Q channel during calibration. The overdrive might have been caused by either the calibration signal or the user input.	Press the PRESET key and, after preset is complete, press the CAL key. If the error message recurs, remove any user inputs and repeat the procedure in the previous sentence.
7200 – DATA BASE I COUPLING ERROR –	This error indicates a possible problem with the instrument firmware. The operation that caused the error was not executed.	Try to preset the instrument (press the PRESET key). If the same error message keeps recurring, a problem exists with the instrument firmware. Refer to the Service Manual for further information.

Table 3-17. Error Messages (Cont.)

ID Number and Error Message	Description	Recovery Sequence
7201 – DATA BASE Q COUPLING ERROR –	This error indicates a possible problem with the instrument firmware. The operation that caused the error was not executed.	Try to preset the instrument (press the PRESET key). If the same error message keeps recurring, a problem exists with the instrument firmware. Refer to the Service Manual for further information.
7202 – DATA BASE DISPLAY MODE ERROR –	This error indicates a possible problem with the instrument firmware. The operation that caused the error was not executed.	Try to preset the instrument (press the PRESET key). If the same error message keeps recurring, a problem exists with the instrument firmware. Refer to the Service Manual for further information.
7203 - 7219 <i>DAC LIMIT ERRORS</i>	If an error message is generated with an Identification (ID) Number that is within this range, one or several Digital to Analog Converters (DACs) in the instrument's circuitry have been set to their upper or lower limits. This has happened because either a CAL Factor DAC value was out of range or a firmware generated DAC setup value was out of range. In either case, circuitry within the instrument might not be functioning properly.	Recalibrate the instrument (Press the front panel CAL key). If the error message keeps recurring, refer to Troubleshooting in the Service Manual for further information.
7222 – DATA BASE DEMOCUPLING ERROR –	This error indicates a possible problem with the instrument firmware.	Press the PRESET key on the front panel of the instrument. If the message recurs, refer to the Recovery Sequence for Microprocessor Errors (ID Numbers 500 - 509).

Table 3-17. Error Messages (Cont.)

ID Number and Error Message	Description	Recovery Sequence
7300 – RAMP INDEX ERROR SUSPECT ILLEGAL TOTAL DELAY –	This error indicates a possible problem with the instrument firmware. The operation that caused the error was not executed.	Try to preset the instrument (press the PRESET key). If the same error message keeps recurring, a problem exists with the instrument firmware. Refer to the Service Manual for further information.
7301 – RAMP RANGE ERROR –	This error indicates a possible problem with the instrument firmware. The operation that caused the error was not executed.	Try to preset the instrument (press the PRESET key). If the same error message keeps recurring, a problem exists with the instrument firmware. Refer to the Service Manual for further information.
7302 - 7307 <i>DAC LIMIT ERRORS</i>	If an error message is generated with an Identification (ID) Number that is within this range, one or several Digital to Analog Converters (DACs) in the instrument's circuitry have been set to their upper or lower limits. This has happened because either a CAL Factor DAC value was out of range or a firmware generated DAC setup value was out of range. In either case, circuitry within the instrument might not be functioning properly.	Recalibrate the instrument (Press the front panel CAL key). If the error message keeps recurring, refer to Troubleshooting in the Service Manual for further information.
7308 – DATA BASE ERROR ILLEGAL TIME SWEEP BEING USED –	This error indicates a possible problem with the instrument firmware. The operation that caused the error was not executed.	Try to preset the instrument (press the PRESET key). If the same error message keeps recurring, a problem exists with the instrument firmware. Refer to the Service Manual for further information.

Table 3-17. Error Messages (Cont.)

ID Number and Error Message	Description	Recovery Sequence
7400 – DATA BASE TRIGGER SOURCE ERROR –	This error indicates a possible problem with the instrument firmware. The operation that caused the error was not executed.	Try to preset the instrument (press the PRESET key). If the same error message keeps recurring, a problem exists with the instrument firmware. Refer to the Service Manual for further information.
7402 – DATA BASE EXTERNAL TRIG LEVEL ERROR –	This error indicates a possible problem with the instrument firmware.	Press the PRESET key on the front panel of the instrument. If the error recurs, refer to the Recovery Sequence for Microprocessor Errors (ID Numbers 500 - 509).
7403 – DATA BASE GATE CONFIGURATION ERROR –	This error indicates a possible problem with the instrument firmware. The operation that caused the error was not executed.	Try to preset the instrument (press the PRESET key). If the same error message keeps recurring, a problem exists with the instrument firmware. Refer to the Service Manual for further information.
7404 - 7406 <i>DAC LIMIT ERRORS</i>	If an error message is generated with an Identification (ID) Number that is within this range, one or several Digital to Analog Converters (DACs) in the instrument's circuitry have been set to their upper or lower limits. This has happened because either a CAL Factor DAC value was out of range or a firmware generated DAC setup value was out of range. In either case, circuitry within the instrument might not be functioning properly.	Recalibrate the instrument (Press the front panel CAL key). If the error message keeps recurring, refer to Troubleshooting in the Service Manual for further information.

Table 3-17. Error Messages (Cont.)

ID Number and Error Message	Description	Recovery Sequence
7500 – CALIBRATION ABORTED –	<p>Calibration was aborted by pressing any front panel key. (If calibration was initiated via HP-IB, it can only be aborted by pressing the LCL key).</p> <p>This message might also be displayed if the calibration routine aborted because of another error condition. In any case, the previous CAL Factors will remain intact.</p>	<p>Try to calibrate the instrument again (press the CAL key). If this is unsuccessful, press CAL again and watch for any other error messages and act on them. If repeated calibration attempts fail, refer to the Service Manual.</p>
8001 – DRIVER PLACED INTO THE IEEE 488.2 INTERRUPTED STATE –	<p>The instrument was sent a query and it did not finish responding to the query before the next command was sent.</p>	<p>Check the controller program to see if the controller is programmed to read the query response data before issuing the next command.</p>
8002 – DRIVER PLACED INTO THE IEEE 488.2 UNTERMINATED STATE –	<p>The controller attempted to read query data back without first sending a Program Message Terminator (the new line (NL) character).</p>	<p>Ensure that the new line character (NL) is being sent before the controller attempts to read the query data back.</p>
8003 – DRIVER PLACED INTO THE IEEE 488.2 DEADLOCK STATE –	<p>The instrument has been asked to buffer more data in internal memory than it has room for.</p>	<p>Correct the controller program so that no more than eight queries are executed on one line of the program.</p>
8004 – NEW QUERY WHILE SENDING INDEFINITE LENGTH QUERY MESSAGE –	<p>A query message requested indefinite length block data from the instrument and then another query was sent before the instrument was finished outputting the block data.</p>	<p>Correct the controller program so that the query that returns indefinite length block data is the last item on the program line.</p>
8005 – DRIVER WAS ADDRESSED TO TALK WITH NOTHING TO SAY –	<p>The controller tried to read HP-IB query data back before first sending the instrument a query.</p>	<p>Correct the controller program so that the controller sends the instrument a pertinent query before attempting to read query data back.</p>

Table 3-17. Error Messages (Cont.)

ID Number and Error Message	Description	Recovery Sequence
8010 – ENTERED DECIMAL DATA WAS OUT OF RANGE –	The decimal numeric data included with the HP-IB command is greater than 1E9999 or less than 1E-9999.	Correct the decimal numeric data so that it is within the range of 1E9999 to 1E-9999.
8020 – INVALID MNEMONIC RECEIVED –	The instrument received an HP-IB command mnemonic it did not recognize.	Correct the HP-IB mnemonic. Refer to the "HP-IB Program Codes" portion of the Detailed Operating Instruction for the function in question for a listing of correct HP-IB mnemonics.
8021 – UNDEFINED DATA TYPE –	The instrument received an HP-IB command with data that did not conform to any of the data types defined in IEEE Std. 488.2.	Check the format of the data sent to the instrument. Ensure that it is the correct type of data. Refer to the "HP-IB Program Codes" portion of the Detailed Operating Instruction for the function in question for a listing of HP-IB commands with their appropriate data.
8022 – INVALID DATA FIELD SEPARATOR –	A data field separator in an HP-IB command was used that was not a comma (,). (Example. In "KEY 44/63/6/7/63", slashes (/) are unacceptable.)	Replace any invalid data field separators with commas (,).
8023 – EMPTY DATA FIELD WITH A MULTIELEMENT MESSAGE UNIT –	A HP-IB command was sent to the instrument that contained two data field separators (commas) with no data in between. (Example. KEY 44, 63.6, .763)	Check and correct the data field by either adding data between the two commas or deleting one of the commas.

Table 3-17. Error Messages (Cont.)

ID Number and Error Message	Description	Recovery Sequence
8024 – CHARACTER DATA NOT ALLOWED FOR ENTERED MNEMONIC –	The instrument received character data with an HP-IB command. This type of data is not valid for this command.	Correct the HP-IB program code so that the included data is a valid type of data for the particular command. Refer to the "HP-IB Program Codes" portion of the Detailed Operating Instruction for the function in question for a listing of HP-IB codes and their appropriate data.
8025 – CHARACTER DATA OVERFLOW –	The instrument received an HP-IB command which contained character data that was over 12 characters long.	Correct the controller program so that the HP-IB program code contains the correct character data. Refer to the "HP-IB Program Codes" portion of the Detailed Operating Instruction for the function in question for a listing of HP-IB codes with their appropriate character data (FNB).
8026 – INVALID CHARACTER DATA TYPE CHARACTER RECEIVED –	The instrument received an HP-IB command with character data that contained one or more invalid characters.	Correct the character data for the command in question. The only valid character data characters are upper and lower case letters, 0 through 9, and the underscore (_). Refer to the "HP-IB Program Codes" portion of the Detailed Operating Instruction for the function in question for a listing of HP-IB codes with their appropriate character data.
8027 – INVALID CHARACTER DATA TYPE TOKEN RECEIVED –	The instrument receives an HP-IB command with character data where the data is not acceptable for that particular command. (Example. CHAN:COUP BC)	Correct the controller program so that the HP-IB program code contains the correct character data. Refer to the "HP-IB Program Codes" portion of the Detailed Operating Instruction for the function in question for a listing of HP-IB codes with their appropriate character data (FNB).

Table 3-17. Error Messages (Cont.)

ID Number and Error Message	Description	Recovery Sequence
8028 – IMPROPER STRING DATA TYPE TERMINATION –	An HP-IB command was sent to the instrument with string data that was not terminated with quotation marks (") or an apostrophe (').	Correct the controller program so the string data in the HP-IB command is terminated with quotation marks (") or an apostrophe ('). (The terminator needs to be the same as the leading delimiter).
8029 – STRING DATA TYPE NOT ALLOWED FOR MNEMONIC –	String data (data enclosed in quotation marks or apostrophes) was sent to the instrument with an HP-IB command where string data is not acceptable.	Correct the controller program so that the data included with the HP-IB command is not enclosed in quotation marks (") or apostrophes (').
8030 – BLOCK DATA TYPE NOT ALLOWED FOR ENTERED MNEMONIC –	Arbitrary block program data was sent to the instrument with an HP-IB command where this type of data is not acceptable.	Correct the controller program so that the data included with the HP-IB command is not arbitrary block program data. Refer to the "HP-IB Program Codes" portion of the Detailed Operating Instruction for the function in question for a listing of HP-IB codes with their appropriate data.
8031 – INVALID BLOCK TYPE –	The instrument received an HP-IB command with block data that was of the wrong type for that command. The block data can be either indefinite length or definite length.	Correct the HP-IB program code so that it contains the correct type of block data. Indefinite length block data begins with the symbol "#0" and definite length block data begins with the symbol "#" followed by a digit from 1 to 9. Refer to IEEE Std 488.2 for further information.
8032 – IMPROPER BLOCK DATA TYPE TERMINATION –	Indefinite length block data was sent to the instrument with an HP-IB command where the data was not properly terminated.	Terminate the indefinite length block data with the new line character (NL).

Table 3-17. Error Messages (Cont.)

ID Number and Error Message	Description	Recovery Sequence
8033 – NON-DECIMAL DATA TYPE NOT ALLOWED FOR MNEMONIC –	Binary, octal, or hexadecimal numeric data was sent to the instrument with an HP-IB command where only decimal numeric data is accepted.	Convert the non-decimal numeric data to decimal numeric data and change the HP-IB command accordingly.
8034 – INVALID NON-DECIMAL DATA TYPE CHARACTER –	The instrument accepts binary, octal, or hexadecimal numeric data for the given HP-IB command but the data contains one or more invalid characters.	Correct the non-decimal numeric data so that it contains only a combination of the following characters: Binary- 0, 1 Octal- 0, 1, 2, 3, 4, 5, 6, 7 Hexadecimal- 0, 1, 2, 3, 4, 5, 6, 7, 8, 9, A/a, B/b, C/c, D/d, E/e, F/f
8035 – NON-DECIMAL DATA TYPE DATA OVERFLOW –	More than 8 bytes of non-decimal numeric data was sent with the HP-IB command.	Correct the non-decimal numeric data so that it contains 8 bytes or less.
8037 – DECIMAL DATA TYPE NOT ALLOWED FOR MNEMONIC –	An HP-IB command was sent to the instrument with decimal numeric data where decimal numeric data is not allowed.	Replace the decimal numeric data in the HP-IB command with appropriate data. Refer to the "HP-IB Program Codes" portion of the Detailed Operating Instruction for the function in question for a listing of HP-IB codes with their appropriate data (FNB).
8038 – IMPROPER DECIMAL DATA TYPE FORMAT –	Decimal numeric data has been sent to the instrument with an HP-IB command where the data does not follow the format as defined by IEEE Std. 488.2.	Correct the decimal numeric data so that it follows the NRf format as defined by IEEE Std. 488.2. Refer to IEEE Std. 488.2 or "Programming Numeric Data" in the "Receiving Data Messages" portion of the Remote Operation section of this manual.

Table 3-17. Error Messages (Cont.)

ID Number and Error Message	Description	Recovery Sequence
8039 – IMPROPER CHARACTER WITHIN DECIMAL DATA TYPE FIELD –	The instrument received an HP-IB command with decimal numeric data where one or more of the data characters were invalid. The only valid characters are 0 through 9, e or E, ., +, -, and the white space ().	Correct the controller program so that the decimal numeric data contains only valid characters. Refer to "Programming Numeric Data" in the "Receiving Data Messages" portion of the Remote Operation section of this manual.
8040 – DECIMAL DATA TYPE EXPONENT OVERFLOW –	An HP-IB command was sent to the instrument with decimal numeric data that had an exponent that was not in the range of -32000 to +32000.	Correct the exponent value of the decimal numeric data in question so that it is within the range of -32000 to +32000.
8041 – DECIMAL DATA TYPE SUFFIX NOT ALLOWED FOR MNEMONIC –	The instrument received an HP-IB command with numeric data that contained a suffix (MS, UV, K, etc.) where suffixes aren't allowed.	Delete the suffix from the numeric data. If necessary, use an exponent. Refer to "Programming Numeric Data" in the "Receiving Data Messages" portion of the Remote Operation section of this manual.
8042 – INVALID SUFFIX WITH DECIMAL DATA TYPE –	Suffixes are allowed with the HP-IB command sent, but the wrong suffix was used for the specific data. [Example. Using MV (millivolts) where the data is in time units (MS, US, PS).]	Use an appropriate, valid suffix for the data being used. Refer to "Programming Numeric Data" in the "Receiving Data Messages" portion of the Remote Operation section of this manual.
8045 – QUERY NOT ALLOWED FOR THIS MNEMONIC –	The instrument was sent an HP-IB command followed by a question mark (?). This normally indicates a query but no query is allowed for this particular command.	If the question mark was unintentionally added to a command, delete the question mark. If a query was intended, delete the whole code.
8046 – GROUP EXECUTE TRIGGER IN MIDDLE OF MESSAGE RECORD –	A Group Execute Trigger command occurred somewhere within a line of HP-IB program code. This is not allowed.	Omit the Group Execute Trigger command from the program. The Vector Modulation Analyzer does not respond to this command.

Table 3-17. Error Messages (Cont.)

ID Number and Error Message	Description	Recovery Sequence
8047 – IMPROPER NON-DECIMAL DATA TYPE FORMAT –	The instrument received an HP-IB command with a type of non-decimal numeric data that is invalid for that particular command.	Convert the incorrect numeric data to numeric data that is valid for that particular HP-IB command. Change the command accordingly.
8048 – IMPROPER EXPRESSION DATA TYPE TERMINATION –	The instrument received an HP-IB command that contained expression data that was not terminated with a parenthesis [)].	Correct the controller program so that the expression data in the HP-IB command is terminated with a parenthesis [)].
8049 – EXPRESSION DATA TYPE NOT ALLOWED FOR MNEMONIC –	The instrument was sent an HP-IB command with data that was enclosed in parentheses [()]. This is not allowed for this particular command.	Correct the controller program so that the data included with the HP-IB command is not enclosed in parentheses [()].
8051 – INVALID CHARACTER IN DEFINED BLOCK LENGTH FIELD –	The defined block length field sent to the instrument with the HP-IB command included a character or characters not in the range of 0 through 9.	Correct the defined block length field so that it contains only the characters 0 through 9. Refer to IEEE Std. 488.2 for further information.
8501 – KEY CODE NOT ASSIGNED –	A KEY command number has been used with the HP-IB "KEY" command that does not correspond to a front panel key or softkey.	Refer to the KEY Command Detailed Operating Instruction and choose a correct KEY command number.
8503 – ILLEGAL IMPEDANCE VALUE LEGAL VALUES ARE 50 & 75 –	An impedance value entry was attempted over HP-IB that was not 50 ohms or 75 ohms.	Correct the HP-IB command so that the data sent with the command is either 50 or 75 as is appropriate.
8600 – INCORRECT NUMBER OF PARAMETERS RECEIVED WITH MNEMONIC –	An HP-IB command was sent to the instrument with more or less data than was expected for that command.	Correct the HP-IB command so that it contains the correct number of data parameters.
8601 – TOO MANY CHARACTERS IN STRING –	Only 10 characters are allowed within the HP-IB string data delimiters (" ", or ' ').	Correct the controller program so that the HP-IB program code contains string data that is no more than 10 characters long (not including delimiters).

Table 3-17. Error Messages (Cont.)

ID Number and Error Message	Description	Recovery Sequence
8602 – NUMERIC DATA EXPECTED –	The instrument received an HP-IB command which included some type of non-numeric data (character, string, block, etc.). Only numeric data is acceptable for the particular command.	Correct the HP-IB program code so that the appropriate type of numeric data is included.
8603 – TRIGGER SOURCE SET TO LINE –	The instrument received an HP-IB command which attempted to set the trigger level, coupling, or slope when the trigger source was set to LINE.	Choose either EXT, INT I, or INT Q, trigger source as appropriate before attempting to set the trigger level, coupling, or slope. Refer to the "Trigger Setup" Detailed Operating Instruction for further information.
8604 – INVALID DATA FORMAT –	The data included with the HP-IB command is not in a format accepted for that particular command.	Refer to the Detailed Operating Instruction for the function in question for a listing of HP-IB codes with their appropriate data and correct the command accordingly.
8605 – DATA OUTSIDE OF VALID RANGE –	The data included with the HP-IB command is outside of the valid range for that particular command.	Refer to the Detailed Operating Instruction for the function in question for a listing of HP-IB codes with their appropriate data and correct the command accordingly.
8606 – TRIGGER SOURCE SET TO EXTERNAL –	Changing trigger coupling is invalid when the external trigger source is selected.	Choose either the INT I or INT Q trigger source if selection of trigger coupling is desired.
8800 - 8809 <i>HP-IB FIRMWARE ERRORS</i>	If an error message is generated with an Identification (ID) Number that is within this range, a possible problem exists with the firmware portion of the HP-IB driver. The operation that caused the error might not be executed.	Attempt to re-execute the HP-IB command. If the same error message recurs after several attempts to re-execute the HP-IB command, a problem exists with the instrument firmware. Refer to the Service Manual for further information.

Gain

Description

The GAIN & OFS key activates a menu that enables the user to set the volts per division (gain) of the I and Q channels in IQ mode and the full scale magnitude (in dBm) in DEMOD mode.

The gain and offset menu also contains a softkey that is used to adjust the I/Q gain ratio of the I and Q channel signals. When this function is used, positive values (entered in dB) scale the signals such that the Q channel gain is reduced. In this case, the I channel gain remains at the normal Full Scale magnitude value and is not changed. Negative values entered for I/Q gain ratio will have an opposite effect on the signals.

Procedure

Setting the Gain

1. Press the GAIN & OFS key. This activates the gain and offset menu on the display. The gain and offset menu will differ depending upon whether the MODE is set to IQ or DEMOD. Go to step 2 if the MODE is set to IQ or step 3 if the MODE is set to DEMOD.
2. Press the softkey that is adjacent to the on-screen text that identifies the desired channel for which the gain must be set (VOLT/DIV I or VOLT/DIV Q). If it is desirable to set gain simultaneously on both channels, press the VOLT/DIV I&Q softkey. Use either a function-data-units entry or the step up/step down keys or knob to set the desired gain. The function parameters are as follows:

Range	±5 mV/div to ±1.0V/div
Knob Resolution	1% of value
Step Up/Down Resolution	1, 2, 5, 10 sequence

Note



Negative gains can be entered in IQ mode using a F-D-U entry and the CHG SIGN key. If a negative gain is entered, the signal will be inverted on the display.

3. Press the FULL SCALE softkey. Use either a function-data-units entry or the step up/step down keys or knob to set the desired full scale magnitude. The function parameters are as follows:

Range	See Comments at the end of this detailed operating instruction
Knob Resolution	0.1 dB
Step Up/Down Resolution	1.0 dB



Setting the I/Q Gain Ratio (DEMOD mode only)

1. Press the GAIN & OFS key. This activates the gain and offset menu on the display.
2. Press the I/Q softkey. Use either a function-data-units entry or the step up/step down keys or knob to set the desired I/Q gain ratio. The function parameters are as follows:

Range	0 to ±40.000 dB
Knob Resolution	0.01 dB
Step Up/Down Resolution	0.1 dB

Example

The user wants to set the Q channel gain to 500 mV/div.

LOCAL (key-strokes)	 VOLT/DIV Q <input type="text"/> <input type="text"/> <input type="text" value="5"/> <input type="text" value="0"/> <input type="text" value="0"/> mV/DIV <input type="text"/> <input type="text"/>
 (Program Codes)	CHANQ:SEN 5.00E-1

HP-IB Program Codes

Command Level	Description	Code (1)
Subsystem (SUBS) Codes	I Channel	CHANI CHANNEL1 CHAN1 CH1

Command Level	Description	Code (1)
Subsystem (SUBS) Codes (cont'd)	Q Channel	CHANQ CHANNEL2 CHAN2 CH2
	Demodulation	DEM
Function (FNA) Codes	Range	RANG RANGE
	Gain	SENS SENSITIVITY
	Full Scale Magnitude	FSCAL
	I/Q Gain Ratio	IQRT

(1) If multiple codes appear in this column, the first one listed is the preferred code. Others are given to be compatible with HPOL (Hewlett-Packard Oscilloscope Language).

Parameter	Program Code (SUBS: FNA FNB)
I channel range	CHANIRANG -10.00 to 10.00 (1)
Q channel range	CHANQRANG -10.00 to 10.00 (1)
I channel gain	CHANISENS -1.000E0 to 1.000E0 (2)
Q channel gain	CHANQSENS -1.000E0 to 1.000E0 (2)
set full scale magnitude	DEM:FSCAL XXX (3)
set I/Q gain ratio	DEM:IQRT 0 to ±40.000 (4)

(1) "-10.00 to 10.00" should be replaced with the selected full scale voltage in volts.

(2) "-1.000E0 to 1.000E0" should be replaced with the selected gain in full volt units (not millivolts).

(3) The range of full scale magnitude values is not fixed. See Comments at the end of this detailed operating instruction.

(4) "0 to ±40.000" should be replaced with the desired I/Q gain ratio in dB.

Indications

When a specific gain, Full Scale magnitude, or I/Q gain ratio softkey is active, the parameter will be displayed in the User Interface Area (UIA). The parameter is always displayed in the Parameter Data Area (PDA). As the parameter is being changed, it will be shown changing in the UIA and PDA. In addition, the parameter for Full Scale magnitude or I/Q gain ratio will be displayed below its softkey label.

Comments**IQ Mode**

When the I and Q channel gains are changed simultaneously (VOLT/DIV I&Q) via a function-data-units (F-D-U) entry, both channels are always set to the same gain. When the step up/step down keys or knob are used to simultaneously change the gain, the ratio of I channel gain to Q channel gain is preserved.

When the input impedance is 50Ω , the lowest gain (SENS) that can be entered via HP-IB is 0.005V and the lowest range (RANG) is 50 mV. When the input impedance is 75Ω , the lowest gain (SENS) that can be entered is 0.01V and the lowest range (RANG) is 100 mV.

The term "division" (DIV) in VOLTS/DIV refers to one division in a 10 X 10 Scope Format. When other modulation formats are used, it is better to use the range (RANG) command which sets the voltage swing of the full display.

DEMODO Mode

When in DEMOD Mode, the Range of full scale magnitude values is not fixed. The Range depends on the gain of the demodulator, the user Gain setting, and the Gain Correction Factor. The range is -22 dBm to +24 dBm (5 mV/div to 1V/div) if gain correction factor is set to zero and the gain of the demodulator is zero. The gain of the demodulator is typically -1 to +1 dB which shifts the entire sensitivity range.

In DEMOD mode, full scale is referenced from the center (the origin) of the display. For example, if a signal varies from zero to positive full scale on the Q axis, the Q versus time display would show the signal going from the center of the display to the top of the display. It will not be centered around 0% of full scale (the center of the display).

The I/Q gain ratio function affects the display along the actual grid axes on the display regardless of whether or not any phase rotation is present in the signals.

Related Sections

Demodulation

Gate Configuration

Description

Pressing the TRIG SOURCE key and the GATE CONFIG softkey activates a menu that allows the user to configure the rear panel GATE input. The GATE input can be enabled or disabled via this menu and its termination can be selected.

When the GATE input is high, the display is blanked asynchronously with the trigger rate. Measurements are disabled when the display is blanked.

Procedure

1. Press the TRIG SOURCE key. This will activate the trigger source menu on the display.
2. Press the GATE CONFIG softkey. This will activate a second level menu for configuring the GATE input. Use the following procedures to enable or disable the GATE, and select the termination:

Enabling or Disabling GATE Input

Check the text (GATE INPUT ENAB/DISAB) that is adjacent to the menu softkey. Either "ENAB" or "DISAB" will be highlighted. If the desired status of the GATE input is highlighted, do not press the softkey. If the opposite is highlighted, press the softkey to toggle the selection.

Selecting GATE Termination

Press the softkey that corresponds to the type of GATE termination threshold and level desired. The choices for GATE termination are described briefly below:

GND TERM TTL LEVEL - This choice selects a 50 Ω to ground termination with a threshold of 1.3 volts.

-2V TERM ECL LEVEL - This choice selects a 50 Ω to -2 volt termination with a threshold of -1.3 volts.

GND TERM 0V LEVEL - This choice selects a 50 Ω to ground termination with a threshold of zero volts.

Example

The user wants to enable the rear panel GATE input. The gate signal is TTL. Assume that the GATE input is currently disabled:

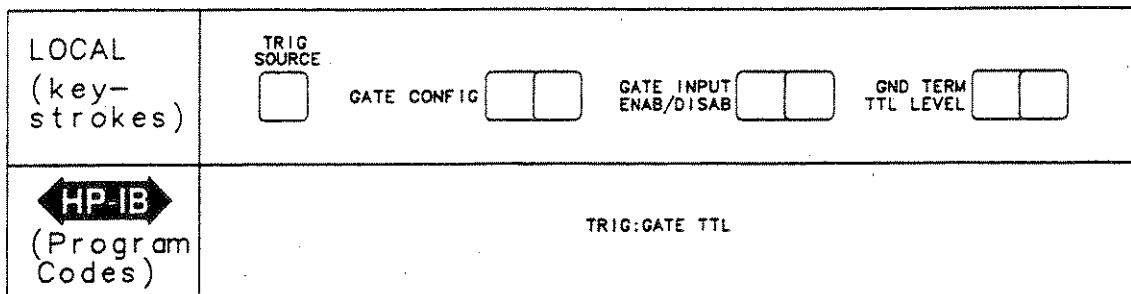

HP-IB Program Codes

Command Level	Description	Code (1)
Subsystem (SUBS) Codes	Trigger	TRIG TRIGGER
Function (FNA) Code	Gate	GATE

(1) If multiple codes appear in this column, the first one listed is the preferred code. Others are given to be compatible with HPOL (Hewlett-Packard Oscilloscope Language).

Parameter	Program Code (SUBS: FNA FNB)
gate disabled	TRIG:GATE OFF
gate enabled with 0V termination, TTL threshold	TRIG:GATE TTL
gate enabled with -2V termination, ECL threshold	TRIG:GATE ECL
gate enabled with 0V termination, 0V threshold	TRIG:GATE GND

Indications

When the gate configuration menu is activated, the active menu items are highlighted (brighter). Note that the screen shows nothing in the Parameter Data Area to indicate the status of the GATE input.

Comments

When the gate termination is selected via HP-IB, the GATE input is automatically enabled. Therefore, no command is provided simply to enable the gate.

If the GATE input is disabled, changing the termination via the softkeys will not cause the hardware termination to change even though the softkey becomes highlighted.

When using the GATE input and printing the display using an external printer, it is recommended that the number of print points be high (>10,000) to provide enough points for a legible print.

HELP Key

Description

The HELP key provides more information about a particular function. When the HELP function is utilized, a short description explaining the function of the key or softkey in question will appear on the screen. In addition, the HP-IB code for the function will appear on the screen.

Procedure

1. If the function in question is a softkey, press the necessary front panel hardkey/menu softkey sequence to activate the menu containing that softkey.
2. Press the HELP key. The instrument will display the prompt "HELP (Press Any Key)" in the User Interface Area.
3. Press the front panel key or menu softkey in question.

Note



No special keys are necessary to exit the HELP function as pressing any other key will exit this function. When any other key is pressed, it is immediately executed. To exit without changing any previous setup, press LCL.

Example

The user needs further information on the simultaneous I and Q delay function (DELAY I&Q in the TIMING menu).

LOCAL (key-strokes)	
 (Program Codes)	NO HP-IB CODES ARE IMPLEMENTED THAT PROVIDE THE SAME FUNCTION AS THE "HELP" KEY.

**HP-IB Program
Codes**

No HP-IB codes are implemented that provide the same function as the HELP key.

Indications

When the HELP key is pressed, the words "HELP (Press Any Key)" appear in the User Interface Area (UIA). When the front panel key or softkey in question is pressed, the usual display disappears. It is replaced by the HELP function text. The word "HELP:" appears on the first line with the keystroke sequence following it. The items in the sequence are separated by commas (,) with the last keystroke (the function in question) underlined.

One line below will be a short description of the function of the key. One line below the description will be the HP-IB code for the key function.

If the only function of the key or softkey is to access more menus, the menu tree for the key will be shown on the display. If the softkey in question is one that will be immediately executable when pressed, its menu will be displayed in the Softkey Menu Area when the HELP text is displayed.

Comments

The only functions that can not be explained using the HELP function are the PRESET key and LINE switch.

Related Sections

Preset

I&Q Versus Time Display

Description

Pressing the "I&Q" key sets up a voltage versus time display with both the I and Q channels being displayed along the time axis. The I and Q axes are displayed in either dBm (instrument in DEMOD mode) or volts per division (instrument in IQ mode).

Nine display formats are useable in the I&Q versus time display mode. These display formats include a standard 10 x 10 oscilloscope format and eight modulation-specific formats. The eight formats are QPSK, 9PRS, 16QAM, 25PRS, 49PRS, 64QAM, 81PRS, and 256QAM.

The SPLIT SCREEN ON/OFF softkey function in the special display menu determines how I&Q versus time will be displayed. If the SPLIT SCREEN function is ON, the signal display area is split into two display format grids. Each grid has 10 divisions along the time axis and 5 divisions along the I and Q axes (2.5 divisions above and below the time axis). A double line separates the two grids. I versus time is displayed in the top half of the screen and the Q versus time is displayed in the bottom half of the screen.

If the SPLIT SCREEN function is OFF, the signal display area can be any of the display grids in the DEMOD/MOD FORMAT menu. The I and Q versus time displays will be superimposed and displayed along the center time axis.

When the I&Q versus time display mode is selected (SPLIT SCREEN OFF), none of the parameters of the previous display are changed. As an example, if a Vector display has an I&Q gain of 1 volt per division, then the I&Q versus time display will also have I and Q channel gains of 1 volt per division.

For more information on displays, see the DISPLAY, GENERAL Detailed Operating Instruction.

Procedure

I&Q Versus Time; Standard Display Mode

1. Press the SPCL DISP key. This will activate the special display menu on the display.
2. Check the text (SPLIT SCREEN ON/OFF) that is adjacent to the menu softkey. Either the "ON" or "OFF" will be highlighted. If the "OFF" is highlighted, do not press the softkey. If the "ON" is highlighted, press the softkey to toggle the selection.
3. Press the front panel "I&Q" key.

I&Q Versus Time; Split Screen Display Mode



1. Press the SPCL DISP key. This will activate the special display menu on the display.
2. Check the text (SPLIT SCREEN ON/OFF) that is adjacent to the menu softkey. Either the "ON" or "OFF" will be highlighted. If the "ON" is highlighted, do not press the softkey. If the "OFF" is highlighted, press the softkey to toggle the selection.
3. Press the front panel "I&Q" key.

Selecting the Display Formats

1. Press the DEMOD key. This activates the demodulator menu on the display.
2. Press the MOD FORMAT softkey. This activates the second level "modulation format" menu on the display.
3. Press the softkey in the MOD FORMAT menu that corresponds to the desired display format. The menu choices are SCOPE FORMAT, QPSK, 9PRS, 16QAM, 64QAM, 256QAM, and MORE. If MORE is pressed, an additional menu will appear with the choices 25PRS, 49PRS, and 81PRS displayed.

Example

A Constellation display is currently on the screen and the user wants to view the corresponding I and Q versus time displays in split screen format. Assume that the standard (split screen off) format is currently selected.

LOCAL (key-strokes)	
 (Program Codes)	DISP:FORM DUAL; MODE 10

HP-IB Program Codes

Command Level	Description	Code (1)
Subsystem (SUBS) Codes	Display	DISP DISPLAY
	Demodulation	DEM
Function (FNA) Codes (under subsystem DISP)	Display Format	FORM FORMAT
	Display Mode	MODE
Function (FNA) Codes (under subsystem DEM)	Display Format	FORM

(1) If multiple codes appear in this column, the first one listed is the preferred code. Others are given to be compatible with HPOL (Hewlett-Packard Oscilloscope Language).

Parameter	Program Code (SUBS: FNA FNB)
split screen off	DISP: FORM SING
split screen on	DISP: FORM DUAL
select I&Q versus time display mode	DISP: MODE CHANIQ
select 10 x 10 oscilloscope format	DEM: FORM NONE
select QPSK display format	DEM: FORM QPSK
select 9PRS display format	DEM: FORM PRS9

Parameter	Program Code (SUBS: FNA FNB)
select 16QAM display format	DEM: FORM QAM16
select 49PRS display format	DEM: FORM PRS49
select 64QAM display format	DEM: FORM QAM64
select 25PRS display format	DEM: FORM PRS25
select 81PRS display format	DEM: FORM PRS81
select 256QAM display format	DEM: FORM QAM256

Indications

When the I&Q key is pressed, all menus, except for the Special Display and 3D Display menus, remain displayed and active. All data in the User Interface Area (UIA) and Parameter Data Area remains displayed. The display mode changes to I&Q versus time with the display format at whatever was selected in the DEMOD/MOD FORMAT menu if SPLIT SCREEN is OFF. If SPLIT SCREEN is ON, the display format will switch to two 5 X 10 grid (oscilloscope) formats. The words "I&Q vs time" appear in the Display Identification area.

If the SPCL DISP key is pressed in order to access the SPLIT SCREEN ON/OFF softkey, the words "SIGNAL INTENSITY= number" will always appear in the UIA.

Comments

If the SPLIT SCREEN function is ON, no provision is made to restrict the I and Q signals to their respective halves of the screen should the gains be increased.

No modulation formats, other than the standard oscilloscope format, are available when SPLIT SCREEN is ON.

When SPLIT SCREEN is ON, I and Q gains are doubled.

Related Sections

Display, General

I Marker Setup

Description

Pressing the "I" key in the MARKERS portion of the front panel activates the I marker menu; the marker is also turned on and automatically set up so that it can be changed via front panel keys or knob. I marker functions are active in all displays, but are not visible in Q versus time displays or when the 3D DISPLAY, VECTOR ALIGN, or CONSTL ALIGN softkeys in the SPCL DISP menu are active. Each of the choices in the I marker menu are explained below.

Note



The function parameters for the I marker and delta I marker will differ depending on whether the instrument is set to IQ mode or DEMOD mode.

Changing marker values in DEMOD mode will not change marker values in IQ mode, and vice versa.

I MARKER VALUE - Pressing this key enables the value of the I marker to be changed via either a function-data-units (F-D-U) entry, or the step up/step down keys or knob. In the IQ mode, the I marker can be set to any value within its specified range via a function-data-units entry even though the set value may be off the display. In this case, the actual set value of the marker will be displayed in the User Interface Area (UIA) and Parameter Data Area (PDA) of the display and the marker itself will appear at the edge of the display. In the DEMOD mode, the I marker can not be set so that it is off the display.

The step up/step down keys or knob can only adjust the I marker over the present range of the display. When the I marker has been set offscreen in the IQ mode and the step up/step down keys or knob are used, the marker value will instantaneously be set to the edge of the display and the marker will move from that point.

I MARKER ON/OFF - This softkey is provided to allow the user to turn the I marker off. The I marker is automatically turned on whenever the front panel "I" marker key is pressed. This softkey provides a toggle function, therefore, repeatedly pressing the softkey will cause the marker to toggle between "ON" and "OFF".

DELTA I ON/OFF - This is a toggle function, therefore, repeatedly pressing this softkey will cause the delta I function to toggle between "ON" and "OFF". When this softkey is pressed, a marker will be anchored at the present I marker position. This "anchor" marker will then stay in the position where it was anchored. Modifications to the delta I marker via a F-D-U entry or the step up/down keys or knob will cause the delta I marker to move away from

the anchor marker. The value displayed in the UIA and PDA will be the difference between the delta I marker and the anchor marker.

I MARKER->CENTER - Pressing this softkey moves the I marker to the center of the display. When the I MARKER->CENTER softkey is pressed, the center screen value will correspond to any I offset that has been added.

ALL MARKERS OFF - Pressing this softkey will turn all five markers off and thereby remove them from the display.

Procedure

Press the "I" key in the MARKERS portion of the front panel. This will activate the I marker menu on the display. Use the following procedures to modify the I marker or delta I markers:

Modifying the I Marker Value

Press the I MARKER VALUE softkey. Use either a function- data-units entry or the step up/step down keys or knob to set the value of the I marker. The function parameters are as follows: note that they are different depending on whether the instrument is in IQ mode or DEMOD mode. Note also that the range for a F-D-U entry differs from the range for modification with the step up/step down keys or knob:

Function Parameters - IQ Mode

Range - function-data-units entry	±20 volts
Range - step up/step down keys or knob	± full screen
Knob Resolution	1% of the current gain value
Step Up/Down Resolution	10% of full scale

Function Parameters - DEMOD Mode

Range	±100% of full scale
Knob Resolution	0.1% of full scale
Step Up/Down Resolution	5% of full scale

Using the Delta I Function

1. Check the text (DELTA I ON/OFF) that is adjacent to the menu softkey. Either the "ON" or "OFF" will be highlighted.

2. Press the softkey so that the "OFF" is highlighted.
3. Use either a function-data-units entry or the step up/step down keys or knob to move the marker to the desired anchor location.
4. Press the DELTA I ON/OFF softkey so that the "ON" is highlighted. Doing this anchors the marker.
5. Use either a function-data-units entry or the step up/step down keys or knob to move the delta I marker to its desired location. The value displayed in the UIA and PDA will be the difference between the anchor marker and the delta I marker.

Centering the I Marker

To move the I marker to the center of the display, press the I MARKER->CENTER softkey.

Turning I Marker On and Off

Check the text (I MARKER ON/OFF) that is adjacent to the menu softkey. Either the "ON" or "OFF" will be highlighted. If the desired status of the I marker is highlighted, do not press the softkey. If the opposite state is highlighted, press the softkey to toggle the selection.

Turning All Markers Off

If it is desirable to turn all five markers off, press the ALL MARKERS OFF softkey.

Examples

Note



In the following examples, the instrument is set to IQ mode.

The following examples consist of a front panel keystroke example and an HP-IB example. This is because the user must know the voltage value of the markers in order to set them via HP-IB. Therefore, HP-IB setup is impractical when trying to find the difference between two points. Example 1 deals with front panel keystrokes and Example 2 deals with HP-IB.

Example 1

The user wants to find the voltage difference between two points in a constellation display. The easiest way to do this is through the use of the delta I function:

LOCAL (key- strokes)	PRESS: I	PRESS: ←→ or ←→ to move the I marker as close as possible to the leftmost (most negative) of the two points. Use the knob to place the I marker directly on this point.
	PRESS: DELTA I ON/OFF □ □ To anchor the marker.	
	PRESS: ←→ to move the delta I marker as close as possible to the rightmost (most positive) of the two points. Note that the anchor marker will stay while the delta I marker separates from the anchor marker. Use the knob to place the delta I marker directly on this point. The value displayed in the UIA and PDA is the voltage difference between the two points.	

Example 2

The programmer needs to set up a display in which the user can easily see if the points in a constellation cloud fall within certain limits on the I axis. The center of the cloud is $I=30$ mV and $Q=30$ mV. All points in the cloud should fall within $+5.0$ mV and -2.5 mV of the value for I. The limits can be shown on the display using the delta I function to set the display up as shown in Figure 3-20:

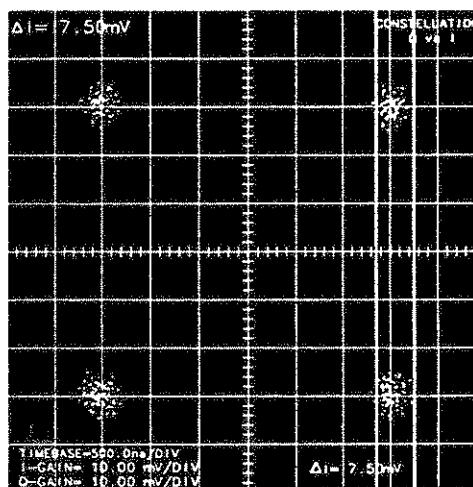



Figure 3-20. Display with I Limits

 (Program Codes)	DISP: IMAR ON; MEAS: IMAV 27.5 MV; IMAD ON; IDEL 7.5 MV
--	--

HP-IB Program Codes

Command Level	Description	Code (1)
Subsystem (SUBS) Codes	Display	DISP DISPLAY
	Measure	MEAS MEASURE
	Demodulation	DEM
Function (FNA) Codes (under subsystem DISP)	Delta I On/Off	IMAD
	I Marker On/Off	IMAR
	All Markers Off	MOFF
Function (FNA) Codes (under subsystems MEAS and DEM)	Delta I Value	IDEL
	I Marker Center	IMAC
	Delta I On/Off	IMAD
	I Marker Value	IMAV

(1) If multiple codes appear in this column, the first one listed is the preferred code. Others are given to be compatible with HPOL (Hewlett-Packard Oscilloscope Language).

Parameter	Program Code (SUBS: FNA FNB)
delta I marker on	DISP:IMAD ON MEAS:IMAD ON DEM:IMAD ON
delta I marker off	DISP:IMAD OFF MEAS:IMAD OFF DEM:IMAD OFF
I marker on	DISP:IMAR ON
I marker off	DISP:IMAR OFF
all markers off	DISP:MOFF
set delta I value (IQ mode)	MEAS:IDEL -40.0 to 40.0 (1)
set delta I value (DEMOM mode)	DEM:IDEL -200 to 200 (2)
move I marker to center	MEAS:IMAC DEM:IMAC
set I marker value (IQ mode)	MEAS:IMAV -20.0 to 20.0 (3)
set I marker value (DEMOM mode)	DEM:IMAV -100 to 100 (4)

(1) "-40.0 to 40.0" should be replaced with a voltage in full volt units that represents the distance the I marker is away from the anchor marker.

(2) "-200 to 200" should be replaced with a number in percent that represents the distance the I marker is away from the anchor marker.

(3) "-20.0 to 20.0" should be replaced with a voltage in full volt units that represents the actual magnitude of the I marker.

(4) "-100 to 100" should be replaced with a number in percent that represents the percent of full scale value of the I marker.

Indications

When the "I" marker key is pressed, the I marker menu appears on the screen with the I MARKER VALUE menu item highlighted (brighter). In addition, the I MARKER ON/OFF function will always be ON and the I marker will appear on the screen. The words "I-MKR=XXX" will appear in the UIA and PDA with XXX being the value that the I marker is set at. As the value of the I marker is being changed via the step up/step down keys or knob, the marker will move and the value will change in the UIA and PDA. If I MARKER ON/OFF is set to OFF, the I marker and associated text will disappear but the menu will remain.

When the delta I function is set to ON, the anchor marker will be dropped. The words " $\Delta I=XXX$ " appear in the UIA and PDA with XXX being the difference between the anchor marker and delta I marker. In this case, both markers are the same so the value will be $0 \mu\text{v}$ in IQ mode or 0.0% in DEMOD mode. As the delta I marker is being changed via either the step up/step down keys or knob, the delta I marker will move and the value will change in the UIA and PDA. The anchor marker will never move when this function is being used.

If the ALL MARKERS OFF softkey is pressed, all displayed markers and associated text will disappear.

Comments

Although the I markers are not visible in Q versus time, 3-dimensional, Vector Align, or Constellation Align displays, they can still be manipulated.

The actual position of the I marker on the screen will be affected by any I offset that has been added (IQ mode only).

The value of the I marker corresponds to the I offset value when the I MARKER->CENTER softkey is pressed. This, then, is an easy way to determine how much I offset has been added to the input signal.

If the delta I function is being used and is then turned OFF, the delta value will be set to zero when the function is reactivated.

The IDEL function code automatically turns the delta I marker on (anchors the marker) if it is not already on.

The IMAD function code is structured under the DISP, MEAS, and DEM subsystems. This is for convenience and DISP:IMAD, MEAS:IMAD, or DEM:IMAD can be used interchangeably.

Related Sections

Offset

Input Coupling

Description

Pressing the INPUT COUPLING key activates a menu that allows the user to select I and Q channel AC, DC, or ground (GND) coupling.

If the instrument is in IQ mode or DEMOD mode when the external demodulator is used, the coupling for each channel can be set independently. If the instrument is in DEMOD mode and the internal demodulator is used, the same coupling is automatically chosen for each channel.

Note



In the internal DEMOD mode, the front panel I and Q channel inputs are not connected. Coupling takes place at the I and Q outputs of the internal demodulator.

The following paragraphs explain each of the three coupling modes further:

I and Q AC Coupling

When selected, the channels are capacitively coupled and any DC component in the input signal is blocked. The input bandwidth is approximately 1 kHz to 350 MHz and maximum input level is $\pm 5V_{\text{peak}}$ AC on a $\pm 25V$ DC component.

I and Q DC Coupling

AC and DC components of the input signal are passed. The bandwidth is from DC to 350 MHz and maximum input is $\pm 5V_{\text{peak}}$.

I and Q GND Coupling

When selected, the input path is disconnected so that exterior input signals are blocked out, and the instrument signal path is grounded internally. This type of coupling is useful when the user wants to set a ground reference.

Procedure

Note





If the instrument is in internal DEMOD mode, the input coupling menu will be different.

1. Press the INPUT COUPLING key. This will activate the input coupling menu on the display.
2. Press the menu key that is adjacent to the on-screen text that identifies the type of coupling desired.

Example

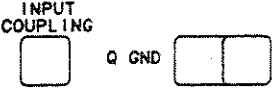
Select Q channel ground coupling. (The instrument is in IQ mode).

LOCAL (key-strokes)	
 (Program Codes)	CHANQ:COUP GND

HP-IB Program Codes

Command Level	Description	Code (1)
Subsystem (SUBS) Codes	I Channel Q Channel Demodulation	CHANI CHANNEL1 CHAN1 CH1 CHANQ CHANNEL2 CHAN2 CH2 DEM
Function (FNA) Codes (under subsystems CHANI, CHANQ, and DEM)	Coupling	COUP COUPLING

(1) If multiple codes appear in this column, the first one listed is the preferred code. Others are given to be compatible with HPOL (Hewlett-Packard Oscilloscope Language).

Parameter	Program Code (SUBS: FNA FNB)
I input AC coupling	CHAN:COUP AC
I input DC coupling	CHAN:COUP DC
I input ground coupling	CHAN:COUP GRO CHAN:COUP GND CHAN:COUP GROUND
Q input AC coupling	CHANQ:COUP AC
Q input DC coupling	CHANQ:COUP DC
Q input ground coupling	CHANQ:COUP GRO CHANQ:COUP GND CHANQ:COUP GROUND
internal demodulator AC coupling	DEM:COUP AC
internal demodulator DC coupling	DEM:COUP DC
internal demodulator ground coupling	DEM:COUP GRO DEM:COUP GND DEM:COUP GROUND

Indications

When the coupling softkeys are pressed, the text for the chosen softkey will be highlighted (brighter). One of the three choices will always be highlighted to indicate the current setting.

Comments

Nothing appears on the screen to indicate the type of input coupling chosen other than the brightness of the menu text when the menu is active.

Related Sections

Trigger

Instrument Information

Description

The SOFTWARE VERSION softkey in the INST STA/OTHER softkey menu displays the installed firmware version number and the date it was released on the display.

Remote commands exist to make the instrument model number, revision date of the firmware, and serial number available to the system controller. These commands are explained below:

***IDN?** - When the instrument receives this command, it returns the following information in the order shown:

HEWLETT PACKARD,8981A,serial number,REV firmware version #

ID? - When the instrument receives this command, it returns the string "HP8981A".

REV? - When the instrument receives this command, it returns the firmware revision date in the format YYMMDD. "YY" is the last two digits of the year, "MM" is the month and "DD" is the day.

SER? - When the instrument receives this command, it returns the instruments serial number.

SER - This command is used to allow the user to store the instrument serial number in non-volatile RAM.

Procedure

1. Press the INST STA key. This activates the instrument state menu on the display.
2. Press the OTHER softkey. This will activate the second level-other (miscellaneous) menu on the display.
3. Press the SOFTWARE VERSION softkey to display the firmware version number and the date it was released.

Example

The user wants to see the release date and firmware version number of the HP 8981A internal firmware being used.

LOCAL (key-strokes)	<div style="display: flex; justify-content: space-around; align-items: center;"> <div style="border: 1px solid black; padding: 2px;">INST STA</div> <div>OTHER</div> <div style="border: 1px solid black; width: 30px; height: 20px; display: flex; justify-content: space-between;"> </div> <div style="border: 1px solid black; padding: 2px;">SOFTWARE VERSION</div> <div style="border: 1px solid black; width: 30px; height: 20px; display: flex; justify-content: space-between;"> </div> </div>
<div style="text-align: center;">  (Program Codes) </div>	REV? *IND?

HP-IB Program Codes

Parameter	Program Code (STM)
send identification string	*IDN?
send instrument model number	ID?
send firmware revision date	REV?
send instrument serial number	SER?
store instrument serial number in RAM	SER "serial number" (1)

(1) "serial number" should be replaced with the instrument serial number in quotes.

Indications

When the SOFTWARE VERSION softkey is pressed, the text becomes highlighted (brighter). The words "SOFTWARE VERSION:" appear in the User Interface Area (UIA) in the extreme upper left corner. The software version number and revision date appear below on one line. This information remains in the UIA as long as the OTHER softkey menu is displayed.

I Versus Time Display

Description

Pressing the "I" key in the DISPLAY portion of the front panel sets up a voltage versus time display with the I Channel being displayed along the time axis. The I axis is displayed in either dBm (instrument in DEMOD mode) or volts per division (instrument in IQ mode).

Nine display formats are useable in the I versus time display mode. These display formats include a standard 10 x 10 oscilloscope format and eight modulation-specific formats. The eight formats are QPSK, 9PRS, 16QAM, 25PRS, 49PRS, 64QAM, 81PRS, and 256QAM.

When the I versus time display mode is selected, none of the parameters of the previous display are changed. As an example, if a Vector display has an I&Q gain of 1 volt per division, then the I versus time display will also have an I channel gain of 1 volt per division.

For more information on displays, see the DISPLAY, GENERAL Detailed Operating Instruction.

Procedure

Selecting I Versus Time Display Mode



To set the Vector Modulation Analyzer in the I versus time display mode, press the "I" key in the DISPLAY portion of the front panel.

Selecting the Display Formats

1. Press the DEMOD key. This activates the demodulator menu on the display.
2. Press the MOD FORMAT softkey. This activates the second level "modulation format" menu on the display.
3. Press the softkey in the MOD FORMAT menu that corresponds to the desired display format. The menu choices are SCOPE FORMAT, QPSK, 9PRS, 16QAM, 64QAM, 256QAM, and MORE. If MORE is pressed, an additional menu will appear with the choices 25PRS, 49PRS, and 81PRS displayed.

Example

A Constellation display is currently on the screen and the user wants to view the corresponding I versus time display.

LOCAL (key-strokes)	
 (Program Codes)	DISP:MODE I

HP-IB Program Codes

Command Level	Description	Code (1)
Subsystem (SUBS) Codes	Display	DISP DISPLAY
	Demodulation	DEM
Function (FNA) Codes (under subsystem DISP)	Display Mode	MODE
Function (FNA) Codes (under subsystem DEM)	Display Format	FORM

(1) If multiple codes appear in this column, the first one listed is the preferred code. Others are given to be compatible with HPOL (Hewlett-Packard Oscilloscope Language).

Parameter	Program Code (SUBS: FNA FNB)
select I versus time display mode	DISP: MODE CHANI
select 10 x 10 oscilloscope format	DEM: FORM NONE
select QPSK display format	DEM: FORM QPSK
select 9PRS display format	DEM: FORM PRS9
select 16QAM display format	DEM: FORM QAM16
select 25PRS display format	DEM: FORM PRS25
select 49PRS display format	DEM: FORM PRS49
select 64QAM display format	DEM: FORM QAM64
select 81PRS display format	DEM: FORM PRS81
select 256QAM display format	DEM: FORM QAM256

Indications

When the "I" key in the DISPLAY portion of the front panel is pressed, all menus, except for the "3D display" menu, remain displayed and active. All data in the User Interface Area and Parameter Data Area remains displayed. The display mode changes to I versus time with the display format at whatever was selected in the DEMOD/MOD FORMAT menu. The words "I vs time" appear in the Display Identification area.

Comments

Pressing the "I" key in the DISPLAY portion of the front panel will activate the gain and offset menu if the 3D DISPLAY menu was active.

Related Sections

Display, General

KEY Command

Description

The KEY Command allows the user to emulate pressing the front panel keys remotely via HP-IB. Almost all functions are programmable directly via HP-IB program codes, therefore, this function would seldom be used. It can, however, be used to access those functions that are not directly programmable via HP-IB (refer to Table 3-3. Functions Not Directly Programmable via HP-IB).

Note



Be aware that it is possible to remotely access functions using the KEY command that could result in loss of control or lock up of the instrument (example. Changing the HP-IB address).

Use of the KEY command only mimics pressing of the front panel keys. If a menu item is to be accessed, the KEY command number that corresponds to the unmarked gray key for that particular menu item must be sent after the number representing the calling front panel key is sent.

As an example, the user wants to set the I channel input coupling to DC. The "I DC" menu item is the second item down in the COUPLING menu. The KEY command number for the unmarked, gray menu key that is the second item down is 55. Therefore, after sending the KEY command number for the INPUT COUPLING key (30), the number 55 must be sent. If the instrument is not in IQ mode, the KEY command number for the front panel DEMOD key and MODE IQ/DEMODO softkey will need to be sent first to cause the coupling menu to change accordingly. Tables 3-19, 3-20, 3-21, and 3-22 list the first level, second level, third level, and fourth level menus and the KEY command numbers for each menu item.

Procedure

The following procedure explains how to build an HP-IB program code using the KEY command. Before this command can be used, the user must know the front panel key sequence for the function being implemented.

Note



It is assumed that the user knows the format guidelines for sending data messages to the Vector Modulation Analyzer. See "Receiving Data Messages" in REMOTE OPERATION, HEWLETT-PACKARD INTERFACE BUS for more information.

1. Begin the program code string by typing the word KEY followed by a space (sp) followed by the KEY command number for the front panel

key being activated. If the KEY command function performs the desired operation, end here. Otherwise, continue with the next step for menus or go to step 3a for data entry.

2. **Menus.** On a new line, type the word KEY, followed by a space (sp), followed by the KEY command number for the menu item being activated. Refer to Table 3-19 for a listing of first level menus and their KEY command numbers. If a second, third, or fourth level menu must also be accessed, type KEY(sp) and these numbers, one to a line, in the order they would be pressed from the front panel. Refer to tables 3-20, 3-21, and 3-22 for listings of second, third, and fourth level menus and their KEY command numbers.

- 3a. **Data Entry.** Type in the KEY command numbers, one to a line, for the appropriate numeric data entry keys after typing KEY(sp).

- 3b. Type KEY(sp) and the KEY command number for the appropriate terminator. Terminator menus are listed in Table 3-23.

Table 3-18. Front Panel Key to KEY Command Number

Front Panel Key	KEY Command Number	Front Panel Key	KEY Command Number
.	21	I marker	61
0	16	INPUT COUPLING	30
1	8	INST STA	26
2	9	KNOB	24
3	12	Knob left	73
4	10	Knob right	72
5	5	LCL	27
6	4	LEVEL	23
7	2	MAGTD	60
8	1	MEAS	59
9	64	PHASE	44
Menu key 1 (1)	63	PRE SET	29
Menu key 2 (1)	55	PREV MENU	62
Menu key 3 (1)	54	Q versus time display	37
Menu key 4 (1)	53	Q marker	47
Menu key 5 (1)	50	SOURCE	17
Menu key 6 (1)	51	SPCL DISP	33
Menu key 7 (1)	49	ENT OFF	58
Arrow up	7	TIME MKR	43
Arrow down	15	TIMING	45
AUTO SCOPE	32	VECTOR	34
BACK SPACE	14		
CAL	25		
CHG SIGN	19		
CONSTL	35		
DEMOD	46		
GAIN & OFS	42		
HELP	22		
HPIB	28		
I&Q versus time display	36		
I versus time display	39		

(1) When looking at the front panel, "Menu key 1" is the uppermost and "Menu key 7" is the lowermost of the menu softkeys. These keys are the unmarked gray keys that are in a column to the right of the display.

Table 3-19. First Level Menu Softkeys to KEY Command Numbers

Calling Key	First Level Menu Softkeys	Use KEY Command Number...
COUPLING (IQ Mode or External DEMOD Mode)	I AC	63
	I DC	55
	I GND	54
	Q AC	53
	Q DC	50
	Q GND	51
COUPLING (Internal DEMOD Mode)	I AND Q AC	63
	I AND Q DC	55
	I AND Q GND	54
DEMOD (IQ Mode)	MOD FORMAT	63
	QUADRATURE ADJUST	55
	PHASE OFFSET ADJUST	54
DEMOD (DEMOD Mode)	MODE IQ/DEMOD	63
	REF FREQ	55
	PHASE ADJ	54
	CORRECTIONS	53
	MOD FORMAT	51
	MORE	49
GAIN & OFS (IQ Mode)	VOLT/DIV I&Q	63
	VOLT/DIV I	55
	VOLT/DIV Q	54
	OFFSET I	53
	OFFSET Q	50
GAIN & OFS (DEMOD Mode)	FULL SCALE	63
	I/Q	50
	I OFFSET	51
	Q OFFSET	49
HPIB	HPIB ADDRESS	63
	TALK/LISTEN	55
	LISTEN ONLY	54
	TALK ONLY	53
	PRINT	50
	PRINT POINTS	51
I marker	I MARKER VALUE	63
	I MARKER ON/OFF	55
	DELTA I ON/OFF	54
	I MARKER->CENTER	51
	ALL MKR OFF	49

Table 3-19. First Level Menu Softkeys to KEY Command Numbers (Cont.)

Calling Key	First Level Menu Softkeys	Use KEY Command Number...
INST STA	SAVE	63
	RECALL	55
	AUTOSCOPE CONFIG	54
	SERVICE	53
	OTHER	50
TRIG LEVEL (EXT source)	AUTO	63
	TTL	55
	ECL	54
	VAR	53
	GND/ECL TERM SLOPE ±	50 51
TRIG LEVEL (INT I or Q source)	COUPLING AC/DC	63
	VARIABLE	55
	SLOPE ±	54
MAGTD	MAGTD MARKER VALUE	63
	MAGTD MARKER ON/OFF	55
	DELTA MAGTD ON/OFF	54
	MAGTD MARKER -> FULL SCALE	51
	ALL MKR OFF	49
MEAS	CONTINUOUS IQ	63
	SINGLE IQ	55
	CONT CONSTL ANALYSIS	54
	SNG CONSTL ANALYSIS	53
	CONSTL POINTS	50
	MEASUREMENT OFF	51
PHASE	PHASE MARKER VALUE	63
	PHASE MARKER ON/OFF	55
	DELTA PHASE ON/OFF	54
	ALL MKR OFF	49
Q marker	Q MARKER VALUE	63
	Q MARKER ON/OFF	55
	DELTA Q ON/OFF	54
	Q MARKER->CENTER	51
	ALL MKR OFF	49

Table 3-19. First Level Menu Softkeys to KEY Command Numbers (Cont.)

Calling Key	First Level Menu Softkeys	Use KEY Command Number...
TRIG SOURCE	EXT INT I INT Q LINE GATE CONFIG	63 55 54 53 49
SPCL DISP	SPLIT SCREEN ON/OFF SIGNAL INTENSITY VECTOR ALIGN CONSTL ALIGN 3 D DISPLAY	63 55 54 53 50
TIME MKR	TIME MARKER VALUE TIME MARKER ON/OFF DELTA TIME ON/OFF TIME MARKER->CENTER ALL MKR OFF	63 55 54 51 49
TIMING	TIME/DIV DELAY I&Q DELAY I DELAY Q AUTO SWEEP TRIG'D SWEEP FREE RUN	63 55 54 53 50 51 49

Table 3-20. Second Level Menu Softkeys to KEY Command Numbers

Calling Softkey	Second Level Menu Softkeys	Use KEY Command Number...
AUTOSCOPE CONFIG (IQ Mode)	AUTO TIME ON/OFF AUTO I CHAN ON/OFF AUTO Q CHAN ON/OFF TRIGGER SCAN ON/OFF	63 55 54 53
AUTOSCOPE CONFIG (DEMOD Mode)	AUTO TIME ON/OFF AUTO MAGTD ON/OFF TRIGGER SCAN ON/OFF	63 55 54
CORRECTIONS	CORRECTIONS ON/OFF QUAD. IQ & OFFSET COR DEMOD GAIN CORRECTION MANUAL CORRECTION SAVE CORRECTIONS RECALL CORRECTIONS	63 55 54 53 51 49
GATE CONFIG	GATE INPUT ENAB/DISAB GND TERM TTL LEVEL -2V TERM ECL LEVEL GND TERM 0V LEVEL	63 55 54 53
MOD FORMAT	SCOPE FORMAT QPSK 9PRS 16QAM 64QAM 256QAM MORE MOD FORMATS	63 55 54 53 50 51 49
MORE	RF ON/OFF EXT FILTERS ON/OFF DEMOD INT/EXT EXIT	63 55 54 49
OTHER	IMPEDANCE 50/75 MULTI SAMPLE ON/OFF SOFTWARE VERSION HOLDFF DITHR ON/OFF	63 55 54 53
PHASE ADJ	PHASE OFFSET ADJUST SET CW PHASE TO REF PHASE REF PHASE	63 54 53

Table 3-20. Second Level Menu Softkeys to KEY Command Numbers (Cont.)

Calling Softkey	Second Level Menu Softkeys	Use KEY Command Number...
SERVICE	SELF TEST	63
	DIRECT CONTROL	55
	VOLTMETER	54
	EXT INPUT LEVEL CAL	53
	SERVICE DEBUG	50
	SERVICE FUNCTION	51
3 D DISPLAY	PHASE ROTATION	63
	HORIZONTAL ROTATION	55
	VERTICAL ROTATION	54
	ZERO ROT. ANGLES	53
	SET ROT. ANGLES	50

Table 3-21. Third Level Menu Softkeys to KEY Command Numbers

Calling Softkey	Third Level Menu Softkeys	Use KEY Command Number...
DEMOD GAIN CORRECTION	START CORRECTION	63
	RF LEVEL	55
	EXIT	49
DIRECT CONTROL	CHAIN NUMBER	63
	START BIT	55
	NUMBER OF BITS	54
	CHAIN DATA ENTRY	53
	EXIT	49
MANUAL CORRECTION	QUAD CORR	63
	I OFS CORR	55
	Q OFS CORR	54
	I/Q CORR	53
	GAIN CORR	50
	CLEAR CURR CORRECTIONS	51
	EXIT	49
MORE MOD FORMATS	25PRS	63
	49PRS	55
	81PRS	54
	EXIT	49
QUAD, IQ & OFFSET COR	START TONE CORRECTION	63
	START 8PSK CORRECTION	55
	EXIT	49
RECALL CORRECTIONS	RECALL 1	63
	RECALL 2	55
	RECALL 3	54
	RECALL 4	53
	RECALL 5	50
	RECALL 6	51

Table 3-21. Third Level Menu Softkeys to KEY Command Numbers (Cont.)

Calling Softkey	Third Level Menu Softkeys	Use KEY Command Number...
SAVE CORRECTIONS	SAVE 1	63
	SAVE 2	55
	SAVE 3	54
	SAVE 4	53
	SAVE 5	50
	SAVE 6	51
	CLEAR SAVED CORRECTIONS	49
SERVICE DEBUG	SERV. STATUS ENAB/DISAB	63
	DISPLAY SERV. BUFFER	55
	PRIMARY TEST PATTERN	50
	FOCUS TEST PATTERN	51

Table 3-22. Fourth Level Menu Softkeys to KEY Command Numbers

Calling Softkey	Fourth Level Menu Softkeys	Use KEY Command Number...
CLEAR SAVED CORRECTIONS	CLEAR 1	63
	CLEAR 2	55
	CLEAR 3	54
	CLEAR 4	53
	CLEAR 5	50
	CLEAR 6	51
	CLEAR ALL	49

Table 3-23. Terminator Menus

Units	Menu	KEY Command Number
Data Entry	ENTER	63
Decibels	dB	63
Degrees	DEG	63
Frequency	GHz MHz kHz	63 55 54
Level	dBm	63
Percent	%	63
Time	ms us ns	63 55 54
Time per Division	ms/DIV us/DIV ns/DIV	63 55 54
Volts	V mV	63 55
Volts per Division	V/DIV mV/DIV	63 55

Example

The user wants to rotate the display about the time axis 25° using the KEY command. In local mode, the following keystroke sequence would be needed:

SPCL DISP , 3 D DISPLAY , PHASE ROTATION , 2 , 5 , DEG

	KEY 33::KEY 50::KEY 63::KEY 9::KEY 5::KEY 63
---	--

Indications

When the KEY command is used, the front panel and display behave in exactly the same way as they do when the keys are physically pressed.

Comments

Using the KEY Command number for Knob left or Knob right will advance the knob its finest resolution in the direction indicated every time the KEY Command number is used. Emulating the knob can typically be accomplished by using a program loop.

KEY commands do not necessarily have to be one to a line in a program. The commands can be strung together on a line. Remember to separate commands from one another with a semicolon (;).

Related Sections

Receiving Data Messages (Remote Operation Section)

Table 3-3. Functions Not Directly Programmable via HP-IB (Remote Operation Section)

Magnitude Marker Setup

Description

Pressing the MAGTD key activates the magnitude marker menu; the marker is also turned on and automatically set up so that it can be changed via front panel keys or knob. Magnitude marker functions are active in all displays, but are not visible in I versus time, Q versus time, I&Q versus time, or 3-Dimensional displays. In Vector, Constellation, Vector Align, or Constellation Align displays, the markers are visible as circles centered around the center of the display. Each of the choices in the magnitude marker menu are explained below.

Note



The function parameters for the magnitude marker and delta magnitude marker will differ depending on whether the instrument is set to IQ mode or DEMOD mode.

Changing marker values in DEMOD mode will not change marker values in IQ mode, and vice versa.

MAGTD MARKER VALUE - Pressing this key enables the value of the magnitude marker to be changed via either a function-data-units (F-D-U) entry, or the step up/step down keys or knob. The marker is always referenced to the gain setting and has a maximum value such that the circle touches the four corners of the display. The magnitude marker can be set to any value within its specified range via a function-data-units entry even though the set value may be off the display. In this case, the actual set value of the marker will be displayed in the User Interface Area (UIA) and Parameter Data Area (PDA) of the display and the marker itself will touch the four corners of the display (the extremes of the display grid).

The step up/step down keys or knob can only adjust the magnitude marker over the present range of the display. When the magnitude marker has been set offscreen and the step up/step down keys or knob are used, the marker value will instantaneously be set to the four corners of the display and the marker will move from that point.

MAGTD MARKER ON/OFF - This softkey is provided to allow the user to turn the magnitude marker off. The magnitude marker is automatically turned on whenever the front panel MAGTD marker key is pressed. This softkey provides a toggle function, therefore, repeatedly pressing the softkey will cause the marker to toggle between "ON" and "OFF".

DELTA MAGTD ON/OFF - This is a toggle function, therefore, repeatedly pressing this softkey will cause the delta magnitude function to toggle between "ON" and "OFF". When this softkey is pressed, a marker will be anchored at the present magnitude marker position. This "anchor" marker will then stay in the position where it was anchored. Modifications to the delta magnitude marker via a F-D-U entry or the step up/down keys or knob will cause the delta magnitude marker to move away from the anchor marker. The value displayed in the UIA and PDA will be the difference between the delta magnitude marker and the anchor marker in dB. If the markers should be set offscreen, the actual delta value will be displayed in the UIA and PDA and the markers will be set so that they are touching the four corners of the display (the extremes of the display grid).

MAGTD MARKER -> FULL SCALE - Pressing this softkey sets the magnitude marker to the full scale magnitude that is set in the gain and offset menu. This sets the marker so that the perimeter of the circle touches the four sides of the display.

ALL MKR OFF - Pressing this softkey will turn all five markers off and thereby remove them from the display.

Procedure

Press the MAGTD key. This will activate the magnitude marker menu on the display. Use the following procedures to modify the magnitude marker or delta magnitude markers:

Modifying the Magnitude Marker Value

Press the MAGTD MARKER VALUE softkey. Use either a function-data-units entry or the step up/step down keys or knob to set the value of the magnitude marker. The function parameters are as follows; note that they are different depending upon whether the instrument is in IQ mode or DEMOD mode. Note also that the range for a F-D-U entry differs from the range for modification with the step up/step down keys or knob:

Function Parameters - IQ Mode

Range - function-data-units entry	$(5 \times \text{square root of } 2)V$
Range - step up/step down keys or knob	$(5 \times \text{square root of } 2)$ times I channel V/DIV setting
Knob Resolution	1% of I channel V/DIV setting
Step Up/Down Resolution	100% of I channel V/DIV setting

Function Parameters - DEMOD Mode

Range	-200 dBm to 3 dB greater than maximum full scale
Knob Resolution	0.01 dBm
Step Up/Down Resolution	1 dBm

Using the Delta Magnitude Function

1. Check the text (DELTA MAGTD ON/OFF) that is adjacent to the menu softkey. Either the "ON" or "OFF" will be highlighted.
2. Press the softkey so that the "OFF" is highlighted.
3. Use either a function-data-units entry or the step up/step down keys or knob to move the marker to the desired anchor location.
4. Press the DELTA MAGTD ON/OFF softkey so that the "ON" is highlighted. Doing this anchors the marker.
5. Use either a function-data-units entry or the step up/step down keys or knob to move the delta magnitude marker to its desired location. The value displayed in the UIA and PDA will be the difference between the anchor marker and the delta magnitude marker in dB.

Turning the Magnitude Marker On and Off

Check the text (MAGTD MARKER ON/OFF) that is adjacent to the menu softkey. Either the "ON" or "OFF" will be highlighted. If the desired status of the magnitude marker is highlighted, do not press the softkey. If the opposite state is highlighted, press the softkey to toggle the selection.

Setting Magnitude Marker to Full Scale

Press the MAGTD MARKER -> FULL SCALE softkey.

Turning All Markers Off

If it is desirable to turn all five markers off, press the ALL MKR OFF softkey.

Examples

Note







In the following examples, the instrument is set to IQ mode.

The following examples consist of a front panel keystroke example and an HP-IB example. This is because the user must know the magnitude value of the markers in order to set them via HP-IB. Therefore, HP-IB setup is impractical when trying to find the difference between two points. Example 1 deals with front panel keystrokes and Example 2 deals with HP-IB.

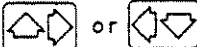
Example 1

The user wants to find the magnitude difference relative to the origin between two points in a constellation display. The easiest way to do this is through the use of the delta magnitude function:

LOCAL (key- strokes)	PRESS: 	PRESS:  or  to move the magnitude marker as close as possible to the innermost (smallest magnitude) of the two points. Use the knob to place the magnitude marker directly on this point.
	PRESS: DELTA MAG ON/OFF 	To anchor the marker.
	PRESS: 	to move the delta magnitude marker as close as possible to the outermost (greatest magnitude) of the two points. Note that the anchor marker will stay while the delta magnitude marker separates from the anchor marker. Use the knob to place the delta magnitude marker directly on this point. The value displayed in the UIA and PDA is the difference between the two points in dB.

Example 2

The programmer needs to set up a display in which the user can easily see if the points in a constellation cloud fall within certain magnitude limits in a QPSK constellation display. All points in the clouds should fall within +1.33 dB of 30 mV. The limits can be shown on the display using the delta magnitude function to set the display up as shown in Figure 3-21:

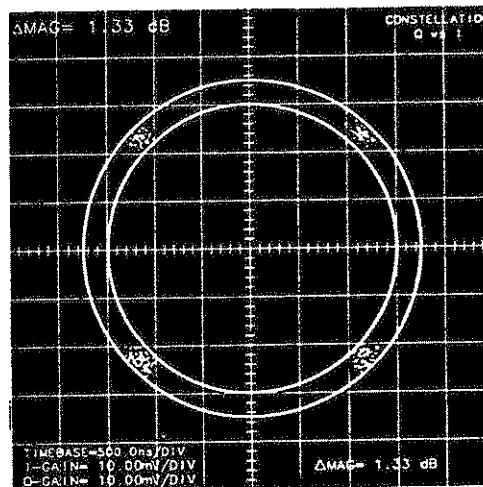



Figure 3-21. Display with Magnitude Limits

 (Program Codes)	DISP:MMAR ON; MEAS:MMAV +30 E-3; MMAD ON; MDEL 1.33
---	--

HP-IB Program Codes

Command Level	Description	Code (1)
Subsystem (SUBS) Codes	Display	DISP DISPLAY
	Measure	MEAS MEASURE
	Demodulation	DEM
Function (FNA) Codes (under subsystem DISP)	Delta Magnitude On/Off	MMAD

Command Level	Description	Code (1)
Function (FNA) Codes (under subsystem DISP) (cont'd)	Magnitude Marker On/Off	MMAR
	All Markers Off	MOFF
Function (FNA) Codes (under subsystems MEAS and DEM)	Delta Magnitude Value	MDEL
	Delta Magnitude On/Off	MMAD
	Magnitude Marker Value	MMAV
	Magnitude Marker to Full Scale	MMAF

(1) If multiple codes appear in this column, the first one listed is the preferred code. Others are given to be compatible with HPOL (Hewlett-Packard Oscilloscope Language).

Parameter	Program Code (SUBS: FNA FNB)
delta magnitude marker on	DISP:MMAD ON MEAS:MMAD ON DEM:MMAD ON
delta magnitude marker off	DISP:MMAD OFF MEAS:MMAD OFF DEM:MMAD OFF
magnitude marker on	DISP:MMAR ON
magnitude marker off	DISP:MMAR OFF
all markers off	DISP:MOFF
set delta magnitude value (IQ mode)	MEAS:MDEL dB(min) to dB(max) (1)

Parameter	Program Code (SUBS: FNA FNB)
set delta magnitude value (DEMODO mode)	DEM:MDEL -326 to 326 (2)
set magnitude marker value (IQ mode)	MEAS:MMAV 0 to 7.07 (3)
set magnitude marker value (DEMODO mode)	DEM:MMAV -200 to FS+3 (4)
set magnitude marker to full scale	DEM:MMAF MEAS:MMAF

(1) "dB(min) to dB(max)" should be replaced with a number in dB with minimum (min) and maximum (max) limits as defined by the following two equations:

$$dB(max)=20\log[(5\sqrt{2V}/mval)]$$

$$dB(min)=20\log(.000001V/mval)$$

Where "mval" is the value of the current anchor marker in volts.

(2) "-326 to 326" should be replaced with a number in dB that represents the distance the magnitude marker is away from the anchor marker.

(3) "0 to 7.07" should be replaced with a voltage in full volt units that represents the actual magnitude of the magnitude marker.

(4) "-200 to FS+3" should be replaced with a number in dBm that represents the actual magnitude of the magnitude marker.

Indications

When the MAGTD marker key is pressed, the magnitude marker menu appears on the screen with the MAGTD MARKER VALUE menu item highlighted (brighter). In addition, the MAGTD MARKER ON/OFF function will always be ON and the magnitude marker will appear on the screen. The words "MAGTD-MKR=XXX" will appear in the UIA and PDA with XXX being the current value of the magnitude marker. As the value of the magnitude marker is being changed via the step up/step down keys or knob, the marker will move and the value will change in the UIA and PDA. If MAGTD MARKER ON/OFF is set to OFF, the magnitude marker and associated text will disappear but the menu will remain.

When the delta magnitude function is set to ON, the anchor marker will be dropped. The words "Δ MAGTD=XXX" appear in the UIA and PDA with XXX being the difference between the anchor marker and the delta magnitude marker in dB. In this case, both markers are the same so the value will be 0. As the delta magnitude marker is being changed via either the step up/step down keys or knob, the marker will move and the value will change in the UIA and PDA. The anchor marker will never move when this function is being used.

If the ALL MKR OFF softkey is pressed, all displayed markers and associated text will disappear.

Comments

Although the magnitude markers are not visible in I versus time, Q versus time, I&Q versus time, or 3-dimensional displays, they can still be manipulated.

If the delta magnitude function is being used and is then turned OFF, the delta value will be set to zero when the function is reactivated.

The MDEL function code automatically turns the delta magnitude marker on (anchors the marker) if it is not already on.

The MMAD function code is structured under the DISP, MEAS, and DEM subsystems. This is for convenience and DISP:MMAD, MEAS:MMAD, or DEM:MMAD can be used interchangeably.

When using the delta magnitude function, the anchor marker value can not be zero.

Measurement Functions

Description

Pressing the MEAS key activates a menu that allows several types of measurements to be taken by the instrument. The results of the measurements are displayed.

There are two types of measurements that can be made: I-Q measurements, and Constellation Analysis measurements. These measurements are described in the following paragraphs.

I-Q Measurements

The Vector Modulation Analyzer can make either single or continuous I-Q measurements. In IQ mode, an I-Q measurement is the measure of the I and Q signal voltages at the time marker instant as measured by the Vector Modulation Analyzer. In DEMOD mode, an IQ measurement is a measure at the time marker instant of where the measured point is along the I and Q axes in percent relative to full scale.

When a single I-Q measurement is made, the measurement is taken and displayed once and the measurement process is ended. When a continuous I-Q measurement is made, measurements are taken and displayed continuously. In this mode, the measurements are made continuously until the user ends the measurement process by pressing the MEASURE OFF softkey or a different measurement is begun. In continuous I-Q measurements, averaging is employed; in single I-Q measurements, averaging is not used.

Constellation Analysis Measurements

When a constellation analysis measurement is made, % Closure, Lock (Phase Error), and Quad (Quadrature Error) are measured and displayed. Before these parameters are displayed, points within the clouds of a constellation display are sampled at the time marker instant. The number of points that are sampled corresponds to the the number entered using the CONSTL POINTS softkey. The following paragraphs explain the parameters.

% Closure. % Closure is the ratio of constellation cloud size to constellation cloud separation in either the I or Q direction.
 $(2 \times \text{rms cloud size} / \text{cloud separation}) \times 100\%$

When this parameter is displayed, two values are actually shown. The two values are I closure and Q closure.

Lock. Lock is equal to the phase error in the system. Phase error occurs when the reference signal from a vector signal generator to a vector demodulator in a vector modulation test system has some phase offset relative to the RF signal into the vector demodulator. Digital radio receivers can also have phase errors in their carrier recovery circuits.

Quad. Quad is equal to the quadrature error in the system. Quadrature error occurs when the I and Q signals in a vector modulation test system have a phase relationship that is not exactly 90° apart.

For more information about phase and quadrature error, refer to the DEMODULATION Detailed Operating Instruction.

Before a constellation analysis measurement can be made, an appropriate modulation format grid must be selected (refer to the DEMODULATION Detailed Operating Instruction) and the constellation pattern must be fairly well aligned to the grid.

The algorithm divides a modulation format grid into fields. The boundaries of these fields are known as decision break boundaries. The decision break boundaries are always half way between the grid lines in a modulation format grid. All points that fall between these boundaries are considered to be part of the same constellation cloud.

In Figure 3-22, the decision break boundaries are shown as dashed lines. The QPSK pattern is offset such that some of the points in the two leftmost constellation clouds are over a decision break boundary. The constellation analysis algorithm will treat the points that are to the right of the boundary as if they are part of the rightmost constellation clouds.

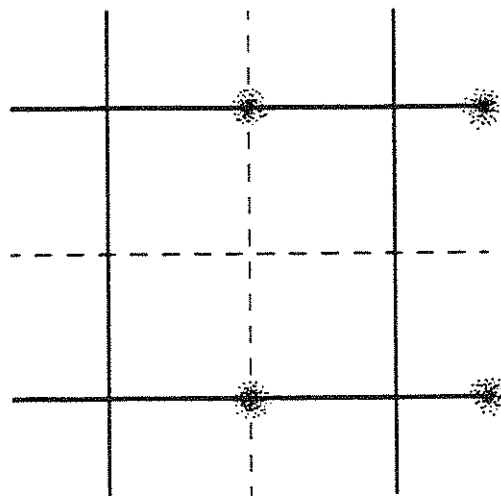

Figure 3-22. Misaligned Constellation Pattern

Note that in an actual display, the decision break boundaries are not shown. In the Figure 3-22 example, I Closure will be unusually high.

Procedure

Single I-Q Measurements

1. Press the MEAS key. This activates the measurement menu on the display.
2. Press the SINGLE I-Q softkey.

Continuous I-Q Measurements

1. Press the MEAS key. This activates the measurement menu on the display.
2. Press the CONTINUOUS I-Q softkey. Each displayed value indicates the average of 16 samples.
3. To turn off the Continuous I-Q function, press the MEASURE OFF softkey.

Single Constellation Analysis

1. Select an appropriate modulation format grid. Refer to the DEMODULATION Detailed Operating Instruction.
2. Align the constellation pattern to the grid so that all constellation clouds fall within the appropriate decision break boundaries.

Note



If the Phase Offset Adjust and Quadrature Adjust functions in the DEMOD menu are used to align the pattern, remember to add the amount of the adjustment to the LOCK and QUAD parameters once constellation analysis is performed in order to get the actual value of the errors.

3. Press the MEAS key. This activates the measurement menu on the display.
4. Press the CONSTL POINTS softkey. Use either the step up/step down keys, knob, or a Function-Data-Units (F-D-U) entry to set the desired number of constellation points. If a F-D-U entry is used, press the ENTER softkey to complete the entry.
5. Press the SNG CONSTL ANALYSIS softkey. Note that if the Constellation Display mode is not already selected, it is automatically selected when this softkey is pressed.

Note



While the single constellation analysis function is running, pressing any key or sending an HP-IB command will abort the function.

Continuous Constellation Analysis

1. Select an appropriate modulation format grid. Refer to the DEMODULATION Detailed Operating Instruction.
2. Align the constellation pattern to the grid so that all constellation clouds fall within the appropriate decision break boundaries.

Note



If the Phase Offset Adjust and Quadrature Adjust functions in the DEMOD menu are used to align the pattern, remember to add the amount of the adjustment to the LOCK and QUAD parameters once constellation analysis is performed in order to get the actual value of the errors.

3. Press the MEAS key. This activates the measurement menu on the display.
4. Press the CONSTL POINTS softkey. Use either the step up/step down keys, knob, or a Function-Data-Units (F-D-U) entry to set the desired number of constellation points. If a F-D-U entry is used, press the ENTER softkey to complete the entry.
5. Press the CONT CONSTL ANALYSIS softkey. Note that if the Constellation Display mode is not already selected, it is automatically selected when this softkey is pressed.
6. To exit the continuous constellation analysis function, press the MEASURE OFF softkey.

Example

The user wants to perform a single constellation analysis on a 16QAM constellation pattern. The 16QAM modulation format grid has already been selected and the constellation pattern has been aligned to the grid. The number of constellation points has been set to 3000.

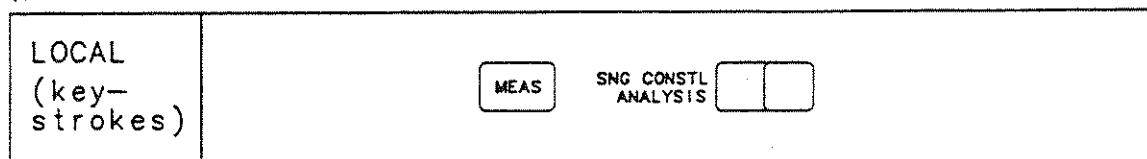

HP-IB Program Codes

The Vector Modulation Analyzer provides the following measurement commands that are compatible with the HP 3709A. These commands are listed below and in Table 3-4.

Parameter	HP 3709A Compatibility Command
perform single constellation analysis measurement and display on front panel only	MSR
collect statistics for calculation of closure and angle errors. Results are not displayed	MST num (1)
output analysis of closure, lock, and quadrature errors. The information is output in this format: I Closure, Q Closure, Lock, Quad. (2)	OAN or OAN?
output statistics on individual constellation clouds in a constellation diagram in ASCII format (2)	OST
output statistics on individual constellation clouds in a constellation diagram in block format (2)	OSTB

- (1) "num" should be replaced with a number that represents the number of constellation points.
 (2) Constellation Analysis must be performed prior to the execution of this command.

Indications

When the CONTINUOUS I-Q softkey is pressed, the following information appears on the left side of the display above the display center:

```
MEASURE I&Q CHANNEL:
I-CH= XXX.XX
Q-CH= XXX.XX
```

Where XXX.XX is the respective channel measurement. This information will be updated at a rate of approximately three times per second. The information will continue to be displayed until the MEASURE OFF softkey is pressed. When the MEASURE OFF softkey is pressed, the I-Q measurement data will disappear from the display.

When the I-Q measurement data is being displayed, other menus can be activated and used. As an example, the phase marker can be activated and moved, and the I-Q measurement data will continue to be updated and displayed.

When the SINGLE I-Q softkey is pressed, the same information is displayed as for a Continuous I-Q measurement. The information is updated, however, only when the SINGLE I-Q softkey is pressed. Although the information is not updated continuously, it remains displayed until the MEASURE OFF softkey is pressed.

If the constellation pattern is properly aligned with the appropriate modulation format, the Parameter Data Area (PDA) is blanked and the following information is displayed in its place when the CONT CONSTL ANALYSIS softkey is pressed:

I-CLOSURE= CCC.C% QUAD= QQ.QQ
Q-CLOSURE= CCC.C% LOCK= LL.LL

Where CCC.C is the respective channel % Closure, QQ.QQ is the quadrature error measured in the system, and LL.LL is the phase error measured in the system. In addition, "CONSTL POINTS= XXX" is displayed in the upper left hand corner of the display. The display mode changes to "CONSTELLATION Q vs I" in the Display Identification area if it has not already been selected. This information will continue to be updated at a rate associated with the number of CONSTL POINTS chosen.

When the MEASURE OFF softkey is pressed, the information in the PDA returns but the Constellation Display mode remains.

When the SNG CONSTL ANALYSIS softkey is pressed, the same information is displayed as when the CONT CONSTL ANALYSIS softkey is pressed. This information is only updated, however, whenever the SNG CONSTL ANALYSIS softkey is pressed. Although the information is not updated continuously, it remains displayed until the MEASURE OFF softkey is pressed.

Several error messages might be displayed when a Constellation Analysis is attempted. Refer to the "Error Messages and Recovery" Detailed Operating Instruction for a listing that includes these error messages and an explanation of what must be done to recover from them.

Comments

Single or Continuous I-Q Measurements can not be made in Vector Align, Constellation Align, or 3D display modes.

If a constellation analysis fails, I-Closure and Q-Closure will be set to 999 and Lock and Quad will be set to 99.

Single or continuous I-Q measurements are always taken at the time marker setting regardless of the display mode. This is true even when the time marker is off.

Related Sections

Demodulation
Display, General
Error Messages and Recovery

Menu Softkeys

Description

The seven, unmarked gray keys that are located in a column along the right side of the display bezel are the menu softkeys.

A softkey only functions when a menu item is displayed on the display adjacent to the softkey. Softkeys are generally activated by pressing a front panel key that refers to a group of functions.

Menu softkeys fall into five basic categories:

Menu Softkey Categories

Entry Prefix Softkeys. When activated, these softkeys allow for the entry of various instrument parameters, such as TIME/DIV in the timing menu.

Toggle Softkeys. When repeatedly pressed, the function of these softkeys alternates between two settings, such as on/off or enable/disable. The two choices are always displayed adjacent to the softkey with a slash (/) separating them. The selection that is active is always highlighted (brighter).

Simple Setup Softkeys. The function of these softkeys is similar to the toggle softkeys insofar as they switch between settings. Their structuring is different, however. In the menu, they are a group of three or more related functions, each softkey being one choice in the group. An example of this is the I AC, I DC, and I GND softkeys in the coupling menu. Only one selection can be active at a given time and activating one selection will cancel any previously chosen selection. The selection that is active will always be highlighted (brighter).

Second or Third Level Menu Activators. When pressed, these softkeys activate a new menu for further control choices.

Units Terminators. At the beginning of a data entry sequence, a menu of units terminators is activated. An example of this is the V/DIV and mV/DIV terminators used in a VOLT/DIV entry. Pressing a units terminator completes the entry and causes the parameter change to take place. Once the terminator is pressed, the original calling menu is redisplayed and reactivated.

PREV MENU Key

The PREV MENU key allows the user to sequence back through up to four previously selected menus. If the PREV MENU key is pressed five or more times, the same four, previously selected menus will continuously sequence.

The only exception is the units terminators. They are not stored and if an attempt is made to sequence back to them, only their calling menu will be reactivated.

Indications

As the PREV MENU key is pressed, the last menu will be recalled and reactivated. All text associated with any active menu items will also be redisplayed in the UIA and PDA. If the PREV MENU key is pressed repeatedly, the last four menus and associated text will continuously sequence in the same order as they were originally called.

Related Sections

Key Command

Offset

Description

In IQ mode, the GAIN & OFS key activates a menu that allows the user to introduce an offset voltage on the display. The offset voltage will correspond to the voltage at the center of the screen. This is useful in vector and constellation displays, where offsets can be used to center these displays. The phase and magnitude markers can then be properly utilized.

In DEMOD mode, the GAIN & OFS key activates a menu that allows the user to offset the display in terms of percent of full scale. This is to say that if with 0% offset a point falls at the origin, with 100% of I offset, the point will fall on the rightmost display screen border.

Procedure

1. Press the GAIN & OFS key. This activates the gain and offset menu on the display.

Note



The gain and offset menu will differ depending upon whether the instrument is in IQ mode or DEMOD mode.

2. Press the menu key that is adjacent to the on-screen text that identifies the desired channel to be offset (OFFSET I or OFFSET Q). Use either a function-data-units entry or the step up/step down keys or knob to set the desired offset. The function parameters are as follows; note that they differ depending upon which mode the instrument is in:

Function Parameters - IQ Mode

Range	±10 times volts/division setting.
Knob Resolution	1% of the value of the corresponding I or Q V/DIV setting.
Step Up/Down Resolution	100% of the value of the corresponding I or Q V/DIV setting.

Function Parameters - DEMOD Mode

Range -100% to +100%
 Knob Resolution 0.1%
 Step Up/Down Resolution 5%

Example

The user wants to set an I channel offset of 127 mV (the instrument is in IQ mode).

LOCAL (key-strokes)	
 (Program Codes)	<p>CHAN1:OFFS 0.127E0</p>

HP-IB Program Codes

Command Level	Description	Code (1)
Subsystem (SUBS) Codes	I Channel	CHAN1 CHANNEL1 CHANI CH1
	Q Channel	CHANQ CHANNEL2 CHAN2 CH2
	Demodulation	DEM

Command Level	Description	Code (1)
Function (FNA) Codes (under subsystems) CHANI or CHANQ)	Offset (IQ Mode)	OFFS OFFSET
Function (FNA) Codes (under subsystems DEM)	I Offset (DEMOD Mode)	IOFF IOFFS IOFFSET
	Q Offset (DEMOD Mode)	QOFF QOFFS QOFFSET

(1) If multiple codes appear in this column, the first one listed is the preferred code. Others are given to be compatible with HPOL (Hewlett-Packard Oscilloscope Language).

Parameter	Program Code (SUBS: FNA FNB)
I channel offset (IQ mode)	CHANI:OFFS -10.00E0 to 10.00E0 (1)
Q channel offset (IQ mode)	CHANQ:OFFS -10.00E0 to 10.00E0 (1)
I channel offset (DEMOD mode)	DEM:IOFF -100 to 100 (2)
Q channel offset (DEMOD mode)	DEM:QOFF -100 to 100 (3)

- (1) "-10.00E0 to 10.00E0" should be replaced with the selected voltage offset in volts.
- (2) "-100 to 100" should be replaced with the selected I offset in percent.
- (3) "-100 to 100" should be replaced with the selected Q offset in percent.

Indications

When the gain and offset menu is activated, the values of the I and Q channel offsets will be displayed under their respective softkey menu items whether the items are active or not. As long as an offset softkey is active, the offset will be displayed in the User Interface Area (UIA). As the parameter is being changed, it will be shown changing in the UIA.

The actual offset will never be shown in the Parameter Data Area, however, the fact that offset is present will be shown in the form of the symbol "[OFS]" to the right of its respective parameter.

Comments

Offsets in DEMOD mode are always relative to the display axes. In IQ mode, phase and quadrature adjustments will affect the offset function.

Related Sections

I Marker Setup
Q Marker Setup

Phase Marker Setup

Description

Pressing the PHASE key activates the phase marker menu; the marker is also turned on and automatically set up so that it can be changed via front panel keys or knob. Phase marker functions are useable in all displays, but are not visible in I versus time, Q versus time, I&Q versus time, or 3-Dimensional displays. In Vector, Constellation, Vector Align, or Constellation Align displays, the markers are visible as rays originating from the center of the display. Each of the choices in the phase marker menu are explained below:

Note



If a marker value is changed in DEMOD mode, it will also change in IQ mode and vice versa.

PHASE MARKER VALUE - Pressing this key enables the value of the phase marker to be changed via either a function-data-units (F-D-U) entry, or the step up/step down keys or knob. The phase value will always be displayed in the User Interface Area (UIA) and Parameter Data Area (PDA) as a number in degrees from 0 to 359 or 0 to -359 regardless of what the user enters. As an example, if the user enters a phase angle value of -405° , it will be displayed in the UIA and PDA as -45° .

PHASE MARKER ON/OFF - This softkey is provided to allow the user to turn the phase marker off. The phase marker is automatically turned on whenever the front panel PHASE marker key is pressed. This softkey provides a toggle function, therefore, repeatedly pressing the softkey will cause the marker to toggle between "ON" and "OFF".

DELTA PHASE ON/OFF - This is a toggle function, therefore, repeatedly pressing this softkey will cause the delta phase function to toggle between "ON" and "OFF". When this softkey is pressed, a marker will be anchored in the present phase marker position. This "anchor" marker will then stay in the position where it was anchored. Modifications to the delta phase marker via a F-D-U entry or the step up/down keys or knob will cause the delta phase marker to move away from the anchor marker. The value displayed in the UIA and PDA will be the difference between the delta phase marker and the anchor marker.

ALL MKR OFF - Pressing this softkey will turn all five markers off and thereby remove them from the display.

Procedure

Press the PHASE key. This will activate the phase marker menu on the display. Use the following procedures to modify the phase marker or delta phase markers:

Modifying the Phase Marker Value

Press the PHASE MARKER VALUE softkey. Use either a function-data-units entry or the step up/step down keys or knob to set the value of the phase marker. The function parameters are as follows:

Range	Any size phase angle may be entered. The Vector Modulation Analyzer will correct and display between 0.0 degrees and +359.0 degrees or -359.0 degrees inclusive.
Knob Resolution	0.1 degree
Step Up/Down Resolution	5 degrees

Using the Delta Phase Function

1. Check the text (DELTA PHASE ON/OFF) that is adjacent to the menu softkey. Either the "ON" or "OFF" will be highlighted.
2. Press the softkey so that the "OFF" is highlighted.
3. Use either a function-data-units entry or the step up/step down keys or knob to move the marker to the desired anchor location.
4. Press the DELTA PHASE ON/OFF softkey so that the "ON" is highlighted. Doing this anchors the marker.
5. Use either a function-data-units entry or the step up/step down keys or knob to move the delta phase marker to its desired location. The value displayed in the UIA and PDA will be the difference in degrees between the anchor marker and the delta phase marker.

Turning Phase Marker On and Off

Check the text (PHASE MARKER ON/OFF) that is adjacent to the menu softkey. Either the "ON" or "OFF" will be highlighted. If the desired status of the phase marker is highlighted, do not press the softkey. If the opposite state is highlighted, press the softkey to toggle the selection.

Turning All Markers Off





If it is desirable to turn all five markers off, press the ALL MKR OFF softkey.

Examples

The following examples consist of a front panel keystroke example and an HP-IB example. This is because the user must know the phase of the markers in order to set them via HP-IB. Therefore, HP-IB setup is impractical when trying to find the angle between two points. Example 1 deals with front panel keystrokes and Example 2 deals with HP-IB.

Example 1

The user wants to verify that the phase difference between two points in a QPSK Constellation display is 90° . The easiest way to do this is through the use of the delta phase function:

LOCAL (key- strokes)	PRESS: PHASE	PRESS:  or  to move the phase marker as close as possible to one of the two points. Use the knob to place the phase marker directly on this point.
	PRESS: DELTA PHASE ON/OFF 	To anchor the marker.
	PRESS:  or 	to move the delta phase marker as close as possible to the other point. Note that the anchor marker will stay while the delta phase marker separates from the anchor marker. Use the knob to place the delta phase marker directly on this point. The value displayed in the UIA and PDA is the phase difference in degrees between the two points.

Example 2

The programmer needs to set up a display in which the user can easily see if the orientation of a 16QAM Constellation display is within specified limits. The phase of the whole pattern should be within $\pm 5^\circ$. One way to accomplish this is to set up a marker at 40° and the other at 50° . The user would then check to see if the two constellation clouds at the 45° angle fall between the two markers. Figure 3-23 shows how this would appear.

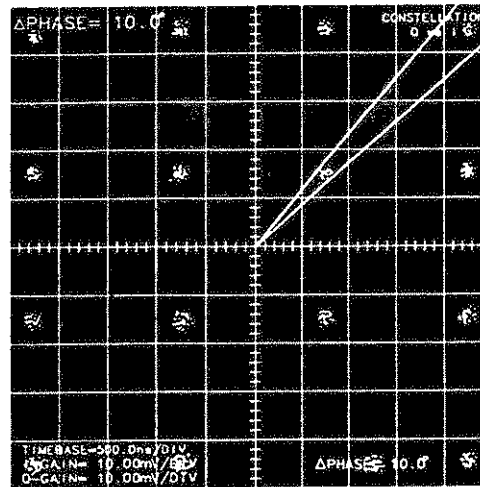



Figure 3-23. Display with Phase Angle Limits

 (Program Codes)	DISP:PMAR ON: MEAS:PMAR 40.0; PMAD ON: PDEL 10.0
---	---

HP-IB Program Codes

Command Level	Description	Code (1)
Subsystem (SUBS) Codes	Display	DISP DISPLAY
	Measure	MEAS MEASURE

Command Level	Description	Code (1)
Function (FNA) Codes (under subsystem DISP)	Delta Phase On/Off	PMAD
	Phase Marker On/Off	PMAR
	All Markers Off	MOFF
Function (FNA) Codes (under subsystem MEAS)	Delta Phase Value	PDEL
	Delta Phase On/Off	PMAD
	Phase Marker Value	PMAV

(1) If multiple codes appear in this column, the first one listed is the preferred code. Others are given to be compatible with HPOL (Hewlett-Packard Oscilloscope Language).

Parameter	Program Code (SUBS: FNA FNB)
delta phase marker on	DISP:PMAD ON MEAS:PMAD ON
delta phase marker off	DISP:PMAD OFF MEAS:PMAD OFF
phase marker on	DISP:PMAR ON
phase marker off	DISP:PMAR OFF
all markers off	DISP:MOFF
set delta phase value	MEAS:PDEL -359.0 to 359.0 (1)
set phase marker value	MEAS:PMAV 0.0 to 359.0 (2)

(1) "-359.0 to 359.0" should be replaced with a number in degrees that represents the angle the phase marker is away from the anchor marker.

(2) "0.0 to 359.0" should be replaced with a number in degrees that represents the actual angle of the phase marker relative to the positive "I" axis. Numbers can be entered that are outside of this range but they will be corrected by the instrument to fall between zero degrees and 359 degrees inclusive.

Indications

When the PHASE key is pressed, the phase marker menu appears on the screen with the PHASE MARKER VALUE menu item highlighted (brighter). In addition, the PHASE MARKER ON/OFF function will always be ON and the phase marker will appear on the screen. The words "PHASE-MKR=XXX" will appear in the UIA and PDA with XXX being the value that the phase marker is set at. As the value of the phase marker is being changed via the step up/step down keys or knob, the marker will move and the value will change in the UIA and PDA. If PHASE MARKER ON/OFF is set to OFF, the phase marker and associated text will disappear but the menu will remain.

When the delta phase function is set to ON, the anchor marker is dropped. The words " Δ PHASE=XXX" appear in the UIA and PDA with XXX being the difference between the anchor marker and the delta phase marker. In this case, both markers are the same so the value will be 0.0°. As the delta phase marker is being changed via either the step up/step down keys or knob, the marker will move and the value will change in the UIA and PDA. The anchor marker will never move when this function is being used.

If the ALL MKR OFF softkey is pressed, all displayed markers and associated text will disappear.

Comments

Although the phase markers are not visible in I versus time, Q versus time, I&Q versus time, or 3-dimensional displays, they can still be manipulated.

If the delta phase function is being used and is then turned OFF, the delta value will be set to zero when the function is reactivated.

The PDEL function code automatically turns the delta phase marker on (anchors the marker) if it is not already on.

The PMAD function code is structured under both the DISP and MEAS subsystems. This is for convenience and either DISP:PMAD or MEAS:PMAD can be used interchangeably.

Preset

Description

The PRESET key sets the Vector Modulation Analyzer to a known state. Preset conditions are as shown in Table 3-24.

Table 3-24. Preset Conditions

Parameter	Condition
Instrument Mode	DEMOD
Demodulator Ref. Frequency	70 MHz
RF Input	ON
External Filters	OFF
Demodulator	Internal
Coherent Reference Phase	45 Degrees
Demodulator Corrections	OFF
Ref. Level (for gain corr.)	0 dBm
Full Scale Magnitude	0 dBm
I/Q Gain Ratio	0 dB
I Offset (DEMOD mode)	0%
Q Offset (DEMOD mode)	0%
I and Q Volts/Div	1.000V/div
I and Q Offset (IQ mode)	0.0V
I and Q Coupling	DC
Time Base	1 μ s/div
I and Q Delay	0 ps
Sweep	Auto
Multi Sample	ON
Holdoff Dither	ON
Trigger Source	External
Trigger Level	Auto
Trigger Slope	Positive
Int. Trig. Levels (IQ)	0V
Int. Trig. Levels (DEMOD)	0%
Internal Trigger Coupling	DC
Internal Trigger Slope	Positive
Gate	Disabled
Gate Termination	0V
Gate Level	TTL
Autoscope Configure	I, Q, Time Base, and Trigger - ON
Display Type	Vector
Display Format	Scope
Signal Intensity	2
Split Screen	ON

Table 3-24. Preset Conditions (Cont.)

Parameter	Condition
Phase Rotation	0 Degrees
Horizontal Rotation	0 Degrees
Vertical Rotation	0 Degrees
Markers	OFF
Text	ON
Measure	OFF
Phase Offset Adjust	0 Degrees
Quad. Offset Adj. (IQ mode)	0 Degrees

Procedure

To set the Vector Modulation Analyzer to the conditions indicated in Table 3-24, press the PRESET key.

HP-IB Program Codes

The preferred program code for PRESET is *RST.

Indications

When the PRESET key is pressed, the display will flash for about two seconds. After the display has settled, the scope display format will be chosen. The DEMOD menu will be displayed with REF FREQ highlighted (brighter) and DEMOD mode chosen. "REF FREQ=70.00 MHz" will be displayed in the User Interface Area and full scale magnitude, timebase, and reference frequency will be displayed in the Parameter Data Area. The words "VECTOR Q vs I" will be displayed in the Display Identification area.

Comments

Once the PRESET key has been pressed, it cannot be interrupted or cancelled.

Correction factors are not affected by PRESET. Correction factors are, however, turned off (disabled) when PRESET is pressed.

The correction factors can be cleared by pressing the CLEAR CORRECTIONS softkey.

Related Sections

Autoscope
Delay Selection
Demodulation
Demodulator Corrections
Gain
Gate Configuration
I Marker Setup
Magnitude Marker Setup
Measurement Functions

Offset
Phase Marker Setup
Q Marker Setup
Special Display
Sweep Selection
Time Base Selection
Time Marker Setup
Trigger Setup

Printer, Use With

Description

Pressing the HP-IB key activates a menu that contains softkey items that allow the instrument to transmit data to a printer. The printer will recreate the analog signal that is on the display as well as the grid and axes shown. In addition, the display type will be indicated as well as a supplementary readout of parameters that includes the time base, I and Q channel gain, I&Q delay, I and Q channel delay, I and Q channel offset, and marker values. A typical printout is shown in Figure 3-24:

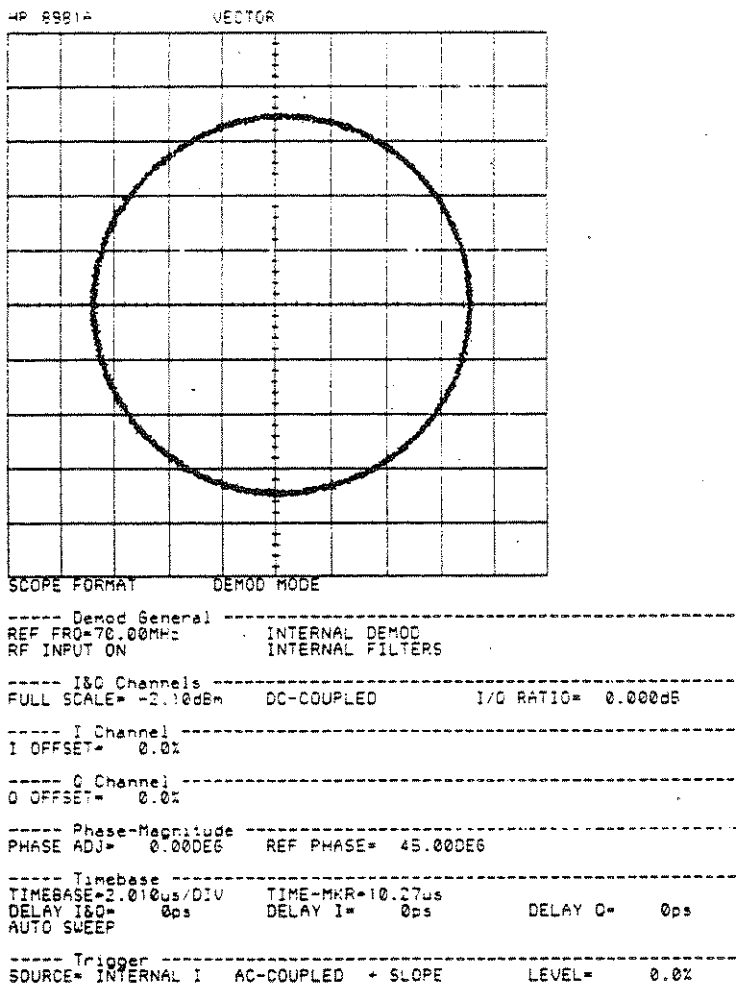











Figure 3-24. Typical Display Printout

The PRINT function is designed to be used with an HP 2225A Thinkjet printer. However, other printers might work if they meet the following criteria:

- HP-IB Compatible
- Graphics Capability
- Listen Only Mode
- Recognizes Control Characters Shown in Table 3-25.

Table 3-25. Printer Control Characters

Print Feature	Control Characters (1)	ASCII Decimal Equivalent (2)	ASCII Hexadecimal Equivalent (2)
Line Spacing, 8 lines/inch	 &18D	27,38,108,56,68	1B,26,6C,38,44
Line Feed	 J	10	0A
Carriage Return	 M	13	0D
Form Feed	 L	12	0C
Low Density Graphics	 *640S	27,42,114,54, 52,48,83	1B,2A,72,36,34, 30,53
Raster Dot Row	 *b#W	27,42,98,#,.,#, 87	1B,2A,62,#,.,#,57
Begin Raster Graphics	 *rA	27,42,114,65	1B,2A,72,41
End Raster Graphics	 *rB	27,42,114,66	1B,2A,72,42

- (1)  represents a keyboard escape key and  represents a keyboard control key.
 (2) # should be replaced with a numeric value. When using the decimal or hexadecimal form of these escape sequences, substitute the decimal or hexadecimal form of each digit of the value field (#).

The user can select the number of print points sampled before the printout through softkey control. These points are selectable in groups of 1024 (1K). The range of the print points that can be sampled is from 1K to 999999K, however, the instrument needs several seconds to process each 1024 points.

The user can exit the print function at any time by pressing any other key.

Procedure

Connecting Printer to Instrument

Before the print function can be used, the printer must be connected to the instrument. Connection is made using a standard HP-IB interconnection cable. See Figure 2-3 for information on Hewlett-Packard Interface Bus connections. Note that the two connector securing screws are metric.

Setting Printer to Listen Only Mode

On many printers, the Listen Only mode is enabled by setting a switch. This switch is usually on the rear panel of the printer or under a protective panel. Refer to the owner's manual for the printer for information on selecting the Listen Only mode.

Note



With the printer set to Listen Only mode, it is not necessary to select an address.

Setting the Vector Modulation Analyzer to Talk Only Mode

1. Press the HP-IB key. This will activate the HP-IB menu on the display.
2. Press the TALK ONLY softkey. All controllers should be disconnected from HP-IB for the duration of the print.

Selecting Print Points

1. Press the HP-IB key on the Vector Modulation Analyzer. This will activate the HP-IB menu on the display.
2. Press the PRINT POINTS softkey.
3. Enter the desired number of print points to be sampled using either the data entry keys or the step up/step down keys or knob. If the data entry keys are used, note that the entry is actually a whole number that represents a group of 1K (1024) print points. As an example, if the user wants to sample 5120 points before the printout, the number 5 must be entered, not 5120.

The function parameters are as follows:

Data Entry Key Resolution	1K (1024) points
Knob Resolution	1K (1024) points
Step Up/Down Resolution	10K (10 240) points

4. Press the ENTER softkey if the Data Entry keys have been used.

Obtaining a Printout

1. Press the HP-IB key. This will activate the HP-IB menu on the display.
2. Press the PRINT softkey.

Note



The printout will not begin immediately. It will take a minimum of several seconds and depends on the amount of print points sampled.

3. To cancel printing at any time, press any key.

Note



When a key is pressed to cancel printing, that key is immediately executed. Pressing LCL is suggested as it will have no other effect on the instrument.

4. The printout is finished when the PRINT DONE message appears on the display.

Example

The user wants a printout of the signal that is currently on the Vector Modulation Analyzer display. Ten-thousand print points will be sampled before the actual printout. After connecting the printer to the instrument and setting the printer to Listen Only mode, perform the following sequences.

LOCAL (key- strokes)	PRINT POINTS <input style="width: 20px; height: 20px;" type="text"/> <input style="width: 20px; height: 20px;" type="text"/> 1 0 ENTER <input style="width: 20px; height: 20px;" type="text"/> TALK ONLY <input style="width: 20px; height: 20px;" type="text"/> <input style="width: 20px; height: 20px;" type="text"/> PRINT <input style="width: 20px; height: 20px;" type="text"/>
(Program Codes)	10 OUTPUT 709; "PRIN 10" 20 SEND 7; UNL LISTEN 1 TALK 9 DATA NOTE THIS EXAMPLE CONTAINS LINES OF BASIC PROGRAM CODE THAT ALSO SET UP THE INSTRUMENT AND PRINTER FOR PROPER OPERATION. THE ACTUAL HP-IB PRINT CODE IS "PRIN 10".

HP-IB Program Codes

Command Level	Description	Code (1)
System (STM) Codes	Print	PRIN

(1) If multiple codes appear in this column, the first one listed is the preferred code. Others are given to be compatible with HPOL (Hewlett-Packard Oscilloscope Language).

Parameter	Program Code (STM PPS)
print current display	PRIN 1 to 999999 (1)

(1) "1 to 999999" should be replaced with a number that represents the amount of print points to be sampled in groups of 1K (1024) points.

Indications

When the PRINT softkey is pressed, the message "Initializing print system" is displayed just above the center of the screen. This message is followed by the message "Processing data trace #1". While the instrument is acquiring the data trace, an intensified dot will sweep through the analog signal at a steady pace. After the intensified dot finishes the sweep, the message "Scaling Print Data" will appear momentarily.

If the amount of print points selected was 1K (1024) the instrument will display the message "Printing data" and the printout will begin. If the print points selected was more than 1K (1024) points, the instrument will run through the "Processing data trace" sequence one time for every 1K (1024)

points sampled.

After the printout is complete, the instrument will display "Print Done". This message will remain on the display until the next key is pressed.

If any other key is pressed while the print process is taking place, the message "PRINT ABORTED" will be shown below the screen center for a few seconds.

Comments

On some printers, the power switch must be cycled OFF and then ON to cause the printer to re-read the HP-IB switches after being set to LISTEN ONLY.

Related Sections

HP-IB Address Selection and Configuring (Section 2)

Q Marker Setup

Description

Pressing the "Q" key in the MARKERS portion of the front panel activates the Q marker menu; the value is also turned on and automatically set up so that it can be changed via front panel keys or knob. Q marker functions are active in all displays, but are not visible in I versus time displays or when the 3D DISPLAY, VECTOR ALIGN, or CONSTL ALIGN softkeys in the Special Display menu are active. Each of the choices in the Q marker menu are explained below.

Note



The function parameters for the Q marker and the delta Q marker will differ depending on whether the instrument is set to IQ mode or DEMOD mode.

Changing marker values in DEMOD mode will not change marker values in IQ mode, and vice versa.

Q MARKER VALUE - Pressing this key enables the value of the Q marker to be changed via either a function-data-units (F-D-U) entry, or the step up/step down keys or knob. In IQ mode, the Q marker can be set to any value within its specified range via a function-data-units entry even though the set value may be off the display. In this case, the actual set value of the marker will be displayed in the User Interface Area (UIA) and Parameter Data Area (PDA) of the display and the marker itself will appear at the edge of the display. In the DEMOD mode, the Q marker can not be set so that it is off the display.

The step up/step down keys or knob can only adjust the Q marker over the present range of the display. When the Q marker has been set offscreen in IQ mode and the step up/step down keys or knob are used, the marker value will instantaneously be set to the edge of the display and the marker will move from that point.

Q MARKER ON/OFF - This softkey is provided to allow the user to turn the Q marker off. The Q marker is automatically turned on whenever the front panel "Q" marker key is pressed. This softkey provides a toggle function, therefore, repeatedly pressing the softkey will cause the marker to toggle between "ON" and "OFF".

DELTA Q ON/OFF - This is a toggle function, therefore, repeatedly pressing this softkey will cause the delta Q function to toggle between "ON" and "OFF". When this softkey is pressed, a marker will be anchored at the present Q marker position. This "anchor" marker will then stay in the position where it was anchored. Modifications to the delta Q marker via a F-D-U entry or

the step up/down keys or knob will cause the delta Q marker to move away from the anchor marker. The value displayed in the UIA and PDA will be the difference between the delta Q marker and the anchor marker.

Q MARKER->CENTER - Pressing this softkey moves the Q marker to the center of the display. When Q MARKER->CENTER is pressed, the center screen value will correspond to any Q offset that has been added.

ALL MARKERS OFF - Pressing this softkey will turn all five markers off and thereby remove them from the display.

Procedure

Press the "Q" key in the MARKERS portion of the front panel. This will activate the Q marker menu on the display. Use the following procedures to modify the Q marker or delta Q markers:

Modifying the Q Marker Value

Press the Q MARKER VALUE softkey. Use either a function- data-units entry or the step up/step down keys or knob to set the value of the Q marker. The function parameters are as follows; note that they are different depending on whether the instrument is in IQ mode or DEMOD mode. Note also that the range for a F-D-U entry differs from the range for modification with the step up/step down keys or knob:

Function Parameters - IQ Mode

Range - function-data-units entry	±20 volts
Range - step up/step down keys or knob	± full screen
Knob Resolution	1% of the current gain value
Step Up/Down Resolution	10% of full scale

Function Parameters - DEMOD Mode

Range	±100% of full scale
Knob Resolution	0.1% of full scale
Step Up/Down Resolution	5% of full scale

Using the Delta Q Function

1. Check the text (DELTA Q ON/OFF) that is adjacent to the menu softkey. Either the "ON" or "OFF" will be highlighted.
2. Press the softkey so that the "OFF" is highlighted.
3. Use either a function-data-units entry or the step up/step down keys or knob to move the marker to the desired anchor location.
4. Press the DELTA Q ON/OFF softkey so that the "ON" is highlighted. Doing this anchors the marker.
5. Use either a function-data-units entry or the step up/step down keys or knob to move the delta Q marker to its desired location. The value displayed in the UIA and PDA will be the difference between the anchor marker and the delta Q marker.

Centering the Q Marker

To move the Q marker to the center of the display, press the Q MARKER->CENTER softkey.

Turning Q Marker On and Off

Check the text (Q MARKER ON/OFF) that is adjacent to the menu softkey. Either the "ON" or "OFF" will be highlighted. If the desired status of the Q marker is highlighted, do not press the softkey. If the opposite state is highlighted, press the softkey to toggle the selection.

Turning All Markers Off

If it is desirable to turn all five markers off, press the ALL MARKERS OFF softkey.

Examples

Note



In the following examples, the instrument is set to IQ mode.

The following examples consist of a front panel keystroke example and an HP-IB example. This is because the user must know the voltage value of the markers in order to set them via HP-IB. Therefore, HP-IB setup is impractical when trying to find the difference between two points. Example 1 deals with front panel keystrokes and Example 2 deals with HP-IB.

Example 1

The user wants to find the voltage difference between two points in a constellation display. The easiest way to do this is through the use of the delta Q function:

LOCAL (key- strokes)	<p>PRESS: MARKERS Q</p>	<p>PRESS: ←→ or →← to move the Q marker as close as possible to the lowermost (most negative) of the two points. Use the knob to place the Q marker directly on this point.</p>
	<p>PRESS: DELTA Q ON/OFF</p>	<p>To anchor the marker.</p>
	<p>PRESS: ←→</p>	<p>to move the delta Q marker as close as possible to the uppermost (most positive) of the two points. Note that the anchor marker will stay while the delta Q marker separates from the anchor marker. Use the knob to place the delta Q marker directly on this point. The value displayed in the UIA and PDA is the voltage difference between the two points.</p>

Example 2

The programmer needs to set up a display in which the user can easily see if the points in a constellation cloud fall within certain limits on the Q axis. The center of the cloud is I=30 mV and Q=30 mV. All points in the cloud should fall within +5.0 mV and -2.5 mV of the value for Q. The limits can be shown on the display using the delta Q function to set the display up as shown in Figure 3-25:

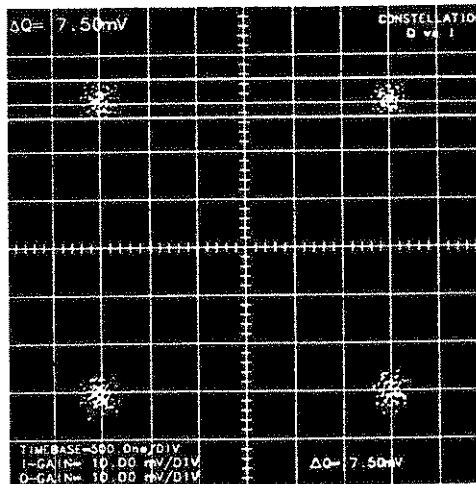



Figure 3-25. Display with Q Limits

	DISP:QMAR ON; MEAS:QMAV 27.5 MV; QMAD ON; QDEL 7.5 MV
---	--

HP-IB Program Codes

Command Level	Description	Code (1)
Subsystem (SUBS) Codes	Display	DISP DISPLAY
	Measure	MEAS MEASURE
	Demodulation	DEM
Function (FNA) Codes (under subsystem DISP)	Delta Q On/Off	QMAD
	Q Marker On/Off	QMAR
	All Markers Off	MOFF
Function (FNA) Codes (under subsystems MEAS and DEM)	Delta Q Value	QDEL
	Q Marker Center	QMAC
	Delta Q On/Off	QMAD
	Q Marker Value	QMAV

(1) If multiple codes appear in this column, the first one listed is the preferred code. Others are given to be compatible with HPOL (Hewlett-Packard Oscilloscope Language).

Parameter	Program Code (SUBS: FNA FNB)
delta Q marker on	DISP:QMAD ON MEAS:QMAD ON DEM:QMAD ON
delta Q marker off	DISP:QMAD OFF MEAS:QMAD OFF DEM:QMAD OFF
Q marker on	DISP:QMAR ON
Q marker off	DISP:QMAR OFF
all markers off	DISP:MOFF
set delta Q value (IQ mode)	MEAS:QDEL -40.0 to 40.0 (1)
set delta Q value (DEMOD mode)	DEM:QDEL -200 to 200 (2)
move Q marker to center	MEAS:QMAC DEM:QMAC
set Q marker value (IQ mode)	MEAS:QMAV -20.0 to 20.0 (3)
set Q marker value (DEMOD mode)	DEM:QMAV -100 to 100 (4)

- (1) "-40.0 to 40.0" should be replaced with a voltage in full volt units that represents the distance the Q marker is away from the anchor marker.
- (2) "-200 to 200" should be replaced with a number in percent that represents the distance the Q marker is away from the anchor marker.
- (3) "-20.0 to 20.0" should be replaced with a voltage in full volt units that represents the actual magnitude of the Q marker.
- (4) "-100 to 100" should be replaced with a number in percent that represents the percent of full scale value of the Q marker.

Indications

When the "Q" marker key is pressed, the Q marker menu appears on the screen with the Q MARKER VALUE menu item highlighted (brighter). In addition, the Q MARKER ON/OFF function will always be ON and the Q marker will appear on the screen. The words "Q-MKR=XXX" will appear in the UIA and PDA with XXX being the value that the Q marker is set at. As the value of the Q marker is being changed via the step up/step down keys or knob, the marker will move and the value will change in the UIA and PDA. If Q MARKER ON/OFF is set to OFF, the Q marker and associated text will disappear but the menu will remain.

When the delta Q function is set to ON, the anchor marker is dropped. The words " $\Delta Q=XXX$ " appear in the UIA and PDA with XXX being the difference between the anchor marker and delta Q marker. In this case, both markers are the same so the value will be 0 μV in IQ mode or 0.0% in DEMOD mode. As the delta Q marker is being changed via either the step up/step down keys or knob, the delta Q marker will move and the value will change in the UIA and PDA. The anchor marker will never move when this function is being used.

If the ALL MARKERS OFF softkey is pressed, all displayed markers and associated text will disappear.

Comments

Although the Q markers are not visible in I versus time, 3-dimensional, Vector Align, or Constellation Align displays, they can still be manipulated.

The actual position of the Q marker on the screen will be affected by any Q offset that has been added (IQ mode only).

The value of the Q marker corresponds to the Q offset value when Q MARKER->CENTER is pushed. This, then, is an easy way to determine how much Q offset has been added.

If the delta Q function is being used and is then turned OFF, the delta value will be set to zero when the function is reactivated.

The QDEL function code automatically turns the delta Q marker on (anchors the marker) if it is not already on.

The QMAD function code is structured under the DISP, MEAS, and DEM subsystems. This is for convenience and DISP:QMAD, MEAS:QMAD, or DEM:QMAD can be used interchangeably.

Related Sections

Offset

Q Versus Time Display

Description

Pressing the "Q" key in the DISPLAY portion of the front panel sets up a voltage versus time display with the Q Channel being displayed along the time axis. The Q axis is displayed in either dBm (instrument in DEMOD mode) or volts per division (instrument in IQ mode).

Nine display formats are useable in the Q versus time display mode. These display formats include a standard 10 x 10 oscilloscope format and eight modulation-specific formats. The eight formats are QPSK, 9PRS, 16QAM, 25PRS, 49PRS, 64QAM, 81PRS, and 256QAM.

When the Q versus time display mode is selected, none of the parameters of the previous display are changed. As an example, if a Vector display has an I&Q gain of 1 volt per division, then the Q versus time display will also have a Q channel gain of 1 volt per division.

For more information on displays, see the DISPLAY, GENERAL Detailed Operating Instruction.

Procedure

Selecting the Q Versus Time Display Mode



To set the Vector Modulation Analyzer in the Q versus time display mode, press the "Q" key in the DISPLAY portion of the front panel.

Selecting the Display Formats

1. Press the DEMOD key. This activates the demodulator menu on the display.
2. Press the MOD FORMAT softkey. This activates the second level "modulation format" menu on the display.
3. Press the softkey in the MOD FORMAT menu that corresponds to the desired display format. The menu choices are SCOPE FORMAT, QPSK, 9PRS, 16QAM, 64QAM, 256QAM, and MORE. If MORE is pressed, an additional menu will appear with the choices 25PRS, 49PRS, and 81PRS displayed.

Example

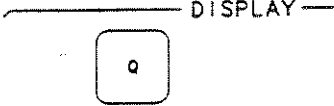
A Constellation display is currently on the screen and the user wants to view the corresponding Q versus time display.

LOCAL (key-strokes)	
 (Program Codes)	DISP:MODE Q

HP-IB Program Codes

Command Level	Description	Code (1)
Subsystem (SUBS) Codes	Display	DISP DISPLAY
	Demodulation	DEM
Function (FNA) Codes (under subsystem DISP) Function (FNA) Codes (under subsystem DEM)	Display Mode	MODE
	Display Format	FORM

(1) If multiple codes appear in this column, the first one listed is the preferred code. Others are given to be compatible with HPOL (Hewlett-Packard Oscilloscope Language).

Parameter	Program Code (SUBS: FNA FNB)
select Q versus time display mode	DISP: MODE CHANQ
select 10 x 10 oscilloscope format	DEM: FORM NONE
select QPSK display format	DEM: FORM QPSK
select 9PRS display format	DEM: FORM PRS9
select 16QAM display format	DEM: FORM QAM16
select 25PRS display format	DEM: FORM PRS25
select 49PRS display format	DEM: FORM PRS49
select 64QAM display format	DEM: FORM QAM64
select 81PRS display format	DEM: FORM PRS81
select 256QAM display format	DEM: FORM QAM256

Indications

When the "Q" key in the DISPLAY portion of the front panel is pressed, all current menus, except for the "3D display" menu, remain displayed and active. All data in the User Interface Area and Parameter Data Area remains displayed. The display mode changes to Q versus time with the display format at whatever was selected in the DEMOD/MOD FORMAT menu. The words "Q vs time" appear in the Display Identification area.

Comments

Pressing the "Q" key in the DISPLAY portion of the front panel will activate the gain and offset menu if the 3D DISPLAY menu was active.

Related Sections

Display, General

Save and Recall (Demodulator Corrections)

Description

The demodulator correction factors for a given frequency can be stored in one of twelve storage registers. After a demodulator correction has been performed at a given reference frequency (refer to the DEMODULATOR CORRECTIONS Detailed Operating Instruction), the correction factors can be stored in a register by pressing any SAVE softkey in the SAVE CORRECTIONS menu. A label will then appear under the softkey label that gives the reference frequency the corrections were made at and whether the corrections were to an external or the internal demodulator. The corrections can be recalled by pressing the appropriate softkey in the RECALL CORRECTIONS menu.

Individual storage registers can be selectively cleared or they can all be cleared by pressing one softkey. An instrument PRESET does not affect any of the registers. If a reference frequency label does not appear below the softkey label, no correction factors are stored in that register.

Procedure

Storing Demodulator Corrections

1. Press the DEMOD key. This will activate the Demodulation menu on the display.
2. Press the MODE IQ/DEMOM softkey to DEMOD.
3. Press the CORRECTIONS softkey. This will activate the Demodulator Corrections menu on the display.
4. Press the SAVE CORRECTIONS softkey. This will activate the third-level Save Corrections menu on the display.
5. Press one of the six softkeys, labeled SAVE 1 through SAVE 6. Note that any correction factors previously stored in a register will be written over when the softkey is pressed.

Recalling Demodulator Corrections

1. Press the DEMOD key. This will activate the Demodulation menu on the display.
2. Press the MODE IQ/DEMOM softkey to DEMOD.
3. Press the CORRECTIONS softkey. This will activate the Demodulator Corrections menu on the display.
4. Press the RECALL CORRECTIONS softkey. This will activate the third-level Recall Corrections menu on the display.
5. Press the appropriate softkey. The frequency that the correction factors were obtained at is shown under the softkey label.

Clearing Demodulator Corrections

1. Press the DEMOD key. This will activate the Demodulation menu on the display.
2. Press the MODE IQ/DEMOM softkey to DEMOD.
3. Press the CORRECTIONS softkey. This will activate the Demodulator Corrections menu on the display.
4. Press the SAVE CORRECTIONS softkey. This will activate the third-level Save Corrections menu on the display.
5. Press the CLEAR SAVED CORRECTIONS softkey. This activates the fourth-level Clear Corrections menu on the display.
6. Press the appropriate softkey of the storage register to be cleared.
- 6a. To clear all internal or external demodulator correction storage registers, press the CLEAR ALL softkey.

Example

The user will store internal demodulator correction factors obtained at 100 MHz and recall them.

LOCAL (key-strokes)	<div style="display: flex; justify-content: space-around; align-items: flex-start;"> <div style="text-align: center;"> <input type="button" value="DEMOK"/> </div> <div style="text-align: center;"> CORRECTIONS <input type="text"/> <input type="text"/> </div> <div style="text-align: center;"> SAVE CORRECTIONS <input type="text"/> <input type="text"/> </div> <div style="text-align: center;"> SAVE 1 <input type="text"/> <input type="text"/> </div> </div> <div style="display: flex; justify-content: space-around; align-items: flex-start; margin-top: 10px;"> <div style="text-align: center;"> <input type="button" value="PREV
MENU"/> </div> <div style="text-align: center;"> RECALL CORRECTIONS <input type="text"/> <input type="text"/> </div> <div style="text-align: center;"> RECALL 1 INT 100.0 MHz <input type="text"/> <input type="text"/> </div> </div>
 (Program Codes)	CORR: SAV 1 CORR: RCL 1

HP-IB Program Codes

Command Level	Description	Code (1)
Subsystem (SUBS) Codes	Corrections	CORR COR
Function (FNA) Codes	Clear Saved Corrections	CLR
	Recall Corrections	RCL
	Save Corrections	SAV

(1) If multiple codes appear in this column, the first one listed is the preferred code. Others are given to be compatible with HPOL (Hewlett-Packard Oscilloscope Language).

Parameter	Program Code (SUBS: FNA FNB)
store demodulator corrections	CORR:SAV 1 to 6
recall demodulator corrections	CORR:RCL 1 to 6
clear individual storage register	CORR:CLR 1 to 6
clear all storage registers	CORR:CLR ALL

Indications

When the DEMOD key is pressed, the menu that is displayed depends on the state of the MODE IQ/DEMOM softkey in that menu. As the MODE IQ/DEMOM softkey is toggled, the menu below it will change.

When one of the six SAVE softkeys are pressed, the softkey label will become highlighted (brighter). If corrections were previously stored in that storage register, a label will appear below the softkey label in the following format: "STAT XX.XXMHZ" where STAT is either INT (internal demodulator corrections) or EXT (external demodulator corrections). XXXX is the frequency the corrections were performed at.

When either a RECALL or CLEAR softkey is pressed, the softkey label will become highlighted (brighter). If an attempt is made to recall correction factors from a storage register that contains none, an error message will appear on the display and no further action will be taken by the instrument.

Comments

Although twelve storage registers are available, only six are available at a given time. Six are used to store internal demodulator corrections and six are used to store external demodulator corrections.

When the CLEAR ALL softkey is pressed, either the six internal demodulator registers or the six external demodulator registers are cleared, but not both. Which are cleared depends on the state of the DEMOD INT/EXT softkey in the DEMOD, [MORE] softkey menu.

Related Sections

Demodulator Corrections

Save and Recall (Instrument State)

Description

The instrument configuration can be stored in one of eight instrument state registers. Almost all states, functions, and entered parameters can be stored. The only exception is the bits that have been set under the DIRECT CONTROL softkey function in the SERVICE softkey menu (The SERVICE softkey is in the INST STA menu).

Procedure

The Storage Register Number (SRN) must be a number from one to eight (1 to 8).

Storing an Instrument State



1. Press the INST STA key. This will activate the instrument state menu on the display.
2. Press the SAVE softkey. The instrument will prompt the user for the SRN.
3. Enter a one digit number from 1 to 8 and press the ENTER softkey terminator to complete the entry.

Recalling the Instrument State

1. Press the INST STA key. This will activate the instrument state menu on the display.
2. Press the RECALL softkey. The instrument will prompt the user for the SRN.
3. Enter the desired storage register number and press the ENTER softkey terminator to complete the entry.

Example

The user will store an instrument configuration in storage register 5 and recall it.

LOCAL (key-strokes)	 SAVE <input type="text"/> <input type="text"/> 5 ENTER <input type="text"/> <input type="text"/>
	 RECALL <input type="text"/> <input type="text"/> 5 ENTER <input type="text"/> <input type="text"/>
 (Program Codes)	*SAV 5 *RCL 5

HP-IB Program Codes

Command Level	Description	Code
System (STM) Codes	Save	*SAV
	Recall	*RCL

Parameter	Program Code (STM SRN)
store instrument state	*SAV 1 to 8
recall instrument state	*RCL 1 to 8

Indications

When the SAVE softkey in the instrument state menu is pressed, the words "STORE REGISTER #: X" appear in the User Interface Area (UIA) with X being the previously entered Storage Register Number (SRN). When the data portion of the function-data-units entry is initiated, the instrument state menu is replaced with the ENTER terminator. After the entry sequence is completed, the instrument state menu returns.

When the RECALL softkey in the instrument state menu is pressed, the words "RECALL REGISTER #: X" appear in the UIA with X being the

previously entered recall register number. When the data portion of the function-data-units entry is initiated, the instrument state menu is replaced with the ENTER terminator. When the ENTER terminator is pressed and the entry sequence completed, the display will be reconfigured to whatever instrument state was stored in the recall register.

Comments

Entering an instrument state in a storage register will erase any instrument state that had been previously stored in that register.

If the user tries to enter a multi-digit number, only the first digit of the entry sequence will be displayed in the UIA and ENTERed. All other digits will be ignored.

Demodulator correction factors are not stored with the instrument state. Recalling instrument state will not change the current correction factors.

Special Display

Description

Pressing the SPCL DISP key activates a menu that allows the user to utilize several special purpose display modes. Each of the choices in the special display menu are described below:

Special Displays

VECTOR ALIGN - Pressing this softkey sets up a display which alternates rapidly between a normal Vector display and a 90° rotated Vector display. This is a useful display for aligning symmetrical modulation patterns in digital modulators. Any difference between the I and Q signal amplitudes will be very noticeable as the pattern alternates.

CONSTL ALIGN - Pressing this softkey sets up a display which alternates rapidly between a normal Constellation display and a 90° rotated Constellation display. This is a useful display for aligning symmetrical modulation patterns in digital modulators. Any difference between the I and Q signal amplitudes will be very noticeable as the pattern alternates.

3 D DISPLAY - Pressing this softkey activates a second level menu that allows the user to rotate the display about the vertical, horizontal, and time axes. The user can also zero all rotational angles with one keystroke and press a key that sets all angles to a preset condition that allows optimal viewing of the relationship between the three axes. No I or Q measurements or Constellation Analysis can be performed when in this mode.

Inducing vertical axis rotation will always cause the display to rotate around the axis that is from the top to the bottom of the display. However, rotation about the horizontal axis is dependent upon vertical axis rotation.

As an example, if there is no vertical axis rotation (rotation=0°), a constellation display will appear like a normal constellation display with the vertical axis from top to bottom ("Y") and the horizontal axis from side to side ("X"). If horizontal rotation is induced in this case, the display will rotate about the "X" axis.

If there is 90° of vertical axis rotation, the vertical axis will still be equal to the "Y" axis. The horizontal axis, however, will be in a position where it is perpendicular to the display face. If horizontal axis rotation is induced in this case, the display will rotate about its center.

Display Formats

Nine display formats are useable in the Special Display mode. These display formats include a standard 10 x 10 oscilloscope format and eight modulation-specific formats. The eight formats are QPSK, 9PRS, 16QAM, 25PRS, 49PRS, 64QAM, 81PRS, and 256QAM.

For more information on displays, see the DISPLAY, GENERAL Detailed Operating Instruction.

Procedure

Selecting the Vector Align Display Mode

1. Press the SPCL DISP key. This activates the special display menu on the display.
2. Press the VECTOR ALIGN softkey.

Selecting the Constellation Align Display Mode

1. Press the SPCL DISP key. This activates the special display menu on the display.
2. Press the CONSTL ALIGN softkey.

Three-Dimensional Display Mode

1. Press the SPCL DISP key. This activates the special display menu on the display.
2. Press the 3 D DISPLAY softkey. This activates the second level three dimensional display menu on the display. Use the following procedures to rotate the display around its three axes:
3. **Rotation About the Time Axis.** Press the PHASE ROTATION softkey. Use either a function-data-units entry or the step up/step down keys or knob to set the desired angle of rotation about the time axis. The PHASE ROTATION function parameters are as follows:

Range	-360 Degrees to 360 Degrees
Knob Resolution	unspecified
Step Up/Down Resolution	5 degrees

- 3a. **Rotation About the Horizontal Display Axis.** Press the HORIZONTAL ROTATION softkey. Use either a function-data-units entry or the step up/step down keys or knob to set the desired angle of rotation about the axis. The HORIZONTAL ROTATION function parameters are as follows:

Range	-360 Degrees to 360 Degrees
Knob Resolution	unspecified
Step Up/Down Resolution	5 degrees

- 3b. **Rotation About the Vertical Display Axis.** Press the VERTICAL ROTATION softkey. Use either a function-data-units entry or the step up/step down keys or knob to set the desired angle of rotation about the axis. The VERTICAL ROTATION function parameters are as follows:

Range	-360 Degrees to 360 Degrees
Knob Resolution	unspecified
Step Up/Down Resolution	5 degrees

- 3d. **Zeroing All Rotational Angles.** Press the ZERO ROT. ANGLES softkey.
3. **Selecting Educational 3 D Display.** Press the SET ROT. ANGLES softkey.

Selecting the Display Formats

1. Press the DEMOD key. This activates the demodulation menu on the display.
2. Press the MOD FORMAT softkey. This activates the second level "modulation format" menu on the display.
3. Press the softkey in the MOD FORMAT menu that corresponds to the desired display format. The menu choices are SCOPE FORMAT, QPSK, 9PRS, 16QAM, 64QAM, 256QAM, and MORE. If MORE is pressed, an additional menu will appear with the choices 25PRS, 49PRS, and 81PRS displayed.

Example

The user needs to adjust a digital modulator so that its 64QAM constellation pattern is symmetrical. Before the adjustment is made, the display must be set up as follows:

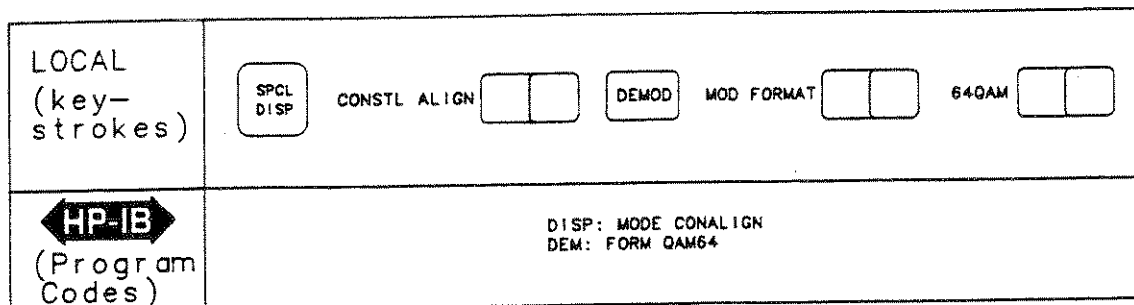

HP-IB Program Codes

Command Level	Description	Code (1)
Subsystem (SUBS) Codes	Display	DISP DISPLAY
	Demodulation	DEM
Function (FNA) Codes (under subsystem DISP)	Display Mode	MODE
Function (FNA) Codes (under subsystem DEM)	Display format	FORM

(1) If multiple codes appear in this column, the first one listed is the preferred code. Others are given to be compatible with HPOL (Hewlett-Packard Oscilloscope Language).

Parameter	Program Code (SUBS: FNA FNB)
select vector align display mode	DISP: MODE VECALIGN
select constellation align display mode	DISP: MODE CONALIGN
select 10 x 10 oscilloscope format	DEM: FORM NONE
select QPSK display format	DEM: FORM QPSK
select 9PRS display format	DEM: FORM PRS9
select 16QAM display format	DEM: FORM QAM16
select 25PRS display format	DEM: FORM PRS25
select 49PRS display format	DEM: FORM PRS49
select 64QAM display format	DEM: FORM QAM64
select 81PRS display format	DEM: FORM PRS81
select 256QAM display format	DEM: FORM QAM256

Indications

When the SPCL DISP key is pressed, the special display menu is activated with SIGNAL INTENSITY always highlighted and the words "SIGNAL INTENSITY= num" in the User Interface Area (UIA).

When the CONSTL ALIGN or VECTOR ALIGN softkeys are pressed, either the words "VECTOR ALIGN" or "CONSTL ALIGN" will appear in the Display Identification area depending on what softkey was pressed. The pattern will also alternate between a normal pattern and a 90° rotated pattern. The pattern will continue alternating until the function is deactivated.

When the 3 D DISPLAY softkey is pressed, the three dimensional (3 D) display menu will appear on the screen after a delay of a few seconds. The last item that was active in the 3 D menu will be active when the menu is reactivated. The word "3 D" will appear in the Display Identification area and the horizontal, vertical, and phase rotation angles will appear in the Parameter Data Area. If the HORIZONTAL ROTATION softkey is active, the words "HORIZ ROT=XX°" will appear in the UIA with XX being the amount of horizontal rotation in degrees. If the VERTICAL ROTATION softkey is active, the words "VERT ROT=XX°" will appear in the UIA with

XX being the amount of vertical rotation in degrees. If the PHASE ROTATION softkey is active, the words "PHASE ROT=XX°" will appear in the UIA with XX being the amount of phase rotation in degrees.

As any of these parameters are changed, the axes and grid will remain stationary and the actual signal pattern will rotate about its respective axis.

When the ZERO ROT. ANGLES softkey is pressed, all display angles will be set to zero and the signal pattern will change accordingly.

When the SET ROT. ANGLES softkey is pressed, the display angles will be set to HORIZ ROT=-30.0°, VERT ROT=45.0°, and PHASE ROT=0.0°. The signal pattern will change accordingly.

Comments

No HP-IB codes are implemented that provide the same function as the 3 D DISPLAY softkey functions in the SPECIAL DISPLAY menu.

Related Sections

Display, General
Measurement Functions

Sweep Selection

Description

Three keys in the TIMING menu select the sweep mode that controls how the instrument is triggered to obtain a display. The three sweep modes are explained briefly below:

AUTO SWEEP - This mode causes the instrument to trigger a sweep asynchronously if a user generated trigger signal is not received within 5 ms of the last one. If $(10 * \text{TIME}/\text{DIV}) + \text{Delay}$ is greater than 3 ms, the sweep will also be triggered asynchronously.

This sweep mode is useful in setting up displays and viewing DC signals. Signals with a rate of less than 200Hz cannot be viewed properly when in AUTO SWEEP mode.

TRIGGERED (TRIG'D) SWEEP - When this mode is selected, the instrument must receive a trigger signal to cause a sweep of the analog trace. If no trigger signal is received, no analog trace will be visible until the next trigger event.

FREE RUN - This mode causes the instrument to trigger the sweep asynchronously at a rate associated with the TIME/DIV setting regardless of whether the instrument receives trigger signals.

This sweep mode is useful for viewing vector displays of low repetition rate signals.

Note





I versus Q Timing Accuracy and Jitter are proportional to time/division and delay settings and may result in unexpected displays.

Procedure

1. Press the TIMING key. This activates the timing menu on the display.
2. Press the softkey, either AUTO SWEEP, TRIG'D SWEEP, or FREE RUN, that corresponds to the desired sweep mode.

Example

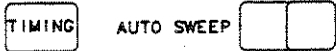
The user is setting up a display and does not know at what voltage level to obtain a valid trigger. The best sweep mode under this circumstance is the AUTO SWEEP mode:

LOCAL (key-strokes)	<div style="text-align: center;">  </div>
 (Program Codes)	TIM:MODE AUTO

HP-IB Program Codes

Command Level	Description	Code (1)
Subsystem (SUBS) Codes	Timing	TIM TIMEBASE
Function (FNA) Codes	Sweep Mode	MODE

(1) If multiple codes appear in this column, the first one listed is the preferred code. Others are given to be compatible with HPOL (Hewlett-Packard Oscilloscope Language).

Parameter	Program Code (SUBS: FNA FNB)
auto sweep mode	TIM:MODE AUTO
triggered sweep mode	TIM:MODE TRIG
free run sweep mode	TIM:MODE FREE

Indications

When the timing menu is activated, several other softkeys that are part of the timing menu will be displayed on the screen in addition to the sweep mode softkeys. Of the sweep mode softkeys, one will always be highlighted (brighter). When another sweep mode softkey is pressed, the adjacent text will be highlighted. Nothing else will happen to the display other than a change to the analog signal if it is affected by the new sweep mode selection.

Comments

In a voltage versus time display, the analog signal may appear garbled in the FREE RUN sweep mode.

Related Sections

Trigger Setup

Time Base Selection

Description

The TIMING key activates a menu that allows the user to set the time per division of the display. This sets the time axis for I, Q, and I&Q versus time displays. Although the time axis is not a part of a vector or constellation display, setting time/div is still necessary. This is necessary because only that part of a waveform that appears on a corresponding I, Q, or I&Q versus time display will be visible on a vector or constellation display.



Procedure

1. Press the TIMING key. This activates the timing menu on the display.
2. Press the TIME/DIV softkey. Use either a function-data-units entry or the step up/step down keys or knob to set the desired time base. The TIME/DIV function parameters are as follows:

Range	500 ps/div to 2 ms/div
Knob Resolution	3% of progressive integer value
Step Up/Down Resolution	1, 2, 5, 10 sequence

Example

The user wants to select a time base of 750 ns per division:

LOCAL (key-strokes)	
 (Program Codes)	TIM:SENS 7.5E-7

HP-IB Program Codes

Command Level	Description	Code (1)
Subsystem (SUBS) Codes	Timing	TIM TIMEBASE
Function (FNA) Codes	Time Base Range	RANG RANGE
	Time Base Sensitivity	SENS SENSITIVITY

(1) If multiple codes appear in this column, the first one listed is the preferred code. Others are given to be compatible with HPOL (Hewlett-Packard Oscilloscope Language).

Parameter	Program Code (SUBS: FNA FNB)
time base range	TIM:RANG 5E-9 to 20E-3 (1)
time base sensitivity	TIM:SENS 5E-10 to 2E-3 (2)

(1) "5E-9 to 20E-3" should be replaced with the selected time base range. This range represents the time for the beam to sweep across the entire display.

(2) "5E-10 to 2E-3" should be replaced with the selected time base per horizontal division.

Indications

When the TIMING key is pressed, the timing menu is activated and the words "TIMEBASE=XXX" appear in the User Interface Area (UIA) with XXX being the value of the currently selected time base. As the value is being changed via either the step up/down keys or knob, the value will change in the UIA and Parameter Data Area (PDA). The analog signal will change in accordance with the changing timebase parameter.

When a function-data-units (FDU) entry is initiated, the timing menu is replaced with the terminator menu. As the new timebase is entered via the numeric keypad, it will change in the UIA and PDA. When the FDU entry is completed by pressing a units terminator, the timing menu will return and the analog signal will change in accordance with the new timebase parameter.

Comments

Other softkeys are activated as part of the TIMING menu, however, these are not used when selecting time base.

The step up/down keys and knob actually work in an inverted sense. Thus, pressing the step down key will cause more of the signal to be displayed, but this causes an increase in the actual numerical value of the time per division.

Related Sections

Constellation Display
Vector Display

Time Marker Setup

Description

Pressing the TIME MKR key activates the time marker menu; the marker is also turned on and automatically set up so that it can be changed via front panel keys or knob. Time marker functions are active in all displays. In I, Q, and I&Q versus time displays, it is visible as a vertical line that is intensified where it crosses the trace. In Vector displays, it is shown as a set of intensified dots corresponding to the constellation at the time marker instant. In a Constellation display, the display instant will correspond to the value of the time marker. Each of the choices in the time marker menu are explained below:

Note



Changing marker values in DEMOD mode will also change the marker values in IQ mode, and vice versa.

TIME MARKER VALUE - Pressing this key enables the value of the time marker to be changed via either a function-data-units (F-D-U) entry, or the step up/step down keys or knob. The time marker can be set to any value within its specified range via a function-data-units entry even though the set value may be off the display. In this case, the actual set value of the marker will be displayed in the User Interface Area (UIA) and Parameter Data Area (PDA) of the display and the marker itself will appear at the rightmost edge of the display.

The step up/step down keys or knob can only adjust the time marker over the present range of the display. When the time marker has been set offscreen and the step up/step down keys or knob are used, the marker value will instantaneously be set to the rightmost edge of the display and the marker will move from that point.

TIME MARKER ON/OFF - This softkey is provided to allow the user to turn the time marker off. The time marker is automatically turned on whenever the front panel TIME MKR key is pressed. This softkey provides a toggle function, therefore, repeatedly pressing the softkey will cause the marker to toggle between "ON" to "OFF".

DELTA TIME ON/OFF - This is a toggle function, therefore, repeatedly pressing this softkey will cause the delta time function to toggle between "ON" and "OFF". When this softkey is pressed, a marker will be anchored at the present time marker position. This "anchor" marker will then stay in the position where it was anchored. Modifications to the delta time marker via a F-D-U entry or the step up/down keys or knob will cause the delta time

marker to move away from the anchor marker. The value displayed in the UIA and PDA will be the difference between the delta time marker and the anchor marker. If the markers should be set offscreen, the actual delta value will be displayed in the UIA and PDA and the markers will appear at the edge of the display.

TIME MARKER->CENTER - Pressing this softkey moves the time marker to the center of the display.

ALL MKR OFF - Pressing this softkey will turn all five markers off and thereby remove them from the display.

Procedure

Press the TIME MKR key. This will activate the time marker menu on the display. Use the following procedures to modify the time marker or delta time markers:

Modifying the Time Marker Value

Press the TIME MARKER VALUE softkey. Use either a function-data-units entry or the step up/step down keys or knob to set the value of the time marker. The function parameters are as follows. Note that the range for a F-D-U entry differs from the range for modification with the step up/step down keys or knob:

Range - function-data-units entry	0.0 to 20 ms
Range - step up/step down keys or knob	ten times TIME/DIV setting
Knob Resolution	unspecified
Step Up/Down Resolution	100% of TIME/DIV setting.

Using the Delta Time Function

1. Check the text (DELTA TIME ON/OFF) that is adjacent to the menu softkey. Either the "ON" or "OFF" will be highlighted.
2. Press the softkey so that the "OFF" is highlighted.
3. Use either a function-data-units entry or the step up/step down keys or knob to move the marker to the desired anchor location.
4. Press the DELTA TIME ON/OFF softkey so that the "ON" is highlighted. Doing this anchors the marker.
5. Use either a function-data-units entry or the step up/step down keys or knob to move the delta time marker to its desired location. The value displayed in the UIA and PDA will be the difference between the anchor marker and the delta time marker.

Centering the Time Marker

To move the time marker to the center of the display, press the TIME MARKER->CENTER softkey.

Turning Time Marker On and Off

Check the text (TIME MARKER ON/OFF) that is adjacent to the menu softkey. Either the "ON" or "OFF" will be highlighted. If the desired status of the time marker is highlighted, do not press the softkey. If the opposite state is highlighted, press the softkey to toggle the selection.

Turning All Markers Off





If it is desirable to turn all five markers off, press the ALL MKR OFF softkey.

Examples

The following examples consist of a front panel keystroke example and an HP-IB example. This is because the user must know the points on the time axis that the markers represent in order to set them via HP-IB. Therefore, HP-IB setup is impractical when trying to find the difference between two points. Example 1 deals with front panel keystrokes and Example 2 deals with HP-IB.

Example 1

The user wants to find the time difference between two points in an I versus time display. The easiest way to do this is through the use of the delta time function:

LOCAL (key- strokes)	PRESS: 	PRESS:  or  to move the time marker as close as possible to the leftmost of the two points. Use the knob to place the time marker directly on this point.
	PRESS: DELTA TIME ON/OFF 	To anchor the marker.
	PRESS: 	to move the delta time marker as close as possible to the rightmost of the two points. Note that the anchor marker will stay while the delta time marker separates from the anchor marker. Use the knob to place the delta time marker directly on this point. The value displayed in the UIA and PDA is the time difference between the two points.

Example 2

The programmer needs to set up a display in which the user can check for a signal glitch that might appear on the I versus time signal 100 ns to 150 ns after the data clock instant. The display will be triggered with the data clock. The limits can be shown on the display using the delta time function to set the display up as shown in Figure 3-26:

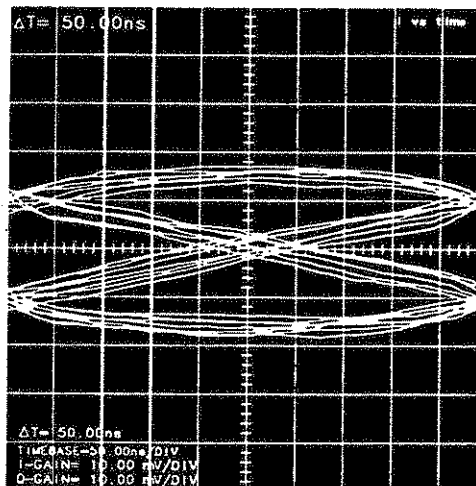



Figure 3-26. Display with Time Window

 (Program Codes)	DISP:TMAR ON; MEAS:TMAY 100NS; TMAD ON; TDEL 50NS
--	--

HP-IB Program Codes

Command Level	Description	Code (1)
Subsystem (SUBS) Codes	Display	DISP DISPLAY
	Measure	MEAS MEASURE

Command Level	Description	Code (1)
Function (FNA) Codes (under subsystem DISP)	Delta Time On/Off	TMAD
	Time Marker On/Off	TMAR
	All Markers Off	MOFF
Function (FNA) Codes (under subsystem MEAS)	Delta Time Value	TDEL
	Time Marker Center	TMAC
	Delta Time On/Off	TMAD
	Time Marker Value	TMAV

(1) If multiple codes appear in this column, the first one listed is the preferred code. Others are given to be compatible with HPOI. (Hewlett-Packard Oscilloscope Language).

Parameter	Program Code (SUBS: FNA FNB)
delta time marker on	DISP:TMAD ON MEAS:TMAD ON
delta time marker off	DISP:TMAD OFF MEAS:TMAD OFF
time marker on	DISP:TMAR ON
time marker off	DISP:TMAR OFF
all markers off	DISP:MOFF
set delta time value	MEAS:TDEL -20E-3 to 20E-3(1)
move time marker to center	MEAS:TMAC
set time marker value	MEAS:TMAV 0.0 to 20E-3(2)

(1) "-20E-3 to 20E-3" should be replaced with a number that represents the time distance the time marker is away from the anchor marker.

(2) "0.0 to 20E-3" should be replaced with a number that represents the placement of the time marker on the time axis.

Indications

When the TIME MKR key is pressed, the time marker menu appears on the screen with the TIME MARKER VALUE softkey highlighted (brighter). In addition, the TIME MARKER ON/OFF function will always be ON and the time marker will appear on the screen. The words "T-MKR=XXX" will appear in the UIA and PDA with XXX being the current value of the time marker. As the value of the time marker is being changed via the step up/step down keys or knob, the marker will move and the value will change in the UIA and PDA. If TIME MARKER ON/OFF is set to OFF, the time marker and associated text will disappear but the menu will remain.

When the delta time function is set to ON, the anchor marker will be dropped. The words " $\Delta T=XXX$ " appear in the UIA and PDA with XXX being the time difference between the anchor marker and delta time marker. In this case, both markers are the same so the value will be 0 ps. As the delta time marker is being changed via either the step up/step down keys or knob, the delta time marker will move and the value will change in the UIA and PDA. The anchor marker will never move when this function is being used.

If the ALL MKR OFF softkey is pressed, all displayed markers and associated text will disappear.

Comments

The actual position of the time marker on the screen will be affected by any delay that has been added.

If the delta time function is being used and is then turned OFF, the delta value will be set to zero when the function is reactivated.

The TDEL function code automatically turns the delta time marker on (anchors the marker) if it is not already on.

The TMAD function code is structured under both the DISP and MEAS subsystems. This is for convenience and either DISP:TMAD or MEAS:TMAD can be used interchangeably.

Related Sections

Constellation Display
Delay Selection
Measurement Functions Vector Display

Trigger Setup

Description

To set the triggering of the selected display, it is usually necessary to select the triggering source, slope, trigger level, and coupling for internal trigger levels. The choices for triggering source are EXT, INT I, INT Q, and LINE. These choices are described briefly below:

EXT - This trigger choice enables a signal at the EXT TRIG input to trigger the display. The signal must be at least 100 mV p-p from DC to 80 MHz or 200 mV p-p from 80 MHz to 150 MHz with a pulse width greater than 3 ns.

INT I - This trigger choice enables the I input signal (at the INPUT I input) or the I signal at the output of the internal demodulator to also function as the display trigger source. The signal at the INPUT I input must be at least 2 divisions p-p from DC to 80 MHz or 3 divisions p-p from 80 MHz to 150 MHz with a pulse width greater than 3 ns.

INT Q - This trigger choice enables the Q input signal (at the INPUT Q input) or the Q signal at the output of the internal demodulator to also function as the display trigger source. The signal at the INPUT Q input must be at least 2 divisions p-p from DC to 80 MHz or 3 divisions p-p from 80 MHz to 150 MHz with a pulse width greater than 3 ns.

LINE - This trigger choice selects an internally generated signal as the trigger signal. This signal is synchronized to the 60 Hz power line.

Procedure

To set up the triggering for the display selected, select the triggering source first and then the level, slope, and coupling. Use the following procedures to do so:

Selecting Trigger Source

1. Press the TRIG SOURCE key. This will activate the trigger source menu on the display.
2. Press the menu key-either EXT, INT I, INT Q, or LINE-that is adjacent to the on-screen text that identifies the triggering source desired.

Selecting External Trigger Level

1. Press the TRIG LEVEL key. When the TRIG LEVEL key is pressed, the external trigger level menu is automatically activated if the EXT trigger source has been selected.

2. Press the menu key-either AUTO, TTL, ECL, or VAR-that is adjacent to the on-screen text that identifies the trigger level desired. The trigger level choices are briefly described below:

AUTO - Sets a trigger threshold that is midway between the positive and negative extremes of the signal.

TTL - Sets a TTL external trigger threshold of +1.3 volts.

ECL - Sets an ECL external trigger threshold of -1.3 volts.

VAR - Sets a condition under which the user can select a level as the trigger threshold for the external trigger input signal.

- 2a. If VAR has been selected, use either a function-data-units entry or the step up/step down keys or knob to set the desired trigger level. The VAR function parameters are as follows:

Range	-5V to +5V
Knob Resolution	0.04V
Step Up/Down Resolution	0.2V

Selecting Internal I or Internal Q Trigger Level

1. Press the TRIG LEVEL key. When the TRIG LEVEL key is pressed, the internal trigger level menu is automatically activated if the INT I or INT Q trigger sources have been selected.
2. Use either a function-data-units entry or the step up/ step down keys or knob to set the desired trigger level. The VARIABLE function parameters are as follows; note that the function parameters differ depending upon whether the instrument is in DEMOD mode or IQ mode.

Function Parameters - IQ Mode

Range	-5V to +5V
Knob Resolution	1% of full scale
Step Up/Down Resolution	5% of full scale

Function Parameters - DEMOD Mode

Range	-100% to 100%
Knob Resolution	0.1%
Step Up/Down Resolution	5%

Selecting Trigger Slope

Check the text (SLOPE +/-) that is adjacent to the menu softkey. Either the "+" or "-" will be highlighted. If the desired slope is highlighted, do not press the softkey. If the opposite slope is highlighted, press the softkey to toggle the selection.

Selecting Internal Trigger Signal Coupling

Selection of the trigger signal coupling is necessary only if an INT I or INT Q source has been selected.

Check the text (COUPLING AC/DC) that is adjacent to the menu softkey. Either "AC" or "DC" will be highlighted. If the desired coupling mode is highlighted, do not press the softkey. If the opposite coupling mode is highlighted, press the softkey to toggle the selection.

Example

The user wants to trigger the instrument with an external trigger signal. Triggering will be on the positive slope at a level of -100 mv. Assume that the slope is currently set to negative:

LOCAL (key- strokes)	TRIG SOURCE <input type="checkbox"/> EXT <input type="checkbox"/> <input type="checkbox"/> TRIG LEVEL <input type="checkbox"/> VAR <input type="checkbox"/> <input type="checkbox"/> - <input type="checkbox"/> 1 <input type="checkbox"/> 0 <input type="checkbox"/> 0 CHG SIGN <input type="checkbox"/> mv <input type="checkbox"/> <input type="checkbox"/> SLOPE +/- <input type="checkbox"/> <input type="checkbox"/>
 (Program Codes)	TRIG:SOUR EXT; LEV -.1; SLOP POS

HP-IB Program Codes

Command Level	Description	Code (1)
Subsystem (SUBS) Codes	Trigger	TRIG TRIGGER
Function (FNA) Codes	Demodulation Source	DEM SOUR SOURCE SRC

Command Level	Description	Code (1)
Function (FNA) Codes (cont'd)	Level Slope Coupling	LEV SLOP SLOPE COUP COUPLING

(1) If multiple codes appear in this column, the first one listed is the preferred code. Others are given to be compatible with HPOL. (Hewlett-Packard Oscilloscope Language).

Parameter	Program Code (SUBS: FNA FNB)
external trigger source	TRIG:SOUR EXT TRIG:SOUR EXT1 TRIG:SOUR EXTERNAL1
I internal trigger source	TRIG:SOUR CHANI TRIG:SOUR CH1 TRIG:SOUR CHANI TRIG:SOUR CHANNEL1 TRIG:SOUR INTI
Q internal trigger source	TRIG:SOUR CHANQ TRIG:SOUR CH2 TRIG:SOUR CHAN2 TRIG:SOUR CHANNEL2 TRIG:SOUR INTQ
line trigger source	TRIG:SOUR LINE TRIG:SOUR LIN
auto trigger level	TRIG:LEV AUTO
TTL trigger level	TRIG:LEV TTL
ECL trigger level	TRIG:LEV ECL
variable external trigger level	TRIG:LEV -5.0 to 5.0 (1)
variable internal trigger level	TRIG:LEV rng (2)
positive trigger slope	TRIG:SLOP POS TRIG:SLOP POSITIVE TRIG:SLOP 1

Parameter	Program Code (SUBS: FNA FNB)
negative trigger slope	TRIG:SLOP NEG TRIG:SLOP NEGATIVE TRIG:SLOP 0
AC trigger coupling	TRIG:COUP AC
DC trigger coupling	TRIG:COUP DC

(1) "-5.0 to 5.0" should be replaced with the selected variable trigger level in volts between -5V and +5V.

(2) "rng" should be replaced with the selected variable trigger level. The voltage level in volts must be within the range of the present display.

Indications

When the TRIG SOURCE key is pressed, the trigger source menu will appear on the screen. One of the four trigger source choices will be highlighted (brighter). When another trigger source softkey is pressed, the adjacent text for that key will become highlighted. The analog signal will change in accordance with the new trigger source selection.

When the TRIG LEVEL key is pressed, the appropriate trigger level menu will be activated for the type of trigger source selected.

When the TRIG LEVEL menu is displayed for an EXTERNAL trigger source, one of four choices for the trigger level, either AUTO, TTL, ECL, or VAR will be highlighted. If AUTO, TTL, or ECL is highlighted, nothing will appear in the User Interface Area (UIA). If VAR is selected, the words "EXT TRIG= XXX" will appear in the UIA with XXX being the previously selected external trigger level. As the value is being changed via either the step up/down keys or knob, it will be seen changing in the UIA. The analog signal will shift or disappear if the instrument can no longer trigger as a result of the change.

When the TRIG LEVEL menu is displayed for INT I or INT Q trigger source, the VARIABLE key will be highlighted. The words "INT TRIG X= XXX" will appear in the UIA with X being the channel (I or Q) and XXX being the previously selected internal trigger level. As the value is being changed via either the step up/down keys or knob, it will be seen changing in the UIA. The analog signal will shift or disappear if the instrument can no longer trigger as a result of the change.

When the SLOPE softkey in either the internal or external trigger source menu is pressed, the analog signal might invert as it triggers on the opposite slope.

Comments

AUTO trigger in the external trigger level menu is not specified for signal rates less than 100 kHz.

The triggering source must be selected before the level, slope, or coupling can be set. This is because the LEVEL key menu is dependent upon the type of trigger source selected.

The GATE CONFIG softkey in the SOURCE menu is not used when selecting trigger source.

The LEVEL key is not functional when the LINE trigger source has been selected.

When in internal DEMOD mode, it is recommended to use external triggering. Otherwise, setting trigger level might not give the desired results due to phase and quadrature adjustments on the displayed signal.

Related Sections

Sweep Selection

Vector Display

Description

Pressing the "VECTOR" key sets up a type of display in which the analog signal displayed is the Q signal displayed versus the I signal. Unlike a Constellation display which displays samples only at the time marker instant, a Vector display shows Q versus I over the entire time sweep period. The I samples are displayed with respect to the horizontal (X) axis and the Q samples are displayed with respect to the vertical (Y) axis.

Nine display formats are useable in the Vector display mode. These display formats include a standard 10 x 10 oscilloscope format and eight modulation-specific formats. The eight formats are QPSK, 9PRS, 16QAM, 25PRS, 49PRS, 64QAM, 81PRS, and 256QAM.

When the VECTOR display mode is selected, none of the parameters of the previous display are changed.

For more information on displays, see the DISPLAY, GENERAL Detailed Operating Instruction.

Procedure

Selecting the Vector Display Mode



To set the Vector Modulation Analyzer in the VECTOR display mode, press the front panel "VECTOR" key.

Selecting the Display Formats

1. Press the DEMOD key. This activates the demodulator menu on the display.
2. Press the MOD FORMAT softkey. This activates the second level "modulation format" menu on the display.
3. Press the softkey in the MOD FORMAT menu that corresponds to the desired display format. The menu choices are SCOPE FORMAT, QPSK, 9PRS, 16QAM, 64QAM, 256QAM, and MORE. If MORE is pressed, an additional menu will appear with the choices 25PRS, 49PRS, and 81PRS displayed.

Example

A Constellation display is currently on the screen but the user needs to view the transitions between the clock periods. A Vector display will show this.

LOCAL (key-strokes)	
 (Program Codes)	DISP:MODE VECTOR

HP-IB Program Codes

Command Level	Description	Code (1)
Subsystem (SUBS) Codes	Display	DISP DISPLAY
	Demodulation	DEM
Function (FNA) Codes (under subsystem DISP)	Display Mode	MODE
	Display Format	FORM

(1) If multiple codes appear in this column, the first one listed is the preferred code. Others are given to be compatible with HPOL (Hewlett-Packard Oscilloscope Language).

Parameter	Program Code (SUBS: FNA FNB)
select VECTOR display mode	DISP: MODE VECTOR
select 10 x 10 oscilloscope format	DEM: FORM NONE
select QPSK display format	DEM: FORM QPSK
select 9PRS display format	DEM: FORM PRS9
select 16QAM display format	DEM: FORM QAM16
select 25PRS display format	DEM: FORM PRS25
select 49PRS display format	DEM: FORM PRS49
select 64QAM display format	DEM: FORM QAM64
select 81PRS display format	DEM: FORM PRS81
select 256QAM display format	DEM: FORM QAM256

Indications

When the VECTOR key is pressed, all current menus, except for the "special display" and "3D display" menus, remain displayed and active. All data in the User Interface Area and Parameter Data Area remains displayed. The display mode changes to Vector with the display format set to whatever was selected in the DEMOD/MOD FORMAT menu. The words "VECTOR Q vs I" appear in the Display Identification area.

Comments

Pressing the VECTOR key activates the gain and offset menu if the 3D DISPLAY menu was active.

In a VECTOR display, the time marker is shown as a set of intensified dots corresponding to the constellation at the time marker instant if the time marker is ON.

Related Sections

Display, General
Time Marker Setup

4

PERFORMANCE TESTS

4-1. Introduction

The procedures in this section test the instrument's electrical performance using the specifications of Table 1-1 as the performance standards. All tests can be performed without access to the interior of the instrument.

Note



If the performance tests are to be considered valid, the following conditions must be met:

- a. The Vector Modulation Analyzer must have a 30-minute warmup.
 - b. The testing environment must be within 5°C of the temperature during internal self-calibration.
 - c. Total, elapsed powered up time from the last internal self-calibration must be no more than eight hours.
 - d. Operation from a 50Ω source with the Vector Modulation Analyzer configured for 50Ω impedance.
 - e. The peak-to-peak input signal must be within the full scale voltage limits.
-

4-2. Equipment Required

Equipment required for the performance tests is listed in Table 1-3, Recommended Test Equipment. Any equipment that satisfies the critical specifications given in the table may be substituted for the recommended model(s).

4-3. Performance Test Record

Results of the performance tests may be tabulated on Table 4-2 which is the Performance Test Record. The Performance Test Record located at the end of this section lists all of the tested specifications and their acceptable limits. The results recorded at incoming inspection can be used for comparison in periodic maintenance and troubleshooting and after repairs or adjustments.

4-4. Calibration Cycle

This instrument requires periodic verification of performance. Depending on the use and environmental conditions, the instrument should be checked using the performance tests at least once each year.

4-5. Abbreviated Performance Test

In most cases, it is not necessary to perform all of the tests in this section. Paragraph 4-7, Abbreviated Performance Test contains a condensed version of the performance tests found in this section. This test may be used for operation verification after a repair or to verify instrument operation without testing all of the specifications listed in Table 1-1. Results of the Abbreviated Performance Test can be recorded in Table 4-1, Abbreviated Performance Test Record.

The Abbreviated Performance Test can also be used for incoming inspection and preventive maintenance. It is not intended to be a complete check of specifications but will provide a high confidence that the instrument is meeting its major performance specifications. The test can be performed with less time and equipment than the full performance tests.

If any part of the Abbreviated Performance Test fails, the performance test relating to the failed measurement should be performed to verify whether the instrument is within specification. This is required since the Abbreviated Performance Test makes assumptions about the accuracy of the testing equipment in order to simplify the tests.

4-6. Performance Test Procedures

The full performance test procedures begin with paragraph 4-8. Paragraph 4-7, Abbreviated Performance Test, is not part of the full performance test procedure. The results of the full performance test procedures can be recorded in Table 4-2, Performance Test Record.

It is assumed that the person performing the following tests understands how to operate the specified test equipment. Equipment settings, other than those for the Vector Modulation Analyzer, are stated in general terms. For example, a test might require that a spectrum analyzer's resolution bandwidth be set to 100 Hz; however, the sweep time would not be specified and the operator would set that control so that the analyzer operates correctly.

It is also assumed that the person performing the tests will supply whatever cables, connectors, and adapters are necessary.

4-7. Abbreviated Performance Test

Turn-on Check

This check will verify that the instrument power-up sequence and preset state is correct. A self-calibration is performed which checks the majority of the circuitry for proper function.

Procedure

1. Set the LINE switch to OFF. Remove all external cables from the front and rear panels of the Vector Modulation Analyzer, including the main power cable.
2. Check that the Vector Modulation Analyzer is set for the correct line voltage by observing the line voltage selection card. This card is visible beneath the fuse on the rear panel. The operating voltage for which the instrument is set will be visible without removing the card.

If the line voltage setting is not correct, refer to Section 2 to set the correct voltage.

3. Connect the main power cable to the Vector Modulation Analyzer and set the LINE switch to the ON position.
4. Observe the display on the front panel of the Vector Modulation Analyzer. The message RUNNING POWER-UP SELFTESTS will be displayed as the instrument checks internal circuitry required for minimal operation.

After a few minutes, the message POWER-UP SELFTEST PASSED should be displayed. If the power-up tests fail, the instrument requires service.

5. Press the PRESET key on the front panel to set the Vector Modulation Analyzer to a known state. The Vector Modulation Analyzer should be preset to the following conditions:

Preset Conditions

Preset Value/Setting	Press these keys/softkeys to view value/setting
DEMOM input mode	DEMOM
0 dBm full scale gain setting	GAIN & OFS, FULL SCALE
1 μ s/DIV timing	TIMING, TIME/DIV
AUTO sweep mode	TIMING
VECTOR display mode	
EXT trigger source	TRIG SOURCE
AUTO trigger level	TRIG LEVEL

- After at least a 30 minute warmup, press the CAL key on the Vector Modulation Analyzer. This will start a self-calibration. **DO NOT** press any keys or rotate the KNOB while a calibration is in progress or the self-calibration will abort. Once the calibration is complete, the message CAL COMPLETE or CAL COMPLETED should be displayed.

If the message CAL ABORTED is displayed when the self calibration is complete, the instrument may require service. Retry the calibration and note the message upon completion of the second self-calibration. If the message CAL ABORTED is displayed again, the instrument requires service.

I&Q Bandwidth and Timing Accuracy

The bandwidth of the I and Q inputs is measured by varying the frequency of an input signal and observing the change in the displayed amplitude while maintaining a constant input power level. A drop in the displayed signal of 70% is equal to a 3 dB change in the frequency response of the Vector Modulation Analyzer. This test depends upon the flatness of the RF source to maintain the RF input at a constant level.

Delta timing accuracy is measured by making a period measurement with the delta time marker on a signal with a known (and accurate) frequency. I vs Q timing accuracy measures the differential delay between the I and Q signals displayed on the Vector Modulation Analyzer.

Equipment

Power Splitter HP 11667A
 Signal Generator HP 8340B

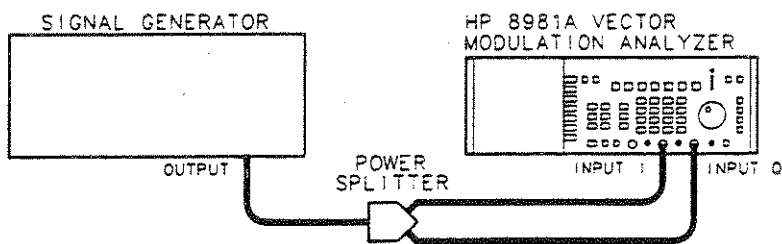

Figure 4-1. Bandwidth and Timing Accuracy Test Setup

Procedure

1. Connect the equipment as shown in Figure 4-1.
2. Set the Vector Modulation Analyzer to the following settings:

Setting	Press these keys/softkeys
Preset	PRESET
Input Mode	DEMOM, MODE IQ/DEMOM to IQ
I&Q channel gain	GAIN & OFS, VOLT/DIV I&Q, 25 mV/div
I channel coupling	INPUT COUPLING, I DC
Q channel coupling	INPUT COUPLING, Q DC
Display mode	I&Q versus time
Sweep mode	TIMING, FREE RUN

3. Press the I marker key and then the I MARKER VALUE softkey. Enter -87.5 mV and then press the DELTA I ON/OFF softkey to ON and enter 175 mV. Doing this sets the markers to the -3 dB limits.
4. Press the Q marker key and then the Q MARKER VALUE softkey. Enter -87.5 mV and then press the DELTA Q ON/OFF softkey to ON and enter 175 mV.
5. Turn the signal generator RF Output on and set the level to -2 dBm.
6. Set the signal generator to 10 MHz and adjust the output level until each of the displayed signals spans 5 divisions vertically.

Note



The signals displayed will appear as noise with definite positive and negative limits.

7. Tune the signal generator from 10 MHz to 350 MHz. The peaks of the displayed signal should not fall below the limits represented by the markers. Check (✓) the space below and in Table 4-1 if the Vector Modulation Analyzer passes this test.

_____ (✓) (I Channel Bandwidth >350 MHz)
 _____ (✓) (Q Channel Bandwidth >350 MHz)

8. Set the Vector Modulation Analyzer to the following settings:

Setting	Press these keys/softkeys
Display mode	I versus time
Trigger Source	TRIG SOURCE, INT I
Trigger Level	TRIG LEVEL, VARIABLE, 0V
Timebase	TIMING, TIME/DIV, 4 ns/DIV
I&Q channel delay	TIMING, DELAY I&Q, 400 ns
Sweep Mode	TIMING, TRIG'D SWEEP
Holdoff dither	INST STA, OTHER_HOLDFF DITHR OFF

9. Reset the signal generator to 125 MHz.

10. If necessary, adjust the Vector Modulation Analyzer trigger level slightly so that either the rising or falling edge of the input signal crosses zero within the first division.
11. Activate the time marker by pressing the TIME MKR key and then the TIME MARKER VALUE softkey. Find the first zero volt crossing of the signal. This is accomplished by moving the time marker with the Knob until the highlighted point on the trace is at the first zero crossing.
12. Press the DELTA TIME ON/OFF softkey so that the ON is highlighted ON is highlighted (brighter). If the DELTA TIME ON/OFF softkey is already set to ON, press it once to OFF and then back to ON. Use the Knob to move the delta time marker to the next zero crossing (one full cycle away). Record the delta time reading directly from the display (approximately 8 ns).

_____ ns (delta time 1)

13. Press the DELTA TIME ON/OFF softkey to OFF and then back to ON to reposition the time marker. Use the Knob to move the delta time marker to the next zero crossing (one cycle away). Record the delta time reading directly from the screen.

_____ ns (delta time 2)

14. Repeat step 9 to obtain a total of four readings.

_____ ns (delta time 3)
 _____ ns (delta time 4)

15. Out of the four readings, record the worst-case reading below and in Table 4-1. It should be between 7.96 and 8.24 ns. This range represents ± 3 Delta Time Accuracy.

Note



The "worst-case" reading is the reading furthest from the actual signal period of 8 ns.

_____ ns (Delta Time Accuracy - 125 MHz)

16. Set the signal generator to 50 MHz at an output level of -10.0 dBm (200 mV peak-to-peak).

17. Set the Vector Modulation Analyzer to the following settings:

Setting	Press these keys/softkeys
Preset	PRESET
Input Mode	DEMODO, MODE IQ/DEMODO to IQ
I&Q channel gain	GAIN & OFS, VOLT/DIV I&Q, 20 mV/div
Display mode	VECTOR
Trigger source	TRIG SOURCE, INT I
Trigger level	TRIG LEVEL, VARIABLE, 0V
Time base	TIMING, TIME/DIV, 2 ns/div
I&Q channel delay	TIMING, DELAY I&Q, 200 ns
Sweep Mode	TIMING, TRIG'D SWEEP
Holdoff dither	INST STA, OTHER, HOLDOFF DITHR OFF

18. Press the TIMING key and then the DELAY I softkey. The display should be a diagonal trace from the lower-left corner to the upper-right corner of the display. It might be a straight line but it will more likely be oval-shaped.
19. Rotate the knob to increase the I delay. If the oval-shaped trace becomes wider at the center, go to the next step. If it becomes narrower, increase I delay until the trace becomes a straight line and skip the next step.
20. Return I delay to 0 ns and press the DELAY Q softkey. Increase Q delay until the trace becomes a straight line.
21. The amount of delay necessary to align the signals is the I versus Q Timing Accuracy. Record the delay (indicated by the display) below and in Table 4-1. It should be less than 0.5 ns.

_____ ns (I versus Q Timing Accuracy - 50 MHz)

DC Vector and Differential Accuracy

Differential accuracy is measured by verifying that the I channel voltage measures the same voltage change as the Q channel when the input voltage change for each channel is exactly the same.

DC vector accuracy is measured by comparing the average dc level reading indicated by the Vector Modulation Analyzer with an external voltmeter measurement.

Equipment

Digital Voltmeter	HP 3456A
Function Generator.....	HP 8116A
Power Splitter	HP 11667A

Note



The power splitter resistance must be within $\pm 0.1\%$ of 50Ω for both signal paths.

Procedure

1. Connect the equipment as shown in Figure 4-2:

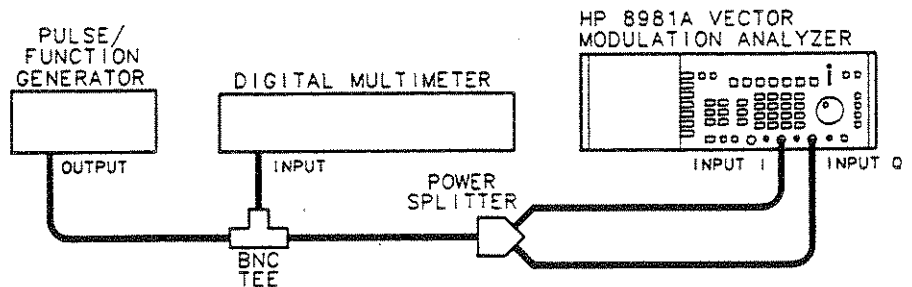

Figure 4-2.DC Vector/Differential Accuracy Test Setup

2. Set the function generator for a +100 mVdc output by disabling all waveforms and using the function generator offset controls to establish a DC voltage.

Note



The function generator frequency should be set to less than 10 Hz to avoid a residual signal at the function generator output.

- Set the Vector Modulation Analyzer to the following settings:

Setting	Press these keys/softkeys
Preset	PRESET
Input Mode	DEMOM, MODE IQ/DEMOM to IQ
I&Q channel gain	GAIN & OFS, VOLT/DIV I&Q, 10 mV/div
I channel offset	GAIN & OFS, OFFSET I, 20 mV
Q channel offset	GAIN & OFS, OFFSET Q, 20 mV
Display mode	VECTOR

- Set the digital voltmeter to read DC volts.
- Divide the digital voltmeter (DVM) reading by 2 to account for the 6 dB power splitter loss. Record the result below.

_____ mV (DVM reading/2)
- Set the Vector Modulation Analyzer for single I-Q measurements by pressing the MEAS key and then the SINGLE I-Q softkey.
- Disconnect the digital voltmeter from the test setup to avoid voltmeter sampling noise from affecting the measurement.
- Press the SINGLE I-Q softkey 10 times, recording the I and Q measurements each time on a separate piece of paper.
- Reconnect the digital voltmeter.
- Average the 10 readings for each channel. Record the averaged readings below for use in calculating the differential accuracy.

_____ mVdc (Channel I averaged positive reading)
 _____ mVdc (Channel Q averaged positive reading)

11. Subtract the averaged readings for each channel from the DVM reference recorded in step 5. The results should be 0.0 ± 2 mV. Record the results below and in Table 4-1.

_____ mV (Channel I dc Vector Accuracy, 20 mV offset)
 _____ mV (Channel Q dc Vector Accuracy, 20 mV offset)

12. Change the Vector Modulation Analyzer's I channel offset and Q channel offset to -20 mV.
13. Set the function generator for a -100 mVdc output.
14. Divide the DVM reading by 2 and record the result.

_____ mV (DVM reading/2)

15. Press the MEAS key on the Vector Modulation Analyzer to activate the measurement functions.
16. Disconnect the digital voltmeter from the test setup to avoid voltmeter sampling noise from affecting the measurement.
17. Press the SINGLE I-Q softkey 10 times, recording the I and Q measurements each time on a separate piece of paper.
18. Average the 10 readings for each channel and record the averaged readings for use in calculating the differential accuracy.

_____ mVdc (Channel I averaged negative reading)
 _____ mVdc (Channel Q averaged negative reading)

19. Reconnect the digital voltmeter.
20. Subtract the readings recorded in step 18 from the DVM reference recorded in step 14. Record the results below and in Table 4-1. The results should be 0.0 ± 2 mV.

_____ mV (Channel I dc Vector Accuracy, -20 mV offset)
 _____ mV (Channel Q dc Vector Accuracy, -20 mV offset)

21. Subtract the Channel I averaged negative reading (step 18) from the Channel I averaged positive reading (step 10) and record the result below.

_____ mV (delta I)

22. Subtract the Channel Q averaged negative reading (step 18) from the Channel Q averaged positive reading (step 10) and record the result below.

_____ mV (delta Q)

23. Calculate the I vs Q Differential Voltage Accuracy using the formula given below. Record the results below and in Table 4-1.

$$\text{Accuracy} = [1 - (\Delta I / \Delta Q)] * 100\%$$

_____ % (I versus Q Differential Voltage Accuracy)

RF Input

The frequency range and full scale input range are tested by splitting an RF signal (50 to 200 MHz) into two signals. One signal is applied to the RF IN connector of the Vector Modulation Analyzer and a power meter to maintain a constant RF level. The other signal is applied to the COHERENT CARRIER input as the phase reference. Since the path length of the RF IN and COHERENT CARRIER signal is different, a phase shift will be introduced as the signal generator is tuned. The nominal displayed phase is zero degrees and the amplitude is proportional to the RF input signal level.

The RF source is tuned from 50 to 200 MHz and the demodulated signal is checked to ensure that the amplitude of the demodulated signal does not drop by more than 3 dB over the full frequency range. A power meter and additional power splitter are used to keep the RF signal at a constant level.

Full scale input range is tested by performing the frequency range test at the most sensitive full scale setting (-20 dBm). The least sensitive full scale setting (-5 dBm) is indirectly tested by the following tests.

Equipment

Power Meter.....	HP 436A
Power Sensor	HP 8482A
Power Splitter (two required).....	HP 11667A
Signal Generator.....	HP 8340B

Procedure

1. Connect the equipment as shown in Figure 4-3. Since a difference in path length will introduce phase and amplitude errors, the cables connected to the RF IN connector and power sensor should be of the same type (BNC or type N) and be within a few centimeters of the same length.

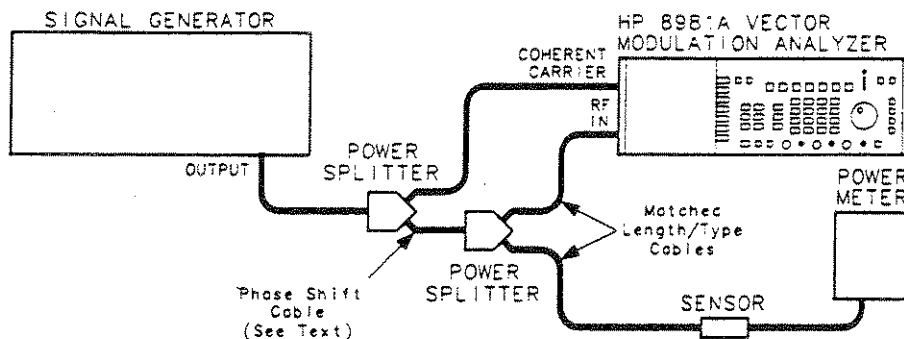

Figure 4-3. RF INPUT Test Setup

Note

For the most thorough test, the phase between the signals at the COHERENT CARRIER and RF IN connectors should be maintained at a 45° phase angle. This will provide equal magnitude I and Q components so that both channels (I and Q) of the internal demodulator are tested. A signal generator such as the HP 8780A can be used to provide a coherent carrier for the Vector Modulation Analyzer COHERENT CARRIER input and an RF signal for the second power splitter. The phase between the coherent carrier and RF output of the HP 8780A can be directly controlled using the TWO STATE modulation format and adjusting the phase of the output signal from the front panel.

In this simplified test, both channels will be tested by allowing the phase to change with the testing frequency. This is indicated by a rotation (phase change) of the displayed dot. The cabling used in this setup will determine how much phase variation will occur as the test frequency is changed.

Connecting the two power splitters together directly will give the least phase variation but is typically sufficient. There should be at least three full revolutions of the dot over the test frequency range. If a sufficient phase change is not observed, a cable connected between the two power splitters can be used to introduce more phase shift.

2. Set the signal generator's RF output to off and zero the power meter.

3. Set the Vector Modulation Analyzer to the following settings:

Setting	Press these keys/softkeys
Instrument preset	PRESET
Preset corrections	DEMOM, CORRECTION, MANUAL CORRECTION, CLEAR CURR CORRECTIONS
Full scale setting	GAIN & OFS, FULL SCALE -20.0 dBm
Reference Frequency	DEMOM, REF FREQ 200 MHz
Magnitude Marker	MARKERS MGTD, MGTD MARKER -> FULL SCALE

4. Set the signal generator to 200 MHz at an output level of -8 dBm (RF output set to ON).
5. Adjust the signal generator RF output level for a power meter indication of -20.0 ± 0.1 dBm.
6. Set the Vector Modulation Analyzer reference level for gain correction to -20 dBm by entering the following key sequence:

DEMOM, CORRECTION, DEMOM GAIN CORRECTION, RF LEVEL, -20 dBm
7. Perform a gain correction by pressing the START GAIN CORRECTION softkey. Once the gain correction is complete, the displayed dot should be at full scale (on the magnitude marker). Check the space below and the appropriate entry in Table 4-1 if the full scale display can be obtained.

_____ (✓) -20 dBm full scale setting at 200 MHz
8. Set the Vector Modulation Analyzer reference frequency (DEMOM, REF FREQ) to 50 MHz.
9. Turn off corrections for the Vector Modulation Analyzer by pressing the DEMOM key followed by CORRECTION, CORRECTIONS ON/OFF (OFF should be highlighted).
10. Reset the signal generator to 50 MHz and adjust the output level until the power meter indicates -20.0 dBm. The power meter calibration factor should be set for a 50 MHz correction before adjusting the signal generator RF level.

11. Adjust the Vector Modulation Analyzer full scale setting (GAIN&OFS, FULL SCALE) and the magnitude marker (MARKERS MGTD, MGTD MARKER -> FULL SCALE) to place the displayed dot at full scale (on the full scale magnitude marker). The magnitude marker will have to be reset for full scale each time the full scale setting is changed.
12. Set the delta magnitude marker to 3 dB below full scale by pressing the MARKERS MGTD key followed by the DELTA MGTD, -3, and then dB keys.
13. Set the signal generator to 80 MHz and adjust the output level for -20.0 dBm (calibration factor set for 80 MHz correction).
14. Set the Vector Modulation Analyzer reference frequency (DEMODO, REF FREQ) for 80 MHz.

The dot displayed on the screen should be outside of the inner magnitude marker on the display. The outside marker indicates the full scale amplitude and the inner marker indicates 3 dB below the reference.

15. Repeat steps 13 and 14, tuning the signal generator from 110 to 200 MHz in 30 MHz steps. The displayed dot should remain outside the inner magnitude marker for each frequency.

_____ (✓) 50-200 MHz RF Input Frequency Range

Demodulated Bandwidth and Timing

The demodulated I and Q bandwidth is measured using the two RF signals offset in frequency to produce a fixed amplitude demodulated signal with changing phase. A signal generator at a fixed frequency and level is used to provide the reference input (COHERENT CARRIER). A second signal generator is used as a variable frequency source to provide the frequency offset.

Providing two signals at slightly different frequencies for the COHERENT CARRIER and RF IN inputs will produce a display at a fixed amplitude with changing phase (a circle in VECTOR display mode). Tuning the variable frequency generator to the reference frequency plus the specified bandwidth produces a circle with an amplitude that reflects the demodulated I and Q baseband bandwidth. The bandwidth is tested by verifying that the displayed amplitude does not change more than 3 dB for frequency offsets of 0 to the maximum specified baseband bandwidth.

Demodulated timing accuracy is measured by pulse modulating the RF input signal (at 45°) and measuring the differential delay between the displayed I and Q components.

Equipment

Pulse Generator..... HP 8116A
COHERENT CARRIER Signal Generator HP 8662A or HP 3335A
RF IN Signal Generator HP 8340B

Procedure

1. Connect the equipment as shown in Figure 4-4.

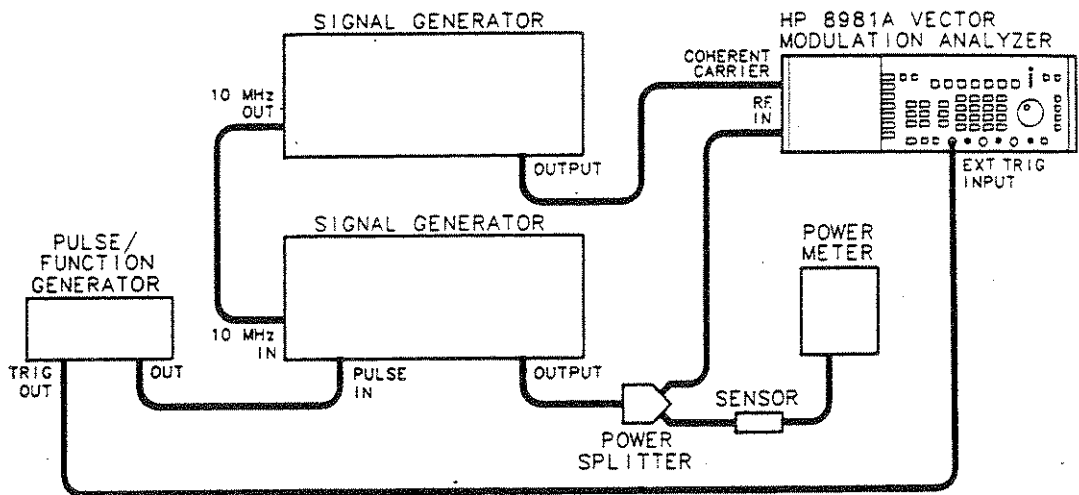

Figure 4-4. Demodulated Bandwidth/Timing Test Setup

Note



In the following procedure, the signal generator connected to the COHERENT CARRIER connector will be referred to as the COHERENT CARRIER signal generator. The signal generator connected to the power splitter will be referred to as the RF IN signal generator.

2. Set the Vector Modulation Analyzer to the following settings:

Setting	Press these keys/softkeys
Instrument preset	PRESET
Full scale setting	GAIN & OFS, FULL SCALE -5.0 dBm
Reference Frequency	DEMOD, REF FREQ 70 MHz
Timing	TIMING, TIME/DIV, 3 ns/DIV
Magnitude Marker	MARKERS MGTD, MGTD MARKER -> FULL SCALE
Delta Marker	MARKERS MGTD, DELTA MGTD, -3 dB

3. Set the COHERENT CARRIER signal generator to 70 MHz at an output level of +0 dBm.
4. Set the RF IN signal generator to 70 MHz at an output level of -5 dBm.
5. Adjust the RF IN signal generator output level until the displayed dot is on the full scale magnitude marker.

Note



The internal filter bandwidth specification is a supplemental specification. However, testing this specification is easier than testing the external filter demodulation bandwidth and will provide a good indication that the demodulation bandwidth is within specification.

The design of the Vector Modulation Analyzer will typically place the response at -3 dB for a 35 MHz signal. This should not be considered a failure for this test.

6. Slowly tune the RF IN signal generator from 70 MHz to 105 MHz and verify that the amplitude of the circle remains greater than the delta magnitude (inner) marker. Record the result below and in Table 4-1.

_____ (✓) Typical Internal Filter Bandwidth >35 MHz

7. Set the pulse generator for a 1 MHz square wave at an amplitude of 5 volts peak-to-peak. Set the dc offset to +2.5 Vdc to make the pulse TTL compatible.

8. Set the Vector Modulation Analyzer to the following settings:

Setting	Press these keys/softkeys
Preset	PRESET
Full scale setting	GAIN & OFS, FULL SCALE -5.0 dBm
Timing	TIMING, TIME/DIV 40 ns/DIV
Reference Frequency	DEMOD, REF FREQ 70 MHz
Magnitude Marker	MARKERS MGTD, MGTD MARKER -> FULL SCALE
Phase Marker	MARKERS PHASE, PHASE MARKER VALUE 45°

9. Set the RF IN signal generator to 70 MHz and activate pulse modulation. Adjust the RF output level until the displayed dot (RF on state) is on the full scale magnitude marker of the Vector Modulation Analyzer.
10. Set the frequency increment of the RF IN signal generator for 1 Hz.
11. Step the frequency of the RF IN (or COHERENT CARRIER) signal generator up by 1 Hz and then back to 70.000000 MHz. This should shift the position of the dot. Repeat the frequency step several times until the dot is displayed near the 45° phase marker.

Note



In the following steps, **DO NOT** adjust the delay on the Vector Modulation Analyzer for any reason. The specification only holds for delay settings of zero.

12. Set the Vector Modulation Analyzer display mode to I&Q and adjust the TIMING (TIME/DIV) to display the rising edge of the two pulses near the center of the display. *Do not set the TIME/DIV setting to anything less than 15 ns/DIV.*

The two displayed pulses should be equal in magnitude and the rising edge of each pulse should occur at nearly the same position on the display. If the amplitudes of the pulses are substantially different, switch to VECTOR display mode and use the procedure in the previous step to adjust the phase until the amplitudes are within one-quarter of a division of each other.

13. Calculate the demodulated timing accuracy specification for the current timebase settings and record the specification below.

The specification is calculated by multiplying the TIME/DIV setting by ten and then dividing the result by 100. This is equivalent to dividing the TIME/DIV setting by ten. If the result is less than 1.5 ns, the specification is equal to 1.5 ns.

_____ ns Calculated Maximum Accuracy Error

14. Set the Vector Modulation Analyzer to the following settings:

Setting	Press these keys/softkeys
I Channel Marker	MARKERS I, I MARKER VALUE 0%
Q Channel Marker	MARKERS Q, Q MARKER VALUE 0%
Time Marker	MARKERS TIME MKR, TIME MARKER VALUE 0 ns

15. Activate the I channel delta marker by pressing MARKERS I, DELTA I ON.
16. Adjust the delta marker until the marker is at the top of the displayed pulse (ignore overshoot and ringing).
17. Note the delta marker setting displayed on the Vector Modulation Analyzer. Using the numeric keypad, reset the delta marker to one-half of the displayed value (the 50% point on the rising edge). For example, if the delta marker setting is 57.2%, reset the delta marker to 28.6%.
18. Activate the Q channel delta marker by pressing MARKERS Q, DELTA Q ON.
19. Adjust the Q channel delta marker until the marker is at the top of the pulse displayed on the Q channel (ignore overshoot and ringing).
20. Note the Q channel delta marker setting displayed on the Vector Modulation Analyzer. Using the numeric keypad, reset the delta marker to one-half of the displayed value.
21. Activate the timing marker by pressing MARKERS TIME MKR and adjust the time marker so that it intersects the first delta marker (I or Q channel).

22. Activate the delta time marker (press DELTA TIME ON) and adjust the marker to intersect the other channel (I or Q) delta marker. The displayed delta time marker setting is the timing skew between the two channels.

Record the timing accuracy for 70 MHz below and in Table 4-1.

_____ ns Timing Accuracy
 _____ ns Calculated maximum accuracy error (Step 13)

Corrected DC Accuracy

The primary errors contributing to dc accuracy (quadrature, I/Q gain imbalance and offsets) are measured individually. These measurements are used as an indication of the demodulation accuracy of the Vector Modulation Analyzer.

Equipment

Power Meter	HP 436A
Power Sensor	HP 8482A
Power Splitter	HP 11667A
Coherent Carrier Signal Generator	HP 8662A
RF IN Signal Generator	HP 8340B

Procedure

1. Connect the equipment as shown in Figure 4-5.

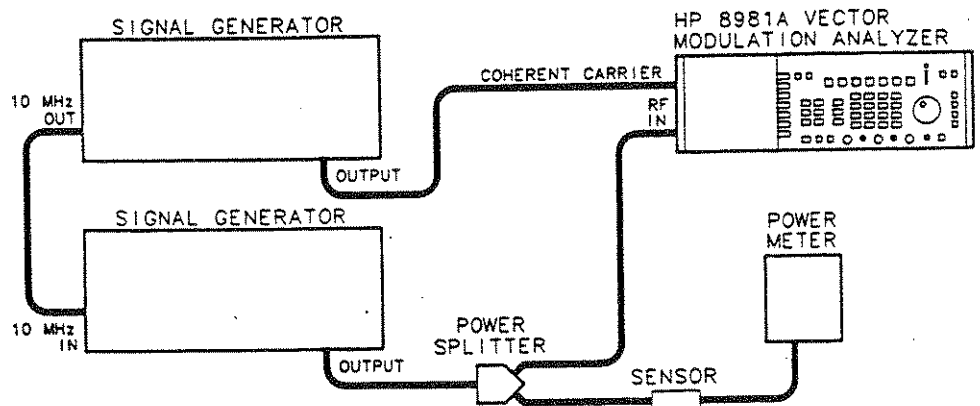

Figure 4-5. Corrected dc Accuracy Test Setup

Note

In the following procedure, the signal generator connected to the RF IN connector of the Vector Modulation Analyzer will be referred to as the RF IN signal Generator. The signal generator connected to the COHERENT CARRIER input will be referred to as the COHERENT CARRIER signal generator.

2. Set the COHERENT CARRIER signal generator to 70 MHz at an output level of 0 dBm.
3. Set the RF IN signal generator to 70.1 MHz (CW mode) at an output level of +1 dBm.

Note

In order to obtain the stability for making the following measurements, all instruments must have a warm up time of at least one hour.

4. Set the Vector Modulation Analyzer to the following settings:

Setting	Press these keys/softkeys
Instrument preset	PRESET
Full scale setting	GAIN & OFS, FULL SCALE -5.0 dBm
Reference Frequency	DEMOD, REF FREQ 70 MHz
Trigger	TRIG SOURCE, INT I
Magnitude Marker	MARKERS MGTD, MGTD MARKER -> FULL SCALE

5. Adjust the RF IN signal generator output level until the displayed circle on the Vector Modulation Analyzer is superimposed on the full scale magnitude marker.
6. Start the automatic correction procedure by pressing DEMOD, CORRECTION, QUAD IQ & OFFSET CORR, and then START TONE CORRECTION. The correction factors will be calculated by the Vector Modulation Analyzer. When the procedure is finished, the message "DEMOD CORRECTION COMPLETE" will be displayed.
7. Once the correction is complete, reset the RF IN signal generator output level for a power meter reading of -5.0 dBm \pm 0.1 dB.

8. Set the reference level for the Vector Modulation Analyzer gain correction for -5 dBm by pressing:

DEMOD, CORRECTION, DEMOD GAIN CORRECTION,
RF LEVEL -5 dBm

9. Start the gain correction procedure by pressing the START GAIN CORRECTION softkey. This will calibrate the Vector Modulation Analyzer to display the current amplitude as -5.0 dBm (full scale).

Once the procedure is complete, the message "GAIN CORRECTION COMPLETE" will be displayed. If any key is pressed before the message is displayed, the correction procedure will abort.

10. Set the display mode to I versus time by pressing the DISPLAY I key.
11. Adjust the timing (TIMING, TIME/DIV) to display exactly one cycle of the waveform displayed. Adjust the triggering as required to provide a stable display. Record the period of the waveform (10 times the TIME/DIV setting) for later use.

_____ μ s Signal Period (nominally 10 μ s)

12. Return the display mode to vector (Q vs I) by pressing the DISPLAY VECTOR key.
13. Activate the I channel differential delay by pressing the TIMING key followed by the DELAY I softkey.
14. Adjust the I delay until the displayed signal becomes a straight (diagonal) line. Record the differential delay setting required to make the signal a straight line.

_____ μ s I Delay

15. Set the I channel differential delay to 0 ns.
16. Activate the Q channel differential delay by pressing the TIMING key followed by the DELAY Q softkey.
17. Adjust the Q delay until the displayed signal becomes a straight (diagonal) line. Record the differential delay setting required to make the signal a straight line.

_____ μ s Q Delay

- 18. Calculate the phase between the I and Q channel signals using the following formulas. Record the resultant phase in below and in Table 4-1.

Phase/ μ s = $(360^\circ)/(\text{Signal Period})$
 Average Delay = $(\text{I Delay} + \text{Q Delay})/2$
 Phase Between I and Q = $(\text{Average Delay}) * (\text{Phase}/\mu\text{s})$

_____ Degrees Measured Phase Between I and Q ($90 \pm 1^\circ$)

For example, for a signal period of 10 μ s and a delay setting of 2.5 μ s (2.48 ns I Delay, 2.52 ns Q Delay) the calculated phase would be:

Phase between I and Q = $(2.5 \mu\text{s}) * (360^\circ / 10 \mu\text{s}) = 90^\circ$

- 19. Adjust the full scale setting (GAIN&OFS, FULL SCALE) to bring the displayed signal fully on screen. The edges of the signal must fall within the displayed grid.
- 20. Activate the I marker by pressing the MARKERS I key.
- 21. Using the KNOB, move the I marker to the leftmost (most negative I) part of the displayed signal.
- 22. Activate the delta marker (DELTA I ON) and set the delta marker to the rightmost (most positive I) part of the signal. Record the delta value indicated by the display (nominally 190%).

_____ %I (I Channel Magnitude)

- 23. Activate the Q marker by pressing the MARKERS Q key.
- 24. Using the KNOB, move the Q marker to the lowermost (most negative Q) part of the displayed signal.
- 25. Activate the delta marker (DELTA Q ON) and set the delta marker to the uppermost (most positive Q) part of the displayed signal. Record the delta value indicated by the display (nominally 190%).

_____ %Q (Q Channel Magnitude)

- 26. Calculate the I/Q gain imbalance using the following formula. The result should be 0 ± 0.25 dB. Record the result below and in Table 4-1.

I/Q Gain Imbalance = $20 * \log(\%I/\%Q)$

_____ dB (I/Q Gain Imbalance)

- 27. Turn the RF input signal off while leaving the coherent carrier signal active by entering the following key sequence:

DEMOM, MORE, RF ON/OFF to OFF

28. Activate the continuous measurement function to measure the I and Q components of the residual signal by pressing the MARKERS MEAS key followed by the CONTINUOUS I,Q key. Record the residual I and Q components below and in Table 4-1. Both offsets should be $0 \pm 1\%$.

_____ % Residual I dc Offset
_____ % Residual Q dc Offset

Hewlett-Packard Company
 Model HP 8981A
 Vector Modulation Analyzer

Tested By _____

Serial Number _____

Date _____

Table 4-1. Abbreviated Performance Test Record

Para No.	Test	Min. Result	Actual Result	Max. Result
4-7	BANDWIDTH AND TIMING ACCURACY I Channel Bandwidth >350 MHz Q Channel Bandwidth >350 MHz Delta Time Accuracy - 125 MHz I versus Q Timing Accuracy - 50 MHz	7.76 ns	_____ (✓) _____ (✓) _____ _____	8.24 ns 0.5 ns
4-7	DC VECTOR AND DIFFERENTIAL ACCURACY Vector Accuracy, 10 mV/div gain Channel I, 20 mV offset Channel Q, 20 mV offset Channel I, -20 mV offset Channel Q, -20 mV offset I Versus Q Differential Voltage Accuracy I versus Q Differential Voltage Accuracy	-2 mV -2 mV -2 mV -2 mV -1%	_____ _____ _____ _____ _____	2 mV 2 mV 2 mV 2 mV +1%
4-7	RF INPUT FULL SCALE INPUT 200 MHz -20 dBm full scale RF INPUT FREQUENCY RANGE 50 to 200 MHz		_____ (✓) _____ (✓)	

Table 4-1. Abbreviated Performance Test Record (Cont.)

Para No.	Test	Min. Result	Actual Result	Max. Result
4-7	DEMODULATED BANDWIDTH AND TIMING Internal Filter Bandwidth (>35 MHz) Timing Accuracy		_____ (✓) _____	_____ ns
4-7	CORRECTED DC ACCURACY Phase between I&Q (Quadrature) I/Q Gain Imbalance Residual I dc Offset Residual Q dc Offset	89.0° -0.25 dB -1% -1%	_____ _____ _____ _____	91.0° +0.25 dB +1% +1%

4-8. Bandwidth Test

Specification

Electrical Characteristics	Performance Limits	Conditions
Bandwidth (-3 dB) -DC coupled	DC to 350 MHz	
-AC coupled	approximately 1 kHz to 350 MHz	

Description

The bandwidth of the I and Q inputs is measured by varying the frequency of an input signal and observing the change in the displayed amplitude while maintaining a constant input power level. A drop in the displayed signal from 10 divisions to 7 divisions is equal to a 3 dB change in the signal level.

Equipment

Power Meter..... HP 436A
 Power Sensor HP 8482A
 Power Splitter HP 11667A
 Signal Generator..... HP 8340B

Procedure

1. Press the PRESET key and then the CAL key on the Vector Modulation Analyzer. Wait for the Calibration Complete message before continuing.

2. Connect the equipment as shown in Figure 4-6:

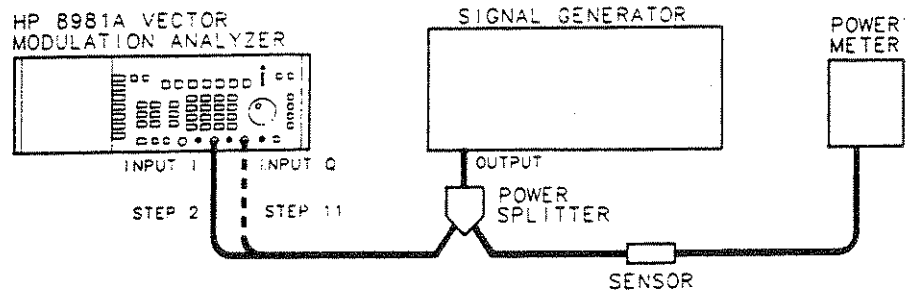

Figure 4-6. Bandwidth Test Setup

3. Set the signal generator's RF output to off and zero the power meter.
4. Set the Vector Modulation Analyzer to the following settings:

Setting	Press these keys/softkeys
Input Mode	DEMOM, MODE IQ/DEMOM to IQ
I&Q channel gain	GAIN & OFS, VOLT/DIV I&Q, 25 mV/div
I channel coupling	INPUT COUPLING, I DC
Q channel coupling	INPUT COUPLING, Q DC
Display mode	I versus time
Sweep mode	TIMING, FREE RUN

5. Press the I marker key and then the I MARKER VALUE softkey. Enter -87.5 mV and then press the DELTA I ON/OFF softkey to ON and enter 175 mV. Doing this sets the markers to the -3 dB limits.
6. Turn the signal generator RF Output on and set the level to -2 dBm.
7. Set the signal generator to 10 MHz and adjust the output level until the displayed signal spans 10 divisions vertically.

Note

The signal as displayed will appear as noise with definite positive and negative limits.

8. Record the power meter reading as the input power reference.

Input Reference Power Level _____ dBm.

9. Tune the signal generator from 10 MHz to 350 MHz. Readjust the signal generator output level as necessary to maintain a power meter reading equal to the level recorded in step 8. The peaks of the displayed signal should not fall below the limits represented by the markers.

Check (✓) the space below and the appropriate entry in Table 4-2 if the Vector Modulation Analyzer passes this test.

_____ (I Channel Bandwidth)

10. Press the Q marker key and then the Q MARKER VALUE softkey. Enter -87.5 mV and then press the DELTA Q ON/OFF softkey to ON and enter 175 mV. Doing this sets the markers to the -3 dB limits.
11. Change the Vector Modulation Analyzer display mode to Q versus time. Repeat steps 7 through 9 with the signal applied to the Q channel.

Check (✓) the space below and the appropriate entry in Table 4-2 if the Vector Modulation Analyzer passes this test.

_____ (Q Channel Bandwidth)

4-9. DC Vector Accuracy Test

Specification

Electrical Characteristics	Performance Limits	Conditions
DC Vector Accuracy	±1% of full scale (or 2 mV if greater) ±1% of offset	

Description

DC Vector Accuracy is measured by applying equal signals to both I and Q channels with the instrument set to IQ mode and comparing the Vector Modulation Analyzer's internal measurement with that of an external voltmeter.

Equipment

Digital Voltmeter HP 3456A
 Function Generator..... HP 8116A
 Power Splitter HP 11667A

Note



The power splitter resistance must be within ±0.1% of 50Ω for both signal paths.

Procedure

Vector Accuracy, 10 mV/div gain

1. Press the PRESET key and then the CAL key on the Vector Modulation Analyzer. Wait for the Calibration Complete message before continuing.

2. Connect the equipment as shown in Figure 4-7:

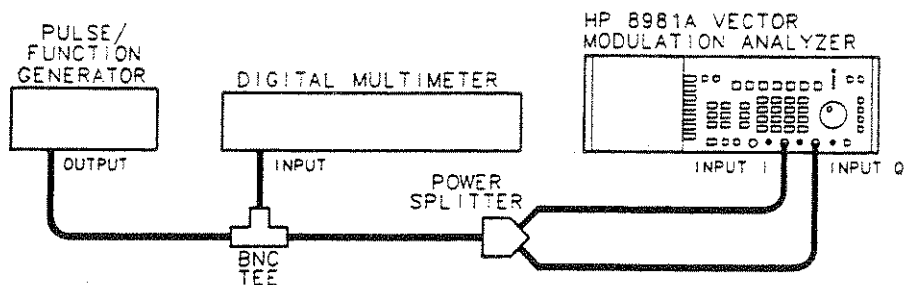

Figure 4-7. DC Vector Accuracy Test Setup

3. Set the function generator for a 100 mVdc output by disabling all waveforms and using the function generator offset controls to establish a DC voltage.

Note 

The function generator frequency should be set to less than 10 Hz to avoid a residual signal at the function generator output.

4. Set the Vector Modulation Analyzer to the following settings:

Setting	Press these keys/softkeys
Input Mode	DEMOM, MODE IQ/DEMOM to IQ
I&Q channel gain	GAIN & OFS, VOLT/DIV I&Q, 10 mV/div
I channel offset	GAIN & OFS, OFFSET I, 50 mV
Q channel offset	GAIN & OFS, OFFSET Q, 50 mV
Display mode	VECTOR

5. Set the digital voltmeter to read DC volts.
6. Divide the digital voltmeter (DVM) reading by 2 and record the result.

_____ mV (DVM reading/2)

7. Set the Vector Modulation Analyzer for single I-Q measurements by pressing the MEAS key and then the SINGLE I-Q softkey.
8. Disconnect the digital voltmeter from the test setup to avoid voltmeter sampling noise from affecting the measurement.
9. Press the SINGLE I-Q softkey 10 times, recording the I and Q measurements each time on a separate piece of paper.
10. Reconnect the digital voltmeter.
11. Average the 10 readings for each channel. Subtract the averaged readings from the DVM reference recorded in step 6.
12. Record the results from step 11 below and in Table 4-2. The results should be 0.0 ± 2 mV.

_____ mV (Channel I, 50 mV offset)
 _____ mV (Channel Q, 50 mV offset)

13. Change the Vector Modulation Analyzer's I channel offset and Q channel offset to -50 mV.
 14. Set the function generator for a -100 mVdc output.
 15. Divide the DVM reading by 2 and record the result.
- _____ mV (DVM reading/2)
16. Press the MEAS key on the Vector Modulation Analyzer to activate the measurement functions.
 17. Disconnect the digital voltmeter from the test setup to avoid voltmeter sampling noise from affecting the measurement.
 18. Press the SINGLE I-Q softkey 10 times, recording the I and Q measurements each time on a separate piece of paper.
 19. Average the 10 readings for each channel and subtract the averaged readings from the DVM reading recorded in step 15.
 20. Reconnect the digital voltmeter.
 21. Record the results from step 19 below and in Table 4-2. The results should be 0.0 ± 2 mV.

_____ mV (Channel I, -50 mV offset)
 _____ mV (Channel Q, -50 mV offset)

Vector Accuracy, 20 mV/div gain

- 22. Change the Vector Modulation Analyzer gain to 20 mV/div with 100 mV offsets.
- 23. Set the function generator for a 200 mVdc output.
- 24. Repeat steps 6 through 11. The results from step 11 should be 0.0 ± 3 mV. Record the results below and in Table 4-2.

_____ mV (Channel I, 100 mV offset)
 _____ mV (Channel Q, 100 mV offset)

- 25. Repeat steps 13 through 25 using an offset of -100 mV in step 13 and a function generator output level of -200 mVdc in step 14. The results from step 19 should be 0.0 ± 3 mV.

Record the results below and in Table 4-2.

_____ mV (Channel I, -100 mV offset)
 _____ mV (Channel Q, -100 mV offset)

Vector Accuracy, 40 mV/div gain

- 26. Change the Vector Modulation Analyzer gain to 40 mV/div with 200 mV offsets.
- 27. Set the function generator for a 400 mVdc output.
- 28. Repeat steps 6 through 11. The results from step 11 should be 0.0 ± 6 mV. Record the results below and in Table 4-2.

_____ mV (Channel I, 200 mV offset)
 _____ mV (Channel Q, 200 mV offset)

- 29. Repeat steps 13 through 20 using an offset of -200 mV in step 13 and a function generator output level of -400 mVdc in step 14. The results from step 19 should be 0.0 ± 6 mV.

Record the results below and in Table 4-2.

_____ mV (Channel I, -200 mV offset)
 _____ mV (Channel Q, -200 mV offset)

Vector Accuracy, 100 mV/div gain

- 30. Change the Vector Modulation Analyzer gain to 100 mV/div with 500 mV offsets.
- 31. Set the function generator for a 1 Vdc output.
- 32. Repeat steps 6 through 11. The results from step 11 should be 0.0 ± 15 mV. Record the results below and in Table 4-2.

_____ mV (Channel I, 500 mV offset)
 _____ mV (Channel Q, 500 mV offset)

- 33. Repeat steps 13 through 20 using an offset of -500 mV in step 13 and a function generator output level of -1Vdc in step 14. The results from step 19 should be 0.0 ± 15 mV.

Record the results below and in Table 4-2.

_____ mV (Channel I, -500 mV offset)
 _____ mV (Channel Q, -500 mV offset)

Vector Accuracy, 200 mV/div gain

- 34. Change the Vector Modulation Analyzer gain to 200 mV/div with 1V offsets.
- 35. Set the function generator for a 2 Vdc output.
- 36. Repeat steps 6 through 11. The results from step 11 should be 0.0 ± 30 mV. Record the results below and in Table 4-2.

_____ mV (Channel I, 1.000V offset)
 _____ mV (Channel Q, 1.000V offset)

- 37. Repeat steps 13 through 20 using an offset of -1 V in step 13 and a function generator output of -2 Vdc in step 14. The results from step 19 should be 0.0 ± 30 mV.

Record the results below and in Table 4-2.

_____ mV (Channel I, -1.000V offset)
 _____ mV (Channel Q, -1.000V offset)

Vector Accuracy, 400 mV/div gain

38. Change the Vector Modulation Analyzer gain to 400 mV/div with 2V offsets.
39. Set the function generator for a 4 Vdc output.
40. Repeat steps 6 through 11. The results from step 11 should be 0.0 ± 60 mV. Record the results below and in Table 4-2.

_____ mV (Channel I, 2.000V offset)
 _____ mV (Channel Q, 2.000V offset)

41. Repeat steps 13 through 20 using an offset of -2 V in step 13 and a function generator output level of -4 Vdc in step 14. The results from step 19 should be 0.0 ± 60 mV.

Record the results below and in Table 4-2.

_____ mV (Channel I, -2.000V offset)
 _____ mV (Channel Q, -2.000V offset)

Vector Accuracy, 1V/div gain

42. Change the Vector Modulation Analyzer gain to 1V/div with 2.5V offsets.
43. Set the function generator for a 5 Vdc output.

Note

The dot will not be at the center of the screen as was the case in the previous steps due to the output voltage limitation of the function generator.

44. Repeat steps 6 through 11. The results from step 11 should be 0.0 ± 125 mV. Record the results below and in Table 4-2.

_____ mV (Channel I, 2.500V offset)
 _____ mV (Channel Q, 2.500V offset)

45. Repeat steps 13 through 20 using an offset of -2.5 V in step 13 and a function generator output level of -5 Vdc in step 14. The results from step 19 should be 0.0 ± 125 mV.

Record the results below and in Table 4-2.

_____ mV (Channel I, -2.500V offset)
 _____ mV (Channel Q, -2.500V offset)

4-10. I Versus Q Differential Voltage Accuracy Test

Specification

Electrical Characteristics	Performance Limits	Conditions
I versus Q Differential Voltage Accuracy	±1%	Measured at 100 mV full scale deflection; typical at all ranges

Description

The test checks the ratio of the measured change in I channel to Q channel for the same input on both channels. The instrument is in IQ mode for this test.

Equipment

Function Generator..... HP 8116A
Power Splitter HP 11667A

Note



The power splitter resistance must be within ±0.1% of 50Ω for both signal paths.

Procedure

1. Press the PRESET key and then the CAL key on the Vector Modulation Analyzer. Wait for the Calibration Complete message before continuing.

2. Connect the equipment as shown in Figure 4-8:

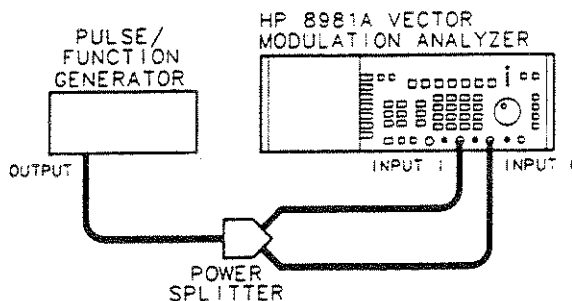

Figure 4-8. I vs Q Differential Accuracy Test Setup

3. Set the function generator for a frequency of <10 Hz and an 80 mVdc output. This is done by disabling all waveforms and then using the function generator offset controls to establish a DC voltage.
4. Set the Vector Modulation Analyzer to the following settings:

Setting	Press these keys/softkeys
Input Mode	DEMOM, MODE IQ/DEMOM to IQ
I&Q channel gain	GAIN & OFS, VOLT/DIV I&Q, 10 mV/div
Display mode	VECTOR

5. Set the Vector Modulation Analyzer for single I-Q measurements by pressing the MEAS key and then the SINGLE I-Q softkey.
6. Press the SINGLE I-Q softkey 10 times, recording the I and Q measurements on a separate piece of paper.
7. Average the 10 readings. Record the averaged measurements below.

_____ mV (I Channel Reference)
 _____ mV (Q Channel Reference)

8. Set the function generator for a -80 mVdc output.
9. Repeat step 6. Average the readings and record the averaged I and Q channel measurements below.

_____ mV (I Channel Measurement)
 _____ mV (Q Channel Measurement)

10. Subtract the I reading in step 9 from the I reading in step 7. Record the Delta I value.

_____ mV (Delta I)

11. Subtract the Q reading in step 9 from the Q reading in step 7. Record the Delta Q value.

_____ mV (Delta Q)

12. Compute the I versus Q Differential Voltage Accuracy using the following formula:

$$\text{I versus Q Differential Voltage Accuracy} = [1 - (\text{Delta I} / \text{Delta Q})] * 100\%$$

Record the I versus Q Differential Voltage Accuracy below and in Table 4-2. The result should be within $\pm 1\%$.

_____ % (I versus Q Differential Voltage Accuracy)

4-11. Delta Time Accuracy Test

Specification

Electrical Characteristics	Performance Limits	Conditions
Delta Time Accuracy	±3%	Delta times greater than 2 divisions or or 6 ns, whichever is larger; start times greater than 1 division or 20 ns, whichever is larger; both start and stop time on screen

Description

Delta time measurements are made on a signal of known frequency and compared with the actual signal period.

Equipment

Frequency Counter HP 5343A
 Function Generator..... HP 8116A
 Power Splitter HP 11667A
 Signal Generator..... HP 8340B

Procedure

1. Press the PRESET key and then the CAL key on the Vector Modulation Analyzer. Wait for the Calibration Complete message before continuing.

2. Connect the equipment as shown in Figure 4-9:

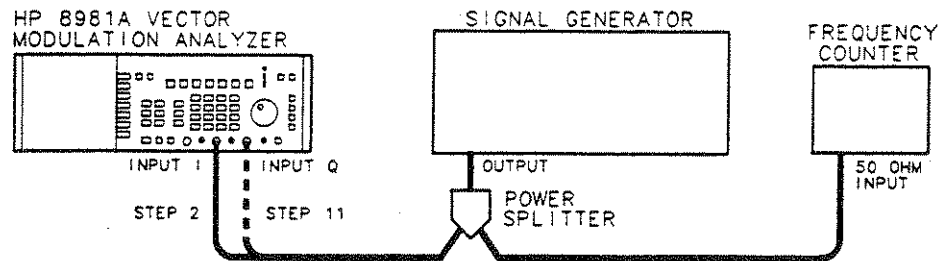

Figure 4-9. Delta Time Accuracy Test Setup

3. Set the signal generator to 125 MHz at an output level of -10 dBm.
4. Set the Vector Modulation Analyzer to the following settings:

Setting	Press these keys/softkeys
Input Mode	DEMOM, MODE IQ/DEMOM to IQ
I&Q channel gain	GAIN & OFS. VOLT/DIV I&Q, 20 mV/div
Display mode	I versus time
Trigger source	TRIG SOURCE, INT I
Trigger level	TRIG LEVEL, VARIABLE, 0V
Timebase	TIMING, TIME/DIV, 4 ns/div
I&Q channel delay	TIMING, DELAY I&Q, 400 ns
Sweep mode	TIMING, TRIG'D SWEEP
Holdoff dither	INST STA. OTHER, HOLDFD DITHR OFF

5. Adjust the signal generator frequency for a frequency counter indication of 125 MHz \pm 1 MHz.
6. Adjust the Vector Modulation Analyzer trigger level slightly so that either the rising or falling edge of the input signal crosses zero within the first division.
7. Activate the time marker by pressing the TIME MKR key and then the TIME MARKER VALUE softkey. Find the first zero volt crossing of the signal. This is accomplished by moving the time marker with the Knob until the highlighted point on the trace is at the first zero crossing.
8. Press the DELTA TIME ON/OFF softkey so that the ON is highlighted (brighter). If the DELTA TIME ON/OFF softkey is already set to ON, press it once to OFF and then back to ON. Use the Knob to move the delta time marker to the next zero crossing (one cycle away). Record the delta time reading directly from the display.

_____ ns (delta time 1)

9. Press the DELTA TIME ON/OFF softkey to OFF and then back to ON to reposition the time marker. Use the Knob to move the delta time marker to the next zero crossing (one cycle away). Record the delta time reading directly from the screen.

_____ ns (delta time 2)

10. Repeat step 9 to obtain a total of four readings.

_____ ns (delta time 3)

_____ ns (delta time 4)

11. Out of the four readings, record the worst-case reading below and in Table 4-2. It should be between 7.76 ns and 8.24 ns. This range represents \pm 3% Delta Time Accuracy.

Note



The "worst-case" reading is the reading furthest from the actual signal period. (Signal Period=1/frequency counter reading).

_____ ns (Delta Time Accuracy - 125 MHz)

12. Remove the signal generator from the test setup and connect the function generator in its place.

13. Set the function generator frequency to 12.5 MHz (± 0.1 MHz as indicated by the frequency counter) at a level of 180 mV p-p (-10 dBm).
14. Set the Vector Modulation Analyzer timebase to 40 ns/div and set the I&Q channel delay to 4 μ s.
15. Press TIME MKR, TIME MARKER -> CENTER to bring the time marker back onto the display.
16. Repeat steps 6 through 10. Out of the four readings, record the worst-case reading below and in Table 4-2. It should be between 77.6 ns and 82.4 ns.

_____ ns (Delta Time Accuracy - 12.5 MHz)

17. Set the Vector Modulation Analyzer timebase to 400 ns/div and set the I&Q channel delay to 40 μ s.
18. Press TIME MKR, TIME MARKER -> CENTER to bring the time marker back onto the display.
19. Adjust the function generator frequency for a frequency counter indication of 125 MHz ± 0.01 MHz.
20. Repeat steps 6 through 10. Out of the four readings, record the worst-case reading below and Table 4-2. It should be between 776 ns and 824 ns.

_____ ns (Delta Time Accuracy - 125 MHz)

21. Set the Vector Modulation Analyzer timebase to 4 μ s/div and set the I&Q channel delay to 400 μ s.
22. Press TIME MKR, TIME MARKER -> CENTER to bring the time marker back onto the display.
23. Adjust the function generator frequency for a frequency counter of indication of 125 kHz ± 1 kHz.
24. Repeat steps 6 through 10. Out of the four readings, record the worst-case reading below and in Table 4-2. It should be between 7.76 μ s and 8.24 μ s.

_____ μ s (Delta Time Accuracy - 125 kHz)

25. Set the Vector Modulation Analyzer timebase to 40 μ s/div and set the I&Q channel delay to 4 ms.

26. Press TIME MKR, TIME MARKER -> CENTER to bring the time marker back onto the display.
27. Adjust the function generator frequency for a frequency counter indication of 12.5 kHz \pm 0.1 kHz.
28. Repeat steps 6 through 10. Out of the four readings, record the worst-case reading below and in Table 4-2. It should be between 77.6 μ s and 82.4 μ s.

Note

In step 7, the highlighted point on the trace might not be present. If it isn't, set the time marker so that it is at the point where the trace and the I axis converge.

_____ μ s (Delta Time Accuracy - 12.5 kHz)

4-12. I Versus Q Timing Accuracy Test

Specification

Electrical Characteristics	Performance Limits	Conditions
I versus Q Timing Accuracy	± 0.5 ns or 1% of full-scale, whichever is greater	Delay I=0 Delay Q=0 Delay I&Q=0

Description

I versus Q Timing Accuracy is measured as the time offset between the I and Q channels with no differential channel delay and the instrument in the IQ mode.

Equipment

Function Generator..... HP 8116A
Power Splitter HP 11667A

Procedure

1. Press the PRESET key and then the CAL key on the Vector Modulation Analyzer. Wait for the Calibration Complete message before continuing.

2. Connect the equipment as shown in Figure 4-10:

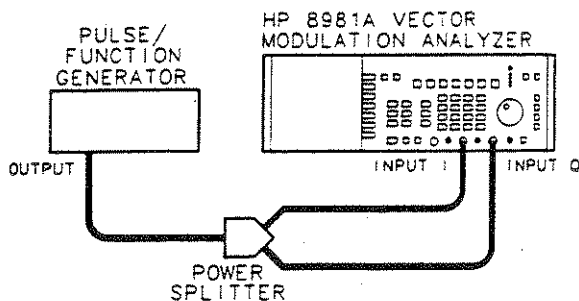

Figure 4-10. I versus Q Timing Accuracy Test Setup

3. Set the function generator for a 50 MHz sine wave at a level of 200 mV p-p.
4. Set the Vector Modulation Analyzer to the following settings:

Setting	Press these keys/softkeys
Input Mode	DEMOM, MODE IQ/DEMOM to IQ
I&Q channel gain	GAIN & OFS, VOLT/DIV I&Q, 20 mV/div
Display mode	VECTOR
Trigger source	TRIG SOURCE, INT I
Trigger level	TRIG LEVEL, VARIABLE, 0V
Time base	TIMING, TIME/DIV, 2 ns/div
I&Q channel delay	TIMING, DELAY I&Q, 200 ns
Sweep Mode	TIMING, TRIG'D SWEEP
Holdoff dither	INST STA, OTHER, HOLDFD DITHR OFF

5. Press the TIMING key and then the DELAY I softkey. The display should be a diagonal trace from the lower-left corner to the upper-right corner of the display. It might be a straight line but it will more likely be oval-shaped.
6. Rotate the knob to increase the I delay. If the oval-shaped trace becomes wider at the center, go to step 7. If it becomes narrower, increase I delay until the trace becomes a straight line and skip step 7.
7. Return I delay to 0 ns and press the DELAY Q softkey. Increase Q delay until the trace becomes a straight line.
8. The amount of delay necessary to align the signals is the I versus Q Timing Accuracy. Record the required delay below and in Table 4-2. It should be less than 0.5 ns.

_____ ns (I versus Q Timing Accuracy - 50 MHz)

9. Set the function generator frequency to 10 MHz and set the Vector Modulation Analyzer to the following settings:

Setting	Press these keys/softkeys
I channel delay	TIMING, DELAY I, 0 ns
Q channel delay	TIMING, DELAY Q, 0 ns
I&Q channel delay	TIMING, DELAY I&Q, 1 μ s
Timebase	TIMING, TIME/DIV, 10 ns/div

10. Repeat Steps 5 through 7. The amount of delay necessary to align the signals is the I versus Q Timing Accuracy. Record the required delay below and in Table 4-2. It should be less than 1 ns.

_____ ns (I versus Q Timing Accuracy - 10 MHz)

11. Set the function generator frequency to 1 MHz and set the Vector Modulation Analyzer to the following settings:

Setting	Press these keys/softkeys
I channel delay	TIMING, DELAY I, 0 ns
Q channel delay	TIMING, DELAY Q, 0 ns
I&Q channel delay	TIMING, DELAY I&Q, 10 μ s
Timebase	TIMING, TIME/DIV, 100 ns/div

12. Repeat Steps 5 through 7. The amount of delay necessary to align the signals is the I versus Q Timing Accuracy. Record the required delay below and in Table 4-2. It should be less than 10 ns.

_____ ns (I versus Q Timing Accuracy - 1 MHz)

13. Set the function generator frequency to 100 kHz and set the Vector Modulation Analyzer to the following settings:

Setting	Press these keys/softkeys
I channel delay	TIMING, DELAY I, 0 ns
Q channel delay	TIMING, DELAY Q, 0 ns
I&Q channel delay	TIMING, DELAY I&Q, 100 μ s
Timebase	TIMING, TIME/DIV, 1 μ s/div

14. Repeat Steps 5 through 7. The amount of delay necessary to align the signals is the I versus Q Timing Accuracy. Record the required delay below and in Table 4-2. It should be less than 100 ns.

_____ ns (I versus Q Timing Accuracy - 100 kHz)

15. Set the function generator frequency to 10 kHz and set the Vector Modulation Analyzer to the following settings:

Setting	Press these keys/softkeys
I channel delay	TIMING, DELAY I, 0 ns
Q channel delay	TIMING, DELAY Q, 0 ns
I&Q channel delay	TIMING, DELAY I&Q, 1 ms
Timebase	TIMING, TIME/DIV, 10 μ s/div

16. Repeat Steps 5 through 7. The amount of delay necessary to align the signals is the I versus Q Timing Accuracy. Record the required delay below and in Table 4-2. It should be less than 1 μ s.

_____ ns (I versus Q Timing Accuracy - 10 kHz)

4-13. Minimum Trigger Level Test

Specification

Electrical Characteristics	Performance Limits	Conditions
Minimum Signal -Internal	2 divisions p-p 3 divisions p-p	DC to 80 MHz 80 MHz to 150 MHz
-External	100 mV p-p into 50 Ω 200 mV p-p into 50 Ω	DC to 80 MHz 80 MHz to 150 MHz

Description

Minimum trigger level is measured as the smallest signal on which a valid (triggered) display can be obtained.

Equipment

Signal Generator..... HP 8340B
Power SplitterHP 11667A

Procedure

1. Press the PRESET key and then the CAL key on the Vector Modulation Analyzer. Wait for a Calibration Complete message before continuing.
2. Press the INST STA key and then the SERVICE softkey on the Vector Modulation Analyzer.
3. If a cable is connected to the EXT TRIG INPUT, disconnect it and then press the EXT INPUT LEVEL CAL softkey. Wait for a Calibration Complete message. This calibrates the external trigger input for specified operation.

4. Connect the equipment as shown in Figure 4-11:

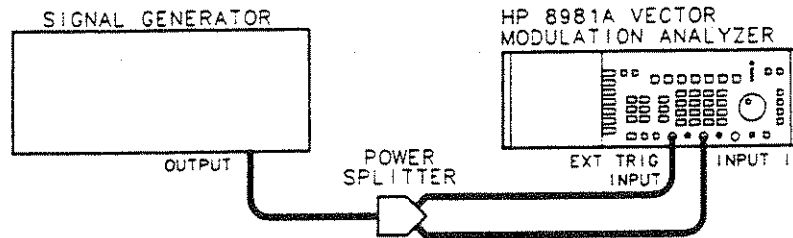

Figure 4-11. Minimum Trigger Level Test Setup

5. Set the signal generator to 80 MHz at an output level of 0 dBm.
6. Set the Vector Modulation Analyzer to the following settings:

Setting	Press these keys/softkeys
Input Mode	DEMOM, MODE IQ/DEMOM to IQ
I&Q channel gain.	GAIN & OFS, VOLT/DIV I&Q, 50 mV/div
Display mode	I versus time
Trigger source	TRIG SOURCE, INT I
Trigger level	TRIG LEVEL, VARIABLE, 0V
Timebase	TIMING, TIME/DIV, 5 ns/div
Sweep mode	TIMING, TRIG'D SWEEP

7. Adjust the signal generator output for 6 divisions peak-to-peak on the Vector Modulation Analyzer display.
8. Reduce the signal amplitude on the signal generator while adjusting trigger level if necessary until the smallest possible signal level is reached that produces a triggered sweep.

9. Record the number of screen divisions for the minimum triggered signal below and in Table 4-2. This should be no more than two divisions peak-to-peak.

_____ divisions (Minimum INT Trigger Level - 80 MHz)

10. Reset the signal generator amplitude to 0 dBm.
11. Repeat steps 7 and 8 with the signal generator set to 150 MHz. Record the number of screen divisions for the minimum triggered signal below and in Table 4-2. This should be no more than three divisions peak-to-peak.

_____ divisions (Minimum INT Trigger Level - 150 MHz)

12. Set the signal generator for a frequency of 80 MHz and an amplitude of 0 dBm.
13. Set the Vector Modulation Analyzer trigger source to EXT.
14. Repeat steps 7 and 8 and record the number of screen divisions for the minimum triggered signal below and in Table 4-2. This should be no more than two divisions peak-to-peak.

_____ divisions (Minimum EXT Trigger Level - 80 MHz)

15. Set the signal generator for a frequency of 150 MHz and an amplitude of 0 dBm.
16. Repeat steps 7 and 8 and record the number of screen divisions for the minimum triggered signal below and in Table 4-2. This should be no more than four divisions peak-to-peak.

_____ divisions (Minimum EXT Trigger Level - 150 MHz)

4-14. RF Input Frequency Range Test

Specification

Electrical Characteristics	Performance Limits	Conditions
MODULATED IF INPUT Input Carrier Frequency Range	50 to 200 MHz	
COHERENT REFERENCE INPUT Input Frequency Range	50 to 200 MHz	

Description

The frequency range is verified by splitting an RF signal (50 to 200 MHz) into two signals. One signal is applied to the RF input and the other signal is applied to the COHERENT CARRIER input. Since the path length of the RF and coherent signal is different, a phase shift will be introduced as the signal generator is tuned. The nominal displayed phase is zero degrees and the amplitude is proportional to the RF input signal.

The RF source is tuned from 50 to 200 MHz and the demodulated signal is checked to ensure that the amplitude of the demodulated signal does not drop by more than 3 dB over the full frequency range. A power meter and additional power splitter are used to keep the RF signal at a constant level.

Equipment

Power Meter..... HP 436A
 Power Sensor HP 8482A
 Power Splitter (two required)..... HP 11667A
 Signal Generator..... HP 8340B

Procedure

1. Press the PRESET key and then the CAL key on the Vector Modulation Analyzer. Wait for the Calibration Complete message before continuing.
2. Connect the equipment as shown in Figure 4-12. Since a difference in path length will introduce phase and amplitude errors, the cables connected to the COHERENT CARRIER connector, RF IN connector and power sensor should be of the same type (BNC or type N) and be within a few centimeters of the same length.

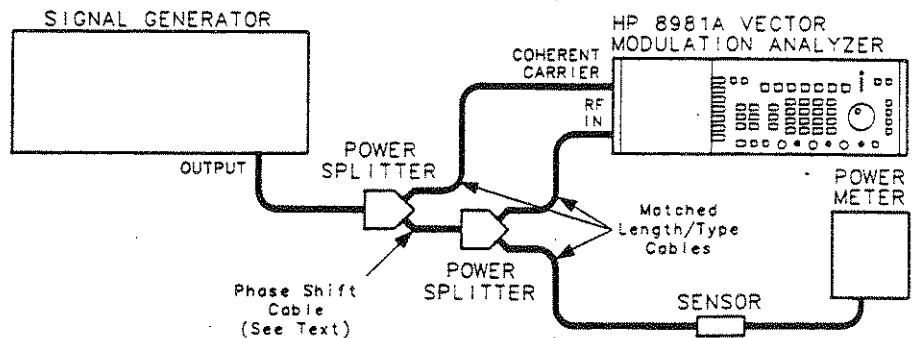

Figure 4-12. Input Frequency Range Test Setup

Note



For the most thorough test, the phase between the signals at the COHERENT CARRIER and RF IN connectors should be 45° (fixed). This will provide equal magnitude I and Q components so that both channels (I and Q) of the internal demodulator are tested. A signal generator such as the HP 8780A can be used to provide a coherent carrier for the Vector Modulation Analyzer COHERENT CARRIER input and an RF signal for the second power splitter. The phase between the coherent carrier and RF output of the HP 8780A can be directly controlled using the TWO STATE modulation format and setting the phase of the signal from the front panel.

In this simplified test, both channels will be tested by allowing the phase to change with the testing frequency. This is indicated by a rotation (phase change) of the displayed dot. The cabling used in this setup will determine how much phase variation will occur as the test frequency is changed.

Connecting the two power splitters together directly will give the least phase variation but is typically sufficient. There should be at least three full revolutions of the dot over the test frequency range. If a sufficient phase change is not observed, a cable connected between the two power splitters can be used to introduce more phase shift.

3. Set the signal generator's RF output to off and zero the power meter.
4. Set the Vector Modulation Analyzer to the following settings:

Setting	Press these keys/softkeys
Full scale setting	GAIN & OFS, FULL SCALE -5.0 dBm
Reference Frequency	DEMOD, REF FREQ 50 MHz
Magnitude Marker	MARKERS MGTD, MGTD MARKER -> FULL SCALE
Delta Marker	MARKERS MGTD, DELTA MGTD -3 dB

5. Set the signal generator to 50 MHz at an output level of +7 dBm (RF output set to ON).
6. Adjust the signal generator RF output level until the dot displayed on the Vector Modulation Analyzer is at full scale (the outer marker).

Record the power meter reading as the reference level for this test.

Reference Level _____ dBm

7. Set the Vector Modulation Analyzer reference frequency to 80 MHz (DEMOD, REF FREQ 80 MHz).
8. Set the signal generator to 80 MHz and adjust the output level until the power meter displays the reference level recorded above. The power meter calibration factor should be set for a 80 MHz correction before adjusting the signal generator RF level.

The dot displayed on the screen should be outside of the inner magnitude marker on the display. The outside marker indicates the full scale amplitude and the inner marker indicates 3 dB below the reference.

9. Repeat steps 7 and 8 tuning the signal generator from 110 to 200 MHz in 30 MHz steps. The displayed dot should remain outside the inner magnitude marker for each frequency.

_____ (✓) 50-200 MHz RF Input Frequency Range

4-15. Full Scale Input Range Test

Specification

Electrical Characteristics	Performance Limits	Conditions
MODULATED IF INPUT Input Level Range	-5 to -20 dBm	

Description

The full scale input range is tested by setting the RF input level and then verifying that the signal displayed can be displayed at full scale. The gain correction performed ensures that the instrument can correct for internal gains to provide a full scale signal display over the specified range.

The test is performed at the worst case frequency of 200 MHz. The test can be repeated at any frequency within the 50 to 200 MHz input range.

Equipment

- Power Meter..... HP 436A
- Power Sensor HP 8482A
- Power Splitter (two required).....HP 11667A
- Signal Generator..... HP 8340B

Procedure

1. Press the PRESET key and then the CAL key on the Vector Modulation Analyzer. Wait for the Calibration Complete message before continuing.
2. Connect the equipment as shown in Figure 4-13. The cable connected to the RF IN connector on the Vector Modulation Analyzer should be matched (type and length) with the cable connected to the power sensor. This will minimize errors due to cable losses.

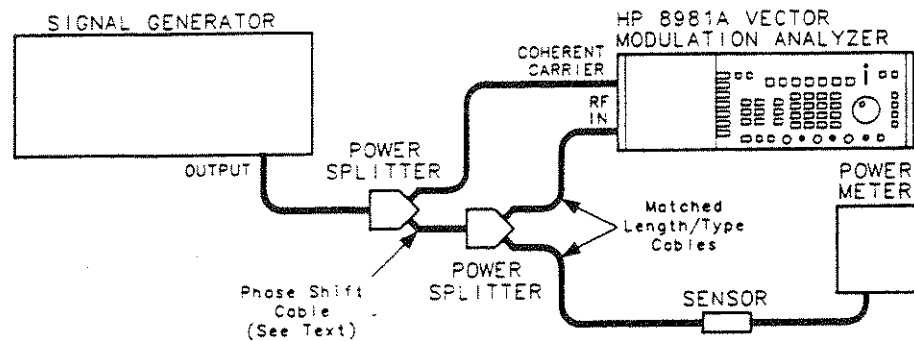

Figure 4-13. Full Scale Input Range Test Setup

Note



For the most thorough test, the phase between the signals at the COHERENT CARRIER and RF IN connectors should be 45° . This will make the amplitude of the I and Q components equal so that both channels of the demodulator are tested. A signal generator such as the HP 8780A can be used to provide a coherent carrier for the Vector Modulation Analyzer COHERENT CARRIER input and an RF signal for the second power splitter. The phase between the coherent carrier and RF output of the HP 8780A can be directly controlled using the TWO STATE modulation format and adjusting the phase of the output signal from the front panel.

In this simplified test, the cable between the two power splitters is used to introduce a phase shift. A longer (shorter) cable can be used to provide more (less) phase change as the test frequency is changed. Any phase angle between 0 and 90° can be used with 45° as the optimum setting.

3. Set the signal generator's RF output to off and zero the power meter.
4. Set the Vector Modulation Analyzer reference frequency for 200 MHz and clear all corrections by entering the following key sequence:

```
DEMOM, REF FREQ, 200 MHz
DEMOM, CORRECTION, MANUAL CORRECTION, CLEAR CURR
CORRECTIONS
```
5. Set the signal generator to 200 MHz at an output level of +7 dBm (RF output set to ON).
6. Adjust the signal generator RF output level until the power meter reads -5.0 dBm ± 0.1 dB.
7. Set the Vector Modulation Analyzer for a -5 dBm full scale reference by entering the following key sequence:

```
GAIN&OFS, FULL SCALE, -5 dBm
```

8. Set the Vector Modulation Analyzer magnitude marker to full scale by pressing the MARKERS MGTD key followed by the MGTD MARKER -> FULL SCALE softkey.
9. Set the gain correction reference level to -5 dBm by entering the following key sequence:

 DEMOD. CORRECTION, DEMOD GAIN CORRECTION, RF LEVEL, -5 dBm
10. Start the gain correction by pressing the START GAIN CORRECTION softkey. This will perform a correction that should place the displayed signal at full scale.
11. Once the correction is complete, verify that the displayed dot is on the full scale magnitude marker.

 _____ (✓) Full Scale Setting at -5.0 dBm
12. Repeat steps 6 through 11 for each of the levels indicated below. A gain correction should place the displayed signal on the full scale magnitude marker for each level. Place a check in the table below and in Table 4-2 to indicate the Vector Modulation Analyzer can display each indicated level at full scale.

Power Meter Indication	Full Scale Signal
-5.0 dBm	_____ (✓)
-10.0 dBm	_____ (✓)
-15.0 dBm	_____ (✓)
-20.0 dBm	_____ (✓)

4-16. Demodulated I and Q Bandwidth Test

Specification

Electrical Characteristics	Performance Limits	Conditions
Baseband Bandwidth With External Filters (3 dB)	>100 MHz	

Description

The demodulated I and Q bandwidth is measured using two RF signals offset in frequency to produce a fixed amplitude demodulated signal with changing phase. A signal generator at a fixed frequency and level is used to provide the reference input (COHERENT CARRIER). A second signal generator is used as a variable frequency source to provide the frequency offset.

In VECTOR display mode, providing two signals at slightly different frequencies for the COHERENT CARRIER and RF IN inputs will produce a display at a fixed amplitude with changing phase (a circle). Tuning the variable frequency generator from the reference frequency to the specified bandwidth produces a circle with an amplitude that reflects the demodulated I and Q bandwidth. The bandwidth is tested by verifying that the displayed amplitude does not change more than 3 dB for frequency offsets of 0 to the maximum specified bandwidth.

Measuring the bandwidth using the external filter connections requires a low pass filter to eliminate feedthrough of the RF signals. The low pass filter is measured for insertion loss so that the measured response takes into account the frequency response of the two low pass filters. Two filters must be fabricated using readily available components (see Figure 1-3).

Equipment

- Power Meter..... HP 436A
- Power Sensor HP 8482A
- Power Splitter HP 11667A
- COHERENT CARRIER Signal Generator HP 8662A
- RF IN Signal Generator HP 8340B
- 110 MHz Low Pass Filter (2 required)..... See Figure 1-3

Procedure

1. Connect the power meter to the RF IN signal generator.
2. Set the RF IN signal generator to each of the frequencies shown below. Record the output level setting required for a power meter reading of 0.0 dBm ±0.1 dB. This will calibrate the signal generator for measuring filter loss.

External Filter Correction Factors

Baseband Frequency	Generator 0 dBm Setting	I Filter Loss	Q Filter Loss
20 MHz	_____ dBm	_____ dB	_____ dB
40 MHz	_____ dBm	_____ dB	_____ dB
60 MHz	_____ dBm	_____ dB	_____ dB
80 MHz	_____ dBm	_____ dB	_____ dB
100 MHz	_____ dBm	_____ dB	_____ dB

3. Connect the I channel filter between the power meter sensor and the RF IN signal generator RF output. Use the same cables that will be used to connect the filter to the Vector Modulation Analyzer for highest accuracy.
4. Set the RF IN signal generator to each of the frequencies indicated in the table above. Set the output level to the recorded level for that frequency to provide a calibrated 0 dBm reference level.

Record the measured filter loss for the filter in the appropriate space of the table. For example, a power meter indication of -1.23 dBm indicates a loss of 1.23 dB for that frequency.

5. Repeat steps 3 and 4 for the Q channel filter. It is recommended that the filters be marked so that the recorded correction factors can be applied to the appropriate filter.

6. Connect the equipment as shown in Figure 4-14. The cable connected to the RF IN connector on the Vector Modulation Analyzer should be matched (type and length) with the cable connected to the power sensor. This will minimize errors due to cable losses.

Connect the I and Q filters to the appropriate rear panel connectors.

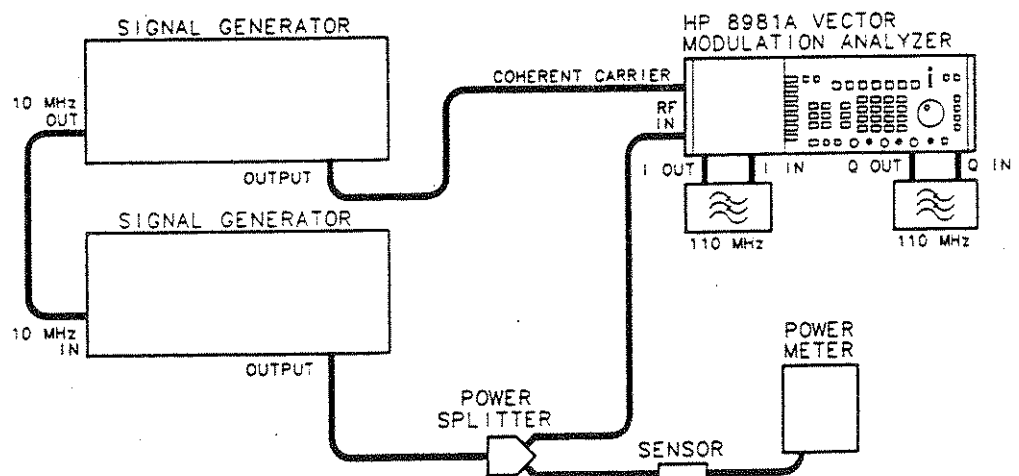

Figure 4-14. Demodulated I and Q Bandwidth Test Setup

7. Set the Vector Modulation Analyzer to the following settings:

Setting	Press these keys/softkeys
Preset	PRESET
Full scale setting	GAIN & OFS, FULL SCALE -5.0 dBm
Timing	TIMING, TIME/DIV, 5 ns/DIV
Reference Frequency	DEMOD, REF FREQ 200 MHz
External Filters	DEMOD, MORE, EXT FILTERS ON/OFF to ON
Magnitude Marker	MARKERS MGTD, MGTD MARKER -> FULL SCALE
Delta Marker	MARKERS MGTD, DELTA MGTD, -3 dB

8. Set the COHERENT CARRIER signal generator to 200 MHz at an output level of 0 dBm.
9. Set the RF IN signal generator to 200 MHz at an output level of +1 dBm.
10. Adjust the RF IN signal generator output level until the displayed dot is on the full scale magnitude marker. Record the power meter level as the reference for this test.

Reference Level _____ dBm

11. Set the RF IN signal generator to 180 MHz and adjust the output level for a power meter indication equal to the recorded reference level.

12. Use the delta magnitude marker (MARKERS MGTD, DELTA MGTD), to measure first the signal crossing on the I axis and then the signal crossing on the Q axis. Depending on how well the two filters are matched, the measurements will be different for the I and Q channels.

Record the delta magnitude marker values for each axis in the table below.

Note



If the delta magnitude marker does not intersect both crossings on the axis, set the marker so that the distance from the marker to the axis crossings is equal (one crossing outside the marker and the other inside the marker). This will compensate for the dc offset.

13. Calculate the corrected response for the measurement and record the corrected value in table below and in Table 4-2. The corrected value is calculated by adding the appropriate filter correction factor (recorded above) to the measured response. For example, a filter correction factor of 1.2 dB and a measured response of -2.2 dB would give a corrected response of -1.0 dB.
14. Repeat steps 9 and 10 for the other frequencies indicated in the table. Reset the RF IN signal generator output level for a power meter indication equal to the reference level recorded for each test frequency.

Verify that all corrected responses are greater (more positive) than -3 dB.

_____ (✓) External Filter Bandwidth >100 MHz

I and Q Channel External Filter Frequency Response

RF IN Frequency	Baseband Frequency	Measured I Response	Measured Q Response	Corrected I Response	Corrected Q Response
180 MHz	20 MHz	_____ dB	_____ dB	_____ dB	_____ dB
160 MHz	40 MHz	_____ dB	_____ dB	_____ dB	_____ dB
140 MHz	60 MHz	_____ dB	_____ dB	_____ dB	_____ dB
120 MHz	80 MHz	_____ dB	_____ dB	_____ dB	_____ dB
100 MHz	100 MHz	_____ dB	_____ dB	_____ dB	_____ dB

4-17. Demodulated I Versus Q Timing Accuracy Test

Specification

Electrical Characteristics	Performance Limits	Conditions
I versus Q Timing Accuracy	± 1.5 ns or 1% of full scale, whichever is greater	Delay I&Q=0, Delay I=0, Delay Q=0

Description

Demodulated timing accuracy is measured using an RF pulse as the input to the Vector Modulation Analyzer. With the phase angle between the RF IN and COHERENT CARRIER inputs adjusted for 45° , the demodulated I and Q components should be pulses of equal magnitude and shape.

For an RF pulse at a 45° phase angle, the demodulated signal should be an equal amplitude I and Q detected pulse. Changing the phase will affect the amplitude of each pulse but not the position of the rising edge. The timing accuracy measured by noting any difference (delay) between the two displayed pulses (I and Q).

The rise time and the incidental phase modulation on the rising edge of the pulse will make the measurement more difficult and less accurate. The most accurate measurement requires an RF pulse with a rise time of less than 1 ns and no incidental phase modulation. Incidental phase modulation is indicated during the VECTOR display mode by a transition from the off state to the on state that is not a straight line.

Equipment

Pulse Generator..... HP 8116A
Signal Generator..... HP 8662A
Signal Generator..... HP 8340B

Procedure

1. Press the PRESET key and then the CAL key on the Vector Modulation Analyzer. Wait for the Calibration Complete message before continuing.
2. Connect the equipment as shown in Figure 4-15.

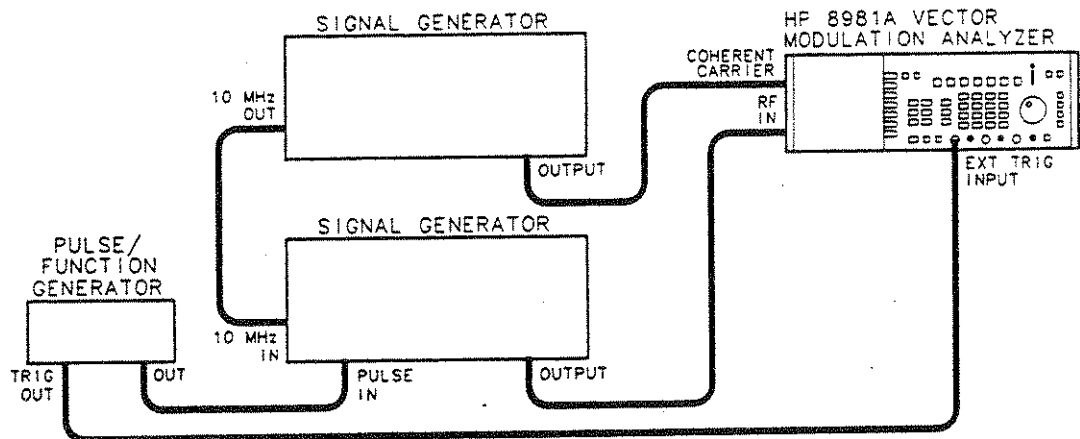

Figure 4-15. I vs Q Timing Accuracy Test Setup

Note



In the following procedure, the signal generator connected to the RF IN connector of the Vector Modulation Analyzer will be referred to as the RF IN signal Generator. The signal generator connected to the COHERENT CARRIER input will be referred to as the COHERENT CARRIER signal generator.

3. Set the pulse generator for a 1 MHz square wave at an amplitude of 5 volts peak-to-peak. Set the dc offset to +2.5 Vdc to make the pulse TTL compatible.

4. Set the Vector Modulation Analyzer to the following settings:

Setting	Press these keys/softkeys
Display Mode	VECTOR
Full scale setting	GAIN & OFS, FULL SCALE -5.0 dBm
Timing	TIMING, TIME/DIV 40 ns/DIV
Reference Frequency	DEMOD, REF FREQ 70 MHz
Magnitude Marker	MARKERS MGTD, MGTD MARKER -> FULL SCALE
Phase Marker	PHASE MARKER, PHASE MARKER VALUE 45°

5. Set the COHERENT CARRIER signal generator to 70 MHz at an output level of 0 dBm.
6. Set the RF IN signal generator to 70 MHz at an output level of -5 dBm.
7. Set the RF IN signal generator to pulse modulation mode and adjust the RF output level until the displayed dot (RF on state) is on the full scale magnitude marker of the Vector Modulation Analyzer.
8. Set the frequency increment of the RF IN signal generator for 1 Hz.
9. Step the frequency of the RF IN (or COHERENT CARRIER) signal generator up by 1 Hz and then back to 70.000000 MHz. This should shift the position of the dot. Repeat the frequency step several times until the dot is displayed within 2° of the 45° phase marker.

Note



In the following steps, **DO NOT** adjust the delay on the Vector Modulation Analyzer for any reason. The specification only holds for delay settings of zero.

10. Set the Vector Modulation Analyzer display mode to I&Q and adjust the TIMING (TIME/DIV) to display the rising edge of the two pulses near the center of the display. *Do not set the TIME/DIV setting to anything less than 15 ns/DIV.*

The two displayed pulses should be equal in magnitude and the rising edge of each pulse should occur at nearly the same position on the display.

If the amplitudes of the pulses are substantially different, set the display mode to VECTOR and use the procedure in the previous step to reset the phase until the amplitudes are within one-quarter of a division of each other.

11. Calculate the demodulated timing accuracy specification for the current timebase settings and record the specification in the table at the end of this procedure.

The specification is calculated by multiplying the TIME/DIV setting by ten and then dividing the result by 100. This is equivalent to dividing the TIME/DIV setting by ten. If the result is less than 1.5 ns, the specification is equal to 1.5 ns.

12. Set the Vector Modulation Analyzer to the following settings:

Setting	Press these keys/softkeys
I Channel Marker	MARKERS I, I MARKER VALUE 0%
Q Channel Marker	MARKERS Q, Q MARKER VALUE 0%
Time Marker	MARKERS TIME MKR, TIME MARKER VALUE 0 ns

13. Activate the I channel delta marker by pressing MARKERS I, DELTA I ON.
14. Adjust the delta marker until the marker is at the top of the displayed pulse (ignore overshoot and ringing).
15. Note the delta marker setting displayed on the Vector Modulation Analyzer. Using the numeric keypad, reset the delta marker to one-half of the displayed value (the 50% point on the rising edge). For example, if the delta marker setting is 57.2%, reset the delta marker to 28.6%.

16. Activate the Q channel delta marker by pressing **MARKERS Q, DELTA Q ON**.
17. Adjust the Q channel delta marker until the marker is at the top of the pulse displayed on the Q channel (ignore overshoot and ringing).
18. Note the Q channel delta marker setting displayed on the Vector Modulation Analyzer. Using the numeric keypad, reset the delta marker to one-half of the displayed value.
19. Activate the timing marker by pressing **MARKERS TIME MKR** and adjust the time marker so that it intersects the first delta marker (I or Q channel).
20. Activate the delta time marker (press **DELTA TIME ON**) and adjust the marker to intersect the other channel (I or Q) delta marker. The displayed delta time marker setting is the timing skew between the two channels.

Record the timing accuracy for 70 MHz in the table below and in Table 4-2.

21. Press the **ALL MKR OFF** softkey to disable all markers.
22. Repeat steps 4 through 21 for RF input frequencies of 140 MHz and 200 MHz. Record the results below and in Table 4-2.

Reference Frequency	Timing Accuracy	Calculated Specification (Step 11)
70 MHz	_____ ns	_____ ns
140 MHz	_____ ns	_____ ns
200 MHz	_____ ns	_____ ns

4-18. Corrected DC Accuracy Test

Specification

Electrical Characteristics	Performance Limits	Conditions
Corrected Vector DC Accuracy (I,Q)	<2% of full scale IF input	From 50 to 200 MHz; measured at 70 MHz; typical elsewhere

Description

Corrected dc accuracy is measured by comparing the demodulated I and Q components displayed on the Vector Modulation Analyzer with the real and imaginary components measured by a network analyzer.

Corrected dc accuracy requires that the Vector Modulation Analyzer built-in correction algorithms be performed before making measurements. The correction procedure for quadrature, gain imbalance and offsets is performed first followed by a gain correction.

The network analyzer display is normalized to display a full scale signal at 0°. This calibrates the network analyzer to read the same values as the Vector Modulation Analyzer. Readings should then be within ±2% of each other.

Four full scale readings are then taken to provide information for a correction factor which compensates for measurement errors involved in the normalizing process. The correction factor is only required if the measurements made are not within specification.

The phase and amplitude of the input signal is then adjusted for various signals and the displayed I and Q components are compared to the network analyzer display to determine the accuracy. All measurements must agree within 2%. If any measurement is out of specification, a correction factor must be applied to the I and Q readings to normalize them to the network analyzer measurements.

Equipment

Network Analyzer.....	HP 3577A or HP 8753A
Signal Generator.....	HP 8662A or HP 3335A
Signal Generator.....	HP 8340B
Power Splitter (two required).....	HP 11667A

Procedure

1. Press the PRESET key and then the CAL key on the Vector Modulation Analyzer. Wait for the Calibration Complete message before continuing.
2. Connect the equipment as shown in Figure 4-16.

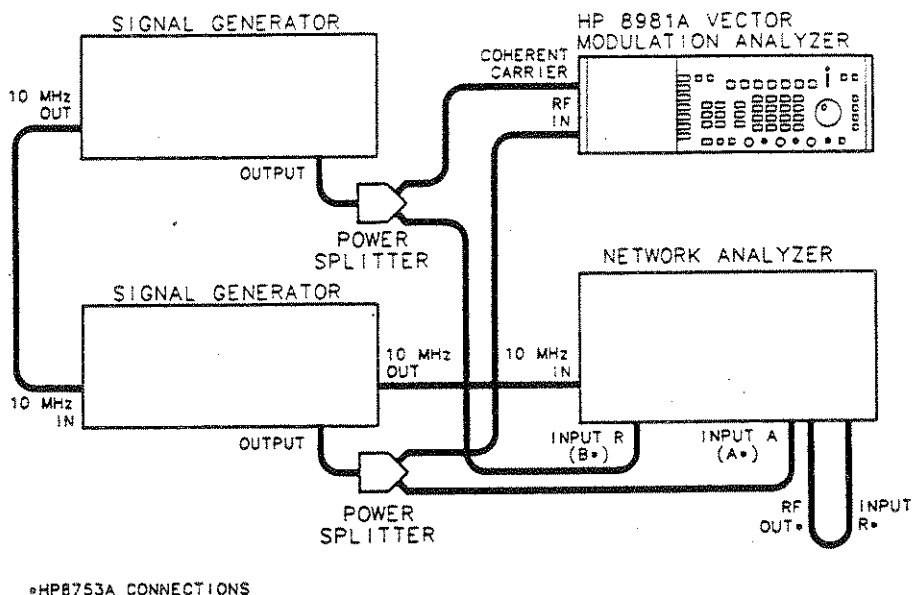

Figure 4-16. Corrected dc Accuracy Test Setup

Note



In the following procedure, the signal generator connected to the RF IN connector of the Vector Modulation Analyzer will be referred to as the RF IN signal Generator. The signal generator connected to the COHERENT CARRIER input will be referred to as the COHERENT CARRIER signal generator.

3. Set the Vector Modulation Analyzer to the following settings:

Setting	Press these keys/softkeys
Full scale setting	GAIN & OFS, FULL SCALE -5.0 dBm
Reference Frequency	DEMOM, REF FREQ 70 MHz
Phase Reference	DEMOM, PHASE ADJ, REF PHASE, 0 DEG
Gain Correction Reference	DEMOM, CORRECTION, DEMOM GAIN CORRECTION, RF LEVEL, -5 dBm
Magnitude Marker	MARKERS MGTD, MGTD MARKER -> FULL SCALE

4. Set the network analyzer to the following settings:

Setting	HP 3577A Press these keys/softkeys	HP 8753A Press these keys/softkeys
Preset	INSTR PRESET	PRESET
Input	INPUT, USER DEF INPUT, A, /, R, ENTER	MEAS, A/B
Display Mode	DISPLY FCTN, POLAR	FORMAT, POLAR
Frequency Sweep Mode	SWEEP TYPE, CW	MENU, NUMBER OF POINTS, 3, X1
Frequency	FREQ, 70 MHz	MENU, CW FREQ, 70, M (MHz)
Amplitude	AMPTD, -10 dBm	MENU, POWER, -10 X1 (dBm)
Bandwidth	RES BW, 10 Hz	AVG, IF BW, 10, X1 (Hz)

Note

In order to obtain the stability for making the following measurements, all instruments must have a warm up time of at least one hour. In addition, the network analyzer and both signal generators must use a common timebase to prevent a frequency error between instruments. A frequency error will produce a continuous phase shift (rotation) of the display or an unstable signal.

5. Set the COHERENT CARRIER signal generator to 70 MHz at an output level of 0 dBm.
6. Set the RF IN signal generator to 70.1 MHz at an output level of +1 dBm.
7. Adjust the RF IN signal generator RF output level until the displayed circle on the Vector Modulation Analyzer is superimposed on the full scale magnitude marker.
8. Start the automatic correction procedure by pressing DEMOD, CORRECTION, QUAD IQ & OFFSET CORR, and then START TONE CORRECTION. The correction factors will be calculated by the Vector Modulation Analyzer. When the procedure is finished, the message "DEMOD CORRECTION COMPLETE" will be displayed.
9. Once the correction is complete, set the RF IN signal generator to 70 MHz and reset the level to +1 dBm.
10. Set the RF IN signal generator frequency increment to 1 Hz.
11. Set the Vector Modulation Analyzer phase marker to 0° by pressing the following keys:

MARKERS PHASE, PHASE MARKER VALUE, 0, DEGREES
12. Step the frequency of the RF IN (or COHERENT CARRIER) signal generator up by 1 Hz and then back to 70.000000 MHz. At a frequency of 70.000001 MHz the dot will rotate around the screen. Stepping the frequency back to 70 MHz will stop the dot at the current position on the screen. Repeat the frequency step several times until the dot is displayed near the phase marker.
13. Perform a gain correction by entering the following key sequence. This will calibrate the Vector Modulation Analyzer to display the current amplitude as -5.0 dBm (full scale).

Once the procedure is complete, the message "GAIN CORRECTION COMPLETE" will be displayed. If any key is pressed before the message is displayed, the correction procedure will abort.

DEMOD. CORRECTION, DEMOD GAIN CORRECTION, START GAIN CORRECTION

14. Once the correction is complete, set the Vector Modulation Analyzer to display the current signal at 0° by pressing the following keys:

DEMOM, PHASE ADJ, SET CW PHASE TO REF PHASE

15. Normalize the network analyzer by entering the following key sequence. Normalizing the displayed signal will place the signal on the horizontal axis (0° phase) with a full scale magnitude.

HP 3577A: MEASR CAL, NORMLIZE

HP 8753A: CAL. CALIBRATE MENU, RESPONSE, THRU, DONE:RESPONSE (when done)

16. Set the network analyzer to read the signal in terms of the real and imaginary components (corresponding to the I and Q components) by entering the following key sequence.

HP 3577A: MKR, MARKER M,P R,I (the R,I portion must be highlighted)

HP 8753A: MKR, MARKER MODE MENU, POLAR MKR MENU, Re/Im MKR

Note



In the following procedure, maximum averaging (16 points for the HP 8753A) should be used on the network analyzer to provide the highest resolution readings. However, to improve overall measurement speed, turn off averaging when changing the phase or amplitude of the input signal. This will enable the network analyzer to respond faster to the changes in magnitude and phase. Reactivate averaging once the signal has settled.

17. Activate the measurement function of the Vector Modulation Analyzer by pressing the MARKERS MEAS key followed by the CONTINUOUS I Q softkey. This will continuously measure and display the magnitude of the displayed dot in percent of full scale.
18. Record the Vector Modulation Analyzer measured I component and the network analyzer real component in the table below. Use averaging if necessary to get the most accurate results. Averaging of the Vector Modulation Analyzer components is best done using the SINGLE I,Q measurement mode and averaging ten readings with a calculator.

Note

A full scale reading on the network analyzer is equivalent to 100%. Convert the network analyzer readings to percent before entering the values in the table. To do this, multiply each reading by 100. For example, a network analyzer reading of 997E-3 (997 mU for the HP 8753A) is equivalent to 99.7%.

19. Set the Vector Modulation Analyzer phase marker to 90° by pressing the MARKERS PHASE key followed by PHASE MARKER VALUE 90° .
20. Step the RF IN or COHERENT CARRIER signal generator frequency up by 1 Hz to rotate the displayed dot. Step the frequency back to 70 MHz to place the dot near (within 5°) of the phase marker.
21. Record the Vector Modulation Analyzer measured Q component and the network analyzer imaginary component in the table below. Average the Vector Modulation Analyzer measurements by using the SINGLE I-Q measurement mode and averaging ten readings with a calculator.
22. Repeat steps 19 through 21 for each of the phase marker settings in the table. Record the real (I) part of the 180° setting and the imaginary (Q) part of the 270° setting.

Full Scale Values

Phase Marker Setting	I or Q Full Scale	Real or Imaginary Full Scale
0°	_____ %	_____ %
90°	_____ %	_____ %
180°	_____ %	_____ %
270°	_____ %	_____ %

23. Set the Vector Modulation Analyzer phase marker to 45° .
24. Step the RF IN or COHERENT CARRIER signal generator frequency up by 1 Hz to rotate the displayed dot. Step the frequency back to 70 MHz to stop the displayed dot near the phase marker. Repeat the frequency step as required to get the displayed dot within 5° of the Vector Modulation Analyzer phase marker.

25. Record the Vector Modulation Analyzer measured I and Q components and the real and imaginary components as indicated by the network analyzer in the Corrected dc Accuracy Results table below.

Note



In order to reduce the possibility of errors due to signal instability or drift, take the readings from the network analyzer and Vector Modulation Analyzer within a few seconds of each other. It is recommended that the I/Real measurements be taken first and then the Q/Imaginary readings to shorten the time between corresponding readings.

26. Set the RF IN signal generator output level to -2 dBm.
27. Record the Vector Modulation Analyzer measured I and Q components and the real and imaginary components measured by the network analyzer.
28. Repeat step 26 and 27 for levels of -5 dBm and -8 dBm.
29. Repeat steps 23 through 28 for phase marker settings of 135°, 225° and 315°. Record the results in the following table.

Corrected dc Accuracy Results

Phase Marker Setting	RF Level	Real Reading	I Reading	Imaginary Reading	Q Reading
45°	+1 dBm	_____ %	_____ %	_____ %	_____ %
45°	-2 dBm	_____ %	_____ %	_____ %	_____ %
45°	-5 dBm	_____ %	_____ %	_____ %	_____ %
45°	-8 dBm	_____ %	_____ %	_____ %	_____ %
135°	+1 dBm	_____ %	_____ %	_____ %	_____ %
135°	-2 dBm	_____ %	_____ %	_____ %	_____ %
135°	-5 dBm	_____ %	_____ %	_____ %	_____ %
135°	-8 dBm	_____ %	_____ %	_____ %	_____ %
225°	+1 dBm	_____ %	_____ %	_____ %	_____ %
225°	-2 dBm	_____ %	_____ %	_____ %	_____ %
225°	-5 dBm	_____ %	_____ %	_____ %	_____ %
225°	-8 dBm	_____ %	_____ %	_____ %	_____ %
315°	+1 dBm	_____ %	_____ %	_____ %	_____ %
315°	-2 dBm	_____ %	_____ %	_____ %	_____ %
315°	-5 dBm	_____ %	_____ %	_____ %	_____ %
315°	-8 dBm	_____ %	_____ %	_____ %	_____ %

30. Using the information in the table above, complete the following table. To obtain the dc accuracy entries, subtract the network analyzer reading from the corresponding Vector Modulation Analyzer reading for each of the phase marker settings. The dc accuracy for each measurement should be $0 \pm 2\%$.

Note

If any measurements are out of specification, refer to the next section to calculate a correction factor to account for measurement inaccuracies. If all measurements are within specification, the results should be copied into Table 4-2 and the correction factors can be ignored.

CORRECTION FACTORS

The specification for dc accuracy is presented as a percentage of full scale. In this test, full scale is assumed to be the magnitude of the signal when the network analyzer is normalized. However, since this point is also subject to the accuracy specification, an average of full scale values must be used to normalize the Vector Modulation Analyzer measurements to the network analyzer measurements.

In most cases, selecting the first full scale signal as the full scale value is sufficient to verify that the instrument is within specification. However, if the reference selected is at one extreme (maximum or minimum), the test may not pass if another full scale value is at the other extreme. An indication that the correction factor should be applied is if the signs of the dc accuracy errors tend to be more positive and the worst case positive error is larger than the worst case negative error (or vice versa).

To correct for this error, a scaling factor must be calculated to scale all of the measured values according to the average full scale reading. For example, if the average full scale is 99% (instead of 100% as set up by the measurement), all of the values must be multiplied by a scaling factor so that the two measurements correspond to 100.5% and 99.5% ($100\% \pm 0.5\%$). This reduces the error measured to within the specification.

To determine the scaling factor, use the following procedure:

- a. Average the four I or Q full scale values recorded in the Full Scale Values table above. These four values represent the four full scale values measured by the Vector Modulation Analyzer. The average of the four values should be close to 100%

_____ I/Q Full Scale Average

- b. Average the four Real or Imaginary full scale values recorded in the Full Scale Values table above. These four values represent the four full scale values measured by the network analyzer. The average of the four values should be close to 100%.

_____ Re/Im Full Scale Average

- c. Calculate the correction factor by dividing the Re/Im Full Scale Average by the I/Q Full Scale Average. For example, if the I/Q Full Scale Average is 99.8% and the Re/Im Full Scale Average is 100.5%, the correction factor would be $(100.5\%/99.8\%)=1.007$.

_____ Correction Factor

- d. Multiply each of the I and Q measurements in the Corrected dc Accuracy Results by the correction factor and record the results below and in Table 4-2. All measurements should be within 2% of the expected value.

dc Accuracy

Phase Marker Setting	RF Level	I Channel dc Accuracy	Q Channel dc Accuracy
45°	+1 dBm	_____ %	_____ %
45°	-2 dBm	_____ %	_____ %
45°	-5 dBm	_____ %	_____ %
45°	-8 dBm	_____ %	_____ %
135°	+1 dBm	_____ %	_____ %
135°	-2 dBm	_____ %	_____ %
135°	-5 dBm	_____ %	_____ %
135°	-8 dBm	_____ %	_____ %
225°	+1 dBm	_____ %	_____ %
225°	-2 dBm	_____ %	_____ %
225°	-5 dBm	_____ %	_____ %
225°	-8 dBm	_____ %	_____ %
315°	+1 dBm	_____ %	_____ %
315°	-2 dBm	_____ %	_____ %
315°	-5 dBm	_____ %	_____ %
315°	-8 dBm	_____ %	_____ %

Hewlett-Packard Company
 Model HP 8981A
 Vector Modulation Analyzer

Tested By _____

Serial Number _____

Date _____

Table 4-2. Performance Test Record

Para. No.	Test	Min. Result	Actual Result	Max. Result
4-8.	BANDWIDTH TEST			
	I Channel Bandwidth		_____ (✓)	
	Q Channel Bandwidth		_____ (✓)	
4-9.	DC VECTOR ACCURACY TEST			
	Vector Accuracy, 10 mV/div gain			
	Channel I, 50 mV offset	-2 mV	_____	+2 mV
	Channel Q, 50 mV offset	-2 mV	_____	+2 mV
	Channel I, -50 mV offset	-2 mV	_____	+2 mV
	Channel Q, -50 mV offset	-2 mV	_____	+2 mV
	Vector Accuracy, 20 mV/div gain			
	Channel I, 100 mV offset	-3 mV	_____	+3 mV
	Channel Q, 100 mV offset	-3 mV	_____	+3 mV
	Channel I, -100 mV offset	-3 mV	_____	+3 mV
	Channel Q, -100 mV offset	-3 mV	_____	+3 mV
	Vector Accuracy, 40 mV/div gain			
	Channel I, 200 mV offset	-6 mV	_____	+6 mV
	Channel Q, 200 mV offset	-6 mV	_____	+6 mV
	Channel I, -200 mV offset	-6 mV	_____	+6 mV
	Channel Q, -200 mV offset	-6 mV	_____	+6 mV
	Vector Accuracy, 100 mV/div gain			
	Channel I, 500 mV offset	-15 mV	_____	+15 mV
Channel Q, 500 mV offset	-15 mV	_____	+15 mV	
Channel I, -500 mV offset	-15 mV	_____	+15 mV	
Channel Q, -500 mV offset	-15 mV	_____	+15 mV	
Vector Accuracy, 200 mV/div gain				
Channel I, 1.000V offset	-30 mV	_____	+30 mV	
Channel Q, 1.000V offset	-30 mV	_____	+30 mV	

Table 4-2. Performance Test Record (Cont.)

Para. No.	Test	Min. Result	Actual Result	Max. Result
4-9.	DC VECTOR ACCURACY TEST (Cont.)			
	Channel I, -1.000V offset	-30 mV	_____	+30 mV
	Channel Q, -1.000V offset	-30 mV	_____	+30 mV
	Vector Accuracy, 400 mV/div gain			
	Channel I, 2.000V offset	-60 mV	_____	+60 mV
	Channel Q, 2.000V offset	-60 mV	_____	+60 mV
4-10.	Channel I, -2.000V offset	-60 mV	_____	+60 mV
	Channel Q, -2.000V offset	-60 mV	_____	+60 mV
4-11.	DC VECTOR ACCURACY TEST (Cont.)			
	Vector Accuracy, 1V/div gain			
	Channel I, 2.500V offset	-75 mV	_____	+75 mV
	Channel Q, 2.500V offset	-75 mV	_____	+75 mV
	Channel I, -2.500V offset	-75 mV	_____	+75 mV
	Channel Q, -2.500V offset	-75 mV	_____	+75 mV
4-11.	I VERSUS Q DIFFERENTIAL VOLTAGE ACCURACY TEST			
	I versus Q Differential Voltage Accuracy	-1%	_____	+1%
	DELTA TIME ACCURACY TEST			
	Delta Time Accuracy - 125 MHz	7.76 ns	_____	8.24 ns
	Delta Time Accuracy - 12.5 MHz	77.6 ns	_____	82.4 ns
4-12.	Delta Time Accuracy - 1.25 MHz	776 ns	_____	824 ns
	Delta Time Accuracy - 125 kHz	7.76 μ s	_____	8.24 μ s
	Delta Time Accuracy - 12.5 kHz	77.6 μ s	_____	82.4 μ s
	I VERSUS Q TIMING ACCURACY TEST			
	I versus Q Timing Accuracy - 50 MHz		_____	0.5 ns
4-12.	I versus Q Timing Accuracy - 10 MHz		_____	1 ns
	I versus Q Timing Accuracy - 1 MHz		_____	10 ns
	I versus Q Timing Accuracy - 100 kHz		_____	100 ns
	I versus Q Timing Accuracy - 10 kHz		_____	1 μ s

Table 4-2. Performance Test Record (Cont.)

Para. No.	Test	Min. Result	Actual Result	Max. Result
4-13.	MINIMUM TRIGGER LEVEL TEST Minimum INT Trigger Level - 80 MHz		_____	2 div. p-p
	Minimum INT Trigger Level - 150 MHz		_____	3 div. p-p
	Minimum EXT Trigger Level - 80 MHz		_____	2 div. p-p
	Minimum EXT Trigger Level - 150 MHz		_____	4 div. p-p
4-14.	RF INPUT FREQUENCY RANGE TEST RF Input Frequency Range (50-200 MHz)		_____ (✓)	
4-15.	FULL SCALE INPUT RANGE TEST -5.0 dBm		_____ (S)	
	-10.0 dBm		_____ (S)	
	-15.0 dBm		_____ (S)	
	-20.0 dBm		_____ (S)	
4-16.	DEMODULATED I AND Q BANDWIDTH TEST External Filter Bandwidth >100 MHz		_____ (✓)	
4-17.	DEMODULATED I VERSUS Q TIMING ACCURACY TEST 70 MHz		_____	_____ ns
	140 MHz		_____	_____ ns
	200 MHz		_____	_____ ns
4-18.	CORRECTED DC ACCURACY TEST I error: 45° +1 dBm	-2%	_____	+2%
	-2 dBm	-2%	_____	+2%
	-5 dBm	-2%	_____	+2%
	-8 dBm	-2%	_____	+2%
	Q error: 45° +1 dBm	-2%	_____	+2%
	-2 dBm	-2%	_____	+2%
	-5 dBm	-2%	_____	+2%
	-8 dBm	-2%	_____	+2%

Table 4-2. Performance Test Record (Cont.)

Para. No.	Test	Min. Result	Actual Result	Max. Result
4-18.	CORRECTED DC ACCURACY TEST (Cont.)			
	I error: 135°			
	+1 dBm	-2%	_____	+2%
	-2 dBm	-2%	_____	+2%
	-5 dBm	-2%	_____	+2%
	-8 dBm	-2%	_____	+2%
	Q error: 135°			
	+1 dBm	-2%	_____	+2%
	-2 dBm	-2%	_____	+2%
	-5 dBm	-2%	_____	+2%
	-8 dBm	-2%	_____	+2%
	I error: 225°			
	+1 dBm	-2%	_____	+2%
	-2 dBm	-2%	_____	+2%
	-5 dBm	-2%	_____	+2%
	-8 dBm	-2%	_____	+2%
	Q error: 225°			
	+1 dBm	-2%	_____	+2%
	-2 dBm	-2%	_____	+2%
	-5 dBm	-2%	_____	+2%
	-8 dBm	-2%	_____	+2%
	I error: 315°			
	+1 dBm	-2%	_____	+2%
	-2 dBm	-2%	_____	+2%
	-5 dBm	-2%	_____	+2%
	-8 dBm	-2%	_____	+2%
	Q error: 315°			
	+1 dBm	-2%	_____	+2%
-2 dBm	-2%	_____	+2%	
-5 dBm	-2%	_____	+2%	
-8 dBm	-2%	_____	+2%	

A

Index

16QAM: 3-74, 3-92, 3-96, 3-97, 3-170, 3-171, 3-186, 3-212, 3-224,
3-244, 3-255, 3-256, 3-278

256QAM: 3-74, 3-92, 3-96, 3-97, 3-170, 3-171, 3-186, 3-244, 3-255,
3-256, 3-278

25PRS: 3-74, 3-92, 3-96, 3-97, 3-170, 3-171, 3-186, 3-244, 3-255,
3-256, 3-278

3-dimensional display: 3-112, 3-122, 3-174, 3-180, 3-201, 3-208, 3-214,
3-222, 3-227, 3-237, 3-243, 3-255, 3-258

49PRS: 3-74, 3-92, 3-96, 3-97, 3-170, 3-171, 3-186, 3-244, 3-255,
3-256, 3-278

50 Ω BNC adapters: 2-6, 2-7

50 Ω replacement BNC adapters: 2-7

64QAM: 3-74, 3-92, 3-96, 3-97, 3-170, 3-171, 3-186, 3-244, 3-255,
3-256, 3-257, 3-278

75 Ω BNC adapters: 1-5, 2-7

75 Ω replacement BNC adapters: 2-7

81PRS: 3-74, 3-92, 3-96, 3-97, 3-170, 3-171, 3-186, 3-244, 3-255,
3-256, 3-278

8PSK: 3-100, 3-102, 3-106

9PRS: 3-74, 3-92, 3-96, 3-97, 3-170, 3-171, 3-186, 3-244, 3-255,
3-256, 3-278

Abbreviated performance test: 4-2
bandwidth and timing accuracy: 4-4
corrected DC accuracy: 4-20
demodulated bandwidth and timing: 4-15
DC vector and differential accuracy: 4-9
RF input: 4-12
turn-on check: 4-3

Abbreviated Performance Test Record table: 4-25

AC coupling: 3-181

Analysis opcode execution errors: 3-139

ANSI standard MC1.1: 1-4, 3-9

Arbitrary block program data: 3-156

ASCII character format: 3-78, 3-82, 3-84

ASCII data format: 3-20

Autoscope HP-IB program code table: 3-69

Autoscope status messages: 3-70

Autoscope: 3-64

- full scale magnitude: 3-65, 3-66
- I channel gain and offset: 3-64, 3-66
- Q channel gain and offset: 3-64, 3-66
- time base: 3-65, 3-67
- triggering: 3-65, 3-67

Autotransformer: 2-2

Bench operation: 2-9

Bit 1 event register enable field: 3-25, 3-28

Bit 1 event register: 3-23, 3-25, 3-27, 3-28

Bit 1 falling edge register: 3-25, 3-28

Bit 1 rising edge register: 3-25, 3-28

Bit 1 status register: 3-25, 3-26, 3-27, 3-28

Bit 7, require service: 3-31

Block data format: 3-20, 3-78

Bus command

- Device Clear (DCL): 3-10
- Go To Local (GTL): 3-10, 3-21
- Parallel Poll Configure (PPC): 3-22
- Parallel Poll Enable (PPE): 3-12, 3-22
- Parallel Poll Unconfigure (PPU): 3-23
- Selected Device Clear (SDC): 3-10
- Serial Poll Enable (SPE): 3-11, 3-22

Calibration factors: 3-71, 3-126, 3-127, 3-140, 3-141, 3-150, 3-151, 3-152, 3-153

Calibration HP-IB program code table: 3-72

Calibration information (error messages): 3-144

Calibration messages: 3-72

Change pages: 1-3

Character data: 3-155

Chassis slide mount kit: 1-6

Chassis tilt slide mount kit: 1-6

Clearing current corrections: 3-108

Coaxial connectors: 2-9

Coherent reference phase: 3-94, 3-98

Constellation align display: 3-112, 3-122, 3-123, 3-174, 3-180, 3-201, 3-214, 3-222, 3-237, 3-243, 3-254, 3-255

Constellation analysis: 3-96, 3-99, 3-123, 3-137, 3-138, 3-139, 3-209, 3-211, 3-212, 3-213, 3-214, 3-254

Constellation display: 1-3, 3-74, 3-112, 3-122, 3-123, 3-171, 3-176, 3-187, 3-201, 3-209, 3-211, 3-212, 3-218, 3-222, 3-240, 3-245, 3-254, 3-263, 3-278, 3-279

Constellation Display HP-IB program code table: 3-76

Constellation points: 3-133, 3-211, 3-212, 3-213

Correction factors: 3-64, 3-93, 3-99, 3-100, 3-101, 3-125, 3-142, 3-143, 3-229, 3-247, 3-248, 3-250, 3-253, 4-21, 4-62, 4-68, 4-71, 4-75

COHERENT CARRIER input: 3-59, 3-91, 3-92, 3-95, 3-102, 3-104, 3-106, 3-145, 3-146, 4-12, 4-13, 4-15, 4-21, 4-52, 4-53, 4-56, 4-58, 4-63, 4-64, 4-69

Data field separators: 3-154

Data gathering and HP-IB transmission: 3-77

Data Gathering and HP-IB Transmission HP-IB program code table: 3-86

Data input format: 3-15

Data message: 3-9

Data output format: 3-20

DAC limit errors: 3-150, 3-151, 3-152

DATA commands: 3-78

DC coupling: 3-181

Decision break boundaries: 3-210, 3-211, 3-212

Defined block length field: 3-159

Definite length block data: 3-153

Definite length block format: 3-82

Delay Selection HP-IB program code table: 3-90

Delay: 3-88, 3-129, 3-130, 3-168, 3-231, 3-271, 4-8, 4-18, 4-22, 4-42, 4-44, 4-46, 4-47, 4-48, 4-65

Delta I marker: 3-127, 3-136, 3-174, 3-175, 3-176, 3-177, 3-180, 4-19, 4-23, 4-28, 4-66

Delta magnitude marker: 3-123, 3-128, 3-136, 3-202, 3-203, 3-204, 3-207, 3-208, 4-15, 4-17

Delta phase marker: 3-222, 3-223, 3-224, 3-227

Delta Q marker: 3-128, 3-136, 3-237, 3-239, 3-242, 3-243, 4-19, 4-23, 4-29, 4-67

Delta time marker: 3-128, 3-266, 3-267, 3-268, 3-269, 3-271, 4-7, 4-20, 4-41, 4-67

Demodulation HP-IB program code table: 3-97, 3-98

Demodulator corrections: 3-64, 3-91, 3-92, 3-102, 3-247

Demodulator Corrections HP-IB program code table: 3-110

Device Under Test (DUT): 3-91

Dimensions: 1-10

Display areas: 3-114

Display identification area: 3-114, 3-173, 3-214, 3-229, 3-246, 3-258

Display modes: 3-112

Display, General HP-IB program code table: 3-117

Environment: 2-1

Error messages and recovery: 3-118

Error messages (display area): 3-114

Error message: 1-4

Event status register enable field: 3-31

Event status register: 3-23, 3-24, 3-29, 3-31, 3-120
command error: 3-24, 3-30
device dependent error: 3-24, 3-30

Event status register (Cont.)
 execution error: 3-24, 3-30
 operation complete: 3-24, 3-30
 power fail: 3-24, 3-30
 query error: 3-24, 3-30

Exponential numeric data format: 3-20

Expression data: 3-159

External demodulator: 1-3, 3-91, 3-93, 3-100, 3-101, 3-102, 3-104,
 3-106, 3-108, 3-110, 3-247, 3-250

External filter inputs: 3-94

EXT TRIG INPUT: 1-5, 3-71, 3-72, 3-272, 4-49

Firmware revision date: 3-184, 3-185

Firmware version number: 3-184, 3-185

First Level Menu Softkeys to KEY Command Numbers table: 3-192

Formula for interpreting data: 3-80, 3-83, 3-84

Fourth Level Menu Softkeys to KEY Command Numbers table: 3-198

Front handle kit: 1-4

Front Panel Key to KEY Command Number table: 3-191

Full scale magnitude: 3-135, 3-202, 3-229

Function command: 3-15, 3-16

Functions not directly programmable via HP-IB: 3-14, 3-189, 3-200

Fuse selection: 2-2

Gain correction: 3-100, 3-105, 3-110, 3-134, 4-14, 4-22, 4-55, 4-57,
 4-68, 4-71

Gain: 3-129, 3-130, 3-231, 4-33, 4-34, 4-35

Graphics printer: 1-6

Ground coupling: 3-181, 3-182

Ground reference: 3-181

Group Execute Trigger: 3-158

Hewlett-Packard Interface Bus: 3-9

HELP function: 3-124

HELP key: 3-168

HP 1124A Active Divider Probe: 1-5

HP 11739A Support Kit: 1-6

HP 11748A Active Probe Set: 1-5

HP 2225A Thinkjet printer: 1-6, 3-232

HP 3709A/B compatibility: 3-18

HP-IB address selection: 2-4

HP-IB address: 2-1, 2-4, 2-5, 3-128, 3-189

HP-IB annunciators: 3-53

HP-IB configuration

talk and listen: 3-20

talk only: 3-20

HP-IB firmware errors: 3-160

HP-IB interface connector: 2-9

HP-IB message

Abort: 3-12, 3-13, 3-15, 3-20, 3-23

Clear Lockout/Set Local: 3-11, 3-12, 3-13, 3-21

Clear (DCL): 3-12

Clear (SDC): 3-12

Clear: 3-10, 3-13, 3-22

Data: 3-10, 3-12, 3-13, 3-14, 3-15, 3-16, 3-20

Device Clear (DCL): 3-20

Local Lockout: 3-11, 3-12, 3-13

Local: 3-10, 3-12, 3-13

Pass Control: 3-21

Pass Control/Take Control: 3-11

Remote: 3-10, 3-21

Require Service: 3-11, 3-12, 3-13, 3-22

Selected Device Clear (SDC): 3-20

Status Bit: 3-12, 3-13, 3-22

Status Byte: 3-11, 3-13, 3-14, 3-22

Trigger: 3-10, 3-21

HP-IB program code: 3-189

HP-IB status: 2-6

TALK ONLY: 2-6, 3-121, 3-233

TALK/LISTEN: 2-6, 3-121

I marker setup: 3-174

I marker: 3-129, 3-136, 3-174, 3-175, 3-176, 3-179, 3-180, 4-6, 4-23,
4-28

I Marker Setup HP-IB program code table: 3-179

I offset correction: 3-100, 3-134

I offset: 3-135

I versus time display: 3-112, 3-122, 3-123, 3-170, 3-186, 3-187, 3-201,
3-208, 3-222, 3-227, 3-237, 3-243, 3-263, 3-266, 3-268, 3-269, 4-22

I Versus Time Display HP-IB program code table: 3-188

I/Q gain ratio correction: 3-100, 3-110, 3-134

I/Q gain ratio: 3-65, 3-134

I-Q measurements: 3-209, 3-211, 3-213, 3-214, 4-10, 4-24, 4-32, 4-37,
4-73

IEEE standard 488: 1-4, 3-9

IEEE standard 488.2: 3-20, 3-78, 3-120, 3-153, 3-154

Impedance selection: 2-1, 2-6

Increment commands: 3-79

Indefinite length block data: 3-156

Initial inspection: 2-1

Input coupling: 3-181, 3-189

Input Coupling HP-IB program code table: 3-183

Instrument information: 3-184

Instrument Information HP-IB program code table: 3-185

Instrument state registers: 3-70

Integer numeric data format: 3-20

Intensity shutoff feature: 3-73, 3-112, 3-117

Interconnection: 2-1, 2-6

Interface functions

AH1: 1-4, 3-9

CO: 1-4, 3-9

DC1: 1-4, 3-9

DT0: 1-4, 3-9

E2: 1-4, 3-9

L3: 1-4, 3-9

Interface functions (Cont.)

LE0: 1-4, 3-9
PPI: 1-4, 3-9
RL1: 1-4, 3-9
SH1: 1-4, 3-9
SR1: 1-4, 3-9
T5: 1-4, 3-9
TE0: 1-4, 3-9

Internal demodulator: 1-3, 3-91, 3-93, 3-99, 3-100, 3-101, 3-102,
3-104, 3-106, 3-108, 3-110, 3-247, 3-250, 3-272, 4-13, 4-53

Interpreting data: 3-80

I&Q versus time display: 3-112, 3-170, 3-201, 3-208, 3-222, 3-227,
3-263, 3-266

I&Q Versus Time Display HP-IB program code table: 3-172

KEY command number: 3-159, 3-189, 3-200

KEY command: 3-189

KNOB key indicator: 3-53

Line voltage selection: 2-1, 2-2

Listen only mode: 3-233, 3-234

Local capability: 3-13

Local lockout: 3-13

Local-to-remote mode changes: 3-12

Lock: 1-3, 3-209, 3-210, 3-211, 3-212, 3-214

Low pass filter parts listing: 1-16

Low pass filter schematic diagram: 1-16

Low pass filters: 3-91, 3-93, 3-94

Low repetition rate signals: 3-260

Magnitude marker setup: 3-201

Magnitude marker: 3-123, 3-131, 3-135, 3-201, 3-202, 3-203, 3-207, 3-218,
4-15, 4-17, 4-18, 4-54, 4-57, 4-61, 4-65, 4-71

Magnitude Marker Setup HP-IB program code table: 3-206

Manual corrections: 3-106, 3-111
gain correction: 3-107
I offset correction: 3-107
I/Q gain ratio correction: 3-107
quadrature correction: 3-107
Q offset correction: 3-107

Manual modification package: 1-3

Measurement capability: 1-3

Measurement functions: 3-138, 3-139, 3-209, 4-11

Measurement Functions HP-IB program code table: 3-213

Menu softkeys: 3-216
entry prefix softkeys: 3-216
second or third level menu activators: 3-216
simple setup softkeys: 3-216
toggle softkeys: 3-216
units terminators: 3-216

Menu tree: 3-169

Metric adapters for non-HP rack enclosures: 1-6

Microfiche manual: 1-1

Microprocessor errors: 3-124, 3-125, 3-138, 3-139, 3-140, 3-141, 3-144,
3-152

Mounting: 2-1

Numeric data: 3-157, 3-158, 3-159, 3-160
exponential: 3-17
floating point: 3-17
integer: 3-17

Offset HP-IB program code table: 3-220

Offset: 3-129, 3-130, 3-175, 3-180, 3-218, 3-219, 3-220, 3-221, 3-231,
3-238, 3-243, 4-11, 4-32, 4-33, 4-34

Operating environment: 2-9

Operation verification: 4-2

Operator's check: 3-53
demodulator check: 3-59
display check: 3-55
markers check: 3-57
preliminary check: 3-53

Origin commands: 3-79

Original packaging: 2-10

Other packaging: 2-10

Parallel poll enable field: 3-33

Parallel poll: 3-33

Parameter Data Area (PDA): 3-76, 3-90, 3-114, 3-117, 3-173, 3-174,
3-179, 3-188, 3-201, 3-202, 3-207, 3-214, 3-217, 3-221, 3-222, 3-223,
3-227, 3-229, 3-237, 3-239, 3-242, 3-246, 3-258, 3-264, 3-266, 3-267,
3-271, 3-280

Percent closure: 1-3, 3-209, 3-214

Performance tests: 2-1, 4-1

bandwidth test: 4-27

corrected DC accuracy test: 4-68

delta time accuracy test: 4-39

demodulated I and Q bandwidth test: 4-58

demodulated I versus Q timing accuracy test: 4-63

DC vector accuracy test: 4-30

full scale input range test: 4-55

I versus Q timing accuracy test: 4-44

I Versus Q differential voltage accuracy test: 4-36

minimum trigger level test: 4-49

RF input frequency range test: 4-52

Performance Test Record table: 4-1, 4-77

Phase adjust: 3-64, 3-221, 3-277

Phase error: 3-98, 3-99, 3-209

Phase marker setup: 3-222

Phase marker: 3-218, 3-222, 3-223, 3-226, 3-227, 4-73, 4-74

Phase Marker Setup HP-IB program code table: 3-226

Phase offset adjust: 3-92, 3-211, 3-212

Phase offset error: 3-92

Phase offset: 3-94, 3-99, 3-133

Power cable: 1-5, 2-1, 2-2

Power consumption: 2-2

Power requirements: 2-1, 2-2

Power-up diagnostics: 1-4

POIN command: 3-77

Preset Conditions table: 3-228

Preset: 3-228, 3-247

Print function: 3-121

Print points: 3-132, 3-232, 3-233, 3-234, 3-235

Printer, Use With HP-IB program code table: 3-235

Printer,use with: 3-231

Probe connectors: 2-9

Programming numeric data: 3-17

PREV MENU key: 3-216

PROBE POWER output: 1-5

Q marker setup: 3-237

Q marker: 3-130, 3-136, 3-237, 3-238, 3-239, 3-242, 3-243, 4-6, 4-23, 4-29

Q Marker Setup HP-IB program code table: 3-242

Q offset correction: 3-100, 3-134

Q offset: 3-135

Q versus time display: 3-112, 3-122, 3-123, 3-170, 3-174, 3-180, 3-201, 3-208, 3-222, 3-227, 3-244, 3-245, 3-246, 3-263, 3-266

Q Versus Time Display HP-IB program code table: 3-246

QPSK: 3-74, 3-92, 3-96, 3-97, 3-101, 3-170, 3-171, 3-186, 3-204, 3-210, 3-224, 3-244, 3-255, 3-256, 3-278

Quad: 3-209, 3-211, 3-212, 3-214

Quadrature adjust: 3-64, 3-92, 3-95, 3-130, 3-211, 3-212, 3-221, 3-277

Quadrature correction: 3-133

Quadrature error correction: 3-101

Quadrature error: 1-3, 3-92, 3-96, 3-98, 3-99, 3-100, 3-101, 3-110, 3-209, 3-214

Quadrature, IQ ratio, and offset correction: 3-102, 3-104

Queries: 3-20, 3-153, 3-158

Rack flange and front handle combination kit: 1-4

Rack flange kit: 1-4

Rack mounting: 2-9

Recommended test equipment

coherent carrier signal generator: 1-15, 4-15, 4-17, 4-20, 4-59, 4-61, 4-73

digital voltmeter: 1-15, 4-9, 4-10, 4-11, 4-30, 4-31, 4-32

frequency counter: 1-15, 4-39, 4-41, 4-42, 4-43

function generator: 1-15, 3-53, 3-54, 3-56, 4-9, 4-11, 4-30, 4-31, 4-32, 4-33, 4-34, 4-35, 4-36, 4-37, 4-39, 4-42, 4-43, 4-44, 4-45, 4-46, 4-47, 4-48

low pass filter: 1-15, 4-59

network analyzer: 1-15, 4-68, 4-69, 4-70, 4-72, 4-73, 4-74, 4-75

power meter: 1-15, 4-12, 4-13, 4-14, 4-20, 4-21, 4-27, 4-28, 4-29, 4-52, 4-54, 4-55, 4-56, 4-59, 4-61

power sensor: 1-15, 4-12, 4-20, 4-27, 4-52, 4-53, 4-55, 4-59

power splitter: 4-5, 4-9, 4-12, 4-13, 4-16, 4-20, 4-27, 4-30, 4-36, 4-39, 4-44, 4-49, 4-52, 4-53, 4-55, 4-56, 4-59, 4-69

pulse generator: 4-16, 4-17, 4-63, 4-64

RF IN signal generator: 4-16, 4-17, 4-18, 4-20, 4-59, 4-61, 4-74

signal generator: 1-15, 3-53, 3-60, 3-111, 4-5, 4-6, 4-7, 4-12, 4-13, 4-14, 4-15, 4-21, 4-27, 4-28, 4-29, 4-39, 4-40, 4-41, 4-49, 4-50, 4-51, 4-52, 4-53, 4-54, 4-55, 4-56, 4-58, 4-63, 4-64, 4-65, 4-69

Recommended Test Equipment table: 1-15, 3-101, 4-1

critical specifications: 1-7, 1-15

recommended model: 1-7, 1-15

use: 1-15

Reference commands: 3-80

Reference frequency: 3-59, 3-108, 3-110, 3-133, 3-229, 3-247, 4-14, 4-15, 4-56, 4-58

Reference phase: 3-135

Remote capability: 3-12

Remote-to-local mode changes: 3-13

Repair tags (blue): 2-10, 3-53, 3-118

RF IN input: 1-5, 3-59, 3-91, 3-92, 3-95, 3-102, 3-104, 3-106, 3-111, 3-145, 3-146, 4-12, 4-13, 4-15, 4-21, 4-52, 4-53, 4-55, 4-56, 4-58, 4-63, 4-64, 4-69

Rotation about the horizontal display axis: 3-256

Rotation about the time axis: 3-255

Rotation about the vertical display axis: 3-256

Safety considerations: 1-1

Sample points: 3-77

Save and recall (demodulator corrections): 3-247
 Save and recall (instrument state): 3-251
 Save and Recall (Demodulator Corrections) HP-IB program code table: 3-249
 Save and Recall (Instrument State) HP-IB program code table: 3-252
 SCOPE FORMAT: 3-74, 3-96, 3-171, 3-186, 3-244, 3-256, 3-278
 Second Level Menu Softkeys to KEY Command Numbers table: 3-195
 Selecting educational 3-D display: 3-256
 Selecting external trigger level: 3-272
 Selecting internal I or internal Q trigger level: 3-273
 Selecting internal trigger signal coupling: 3-274
 Selecting trigger slope: 3-274
 Selecting trigger source: 3-272
 Serial number prefix: 1-3
 Serial number: 1-3
 Serial poll: 3-23
 Service request: 3-23, 3-25, 3-28, 3-29
 Set CW phase to reference phase function: 3-92
 Shipment: 2-1
 Signal intensity: 3-115, 3-117, 3-128, 3-173, 3-258
 Softkey menu area: 3-114, 3-117, 3-169
 SOURce command: 3-77
 Special display: 1-3, 3-254
 Special Display HP-IB program code table: 3-258
 Specifications table: 1-7
 Specifications: 1-1
 Bandwidth - I and Q inputs, AC coupled: 1-8, 4-27
 Bandwidth - I and Q inputs, DC coupled: 1-8, 4-27
 Baseband bandwidth with external filters: 1-7, 4-58
 Corrected vector DC accuracy: 1-7, 4-68
 DC vector accuracy: 1-8, 4-30

Specifications (Cont.)

Delay I&Q range: 1-8
 Delta time accuracy: 1-8, 4-39
 Dimensions: 1-9
 EMI: 1-9
 I delay, Q delay range: 1-8
 Input sensitivity: 1-8
 I or Q offset range: 1-8
 I versus Q differential voltage accuracy: 1-8, 4-36
 I versus Q timing accuracy: 1-7, 1-8, 4-44, 4-63
 Input carrier frequency range, modulated IF input: 1-7, 4-52
 Input frequency range, coherent reference input: 1-7, 4-52
 Input level range, coherent reference input: 1-7
 Input level range, modulated IF input: 1-7, 4-55
 Maximum external trigger input: 1-8
 Maximum input - I and Q inputs, AC coupled: 1-7
 Maximum input - I and Q inputs, DC coupled: 1-7
 Minimum trigger signal, external: 1-8, 4-49
 Minimum trigger signal, internal: 1-8, 4-49
 Net weight: 1-9
 Operating temperature range: 1-9
 Power dissipation: 1-9
 Power requirements, line frequency: 1-9
 Power requirements, line voltage: 1-9
 Time per division range: 1-8

Split screen function: 3-170, 3-173

Staggered modulation signals: 3-88

Standard inch rack adapters: 1-6

Status register enable field: 3-22, 3-25, 3-29, 3-31

Status register: 3-22, 3-23, 3-25, 3-28, 3-31
 events: 3-24
 message available: 3-24
 overdrive errors: 3-24
 require service: 3-24

Storage environment: 2-10

Storage Register Number (SRN): 3-251, 3-252

Storage: 2-1

String data delimiters: 3-159

String data: 3-156, 3-159

Subsystem command: 3-15, 3-16

Suffixes: 3-158
angle: 3-17
frequency: 3-18
percent: 3-18
power: 3-17
thousands: 3-17
time: 3-17
voltage: 3-17

Supplemental characteristics: 1-1

Supplemental Characteristics table: 1-11

Sweep selection: 3-260

Sweep Selection HP-IB program code table: 3-261

Symmetrical modulation pattern: 3-254

System level command: 3-15, 3-16

System level program codes: 3-15, 3-16

Tagging for service: 2-10

Terminator Menus table: 3-199

Third Level Menu Softkeys to KEY Command Numbers table: 3-197

Time base selection: 3-263

Time base: 3-131, 3-229, 3-231, 3-263, 3-264, 3-265, 4-19, 4-42, 4-66

Time Base Selection HP-IB program code table: 3-264

Time marker instant: 3-209, 3-266, 3-280

Time marker setup: 3-266

Time marker: 3-132, 3-209, 3-214, 3-266, 3-267, 3-268, 3-270, 3-271, 3-280, 4-7, 4-19, 4-41, 4-42, 4-43, 4-67

Time Marker Setup HP-IB program code table: 3-270

Timing jitter: 3-90

Trigger level: 3-131, 3-132, 3-137

Trigger setup: 3-272

Trigger Setup HP-IB program code table: 3-275

Two-leveled subsystem program codes: 3-15, 3-16

Universal unlisten command: 3-15

Universal untalk command: 3-20

User Interface Area (UIA): 3-76, 3-90, 3-114, 3-117, 3-169, 3-173, 3-174, 3-179, 3-185, 3-188, 3-201, 3-202, 3-207, 3-217, 3-220, 3-222, 3-223, 3-227, 3-229, 3-237, 3-239, 3-242, 3-246, 3-252, 3-253, 3-258, 3-264, 3-266, 3-267, 3-271, 3-276, 3-280

Vector align display: 3-112, 3-122, 3-123, 3-174, 3-180, 3-201, 3-214, 3-222, 3-237, 3-243, 3-255

Vector display: 1-3, 3-112, 3-122, 3-123, 3-186, 3-201, 3-218, 3-222, 3-254, 3-260, 3-266, 3-278, 3-279, 4-58, 4-63

Vector Display HP-IB program code table: 3-280

Vector modulation test system: 3-91, 3-92, 3-210

Voltage versus time display: 1-3, 3-186, 3-244, 3-262

Zeroing all rotational angles: 3-256