

Agilent 87421/2A Power Supply

Operating and Service Manual



Agilent Technologies

Notices

© Agilent Technologies, Inc. 1992, 1998, 2001, 2009

No part of this manual may be reproduced in any form or by any means (including electronic storage and retrieval or translation into a foreign language) without prior agreement and written consent from Agilent Technologies, Inc. as governed by United States and international copyright laws.

Manual Part Number

87421-90001

Edition

Third Edition, May 2009

Printed in Malaysia

Agilent Technologies, Inc.
Phase 3 Bayan Lepas Free Industrial Zone
Bayan Lepas, Penang 11900 Malaysia

Certification

Agilent Technologies certified that this product met its published specifications at the time of shipment from the factory. Agilent Technologies further certifies that its calibration measurements are traceable to the United States National Institute of Standards and Technology (NIST, formerly NBS), to the extent allowed by the Institute's calibration facility, and to the calibration facilities of other International Standards Organization members.

Warranty

The material contained in this document is provided "as is," and is subject to being changed, without notice, in future editions. Further, to the maximum extent permitted by applicable law, Agilent disclaims all warranties, either express or implied, with regard to this manual and any information contained herein, including but not limited to the implied warranties of merchantability and fitness for a particular purpose. Agilent shall not be liable for errors or for incidental or consequential damages in connection with the furnishing, use, or performance of this document or of any information contained herein. Should Agilent and the user have a separate written agreement with warranty terms covering the material in this document that conflict with these terms, the warranty terms in the separate agreement shall control.

Technology Licenses

The hardware and/or software described in this document are furnished under a license and may be used or copied only in accordance with the terms of such license.

Restricted Rights Legend

U.S. Government Restricted Rights. Software and technical data rights granted to the federal government include only those rights customarily provided to end user customers. Agilent provides this customary commercial license in Software and technical data pursuant to FAR 12.211 (Technical Data) and 12.212 (Computer Software) and, for the Department of Defense, DFARS 252.227-7015 (Technical Data - Commercial Items) and DFARS 227.7202-3 (Rights in Commercial Computer Software or Computer Software Documentation).

Safety Notices

CAUTION

A **CAUTION** notice denotes a hazard. It calls attention to an operating procedure, practice, or the like that, if not correctly performed or adhered to, could result in damage to the product or loss of important data. Do not proceed beyond a **CAUTION** notice until the indicated conditions are fully understood and met.

WARNING

A **WARNING** notice denotes a hazard. It calls attention to an operating procedure, practice, or the like that, if not correctly performed or adhered to, could result in personal injury or death. Do not proceed beyond a **WARNING** notice until the indicated conditions are fully understood and met.

WEEE Compliance



This product complies with the WEEE Directive (2002/96/EC) marking requirements. The affixed label indicates that you must not discard this electrical/electronic product in domestic household waste.

Product Category: With reference to the equipment types in the WEEE Directive Annex I, this product is classed as a “Monitoring and Control Instrumentation” product.

Do not dispose in domestic household waste.

To return unwanted products, contact your local Agilent office, or see www.agilent.com for more information.

Contacting Agilent

For more information, please contact your nearest Agilent office.

Americas

Canada	(877) 894-4414
Latin America	305 269 7500
United States	(800) 829-4444

Asia Pacific

Australia	1 800 629 485
China	800 810 0189
Hong Kong	800 938 693
India	1 800 112 929
Japan	81 426 56 7832
Korea	080 769 0800
Malaysia	1 800 888 848
Singapore	1 800 375 8100
Taiwan	0800 047 866
Thailand	1 800 226 008

Europe







Austria	0820 87 44 11
Belgium	32 (0) 2 404 93 40
Denmark	45 70 13 15 15
Finland	358 (0) 10 855 2100
France	0825 010 700
Germany	01805 24 6333
Ireland	1890 924 204
Italy	39 02 92 60 8484
Netherlands	31 (0) 20 547 2111
Spain	34 (91) 631 3300
Sweden	0200-88 22 55
Switzerland (French)	41 (21) 8113811 (Opt 2)
Switzerland (German)	0800 80 53 53 (Opt 1)
United Kingdom	44 (0) 118 9276201
Other European Countries:	www.agilent.com/find/contactus



Or, go to www.agilent.com/find/assist for more information.

Safety and Regulatory Information

Review this product and related documentation to familiarize yourself with safety markings and instructions before you operate the instrument. This product has been designed and tested in accordance with international standards.

Instrument Markings

	When you see this symbol on your instrument, you should refer to the instrument's instruction manual for important information.
	This symbol indicates hazardous voltages.
	The laser radiation symbol is marked on products that have a laser output.
	This symbol indicates that the instrument requires alternating current (ac) input.
	The CE mark is a registered trademark of the European Community. If it is accompanied by a year, it indicates the year the design was proven.
	The CSA mark is a registered trademark of the Canadian Standards Association.
ISM1-A	This text indicates that the instrument is an Industrial Scientific and Medical Group 1 Class A product (CISPER 11, Clause 4).

ICES/NMB-001	ICES/NMB-001 indicates that this ISM device complies with Canadian ICES-001. Cet appareil ISM est conforme a la norme NMB-001 du Canada.
 N10149	The C-Tick mark is registered trademark of the Spectrum Management Agency of Australia. This signifies compliance with the Australian EMC Framework Regulations under the terms of the Radio communications Act of 1992.
	This symbol indicates that the power line switch is ON.
	This symbol indicates that the power line switch is OFF or in STANDBY position.

Safety Earth Ground

This is Safety Class I product (provided with a protective earthing terminal). An uninterruptible safety earth ground must be provided from the main power source to the product input wiring terminals, power cords, or supplied power cord set. Whenever it is likely that the protection has been impaired, the product must be made inoperative and secured against any unintended operation.

Before Applying Power

Verify that the product is configured to match the available main power source as described in the input power configuration instructions in this manual. If this product is to be powered by autotransformer, make sure the common terminal is connected to neutral (grounded) side of the ac power supply.

Declaration of Conformity

A copy of the Manufacturer's Declaration of Conformity for this instrument can be obtained by contacting your local Agilent Technologies sales representative.

Contents

1	Introduction	11
	Product Overview	12
	87421A Power Supply	12
	87422A Power Supply	13
2	Specifications	15
	Product Specifications	16
	Physical Specifications	17
	Environment Specifications	19
3	Operating and Service	21
	Operating and Service	22

Contents

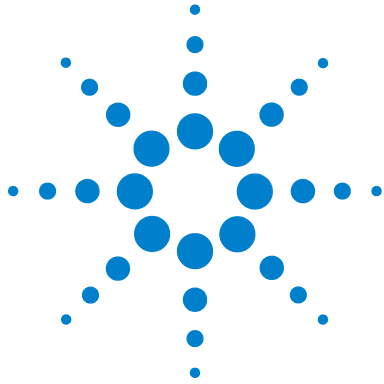

1 Introduction

Product Overview 12

“87421A Power Supply” on page 12

“87422A Power Supply” on page 13

This chapter provides you the overview of Agilent 87421A and 87422A power supply.



Product Overview

The 87421A and 87422A power supplies are universal input, dc switching power supplies designed to provide the bias voltages needed to operate microwave system amplifiers.



Figure 1 87421A and 87422A Power Supply

87421A Power Supply

The 87421A is a 25watt, $\pm 12\text{Vdc}$ power supply designed to power the 83006A, 83017A, and 87415A microwave system amplifiers.

- The power supply includes an AC power cord with protective ground for connection to 100- 240Vac.
- Also included is a 2 meter cable with a 3- pin connector on one end and a D- subminiature connector (83006- 60005) on the other end for direct connection to the microwave system amplifiers.

The 87421A may also be used to provide bias voltages for the 83440C high speed lightwave converter. Using the 83440- 60009 lightwave converter power supply adapter, the 87421A becomes a compact convenient power supply for use with the lightwave converter.

87422A Power Supply

The 87422A is a 90watt, $\pm 15\text{Vdc}$ power supply designed to power the 83020A microwave system power amplifier. One additional $\pm 12\text{V}$ dc output is provided to power a preamplifier such as the 83006A or 83017A.

The power supply includes an AC power cord with protective ground for connection to 100- 240Vac and two 2 meter cables:

- one cable (83006- 60005) with a 3- pin connector on one end and a D- subminiature connector on the other end
- one cable (87422- 60001) for direct connection to the 83020A amplifier



2 Specifications

Product Specifications	16
Physical Specifications	17
Environment Specifications	19

This chapter provides you the specifications of Agilent 87421A and 87422A power supply.



Product Specifications

Model Number	87421A	87422A
Output voltage/current	+12V at 2A -12V at 200mA	+15V at 4A -15V at 20mA +12V at 2A -12V at 200mA
Output power	25W	90W
Line regulation	0.1%	0.1%
Load regulation (20 % to full load)	2.0%	1.0%
Output ripple	25mV RMS max	25mV RMS max
Output noise	2% peak to peak max	2% peak to peak max
Overvoltage limit protected	Yes	Yes
Short circuit protection	Current limited for overload and short circuit protection. Normal operation returns upon removal of overload.	Current limited for overload and short circuit protection. Normal operation returns upon removal of overload.
AC input voltage	100 - 240Vac, 50/60Hz	100 - 240Vac, 50/60Hz
Fuse	1A, slow blow	T 3.15A

Physical Specifications

Model Number	87421A	87422A
Mechanical Dimensions	Figure 2	Figure 3
Weight	0.9kg (2.0lb)	2.1kg (4.6lb)
Shipping Weight	1.8kg (4.0lb)	3.2kg (7.0lb)

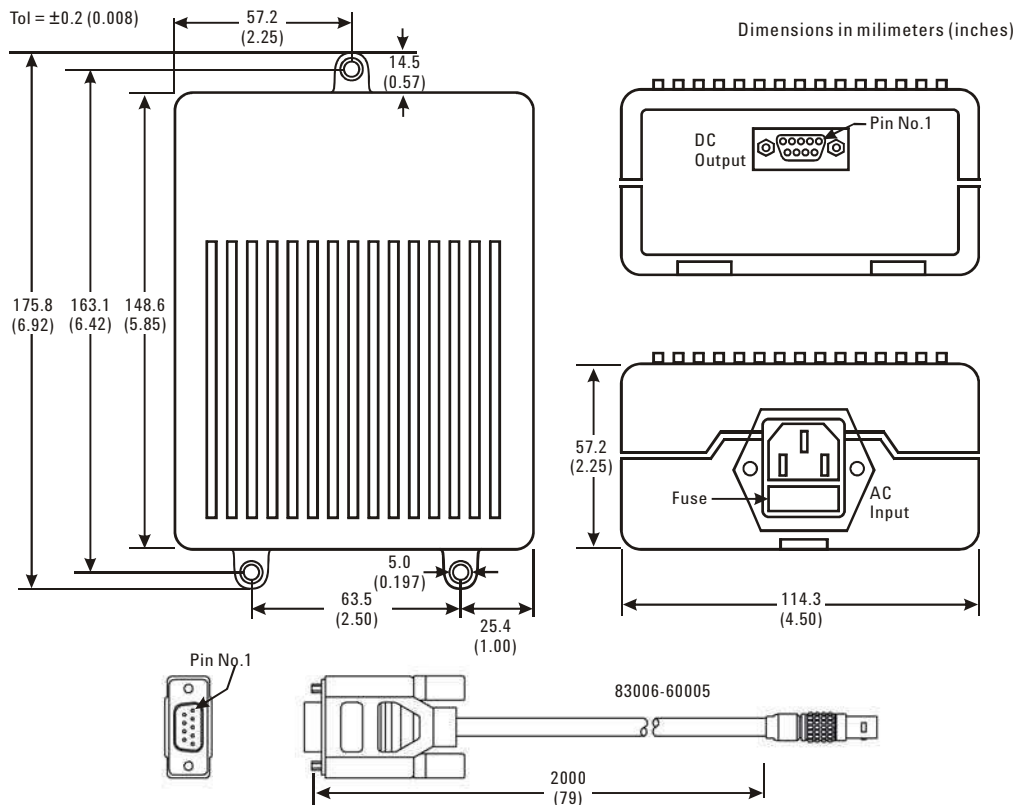

Figure 2 Mechanical Dimension of 87421A

2 Specifications

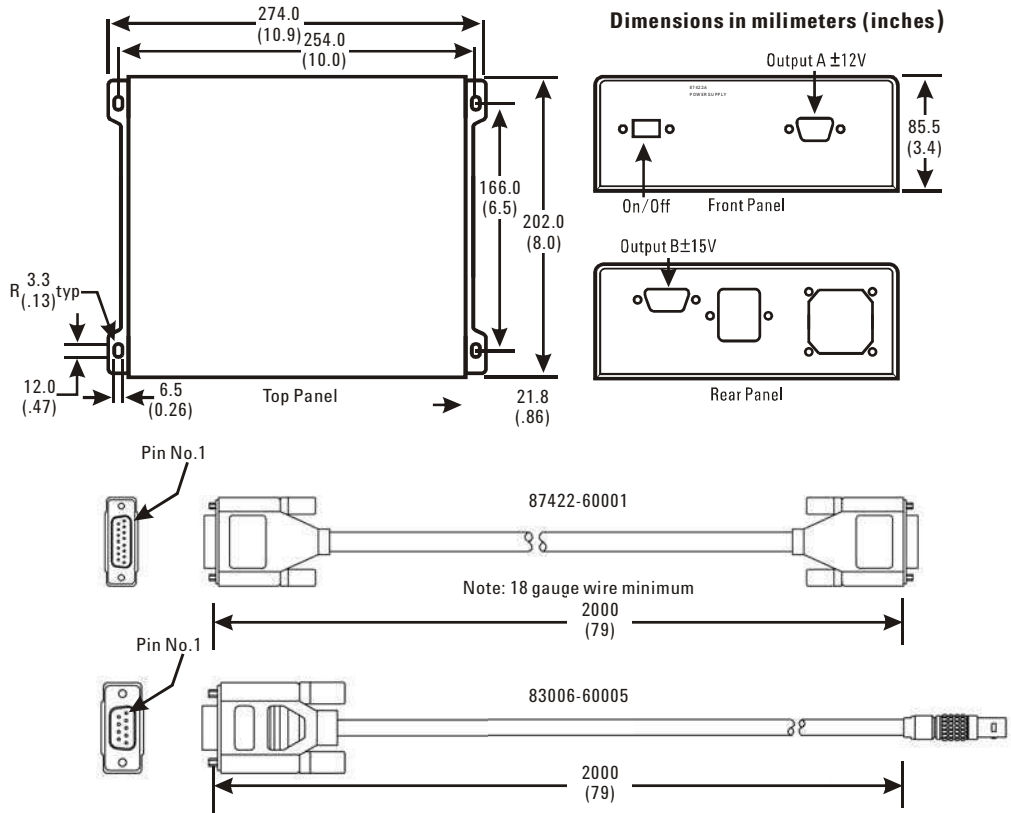
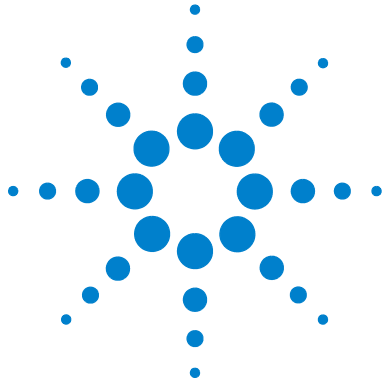

Figure 3 Mechanical Dimension of 87422A

Environment Specifications

Agilent Model Number	87421A and 87422A
Temperature	
• Operating	0°C to 55°C
• Storage	-40°C to 70°C
Humidity	
• Operating	15% to 95% RH at 40°C
• Non Operating Supersoak	90% RH at 65°C for 24 hours
• Condensation	After stabilizing at 50% RH/25°C, product shall be subjected to 95% RH at 40°C. Product shall suffer no damage and operate within specifications within 15min.
Shock	
• End Use Handling Shock	Half-sine shock, < 3ms duration, 155in/s ΔV , minimum 3 shocks each face
• Transportation Shock (Type 1)	Trapezoid shock, 30g acceleration, 292in/s ΔV , minimum 3 shocks each face
Vibration	
• Operating	Random: 0.0001 g^2 /hz for 5Hz to 350Hz, -6dB/octave for 350Hz to 500Hz, minimum 10min/axis for all 3 axes
• Survival	Random: 0.015 g^2 /Hz from 5Hz to 100 Hz, -6dB/octave from 100Hz to 137Hz, 0.008 g^2 /Hz from 137Hz to 350Hz, -6dB/octave from 350Hz to 500Hz, minimum 10min/axis for all 3 axes Swept Sine: Resonant search from 5Hz to 500Hz, 1octave/min sweep rate, 5min resonant dwell at 4 resonances/axis
Altitude	
• Operating	4,600m
• Storage	15,300m
ESD immunity	
• Direct Discharge	4kV
• Air Discharge	8kV

2 Specifications



3 Operating and Service

Operating and Service 22

This chapter provides you the operating instructions and service information.



Operating and Service

Operating Instructions

To operate the power supplies, connect the power supplies output to the amplifier dc input with the cable provided. The power supplies include a power cord with protective ground for connection to 100- 240Vac.

Mounting holes are provided as shown in the diagrams (Figure 2 and Figure 3). The power supplies may be mounted in any orientation with user supplied hardware.

NOTE

- To ensure continued compliance to product safety and EMC specifications, connect the power supplies to an amplifier only with the cable provided.
 - Do not attempt to modify or extend the dc output cable. Contact your local Agilent Technologies Sales and Service office for help with special applications requiring longer cables.
-

Fuse Replacement

The power supplies have a fuse located next to the IEC appliance inlet. If it is necessary to replace the fuse, disconnect the power supply from both AC power and the amplifier. Using a slotted screw driver, open the fuse cover and replace the fuse.

Service Information

The power supplies contain no user serviceable parts (with the exception of the fuse). If service is required, contact your nearest Agilent Technologies Service Center. Refer to “[Contacting Agilent](#)” on page 4.

Available Instruments and Accessories

- 83006A microwave system amplifier 0.01- 26.5GHz
- 83017A microwave system amplifier 0.5- 26.5GHz
- 83018A microwave system amplifier 2- 26.5GHz
- 83020A microwave system power amplifier 2- 26.5GHz
- 87415A microwave system amplifier 2- 8GHz
- 87405C microwave system pre-amplifier 0.1- 18GHz
- 83440- 60009 lightwave converter power supply adapter

