

---

## HP 8711B and HP 8713B RF Network Analyzers

The HP 8711B and 8713B are easy-to-use RF network analyzers optimized for production measurements of reflection and transmission parameters. The instrument integrates an RF synthesized source, transmission/reflection test set, multi-mode receivers, and display in one compact box.

The source features 1 Hz resolution, 50 ms (or faster) sweep time, and up to +16 dBm output power.

The three-channel, dual mode receivers provide dynamic range of greater than 100 dB in narrowband measurement mode. For measurements of frequency-translating devices, the network analyzer features broadband internal and external detector inputs. The receivers incorporate digital signal processing and microprocessor control to speed operation and measurement throughput.

Two independent measurement channels and a large CRT display the measured results of one or two receiver channels in several user-selectable formats.

Measurement functions are selected with front panel hardkeys and softkey menus. Measurements can be printed or plotted directly with a compatible peripheral. Instrument states can be saved to the internal floppy disk, internal non-volatile memory, internal volatile memory, or to a compatible external disk drive. Built-in service diagnostics are available to simplify troubleshooting procedures.

Measurement calibrations and data averaging provide performance improvement and flexibility. Measurement calibrations consist of normalizing data, utilizing the internal factory calibration, or calibrating with external standards. Measurement calibration reduces errors associated with directivity, frequency response, and source match. Directivity is corrected to 40 dB and source match to 20 dB for improved reflection measurements.

---

## How to Use This Guide

The first 7 chapters of this guide explain how to perform measurements, calibrate the instrument, and use the most common instrument functions.

Chapters 8 through 14 are reference material. Use these chapters to look up information such as front panel features, specific key functions and specifications.

---

## Contents

<b>1. Installing the Analyzer</b>	
Step 1. Check the Shipment . . . . .	1-3
Step 2. Meet Electrical and Environmental Requirements . . . . .	1-4
Step 3. Check the Analyzer Operation . . . . .	1-9
Step 4. Configure the Analyzer . . . . .	1-10
Connecting Peripherals and Controllers . . . . .	1-11
Installing the Analyzer In a Rack . . . . .	1-16
<b>2. Getting Started</b>	
Front Panel Tour . . . . .	2-3
Entering Measurement Parameters . . . . .	2-4
Performing the Operator's Check . . . . .	2-12
Equipment List . . . . .	2-13
Make a Transmission Measurement . . . . .	2-14
Make a Reflection Measurement . . . . .	2-16
If the Analyzer Fails the Operator's Check . . . . .	2-18
<b>3. Making Measurements</b>	
Measuring Devices with Your Network Analyzer . . . . .	3-3
When to Use Attenuation and Amplification in a Measurement Setup . . . . .	3-9
The Typical Measurement Sequence . . . . .	3-11
Using the BEGIN Key to Make Measurements . . . . .	3-12
BEGIN Key Overview . . . . .	3-13
Using the BEGIN Key To Configure Measurements . . . . .	3-15
The User BEGIN Function (Option 1C2 only) . . . . .	3-17
Measuring Transmission Response . . . . .	3-18
Enter the Measurement Parameters . . . . .	3-18
Calibrate For a Transmission Response Measurement . . . . .	3-19
Connect the DUT . . . . .	3-21
View and Interpret the Transmission Measurement Results . . . . .	3-22
Measuring Reflection Response . . . . .	3-24
Enter the Measurement Parameters . . . . .	3-24
Calibrate For a Reflection Response Measurement . . . . .	3-25
Connect the DUT . . . . .	3-27

View and Interpret the Reflection Measurement Results	3-28
Making a Broadband Power Measurement . . . . .	3-30
Enter the Measurement Parameters . . . . .	3-31
Connect the DUT . . . . .	3-32
View and Interpret the Power Measurement Results . . . . .	3-33
Measuring Conversion Loss . . . . .	3-35
Enter the Measurement Parameters . . . . .	3-37
Perform a Normalization Calibration . . . . .	3-38
Connect the DUT . . . . .	3-39
View and Interpret the Conversion Loss Results . . . . .	3-40
Measuring AM Delay (Option 1DA or 1DB) . . . . .	3-42
Enter the Measurement Parameters . . . . .	3-43
Calibrate For an AM Delay Measurement . . . . .	3-44
Connect the DUT . . . . .	3-45
View and Interpret the AM Delay Results . . . . .	3-46
Making Measurements with the Auxiliary Input . . . . .	3-48
Auxiliary Input Characteristics . . . . .	3-48
<b>4. Using Instrument Functions</b>	
Using Markers . . . . .	4-3
To Activate Markers . . . . .	4-5
To Turn Markers Off . . . . .	4-6
To Use Marker Search Functions . . . . .	4-7
To Use Marker Math Functions . . . . .	4-16
To Use Delta ( $\Delta$ ) Marker Mode . . . . .	4-22
To Use Other Marker Functions . . . . .	4-24
Using Limit Lines . . . . .	4-25
To Create a Flat Limit Line . . . . .	4-26
To Create a Sloping Limit Line . . . . .	4-27
To Create a Single Point Limit . . . . .	4-29
To Use Marker Limit Functions . . . . .	4-30
Other Limit Line Functions . . . . .	4-31
Additional Notes on Limit Testing . . . . .	4-32
Saving and Recalling Measurement Results . . . . .	4-35
Saving Instrument Data . . . . .	4-36
To Recall from a Disk or Internal Memory . . . . .	4-40
Other File Utilities . . . . .	4-41
To Use Directory Utilities . . . . .	4-44
Formatting a Floppy Disk . . . . .	4-46
Connecting and Configuring Printers and Plotters . . . . .	4-49
Select a Compatible Printer or Plotter . . . . .	4-49

Select an Appropriate Interface Cable . . . . .	4-50
Connect the Printer or Plotter . . . . .	4-51
Configure the Hardcopy Port . . . . .	4-52
Define the Printer or Plotter Settings . . . . .	4-54
Printing and Plotting Measurement Results . . . . .	4-57
To Select the Copy Port . . . . .	4-57
Define the Output . . . . .	4-58
Using a Keyboard . . . . .	4-62
To Connect the Keyboard . . . . .	4-62
To Use the Keyboard to Edit . . . . .	4-63
Keyboard Front Panel Equivalents . . . . .	4-64

## 5. Optimizing Measurements

Increasing Sweep Speed . . . . .	5-3
To Increase the Start Frequency . . . . .	5-3
To Set the Sweep Time to AUTO Mode . . . . .	5-4
To Widen the System Bandwidth . . . . .	5-4
To Reduce the Amount of Averaging . . . . .	5-5
To Reduce the Number of Measurement Points . . . . .	5-5
To View a Single Measurement Channel . . . . .	5-6
To Turn Off Alternate Sweep . . . . .	5-7
To Turn Off Markers and Marker Tracking . . . . .	5-7
To Turn Off Spur Avoidance . . . . .	5-8
To Avoid Frequency Bandcrossings by Minimizing the Span (HP 8713B only) . . . . .	5-9
Increasing Network Analyzer Dynamic Range . . . . .	5-10
To Increase the Receiver Input Power . . . . .	5-10
To Reduce the Receiver Noise Floor . . . . .	5-11
Reducing Trace Noise . . . . .	5-13
To Activate Averaging for Reducing Trace Noise . . . . .	5-13
To Change System Bandwidth for Reducing Trace Noise . . . . .	5-14
To Eliminate Receiver Spurious Responses . . . . .	5-14
Reducing Mismatch Errors . . . . .	5-17
Reducing Mismatch Errors in a Reflection Measurement . . . . .	5-17
Reducing Mismatch Errors in a Transmission Measurement . . . . .	5-18
Reducing Mismatch Errors When Measuring Both Reflection and Transmission . . . . .	5-18
Measuring Devices with Long Electrical Delay . . . . .	5-19

<b>6. Calibrating for Increased Measurement Accuracy</b>	
Measurement Calibration Overview . . . . .	6-3
Determine if a Calibration is Necessary . . . . .	6-6
When a Calibration <i>Is Not</i> Necessary . . . . .	6-6
When a Calibration <i>Is</i> Necessary . . . . .	6-6
Choose an Appropriate Calibration Method . . . . .	6-7
To Perform a Normalization Calibration . . . . .	6-8
To Perform a Transmission Calibration . . . . .	6-9
To Perform a Reflection Calibration . . . . .	6-11
To Perform an AM Delay Calibration (option 1DA or 1DB only) . . . . .	6-13
To Perform a Calibration With Non-Standard Connectors . . . . .	6-14
Writing or Editing Your Own Cal Kit File . . . . .	6-16
Save the Calibration . . . . .	6-21
<b>7. Automating Measurements</b>	
Configuring Your Test System . . . . .	7-4
Measurement System Topology . . . . .	7-4
Expandability and Large Systems . . . . .	7-10
Throughput Considerations . . . . .	7-10
Selecting a Measurement Controller . . . . .	7-11
Selecting a Programming Language . . . . .	7-13
Operator Interaction . . . . .	7-15
Prompting the Operator . . . . .	7-17
Using Graphics to Create On-Screen Diagrams . . . . .	7-18
User-Defined <b>BEGIN</b> Key Menu . . . . .	7-19
Data Entry Using a Bar Code Reader . . . . .	7-26
Data Entry Using an External Keyboard . . . . .	7-27
Using the Analyzer's Title Feature . . . . .	7-28
Hot Keys on External Keyboard For Common Functions	7-29
User-Defined TTL Input/Output . . . . .	7-31
Using a Foot Switch or Button Box . . . . .	7-32
Limit Test Pass/Fail TTL Input/Output . . . . .	7-34
Analyzer Port Numbers . . . . .	7-36
Output for Large Screen External Monitor . . . . .	7-37
Measurement Setup and Control with Fast Recall . . . . .	7-38
Using Fast Recall with the Front Panel or a Keyboard . . . . .	7-38
Using Fast Recall with a Switch . . . . .	7-40
Automated Measurement Setup and Control . . . . .	7-41
Setting the Instrument State . . . . .	7-43

SCPI Commands That Modify a Single Parameter . . .	7-46
Fast Iterative Control . . . . .	7-47
Responsive Communication using SRQs . . . . .	7-49
Using Both of the Analyzer's Channels . . . . .	7-49
AUTOST files . . . . .	7-50
Controlling Peripherals . . . . .	7-51
Using the Parallel Port . . . . .	7-51
Writing to the Parallel Port . . . . .	7-53
Reading from the Parallel Port . . . . .	7-56
Hardcopy Considerations . . . . .	7-57
Using the Serial Port . . . . .	7-58
Displaying Measurement Results . . . . .	7-59
Graticule On/Off . . . . .	7-60
Limit Testing . . . . .	7-61
Customized X-axis Annotation . . . . .	7-62
Customized Channel Annotation . . . . .	7-64
Markers . . . . .	7-65
Title and Clock . . . . .	7-66
Saving Measurement Results . . . . .	7-67
Querying Measurement Data . . . . .	7-67
Saving the Measurement to Disk—Save ASCII . . . . .	7-68
Saving the Measurement to Disk—Save Data . . . . .	7-69
Querying Marker Searches . . . . .	7-69
Saving Measurement Results to Disk . . . . .	7-70
Using Hardcopy Features to Print or Plot Results . . . . .	7-71
Custom Data Sheets . . . . .	7-75
Statistical Process Control . . . . .	7-77
Transferring Files . . . . .	7-77

**8. Front/Rear Panel**

Connectors . . . . .	8-3
BNC Connectors . . . . .	8-5
Multi-pin Connectors . . . . .	8-8
RF Connectors . . . . .	8-13
Display . . . . .	8-14
Knob . . . . .	8-16
Line Power Switch . . . . .	8-17
Display Intensity Control . . . . .	8-19
Disk Drive . . . . .	8-20
Line Module . . . . .	8-21
Power Cables . . . . .	8-21

The Line Fuse . . . . .	8-23
The Voltage Selector Switch . . . . .	8-24

**9. Menu Maps**

**10. HARDKEY / Softkey Reference**

Numeric Entries . . . . .	10-3
A . . . . .	10-4
B . . . . .	10-9
C . . . . .	10-12
D . . . . .	10-17
E . . . . .	10-22
F . . . . .	10-25
G . . . . .	10-29
H . . . . .	10-31
I . . . . .	10-34
K . . . . .	10-36
L . . . . .	10-37
M . . . . .	10-40
N . . . . .	10-47
O . . . . .	10-50
P . . . . .	10-51
R . . . . .	10-53
S . . . . .	10-57
T . . . . .	10-68
U . . . . .	10-71
V . . . . .	10-72
W . . . . .	10-73
X . . . . .	10-74
Y . . . . .	10-75

**11. Specifications and Characteristics**

System Specifications . . . . .	11-2
Dynamic Range . . . . .	11-2
Measurement Port Specifications . . . . .	11-3
Instrument Specifications and Characteristics . . . . .	11-4
Source Specifications . . . . .	11-4
Receiver Specifications . . . . .	11-8
<i>Typical Measurement Uncertainty</i> . . . . .	11-11
Delay Specifications . . . . .	11-12
Display Characteristics . . . . .	11-12



General Characteristics . . . . .	11-13
Front Panel Connectors . . . . .	11-13
Rear Panel Connectors . . . . .	11-13
Environmental Characteristics . . . . .	11-15
Warranty . . . . .	11-17
Limitation of Warranty . . . . .	11-17
Exclusive Remedies . . . . .	11-18
Hewlett-Packard Sales and Service Offices . . . . .	11-19

**12. Preventive Maintenance**

**13. Safety and Regulatory Information**

Safety Information . . . . .	13-3
Warnings . . . . .	13-3
Cautions . . . . .	13-4
Statement of Compliance . . . . .	13-4
Cleaning Instructions . . . . .	13-4
Shipping Instructions . . . . .	13-5
Instrument Markings . . . . .	13-5
Regulatory Information . . . . .	13-6
Notice for Germany: Noise Declaration . . . . .	13-6
Declaration of Conformity . . . . .	13-6

**14. Preset State and Memory Allocation**

Preset and Peripheral States . . . . .	14-2
Preset State . . . . .	14-2
Peripheral State . . . . .	14-8
Save/Recall Memory Allocation . . . . .	14-12
Types of Storage Disks . . . . .	14-12
Types of Storable Information . . . . .	14-14
How to Determine the Size of Disk Files . . . . .	14-15
Memory Usage Notes . . . . .	14-17

**Index**

---

## Figures

1-1. Voltage Selector Switch Location . . . . .	1-4
1-2. Protective Earth Ground . . . . .	1-6
1-3. Ventilation Clearance Requirements . . . . .	1-7
1-4. Network Analyzer Rear Panel Line Module and Selected Connectors . . . . .	1-11
1-5. HP-IB Connection Configurations . . . . .	1-12
2-1. Network Analyzer Front Panel Features . . . . .	2-2
2-2. Connect the Filter to the Analyzer . . . . .	2-5
2-3. Reference Positions . . . . .	2-9
2-4. Both Channels Active . . . . .	2-10
2-5. Split Display . . . . .	2-11
2-6. Equipment Setup for Transmission Measurement . . . . .	2-14
2-7. Verify Transmission Measurement . . . . .	2-15
2-8. Verify Reflection Measurement . . . . .	2-16
2-9. Connect the Load . . . . .	2-17
3-1. DUT Response to an RF Signal . . . . .	3-3
3-2. Simplified Block Diagram . . . . .	3-5
3-3. Block Diagram . . . . .	3-7
3-4. The <b>BEGIN</b> Key . . . . .	3-12
3-5. Equipment Setup For a Transmission Response Calibration . . . . .	3-19
3-6. Equipment Setup For a Transmission Response Measurement . . . . .	3-21
3-7. Example of a Transmission Measurement Display . . . . .	3-23
3-8. Equipment Setup For a Reflection Response Calibration . . . . .	3-26
3-9. Equipment Setup For a Reflection Measurement of a Two-Port Device . . . . .	3-27
3-10. Equipment Setup For a Reflection Measurement of a One-Port Device . . . . .	3-27
3-11. Example of a Reflection Measurement Display . . . . .	3-29
3-12. Equipment Setup For a Power Measurement . . . . .	3-32
3-13. Example of a Power Measurement . . . . .	3-34
3-14. Filtering Out the Unwanted Mixing Product . . . . .	3-36
3-15. Equipment Setup For a Conversion Loss Measurement . . . . .	3-39
3-16. Example of a Conversion Loss Measurement . . . . .	3-41
3-17. Equipment Setup For an AM Delay Response Calibration . . . . .	3-44
3-18. Equipment Setup For an AM Delay Measurement . . . . .	3-45
3-19. Example of an AM Delay Measurement . . . . .	3-47
4-1. The <b>MARKER</b> Key . . . . .	4-3

## Contents

4-2. Connect the Filter to the Analyzer . . . . .	4-4
4-3. Markers at Minimum and Maximum Values . . . . .	4-8
4-4. -6 dB Bandwidth Marker Search . . . . .	4-11
4-5. -6 dB Notch Marker Search . . . . .	4-13
4-6. Multi-Peak Search Mode . . . . .	4-14
4-7. Multi-Notch Search Mode . . . . .	4-15
4-8. Marker Statistics Function . . . . .	4-17
4-9. Marker Flatness Function . . . . .	4-19
4-10. RF Filter Statistics Function . . . . .	4-21
4-11. Delta Marker Mode . . . . .	4-23
4-12. Limit Lines . . . . .	4-28
4-13. Limit Lines Example 1 . . . . .	4-33
4-14. Limit Lines Example 2 . . . . .	4-34
4-15. Peripheral Connections . . . . .	4-51
4-16. Hardcopy Components and Formats Available . . . . .	4-58
4-17. Trace List Values . . . . .	4-59
5-1. Relationship Between Frequency Span, Sweep Time, and Number of Points . . . . .	5-6
6-1. Sources of Errors . . . . .	6-3
6-2. Mismatch Errors . . . . .	6-4
7-1. Stand-Alone Network Analyzer . . . . .	7-5
7-2. Stand-Alone Network Analyzer Running IBASIC . . . . .	7-7
7-3. Network Analyzer Without IBASIC, Controlled by a Computer . . . . .	7-8
7-4. Network Analyzer Running IBASIC, Controlled by a Computer . . . . .	7-9
7-5. Example Test System Setup . . . . .	7-16
7-6. Connect a Switch to the USER TTL IN/OUT Connector . . . . .	7-25
7-7. Connect a Switch to the USER TTL IN/OUT Connector . . . . .	7-40
7-8. Measurement Control . . . . .	7-41
7-9. Writing to the Parallel Port . . . . .	7-54
7-10. Digital Latch Circuit . . . . .	7-55
7-11. Customized Annotation . . . . .	7-59
7-12. Paper Numbering . . . . .	7-73
7-13. Example Data Sheet . . . . .	7-76
8-1. Analyzer Connectors - Front Panel . . . . .	8-3
8-2. Analyzer Connectors - Rear Panel . . . . .	8-4
8-3. HP-IB Connector and Cable . . . . .	8-8
8-4. Parallel Port Pinouts . . . . .	8-10
8-5. RS-232 Connector . . . . .	8-11
8-6. Probe Power Connector . . . . .	8-12
8-7. The Analyzer Line Power Switch . . . . .	8-17
8-8. Display Intensity Control . . . . .	8-19

**Contents**

8-9. Disk Drive . . . . .	8-20
8-10. Power Cable and Line (Mains) Plug Part Numbers . . . . .	8-22
8-11. Location of Line Fuses . . . . .	8-23
8-12. Voltage Selector Switch Location . . . . .	8-24
10-1. Next Peak . . . . .	10-48
11-1. Receiver Dynamic Accuracy (narrowband) . . . . .	11-9
11-2. Absolute Power Accuracy (broadband) . . . . .	11-10
12-1. Maximum and Minimum Protrusion of Center Conductor From Mating Plane . . . . .	12-2

---

## Tables

1-1. Maximum HP-IB Cable Lengths . . . . .	1-12
3-1. Measurement Configurations from the <b>BEGIN</b> Key . . . . .	3-16
4-1. Disk Access . . . . .	4-43
4-2. Typical Print Times . . . . .	4-61
5-1. Relationship Between System Bandwidth and Sweep Speed . . . . .	5-4
7-1. Keyboard Template Definition . . . . .	7-30
7-2. Writeable Ports . . . . .	7-36
7-3. Readable Ports . . . . .	7-37
7-4. Writeable Ports . . . . .	7-52
7-5. Readable Ports . . . . .	7-52
7-6. Parallel Port Pins . . . . .	7-54
8-1. General Bus Management Lines . . . . .	8-9
11-1. Hewlett-Packard Sales and Service Offices . . . . .	11-20
14-1. Disk Capacities . . . . .	14-12
14-2. Maximum Number of Files and Directories . . . . .	14-13
14-3. Sizes of Instrument State Components . . . . .	14-16

**Contents**



---

## Installing the Analyzer

---

## Installing the Analyzer

This chapter will guide you through the four steps needed to correctly and safely install your network analyzer. The four steps are:

1. Check the Shipment
2. Meet Electrical and Environmental Requirements
3. Check the Analyzer Operation
4. Configure the Analyzer



---

## Step 1. Check the Shipment

After you have unpacked your instrument, it is recommended that you keep the packaging materials so they may be used if your instrument should need to be returned for maintenance or repair.

Check the items received against the Product Checklist to make sure that you received everything.

Inspect the analyzer and all accessories for any signs of damage that may have occurred during shipment. If your analyzer or any accessories appear to be damaged or missing, call your nearest Hewlett-Packard Sales or Service office. Refer to Table 11-1 in Chapter 11 for the nearest office.

---

## Step 2. Meet Electrical and Environmental Requirements

1. Set the line voltage selector to the position that corresponds to the ac power source you will be using.

---

### CAUTION

---

Before switching on this instrument, make sure that the line voltage selector switch is set to the voltage of the power supply and the correct fuse (T 5A 250 V) is installed. Assure the supply voltage is in the specified range.

### NOTE

The working fuse and a spare are located in the power cable receptacle. See Figure 8-11.

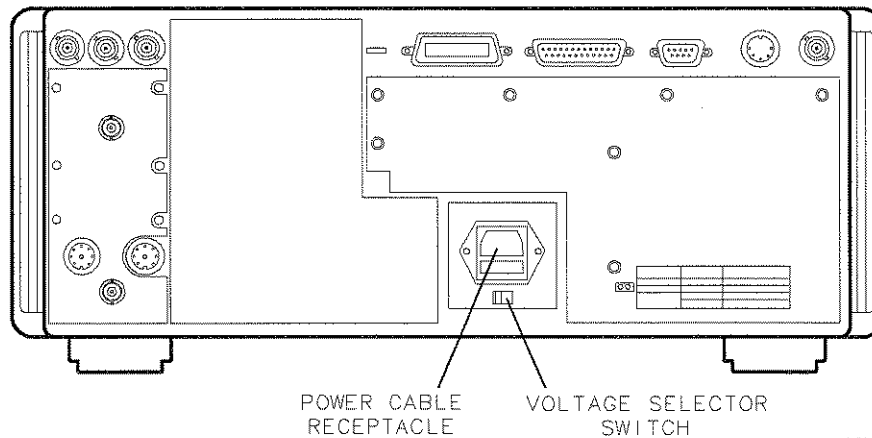

**Figure 1-1. Voltage Selector Switch Location**

**Step 2. Meet Electrical and Environmental Requirements**

2. Ensure the available ac power source meets the following requirements:

<b>Nominal Setting</b>	<b>AC Line Power</b>
110 V	90 to 132 Vac (47 to 63 Hz)
220 V	198 to 254 Vac (47 to 63 Hz)

If the ac line voltage does not fall within these ranges, an autotransformer that provides third wire continuity to ground should be used.

3. Ensure the operating environment meets the following requirements for safety:
- indoor use
  - altitude up to 15,000 feet (4,572 meters)
  - temperature 0 °C to 55 °C
  - maximum relative humidity 80% for temperatures up to 31 °C decreasing linearly to 50% relative humidity at 40 °C
  - mains supply voltage fluctuations not to exceed the specified range
  - transient overvoltages according to INSTALLATION CATEGORY II, according to IEC 1010
  - POLLUTION DEGREE 2 according to IEC 664

**NOTE**

The above requirements are for safety only. Separate conditions that must be met for specified performance are noted in Chapter 11.

**Step 2. Meet Electrical and Environmental Requirements**

4. Verify that the power cable is not damaged, and that the power source outlet provides a protective earth ground contact. Note that the following illustration depicts only one type of power source outlet. Refer to Figure 8-10 to see the different types of power cord plugs that can be used with your analyzer.

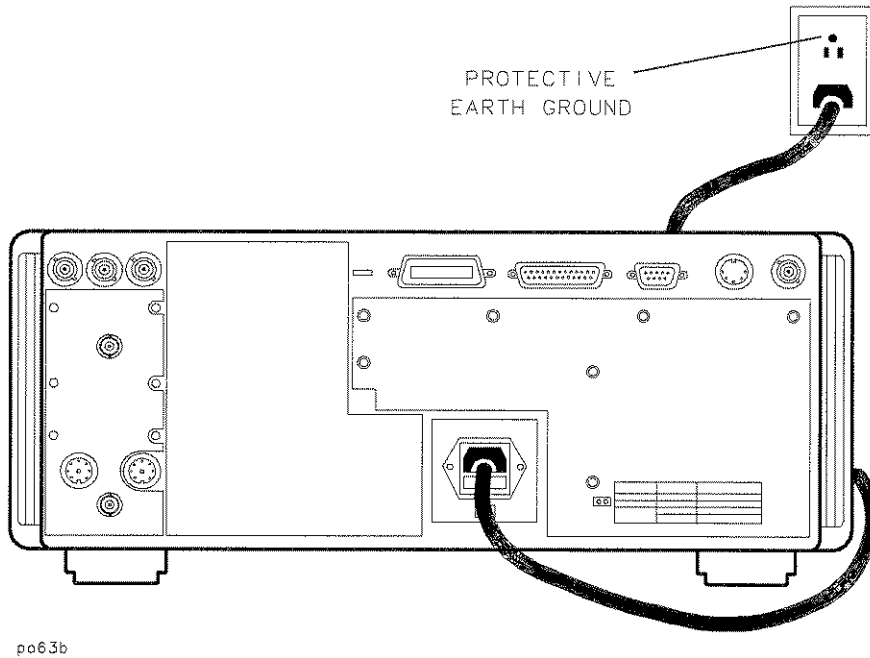

**Figure 1-2. Protective Earth Ground**

**WARNING**

This is a Safety Class I product (provided with a protective earthing ground incorporated in the power cord). The mains plug shall only be inserted in a socket outlet provided with a protective earth contact. Any interruption of the protective conductor, inside or outside the instrument, is likely to make the instrument dangerous. Intentional interruption is prohibited.

**Step 2. Meet Electrical and Environmental Requirements**

**WARNING**

If this instrument is to be energized via an external autotransformer for voltage reduction, make sure that its common terminal is connected to a neutral (earthed pole) of the power supply.

5. Ensure there are at least two inches of clearance around the sides and back of either the stand-alone analyzer or the system cabinet.

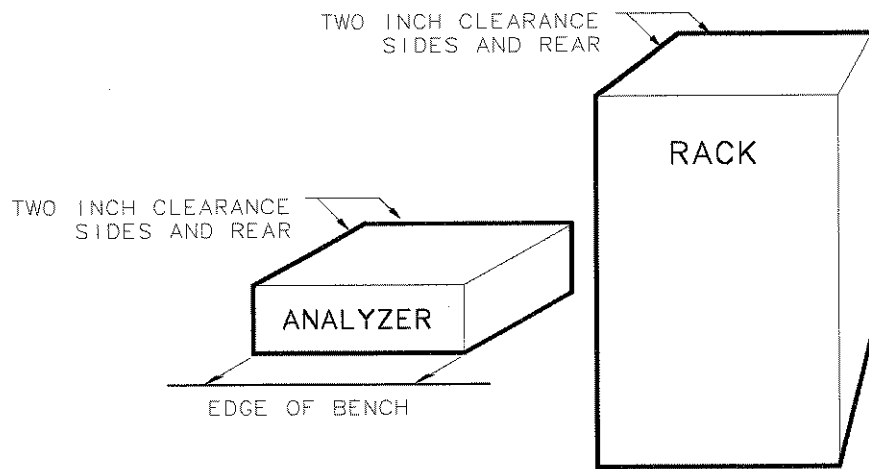

po64b

**Figure 1-3. Ventilation Clearance Requirements**

Installing the Analyzer

**Step 2. Meet Electrical and Environmental Requirements**

6. Set up a static-safe workstation. Electrostatic discharge (ESD) can damage or destroy components.

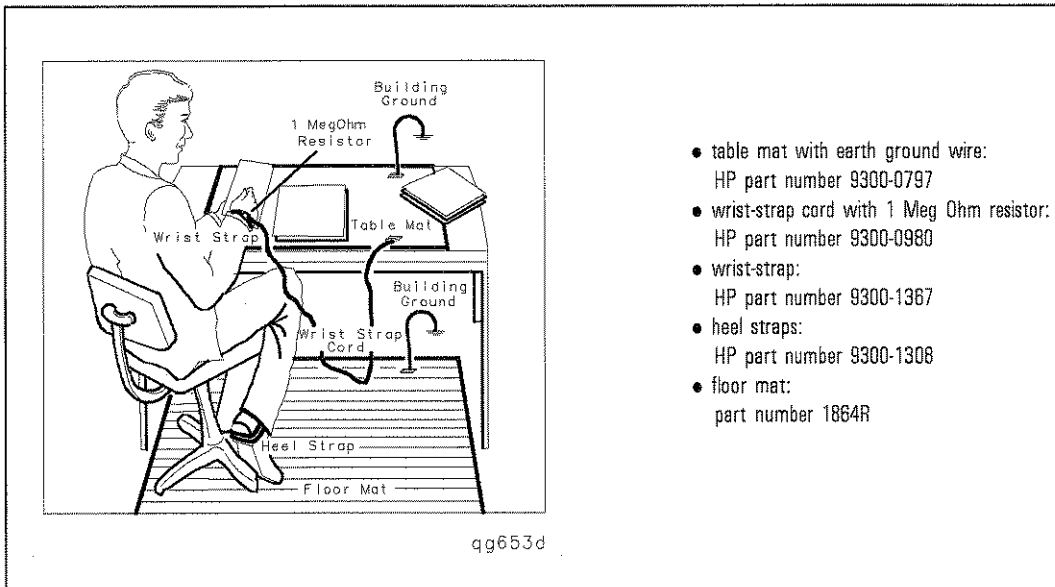

---

## Step 3. Check the Analyzer Operation

1. Turn on the line switch of the analyzer. After approximately 30 seconds, a display box should appear on the screen with the following information:
  - The model number of your analyzer (either HP 8711B or HP 8713B)
  - The firmware revision
  - The serial number of your analyzer
  - Installed options
2. Verify that the serial number and options displayed on the screen match the information on the rear panel serial label.
3. The operator's check should be performed on the analyzer to provide a high degree of confidence that the analyzer is working properly. Refer to Chapter 2 for instructions on how to perform the operator's check.

---

## Step 4. Configure the Analyzer

You can begin making measurements by simply connecting your analyzer to an appropriate power source and turning it on. This section, however, will explain how to connect common peripherals and controllers, and how to install your analyzer into a rack system.



## Connecting Peripherals and Controllers

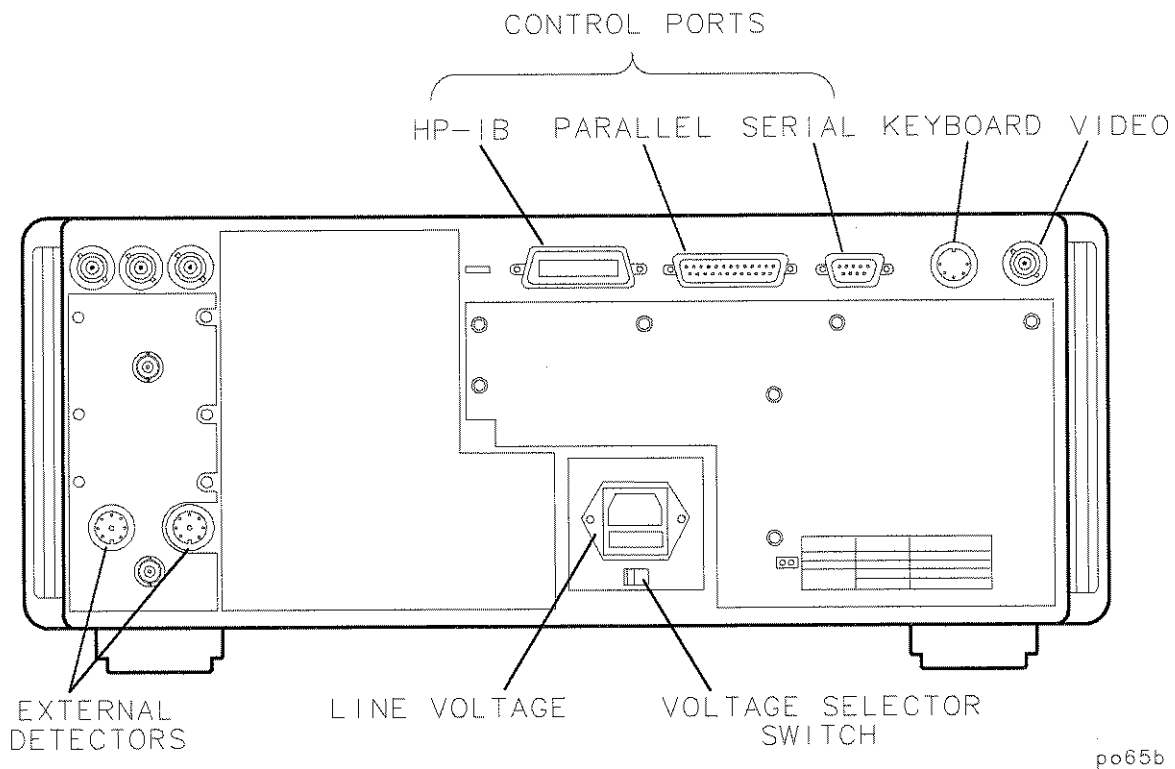

**Figure 1-4. Network Analyzer Rear Panel Line Module and Selected Connectors**

Refer to Figure 1-4. The HP-IB port is for use with computers and peripherals (printers, plotters, etc.) The parallel and RS-232 (serial) ports are also for peripherals. The parallel and serial ports can also be programmed via IBASIC for general I/O control.

**Step 4. Configure the Analyzer**

**HP-IB Connections**

An HP-IB system may be connected in any configuration as long as the following rules are observed:

- The total number of devices is less than or equal to 15.
- The total length of all the cables used is less than or equal to 2 meters times the number of devices connected together up to an absolute maximum of 20 meters. For example, the maximum cable length is 4 meters if only 2 devices are involved. The length between adjacent devices is not critical as long as the overall restriction is met.

See Figure 1-5 for different connection configurations.

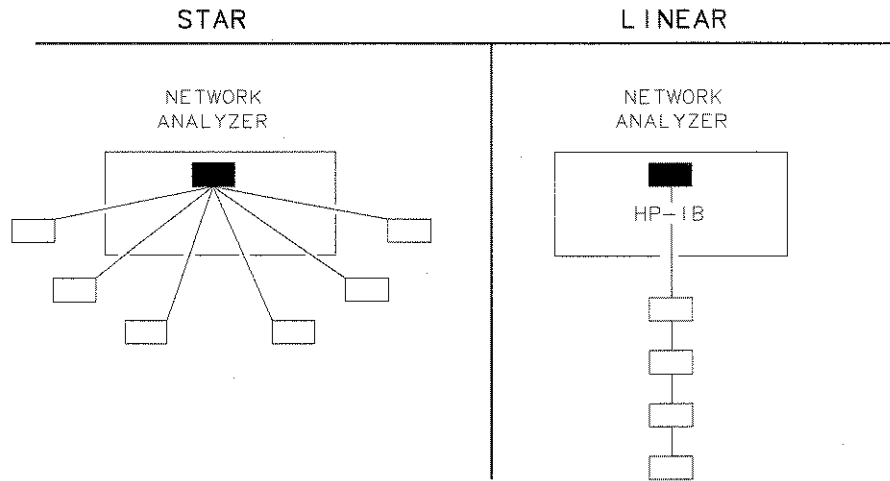

po67b

**Figure 1-5. HP-IB Connection Configurations**

**Table 1-1. Maximum HP-IB Cable Lengths**

Instruments/Peripherals in System	Maximum HP-IB Cable Length Between Each Pair of Devices
Two	4 m
Fifteen (max)	20 m (total)

**Step 4. Configure the Analyzer**

**Parallel and Serial Connections**

Parallel and serial devices often require specific cables—check their manuals for details. Parallel cable length should not exceed 25 feet. The analyzer may experience problems talking to the printer if this length is exceeded. Connect the required control cables and secure them. (Tighten the knurled screws or comparable fasteners.)

**Other Connections**

If you plan to use a keyboard, external video monitor, or external detectors, connect them to the appropriate rear panel connectors. See Figure 1-4.

**NOTE**

Turning on the network analyzer at the same time a system controller is addressing the analyzer will result in the following message:

Error: Unable to power up while  
being addressed via HP-IB.

Ensure that the analyzer is not  
being addressed, or disconnect HP-IB.

Cycle analyzer power to continue.

To remedy this problem, follow the instructions in the message.

**Step 4. Configure the Analyzer**

**To Set HP-IB Addresses** To communicate via HP-IB, each external device must have a unique address and the network analyzer must recognize each address. To check or set each external device's actual address, refer to the device's manual (most addresses are set with switches).

The following are examples of how to check or set the device's recognized address on the network analyzer:

- **External Disk Drive:** press **SAVE RECALL** **Select Disk** **Configure Ext Disk** **Ext Disk Address**. The default setting is 0 (zero). To select another address, enter the number and press **Enter**.
- **Printer:** press **HARDCOPY** **Select Copy Port**. Use the front panel knob to highlight the line that reads HP PRINTER PCL HP-IB. Press **Select**. The second line of the screen displays settings: in this case the address. The default address is 5, however most printers are factory set to address 1 (one). To change the recognized address, press **Hardcopy Address** **number** **Enter** **Select**.
- **Plotter:** press **HARDCOPY** **Select Copy Port**. Use the front panel knob to highlight the line that reads HP Plotter HPGL HP-IB. Press **Select**. The second line of the screen displays settings: in this case the address. The default address is 5 and most plotters are factory set to address 5 (five), so changing the address is probably not necessary. To change the recognized address, press **Hardcopy Address** **number** **Enter** **Select**.

**NOTE**

Only one hardcopy address can be set at a time. Changing the printer address, for example, changes the plotter to the same address.

**Step 4. Configure the Analyzer**

- HP 8711B or HP 8713B: press **SYSTEM OPTIONS** **HP-IB** **HP 8711B Address** or **HP 8713B Address**. The network analyzer's address will appear (the default is 16). To change the address, press **number** **Enter**.

**To Configure Peripheral Settings**

If your system uses serial or parallel peripherals, follow the guidelines below to configure the system. Refer to the peripheral's manual for correct cables and settings. The parallel and serial ports have standard Centronics DB-25 and RS232 pinouts respectively as explained in Chapter 8, "Front/Rear Panel Features."

- Serial Devices: press **HARDCOPY** **Select Copy Port**, use the entry controls to highlight your type of printer or plotter and press **Select**. If the baud rate or handshake at the top of the screen are incorrect, use the softkeys to change them.
- Parallel Devices: press **HARDCOPY** **Select Copy Port**, use the entry controls to highlight your type of printer or plotter and press **Select**.

**NOTE**

When **Select Copy Port** is selected, the first two lines in the box that appears at the top of the display screen show the current settings for your convenience.

---

## Installing the Analyzer In a Rack

Use only the recommended rack mount kit (Option 1CM when ordered with the analyzer or HP part number 08711-60058 when ordered separately) with this instrument; it needs side support rails. Do not attempt to mount it by the front panel (handles) only. This rack mount kit allows you to mount the analyzer with or without handles.

To install the network analyzer in an HP 85043D rack, follow the instructions in the rack manual.

---

### **CAUTION**

To install the network analyzer in other racks, note that they may promote shock hazards, overheating, dust contamination, and inferior system performance. Consult your HP customer engineer about installation, warranty, and support details.

---

### **CAUTION**

When installing the instrument in a cabinet, the convection into and out of the instrument must not be restricted. The ambient temperature (outside the cabinet) must be less than the maximum operating temperature of the instrument by 4 °C for every 100 watts dissipated in the cabinet. If the total power dissipated in the cabinet is greater than 800 watts, then forced convection must be used.

Place other system instruments (computer, printer, plotter, external disk drive) where convenient, within the HP-IB cable length limits (see Table 1-1) or other interface cabling limits.

---

## Getting Started

---

## Getting Started

The HP 8711B and HP 8713B are easy-to-use fully integrated RF component test systems. Each instrument includes a synthesized source, wide dynamic range receivers and a built-in test set. Features are grouped by functional block and displayed on the instrument CRT. This section familiarizes new users with the layout of the front panel and the process of entering measurement parameters into the analyzer.

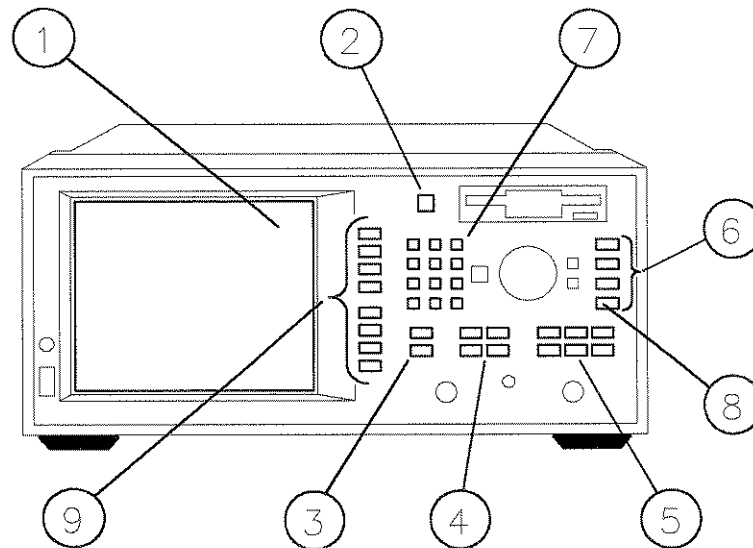

po648b

**Figure 2-1. Network Analyzer Front Panel Features**



## Front Panel Tour



1 The CRT Display	The analyzer's large CRT displays data, markers, limit lines, Instrument BASIC (IBASIC) programming code, softkey menus and measurement parameters quickly and clearly. Refer to "Display" in Chapter 8 for more information.
2 <b>BEGIN</b>	The <b>BEGIN</b> key simplifies measurement setups. The begin key allows quick and easy selection of basic measurement parameters for a user-specified class of devices (e.g., filters, amplifiers, or mixers). For example, when making a transmission measurement, selecting FILTER as your device type puts the analyzer into narrowband detection mode, maximizing measurement dynamic range. In comparison, selecting MIXER as your device type puts the analyzer into broadband detection mode, enabling frequency translation measurements. This capability allows new users to start making measurements with as few as four keystrokes.
3 MEAS	The measure keys select the measurements for each channel. The analyzer's measurement capabilities include transmission, reflection, power, conversion loss, and AM delay (options 1DA and 1DB only).
4 SOURCE	The source keys select the desired source output signal to the device under test, for example, selecting source frequency range or output power. The source keys also control sweep time, number of points, and sweep triggering.
5 CONFIGURE	The configure keys control receiver and display parameters. These parameters include receiver bandwidth and averaging, display scaling and format, marker functions, and instrument calibration.
6 SYSTEM	The system keys control system level functions. These include instrument preset, save/recall, and hardcopy output. HP-IB parameters and IBASIC are also controlled with these system keys.
7 The Numeric Keypad	Use the number keys to enter a specific numeric value for a chosen parameter. Use the <b>ENTER</b> key or the softkeys to terminate the numeric entry with the appropriate units. You can also use the front panel knob for making continuous adjustments to parameter values, while the <b>↑</b> and <b>↓</b> keys allow you to change values in steps.
8 <b>HARDKEYS</b>	Hardkeys are front panel keys physically located on the instrument front panel. In text, these keys will be represented by the key name with a box around it such as: <b>PRESET</b> .
9 <b>Softkeys</b>	Softkeys are keys whose labels are determined by the analyzer's firmware. The labels are displayed on the screen next to the 8 blank keys next to the display screen on the analyzer. In text, these keys will be represented by the key name with shading behind it such as: <b>Sweep Time</b> .

---







## Entering Measurement Parameters

This section describes how to input measurement parameter information into the network analyzer.

### NOTE

When entering parameters, you can use the numeric key pad, as described in each example, or you can use the   keys or the front panel knob to enter data.

### NOTE

When you are instructed to enter numeric values in this manual, it often can get cluttered and confusing to depict each key stroke. So in this manual, numbers (no matter how many characters) are depicted inside one keycap. For example, if you are instructed to enter the number  $-42.5$ , it will be depicted inside one keycap like this: . To enter this number, the following keys need to be pressed in succession:     .

You can follow along with these examples by connecting the filter and cable that were supplied with your instrument as shown in Figure 2-2.

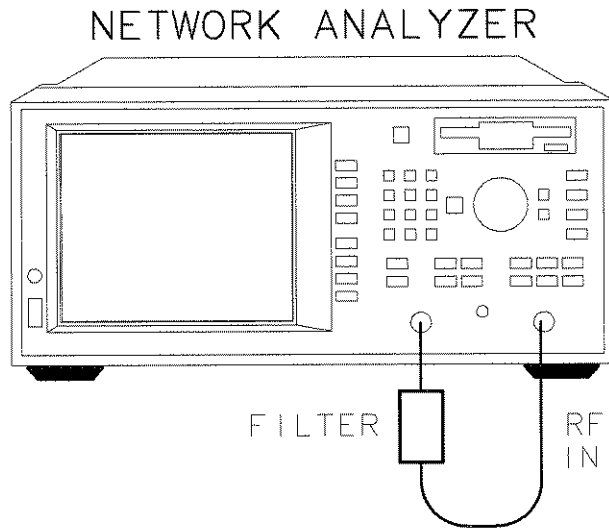

pc047b

**Figure 2-2. Connect the Filter to the Analyzer**

## Getting Started

### Entering Measurement Parameters

**Presetting the Analyzer** Press the **PRESET** key. When the analyzer is preset with the **PRESET** key, it reverts to a known operating condition. When this key is pressed, the following major default conditions apply:

Frequency range <sup>1</sup>	0.3 to 1300 MHz
Frequency range <sup>2</sup>	0.3 to 3000 MHz
Power level	0 dBm
Channel 1 measurement	Transmission
Channel 2 measurement	Off
Format	Log Magnitude
Number of points	201
Sweep time	Auto
Scale	10 dB/div
Reference	0 dB
System Bandwidth	Medium

1 HP 8711B only

2 HP 8713B only

#### NOTE

The measurement parameters that you enter will be retained in the analyzer's memory when the power is turned off, and will be restored when the power is turned back on.

#### See Also

Refer to Chapter 14, "Preset State and Memory Allocation," for a comprehensive table of preset conditions.

**Entering Frequency  
Range**

1. Press the **FREQ** key to access the frequency softkey menu.
2. To change the low end of the frequency range to 10 MHz, press **Start** **10** **MHz**.
3. To change the high end of the frequency range to 900 MHz, press **Stop** **900** **MHz**.
4. You can also set the frequency range by using the **Center** and **Span** softkeys. For instance if you set the center frequency to 160 MHz and the span to 300 MHz, the resulting frequency range would be 10 to 310 MHz.

**NOTE**

When entering frequencies, be sure to terminate your numeric entry with the appropriate softkey to obtain the correct units. If you use the **ENTER** key to terminate a frequency entry, the units default to Hz.

The default displayed frequency resolution is kHz. You can change the resolution by pressing **FREQ** **Disp Freq Resolution**, and then selecting a new resolution.

Getting Started

## Entering Measurement Parameters

### Entering Source Power Level

1. Press the **POWER** key to access the power level softkey menu.
2. To change the power level to 3 dBm, press **Level** **3**, and **dBm** or **ENTER**.
3. To change the power level to -1.6 dBm, press **Level** **-1.6** **dBm** or **ENTER**.

#### NOTE

Your analyzer's power level (depending upon its option configuration) may not be settable to below 0 dBm.

**Scaling the  
Measurement Trace**

1. Press the **SCALE** key to access the scale menu.
2. To view the complete measurement trace on the display, press **Autoscale**.
3. To change the scale per division to 5 dB/division press **Scale/Div** **5** **Enter**.
4. To move the reference position (indicated by the **▶** symbol on the left side of the display) to the first graticule down from the top of the display, press **Reference Position** **9** **Enter**. Figure 2-3 shows which graticule each reference position designates.
5. To change the reference level to 0 dB, press **Reference Level** **0** **Enter**.

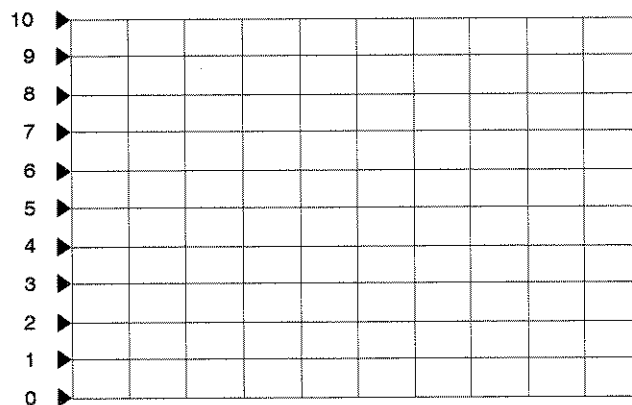

po852b\_c

**Figure 2-3. Reference Positions**

Getting Started

**Entering Measurement Parameters**

**Entering the Active Channel and Type of Measurement**

The **CHAN 1** and **CHAN 2** keys allow you to choose which channel is active, and measurement parameters for that channel. You can select many of the measurement and display functions independently for each channel.

1. To measure transmission on channel 1 and reflection on channel 2, press the following keys:

**PRESET** **CHAN 1** **Transmissn**

**CHAN 2** **Reflection**

2. Both channels measurements are now visible on the analyzer's display screen. Note that the active channel's (channel 2) measurement trace is brighter than the other channel's trace.

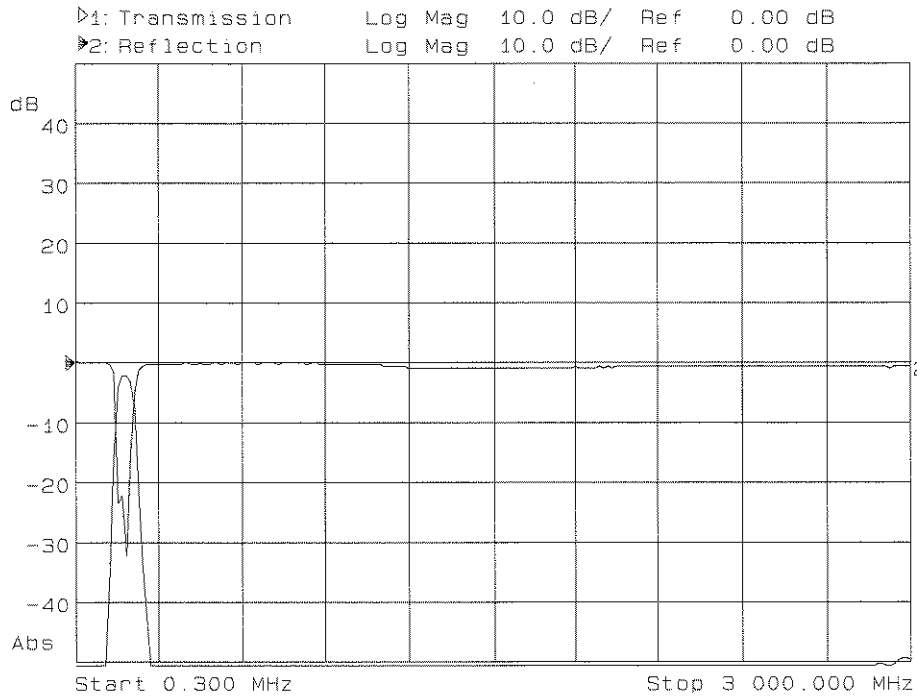
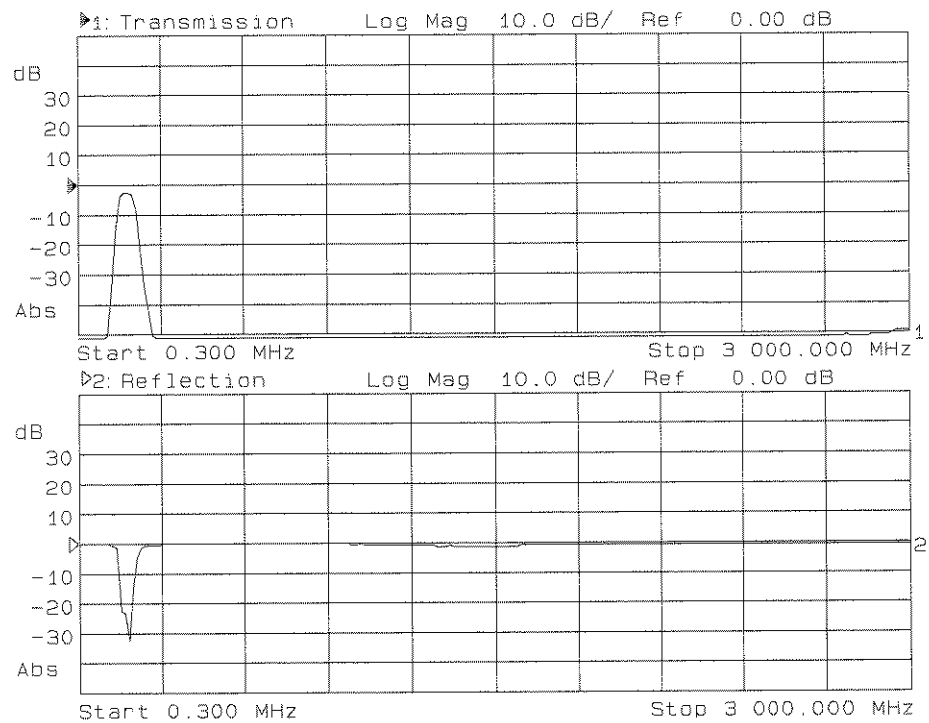

**Figure 2-4. Both Channels Active**



### Viewing Measurement Channels

1. To view only the channel 2 reflection measurement press **CHAN 1** **Chan OFF**.
2. To view both channels again, press **CHAN 1**.
3. To view both channels separately on a split screen, press **DISPLAY** **More Display** **Split Display** **FULL split**.



**Figure 2-5. Split Display**

You have now learned how to enter common measurement parameters and how to manipulate the display for optimum viewing of your measurement. You can now proceed on to performing the operator's check, or refer to Chapter 3 for detailed information on making specific types of measurements.

---

## Performing the Operator's Check

The operator's check should be performed when you receive your instrument, and any time you wish to have confidence that the analyzer is working properly. The operator's check does not verify performance to specifications, but should give you a high degree of confidence that the instrument is performing properly if it passes.

The operator's check consists of making a transmission measurement with the cable that was supplied with your analyzer, and a reflection measurement with the cable and again with a 50  $\Omega$  or 75  $\Omega$  termination (load).

---

## Equipment List

To perform the operator's check you will need the following:

- A known good cable such as the one that was supplied with your analyzer. The cable you use should have  $\leq 0.5$  dB of insertion loss up to 1.3 GHz and  $\leq 0.75$  dB of insertion loss from 1.3 to 3.0 GHz.
- A known good load ( $> 40$  dB return loss) that matches the test port impedance of your analyzer such as one from calibration kit HP 85032B/E (50  $\Omega$ ) or HP 85036B/E (75  $\Omega$ ).

---

## Make a Transmission Measurement

1. Connect the equipment as shown in Figure 2-6. Use a known good cable such as the one that was supplied with your analyzer.

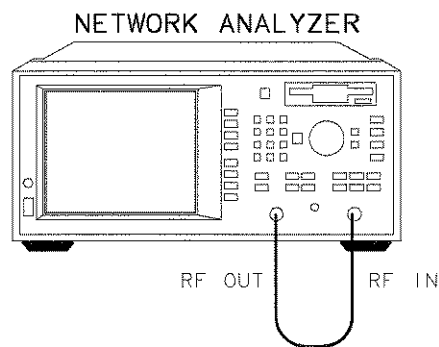
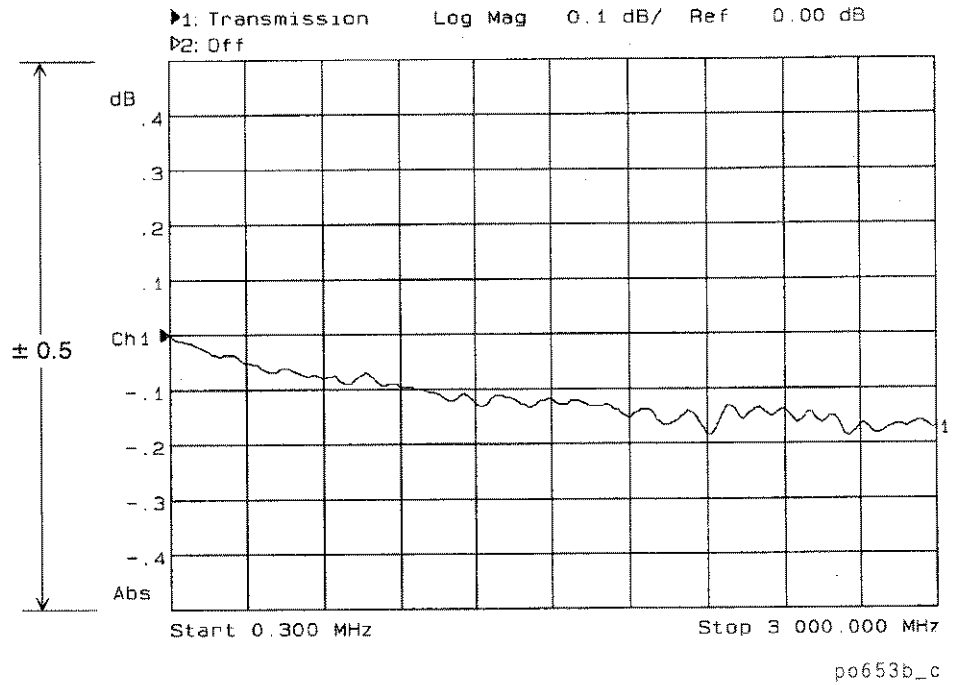

Figure 2-6. Equipment Setup for Transmission Measurement

2. Press **PRESET** **SCALE** **1** **Enter**.
3. Verify that the data trace falls within  $\pm 0.5$  dB of 0 dB. See Figure 2-7 for a typical result.

Getting Started  
Performing the Operator's Check



**Figure 2-7. Verify Transmission Measurement**

**NOTE**

The quality of the cable will affect this measurement; make sure you use a cable with the characteristics described in "Equipment Required."

---

## Make a Reflection Measurement

1. Leave the cable connected to the analyzer.
2. Press **CHAN 1** **Reflection** **SCALE** **10** **Enter**.
3. Verify that the data trace falls completely below  $-16$  dB. See Figure 2-8 for a typical result.

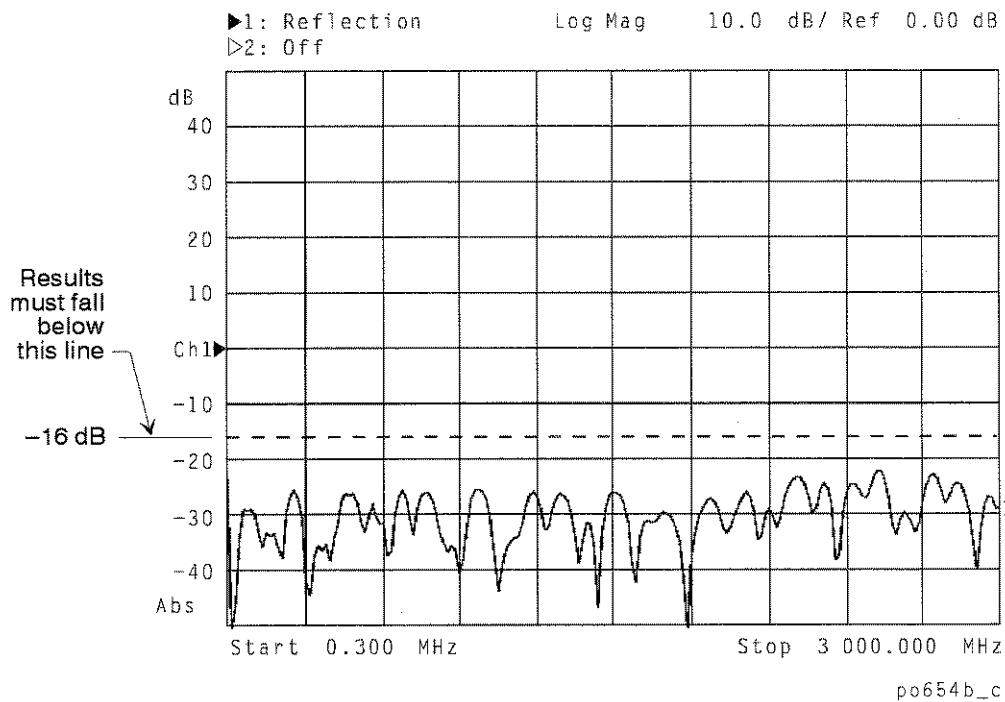
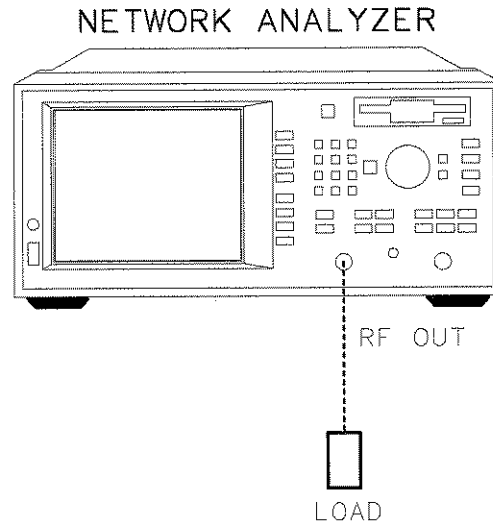

Figure 2-8. Verify Reflection Measurement

4. Disconnect the cable and connect a known good load to the RF OUT port as shown in Figure 2-9.



po64db

**Figure 2-9. Connect the Load**

5. Verify that the data trace falls below  $-30$  dB. If the data trace is off the screen, press **SCALE** **Reference Level** and the **↓** key until the trace moves up onto the screen.

---

## If the Analyzer Fails the Operator's Check

If your analyzer does not meet the criteria in the operator's check, your analyzer may need adjustment or servicing. Have a qualified service technician check the instrument or contact any Hewlett-Packard Sales or Service Office for assistance. Refer to Table 11-1 in Chapter 11 for the nearest office.





---

## Making Measurements

---

## Making Measurements

This chapter provides an overview of basic network analyzer measurement theory, a section explaining the typical measurement sequence, a segment describing the use of the **BEGIN** key, and detailed examples of the following measurements:

- Measuring Transmission Response
- Measuring Reflection Response
- Making a Broadband Power Measurement
- Measuring Conversion Loss
- Measuring AM Delay (Option IDA or IDB)
- Making Measurements with the Auxiliary Input

---

## Measuring Devices with Your Network Analyzer

This section provides a basic overview of how the network analyzer measures devices. The analyzer has an RF signal source that produces an incident signal that is used as a stimulus to the device under test. Your device responds by reflecting a portion of the incident signal and transmitting the remaining signal. Figure 3-1 shows how a device under test (DUT) responds to an RF source stimulus.

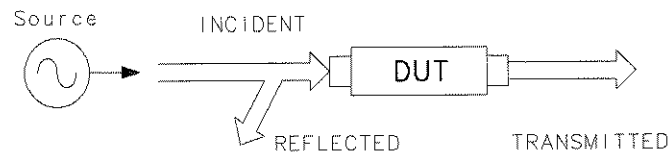

ad620a

**Figure 3-1. DUT Response to an RF Signal**

**Measuring Devices with Your Network Analyzer**

Refer to Figure 3-2 for the following discussion regarding detection schemes and modes. The transmitted signal (routed to input B) and the reflected signal (input A) are measured by comparison to the incident signal. The network analyzer couples off a small portion of the incident signal to use as a reference signal (routed to input R). The network analyzer sweeps the source frequencies, resulting in a measured and displayed response of your test device. Figure 3-2 shows the transmitted, reflected, and reference signal inputs.



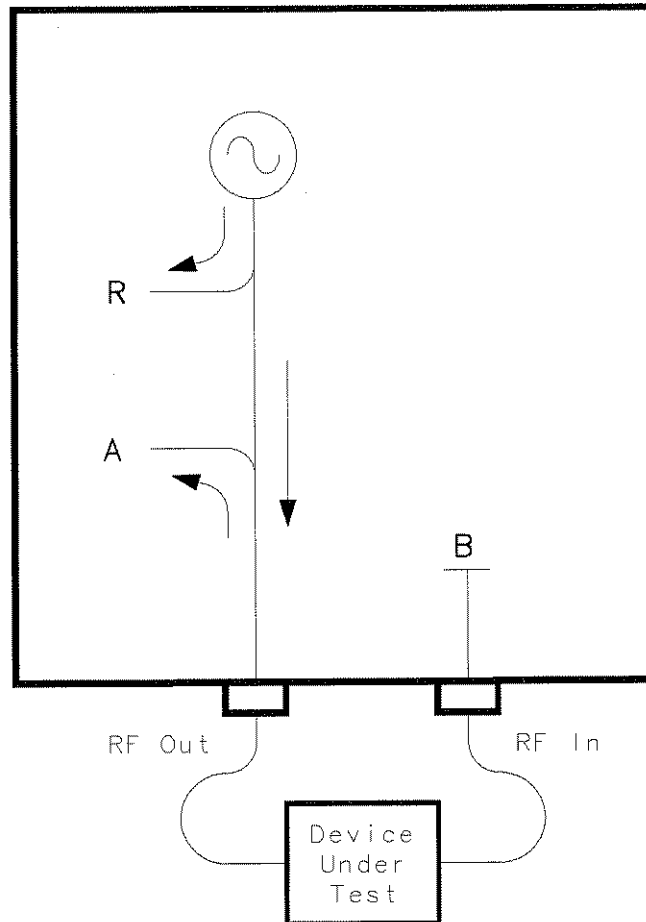

po88b

Figure 3-2. Simplified Block Diagram

**Measuring Devices with Your Network Analyzer**

Refer to Figure 3-3 for the following discussion. The network analyzer receiver has two signal detection modes:

- broadband detection mode
- narrowband detection mode

There are two internal broadband detector inputs:  $B^*$  and  $R^*$ , and two external broadband detectors: X and Y. When the network analyzer is in the broadband detection mode, it measures the total power of all signals present at these measurement ports, independent of signal frequency. This enables the characterization of frequency translation devices such as mixers, receivers, and tuners, where the RF input and output frequencies are not the same. Figure 3-3 labels the transmitted signal for broadband detection input as  $B^*$ , and the reference signal as  $R^*$ .

When the network analyzer is in the narrowband detection mode, the receiver is tuned to the source frequency. This technique provides greater dynamic range by decreasing the receiver's bandwidth. Figure 3-3 shows the transmitted signal for narrowband detection input as B, and the reference signal as R.

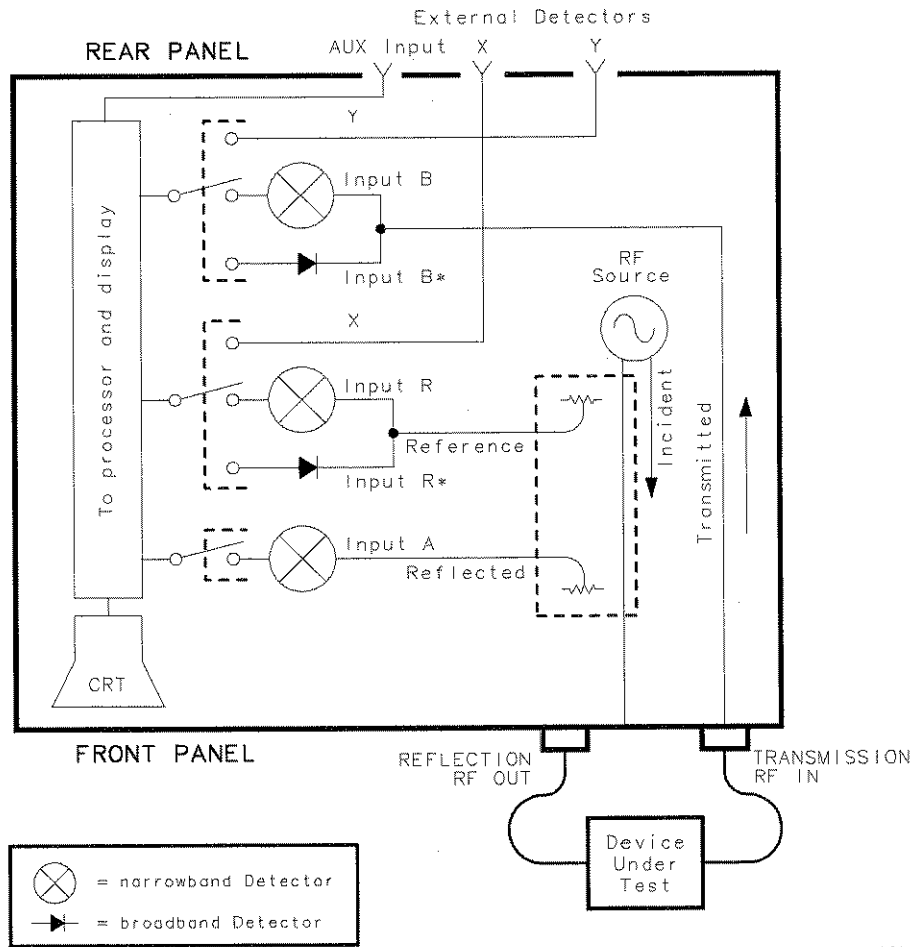

po69b

**Figure 3-3. Block Diagram**

Making Measurements

**Measuring Devices with Your Network Analyzer**

The following table shows the correlation between different types of measurements, input channels and signals.

<b>Measurement</b>	<b>Detection Mode</b>	<b>Input Channels</b>	<b>Input Signals</b>
Transmission	Narrowband	B/R	transmitted/incident
Reflection	Narrowband	A/R	reflected/incident
Power	Broadband	B*	transmitted
Conversion Loss	Broadband	B*/R*	transmitted/incident



---

## When to Use Attenuation and Amplification in a Measurement Setup

### When to Use Attenuation

- For accurate measurements use attenuation on the RF IN port to avoid exceeding the receiver's specified maximum input level. See "Receiver Specifications" in Chapter 11 for the maximum input level for your analyzer.

---

### CAUTION

*Always* use attenuation on the TRANSMISSION RF IN port if your test device's output power exceeds the receiver damage limit of +20 dBm or  $\pm 25$  Vdc.

- Use attenuation on the RF IN port to reduce mismatch errors. See "Reducing Mismatch Errors" in Chapter 5 for more information.
- In an AM delay measurement (options 1DA and 1DB only), use attenuation directly *before* the DUT if the device's input power must be less than the  $-10$  dBm minimum specified detector level. (If you reduce the input power to the DUT by lowering the analyzer's source power, the reference detector, X, will be below its specified range.)

Use attenuation directly *after* the DUT if the device's output power is greater than the  $+13$  dBm maximum specified detector level.

### When to Use Amplification

- For accurate measurements, amplification may be needed on the analyzer's RF OUT port. Use amplification when your test device requires input power that exceeds the analyzer's maximum specified output power.

The maximum specified output power is highly dependent upon the model and option configuration of your analyzer as well as the frequency range of your test setup.

See "Source Specifications" in Chapter 11 to determine the maximum specified output power of your analyzer.

- In an AM delay measurement (options 1DA and 1DB only), use amplification directly *before* the DUT if the device's input power must be greater than the maximum power available at the power splitter output.

Making Measurements

**Measuring Devices with Your Network Analyzer**

Use amplification directly *after* the DUT if the device's output power is less than the  $-10$  dBm minimum specified level needed by the test detector (Y).

---

## The Typical Measurement Sequence

A typical measurement consists of performing four major steps:

### Step 1. Enter the Measurement Parameters

The easiest way to set up the analyzer's parameters for a simple measurement is to use the **BEGIN** key. (See "Using the BEGIN Key to Make Measurements," next, in this chapter.)

For some measurements you may wish to enter your own specific measurement parameters. Use the instrument's keys to input your parameters.

### Step 2. Calibrate the Analyzer

This step may be omitted under certain conditions. Your analyzer can provide highly accurate measurements without performing any additional user-calibrations if certain conditions are met. Chapter 6 explains when additional calibration is necessary.

### Step 3. Connect the Equipment

Connect the DUT and any other required test equipment. See the measurement examples later in this chapter for typical equipment setup configurations.

### Step 4. View and Interpret the Measurement

Use the **SCALE**, **DISPLAY**, and **FORMAT** functions to optimize viewing of the measurement results.

Markers, limit lines, and hard copies of the display are common means of interpreting measurement results.

See Chapter 4 for detailed information on using instrument functions to view and interpret your measurements.

---

## Using the BEGIN Key to Make Measurements

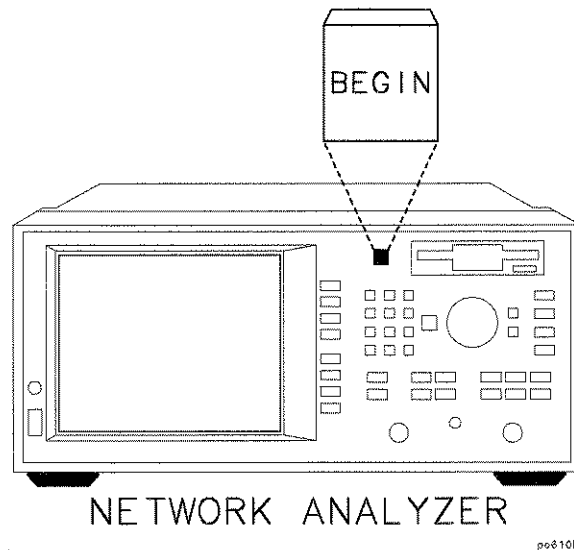

**Figure 3-4. The **BEGIN** Key**

The **BEGIN** key allows you to quickly and easily configure the analyzer (from the **PRESET** condition) to measure the following devices:

- amplifiers
- filters
- broadband passive devices
- mixers
- cables (option 100 only)

Configuring basic measurements from the **BEGIN** key helps you ensure correct instrument set up. The analyzer guides you through the initial steps and configures itself for the device type you select.

---

## **BEGIN** Key Overview

The **BEGIN** key sets up a generic instrument state for the testing of various types of devices.

The **BEGIN** key has two different behaviors, depending on whether you are selecting a new *device* type, or a new *measurement* type.

**Selecting a New Device** When you use the **BEGIN** key to select a new device type and measurement, the analyzer does the following:

- presets the analyzer (except for external reference parameters, and trigger mode)
- takes a sweep
- autoscales the measurement
- places a marker on the maximum or minimum point (depending on the type of measurement)
- makes the marker active
- displays the AM delay connection diagram (when AM delay measurement is chosen; option 1DA or 1DB only)
- modifies the sweep time (option 100 only)

See Table 3-1 for a table of parameters for each measurement type.

### **Selecting a New Measurement**

Once you have selected your device, you can use the softkeys to select the measurement you wish to make. When you select a new measurement, a preset is not done. It is assumed that you are simply changing measurement types and that you may have changed some of the analyzer's parameters (such as frequency, power, etc.) for your DUT, and that you would not want these parameters changed for subsequent measurements.

### Using the BEGIN Key to Make Measurements

#### NOTE

If the new measurement selected is a broadband measurement such as power, conversion loss, or AM delay, the start frequency is limited to at least 10 MHz. Therefore, if your customized setup contains a start frequency below 10 MHz and you choose power, conversion loss, or AM delay, the start frequency will be changed to 10 MHz. The stop frequency will remain unchanged, unless it was set to below 10 MHz.

#### The BEGIN Key and Measurement Channels

The BEGIN key is designed to work when channel 1 is active. However, it does change the measurement mode of channel 2 as well.

If channel 2 is active when the BEGIN key is used to select a new *device* type, channel 2 is turned off, and channel 1 is made active.

If channel 2 is active when the BEGIN key is used to select a new *measurement* type, channel 2 will be left on *and* active. However, the analyzer then proceeds to setup channel 1 for the requested measurement type, even though channel 2 is the active channel.

---

## Using the **BEGIN** Key To Configure Measurements

This procedure shows you how to configure the network analyzer for measurements.

1. Press **PRESET**. Presetting the instruments puts it into a known state with predefined parameters.
2. Press **BEGIN** and then use a softkey to select the type of device that you will be measuring (amplifier, filter, broadband passive device or mixer).
3. Connect your test device to the network analyzer.
4. Use the softkeys to select the type of measurement you want to make:
  - Press **Transmissn** if you want to measure the transmission characteristics of an amplifier, filter, or broadband passive device.
  - Press **Reflection** if you want to measure the reflection characteristics of your device.
  - Press **Power** if you want to measure the RF power of a device. (The **Power** selection is under the **Amplifier** menu.)
  - Press **Conversion Loss** if you want to measure the conversion loss of a device. (The **Conversion Loss** selection is under the **Mixer** menu.)
  - Press **AM Delay** (option 1DA or 1DB only) if you want to measure the delay of a device. (The AM Delay selection is under the **Mixer** menu.)
  - Press **SRL** (option 100 only) if you want to measure the structural return loss of a cable.
  - Press **Fault Location** (option 100 only) if you want to measure the cable fault location.

**Using the BEGIN Key to Make Measurements**

Depending on your selection, the analyzer is set to one of the following configurations:

**Table 3-1. Measurement Configurations from the **BEGIN** Key**

	<b>Transmission</b>	<b>Reflection</b>	<b>Power</b>	<b>Conversion Loss</b>	<b>AM Delay<sup>1</sup></b>
<b>Frequency Range<sup>2</sup></b>	0.300 MHz–1300 MHz	0.300 MHz–1300 MHz	10 MHz–1300 MHz	10 MHz–1300 MHz	10 MHz–1300 MHz
<b>Frequency Range<sup>3</sup></b>	0.300 MHz–3000 MHz	0.300 MHz–3000 MHz	10 MHz–3000 MHz	10 MHz–3000 MHz	10 MHz–3000 MHz
<b>Power Level</b>	0 dBm	0 dBm	0 dBm	0 dBm	maximum specified <sup>4</sup>
<b>Channel 1</b>	Transmission	Reflection	Power	Conversion Loss	AM Delay
<b>Channel 2</b>	Off	Off	Off	Off	Off
<b>Format</b>	Log Mag	Log Mag	Log Mag	Log Mag	N/A
<b>Number of Points</b>	201	201	201	201	201
<b>Sweep Time Mode</b>	Auto	Auto	Auto	Auto	Auto
<b>Sweep Triggering</b>	Continuous	Continuous	Continuous	Continuous	Continuous
<b>Detection Mode</b>	Narrowband	Narrowband	Broadband	Broadband Internal	Broadband External
<b>Measurement Paths</b>	B/R	A/R	B*	B*/R*	Y/X
<b>Averaging</b>	Off	Off	Off	Off	Off
<b>System Bandwidth</b>	Medium	Medium	Medium	Medium	Narrow

1 Options 1DA and 1DB only

2 HP 8711B

3 HP 8713B

4 Maximum power is dependent upon the option configuration of your analyzer. See Chapter 11 to determine the maximum specified power for your analyzer.



---

## The User BEGIN Function (Option 1C2 only)

The **User BEGIN** softkey gives you the capability to redefine the **BEGIN** key menu and install user-defined macro functions. The **User BEGIN** key is only available if your analyzer has the IBASIC option (1C2) installed. Use this key to define macros such as:

- Softkeys to implement *fast save/recall*
- Softkeys to implement most used functions or features
- Softkeys to implement often-used features that involve a number of steps

Macros must be defined within an IBASIC program. If no **User BEGIN** program is currently installed (either by AUTOST or **Recall Program**) the analyzer will automatically create a default program.

**User BEGIN on OFF** selects the **BEGIN** key menu to “user” mode when ON, and to normal operation when OFF.

Once you have changed the **User BEGIN** mode to ON, the same menu will be displayed for subsequent key presses of the **BEGIN** hardkey. (This is not true if your IBASIC program has changed. If the program has changed, the **User BEGIN** mode is reset to OFF.)

Use of the **User BEGIN** function does not restrict access to any normally available instrument feature such as marker functions, etc., nor does this key affect sweep update rates.

Refer to example programs provided on the IBASIC programs disk for implementation requirements. Keystroke recording may be used to modify or update **User BEGIN** programs.

See Chapter 7, “Using Automation,” for more information.

---

## Measuring Transmission Response

This section uses an example measurement to describe how to calibrate for and make a basic transmission response measurement. In this example, a bandpass filter like the one that was supplied with your network analyzer is used.

---

### Enter the Measurement Parameters

Press **PRESET** on the analyzer to set the analyzer to the default mode which includes measuring transmission on channel 1.

**NOTE**

This example measurement uses the default instrument parameters for a transmission measurement. If your particular transmission measurement requires specific parameters (such as frequency range, source power level, number of data points, and sweep time) enter them now.

---

## Calibrate For a Transmission Response Measurement

Your analyzer can provide highly accurate measurements without performing any additional user-calibrations if certain conditions are met. This example describes how to perform a transmission response calibration. When you perform a transmission response calibration, the analyzer performs correction at the selected number of data points across the selected frequency band. Interpolation recalculates the error correction array for reduced frequency spans.

Chapter 6 provides detail about when additional calibration is necessary, and information about other calibrations available for transmission measurements. If you wish to calibrate your instrument for a transmission response measurement, perform the following steps:

1. Press **CAL** **Transmissn** **Response**.
2. The instrument prompts you to connect a through cable. See Figure 3-5.

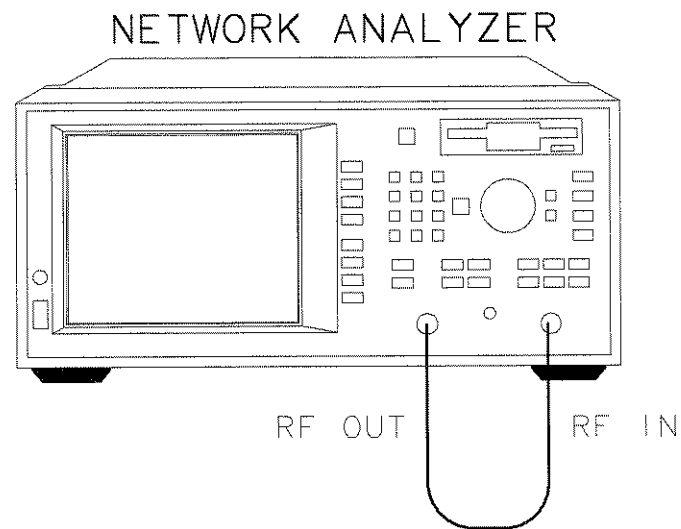

po811b

**Figure 3-5. Equipment Setup For a Transmission Response Calibration**

Making Measurements

**Measuring Transmission Response**

3. Press **Measure Standard**.
4. The analyzer will measure the standard (the through cable) and calculate the new calibration coefficients. The message "Calibration complete." will appear for a few seconds when the analyzer is done calculating the new error correction array.
5. The calibration may be saved in memory or on a disk for later use if you wish. However, the current calibration for each channel is always saved in nonvolatile (battery-backed) memory and will be used the next time the analyzer is preset (see note below) or turned on. See Chapter 6 for information on saving calibrations to the analyzer's internal memory, the analyzer's random access memory (RAM), or to a floppy disk.

**NOTE**

Changing sweep frequencies (and other source parameters) may affect your calibration. See Chapter 6, "Calibrating For Increased Measurement Accuracy," for more information.

---

**Connect the DUT**

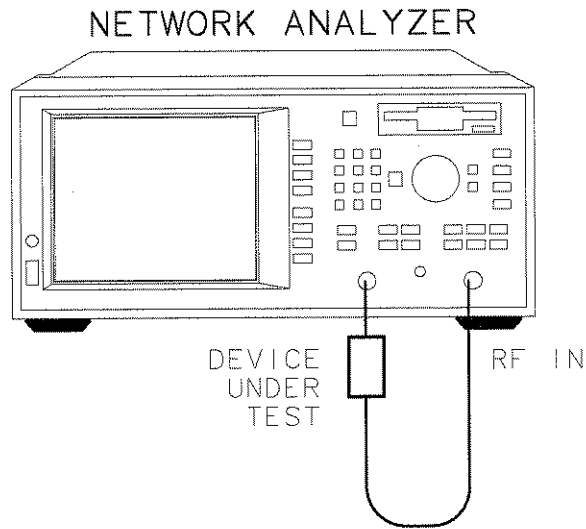

pa612b

**Figure 3-6. Equipment Setup For a Transmission Response Measurement**

---

## View and Interpret the Transmission Measurement Results

1. To view the entire measurement trace on the display, press **SCALE** **Autoscale**.
2. To interpret the transmission measurement, refer to Figure 3-7 or your analyzer's display if you are making this measurement on your instrument.
  - a. The values shown on the horizontal axis are the frequency in MHz. The values shown on the vertical axis are the power ratio in decibels (dB) of the transmitted signal through the device divided by the incident power. To display the result in logarithmic magnitude format (designated by "Log Mag" at the top of the measurement screen), the analyzer computes the measurement trace using the following formula:

$$Transmission (dB) = 10 \log \left( \frac{P_{trans}}{P_{inc}} \right)$$

where  $P_{trans}$  = the power transmitted through the device and  
where  $P_{inc}$  = the incident power.

- b. A level of 0 dB would indicate a perfect through cable or device (no loss or gain). Values greater than 0 dB indicate that the DUT has gain. Values less than 0 dB indicate loss.
3. To quickly determine the filter's minimum insertion loss, press **MARKER** **Marker Search** **Max Search** **Mkr -> Max**.
  4. Note the marker readout in Figure 3-7 provides the frequency and amplitude of the minimum insertion loss point.

Making Measurements  
**Measuring Transmission Response**

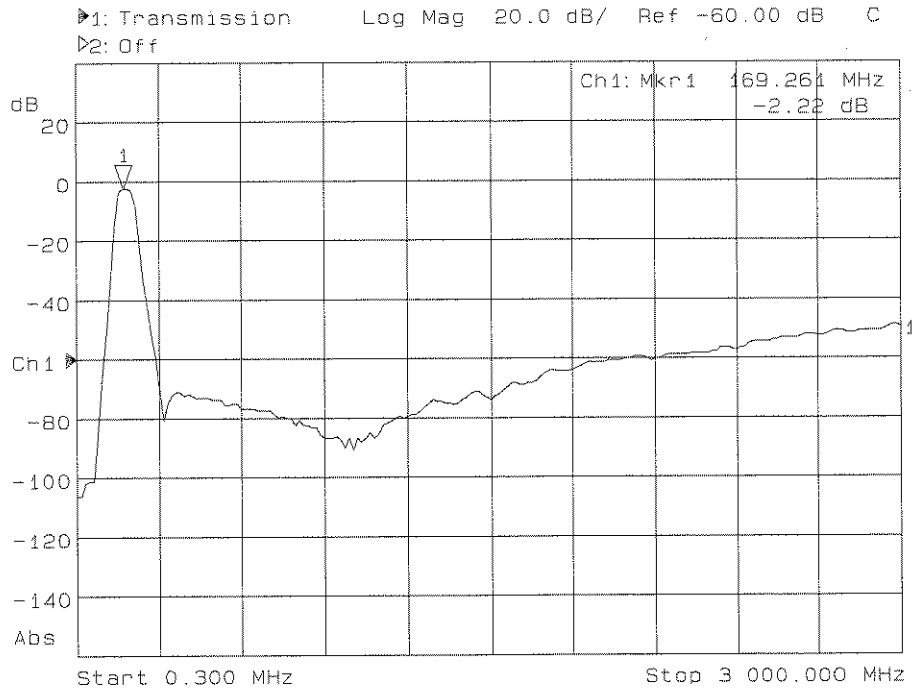

**Figure 3-7. Example of a Transmission Measurement Display**

5. See "Using Markers" in Chapter 4 for more detailed information on using markers to interpret measurements.

**NOTE**

For the measurement to be valid, input signals must fall within the dynamic range of the analyzer. See Chapter 5 for techniques to increase the dynamic range of the analyzer.

---

## Measuring Reflection Response

This section uses an example measurement to describe how to calibrate for and make a basic reflection response measurement. In this example, a bandpass filter like the one that was supplied with your network analyzer is used.

---

### Enter the Measurement Parameters

Press the following keys on the analyzer:

**PRESET**

**CHAN 1**

**Reflection**

#### **NOTE**

This example measurement uses the default instrument parameters for a reflection response measurement. If your particular reflection measurement requires specific parameters (such as frequency range, source power level, number of data points, and sweep time), enter them now.



---

## Calibrate For a Reflection Response Measurement

Your analyzer can provide highly accurate measurements without performing any additional user-calibrations if certain conditions are met. This example describes how to perform a reflection one-port calibration. A one port calibration uses known standards to correct for directivity, source match, and frequency response errors in narrowband measurements.

To perform a reflection one-port calibration you will need one of the following calibration kits depending on the nominal impedance of your analyzer:

HP 85032E	for 50 $\Omega$ type-N female connector calibrations
HP 85032B	for type-N female or type-N male 50 $\Omega$ connector calibrations
HP 85036E	for 75 $\Omega$ type-N female connector calibrations
HP 85036B	for type-N female or type-N male 75 $\Omega$ connector calibrations
HP 85033D	for 3.5 mm female or 3.5 mm male 50 $\Omega$ connector calibrations
HP 85039A	for Type-F 75 $\Omega$ connector calibrations

### **NOTE**

If you are going to be using calibration standards other than the default (female type-N), you must select the type of connector type by pressing **CAL** **Cal Kit** and then selecting the appropriate type.

**Measuring Reflection Response**

Chapter 6 provides detail about when this calibration is necessary. If you wish to calibrate your instrument for a reflection one-port measurement, perform the following steps:

1. Press **CAL** **Reflection One Port**
2. The instrument will prompt you to connect three standards (open, short and load) and measure them. See Figure 3-8.

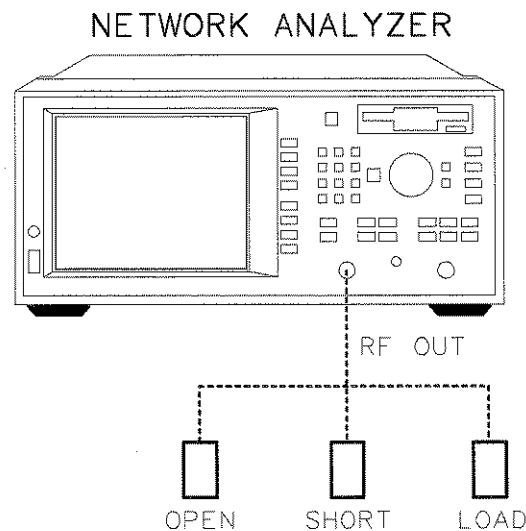
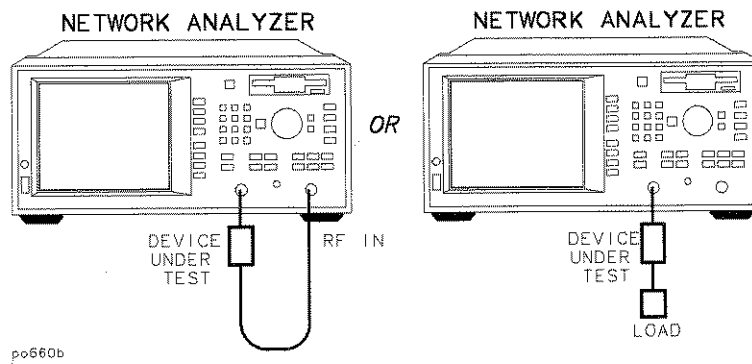

**Figure 3-8. Equipment Setup For a Reflection Response Calibration**

3. Press **Measure Standard** after connecting each standard.
4. The analyzer will measure each standard and then calculate new calibration coefficients. The message "Calibration complete." will appear for a few seconds when the analyzer is done calculating the new error correction array.
5. The calibration may be saved in memory for later use if you wish. See Chapter 6 for information on saving calibrations.

---

## Connect the DUT



**Figure 3-9. Equipment Setup For a Reflection Measurement of a Two-Port Device**

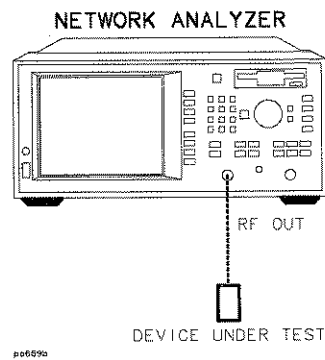

**Figure 3-10. Equipment Setup For a Reflection Measurement of a One-Port Device**

---

## View and Interpret the Reflection Measurement Results

1. To view the entire measurement trace on the display, press **SCALE** **Autoscale**
2. To interpret the reflection measurement, refer to Figure 3-11 or your analyzer's display if you are making this measurement on your instrument.
  - a. The values shown on the horizontal axis are the frequency in MHz. The values shown on the vertical axis are the power ratio in decibels (dB) of the reflected signal divided by the incident power. To display the result in logarithmic magnitude format (designated by Log Mag at the top of the measurement screen), the analyzer computes the measurement trace using the following formula:

$$Reflection (dB) = 10 \log \left( \frac{P_{refl}}{P_{inc}} \right)$$

where  $P_{refl}$  = the power of the signal reflected from the device and  
where  $P_{inc}$  = the incident power.

- b. A level of 0 dB indicates that all of the power applied to the DUT is reflected back, and that none of it passes through the DUT or is absorbed by the DUT.
- c. Values less than 0 dB indicate that power is either absorbed or transmitted by the DUT. Although they are not typically seen, values greater than 0 dB do occur under certain circumstances such as when the measurement needs to be enhanced by calibration, or when the device is active (an amplifier for instance) and perhaps oscillating.

Making Measurements  
**Measuring Reflection Response**

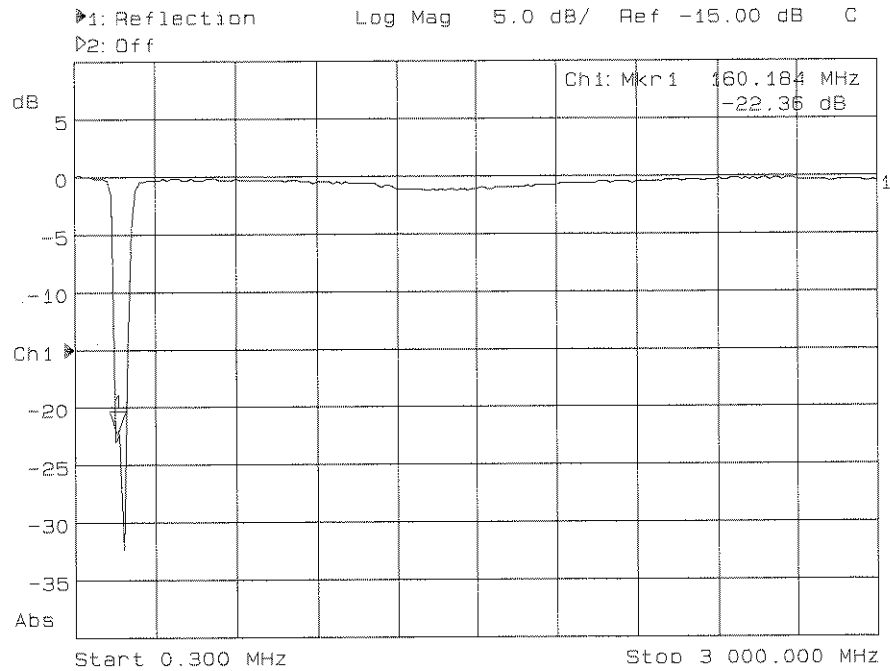

**Figure 3-11. Example of a Reflection Measurement Display**

3. To quickly determine the filter's return loss, press **MARKER** and then use the front panel knob, the **↑** **↓** keys, or the numeric keypad to read the value of return loss at the desired frequency.
4. See "Using Markers" in Chapter 4 for detailed information on using markers to interpret measurements.

---

## Making a Broadband Power Measurement

There are two kinds of power measurements: broadband and narrowband. The example in this section is of a broadband power measurement. (If you are only interested in the output power of your device at the same frequency as the analyzer's source, you can select **CHAN 1** **Detection Options** **Narrowband Internal B**, for a narrowband power measurement. A narrowband power measurement only measures the power within the tuned receiver's bandwidth centered at the source frequency.)

When you measure a device for absolute output power, the network analyzer uses the broadband detection mode and measures the transmitted signal ( $B^*$ ) at all frequencies. This signal may contain frequencies other than the source frequency such as when the DUT is a mixer.

This section uses an example measurement to describe how to normalize the instrument and measure the total output power of an amplifier.

**NOTE**

Broadband power measurements are only specified for measurements with a start frequency of  $\geq 10$  MHz.

---

## Enter the Measurement Parameters

Press the following keys on the analyzer:

**PRESET**

**CHAN 1**

**Power**

**FREQ Start 10 MHz**

### **NOTE**

This example measurement uses the default instrument parameters for a power measurement. If your particular power measurement requires specific parameters (such as frequency range, source power level, number of data points, and sweep time) enter them now.

---

### **CAUTION**

Damage to your analyzer will occur if the receiver input power exceeds +20 dBm or 25 Vdc. The analyzer's source cannot significantly exceed this level, however if your DUT has gain, then attenuation on the RF IN port may be necessary. See "When to Use Attenuation and Amplification" earlier in this chapter for more information.

---

---

## Connect the DUT

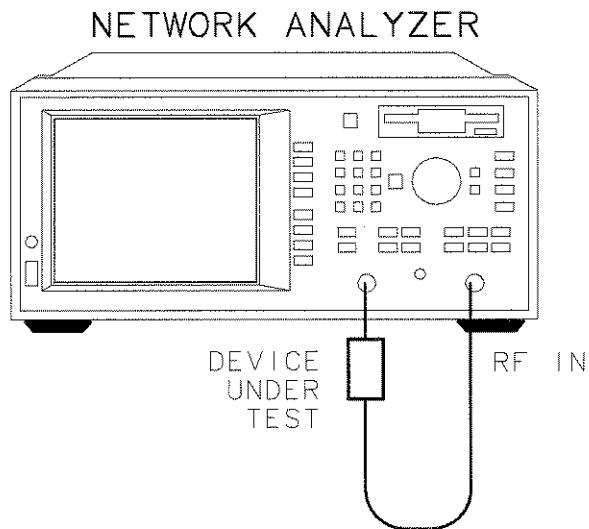

po612b

**Figure 3-12. Equipment Setup For a Power Measurement**



---

## View and Interpret the Power Measurement Results

1. To view the measurement trace, press **SCALE** **Autoscale**.
2. Figure 3-13 shows the results of an example power measurement.
3. To interpret the power measurement, refer to Figure 3-13 or your analyzer's display if you are making this measurement on your instrument.
  - a. When making a power measurement, the display shows the output power measured at the analyzer's RF IN connector. This power is absolute power, as opposed to a power ratio.
  - b. Note that when making a power measurement, the values associated with the vertical axis are in units of dBm, which is the power measured in reference to 1 mW.

$$0 \text{ dBm} = 1 \text{ mW}$$

$$-10 \text{ dBm} = 100 \mu\text{W}$$

$$+10 \text{ dBm} = 10 \text{ mW}$$

Making Measurements

**Making a Broadband Power Measurement**

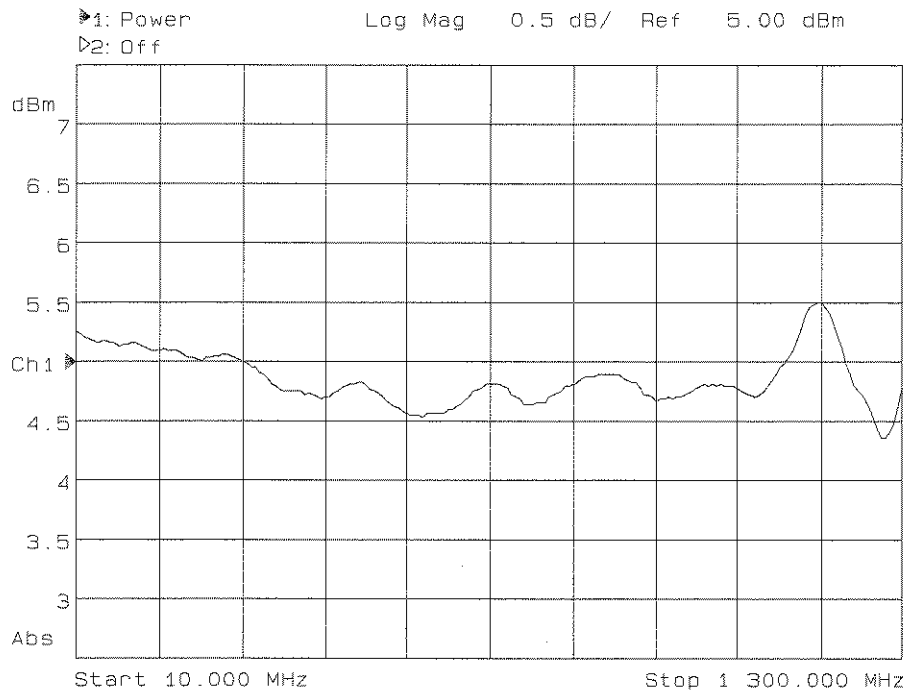

**Figure 3-13. Example of a Power Measurement**

**CAUTION**

If the analyzer's RF output power level is set to higher than the specified output power for your analyzer, the source could go unlevelled. See Chapter 11 for source and receiver specifications. If your device requires input power greater than your analyzer's specified output power, you may need to use a preamplifier in your measurement setup. However, remember to not exceed the receiver damage limit of +20 dBm.

---

## Measuring Conversion Loss

Conversion loss is the ratio of IF output power to RF input power expressed in dB. This section uses an example measurement to describe how to measure the conversion loss of a broadband mixer.

When characterizing a device's conversion loss, the analyzer uses broadband detection to compare the transmitted signal ( $B^*$ ) to the reference signal ( $R^*$ ). This is because the input and output signals of a frequency-translating device may be different. Since broadband detection measures signals at all frequencies, you may want to use a filter to remove unwanted signals such as LO feedthrough when performing this measurement.

For example, an RF signal at 900 MHz mixed with an LO signal at 200 MHz, results in mixing product signals at 700 MHz and 1100 MHz, as well as the original 900 MHz and 200 MHz RF and LO signals.

Making Measurements  
**Measuring Conversion Loss**

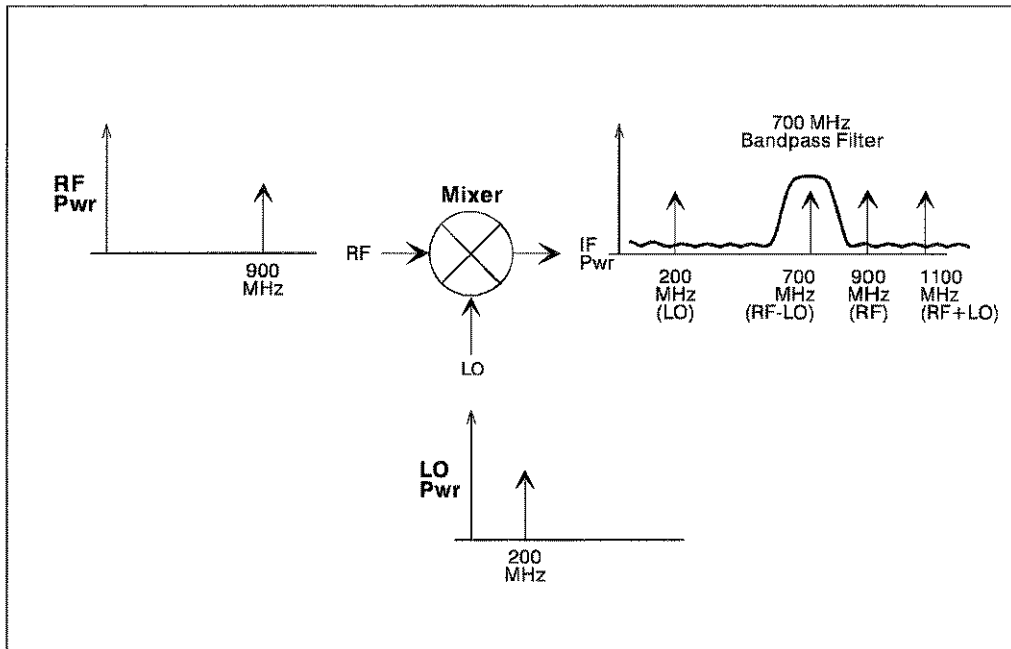

po650b\_c

**Figure 3-14. Filtering Out the Unwanted Mixing Product**

Inserting a 700 MHz bandpass filter in the measurement setup removes the unwanted signals at 200 MHz, 900 MHz and 1100 MHz, providing an accurate measurement of the desired IF signal at 700 MHz.

---

## Enter the Measurement Parameters

Press the following keys on the analyzer:

**PRESET**

**CHAN 1**

**Conversion Loss**

### **NOTE**

This example measurement uses the default instrument parameters for a conversion loss measurement. If your particular conversion loss measurement requires specific parameters (such as frequency range, source power level, number of data points, and sweeptime) enter them now.

---

## Perform a Normalization Calibration

Normalization is the simplest type of calibration. The analyzer stores normalized data into memory and divides subsequent measurements by the stored data to remove unwanted frequency response errors. This calibration is used for this measurement to remove the insertion loss error of the IF filter. Changing frequency range or the number of measurement points will invalidate a normalization calibration.

1. Connect the equipment as shown in Figure 3-15, except replace the DUT with a through cable.
2. Press **CAL** **Normalize**.

---

Connect the DUT

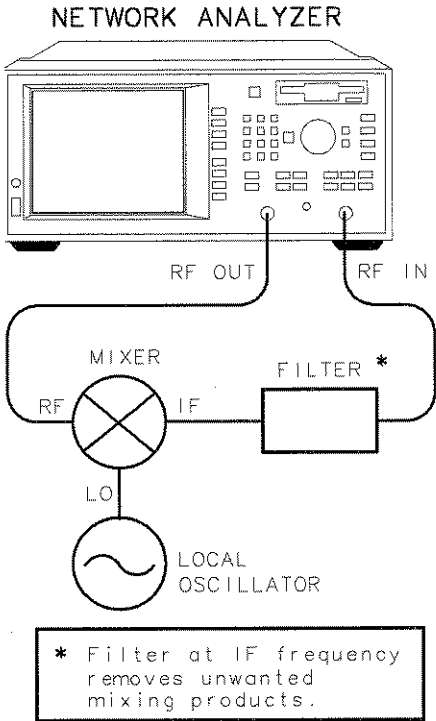

po616b.

**Figure 3-15. Equipment Setup For a Conversion Loss Measurement**

---

## View and Interpret the Conversion Loss Results

1. If necessary to view the measurement trace, press **[SCALE]** **Autoscale**.
2. To interpret the conversion loss measurement, refer to Figure 3-16 or your analyzer's display if you are making this measurement on your instrument.

- a. The values shown on the horizontal axis represent the source RF output. The values shown on the vertical axis are the power ratio in decibels (dB) of the transmitted signal through the device divided by the incident power. To display the result in logarithmic magnitude format (designated by Log Mag at the top of the measurement screen), the analyzer computes the measurement trace using the following formula:

$$\text{Conversion Loss (dB)} = 10 \log \left( \frac{P_{trans}}{P_{inc}} \right)$$

where  $P_{trans}$  = the power measured at the IF output of the mixer and  
where  $P_{inc}$  = the incident power at the RF input.

- b. A level of 0 dB would indicate a perfect device (no loss or gain). Values greater than 0 dB indicate that the mixer has gain. Values less than 0 dB indicate mixer conversion loss.
3. If you wish, you can quickly determine the mixer's minimum conversion loss by pressing **[MARKER]** **Marker Search** **Max Search** **Mkr → Max..**



Making Measurements  
**Measuring Conversion Loss**

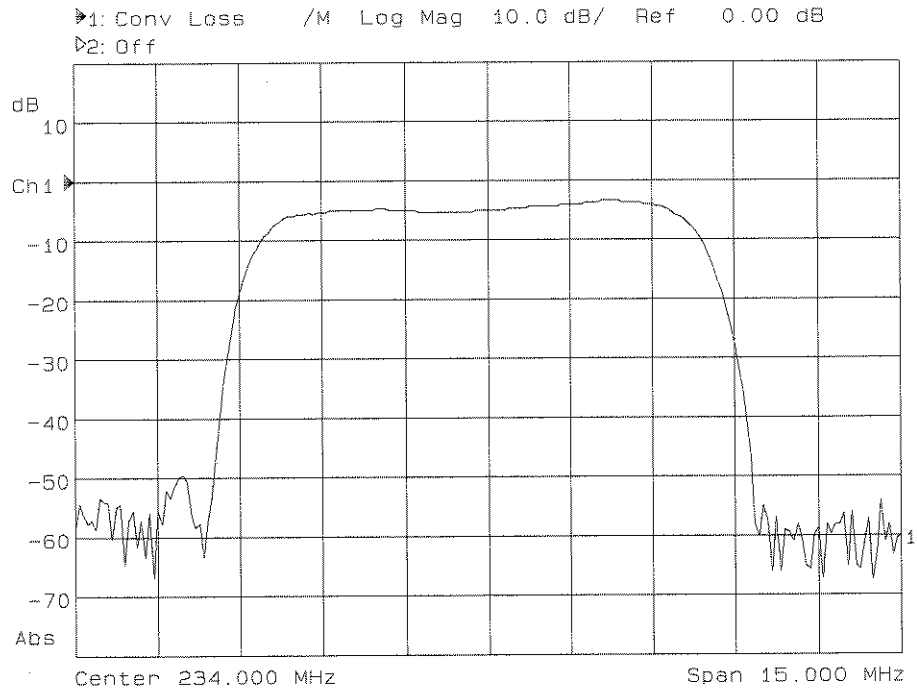

**Figure 3-16. Example of a Conversion Loss Measurement**

**NOTE**

For the measurement to be valid, input signals must fall within the dynamic range and frequency range of the analyzer. See Chapter 5 for techniques to increase the dynamic range of the analyzer.

---

## Measuring AM Delay (Option 1DA or 1DB)

An AM delay measurement characterizes the group delay (or envelope delay) of a device. To perform this measurement you must have ordered either option 1DA (AM Delay, 50 ohm) or option 1DB (AM Delay, 75 ohm). These options include internal instrument hardware and firmware, two external scalar detectors and a power splitter.

Group delay flatness can be a key specification for many components and systems. Distortionless transmission of a signal requires constant amplitude and group delay response over the frequency bandwidth. Group delay is the measurement of signal transmission time through a device. It is defined as the derivative of the phase characteristic with respect to frequency.

If the device under test is a frequency translator, the device input and output frequencies will by definition be different. This generally makes the measurement of the device phase response (and therefore group delay) very difficult.

The AM Delay option overcomes this difficulty by using an amplitude modulation technique to measure group delay. In this technique, a small amount of amplitude modulation is applied to the RF output of the analyzer. Scalar detectors are used to detect this modulation both before and after the device under test. The group delay can then be calculated from the phase difference between these two signals (modulation envelopes). Since broadband detection is used, the option 1DA/1DB analyzer can measure delay through nearly any device, including frequency translators.

There are several important considerations in an AM delay measurement. If the device is a limiter or has AGC (automatic gain control), this will tend to distort or remove the amplitude modulation used for the measurement. Any limiting or AGC in the device should be disabled before making an AM delay measurement. The broadband detection used for AM delay is susceptible to spurious signals and noise. High-level spurious signals should be removed with filtering. The signal levels at both the reference and test detectors should be kept as high as possible. The specified incident power range for both detectors in an AM delay measurement is  $-10$  to  $+13$  dBm. If the device *input* power must be outside this range, amplification or attenuation must be used directly before the device. If the device *output* power is outside the  $-10$  to  $+13$  dBm range, attenuation or amplification must be used directly after the device.

---

## Enter the Measurement Parameters

Connect the detectors and power splitter to the analyzer as shown in Figure 3-17 and then press the following keys on the analyzer:

PRESET

CHAN 1

AM Delay

You may also press the following keys to access AM delay. Pressing these keys will result in a connection diagram being displayed on the screen of the analyzer.

PRESET

BEGIN

Mixer

AM Delay

### NOTE

This example measurement uses the default instrument parameters for an AM delay measurement. If your particular AM delay measurement requires specific parameters (such as frequency range, source power level, number of data points, and sweeptime) enter them now.

---

## Calibrate For an AM Delay Measurement

1. Connect the equipment as shown:

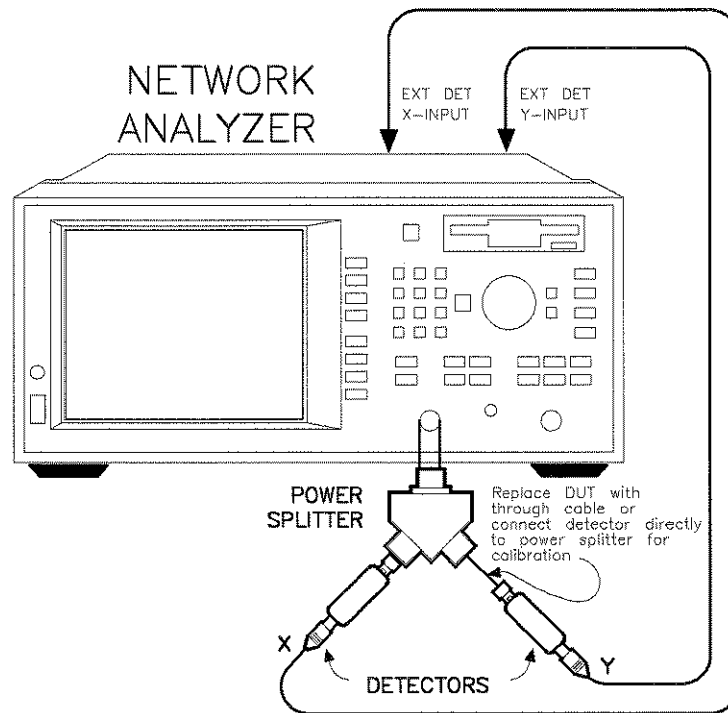

po617b

**Figure 3-17. Equipment Setup For an AM Delay Response Calibration**

2. Press **CAL** **AM Delay** **Response** **Measure Standard**.

**Connect the DUT**

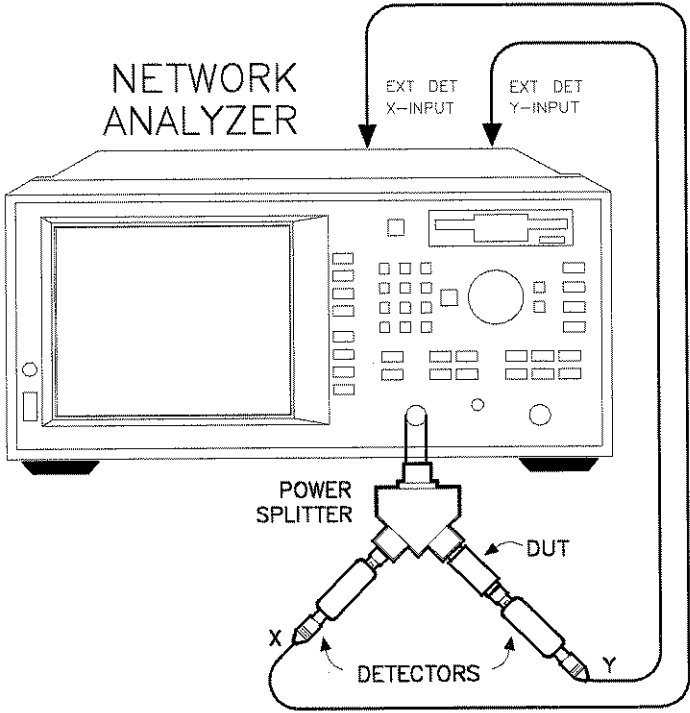

po618b

**Figure 3-18. Equipment Setup For an AM Delay Measurement**

---

## View and Interpret the AM Delay Results

This example is an AM delay measurement of a frequency converter.

1. To view the measurement trace, press **SCALE** **Autoscale**.
2. To interpret the AM delay measurement, refer to Figure 3-19.
  - a. Note that the vertical axis is displaying time rather than power as in previous example measurements. The AM delay measurement measures the time required for power to travel through the DUT at various frequencies. The measurement trace will be noisier as the power level is attenuated by the DUT.
  - b. Since delay is proportional to the derivative of phase, flat (constant) delay indicates linear phase. Delay measurements are typically performed to measure the deviation from linear phase. Deviation from linear phase (flat delay) would indicate that the DUT is distorting the signal.

Making Measurements  
**Measuring AM Delay (Option 1DA or 1DB)**

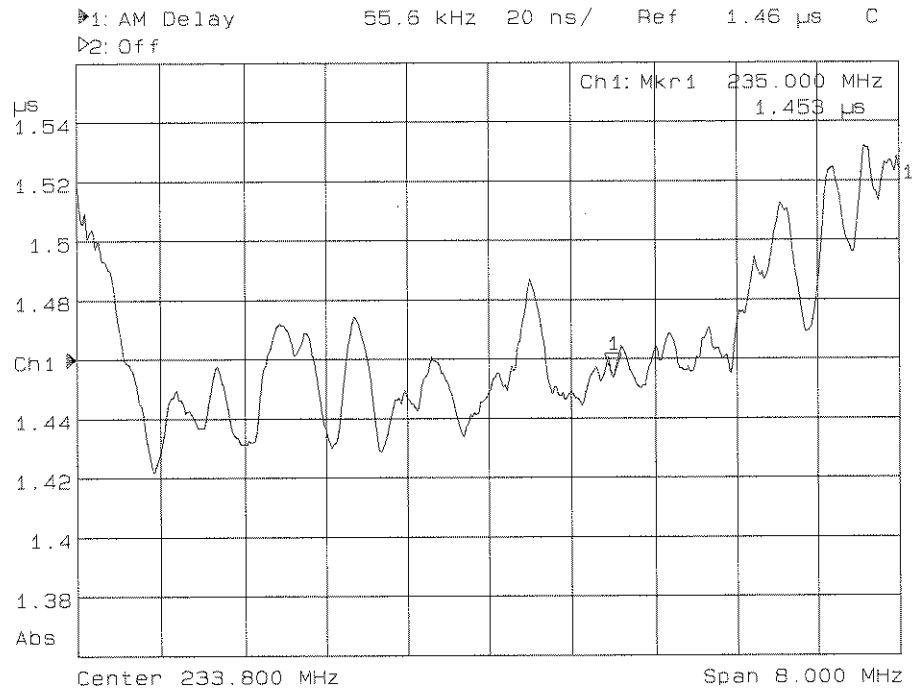

**Figure 3-19. Example of an AM Delay Measurement**

3. Use the marker delta function to determine the maximum deviation. See Chapter 4 for how to use the marker functions.

---

## Making Measurements with the Auxiliary Input

The auxiliary input (AUX INPUT) is located on the rear panel of your analyzer. This input is designed to monitor sweep related dc control signals of devices generally used in conjunction with the analyzer, such as a dc-biased amplifier, or a Voltage Controlled Oscillator (VCO).

The AUX INPUT is *not* recommended for use as an oscilloscope, for several reasons. This input is sampled only once per data point regardless of sweep speed, bandwidth, or number of points per sweep, and sampled data points may not occur at evenly spaced intervals unless the analyzer is in CW mode.

The AUX INPUT sampling rate depends upon the instrument state and sweep. In CW mode with the fastest possible sweep time (**Sweep Time** set to AUTO), system bandwidth has the most significant effect on this timing. Data points are typically taken at about 0.2, 0.6, 7.2, and 70 ms in wide, medium, narrow, and fine bandwidths, respectively. This effect must be taken into account if attempting to view signals that are unrelated to the sweep ramp. For best accuracy, input signal slew rate should be less than 700 volts per second.

Even though the AUX INPUT is not recommended for use as an oscilloscope, it is possible to view sine wave signals up to about 400 Hz with reasonable accuracy by placing the analyzer in CW mode with wide system bandwidth.

---

## Auxiliary Input Characteristics

<b>Nominal impedance</b>	10 k $\Omega$
<b>Accuracy</b>	$\pm$ 3% of reading + 20 mV
<b>Calibrated range</b>	$\pm$ 10 V
<b>Usable range</b>	$\pm$ 15 V
<b>Max input</b>	$\pm$ 15 V



---

**Using Instrument  
Functions**

---

## Using Instrument Functions

This chapter explains some common analyzer functions that can help you to examine, store, and print measurement data.

The following functions are explained in this chapter:

- Using Markers
- Using Limit Lines
- Saving and Recalling Measurement Results
- Connecting and Configuring Printers and Plotters
- Printing and Plotting Measurement Results
- Using a Keyboard

---

## Using Markers

The markers provide numerical readout of trace data. Markers have a stimulus value (the x-axis value) and a response value (the y-axis value).

When you switch on a marker, and no other function is active, the analyzer shows the marker stimulus value in the active entry area.

You can control markers with the front panel knob, the step keys, or the front panel numeric keypad. The markers are activated by pressing the **MARKER** key. See Figure 4-1.

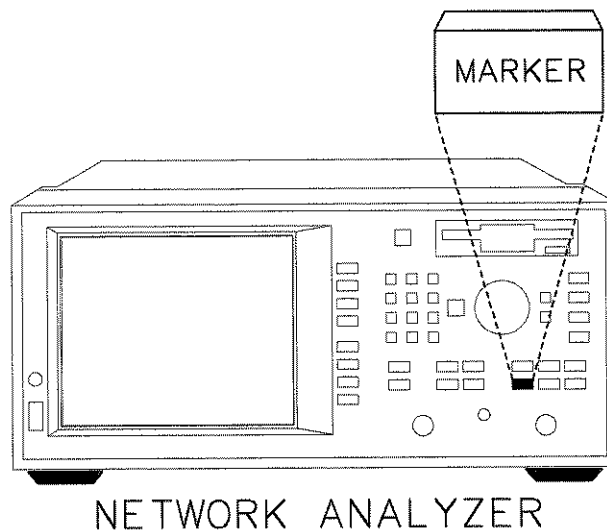

pa612b

Figure 4-1. The **MARKER** Key

### Using Markers

If a marker is on, two lines of numbers follow the marker annotation: the upper line indicates the frequency in MHz, and the lower line indicates the magnitude.

The examples in this section are shown with a transmission response measurement of a filter. To follow along with these examples, use the filter that was shipped with your analyzer, connect the equipment as shown, and set up the analyzer by pressing the keys shown below the equipment setup.

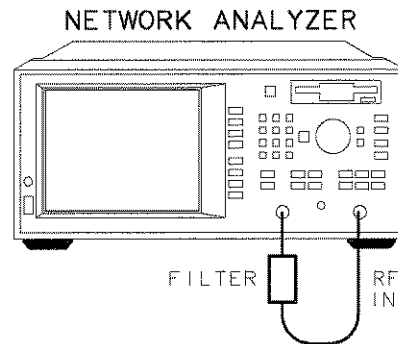

Figure 4-2. Connect the Filter to the Analyzer

PRESET

FREQ Center 175 MHz

Span 349 MHz

SCALE Autoscale

#### NOTE

When you make a hardcopy of your measurement results that contain displayed markers, you can choose to have a marker table appear on the hardcopy. Refer to "To Print and Plot Measurement Results" later in this chapter.

---

## To Activate Markers

1. Press the **MARKER** key to activate marker 1.
2. To activate markers 2 through 4, use the softkeys. For example, press softkey **3:** to activate marker 3. To activate markers 5 through 8, first press **More Markers** and then the softkey that corresponds to the marker you wish to activate.
3. Each marker, when activated, is either placed at its previous x-axis value, or at the center of the x-axis.

### **Active Marker Definition**

Although there may be up to eight markers on the display screen at one time, only one marker can be "active" at any given time. The active marker is designated by a triangle pointing down ( $\nabla$ ) with the marker number above it. Any other markers on the display are inactive and are designated by a triangle pointing up ( $\triangle$ ) with the marker number below it. Any marker can be made active by selecting its corresponding softkey. The active marker's values are always displayed in the upper right corner of the display screen, and you can modify the stimulus value of the active marker using the front panel knob, the step keys, or the numeric keypad.

---

## To Turn Markers Off

1. All markers can be turned off by pressing **MARKER All Off**.
2. To turn off an individual marker, make it the active marker by pressing its corresponding softkey, and then press **Active Marker Off** (accessed by pressing **More Markers** if necessary).

---

## To Use Marker Search Functions

Markers can be used to:

- search a measurement trace for maximum or minimum points
- search for a target value
- automatically calculate bandwidth or notch parameters of filters
- automatically search for multiple maximums or minimums

### **NOTE**

Marker tracking can be useful for tuning DUTs when combined with the marker search functions. When tracking is turned on, the marker search is applied to the active marker and is updated with each sweep. To turn tracking on, press **MARKER** **Marker Search** **Tracking ON**.

---

### **CAUTION**

It is possible to select marker search types on channel 1 that are incompatible with those on channel 2, and vice versa. Doing so can cause the markers on the inactive channel to be moved. Be careful to ensure you are using the correct markers for the channel you are currently measuring, especially when marker tracking is turned on.

---

Using Instrument Functions

**Using Markers**

**To Search For a  
Maximum or Minimum  
Value**

1. Press **MARKER** **Marker Search** **Min Search** **Mkr** **->** **Min** to place marker 1 at the minimum value on the trace.
2. Press **Prior Menu** **2** **Marker Search** **Max Search** **Mkr** **->** **Max** to place marker 2 at the maximum value on the trace.
3. Figure 4-3 shows markers 1 and 2 at the maximum and minimum points, respectively.

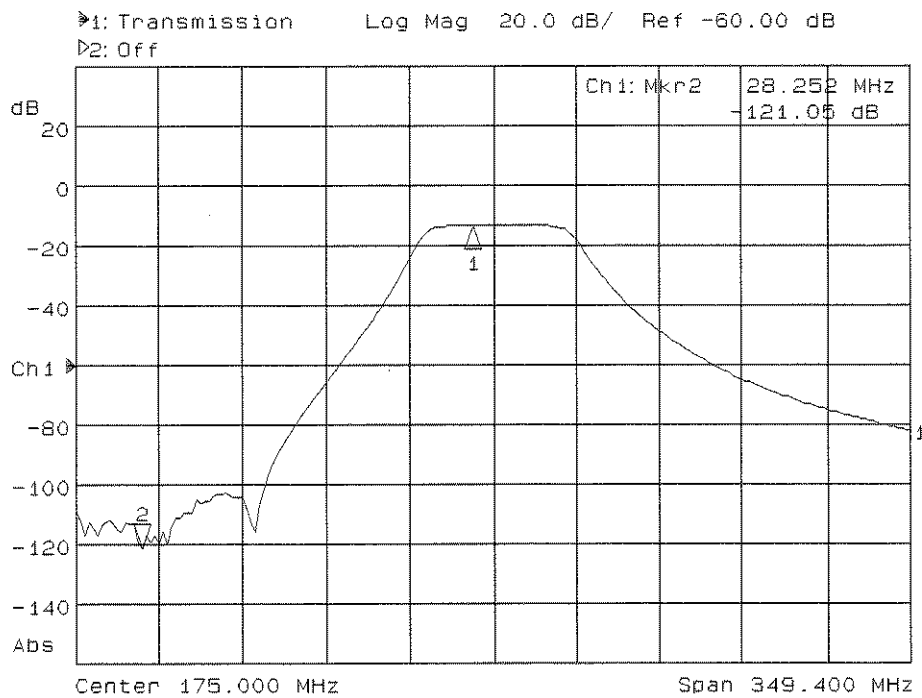

**Figure 4-3. Markers at Minimum and Maximum Values**



**To Search for Target Values**

1. Press **Prior Menu All Off 1: Marker Search Target Search**.
2. Press **Target Value** to choose the target level and enter the target value. (The default value is  $-3$  dB.)
3. Press **Search Right** and notice the marker moves to the first occurrence of the target value to the right. The target value is in reference to 0 dB.
4. Press **Search Left** and notice the marker moves to the first occurrence of the target value to the left.
5. Each time you press **Search Right** or **Search Left** the marker moves to the next occurrence of the target level. If no occurrence is found the message, "Target not found." appears momentarily on the display.

## Using Markers

### To Search for Bandwidth Values

#### NOTE

The bandwidth search function is intended for transmission or power measurements in log mag format only.

1. Press **(MARKER)** **Marker Search** **Bandwidth**. The bandwidth search feature analyzes a bandpass filter and calculates the bandwidth, center frequency, and Q (see note below) for the specified bandwidth level. (The default bandwidth search level is  $-3$  dB.) The bandwidth information is displayed in the upper-right corner of the network analyzer screen. The bandwidth feature puts marker 1 in delta marker mode. (Delta marker mode is explained later in this chapter.)

#### NOTE

Q stands for "quality factor," defined as the ratio of a circuit's resonant frequency to its bandwidth. Your analyzer calculates Q as the center frequency divided by the bandwidth.

2. Press **(-6)** **(ENTER)** to change the  $-3$  dB bandwidth target level to  $-6$  dB.
3. If you want to change the marker frequency resolution, press **(FREQ)** **Disp Freq Resolution** and enter a different resolution value.

Each marker's dedicated use is listed in the following table. Figure 4-4 shows a  $-6$  dB bandwidth marker search.

**Dedicated Use of Markers in Bandwidth Search Mode**

Dedicated Use	Channel 1	Channel 2
maximum power value	marker 1	marker 2
center frequency of pass band <sup>1</sup>	marker 3	marker 4
bandwidth cutoff point (left)	marker 5	marker 7
bandwidth cutoff point (right)	marker 6	marker 8

<sup>1</sup> The center frequency is defined by the analyzer as the midpoint between the two bandwidth cutoff points

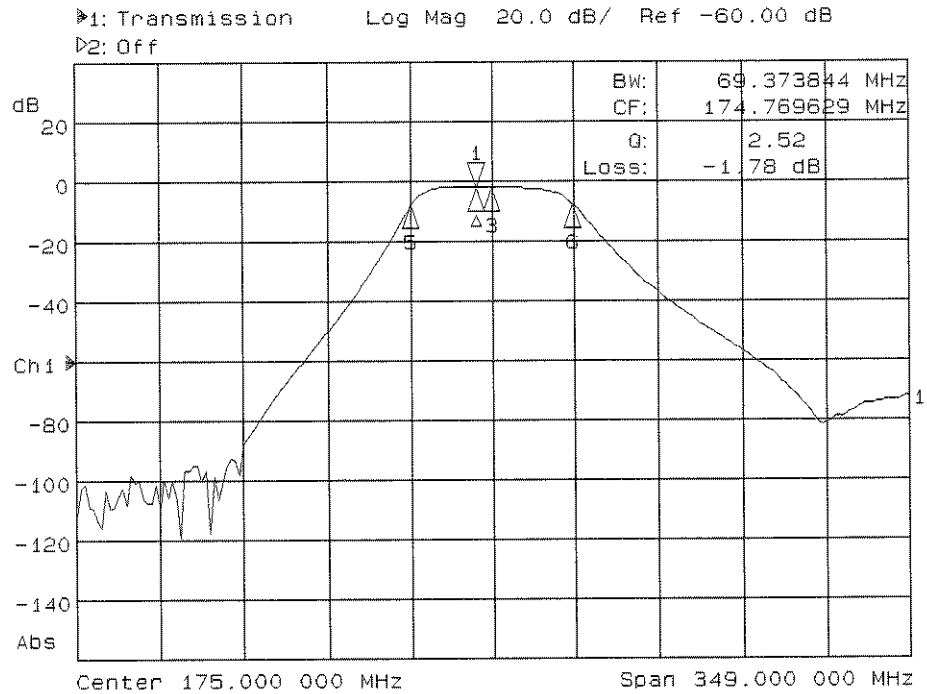

**Figure 4-4. -6 dB Bandwidth Marker Search**

**To Search for Notch Values**

**NOTE**

The notch search function is intended for transmission or power measurements in log mag format only.

1. To follow along with this example you will need to connect a notch filter to the analyzer in place of the bandpass filter shown in Figure 4-2.
2. Press **(MARKER) All Off Marker Search Notch**.
3. The notch search feature analyzes a notch filter and calculates the bandwidth, center frequency, and Q (see note below) for the specified notch level. (The default notch search level is  $-6$  dB.) The resulting information is displayed in the upper-right corner of the network analyzer screen. The notch feature puts marker 1 in delta marker mode. (Delta marker mode is explained later in this chapter.)

**NOTE**

Q stands for "quality factor," defined as the ratio of a circuit's resonant frequency to its bandwidth. Your analyzer calculates Q as the center frequency divided by the bandwidth.

Each marker's dedicated use is listed in the following table. Figure 4-5 shows a channel 1  $-6$  dB notch marker search.

**Dedicated Use of Markers in Notch Search Mode**

Dedicated Use	Channel 1	Channel 2
maximum power value	marker 1	marker 2
center frequency of stop band <sup>1</sup>	marker 3	marker 4
notch -n dB point <sup>2</sup> (left)	marker 5	marker 7
notch -n dB point <sup>2</sup> (right)	marker 6	marker 8

- 1 The center frequency is defined by the analyzer as the midpoint between the left and right notch points
- 2 Where n is the target value, and the -n dB point is relative to the maximum response (marker 1)

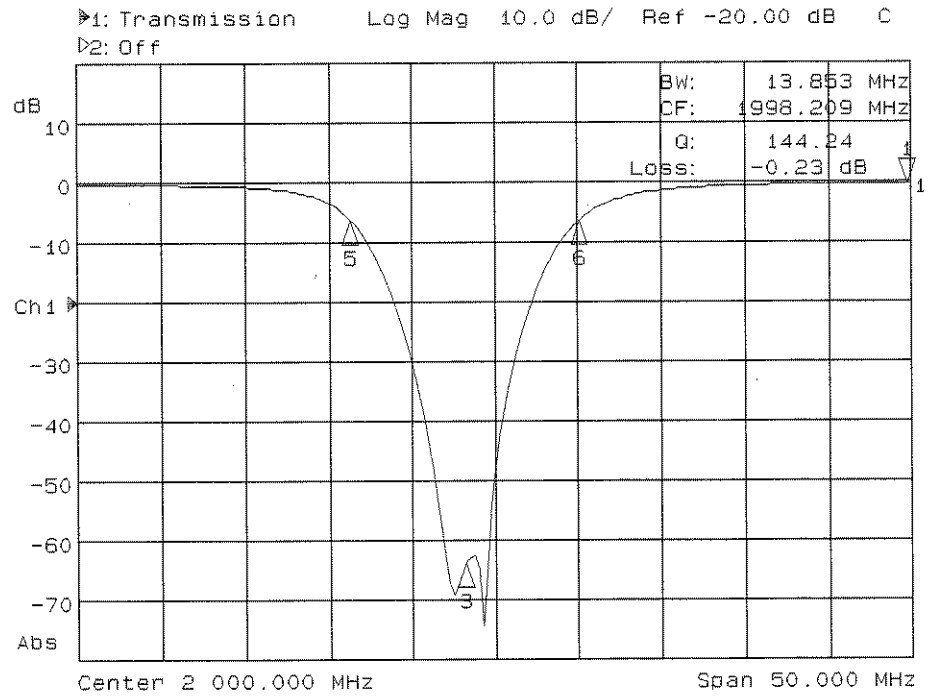

**Figure 4-5. -6 dB Notch Marker Search**

**Using Markers**

**To Use Multi-Peak or  
Multi-Notch Search**

Multi-peak and multi-notch searches are designed for use when measuring multi-pole filters. Both searches automatically search the measurement trace from left to right, and position a marker at each local maximum or minimum. Up to eight maximums or minimums will be found. Searches are limited to responses above -60 dB. With marker tracking ON, the multi-peak/notch search will be performed after each sweep.

Connect a multi-pole filter and press **MARKER** **Marker Search More** and **Multi Peak** if measuring a multi-pole bandpass filter or **MultiNotch** if measuring a multi-pole notch filter.

See Figure 4-6 and Figure 4-7 for examples of a multi-peak and a multi-notch search, respectively.

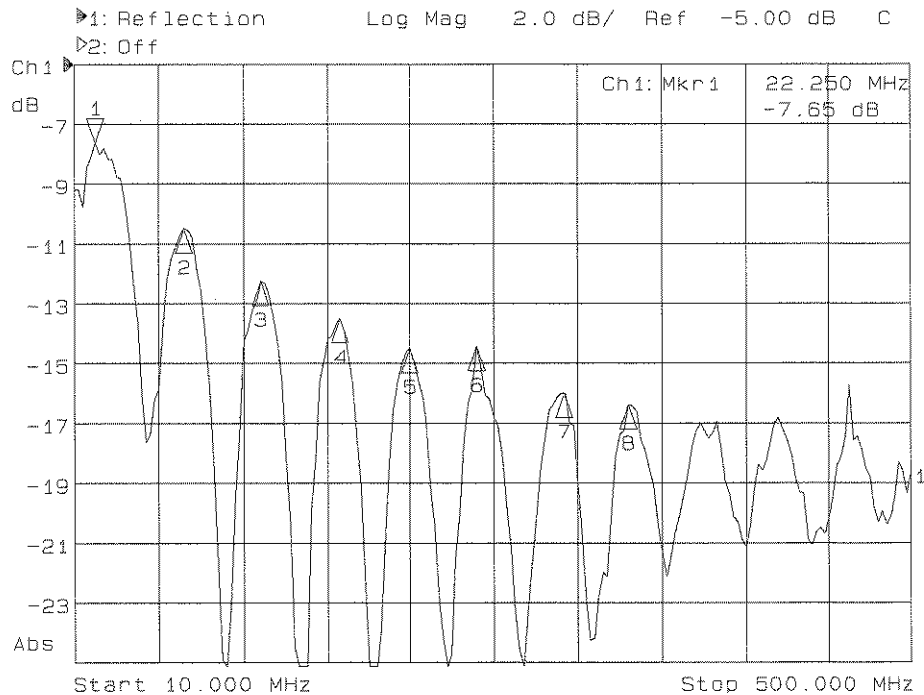

**Figure 4-6. Multi-Peak Search Mode**

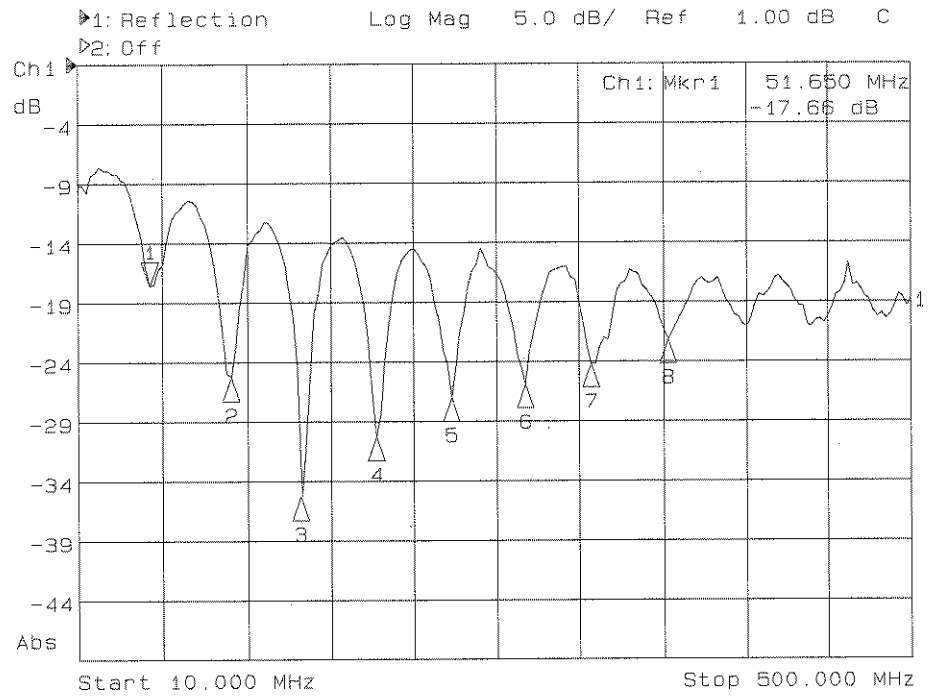

**Figure 4-7. Multi-Notch Search Mode**

---

## To Use Marker Math Functions

The three marker math functions: statistics, flatness, and RF filter stats, perform certain mathematical calculations on the amplitude data of user-defined trace segments.

For channel 1 measurements, the trace segment is defined with markers 1 and 2; for channel 2 measurements the trace segment is defined with markers 3 and 4. The marker math parameters are updated after each sweep, as well as any time a marker is moved. Regular marker tracking is not available with the marker math functions.

### **NOTE**

You cannot have marker math functions active at the same time as marker search functions.

### **To Use Marker Statistics**

The marker statistics function measures a user-defined segment of the measurement trace and calculates the following:

- frequency span
- mean and standard deviation of the amplitude response
- peak-to-peak ripple

Limit testing may be performed on the statistical mean and peak-to-peak ripple. See "To Use Marker Limit Functions," later in this chapter for information.

1. On channel 1 press **MARKER** and set markers 1 and 2 to define the beginning and end of the trace segment that you want to measure. (When using channel 2, use markers 3 and 4 to define the trace segment.)
2. Press **Marker Functions** **Marker Math** **Statistics**.
3. Figure 4-8 shows a defined trace segment. Notice the marker readout in the upper right corner of the display.



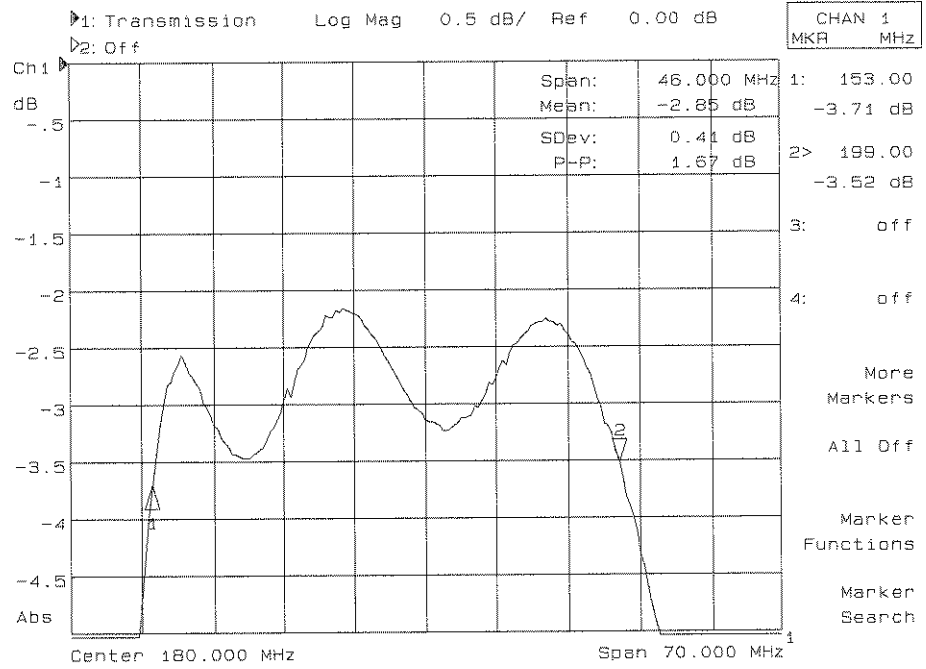

**Figure 4-8. Marker Statistics Function**

## Using Markers

**To Use Marker Flatness** The marker flatness search function measures a user-defined segment of the measurement trace and calculates the following:

- frequency span
- gain
- slope
- flatness

The analyzer calculates flatness by drawing a straight line between the markers. A maximum vertical deviation from this line is computed for each measurement point. Flatness is the magnitude difference of the maximum and minimum calculated deviations from the straight line.

Limit testing may be performed on the flatness parameter. See "To Use Marker Limit Functions," later in this chapter for information.

1. On channel 1 press **MARKER** and set markers 1 and 2 to define the beginning and end of the trace segment that you want to measure. (When using channel 2, use markers 3 and 4 to define the trace segment.)
2. Press **Marker Functions** **Marker Math** **Flatness**.
3. Figure 4-9 shows a defined trace segment. Notice the marker readout in the upper right corner of the display.

Using Instrument Functions  
**Using Markers**

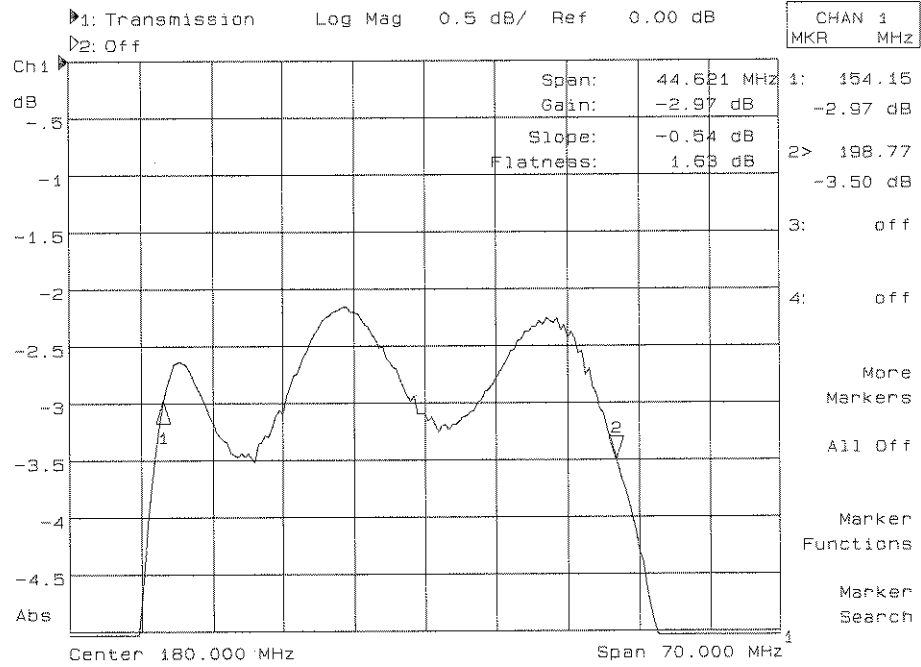

**Figure 4-9. Marker Flatness Function**

## Using Markers

### To Use RF Filter Statistics

The RF filter statistics function measures both the passband and the stopband (reject-band) of a filter with a single sweep.

1. On channel 1 press **MARKER** and place marker 1 at the beginning of the passband and marker 2 at the end of the passband. Place markers 3 and 4 at the beginning and end of the stopband. (When using channel 2, use markers 5 through 8 to define the passband and stopband.)
2. Press **Marker Functions** **Marker Math** **RF Filter Stats**.
3. At the end of each sweep, this feature calculates the insertion loss and peak-to-peak ripple of the passband, as well as the maximum signal amplitude in the stopband. The insertion loss is defined as the minimum point between markers 1 and 2 with respect to 0 dB. The peak-to-peak ripple of the passband is defined as the difference between the maximum and minimum points in the passband (as defined by markers 1 and 2). The reject parameter is defined as the difference between the minimum point in the passband and the maximum point in the stopband.
4. See Figure 4-10 for an example of an RF filter stats search.

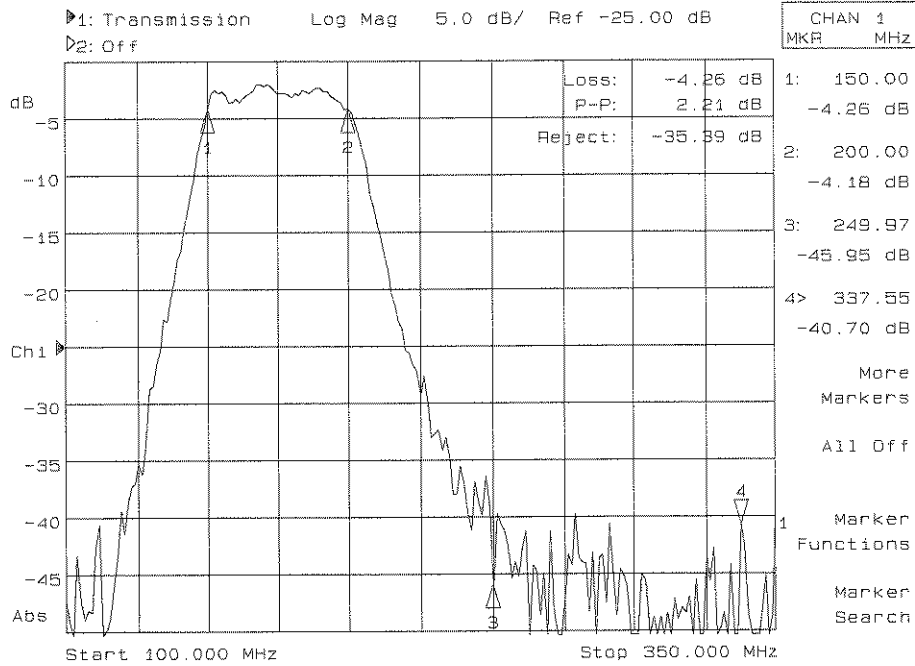

**Figure 4-10. RF Filter Statistics Function**

## To Use Delta ( $\Delta$ ) Marker Mode

In marker delta mode, a reference marker is placed at the active marker position. All marker values are then displayed in reference to this delta marker. When the amplitude of the measurement trace changes, the reference marker value also changes. The delta marker is represented by a triangle pointing up ( $\Delta$ ) with a delta symbol ( $\Delta$ ) below it rather than a number.

To follow along with this example, set up the instrument for a transmission measurement of the bandpass filter that was shipped with your instrument.

1. Press **MARKER All Off Marker Search Mkr ->Max** to move marker 1 (the active marker) to the maximum value on the trace.
2. Press **Prior Menu Marker Functions Delta Mkr ON** to place a reference marker at the active marker position.
3. Press **Prior Menu Marker Search Min Search Mkr -> Min** to place marker 1 to the minimum point on the trace.
4. The difference between the markers' frequency and amplitude value is shown in the upper-right corner of the analyzer screen.
5. Press **Prior Menu 2:**. Use the front panel knob to move marker 2 towards the right-hand side of the display screen. Note that the marker 2 values are also in reference to the delta marker.

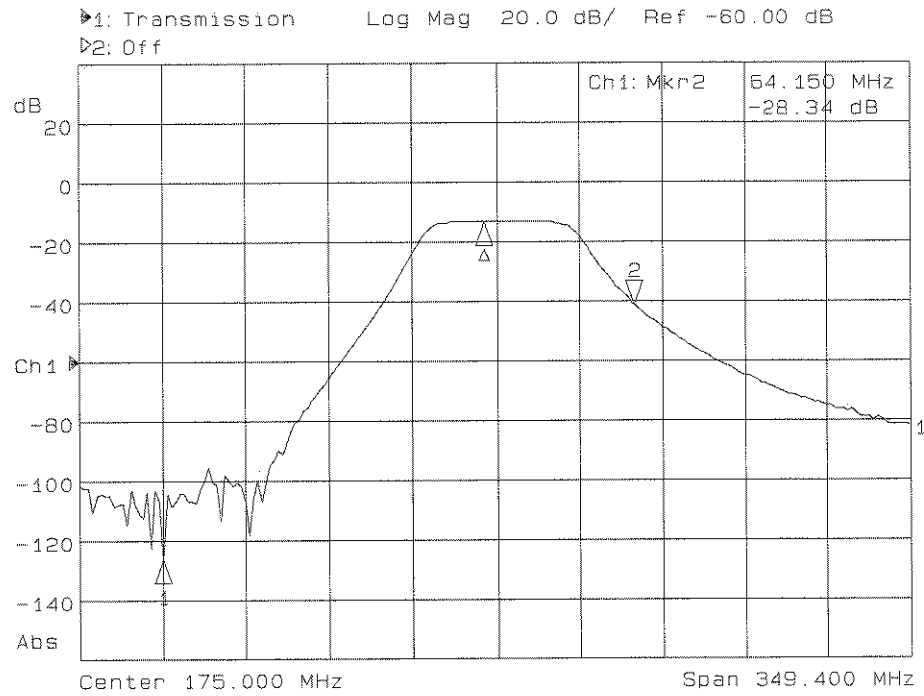

**Figure 4-11. Delta Marker Mode**

---

## To Use Other Marker Functions

### To Use Marker to Center Frequency

This function changes the analyzer's center frequency to that of the active marker and limits the span if necessary. If the markers are all off, and this function is selected, it first turns on marker 1 at its previous setting or, if no previous setting, at the center frequency (default).

1. Press **MARKER** and then use the front panel knob or the numeric keypad to move the marker to 200 MHz.
2. Press **Marker Functions** **Marker -> Center** and note that the trace has now shifted and that the center frequency of the analyzer is now 200 MHz.

### To Use Marker to Reference

This function changes the value of the analyzer's reference level to the amplitude value of the active marker. This function does not change the reference *position*. If the markers are all off, and this function is selected, it first turns on marker 1 at its previous setting or, if no previous setting, at the center frequency (default).

1. Press **MARKER** and then use the front panel knob or the numeric keypad to move the marker to about -10 dB.
2. Press **Marker Functions** **Marker -> Reference** and note that the trace has now shifted up and that the marker is exactly on the reference level.



---

## Using Limit Lines

Limit testing is a measurement technique that compares measurement data to constraints that you define. Depending on the results of this comparison, the analyzer can indicate if your device either passes or fails the test.

Limit testing is useful for real-time tuning of devices to specifications. When limit-line testing is turned on, pass/fail results are output to the display and also to the LIMIT TEST TTL IN/OUT connector on the rear panel. See “BNC Connectors,” in Chapter 8 for more information.

Limit testing is implemented by creating individual flat, sloping, or single point limits on the analyzer display. These types of lines may be used individually or combined to represent the performance parameters for your device under test. Also available are limit testing capabilities for three types of marker searches: statistical mean, peak-to-peak ripple, and flatness.

### NOTE

Limit testing is only performed on the measurement data trace. It cannot be performed on a memory trace.

The following examples are performed using a transmission measurement of the bandpass filter shipped with your instrument. To follow along with these examples, connect your filter to the analyzer and press:

```
PRESET
FREQ Center 175 MHz
Span 200 MHz
SCALE 5 Enter
Reference Level -15 Enter
```

---

## To Create a Flat Limit Line

In this example, you will create a minimum limit line from 155 MHz to 195 MHz at a level of -3 dB.

1. To access the limit line menu press **DISPLAY** **Limit Menu**.
2. To create a new minimum limit line press **Add limit** **Add Min Line**.
3. Press **Begin Frequency**, and enter **155** **MHz**.
4. Press **End Frequency**, and enter **195** **MHz**.
5. Press **Begin Limit**, and press **-3** **Enter**.
6. Press **End Limit**, and press **-3** **Enter**.
7. Notice that the analyzer has generated a limit line at about the center of the display.
8. To get a less distracting view of the limit line, press **DISPLAY** **More Display** **Graticule Off**.
9. To see if your filter meets the minimum limit you have just set up, press **Prior Menu** **Limit Menu** **Limit Test On**.
10. The display will now indicate on the right-hand side of the display whether the DUT has passed or failed when compared to the current limits. If you are using the filter that was shipped with your instrument, you should see a PASS indicator.
11. To edit a current limit line and to see what a fail indicator looks like, press **Edit Limit** and set the **Begin Limit** and **End Limit** to 0 dB.
12. Notice the display now shows the FAIL  indicator.
13. Before continuing to the next section, edit the limit line to change it back to having a begin and end limit of -3 dB.

---

## To Create a Sloping Limit Line

A sloping limit line has different values for its begin and end limits. For example, create a sloping limit line between 130 MHz and 155 MHz with a beginning level of -35 dB and an ending level of -3 dB.

1. Press **Prior Menu** **Add Limit** **Add Min Line** **Begin Frequency** **130** **MHz**.
2. Press **End Frequency** **155** **MHz**.
3. Press **Begin Limit** **-35** **Enter**.
4. Press **End Limit** **-3** **Enter**.

### NOTE

When creating limit lines, you can enter frequency and limit values using the front panel knob or the **↑** **↓** keys as well as the numeric keypad.

Figure 4-12 shows limit lines created that dictate the specified shape of a bandpass filter. In this example, a filter was connected, and tuned to fall within the created limit lines. The pass/fail indicator gives constant feedback regarding status.

Using Instrument Functions  
**Using Limit Lines**

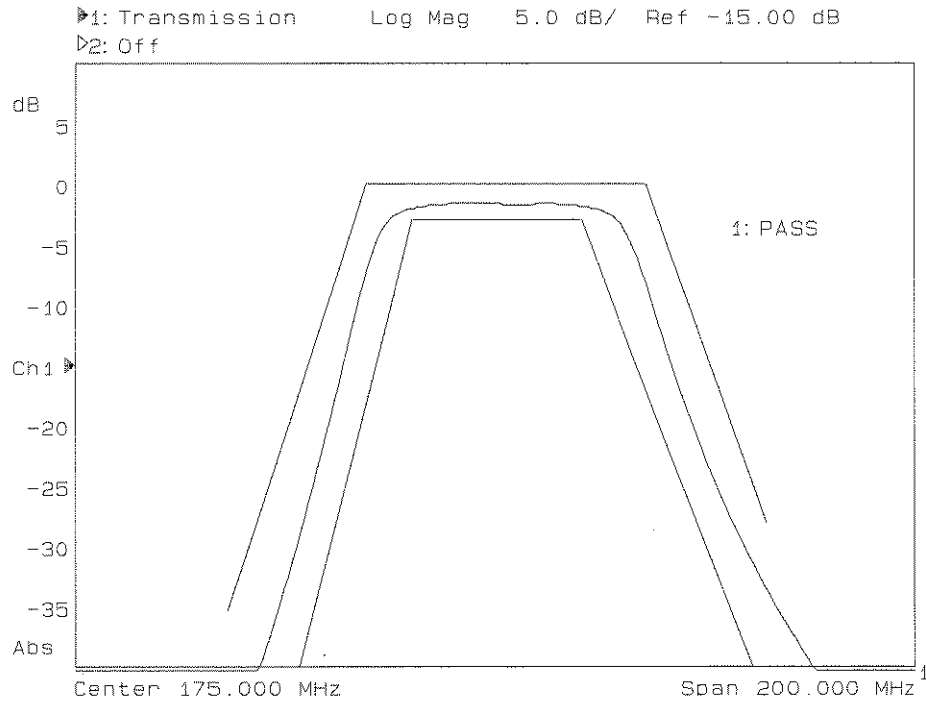

**Figure 4-12. Limit Lines**

---

## To Create a Single Point Limit

Sometimes you may only be interested in the level at one particular frequency. In this case, you may wish to use a single point limit. Using the setup from the previous examples and building on them, let's assume that when testing your bandpass filter, it is specified that the insertion loss at 174 MHz must be less than 3 dB. The following example creates a single point limit at -3 dB at 174 MHz.

---

### CAUTION

Limit tests are only performed on actual data points, *not* the interpolated values between. When setting a single point limit, the limit is actually applied to the closest data point to the frequency of the set limit. See "Additional Notes on Limit Testing," later in this chapter for more information.

1. Press **Prior Menu** **Add Limit** **Add Min Point**.
2. Press **Frequency** **174** **MHz**.
3. Press **Limit** **-3** **Enter**.

---

## To Use Marker Limit Functions

You can use pass/fail limit testing on three of the marker search functions: statistical mean, peak-to-peak ripple, and flatness. (See “To Use Marker Statistics” and “To Use Marker Flatness” earlier in this chapter for more information on these types of searches.) These special marker limit functions can be used in conjunction with regular limit line testing.

To use limit testing on these functions:

1. These searches require that you define a segment of the measurement trace using markers 1 and 2 (for channel 1 measurements) or 3 and 4 (for channel 2 measurements).
2. Press **DISPLAY** **Limit Menu** **Mkr Limits**.
3. Use the front panel knob or the **↑** **↓** keys to select limit testing for the statistical mean, peak-to-peak ripple, or flatness. Then press **Mkr Limit on OFF** so that the word “on” is now in capital letters.
4. Press **Max Limit** and enter the maximum limit using the front panel keypad and terminating the entry with the **ENTER** key.
5. Press **Min Limit** and enter the minimum limit using the front panel keypad and terminating the entry with the **ENTER** key.
6. If limit testing has not been turned on, turn it on by pressing **Prior Menu** **Limit Test on OFF**.

### NOTE

Note that there are no visible limit lines or indicators on the display with these functions. Therefore the **Limit Line on OFF** function has no effect when using marker limits.

---

## Other Limit Line Functions

### To Turn Limit Lines On and Off

Using the **Limit Line On/Off** softkey toggles any created limit lines on and off; it does not delete them. You can still use the limit test function (pass/fail) without the limit lines appearing on the display screen.

### To Delete Limit Lines

1. To select a limit line or point to delete, you must be in the main limit line menu.
2. To easily ensure you are in the main limit line menu, press **DISPLAY Limit Menu**.
3. Use the front panel knob or the **↑** **↓** keys to select the limit you wish to delete.  
The selected limit will appear in inverse video in the limit table.
4. Press **Delete Limit**. The analyzer then gives you the option to cancel the deletion, go ahead with the individual deletion, or delete all the currently set limits.

### Using a Marker During Limit Entry

Pressing the **MARKER** softkey while entering a limit line will activate a marker. The marker can be used to determine a frequency or level of interest on the device response.

---

## Additional Notes on Limit Testing

**Stimulus and Amplitude Values** In frequency sweep mode, the stimulus values are interpreted as frequencies; in power sweep mode, the stimulus values are interpreted as output power levels.

---

**CAUTION**

The values entered for stimulus and amplitude are unitless. If the measurement format is changed after limit lines are set, the amplitude values do not automatically change. Therefore, you should select the format you want to use *before* entering your limits.

---

**Limit Testing and Measurement Points**

Limit testing is only performed on actual data points, *not* interpolated values between them. The limit lines or points that you enter are converted to values at each measurement point. Most of the time, this has little or no effect on the validity of the limit testing. However, note the following examples of problems that could arise when using limit lines:



**Example 1.**

When using a small number of measurement points, limit lines must be set carefully, or the results may be confusing, because the analyzer connects the measurement points with straight lines. The following illustration shows a data trace with three measurement points: A, B, and C, along with a minimum limit line.

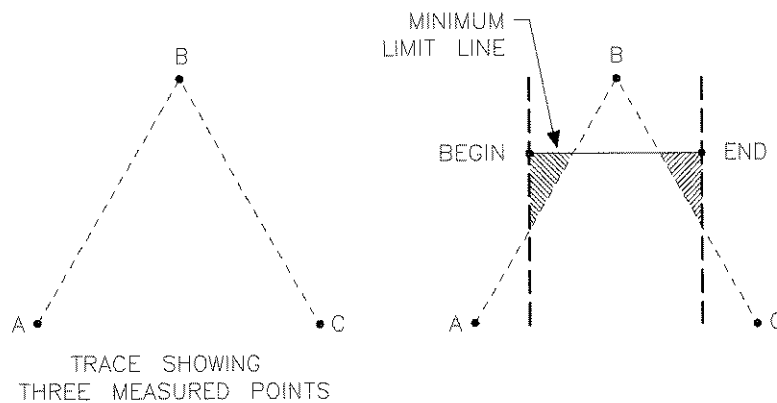

po653b

**Figure 4-13. Limit Lines Example 1**

Note that the beginning of the limit line falls between points A and B along the horizontal frequency axis. The end of the limit line falls between points B and C along the frequency axis. Therefore, only one measurement point is encountered between the beginning and end of the limit line. This particular example would result in a limit test result of "PASS" when it appears that it could fail. More measurement points are needed to evaluate this measurement.

**Using Limit Lines**

**Example 2.**

In this example, the analyzer has been set up with the following parameters:

Start frequency = 90 MHz

Stop frequency = 210 MHz

Number of points = 11

Maximum limit line begin frequency = 90 MHz

Maximum limit line end frequency = 200 MHz

Refer to the illustration below for the discussion. Here, the data trace passes through the limit line, and is above it, but this test passes because the last point *tested* is at 198 MHz. The last point (210 MHz) does not cause the limit test to fail because it is past the limit line stop frequency of 200 MHz. But there is an area on the data trace between 198 MHz and 200 MHz that is above the displayed limit line.

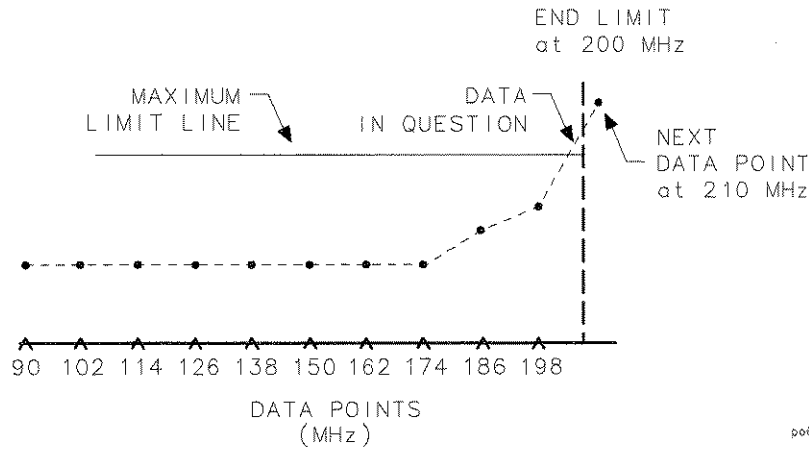

**Figure 4-14. Limit Lines Example 2**

---

## Saving and Recalling Measurement Results

The network analyzer allows you to save the following information:

<b>Instrument State</b>	Instrument state settings consist of all the stimulus and response parameters that set up the analyzer to make a specific measurement including markers, limit lines, memory traces, and user-defined calibrations. Instrument state information is saved and recalled for both channels.
<b>Cal</b>	The measurement calibration information is the measurement correction data that the analyzer creates when you make a calibration. Measurement calibration information is saved and recalled for both channels.
<b>Data</b>	The measurement data consists of the actual measurement data trace.

You can save any combination of the above three and recall them to be displayed on the network analyzer. You can also dump the measurement channel data to an ASCII format file that you can use for graphing and manipulation in spreadsheets.

---

**NOTE**

When saving calibration information, the instrument state settings will also be automatically saved.

---

## Saving Instrument Data

When you save data to a file, the analyzer automatically selects a file name for you. Since these names may not be as descriptive as desirable, you may change the name of the file after it has been saved, or you can save it to a file name of your choice by using the **Re-Save State** function. See “Other File Utilities” later in this chapter for information on how to change a file name. When saving a file using the **Re-Save State** function, enter the file name in one of the following ways:

- Use an external DIN keyboard connected to the network analyzer rear panel and type in the filename. (For information on using a keyboard, see “Using a Keyboard” later in this chapter.)
- Use the front panel knob and **Select Character** key to point and select each character of the new filename. Then press **Enter**.

### **NOTE**

Refer to Chapter 14 at the end of this guide for information on the analyzer’s instrument state memory allocation.

**Select the Disk**

1. If you are using a floppy disk, place a formatted disk in the disk drive you are using. If your disk is not formatted, refer to the procedure in "Formatting a Floppy Disk" located later in this section.
2. Press **SAVE RECALL** **Select Disk** and press the key that corresponds to the disk where you are going to save data:
  - Press **Non Vol RAM Disk** to save to the analyzer's internal non-volatile memory. (Nonvolatile means that the information will be retained in memory when the power to the analyzer is turned off.) This is the default selection.
  - Press **Volatile RAM Disk** if you are saving to the analyzer's internal volatile memory. (Volatile means that the information will be lost if power to the analyzer is turned off.)
    - ◊ If you have the IBASIC Option 1C2 installed in your analyzer you can configure the volatile RAM disk by pressing the **Configure VOL\_RAM** softkey. (This softkey will not do anything on instruments without IBASIC.)
    - ◊ When this key is pressed, a message appears, displaying the current percentage allocation between RAM disk and IBASIC memory. The default allocation is 10% to IBASIC and 90% to volatile RAM.
    - ◊ To change the memory allocation, press **Modify Size**, then enter the new RAM disk allocation.
    - ◊ The power must be cycled on the analyzer for the changes in memory allocation to take effect.
  - Press **Internal 3.5 Disk** if you are saving to the 3.5 inch disk in the analyzer's built-in disk drive (Both MS-DOS and LIF format disks can be used.)

### Saving and Recalling Measurement Results

- Press **External Disk** if you are saving to a disk in an external HP-IB disk drive (this could be a hard disk or a floppy disk drive).
  - ◊ If you are configuring the network analyzer for the external disk drive, press **Configure Ext Disk** and then the following keys:
    - ◊ **Ext Disk Address** and enter the disk drive HP-IB address
    - ◊ **Ext Disk Unit** and enter the disk unit number
    - ◊ **Prior Menu External Disk**

#### Define and Save Data

1. Press **Prior Menu Define Save**.
  - Press **Inst State OFF** if you DO NOT want the instrument state saved.
  - Press **Cal ON** if you want to save the active measurement calibration.
  - Press **Data ON** if you want to save the measurement data that is displayed on the network analyzer screen.

#### NOTE

Note that the **Inst State** toggle is automatically turned **ON** when **Cal** is **ON**.

2. Press **Prior Menu Save State** to save the instrument state file.

The filename appears on the screen as STATE#.STA (where # is a number the analyzer selects from 0 to 999). The type of file appears on the screen as DOS if you are using a disk formatted in MS-DOS, or as BDAT if you are using a disk formatted in LIF.

**To Save Measurement Data in ASCII Format**

Your measurement data can be saved in an ASCII format that is compatible with many personal computer software packages such as Lotus®1-2-3®. The file is saved in a two column format, where column 1 is the frequency and column 2 is the measured value at that point.

To save the measurement trace as an ASCII file:

1. Press **SAVE RECALL** **Select Disk** and select the softkey that corresponds to where you want to save your file. (See "Select the Disk," earlier in this section.)
2. Press **Prior Menu** **Define Save** **Save ASCII** and either **Save Chan 1** or **Save Chan 2**, depending on which measurement channel data you want to save.
3. The filename appears on the network analyzer screen as **TRACE#.PRN** (where # is a number the analyzer selects from 0 to 999).

**NOTE**

Your analyzer can store files on floppy disks that are formatted in either MS-DOS or LIF. The table below shows the relationships between the disk format, type of save, and the file name and type.

Disk Format	Type of Save	File Name	Type
MS-DOS	Data	STATE#.STA	DOS
	ASCII	TRACE#.PRN	DOS
LIF	Data	STATE#	BDAT
	ASCII	TRACE#	ASCII

---

## To Recall from a Disk or Internal Memory

The network analyzer allows you to recall and display measurement results that you saved as STATE files. You can then compare the recalled measurements to subsequent measurements. The analyzer can display both a data and memory trace for each channel. The data trace is saved when you select **Data ON** in the **Define Save** menu. The memory trace is saved as part of the instrument state. These traces will be automatically re-displayed when you recall the file from a disk or internal memory.

Calibration sets are linked to the instrument state and measurement parameter for which the calibration was done. Therefore a saved calibration can be used for multiple instrument states as long as the measurement parameter, frequency range, and number of points are the same.

1. Press **SAVE RECALL** **Select Disk** and press the key that corresponds to the location where your desired file exists.
2. If necessary, change directories to the directory that contains the desired file as described in "To Use Directory Utilities" in the next section.
3. Press **Prior Menu** **Prior Menu** and turn the front panel knob to move the highlighted bar to the file you want to recall.
4. Press **Recall State** to recall the desired file to the network analyzer.

### **NOTE**

Refer to "Measurement Setup and Control with Fast Recall" in Chapter 7 for information on using the analyzer's fast recall feature to quickly recall often-used instrument states.



---



## Other File Utilities

### To Rename a File



1. Press **SAVE RECALL** **Select Disk** and press the key that corresponds to the disk where the desired file is located.
2. Use the front panel knob to move the highlighted bar to the file you want to rename.
3. Press **Prior Menu** **File Utilities** **Rename File**.
4. Use the **Backspace** key repeatedly, or press **Clear Entry** to erase the current filename from the analyzer screen.
5. Enter the new filename in one of the following ways:
  - Use an external DIN keyboard connected to the network analyzer rear panel and type in the new filename. (For information on using a keyboard, see “Using a Keyboard” later in this chapter.)
  - Use the front panel knob and **Select Character** key to point and select each character of the new filename. Then press **Enter**.

**Saving and Recalling Measurement Results**

**To Delete a File**

1. Highlight the file to be deleted by using the front panel knob or the   keys.
2. Press **Delete File YES**.
3. To delete all files within the current directory, press **Delete All Files YES**.

**To Copy a File**

1. Highlight the file to be copied by using the front panel knob or the   keys.
2. Press **Copy File** and then select the destination disk for the file to be copied. You will then be given the opportunity to edit the destination file name if you wish.
3. Use a keyboard (if connected) or the front panel knob and the softkeys to enter the destination filename.

**CAUTION**

There will be no warning from the analyzer if the destination file already exists. It will be overwritten without warning. For instance, **STATE1.STA** on the internal memory disk and **STATE1.STA** on a floppy disk in the built-in disk drive may contain completely different sets of data. If you copy one of those files to the other without editing the file name, the file will be overwritten with the source file.

4. To copy the file press **Enter**.
5. To copy all the files in the current directory, press **Copy All Files** and then select the destination disk for the files to be copied.
6. You will then be prompted to tell the analyzer where on the destination disk to put the files to be copied.
7. Press **Enter** if you want the files to go into the main, or root, directory of the destination disk. Use a keyboard (if connected) or the front panel knob and the softkeys to enter a subdirectory on the destination disk before pressing **Enter**.

**To Access Files From  
SCPI or IBASIC**

Files on each disk can be accessed via HP-IB using SCPI commands, as well as directly from IBASIC. The table below shows the names used for each disk. You will notice that when using the file utilities, the analyzer displays the SCPI name in the disk catalog window and in the filename entry windows.

**Table 4-1. Disk Access**

<b>Disk</b>	<b>SCPI name</b>	<b>IBASIC name</b>
Non-Volatile RAM Disk	<b>MEM: file</b>	<i>file:MEMORY,0,0</i>
Volatile RAM Disk	<b>RAM: file</b>	<i>file:MEMORY,0,1</i>
Internal 3.5" Disk	<b>INT: file</b>	<i>file:INTERNAL</i>
External Disk	<b>EXT: file</b>	<i>file: ,7xx,unit<sup>1</sup></i>

<sup>1</sup> where "xx" - the HP-IB address of the external disk drive and unit is the disk unit number.

For more details on HP-IB programming, refer to the *Programmer's Guide*. For more details on IBASIC disk access, refer to the IBASIC "MASS STORAGE IS" keyword in the *HP 8711B/12B/13B/14B HP Instrument Basic User's Handbook*.

---

## To Use Directory Utilities

This section describes how to make directories so you can store files into categories, how to change between the various existing directories, and how to remove an unwanted directory. You can make directories for floppy disks and the analyzer's internal memory, and RAM disk.

### NOTE

Disks formatted in LIF do not support directories.

### Make a Directory

1. If you are going to use a floppy disk, place an MS-DOS formatted disk in the drive you are using for data storage. If your disk is not formatted, refer to the procedure in "To Format a Floppy Disk" located later in this section.
2. Press **SAVE RECALL** **Select Disk**.
3. Choose the location of the disk you want to make the directory on: internal non-volatile RAM disk, internal volatile RAM disk, internal 3.5" disk (the analyzer's built-in disk drive), or external disk.

---

### CAUTION

Remember that volatile RAM disk memory *will* be lost if the power to the instrument is turned off.

4. Press **File Utilities** **Directory Utilities** **Make Directory**.

Think of a logical name to call a directory. Standard MS-DOS naming conventions apply to the name of the directory (maximum of eight characters plus a three character extension).

5. Enter the name of the new directory in one of the following ways:
  - Use an external DIN keyboard connected to the network analyzer rear panel and type in the new filename. (For information on using a keyboard, see "Using a Keyboard" later in this chapter.)

- Use the front panel knob and **Select Character** key to point to and select each character of the new directory name. Then press **Enter**.
6. Press **Make Directory** to create the directory.

**NOTE**

You can also change to a directory and use **Make Directory** to create a subdirectory. The number of characters in a directory and subdirectory path cannot exceed the MS-DOS limitation of 63.

**Change to a Directory**

1. Press the **↑** **↓** keys to highlight the directory you want to change to. Then press **Change Directory**. After changing directories, the current directory name appears in the top box of the displayed table.
2. To change to the previous directory, highlight **..<PARENT>** and press **Change Directory** to return to the disk's previous directory.
3. To change to the disk's main or root directory, continue highlighting and changing to the **..<PARENT>** directory until the current directory name in the top box is simply a backslash "**\.**"

**Remove a Directory**

1. A directory must be empty before it can be removed. If there are files in the directory that you want to move elsewhere and delete, refer to "Other File Utilities," later in this chapter for information on how to copy and delete files.
2. Highlight the directory to be removed by using the front panel knob or the **↑** **↓** keys.
3. Press **Remove Directory**.

---

## Formatting a Floppy Disk

You must format unformatted floppy disks before you can save data on them. The analyzer internal memory and RAM disk memory do not need to be formatted.

---

### **CAUTION**

All information on the disk will be erased during the formatting process.

- If you are saving files to recall on an MS-DOS computer, follow the procedure in “To Format a Disk in the Internal Drive with MS-DOS Format” or “To Format a Disk in an External Drive with MS-DOS Format,” depending on your storage device.
- If you are saving files to recall on an instrument controller that requires LIF formatted disks, follow the procedure in “To Initialize a Disk in the Internal Drive with LIF Format.”

### **To Format a Disk in the Internal Drive with MS-DOS Format**

1. Make sure the disk is not write protected by ensuring the write protect tab is in the proper position.
2. Insert the disk into the analyzer’s disk drive.
3. Press **SAVE RECALL** **File Utilities** **Format Disk Menu** **Format Int Disk Yes**.
4. It will take approximately 2.5 minutes for the disk to be formatted.

**To Format a Disk in an  
External Drive with  
MS-DOS Format**

1. Make sure the disk is not write protected by ensuring the write protect tab is in the proper position (floppy disks only).
2. Insert the disk into the analyzer's disk drive (floppy disks only).
3. Disconnect any system controller from the network analyzer.
4. Press **SYSTEM OPTIONS** **HP-IB** **System Controller** to make the analyzer the HP-IB controller.
5. Press **SAVE RECALL** **Select Disk** **External Disk**.
6. Press the following keys to configure the network analyzer for an external disk drive:
  - Ext Disk Address** and enter the address (the default is 0)
  - Ext Disk Unit** and enter the disk unit number  
(the default is 0)
7. Press **Prior Menu** **Prior Menu** **File Utilities**  
**Format Disk** **Format Ext Disk** **YES**.

**Saving and Recalling Measurement Results**

**To Initialize a Disk in  
the Internal Drive with  
LIF Format**

**NOTE**

To perform this procedure, you must have the IBASIC option (Option 1C2) installed in your instrument.

1. Make sure the disk is not write protected by ensuring the write protect tab is in the proper position.
2. Insert the disk into the analyzer's disk drive and then perform step 3 if you have a keyboard connected to your analyzer, or step 4 if you do not have a keyboard connected.
3. *(with external keyboard)*
  - a. Press **Esc** on an external keyboard to display an IBASIC command line at the bottom of the screen.
  - b. Type **INITIALIZE "LIF:INTERNAL"** to begin initialization.
  - c. Press **Esc** to turn off the command line.
4. *(without external keyboard)*
  - a. Press **SYSTEM OPTIONS** **IBASIC** **Edit** **Insert Line**.
  - b. Use the front panel knob and press **Select Char/Word** for each character in the following commands.  

**10 INITIALIZE "LIF:INTERNAL"** (press **Enter**)

**20 END** (press **Enter**)
  - c. Press **Prior Menu** **Prior Menu** **Run** to initialize the disk.



---

## Connecting and Configuring Printers and Plotters

The analyzer is capable of plotting or printing displayed measurement results directly (without the use of an external computer) to a compatible peripheral. The analyzer supports HP-IB, serial, and parallel peripherals.

---

### Select a Compatible Printer or Plotter

Most Hewlett-Packard desktop printers and plotters are compatible with the analyzer. Some common compatible peripherals are listed here (some are no longer available for purchase but are listed here for your reference):

**These plotters are compatible**

- HP 7440A ColorPro Eight-Pen Color Graphics Plotter
- HP 7470A Two-Pen Graphics Plotter
- HP 7475A Six-Pen Graphics Plotter
- HP 7550A/B High-Speed Eight-Pen Graphics Plotter

**These printers are compatible**

- All HP DeskJets (HP DeskJet 1200C can also be used to plot)
- All HP LaserJets (LaserJet III and 4 can also be used to plot)
- HP DeskJet Portable
- HP PaintJet 3630A
- Epson printers which are compatible with the FX-86e/FX-800 printer control language

---

## Select an Appropriate Interface Cable

If your peripheral is to be connected to HP-IB, choose one of the following cables:

- HP 10833A HP-IB Cable, 1.0 m (3.3 ft.)
- HP 10833B HP-IB Cable, 2.0 m (6.6 ft.)
- HP 10833D HP-IB Cable, 0.5 m (1.6 ft.)

If your peripheral is to be connected via the serial or parallel port on the analyzer, choose from the following recommended cables:

- HP C2912B Centronics (Parallel) Interface Cable, 3.0 m (9.9 ft.)
- HP C2913A RS-232C (Serial) Interface Cable, 1.2 m (3.9 ft.)
- HP C2914A Serial Interface Cable, 1.2 m (3.9 ft.)
- HP 24542G Serial Interface Cable, 3 m (9.9 ft.)
- HP 24542D Parallel Interface Cable, 2 m (6 ft.)
- HP 92284A Parallel Interface Cable, 2 m (6 ft.)

---

## Connect the Printer or Plotter

1. Turn off the analyzer and the peripheral.
2. Connect as shown in Figure 4-15.

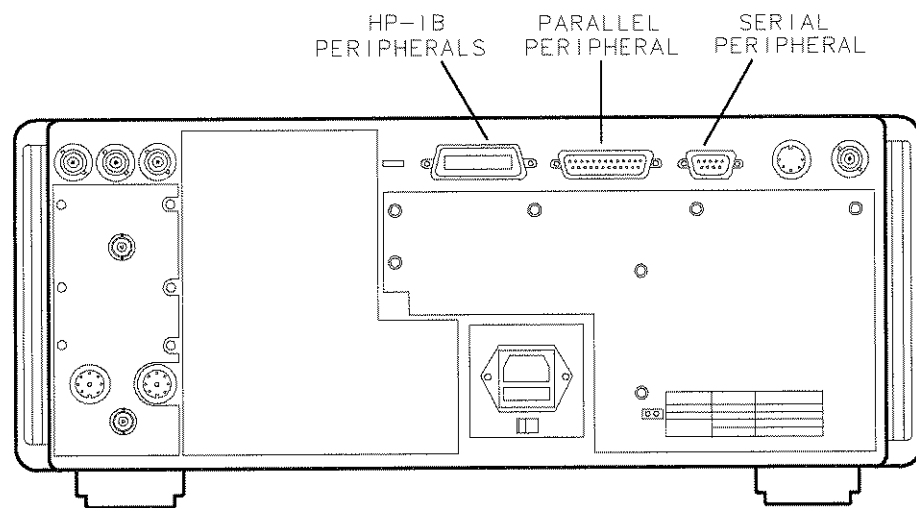

pa620b.

**Figure 4-15. Peripheral Connections**

---

## Configure the Hardcopy Port

You will only have to do this setup once if you make all your hardcopies with the same printing of plotting device. You can configure the analyzer for any of the peripherals listed below:

DEVICE TYPE	LANGUAGE	HARDCOPY PORT
HP Plotter	HPGL	Parallel Port
HP Plotter	HPGL	RS232 Serial
HP Plotter	HPGL	HP-IB
HP Printer	PCL	Parallel Port
HP Printer	PCL	RS232 Serial
HP Printer	PCL	HP-IB
Epson Compatible	Epson	Parallel Port
Epson Compatible	Epson	RS232 Serial
File	HPGL	Internal Disk
File	PCX	Internal Disk

The analyzer can send print commands in either HPGL, PCL, or Epson modes. The commands the analyzer uses are common to early versions of each language. For example, PCL commands that the network analyzer sends will work with PCL3 devices as well as PCL5 devices. The analyzer also uses commands that are common to IBM mode devices and FX-86e/FX-800 mode Epson compatible devices.

**Selecting a Device**

Press **HARD COPY** **Select Copy Port** and turn the front panel knob to move the highlighted bar to your printing or plotting device, then press **Select**.

**Configuring the Analyzer for HP-IB Devices**

If your HP-IB printing/plotting device has a different address than the analyzer default of 05, press **Hardcopy Address** and enter the address of your printing/plotting device (factory defaults: printer = 01, plotter = 05). Use the front panel numeric key pad to make your entry.

**Configuring the Analyzer for RS-232 Devices**

1. If the baud rate of your printing/plotting device is different than the default (19200), press **Baud Rate** and enter the baud rate of your printing/plotting device. (Refer to your printer or plotter manual for the baud rate of your device.) You can set the baud rate to 1200, 2400, 4800, 9600, or 19200 baud. If you are sending graphics to the hardcopy device, 9600 or 19200 baud is recommended.
2. Choose between Xon/Xoff (the default: specifies a software handshake) and DTR/DSR (specifies a hardware handshake).

---

## Define the Printer or Plotter Settings

You will only have to do this setup once if you make all your hardcopies with the same printing or plotting device.

Press **HARDCOPY** and then either **Define Printer** or **Define Plotter**, depending on which device you are using. Note that only one of these choices is selectable at a time.

Two procedures follow. Use "Defining a Printer" if you are using a printer. Otherwise, go to "Defining a Plotter."

### Defining a Printer

Make the following selections in the analyzer menus:

1. Press **Restore Defaults** to restore the default parameters for a printer. The defaults are:

Parameter	Default
Monochrome/Color	Monochrome
Orientation	Portrait
Auto Feed	ON
Printer Resolution	96 Dots Per Inch
Top Margin	0.00 mm
Left Margin	0.00 mm
Print Width	150 mm (5.91 in)

2. Select the type of printer you have: either **Monochrome** or **Color**.
3. Select the orientation of the paper to the information printed, either **Portrait** or **Landscape**. The portrait choice orientates the printout vertically, the landscape orientates the printout horizontally.
4. If you do *not* want auto feed active, press **Auto Feed Off**.

5. Press **More Printer** to change the printer resolution, margins, and print width:
- a. **Printer Resolution**: Refer to the following table for some specific printers and their valid print resolutions.

Printer	Valid Resolutions (in DPI)
HP ThinkJet	96
HP PaintJet	90, 180
HP LaserJet	75, 100, 150, 300, 600
HP DeskJet <sup>1</sup>	75, 100, 150, 300, 600
HP QuietJet	96, 192
Epson	60, 120, 240, 360

<sup>1</sup> HP DeskJet 540 should not be used at 100 dpi.

- b. **Top Margin**: Sets the top margin (non-printing space) of the printout in mm. Minimum setting is 0.00 mm; maximum setting is 200.00 mm.
- c. **Left Margin**: Sets the left margin (non-printing space) of the printout in mm. Minimum setting is 0.00 mm; maximum setting is 200.00 mm.
- d. **Print Width**: Sets print width (printing space) of printout in mm. Minimum setting is 80 mm; maximum is 500 mm. Width is defined relative to the printer. It is the dimension at right angle to the travel of the paper. Landscape mode is rotated one-quarter turn relative to portrait mode. Thus, in landscape mode, print width actually defines the height of the printed image.

**Connecting and Configuring Printers and Plotters**

**Defining a Plotter**

Make the following selections in the analyzer menus:

1. Press **Restore Defaults** to restore the default parameters for a plotter. The defaults are:

Parameter	Default
Monochrome/Color	Monochrome
Auto Feed	ON
Color Plotter Pen Numbers	Trace 1 = Pen 1 Trace 2 = Pen 2 Memory 1 = Pen3 Memory 2 = Pen 4 Graticule = Pen 5 Graphics = Pen 6

2. Select the type of plotter you have: either monochrome or color.
3. Use **Set Pen Numbers** to select the pen number(s) for the data traces, memory traces, graticule, and graphics. Press **Prior Menu** when done selecting pens.
4. If you do *not* want auto feed active, press **Auto Feed Off**.



---

## Printing and Plotting Measurement Results

To print or plot measurement results, perform the following steps:

1. Select the appropriate copy port:
  - Printer *or*
  - Plotter *or*
  - Internal 3.5 in floppy disk
2. Define the output
3. Generate the output:
  - Hardcopy *or*
  - Plot to 3.5 in disk

---

### To Select the Copy Port

Press **HARDCOPY** **Select Copy Port**. Use the front panel knob to highlight a printer, plotter, or an HPGL or PCX file (dumped to the analyzer's built-in disk drive). Files saved in HPGL or PCX format can be imported to many personal computer (PC) applications such as word processors and drawing programs. This allows a simple method for screen dumps to be used in reports, memos, or other communications.

#### **NOTE**

If you are dumping to an external device (printer or plotter) you should have already configured the analyzer for use with the printer or plotter. See the previous section, "Connecting and Configuring Printers and Plotters," for more information.

## Define the Output

1. The first step in defining the output is deciding which hardcopy components you want in your printout, plot, or file. Refer to Figure 4-16 and Figure 4-17 to see the available hardcopy components and formats.

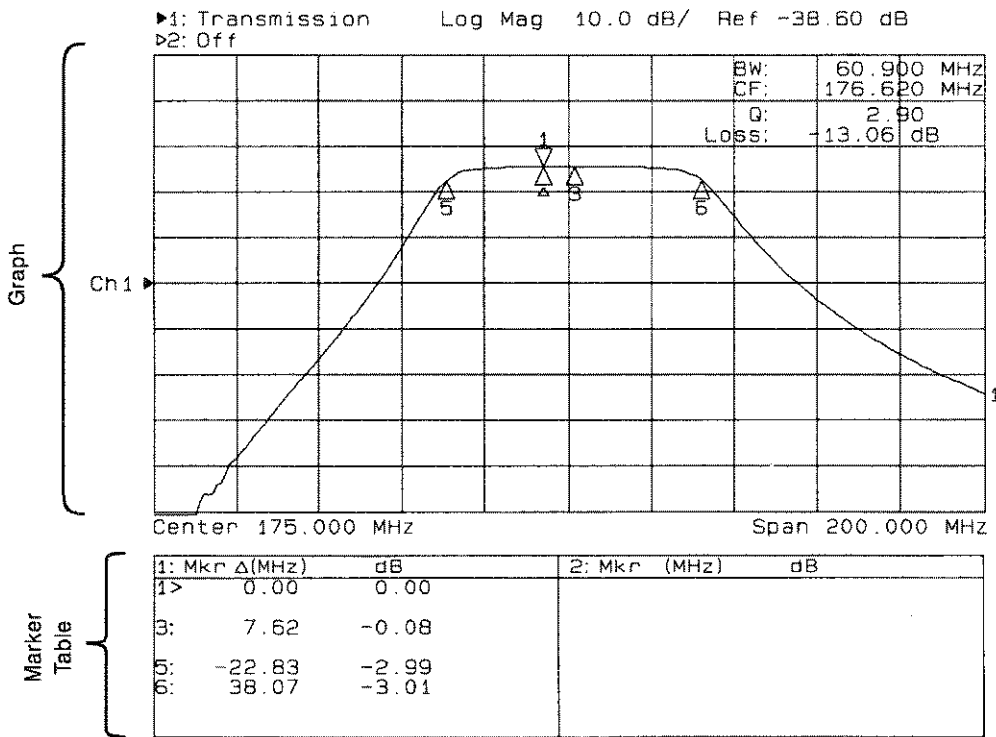

po657b\_c

**Figure 4-16. Hardcopy Components and Formats Available**

Trace Values

---

CHANNEL 1: Transmission		
FREQ(MHz)	dB	Mkr#
0.300	-47.01	
2.047	-66.92	
3.794	-71.87	
5.541	-76.94	
7.288	-82.18	
9.035	-89.23	
10.782	-77.77	
12.529	-82.95	
14.276	-89.84	
16.023	-85.46	
17.770	-79.86	
19.517	-88.07	
21.264	-80.75	
23.011	-83.53	
24.758	-87.51	
26.505	-84.91	
28.252	-83.51	
29.999	-86.01	

Figure 4-17. Trace List Values

2. To select your choice of format, press **HARDCOPY** **Define Hardcopy** and then one of the following:

**Graph and Mkr Table** outputs both the graph and marker table.

**Graph Only** outputs only the graph. (This selection allows printing of the limit-line table as well.)

**Mkr Table Only** outputs only the marker table. (This selection allows printing of the limit-line table as well.)

**List Trace Values** outputs a list of the data trace point values. (This selection is only available for output to a printer.)

**Printing and Plotting Measurement Results**

**NOTE**

You may notice a decrease in measurement speed when the network analyzer is outputting to a printer or plotter that doesn't have a built-in buffer. For the fastest possible hardcopy dump to such devices, press **MENU Trigger Hold** before beginning the print or plot. Refer to the table below for some typical print times.

**Table 4-2. Typical Print Times**

Number of Measurement Points	Printer Resolution (dpi)	Portrait Format (min:sec)				Landscape Format (min:sec)			
		DeskJet 540C <sup>1</sup>	DeskJet 560C <sup>2</sup>	DeskJet 1200C <sup>3</sup>	LaserJet 4L	DeskJet 540C <sup>1</sup>	DeskJet 560C <sup>2</sup>	DeskJet 1200C <sup>3</sup>	LaserJet 4L
<b>MONO</b>									
201	100 <sup>4</sup>	0:36	0:35	0:24	0:45	0:52	0:57	0:32	0:50
201	300	0:48	0:48	0:45	1:06	1:14	1:17	1:09	1:28
1601	100 <sup>4</sup>	0:42	0:41	0:31	0:51	1:00	1:03	0:39	0:57
1601	300	0:54	0:55	0:51	1:13	1:22	1:25	1:16	1:35
1601	HPGL <sup>5</sup>	N/A	N/A	0:13	0:43	N/A	N/A	0:20	0:44
<b>COLOR</b>									
201	100 <sup>4</sup>	1:45	1:43	0:44	N/A	2:42	3:42	1:15	N/A
201	300	5:04	5:24	3:04	N/A	8:28	9:08	5:14	N/A
1601	100 <sup>4</sup>	1:52	1:50	0:51	N/A	2:52	2:53	1:22	N/A
1601	300	5:11	5:31	3:11	N/A	8:35	9:15	5:21	N/A
1601	HPGL <sup>5</sup>	N/A	N/A	0:24	N/A	N/A	N/A	0:46	N/A

1 Do not use a color cartridge for mono print on the DeskJet 540C.

2 These times were measured with the HP DeskJet 560C in EconoMode.

3 These times were measured with the HP DeskJet 1200C in "paper-fast" mode.

4 Use 150 dpi for the DeskJet 540C.

5 HPGL dumps require an IBASIC program to initialize the printer.

---

## Using a Keyboard

You can use an IBM PC-AT compatible keyboard with your analyzer. A keyboard is useful when entering and editing names for files and directories. It is also useful for creating and editing IBASIC programs (Option 1C2).

All of the analyzer front panel hardkey and softkey functions can be activated from a keyboard also. See "Keyboard Front Panel Equivalents," later in this section.

---

## To Connect the Keyboard

To connect a keyboard, first turn off the analyzer. Then connect a compatible keyboard with a DIN connector to the rear panel DIN connector. See Figure 1-4 in Chapter 1 for the location of the keyboard connector. Turn the analyzer back on after the keyboard connector is fully inserted into the connector.

### **NOTE**

If your keyboard has a mini-DIN connector, you will need to use a mini-DIN to DIN adapter to connect the keyboard to the analyzer. One of these adapters (HP part no. C1405-80015) is shipped with the analyzer if you ordered the keyboard option (1CL).

---

## To Use the Keyboard to Edit

Using a keyboard makes editing of file and directory names, or program lines quick and easy. You can edit these items from the front panel of the instrument using the front panel knob and the softkeys, however this process is very tedious.

Following is an example procedure to use a keyboard and the Re-Save State function to save an instrument state that you want to call "mixer".

1. Set up the instrument with the measurement parameters that you want to save. See "Saving and Recalling Measurement Results," earlier in this chapter, for more information.
2. Press **SAVE RECALL** **Select Disk** and choose where to store the instrument state.
3. Press **Prior Menu** **Re-Save State**.
4. Use the keyboard to backspace over the existing file name (don't worry, the existing file will not be written over), and then use the keyboard to type in **mixer**.
5. Press **ENTER** on the keyboard (or the analyzer) and the current instrument state will be saved to a file titled "mixer."

---

## Keyboard Front Panel Equivalents

A keyboard template was supplied with your shipment. If you place the template on your keyboard you will always have the following information on hand. Should you misplace your keyboard template, you can reorder with HP part number 08712-80004.

You can use the key combinations below with a DIN keyboard to activate the indicated front panel hardkeys and softkeys. Softkeys are the eight unlabeled keys to the right of the display. They are numbered from one (top) through eight (bottom).

**Keyboard Front Panel Key Equivalents**

Keyboard Function Key	Front Panel Equivalents		
		Shift	Ctrl
f1	Softkey 1	CHAN 1	SAVE RECALL
f2	Softkey 2	CHAN 2	HARD COPY
f3	Softkey 3	FREQ	SYSTEM OPTIONS
f4	Softkey 4	POWER	PRESET
f5	Softkey 5	SWEEP	BEGIN
f6	Softkey 6	MENU	
f7	Softkey 7	SCALE	
f8	Softkey 8	MARKER	
f9		DISPLAY	
f10		FORMAT	
f11		CAL	
f12		AVG	



For example, to select channel 1 as the active channel, on the keyboard press **Shift** with **f1**. To preset the network analyzer with the keyboard, press **Ctrl** with **f4**. In each case hold down the first key as you press the second key.

To select **Softkey 1**, press **f1** alone. In case of difficulty, make sure that the keyboard is connected to the DIN KEYBOARD connector on the rear panel. The keyboard must be IBM PC/AT compatible.

Print capabilities:

Press **Shift** **Print Screen** on the keyboard to dump graph with softkey menus.

When you use the analyzer **HARDCOPY** function to dump a graph, you don't get the softkey menu that appears on the right-hand side of the analyzer display.

Pressing **Shift** **Print Screen** on a keyboard will dump the current graph along with the current softkey menu.

Using Instrument Functions



---

## Optimizing Measurements

---

## Optimizing Measurements

This chapter describes techniques and analyzer functions that help you achieve the best measurement results. The following sections are included in this chapter:

- Increasing Sweep Speed
- Increasing Network Analyzer Dynamic Range
- Reducing Trace Noise
- Reducing Mismatch Errors
- Measuring Devices with Long Electrical Delay

---

## Increasing Sweep Speed

You can increase the analyzer sweep speed by avoiding the use of some features that require computational time for implementation and updating, such as bandwidth marker tracking.

You can also increase the sweep speed by making adjustments to the measurement settings. Listed below are some of the things that can be done to increase sweep speed.

- increase the start frequency
- sweep time in AUTO mode
- widen the system bandwidth
- reduce the amount of averaging
- reduce the number of measurement points
- only view a single channel
- turn off alternate sweep
- turn off markers and marker tracking
- turn off spur avoidance
- minimize frequency span to avoid bandcrossings (HP 8713B only)

---

## To Increase the Start Frequency

Since the analyzer sweeps frequencies below approximately 20 MHz at a slower rate, you can increase the start frequency to speed up the sweep.

1. Press **FREQ** **Start**.
2. Enter the highest start frequency possible for your measurement.

---

## To Set the Sweep Time to AUTO Mode

Auto sweep time mode (the preset instrument mode), maintains the fastest sweep speed possible for any particular measurement settings.

1. Press **[SWEEP]** and look at the **Sweep Time/AUTO man** softkey label. When AUTO is all capital letters, it indicates that the analyzer is in auto sweep time mode. If MAN is all capital letters, the analyzer is in manual sweep time mode.
2. If necessary, press **Sweep Time/auto MAN** to toggle the time mode to AUTO.

---

## To Widen the System Bandwidth

Wide system bandwidth is recommended for some broadband detection measurements.

Press **[AVG] System Bandwidth** to widen the IF bandwidth. As the bandwidth increases the sweep time decreases:

**Table 5-1. Relationship Between System Bandwidth and Sweep Speed**

System Bandwidth	Sweep Speed
Wide	fastest
Medium	fast
Narrow	slow
Fine	slowest

---

## To Reduce the Amount of Averaging

If averaging has been turned on, (it is off in the preset condition) reducing the averaging factor (or turning it off altogether) will increase the analyzer's measurement speed. Averaging requires multiple sweeps which increases measurement time. Turning off averaging and using a narrower system bandwidth may produce faster results.

1. Press **AVG** **Avg Factor** and enter an averaging factor that is less than the value displayed on the analyzer screen and press **ENTER**.
2. If you want to turn the averaging off, press **AVG** **Averaging OFF**.

---

## To Reduce the Number of Measurement Points

To reduce the number of measurement points, press **MENU** **Number of Points** and use the front panel knob, the **↑** **↓** keys, or the numeric keypad to enter the reduced number.

Generally, as the number of points is decreased, so is the sweep time. However, other factors will affect the sweep time such as:

- using frequency bands that contain very low frequencies (below approximately 20 MHz)
- the number of band crossing points encountered in a sweep (at approximately 1900 MHz, 2310 MHz, and 2620 MHz) (HP 8713B only)
- if the MHz/msec rate is above the maximum rate at which the source can be swept

The following graph shows an example of the relationship between the number of points, frequency span, and sweep time. This graph was created with data from a setup on an HP 8713B using a center frequency of 1500 MHz, and a system bandwidth setting of medium.

Optimizing Measurements  
**Increasing Sweep Speed**

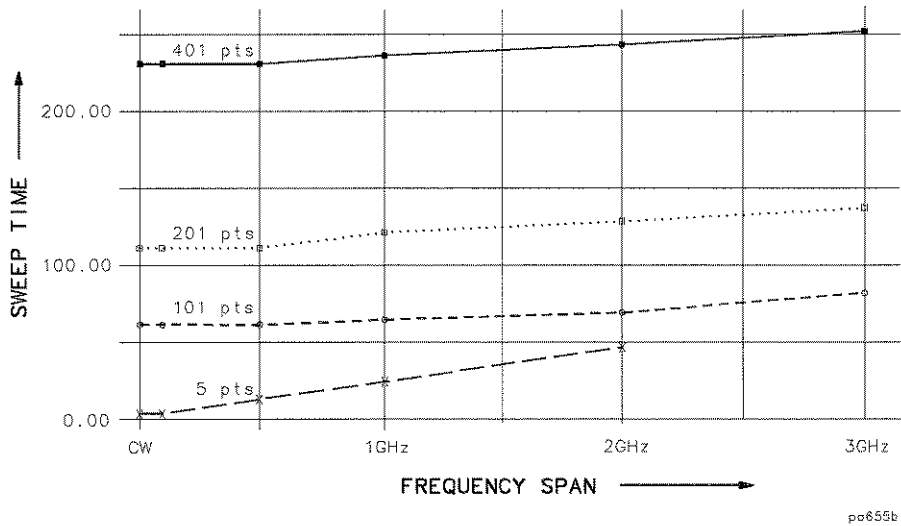

**Figure 5-1. Relationship Between Frequency Span, Sweep Time, and Number of Points**

Note the following in the graph above:

- As the frequency span decreases, the sweep time generally decreases.
- As the number of points decreases, the sweep time decreases.

---

### To View a Single Measurement Channel

If you are viewing both measurement channels but only need one, you can decrease measurement time by turning one of the channels off.

Select the channel you wish to turn off with either the **CHAN 1** or **CHAN 2** button. Then select **Chan OFF**.



---

## To Turn Off Alternate Sweep

Alternate sweep is turned off when the analyzer is preset, but is automatically activated with some dual channel measurements. The alternate sweep feature sweeps and measures one channel at a time. By disengaging this feature, you increase the sweep speed by 50 percent.

1. Press **(SWEEP)** and look at the **Alt Sweep on/OFF** softkey.
2. If ON is in capital letters, toggle the softkey to disengage the alternate sweep feature (the softkey should appear **Alt Sweep on/OFF**).

---

## To Turn Off Markers and Marker Tracking

When markers are on, time is required to update the marker readouts. Turning off markers can reduce sweep cycle time by up to 30 ms. When the marker softkey menu is active, it too must be updated, adding up to 10 ms to the sweep cycle time.

Press **(MARKER)** **All Off**

When marker tracking is on, the analyzer performs a search after each sweep. Simple searches like **Mkr -> Max** can take 10 to 20 ms per sweep. Lengthy calculations like **Bandwidth** can add over 100 ms to each sweep.

1. Press **(MARKER)** **Marker Search** and look at the **Tracking on OFF** softkey.
2. If the word "ON" is in capital letters, toggle the softkey to the OFF position.

---

## To Turn Off Spur Avoidance

When spur avoidance is on (preset default is off), the analyzer breaks each sweep into segments. Between sweep segments, the analyzer stops and changes internal frequencies to move mixing products. Since the analyzer sweep is not interrupted when this feature is off, turn off spur avoidance to increase sweep speed.

1. Press **MENU** **Spur Avoid Options** and look at the **Spur Avoid** softkey.
2. If the **Spur Avoid** key is highlighted with a box around it, press the **None** key.

### **NOTE**

If Spur Avoid *must* be used in your measurement, set the start frequency as high as possible to obtain the fastest possible sweeps.

---

## To Avoid Frequency Bandcrossings by Minimizing the Span (HP 8713B only)

Sweep time is increased when the analyzer encounters a bandcrossing point. The frequency bandcrossing points are approximately:

1900 MHz

2310 MHz

2620 MHz

Press **FREQ** and then change the start frequency, stop frequency, or span to avoid these band crossing points when possible.

---

## Increasing Network Analyzer Dynamic Range

Receiver dynamic range is the difference between the analyzer's maximum allowable input level and its noise floor. For a measurement to be valid, input signals must be within these boundaries. The dynamic range is affected by two factors:

- input power to the device under test (DUT)
- receiver noise floor

---

### To Increase the Receiver Input Power

You should maximize the receiver input power to achieve the highest dynamic range. You can increase the analyzer's source output power so that the test device output power is within the measurement range of the analyzer.

Press **POWER** **Level** and enter the new source power level.

If your test device output power stays within the maximum input limits shown below, the receiver compression will be minimized.

**Maximum Recommended Input Power Levels**

	<b>Maximum Input Level</b>
Narrowband Mode	+10 dBm
Broadband Mode	+16 dBm

---

#### **CAUTION**

Remember to not exceed the receiver input damage limit of +20 dBm.

---

## To Reduce the Receiver Noise Floor

Receiver dynamic range is the difference between the analyzer's maximum allowable input level and its noise floor.

### Changing System Bandwidth

Reducing the system bandwidth lowers the noise floor by digitally reducing the receiver input bandwidth. As system bandwidth is reduced, more receiver measurements are used per frequency point, increasing the sweep time. However with system bandwidth reduction, unlike averaging, only one sweep is required for the reduced noise floor effect.

The analyzer offers a choice of four system bandwidths: medium (default setting), wide, narrow, and fine.

1. Press **AVG** **System Bandwidth**.
2. Press the key that corresponds to the bandwidth you want.
  - **Wide 6500 Hz**
  - **Medium 3700 Hz**
  - **Narrow 250 Hz**
  - **Fine 15 Hz**

#### NOTE

It is recommended that wide system bandwidth only be used for broadband detection measurements due to trace noise effects.

## Increasing Network Analyzer Dynamic Range

### Changing Measurement Averaging

In averaging mode, the analyzer measures each frequency point once per sweep and averages the current and previous trace up to the averaging factor specified by the user. The instrument computes each data point based on an exponential average of consecutive sweeps weighted by the user-specified averaging factor.

As the averaging factor is increased:

- signal-to-noise ratio increases
- time for each individual sweep remains the same, but
- total time to update the trace increases.

Averaging is better than system bandwidth reduction at minimizing very low frequency noise.

1. Press **AVG** **Average Factor**.
2. Press **Average ON off**.

---

## Reducing Trace Noise

You can use three analyzer functions to help reduce the effect of noise on the data trace:

- activate measurement averaging
- reduce system bandwidth
- eliminate spurious responses

---

### To Activate Averaging for Reducing Trace Noise

The analyzer uses a weighted running average for averaging. The noise is reduced with each new sweep as the effective averaging factor increments.

1. Press **AVG** **Average Factor**.
2. Enter a value followed by **ENTER**.
3. Press **Average ON off**.

Averaging is explained more fully in the previous section.

---

## To Change System Bandwidth for Reducing Trace Noise

By reducing the system bandwidth you reduce the noise that is measured during the sweep. However, the bandwidth may slow down the sweep. While averaging requires multiple sweeps to reduce noise, narrowing the system bandwidth reduces the noise on each sweep. See the previous section for a more detailed explanation of system bandwidth.

Press **AVG** **System Bandwidth** **Narrow** or **Fine**.

Narrower system bandwidths cause longer sweep times. When in auto sweep time mode, the analyzer uses the fastest sweep time possible for any selected system bandwidth. Auto sweep time mode is the default analyzer setting.

---

## To Eliminate Receiver Spurious Responses

Spurious responses are undesirable signals that result from various different internal mixing products.

The analyzer has two features to eliminate spurious responses. Both features shift the frequency of the spur without changing the RF output frequency. They shift the spur by changing frequencies internal to the analyzer that mix to produce the RF frequency. The features are:

- dither
- spur avoid

Dither is usually most effective for narrow frequency span measurements (generally <15 MHz) as explained below. If dither does not eliminate visible spurs, use spur avoid instead.



**Dithering to Shift Spurs** Dither shifts all spurs by a small amount once, thus it imposes no sweep time penalty. But some spurs occurring within the measured frequency band may not be shifted out of band, and others may be shifted in. Therefore dither is most effective for narrowband measurements with a user defined measurement calibration. To activate dithering:

1. Press **MENU** **Spur Avoid Options** **Dither**.
2. Make a user-defined measurement calibration. Refer to Chapter 6 "Calibrating for Increased Measurement Accuracy," for calibration procedures.

---

**CAUTION**

---

The measurement calibration must be performed with the same dither mode used in the measurement or your results may be invalid.

Optimizing Measurements  
**Reducing Trace Noise**

**Activating Spur Avoidance**

When you activate spur avoidance the analyzer sweeps to a point before a spur, stops the sweep, shifts the spur, sweeps through the spur location, then shifts the spur back and continues the sweep. The analyzer determines which spurs need to be avoided with an algorithm based on frequencies, number of points, sweep time, and system bandwidth.

To activate spur avoidance:

1. Press **(MENU)** **Spur Avoid Options** **Spur Avoid**.
2. Make a user-defined measurement calibration. Refer to Chapter 6 "Calibrating for Increased Measurement Accuracy," for calibration procedures.

**NOTE**

Using spur avoid increases sweep time. Since there are more spurs at the lower frequencies, the time penalty can be reduced by setting the start frequency of the measurement as high as possible.

**CAUTION**

The measurement calibration must be performed with the same spur avoid mode used in the measurement or your results may be invalid.

**CAUTION**

You will invalidate the measurement calibration if you turn spur avoid off.

---

## Reducing Mismatch Errors

Mismatch errors result from differences between the DUT's port impedance and the analyzer's port impedance. Source match errors are produced on the source (analyzer RF OUT) side of the DUT; load match errors on the load (analyzer RF IN) side. If the DUT is not connected directly to the port, the mismatch errors due to cables, adapters, etc. are considered part of the source or load match errors. Source match and load match error terms can be reduced by using the methods described in this section.

---

## Reducing Mismatch Errors in a Reflection Measurement

The best way to reduce mismatch errors in a reflection measurement is to perform a reflection calibration ( **CAL** Reflection ) directly at the DUT connector, using the exact frequency parameters that you will be using for the measurement.

---

## Reducing Mismatch Errors in a Transmission Measurement

The best way to reduce mismatch errors in a transmission measurement is to put attenuators directly on both the input and output ports of the DUT. Doing this will reduce both source match and load match error terms.

### **NOTE**

Always use high quality attenuators. Six to ten dB of attenuation should be sufficient to significantly reduce mismatch errors.

---

## Reducing Mismatch Errors When Measuring Both Reflection and Transmission

When you want to measure reflection and transmission simultaneously, or without changing the test setup, perform a reflection calibration using the exact frequency parameters that you will be using for the measurement, and put a 6 to 10 dB pad directly on the output of the DUT.

### **NOTE**

Using an attenuator on the output of the DUT will reduce the system dynamic range.

---

## Measuring Devices with Long Electrical Delay

When making a narrowband measurement of a device with long electrical delay, measured levels can be affected by the rate at which the source is changing frequency. This sensitivity is related to the time required for the source signal to travel through cables or devices which are connected between the RF OUT and RF IN ports. Since the source frequency is changing rapidly during a sweep, a long distance or delay between RF OUT and RF IN will mean that the signal arriving at the RF IN port will be of slightly lower frequency than the RF OUT signal at the same moment in time. This effect is referred to as "frequency shift." The amount of frequency shift is given by the following equation:

$$\text{frequency shift} = \text{transit time} \times \frac{\text{frequency span}}{\text{sweep time}}$$

The narrowband receiver at the RF IN port is tuned to the exact frequency being emitted at the RF OUT port, with an input bandwidth determined by the System Bandwidth selection. If the RF IN signal is lower than the RF OUT signal, the measurement of RF IN will be attenuated by the receiver's frequency response. The amount of attenuation increases as the amount of frequency shift increases. The amount of attenuation also increases as the System Bandwidth decreases.

The analyzer has been designed to minimize the effect of frequency shift when a short cable is connected between RF OUT and RF IN. When a long cable (or a device with long electrical delay) is connected, however, it is possible for the measurement to be affected, especially at the analyzer's fastest sweep rates. If frequency shift is suspected, use the following techniques to reduce its effect:

- increase sweep time
- decrease frequency span
- select a wider system bandwidth
- use shorter cables to connect the DUT to the analyzer
- use broadband detection to completely eliminate the effect of frequency shift

## Optimizing Measurements



---

Calibrating for Increased  
Measurement  
Accuracy

---

## Calibrating for Increased Measurement Accuracy

This chapter first explains measurement calibration in the section titled, "Measurement Calibration Overview." The sections following the overview provide instructions for choosing, performing, and saving measurement calibrations.

Each example measurement in Chapter 3 provides an example calibration for the particular type of measurement.





## Measurement Calibration Overview

Measurement calibration is a process that improves measurement accuracy by using error correction arrays to compensate for systematic measurement errors. Measurement calibration is also called cal, accuracy enhancement, and error correction. Measurement errors are classified as random, drift, and systematic errors. Random errors, such as noise and connector repeatability, are non-repeatable and not correctable by measurement calibration. Drift errors, such as frequency and temperature drift, are also non-repeatable and not correctable by a cal.

Systematic errors, such as tracking and crosstalk, are the most significant errors in most RF measurements. Fortunately systematic errors are repeatable and for the most part correctable, though small residual errors may remain. In brief, the systematic errors are correctable.

Repeatable systematic errors are due to system frequency response, isolation between the signal paths, and mismatch and leakage in the test setup.

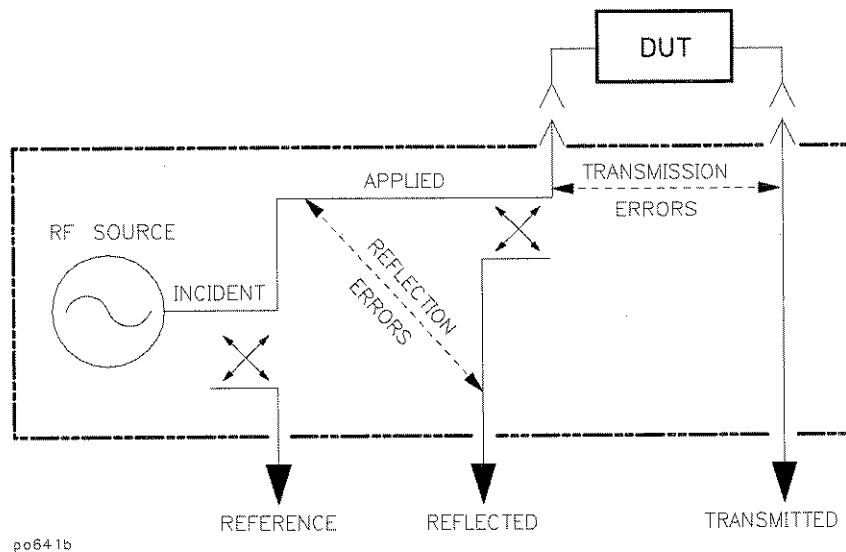

Figure 6-1. Sources of Errors

**Measurement Calibration Overview**

Frequency response errors (transmission and reflection tracking) are errors that are a function of frequency.

Isolation errors result from energy leakage between signal paths. In transmission measurements, this leakage is due to crosstalk. In reflection measurements, it is due to imperfect directivity.

Mismatch errors result from differences between the DUT's port impedance and the analyzer's port impedance. Source match errors are produced on the source (network analyzer RF OUT) side of the DUT; load match errors on the load (network analyzer RF IN) side. If the DUT is not connected directly to the port, the mismatch errors due to cables, adapters, etc. are considered part of the source or load match errors.

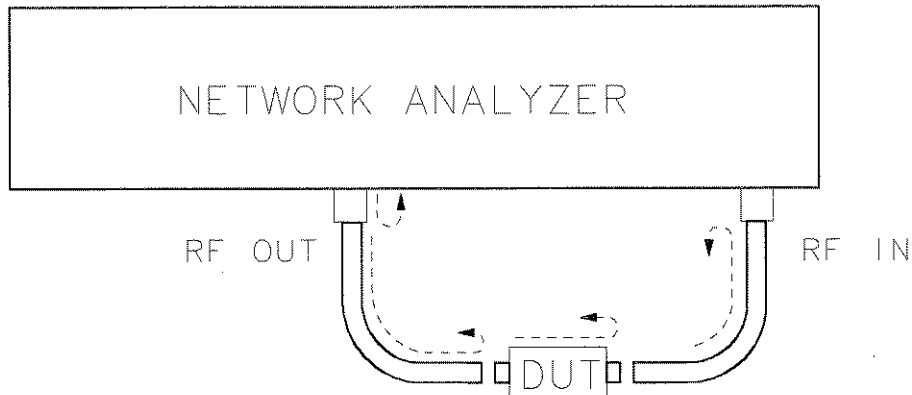

po642b

**Figure 6-2. Mismatch Errors**

When a user-defined calibration is performed, the analyzer compares the measurement data of known calibration standards to ideal measurement data. The network analyzer then calculates the difference between the measurement data and the calibration standard models to create error correction arrays. The network analyzer uses the error correction array data to correct subsequent measurement data.

### Measurement Calibration Overview

To perform a quality calibration:

- Use the highest quality standards available and take care of them.
- Be sure to select the correct cal kit by pressing **CAL** **Cal Kit**.
- Make consistent connections (use a torque wrench with 3.5 mm connectors if possible) of the standards and DUTs.
- Minimize temperature variations.
- Minimize movement of cables.

---

## Determine if a Calibration is Necessary

This section shows you how to determine if your measurement system requires a user-defined calibration.

---

## When a Calibration Is Not Necessary

- Your test doesn't require the best accuracy possible.
- Your test device is connected directly to the reflection port with no adapters or intervening cables.
- Your test device impedance matches the impedance of the analyzer.

If your test setup meets these conditions, you do not need to perform any additional calibrations, however the analyzer is not guaranteed to meet its published specifications.

---

## When a Calibration Is Necessary

- You want the best accuracy possible.
- You are adapting to a different connector type or impedance.
- You are connecting a cable between the test device and the analyzer test ports.
- You are measuring a narrowband or electrically long device.
- You are connecting any attenuator or other such device on the input or output of the test device.

---

## Choose an Appropriate Calibration Method

Once you have decided that it is necessary to perform a calibration, you will need to choose the calibration method suited to the type of measurement you will be performing. After you have selected the type of measurement under the **CHAN 1** or **CHAN 2** key, press the **CAL** key. The types of calibrations available for that type of measurement will be in bright text in the softkey area. Cals that are not available for that type of measurement will be dimmed and will not be selectable.

The network analyzer has several methods of measuring and compensating for these test system errors. Each method removes one or more of the systematic errors using an equation called an error model. Measurement of high quality standards (short, open, load, through) allows the network analyzer to solve for the error terms in the error model. The accuracy of the calibrated measurements is dependent on the quality of the standards used for calibrating. Since calibration standards are very precise, great accuracy is achieved.

The types of calibration available are:

- normalization
- transmission
- reflection
- AM Delay (option 1DA or 1DB only)

### **NOTE**

The active calibration will be retained in the analyzer's memory when power is turned off, and will be restored when power is turned back on.

---

## To Perform a Normalization Calibration

Normalization is the simplest type of calibration. The analyzer stores data into memory and divides subsequent measurements by the stored data to remove frequency response errors.

Follow these general steps when performing a normalization calibration:

1. Setup the analyzer for your measurement:
  - select the type of measurement
  - enter operating parameters other than the default
2. Connect your equipment as you would for an actual measurement, but omit the DUT.
3. Press **CAL** **Normalize**.
4. Notice that the top of the display on the analyzer now shows the type of measurement followed by "/M" to indicate that the displayed data is actually the measurement divided by memory.

---

### **CAUTION**

The normalization cal will be invalidated if any frequency settings are changed after calibration. There is *no* correction interpolation with a normalization cal.

**Choose an Appropriate Calibration Method**

---

## To Perform a Transmission Calibration

Transmission calibrations measure narrowband response, or response and isolation to correct for frequency response tracking errors and crosstalk errors. This type of calibration is for narrowband measurements only.

For an example of performing a response calibration for a transmission measurement refer to “Measuring Transmission Response” in Chapter 3.

Otherwise, follow these general steps when performing a transmission calibration:

1. Setup the analyzer for your measurement:

- select **CHAN 1** or **CHAN 2** **Transmission**
- enter operating parameters other than the default

2. Press **CAL** **Transmissn**, and then one of the following softkeys:

Restore Defaults

Restoring the default calibration recalls error correction arrays that the network analyzer previously generated by an adjustment test and permanently stored in memory. This calibration was performed at the factory or during servicing using full band (entire frequency span) and 401 frequency points. It is quick and convenient but not as accurate at narrow frequency spans. This calibration is also known as the default calibration.

Response

A response calibration prompts you to connect a through cable as the calibration standard, and then measures it across the frequency band you have defined, using the number of points you have defined. Widening the frequency span after performing this calibration will invalidate it, and restore the default calibration. You may narrow the span and the analyzer will interpolate correction for the narrower span.

**Choose an Appropriate Calibration Method**

Note that after you have calibrated, a “C” appears in the upper right hand corner of the display. This “C” indicates that a user-defined cal is in use. If you change to a narrower span, note that the “C” changes to “C?”, indicating the analyzer is now interpolating between calibrated measurement points. The “C?” notation also appears when other system parameters, such as power, number of points, or sweep time, have changed.

**Response & Isolation**

This method of calibration is only necessary when trying to achieve maximum dynamic range (>100 dB). A response and isolation calibration prompts you to connect loads to both ports and then to connect a through cable. This cal is measured across the frequency band you have defined, using the number of points you have defined. Widening the frequency span after performing this calibration will invalidate it, and restore the default calibration. You may narrow the span and the analyzer will interpolate correction for the narrower span.

Note that after you have calibrated, a “C” appears in the upper right hand corner of the display. This “C” indicates that a user-defined cal is in use. If you change to a narrower span, note that the “C” changes to “C?”, indicating the analyzer is now interpolating between calibrated measurement points. The “C?” notation also appears when other system parameters, such as power, number of points, or sweep time, have changed.





**Choose an Appropriate Calibration Method**

---

## To Perform a Reflection Calibration

Reflection calibrations measure directivity, source match, and tracking to correct for directivity, source match and frequency response errors. This type of calibration is also for narrowband measurements only.

For an example of performing a reflection calibration for a transmission measurement refer to “Measuring Reflection Response” in Chapter 3.

Otherwise, follow these general steps when performing a transmission calibration:

1. Setup the analyzer for your measurement:

- select **CHAN 1** or **CHAN 2** **Reflection**
- enter operating parameters other than the default

2. Press **CAL** **Reflection**, and then one of the following softkeys:

Restore Defaults

Restoring the default calibration recalls error correction arrays that the network analyzer previously generated by an adjustment test and stored permanently in memory. This calibration was performed at the factory or during servicing using full band (entire frequency span) and 401 frequency points. It is quick and convenient but not as accurate at narrow frequency spans. This calibration is also known as the default calibration.

One Port

A one-port calibration prompts you to connect three measurement standards: an open, a short, and a load. The analyzer measures each standard across the frequency band you have defined, using the number of points you have defined. Widening the frequency span after performing this calibration will invalidate it, and restore the default calibration. You may narrow the span and the analyzer will interpolate correction for the narrower span.

Calibrating for Increased Measurement

Accuracy

**Choose an Appropriate Calibration Method**

Note that after you have calibrated, a "C" appears in the upper right hand corner of the display. This "C" indicates that a user-defined cal (not the default) is in use. If you change to a narrower span, note that the "C" changes to "C?", indicating the analyzer is now interpolating between calibrated measurement points. The "C?" notation also appears when other system parameters, such as power, number of points, or sweep time, have changed.

**Choose an Appropriate Calibration Method**

---

## To Perform an AM Delay Calibration (option 1DA or 1DB only)

For an example of performing an AM delay calibration refer to “Measuring AM Delay” in Chapter 3.

Otherwise, follow these general steps when performing an AM delay calibration:

1. Setup the analyzer for an AM delay measurement:

- select **CHAN 1** or **CHAN 2** **AM Delay**
- enter operating parameters other than the default

2. Press **CAL** **AM Delay**, and then one of the following softkeys:

Restore Defaults

This selection removes all frequency response correction. Absolute group delay measurements will be uncalibrated. The accuracy of relative group delay (group delay flatness) measurements will not be degraded as long as the delay of the cables and adapters connected to the DUT is negligible.

Response

A response calibration prompts you to connect a through cable in place of the DUT as the calibration standard, and then measures it across the frequency band you have defined, using the number of points you have defined. Widening the frequency span after performing this calibration will invalidate it, and restore the default calibration. You may narrow the span and the analyzer will interpolate correction for the narrower span.

Refer to “Measuring AM Delay” in Chapter 3 for more information about AM delay measurements.

**Choose an Appropriate Calibration Method**

---

## To Perform a Calibration With Non-Standard Connectors

When using a calibration kit other than one that is compatible with the standard type-N female connectors (cal kit model number HP 85032B/E for 50  $\Omega$  analyzers or HP 85036B/E for 75  $\Omega$  analyzers), you can either select a connector type that is stored in the analyzer or input your own cal kit definitions.

The following table shows the connector types that are stored in the analyzer along with the appropriate cal kit model number.

Type-N (m) (50 $\Omega$ )	HP 85032B/E
Type-N (m) (75 $\Omega$ )	HP 85036B/E
Type-F (f)	HP 85039A
3.5 mm	HP 85033D

To select the connector type by pressing **CAL** **Cal Kit** and then the connector type applicable to your measurement.

If you are calibrating with type-F connectors, you must follow the procedure in the *HP 85039A Calibration Kit User Information*.

For other connector types, the easy way to enter definitions is to download them from a file on disk. Use the template program on the Example Programs disk as a starting point. The format of a cal kit file is explained in the next section.

**Choose an Appropriate Calibration Method**

**How to Download  
Standards**

1. Insert the disk with the cal standard definitions into the analyzer's built-in disk drive.
2. Press **SAVE RECALL** and note the first word of the second line on the screen. If it is not "INT:\\" (for internal disk), press **Select Disk Internal Disk Prior Menu**.
3. Highlight the file (CALKIT, in the case of the Example Programs disk).
4. Press **Recall State** and wait for the prompt:  
  
Loaded cal kit information for 4 calibration standards  
Recall of cal kit from CALKIT complete
5. Press **CAL Cal Kit User Defined**.

**NOTE**

Cal kit coefficients are displayed in the cal kit block of the operating parameters screen; press **SYSTEM OPTIONS Operating Parameters Next Screen Next Screen**.

---

## Writing or Editing Your Own Cal Kit File

There are several situations that may require you to define your own calibration kit definition. Here are three examples:

- You are using a connector type (TNC or BNC for example) which is not one of the selections under the CAL KIT menu.
- You are using a built-in connector type, but your standards (such as a short) have different characteristics than the built-in kit uses when performing a calibration.
- You are using a test fixture.

The following steps (explained later in detail) should be performed when defining your own cal kit:

1. Determine the standard characteristics for the connector type you plan to use.
2. Create a cal kit ASCII file or edit the one provided on the Example Programs Disk.
3. Verify performance.

### **Step 1: Determine the Standard Characteristics**

Determine the standard characteristics for the connector type you plan to use. In particular, these are the characteristic impedance ( $Z_0$ ), the delay, and the loss. These characteristics are common for the four supported types used by the analyzer. Additionally, the capacitive model parameters, C0, C1, C2, and C3 are necessary for fully defining the open. These electrical characteristics can be mathematically derived from the physical dimensions and material of each calibration standard or from its actual measured response.

#### **About Calibration Standards.**

A calibration standard is a specific, well-defined, physical device used to determine systematic errors. Each standard has a precisely known or predictable magnitude and phase response as a function of frequency. The response of each standard is mathematically defined in the error models used by the network analyzer.

A standard type is one of four basic types that define the form or structure of the model to be used with that standard (e.g. short or load).

**Choose an Appropriate Calibration Method**

Standard characteristics are the numerical, physical characteristics of the standards used in the model selected.

Typical calibration standards are cables (or throughs), opens, shorts, and loads. They are used singly or in combination, depending on the type of cal. In essence, for each type of measurement error that is to be corrected, one standard is measured.

**Open** Open defines the standard type of an open circuit used for calibrating reflection measurements. As a reflection standard, an open circuit offers the advantage of broadband frequency coverage. At high frequencies, however, an open rarely has perfect reflection characteristics because the fringing capacitance effects cause phase shift that varies with frequency.

These effects are impossible to eliminate, but the calibration calculation built into the analyzer includes an open circuit capacitance model. This capacitance model is a cubic polynomial as a function of frequency, where the polynomial coefficients are user-definable.

The capacitance model equation is:

$$C = (C0) + (C1*f) + (C2*f^2) + (C3*f^3)$$

where f is the measurement frequency.

The terms in the equation are defined when specifying the open as follows:

C0 is used to enter the C0 term, which is the constant term of the cubic polynomial and is expressed in Farads.

C1 is used to enter the C1 term, expressed in F/Hz (Farads/Hz).

C2 is used to enter the C2 term, expressed in F/Hz<sup>2</sup>.

C3 is used to enter the C3 term, expressed in F/Hz<sup>3</sup>.

**Short** Short defines the standard type of a short for calibrating reflection measurements.

**Load** Load defines the standard type of a load used for calibrating reflection measurements.

**Through** Through defines the standard type as a transmission line of specified length for transmission calibrations.

Calibrating for Increased Measurement

Accuracy

**Choose an Appropriate Calibration Method**

For all four standard types the  $Z_0$  (characteristic impedance), Delay, and Loss must be set.

**NOTE**

When creating a cal kit file, if a standard is not defined, the currently defined values for that standard will be retained. The best practice is to define all of your standards and characteristics when loading in a new cal kit.

$Z_0$	$Z_0$ is usually set to the system characteristic impedance (usually either 50 or 75 ohms).
Delay	Delay is equivalent to a uniform length of transmission line between the standard being defined and the actual measurement plane. The DELAY is entered as the one-way travel time from the measurement plane to the standard in seconds. Delay can be determined from the precise physical length of the standard, multiplied by the velocity factor (reciprocal of the dielectric constant).
Loss	Loss is used to specify energy loss, due to skin effect, along a one-way length of coaxial delay. The value of loss is entered as ohms/nanosecond (or Gigohms/second) at 1 GHz. For many applications, the loss value can be set to zero without noticeable degradation.

For further information, on calibration kits and standard characteristics determination, refer to HP Product Note 8510-5A (HP Part No. 5954-1559).

**Step 2: Create a Cal Kit ASCII File**

Create a cal kit ASCII file or edit the one provided on the Example Programs disk. (Remember that these files are compatible with MS-DOS, and thus, you could use any IBM Compatible PC and a text editor that can modify ASCII files. Just be sure to include the line numbers as if it were an IBASIC program.) The example file, "CALKIT," provided on the Example Programs disk, is listed on the next page.



**Choose an Appropriate Calibration Method**

When reading the cal kit file, the analyzer recognizes only the information after the “!” and ignores everything after a “\$”. You can add comments after a “\$”. The first line of a cal kit file *must* contain a “!” with a “\$” directly after it. No characters are allowed between the “!” and the “\$” on the first line of a cal kit file.

```
10  !$ Standard Definitions for HP 85054B Precision Type-N Cal Kit.
20  !
30  !$ Definitions for 50 Ohm jack (FEMALE center contact) test
40  !$ ports, plug (MALE center contact) standards.
50  !
60  ! OPEN: $ HP 85054-60027 Open Circuit Plug
70  !     ZO 50.0 $ Ohms
80  !     DELAY 57.993E-12 $ Sec
90  !     LOSS 0.8E+9 $ Ohms/Sec
100 !     CO 88.308E-15 $ Farads
110 !     C1 1667.2E-27 $ Farads/Hz
120 !     C2 -146.61E-36 $ Farads/Hz^2
130 !     C3 9.7531E-45 $ Farads/Hz^3
140 !
150 ! SHORT: $ HP 85054-60025 Short Circuit Plug
160 !     ZO 50.0 $ Ohms
170 !     DELAY 63.078E-12 $ Sec
180 !     LOSS 8.E+8 $ Ohms/Sec
190 !
200 ! LOAD: $ HP 00909-60011 Broadband Load Plug
210 !     ZO 50.0 $ Ohms
220 !     DELAY 0.0 $ Sec
230 !     LOSS 0.0 $ Ohms/Sec
240 !
250 ! THRU: $ HP 85054-60038 Plug to Plug Adapter
260 !     ZO 50.0 Ohms
270 !     DELAY 196.0E-12 $ Sec
280 !     LOSS 2.2E+9 $ Ohms/Sec
290 !
300 END
```

Calibrating for Increased Measurement

Accuracy

**Choose an Appropriate Calibration Method**

**Step 3: Verify  
Performance**

Once a measurement calibration has been generated with a user-defined calibration kit, its performance should be checked before making device measurements. To check the accuracy that can be obtained using the new calibration kit, a device with a well-defined frequency response (preferably unlike any of the standards used) should be measured. The verification device must not be one of the calibration standards: measurement of one of these standards is merely a measure of repeatability.

To achieve more complete verification of a particular measurement calibration, accurately known verification standards with a diverse magnitude and phase response should be used. NBS traceable or HP standards are recommended to achieve verifiable measurement accuracy.

---

**CAUTION**

---

The published specifications for your analyzer system include accuracy enhancement with compatible calibration kits. Measurement calibrations made with user-defined or modified calibration kits are not subject to those analyzer specifications.



---

## Save the Calibration

After you have performed your calibration, you will probably want to save it for future use. To save your calibration:

1. Press **SAVE RECALL** **Define Save Cal on OFF**, which will toggle the save cal function to "ON."
2. Press **Prior Menu** **Select Disk** and select where you want the calibration saved. See "Saving and Recalling Measurement Results" in Chapter 4 for information on the four available selections.
3. Press **Prior Menu** **Save State** to save the calibration.
4. The analyzer will save the calibration along with the current instrument state to a file on the disk you have selected.
5. Refer to "Saving and Recalling Measurement Results" in Chapter 4 for more information on saving, renaming, and copying files.

Calibrating for Increased Measurement  
Accuracy



---

## Automating Measurements

---

## Automating Measurements

### **NOTE**

This chapter assumes that you are familiar with the information provided in the *Programmer's Guide* (supplied with your analyzer) and the *HP Instrument BASIC User's Handbook* (supplied with Option 1C2 analyzers).

An automated measurement system is a system where a computer performs some of the tasks that you would normally have to do manually.

The information in this chapter will help you learn about how to automate your measurement system. Several features of the instrument that are useful for automation are explained.

Some of the analyzer features that support automation are built-in and operate solely on the analyzer; limit testing is one example of a built-in automated feature. Other features can be executed by programs running on IBASIC (Option 1C2) or an external computer. Use of automation improves the productivity of a measurement system by increasing the system's throughput. For the discussions in this document, throughput is defined as the sum of the following factors:

- operator interaction time
- measurement speed
- data transfer speed
- computation speed (when applicable)

Be sure to consider all of these factors when choosing and setting up an automated system.

An automated system can perform repetitive tasks quickly and repeatedly. Automation can be used to direct you through a sequence of tests, to set instrument parameters, and to send prompts with helpful directions or diagrams. Automation is also used to collect data, to monitor production

line performance, and to archive and analyze data. Automating your measurements can help ensure consistent quality on a production line.

Using a consistent, documented production process, while monitoring product quality are important attributes of modern production standards such as ISO-9000. These attributes are best achieved with an automated system.

**NOTE**

Hewlett-Packard offers professional consulting services to help increase your manufacturing productivity. A complete test process analysis can be performed by HP system engineers, who will work with your factory management, engineering, and production groups to evaluate various automation solutions. For more information contact the nearest HP sales office. Refer to Chapter 11 for a table of sales and service offices.

The following sections are included in this chapter:

- Configuring Your Test System
- Operator Interaction
- Measurement Setup and Control with Fast Recall
- Automated Measurement Setup and Control
- Controlling Peripherals
- Displaying Measurement Results
- Saving Measurement Results

**NOTE**

IBASIC (Option 1C2), when installed on your network analyzer, acts as a complete system controller residing inside your analyzer.

---

## Configuring Your Test System

---

### Measurement System Topology

When configuring your test system, there are many things to consider, such as:

- How many test stations do you need?
- How many test stations will be needed in the future?
- How much space is available at each test station?
- What type of testing will be done?
- How will the measurement be controlled?
- How will the data be analyzed and archived?
- What level of throughput is required?

After answering these questions, you should decide which of the following configurations best meets your needs.



**Stand-Alone Network Analyzers**

In this configuration, the measurement is controlled directly by the operator, with very little automation. No computer or IBASIC control is used, however the fast recall feature may be used for quickly changing to different instrument states. This configuration is well suited for simple go/no-go device testing using the built-in limit testing features. Configure your system as a stand-alone analyzer if you would like to:

- Simplify test system configuration
- Reduce capital expense
- Allow for future expansion with minimal effort
- Minimize the space required for a system

Figure 7-1 shows a stand-alone network analyzer.

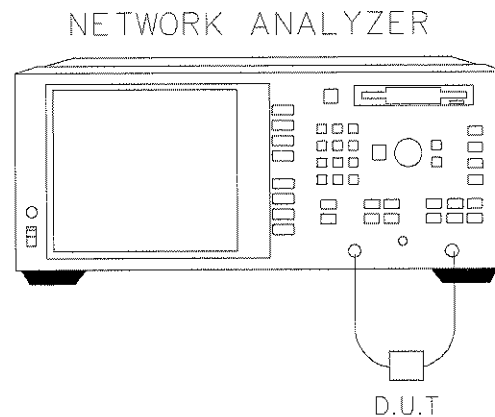

**Figure 7-1. Stand-Alone Network Analyzer**

Automating Measurements  
**Configuring Your Test System**

**Stand-Alone Analyzers  
Running IBASIC**

In this configuration, the measurement is controlled by an IBASIC program running inside the analyzer. With IBASIC, the measurement setup and control can be highly automated, reducing the burden on the operator. Since the measurement is under programmatic control, statistics can be collected in order to monitor your process and quality. IBASIC's keystroke recording lets you construct programs quickly, without needing to refer to the programming documentation. Using AUTOST files, the analyzer will load and run your program when power is turned on.

Since no external computer is required, there are fewer system components to purchase, maintain, connect, and synchronize.

Configure your system as a stand-alone instrument with IBASIC (Option 1C2) if you would like to:

- Simplify test system configuration
- Allow for future expansion
- Minimize the space required for a system
- Simplify programming with keystroke recording
- Use **BEGIN** key macros
- Automate measurement setup and control
- Simplify measurements
- Collect data
- Run application programs on the analyzer

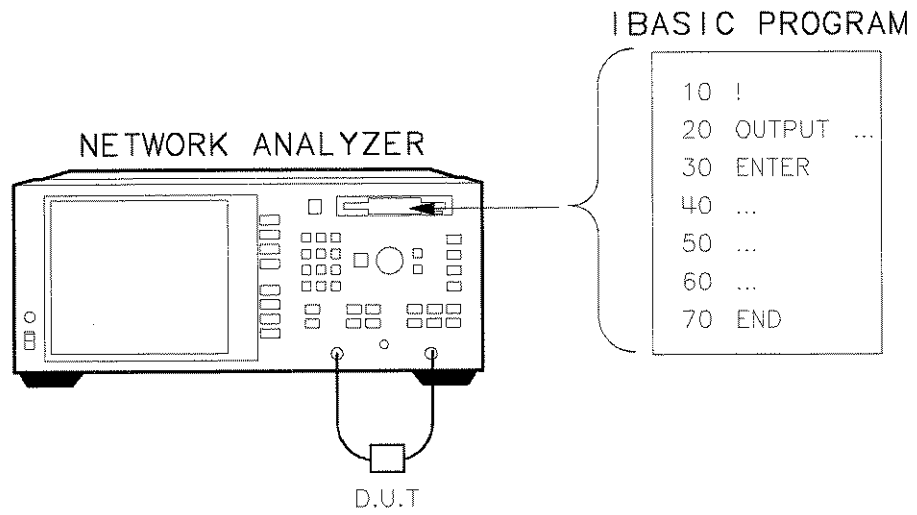

po670b

**Figure 7-2. Stand-Alone Network Analyzer Running IBASIC**

Automating Measurements  
**Configuring Your Test System**

**Network Analyzers  
Without IBASIC  
Controlled by  
Computer(s)**

In this configuration, the measurement is controlled by a computer external to the analyzer, using the HP-IB interface. The measurement setup and control can be highly automated, reducing the burden on the operator, and statistics can be collected in order to monitor your process and quality. You can connect one or more analyzers to each computer. Since the computer can be connected to other computers via Local Area Network (LAN), measurement statistics can be easily tracked and archived using computer applications. Configure your system as an analyzer controlled by an external computer if you would like to:

- Centralize automation and application programs
- Develop a more sophisticated system
- Add networking

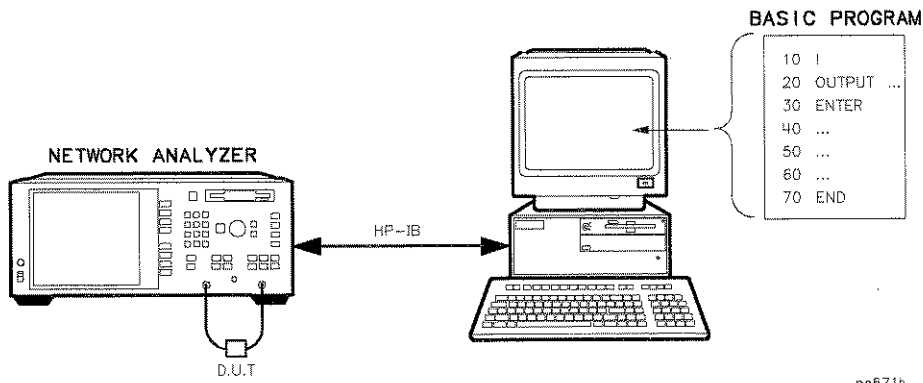
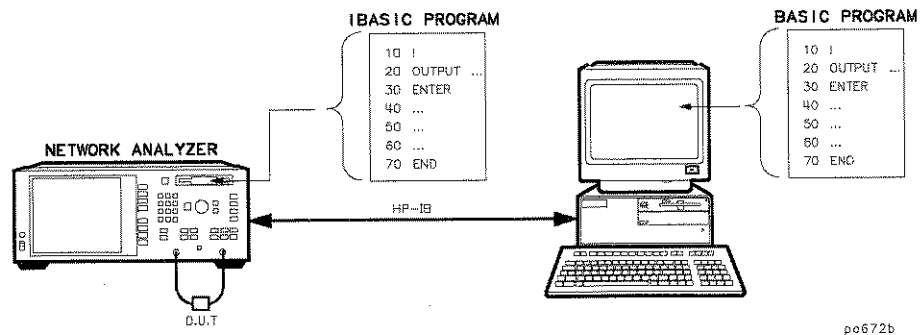

**Figure 7-3. Network Analyzer Without IBASIC, Controlled by a Computer**

**Network Analyzers  
With IBASIC Controlled  
by Computer(s)**

In this configuration, the measurement is controlled by an IBASIC program running inside the analyzer. IBASIC can provide high-speed measurement control and data collection, and save the results in program memory or on disk. The external computer then communicates with IBASIC, and collects the measurement results at some defined interval. This configuration can result in higher throughput, especially if the measurement setup and control is complex. Configure your system as an analyzer with IBASIC (Option 1C2) and an external computer if you would like to:

- Centralize automation and application programs
- Develop a more sophisticated system
- Add networking
- Add local automation capability



**Figure 7-4. Network Analyzer Running IBASIC, Controlled by a Computer**

---

## Expandability and Large Systems

When connecting more than one analyzer to one computer using HP-IB, you can connect up to 10 analyzers and achieve maximum HP-IB bus speed. The IEEE-488 standard states that the bus can achieve a data rate of 500 KB per second for buses up to 20 meters in length, with up to one device per 2 meters of cable.

IEEE-488 provides for 31 unique addresses (0 through 30), however it restricts the number of devices on the bus to 15. Due to this restriction, you may need to add more computers as you add more analyzers. Set each analyzer's address via the **SYSTEM OPTIONS** **HP-IB** menu.

---

## Throughput Considerations

When considering the throughput of the system configuration, contributing factors are:

- operator interaction time
- measurement speed
- data transfer speed
- computation speed (when applicable)

Each system should be evaluated for throughput based on the sums of these four factors.

---

## Selecting a Measurement Controller

There are three standard configurations that you can use to control the analyzer.

### **Stand-Alone Operation using IBASIC**

IBASIC, in effect, puts a controller inside your analyzer and eliminates the need for an external controller. IBASIC controls the analyzer by sending SCPI commands to address 800 (`OUTPUT 800;"Command"`), or by using high speed built-in subprograms. Since IBASIC shares CPU time with the analyzer, it may cause some degradation in measurement throughput if your program performs intensive computations. However, for most applications, it provides excellent performance and convenience. Refer to the *HP Instrument BASIC User's Handbook* for more information.

### **Computer Controlled Operation**

An external controller can be used to control the analyzer. It can be a personal computer (PC) or an HP BASIC computer. The external controller sends standard SCPI commands to address 716 (default) (`OUTPUT 716;"Command"`) to control the analyzer. Refer to the *Programmer's Guide* for more information.

You can use one controller to control several analyzers (see "Expandability and Large Systems" earlier in this chapter). However, if a large number of SCPI commands are required per measurement, throughput may be degraded. Typical limits are 3 to 10 analyzers per computer.

**Operation of an  
Analyzer Running  
IBASIC Under Computer  
Control**

Commands can be sent from an external computer or from IBASIC, or both at the same time, if certain precautions are observed. Things to consider:

1. If both the analyzer and the computer send SCPI commands at the same time, the analyzer may not finish the IBASIC command before executing the computer's command, or vice-versa. The programmer must ensure that SCPI commands executed by IBASIC do not overlap with SCPI commands sent from an external controller, otherwise the system may deadlock. Synchronization between the analyzer and the controller must be ensured. See "Synchronizing the Analyzer and a Controller" in the supplement to the *HP Instrument BASIC User's Handbook* for additional information.
2. Both IBASIC (SelectCode 8) and the external controller (SelectCode 7) share the same HP-IB status model (the same analyzer status bits go to each). Be careful sending commands which affect status reporting, such as \*CLS, STAT:PRES, \*RST, etc.



---

## Selecting a Programming Language

### **HP BASIC**

HP BASIC has long been a favorite programming language for instrument control. It features an extensive list of keywords, and powerful OUTPUT and ENTER formatting, making it easy to perform common tasks. This generally results in very high programming productivity. HP BASIC runs on HP series 700 and 300 workstations.

### **IBASIC**

IBASIC is a version of BASIC that runs inside of the network analyzer. You may order IBASIC with your analyzer by specifying Option 1C2.

IBASIC is a sub-set of HP's BASIC-UX. It has roughly the same keywords as HP BASIC 4.0. With very little effort, you can design your program so that it will run either inside the analyzer or on a computer with no modification.

The IBASIC program runs concurrently with normal instrument measurement processing. Since IBASIC has direct access to the analyzer's measurement arrays, it can read them and write to them very quickly, eliminating the need to use SCPI commands. Using IBASIC's keystroke recording, you can write a large portion of your instrument control program by pressing the keys on the analyzer's front panel. IBASIC can be used in a stand-alone instrument, or in conjunction with an external computer.

For more information on IBASIC, refer to the *HP Instrument BASIC User's Handbook*.

Automating Measurements  
**Configuring Your Test System**

**HP VEE**

HP VEE is a powerful application which lets you graphically create programs to control your instrument. VEE automatically handles the programming details so you can focus on higher level tasks. It also contains statistical functions which you can use to monitor your production process.

VEE runs on PCs and HP-UX and Sun Workstations.

VEE is used in conjunction with a VEE instrument driver. The VEE instrument driver presents the user with a picture of the instrument's front panel on the computer display. Using the mouse, the user clicks on the front panel keys to control the instrument, similar to IBASIC keystroke recording.

For information on VEE including literature and preview disks, please call the HP Test and Measurement Call Center at 1-800-452-4844, extension 9141. Outside the U.S., contact your nearest HP Sales or Service office. Refer to Chapter 11 for a table of sales and service offices.

**Microsoft®  
QuickBasic™**

QuickBasic has been a popular programming language, since it runs on PCs. It does not offer a rich keyword set as does HP BASIC, and is not optimized for instrument control. To control the analyzer via HP-IB, an HP-IB card and driver library must be installed. The driver library will provide subroutines such as IOOUTPUT and IOENTER which let you control your analyzer.

**C and C++**

If you are using C or C++, you will need to link in a driver library to use your HP-IB card. HP offers a library called Standard Instrument Control Library (SICL). SICL is available for PCs running Microsoft Windows and using HP's HP-IB card. SICL is also available on HP series 700 UNIX workstations.

**Example Programs**

The *Programmer's Guide* contains detailed information on controlling the analyzer via the HP-IB, including several example programs written in HP BASIC.

The *HP Instrument BASIC User's Handbook* contains detailed information and examples showing how to control the analyzer using IBASIC.

---

## Operator Interaction

Many tests are performed by technicians or testers, who interact with the measurement system. When designing the automation system, it is important that the system allow operators to perform the measurement tasks quickly and consistently. The system must also be easy to learn and easy to use, providing the user with instructions and feedback.

The analyzer provides many features to satisfy these requirements. The features include:

- User-defined pop-up messages to prompt the operator
- On-screen graphics to create custom diagrams
- User-defined channel and frequency annotation
- Ability to define the **BEGIN** key menu with custom softkeys (requires IBASIC, Option 1C2)
- IBASIC display window; configurable as full or split
- IBASIC "DISP" line and "INPUT" line
- Data entry using a bar code reader
- Data entry using an external keyboard
- Hot keys on external keyboard for common functions
- Operator control of measurements using a foot switch or button box
- Beeper with adjustable volume and pitch
- Limit test pass/fail TTL output
- User-defined TTL input/output
- Output for large screen external monitor

The following sections explain how to use these features, and show several examples.

Automating Measurements  
**Operator Interaction**

Figure 7-5 shows an example test system setup which utilizes the extensive connectivity capabilities of the analyzer. All of the interface ports shown are standard equipment on your analyzer.

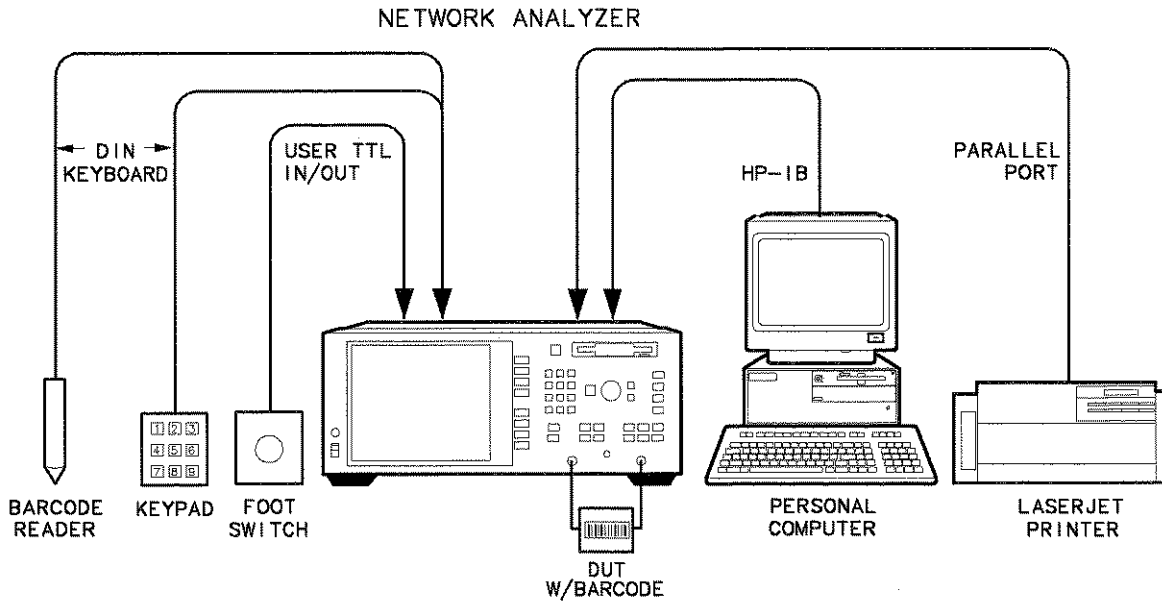

po669b

**Figure 7-5. Example Test System Setup**

---

## Prompting the Operator

You can display a message in the center of the analyzer's display by using the following SCPI command:

```
DISPlay:ANNotation:MESSage <STRING>
```

For example:

```
OUTPUT @Rfna;"DISP:ANN:MESS 'Connect device, then press button'"
```

You can specify how long you want the message to remain on the screen by using one of the following timeout words: **SHORT**, **MEDIUM**, **LONG**, **NONE**. For example:

```
OUTPUT @Rfna;"DISP:ANN:MESS 'Test passed.'" ,MEDIUM
```

To clear the message immediately, use the command:

```
DISPlay:ANNotation:MESSage:CLEar
```

The message string can contain a maximum of 25 lines with up to 47 characters per line. However, it cannot be more than 254 characters in length, including carriage returns and line feeds.

If you are using IBASIC, you can use the BASIC keyword **DISP** to display a small one-line message near the bottom of the screen. For example:

```
DISP "Connect device to REFLECTION port"
```

---

## Using Graphics to Create On-Screen Diagrams

Diagrams showing how to connect devices or perform measurements can be a powerful tool. You can draw diagrams on the analyzer's display using the following SCPI commands:

```
DISP:WINDow[1|2|10]:GRAPhics:command
```

These commands let you draw lines, rectangles, circles, and text onto the screen. The number specified in the **WINDow** part of the command selects where the graphics are to be drawn:

**WINDow1**        draws the graphics to the channel 1 measurement window  
**WINDow2**        draws the graphics to the channel 2 measurement window  
**WINDow10**       draws the graphics to the IBASIC display window

Using split display, you can display the measurement in one half of the screen while displaying a connection diagram in the other half.

For more details on SCPI graphics commands, refer to "Using Graphics" in the *Programmer's Guide*.

If you are using IBASIC, you can use the BASIC graphics keywords such as **MOVE** and **DRAW** to draw diagrams in the IBASIC window.

```
MOVE X1,Y1  
DRAW X2,Y2
```

Since IBASIC's keywords always draw to the IBASIC window, you cannot use them to draw in the same window as your measurement. To draw in the measurement window, your IBASIC program must use the standard SCPI commands.

```
DISP:WIND1:GRAPhICS:command
```

and

```
DISP:WIND2:GRAPhICS:command
```

For more details on IBASIC graphics, refer to "Graphics and Display Techniques" in the manual supplement *Using HP Instrument BASIC with the HP 8711B/12B/13B/14B*, provided in the *HP Instrument BASIC User's Handbook*.

## User-Defined **BEGIN** Key Menu

This feature requires the IBASIC option (1C2). User BEGIN adds the following capabilities:

- Redefine softkeys to implement single key press functions; for example, *fast* Save or Recall
- Redefine softkeys to implement your most used functions/features
- Redefine softkeys to implement new features created with IBASIC; for example, a gain compression implementation.
- Redefine softkeys to implement application support

The feature is designed to provide the fastest possible sweep speeds while taking advantage of the flexibility provided by IBASIC. This is the simplest way for recalling instrument states or configuring most used softkey functions under a single softkey menu. The **BEGIN** menu softkey #8 provides access to the menus below. Toggle softkey 8 to enable/disable **BEGIN** or **User BEGIN**. You cannot redefine softkey 8.

<b>BEGIN</b>		<b>User BEGIN</b>
Amplifier		User label 1
Filter		User label 2
Broadband Passive		User label 3
Mixer		User label 4
Cable (option 100 only)		User label 5
		User label 6
		User label 7
User BEGIN on OFF	---->	User BEGIN ON off

**Operator Interaction**

Once you have selected a menu, the same menu will be displayed for subsequent key presses of the **BEGIN** hardkey. (This is not true if your IBASIC program has changed. If your program has changed, the **User BEGIN** mode is reset to OFF.)

By selecting **SYSTEM OPTIONS** **System Config** **Softkey Auto-Step** **User TTL Input** you can automatically step through the user-defined **BEGIN** menu keys by use of a switch connected to the USER TTL IN/OUT rear panel connector. See "Using User-Defined **BEGIN** with a Switch," later in this chapter for more information.

Selecting the **User BEGIN** softkey will run a macro function defined by a sequence of IBASIC commands defined within an IBASIC program. IBASIC programs to be used for **User BEGIN** must have the following structure:

```

10      !The following label must be present.  DO NOT REMOVE
20      User_begin: !
30      ...
40      ! Define softkey labels
50      OUTPUT @871X;"DISP:MENU2:KEY1 'Test Setup 1';*WAI"
60      OUTPUT @871X;"DISP:MENU2:KEY2 'Test Setup 2';*WAI"
70      OUTPUT @871X;"DISP:MENU2:KEY3 'Save Results';*WAI"
80      OUTPUT @871X;"DISP:MENU2:KEY4 'Print Results 4';*WAI"
100     User_pause: PAUSE
110     GOTO User_pause
120     !The following key labels must be present.  DO NOT REMOVE
140     User_key1: !Insert code for softkey 1 here
150     GOTO User_pause
160     User_key2: !Insert code for softkey 2 here
170     GOTO User_pause
...
200     User_key7: !Insert code for softkey 7 here
210     GOTO User_pause

```



The labels required are:

User\_begin  
User\_pause  
User\_key1  
User\_key2  
User\_key3  
User\_key4  
User\_key5  
User\_key6  
User\_key7

Your **User BEGIN** program must contain all of these labels, even if you are not using all of the softkeys.

A default **User BEGIN** program is created automatically when there is no IBASIC program installed. In the default program, softkey #3 is defined to be the **Mkr -> Max** function, softkey #4 prompts the user for a title, and also enables the clock. The default program is listed next. You may edit this program to change the functions you need. Once you have edited the program, be sure to save the program to memory for later recall.

```
1      ! The following line is required. DO NOT REMOVE!  
2 User_begin:    ASSIGN @Hp8714 TO 800 ![User Begin] Program  
3      !  
4      ! To Modify:  
5      ! Use [IBASIC][EDIT] or [IBASIC][Key Record]  
6      !  
7      !  
8      ! Declare storage for variables.  
9      DIM Name$[60],Str1$[60],Str2$[60],Str3$[60]  
10     !  
11     ! Clear the softkey labels  
12     OUTPUT @Hp8714;"DISP:MENU2:KEY8 '';*WAI"  
13     !  
14     ! Re-define softkey labels here.  
15     OUTPUT @Hp8714;"DISP:MENU2:KEY1 '*;*WAI"  
16     OUTPUT @Hp8714;"DISP:MENU2:KEY2 '*;*WAI"
```

Automating Measurements

**Operator Interaction**

```
17  OUTPUT @Hp8714;"DISP:MENU2:KEY3 'Mkr -> Max';*WAI"
18  OUTPUT @Hp8714;"DISP:MENU2:KEY4 'Title and Clock';*WAI"
19  OUTPUT @Hp8714;"DISP:MENU2:KEY5 '*';*WAI"
20  OUTPUT @Hp8714;"DISP:MENU2:KEY6 '*';*WAI"
21  OUTPUT @Hp8714;"DISP:MENU2:KEY7 '*';*WAI"
22  !
23  !The following 2 lines are required. DO NOT REMOVE!
24  User_pause:  PAUSE
25  GOTO User_pause
26  !
27  User_key1:   ! Define softkey 1 here.
28  GOSUB Message ! Remove this line.
29  GOTO User_pause
30  !
31  User_key2:   ! Define softkey 2 here.
32  GOSUB Message ! Remove this line
33  GOTO User_pause
34  !
35  User_key3:   ! Example Marker Function
36  OUTPUT @Hp8714;"CALC1:MARK1 ON"
37  OUTPUT @Hp8714;"CALC1:MARK:FUNC MAX"
38  GOTO User_pause
39  !
40  User_key4:   ! Example Title Entry
41  INPUT "Enter Title Line 1. Press [Enter] when done.",Name$
42  OUTPUT @Hp8714;"DISP:ANN:TITL1:DATA '&Name$&'"
43  OUTPUT @Hp8714;"DISP:ANN:TITL ON"
44  GOTO User_pause
45  !
46  User_key5:   ! Define softkey 5 here.
47  GOSUB Message ! Remove this line.
48  GOTO User_pause
49  !
50  User_key6:   ! Define softkey 6 here.
51  GOSUB Message ! Remove this line.
52  GOTO User_pause
53  !
54  User_key7:   ! Define softkey 7 here.
55  GOSUB Message ! Remove this line.
56  GOTO User_pause
57  !
```

```
58 Message:      !
59   Str1$="This key is programmable."
60   Str2$="To modify, select"
61   Str3$="[System Options], [IBASIC], [Edit]."
```

```
62   OUTPUT @Hp8714;"DISP:ANN:MESS '"&Str1$&CHR$(10)&
      Str2$&CHR$(10)&Str3$&"', MEDIUM"
63   RETURN
64   !
65   END
```

**NOTE**

For more **User BEGIN** programs, see the *IBASIC Example Programs Disk* and the *HP Instrument BASIC User's Handbook* supplement. The disk and handbook are shipped with analyzers with the IBASIC Option 1C2.

**Loading a  
User BEGIN  
Program**

A **User BEGIN** program can be automatically loaded at power up if the program is named "AUTOST". An "AUTOST" program is loaded at power up from the internal non-volatile memory or from a 3.5" floppy disk inserted into the analyzer's 3.5" disk drive. When the **User BEGIN** key is pressed, the program will remain idle until it is needed. The program remains idle until a softkey is pressed and code related to that softkey is executed. After the code is executed, the program returns to idle. Refer to example programs provided on the IBASIC programs disk for **User BEGIN** example programs. Use of the **User BEGIN** does *not* restrict access to any normally available front panel feature, nor does this key affect sweep update rates.

**Operator Interaction**

**Modifying a  
User BEGIN  
Program.**

You can modify the **User BEGIN** program with the built-in editor, an ASCII file editor on a computer, or with keystroke recording. For example, to modify the default program to recall a setup:

1. Select **(SYSTEM OPTIONS) IBASIC Edit**. Move the edit cursor to line:

```
15      OUTPUT @Hp8714;"DISP:MENU2:KEY1 '*' ;*WAI"
```

2. Use an external keyboard to replace '\*' with 'Setup 1'.
3. Move the edit cursor to line 28. Delete the line.
4. Use keystroke recording to create a setup function if you like, or you can now insert code you have written.

To use keystroke recording to modify the program:

5. Exit the editor by selecting **Prior Menu**.
6. Enable keystroke recording with **Key Record ON**.
7. Now perform the keystrokes required for setup 1.
8. When the setup is completed, select **(SYSTEM OPTIONS) IBASIC Key Record OFF**.
9. To verify your change, select **(PRESET) (BEGIN) User BEGIN ON**.
10. Select softkey 1 which should be labelled "Setup 1". This should return you to your correct setup.
11. You may save this program as an AUTOST file or other file for later recall.

Refer to the manual supplement, *Using HP IBASIC with the HP 8711B/12B/13B/14B*, provided in the *HP Instrument BASIC User's Handbook*, for more information about editing, saving and recalling program files.

**Using User-Defined  
BEGIN with a Switch**

When user-defined **BEGIN** is used in conjunction with a switch connected to the USER TTL IN/OUT rear panel connector, you can cycle through up to seven softkeys in sequence by activating the switch.

1. Connect a switch to the USER TTL IN/OUT rear panel connector as shown in Figure 7-6.

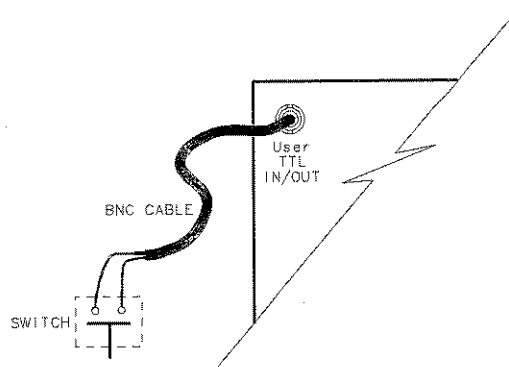

po699b

**Figure 7-6. Connect a Switch to the USER TTL IN/OUT Connector**

2. Make sure the analyzer is configured to use the USER TTL IN/OUT connector for softkey sequencing: press **SYSTEM OPTIONS** **System Config** **Softkey Auto-Step** **User TTL Input**.
3. Press the switch several times while observing the analyzer.
4. Notice that with each press of the switch, the softkey labels are highlighted (boxed) in succession, and that after the last available key has been used, the sequence starts again at the top of the softkey menu.

## Data Entry Using a Bar Code Reader

Devices under test (DUTs) are often labelled with a serial number and part number. If the DUT is labelled with this information in bar code form, a bar-code reader can be used to enter the DUT information into the analyzer or into the computer controlling the analyzer. Doing so provides a simple and safe link between the device under test and the measurement data. Information such as the operator's name or test station number can also be entered, to allow correlation of the devices tested with the test station.

Connect a bar code reader, such as the HP KeyWand HBCK-1210, to the analyzer's DIN KEYBOARD connector (on the rear panel). Once connected, the bar code reader will send scanned bar code characters to the analyzer just as if they were typed on a keyboard. The bar code characters will be followed by a carriage return. The bar code wand and the external keyboard can be connected simultaneously.

See "Using the Analyzer's Title Feature," next in this section, for more information on using the title feature with a bar code reader.

In addition to Hewlett-Packard's bar code wand, other vendors offer products such as cordless bar code readers, laser scanner readers, bar code label printers, bar code fonts for Windows®, and bar code labeling software.

---

## Data Entry Using an External Keyboard

An IBM PC-AT compatible keyboard can be connected to your analyzer's DIN KEYBOARD connector and used to quickly and conveniently enter file names for instrument state save/recall, or text for title lines.

**NOTE**

If your keyboard has a mini-DIN connector, you will need to use a mini-DIN to DIN adapter to connect the keyboard to the analyzer. One of these adapters (HP part no. C1405-60015) is shipped with the analyzer if you ordered the keyboard option (1CL).

See "Using the Analyzer's Title Feature," next in this section, for more information.

---

## Using the Analyzer's Title Feature

The analyzer has two 30-character title lines which can be entered using the bar code reader. From the front panel, press **DISPLAY** **More** **Title and Clock Title Line 1**, or on an external keyboard, press F9. Then use the bar code reader to scan in the information from the DUT or use a keyboard to type in the information. Once stored in the title line, the information will be included on hardcopy dumps. The title lines can also be set or queried using the following SCPI command:

```
DISPlay:ANNotation:TITLe[1|2]:DATA <STRING>
```

For example:

```
OUTPUT @Rfna;"DISP:ANN:TITL1:DATA 'BPF-177, SN US95170001'"
```

and

```
OUTPUT @Rfna;"DISPlay:ANNotation:TITLe1:DATA?"  
ENTER @Rfna;Title1$
```

Use the command

```
"DISPlay:ANNotation:TITLe[1|2] ON|OFF"
```

to display or hide the title. If you are using IBASIC, you can use the INPUT statement to read in bar code or keyboard characters. For example:

```
30 INPUT "Scan in the Bar Code now",Dut$  
40 OUTPUT 800;"DISP:ANN:TITL1:DATA '";Dut$;"'"  
50 OUTPUT 800;"DISP:ANN:TITL1 ON"  
60 END
```



---

## Hot Keys on External Keyboard For Common Functions

You can use a keyboard's keys instead of the analyzer's keys to control the analyzer. Table 7-1 provides the same information that can be found on a template that is supplied with each analyzer (HP part number 08712-80004). Function keys F9, F10, and F11 are "hot keys" which perform common operations such as entering measurement titles and saving measurement results to disk.

Automating Measurements  
**Operator Interaction**

**Table 7-1. Keyboard Template Definition**

Keyboard Key Name	Analyzer Function	Keyboard Key Name	Analyzer Function
Esc	Opt IBASIC Command Line On/Off	Shift F4	<b>POWER</b>
F1	Softkey 1	Shift F5	<b>SWEEP</b>
F2	Softkey 2	Shift F6	<b>MENU</b>
F3	Softkey 3	Shift F7	<b>SCALE</b>
F4	Softkey 4	Shift F8	<b>MARKER</b>
F5	Softkey 5	Shift F9	<b>DISPLAY</b>
F6	Softkey 6	Shift F10	<b>FORMAT</b>
F7	Softkey 7	Shift F11	<b>CAL</b>
F8	Softkey 8	Shift F12	<b>AVG</b>
F9	Title Keys Line 1 <i>or</i> RCL <sup>1</sup>	Shift Print Screen	Hard Copy Graph and Softkeys
F10	Title Keys Line 2 <i>or</i> Edit <sup>1</sup>	Ctrl F1	<b>SAVE RECALL</b>
F11	Title Keys Clock <i>or</i> Window <sup>1</sup>	Ctrl F2	<b>HARD COPY</b>
F12	Re-save File <i>or</i> Run <sup>1</sup>	Ctrl F3	<b>SYSTEM OPTIONS</b>
Print Screen	Help	Ctrl F4	<b>PRESET</b>
Shift F1	<b>CHAN 1</b>	Ctrl F5	<b>BEGIN</b>
Shift F2	<b>CHAN 2</b>	Ctrl Print Screen	Hard Copy Keyboard Template
Shift F3	<b>FREQ</b>		

<sup>1</sup> when IBASIC command line is enabled

---

## User-Defined TTL Input/Output

The USER TTL signal can be used as either a general-purpose input or output. Like the LIMIT TEST IN/OUT line, the USER TTL IN/OUT line is an open collector drive. When used as an input, the state of the USER TTL IN/OUT line can be read with either the SCPI command

```
"DIAG:PORT:READ? 15,1"
```

or with the IBASIC command

```
I = READIO(15,1)
```

When used as an output, the state of the USER TTL IN/OUT line can be set with either the SCPI command

```
"DIAG:PORT:WRITE 15,1,value"
```

or with the IBASIC command

```
WRITEIO 15,1;value
```

---

### **CAUTION**

Be sure to observe static precautions when using this port.

## Using a Foot Switch or Button Box

You can connect a foot switch, button box, or custom keyboard which has a few function keys that are custom-labeled, and use this in conjunction with IBASIC to allow consistent, error-free step-by-step measurement control. The operator presses one key, then the next, in order.

The foot-switch simply connects two wires together, grounding the center pin of the analyzer's USER TTL IN/OUT rear panel connector. The status of the USER TTL IN/OUT can be read using the SCPI commands:

```
30 OUTPUT 716;"DIAG:PORT:READ? 15,1"
```

```
40 ENTER 716;X
```

or the IBASIC command:

```
30 X=READIO(15,1)
```

When the foot-switch is open, the variable "X" will be set to 1. When it is closed, the variable "X" will be set to 0. Switch debounce is generally not a problem, due to the relatively slow polling rate of the program.

Refer to the section titled "Analyzer Port Numbers" for tables describing the various analyzer ports that you can access using SCPI or IBASIC commands.

Below are two example programs which shows how to display a message and read the foot switch to control your measurements. The first program uses the SCPI "DIAG:PORT:READ" query, while the second uses the IBASIC READIO function.

Following is an example program which shows how to display a message and read the foot switch to control your measurements. This program is named TTL\_IO on your Example Programs Disk.

For an example which uses the IBASIC READIO command, refer to the program USER\_BIT on your IBASIC Example Programs Disk.

```
100 ! Filename: TTL_IO
110 !
120 ! This program reads the USER TTL IO
130 ! port, and counts how many times a
140 ! switch connected to the port is pressed.
150 !
```

```
160 DIM Msg$[200]
170 INTEGER X
180 !
190 IF POS(SYSTEM$("SYSTEM ID"),"HP 871") THEN
200     ASSIGN @Hp8711 TO 800
210 ELSE
220     ASSIGN @Hp8711 TO 716
230     ABORT 7
240     CLEAR 716
250 END IF
260 !
270 Pass_count=0
280 Start: !
290 LOOP
300     ! Display message
310     Msg$="'DUTs passed: "&VAL$(Pass_count)&CHR$(10)
320     Msg$=Msg$&"Press button to measure next DUT.'"
330     OUTPUT @Hp8711;"DISP:ANN:MESS ";Msg$
340     !
350     ! Wait for button to be pressed
360     REPEAT
370         OUTPUT @Hp8711;"DIAG:PORT:READ? 15,1"
380         ENTER @Hp8711;X
390     UNTIL X = 0
400     DISP "Button is now pressed."
410     OUTPUT @Hp8711;"DISP:ANN:MESS:CLEAR"
420     !
430     ! Wait for button to be released
440     REPEAT
450         OUTPUT @Hp8711;"DIAG:PORT:READ? 15,1"
460         ENTER @Hp8711;X
470     UNTIL X = 1
480     DISP "Button is now released."
490     !
500     OUTPUT @Hp8711;"DISP:ANN:MESS 'Measuring...'"
510     ! Add code here to take sweep
520     ! and measure DUT.
530     WAIT 1
540     Pass_count=Pass_count+1
550 END LOOP
560 END
```

---

## Limit Test Pass/Fail TTL Input/Output

When limit testing is turned on, the LIMIT TEST IN/OUT rear-panel BNC connector indicates the status of the limit test. If the limit test passes, this TTL output goes high. If the limit test fails, this TTL output goes low. This signal can be used, for example, as an input to a materials handler.

---

**CAUTION**

---

Since the TTL output has limited current drive capability, it should be buffered when controlling high current devices such as mechanical relays. Otherwise, damage to the instrument may result.

The limit test TTL can also be used as a general-purpose input, since the analyzer drive to this line is open collector. When used as an input, limit testing should be turned *off* so the instrument will allow the limit test line to float high. The line can then be connected to an external switch which should only pull the signal to ground or let it float (an external circuit should not drive this line). A push button or foot switch can then be attached to the line to pull the signal to ground.

The state of the signal can be monitored by the automated system to determine when the operator is ready for some action. The state of the Limit TTL line can be read with either the SCPI commands

```
20 INTEGER X
30 OUTPUT 716;"DIAG:PORT:READ? 15,2"
40 ENTER 716;X
```

or using the IBASIC

```
30 X=READIO(15,2)
```

Finally, the LIMIT TEST TTL IN/OUT line can be used as a general-purpose output line. With limit testing turned off, the state of the line can be set to logic high or low with either the SCPI command

```
"DIAG:PORT:WRITE <port number>"
```

or with the IBASIC command

```
"WRITEIO <number>,value".
```

Following is an example of reading the LIMIT TEST TTL IN/OUT line when used as an input:

```
30 Limit = READIO(15,2)
40 ! The "Limit" variable will be set to 0 if the signal is low,
50 ! and 1 if the signal is high.
```

## Analyzer Port Numbers

### Writeable Ports

Table 7-2. Writeable Ports

Port Number	Register	Description
15	0	Outputs 8-bit data to the Cent_D0 thru D7 lines of the Centronics port. Cent_D0 is the least significant bit, Cent_D7 is the most significant bit. Checks Centronics status lines for: Out of Paper Printer Not on Line BUSY ACKNOWLEDGE
15	1	Sets/clears the user bit according to the least significant bit of A. A least significant bit equal to 1 sets the user bit high. A least significant bit of 0 clears the user bit.
15	2	Sets/clears the limit pass/fail bit according to the least significant bit of A. A least significant bit equal to 1 sets the pass/fail bit high. A least significant bit of 0 clears the pass/fail bit.
15	3	Outputs 8-bit data to the Cent_D0 thru D7 lines of the Centronics port. Cent_D0 is the least significant bit, Cent_D7 is the most significant bit. Sets the Printer_select signal high (de-select). Does not check Centronics status lines.
9	0	Outputs a byte to the serial port. The byte is output serially according to the configuration for the serial port.

#### NOTE

When using the `WRITEIO(15,0)` or `WRITEIO(15,3)` command, the Printer\_Select Line is set High. However, when the instrument is doing hardcopy, the Printer\_Select Line is set low. The Printer\_Select line may or may not be used by individual printers. Check with your printer manual.



**Readable Ports**

**Table 7-3. Readable Ports**

Port Number	Register	Description
9	0	Reads the serial port.
15	0	Reads the 8-bit data port Cent_DO thru D7.
15	1	Reads the user bit.
15	2	Reads the limit test pass/fail bit.
15	10	Reads the 8-bit status port. D0—Cent_acknowledge D1—Cent_busy D2—Cent_out_of_paper D3—Cent_on_line D4—Cent_printer_err

---

## Output for Large Screen External Monitor

You can connect an external monitor to the VIDEO OUT BNC connector for a large-screen view of your measurement if you wish. See “BNC Connectors” in Chapter 8 for information on using an external monitor with your system.

---

## Measurement Setup and Control with Fast Recall

The production of RF components often involves several steps, each step requiring a unique set of instrument settings. Likewise, the different test configurations at each step may require associated calibrations. Manually entering these sets of parameters (or “states”) or calibrating at each step in the manufacturing process is slow, prone to error, and costly. The fast recall feature allows you to recall an instrument state with just 1 or 2 key presses, or to cycle through up to seven different instrument states with a foot switch.

---

### Using Fast Recall with the Front Panel or a Keyboard

**NOTE**

The following explanation assumes that you are familiar with the information presented in “Saving and Recalling Measurement Results” in Chapter 4.

1. Press **SAVE RECALL**.
2. If the measurement display area changes to a listing of files on the currently selected disk, fast recall is OFF.  
If the measurement display area remains unchanged, fast recall is ON. To follow along with this explanation, turn fast recall OFF by pressing the **FastRecall ON off** softkey.
3. If necessary, select the internal non-volatile RAM disk by pressing **Select Disk Non-Vol RAM Disk**.
4. If you have previously saved any files to this disk they will now be listed on the display.

5. The fast recall feature utilizes only the first seven files listed that contain instrument state, calibration or measurement data.
6. If you have not previously saved any files to this disk, you may want to save a few instrument states now, to follow along.
7. Press **Prior Menu FastRecall on OFF**. Note that the measurement display now reappears on the screen and that there are file names next to the first seven softkeys. (If any of the softkeys are blank, it's because you had less than seven files saved on the disk.)

The files are placed on the softkeys in the order in which they appear in the disk's directory table.

**NOTE**

You may want to use the **Rename File** feature to give your files more meaningful names. See "Other File Utilities" in Chapter 4 for information on renaming files.

8. To "fast recall" an instrument state, press the softkey next to the file that contains the instrument state.
9. The fast recall toggle will remain on (even when the analyzer is **PRESET**) until manually turned off.
10. With the fast recall feature turned on, you will always be only 1 or 2 key presses away from recalling an instrument state.
11. With an external keyboard connected to the rear panel DIN connector, keys F1 through F7 are equivalent to pressing softkeys 1 through 7 on the analyzer. See "Using a Keyboard" in Chapter 4 for information on connecting and using an external keyboard.

---

## Using Fast Recall with a Switch

When fast recall is used in conjunction with a switch connected to the USER TTL IN/OUT rear panel connector, you can cycle through up to seven instrument states in sequence by activating the switch.

1. Connect a switch to the USER TTL IN/OUT rear panel connector as shown in Figure 7-7.

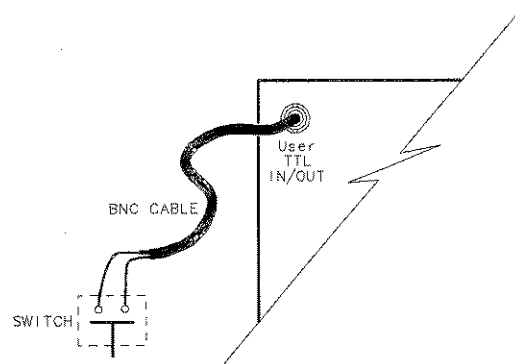

pc689b

**Figure 7-7. Connect a Switch to the USER TTL IN/OUT Connector**

2. Make sure the analyzer is configured to use the USER TTL IN/OUT connector for softkey sequencing: press **SYSTEM OPTIONS** **System Config** **Softkey Auto-Step** **User TTL Input**.
3. With fast recall toggled to ON, press the switch several times while observing the analyzer.
4. Notice that with each press of the switch, the files are highlighted (boxed) in succession, and that after the last available file has been used, the sequence starts again at the top of the softkey menu.

## Automated Measurement Setup and Control

The production of RF components often involves several steps, each step requiring a unique set of instrument settings. Likewise, the different test configurations at each step may require associated calibrations. Requiring the operator to manually enter these sets of parameters (or "states") or to calibrate at each step in the manufacturing process is slow, prone to error, and costly.

An automated measurement system can be used to achieve fast and consistent transitions between measurement setups. In an automated system, the instrument parameters are set under program control. The control program can be an IBASIC program running inside the analyzer, or be in another language running on an external computer. The control program sends SCPI and IEEE-488 commands to the analyzer's HP-IB interface. The HP-IB commands rapidly change the instrument settings or calibration.

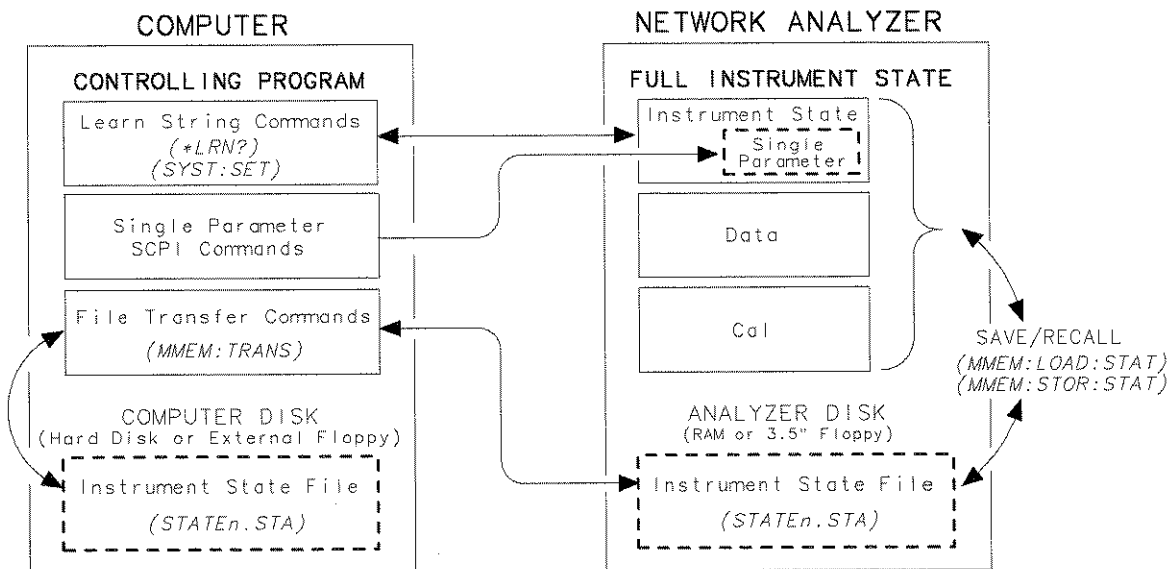

po677b

Figure 7-8. Measurement Control

**Automated Measurement Setup and Control**

The HP-IB interface can also be used to trigger sweeps, read measurement values, or signal events within the analyzer. Most operations that can be done from the front panel can also be done over the HP-IB interface. See the *Programmer's Guide* for details.

This section describes methods for changing instrument settings rapidly under program control. It then briefly discusses how to synchronize the modification of instrument settings with the collection of data and how to use Service Requests (SRQs) to signal instrument states. Finally, it describes how to utilize both instrument channels and a feature to automatically start an IBASIC control program.

For information on techniques that can improve you sweep speed, refer to Chapter 5, "Optimizing Measurements."

---

## Setting the Instrument State

A DUT will often undergo several different tests while at a single test station. The analyzer's parameters (such as sweep frequencies, output power, markers, and limits) must be set to the desired values before each test is done. In an automated test system the controlling computer modifies the instrument settings for the operator. The analyzer offers several techniques for quickly changing the instrument's measurement parameters:

- Recall of instrument states from disk
- The learn string HP-IB command (\*LRN)
- SCPI commands that change specific parameters

### Recalling Instrument States From Disk

The analyzer has two built-in memory (RAM) disks, "Non-Vol RAM Disk" and "Volatile RAM Disk". In addition, the analyzer has a built-in 3.5" floppy disk drive accessible on the front panel. A "RAM Disk" is a block of memory inside the analyzer which you can access in the same way that you access files on a floppy disk.

The "Non-Vol RAM Disk" is non-volatile, meaning that its contents are preserved while the analyzer is turned off. The contents of the "Volatile RAM Disk" are erased when the analyzer is turned off. The Volatile RAM Disk can be configured to be much larger than the Non-Vol RAM Disk, allowing it to hold many more instrument states.

For all three types of disk, the instrument settings and calibrations associated with several tests can be saved to instrument state files. The instrument states can later be recalled during the test sequence. The advantage of using RAM disks rather than the 3.5" floppy disk is that recalling a state from RAM Disks takes several seconds less than recalling a state from the floppy disk.

For example, suppose the instrument settings are entered for the third test of a sequence of tests. The instrument settings can be saved in a file with the name "TEST3.STA" on the Non-Vol RAM Disk. When the third test must be performed, the control program can recall the instrument state from the non-volatile RAM disk with this SCPI command:

```
MMEM:LOAD:STATe 1,'MEM:TEST3.STA'
```

**Automated Measurement Setup and Control**

Recalling a state from RAM disk typically takes 4 seconds, but the time is dependent on settings such as number of points.

One strategy for managing a large set of recall states is to initially store them on a floppy disk. The files can then be copied from the floppy disk to the volatile RAM disk at the start of each day. For example, to copy the file 'TEST3.STA' from the floppy to the RAM disk, use this SCPI command:

```
MMEM:COPY 'INT:TEST3.STA', 'RAM:'
```

For more details, see the *Programmer's Guide*

When controlling the analyzer with a computer, you may want to copy a state file from your computer's disk to the analyzer's built-in RAM disk or floppy disk. Later, the instrument can be instructed to recall the state from its internal disk. The file can be sent from the computer to the analyzer's disk using the SCPI **MMEMory:TRANsfer** commands. For more details, see the *Programmer's Guide*.

For manually controlled test systems, the instrument state files for each measurement can be stored onto disk by the test system designer. During the test sequence, the operator can press the **SAVE RECALL** key and recall the state corresponding to a particular measurement.



**Using Learn Strings to  
Save and Recall  
Instrument States**

The IEEE 488 \*LRN ("learn") command can also be used to set or query a complete set of instrument parameters. This can be used as a programming convenience, eliminating the need for using disk files when saving and recalling instrument states.

To obtain the learn string containing the instrument state, use the command \*LRN? as follows:

```
10 DIM State1$[4000]
20 OUTPUT @Rfna;"*LRN?"
30 ENTER @Rfna USING "-K";State1$
...
160 ! Put the learn string back
170 OUTPUT @Rfna;State1$
```

Since \*LRN?, by IEEE definition, only contains the actual instrument state, exclusive of data traces and calibration arrays, the network analyzer provides the command

```
SYST:SET:LRNLong?
```

This command saves the data traces and calibration arrays if they are enabled under **SAVE RECALL** **Define Save** or using the **MMEM:STOR:STATE** SCPI commands. Using the \*LRN command to set the instrument settings takes about the same amount of time as recalling a file from disk using **MMEM:LOAD:STATE**.

For more details on learn strings, refer to "Example Programs" in the *Programmer's Guide*.

---

## SCPI Commands That Modify a Single Parameter

**Tip**

If several measurement setups are similar — differing only by a few instrument parameters — the fastest way to switch between the states is for the control program to send the SCPI commands that modify those parameters.

For example, if center frequency and source power are the only parameters that change in consecutive measurement setups, send the SCPI commands `SENS1:FREQ:CENT` and `SOUR1:POW` to change these parameters, leaving all other instrument settings unchanged. This will be faster than either recalling an instrument state or sending a learn string.

---

## Fast Iterative Control

You may want to quickly and iteratively change the analyzer's parameters and monitor their effect on your device under test. This section describes how to quickly change a parameter, take a sweep, and query a marker.

For example, when measuring an amplifier, you may wish to quickly choose the optimal input power to the amplifier which will result in a maximum output of +10 dBm. To do so, you can first set the analyzer's source power level, then measure the amplifier's output, and then change the analyzer's source power in the direction that will cause the measured signal to approach the desired value. This process can be repeated until the measured amplifier output is within some specified range of the target value.

When data at only a single frequency is needed, you can achieve the fastest possible sweep by selecting a CW frequency and setting the number of points to the minimum value of 3. A SCPI marker command can be used to read the trace value.

Using this approach, you can typically achieve 3 to 5 sweeps per second. Following is a listing of an example program named "FAST\_CW" that can be found on your *Example Programs Disk*.

```
100 DIM Freq_str$[20]
110 DIM Msg$[100]
120 !
130 IF POS(SYSTEM$("SYSTEM ID"),"HP 871") THEN
140     ASSIGN @Hp8711 TO 800
150 ELSE
160     ASSIGN @Hp8711 TO 716
170     ABORT 7
180     CLEAR 716
190 END IF
200 !
210 ! PRESET, to ensure known state.
220 OUTPUT @Hp8711;"SYST:PRES;*WAI"
230 CLS
240 !
250 ! Set up the analyzer to measure 3 data points.
260 OUTPUT @Hp8711;"SENS1:SWE:POIN 3;*WAI"
270 !
```

**Automated Measurement Setup and Control**

```
280 ! Select CW display and sweep
290 OUTPUT @Hp8711;"DISP:ANN:FREQ1:MODE CW"
300 OUTPUT @Hp8711;"SENS1:FREQ:SPAN 0 Hz;*WAI"
310 !
320 ! Take a single sweep, leaving the analyzer
330 ! in trigger hold mode.
340 OUTPUT @Hp8711;"ABOR;:INIT1:CONT OFF;*WAI"
350 !
360 ! Turn on Marker 1
370 OUTPUT @Hp8711;"CALC:MARK1 ON"
380 !
390 Count=0
400 T0=TIMEDATE
410 ! Step from 175 MHz 463 MHz by 6 MHz
420 FOR Freq=175 TO 463 STEP 6
430 ! Take a sweep
440 Freq_str$=VAL$(Freq)&" MHz"
450 OUTPUT @Hp8711;"SENS1:FREQ:CENT ";Freq_str$
460 OUTPUT @Hp8711;"INIT1;*WAI"
470 !
480 ! Set marker to frequency
490 OUTPUT @Hp8711;"CALC:MARK:X ";Freq_str$
500 !
510 ! Query the marker value
520 OUTPUT @Hp8711;"CALC:MARK:Y?"
530 ENTER @Hp8711;Response
540 !
550 ! Display the first three numbers in the array.
560 Msg$="'"&Freq_str$&": "&VAL$(Response)&"'"
570 OUTPUT @Hp8711;"DISP:ANN:MESS ";Msg$
580 PRINT Msg$
590 Count=Count+1
600 NEXT Freq
610 T1=TIMEDATE
620 PRINT "Sweeps per second: ";Count/(T1-T0)
630 DISP "Sweeps per second: ";Count/(T1-T0)
640 END
```

## Responsive Communication using SRQs

Service Requests (SRQs) are a method by which you can instruct the analyzer to tell your computer program when a condition changes or when an event of interest occurs. This communication is done via HP-IB signals.

Analyzer SRQ events include:

- Limit test fails
- A front panel key or external keyboard key is pressed
- Hardcopy in progress or complete
- Sweep in progress or complete
- Power has been cycled

The analyzer can be set to cause an SRQ on any combination of the above events. Using SRQs allows your program to be interrupt driven, reducing the latency and inefficiency of polling. For more details, refer to Chapter 5, "Using Status Registers" in the *Programmer's Guide*.

---

## Using Both of the Analyzer's Channels

The analyzer is capable of making different measurements on each of its two channels. For example, you can set channel 1 to measure Transmission over one set of sweep frequencies, while channel 2 is set to measure Reflection from another set of sweep frequencies. Thus, two measurements can be made by the operator at the same time. Also, the controller can switch between channel 1 and channel 2, while turning the inactive channel off, to quickly change the test setup between two test states.

---

## AUTOST files

When IBASIC is used, the measurement control program can be saved as an AUTOST file on the analyzer's non-volatile RAM disk. When the analyzer's power is turned on, it will first check for this file on the non-volatile RAM disk and then on the 3.5" disk, and if found, load it and run it. This feature simplifies the task of turning on an automated test station at the beginning of a working day, or test session.

---

## Controlling Peripherals

The analyzer lets you access its rear panel interface ports from your measurement control program. Using this capability, you can communicate with peripherals such as material handlers, custom DUT interface circuits, external switch boxes, and printers.

Communication with the DIN KEYBOARD interface, the USER TTL, and LIMIT TEST TTL connectors is described in detail in the section titled "Operator Interaction." This section will focus on use of the Centronics parallel port and the RS-232 serial port.

---

## Using the Parallel Port

The analyzer's parallel port can be used as an 8-bit TTL output port and as a 5-bit TTL input port. The eight TTL outputs are for output only, and cannot be read or used as bi-directional I/O lines. The parallel port does not support the IEEE-1284-defined Extended Capabilities Port (ECP) Mode or Enhanced Parallel Port (EPP) Mode.

The outputs signals are driven by standard TTL drivers. They should be buffered for heavy duty applications, to avoid damaging the analyzer. The inputs are standard TTL inputs, designed to accept signals in the 0V to 5V range.

The analyzer provides two ways to access the parallel port. You can use the SCPI commands

```
OUTPUT @Rfna;"DIAG:PORT:WRITE <port>,<register>,<data>  
and  
OUTPUT @Rfna;"DIAG:PORT:READ? <port>,<register>  
ENTER @Rfna;Data
```

or you can use IBASIC and its READIO and WRITEIO commands. See the following tables for more information.

**Table 7-4. Writeable Ports**

Port Number	Register	Description
15	0	Outputs 8-bit data to the Cent_D0 thru D7 lines of the Centronics port. Cent_D0 is the least significant bit, Cent_D7 is the most significant bit. Checks Centronics status lines for: Out of Paper Printer Not on Line BUSY ACKNOWLEDGE
15	1	Sets/clears the user bit according to the least significant bit of A. A least significant bit equal to 1 sets the user bit high. A least significant bit of 0 clears the user bit.
15	2	Sets/clears the limit pass/fail bit according to the least significant bit of A. A least significant bit equal to 1 sets the pass/fail bit high. A least significant bit of 0 clears the pass/fail bit.
15	3	Outputs 8-bit data to the Cent_D0 thru D7 lines of the Centronics port. Cent_D0 is the least significant bit, Cent_D7 is the most significant bit. Sets the Printer_select signal high (de-select). Does not check Centronics status lines.
9	0	Outputs a byte to the serial port. The byte is output serially according to the configuration for the serial port.

**Table 7-5. Readable Ports**

Port Number	Register	Description
9	0	Reads the serial port.
15	0	Reads the 8-bit data port Cent_D0 thru D7.
15	1	Reads the user bit.
15	2	Reads the limit test pass/fail bit.
15	10	Reads the 8-bit status port. D0—Cent_acknowledge D1—Cent_busy D2—Cent_out_of_paper D3—Cent_on_line D4—Cent_printer_err



**NOTE**

When using the `WRITEIO(15,0)` or `WRITEIO(15,3)` command, the Printer\_Select Line is set High. However, when the instrument is doing hardcopy, the Printer\_Select Line is set low. The Printer\_Select line may or may not be used by individual printers. Check with your printer manual.

---

## Writing to the Parallel Port

To write the value 52 decimal (34 hex, 0011 0100 binary) to the parallel port's output pins, use one of the following commands:

```
OUTPUT @Rfna;"DIAG:PORT:WRITE 15,3,52"  
WRITEIO 15,3;52
```

When the write command is executed, the parallel port's data lines (pins 2-9) will be set to the specified value, and then a pulse of at least 1  $\mu$ s duration will occur on the strobe line (pin 1). A data setup and data hold time of at least 1  $\mu$ s are guaranteed. See Figure 7-9.

Automating Measurements  
**Controlling Peripherals**

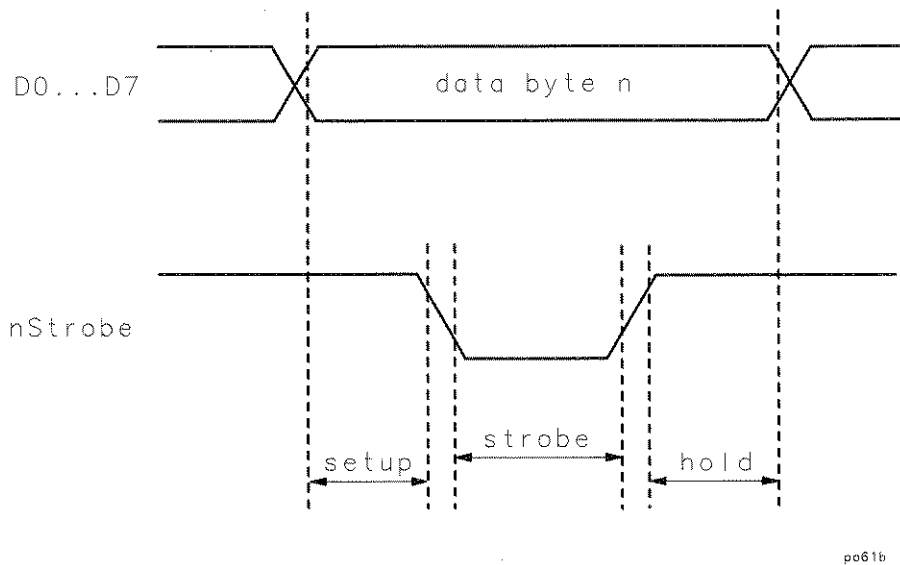

**Figure 7-9. Writing to the Parallel Port**

Table 7-6 shows the pin numbers, data bus bit numbers, and signal names:

**Table 7-6. Parallel Port Pins**

Pin	Bit	Name	Pin	Bit	Name
1	N/A	Strobe	6	D4	Data 5
2	D0	Data 1	7	D5	Data 6
3	D1	Data 2	8	D6	Data 7
4	D2	Data 3	9	D7	Data 8
5	D3	Data 4			

The data will typically remain valid until the next write to the parallel port, but you should always latch the data using the strobe. Figure 7-10 shows a simple circuit which can be used to write to an 8-bit DAC and a digital latch.

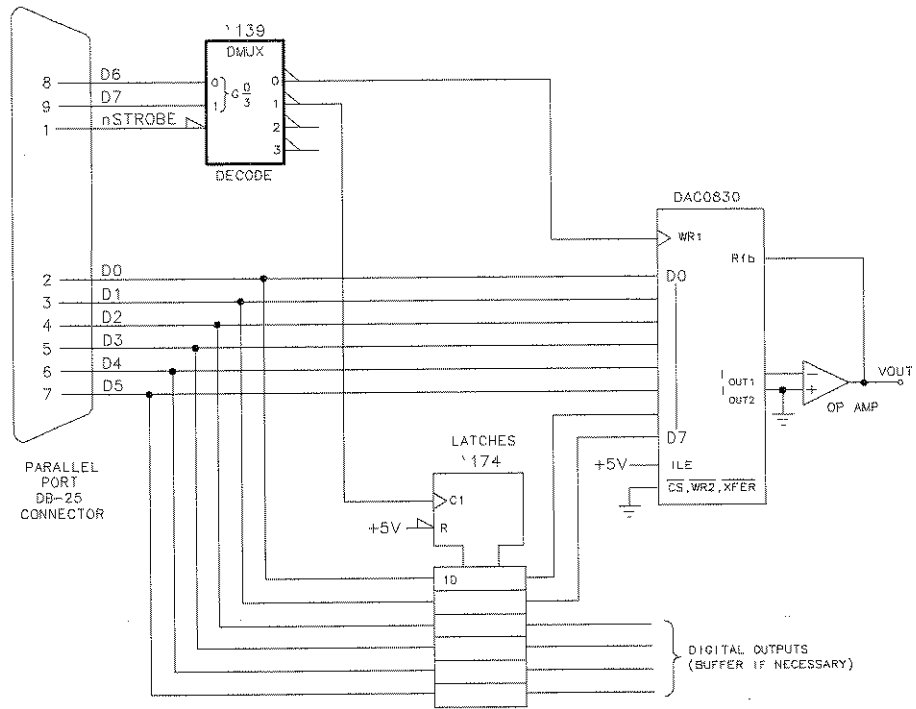

NOTE: ESD PROTECTION, POWER SUPPLIES AND DECOUPLING ARE NOT SHOWN.

pc673b

**Figure 7-10. Digital Latch Circuit**

## Reading from the Parallel Port

The parallel port has five TTL input signals, normally used for determining the printer's status, which can be read. The signals and the corresponding data bits and pins are shown in the following table:

Pin	Bit	Name
10	D0	Acknowledge
11	D1	Busy
12	D2	Out of Paper
13	D3	On Line
15	D4	Printer Error

Your custom interface circuit can drive these signals, and they can be read using any of these commands:

SCPI commands:

```
OUTPUT @Rfna;"DIAG:PORT:READ? 15,10"  
ENTER @Rfna;Parallel_in
```

IBASIC command:

```
Parallel_in = READIO(15,10)
```

---

## Hardcopy Considerations

The analyzer's **HARDCOPY** feature can send output to printers connected to the parallel port. If you have a custom interface circuit attached to the parallel port, you don't want the hardcopy output to interfere with it.

To address this issue, the analyzer uses the parallel port's Printer-Select signal (pin 17) to differentiate between hardcopy dumps and user-issued **WRITEIO** and **DIAG:PORT:WRITE** commands. During a hardcopy to the parallel port, the Printer-Select signal is driven low. During **WRITEIO** and **DIAG:PORT:WRITE** commands, it is driven high.

Using the Printer-Select signal, you can connect both an interface circuit and a printer to the parallel port. The interface circuit should only respond to the data strobe (pin 1) when the Printer-Select signal is high. The printer should only respond to the data strobe when the Printer-Select signal is low. Most printers require the Printer-Select line to be low, or else they will not print. Other printers ignore this line. If you are using a printer which ignores this line you have two choices:

1. Consult the manual for a DIP switch setting that controls how the printer responds to the Printer-Select signal, or
2. Design your interface circuit so that it gates and inhibits the data strobe signal (pin 1) going to the printer when Printer-Select is high.

Similar to the output signals, you can use the Printer-Select signal to multiplex the input signals, selecting either the signals from your interface circuit or those from the printer.

## Using the Serial Port

Like the parallel port, the RS-232 serial port can also be accessed using SCPI and IBASIC commands.

To write a byte with a value of 52 decimal (34 hex, 0011 0100 binary) to the serial port, use one of the following commands:

```
OUTPUT @Rfna;"DIAG:PORT:WRITE 9,0,52"  
WRITEIO 9,0;52
```

To read a byte from the serial port, use the following commands:

```
OUTPUT @Rfna;"DIAG:PORT:READ? 9,0"  
ENTER @Rfna;Serial_in
```

If you are using IBASIC, you can simply use the READIO statement:

```
Serial_in = READIO(9,0)
```

For general purpose I/O, the parallel port is much easier to interface to than the serial port. To interface to the serial port, a Universal Asynchronous Receiver Transmitter (UART) is typically used to decode the RS-232 signals. Most UARTs are designed to be used with microprocessors.

The advantage of the serial port is that it can operate over long distances, up to 30 meters using the RS-232-C standard. Its disadvantage is its slow speed; limited to 19200 bits/second.

Before using the serial port, you must select the baud rate and handshake style using the SCPI commands:

```
SYSTEM:COMMunicate:SERial:TRANsmit:BAUD  
SYSTEM:COMMunicate:SERial:TRANsmit:HANDshake {XON|DTR}
```

One type of application for the serial port would be to use it for data logging to a remote computer. After each device is measured, an IBASIC program could use the WRITEIO command shown above to send a brief summary of the measurement result, such as a filter's 3 dB bandwidth and its serial number, to the remote computer. A program on the remote computer would monitor the serial port and read the incoming data and archive it to hard disk or the network.

## Displaying Measurement Results

It is often helpful to eliminate unnecessary information and annotation that might distract an operator, and only show the information necessary to perform a particular task.

The analyzer provides several features to let you customize the information shown on the display as shown in the following figure.

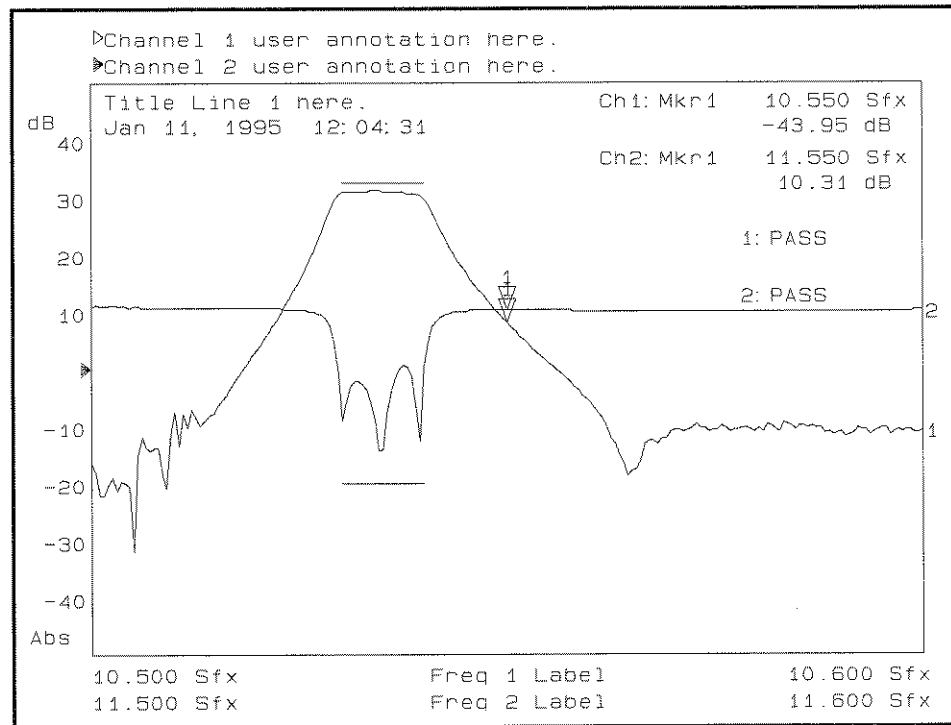

Figure 7-11. Customized Annotation

Customizing features such as limit testing, annotating the X-axis, and using the title feature are described in this section.

---

## Graticule On/Off

The graticule is the set of grid lines that designate increments of value on the x-axis and y-axis of the measurement.

If the operator is comparing the trace against limit lines or marker values, turning off the graticule makes it easier to view the measurement trace, limit lines, and markers. To turn the graticule off, press **DISPLAY** **More Display** **Graticule ON off** or use this SCPI command:

```
DISPlay:WINDow[1|2]:TRACe:GRATICule:GRID OFF
```

where the window number is 1 if in full screen display, and 1 or 2 for the upper and lower split screen displays.

See Figure 7-11 for an example of a display with the graticule turned off.



---

## Limit Testing

The measurement trace can be automatically compared to limits which you define. The limits, entered as lines and points, can be displayed on the screen or can be hidden. Whether or not the limits are displayed, the analyzer will display "PASS" if the measurement satisfies the limits and will display the



symbol if the measurement exceeds the limits. Using limits gives the operator visual guides when tuning devices, provides standard criteria for meeting device specifications, and shows an instant indication of the comparison of data vs. specifications.

To turn limit lines on or off, press **DISPLAY** **Limit Menu** **Limit Line ON off** or use these SCPI commands:

```
CALC[1|2]:LIMit:DISPlay ON  
CALC[1|2]:LIMit:DISPlay OFF
```

where [1|2] indicates the channel number, either 1 or 2.

For more information on limit lines, see "Using Limit Lines" in Chapter 4.

See Figure 7-11 for an example of a measurement using limit lines with a "PASS" test result.

---

## Customized X-axis Annotation

X-axis annotation consists of one or two lines of information that appear below the graticule.

By default, the X-axis annotation displays the stimulus frequencies (default resolution is kHz), or powers if in power sweep. It can be, however, customized using SCPI commands to show your own start and stop x-axis values and units. For example, when measuring mixers which introduce a frequency offset, you can annotate the frequencies at the output of the mixer.

To turn on user-defined X-axis annotation, use the command:

```
DISPlay:ANNOtation:FREQuency[1|2]:USER[:STATe] {OFF|0|ON|1}
```

For example:

```
DISPlay:ANNOtation:FREQuency1:USER ON
```

To specify your start and stop values, use:

```
DISPlay:ANNOtation:FREQuency[1|2]:USER:STARt <num>~  
DISPlay:ANNOtation:FREQuency[1|2]:USER:STOP <num>~
```

The value <num> must be between -10,000 and 10,000. For example:

```
DISPlay:ANNOtation:FREQuency1:USER:STAR -100  
DISPlay:ANNOtation:FREQuency1:USER:STOP +100
```

To specify a custom suffix, use:

```
DISPlay:ANNOtation:FREQuency[1|2]:USER:SUFFix[:DATA] <STRING>
```

for example:

```
DISPlay:ANNOtation:FREQuency1:USER:SUFFix 'uV'
```

The suffix can be up to 3 characters long.

**NOTE**

When using custom X-axis annotation, the SCPI command `CALC:MARK:X` and query `CALC:MARK:X?` will return the analyzer's stimulus value, not your custom annotation values. If this is a problem, you can use the SCPI command `CALC:MARK:POIN` to specify the X-axis point number at which you wish to position the marker.

For example:

```
OUTPUT @HP8711;"CALC:MARK1:POIN 134"
```

will put the marker at point number 134.

Custom X-axis annotation has no effect on marker Y values (`CALC:MARK:Y?`).

Note the customized X-axis annotation in Figure 7-11.

---

## Customized Channel Annotation

The analyzer displays channel annotation above the graticule. This annotation shows the measurement type, format, scale/div, and reference level.

You may replace this annotation with your own text or eliminate the channel annotation completely. To do so, use the following command to enable user-defined annotation:

```
DISPlay:ANNotation:CHANnel[1|2]:USER[:STATe] {OFF|O|ON|1}
```

For example:

```
DISPlay:ANNotation:CHANnel1:USER ON
```

To specify the string to be displayed use the command:

```
DISPlay:ANNotation:CHANnel[1|2]:USER:LABel[:DATA] <STRING>
```

For example:

```
DISP:ANN:CHAN1:USER:LABel '1: SuperNotch filter, test #3'
```

To restore the default channel annotation, use:

```
DISPlay:ANNotation:CHANnel1:USER OFF
```

---

## Markers

The active marker's value is displayed in the upper right area of the graticule. If marker bandwidth (or notch) search is selected, the bandwidth (or notch) information is displayed instead. This marker information can be used to view exact measured data at critical frequency points. Note the customized channel notation in Figure 7-11. In addition to the active marker's readout, four of the marker's values are displayed in the softkey area during front panel use. This makes it easy to quickly read the measured data at several marker positions.

The triangular marker symbols can also be used to graphically indicate critical frequency points of the measurement. For example, a marker can be set at the desired center frequency for a notch filter, and the operator can tune the filter until the notch is at the same frequency as the marker.

Marker search types include:

- max search
- min search
- bandwidth
- notch
- multi peak
- multi notch

When marker tracking is turned on, these searches will be automatically performed at the end of each sweep. This can be useful in tuning applications.

Other marker functions that can be useful are the marker math functions:

- statistics
- flatness
- RF filter stats

These functions perform certain mathematical calculations on the amplitude data of user-defined trace segments. See "To Use Marker Math Functions" in Chapter 4 for more information on these features.

---

## Title and Clock

The analyzer has two 30-character title lines. One of these lines can be replaced with a real-time clock readout.

The title line can be set to show the serial number and type of the DUT. Doing so provides a simple and safe link between the device under test and the measurement data.

The title and clock lines are, by default, included on hardcopy printouts. These can be configured using the **HARDCOPY** **Define Hardcopy** menu. For more details and a simple example, refer to the “Operator Interaction” section of this chapter.

---

## Saving Measurement Results

After measuring a device, you will probably want to save the measurement results in order to perform statistical analysis on them. Statistical quality control (SQC) can be a powerful tool to indicate process drift or variation.

You may also want to produce a print or plot of the DUT's response, and ship this to your customer along with the DUT.

---

## Querying Measurement Data

To save the complete measurement trace, use the SCPI command:

```
CALC1:DATA?
```

or

```
TRACE1:DATA? CH1FDATA
```

Refer to the chapter titled "Trace Data Transfers" in the *Programmer's Guide* for more details.

From IBASIC, you can also use `Read_fdata( )`, which is faster. Refer to the chapter titled "Using Subprograms" in the supplement to the *HP Instrument BASIC User's Handbook*.

---

## Saving the Measurement to Disk—Save ASCII

The analyzer has a **Save ASCII** feature which saves the measurement trace in a format compatible with many popular spreadsheet programs such as Lotus® 1-2-3® and Microsoft® Excel®. The measurement is saved to a file on the analyzer's disk.

The following program segment shows how to save the measurement to a file on the analyzer's non-volatile RAM disk, and then how to transfer that file into your program and store it as a file on your computer disk.

```
10 DIM A$[32000]
15 Dest$="SAV_DUT1.PRN"
20 OUTPUT 716;"MMEM:STOR:TRAC CH1FDATA, 'MEM:DUT1.PRN'

30 OUTPUT 716;"MMEM:TRAN? 'MEM:DUT1.PRN'
40 ENTER 716 USING "W,-K";Word1,A$
370 CREATE Dest$,32000
380 ASSIGN @File TO Dest$
390 OUTPUT @File;A$
400 ASSIGN @File TO *
```

With the **Save ASCII** feature, you can read the measurements into your spreadsheet, and perform statistical analysis on the data, such as mean and standard deviation on groups of DUTs.

For information on transferring disk files between the analyzer and your computer, refer to the "Example Programs" chapter of the *Programmer's Guide*.



---

## Saving the Measurement to Disk—Save Data

Similar to Save ASCII, the analyzer can also save the measurement data onto disk as an instrument state file. Use **Define Save**, and turn Data ON and turn Inst State and Cal OFF.

### Tip

A file saved in this manner is smaller than a file saved using **Save ASCII**. **Save Data** uses 6 bytes per point, as opposed to about 20 bytes per point for **Save ASCII**. However, the file type is binary, and contains a header, making it difficult to read.

---

## Querying Marker Searches

The analyzer can measure a filter and compute its center frequency, bandwidth, Q, and Loss. You can query this information using the SCPI command

```
CALC:MARK:FUNC:RES?
```

For example:

```
10 OUTPUT @Rfna;"CALC:MARK:BWID -3"      ! -3 dB bandwidth
20 OUTPUT @Rfna;"CALC:MARK:FUNC:RES?"    ! Get result of bandwidth search
30 ENTER @Rfna;Bwidth,Center_freq,Q,Loss
```

For more details, refer to the "Example Programs" chapter of the *Programmer's Guide*.

---

## Saving Measurement Results to Disk

The analyzer provides two internal RAM disks and one internal 3.5" floppy disk to which measurement results can be saved.

For the fastest saves, measurements should be saved to RAM disk. From RAM disk, they can be copied to the internal floppy disk by pressing **SAVE RECALL** **File Utilities Copy All Files**, or using the SCPI command

```
MMEM:COPY 'MEM:*.*', 'INT:'
```

or

```
MMEM:COPY 'RAM:*.*', 'INT:'
```

The following mass storage specifiers can be used:

Disk	SCPI name
Non-Volatile RAM Disk	MEM: <i>file</i>
Volatile RAM Disk	RAM: <i>file</i>
Internal 3.5" Disk	INT: <i>file</i>
External Disk	EXT: <i>file</i>

The files can also be transferred over HP-IB using the SCPI command **MMEM:TRANSfer**. Refer to the "Example Programs" chapter in the *Programmer's Guide* for details.

---

## Using Hardcopy Features to Print or Plot Results

The analyzer's **HARDCOPY** feature dumps the measurement display to a printer or plotter in any one of the following formats:

- measurement graph and marker table (default)
- measurement graph only
- marker table only
- trace values at each point only

The **HARDCOPY** feature can also save the measurement display to a floppy disk in either HP-GL or PCX format. These files can be imported into various computer applications, such as Microsoft® Word® or Lotus® AmiPro®, and integrated with other text and graphics. You can use the SCPI **MMEM:TRANSFER** command to copy files from the analyzer's floppy disk to an external computer. This is described in "Example Programs" in the *Programmer's Guide*.

HP-GL format files can also be archived on the analyzer's floppy disk drive, and later sent to a printer or plotter. Under program control, the files can be printed using various page layouts, such as one to a page, two to a page, and so on, using either portrait or landscape orientation. This is done using the HP-GL **IP** command, described later.

The analyzer provides an HP-IB interface and a Centronics parallel interface, both of which are well suited for printing. If you are controlling the analyzer via the HP-IB port, you can use the parallel port for hardcopy. Or you can have your computer collect the measurement results and format them itself and dump them to its own printer.

If you have a custom interface circuit connected to the analyzer's parallel port, you can still connect a printer in addition, and use the Printer-Select line to select either the printer or your custom interface circuit. For more details, refer to the section titled "Controlling Peripherals" in this chapter.

## Saving Measurement Results

### Faster Hardcopies using a PCL-5 Printer

Printers that support HP PCL-5 can accept HP-GL language printouts, just as plotters can. Using HP-GL format for high resolution hardcopies can result in a speed improvement of up to 10 times, compared to using raster formats such as PCL, Epson-compatible, or PCX. Since the analyzer measurement speed decreases while performing hardcopy rasterization, using HP-GL format will restore your measurements to full speed more quickly.

Some printers that support PCL-5 include:

HP LaserJet 4

HP PaintJet 1200 XL

In order to send HP-GL hardcopy output to your PCL-5 printer, you must first instruct the printer to accept HP-GL commands. On some printers, this can be done using the printer's built-in menu. You can also send the printer a PCL-5 escape sequence to instruct it to accept HP-GL. This can be done using IBASIC or SCPI commands. Refer to your printer manual for details. Refer, also, to the example program titled "FAST\_PRT" on the *Example Programs Disk*. This program configures your PCL5 printer to accept HP-GL commands.

Once your printer is set to accept HP-GL commands, you can perform a hardcopy using the SCPI `HCOP;*WAI` command. By default, the printer will re-size the hardcopy output to fill the entire page. This can result in stretched images, with circles which appear as ellipses, and squares that are rectangular. To avoid this problem, you will need to instruct the printer to use a specific rectangular region on the paper. This is done by sending the printer the IP HP-GL command.

The IP command specifies the size and the position of the printed image on the paper. The units are thousandths of an inch, so 8500 units would be 8.5 inches. The arguments to the IP command are

```
IP LowerLeftX,LowerLeftY,UpperRightX,UpperRightY;
```

The paper is numbered as shown in Figure 7-12.

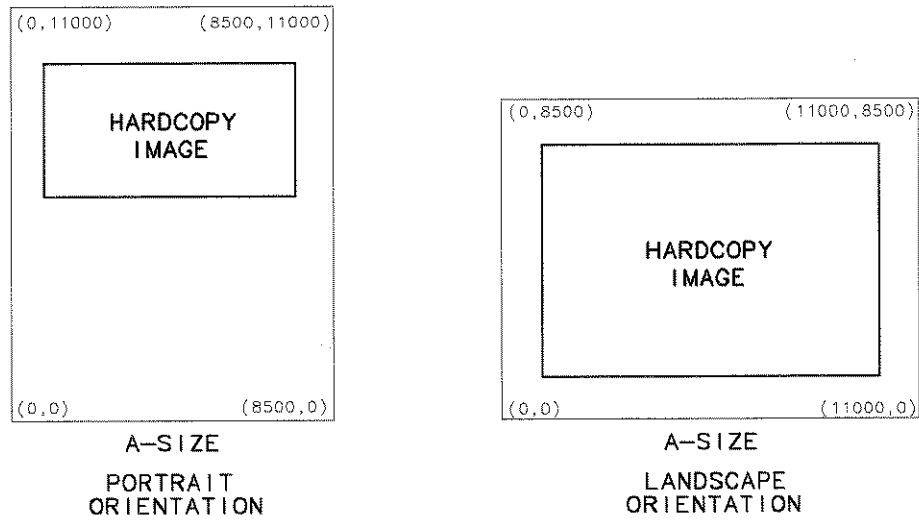

po878b

**Figure 7-12. Paper Numbering**

Typically, a margin around the image of 0.5 to 1.0 inches (500 to 1000 units) is used.

**Saving Measurement Results**

**Tip**

When performing hardcopies of the measurement graph only (excluding the marker table), the hardcopy image looks best with an aspect ratio of approximately 1.30:1 (x:y).

For example, to print the hardcopy image on the top of a portrait A-size sheet of paper, you can use about 7.5 inches of the paper's 8.5 inch width. The width of the image would be 7500 units, beginning at the left margin of 500 units and ending at the right margin of 8000 units. Using an aspect ratio of 1.30:1, the height should be  $7500 / 1.3 = 5769$ . The top margin of the paper is at 10000, so the bottom of the image should be at  $10000 - 5769 = 4231$ . Plugging these numbers into the HP-GL IP command gives:

IP 500,4231,8000,10000;

Using the same calculations for an A-size sheet of paper in landscape orientation gives:

IP 500,7,10500,7700;

The numbers shown in these examples work well on an HP LaserJet 4. Your printers margins may vary slightly.

---

## Custom Data Sheets

You can write programs to set the printer font, output text to the printer, and send hardcopy of measurement test results to the printer to create your custom data sheet. Refer to the example program called REPORT which is included with IBASIC (Option 1C2) example programs. A data sheet created by the "REPORT" program is shown in Figure 7-13.

The example program uses hardcopy output to generate a report with custom text. Five different text fonts are used. The fonts are available for HP LaserJet printers. Refer to your printer manual to modify the example fonts for your printer.

Automating Measurements  
**Saving Measurement Results**

COMPANY NAME  
 CITY, STATE, COUNTRY

## BPF-177 Bandpass Filter

PASS BAND	Level	Bandwidth
	-3 dB	60 MHz +/- 3 MHz
	-20 dB	95 MHz +/- 5 MHz
	-60 dB	200 MHz +/- 8 MHz

SWR PASSBAND (typical) 1.5:1  
 Cost per unit: \$24.95

### Transmission Characteristics

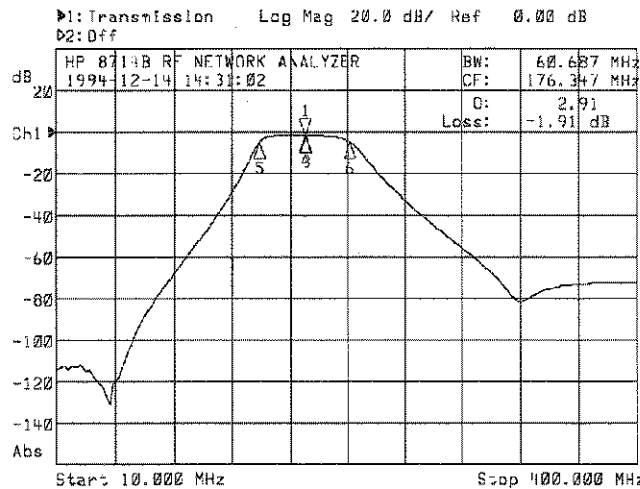

**IN STOCK! IMMEDIATE DELIVERY!**

For more information: Call 1-800-Filter

Figure 7-13. Example Data Sheet



---

## Statistical Process Control

If you collect data on your production process, you can use statistics to control and improve your process. Tools such as histograms, Pareto diagrams, and scatter plots can help you to quantify your process's behavior, and identify trends, cycles, and other "unnatural" patterns.

You can purchase computer programs such as SAS and SPlus to perform statistical analyses. HP VEE, which you can use to control your analyzer, also offers some statistical capability. You can also use add-in macros for popular spreadsheet programs.

---

## Transferring Files

Two example programs ("GETFILE" and "PUTFILE") demonstrate how to transfer files from the analyzer's mass memory to and from mass memory of an external controller via HP-IB. Instrument states and program files may be transferred to or from the analyzer's internal non-volatile memory, MEM, internal-volatile memory, RAM, and the internal 3.5" floppy disk, INT. This can be a convenient method to archive data and programs to a central large mass storage hard drive.

These example programs are found on the *Example Programs Disk* that was shipped with your analyzer, and are described and listed in the *Programmer's Guide*. To run these programs, connect an external controller to the analyzer with an HP-IB cable.

Automating Measurements



 Front/Rear Panel

---

## Front/Rear Panel

This chapter contains detailed information on various aspects of the analyzer front and rear panel. Information on the following can be found in this chapter:

- Connectors
- Display
- Knob
- Line Power Switch
- Display Intensity Control
- Disk Drive
- Line Module

The front panel keys are not documented in this chapter. Refer to Chapter 10 for information on a particular front panel key.

## Connectors

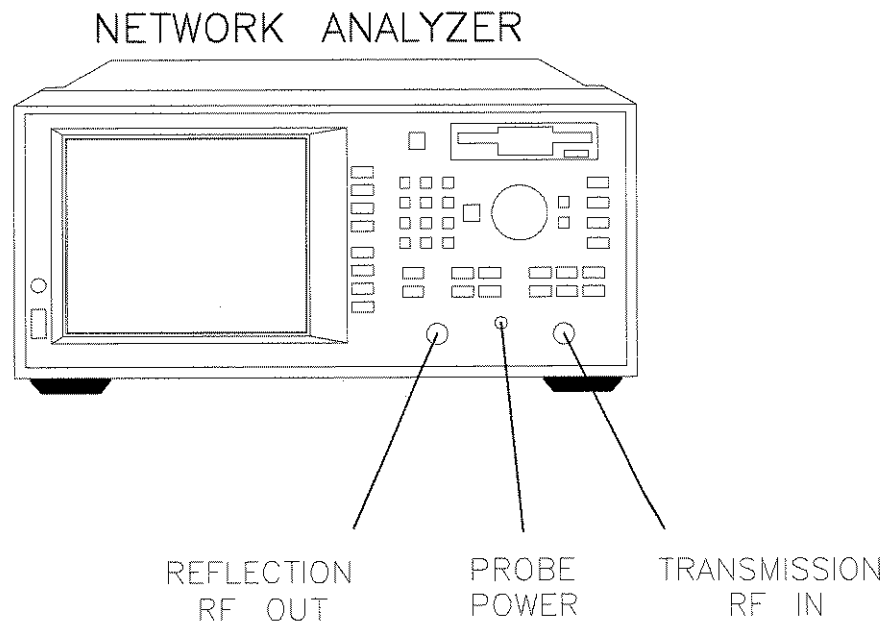

ps621b

**Figure 8-1. Analyzer Connectors - Front Panel**

Front/Rear Panel  
**Connectors**

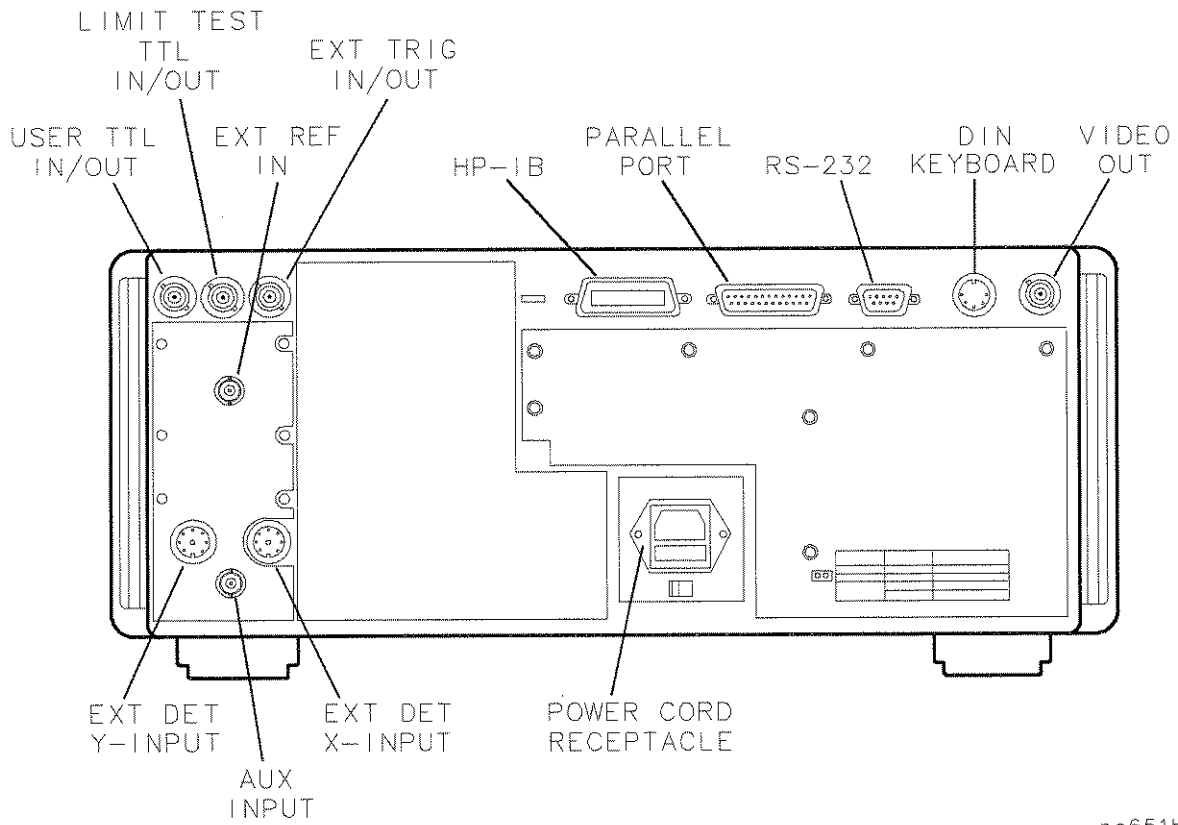

po651b

**Figure 8-2. Analyzer Connectors - Rear Panel**

---

## BNC Connectors

AUX INPUT	This rear panel female BNC connector is for low frequency (dc to approximately 360 Hz), low voltage measurements. This input is calibrated for inputs up to $\pm 10$ V, but will accept signals up to $\pm 15$ V. See "Making Measurements with the Auxiliary Input" in Chapter 3 for more information.
EXT REF IN	This rear panel female BNC connector accepts a $> -5$ dBm 10 MHz signal from an external time base reference. The nominal input impedance is $50 \Omega$ .
EXT TRIG IN/OUT	This rear panel female BNC connector allows external triggering of a sweep. When the TTL level is pulled high, a sweep is triggered. When the TTL level is pulled to ground, the sweep is inhibited. This is an open-collector signal which you can drive low, but must not drive high, since the analyzer also drives it.
LIMIT TEST TTL IN/OUT	This rear panel female BNC connector provides a bi-directional open-collector TTL high signal. The output goes high when the limit test passes. The output goes low if the limit test fails. This is an open-collector signal which you can drive low, but must not drive high, since the analyzer also drives it.

### **NOTE**

Limit lines can be set independently on each of the two measurement channels. If both channels are being used, and the limit test is ON for both channels, both channels must pass for the output to go high. See the table below.

Front/Rear Panel  
**Connectors**

Channel 1	Channel 2	Limit Test TTL Output
Pass	Pass	High (pass)
Pass	Fail	Low (fail)
Fail	Pass	Low (fail)

If limit line testing is turned off on both channels, this connector also serves as a user-defined TTL input and output that can be set and read from IBASIC or SCPI (HP-IB). See Chapter 7, "Automating Measurements," for more information.

**USER TTL  
IN/OUT**

This rear panel female BNC connector provides a bidirectional open-collector TTL signal which can be set or read from IBASIC or SCPI (HP-IB). This is an open-collector signal which you can drive low, but must not drive high, since the analyzer also drives it. See Chapter 7, "Automating Measurements," for more information.

**VIDEO OUT**

This rear panel female BNC connector provides a signal to drive external multi-sync monitors with these characteristics:

- BNC video input
- 75  $\Omega$  input impedance
- analog video with sync on green/monochrome
- 1 volt p-p (0.7 volt = white, 0 volt = black, -0.3 volt = sync)
- 60 Hz vertical refresh rate
- 24.1 kHz horizontal scan rate



**NOTE**

Most modern multi-sync monitors, including those currently made by HP, cannot achieve a horizontal scan rate of 24.1 kHz. Most will not synchronize to scan rates below 31 kHz (VGA). The following HP monitors are compatible but are no longer available:

- HP 35721A
- HP 35731A
- HP 35741A

**CAUTION**

Some external monitors can be damaged if they are driven at frequencies outside their specified range.

The analyzer provides an external CRT adjustment feature which can be used to get an external monitor to synchronize properly, and to optimize the display size and shape. To access and use this feature:

1. Press **SYSTEM OPTIONS** **System Config**  
**External CRT Adjust**.
2. Vary the vertical and horizontal front and back porch times until the display is optimal. Use **Restore Defaults** if necessary.
3. These settings are retained when the analyzer is turned off.

**CAUTION**

These settings will also affect the internal display.

## Multi-pin Connectors

### HP-IB

This connector allows the analyzer to be connected to other instruments or devices on the interface bus. Details of this cable are shown in Figure 8-3. HP part numbers for various HP-IB cables that are available are shown in the table following the figure.

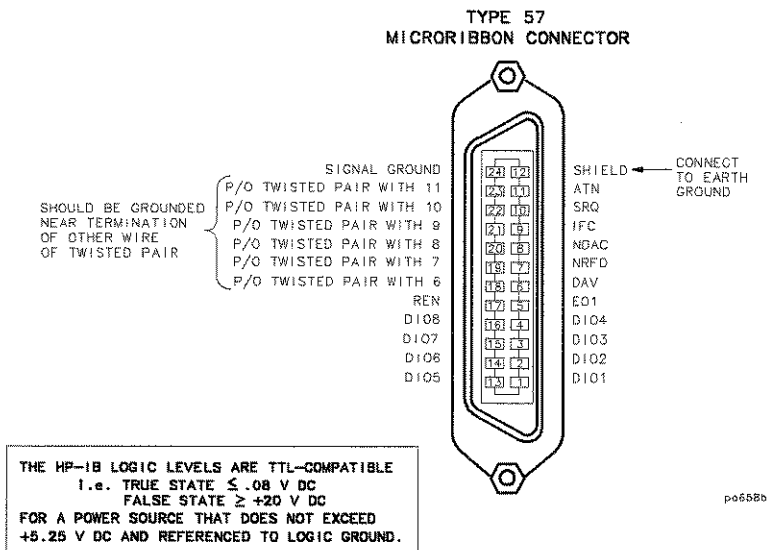

Figure 8-3. HP-IB Connector and Cable

### HP-IB Interface Cables Available

HP-IB Cable Part Number	Length
HP 10833A	1 m (3.3 ft)
HP 10833B	2 m (6.6 ft)
HP 10833C	4 m (13.2 ft)
HP 10833D	0.5 m (1.6 ft)

As many as 14 HP-IB instruments can be connected to the analyzer (15 total instruments in the system). The cables can be interconnected in a star pattern (one central instrument with the HP-IB cables emanating from that instrument like spokes on a wheel), or in a linear pattern (like boxcars on a train), or a combination of the two. See Figure 1-5 in Chapter 1. There are certain restrictions that must be followed when interconnecting instruments:

- Each instrument must have a unique HP-IB address, ranging from 0 to 30.
- In a two-instrument system that uses just one HP-IB cable, the cable length must not exceed 4 meters (13.2 ft).
- When more than two instruments are connected on the bus, the cable length to each instrument must not exceed two meters (6.6 ft).
- The total cable length between all instruments must not exceed 20 meters (66 ft).

Hewlett-Packard manufactures HP-IB extender instruments (Models HP 37201A and HP 37204A/B) that overcome the range limitations imposed by the cabling rules. These extenders allow twin pair cable operation up to 1 km (3,280 ft), and telephone modem operation over any distance. HP Sales and Service Offices can provide additional information on the HP-IB extenders.

**Table 8-1. General Bus Management Lines**

<b>Name</b>	<b>Mnemonic</b>	<b>Description</b>
Attention	ATN	Controls whether the bus is in Command Mode (ATN TRUE) or Data Mode (ATN FALSE).
Interface Clear	IFC	Initializes the interface to an idle state (no activity on the bus).
Service Request	SRQ	Alerts the Controller to a need for communication.
Remote Enable	REN	Enables devices to respond to Remote Program Control when addressed to listen.
End Or Identify	EOI	Indicates last data byte of a multibyte sequence; also used with ATN to parallel poll devices for their status bit.

**Connectors**

**PARALLEL PORT**

This rear panel connector is used with peripherals with parallel interface such as printers and plotters. The pin-out is standard IBM PC compatible Centronics interface, using a female DB-25 connector, as shown in Figure 8-4. All pins are ESD protected, data and strobe pins have 2200 pF capacitors, voltage levels are TTL compatible, output pins can source 15 mA and sink 24 mA. See "Configure the Hardcopy Port," in Chapter 4 for information on using this port with a printer or plotter.

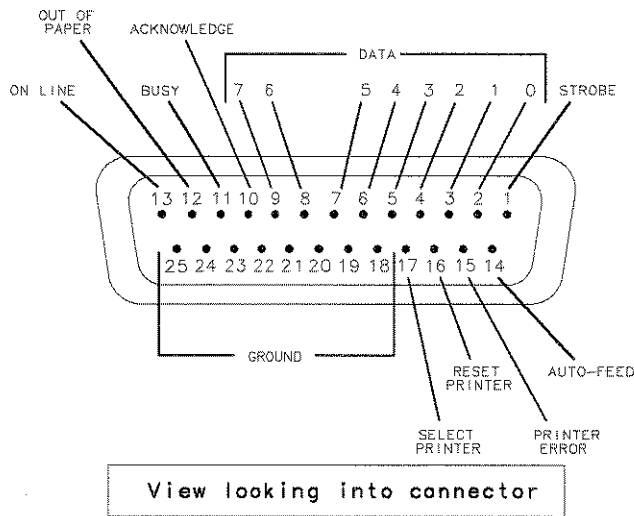

po622b

**Figure 8-4. Parallel Port Pinouts**

**RS-232**

The RS-232 connector is a rear panel connector used with serial peripherals such as printers and plotters. The pinout is shown in Figure 8-5. The connector is a male DB-9. See "Configure the Hardcopy Port," in Chapter 4 for information on using this port with a printer or plotter.

PIN #	SIGNAL DESCRIPTION	SIGNAL NAME
1	Data Carrier Detect	CD
2	Receive Data	RD
3	Transmit Data	TD
4	Data Terminal Ready	DT
5	Ground, 0 V	AB
6	Data Set Ready	DS
7	Request to Send	RS
8	Clear to Send	CS
9	Ring Indicator	RI

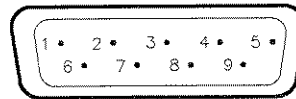

View looking into connector

po623b

**Figure 8-5. RS-232 Connector**

**Connectors**

**DIN KEYBOARD** This rear panel connector can be used with an optional keyboard or bar code reader. See "Using a Keyboard" in Chapter 4 for more information. Signals are IBM PC/AT compatible, 5-pin, fused on the CPU board.

**EXT DET Y-INPUT**  
**EXT DET X-INPUT** These rear panel connectors power external detectors and accept input from them for processing and display. Compatible detectors are:

- HP 86201B
- HP 86200B

**PROBE POWER (FUSED)** This front panel connector provides fused power for active probes and other devices. Figure 8-6 shows the pinout of the connector looking into the connector.

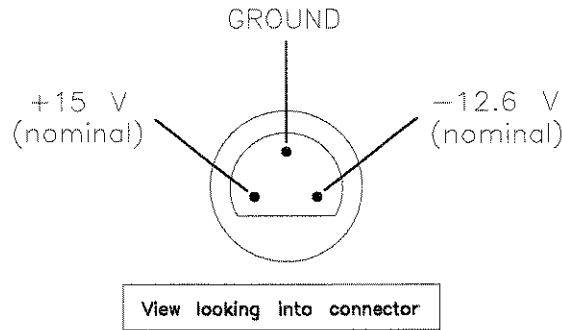

**Figure 8-6. Probe Power Connector**

The probe power output specifications are:

+15 V supply:  $I_{out} = 200 \text{ mA max}$

-12.6 supply:  $I_{out} = 150 \text{ mA max}$

Applying loads that result in current levels beyond these specifications can result in improper instrument operation, or damage to the analyzer.

Both outputs are fused with 0.75 Amp fuses, which are located on a circuit board on the inside front panel of the analyzer. The fuses are plastic bi-pin type. The replacement HP part number for these fuses is 2110-0424.

---

## RF Connectors

### **REFLECTION RF OUT**

The standard front panel RF OUT connector is a female type-N 50  $\Omega$  connector. When Option 1EC is ordered, this front panel connector is a female type-N 75  $\Omega$  connector.

This port outputs the RF signal and also serves as an input for reflection measurements.

### **TRANSMISSION RF IN**

The standard front panel RF IN connector is a female type-N 50  $\Omega$  connector. When Option 1EC is ordered, this front panel connector is a female type-N 75  $\Omega$  connector.

This port receives the RF signal for internal transmission measurements.

---

### **CAUTION**

---

While 50  $\Omega$  and 75  $\Omega$  Type-N connectors are similar in appearance, they are *not* compatible. 75  $\Omega$  type-N connectors have a smaller center pin. Connector damage can result if you attach a 50  $\Omega$  male connector to a 75  $\Omega$  female connector.

To adapt from 50  $\Omega$  to 75  $\Omega$ , always use a minimum loss pad:

- For adapting from 50  $\Omega$  female to 75  $\Omega$  female use an HP 11852B, option 004, minimum loss pad.
- For adapting from 75  $\Omega$  female to 50  $\Omega$  female, use a standard HP 11852B minimum loss pad.

# Display

The analyzer display shows various measurement information. The following illustration shows several locations where information is provided on the screen.

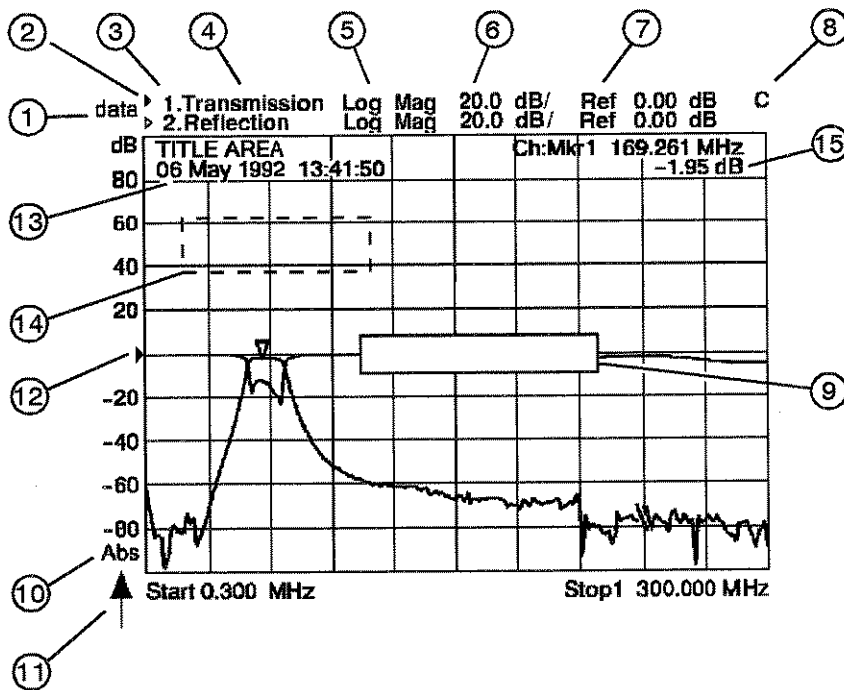

po625b\_c



<b>1</b>	The data ? status notation in the upper left corner of the display screen indicates that the analyzer source or receiver parameters have changed since the last complete sweep.
<b>2</b>	The active channel indicator is designated by a solid triangle (▶). The active channel's data trace and other parameter data is indicated by being brighter than the inactive channel's data.
<b>3</b>	The channel parameters for both channels always appear at the top of the display in this area.
<b>4</b>	The type of measurement for each channel is displayed here. If a channel is turned off, the display says "Off" here.
<b>5</b>	This is the display format that is selected using the <b>FORMAT</b> key.
<b>6</b>	This is the Scale/Div that is selected using the <b>SCALE</b> key, in units appropriate to the current measurement.
<b>7</b>	This is the reference level. This value is the reference line in Cartesian formats or the outer circle in polar formats. The reference level is selected using the <b>SCALE</b> key.
<b>8</b>	A "C" appears here when a user-defined calibration is in use. If the frequency span has been narrowed, the notation becomes "C?" to indicate that interpolated error correction is on. <sup>1</sup>
<b>9</b>	The message area is where you will receive messages from the analyzer from time to time. Most messages appear only for a few moments, before disappearing.
<b>10</b>	This area indicates whether the scale is absolute (Abs) or relative (Rel).
<b>11</b>	The sweep indicator appears here in the lower left corner of the display at when the analyzer is sweeping at a rate of less than 1.5 second. At sweeptimes above 1.5 second the sweep indicator moves across the screen with the data trace.
<b>12</b>	The reference level for the active channel is indicated by a small triangle (▶) adjacent to the graticule on the left.
<b>13</b>	Title and date area.
<b>14</b>	Active entry area: used to enter or adjust values for operating parameters.
<b>15</b>	Marker annotation area.

<sup>1</sup> A "U" (for uncalibrated) will appear here immediately after loading new firmware. Installing the analyzer's calibration constants from disk will load the default factory calibration into the analyzer and eliminate the "U" indicator. If a "U" appears here at any other time, your instrument will not perform accurate measurements and needs servicing. See Table 11-1 in Chapter 11 for a list of Hewlett-Packard sales and service offices.

---

## Knob

The front panel knob is used to increase or decrease parameter values. The front panel knob is used to give an analog feel to the setting of the values. Any of the values that can be set through the numeric entry pad, or the step keys, can also be set using the knob. However, the rate at which the active parameter varies, for a given amount of knob rotation, is dependent on the parameter that is being controlled.

---

## Line Power Switch

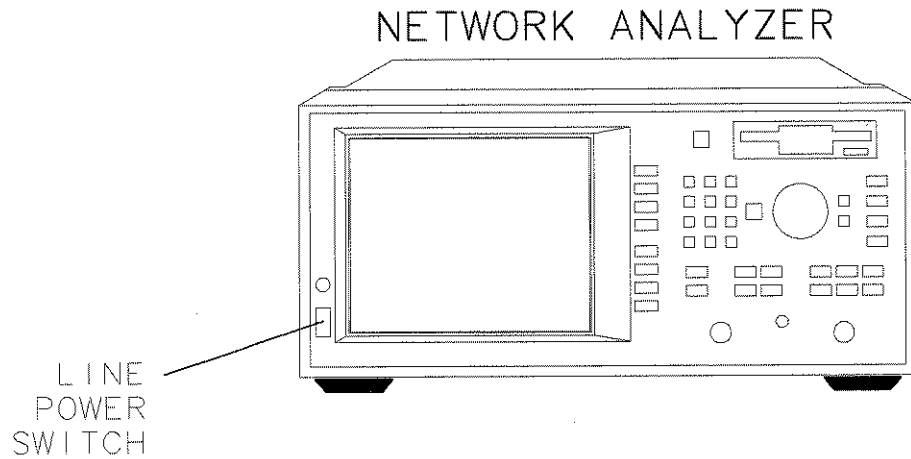

**Figure 8-7. The Analyzer Line Power Switch**

The line POWER switch turns power to the analyzer to either on ( I ) or standby ( ⏻ ).

The analyzer line POWER switch is located at the bottom left corner of the front panel. When set to standby, the analyzer circuitry is powered off, but a portion of the power supply stays on.

**Tip**

When not using the analyzer, leave it plugged in and switched to standby. When in standby, the analyzer supplies power to the non-volatile memory, thereby increasing the life of the internal non-volatile memory battery.

Front/Rear Panel

**Line Power Switch**

---

**WARNING**

---

Before turning the analyzer on, make sure that it is grounded through the protective conductor of the power cable to a mains power receptacle provided with protective earth contact. Any interruption of the protective grounding conductor inside or outside of the analyzer or disconnection of the protective earth terminal can result in personal injury.



---

## Display Intensity Control

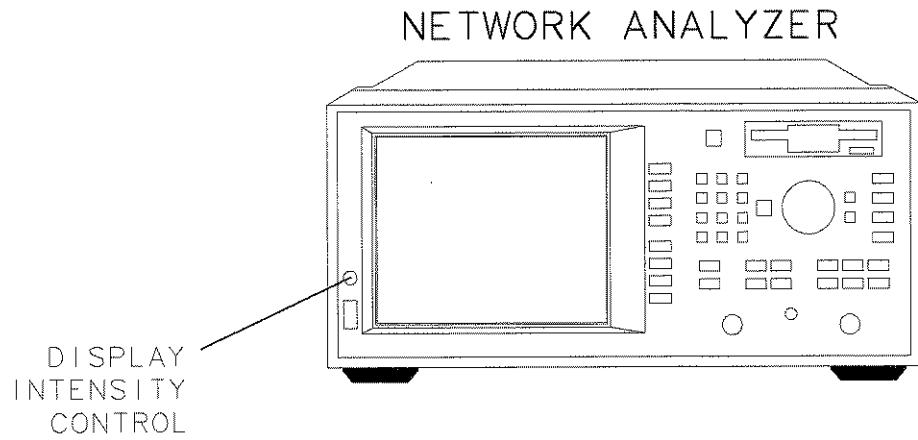

po627b.

**Figure 8-8. Display Intensity Control**

The intensity control adjusts the brightness of the display.

---

## Disk Drive

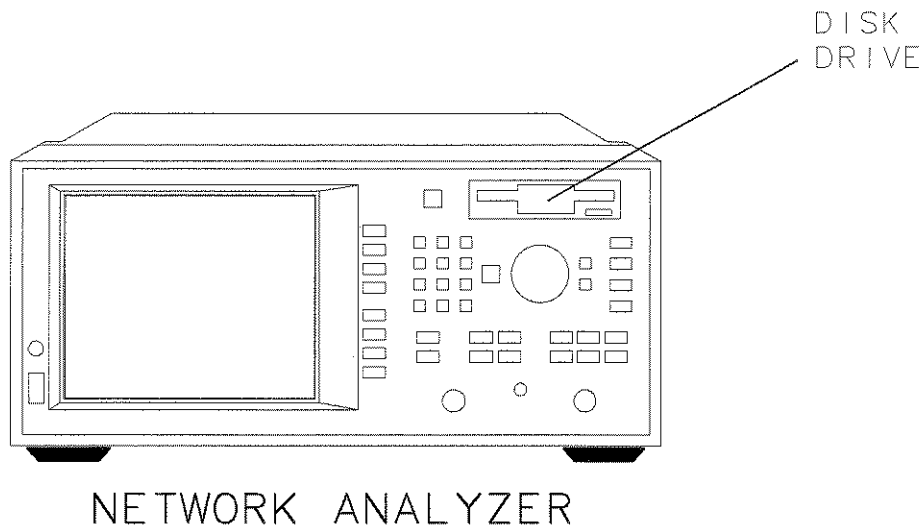

**Figure 8-9. Disk Drive**

pp628b

The built-in 3.5 inch disk drive offers permanent information storage capacity. You can use the disk drive to save and recal instrument states, and IBASIC programs. In conjunction with IBASIC (option 1C2), it allows the analyzer to enter a known state or an automated routine at power-on.

The disk drive recognizes double-sided 3.5 inch disks formatted in DOS or LIF, and will utilize both high density (HD) disks (1.44 MB) and 720 KB disks.

The analyzer's firmware and calibration constants can be updated when necessary, using the appropriate disk in this drive. Refer to the *HP 8711B/12B/13B/14B Service Guide* for more information.

---

## Line Module

The line module contains:

- the power cable receptacle
- the line fuse (and an extra fuse)
- the voltage selector switch.

---

## Power Cables

The line power cable is supplied in one of several configurations, depending on the destination of the original shipment.

Each instrument is equipped with a three-wire power cable. When connected to an appropriate ac power receptacle, this cable grounds the instrument chassis. The type of power cable shipped with each instrument depends on the country of destination. See Figure 8-10, "Power Cable and Line (Mains) Plug Part Numbers", for the part numbers of these power cables. Cables are available in different lengths. Check with your nearest Hewlett-Packard service center for descriptions and part numbers of cables other than those described in Figure 8-10.





---

### **WARNING**

This is a Safety Class I product (provided with a protective earthing ground incorporated in the power cord). The mains plug shall only be inserted in a socket outlet provided with a protective earth contact. Any interruption of the protective conductor, inside or outside the instrument, is likely to make the instrument dangerous. Intentional interruption is prohibited.

---

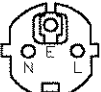
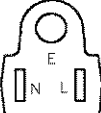
Front/Rear Panel  
**Line Module**

PLUG TYPE **	CABLE HP PART NUMBER	PLUG DESCRIPTION	CABLE LENGTH CM (INCHES)	CABLE COLOR	FOR USE IN COUNTRY
<b>250V</b> 	8120-1351	Straight* BS1363A 90°	229 (90)	Mint Gray	Great Britain, Cyprus, Nigeria, Singapore, Zimbabwe
	8120-1703		229 (90)	Mint Gray	
<b>250V</b> 	8120-1369	Straight* NZSS198/ASC112 90°	201 (79)	Gray	Argentina, Australia, New Zealand, Mainland China
	8120-0696		221 (87)	Gray	
<b>250V</b> 	8120-1689	Straight* CEE7-Y11 90°	201 (79)	Mint Gray	East and West Europe, Central African Republic, United Arab Republic (unpolarized in many nations)
	8120-1692		201 (79)	Mint Gray	
<b>125V</b> 	8120-1348	Straight* NEMA5-15P 90°	203 (80)	Black	United States Canada, Japan (100 V or 200 V), Brazil, Colombia, Mexico, Philippines, Saudia Arabia, Taiwan
	8120-1538		203 (80)	Black	
	8120-1378	Straight* NEMA5-15P	203 (80)	Jade Gray	
	8120-4753	Straight	230 (90)	Jade Gray	
	8120-1521	90°	203 (80)	Jade Gray	
8120-4754	90°	230 (90)	Jade Gray		
<b>250V</b> 	8120-5182	Straight* NEMA5-15P 90°	200 (78)	Jade Gray	Israel
	8120-5181		200 (78)	Jade Gray	
<p>* Part number for plug is industry identifier for plug only. Number shown for cable is HP Part Number for complete cable, including plug.</p> <p>** E = Earth Ground; L = Line; N = Neutral.</p>					

FORMAT80

**Figure 8-10. Power Cable and Line (Mains) Plug Part Numbers**



---

## The Line Fuse

The line fuse (HP part number 2110-0882), and a spare, reside within the line module. Figure 8-11 illustrates where the fuses are and how to access them.

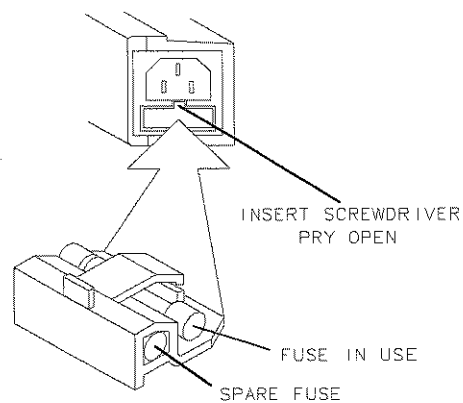

FORMAT4B

**Figure 8-11. Location of Line Fuses**

---

### **WARNING**

For continued protection against fire hazard replace line fuse only with same type and rating (T 5A 250 V). The use of other fuses or material is prohibited.

---

## The Voltage Selector Switch

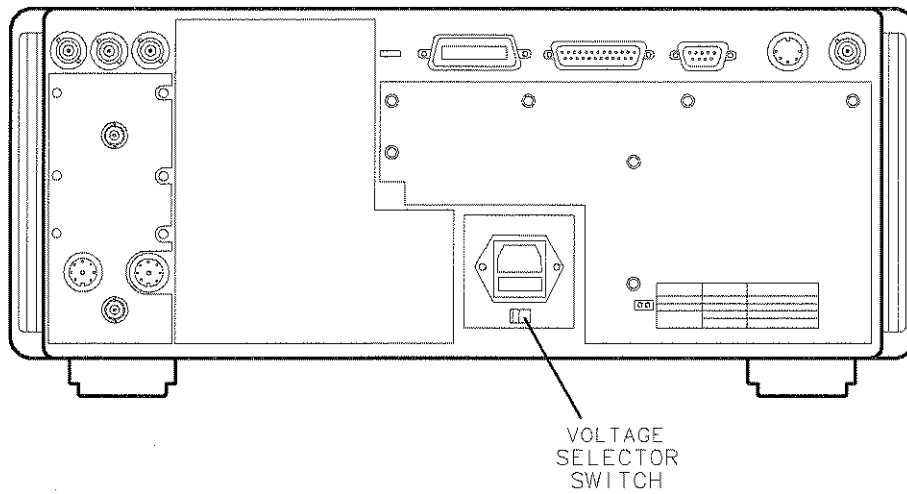

po629b

**Figure 8-12. Voltage Selector Switch Location**

Use a screwdriver to set the line voltage selector switch to the proper position (either 110 V or 220 V).

The power source must meet the following requirements:

Nominal Setting	AC Line Power
110 V	90 to 132 VAC (at 47 to 63 Hz)
220 V	198 to 254 VAC (at 47 to 63 Hz)

If the ac line voltage does not fall within these ranges, an autotransformer that provides third wire continuity to ground may be used.

---

**Menu Maps**

# Menu Maps

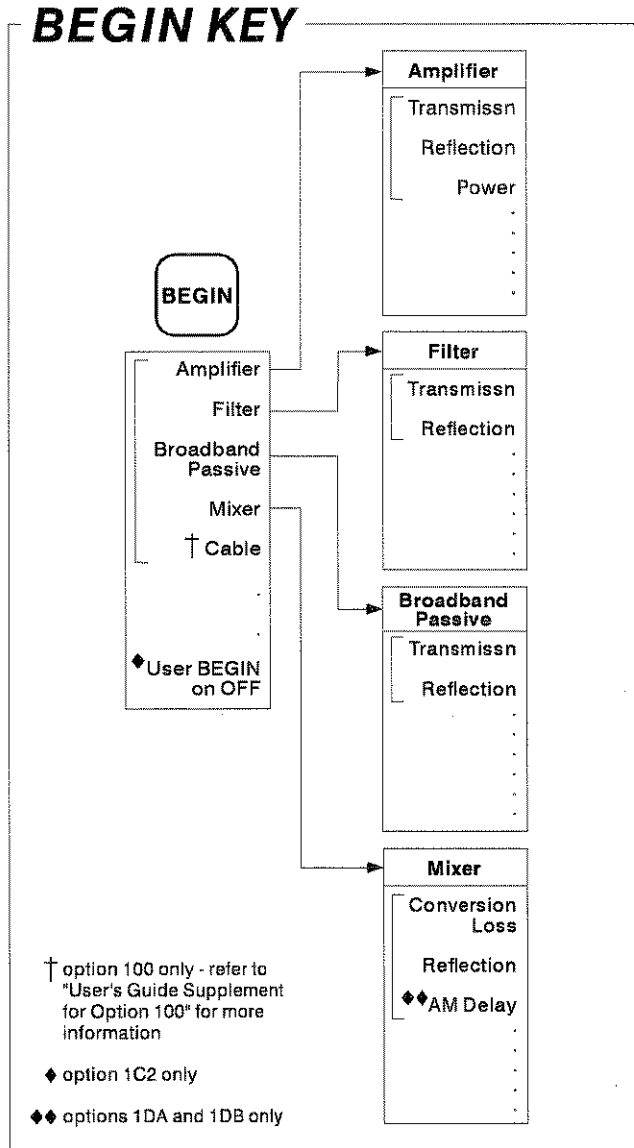

po687b

# MEAS KEYS

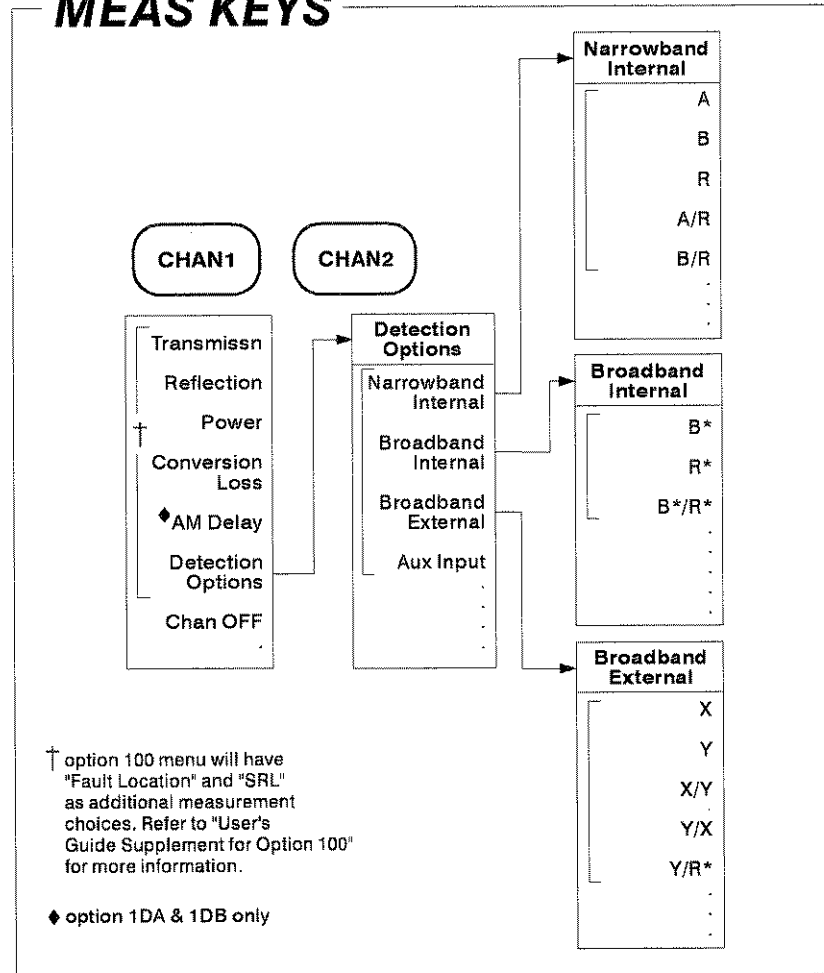

po888b

## SOURCE KEYS

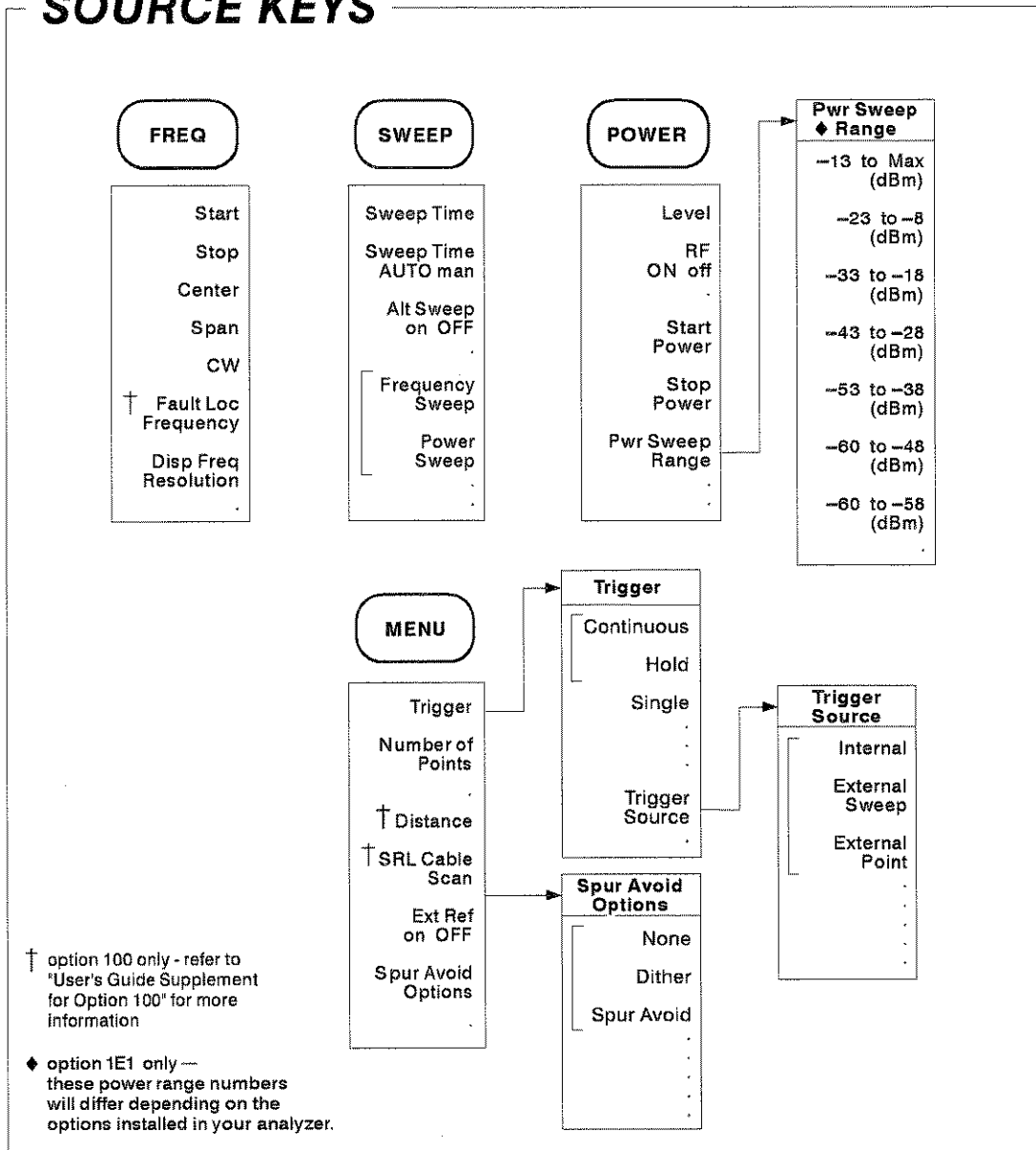

† option 100 only - refer to "User's Guide Supplement for Option 100" for more information

◆ option 1E1 only -- these power range numbers will differ depending on the options installed in your analyzer.

po889b

# CONFIGURE KEYS

(1 of 5 pages)

## SCALE

Autoscale  
Scale/Div  
Reference  
Level  
Reference  
Position

po882b\_c

# CONFIGURE KEYS

(continued)

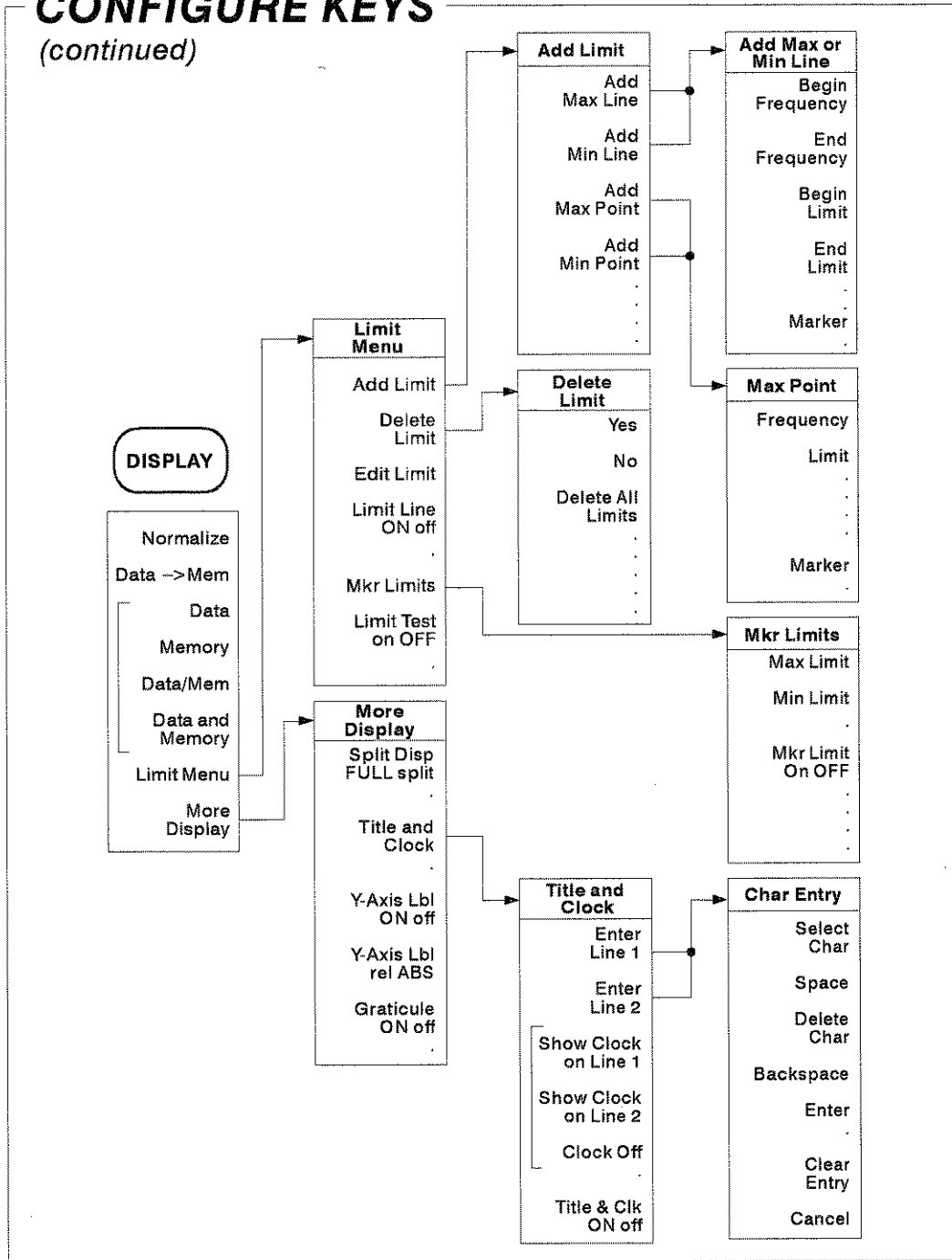

po690b



# CONFIGURE KEYS

(continued)

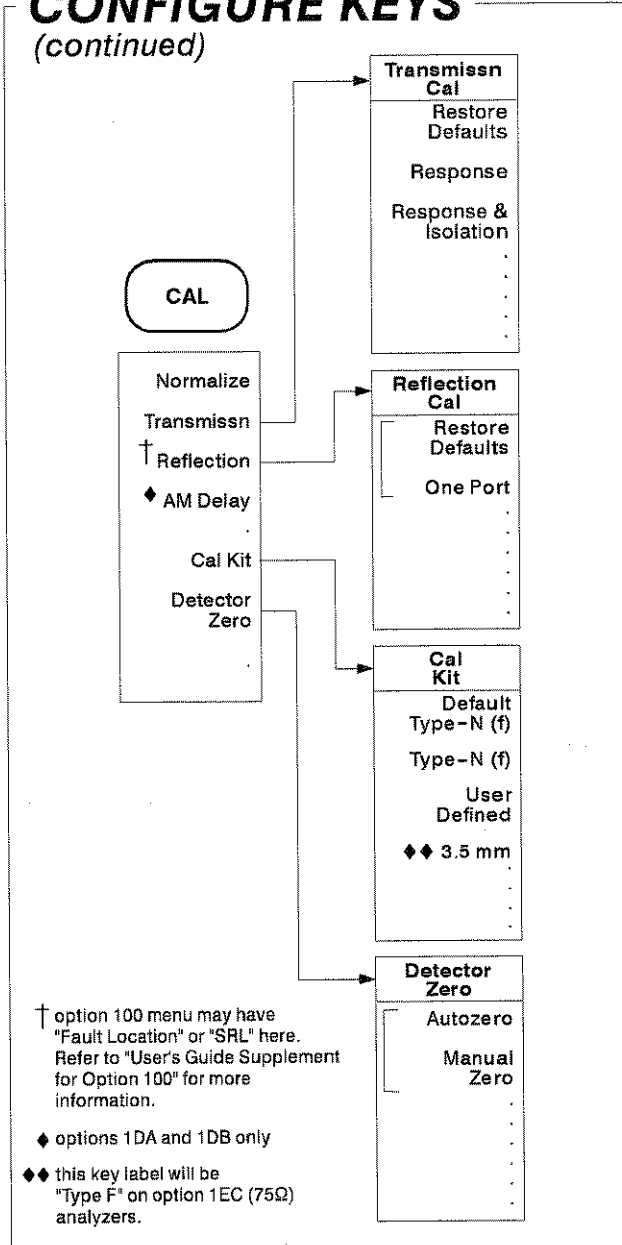

† option 100 menu may have "Fault Location" or "SRL" here. Refer to "User's Guide Supplement for Option 100" for more information.

◆ options 1DA and 1DB only

◆◆ this key label will be "Type F" on option 1EC (75Ω) analyzers.

pc691b

# CONFIGURE KEYS

(continued)

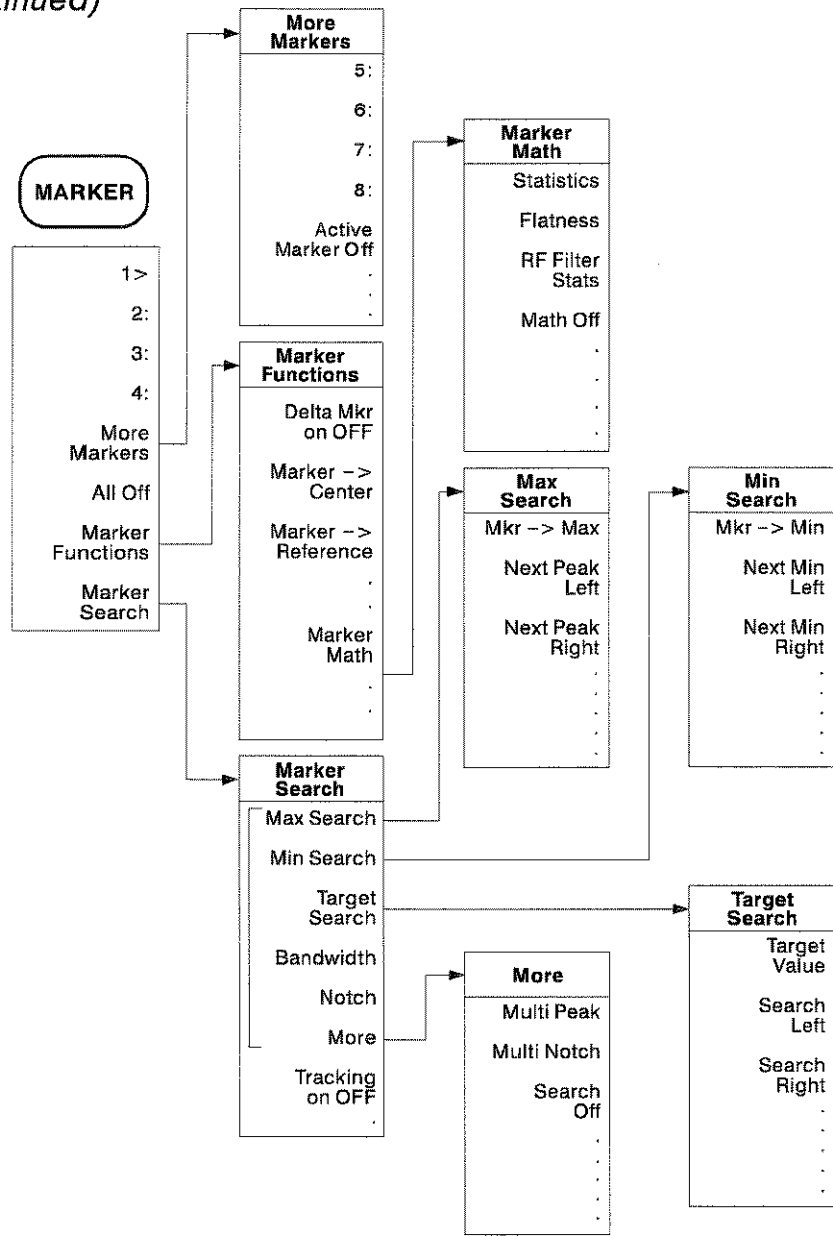

## CONFIGURE KEYS

(continued/end)

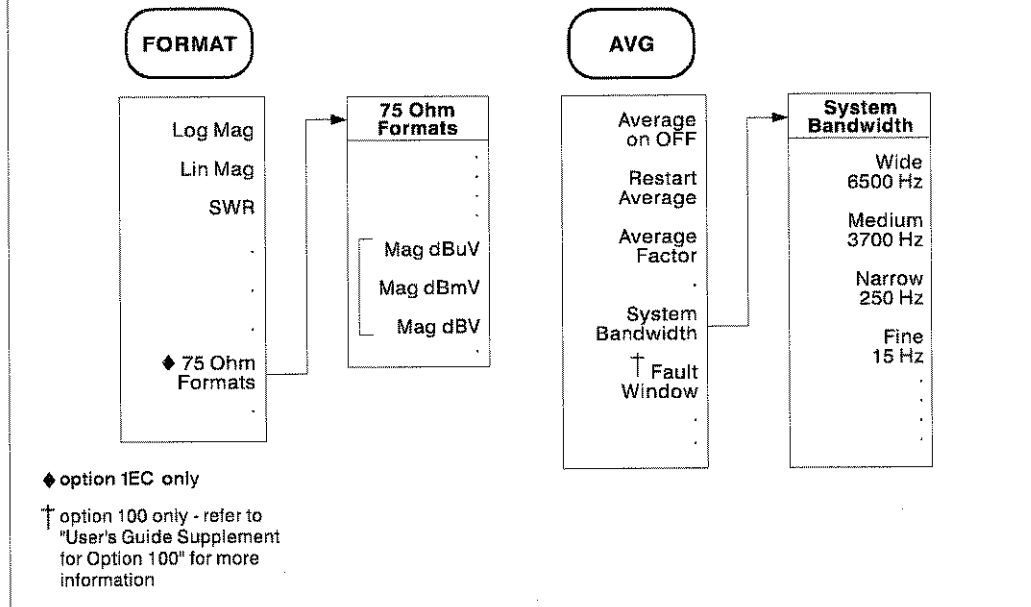

pc692b

# SYSTEM KEYS

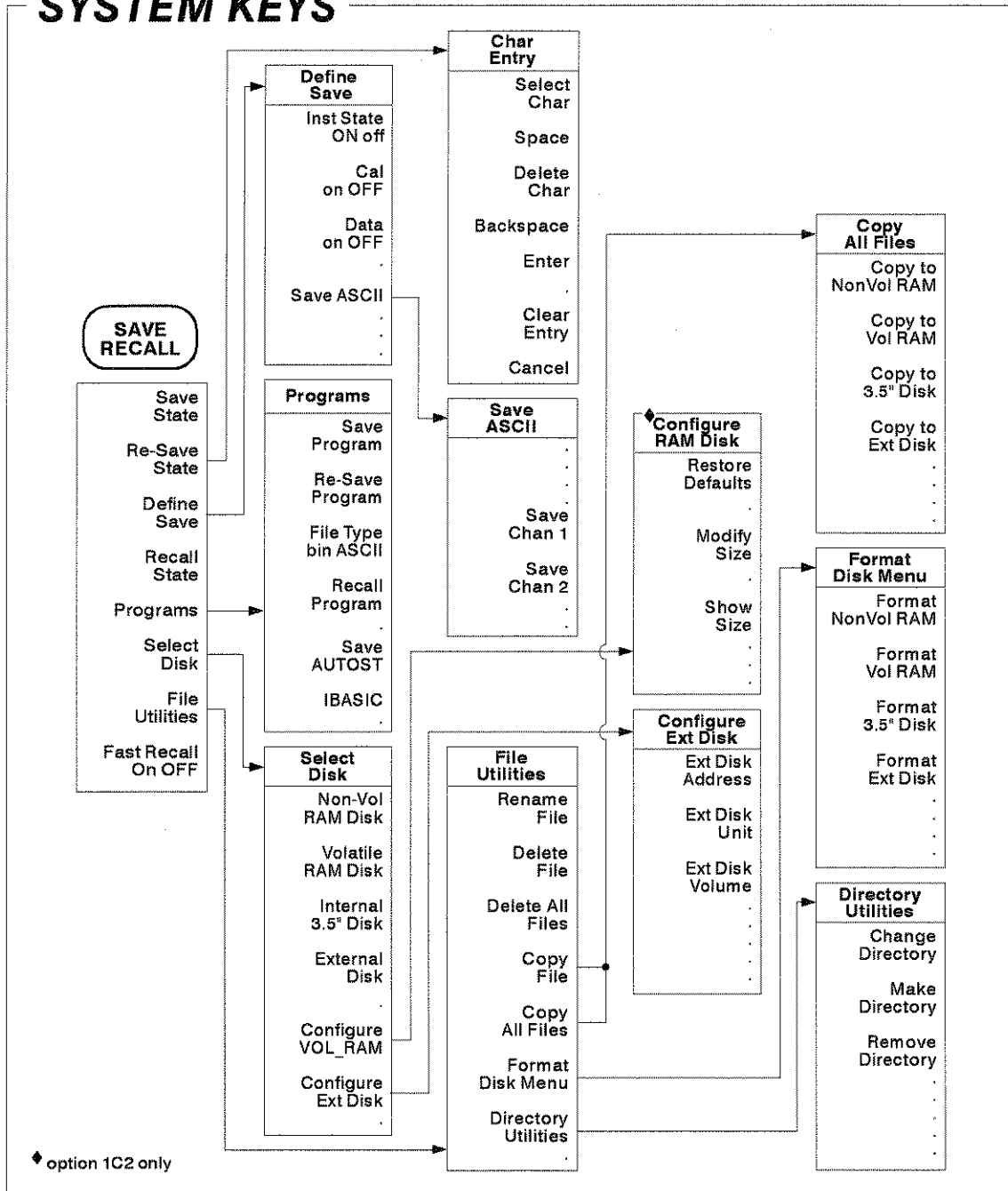

po693b

# SYSTEM KEYS

(continued)

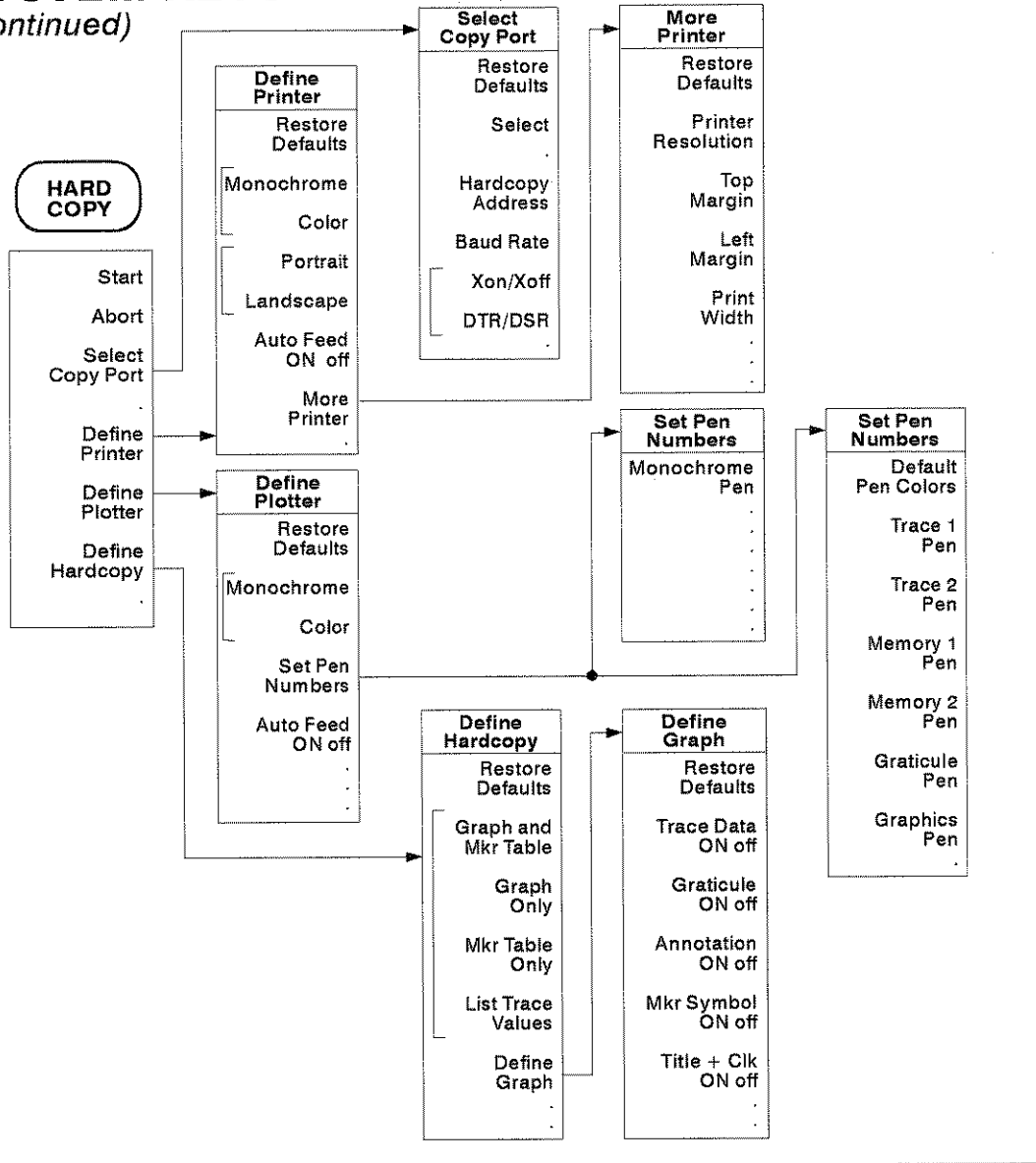

pc698b\_c

# SYSTEM KEYS

(continued)  
page 1 of 2

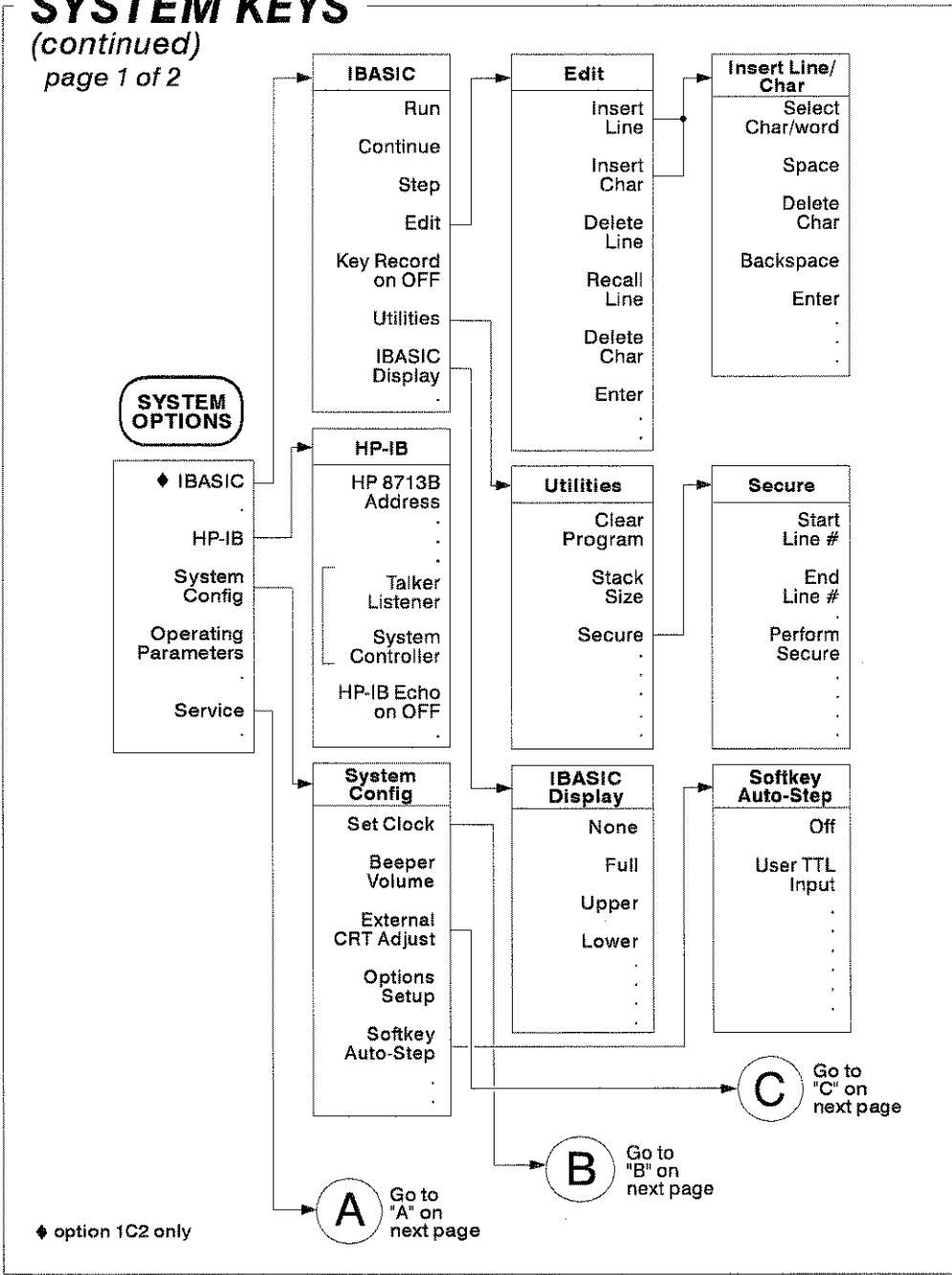

po694b

# SYSTEM KEYS

(continued)  
page 2 of 2

Service ▶

A

- Service
  - ◆ Tests and Adjustments
  - Instrument Info
  - Update Corr Const
  - ◆ Service Utilities

- Update Corr Const
  - Install CC From Disk
  - Help Message
  - Load CC From Disk
  - Store CC To EPROM
  - Store CC To Disk

External CRT Adjust ▶

B

- External CRT Adjust
  - Restore Defaults
  - Vertical Back Porch
  - Vertical Frnt Porch
  - Horizontal Back Porch
  - Horizontal Frnt Porch
  - Done
  - Prior Menu

Set Clock ▶

C

- Set Clock
  - Set Year
  - Set Month
  - Set Day
  - Set Hour
  - Set Minute
  - Round Seconds
  - Clock Format
  - Done
  - Prior Menu

- Clock Format
  - YYYY-MM-DD HH:MM
  - MM-DD-YYY HH:MM
  - DD-MM-YYY HH:MM
  - Numeric
  - Alpha
  - Seconds ON off

◆ See Service Guide for more details.

po695b

Menu Maps





---

**HARDKEY** / Softkey  
Reference

---

**HARDKEY** / **Softkey Reference**

This chapter provides a brief description of each of the analyzer's hardkeys and softkeys. This chapter is arranged alphabetically for ease of use.



---

## Numeric Entries

**1:** ... **8:** Markers number one through eight in the **MARKER** menu. Pressing any one of these softkeys makes the marker the active marker and (if previously off) turns it on. ">" in front of the marker number means the marker is the active marker. ":" means the marker is not the active marker, it may be on or off.

See "Using Markers" in Chapter 4 for an explanation of "active marker," and for more information on using markers.

**3.5 mm** Softkey in cal kit menu of 50 ohm instruments. Selects type of cal kit as 3.5 mm. Coefficients for male and female test ports are identical and based on the HP 85033C cal kit standards.

See Chapter 6, "Calibrating for Increased Measurement Accuracy" for more information.

Access Keys: **CAL** **Cal Kit**

## A

**A** Softkey used to select tuned receiver measurement of input A.

See “Measuring Devices With Your Network Analyzer” in Chapter 3 for more information on input A.

Access keys: **CHAN 1** or **CHAN 2**, **Detection Options**  
**Narrowband Internal**

**A/R** Softkey in narrowband internal menu. Selects tuned receiver reflection measurement A/R.

See “Measuring Devices With Your Network Analyzer” in Chapter 3 for more information on measuring A/R.

Access keys: **CHAN 1** or **CHAN 2**, **Detection Options**  
**Narrowband Internal**

**Abort** Softkey in **HARD COPY** menu. Stops sending data from the network analyzer to the hardcopy device.

### **NOTE**

Hardcopy devices with large buffers may continue to operate for quite a while after this command. To stop such devices immediately, turn off power to the hardcopy device.

**Active Marker Off** Softkey in marker menu that turns off the active marker and makes the lowest numbered marker (if any) the active marker.  
See "Using Markers" in Chapter 4 for an explanation of "active marker," and for more information on using markers.

Access Keys: **MARKER** More Markers

**Add Limit** Softkey in limit line menu. Displays menu to add limit lines or points to the limit table.

See "Using Limit Lines" in Chapter 4 for detailed information on using limit lines.

Access Keys: **DISPLAY** Limit Menu

**Add Max Line** Softkey in add limit menu Displays menu to add a maximum limit line.

See "Using Limit Lines" in Chapter 4 for detailed information on using limit lines.

Access Keys: **DISPLAY** Limit Menu Add limit

**Add Max Point** Softkey in add limit menu. Displays menu to add a maximum limit point.

See "Using Limit Lines" in Chapter 4 for detailed information on using limit lines.

Access Keys: **DISPLAY** Limit Menu Add limit

**Add Min Line** Softkey in add limit menu. Displays menu to add a minimum limit line.

See "Using Limit Lines" in Chapter 4 for detailed information on using limit lines.

Access Keys: **DISPLAY** Limit Menu Add limit

**Add** Softkey in add limit menu. Displays menu to add a minimum limit point.  
**Min Point** See “Using Limit Lines” in Chapter 4 for detailed information on using limit lines.

Access Keys: **DISPLAY** **Limit Menu** **Add limit**

**All Off** Softkey in the **MARKER** menu that turns off all of the markers, the delta marker, and marker tracking on the active channel.  
See “Using Markers” in Chapter 4 for detailed information on using markers.

**Alpha** Formats the real-time internal clock to display the first three letters of the month rather than a number (for example, Mar for March instead of 03).

Access keys: **SYSTEM OPTIONS** **System Config** **Set Clock**  
**Clock Format**

**Alt Sweep on OFF** Softkey in **SWEEP** menu. When on, alternate sweep allows operation with different instrument states on its two displayed channels. When on, the settings of the two channels can differ: frequency span, detection option type, number of points, system bandwidth, trigger, sweep time. When off, the preceding settings match. Note: some settings, such as power level, always match.

**AM Delay** (Options 1DA and 1DB only) Softkey in mixer menu, **CAL** menu, and **CHAN 1** or **CHAN 2** menus. Used to measure or calibrate for AM delay.

See “Measuring AM Delay,” in Chapter 3 for more information.

Access Keys: **BEGIN** **Mixer** or **CAL** or **CHAN 1** or **CHAN 2**

**Amplifier** Softkey in **BEGIN** menu. Displays menu of measurements suitable for amplifier measurements: transmission, reflection, and power.

**Annotation** Softkey in define graph menu. When annotation is on, printed or plotted hardcopies will contain screen annotation such as the marker readout that appears in the upper right corner of the display. When off, the screen annotation is suppressed from the hardcopy.

ON off

Access Keys: **HARD COPY** **Define Hardcopy** **Define Graph**

**Auto Feed** Softkey in define printer and define plotter menus. Toggles paper autofeed feature on and off. Default is on.

ON off

Access Keys: **HARD COPY** **Define Printer** or **Define Plotter**

**Autoscale** Softkey in **SCALE** menu. Scales the data trace vertically to fit within the graticule area of the display.

**Autozero** Softkey in detector zero menu. Periodically compensates for external detector drift due to changes in temperature. When this feature is selected, the external detector(s) are automatically zeroed every five minutes.

---

**CAUTION**

---

Do not use **Autozero** with an external source. See **Manual Zero**.

Access Keys: **CAL** **Detector Zero**

**Aux Input** Softkey in detection options menu. Choose this selection to make very low frequency voltage measurements.

See "Making Measurements With the Auxiliary Input" in Chapter 3 for more information.

Access Keys: **CHAN 1** or **CHAN 2** **Detection Options**

**Average Factor** Softkey in **AVG** menu. Enters the averaging factor (number) in powers of 2. Acceptable values are: 1, 2, 4, 8, 16, 32, and 64. The default averaging factor is 16, the maximum is 64.

See "To Reduce the Receiver Noise Floor" in Chapter 5 for more information on how averaging works.

**Average on OFF** Softkey in **AVG** menu. Toggles the averaging function on and off . Averaging reduces random noise by averaging the measurement data from sweep to sweep.

See “To Reduce the Receiver Noise Floor” in Chapter 5 for more information on how averaging works.

**AVG** Hardkey in the CONFIGURE area. Displays the menu that allows selection of averaging parameters as well as system bandwidth and delay aperture selections.

See “To Reduce the Receiver Noise Floor” in Chapter 5 for more information on how averaging works.



---

**B**

**B** Softkey in the narrowband internal menu. Selects tuned receiver transmission measurement of input B (power transmitted to RF IN port).

See “Measuring Devices with Your Network Analyzer” in Chapter 3 for more information on input B.

Access keys: **CHAN 1** or **CHAN 2**, **Detection Options**  
**Narrowband Internal**

**B\*** Softkey in broadband internal menu. Selects diode detector measurement of input B\* (power transmitted to RF IN port). This is the “power” measurement detector.

See “Measuring Devices with Your Network Analyzer” in Chapter 3 for more information on input B\*.

Access keys: **CHAN 1** or **CHAN 2**, **Detection Options**  
**Broadband Internal**

**B\*/R\*** Softkey in broadband internal menu. Selects diode detector transmission measurement; ratio of input B\* (broadband transmitted power) to input R\* (broadband reference signal).

See “Measuring Devices with Your Network Analyzer” in Chapter 3 for more information on ratioed measurement B\*/R\*.

Access Keys: **CHAN 1** or **CHAN 2**, **Detection Options**  
**Broadband Internal**

**B/R** Softkey in narrowband internal menu. Selects tuned receiver transmission measurement; ratio of input B (transmitted power) to input R (reference signal).

See “Measuring Devices with Your Network Analyzer” in Chapter 3 for more information on ratioed measurement B/R.

Access keys: **CHAN 1** or **CHAN 2**, **Detection Options**  
**Narrowband Internal**

**Backspace** Softkey used for editing titles, file names, directory names, and IBASIC programs from the front panel of the analyzer. Deletes the character to left of cursor.

**Bandwidth** Softkey in marker search menu. Automatically calculates -3 dB (default) or other user-specified bandwidth, center frequency, and Q of a bandpass filter. See "Using Markers" in Chapter 4 for more information.

Access Keys: **MARKER** **Marker Search**

**Baud Rate** Softkey in select copy port menu. Sets the transmission baud rate of the analyzer for serial devices. Make sure the rate you set matches the requirement of the output device (see its manual for details).

Access keys: **HARDCOPY** **Select Copy Port**

**Beeper Volume** Softkey in system configuration menu. Sets the analyzer beeper volume from off (0) to high (100). The default is 90.

Access keys: **SYSTEM OPTIONS** **System Config**

**BEGIN** Hardkey to left of disk drive. An appropriate place to begin measuring any of the four types of devices in the begin menu. Recommended for one channel measurements.

See "Using the **BEGIN** Key" in Chapter 3 for more information.

**Begin** Softkey used to define a limit line.

**Frequency** See "Using Limit Lines" in Chapter 4 for more information.

Access Keys: **DISPLAY** **Limit Menu** **Add limit** **Add Max Line** or **Add Min Line**

**Begin Limit** Softkey used to define a limit line.

See "Using Limit Lines" in Chapter 4 for more information.

Access Keys: **DISPLAY** **Limit Menu** **Add limit** **Add Max Line** or  
**Add Min Line**

**Broadband External** Softkey in detection options menu. Displays menu to select detection modes when using external detectors.

Access Keys: **CHAN 1** or **CHAN 2** **Detection Options**

**Broadband Internal** Softkey in detection options menu. Displays menu to select measurements made with internal broadband detectors: B\*, R\*, or B\*/R\*.

Access Keys: **CHAN 1** or **CHAN 2** **Detection Options**

**Broadband Passive** Softkey in **BEGIN** menu. Used to set up the analyzer to make transmission or reflection measurements of passive devices such as cables.

---

C

**Cable** (Option 100 only) Softkey in **BEGIN** menu. Used to perform fault location and SRL measurements. See your *User's Guide Supplement for Option 100* for information.

**CAL** Hardkey in the CONFIGURE area. Displays the calibration menu.  
See Chapter 6 for information on calibrating the analyzer.

**Cal Kit** Softkey in **CAL** menu. Allows selection of type of cal kit: Type-N female (default), Type-N male, 3.5 mm (standard analyzers only), Type-F female (75  $\Omega$  analyzers only), or user-defined.

By convention, cal kits indicate the sex of the *port* with which they are used. For example the default cal kit for the analyzer is type-N *female* because the front panel RF ports are female (the calibration standards, in turn, are male). This same convention applies to whatever test "port" the standard is attached to, be it an adapter, cable, fixture, etc.

See Chapter 6 for more information on calibrating the analyzer.

**Cal on OFF** Softkey in define save menu. Toggle to ON if you want to save the active measurement calibration along with the current instrument state.

See "Saving and Recalling Measurement Results" in Chapter 4 for information on saving instrument states and measurement results to files.

Access Keys: **SAVE RECALL** **Define Save**

**Cancel** Softkey available when editing titles, file names, directory names, and IBASIC programs from the front panel of the analyzer. Cancels the editing mode and any changes that were made but not saved by pressing **Enter**.

**Center** Softkey in **FREQ** menu. Sets the center frequency of the internal RF source and changes screen annotation to center and span, as opposed to start and stop.

**CHAN 1** Hardkey in MEAS area. Turns on channel 1 as the active channel. Default mode is transmission measurement.

**CHAN 2** Hardkey in MEAS area. Turns on channel 2 as the active channel. Default is channel off; selecting it changes setting to the most recent type of measurement, or transmission if not been used.

**Chan OFF** Softkey in **CHAN 1** or **CHAN 2** menu. Turns the active channel off.

**Change Directory** Softkey in directory utilities menu. Used to change directories on an internal or external DOS storage device.

See "To Use Directory Utilities" in Chapter 4 for more information.

Access Keys: **SAVE RECALL** **File Utilities** **Directory Utilities**

**Clear Entry** Softkey available when editing titles, file names, directory names, and IBASIC programs from the front panel of the analyzer. Clears the entire title, name or line if pressed.

**Clear Program** (Option 1C2, IBASIC, only) Softkey in IBASIC utilities menu. Clears (erases) the current IBASIC program from internal memory.

See the *HP Instrument BASIC User's Handbook* for more information.

Access Keys: **SYSTEM OPTIONS** **IBASIC** **Utilities**

**Clock Format** Softkey in set clock menu. Determines how the date and time are displayed when they are turned on.

Date abbreviations:

YYYY stands for year.

MM stands for month.

DD stands for day.

Time abbreviations:

HH stands for hour, 24 hour mode.

MM stands for minute.

In numeric format, the month is displayed by number (for example, March is 03). In alpha format, the first three letters of the month are displayed (for example, Mar).

See **Title+Clk ON off** and **Set Clock** in this chapter for more information on viewing and setting the internal clock.

Access Keys: **SYSTEM OPTIONS** **System Config** **Set Clock**

**Clock Off** Softkey in title and clock menu. Suppresses display of clock in the title area.

Access Keys: **DISPLAY** **More Display** **Title and Clock**

**Color** Softkey in define printer and define plotter menus. Used to define the printer or plotter as a multi-color device as opposed to a one color (monochrome) device.

See "Connecting and Configuring Printers and Plotters" in Chapter 4 for more information.

Access Keys: **HARD COPY** **Define Printer** or **Define Plotter**

**Configure Ext Disk** Softkey in select disk menu. Displays menu to set the HP-IB address, unit number, and volume number of an external disk drive. For details, see the disk drive manual.

See "Step 4. Configure the Analyzer" in Chapter 1 for more information.

Access Keys: **SAVE RECALL** **Select Disk**

**Configure RAM Disk** (Option 1C2, IBASIC, only) Softkey in select disk menu. Displays menu to modify the memory allocation for the internal volatile RAM disk.

Access Keys: **SAVE RECALL** **Select Disk**

**Continue** (Option 1C2, IBASIC, only) Softkey in IBASIC menu. Restarts a program that has been paused.

See the *HP Instrument BASIC User's Handbook* for more information on using IBASIC.

Access Keys: **SYSTEM OPTIONS** **IBASIC**

**Continuous** Softkey in trigger menu. Continuous is the default trigger mode; the analyzer begins its next sweep at the conclusion of the current sweep.

Access Keys: **MENU** **Trigger**

**Conversion Loss** Softkey in mixer menu and measurement menu, for measuring frequency translating devices, selects a broadband internal transmission measurement.

See "Measuring Conversion Loss" in Chapter 3 for more information.

Access Keys: **BEGIN** **Mixer** or **CHAN 1** or **CHAN 2**

**Copy** Softkey in file utilities menu. Used to copy files.

**All Files** See "Other File Utilities" in Chapter 4 for more information.

Access Keys: **SAVE RECALL** **File Utilities**

**Copy** Softkey in file utilities menu. Used to copy files.

**File** See "Other File Utilities" in Chapter 4 for more information.

Access Keys: **SAVE RECALL** **File Utilities**

**Copy to  
3.5" Disk** Softkey in copy file menu. Used to select the analyzer's built-in disk drive as the destination drive for copying of files. Displays character entry menu to rename file (if desired) prior to copying.

Access Keys: **SAVE RECALL** **File Utilities** **Copy File** *or*  
**Copy All Files**

**Copy to  
Ext Disk** Softkey in copy file menu. Used to select an external disk drive as the destination drive for copying of files. Displays character entry menu to rename file (if desired) prior to copying.

Access Keys: **SAVE RECALL** **File Utilities** **Copy File** *or*  
**Copy All Files**

**Copy to  
NonVol RAM** Softkey in copy file menu. Used to select the analyzer's internal non-volatile RAM as the destination drive for copying of files. Displays character entry menu to rename file (if desired) prior to copying.

Access Keys: **SAVE RECALL** **File Utilities** **Copy File** *or*  
**Copy All Files**

**Copy to  
Vol RAM** Softkey in copy file menu. Used to select the analyzer's internal volatile RAM as the destination drive for copying of files. Displays character entry menu to rename file (if desired) prior to copying.

Access Keys: **SAVE RECALL** **File Utilities** **Copy File** *or*  
**Copy All Files**

**CW** Softkey in **FREQ** menu. Selects CW (continuous wave, single frequency) source operation.



## D

**Data** Softkey in **DISPLAY** menu. Displays the current measurement data trace.

**Data and Memory** Softkey in **DISPLAY** menu. Displays both the current data and memory traces, with identical scaling and format. You must have selected **Data->Mem** first for this key to function.

**CAUTION**

Use care in interpreting memory trace values. The memory trace may have been stored under conditions different from the current measurement trace.

**Data on OFF** Softkey in the define save menu. Toggle to ON if you want to save the current measurement data. Data can be saved by itself or with the instrument state and current calibration.

**Data/Mem** Softkey in **DISPLAY** menu. Divides current trace data by data in memory. For this key to function, you must first have selected **Data->Mem** and stored a data trace in memory.

**Data->Mem** Softkey in **DISPLAY** menu. Stores the active data trace in the memory of the active channel.

**DD-MM-YYYY** Softkey in clock format menu. Formats the real-time internal clock to display time as Day-Month-Year Hour:Minute.

**HH:MM**

See **Clock Format** in this chapter for more information on clock format.

Access Keys: **SYSTEM OPTIONS** **System Config** **Set Clock**  
**Clock Format**

**Default Pen Colors** Softkey in set pen numbers menu. Resets plotter pen number assignments to their default values.

See "Define the Printer or Plotter Settings" in Chapter 4 for default values.

Access Keys: **HARD COPY** **Define Plotter** **Set Pen Numbers**

**Define Graph** Softkey in define hardcopy menu. Displays menu to define which parts of the graph are to be printed or plotted: trace data, graticule, annotation, marker symbol, title and clock, or combinations.

See "Printing and Plotting Measurement Results" in Chapter 4.

Access Keys: **HARD COPY** **Define Hardcopy**

**Define Hardcopy** Softkey in **HARDCOPY** menu. Displays menu to define the hardcopy in terms of information to be copied. Default setting is **Graph Only**.

See "Printing and Plotting Measurement Results" in Chapter 4.

**Define Plotter** Softkey in **HARDCOPY** menu. Displays menu to define the plotter in terms of color, pen numbers, and autoseed.

See "Connecting and Configuring Printers and Plotters" in Chapter 4 for more information.

**Define Printer** Softkey in **HARDCOPY** menu. Displays menu to define the printer in terms of color, orientation, autoseed, resolution, and margins.

See "Connecting and Configuring Printers and Plotters" in Chapter 4 for more information.

**Define Save** Softkey in **SAVE RECALL** menu. Displays menu to save the instrument state, measurement calibration, measurement data, or combinations. Allows choice of saving trace data in ASCII format for output to spreadsheets. ASCII format is compatible with Lotus 1-2-3.

See "Saving and Recalling Measurement Results" in Chapter 4 for more information.

**Delete All Files** Softkey in file utilities menu. Deletes all files in the current directory. Before the files are deleted you will be asked to confirm this selection. Also deletes empty directories on DOS disks.

See "Other File Utilities" in Chapter 4 for more information.

Access Keys: **SAVE RECALL** **File Utilities**

**Delete All Limits** Softkey in delete limit menu. Deletes all of the limit lines in the limit line table. Asks for confirmation before deletion occurs.

See "Using Limit Lines" in Chapter 4 for more information on using limit lines.

Access Keys: **DISPLAY** Limit Menu Delete Limit

**Delete Char** Softkey used for editing titles, file names, directory names, and IBASIC programs.

**Delete File** Softkey in file utilities menu. Deletes the file that is highlighted. See "Other File Utilities" in Chapter 4 for more information on file utilities.

Access Keys: **SAVE RECALL** File Utilities

**Delete Limit** Softkey in limit line menu. Displays menu to delete one segment (or point) of a limit line or all limits.

See "Using Limit Lines" in Chapter 4 for more information on limit lines.

Access Keys: **DISPLAY** Limit Menu

**Delete Line** (Option 1C2, IBASIC, only) Softkey in edit menu of IBASIC. Allows deletion of one line of code at a time.

Access Keys: **SYSTEM OPTIONS** IBASIC Edit

**Delta Mkr on OFF** Softkey in marker functions menu. Makes the active marker the delta marker or reference point.

See "To Use Delta ( $\Delta$ ) Marker Mode" in Chapter 4 for more information.

Access Keys: **MARKER** Marker Functions

**Detection Options** Softkey in **CHAN 1** and **CHAN 2** menus. Selects measurement type: narrowband or broadband internal, broadband external or aux input. See "Measuring Devices with Your Network Analyzer" in Chapter 3 for more information on detection modes.

**Detector Zero** Softkey in **CAL** menu. Displays detector zero menu for selection of type of detector zeroing (compensating for drift). Default is autozero. Only internal or external detectors in use are zeroed. In autozero mode, the network analyzer zeros on selection and as required (about every five minutes depending on ambient temperature). In manual zero mode, the analyzer zeros once each time **Manual Zero** is pressed.

**CAUTION**

Do not apply RF power to a detector during zeroing. With an external source, use **Manual Zero** to coordinate RF power off with zeroing.

**Directory Utilities** Softkey in file utilities menu. Displays menu to change, make, or remove directories on DOS disks. See "To Use Directory Utilities" in Chapter 4 for more information.

Access Keys: **SAVE RECALL** **File Utilities**

**Disp Freq Resolution** Softkey in **FREQ** menu. Selects the resolution of the displayed frequency resolution as MHz, kHz, or Hz. For example, a frequency of 1,234,567 Hz can be displayed as: 1 MHz (note rounding down), 1.235 MHz (note rounding up), or 1.234 567 MHz. Default is kHz.

**DISPLAY** Hardkey in CONFIGURE area of front panel. Displays menu with selections concerning type of data to be displayed, split or full screen, title and limit lines.

**Distance** (Option 100 only) Softkey available under the **MENU** key and the add max point and add min point menus. Used to perform fault location measurements. See your *User's Guide Supplement for Option 100* for information.

**Dither** Softkey in spur avoid options menu. When selected, shifts spurs which may be visible in low level measurements.

See "Reducing Trace Noise" in Chapter 5 for more information.

Access Keys: **MENU** Spur Avoid Options

**DTR/DSR** Softkey in select copy port menu. A hardware handshake for some serial devices. Toggles with **Xon/Xoff**.

Access Keys: **HARD COPY** Select Copy Port

---

## E

**Edit** (Option 1C2, IBASIC, only) Softkey in IBASIC menu. Displays the IBASIC edit menu and a rudimentary word and character editor.

See the *HP Instrument BASIC User's Handbook* for more information.

Access Keys: **SYSTEM OPTIONS** **IBASIC**

**Edit limit** Softkey in limit line menu. Displays menu to change the frequency or amplitude of previously entered limits, or add a data trace marker.

Access Keys: **DISPLAY** **Limit Menu**

**End** Softkey in add max line and add min line menus. Sets the end (or stop) frequency of a limit line.

**Frequency**

See "Using Limit Lines" in Chapter 4 for more information on limit lines.

Access Keys: **DISPLAY** **Limit Menu** **Add limit** **Add Max Line** or **Add Min Line**

**End** Softkey in add max line and add min line menus. Sets the end (or stop) amplitude (height) of a limit line.

**Limit**

See "Using Limit Lines" in Chapter 4 for more information on limit lines.

Access Keys: **DISPLAY** **Limit Menu** **Add limit** **Add Max Line** or **Add Min Line**

**End** (Option 1C2, IBASIC, only) Softkey in secure menu of instruments with IBASIC option.

**Line #**

See the *HP Instrument BASIC User's Handbook* for information on the secure function.

Access Keys: **SYSTEM OPTIONS** **IBASIC** **Utilities** **Secure**

**Enter Line 1** Softkey in title and clock menu. Displays menu to edit screen title on line 1 of display. Maximum number of characters is 36.  
 Access Keys: **DISPLAY** More Display Title and Clock

**Enter Line 2** Softkey in title and clock menu. Displays menu to edit screen title on line 2 of display. Maximum number of characters is 36.  
 Access Keys: **DISPLAY** More Display Title and Clock

**Ext Disk Address** Softkey in configure external disk menu. Sets the HP-IB address of an external disk drive; default is 0 (zero).  
 Access Keys: **SAVE RECALL** Select Disk External Disk

**Ext Disk Unit** Softkey in configure external disk menu. Sets the unit number of the external disk drive; 0 is left drive, 1 is right drive.  
 Access Keys: **SAVE RECALL** Select Disk Configure Ext Disk

**Ext Disk Volume** Softkey in configure external disk menu. Shows the volume number of the external disk drive. This value is always set to 0 (zero).  
 Access Keys: **SAVE RECALL** Select Disk Configure Ext Disk

**Ext Ref on OFF** Softkey in source **MENU**. When on, sets network analyzer to use external 10 MHz signal as frequency standard. When on, if signal is not present at EXT REF IN connector, network analyzer will not sweep. Default is off.

**NOTE**

External reference should be disconnected from EXT REF IN or power reduced when not in use.

**External CRT Adjust** Softkey in system configuration menu. Displays menu to set external CRT timing parameters for best image. These settings are not affected by presetting the analyzer.

**NOTE**

These adjustments also affect the internal CRT of the analyzer.

See “BNC Connectors” in Chapter 8 for more information.

Access Keys: **SYSTEM OPTIONS** **System Config**

**External Disk** Softkey in select disk menu. Selects the external disk drive as the location to save and recall data from.

See “Saving and Recalling Measurement Results” in Chapter 4 for more information.

Access Keys: **SAVE RECALL** **Select Disk**

**External Point** Softkey in trigger source menu. Enables the analyzer to sweep to the next (frequency) point when externally triggered through EXT TRIG IN/OUT rear panel connector, one point per trigger.

Access Keys: **MENU** **Trigger** **Trigger Source**

**External Sweep** Softkey in trigger source menu. Enables the analyzer to begin one complete sweep when externally triggered.

Access Keys: **MENU** **Trigger** **Trigger Source**



## F

**FastRecall on OFF** Softkey in the **SAVE RECALL** menu. Toggles the fast recall feature on or off. See "Measurement Setup and Control with Fast Recall" in Chapter 4 for more information.

**Fault Location** (Option 100 only) Softkey in reflection or cable menu. Sets up the analyzer to perform fault location measurements. See your *User's Guide Supplement for Option 100* for information.

**Fault Window** (Option 100 only) Softkey in **AVG** menu. Used when making fault location measurements. See your *User's Guide Supplement for Option 100* for information.

**Fault Max Freq Span** (Option 100 only) Softkey in **FREQ** menu. Used when making fault location measurements. See your *User's Guide Supplement for Option 100* for information.

**File Type bin ASCII** (Option 1C2, IBASIC, only) Softkey in programs menu. This key is used to select how the IBASIC program is saved to disk. It can be saved in either binary or ASCII format.

**ASCII** Save a program in ASCII format for ease of transportability. Programs saved in ASCII format can be read by any HP BASIC computer or instrument running IBASIC.

**bin(ary)** Binary format is specific to this family of analyzers (HP 8711B/12B/13B/14B). A program saved in binary format is not readable by an IBASIC computer or other instruments running IBASIC.

Binary format, however, is required if you are going to use the LOADSUB keyword.

See the *HP 8711B/12B/13B/14B Instrument BASIC User's Handbook* for more information on saving programs.

Access Keys: **SAVE RECALL** **Programs**

**F**

**File Utilities** Softkey in **SAVE RECALL** menu. Displays menu to rename, delete, or copy files; format disk or memory; and change or make directories.  
See "Other File Utilities" in Chapter 4 for more information.

**Filter** Softkey in **BEGIN** menu. This key is used to set up the analyzer for transmission or reflection measurements of filters.  
See "Using the **BEGIN** Key to Make Measurements" in Chapter 3 for more information.

**Fine 15 Hz** Softkey in system bandwidth menu. This is the narrowest system bandwidth available. (Medium is the default system bandwidth.)  
See Chapter 5, "Optimizing Measurements," for information on how system bandwidth can affect your measurements.  
Access Keys: **AVG** **System Bandwidth**

**Flatness** Softkey in marker math menu. Calculates the flatness of a trace segment.  
See "To Use Marker Math Functions" in Chapter 4 for more information.  
Access Keys: **MARKER** **Marker Functions** **Marker Math**

**FORMAT** Hardkey in the CONFIGURE area. Pressing this key displays a menu of choices for the display format of your measurement.  
The choices available are: Log Mag, Lin Mag and SWR. For more information on each of these choices, see its entry in this chapter.

**Format 3.5" Disk** Softkey in format disk menu. Formats a disk in the internal disk drive in DOS format.  
See "Formatting a Floppy Disk" in Chapter 4 for more information.  
Access Keys: **SAVE RECALL** **File Utilities** **Format Disk Menu**

**Format Disk Menu** Softkey in file utilities menu. Displays format disk menu to select disk. Disk can be internal non-volatile memory, internal volatile memory, built-in 3.5" disk, or an external disk.

**NOTE**

The analyzer formats disks in DOS only, but can read and save to DOS- and LIF-formatted disks. To format in LIF, use IBASIC (optional) or an external computer and disk drive. For examples, see "Formatting a Floppy Disk," in Chapter 4.

Access Keys: **SAVE RECALL** **File Utilities**

**Format Ext Disk** Softkey in format disk menu. Formats a disk in the external disk drive in DOS format.

See "Formatting a Floppy Disk" in Chapter 4 for more information.

Access Keys: **SAVE RECALL** **File Utilities** **Format Disk Menu**

**Format NonVol RAM** Softkey in format disk menu. Formats the internal non-volatile RAM disk.

**CAUTION**

Formatting the internal non-volatile RAM disk erases all existing files and directories on the disk.

Access Keys: **SAVE RECALL** **File Utilities** **Format Disk Menu**

**HARDKEY** / **Softkey** Reference

F

**Format Vol RAM** Softkey in format disk menu. Formats the internal volatile RAM disk.

---

**CAUTION**

---

Formatting the internal volatile RAM disk erases all existing files and directories on the disk.

Access Keys: **SAVE RECALL** **File Utilities** **Format Disk Menu**

**FREQ** Hardkey in SOURCE area. Displays the frequency menu which allows you to enter the frequency range for your measurement. Also allows you to change the resolution of the displayed frequency.

See "Entering Measurement Parameters" in Chapter 2 for an example of how to enter frequency range.

**Frequency** Softkey in add max point and add min point menus. Sets the frequency of a limit point.

See "To Create a Single Point Limit" in Chapter 4 for an example of how to set a limit point.

Access Keys: **DISPLAY** **Limit Menu** **Add limit** **Add Max Point** or **Add Min Point**

**Frequency Sweep** Softkey in **SWEEP** menu. This key is used to return the analyzer to frequency sweep mode, after it has been used in power sweep mode.

**Full** (Option 1C2, IBASIC, only) Softkey in the IBASIC display menu. Displays the IBASIC program on the full screen without measurement data.

Access Keys: **SYSTEM OPTIONS** **IBASIC** **IBASIC Display**

## G

**Graph and Mkr Table** Softkey in define hardcopy menu. Defines hardcopy to print both graph and marker table.

**NOTE**

The marker table prints only if one or more markers are on.

See "Define the Output" in Chapter 4 for more information.

Access Keys: **HARD COPY** **Define Hardcopy**

**Graph Only** Softkey in define hardcopy menu. Defines hardcopy as the graph. See "Define the Output" in Chapter 4 for more information.

Access Keys: **HARD COPY** **Define Hardcopy**

**Graphics Pen** Softkey in set pen numbers menu. Sets pen number assignment (color) for the annotation on a hardcopy.

Access Keys: **HARDCOPY** **Define Plotter** **Set Pen Numbers**

**Graticule ON off** Softkey available in two different menus: the more display menu and the define graph menu. This softkey toggles the display graticule (grid) on and off. When pressed in the more display menu, the graticule are suppressed from showing on the CRT. When pressed in the define graph menu, the graticule are suppressed from printing or plotting on a hardcopy.

Access Keys: **DISPLAY** **More Display** or **HARDCOPY** **Define Hardcopy**  
**Define Graph**

**HARDKEY** / **Softkey** Reference  
**G**

**Graticule Pen** Softkey in set pen numbers menu. Sets pen number assignment (color or width) for grid on hardcopy.

Access Keys: **HARDCOPY** **Define Plotter** **Set Pen Numbers**

## H

**HARDCOPY** Hardkey in the SYSTEM area of the front panel. Displays the menu to start or stop prints or plots, set up the printer or plotter, and determine the appearance of the copy.

See “Connecting and Configuring Printers and Plotters” and “Printing and Plotting Measurement Results” in Chapter 4 for more information.

**Hardcopy Address** Softkey in select copy port menu. Sets recognized HP-IB address of hardcopy device at HP-IB port, for HP-IB printers and plotters only. The default address is 5. The “recognized HP-IB address” is the address that the network analyzer uses to communicate with the device. The actual address of the device must be set independently to match.

See “Connecting and Configuring Printers and Plotters” in Chapter 4 for more information.

Access Keys: **HARD COPY** **Select Copy Port**

**Help Message** Softkey in update correction constants menu. Displays the help message that describes the actions of the other softkeys in the update correction constants menu.

Access Keys: **SYSTEM OPTIONS** **Service** **Update Corr Const**

**Hold** Softkey in trigger menu. Stops the current data trace sweep immediately and holds the sweep until **Continuous** or **Single** is selected.

Access Keys: **MENU** **Trigger**

**Horizontal Back Porch** Softkey in external CRT adjustment menu. CRT timing adjustment for use with external monitors. Also affects network analyzer’s internal CRT. Default setting is 3.6  $\mu$ sec.

See “BNC Connectors” in Chapter 8 for information on using an external monitor.

Access Keys: **SYSTEM OPTIONS** **System Config** **External CRT Adjust**

**HARDKEY** / **Softkey** Reference

**H**

**Horizontal Frnt Porch** Softkey in external CRT adjustment menu. CRT timing adjustment for use with external monitors. Also affects network analyzer's internal CRT. Default setting is 41.4  $\mu$ sec.

See "BNC Connectors" in Chapter 8 for information on using an external monitor.

Access Keys: **SYSTEM OPTIONS** **System Config** **External CRT Adjust**

**HP 8711B Address** Softkey in HP-IB menu. Sets actual HP-IB address of the network analyzer. Default HP-IB address is 16. This setting is not affected by **PRESET** or power-on.

Access Keys: **SYSTEM OPTIONS** **HP-IB**

**HP 8713B Address** Softkey in HP-IB menu. Sets actual HP-IB address of the network analyzer. Default HP-IB address is 16. This setting is not affected by **PRESET** or power-on.

Access Keys: **SYSTEM OPTIONS** **HP-IB**

**HP-IB** Softkey in **SYSTEM OPTIONS** menu. Displays menu to set the HP-IB address of network analyzer, set and change network analyzer HP-IB status, and set HP-IB echo feature.

**HP-IB Echo on OFF** Softkey in HP-IB menu. When on, displays HP-IB mnemonics on screen as keys are pressed, a convenient way to see the mnemonics associated with the keys.

**NOTE**

Not all keys (especially those that display menus) have mnemonics.

Access Keys: **SYSTEM OPTIONS** **HP-IB**



**Hz** Softkey in display frequency resolution menu. Displays frequency to Hz resolution.

Access Keys: **FREQ** **Disp Freq Resolution**

## I

**IBASIC** (Option 1C2, IBASIC, only) Softkey in **SYSTEM OPTIONS** menu. IBASIC menu functions include run, continue, step, edit, key record, and clear.

See Chapter 7, "Using Automation," and the *HP Instrument BASIC User's Handbook* for more information.

**IBASIC Display** (Option 1C2, IBASIC, only) Softkey in IBASIC menu. Displays a menu to allow selection of how to display an IBASIC program.

See the *HP Instrument BASIC User's Handbook* for more information.

Access Keys: **SYSTEM OPTIONS** **IBASIC**

**Insert Char** (Option 1C2, IBASIC, only) Softkey in IBASIC edit menu. Invokes the insert character menu for editing IBASIC programs.

See the *HP Instrument BASIC User's Handbook* for more information.

Access Keys: **SYSTEM OPTIONS** **IBASIC** **Edit**

**Insert Line** (Option 1C2, IBASIC, only) Softkey in IBASIC edit menu. Invokes the insert line menu for editing IBASIC programs.

See the *HP Instrument BASIC User's Handbook* for more information.

Access Keys: **SYSTEM OPTIONS** **IBASIC** **Edit**

**Inst State** Softkey in define save menu. When on, allows save of instrument state.

**ON off** See "Saving and Recalling Measurement Results" in Chapter 4 for more information.

Access Keys: **SAVE RECALL** **Define Save**

**Install CC From Disk** Softkey in update correction constants menu. Loads a permanent copy of CC data from a floppy disk to internal EPROM. This must be done after loading new firmware into the analyzer.

See the *Service Guide* for more information.

Access Keys: **SYSTEM OPTIONS** **Service** **Update Corr Const**

**Instrument Info** Softkey in service menu. Displays information about the network analyzer: firmware revision and date, bootROM version, serial number, options, system impedance, and amount of memory.

Access Keys: **SYSTEM OPTIONS** **Service**

**Internal** Softkey in trigger source menu. Default mode, network analyzer is triggered automatically (in **Continuous** mode) or as desired (in **Single** mode).

Access Keys: **MENU** **Trigger** **Trigger Source**

**Internal 3.5" Disk** Softkey in select disk menu. Selects the analyzer's built-in disk drive as the location where information is saved, re-saved, or recalled.

See "Saving and Recalling Measurement Results" in Chapter 4 for more information.

Access Keys: **SAVE RECALL** **Select Disk**

---

## K

**Key Record on OFF** (Option 1C2, IBASIC, only) Softkey in IBASIC menu. Translates front panel keystrokes into program lines to automatically set up and run the analyzer.

Press **SYSTEM OPTIONS** **IBASIC** **Key Record ON** **PRESET** to begin program. Press **SYSTEM OPTIONS** **IBASIC** **Key Record OFF** to end program. Only one program can be stored in memory at a time, but programs can also be stored to internal and external disks.

**NOTE**

When editing an IBASIC program, **Key Record** should be off.

See the *HP Instrument BASIC User's Handbook* for more information.

Access Keys: **SYSTEM OPTIONS** **IBASIC**

**kHz** Softkey in display frequency resolution menu. Displays frequency to kHz resolution. For example, 1.234 567 MHz is displayed as 1.235 MHz (note rounding up).

Access Keys: **FREQ** **Display Freq Resolution**

## L

**Landscape** Softkey in define printer menu. Sets printer to print hardcopy so that paper is oriented with longer edge at top and shorter edges at sides. Toggles with **Portrait**.

Access Keys: **HARD COPY** **Define Printer**

**Left Margin** Softkey in more printer menu. Sets left margin (non-printing space) in mm (25.4 mm = 1.00 inches). Minimum setting is 0.00 mm (default); maximum is 200 mm.

Access Keys: **HARD COPY** **Define Printer** **More Printer**

**Level** Softkey in **POWER** menu. Sets the RF power level of the analyzer's source. See Chapter 11, "Specifications and Characteristics," for the minimum and maximum power levels for your analyzer.

**Limit** Softkey in add max point or add min point menus. Sets the amplitude of a limit point.

See "To Create a Single Point Limit" in Chapter 4 for an example of how to set a limit point.

Access Keys: **DISPLAY** **Limit Menu** **Add limit** **Add Max Point** or **Add Min Point**

**Limit Menu** Softkey in **DISPLAY** menu. Displays limit-line menu to display, add, delete, and edit limit lines, and select limit test.

See "Using Limit Lines" in Chapter 4 for more information.

**Limit Menu** Softkey in limit line menu. When on, limit lines or points in limit table are visible on the CRT.  
**on OFF**

See "Using Limit Lines" in Chapter 4 for more information.

Access Keys: **DISPLAY** **Limit Menu**

**Limit Test** Softkey in limit line menu. Sets limit test status. When limit test is on, "FAIL" or "PASS" notation is displayed on the CRT. The limits need not be visible (set to ON) for the limit test to be valid.  
**on OFF**

See "Using Limit Lines" in Chapter 4 for more information.

Access Keys: **DISPLAY** **Limit Menu**

**Lin Mag** Softkey in **FORMAT** menu. Displays a transmission trace in terms of transmission coefficient, displays a reflection trace in terms of reflection coefficient, displays an aux input trace in volts (from 1 mV/div to 20 V/div).

**List Trace Values** Softkey in define hardcopy menu. Defines the hardcopy as a list of data trace values (frequency and amplitude), one pair for each data point.

**NOTE**

Plotting lists with many data points can be very time consuming.

See "Printing and Plotting Measurement Results" in Chapter 4 for more information.

Access Keys: **HARD COPY** **Define Hardcopy Menu**

**Load CC From Disk** Softkey in update correction constants menu. Loads a temporary copy of CC data from floppy disk to the analyzer's internal volatile RAM.

See the *Service Guide* for more information.

Access Keys: **SYSTEM OPTIONS** **Service Update Corr Const**

**Log Mag** Softkey in **FORMAT** menu. Displays the logarithmic magnitude of the data in dB. This is the default format.

**Lower** (Option 1C2, IBASIC, only) Softkey in IBASIC display menu. Displays the IBASIC program on the lower half of the screen and measurement data on the upper half.

See the *HP Instrument BASIC User's Handbook* for more information.

Access Keys: **SYSTEM OPTIONS** **IBASIC** **IBASIC Display**

---

## M

**Mag dBmV** (Option 1EC, 75  $\Omega$  analyzer, only) Softkey in 75 ohm formats menu. In 75  $\Omega$  instruments, displays the data scaled in dBmV per division.

Access Keys: **FORMAT** 75 Ohm Formats

**Mag dB $\mu$ V** (Option 1EC, 75  $\Omega$  analyzer, only) Softkey in 75 ohm formats menu. In 75  $\Omega$  instruments, displays the data scaled in dB $\mu$ V per division.

Access Keys: **FORMAT** 75 Ohm Formats

**Mag dBV** (Option 1EC, 75  $\Omega$  analyzer, only) Softkey in 75 ohm formats menu. In 75  $\Omega$  instruments, displays the data scaled in dBV per division.

Access Keys: **FORMAT** 75 Ohm Formats

**Make Directory** Softkey in the directory utilities menu. Displays character entry menu for entry of directory name.

See "To Use Directory Utilities" in Chapter 4 for more information.

Access Keys: **SAVE RECALL** File Utilities Directory Utilities

**Manual Zero** Softkey in detector zero menu. Compensates for detector drift once when selected. Recommended setting with external RF source at detectors to coordinate RF off and zeroing.

Access Keys: **CAL** Detector Zero

**Marker** Softkey in add max line, add min line, add max point, and add min point menus. Adds a marker to the data trace and allows it to be moved to identify trace frequencies and amplitudes.

Access Keys: **DISPLAY** Limit Menu Add Limit Add Max Line or Add Min Line or Add Max Point or Add Min Point



**MARKER** Hardkey in the CONFIGURE area. Displays menu to set markers, use marker search and delta markers.

See “Using Markers” in Chapter 4 for more information.

**Marker →  
Center** Softkey in marker functions menu. Changes the center frequency to that of the active marker and modifies the frequency span accordingly. If markers are off, it first turns on marker #1 at its previous setting or at the center frequency (default).

Access Keys: **MARKER** **Marker Functions**

**Marker →  
Reference** Softkey in marker functions menu. Makes reference level of graticule equal to marker value; does not change reference *position*. If markers are off, it first turns on marker #1 at its previous setting or the center frequency (default).

Access Keys: **MARKER** **Marker Functions**

**Marker  
Functions** Softkey in **MARKER** menu. Invokes menu to select delta marker mode, marker to center, marker to reference, and marker math functions.

**Marker  
Math** Softkey in marker functions menu. Brings up menu to select statistics, flatness, and RF filter statistics calculations on user-defined trace segments.

See **Flatness**, **RF Filter Stats**, and **Statistics** in this chapter.

Access Keys: **MARKER** **Marker Functions**

**Marker  
Search** Softkey in **MARKER** menu. Displays marker search menu to set active marker to maximum or minimum point or user defined target value. Also presents bandwidth and notch search functions, as well as the marker tracking mode.

See “Using Markers” in Chapter 4 for more information.

**Max Limit** Softkey in marker limits menu. Use this key to set the maximum limit for the statistical mean in a statistics marker search, or to set the maximum flatness in a flatness marker search.

See “To Use Marker Limit Functions” in Chapter 4 for more information.

Access Keys: **DISPLAY** **Limit Menu** **Mkr Limits**

**Max Search** Softkey in marker search menu. Places the active marker at the frequency point of maximum amplitude. If tracking is off, marker remains at that frequency. If tracking is on, marker moves to the maximum point with each sweep.

See “Using Markers” in Chapter 4 for more information.

Access Keys: **MARKER** **Marker Search**

**Medium** Softkey in the system bandwidth menu. Medium is the default system bandwidth.  
**3700 Hz**

See Chapter 5, “Optimizing Measurements,” for information on how system bandwidth can affect your measurements.

Access Keys: **AVG** **System Bandwidth**

**Memory** Softkey in **DISPLAY** menu. Displays the trace memory of the active channel, using the current display format, scale, and reference.

**NOTE**

Trace data must have been saved in memory previously with **Data->Mem**.

**Memory 1 Pen** Softkey in the set pen numbers menu. Sets pen number assignment (color) for memory trace 1 on hardcopy.

Access Keys: **HARD COPY** **Define Plotter** **Set Pen Numbers**

**Memory 2 Pen** Softkey in the set pen numbers menu. Sets pen number assignment (color) for memory trace 2 on hardcopy.

Access Keys: **HARD COPY** **Define Plotter** **Set Pen Numbers**

**MENU** Hardkey in the SOURCE area. Displays menu with source setting selections: trigger functions, number of points, external reference, and spur avoid features.

**MHz** Softkey in display frequency resolution menu. Displays frequency to MHz resolution. For example, 1.234 567 MHz is displayed as 1 MHz (note rounding down).

Access Keys: **FREQ** **Disp Freq Resolution**

**Min Limit** Softkey in marker limits menu. Use this key to set the minimum limit for the statistical mean in a statistics marker search, or to set the minimum flatness in a flatness marker search.

See "To Use Marker Limit Functions" in Chapter 4 for more information.

Access Keys: **DISPLAY** **Limit Menu** **Mkr Limits**

**Min Search** Softkey in marker search menu. Places the active marker at the frequency point of minimum amplitude. If tracking is off, marker remains at that frequency. If tracking is on, marker moves to the minimum point with each sweep.

See "Using Markers" in Chapter 4 for more information.

Access Keys: **MARKER** **Marker Search**

**Mixer** Softkey in **BEGIN** menu. Displays menu with selections suitable for mixer and frequency converter measurements: conversion loss, reflection, and AM delay (for analyzers with option 1DA or 1DB).

See "Measuring Conversion Loss" in Chapter 3 for an example conversion loss measurement.

**Mkr Limit** Softkey in marker limits menu. Turns marker limit testing on or off.

**on OFF** See "To Use Marker Limit Functions" in Chapter 4 for more information.

Access Keys: **DISPLAY** **Limit Menu** **Mkr Limits**

**Mkr Limits** Softkey in limit menu. Displays marker limits menu where limit testing can be placed on statistics or flatness marker searches.

See "To Use Marker Limit Functions" in Chapter 4 for more information.

Access Keys: **DISPLAY** **Limit Menu**

**Mkr Symbol** Softkey in define graph menu. When on (default setting), prints or plots contain marker symbols.  
**ON off**

**NOTE**

**Graph and Mkr Table** or **Graph Only** must be selected for marker symbols to print or plot.

Access Keys: **HARD COPY** **Define Hardcopy** **Define Graph**

**Mkr Table Only** Softkey in define hardcopy menu. Defines the hardcopy output as a table of marker values (frequency and amplitude).

Access Keys: **HARD COPY** **Define Hardcopy**

**Mkr->Max** Softkey in marker search menu. Places the active marker at the frequency point of maximum amplitude. If tracking is off, marker remains at that frequency. If tracking is on, marker moves to the maximum point with each sweep.

See "Using Markers" in Chapter 4 for more information.

Access Keys: **MARKER** **Marker Search**

**Mkr->Min** Softkey in marker search menu. Places the active marker at the frequency point of minimum amplitude. If tracking is off, marker remains at that frequency. If tracking is on, marker moves to the minimum point with each sweep.

See "Using Markers" in Chapter 4 for more information.

Access Keys: **MARKER** **Marker Search**

**MM-DD-YYYY** Softkey in clock format menu. Formats the real-time internal clock to display time as Month-Day-Year Hour:Minute.

**HH:MM**

Access Keys: **SYSTEM OPTIONS** **System Config** **Set Clock**  
**Clock Format**

**Modify Size** Softkey in the configure RAM disk menu. Allows you to modify the memory allocation on the internal non-volatile RAM disk.

Access Keys: **SAVE RECALL** **Select Disk** **Configure RAM Disk**

**M**

**Monochrome** Softkey in define printer and define plotter menus. Toggles with **Color** to define printer or plotter as one color (black and white) or multi-color.  
See “Connecting and Configuring Printers and Plotters” in Chapter 4 for more information.

Access Keys: **HARD COPY** **Define Printer** *or* **Define Plotter**

**Monochrome Pen** Softkey in set pen numbers menu. Sets pen number assignment for hardcopy in monochrome plot mode.  
See “Connecting and Configuring Printers and Plotters” in Chapter 4 for more information.

Access Keys: **HARD COPY** **Define Plotter** **Set Pen Numbers**

**Multi Notch** Softkey in marker search more menu. Designed for use when measuring multi-pole filters. Automatically searches the measurement trace from left to right and positions up to 8 markers on consecutive minimum points.  
See “To Use Marker Search Functions” in Chapter 4 for more information.

Access Keys: **MARKER** **Marker Search** **More**

**Multi Peak** Softkey in marker search more menu. Designed for use when measuring multi-pole filters. Automatically searches the measurement trace from left to right and positions up to 8 markers on consecutive maximum points.  
See “To Use Marker Search Functions” in Chapter 4 for more information.

Access Keys: **MARKER** **Marker Search** **More**

## N

**Narrow 250 Hz** Softkey in the system bandwidth menu. The default system bandwidth is medium.

See Chapter 5, "Optimizing Measurements," for information on how system bandwidth can affect your measurements.

Access Keys: **AVG** **System Bandwidth**

**Narrowband Internal** Softkey in the detection options menu. Selects tuned receiver type measurements of inputs A, B, or R or the ratios A/R or B/R.

See "Measuring Devices with Your Network Analyzer" in Chapter 3 for more information.

Access Keys: **CHAN 1** or **CHAN 2** **Detection Options**

**Next Min Left** Softkey in the min search menu. Moves the active marker to the next nearest minimum point to the left. The next minimum point must be  $> -60$  dB, and the current minimum point difference to the next minimum point difference must be at least  $1/2$  of a vertical division. See Figure 10-1.

Access Keys: **MARKER** **Marker Search** **Min Search**

**Next Min Right** Softkey in the min search menu. Moves the active marker to the next nearest minimum point to the right. The next minimum point must be  $> -60$  dB, and the current minimum point difference to the next minimum point difference must be at least  $1/2$  of a vertical division. See Figure 10-1.

Access Keys: **MARKER** **Marker Search** **Min Search**

**Next Peak Left** Softkey in the max search menu. Moves the active marker to the next nearest peak to the left. The next peak must be  $> -60$  dB, and the current peak difference to the next peak difference must be at least  $1/2$  of a vertical division. See Figure 10-1.

Access Keys: **MARKER** **Marker Search** **Max Search**

**HARDKEY** / **Softkey** Reference

**N**

**Next Peak Right** Softkey in the max search menu. Moves the active marker to the next nearest peak to the right. The next peak must be  $> -60$  dB, and the current peak difference to the next peak difference must be at least  $1/2$  of a vertical division. See Figure 10-1.

Access Keys: **MARKER** **Marker Search** **Max Search**

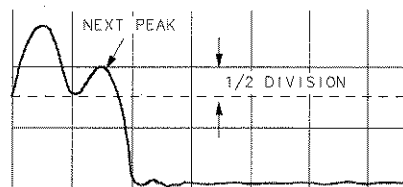

md66a

**Figure 10-1. Next Peak**

**Non-Vol RAM Disk** Softkey in the select disk menu. Selects the analyzer's internal non-volatile RAM as the location where information is saved, re-saved, or recalled. See "Saving and Recalling Measurement Results" in Chapter 4 for more information.

Access Keys: **SAVE RECALL** **Select Disk**

**None** (Option 1C2, IBASIC, only) Softkey in IBASIC display menu. Displays the measurement data on the full screen. (Does not show the IBASIC program on the display at all.)



**Normalize** Softkey in **DISPLAY** and **CAL** menus. Equivalent to selecting **Data->Mem** and **Data/Mem**. Corrects for frequency response errors only. The only type of measurement “calibration” for power or conversion loss measurements.

**NOTE**

This type of “calibration” is not interpolated: changes in frequency or the number of points invalidate it.

See “To Perform a Normalization Calibration” in Chapter 6 for more information.

**Notch** Softkey in marker search menu. Automatically calculates –6 dB (default) or other user-specified bandwidth, center frequency, and Q of a notch filter.

See “Using Markers” in Chapter 4 for more information.

Access Keys: **MARKER** **Marker Search**

**Number of Points** Softkey in the source **MENU**. Allows selection of the number of measurement points in a sweep: 3, 5, 11, 21, 51, 101, 201 (default), 401, 801, or 1601. As the number of points increases, frequency resolution increases and sweep speed decreases.

See “To Reduce the Number of Measurement Points” in Chapter 5 for information on how the number of measurement points selected can affect your measurements.

**Numeric** Softkey in clock format menu. Formats the real-time internal clock to display the number of the month (for example, 03 for March).

Access Keys: **SYSTEM OPTIONS** **System Config** **Set Clock**  
**Clock Format**

---

O

**One Port**

Softkey in reflection cal menu for starting a user-defined reflections calibration.

See "To Perform A Reflection Calibration" in Chapter 6 for more information.

Access Keys: **CAL** **Reflection**

**Operating  
Parameters**

Softkey in **SYSTEM OPTIONS** menu. Displays five screens of channel settings, cal kit definitions, instrument settings, and instrument configuration.

P

**Perform Secure** (Option 1C2, IBASIC, only) Softkey in secure menu. Use with caution: secured program lines can not be listed, seen, or edited.

See the *HP Instrument BASIC User's Handbook* for more information.

Access Keys: **SYSTEM OPTIONS** **IBASIC** **Utilities** **Secure**

**Portrait** Softkey in define printer menu. Sets printer to print hardcopy so that paper is oriented with shorter edge at top and longer edges at sides. Portrait is the default setting, and toggles with **Landscape**.

Access Keys: **HARD COPY** **Define Printer**

**Power** Softkey in amplifier and measurement menus, suitable for power measurements.

See "Making a Power Measurement" in Chapter 3 for an example power measurement.

Access Keys: **BEGIN** **Amplifier** or **CHAN 1** or **CHAN 2**

**POWER** Hardkey in SOURCE area. Sets the power level of the internal RF source and turns it on and off. Also allows setting of parameters for power sweep.

**Power Sweep** Softkey in **SWEEP** menu. This softkey turns on a power sweep mode that is used to characterize power-sensitive circuits. In this mode, power is swept at a single frequency. The start- and stop-power values are selectable under the **POWER** key. This feature is convenient for such measurements as gain compression or automatic gain control (AGC) slope.

The span of the swept power is limited to being equal to or within one of the seven pre-defined power ranges.

Power sweep is independent of level. Use this function with frequency CW mode only.

**PRESET** Hardkey in SYSTEM area. Pushing this key returns the analyzer to a known state. See Chapter 14 for a complete list of preset state default parameters.

**PRESET** can also be used in the event that your analyzer system locks up, or you receive an “Unrecoverable error.” If this should happen, cycle the power on the analyzer, and press the **PRESET** key several times while the analyzer is booting up. (The **PRESET** key must be pressed at least twice after you hear the double beep). Then, follow the on-screen instructions.

**Print** Softkey in more printer menu. Sets print width (printing space) in mm.

**Width** See “Connecting and Configuring Printers and Plotters” in Chapter 4 for more information.

Access Keys: **HARD COPY** **Define Printer** **More Printer**

**Printer Resolution** Softkey in more printer menu. Sets printer resolution in terms of dots per inch. Check printer manual for appropriate setting. Default is 96 dots per inch.

See “Connecting and Configuring Printers and Plotters” in Chapter 4 for more information on printer resolution.

Access Keys: **HARD COPY** **Define Printer** **More Printer**

**Programs** (Option 1C2, IBASIC, only) Softkey in **SAVE RECALL** menu. Displays menu to save, re-save, recall programs, or save a program as an autostart (AUTOST) program.

See the *HP Instrument BASIC User's Handbook* for more information.

**Pwr Sweep Range** Softkey in **POWER** menu. Leads to the power sweep ranges menu. There are 7 predetermined power ranges to choose from.

See **Power Sweep** entry in this chapter for more information on the power sweep function.

## R

**R** Softkey in narrowband internal menu. Selects tuned receiver type of measurement of input R (reference signal).

See "Measuring Devices with Your Network Analyzer" in Chapter 3 for information on receiver inputs.

Access Keys: **CHAN 1** or **CHAN 2** **Detection Options**  
**Narrowband Internal**

**R\*** Softkey in broadband internal menu. Selects diode detection type measurement of input R\* (broadband internal reference signal).

See "Measuring Devices with Your Network Analyzer" in Chapter 3 for information on receiver inputs.

Access Keys: **CHAN 1** or **CHAN 2** **Detection Options**  
**Broadband Internal**

**Re-Save Program** (Option 1C2, IBASIC, only) Softkey in programs menu. Displays character entry menu to re-title program and save it to memory or disk.

See the *HP Instrument BASIC User's Handbook* for more information.

Access Keys: **SAVE RECALL** **Programs**

**Re-Save State** Softkey in **SAVE RECALL** menu. Displays character entry menu to re-title file and save it to memory or disk. Also can be used when saving a file for the first time if you wish to give the file a specific name, rather than having the analyzer automatically name it.

**Recall** (Option 1C2, IBASIC, only) Softkey in IBASIC edit menu.

**Line** Access Keys: **SYSTEM OPTIONS** **IBASIC Edit**

**Recall Program** (Option 1C2, IBASIC, only) Softkey in programs menu. Recalls to the network analyzer a program from internal memory, internal disk, or external disk.

See the *HP Instrument BASIC User's Handbook* for more information.

Access Keys: **SAVE RECALL** **Programs**

**Recall State** Softkey in **SAVE RECALL** menu. Recalls instrument state files (not plot files) from internal memory, internal disk, or external disk.

See "Saving and Recalling Measurement Results" in Chapter 4 for more information.

**Reference Level** Softkey in **SCALE** menu. Sets the value of the reference line. The reference value is noted on the screen as "Ref".

**Reference Position** Softkey in **SCALE** menu. Sets the position of the reference line from the top of the graticule (10) to the bottom (0) or in between. Default position is middle (5).

See Figure 2-3 in Chapter 2.

**Reflection** Softkey in amplifier, filter, broadband passive, mixer, measurement, and calibration menus. Selects forward reflection type of measurement. Power is output from the RF OUT port and also measured there.

See "Measuring Reflection Response" in Chapter 3 and "To Perform a Reflection Calibration" in Chapter 6 for more information.

Access Keys: **CHAN 1** or **CHAN 2** or **BEGIN** or **CAL**

**Remove Directory** Softkey in directory utilities menu. First highlight the intended directory, then press **Remove Directory**. Deletes empty directories only.

See "To Use Directory Utilities" in Chapter 4 for more information.

Access Keys: **SAVE RECALL** **File Utilities** **Directory Utilities**

**Rename File** Softkey in file utilities menu. Displays character entry menu to rename the highlighted file.

See "Other File Utilities" in Chapter 4 for more information.

Access Keys: **SAVE RECALL** File Utilities

**Response** Softkey in transmission cal menu. A measurement calibration that corrects for frequency response errors. Frequency response errors are signal changes as a function of frequency.

See Chapter 6, "Calibrating for Increased Measurement Accuracy" for more information.

Access Keys: **CAL** Transmission

**Response & Isolation** This calibration removes the same frequency response errors as the response calibration. In addition, it effectively removes the isolation errors in transmission measurements. Isolation errors result from leakage between signal paths (crosstalk).

See Chapter 6, "Calibrating for Increased Measurement Accuracy" for more information.

Access Keys: **CAL** Transmission

**Restart Average** Softkey in **AVG** menu. Clears the running average and restarts it with the next sweep.

See "To Reduce the Receiver Noise Floor" in Chapter 5 for information on averaging.

**Restore Defaults**

Softkey in several menus such as the calibration menus, the hardcopy menus, and the external CRT adjust menu.

1. If this key is pressed in the transmission, reflection, and AM delay calibration menus, the default measurement calibration becomes the active calibration. This calibration is originally performed and stored in non-volatile memory at the factory by performing an adjustment test. It is a full frequency span cal of 401 points. When selected, it erases a user defined cal, if any.

See Chapter 6 for more information on measurement calibrations.

2. If this key is pressed in the hardcopy menus, it resets parameters such as addresses, baud rates, handshakes, color, pens, resolution, and margins to predetermined values.

See "Printing and Plotting Measurement Results" in Chapter 4 for more information on using the **HARD COPY** menus.

3. If this key is pressed in the external CRT adjustment menu, it restores the default CRT timing values.

**RF Filter Stats**

Softkey in marker math menu. Measures both the passband and stopband of a filter in one sweep.

See "To Use Marker Math Functions" in Chapter 4 for more information.

Access Keys: **MARKER** **Marker Functions** **Marker Math**

**RF ON off**

Softkey in **POWER** menu. Turns the internal RF source off and on. Default is ON.

**Round Seconds**

Softkey in set clock menu. Rounds off seconds to nearest minute. Rounds down with less than 30 seconds; rounds up to next minute with more than 30 seconds.

Access Keys: **SYSTEM OPTIONS** **System Config**

**Run**

(Option 1C2, IBASIC, only) Softkey in IBASIC menu that starts a program.

See the *HP Instrument BASIC User's Handbook* for more information.

Access Keys: **SYSTEM OPTIONS** **IBASIC**



## S

**Save ASCII** Softkey in define save menu. Selects which channel's (1 or 2) trace data is to be saved in ASCII format for output. Can be used with spreadsheets.

See "Saving and Recalling Measurement Results" in Chapter 4 for more information.

Access Keys: **SAVE RECALL** **Define Save**

**Save** (Option 1C2, IBASIC, only) Softkey in programs menu. Titles the current program AUTOST and saves it to memory or disk as set by **Select Disk**.  
**AUTOST** At power-up, the network analyzer searches the internal non-volatile disk and the internal floppy disk for an AUTOST (auto-start) file, loads it, and executes it if present.

Access Keys: **SAVE RECALL** **Programs**

**Save** Softkey in Save ASCII menu. Selects channel 1 measurement data to be saved as ASCII data. This data can be imported into a spreadsheet or word processing program.  
**Chan 1**

See "Saving and Recalling Measurement Results" in Chapter 4 for more information.

Access Keys: **SAVE RECALL** **Define Save** **Save ASCII**

**Save** Softkey in Save ASCII menu. Selects channel 1 measurement data to be saved as ASCII data. This data can be imported into a spreadsheet or word processing program.  
**Chan 2**

See "Saving and Recalling Measurement Results" in Chapter 4 for more information.

Access Keys: **SAVE RECALL** **Define Save** **Save ASCII**

**S**

**Save Program** (Option 1C2, IBASIC, only) Softkey in programs menu. Saves the current program to memory or disk.

See the *HP Instrument BASIC User's Handbook* for more information.

Access Keys: **SAVE RECALL** **Programs**

**SAVE RECALL** Hardkey in SYSTEM area of front panel. Displays menus to save, title, define, and recall states and programs; rename, delete, and copy files; and select, configure, and format disks.

See "Saving and Recalling Measurement Results" in Chapter 4 for examples.

**Save State** Softkey in **SAVE RECALL** menu. Saves information to memory or disk, automatically naming the file "STATE#."

See "Saving and Recalling Measurement Results" in Chapter 4 for more information.

**SCALE** Hardkey in CONFIGURE area of front panel. Allows changing of scale per division, and reference level and position for optimum viewing of measurements.

See "Entering Measurement Parameters" in Chapter 2 for more information on using the **SCALE** functions.

**Scale/Div** Softkey in **SCALE** menu. Sets the value of vertical divisions of graticule. For example, if the scale/div is 10 dB, each graticule line is 10 dB higher than the one below.

**Search left** Softkey in target search menu. During a target search, moves the active marker to the left (lower frequency) to the first occurrence on the data trace where the amplitude equals the target value. That first occurrence may be an actual data point or an interpolated value.

See "To Use Marker Search Functions" in Chapter 4 for an example of how to use the target search function.

Access Keys: **MARKER** **Marker Search** **Target Search**

**Search Off** Softkey in marker search menu. With tracking on, disables searching for maximum, minimum, target value, bandwidth, or notch.

See “Using Markers” in Chapter 4 for more information on using marker search functions.

Access Keys: **MARKER** Marker Search

**Search right** Softkey in target search menu. During a target search, moves the active marker to the right (higher frequency) to the first occurrence on the data trace where the amplitude equals the target value. That first occurrence may be an actual data point or an interpolated value.

See “To Use Marker Search Functions” in Chapter 4 for an example of how to use the target search function.

Access Keys: **MARKER** Marker Search Target Search

**Seconds ON off** Softkey in clock format menu. Toggles on and off the seconds annotation that is displayed or printed as part of the clock.

Access Keys: **SYSTEM OPTIONS** System Config Set Clock  
Clock Format

**Secure** (Option 1C2, IBASIC, only) Softkey in utilities menu. Enables user to define part or all of a program by start and end lines. Once secured, the defined lines can not be listed, seen, or edited.

See the *HP Instrument BASIC User's Handbook* for more information.

Access Keys: **SYSTEM OPTIONS** IBASIC Utilities

**Select** Softkey in select copy port menu. Selects the hardcopy port device highlighted in the select copy port list.

See “Connecting and Configuring Printers and Plotters” in Chapter 4 for more information.

Access Keys: **HARD COPY** Select Copy Port

**Select Char** Softkey in character entry menu. Adds the character selected by the pointer to the end of a title or file name.

**Select Char/Word** (Option 1C2, IBASIC, only) Softkey in insert line and insert character menus. Adds character or word selected by pointer to an IBASIC program.

Access Keys: **SYSTEM OPTIONS** **IBASIC** **Edit** **Insert Line** or **Insert Char**

**Select Copy Port** Softkey in **HARDCOPY** menu. Displays menu to select the hardcopy output device and its operating parameters. Default settings (not affected by preset) are HP printer, PCL language, parallel port. Use the front panel knob or arrow keys to highlight the device, then press **Select**.

**NOTE**

"Hardcopy Address" applies only to HP-IB devices; "Baud Rate," "Xon/Xoff," and "DTR/DSR" apply only to serial devices.

See "Connecting and Configuring Printers and Plotters" in Chapter 4 for more information.

**Select Disk** Softkey in **SAVE RECALL** menu. Displays menu to select type of disk or memory location to save to or recall from: internal non-volatile memory, internal volatile memory, built-in 3.5" disk, or external disk. Also allows configuration of external disk and internal non-volatile memory.

See "Saving and Recalling Measurement Results" in Chapter 4 for more information.

**Service** Softkey in **SYSTEM OPTIONS** menu. Displays menus related to service, including displaying instrument information (see **Instrument Info**). See the *Service Guide* for more information.

**Service** Softkey in service menu. Displays menu of service functions.

**Utilities** See the *Service Guide* for details.

**Set Clock** Softkey in the system configure menu. Displays menu to set real-time internal clock of network analyzer and its format.

Access Keys: **SYSTEM OPTIONS** **System Config**

**Set Day** Softkey in set clock menu. Use this key to set the day of the month.

Access Keys: **SYSTEM OPTIONS** **System Config** **Set Clock**

**Set Hour** Softkey in set clock menu. Use this key to set the hour value on the clock.

Access Keys: **SYSTEM OPTIONS** **System Config** **Set Clock**

**Set Minute** Softkey in set clock menu. Use this key to set the minute value on the clock.

Access Keys: **SYSTEM OPTIONS** **System Config** **Set Clock**

**Set Month** Softkey in set clock menu. Use this key to set the month.

**NOTE**

When selecting the month, you will always input a number that corresponds to the month desired. If the clock format is set to "alpha," however, the displayed month will be a three letter abbreviation (such as Mar for March).

Access Keys: **SYSTEM OPTIONS** **System Config** **Set Clock**

**Set Pen Numbers** Softkey in define plotter menu. Displays set pen numbers menu to assign pen numbers to items to be plotted (like traces, graticule, etc.). In color setting, different items can be plotted with different pens. In monochrome setting, all items are printed with the same pen.

See “Connecting and Configuring Printers and Plotters” in Chapter 4 for more information.

Access Keys: **HARD COPY** **Define Plotter**

**Set Year** Softkey in set clock menu. Use this key to set the year on the clock.

Access Keys: **SYSTEM OPTIONS** **System Config** **Set Clock**

**Show Clock on Line 1** Softkey in title and clock menu. Displays the clock on the uppermost line of the title area when **Title+Clk ON off** is on.

Access Keys: **DISPLAY** **More Display** **Title and Clock**

**Show Clock on Line 2** Softkey in title and clock menu. Displays the clock on the uppermost line of the title area when **Title+Clk ON off** is on.

Access Keys: **DISPLAY** **More Display** **Title and Clock**

**Show Size** Softkey in the configure RAM disk menu. Displays a message box that shows the total memory available and the current memory allocation for the internal non-volatile RAM disk.

Access Keys: **SAVE RECALL** **Select Disk** **Configure RAM Disk**

**Single** Softkey in trigger menu. Immediately stops the current sweep, takes one complete sweep, and holds until retriggered by pressing **Single** again, or **Continuous**.

Access Keys: **MENU** **Trigger**

**Softkey** Softkey in the system config menu. Displays a pop-up message with a description of softkey sequencing and softkeys to enable or disable the auto-step function.

**Auto-Step**

See “Measurement Setup and Control with Fast Recall” in Chapter 7 for more information.

Access Keys: **SYSTEM OPTIONS** **System Config**

**Space** Softkey in character entry menu. Adds a blank space to a title or filename.

**Span** Softkey in **FREQ** menu. Used in conjunction with **Center**. Selects the frequency span of source. When selected, it changes the frequency annotation from start/stop to center/span.

See “Entering Measurement Parameters” in Chapter 2 for more information.

**Split Disp** Softkey in more display menu. Toggles the display mode between split (channel 1 on top, channel 2 on the bottom) and full (both channels on full screen).

**FULL split**

See “Entering Measurement Parameters” in Chapter 2 for more information.

Access Keys: **DISPLAY** **More Display**

**Spur Avoid** Softkey in spur avoid options menu. If this option is selected, the analyzer switches between the default and an alternate configuration during a sweep to avoid spurs.

#### NOTE

Sweeptime usually increases when this option is selected.

See “Reducing Trace Noise” in Chapter 5 for more information.

Access Keys: **MENU** **Spur Avoid Options**

**Spur Avoid Options** Softkey in source **MENU**. Displays selections for spur avoidance: dither, spur avoid, or none.

**SRL** (Option 100 only) Softkey in reflection or cable menu. Sets up the analyzer to perform structural return loss (SRL) measurements. See your *User's Guide Supplement for Option 100* for information.

**Stack** (Option 1C2, IBASIC, only) Softkey in utilities menu.

**Size** Access Keys: **SYSTEM OPTIONS** **IBASIC Utilities**

**Start** Softkey in two menus: **FREQ** and **HARD COPY**.

1. In **FREQ** menu, sets the start frequency of source. Minimum frequency is 300 kHz. When start is selected, the other frequency parameter is stop.

See "Entering Measurement Parameters" in Chapter 2 for more information.

2. In **HARD COPY** menu, starts print or plot as set in select copy port menu.

See "Printing and Plotting Measurement Results" in Chapter 4 for more information.

**Start** (Option 1C2, IBASIC, only) Softkey in secure menu.

**Line #** See the *HP Instrument BASIC User's Handbook* for more information.

**Start Power** Softkey in **POWER** menu. Sets starting point (in dBm) for a power sweep measurement. **Power Sweep** in **SWEEP** menu must be selected before setting the start and stop power points.

See **Power Sweep** entry in this chapter for more information on the power sweep function.



**Statistics** Softkey in marker math menu. Measures a user-defined segment of a measurement trace and calculates the frequency span, mean, and standard deviation of the amplitude response, and the peak-to-peak ripple.

See "To Use Marker Math Functions" in Chapter 4 for more information.

Access Keys: **MARKER** **Marker Functions** **Marker Math**

**Step** (Option 1C2, IBASIC, only) Softkey in IBASIC menu. When a program is ready to run, this softkey steps through the program one line at a time. Good de-bugging tool.

See the *HP Instrument BASIC User's Handbook* for more information.

Access Keys: **SYSTEM OPTIONS** **IBASIC**

**Stop** Softkey in **FREQ** menu. Sets the stop frequency of source. Maximum frequency is 1.3 GHz for HP 8711B and 3.0 GHz for HP 8713B.

**Stop Power** Softkey in **POWER** menu. Sets stopping point (in dBm) for a power sweep measurement. **Power Sweep** in **SWEEP** menu must be selected before setting the start and stop power points.

See **Power Sweep** entry in this chapter for more information on the power sweep function.

**Store CC To Disk** Softkey in update correction constants menu. Writes a copy of CC data from internal volatile RAM to a disk. This function is used to make a backup copy of CC data.

See the *Service Guide* for more information.

Access Keys: **SYSTEM OPTIONS** **Update Corr Const**

**Store CC To EPROM** Softkey in update correction constants menu. Writes a copy of CC data from internal volatile RAM to EPROM. This function is used so that current CC data is not lost when power to the analyzer is turned off.

See the *Service Guide* for more information.

Access Keys: **SYSTEM OPTIONS** **Update Corr Const**

**S**

**SWEEP** Hardkey in SOURCE area of front panel. Displays menu to select automatic sweep time (fastest possible), manual sweep, alternate sweep, or power sweep.

**Sweep Time** Softkey in **SWEEP** menu. Sets the sweep time from fastest possible to three days (259.2 ks); overrides auto sweep time. Fastest possible sweep time varies, and depends on other analyzer settings.

See Chapter 5, "Optimizing Measurements" for more information on sweep time.

**Sweep Time** Softkey in **SWEEP** menu. Sets the network analyzer to sweep as fast as possible (automatic) or at the sweep time of your choice (manual).  
**AUTO man**

See Chapter 5, "Optimizing Measurements" for more information on sweep time.

**SWR** Softkey in **FORMAT** menu. Displays the data formatted as SWR (standing wave ratio).

**System** Softkey in the **AVG** menu. Displays menu to set bandwidth of IF filters in receiver section of network analyzer.  
**Bandwidth**

See "To Reduce the Receiver Noise Floor" and the table below for more information on system bandwidth.

System BW	Dynamic Range	Sweep Speed	Approximate BW
Wide	Low	Fastest	6500 Hz
Medium (default)	Medium	Fast	3700 Hz
Narrow	High	Slow	250 Hz
Fine	High	Slowest	15 Hz

**System Config** Softkey in **SYSTEM OPTIONS** menu. Displays menu to adjust clock setting, set beeper volume, and adjust external CRT settings.

**System Controller** Softkey in HP-IB menu. Makes the network analyzer the system controller of the HP instrument bus. Required mode for interfacing with HP-IB peripherals (printers, plotters, and disk drives). Also required by IBASIC to talk to HP-IB peripherals. This operation mode is not selectable with another active controller on the bus.

See the *Programmer's Guide* for more information.

Access Keys: **SYSTEM OPTIONS** **HP-IB**

**SYSTEM OPTIONS** Hardkey in SYSTEM area of front panel.

---

T

**Talker Listener** Softkey in HP-IB menu. HP-IB mode normally used for remote (computer) control of the network analyzer. The computer can designate the network analyzer as talker or listener. The network analyzer cannot talk directly with other peripherals in this mode unless the computer establishes a data path for it.

Access Keys: **SYSTEM OPTIONS** **HP-IB**

**Target Search** Softkey in marker search menu. Displays menu to set target search value, search left, or search right.

See "Using Markers" in Chapter 4 for more information.

Access Keys: **MARKER** **Marker Search**

**Target Value** Softkey in target search menu. Sets value of target sought by **Search Left** or **Search Right**. Default value is -3 dB.

**NOTE**

Since markers are continuous but frequency points are discrete, target values may be interpolated.

See "Using Markers" in Chapter 4 for more information.

Access Keys: **MARKER** **Marker Search** **Target Search**

**Tests and Adjustments** Softkey in service menu. Displays menu to perform tests, including self-tests, and adjustments.

See the *Service Guide* for information on tests and adjustments.

**Title+Clk ON off** Softkey in title and clock menu. Used to show the title (if any) and date/time on the display and/or on a hardcopy output.

Access Keys: **DISPLAY** **More Display** **Title and Clock** or **HARD COPY**  
**Define Hardcopy** **Define Graph**

**Title and Clock** Softkey in more display menu. Displays menu to display and edit screen title and display clock.

Access Keys: **DISPLAY** **More Display**

**Top Margin** Softkey in more printer menu. Sets top margin of printout (non-printing space) in mm. Minimum setting is 0.00 mm (default); maximum setting is 200.00 mm.

Access Keys: **HARD COPY** **Define Printer** **More Printer**

**Trace 1 Pen** Softkey in set pen numbers menu. Sets pen number assignment for data trace 1 on hardcopy. Different pen numbers can represent different color or width pens.

See "Connecting and Configuring Printers and Plotters" in Chapter 4 for more information.

Access Keys: **HARD COPY** **Define Plotter** **Set Pen Numbers**

**Trace 2 Pen** Softkey in set pen numbers menu. Sets pen number assignment for data trace 2 on hardcopy. Different pen numbers can represent different color or width pens.

See "Connecting and Configuring Printers and Plotters" in Chapter 4 for more information.

Access Keys: **HARD COPY** **Define Plotter** **Set Pen Numbers**

**Trace Data** Softkey in define graph menu. When on, prints or plots measurement trace data when **Graph and Mkr Table** or **Graph Only** is selected.

**ON off**

Access Keys: **HARD COPY** **Define Hardcopy** **Define Graph**

**Tracking** Softkey in marker search menu. When tracking is on, the marker-to-max, marker-to-min, bandwidth, target search, and notch functions are updated with each trace. When tracking is off (default setting), the functions are performed only once, when selected.

**on OFF**

See "Using Markers" in Chapter 4 for more information.

Access Keys: **MARKER** **Marker Search**

**Transmissn** Softkey in amplifier, filter, broadband passive, measurement, and calibration menus. Selects ratioed forward transmission type of measurement, or transmission calibration selections.

See "Measuring Transmission Response" in Chapter 3 and "To Perform a Transmission Calibration" in Chapter 6 for more information.

**Trigger** Softkey in source **MENU**. Displays menu with choices for triggering the analyzer. The analyzer can be triggered continuously (default setting) or once. It can be triggered internally (default setting), externally, or externally one frequency point at a time.

**Trigger** Softkey in trigger menu. Displays menu for choice of internal or external triggering.

**Source**

Access Keys: **MENU** **Trigger**

## U

**Update** Softkey in service menu. Displays a menu to store correction constants to  
**Corr Const** disk or memory, or load them from disk.

See the *Service Guide* for more information.

**Upper** (Option 1C2, IBASIC, only) Softkey in IBASIC display menu. Displays the  
IBASIC program on the upper half of the screen and measurement data on the  
lower half.

Access Keys: **SYSTEM OPTIONS** **IBASIC** **IBASIC Display**

**User BEGIN** (Option 1C2, IBASIC, only) Softkey in **BEGIN** menu.

**on OFF** See “The User BEGIN Function” in Chapter 3 for more information.

**User TTL** Softkey in the softkey sequencing menu. Enables the softkey auto-step  
**Input** capability when a switch is connected to the USER TTL IN/OUT rear panel  
connector.

See “Measurement Setup and Control with Fast Recall” in Chapter 7 for more  
information.

Access Keys: **SYSTEM OPTIONS** **System Config** **Softkey Auto-Step**

**Utilities** (Option 1C2, IBASIC, only) Softkey in IBASIC menu. Enables user to clear  
program, set memory size, or secure programs.

See the *HP Instrument BASIC User's Handbook* for more information.

Access Keys: **SYSTEM OPTIONS** **IBASIC**

---

V

**Vertical Back Porch** Softkey in external CRT adjustment menu. CRT timing adjustment for use with external monitors. Also affects network analyzer's internal CRT. Default setting is 622.8  $\mu$ sec.

See "BNC Connectors" in Chapter 8 for more information.

Access Keys: **SYSTEM OPTIONS** **System Config** **External CRT Adjust**

**Vertical Frnt Porch** Softkey in external CRT adjustment menu. CRT timing adjustment for use with external monitors. Also affects network analyzer's internal CRT. Default setting is 16.6 msec.

See "BNC Connectors" in Chapter 8 for more information.

Access Keys: **SYSTEM OPTIONS** **System Config** **External CRT Adjust**

**Volatile RAM Disk** Softkey in select disk menu. Selects the analyzer's internal volatile RAM as the place where information will be saved to or recalled from.

---

**CAUTION**

Any information stored on the volatile RAM disk will be lost if the analyzer's power is turned off.

See "Saving and Recalling Measurement Results" in Chapter 4 for more information.

Access Keys: **SAVE RECALL** **Select Disk**



---

W

**Wide** Softkey in the system bandwidth menu. This is the widest system bandwidth available. (Medium is the default system bandwidth.)  
**6500 Hz**

See Chapter 5, "Optimizing Measurements," for information on how system bandwidth can affect your measurements.

Access Keys: **AVG** System Bandwidth

## X

**X** Softkey in broadband external menu. Selects diode detection type of measurement with an external detector connected to the EXT DET X-INPUT on the rear panel.

Access Keys: **CHAN 1** or **CHAN 2** **Detection Options**  
**Broadband External**

**X/Y** Softkey in broadband external menu. Selects measurement of the ratio of external detectors at inputs X and Y.

Access Keys: **CHAN 1** or **CHAN 2** **Detection Options**  
**Broadband External**

**Xon/Xoff** Softkey in select copy port menu. A software handshake for some serial devices. Toggles with **DTR/DSR**.

Access Keys: **HARD COPY** **Select Copy Port**

Y

**Y** Softkey in broadband external menu. Selects diode detection type of measurement with an external detector connected to the EXT DET Y-INPUT on the rear panel.

Access Keys: **CHAN 1** or **CHAN 2** **Detection Options**  
**Broadband External**

**Y-axis Lbl** Softkey in more display menu. Toggles annotations to left of graticule on and off: reference line indicator, graticule values, etc.  
**ON off**

**NOTE**

Graticule values are limited to four characters including "." and "-". If any graticule value exceeds four characters, all values are blanked. For example, 23.45 blanks the values; it is not truncated as 23.4 or rounded up as 23.5. Similarly -1.23 blanks the graticule values.

Access Keys: **DISPLAY** **More Display**

**Y-axis Lbl** Softkey in more display menu. Toggles graticule value annotation and values: in ABS mode, absolute value of each horizontal graticule line is indicated; in REL mode, value of each horizontal graticule is indicated relative to the value of the reference line.  
**rel ABS**

Access Keys: **DISPLAY** **More Display**

**Y/R\*** Softkey in broadband external menu. Selects measurement of the ratio of the external detectors at inputs Y and R\*.

Access Keys: **CHAN 1** or **CHAN 2** **Detection Options**  
**Broadband External**

**Y/X** Softkey in broadband external menu. Selects measurement of the ratio of the external detectors at inputs Y and X.

Access Keys: **CHAN 1** or **CHAN 2** **Detection Options**  
**Broadband External**

**YYYY-MM-DD** Softkey in clock format menu. Formats the real-time internal clock to display time as Year-Month-Day Hour:Minute.

**HH:MM**

Access Keys: **SYSTEM OPTIONS** **System Config** **Set Clock**  
**Clock Format**

YYYY-MM-DD HH:MM

---

Specifications and  
Characteristics

---

## Specifications and Characteristics

### System Specifications

The specifications and characteristics in this section describe the system performance of the analyzer. The system is defined as the network analyzer itself (which includes a built-in transmission/reflection test set) and the following:

A calibration kit — either HP 85032E (50  $\Omega$ ) or HP 85036E (75  $\Omega$ )

A test port cable — either HP part number 8120-6469 (50  $\Omega$ ) or HP part number 8120-6468 (75  $\Omega$ )

Specifications describe the instrument's warranted performance over the temperature range of  $25^{\circ} \pm 5^{\circ} \text{C}$ , unless otherwise stated.

*Supplemental characteristics* (indicated by italics) are typical, but nonwarranted parameters, intended to provide information useful in applying the instrument.

---

### Dynamic Range

Receiver dynamic range is calculated as the difference between the maximum receiver input level and the receiver's noise floor. System dynamic range applies to transmission narrowband measurements only, since reflection measurements are limited by directivity.

Noise floor is specified as the mean of the noise trace at specified CW frequencies. A signal at this level would have a signal/noise power ratio of 3 dB. Noise floor is measured with the test ports terminated in loads, response and isolation calibration, 15 Hz IF bandwidth, 0 dBm test port power and no averaging. Dynamic range specifications are listed later in the "Receiver Specifications" section of this chapter.

## Measurement Port Specifications

The following specifications describe the residual system uncertainties. These specifications apply after a user calibration has been performed and with an environmental temperature of  $25 \pm 5^\circ \text{C}$ , with less than  $1^\circ \text{C}$  deviation from the calibration temperature.

**Measurement Port Specifications**

Parameter	HP 8711B	HP 8713B
Directivity	40 dB	40 dB
Source Match (Ref)	20 dB	20 dB
Source Match (Trans)		
$\geq 1 \text{ MHz to } 1300 \text{ MHz}$	14 dB	
300 kHz to 1300 MHz		23 dB
1300 MHz to 3000 MHz		20 dB
Load Match		
300 kHz to 1300 MHz	18 dB	20 dB
1300 MHz to 3000 MHz	18 dB	18 dB

---

## Instrument Specifications and Characteristics

Specifications describe the instrument's warranted performance over the temperature range of  $25^{\circ} \pm 5^{\circ}\text{C}$ , unless otherwise stated.

*Supplemental characteristics* (indicated by italics) are typical, but nonwarranted parameters, intended to provide information useful in applying the instrument.

---

## Source Specifications

### Frequency

<b>Range</b> HP 8711B HP 8713B	300 kHz to 1300 MHz 300 kHz to 3000 MHz
<b>Resolution</b>	1 Hz
<i>Stability</i>	<i><math>\pm 5</math> ppm at 0 to 55 °C</i>
<b>Accuracy</b>	$\pm 5$ ppm at 25 °C $\pm 5$ °C <i>&lt;1 Hz at 10% change in line voltage</i>



**Output Power**

<b>Resolution<sup>1</sup></b>	0.01 dB
<b>Level Accuracy<sup>1</sup></b>	$\pm 1.0$ dB $\pm 1.5$ dB (Option 1EC) <sup>2</sup> $\pm 2.0$ dB (Option 1E1) <sup>3</sup> $\pm 3.0$ dB (Options 1EC and 1E1) <sup>2,3</sup>

- 1 All power characteristics for HP 8713B analyzers with option 1EC (75 ohm ports) are typical above 2000 MHz.  
2 75 ohm test ports  
3 Attenuator option

**Maximum Specified Test Port Power**

Frequency	HP 8711B (Std) <sup>1</sup>	HP 8713B (Std) <sup>1</sup>
$\leq 1000$ MHz	+16 dBm	+10 dBm
$> 1000$ MHz	+13 dBm	+10 dBm

- 1 This value will change depending upon the options installed in your analyzer. See "Determining Test Port Power" to determine the maximum test port power output for your particular instrument

**Minimum Test Port Power**

Analyzer	HP 8711B (Std)	HP 8713B (Std)
Standard <sup>1</sup>	0 dBm	-5 dBm
Option 1E1 (Attenuator)	-60 dBm	-60 dBm

- 1 This value will change depending upon the options installed in your analyzer. See "Determining Test Port Power" to determine the minimum test port power output for your particular instrument

**Instrument Specifications and Characteristics****Determining Test Port Power**

The maximum test port power output of your analyzer depends upon the options that are installed. If you have a standard instrument with no options installed, then the values in the table preceding this note apply to your analyzer. Otherwise, use the following table to determine your instrument's maximum test port power:

Option	HP 8711B	HP 8713B
1E1 (Attenuator)	subtract 1 dB	subtract 1 dB
1EC (75 ohm)	subtract 3 dB	subtract 3 dB
1DA or 1DB (AM delay)	subtract 2 dB	subtract 4 dB

For each option installed, subtract the indicated amount from the maximum and minimum powers stated in the standard tables. For example, if you have an HP 8713B with options 1EC and 1DB installed, you would subtract a total of 7 dB from the standard values found in the tables to get a final correct maximum output of 3 dB for your analyzer, and -12 dB for the minimum output power. However, the minimum output power for any analyzer with option 1E1 (attenuator) is -60 dBm, regardless of other options installed.

If you are not sure which options (if any) are installed in your analyzer, press **SYSTEM OPTIONS** **Service Instrument Info** for a display of the options installed.

**Source Harmonics (measured at +7 dBm\*)**

Frequency	HP 8711B	HP 8713B
<1 MHz	<-20 dBc	<-30 dBc
≥1 MHz	<-30 dBc	<-30 dBc

\* The "measured at" value depends on your analyzer's option configuration. Standard instruments are measured at +7dBm. Subtract the amount(s) shown in "Determining Test Port Power" from +7 dBm to determine the "measured at" value for your particular analyzer.

**Signal Purity**

Parameter	HP 8711B	HP 8713B
<i>Nonharmonic Spurious</i>		
$\geq 50$ kHz from carrier	$< -20$ dBc	$< -30$ dBc
$< 1$ MHz	$< -30$ dBc	$< -30$ dBc
$\geq 1$ MHz		
$< 50$ kHz from carrier	$< -25$ dBc	$< -25$ dBc
Phase noise <sup>1</sup>	$-70$ dBc/Hz	$-67$ dBc/Hz
Residual AM <sup>2</sup>	$< -50$ dBc	$< -50$ dBc
Residual FM <sup>3</sup>	$< 1.5$ kHz peak	$< 1.5$ kHz peak

1 at 10 kHz offset

2 in 100 kHz bandwidth

3 30 Hz to 15 kHz

Specifications and Characteristics  
**Instrument Specifications and Characteristics**

---

## Receiver Specifications

### Frequency Range

Type of Detection	HP 8711B	HP 8713B
Narrowband	0.3 to 1300 MHz	0.3 to 3000 MHz
Broadband	10 to 1300 MHz	10 to 3000 MHz

### Dynamic Range

Frequency	HP 8711B (50 ohm)	HP 8711B (75 ohm)	HP 8713B (50 ohm)	HP 8713B (75 ohm)
Narrowband				
<5 MHz	>60 dB <sup>1</sup>	>57 dB <sup>2</sup>	>100 dB <sup>3</sup>	>97 dB <sup>4</sup>
≥5 MHz	>100 dB <sup>3</sup>	>87 dB <sup>4</sup>	>100 dB <sup>3</sup>	>97 dB <sup>4</sup>
Broadband				
All	>66 dB <sup>5</sup>	>63 dB <sup>6</sup>	>66 dB <sup>5</sup>	>63 dB <sup>6</sup>

1 +10 to -50 dBm

2 +10 to -47 dBm

3 +10 to -90 dBm

4 +10 to -87 dBm

5 +16 to -50 dBm

6 +16 to -47 dBm

### Maximum Input

Type of Detection	HP 8711B	HP 8713B
narrowband <sup>1</sup>	+10 dBm	+10 dBm
broadband <sup>2</sup>	+16 dBm	+16 dBm

1 at 0.5 dB compression

2 at 0.55 dB compression

Damage Level: +20 dBm or  $\pm 25$  Vdc

Receiver Dynamic Accuracy (narrowband)

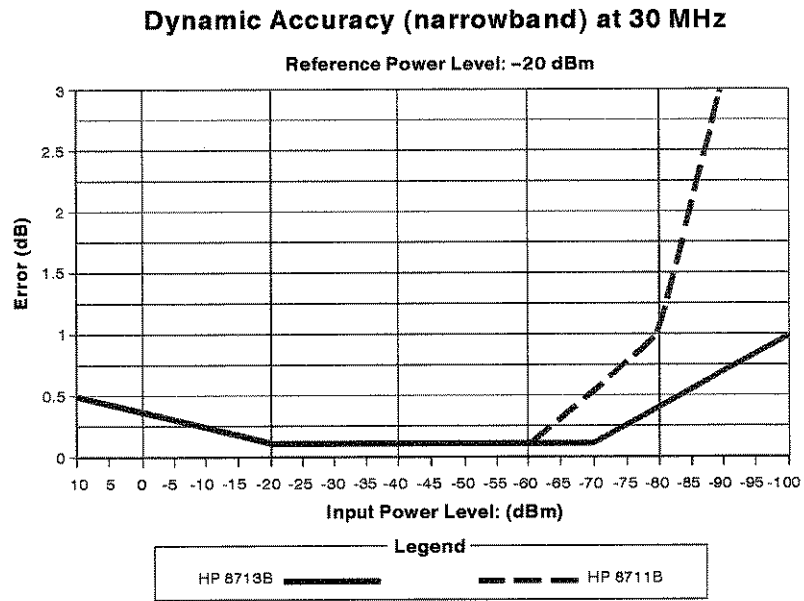

po685b\_c

Figure 11-1. Receiver Dynamic Accuracy (narrowband)

Specifications and Characteristics  
**Instrument Specifications and Characteristics**

**Absolute Power Accuracy (broadband)**

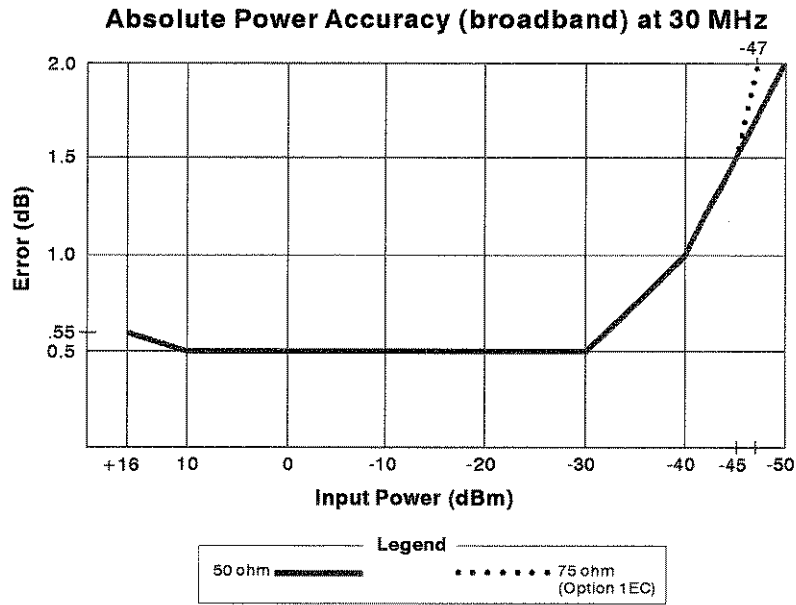

pc684b\_c

**Figure 11-2. Absolute Power Accuracy (broadband)**

**Frequency Response (broadband)**

**Typical Frequency Response (broadband)**

HP 8711B	HP 8713B
±0.5 dB	±1.0 dB

**Total Power Accuracy**    *Total Power Accuracy = Absolute Power Accuracy + Frequency Response*

## Typical Measurement Uncertainty

The following graphs show the typical measurement uncertainty for the HP 8711B and HP 8713B. The assumptions made to generate these curves were:

For transmission uncertainty, the DUT is assumed to be well-matched.

For reflection uncertainty, the DUT is assumed to be lossless.

Power = 0 dBm for reflection measurements

Power = -20 dBm for transmission measurements

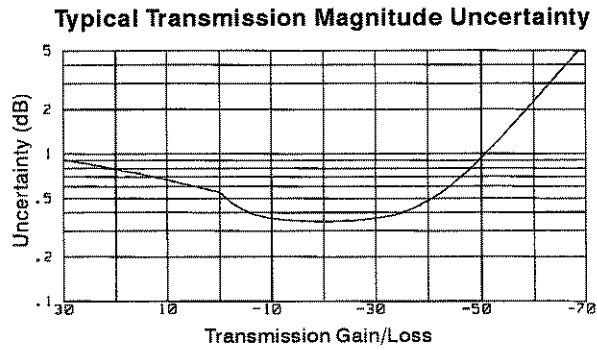

po679b\_c

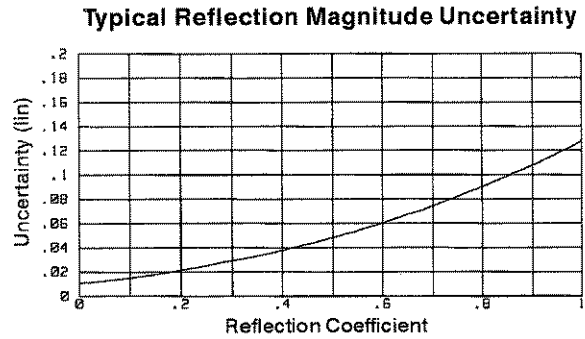

po681b\_c

---

## Delay Specifications

**AM Delay (Options 1DA  
and 1DB)**

Aperture: 55.56 kHz

Resolution: 1 ns/division

Accuracy:  $\pm 4$  ns (specified at 0 dBm, 16 averages, well-matched device,  
normalized)

Delay Range: 30  $\mu$ sec (9000 m)

*Amplitude Range: -10 to +13 dBm*

**Typical AM Delay Accuracy (calibrated at +10 dBm)**

Power	Delay
0 to +13 dBm	$\pm 10$ ns
-10 to 0 dBm	$\pm 20$ ns

---

## Display Characteristics

**Amplitude**

<b>Display Resolution</b>	0.01 dB/division
<b>Marker Reference Level</b>	Range: $\pm 500$ dB Resolution: 0.01 dB



---

## General Characteristics

---

---

### Front Panel Connectors

<b>RF Connectors</b>	Connector Type: Type-N female Nominal Impedance: 50 $\Omega$ (standard), 75 $\Omega$ (Option 1EC)
<b>Probe Power</b>	+15 V, 200 mA -12.6 V, 150 mA



---

### Rear Panel Connectors

<b>External Reference</b>	Frequency: 10 MHz Level: > -5 dBm Impedance: 50 $\Omega$
<b>Auxiliary Input</b>	Calibrated range: $\pm 10$ V Accuracy: $\pm(3\%$ of reading + 20 mV) Damage Level: >15 Vdc
<b>External Trigger</b>	This rear panel female BNC connector allows external triggering of a sweep. When the TTL level is pulled high, a sweep is triggered. When the TTL level is pulled to ground, the sweep is inhibited.

Specifications and Characteristics

**General Characteristics**

<b>Limit Test Output</b>	This connector outputs a TTL signal of the limit test results. Pass: TTL high; Fail: TTL low.	
<b>Video Output</b>	This connector provides an RS-343A compatible multisync video signal that is not compatible with EGA or VGA monitors. Vertical rate: 60 Hz Horizontal rate: 24.1 kHz Pixel rate: 33.3 MHz	
<b>HP-IB</b>	This connector allows communication with compatible devices including external controllers, printers, plotters, disk drives, and power meters.	
<b>Parallel Port</b>	This 25-pin female connector is used with parallel (or Centronics interface) peripherals such as printers and plotters. It can also be used as a general purpose I/O port, with control provided by IBASIC and SCPI commands.	
<b>RS-232</b>	This 9-pin male connector is used with serial peripherals such as printers and plotters.	
<b>DIN Keyboard</b>	This connector is used for connecting and using an IBM PC-AT compatible keyboard for title entry, remote front-panel operation, and for IBASIC programming (Option 1C2).	
<b>Line Power</b>	47 to 63 Hz 110 V nominal (90 V to 132 V) or 220 V nominal (198 V to 254 V). 230 VA max.	
<b>User TTL Input/Output</b>	This connector provides a bi-directional open collector TTL signal that can be accessed by IBASIC and SCPI commands.	
<b>X and Y External Detector Inputs</b>	These connectors provide for two external scalar detector inputs.	

---

## Environmental Characteristics

<b>General Conditions</b>	<p>RFI and EMI susceptibility: defined by CISPR Publication 11, and FCC Class B Standards.</p> <p>ESD (electrostatic discharge): must be eliminated by use of static-safe work procedures and an anti-static bench mat (such as HP 92175T).</p> <p>Dust: The flexible rubber keypad protects key contacts from dust, but the environment should be as dust-free as possible.</p>
<b>Operating Environment</b>	<p>Indoor use only</p> <p>Operating temperature: 0 ° to 55 °C</p> <p>Maximum relative humidity: 80 percent for temperatures up to 31 °C decreasing linearly to 50 percent relative humidity at 40 °C.</p> <p>Altitude: up to 15,000 feet (4,572 meters)</p>
<b>Non-Operating Storage Conditions</b>	<p>Temperature: -40 °C to +70 °C</p> <p>Humidity: 0 to 90 percent relative at +65 °C (non-condensing)</p> <p>Altitude: 0 to 15,240 meters (50,000 feet)</p>
<b>Weight</b>	<p>Net: Approximately 21 kg</p> <p>Shipping: Approximately 35 kg</p>
<b>Cabinet Dimensions</b>	<p>These dimensions exclude front and rear panel protrusions.</p> <p>179 mm H × 425 mm W × 514 mm D (7.0 in × 16.75 in × 20.25 in)</p>

Specifications and Characteristics

**General Characteristics**

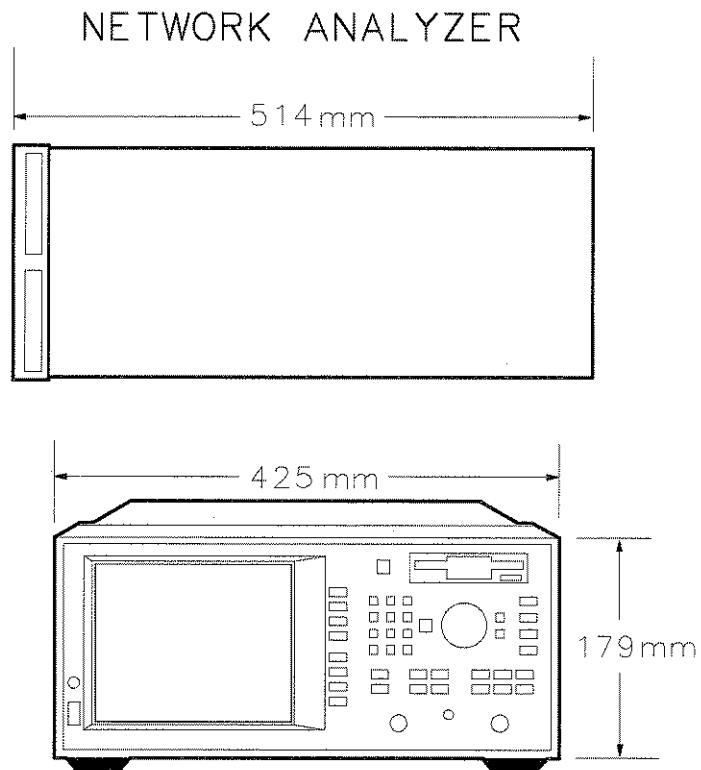

po674b

**Physical Dimensions**

---

## Warranty

This Hewlett-Packard instrument product is warranted against defects in material and workmanship for a period of one year from date of shipment. During the warranty period, Hewlett-Packard Company will, at its option, either repair or replace products which prove to be defective.

Warranty service will be performed at Buyer's facility at no charge within Hewlett-Packard service travel areas. Outside Hewlett-Packard service travel areas, warranty service will be performed at Buyer's facility only upon Hewlett-Packard's prior agreement and Buyer shall pay Hewlett-Packard's round trip travel expenses. In all other areas, products must be returned to a service facility designated by Hewlett-Packard.

For products returned to Hewlett-Packard for warranty service, Buyer shall prepay shipping charges to Hewlett-Packard and Hewlett-Packard shall pay shipping charges to return the product to Buyer. However, Buyer shall pay all shipping charges, duties, and taxes for products returned to Hewlett-Packard from another country.

Hewlett-Packard warrants that its software and firmware designated by Hewlett-Packard for use with an instrument will execute its programming instructions when properly installed on that instrument. Hewlett-Packard does not warrant that the operation of the instrument, or software, or firmware will be uninterrupted or error-free.

---

## Limitation of Warranty

The foregoing warranty shall not apply to defects resulting from improper or inadequate maintenance by Buyer, Buyer-supplied software or interfacing, unauthorized modification or misuse, operation outside of the environmental specifications for the product, or improper site preparation or maintenance.

NO OTHER WARRANTY IS EXPRESSED OR IMPLIED. HEWLETT-PACKARD SPECIFICALLY DISCLAIMS THE IMPLIED WARRANTIES OF MERCHANTABILITY AND FITNESS FOR A PARTICULAR PURPOSE.

**Warranty**

---

**Exclusive Remedies**

THE REMEDIES PROVIDED HEREIN ARE BUYER'S SOLE AND EXCLUSIVE REMEDIES. HEWLETT-PACKARD SHALL NOT BE LIABLE FOR ANY DIRECT, INDIRECT, SPECIAL, INCIDENTAL, OR CONSEQUENTIAL DAMAGES, WHETHER BASED ON CONTRACT, TORT, OR ANY OTHER LEGAL THEORY.



---

## Hewlett-Packard Sales and Service Offices

If you should need technical assistance, contact the nearest Hewlett-Packard sales or service office. See Table 11-1 on the next page.

**Table 11-1. Hewlett-Packard Sales and Service Offices**

<b>US FIELD OPERATIONS</b>			
<b>Headquarters</b> Hewlett-Packard Co. 19320 Pruneridge Ave. Cupertino, CA 95014 (800) 752-0900	<b>California, Northern</b> Hewlett-Packard Co. 301 E. Evelyn Mountain View, CA 94041 (415) 694-2000	<b>California, Southern</b> Hewlett-Packard Co. 1421 South Manhattan Ave. Fullerton, CA 92631 (714) 999-6700	<b>Colorado</b> Hewlett-Packard Co. 24 Inverness Place, East Englewood, CO 80112 (303) 649-5512
<b>Georgia</b> Hewlett-Packard Co. 2000 South Park Place Atlanta, GA 30339 (404) 955-1500	<b>Illinois</b> Hewlett-Packard Co. 5201 Tollview Drive Rolling Meadows, IL 60008 (708) 255-9800	<b>New Jersey</b> Hewlett-Packard Co. 150 Green Pond Rd. Rockaway, NJ 07866 (201) 586-5400	<b>Texas</b> Hewlett-Packard Co. 930 E. Campbell Rd. Richardson, TX 75081 (214) 231-6101
<b>EUROPEAN FIELD OPERATIONS</b>			
<b>Headquarters</b> Hewlett-Packard S.A. 150, Route du Nant-d'Avril 1217 Meyrin 2/Geneva Switzerland (41 22) 780.8111	<b>France</b> Hewlett-Packard France 1 Avenue Du Canada Zone D'Activite De Courtaboeuf F-91947 Les Ulis Cedex France (33 1) 69 82 60 60	<b>Germany</b> Hewlett-Packard GmbH Hewlett-Packard Strasse 61352 Bad Homburg v.d.H Germany (49 6172) 16-0	<b>Great Britain</b> Hewlett-Packard Ltd. Eskdale Road, Winnersh Triangle Wokingham, Berkshire RG41 5DZ England (44 734) 696622
<b>INTERCON FIELD OPERATIONS</b>			
<b>Headquarters</b> Hewlett-Packard Company 3495 Deer Creek Road Palo Alto, California, USA 94304-1316 (415) 857-5027	<b>Australia</b> Hewlett-Packard Australia Ltd. 31-41 Joseph Street Blackburn, Victoria 3130 (61 3) 895-2895	<b>Canada</b> Hewlett-Packard (Canada) Ltd. 17500 South Service Road Trans- Canada Highway Kirkland, Quebec H9J 2X8 Canada (514) 697-4232	<b>China</b> China Hewlett-Packard Company 38 Bei San Huan X1 Road Shuang Yu Shu Hai Dian District Beijing, China (86 1) 256-6888
<b>Japan</b> Hewlett-Packard Japan, Ltd. 1-27-15 Yabe, Sagami-hara Kanagawa 229, Japan (81 427) 59-1311	<b>Singapore</b> Hewlett-Packard Singapore (Pte.) Ltd. 150 Beach Road #29-00 Gateway West Singapore 0718 (65) 291-9088	<b>Taiwan</b> Hewlett-Packard Taiwan 8th Floor, H-P Building 337 Fu Hsing North Road Taipei, Taiwan (886 2) 712-0404	



---

Preventive Maintenance

---

## Preventive Maintenance

Preventive maintenance consists of two tasks. It should be performed at least every six months—more often if the instrument is used daily on a production line or in a harsh environment.

### Clean the CRT

Use a soft cloth and, if necessary, a mild cleaning solution.

### Check the RF Front Panel Connectors

Visually inspect the front panel connectors. The most important connectors are those to which the DUT is connected, typically the RF cable end or the RF IN connector. All connectors should be clean and the center pins centered. The fingers of female connectors should be unbroken and uniform in appearance.

If you are unsure whether the connectors are good, gauge the RF IN and RF OUT connectors to confirm that their dimensions are correct.

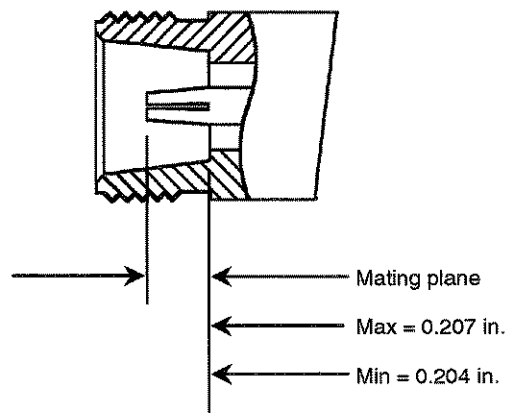

pc644 b\_c

**Figure 12-1. Maximum and Minimum Protrusion of Center Conductor From Mating Plane**

---

**Safety and Regulatory  
Information**

---

## Safety and Regulatory Information

This chapter contains required safety and regulatory information that is not included elsewhere in the manual.



---

## Safety Information

Much of the required safety information is distributed throughout this manual in appropriate places. This section contains all required safety information that is not included elsewhere in this manual.

---

### Warnings

---

**Warning Definition**

---

Warning denotes a hazard. It calls attention to a procedure which, if not correctly performed or adhered to, could result in injury or loss of life. Do not proceed beyond a warning note until the indicated conditions are fully understood and met.

Warnings applicable to this instrument are:

---

**WARNING**

---

No operator serviceable parts inside. Refer servicing to qualified personnel. To prevent electrical shock, do not remove covers.

---

**WARNING**

---

If this instrument is not used as specified, the protection provided by the equipment could be impaired. This instrument must be used in a normal condition (in which all means for protection are intact) only.

---

**WARNING**

---

For continued protection against fire hazard replace line fuse only with same type and rating (T 5 A/250 V). The use of other fuses or material is prohibited.

---

**WARNING**

---

This is a Safety Class I product (provided with a protective earthing ground incorporated in the power cord). The mains plug shall only be inserted in a socket outlet provided with a protective earth contact. Any interruption of the protective conductor, inside or outside the instrument, is likely to make the instrument dangerous. Intentional interruption is prohibited.

---

## Cautions

---

### Caution Definition

Caution denotes a hazard. It calls attention to a procedure that, if not correctly performed or adhered to, would result in damage to or destruction of the instrument. Do not proceed beyond a caution sign until the indicated conditions are fully understood and met.

Cautions applicable to this instrument are:

---

### CAUTION

Always use the three-prong ac power cord supplied with this instrument. Failure to ensure adequate earth grounding by not using this cord may cause instrument damage.

---

## Statement of Compliance

This instrument has been designed and tested in accordance with IEC Publication 348, Safety Requirements for Electronic Measuring Apparatus, and has been supplied in a safe condition. The instruction documentation contains information and warnings which must be followed by the user to ensure safe operation and to maintain the instrument in a safe condition.

---

## Cleaning Instructions

Clean the cabinet using a damp cloth only.



---

## Shipping Instructions

Always transport or ship the instrument using the original packaging or comparable.

---

## Instrument Markings



The instruction manual symbol. The product is marked with this symbol when it is necessary for the user to refer to the instructions in the manual.

CE

The CE mark shows compliance with European Community. (If accompanied by a year, it is the year when the design was proven.)

CSA

The CSA mark is the Canadian Standards Association safety mark.

ISM1-A

This is a symbol of an Industrial Scientific and Medical Group 1, Class A product.

---

## Regulatory Information

---

## Notice for Germany: Noise Declaration

LpA < 70 dB  
am Arbeitsplatz (operator position)  
normaler Betrieb (normal position)  
nach DIN 45635 T. 19 (per ISO 7779)

---

## Declaration of Conformity



## DECLARATION OF CONFORMITY

according to ISO/IEC Guide 22 and EN 45014

**Manufacturer's Name:** Hewlett-Packard Co.  
**Manufacturer's Address:** Microwave Instruments Division  
1212 Valley House Drive  
Rohnert Park, CA 94928  
USA

declares that the product

**Product Name:** Network Analyzer  
**Model Number(s):** 8711B, 8712B, 8713B, 8714B  
**Product Option(s):** including all options

conforms to the following Product Specifications:

**Safety:** IEC 348:1978 / HD 401 S1:1981  
CSA-C22.2 No. 231 (Series M-89)

**EMC:** CISPR 11:1990 / EN 55011:1991 Group 1, Class A  
IEC 801-2:1984 / EN 50082-1:1992 4 kV AD, 8 kV AD  
IEC 801-3:1984 / EN 50082-1:1992 3 V/m  
IEC 801-4:1988 / EN 50082-1:1992 0.5kV Sig. Lines, 1kV Power Lines

### Supplementary Information:

The product herewith complies with the requirements of the Low Voltage Directive 73/23/EEC and the EMC Directive 89/336/EEC.

Rohnert Park, CA

11-14-94

Date



Dixon Browder / Quality Manager

European Contact: Your local Hewlett-Packard Sales and Service Office or Hewlett-Packard GmbH, Department ZQ / Standards Europe, Herrenberger Straße 130, D-71034 Boeblingen, Germany (FAX +49-7031-14-3143)

Safety and Regulatory Information



---

Preset State and Memory  
Allocation

---

## Preset State and Memory Allocation

### Preset and Peripheral States

---

#### Preset State

When the network analyzer is preset with the **PRESET** hardkey or SCPI command "SYST:PRESET", it sets itself to the pre-defined conditions shown below.

**NOTE**

The HP-IB command "\*RST" is not the same as "SYST:PRESET".

**BEGIN** Key Settings

<b>BEGIN</b> key device	None
-------------------------	------

**MEAS Key Settings**

<b>CHAN 1</b> On/Off Measurement	On Transmission
<b>CHAN 2</b> On/Off Measurement	Off Transmission

**SOURCE Key Settings**

<b>FREQ</b>	
Start frequency	0.3 MHz
Stop frequency <sup>1</sup>	1300 MHz
Stop frequency <sup>2</sup>	3000 MHz
Band pass max span <sup>3,1</sup>	1299.700 MHz
Band pass max span <sup>3,2</sup>	2999.700 MHz
Frequency resolution	kHz
<b>SWEEP</b>	
Sweep type	Frequency
Alternate sweep	Off
Sweep time	Auto (fastest possible)
<b>POWER</b>	
Power level	0 dBm
RF power	On
Power sweep start power	0.0 dBm
Power sweep stop power	1.0 dBm
<b>MENU</b>	
Trigger source	Internal
Trigger mode	Continuous
Number of points	201
Start distance <sup>3</sup>	0.00 ft (0.00 m)
Stop distance <sup>3</sup>	100.00 ft (30.48 m)
External reference	Off
Spur avoid options	None

1 HP 8711B

2 HP 8713B

3 Analyzers with option 100 only

**CONFIGURE Key Settings**

<b>SCALE</b>	
Scale/div	10 dB/div
Reference level	0 dB
Reference position	5
<b>DISPLAY</b>	
Full/split display	Full
Display trace	Data
Graticule	On
Y-axis label state	On
Y-axis label mode	Absolute
Title + Clock	Off
Clock title line	Clock on line 2
Title line 1	Blank
Title line 2	Blank
Limit lines	Off
Marker limits	Off
Limit test	Off
Previously set limits	Deleted

**CONFIGURE Key Settings (continued)**

<p><b>CAL</b></p> <p>Active calibration</p> <p>Detector zero</p> <p>Cal kit</p>	<p>Last active cal if valid; otherwise, default cal</p> <p>Autozero</p> <p>Type-N female</p>
<p><b>MARKER</b></p> <p>On/off</p> <p>Delta marker state</p> <p>Search</p> <p>Bandwidth search level</p> <p>Notch search level</p> <p>Target search level</p> <p>Tracking</p>	<p>All off</p> <p>Off</p> <p>Off</p> <p>—3</p> <p>—6</p> <p>—3</p> <p>Off</p>
<p><b>FORMAT</b></p> <p>Format type</p>	<p>Log mag</p>
<p><b>AVG</b></p> <p>Averaging</p> <p>Average factor</p> <p>System bandwidth</p> <p>Fault Window<sup>1</sup></p>	<p>Off</p> <p>16</p> <p>Medium</p> <p>Medium</p>

<sup>1</sup> Analyzers with option 100 only



**SYSTEM Key Settings**

<p><b>SAVE RECALL</b></p> <p>Define save</p>	<p>Instrument state = On                      Cal = Off                      Data = Off</p>
<p><b>HARDCOPY</b></p>	<p>See "Peripheral State"</p>
<p><b>SYSTEM OPTIONS</b></p> <p>Beeper volume                      IBASIC display<sup>1</sup></p>	<p>90%                      None</p>

1. Analyzers with option 1C2 only

## Peripheral State

When you preset the analyzer with the **PRESET** hardkey or the SCPI command "SYST:PRESET", or cycle power, the settings below are saved in non-volatile memory and thus are not affected. The analyzer is shipped from the factory with the settings in the following table. These setting will remain as shown, until changed.

### **BEGIN** Key Settings

User BEGIN menu	Off
-----------------	-----

### **SAVE RECALL** Key Settings

Select Disk	Non-Vol RAM disk
Volatile RAM disk percent <sup>1</sup>	10%
External Disk Address	0
External Disk Volume	0
External Disk Unit	0
IBASIC file type <sup>1</sup>	ASCII
Fast recall	Off

<sup>1</sup> Option 1C2 only

### **MENU** Key Settings

Distance Units <sup>1</sup>	Feet
-----------------------------	------

<sup>1</sup> Analyzers with option 100 only

**SYSTEM OPTIONS** Key Settings

Analyzer HP-IB Address	16
Power Meter HP-IB Address	13
System Controller Address	21
User TTL Input for softkey autostep	On
<b>Clock:</b>	
Format	YYYY-MM-DD HH:MM:SS
Numeric/Alpha	Numeric
Seconds	On
<b>HP-IB:</b>	
Status	Talker/Listener
SRE Register	0
ESE Register	0
PSC Flag	1

Preset State and Memory Allocation

**HARDCOPY** Key Settings

<b>Select Copy Port:</b>	
Hardcopy Device	HP printer
Printer Language	PCL
Hardcopy Port	parallel
Hardcopy HP-IB Address	5
Baud Rate	19200
Handshake	Xon/Xoff
<b>Define Hardcopy</b>	Graph and Marker Table
<b>Define Graph:</b>	
Trace Data	On
Graticule	On
Annotation	On
Marker Symbol	On
Title + Clock	On
<b>Define Printer:</b>	
Mono/Color	Monochrome
Orientation	Portrait
Auto Feed	On
Resolution	96 dpi
Top Margin	0 mm
Left Margin	0 mm
Print Width	150 mm (5.9 in)

**HARDCOPY** Key Settings (continued)

<b>Define Plotter:</b>	
Mono/Color	Monochrome
Auto Feed	On
Pen Numbers:	
Monochrome	Pen 1
Trace 1	Pen 1
Trace 2	Pen 2
Memory 1	Pen 3
Memory 2	Pen 4
Graticule	Pen 5
Graphics	Pen 6

---

## Save/Recall Memory Allocation

Before reading this section, please refer to "Saving and Recalling Measurement Results," in Chapter 4 for an overview of the Save/Recall functions.

This section provides details on the size of Save/Recall instrument state files. Since disks have limited storage capacities, it is often important to know how many instrument state files will fit on a disk, and how to reduce the size of each file in order to maximize storage.

---

## Types of Storage Disks

The analyzer is capable of saving complete instrument states for later retrieval. It can store these instrument states to any one of the following:

**Table 14-1. Disk Capacities**

<b>Disk</b>	<b>Capacity</b>
Internal non-volatile RAM disk	over 400 KB
Internal volatile RAM disk <sup>1</sup>	over 200 KB to 2.0 MB
Internal 3.5 " floppy disk	1.44 MB
External HP-IB disk drive	depends on type of disk; refer to the disk drive manual.

<sup>1</sup> Expandable by adding SIMM DRAM (See the *Service Guide* for details)

The non-volatile RAM disk is powered by a battery, to provide short term storage of data when the analyzer is not connected to ac power. With this battery protection, data can typically be retained in memory for approximately 250 days at 70 °C and for more than 5 years at 25 °C.

The number of files that can be saved to disk is limited by the space available on the disk.

The number of bytes available for storage are displayed in the upper right-hand portion of the disk catalog window, after the words "Bytes Free."

In addition, each directory can only hold a limited number of files or directories. The table below shows these limits:

**Table 14-2. Maximum Number of Files and Directories**

	<b>Root Directory</b>	<b>Any Subdirectory</b>
Non-volatile RAM Disk	128	> 1000
Volatile RAM Disk	256	> 1000

If you have more files than will fit in a single directory, use additional subdirectories. With fewer files in each directory, your disk access time will be faster.

The **SAVE RECALL** disk catalog window can display at most nine pages of files, with 21 files or directories per page, for a total of 189. This means that if you have over 188 files (in addition to the parent directory), you will not be able to see all of the files. However, even though you cannot see all of the files using the disk catalog window, you can still access them programmatically using SCPI or IBASIC.

## Types of Storable Information

The instrument states can contain the instrument state, calibration data, and trace data.

- Inst State** (Instrument state.) Data sufficient to set up the network analyzer. The amount of memory used is independent of the number of measurement points unless memory trace functions are used. Memory trace functions are **Data/Mem** and **Data and Memory**. You should save instrument states when you want to return to the same instrument setup.
- Cal** (Calibration data.) Error correction arrays. The amount of memory used increases with the number of data points. Reflection cals are larger than transmission cals. The instrument state is automatically saved with cal data. You should save calibrations to avoid having to repeat the calibration procedure.
- Data** (Measurement or trace data.) The amount of memory used increases with the number of data points. When data is put into memory (by pressing **Data->Mem**) it becomes a memory trace.
- Save ASCII** Saves trace data in ASCII format for output to spreadsheets.



---

## How to Determine the Size of Disk Files

This section explains how to calculate the size of the files that you save to disk when using **SAVE RECALL**.

As mentioned earlier, there are three types of information that can be saved:

- Instrument state
- Cal
- Data

Each of these can be enabled or disabled using **SAVE RECALL Define Save**, based on your needs.

The following table shows how much space is required to save each of the three components of the instrument state. By adding the numbers for the items which you are saving, you can calculate, approximately, the size of the instrument state file that will be saved to disk.

Preset State and Memory Allocation  
**Save/Recall Memory Allocation**

**Table 14-3. Sizes of Instrument State Components**

Item Saved	Size <sup>1</sup> (bytes)
File header	768
State header	140
Instrument state	
off	0
without memory trace	2924
with 1 memory trace	$2924 + 1 \times 6 \times N_{pts}^2$
with 2 memory traces	$2924 + 2 \times 6 \times N_{pts}^2$
Data (per active channel)	
off	0
each channel active	$178 + 6 \times N_{pts}^2$
Cal (per active channel)	
off	0
transmission	$246 + 2 \times 6 \times Cal_{pts}^3$
response and isolation	$246 + 2 \times 6 \times Cal_{pts}^3$
reflection	$246 + 3 \times 6 \times Cal_{pts}^3$

- 1 Sizes are subject to change with future firmware revisions
- 2  $N_{pts}$  = number of measurement points
- 3  $Cal_{pts}$  = number of points over which the calibration was performed

Memory traces are saved with the instrument state for each active channel whose display is set to **Memory**, **Data/Mem**, or **Data and Memory** in the **DISPLAY** menu.

Totals are rounded up to the next highest multiple of 256, since the disk sector size is 256 bytes. Here are some examples:

- **PRESET** state, saving instrument state only:  

$$\text{Size} = 768 + 140 + 2924 = 3832 \text{ (round up to 3840)}$$
- Using 201 points, with Data/Mem on channel 1, channel 2 off:  

$$\text{Size} = 768 + 140 + 2924 + 6 \times 201 = 5038 \text{ (round up to 5120)}$$
- Using 201 points, with Data/Mem on channel 1, channel 2 off, and saving both the instrument state and data:  

$$\text{Size} = 768 + 140 + 2924 + 6 \times 201 + 178 + 6 \times 201 = 6422$$

$$\text{(round up to 6656)}$$
- Same as above, but after performing a transmission calibration and saving the calibration:  

$$\text{Size} = 768 + 140 + 2924 + 6 \times 201 + 178 + 6 \times 201 + 246 + 2 \times 6 \times 201 = 9080 \text{ (round up to 9216)}$$

---

## Memory Usage Notes

In general, memory usage increases with number of points and complexity of information saved.

Reflection calibrations use more memory than transmission calibrations because they use more error arrays.

When multiple types of information are saved together, the total can be less than indicated above because redundant internal information is eliminated.

Preset State and Memory Allocation

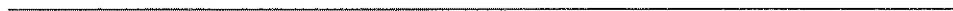

---

**Index**

---

# Index

Special characters  , 4-26

- 1 10 MHz reference, 8-5, 11-13
  - 1 through 8, 10-3
  
- 3 3.5 mm, 10-3
  
- A A, 10-4
  - Abort, 10-4
  - absolute output power
    - measuring, 3-30
  - absolute power, 3-33
  - absolute power accuracy specifications, 11-10
  - ac line power, 11-14
  - activating spur avoidance, 5-16
  - active channel, 2-10
  - Active Marker Off, 10-5
  - Add Limit, 10-5
  - Add Max Line, 10-5
  - Add Max Point, 10-5
  - Add Min Line, 10-5
  - Add Min Point, 10-6
  - address
    - plotter, 1-14
    - printer, 1-14
  - addresses
    - HP-IB, 1-14
  - "A" detector, 3-4
  - allocations
    - memory:changing, 4-37
  - All Off, 10-6
  - Alpha, 10-6
  - alternate sweep, 5-7, 10-6
  - altitude conditions, 11-15

**Alt Sweep**, 10-6  
AM delay  
  theory, 3-42  
  when to use amplification, 3-9  
  when to use attenuation, 3-9  
**AM Delay**, 10-6  
AM delay specifications, 11-12  
amplification  
  when to use in a measurement, 3-9  
**Amplifier**, 10-6  
**Annotation ON off**, 10-7  
anti-static mat, 11-15  
**A/R**, 10-4  
atmospheric conditions, 11-15  
attenuation  
  when to use in a measurement, 3-9  
**Auto Feed ON off**, 10-7  
automation, 7-2-77  
  selecting a controller, 7-11  
**Autoscale**, 2-9, 10-7  
auto-step, 7-25, 7-40  
AUTOST files, 7-6, 7-50  
AUTOST program, 7-23  
**Autozero**, 10-7  
auxiliary input, 3-48, 8-5, 11-13  
**Aux Input**, 10-7  
AUX INPUT connector, 3-48, 8-5, 11-13  
**Average Factor**, 10-7  
**Average on OFF**, 10-8  
averaging changing, 5-12  
averaging, how it works, 5-12  
**(AVG)**, 10-8

**B**  
**B**, 10-9  
**B\***, 10-9  
**Backspace**, 10-10  
bandwidth  
  system, 5-11  
**Bandwidth**, 10-10  
bandwidth change, 5-14  
bandwidth changing, 5-11  
bar code reader, 7-26  
basic functions  
  front panel, 2-3

battery, 14-12  
baud rate, 4-53  
**Baud Rate**, 10-10  
B\* detector, 3-6  
"B" detector, 3-4  
**Beeper Volume**, 10-10  
**BEGIN**, 3-12-17, 10-10  
    customized, 3-17, 7-19  
    user, program structure, 7-20  
**Begin Frequency**, 10-10  
**BEGIN** key  
    measurement configurations, 3-12  
    network analyzer internal configurations, 3-16  
    user-defined, 3-17, 7-19  
**Begin Limit**, 10-11  
BNC connectors, 8-4-7  
B/R, 10-9  
B\*/R\*, 10-9  
broadband detection mode, 3-6  
**Broadband External**, 10-11  
**Broadband Internal**, 10-11  
**Broadband Passive**, 10-11  
broadband power measurement  
    example, 3-30  
button box, 7-32

## C C

    programming language, 7-14  
C++  
    programming language, 7-14  
cabinet dimensions, 11-15  
cabinet installation, 1-16  
**Cable**, 10-12  
cables  
    interface, 4-50  
**CAL**, 10-12  
calibration  
    for a reflection measurement, 3-25, 3-26  
    for a transmission measurement, 3-19  
    isolation, 10-55  
    response, 10-55  
    when it is necessary, 6-6  
calibration information  
    to save, 4-35  
calibration kit



- sex of connectors, 10-12
- calibration kits, 3-25
- calibration saving, 4-38
- cal kit
  - sex of connectors, 10-12
- Cal Kit**, 10-12
- cal kit file
  - to create, 6-18
- cal kits
  - model numbers, 3-25
- cal kit standards
  - downloading, 6-15
- Cal on OFF**, 10-12
- Cancel**, 10-12
- caution
  - receiver input damage level, 5-10
- caution definition, 13-4
- CE mark definition, 13-5
- Center**, 2-7, 10-13
- Centronics interface, 11-14
- CHAN 1**, 2-10, 10-13
- CHAN 2**, 2-10, 10-13
- change directories, 4-45
- Change Directory**, 4-45, 10-13
- changing directories, 4-45
- channel
  - selecting, 2-10
  - viewing, 2-11
- Chan OFF**, 10-13
- characteristics
  - definition, 11-2
- check
  - operator's or confidence, 2-12-18
- checking the shipment, 1-3
- cleaning instructions, 13-4
- Clear Entry**, 10-13
- Clear Program**, 10-13
- Clock Format**, 10-14
- Clock Off**, 10-14
- coaxial connectors, 8-4-7
- Color**, 10-14
- computer
  - selecting for automation, 7-11
- computer connections, 7-10
- conditions for environment, 11-15
- confidence check, 2-12-18

configurations  
  of system for automation, 7-4  
**Configure Ext Disk**, 10-15  
**Configure RAM Disk**, 10-15  
configure the hardcopy port, 4-52  
configuring measurements from the **BEGIN** key, 3-12  
configuring memory allocations, 4-37  
configuring the analyzer, 1-10  
connecting analyzers to a computer, 7-10  
connecting computers, 1-11  
connecting controllers, 1-11  
connecting peripherals, 1-11  
connectors, 8-3  
  coaxial, 8-4-7  
  damage levels, 8-4-7  
  front panel, 8-3  
  HP-IB, 8-8  
  impedances, 8-4-7  
  multi-pin, 8-8-12  
  rear panel, 8-3  
connectors on rear panel, 11-13  
contents of shipment, 1-3  
**Continue**, 10-15  
**Continuous**, 10-15  
control  
  intensity, 8-19  
controller  
  selecting for automation, 7-11  
controller connections, 7-10  
controllers  
  connecting, 1-11  
conversion loss  
  formula, 3-40  
  measuring, 3-35  
**Conversion Loss**, 10-15  
**Copy All Files**, 10-15  
**Copy File**, 10-16  
**Copy to 3.5" Disk**, 10-16  
**Copy to Ext Disk**, 10-16  
**Copy to NonVol RAM**, 10-16  
**Copy to Vol RAM**, 10-16  
crosstalk, 10-55  
CRT adjustment  
  for external monitor, 8-7  
CSA mark definition, 13-5

---

Index-6

CW, 10-16

## D Data, 10-17

Data and Memory, 10-17

Data/Mem, 10-17

Data->Mem, 10-17

Data on OFF, 10-17

data storage, 14-12

date

format, 10-14

DD-MM-YYYY HH:MM, 10-17

declaration of conformity, 13-6

default conditions

presetting the analyzer, 2-6

Default Pen Colors, 10-17

Define Graph, 10-18

Define Hardcopy, 10-18

Define Plotter, 10-18

Define Printer, 10-18

Define Save, 10-18

defining a printing device, 4-54

defining what you save, 4-38

delay

AM, 3-42

AM specifications, 11-12

electrical:effect on measurements, 5-19

delay specifications, 11-12

Delete All Files, 10-18

Delete All Limits, 10-19

Delete Char, 10-19

Delete File, 10-19

Delete Limit, 10-19

Delete Line, 10-19

deleting files, 4-42

deleting limit segments, 4-31

delta markers, 4-22

Delta Mkr on OFF, 10-19

delta ( $\Delta$ ) markers, 4-22

description of instrument, iii

detection

broadband, 3-6

- narrowband, 3-6
- detection modes, 3-4, 3-6
- Detection Options**, 10-20
- detector "A", 3-4
- detector "B", 3-4
- detector B\*, 3-6
- detector connectors, 1-11
- detector "R", 3-4
- detector R\*, 3-6
- detectors
  - internal, 3-4
- Detector Zero**, 10-20
- device measurement, 3-3
- diagrams
  - on-screen, 7-18
- dimensions of analyzer, 11-15
- DIN keyboard, 11-14
- directory
  - to make or change, 4-44
- Directory Utilities**, 10-20
- disk
  - formatting, 4-46
- disk access time, 7-44
- disk or memory recall, 4-40
- disks
  - LIF formatted, 4-44
  - LIF formatting, 4-48
  - MS-DOS formatting, 4-46
- disk selecting, 4-36
- disk storage capacity, 14-12
- Disp Freq Resolution**, 10-20
- display, 8-14
  - split, 7-18
- DISPLAY**, 2-11, 10-20
- display intensity control, 8-19
- display resolution specifications, 11-12
- Distance**, 10-20
- Dither**, 10-21
- dithering, 5-15
- DOS formatted disks, 4-46
- downloading cal kit standards, 6-15
- DRAW
  - graphics keyword, 7-18
- DTR/DSR**, 10-21
- dual channel measurements, 2-11
- dynamic range
  - change measurement averaging, 5-12

- changing system bandwidth, 5-11
- factors, 5-10
- increase receiver input power, 5-10
- increasing, 5-10
  - receiver, 11-8
  - reduce receiver floor, 5-11
- dynamic range , iii
- dynamic range specifications, 11-2

## **E Edit** , 10-22

- Edit Limit** , 10-22
- edit limit example, 4-26
- electrical delay
  - effect on measurements, 5-19
- electrical requirements, 1-4
- electrostatic
  - discharge, 1-8, 11-15
  - precautions, 1-8, 11-15
- eliminate receiver spurious responses, 5-14
- End Frequency** , 10-22
- End Limit** , 10-22
- End Line #** , 10-22
- entering parameters, 2-4
- Enter Line 1** , 10-23
- Enter Line 2** , 10-23
- environmental characteristics, 11-15
- environmental requirements, 1-4
- error
  - unrecoverable, 10-52
- ESD precautions, 1-8, 11-15
- Ext Disk Address** , 10-23
- Ext Disk Unit** , 10-23
- Ext Disk Volume** , 10-23
- external auxiliary input (AUX INPUT), 3-48, 8-5, 11-13
- External CRT Adjust** , 8-7, 10-24
- external detector connectors, 1-11
- external disk, 4-38
- External Disk** , 10-24
- external disk drive
  - MS-DOS formatting, 4-47
- external keyboard, 7-27, 11-14
- external keyboard hot keys, 7-29
- external monitor, 7-37
- external monitor connector, 8-6

**External Point**, 10-24  
external reference input, 8-5, 11-13  
**External Sweep**, 10-24  
external trigger input, 8-5, 11-13  
external video monitor, 11-14  
EXT REF IN, 8-5, 11-13  
**Ext Ref on OFF**, 10-23  
EXT TRIG IN/OUT, 8-5, 11-13

**F** fast recall, 7-38, 10-63  
**FastRecall on OFF**, 10-25  
**Fault Location**, 10-25  
**Fault Max Freq Span**, 10-25  
**Fault Window**, 10-25  
file  
    to delete, 4-42  
    to rename, 4-41  
file renaming, 4-41  
file saving, 4-36  
**File Type bin ASCII**, 10-25  
**File Utilities**, 10-26  
filter  
    multi-pole, 4-14  
**Filter**, 10-26  
**Fine 15 Hz**, 10-26  
fine bandwidth, 5-11  
flat limit lines, 4-26  
flatness, 4-30  
**Flatness**, 10-26  
floppy disk, 4-36  
floppy disk formatting, 4-46  
foot switch, 7-32  
**FORMAT**, 10-26  
**Format 3.5" Disk**, 10-26  
format a floppy disk, 4-46  
**Format Disk Menu**, 10-27  
**Format Ext Disk**, 10-27  
**Format NonVol RAM**, 10-27  
**Format Vol RAM**, 10-28  
**FREQ**, 2-7, 10-28  
**Frequency**, 10-28  
frequency change to increase sweep speed, 5-3

- frequency range
  - entering, 2-7
- frequency response errors, 10-55
- frequency shift
  - how to minimize, 5-19
- frequency shift due to long electrical delay, 5-19
- Frequency Sweep**, 10-28
- front and rear panel connectors, 8-3
- front and rear panel features, 8-2-24
- front panel display, 8-14
- front panel features, 8-2-24
- front panel knob, 8-16
- front panel tour, 2-3
- Full**, 10-28
- fuse
  - line, 1-4, 8-23
  - part number, 8-23

**G** **Graph and Mkr Table**, 10-29

- graphics, 7-18
- Graphics Pen**, 10-29
- Graph Only**, 10-29
- Graticule ON off**, 10-29
- Graticule Pen**, 10-30

**H** hardcopy

- faster, 7-72
- typical times, 4-61
- HARDCOPY**, 10-31
- Hardcopy Address**, 10-31
- hardcopy port configuration, 4-52
- hardcopy speed, 4-60
- harmonics
  - specifications, 11-6
- Help Message**, 10-31
- Hold**, 10-31
- Horizontal Back Porch**, 8-7, 10-31
- Horizontal Frnt Porch**, 10-32
- Horizontal Front Porch**, 8-7
- hot keys
  - external keyboard, 7-29
- how to
  - create flat limit lines, 4-26

- create single point limits, 4-29
- delete limit segments, 4-31
- use delta ( $\Delta$ ) markers, 4-22
- use limit lines, 4-25
- HP 8711B Address**, 10-32
- HP 8713B Address**, 10-32
- HP BASIC
  - programming language, 7-13
- HP-IB
  - addresses, 1-14
  - HP-IB**, 10-32
  - HP-IB address
    - plotter, 1-14
    - printer, 1-14
  - HP-IB cable length, 1-12
  - HP-IB cables, 4-50
  - HP-IB connector, 8-8, 11-14
  - HP-IB Echo on OFF**, 10-32
  - HP-IB extender instruments, 8-9
  - HP-IB interconnections, 1-12, 8-9
  - HP-IB interface capabilities, 8-9
  - HP-IB port, 1-11
  - HP-IB restrictions, 8-9
- HP VEE
  - programming language, 7-14
- humidity conditions, 11-15
- Hz**, 10-33

- I IBASIC, 7-3
  - programming language, 7-13
  - IBASIC**, 10-34
  - IBASIC and automation, 7-6
  - IBASIC Display**, 10-34
  - impedance matching errors
    - how to reduce, 5-17
  - incident signal, 3-3
  - increase receiver input power, 5-10
  - increase start frequency, 5-3
  - increasing dynamic range, 5-10
  - increasing sweep speed, 5-3
  - information saved, 4-35
  - initializing a disk, 4-46
  - input
    - auxiliary, 3-48, 8-5, 11-13
    - external reference, 8-5, 11-13
    - external trigger, 8-5, 11-13

---

Index-12



**Insert Char**, 10-34  
insertion loss, 3-22  
**Insert Line**, 10-34  
installation, 1-2  
    rack, 1-16  
installation category, 1-5  
**Install CC From Disk**, 10-35  
installing the analyzer, 1-2  
, 13-5  
instruction manual symbol  
    defined, 13-5  
instrument description, iii  
**Instrument Info**, 10-35  
instrument markings and symbols, 13-5  
instrument preset state parameters, 14-2  
**Instrument State ON off**, 10-34  
instrument states  
    recalling, 4-35, 7-43  
instrument state settings  
    to save, 4-35  
intensity control, 8-19  
interface  
    cables, 4-50  
    parallel, 11-14  
interface capabilities  
    HP-IB, 8-9  
**Internal**, 10-35  
**Internal 3.5" Disk**, 10-35  
internal detectors, 3-4  
internal disk, 4-37  
internal disk drive  
    LIF formatting, 4-48  
internal drive  
    MS-DOS formatting, 4-46  
introduction  
    front panel, 2-3  
ISM1-A mark definition, 13-5  
isolation  
    calibration, 10-55  
iterative control, 7-47

**K** keyboard  
    external, 7-27  
keyboard connector, 1-11, 4-62, 8-12  
keyboard (DIN), 11-14  
keyboard, external  
    hot keys, 7-29  
keyboards  
    to connect, 4-62  
    using, 4-62  
keyboard template, 7-29  
**Key Record on OFF**, 10-36  
keystroke recording, 7-24  
**kHz**, 10-36  
kits  
    calibration, 3-25  
knob, 8-16

**L** **Landscape**, 10-37  
language  
    programming, 7-13  
learn strings, 7-45  
**Left Margin**, 10-37  
level  
    power, 2-8  
    reference, 2-9  
**Level**, 10-37  
LIF formatted disks, 4-44  
LIF formatting, 4-48  
limit  
    edit example, 4-26  
**Limit**, 10-37  
**Limit Line on OFF**, 10-38  
limit lines  
    stimulus and amplitude values, 4-32  
limit lines testing, 4-25  
**Limit Menu**, 10-37  
limit testing, 7-34  
    creating flat limit lines, 4-26  
    creating single point limits, 4-29  
    deleting limit segments, 4-31  
**Limit Test on OFF**, 10-38  
limit test output, 8-5  
limit test port  
    used as general purpose I/O, 7-34  
LIMIT TEST TTL IN/OUT, 8-5  
line fuse

- location, 8-23
- ratings, 13-3
- type, 1-4
- line module, 8-21
- line power, 11-14
- line power requirements, 1-5, 8-24
- line power switch, 8-17
- line switch, 8-17
- line voltage requirements, 1-4
- line voltage selector, 8-24
- line voltage selector switch, 1-4
- Lin Mag**, 10-38
- List Trace Values**, 10-38
- Load CC From Disk**, 10-39
- lock-up
  - how to fix, 10-52
  - system, 10-52
- lock-up, how to fix, 1-13
- Log Mag**, 10-39
- loss
  - conversion, 3-35
  - insertion, 3-22
- Lower**, 10-39
- \*LRN, 7-45

**M** macro recording, 7-24

- Mag dB $\mu$ V**, 10-40
- Mag dBmV**, 10-40
- Mag dBV**, 10-40
- make and change directories, 4-44
- Make Directory**, 10-40
- Manual Zero**, 10-40
- Marker**, 10-40
- MARKER**, 10-41
- Marker Functions**, 10-41
- marker limit, 4-30
- marker math, 4-16
- Marker Math**, 10-41
- Marker -> Center**, 10-41
- Marker -> Reference**, 10-41
- markers
  - delta ( $\Delta$ ), 4-22
  - reference, 4-22

- relative mode, 4-22
- search:bandwidth values, 4-10
- search:notch values, 4-12
- use with limit lines, 4-31
- markers and sweep time, 5-7
- marker search
  - tracking function, 4-7
- Marker Search**, 10-41
- marker search and sweep time, 5-7
- marker statistics, 4-16
- marker tracking and sweep time, 5-7
- math, marker, 4-16
- Max Limit**, 10-42
- Max Search**, 10-42
- mean, 4-16
- measure
  - using limit lines, 4-25
- measurement
  - reflection response, 3-24
  - steps, 3-11
  - transmission response, 3-18
  - typical sequence, 3-11
- measurement averaging, 5-12
- measurement calibration, iii
  - When it is necessary, 6-6
- measurement calibration, theory of, 6-3
- measurement channel, 2-10
- measurement data
  - to save, 4-35
- measurement detection modes, 3-6
- measurement example
  - reflection response, 3-24
  - transmission response, 3-18
- measurement port specifications, 11-3
- measurements
  - explained, 3-3
  - from the **BEGIN** key, 3-12
  - optimizing, 5-2
  - When a calibration is necessary, 6-6
- measurement speed with hardcopy, 4-60
- measurement theory, 3-3
- measurement uncertainty, 11-11
- measuring absolute output power, 3-30
- measuring devices, 3-3
- Medium 3700 Hz**, 10-42
- medium bandwidth, 5-11
- memory, 7-43
- Memory**, 10-42

**Memory 1 Pen**, 10-43  
**Memory 2 Pen**, 10-43  
memory allocations  
    changing, 4-37  
memory or disk recall, 4-40  
**MENU**, 10-43  
message string, 7-17  
**MHz**, 10-43  
**Min Limit**, 10-43  
**Min Search**, 10-43  
mismatch errors  
    how to reduce, 5-17  
**Mixer**, 10-44  
Mkr Limit on OFF}}, 10-44  
**Mkr Limits**, 10-44  
**Mkr->Max**, 10-45  
**Mkr->Min**, 10-45  
**Mkr Symbol ON off**, 10-44  
**Mkr Table Only**, 10-45  
**MM-DD-YYYY HH:MM**, 10-45  
modifying a program, 7-24  
**Modify Size**, 10-45  
monitor, 11-14  
    external, 7-37, 8-6  
**Monochrome**, 10-46  
**Monochrome Pen**, 10-46  
MOVE  
    graphics keyword, 7-18  
MS-DOS formatting, 4-46  
    external disk drive, 4-47  
**Multi Notch**, 10-46  
multi-notch marker search, 4-14  
**Multi Peak**, 10-46  
multi-peak marker search, 4-14  
multi-pin connectors, 8-8-12

- N **Narrow 250 Hz**, 10-47
  - narrowband detection mode, 3-6
  - Narrowband Internal**, 10-47
  - narrowband power measurement, 3-30
  - narrow bandwidth, 5-11
  - networking, 7-10
  - Next Min Left**, 10-47
  - Next Min Right**, 10-47
  - Next Peak Left**, 10-47
  - Next Peak Right**, 10-48
  - noise
    - trace:activate averaging, 5-13
    - trace:change system bandwidth, 5-14
    - trace:eliminate receiver spurious responses, 5-14
    - trace: reduction, 5-13
  - noise floor, 11-2
  - noise floor reduction, 5-11
  - None**, 10-48
  - non-operating storage conditions, 11-15
  - non-volatile memory
    - battery powered, 14-12
  - non-volatile RAM disk, 7-43
  - Non-Vol RAM Disk**, 10-48
  - Normalize**, 10-49
  - Notch**, 10-49
  - Number of Points**, 10-49
  - Numeric**, 10-49
  
- O **One Port**, 10-50
  - one port calibration
    - example, 3-26
  - on-screen diagrams, 7-18
  - operating conditions, 11-15
  - Operating Parameters**, 10-50
  - operational check, 2-12-18
  - operator's check, 2-12-18
  - optimizing measurements, 5-2
  - output
    - video, 11-14
  - output power, iii
    - absolute, 3-30
  - output power specifications, 11-5

**P** panel  
front and rear, 8-2-24  
parallel port, 1-11, 4-52, 4-53, 7-51-56, 11-14  
part number  
rack kit, 1-16  
part numbers  
static-safe equipment, 1-8  
parts supplied with shipment, 1-3  
performance  
system, 11-2  
**Perform Secure**, 10-51  
peripherals  
connecting, 1-11  
physical dimensions, 11-15  
plotter address, 1-14  
point limit creation, 4-29  
points reduction, 5-5  
pollution degree rating, 1-5  
port  
HP-IB, 1-11  
parallel, 1-11, 4-52, 4-53, 7-51-56  
RS-232, 1-11  
serial, 1-11, 4-52, 4-53  
port configuration for hardcopy, 4-52  
**Portrait**, 10-51  
position  
reference, 2-9  
power  
absolute, 3-30, 3-33, 11-10  
broadband measurement, 3-30  
line, 11-14  
narrowband measurement, 3-30  
output specifications, 11-5  
probe, 8-12, 11-13  
**Power**, 10-51  
**POWER**, 2-8, 10-51  
power cable configurations, 8-21  
power cables, 8-21  
power level  
entering, 2-8  
power module, 8-21  
power requirements, 1-5, 8-24  
**Power Sweep**, 10-51  
power switch, 8-17  
precautions  
electrostatic, 1-8, 11-15  
**PRESET**, 2-6, 10-52  
preset conditions, 2-6, 14-2-7

- preset state parameters, 14-2
- printer address, 1-14
- Printer Resolution**, 10-52
- printing and plotting, 4-57, 7-72
  - baud rate, 4-53
- printing device definition, 4-54
- printing speed, 4-61
- print times, 4-61
- Print Width**, 10-52
- probe power, 8-12, 11-13
- procedure
  - creating flat limit lines, 4-26
  - creating single point limits, 4-29
  - deleting limiting segments, 4-31
  - increasing dynamic range, 5-10
  - increasing sweep speed, 5-3
  - set sweep to auto mode, 5-4
  - test with limit lines, 4-25
  - turn off alternate sweep, 5-7
  - using delta ( $\Delta$ ) markers, 4-22
  - widen system bandwidth, 5-4
- programming languages, 7-13
- Programs**, 10-52
- prompting
  - how to display pop-up messages, 7-17
- Pwr Sweep Range**, 10-52

**R**

- R**, 10-53
- R\***, 10-53
- rack installation, 1-16
- rack kit
  - part number, 1-16
- RAM disks, 7-43
- range
  - frequency, 2-7
- R\* detector, 3-6
- "R" detector, 3-4
- readable ports, 7-37, 7-52
- rear panel connectors, 11-13
- rear panel features, 8-2-24
- recall, fast, 7-38
- recall from a disk or memory, 4-40, 7-38
- recalling states, 7-38, 7-43
- Recall Line**, 10-53
- Recall Program**, 10-54
- Recall State**, 10-54

---

Index-20



receiver damage level, 11-9  
receiver dynamic range, 11-8  
receiver input damage level, 5-10  
receiver input power increase, 5-10  
receiver inputs, 3-4  
receiver noise  
    dithering, 5-14  
    spur avoidance, 5-16  
receiver noise floor reduction, 5-11  
receiver specifications, 11-8  
recording  
    keystroke, 7-24  
redefining softkeys  
    with User **BEGIN**, 7-19  
reduce number of measurement points, 5-5  
reduce receiver noise floor, 5-11  
reduce the amount of averaging, 5-5  
reducing mismatch errors, 5-17  
reducing trace noise, 5-13  
**Reference Level**, 2-9, 10-54  
reference markers, 4-22  
**Reference Position**, 2-9, 10-54  
reference signal, 3-4  
    external, 8-5, 11-13  
reflection  
    calibration example, 3-25  
    formula, 3-28  
**Reflection**, 10-54  
reflection measurement  
    calibration, 3-26  
reflection measurements, 3-24-29  
relative marker mode, 4-22  
**Remove Directory**, 10-54  
**Rename File**, 10-55  
renaming a file, 4-41  
requirements  
    electrical and environmental, 1-4  
**Re-Save Program**, 10-53  
**Re-Save State**, 10-53  
**Response**, 10-55  
response calibration, 10-55  
**Response & Isolation**, 10-55  
**Restart Average**, 10-55  
**Restore Defaults**, 10-56  
restrictions

HP-IB, 8-9  
return loss, 3-29  
RF connectors, 8-13  
**RF Filter Stats**, 10-56  
**RF ON off**, 10-56  
RF power out  
  setting, 2-8  
**Round Seconds**, 10-56  
rpg knob, 8-16  
RS-232 (serial) port, 1-11, 4-52, 4-53, 8-11  
**Run**, 10-56

**S** safety information, 13-3  
safety warnings, 13-3  
**Save ASCII**, 10-57  
**Save AUTUST**, 10-57  
**Save Chan 1**, 10-57  
**Save Chan 2**, 10-57  
save definition, 4-38  
**Save Program**, 10-58  
**SAVE RECALL**, 7-44, 10-58  
**Save State**, 10-58  
saving a calibration, 4-38  
saving and recalling measurement results, 4-35  
saving data, 4-36  
**SCALE**, 2-9, 10-58  
**Scale/Div**, 10-58  
screen annotation, 10-7  
**Search Left**, 10-58  
**Search Off**, 10-59  
**Search right**, 10-59  
**Seconds ON off**, 10-59  
**Secure**, 10-59  
segment deleting, 4-31  
**Select**, 10-59  
**Select Char**, 10-60  
**Select Char/Word**, 10-60  
**Select Copy Port**, 10-60  
**Select Disk**, 4-37, 10-60  
selecting the disk, 4-36

- selector switch
  - voltage, 8-24
- serial port, 1-11, 4-52, 4-53, 7-58, 8-11
- Service**, 10-61
- Service Utilities**, 10-61
- Set Clock**, 10-61
- Set Day**, 10-61
- Set Hour**, 10-61
- Set Minute**, 10-61
- Set Month**, 10-61
- Set Pen Numbers**, 10-62
- setting HP-IB addresses, 1-14
- setting the line voltage, 1-4
- setting up the analyzer, 1-10
- Set Year**, 10-62
- shift spurs, 5-14
- shipment contents, 1-3
- shipment weight, 11-15
- shipping instructions, 13-5
- Show Clock on Line 1**, 10-62
- Show Clock on Line 2**, 10-62
- Show Size**, 10-62
- SICL, 7-14
- signal detection, 3-6
- signal purity specifications, 11-7
- Single**, 10-62
- single point limits, 4-29
- softkey auto-step, 7-25, 7-40
- Softkey Auto-Step}}, 10-63
- softkey redefinition
  - with User **BEGIN**, 7-19
- source harmonics, 11-6
- source power
  - entering, 2-8
- source resolution, iii
- source specifications, 11-4
- Space**, 10-63
- Span**, 2-7, 10-63
- specifications, 11-2-16
  - definition, 11-2
  - receiver, 11-8
  - source, 11-4
- speed increase of sweep, 5-3
- speed with hardcopy, 4-60

**Split Disp FULL split**, 10-63  
split display, 2-11, 7-18  
**Spur Avoid**, 10-63  
spur avoidance, 5-8, 5-16  
**Spur Avoid Options**, 10-64  
**SRL**, 10-64  
**SRQ**, 7-49  
**Stack Size**, 10-64  
standard deviation, 4-16  
standby, 8-17  
**Start**, 2-7, 10-64  
start frequency change to increase sweep speed, 5-3  
**Start Line #**, 10-64  
**Start Power**, 10-64  
states  
    recalling, 7-43  
static-safe equipment  
    part numbers, 1-8  
statistics, 4-30  
**Statistics**, 10-65  
statistics, marker, 4-16  
**Step**, 10-65  
**Stop**, 2-7, 10-65  
**Stop Power**, 10-65  
stop printer, 10-4  
storage conditions, 11-15  
**Store CC To Disk**, 10-65  
**Store CC To EPROM**, 10-65  
storing measurement results, 4-35  
string  
    message, 7-17  
strings  
    learn, 7-45  
**SWEEP**, 10-66  
sweep speed  
    increase start frequency, 5-3  
    increasing, 5-3  
    reduce averaging, 5-5  
    reduce number of points, 5-5  
    turn off alternate sweep, 5-7  
    turn off spur avoidance, 5-8  
    use auto mode, 5-4  
    view single measurement channel, 5-6  
**Sweep Time**, 10-66

**Sweep Time AUTO man.**, 10-66  
switch  
  foot, 7-32  
  line power, 8-17  
  line voltage selector, 1-4  
**SWR**, 10-66  
symbols and markings  
  instrument, 13-5  
synchronization  
  of external monitor, 8-7  
system  
  automated, configuration, 7-4  
systematic errors, 6-3  
system bandwidth, 5-11  
**System Bandwidth**, 10-66  
system bandwidth change, 5-14  
system bandwidth, how it works, 5-11  
**System Config.**, 10-67  
**System Controller**, 10-67  
system lock-up  
  how to recover, 10-52  
**SYSTEM OPTIONS**, 10-67  
system performance, 11-2  
system specifications, 11-2

**T** **Talker/Listener**, 10-68  
**Target Search**, 10-68  
**Target Value**, 10-68  
techniques  
  optimizing measurements, 5-2  
  temperature conditions, 11-15  
template  
  keyboard, 7-29  
testing with limit lines, 4-25  
**Tests and Adjustments**, 10-69  
theory  
  measurement, 3-3-10  
throughput  
  of an automated system, 7-10  
time  
  disk access, 7-44  
  format, 10-14  
**Title and Clock**, 10-69  
**Title+Clk ON off**, 10-69  
title feature, 7-28

**Top Margin**, 10-69  
topology  
    measurement system, 7-4  
**Trace 1 Pen**, 10-69  
**Trace 2 Pen**, 10-69  
**Trace Data DM off**, 10-70  
trace noise  
    activate averaging, 5-13  
    change system bandwidth, 5-14  
    eliminate receiver spurious responses, 5-14  
    factors, 5-13  
    reduction, 5-13  
tracking, 4-7  
    marker, 5-7  
**Tracking on OFF**, 10-70  
transmission  
    formula, 3-22  
transmission measurement  
    calibration, 3-19  
transmission measurements, 3-18-23  
**Transmissn**, 10-70  
transporting instructions, 13-5  
trigger  
    external, 8-5  
    external input, 11-13  
**Trigger**, 10-70  
**Trigger Source**, 10-70  
TTL signals, 7-32  
type-F connectors, 6-14

**U** uncertainty  
    measurement, 11-11  
unpacking the analyzer, 1-3  
unrecoverable error, 10-52  
**Update Corr Const**, 10-71  
**Upper**, 10-71  
**User BEGIN**, 3-17, 7-19  
    default program, 7-21  
**User BEGIN on OFF**, 10-71  
**User BEGIN** program  
    to load, 7-23  
User BEGIN program structure, 7-20  
USER TTL IN/OUT port, 7-31, 8-6  
**User TTL Input**, 10-71

**Utilities**, 10-71

**V VEE**

programming language, 7-14  
**Vertical Back Porch**, 8-7, 10-72  
**Vertical Frnt Porch**, 10-72  
**Vertical Front Porch**, 8-7  
vertical scale, how to set, 10-7  
VIDEO OUT connector, 1-11, 8-6, 11-14  
view a single measurement channel, 5-6  
volatile RAM disk, 7-43  
**Volatile RAM Disk**, 10-72  
voltage requirements, 1-4  
voltage selector switch, 8-24

**W** warning definition, 13-3

warranty, 11-17  
weight, 11-15  
**Wide 6500 Hz**, 10-73  
wide bandwidth, 5-11  
writeable ports, 7-36, 7-52

**X** **X**, 10-74

**Xon/Xoff**, 10-74  
**X/Y**, 10-74

**Y** **Y**, 10-75

**Y-axis Lbl ON off**, 10-75  
**Y-axis Lbl rel ABS**, 10-75  
**Y/R\***, 10-76  
**Y/X**, 10-76  
**YYYY-MM-DD HH:MM**, 10-76

