

Operation
and Service
Manual

HP 8642M
Synthesized Signal Generator

**HP 8642M
SYNTHESIZED SIGNAL GENERATOR
OPERATION AND SERVICE MANUAL**

SERIAL NUMBERS

This manual applies directly to instruments with serial numbers prefixed:

2626A

For additional information about serial numbers, see INSTRUMENTS COVERED BY THIS MANUAL in Section 0, General Information.

First Edition

© HEWLETT-PACKARD COMPANY 1987
EAST 24001 MISSION AVENUE, TAF C-34, SPOKANE, WA., U.S.A., 99220

Manual Part Number: 08642-90268

Printed: September 1987



**HEWLETT
PACKARD**

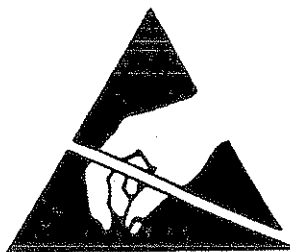

ATTENTION Static Sensitive Devices

This instrument was constructed in an ESD (electro-static discharge) protected environment. This is because most of the semiconductor devices used in this instrument are susceptible to damage by static discharge.

Depending on the magnitude of the charge, device substrates can be punctured or destroyed by contact or mere proximity of a static charge. The results can cause degradation of device performance, early failure, or immediate destruction.

These charges are generated in numerous ways such as simple contact, separation of materials, and normal motions of persons working with static sensitive devices.

When handling or servicing equipment containing static sensitive devices, adequate precautions must be taken to prevent device damage or destruction.

Only those who are thoroughly familiar with industry accepted techniques for handling static sensitive devices should attempt to service circuitry with these devices.

In all instances, measures must be taken to prevent static charge build-up on work surfaces and persons handling the devices.

For further information on ESD precautions, refer to "SPECIAL HANDLING CONSIDERATIONS FOR STATIC SENSITIVE DEVICES" in Section VIII Service Section.

CERTIFICATION

Hewlett-Packard Company certifies that this product met its published specifications at the time of shipment from the factory. Hewlett-Packard further certifies that its calibration measurements are traceable to the United States National Bureau of Standards, to the extent allowed by the Bureau's calibration facility, and to the calibration facilities of other International Standards Organization members.

WARRANTY

This Hewlett-Packard instrument product is warranted against defects in material and workmanship for a period of one year from date of shipment. During the warranty period, Hewlett-Packard Company will at its option, either repair or replace products which prove to be defective.

For warranty service or repair, this product must be returned to a service facility designated by HP. Buyer shall prepay shipping charges to HP and HP shall pay shipping charges to return the product to Buyer. However, Buyer shall pay all shipping charges, duties, and taxes for products returned to HP from another country.

HP warrants that its software and firmware designated by HP for use with an instrument will execute its programming instructions when properly installed on that instrument. HP does not warrant that the operation of the instrument, or software, or firmware will be uninterrupted or error free.

LIMITATION OF WARRANTY

The foregoing warranty shall not apply to defects resulting from improper or inadequate maintenance by Buyer, Buyer-supplied software or interfacing, unauthorized modification or misuse, operation outside of the environmental specifications for the product, or improper site preparation or maintenance.

NO OTHER WARRANTY IS EXPRESSED OR IMPLIED. HP SPECIFICALLY DISCLAIMS THE IMPLIED WARRANTIES OF MERCHANTABILITY AND FITNESS FOR A PARTICULAR PURPOSE.

EXCLUSIVE REMEDIES

THE REMEDIES PROVIDED HEREIN ARE BUYERS'S SOLE AND EXCLUSIVE REMEDIES. HP SHALL NOT BE LIABLE FOR ANY DIRECT, INDIRECT, SPECIAL, INCIDENTAL, OR CONSEQUENTIAL DAMAGES, WHETHER BASED ON CONTRACT, TORT, OR ANY OTHER LEGAL THEORY.

ASSISTANCE

Product maintenance agreements and other customer assistance agreements are available for Hewlett-Packard products.

For any assistance, contact your nearest Hewlett-Packard Sales and Service Office. Addresses are provided at the back of this manual.

SAFETY CONSIDERATIONS

GENERAL

This product and related documentation must be reviewed for familiarization with safety markings and instructions before operation.

This product is a Safety Class I instrument (provided with a protective earth terminal).

BEFORE APPLYING POWER

Verify that the product is set to match the available line voltage and the correct fuse is installed.

SAFETY EARTH GROUND

An uninterruptible safety ground must be provided from the main power source to the product input wiring terminals, power cord, or supplied power cord set.

SAFETY SYMBOLS



Instruction manual symbol: the product will be marked with this symbol when it is necessary for the user to refer to the instruction manual (refer to Table of Contents).



Indicates hazardous voltages.



Indicates earth (ground) terminal.

WARNING

The WARNING sign denotes a hazard. It calls attention to a procedure, practice, or the like, which, if not correctly performed or adhered to, could result in personal injury. Do not proceed beyond a WARNING sign until the indicated conditions are fully understood and met.

CAUTION

The CAUTION sign denotes a hazard. It calls attention to an operating procedure, practice, or the like, which if not correctly performed or adhered to, could result in damage to or destruction of part or all of the product. Do not proceed beyond a CAUTION sign until the indicated conditions are fully understood and met.

SAFETY CONSIDERATIONS

WARNING

Any interruption of the protective (grounding) conductor (inside or outside the instrument) or disconnecting the protective earth terminal will cause a potential shock hazard that could result in personal injury. (Grounding one conductor of a two conductor outlet is not sufficient protection).

Whenever it is likely that the protection has been impaired, the instrument must be made inoperative and be secured against any unintended operation.

If this instrument is to be energized via an auto-transformer (for voltage reduction) make sure the common terminal is connected to the earth terminal of the power source.

Servicing instructions are for use by service-trained personnel only. To avoid dangerous electric shock, do not perform any servicing unless qualified to do so.

Adjustments described in the manual are performed with power supplied to the instrument while protective covers are removed. Energy available at many points may, if contacted, result in personal injury.

Capacitors inside the instrument may still be charged even if the instrument has been disconnected from its source of supply.

For continued protection against fire hazard, replace the line fuse(s) only with 250V fuse(s) of the same current rating and type (for example, normal blow, time delay, etc.). Do not use repaired fuses or short circuited fuseholders.

TABLE OF CONTENTS

		Page
SECTION 0	GENERAL INFORMATION	
0-1	Scope	0-1
0-2	Safety Considerations	0-1
0-3	Instruments Covered by This Manual	0-1
0-4	Description	0-1
0-5	Warranty Information	0-2
0-6	Equipment That Can Be Ordered for the Signal Generator	0-2
0-7	Module Exchange Program	0-2
0-8	Storage	0-2
0-9	Packaging	0-3
0-10	Recommended Tools and Test Equipment	0-3
0-11	Technical Characteristics	0-5
SECTION I	OPERATING INSTRUCTIONS	
1-1	Description and Use of Operator's Controls, Indicators, and Connectors	1-1
1-2	Installation	1-21
1-3	Initial Inspection	1-21
1-4	Preparation For Use	1-21
	Power Requirements	1-21
	Power Cables	1-23
	HP-IB Address Selection	1-23
	Interconnections	1-23
	Mating Connectors	1-23
	Operating Environment	1-25
1-5	Operation under Usual Conditions	1-25
1-6	Turn-On Procedures	1-25
1-7	Operating Messages	1-27
	Parameters Changed Messages	1-27
	Execution Error Messages	1-27
	Hardware Error Messages	1-28
	Information Messages	1-28
	Prompt Messages	1-28
	Out-of-Lock Messages	1-28
	Writing Messages	1-29
	When Using the Instrument Locally	1-29
	When Controlling the Instrument via HP-IB	1-29
	Messages	1-29
1-8	Operating Procedures	1-46

TABLE OF CONTENTS—Continued

	Page
SECTION I	OPERATING INSTRUCTIONS—Continued
1-9	Setting Instrument Functions 1-46
	RF Frequency 1-46
	Amplitude 1-46
	Off On 1-47
	Modulation 1-47
	Modulation Oscillator Output 1-50
	Simultaneous Modulation Source 1-50
1-10	Modifying Settings 1-51
	Tune Knob 1-51
	Step, Increment Set 1-51
	Knob Increment 1-52
	Knob Hold 1-52
	Entry Off 1-52
	Display Editing 1-53
1-11	Making Relative Settings 1-53
	Amplitude Relative 1-53
	Frequency Relative 1-54
1-12	Selecting Special Functions 1-54
	Help Function 1-54
	Special Functions 1-55
	Detailed Descriptions of all Special Functions 1-55
1-13	Selecting a Sweep 1-61
	Stepped Frequency Sweep 1-61
	Phase Continuous Frequency Sweep 1-61
	Amplitude Sweep 1-62
	Sweep Time Calculations 1-63
1-14	Recalling Instrument Settings 1-68
	Save 1-68
	Recall 1-68
	Sequence, Set Sequence 1-68
1-15	HP-IB Remote Operation 1-69
	HP-IB Address 1-69
	HP-IB Capabilities 1-70
	Data Input 1-72
	Data Output 1-75
	Output Messages 1-76
	Clear 1-80
	Remote, Local 1-81
	Local Lockout, Set Local 1-83
	Service Request 1-83
	Status Byte 1-84
	System Controller 1-86
	Additional HP-IB Information 1-87

TABLE OF CONTENTS—Continued

		Page
SECTION I	OPERATING INSTRUCTIONS—Continued	
1-16	Writing Messages to Display	1-90
SECTION II	THEORY OF OPERATION	
2-1	Introduction	2-1
2-2	A2 Modulation Module	2-3
2-3	A6 FM/Counter/Timebase Module	2-5
	A6 FM Loop	2-6
	A6 Timebase	2-7
	A6 Counter	2-7
2-4	A7 SAWR Loop Module	2-8
2-5	A9 IF Loop Module	2-10
2-6	A11 Reference Loop Module	2-12
2-7	A12 Sum Loop/Divider Module	2-14
	Sum Loop	2-14
	Divider	2-14
2-8	A13 Output Filters/ALC Module	2-16
2-9	A14 Heterodyne Module	2-18
2-10	A17 Regulators/Attenuator Drivers Module	2-20
	A18 Rectifier/Filter Module	2-20
	Power Supply	2-20
	A17 Drivers	2-20
2-11	A19 Doubler Module	2-23
SECTION III	DIAGNOSTICS	
3-1	Introduction	3-1
3-2	On-Site Service Strategy	3-1
3-3	HP 8642 Service Design	3-1
3-4	On-Site Service Overview	3-3
3-5	Introduction to On-Site Troubleshooting	3-3
3-6	To Begin Troubleshooting the 8642	3-5
	Instrument Level Diagnostics	3-9
3A-1	Introduction	3-9
3-8	Module Troubleshooting Order	3-14
	Power Supply Section	3-17
3B-1	Introduction	3-17
3B-2	Introduction	3-19
	A17 Inputs Verification	3-20
3B-3	Introduction	3-20

TABLE OF CONTENTS—Continued

	Page
SECTION III DIAGNOSTICS—Continued	
A17 & A18 Module Substitution	3-21
3B-4 Introduction	3-21
Power Supply Diagnostics	3-22
A17 Module Diagnostics	3-38
Control Section Diagnostics	3-53
3C-1 Introduction	3-53
A4 Module Substitution	3-54
3C-2 Introduction	3-54
A3 Module Substitution	3-55
3C-3 Introduction	3-55
A1 Module Substitution	3-56
3C-4 Introduction	3-56
Control Section Diagnostics	3-57
RF Section Diagnostics	3-73
A2 Modulation Module	3-75
3E-1 Introduction	3-75
A2 Module Substitution	3-76
3E-2 Introduction	3-76
A2 Inputs/Outputs Verification	3-77
3E-3 Introduction	3-77
A2 Module Diagnostics	3-78
A6 FM Loop/Counter/Timebase Module	3-105
3F-1 Introduction	3-105
A6 Module Substitution	3-106
3F-2 Introduction	3-106
A6 Inputs Verification	3-107
3F-3 Introduction	3-107
A6 Module Diagnostics	3-108
A7 SAWR Loop Module	3-141
3G-1 Introduction	3-141
A7 Module Substitution	3-142
3G-2 Introduction	3-142
A7 Inputs Verification	3-143
3G-3 Introduction	3-143
A7 Module Diagnostics	3-144
A9 IF Loop Module	3-169
3H-1 Introduction	3-169
A9 Module Substitution	3-170
3H-2 Introduction	3-170
A9 Inputs Verification	3-171
3H-3 Introduction	3-171
A9 Module Diagnostics	3-172

TABLE OF CONTENTS—Continued

		Page
SECTION III	DIAGNOSTICS—Continued	
	A11 Reference Loop Module	3-199
3I-1	Introduction	3-199
	A11 Inputs Verification	3-200
3I-2	Introduction	3-200
	A11 Module Substitution	3-201
3I-3	Introduction	3-201
	A11 Module Diagnostics	3-202
	A12 Sum Loop/Divider Module	3-231
3J-1	Introduction	3-231
	A12 Inputs Verification	3-232
3J-2	Introduction	3-232
	A12 Module Substitution	3-233
3J-3	Introduction	3-233
	A12 Module Diagnostics	3-234
	A13 Output Filters/ALC Module	3-265
3K-1	Introduction	3-265
	A13 Module Substitution	3-266
3K-2	Introduction	3-266
	A13 Module Inputs Verification	3-267
3K-3	Introduction	3-267
	A13 Module Diagnostics	3-268
	A14 Heterodyne Module	3-295
3L-1	Introduction	3-295
	A14 Module Substitution	3-296
3L-2	Introduction	3-296
	A14 Inputs Verification	3-297
3L-3	Introduction	3-297
	A14 Power Level Diagnostics	3-298
3L-4	Introduction	3-298
	A14 Module Diagnostics	3-299
	A16 Attenuator Module	3-333
	A19 Doubler/Attenuator Module	3-335
3N-1	Introduction	3-335
	A19 Module Substitution	3-336
3N-2	Introduction	3-336
	A19 Inputs Verification	3-337
3N-3	Introduction	3-337
	A19 Module Diagnostics	3-338
	Exceptional Cases	3-371
3O-1	Introduction	3-371
3O-2	Exceptional Case Descriptions	3-371
3O-3	Troubleshooting Suggestions	3-371
3O-4	Exceptional Case 1	3-372

TABLE OF CONTENTS—Continued

	Page	
SECTION III	DIAGNOSTICS—Continued	
30-5	Exceptional Case 2	3-376
30-6	Exceptional Case 3	3-376
SECTION IV	REPLACING A MODULE	
4-1	Introduction	4-1
SECTION V	MECHANICAL PROCEDURES	
5-1	Introduction	5-1
5-2	Tools	5-3
5-3	Top Cover	5-4
5-4	RF Modules A6, A7, A9, A11, A12, A13, A14, and A19	5-5
5-5	Control Module A3	5-6
5-6	Control Module A4	5-7
5-7	Front Panel	5-8
5-8	Deleted	5-10
5-9	RF Module A2	5-11
5-10	Control Module A1	5-12
5-11	LCD Display Assembly A1A2	5-14
5-12	LCD Display Incandescent Lamps	5-15
5-13	Right Side Cover	5-16
5-14	Power Supply Module A17	5-17
5-15	Rear Bottom Cover	5-19
5-16	Power Supply Module A18	5-20
5-17	Calibration Module A20	5-22
5-18	Deleted	5-23
5-19	Fan B1	5-24
5-20	A5 Ribbon Cables W1 thru W8, W11, W14, and W15	5-25

TABLE OF CONTENTS—Continued

	Page
SECTION VI	PERFORMANCE TESTS AND ADJUSTMENTS
6-1	Performance Tests
	Initialized Setup
	RF Power Test
	RF Harmonics Test
	Pulse On/Off Ratio Test
	Pulse Rise/Fall Test
	Residuals Test
	AM Test
	AM Depth Test
	FM Test
	FM Deviation Test
6-2	Adjustments
SECTION VII	REPLACEABLE PARTS
7-1	Introduction
7-2	Replaceable Parts List
7-3	Restored Module Exchange
7-4	Ordering Information
7-5	Packaging Information
7-6	Parts List Updating
APPENDIX A	AMPLITUDE UNITS CONVERSION
A-1	General
GLOSSARY

TABLE OF CONTENTS—Continued

TABLES

No.		Page
1-1	AC Power Cables Available	1-24
1-2	Out of Lock Messages	1-44
1-3	Summary of Special Functions; Function to Code	1-56
1-4	HP-IB Capability Reference Table	1-71
1-5	Relationships Between Keystrokes and HP-IB Code Sequences	1-72
1-6	Output Active Function String Formats	1-78
1-7	Output Display; Binary Weight of Annunciators	1-81
1-8	Error Code and Message Recovery Example Program	1-82
1-9	HP-IB Status Byte Bit Definitions	1-86
1-10	Signal Generator Function to HP-IB Code	1-88
1-11	Signal Generator HP-IB Code to Function	1-89
1-12	Special Functions That Can be Used to Write to the Display	1-91
1-13	ASCII Character Codes	1-92
3E-1	W14P2 Control Bits	3-96
3F-1	W1P2 Control Bits	3-119
3F-2	W1P2 Control Bits	3-121
3F-3	A5J1 Control Bits	3-125
3F-4	A5J1 Control Bits	3-127
3H-1	W3P2 Control Bits	3-183
3H-2	A5J3 Control Bits	3-187
3J-1	W5P2 Control Bits	3-238
3J-2	W5P2 Control Bits	3-240
3J-3	A5J5 Control Bits	3-242
3J-4	A5J5 Control Bits	3-244
3L-1	W7P2 Control Bits	3-312
3L-2	A5J7 Control Bits	3-315
3N-1	Attenuator Relay Selection	3-350
3O-1	Troubleshooting Suggestions for Condition 4	3-375
3O-2	Exceptional Cases Troubleshooting Suggestions	3-376
3O-3	Service Special Functions for Exceptional Cases	3-378
7-1	Replaceable Parts	7-4
7-2	Code List of Manufacturers	7-6

TABLE OF CONTENTS—Continued

FIGURES

No.		Page
1-1	Operator's Controls, Indicators, and Connectors, Front View	1-1
1-2	Operator's Controls, Indicators, and Connectors, Rear View	1-19
1-3	Line Voltage and Fuse Selection	1-22
1-4	Hewlett-Packard Interface Bus Connections	1-26
1-5	Flowcharts for Sequence Dependency	1-74
1-6	The Status Byte and RQS Mask	1-85
	A1, A3, A4 Module Simplified Block Diagram	2-2
	A2 Module Simplified Block Diagram	2-4
	A6 Module Simplified Block Diagram	2-6
	A7 Module Simplified Block Diagram	2-9
	A9 Module Simplified Block Diagram	2-11
	A11 Module Simplified Block Diagram	2-13
	A12 Module Simplified Block Diagram	2-15
	A13 Module Simplified Block Diagram	2-17
	A14 Module Simplified Block Diagram	2-19
	A17 Module Simplified Block Diagram	2-21
	A18 Module Simplified Block Diagram	2-22
	A19 Module Simplified Block Diagram	2-24
3-100	RF Section Signal Flow Diagram	3-7
3A-100	Instrument Level Diagnostics	3-15
3B-1	Connector A17J1 Signal Locator	3-26
3B-2	Cable W13 Connector Locator	3-27
3B-3	Connector A18J1 Signal Locator	3-32
3B-4	Cable Plug W9P2 Signal Locator	3-41
3B-6	Cable Plug W9P2 Signal Locator	3-43
3B-5	Cable Plug W9P2 Signal Locator	3-45
3B-100	A18 Rectifier/Filters Module and P/O A17 Power Supply	3-49
	Regulators/Attenuator Drivers Module Diagnostics	
3B-200	P/O A17 Power Supply Regulators/Attenuator Drivers Module	
	Diagnostics	3-51
3C-1	A4J1 Service Test Points Signal Locator	3-57
3C-2	A3J4 Service Test Points Signal Locator	3-63
3C-3	Connector A1A1J1 Signal Locator	3-67
3C-100	A1, A3, and A4 Control Section Diagnostics	3-71
3E-1	Cable Plug W14P2 Signal Locator	3-97
3E-2	Cable Plug W14P2 Signal Locator	3-99
3E-100	A2 Modulation Module Diagnostics	3-103
3F-1	Cable Plug W1P2 Signal Locator	3-119
3F-2	Cable Plug W1P3 Signal Locator	3-122
3F-3	A5J1 Signal Locator (Solder Side View)	3-125
3F-3	Cable Plug W1P2 Signal Locator	3-129
3F-4	Cable Plug W1P3 Signal Locator	3-130

TABLE OF CONTENTS—Continued

FIGURES—Continued

No.		Page
3F-5	A5J1 Signal Locator (Solder Side View)	3-132
3F-100	A6 FM Loop/Counter/Timebase Module Diagnostics	3-139
3G-1	Cable Plug W2P2 Signal Locator	3-155
3G-2	A5J2 Signal Locator (Solder Side View)	3-158
3G-3	Cable Plug W2P2 Signal Locator	3-161
3G-4	A5J2 Signal Locator (Solder Side View)	3-163
3G-100	A7 SAWR Loop Module Diagnostics	3-167
3H-1	Cable Plug W3P2 Signal Locator	3-184
3H-2	Cable Plug A5J3 Signal Locator	3-187
3H-3	Cable Plug W3P2 Signal Locator	3-190
3H-4	A5J3 Signal Locator (Solder Side View)	3-192
3H-100	A9 IF Reference Module Diagnostics	3-197
3I-1	Cable Plug W4P2 Signal Locator	3-206
3I-2	A5J4 Signal Locator (Solder Side View)	3-209
3I-3	Cable Plug W4P2 Signal Locator	3-212
3I-4	A5J4 Signal Locator (Solder Side View)	3-214
3I-100	A11 Reference Loop Module Diagnostics	3-229
3J-1	Cable Plug W5P2 Signal Locator	3-238
3J-2	A5J5 Signal Locator (Solder Side View)	3-242
3J-3	Cable Plug W5P2 Signal Locator	3-246
3J-4	A5J5 Signal Locator (Solder Side View)	3-248
3J-100	A12 Sum Loop/Divider Module Diagnostics	3-263
3K-1	Cable Plug W6P2 Signal Locator	3-279
3K-2	A5J6 Signal Locator (Solder Side View)	3-283
3K-3	Cable Plug W6P2 Signal Locator	3-286
3K-4	A5J6 Signal Locator (Solder Side View)	3-288
3K-100	A13 Output Filters/ALC Module Diagnostics	3-293
3L-1	Cable Plug W7P2 Signal Locator	3-312
3L-2	A5J7 Signal Locator (Solder Side View)	3-315
3L-3	Cable Plug W7P3 Signal Locator	3-318
3L-4	A5J7 Signal Locator (Solder Side View)	3-321
3L-5	Cable Plug W7P2 Signal Locator	3-324
3L-6	A5J7 Signal Locator (Solder Side View)	3-326
3L-100	A14 Heterodyne Module Diagnostics	3-331
3N-1	Cable Plug W11P2 Signal Locator	3-347
3N-2	A5J8 Signal Locator (Solder Side View)	3-349
3N-3	Cable Plug W11P2 Signal Locator	3-353
3N-4	A5J8 Signal Locator (Solder Side View)	3-357
3N-100	A19 Doubler/Attenuator Module Diagnostics	3-369
3O-100	Exceptional Cases Troubleshooting Diagram	3-379
4-100	Replacing a Module	4-17
5-100	Mechanical Procedure Diagrams	5-29

TABLE OF CONTENTS—Continued

FIGURES—Continued

No.		Page
3G-3	Cable Plug W2P2 Signal Locator	3-161
3G-4	A5J2 Signal Locator (Solder Side View)	3-163
3G-100	A7 SAWR Loop Module Diagnostics	3-167
3H-1	Cable Plug W3P2 Signal Locator	3-184
3H-2	Cable Plug A5J3 Signal Locator	3-187
3H-3	Cable Plug W3P2 Signal Locator	3-190
3H-4	A5J3 Signal Locator (Solder Side View)	3-192
3H-100	A9 IF Reference Module Diagnostics	3-197
3I-1	Cable Plug W4P2 Signal Locator	3-206
3I-2	A5J4 Signal Locator (Solder Side View)	3-209
3I-3	Cable Plug W4P2 Signal Locator	3-212
3I-4	A5J4 Signal Locator (Solder Side View)	3-214
3I-100	A11 Reference Loop Module Diagnostics	3-229
3J-1	Cable Plug W5P2 Signal Locator	3-238
3J-2	A5J5 Signal Locator (Solder Side View)	3-242
3J-3	Cable Plug W5P2 Signal Locator	3-246
3J-4	A5J5 Signal Locator (Solder Side View)	3-248
3J-100	A12 Sum Loop/Divider Module Diagnostics	3-263
3K-1	Cable Plug W6P2 Signal Locator	3-279
3K-2	A5J6 Signal Locator (Solder Side View)	3-283
3K-3	Cable Plug W6P2 Signal Locator	3-286
3K-4	A5J6 Signal Locator (Solder Side View)	3-288
3K-100	A13 Output Filters/ALC Module Diagnostics	3-293
3L-1	Cable Plug W7P2 Signal Locator	3-312
3L-2	A5J7 Signal Locator (Solder Side View)	3-315
3L-3	Cable Plug W7P3 Signal Locator	3-318
3L-4	A5J7 Signal Locator (Solder Side View)	3-321
3L-5	Cable Plug W7P2 Signal Locator	3-324
3L-6	A5J7 Signal Locator (Solder Side View)	3-326
3L-100	A14 Heterodyne Module Diagnostics	3-331
3N-1	Cable Plug W11P2 Signal Locator	3-347
3N-2	A5J8 Signal Locator (Solder Side View)	3-349
3N-3	Cable Plug W11P2 Signal Locator	3-353
3N-4	A5J8 Signal Locator (Solder Side View)	3-357
3N-100	A19 Doubler/Attenuator Module Diagnostics	3-369
3O-100	Exceptional Cases Troubleshooting Diagram	3-379
4-100	Replacing a Module	4-17
5-100	Mechanical Procedure Diagrams	5-29

20

20

20

Section 0 GENERAL INFORMATION

0-1. SCOPE.

This manual contains operation and service instructions for the Hewlett-Packard Model 8642M Signal Generator.

0-2. SAFETY CONSIDERATIONS.

This product is a Safety Class I instrument; that is, one provided with a protective earth terminal. Before operating or servicing the Signal Generator, personnel should familiarize themselves with both the safety markings on the equipment and the safety information presented at the beginning of this manual.

0-3. INSTRUMENTS COVERED BY THIS MANUAL.

Serial Numbers. Attached to the instrument is a serial-number plate. The serial number is in this form: 0000A00000. The first four digits and the letter are the serial prefix. The last five digits form the suffix that is unique to each instrument. The contents of this manual apply directly to instruments having the same serial prefix(es) as those listed at the beginning of this manual.

Manual Updates. An instrument manufactured after the printing of this manual may have a serial prefix that is not listed at the beginning of this manual. An unlisted serial prefix number indicates that the instrument differs in some way from those being documented when this manual was released.

A "MANUAL UPDATES" packet is shipped with the manual when necessary to provide you with the most current information available at the time of shipment. These packets consist of replacement and addition pages which should be incorporated into the manual to bring it up to date.

Hewlett-Packard offers a Documentation Update Service that will provide you with further updates as they become available.

If you service instruments of different serial prefixes, we strongly recommend that you join this service immediately to ensure that your manual is kept current. For more information, refer to the Documentation Update Service reply card included with this manual or contact:

Hewlett-Packard Company
Technical Writing Department
24001 E. Mission-TAF C-34
Spokane, WA 99220
(509) 922-4001

0-4. DESCRIPTION.

The Hewlett-Packard 8642M Signal Generator has a frequency range of from 100KHz to 2GHz and frequency resolution of 1Hz at all frequencies. The output is leveled and calibrated from +15dBm to -140dBm at all frequencies. Amplitude Modulation, Frequency Modulation, and Pulse Modulation modes are selectable. Frequency, modulation modes, output level, and most other functions can be remotely programmed via the interface.

0-5. WARRANTY INFORMATION.

The HP 8642 is warranted by Hewlett-Packard Company for one year. Warranty starts on the date of shipment to the original buyer.

0-6. EQUIPMENT THAT CAN BE ORDERED FOR THE SIGNAL GENERATOR

Bench Service Kit. This kit, in conjunction with the HP 8642 Synthesized Signal Generator Service Manual, is directed at component-level repair and module calibration of the HP 8642. The kit contains special tools and troubleshooting aids such as: a Torx torque driver and Torx bits, special cables and cable adapters, test adapters, etc. Order the Bench Service Kit with HP part number 11802A.

Fiberglass Transit Case. This is a protective case for shipping and transporting the HP 8642 Signal Generator. Order the case with HP part number 9211-2661.

0-7. MODULE EXCHANGE PROGRAM

All modules contained in the Signal Generator may be replaced. In addition, most replacement modules are available as restored (factory repaired and calibrated) parts on an exchange basis, thus providing a considerable cost savings. (Refer to the REPLACEABLE PARTS section for ordering information.)

The modules should be packaged in the cartons supplied for shipment.

0-8. STORAGE.

The instrument should be stored in a clean, dry environment. The following environmental limitations apply to both storage and shipment:

Temperature	-55°C to +75°C
Humidity	5% to 95% (maximum wet-bulb temperature = 40°C)
Altitude	50,000 feet (15,300 meters)

0-9. PACKAGING.

Original Packaging. Containers and materials identical to those used in factory packaging are available through Hewlett-Packard offices. If the instrument is being returned to Hewlett-Packard for servicing, attach a tag indicating the type of service required, return address, model number, and full serial number. Also mark the container FRAGILE to assure careful handling. In any correspondence refer to the instrument by model number and full serial number.

Other Packaging. The following general instructions should be used for repackaging with commercially available materials:

1. Wrap the instrument in heavy paper or plastic. (If shipping to a Hewlett-Packard office or service center, attach a tag indicating the service required, return address, model number, and full serial number.)
2. Use a strong shipping container. A double wall carton made of 2.4 MPa (350 psi) test material is adequate.
3. Use enough shock-absorbing material (75 to 100 mm layer, 3 to 4 in.) around all sides of the instrument to provide firm cushion and prevent movement in the container. Protect the front panel with cardboard.
4. Seal the shipping container securely.
5. Mark the shipping container FRAGILE to ensure careful handling.

0-10. RECOMMENDED TOOLS AND TEST EQUIPMENT.

The following list of test equipment is required for testing, and servicing the Signal Generator. Note that some of the equipment listed is part of On-Site Service Kit.

INSTRUMENT	CRITICAL SPECIFICATION	MODEL NUMBER
Digital Voltmeter	10mV to 600V, $\pm 0.05\%$ of reading ± 1 digit	HP 3466A/3455A
Oscilloscope	10mV/div, 100MHz BW	HP 1740A
Power Meter	10MHz to 2GHz, -27 to +7dBm $\pm 1\%$	HP 432A
Thermistor Mount	10MHz to 2GHz, -27 to +7dBm $\pm 1\%$	HP 478A
Attenuator	450KHz to 2GHz, 10dB, ± 0.1 dB, <1.3 SWR	HP 8491B/010
Spectrum Analyzer	900KHz to 1GHz, 50KHz-250MHz Span/DIV	HP 8562A
Pulse Generator	50KHz max rate, <6 μ sec PW, ≤ 100 nsec rise time	HP 214B
Modulation Analyzer	No substitute	HP 8901A
Distortion Analyzer	0-5% AM, 0-2% FM distortion 0-4vpeak input	HP 334A
Frequency Counter	0-2GHz, ± 1 Hz	HP 5345A
Low Frequency Spectrum Analyzer	100Hz to 40MHz, ≤ 10 Hz RES BW, 90dB dynamic range	HP 3585A

0-10. RECOMMENDED TOOLS AND TEST EQUIPMENT—Continued.

INSTRUMENT	CRITICAL SPECIFICATION	MODEL NUMBER
Adapter	BNC to type N	
Adapter	BNC to dual banana	
Cable Assembly	50Ω BNC-BNC (2 each)	
BNC Tee		
Test Conn	BD ASSY PS TEST CONN	HP 08642-80053
Cable Assembly	Flat	HP 08642-60959
Cable Assembly	Long	HP 08662-60075
Cable Assembly	Short	HP 08662-60080
Adapter	(M) SMC to (M) SMC (4)	HP 1250-0827
Adapter	(F) BNC to (F) SMC (2)	HP 1250-0832
Adapter	(M) SMC TEE	HP 1250-0837
Adapter	(M) SMA to (F) SMC (2)	HP 1250-1697
Adapter	50 Pin Test Connector	HP 1251-5653
Adapter	16 Pin Test Connector	HP 1251-8105
Adapter	26 Pin Test Connector	HP 1251-8248
Adapter	34 Pin Test Connector	HP 1250-8601
Adapter	20 Pin Test Connector	HP 1251-8812
Adapter	14 Pin Test Connector	HP 1251-8823
Adapter	10 Pin Test Connector	HP 1252-0153
Adapter	Binding Post	HP 5021-0844
Test Lead Kit		HP 34118A

0-11. TECHNICAL CHARACTERISTICS.

CONTINUOUS WAVE (CW) SPECIFICATIONS:

Frequency Range with specified RF performance	100KHz to 2000MHz
Frequency Range without specified RF performance	10KHz to 2000MHz
Resolution	1Hz
Display Accuracy	± 2 ppm (15° C to 35° C) and ± 10 ppm (0° C to 50° C)
Frequency Stability:	
Stability vs Time	± 0.05 ppm /hour and ± 2 ppm/90 days
Stability vs Temperature	± 2 ppm (15° C to 35° C) and ± 10 ppm (0° C to 50° C)
Stability vs Line Voltage	± 0.05 ppm for a 10% change in power source voltage
Stability vs Output Level	± 0.01 ppm
Spectral Purity:	
Harmonics	< -25 dBc from $< +13$ dBm @ < 1057.5 MHz and $< +7$ dBm @ > 1057.5 MHz
Sub Harmonics	< -100 dBc (to 1057.5MHz) and < -45 dBc (to 2GHz)
Spurious Signals	-70 dBc (to 132.1875MHz), -90 dBc (132.1875MHz to 1057.5MHz), and -84 dBc (above 1057.5MHz) offset > 10 KHz from carrier
Residual AM	$< 0.01\%$ AMrms (0.3 to 3 KHz post-detection bandwidth)
Residual FM	< 4 Hz (to 132.1875MHz), < 2 Hz (132.1875MHz to 1057.5MHz), and < 5 Hz (above 1057.5MHz) in a 0.3 to 3KHz post-detection noise bandwidth
SSB Phase Noise	-127 dBc/Hz (to 132.1875MHz), -134 dBc/Hz (132.1875MHz to 1057.5MHz) and -125 dBc/Hz (above 1057.5MHz). measured in a 1Hz bandwidth, offset 20KHz from the carrier
Noise Floor	< -135 dBc/Hz (to 132.1875MHz), < -140 dBc/Hz (to 1057.5MHz), and < -134 dBc/Hz (to 2.0GHz) at 3MHz offset

RF OUTPUT SPECIFICATIONS:

RF Output Level	Carrier level $> +15$ dBm to -140 dBm (all frequencies) and $+18$ dbm down to -140 dBm (< 528.75 MHz)
Output Impedance	50 Ω nominal
Reverse Power Protection	50 watts, 50 volts (to 1000MHz) and 25 watts, 50 volts (above 1000MHz)
VSWR	$< 1.5:1$ (to 1000MHz) and $< 2.5:1$ (above 1000MHz) when terminated in a 50 Ω resistive load
RF Output Connector	Female Type N coaxial connector
Output Level Resolution	0.1dB
Output Leveling Flatness	± 1.5 dB (to 500MHz), ± 2.0 dB (500MHz to 1000MHz), and ± 2.5 dB (above 1000MHz)
Attenuator Accuracy	± 2.0 dB
Absolute Level Accuracy ...	$\leq \pm 0.1$ dB (-127 to $+15$ dBm) and $\leq \pm 3.5$ dB (< -127 to $> +15$ dBm)

0-11. TECHNICAL CHARACTERISTICS—Continued.

MODULATION SPECIFICATIONS:

(Internal and external AM, FM, ØM, and Pulse Modulation)

Amplitude Modulation:

Frequency Range	100KHz to 1057.5MHz
Modulation Depth	0% to 99.9% (to 1057.5MHz) in 0.1% increments
Frequency Response	DC to 100KHz external, 20Hz to 100KHz internal
Sensitivity	0.1% per mv peak into 600Ω
Maximum Input Level	±20 volts (30 seconds)
Distortion	<1.5% (30% depth), <3% (30 to 70% depth), and <5% (70 to 90% depth) modulation at a 1KHz rate to 1057.5MHz
Incidental ØM	<0.2 radians (30% depth, 1KHz rate, in a 0.3 to 3KHz post-detection noise bandwidth)

Impedance	600Ω ±10%
AM Input Connector	Female type BNC coaxial connector

Frequency Modulation:

Frequency Response	DC to 100KHz external, 20Hz to 100KHz internal in 1% increments
Deviation	≤300KHz (30MHz to 132.1875MHz), ≤375KHz (132.1875MHz to 528.75MHz), and ≤1.5MHz (above 528.75MHz) for a modulating rate between DC and 100KHz
Sensitivity	1 volt peak into 600Ω ±10% for maximum deviation
Maximum Input Level	±20 volts (30 seconds)
Distortion	4% (for maximum DC Coupled deviation), 2% (for 1/2 maximum DC Coupled deviation), and 0.4% (for 1/15 maximum DC Coupled deviation) for a modulating rate between 20Hz and 100KHz

Incidental AM	<0.3% (>400KHz carrier, 20KHz peak deviation, 1KHz rate)
Impedance	600Ω ±10%
FM Input Connector	Female type BNC coaxial connector

Pulse Modulation:

Operating range	10MHz to 2000MHz
Pulse Modulation Input Connector	Female Type BNC coaxial connector
Impedance	50Ω ±5Ω (10Hz to 200KHz)
Pulse Repetition Rate Range	DC to 50KHz
Duty Cycle Maximum	≥50%
Pulse Duration Range	6μsec to 50msec (measured from (DC volts to turn on pulse) to (DC volts turn off pulse))
Pulse First and Last Transition Duration (10% to 90% rise/fall time)	3μsec to 20msec
Pulse Amplitude	±3V to ±10V
Pulse Baseline Maximum Amplitude	Less negative than -0.5V and less positive than +0.5V
Pulse Topline Minimum Amplitude	More negative than -3.5V and more positive than +3.5V
Maximum Input Level	±20 volts (30 seconds)
RF Pulse Envelope Duration	±5% of the input pulse duration

0-11. TECHNICAL CHARACTERISTICS—Continued.

MODULATION SPECIFICATIONS—Continued:

Pulse Modulation—Continued:

RF Pulse Envelope First/Last Transition Duration (10%-90% rise/fall time) <0.5 μ sec
RF Pulse Envelope Overshoot/Undershoot <20% of the RF pulse envelope amplitude
RF Pulse Envelope first and Last Settling Duration <1 μ sec to within \pm 1% of final
value (measured from two
90% points)
RF Pulse Envelope On/Off Ratio >40dB (10MHz to 2000MHz)

Phase Modulation:

Maximum Deviation 100 radians (from 100KHz to 132.1875MHz), 25 radians (from
132.1875MHz to 264.375MHz), 50 radians (from
264.375MHz to 528.75MHz), 100 radians (from 528.75MHz
to 1057.5MHz), 200 radians (from 1057.5MHz to 2.0GHz)

Bandwidth DC to 15KHz external (DC coupled) and 20Hz to 15KHz internal and
external (AC coupled)

Resolution 0.7% of setting or 0.0004% of maximum deviation, whichever is greater

Accuracy \pm (5% of setting +0.09 radians) at 1KHz rate

Distortion <0.4% at 1KHz rate

External Sensitivity 1 volt peak for selected peak phase deviation

Maximum Input Level \pm 15 volts (30 seconds)

Impedance 50 Ω \pm 5 Ω (10Hz to 200KHz)

\varnothing M Input Connector Female type BNC coaxial connector

Internal Modulation Oscillator:

Frequency Range: 20Hz to 100KHz

Frequency Resolution: 1% of setting

Frequency Accuracy: 2% of setting

Output Level Range: 0 to 3 volts peak into 600 Ω

Output Level Resolution: 4mV

Output Level Accuracy (within 1 sec): \pm (4%+15mV)

Distortion (>0.5V peak): <0.02% (20Hz to 15.8KHz), <0.15% (15.8KHz to 100KHz)

Output Impedance: 600 Ω

Output Connector Female type BNC coaxial connector

REAR PANEL CONNECTOR SPECIFICATIONS:

Interface Connector:

Type ANSI / IEEE Standard 488-1978 interface with SH1, AH1, T1, 2 5, or 6,
L1, 2, 3, or 4, SR1, RL1, PPO, DC1, ETO, and CO functions
implemented

Control All front panel functions, except power switch and increment knob,
may be controlled through the interface

X-Axis Connector 0—10Vdc, \pm 10%

Z-Axis Connector TTL positive true for CRT display blanking during retrace

External Reference Input 1,2,5 or 10MHz, \pm 25ppm, >0.5Vp-p 500 Ω input

10MHz Output 10MHz, >1.4Vp-p into 50 Ω , 75 Ω impedance output

0-11. TECHNICAL CHARACTERISTICS—Continued.

OPERATING POWER REQUIREMENTS:

Voltage 115/230 VAC
Frequency 50 to 400Hz
Power Dissipation 300VA maximum

ENVIRONMENTAL REQUIREMENTS:

Operating Temperature Range 0 to +55°C
Operating Altitude <4570 meters (15,000 feet)
Operating Humidity 5 to 95% at 40°C

OVERALL DIMENSIONS AND WEIGHT:

Height 5.25 IN. (133mm)
Width 16.75 IN. (425mm)
Depth 23.8IN. (617mm)
Weight 71.5LB (32.7kg) NET

ACCESSORIES FURNISHED:

Power Cable, 115V operation 1 each HPN 8120-1378
Fuse, 230V operation 1 each HPN 2110-0002
Fuse, 115V operation 1 each HPN 2110-0003
Front Handle Kit 1 each HPN 5061-9689

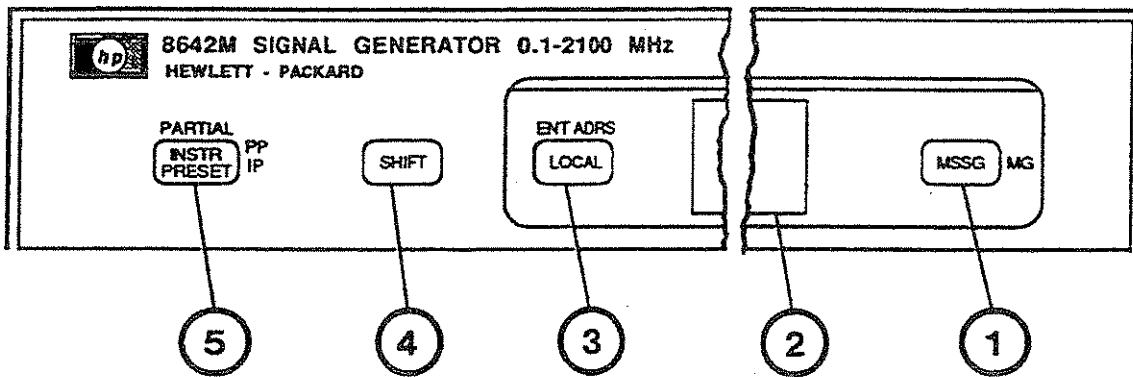

VIEW A

KEY	CONTROL, INDICATOR, OR CONNECTOR	FUNCTION
1	MESSAGE push button	When pressed, queued-up operating messages are displayed. MSSG annunciator and flashing display are indications that messages are present. Press SHIFT MESSAGE push buttons to view previous messages.
2	Display RMT LSTN TLK SRQ START annunciator FREQ annunciator REL annunciator EMF annunciator SPCL annunciator SWPNG annunciator HILO annunciators ØM FM AM annunciators	Displays various Signal Generator messages and settings. The cursor designates which Signal Generator function is active. These annunciators indicate the HP-IB status of the Signal Generator. Indicates that RF frequency sweep is selected and a start frequency is currently displayed or that a sequence is being set. Indicates the RF frequency is being displayed. Indicates the current RF frequency is displayed in relative units. Indicates the current amplitude is in EMF units. Indicates a special function is currently selected. Indicates that either an RF frequency or amplitude sweep is currently taking place. Used to indicate whether the external modulation source level is too high or too low to obtain the displayed depth or deviation. Reference level is 1V _{peak} , ±5%. Not used for pulse modulation. Indicate the type or types of modulation selected.

KEY	CONTROL, INDICATOR, OR CONNECTOR	FUNCTION
	<p>START annunciator</p> <p>INT EXT AC DC</p> <p>AMPTD annunciator</p> <p>REL annunciator</p> <p>STOP annunciator</p> <p>MSSG annunciator</p>	<p>When the START annunciator in the left portion of the display appears with the AMPTD annunciator, a start amplitude is currently displayed. When this annunciator appears without the AMPTD annunciator, a sequence is being set.</p> <p>Combinations of these annunciators display the current status of the modulation source for the displayed modulation type.</p> <p>Indicates that the output amplitude is being displayed.</p> <p>Indicates the current output amplitude is displayed in relative units.</p> <p>Indicates that:</p> <ol style="list-style-type: none"> 1) stop frequency of the RF frequency sweep is currently being displayed, or 2) stop amplitude of amplitude sweep is currently being displayed, or 3) that sequence is being set. <p>When displayed, select the Message push button to display a queued-up message.</p>
3	LOCAL push button	Used only when external controller is connected to Signal Generator. When used, Signal Generator is switched out of remote operation.
3A	ENT ADRS	Used to display or change address. Press SHIFT then LOCAL to display present address. Press SHIFT, LOCAL, desired number from 00 to 30, then HZ μ V push buttons to enter new address.
4	SHIFT push button	Allows for access to the functions labeled in blue. To bypass the power-up checks, press and hold SHIFT push button down during power-up until instrument settings are displayed. Pressing Shift twice clears any messages and returns the display to showing normal instrument settings.
5	INSTR PRE SET	Sets the Signal Generator to an initialized state. Push for on.

KEY	CONTROL, INDICATOR, OR CONNECTOR	FUNCTION
5A	PARTIAL	<p>Sets the Signal Generator to another initialized state without affecting certain instrument settings. RF Frequency, Amplitude Reference, EMF Mode, and Sweep Mode are not affected. AM Depth, FM Deviation, Phase Deviation, Pulse Modulation, Modulation Output Level, Start Frequency, Stop Frequency, Frequency Reference, Start Amplitude, and Stop Amplitude are turned off but previously entered values remain. Push Shift then INSTR PRE SET for on.</p>

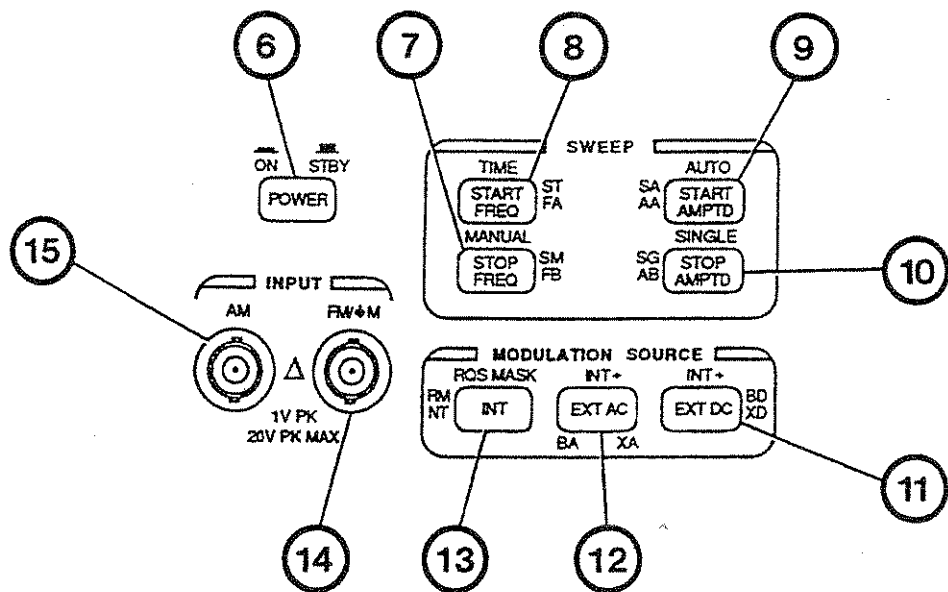

VIEW B

KEY	CONTROL, INDICATOR, OR CONNECTOR	FUNCTION
6	POWER switch	Changes Signal Generator from standby to on. Push in for on and push in again for standby.
7	STOP FREQ push button	Used to enter or display a stopping frequency in sweep mode. Press to display present stop value in the display. Press and use data entry push buttons to enter a new stop frequency. Stop frequency may be less than or greater than start frequency.
7A	MANUAL	Used to activate sweep circuitry, but does not start a sweep. TUNE knob or the STEP push buttons control frequency/amplitude sweep. Beginning frequency/amplitude is controlled by START push button, ending frequency/amplitude is controlled by STOP push button, and step size is controlled by TIME push button. Sweep time of each step is controlled by operator. Press SHIFT then STOP FREQ push button to activate.
8	START FREQ push button	Used to enter or display a starting frequency in sweep mode. Press to display present start value in the display. Press and use data entry push buttons to enter a new start frequency. Start frequency may be less than or greater than stop frequency.

KEY	CONTROL, INDICATOR, OR CONNECTOR	FUNCTION
8A	TIME	Used to enter and display time interval between START FREQ to STOP FREQ or START AMPTD to STOP AMPTD. Press SHIFT and hold START FREQ to show present time value in display. To enter a new time, press SHIFT, START FREQ push button, enter desired time using data entry push buttons, and press MHz V (sec) or KHz mV (msec) push button. Allowable values for frequency time range are 275msec (5msec for phase continuous sweep) to 999sec in 1msec increments. The minimum calculated step size is 1Hz. Allowable values for amplitude time range are 20msec to 999sec in 1msec increments. The minimum calculated step size is 0.1dB.
9	START AMPTD push button	Used to enter or display a starting amplitude in sweep mode. Press to display present start value in the display. Press and use data entry push buttons to enter a new start amplitude. Start amplitude may be less than or greater than stop amplitude.
9A	AUTO	Used to start frequency/amplitude sweep, restarting at end of each sweep. Beginning frequency/amplitude is controlled by START push button, ending frequency/amplitude is controlled by STOP push button, and sweep time is controlled by TIME push button. Press SHIFT then START AMPTD push button to activate.
10	STOP AMPTD push button	Used to enter or display a stopping amplitude in sweep mode. Press to display present stop value in the display. Press and use data entry push buttons to enter a new stop amplitude. Stop amplitude may be less than or greater than start amplitude.

KEY	CONTROL, INDICATOR, OR CONNECTOR	FUNCTION
10A	SINGLE	Used to start frequency/amplitude sweep, stopping at end of each sweep. After one complete sweep, all values remain at stopping point value. Beginning frequency/amplitude is controlled by START push button. Ending frequency/amplitude is controlled by STOP push button. Sweep time is controlled by TIME push button. Press SHIFT then STOP AMPTD push button to activate.
11	EXT DC push button	Selects an external, dc-coupled signal to modulate the Signal Generator RF Output. External signal is connected to AM/PULSE/FM/ØM connector. Push for on.
11A	INT + (EXT DC)	Selects an external, dc-coupled signal and internal modulation oscillator signal to be summed together to modulate the Signal Generator RF Output.
12	EXT AC push button	Selects an external, ac-coupled signal to modulate the Signal Generator RF Output. External signal is connected to AM/PULSE/FM/ØM connector. Push for on.
12A	INT + (EXT AC)	Selects an external, ac-coupled signal and internal modulation oscillator signal to be summed together to modulate the Signal Generator RF Output.
13	INT push button	Selects Signal Generator internal modulation oscillator to modulate the RF Output. Push for on.
13A	RQS MASK	Used for remote operation only. Displays or changes service request status byte value. Press SHIFT then INT push button to display present value. Press SHIFT, INT, desired decimal number from 0 to 255, then HZ µV push buttons to enter new value.

KEY	CONTROL, INDICATOR, OR CONNECTOR	FUNCTION
14	FM/ØM connector	BNC female connector with 600 ohms input impedance used to connect an externally supplied DC to 100KHz, 1 volt peak $\pm 5\%$ signal for frequency modulation of Signal Generator RF output. FM deviation is selectable from 300KHz to 1.5MHz for a 1 volt peak signal. Also used for phase modulation.
15	AM connector	BNC female connector with 600 ohms input impedance used to connect an externally supplied DC to 100KHz, 1 volt peak $\pm 5\%$ signal for amplitude modulation of Signal Generator RF output. AM Depth is selectable from 0 to 99.9% with 1 volt peak signal.

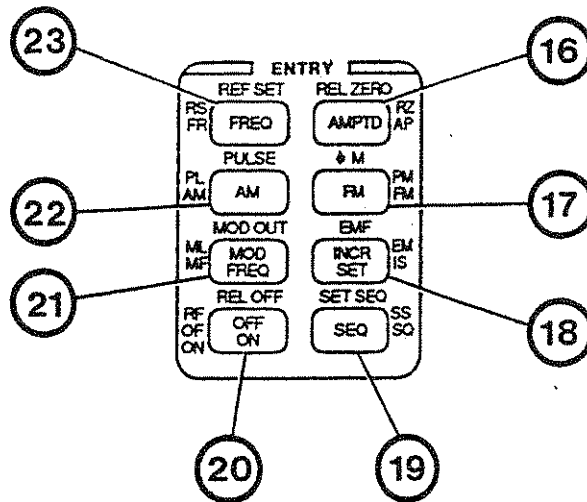

VIEW C

KEY	CONTROL, INDICATOR, OR CONNECTOR	FUNCTION
16	AMPTD push button	Used to enter an output amplitude level. Push and use either data entry push buttons, TUNE KNOB, STEP push buttons, or the OFF ON push button to enter a new amplitude. New value may be entered in dBm, V, mV, μ V, or dB μ V (RAD % push button). Amplitude is shown with a cursor above display indicating it is the active function.
16A	REL ZERO	Used to store the current RF output frequency/amplitude setting as the new frequency/amplitude reference. After pressing, display will show 0MHz/0dB. All subsequent frequency/amplitude settings will be entered and displayed as MHz/dB relative to the stored frequency/amplitude reference value.

KEY	CONTROL, INDICATOR, OR CONNECTOR	FUNCTION
17	FM push button	<p>Used to activate frequency modulation mode. When using internal source, push FM then INT to activate internal modulation oscillator. Push FM and use either data entry push buttons, TUNE KNOB, STEP push buttons, or the OFF ON push button to enter a FM deviation in GHz, MHz, KHz, or Hz. When external signal source is used for FM mode, press FM and enter FM deviation in GHz, MHz, KHz, or Hz for a 1 volt peak signal applied to FM connector . Actual FM deviation is controlled by amplitude of input signal and FM deviation selection. FM deviation is shown with a cursor above display indicating it is the active function. May be used simultaneously with either AM or Pulse Modulation.</p>
17A	PHASE (ØM)	<p>Used to activate Phase modulation mode. When using internal source, push SHIFT FM then INT to activate internal modulation oscillator. Push SHIFT FM and use either data entry push buttons, TUNE KNOB, STEP push buttons, or the OFF ON push button to enter a ØM deviation from 0 to 100 radians. When external signal source is used for ØM mode, press SHIFT FM and enter 0 to 100 radians for a 1 volt peak signal applied to ØM connector . Actual ØM deviation is controlled by amplitude of input signal and ØM deviation selection. ØM deviation is shown with a cursor above display indicating it is the active function. May be used simultaneously with either AM or Pulse Modulation.</p>
18	INCR SET push button	<p>Used to enter a new increment value or display a previously stored increment value. Push to display stored increment. Press and use numeric push buttons to enter a new increment. TUNE KNOB or STEP push buttons can increase or decrease selected functions by INCR SET stored value. Both frequency and amplitude functions can be entered.</p>

KEY	CONTROL, INDICATOR, OR CONNECTOR	FUNCTION
18A	EMF	The EMF mode enables you to display and enter amplitude values in EMF units. Press SHIFT, INCR SET, then OFF ON push button to activate EMF mode. The EMF amplitude is set by selecting the desired AMPTD function.
19	SEQ push button	The SEQ push button enables you to sequentially step through the recall registers in ascending sequence. Range is determined by SET SEQ.
19A	SET SEQ	Used to select a particular range of recall registers to be viewed. Press SHIFT SEQ push buttons and enter desired start and stop registers from 00 to 50.
20	OFF ON push button	The OFF ON push button toggles an active function off or on with a single push button stroke. When OFF ON is used to activate a function, it turns on to the default value or value previously stored. The OFF ON push button can also be used to turn on or turn off the EMF mode, a Reference Set value, the Knob Hold mode, or the Help mode (off only).
20A	REL OFF	Used to turn off Frequency/Amplitude Relative Mode. Press SHIFT OFF ON.
21	MOD FREQ push button	Used to enter a Modulation frequency when using internal modulation oscillator in AM, FM, and \emptyset M modulation modes. MOD connector output frequency is also entered by MOD FREQ push button. Push and use either data entry push buttons, TUNE KNOB, STEP push buttons, or the OFF ON push button. to enter a new modulation frequency. New value may be entered in KHz or Hz. Modulation frequency is shown in display.

KEY	CONTROL, INDICATOR, OR CONNECTOR	FUNCTION
21A	MOD OUT	Used to control the output level from the MOD connector. Press SHIFT MOD FREQ push buttons and enter an output level from 0 to 3Vpk using either data entry push buttons, TUNE KNOB, STEP push buttons, or the OFF ON push button. Modulation output level is shown with a cursor above display indicating it is the active function.
22	AM push button	Used to activate amplitude modulation mode. When using internal source, push AM then INT to activate internal modulation oscillator. Push AM and use either data entry push buttons, TUNE KNOB, STEP push buttons, or the OFF ON push button to enter a modulation depth from 0 to 99.9%. When external signal source is used for AM mode, press AM and enter 0% to 99.9% full scale modulation for a 1 volt peak signal applied to AM connector. Actual AM depth is controlled by amplitude of input signal and AM depth selection. Depth is shown with a cursor above display indicating it is the active function. May be used simultaneously with either FM or Phase Modulation.
22A	PULSE	Used to activate Pulse modulation mode. When using internal source, push SHIFT, AM then INT to activate internal modulation oscillator. When using external signal source, press SHIFT AM then EXT DC push buttons. Press SHIFT AM, and OFF ON push buttons to activate mode. Trigger voltage is ± 1.5 volts.
23	FREQ push button	Used to enter an RF frequency. Push and use either data entry push buttons, TUNE KNOB, STEP push buttons, or the OFF ON push button. to enter a new frequency. New value may be entered in GHz, MHz, KHz, or Hz. Frequency is shown with a cursor above display indicating it is the active function.

KEY	CONTROL, INDICATOR, OR CONNECTOR	FUNCTION
23A	REF SET	Used to enter or display the frequency/amplitude reference. Press SHIFT, FREQ to display present value. Press SHIFT, FREQ, and using the data entry push buttons, enter the new frequency/amplitude reference value. Displayed value will be offset from the stored frequency/amplitude reference value. All subsequent settings will be entered and displayed as offset from the stored frequency/amplitude reference value.

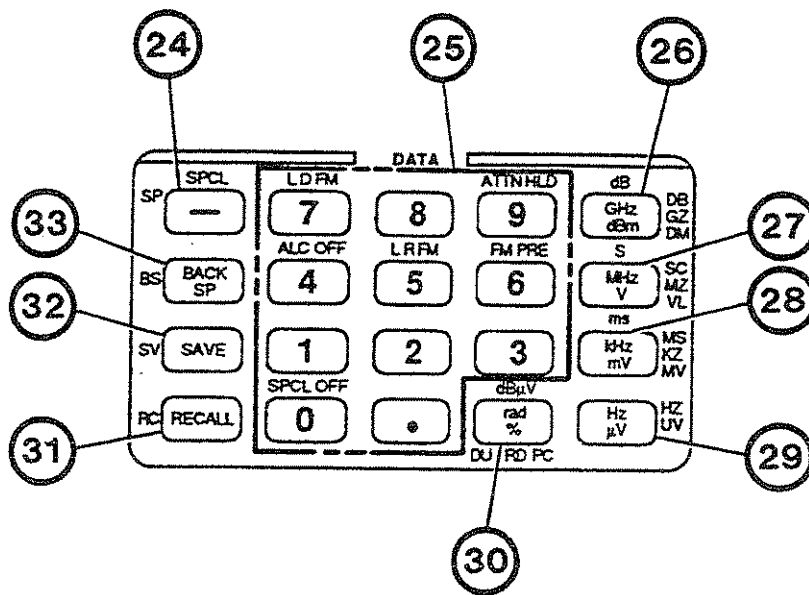

VIEW D

KEY	CONTROL, INDICATOR, OR CONNECTOR	FUNCTION
24	— push button	Used to enter negative numeric value for all Signal Generator Functions. Push for minus.
24A	SPCL	Used to select special functions. Push SHIFT SPCL push button, followed by a valid special function number. (All of the single-digit special functions are labeled in light grey print above digit push buttons.)
25	Numeric push buttons	Used to enter numeric value with decimal point for all Signal Generator Functions. After data is entered, terminator push buttons (KHz mV, etc) are pressed to enter value. Press desired push button.
26	GHz dBm push button	Used to internally store entries from numeric push buttons. Frequency functions are assigned GHz. Amplitude functions are assigned dBm/dB (REF/EMF). Push for on.
27	MHz V push button	Used to internally store entries from numeric push buttons. Frequency functions are assigned MHz. Amplitude functions are assigned volts. Time functions are assigned seconds. Push for on.

KEY	CONTROL, INDICATOR, OR CONNECTOR	FUNCTION
28	kHz mV push button	Used to internally store entries from numeric push buttons. Frequency functions are assigned kHz. Amplitude functions are assigned millivolts. Time functions are assigned milliseconds. Push for on.
29	Hz μ V push button	Used to internally store entries from numeric push buttons. Frequency functions are assigned Hz. Amplitude functions are assigned microvolts. Push for on.
30	rad % push button	Used to internally store entries from numeric push buttons. \emptyset M (Phase modulation) is assigned radians. AM depth is assigned percent. Amplitude functions are assigned db μ V. Push for on.
31	RECALL push button	Used to recall a previously stored Signal Generator operational setup. When selected, front panel settings change to recalled settings. Push RECALL and register number (00 thru 50) to recall a stored setup.
32	SAVE push button	Used to store a Signal Generator operational setup. All front panel controls and indicators, except Messages, HP-IB Address, Local/Remote Mode, Sequential settings, and Special functions can be stored. Push SAVE and register number (00 thru 50) or STEP push buttons to store a setup.
33	BACK SP push button	Clears one digit at a time starting with least significant digit and is used only during data entry and before any terminator push button is pressed.

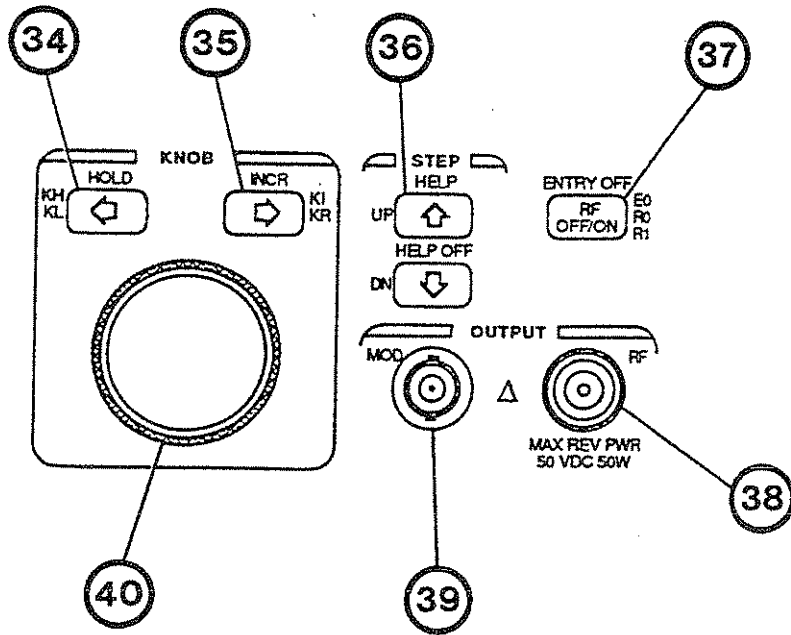

VIEW E

KEY	CONTROL, INDICATOR, OR CONNECTOR	FUNCTION
34/35	→ ← push buttons	Used to select desired digit to be modified by positioning cursor in display. If cursor positioned over 3rd digit, knob will increment/decrement 3rd digit. → moves cursor to right, ← moves cursor to left. Will not move cursor from one function to another (frequency to amplitude). Push to move.
34A	HOLD	Used to maintain TUNE KNOB control over one function, while allowing any other function to be controlled by STEP or data entry push buttons. Dual cursors indicate the function that is controlled by the TUNE KNOB while a single cursor indicates the function controlled by STEP or data entry push buttons. Push SHIFT, ←, OFF ON to activate.
35A	INCR	Used to set the TUNE KNOB increment to the value entered and stored as INCR SET. Press SHIFT → to transfer the increment value to the TUNE KNOB.

KEY	CONTROL, INDICATOR, OR CONNECTOR	FUNCTION
36	STEP (UP/DOWN) push buttons	Used to vary values shown with cursor in display. UP push button increases value and DOWN push button decreases value. Step size is determined by default value or value previously stored in INCR SET. Frequency, Start Frequency, Stop Frequency, Amplitude, Start Amplitude, Stop Amplitude, AM Depth, FM Deviation, ØM Deviation, Modulation Frequency, Modulation Output, Sweep Time, Manual Sweep, Save, Recall, and Help can be controlled by the STEP push buttons. Press for on. Press and hold to repeat.
36A	HELP	The Help function enables you to display the numbers and descriptions of special functions. Press SHIFT STEP (UP) push button to activate, SHIFT STEP (DOWN) push button to deactivate.
37	RF OFF/ON push button	Used to turn RF OUTPUT connector on or off. Provides a convenient and rapid way to toggle the RF Output off and on without changing the attenuators. When RF output is on, Signal Generator has a normal RF signal at RF OUTPUT connector.
37A	ENTRY OFF	Used to disable the active function as well as all TUNE KNOB related functions. When activated, display will not show cursors. TUNE KNOB and STEP push buttons will not change displayed values. Press SHIFT RF OFF/ON to activate.
38	RF OUTPUT connector	Type N female connector with output impedance of 50 ohms used to connect Signal Generator to a load. Supplies RF output over entire frequency range of 100KHz to 2.0GHz. Reverse power protection up to 50 W.
39	MOD connector	Used to supply a 20Hz to 100KHz sinewave signal for modulation. Output level is 0 to 3Vpeak. Output impedance is 600Ω. Leave open for normal operation. Connector mates with BNC plug.

KEY	CONTROL, INDICATOR, OR CONNECTOR	FUNCTION
40	TUNE KNOB	<p>Used to vary values shown with cursor in display. Clockwise rotation increases value and counterclockwise rotation decreases value. Step size is either determined by value stored in INCR SET or cursor positioning push buttons. Frequency, Start Frequency, Stop Frequency, Amplitude, Start Amplitude, Stop Amplitude, AM Depth, FM Deviation, ØM Deviation, Modulation Frequency, Modulation Output, Sweep Time, Manual Sweep, and Help can be controlled by the TUNE KNOB.</p>

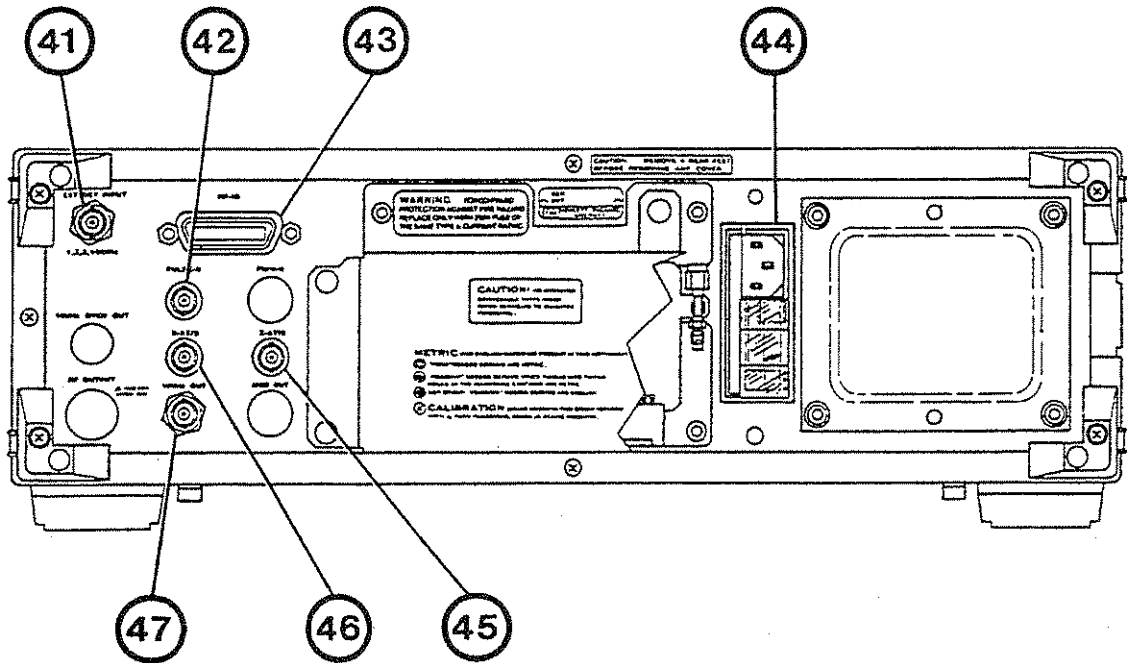

Figure 1-2. Operator's Controls, Indicators, and Connectors, rear view.

KEY	CONTROL, INDICATOR, OR CONNECTOR	FUNCTION
41	EXT REF INPUT connector	Used to connect a 1, 2, 5, or 10Mhz external reference to Signal Generator. Input power can be no less than 0.5Vp-p. Maximum input is ± 5 volts. Leave open for normal operation. Impedance is 500Ω . Connector mates with BNC plug.
42	Pulse connector	BNC female connector with 50 ohms input impedance used to connect an externally supplied DC to 50KHz, 1 to 15 volt peak signal for pulse modulation of Signal Generator RF output. Trigger voltage is 1.5 volts. Accepts TTL levels.
43	HPIB Interface connector	Used as input and output connector for external devices during remote operation. Connector has 24 pins with metric posts.

KEY	CONTROL, INDICATOR, OR CONNECTOR	FUNCTION
44	Line Power Module	Used as power input connector for Signal Generator. Also contains line fuse and voltage selection facilities. Voltage selection provided for operation from 100, 120, 220, or 240 VAC. Number visible in window displays nominal line voltage for which the Signal Generator is set to operate. Power input connector accepts female end of power cable (supplied). Protective grounding conductor connects to Signal Generator through this connector. Line power fuse is 3 amp, 250 volts for 100/120 VAC operation and 2 amp, 250 volts for 220/240 VAC operation. Remove power cable, slide plastic window over connector, and pull extractor to remove fuse.
45	Z-Axis connector	Connection providing a TTL positive true blanking pulse for external oscilloscope display blanking during retrace. Leave open for normal use. Connector mates with BNC plug.
46	X-Axis connector	Connection providing a 0 to 10Vdc $\pm 10\%$ voltage stepped output for use with an external oscilloscope. Leave open for normal use. Connector mates with BNC plug.
47	10MHz connector	Used for a signal reference to synchronize external devices to Signal Generator. Output power is $>1.4Vp-p$ at 50Ω . Output frequency is 10MHz. Output impedance is 75Ω . Leave open for normal operation. Connector mates with BNC plug.

1-2. INSTALLATION.

The following paragraphs provide the information needed to install the HP 8642 Synthesized Signal Generator. Included is information pertinent to initial inspection, power requirements, line voltage selection, power cables, interconnection, and environment.

1-3. INITIAL INSPECTION.

WARNING

To avoid hazardous electrical shock, do not perform electrical tests when there are signs of shipping damage to any portion of the outer enclosure (covers and panels).

Inspect the shipping container for damage. If the shipping container or cushioning material is damaged, it should be kept until the contents of the shipment have been checked for completeness and the instrument has been checked mechanically and electrically. Procedures for checking electrical performance are given in Section VI. If the contents are incomplete, if there is mechanical damage or defect, or if the instrument does not pass the electrical performance test, notify the nearest Hewlett-Packard office. If the shipping container is damaged, or the cushioning material shows signs of stress, notify the carrier as well as the Hewlett-Packard office. Keep the shipping materials for the carrier's inspection.

1-4. PREPARATION FOR USE.

Power Requirements

The Signal Generator requires a power source of 100 Vac (90 to 105 Vac), 120 Vac (108 to 126 Vac), 220 Vac (198 to 231 Vac), or 240 Vac (216 to 252 Vac), 47.5 to 440 Hz single phase. Power consumption is 260 VA maximum (270 VA during attenuator switching).

WARNING

This is a Safety Class 1 product (i.e., provided with a protective earth terminal). An uninterruptible safety earth ground must be provided from the power source to the product input wiring terminals, power cord, or supplied power cord set. Whenever it is likely that the protection has been impaired, the instrument must be made inoperative and be secured against any unintended operation.

If this instrument is to be energized via an external autotransformer for voltage reduction, make sure that the common terminal is connected to the earthed pole of the power source.

CAUTION

BEFORE PLUGGING THIS INSTRUMENT into the Line voltage, be sure the correct voltage and fuse have been selected.

A rear-panel, line power module permits operation from 100, 120, 220, or 240 Vac. The number visible in the window (located on the module) indicates the nominal line voltage to which the instrument must be connected. Verify that the line voltage selection card and the fuse are matched to the power source. Refer to Figure 1-3, Line Voltage and Fuse Selection.

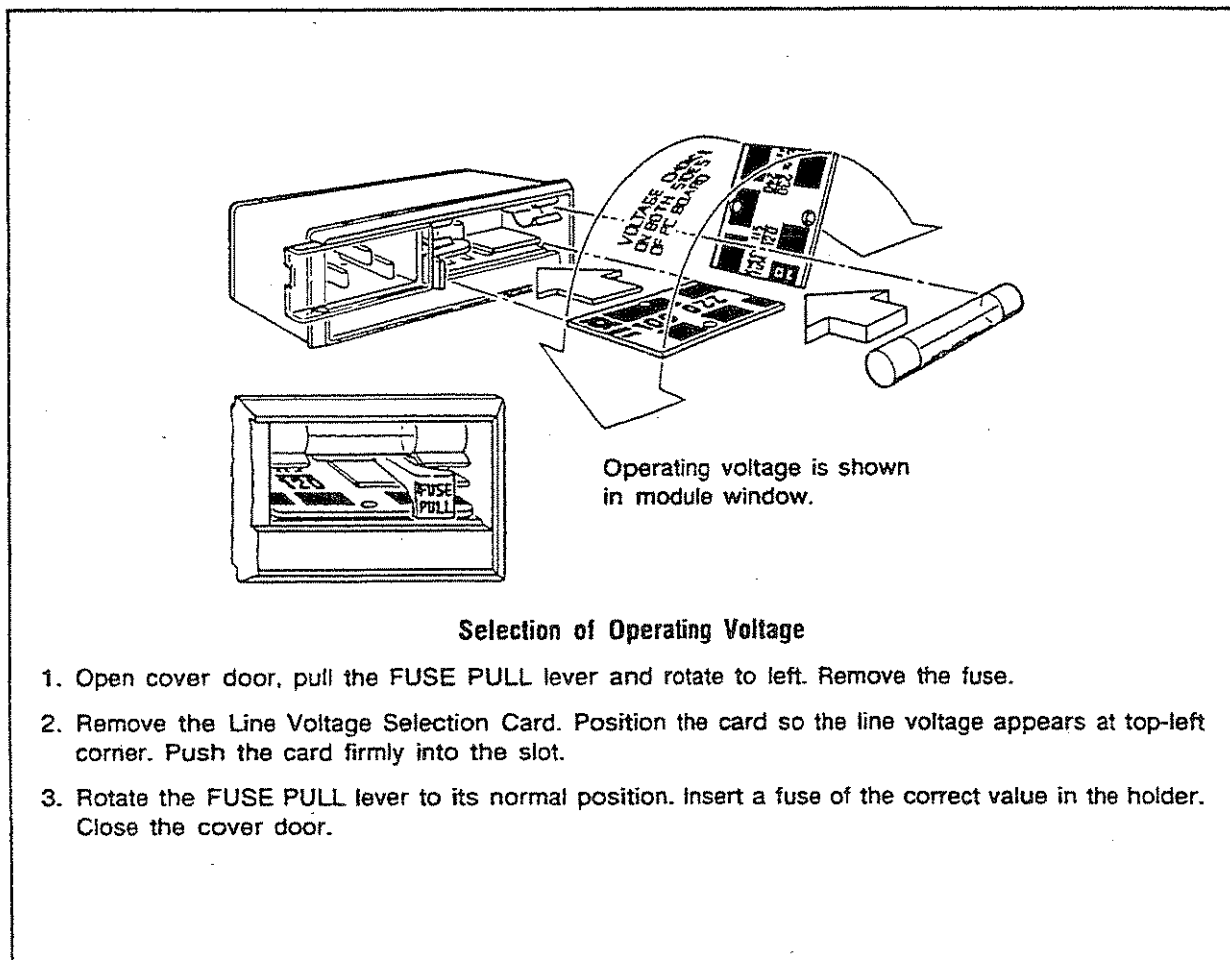

Figure 1-3. Line Voltage and Fuse Selection.

Two fuses are supplied with each instrument. One fuse has the proper rating for 110/120 Vac line operation (HP part number 2110-0003; 3A, 250V, non-time-delay). The other fuse is rated for 200/220 Vac operation (HP part number 2110-0002; 2A, 250V, non-time-delay).

One fuse is installed in the instrument at the time of shipment. The rating of the installed fuse is selected according to the line voltage specified by the customer. If the voltage is not specified, the rating of the installed fuse will be selected according to the country of destination.

WARNING

For protection against fire hazard, the line fuse should only be a 250V normal blow fuse with the correct current rating.

Power Cables

WARNING

BEFORE CONNECTING THIS INSTRUMENT, the protective earth terminal of the instrument must be connected to the protective conductor of the line power cord. The line plug shall only be inserted in a socket outlet provided with a protective earth contact. The protective action must not be negated by the use of an extension cord (power cable) without a protective conductor (grounding). Grounding one conductor of a two conductor outlet is not sufficient protection.

This instrument is equipped with a three-wire power cable. When connected to an appropriate ac power receptacle, this cable grounds the instrument cabinet. The type of power cable plug shipped with each instrument depends on the country of destination. Refer to Table 1-1 for the part numbers of the power cables and line plugs available.

HP-IB Address Selection

The Signal Generator's address is set to 19 at the factory both in RAM memory and an internal switch located inside the instrument. The address stored in RAM remains valid through switching the power from standby to on and unplugging of the ac power cord (unless the internal battery power is lost which would cause RAM memory to be lost). If RAM memory is ever lost, the address on the internal switch is read and becomes the address at turn on. Refer to HP-IB operation for procedures to set the Signal Generator's HP-IB address.

Interconnections





Interconnection data for the Hewlett-Packard Interface Bus is provided in Figure 1-4, Hewlett-Packard Interface Bus Connections.

Mating Connectors

Interface Connector. The HP-IB mating connector is shown in Figure 1-4. Note that the two securing screws are metric.

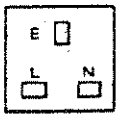
Coaxial Connectors. Coaxial mating connectors used with the Signal Generator should be either the 50-ohm BNC male connectors or 50-ohm Type-N male connectors that are compatible with those specified in US MIL-C-39012.

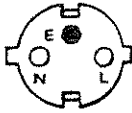
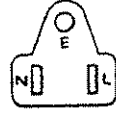
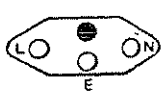
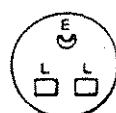
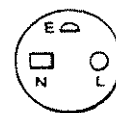
Table 1-1. AC Power Cables Available

Plug Type	Cable HP Part Number	C D	Plug Description	Cable Length (inches)	Cable Color	For Use In Country
250V 	8120-1351 8120-1703	0 6	Straight*BS1363A 90°	90 90	Mint Gray Mint Gray	United Kingdom, Cyprus, Nigeria, Rhodesia, Singapore
250V 	8120-1369 8120-0696	0 4	Straight*NZSS198/ASC112 90°	79 87	Gray Gray	Australia, New Zealand
250V 	8120-1689 8120-1692	7 2	Straight*CEE7-Y11 90°	79 79	Mint Gray Mint Gray	East and West Europe, Saudi Arabia, Egypt, So. Africa, India (unpolarized in many nations)
125V 	8120-1378 8120-1398 8120-1754 8120-1378 8120-1521 8120-1676	5 5 7 1 6 2	Straight*NEMA5-15P 90° Straight*NEMA5-15P Straight*NEMA5-15P 90° Straight*NEMA5-15P	80 80 36 80 80 36	Black Black Black Jade Gray Jade Gray Jade Gray	United States, Canada, Japan (100V or 200V), Mexico, Phillipines, Taiwan
250V 	8120-2104	3	Straight*SEV1011 1959-24507 Type 12	79	Gray	Switzerland
250V 	8120-0698	6	Straight*NEMA6-15P			United States, Canada
220V 	8120-1957 8120-2956	2 3	Straight*DHCK107 90°	79 79	Gray Gray	Denmark
250V 	8120-1860	6	Straight*CEE22-VI (Systems Cabinet use)			
<p>*Part number shown for plug is industry identifier for plug only. Number shown for cable is HP Part Number for complete cable including plug. E = Earth Ground; L = Line; N = Neutral</p>						

Operating Environment

Temperature	0°C to +55°C
Humidity	5 to 95% (maximum wet bulb temperature = 40°C)
Altitude	<4570 meters (15,000 feet)
Airflow	5.8 mm (0.23 in.) minimum clearance underneath the instrument and sufficient clearance at the instrument's right side for air flow that is not obstructed.

1-5. OPERATION UNDER USUAL CONDITIONS.

Operating procedures are broken down into individual functions and are provided starting in paragraph 1-8. Operating messages that may be encountered during operation and maintenance are listed in paragraph 1-7.

1-6. TURN-ON PROCEDURES.

1. Apply power to the Signal Generator. Signal Generator will perform a self test for approximately 30 seconds. Verify that the fan on the rear panel is operating.
2. After 30 seconds, verify that the display has no operating message indications. If MSSG Annunciator is on or display is flashing, press MSSG push button and see paragraph 1-7 for explanation. Verify the following condition exists on the Signal Generator front panel:

RF Frequency	100MHz
Start Frequency	OFF(100MHz)
Stop Frequency	OFF(100.1MHz)
Frequency Reference	OFF(100MHz)
Amplitude	ON(-140dBm)
Start Amplitude	OFF(-140dBm)
Stop Amplitude	OFF(-135dBm)
Amplitude Reference	OFF(1.0µV)
EMF Mode	OFF
AM Depth	OFF(50% Internal)
FM Deviation	OFF(50KHz Internal)
Phase Deviation	OFF(1.0 radians Internal)
Pulse Modulation	OFF(External DC Source)
Modulation Frequency	1.0KHz
Modulation Output Level	OFF (1V)
Frequency Sweep Mode	AUTO
Amplitude Sweep Mode	AUTO
Sweep Time	500msec
All other controls and indicators	OFF

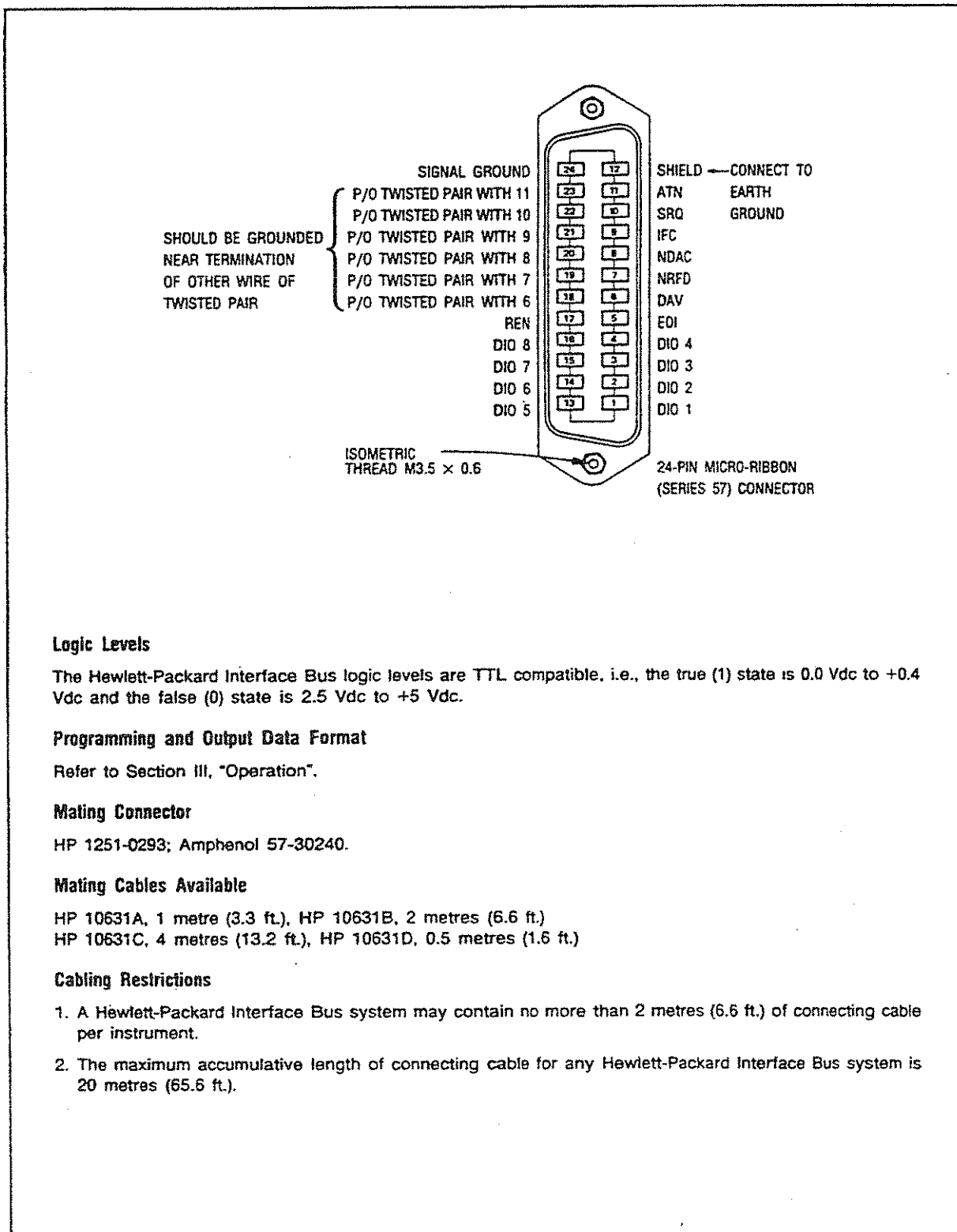

Figure 1-4. Hewlett-Packard Interface Bus Connections.

1-7. OPERATING MESSAGES.

Some operator actions and Signal Generator failures cause operating messages. If a message appears in the display, or MSSG Annunciator lights, or the display flashes, press MSSG push button to display message.

Operating Messages are grouped into seven categories as follows:

Parameters Changed Messages

Local: These messages are automatically displayed except for C32 and C33.

HP-IB: All of these messages can be output via HP-IB using "OC".

Parameters Changed messages (message code is prefixed with "C") inform you that the Signal Generator has changed some other setting to allow a new setting. Some of the Signal Generator's functions cannot occur simultaneously with other functions, so the Parameters Changed message indicates the Signal Generator has automatically adjusted or turned off the functions that are preventing the new setting. These messages occur immediately after executing a command that causes some other parameter to automatically change.

HP-IB: You can read only the first Parameters Changed message if more than one has occurred. For example, assume that more than one Parameters Changed message has occurred since either the Status Byte was cleared or since the last time "OC" was executed. Then a Parameters Changed message using "OC" will enable you to read out only the first message.

Execution Error Messages

Local: These messages are automatically displayed.

HP-IB: All of these messages are output via HP-IB using "OE".

Execution Error messages (message code is prefixed with "E") describe the Signal Generator's reason for not executing an attempted setting. Some settings are not possible because functions are coupled together due to limitations of internal circuit configuration. This coupling will sometimes limit the execution of a setting because one function limits the setting of the other. When your setting attempt cannot occur, the Signal Generator explains the restriction. Execution Error messages occur immediately after executing a command that does not execute.

HP-IB: You can read only the first Execution Error message if more than one has occurred. For example, assume that more than one Execution Error message has occurred since either the Status Byte was cleared or since the last time "OE" was executed. Then reading an Execution Error message using "OE" will enable you to read out only the first message.

Hardware Error Messages

Local: These messages are all queued up and can be displayed using the MSSG push button.

HP-IB: All of these messages are output via HP-IB using "OH".

Hardware Error messages (message number is prefixed with "H") signal the presence of either an internal circuit hardware problem or a firmware problem that you might be able to resolve. Hardware Error messages may occur independently of function execution. A maximum of 20 Hardware Error messages can be queued up to be accessed either by the MSSG push button on the front panel, or via HP-IB using "OH". If you are unable to repair the hardware error, refer to Section III for more information.

Information Messages

Local: These messages are automatically displayed when you execute a function.

HP-IB: Most of these messages can be output via HP-IB using the Output Display capability after you execute a function. 11, 12, 159, and 160 cannot be read via HP-IB. To understand a way to read 141 through 149 and 151 through 159, refer to that message description on the following page.

Information messages (message code is prefixed with "I") provide useful information about instrument settings or conditions.

Prompt Messages

Local: These messages are automatically displayed when you execute a function.

HP-IB: Most of these messages can be output via HP-IB using the Output Display capability after you execute a function. P91 cannot be read via HP-IB.

Prompt messages (message code is prefixed with "P") instruct you towards completion of the task or function selection you begin.

Out-of-Lock Messages

Out-of-lock messages might appear as queued up messages during operation. (These messages will be disabled if Special Function 119, Disable Settling, is selected.) If any of these messages occur, the instrument might not be functioning properly and need to be serviced. However, some of the messages might be displayed because you have exceeded the instrument's limits. The out-of-lock messages are listed in the Table 1-2. The solution column provides the number(s) of the solution(s) listed below that might eliminate the out-of-lock condition. IF THE PRESCRIBED SOLUTION DOES NOT ELIMINATE THE MESSAGE, THE INSTRUMENT SHOULD BE SERVICED.

Also, these messages can be output using "OH".

Writing Messages

The messages listed (message code is prefixed with "V") might occur when you are accessing the special functions.

When using the instrument locally you will usually be able to view each message whenever it occurs.

When using the instrument via HP-IB, you can access some messages using the "OE" or "OH" commands. Messages accessed this way can be output in the form of a message code number or an actual alphanumeric message string. In the following message listing, the message code number that can be output over HP-IB is provided to the far right of the message. If no message code number is provided, then that message can only be read over HP-IB using Output Display (unless otherwise stated), which is also described in Data Output. The messages that can be output using "OE" or "OH" can also be made to issue a service request.

Messages are displayed in a format that shows the wording of the message followed by an alphanumeric code. (Alphanumeric codes combine a letter and a number; for example, C31.) The message listing lists the messages as they are displayed, with the alphanumeric code to the right of the message wording (not to be confused with the message code number in the right margin of the listing). The messages are listed in alphanumeric order.

When Using the Instrument Locally. You will usually be able to view each message whenever the Signal Generator is ready to give you information. That is, you don't need to do anything to the instrument to see a message. However, when you execute some instrument functions, a message is queued up and can be displayed using the MSSG push button (these messages are noted in the listing). The MSSG annunciator in the right portion of the display notifies you that a message is queued up. To read queued up messages, just select the MSSG push button repeatedly. When you read "END OF MESSAGE LIST .00" you know there are no more messages in that list.

When Controlling the Instrument via HP-IB. You can access most of the messages using the "OC", "OE", and "OH" commands. Messages accessed this way can be output in the form of a message code number or as an actual alphanumeric message string. In the message listing in this instruction, the message code number that can be output over HP-IB is provided to the far right of the message. If no message code number is provided in the listing, then that message can be read over HP-IB using Output Display (unless otherwise stated). If any unique message retrieval procedures exist for a message, they will be described in the individual message description. Also, any message that cannot be read via HP-IB will be noted.

Many of the messages that can be output over HP-IB can be made to initiate a service request.

NO MESSAGES .00 0

No messages are queued up to be displayed or output over HP-IB.

HP-IB: This message may be output with "OH" (or "MG" in combination with Output Display).

NO MESSAGE .00 0

No message is available for output over HP-IB. This message is never displayed locally.

HP-IB: This message may be output with "OC" or "OE".

END OF MESSAGE LIST**.00 0**

The end of the copied list has been reached. This message is viewed after displaying the entire copied message list (by repeatedly selecting the MSSG push button).

HP-IB: This message may be output with "OH" (or "MG" in combination with Output Display).

FR.SWP+PULSE TURNED OFF**.C1 2001**

RF frequency sweep with pulse modulation was turned off. Either START AMPTD or STOP AMPTD was selected (HP-IB: AA or AB) when RF frequency sweep was on with pulse modulation.

AMPTD REF SET TO 1.00UV**.C2 2002**

Amplitude reference was set to 1.00 μ V. The amplitude reference was set to the dB μ V reference (which is 1.00 μ V) due to the selection of dB μ V (HP-IB: DU). Subsequent amplitude displays will be in dB μ V.

ADJUSTED .002UV RESOLN'N**.C3 2003**

Amplitude setting was adjusted to 0.002 μ V resolution. In EMF mode, if an attempt is made to set an increment or amplitude reference with an odd number of nanovolts (for example, 0.501, 0.503, 0.505 μ V, etc.), that value will be adjusted up to an even number of nanovolts.

INCR+AMPTD REF CHANGED**.C4 2004**

The increment setting and amplitude reference were changed. Changing between EMF and non-EMF amplitude modes could cause the increment and amplitude settings to be reset to allowable values.

AM TURNED OFF**.C11 2011**

AM was turned off. Either START AMPTD, STOP AMPTD, or PULSE (SHIFT AM) was selected (HP-IB codes: AA, AB, or PL) when AM was on. AM is not possible with pulse modulation or amplitude sweep.

FM TURNED OFF**.C12 2012**

FM was turned off. \emptyset M was selected when FM was on. FM cannot be done simultaneously with \emptyset M.

PHASE MOD TURNED OFF**.C13 2013**

\emptyset M was turned off. FM was selected when \emptyset M was on. \emptyset M cannot be done simultaneously with FM.

PULSE MOD TURNED OFF**.C14 2014**

Pulse modulation was turned off. Either START AMPTD, STOP AMPTD, or AM was selected (HP-IB codes: AA, AB, or AM) when pulse modulation was on. Pulse modulation is not possible when amplitude sweep or AM are on.

SWEEP TIME ADJUSTED**.C21 2021**

Sweep time was adjusted to the minimum allowed setting. The sweep time setting was less than the minimum allowed for the type of sweep selected. Either a Stepped Frequency Sweep was set with the sweep time set less than 275 ms, or amplitude sweep was set with the sweep time set less than 20 ms.

FREQ SWEEP TURNED OFF**.C22 2022**

RF frequency sweep was turned off. Either FREQ, START AMPTD, or STOP AMPTD was selected (HP-IB codes: FR, AA, AB) when RF frequency sweep was on.

FR.SWP+AM TURNED OFF	.C23	2023
RF frequency sweep and AM were turned off. Either START AMPTD or STOP AMPTD was selected (HP-IB codes: AA, AB) when RF frequency sweep was on with AM.		
AMPTD SWP TURNED OFF	.C31	2031
Amplitude sweep was turned off. One of the following functions was selected when amplitude sweep was on: START FREQ, STOP FREQ, AMPTD, AM, or PULSE (SHIFT AM). (HP-IB codes: FA, FB, AP, AM, PL).		
AA.OFF...30DB MAX SPAN	.C32	2032
Start amplitude setting was turned off because the new stop amplitude setting was set more than 30 dB away from the start amplitude setting. This message is queued up until it is read, amplitude sweep is turned off, or the start amplitude is set again.		
AB.OFF...30DB MAX SPAN	.C33	2033
Stop amplitude setting was turned off because the new start amplitude setting was set more than 30 dB away from the stop amplitude setting. This message is queued up until it is read, amplitude sweep is turned off, or the stop amplitude is set again.		
INCR ADJUSTED	.C41	2041
AMPTD REF ADJUSTED	.C42	2042
Increment setting adjusted. Amplitude reference setting adjusted. Changing between EMF and non-EMF amplitude modes could cause the increment and/or amplitude settings to be reset to allowable values.		
NEXT STEP NOT POSSIBLE	.E1	4001
Next step is not possible. The current setting cannot be stepped up or down (as attempted) with the increment set value. To clear the message without changing instrument settings, select the SHIFT push button twice. If you want to read a message that might more specifically describe the setting problem, attempt a data setting similar to the step attempt that caused this error message.		
NOT POSSIBLE. ABOVE MAX	.E2	4002
Not possible above the maximum setting ever allowed. The attempted setting is above the function's maximum possible setting (independent of other functions.)		
NOT POSSIBLE. BELOW MIN	.E3	4003
Not possible below the minimum setting ever allowed. The attempted setting is below the function's minimum possible setting (independent of other functions.)		
SELECT MOD.PREFIX FIRST	.E4	4004
Select the type of modulation first. A modulation source was selected when a modulation setting was not displayed. Before selecting the modulation source, select any of the following modulation types: AM, FM, ØM (SHIFT FM), or PULSE (SHIFT AM). HP-IB: Specify the modulation type code (AM, FM, PM, or PL) before the modulation source prefix code (NT, XA, XD, BA, or BD).		

SELECT SWP.PREFIX FIRST .E5 4005
Select the type of sweep first. A sweep mode (auto, manual, or single) was selected without specifying the sweep type (frequency or amplitude sweep). Select START FREQ, STOP FREQ, START AMPTD, or STOP AMPTD before selecting the sweep mode.

HP-IB: Specify the sweep type code (FA, FB, AA, or AB) before the sweep mode code (SA, SM, or SG).

PLEASE SELECT FUNCTION .E6 4006
Please select an active function. A data value was attempted during manual sweep or when no active function existed. Select a valid function before attempting to enter a data value.

HP-IB: Precede the data entry with a function prefix code.

SP6 PREVENTS INT+EXT.FM .E7 4007
Special Function 6 (FM Pre-Emphasis On) prevents the selection of a summed internal and external FM source. Select Special Function 206 (FM Pre-Emphasis Off) to select INT+(EXT AC), INT+(EXT DC), or Special Function 112 (Internal + External Low Rate FM).

HP-IB: Select SP206 before selecting FM source codes FMBA, FMBD, or SP112.

TURN.OFF.SWP FIRST...SP123 .E8 4008
Turn off the frequency sweep before attempting those settings because Special Function 123 (Phase Continuous Frequency Sweep) is the type of frequency sweep currently selected. Turn off either START FREQ or STOP FREQ and then try your setting again.

HP-IB: Turn off the frequency sweep with FAOF or FBOF, then retry settings.

SP9+AM LIMIT MAX AMPTD .E9 4009
Special Function 9 (Attenuator Range Hold) selected with the current AM setting limits amplitude levels attainable. Turn off Attenuator Range Hold (with Special Function 209) and/or reduce AM to a depth that will allow the amplitude setting, or refer to sequence dependency in paragraph 1-15.

FUNCTION OFF.NO STEP .E10 4010
The active function is off so its value cannot be stepped. Turn on or set the active function to a valid setting before using the Step push buttons.

FUNC DISALLOWS OFF/ON .E11 4011
The active function cannot be turned off or on. You attempted to turn off or turn on either FREQ, MOD FREQ, or sweep TIME (SHIFT START FREQ) (HP-IB codes FR, MF, or ST).

ONLY OFF/ON IS ACTIVE .E12 4012
Only the OFF ON push button can be selected. Select an active function other than PULSE (SHIFT AM), EMF (SHIFT INCR SET), or KNOB HOLD (SHIFT <—) before entering data.

HP-IB: Don't send data immediately after selecting PL, EM, or KH.

NO ACTIVE FUNCTION .E13 4013
Currently no function is active. Select an active function and then try your setting again.

NOTHING TO BACKSPACE .E14 4014
There is no data in the display to backspace. Select an active function before using BACK SP.

NO CURSOR TO MOVE	.E15	4015
Currently no function is active so no cursor can be moved. Select an active function to activate the Knob before attempting to move cursors.		
INVALID SHIFT FUNC	.E16	4016
The push button you have selected cannot be preceded by the SHIFT push button. Select a valid shift function.		
HP-IB: Select the proper function code without SH. SH should only be used with the Display Output capability or to get back the normal display of instrument settings (HP-IB code: SHSH). Refer to Output Display information in paragraph 1-15.		
INVALID TERMINATOR	.E17	4017
This message is never displayed locally.		
HP-IB: Invalid terminator received. Send correct terminator code for function you are trying to set.		
BAD PREFIX RECEIVED	.E18	4018
A bad prefix has been detected by the Signal Generator. Terminator push buttons do not have shift functions.		
HP-IB: The Signal Generator received a set of characters that cannot be recognized. Send a valid HP-IB code or use the HP-IB Device Clear command and try again.		
MAXIMUM OF 10 DIGITS	.E19	4019
This message is never displayed locally.		
HP-IB: The Signal Generator ignored some digits in the entry. Only send 10 digits (including significant leading zeros).		
NUMBER OUT OF RANGE	.E20	4020
The attempted setting exceeds a numeric value which can be represented internally as a number. Select a value within the Signal Generator's settable range.		
AMPTD LIMITS MAX AM	.E24	4024
The amplitude setting limits the maximum AM setting. Reduce either the amplitude setting or the attempted AM setting and try again.		
AM LIMITS MAX AMPTD	.E25	4025
The AM setting limits the maximum amplitude setting. Reduce either the AM setting or the attempted amplitude setting and try again.		
ONLY INT/EXT.DC PULSE	.E26	4026
Only an internal or external dc source is possible with pulse modulation. With pulse modulation, select only INT or EXT DC. For other modulation sources, select the modulation type of AM, FM, or ØM (SHIFT EM) before selecting the modulation source.		
HP-IB: Send only PLNT or PLXD, or ensure codes AM, FM, or PM are sent before XA, BA, or BD.		

PULSE MOD ONLY	.E27	4027
Pulse modulation can only be off or on. Since pulse modulation can only be turned off or on, knob rotation, cursor positioning push buttons, and Step push buttons cannot affect the pulse modulation function.		
HP-IB: Select a function code before UP, DN, KL, or KR.		
AM PREVENTS PULSE MOD	.E28	4028
AM is not possible with pulse modulation. Turn off AM (HP-IB: AMOF) before selecting pulse modulation.		
PULSE MOD PREVENTS AM	.E29	4029
Pulse modulation is not possible with AM. Turn off pulse modulation (HP-IB: PLOF) before selecting AM.		
TURN OFF EMF FOR DBM	.E30	4030
When in the EMF mode, dBm units are not possible. Turn off EMF before selecting dBm amplitude units.		
NO RELATIVE AMPTD SWP	.E31	4031
Relative values for amplitude sweep cannot be set directly. Convert the desired relative setting value to absolute units, then set the amplitude sweep in absolute units. Select only FREQ or AMPTD (HP-IB code FR or AP) before attempting relative settings.		
NO RELATIVE FREQ SWP	.E32	4032
Relative values for frequency sweep are not possible. Select only FREQ or AMPTD (HP-IB: FR or AP) before attempting relative settings.		
ONLY FREQ/AMPTD REL	.E33	4033
No relative units are possible with the requested setting. Select only FREQ or AMPTD (HP-IB: FR or AP) before attempting relative settings.		
AP.REF DISALLOWS DBμV	.E34	4034
An amplitude reference cannot be set in dB μ V. Set amplitude to the desired value in dB μ V, then select REL ZERO (HP-IB: APRZ).		
AP.SWP DISALLOWS DBμV	.E35	4035
An amplitude sweep cannot be directly set in dB μ V. Convert the desired dB μ V setting value to absolute units, then set the amplitude sweep in absolute units.		
FM COUPLED FUNC LIMIT	.E38	4038
FM is coupled with an attempted setting. You are either attempting a setting that is impossible or attempting to set functions in an incorrect order. This message could also have been caused by executing Special Function 0 or 100 when one special function was coupled to other instrument settings.		
INT+EXT.FM PREVENT SP6	.E39	4039
Special Function 6 (FM Pre-Emphasis) cannot be selected when an internal source is summed with an external source. Select a single FM source (INT , EXT AC , EXT DC , or Special Function 5; HP-IB: FMNT , FMXA , FMXD , or SP5) before selecting FM Pre-Emphasis, or refer to sequence dependency in paragraph 1-15.		

- PM LIMITS MIN FREQ** .E40 4040
 The ØM setting limits the minimum RF frequency value that can be selected. Either reduce ØM deviation, or select an RF frequency that allows the ØM deviation, or refer to sequence dependency in paragraph 1-15.
- PM LIMITS MAX FREQ** .E41 4041
 The ØM setting limits the maximum RF frequency value that can be selected. Either reduce ØM deviation, or select an RF frequency that allows the ØM deviation, or refer to to sequence dependency in paragraph 1-15.
- FREQ LIMITS MAX PM** .E42 4042
 The RF frequency setting limits the maximum value of ØM deviation that can be selected. Set the RF frequency to a value in a band that allows the desired value of ØM deviation, or select a ØM deviation that is allowed to the current RF frequency, or refer to sequence dependency in paragraph 1-15.
- FR.SWP+AUTO LIMITATION** .E45 4045
 Stepped Frequency Sweep cannot sweep in the Auto sweep mode under the following conditions:
 Setting start and stop end-points if one end-point is less than 4.130860 MHz with a second end-point greater than 132.187500 MHz.
 Setting a Stepped Frequency Sweep across 1057.500000 MHz.
 If neither of these restrictions apply to the attempted setting, refer to sequence dependency in paragraph 1-15.
- TURN OFF SWEEP FIRST** .E46 4046
 Turn off frequency sweep first. To access Special Function 123 (Phase Continuous Frequency Sweep), turn off the start and the stop frequency that was set for the Stepped Frequency Sweep. If this solution does not apply to your attempted setting, refer to sequence dependency in paragraph 1-15.
- FREQ SWP + SP8 LIMIT** .E47 4047
 Stepped Frequency Sweep cannot sweep in the auto sweep mode across 132.187500 MHz. Select manual or single sweep, or refer to sequence dependency in paragraph 1-15.
- FR.SWP+SP223 LIMIT.TIME** .E48 4048
 Special Function 223 (Stepped Frequency Sweep) limits the minimum sweep time that can be selected. Either turn off frequency sweep (HP-IB: FAOF FBOF) before setting the sweep time, or refer to sequence dependency in paragraph 1-15.

FREQ.SWP+SWP.TIME LIMIT**.E49****4049**

The start or stop frequency setting is limited by the currently selected combination of:

Phase Continuous Frequency Sweep (Special Function 123), and the current sweep time setting, and possibly the current start and stop frequency settings, and possibly FM.

To resolve this error, either

1. Turn off frequency sweep (HP-IB: FAOF FBOF) and then possibly select Stepped Frequency Sweep (Special Function 223), or
2. Select a valid sweep time setting, or
3. Possibly turn off FM, or
4. Refer to sequence dependency in paragraph 1-15.

SP123 LIMITS MIN TIME**.E50****4050**

The minimum sweep time that can be selected is limited by the currently selected combination of:

Phase Continuous Frequency Sweep (Special Function 123), and the current start and stop frequency settings, and possibly FM.

To resolve this error, either:

1. Turn off frequency sweep (HP-IB: FAOF or FBOF) and then possibly select Stepped Frequency Sweep (Special Function 223), or
2. Select a valid sweep time setting, or
3. Possibly turn off FM, or
4. Refer to sequence dependency in paragraph 1-15.

SP123 LIMITS MAX TIME**.E51****4051**

The maximum sweep time that can be selected is limited by the currently selected combination of:

Phase Continuous Frequency Sweep (Special Function 123), and the current start and stop frequency settings, and possibly FM.

To resolve this error, either:

1. Turn off frequency sweep (HP-IB: FAOF FBOF) and then possibly select Stepped Frequency Sweep (Special Function 223), or
2. Select a valid sweep time setting, or
3. Possibly turn off FM, or
4. Refer to sequence dependency in paragraph 1-15.

AP.SWP PREVENTS FR.SWP**.E52****4052**

Amplitude sweep and frequency sweep cannot be done simultaneously. Turn off amplitude sweep (HP-IB: AAOF ABOF) before attempting frequency sweep.

FM PREVENTS AUTO SWP**.E53****4053**

FM during Stepped Frequency Sweep is only possible in manual and single sweep modes. Possibly refer to sequence dependency in paragraph 1-15.

- AUTO SWP PREVENTS FM** .E54 4054
 FM during Stepped Frequency Sweep is only possible in manual and single sweep modes. Possibly refer to sequence dependency in paragraph 1-15.
- FR.SWP+FM...LIMIT** .E55 4055
 FM is coupled with frequency sweep and one of those settings is limiting the setting of the other. This message could also have been caused by executing Special Function 0 or 100 when one special function was coupled to other instrument settings. Either set FM deviation to a value that is allowed by start and stop frequencies, or set start and stop frequencies to values that allow the FM setting, or refer to sequence dependency in paragraph 1-15.
- DCFM+SP117+216 LIMIT** .E56 4056
 DC-coupled FM, Special Function 117 (DCFM Update Mode), and Special Function 216 (DCFM Correction On) are coupled with Special Function 123 (Phase Continuous Frequency Sweep), and one of those settings is limiting the selection of a frequency sweep. To resolve this error, either:
1. Turn off FM, or
 2. Select a non-dc-coupled FM source, or
 3. Turn off Special Function 117, or
 4. Turn on Special Function 116 (DC FM Correction Off), or
 5. Select a combination of those special functions, or
 6. Refer to sequence dependency in paragraph 1-15.
- PM PREVENTS AUTO SWP** .E57 4057
 ØM during Stepped Frequency Sweep is only possible in manual and single sweep modes. Possibly refer to Figure 1-5.
- AUTO SWP PREVENTS PM** .E58 4058
 ØM during Stepped Frequency Sweep is only possible in manual and single sweep modes. Possibly refer to Figure 1-5.
- FREQ SWEEP + PM LIMIT** .E59 4059
 ØM is coupled with frequency sweep and one of those settings is limiting the setting of the other. Either set ØM deviation to a value that is allowed by start and stop frequencies, or set start and stop frequencies to values that allow the ØM setting, or refer to sequence dependency in paragraph 1-15.
- AMPTD SPAN 30DB MAX** .E63 4063
 An amplitude span of 30 dB is the maximum possible span. Either select an amplitude sweep setting within the 30 dB span limitation or turn off the other amplitude sweep start or stop value (HP-IB: AAOF or ABOF).
- AP.SWP LIMITS MIN TIME** .E64 4064
 The minimum sweep time possible for amplitude sweep is 20 ms. Either select another sweep time or turn off amplitude sweep (HP-IB: AAOF ABOF).
- AP.SWP PREVENTS SP9** .E65 4065
 Special Function 9 (Attenuator Range Hold) is not possible during amplitude sweep. Turn off amplitude sweep (HP-IB: AAOF ABOF) and set amplitude (HP-IB: AP) before selecting attenuator range hold (HP-IB: SP9).

SP9 PREVENTS AP.SWP .E66 4066
Amplitude sweep is not possible when Special Function 9 (Attenuator Range Hold) is selected. Select Attenuator Range Hold Off (Special Function 209) before selecting amplitude sweep.

AM PREVENTS AP.SWP .E68 4068
Amplitude sweep is not possible when AM is selected. Turn off AM (HP-IB: AMOF) before selecting amplitude sweep.

AP.SWP PREVENTS AMPTD .E69 4069
Output amplitude cannot be set during amplitude sweep. Turn off amplitude sweep (HP-IB: AAOF ABOF) before selecting the output amplitude.

AMPTD SWP PREVENTS AM .E70 4070
AM is not possible during an amplitude sweep. Turn off amplitude sweep (HP-IB: AAOF ABOF) before selecting AM.

AP.SWP PREVENTS AP.OFF .E71 4071
Output amplitude cannot be turned off during amplitude sweep. Turn off the amplitude sweep (HP-IB: AAOF ABOF) before turning off the output amplitude.

AP.SWP PREVENTS PULSE .E72 4072
Pulse modulation is not possible during an amplitude sweep. Turn off the amplitude sweep (HP-IB: AAOF ABOF) before selecting pulse modulation.

AP.SWP PREVENTS SP4 .E73 4073
Special Function 4 (ALC OFF) is not possible during amplitude sweep. Turn off amplitude sweep (HP-IB: AAOF ABOF) before selecting ALC OFF (HP-IB: SP4).

SP4 PREVENTS AP.SWP .E74 4074
Amplitude sweep is not possible when Special Function 4 (ALC OFF) is selected. Select Disable ALC OFF (Special Function 204) before selecting amplitude sweep.

SP9 LIMITS MIN AMPTD .E75 4075
Special Function 9 (Attenuator Range Hold) limits the minimum amplitude that can be selected. To resolve this problem, either

1. Select Attenuator Range Hold Off (Special Function 209), or
2. Select an amplitude within the held amplitude range selected, or
3. Refer to sequence dependency in paragraph 1-15.

SP9 LIMITS MAX AMPTD .E76 4076
Special Function 9 (Attenuator Range Hold) limits the maximum amplitude that can be selected. To resolve this problem, either

1. Select Attenuator Range Hold Off (Special Function 209), or
2. Select an amplitude within the held amplitude range selected, or
3. Refer to sequence dependency in paragraph 1-15.

AMPTD+SP9 LIMIT MAX.AM**.E77****4077**

The amplitude selected with Special Function 9 (Attenuator Range Hold) limits the maximum value of AM that can be selected. To resolve this problem, either

1. Select Attenuator Range Hold Off (Special Function 209), or
2. Reduce the amplitude setting to get the desired AM setting, or
3. Select an AM setting allowed with the held range and amplitude setting selected, or
4. Refer to sequence dependency in paragraph 1-15.

SP9 PREVENTS PULSE**.E78****4078**

Pulse modulation is not possible when Special Function 9 (Attenuator Range Hold) is selected. Select Attenuator Range Hold Off (Special Function 209) before selecting pulse modulation.

PULSE PREVENTS SP9**.E79****4079**

Special Function 9 (Attenuator Range Hold) is not possible when pulse modulation is selected. Turn off pulse modulation (HP-IB: PLOF) and set output amplitude (HP-IB: AP) to the desired level before selecting attenuator range hold (HP-IB:SP9).

SP9 PREVENTS SP4**.E80****4080**

Special Function 4 (ALC Off) is not possible when Special Function 9 (Attenuator Range Hold) is selected. Select Attenuator Range Hold Off (Special Function 209) before selecting ALC off.

HP-IB: Send SP209 before SP4.

SP4 PREVENTS SP9**.E81****4081**

Special Function 9 (Attenuator Range Hold) is not possible when Special Function 4 (ALC Off) is selected. Disable ALC Off (Special Function 204) before selecting attenuator range hold.

HP-IB: Send SP204 before SP9.

AM PREVENTS SP4**.E82****4082**

Special Function 4 (ALC Off) is not possible when AM is selected. Turn off AM before selecting ALC off.

HP-IB: Send AMOF before SP4.

PULSE PREVENTS SP4**.E83****4083**

Special Function 4 (ALC Off) is not possible when pulse modulation is selected. Turn off pulse modulation before selecting ALC off.

HP-IB: Send PLOF before SP4.

SP4 PREVENTS AM**.E84****4084**

AM is not possible when Special Function 4 (ALC Off) is selected. Select Disable ALC Off (Special Function 204) before setting AM.

HP-IB: Send SP204 before AM.

SP4 PREVENTS PULSE**.E85****4085**

Pulse modulation is not possible when Special Function 4 (ALC Off) is selected. Select Disable ALC Off (Special Function 204) before selecting pulse modulation.

HP-IB: Send SP204 before PL.

INVALID SPCL FUNCTION	.E86	4086
An invalid special function number was selected. Select a special function number that exists.		
SOME SPCLS STAYED ON	.E87	4087
Some special functions remained selected after you selected Special Function 0 or 100 because certain special functions were coupled to other instrument settings. (This message will only occur if more than one special function remains on. Special Function 0 or 100 not turning off just one special function will display a message describing the reason that one special function was not turned off.) View the special functions to see which are still on by selecting SPCL (SHIFT -) (HP-IB: Use SP and read the display; refer to the Output Display information discussion in HP-IB Remote Operation. The special functions might remain selected because of a sequence dependency problem. Possibly refer to sequence dependency in paragraph 1-15.		
0.9 HZ LIMIT REACHED	.E88	4088
A maximum RF frequency change of 0.9 Hz can be accumulated using Special Function 240 (Decrement Frequency 0.1 Hz) or Special Function 241 (Increment Frequency 0.1 Hz). To get another 0.1 Hz step, directly set the RF frequency to 1 Hz resolution.		
SAVE/RECALL MAX = 50	E.92	4092
The maximum recall register number is 50. Select register numbers only between 00 and 50.		
RECALL NOT DEFINED	.E93	4093
No instrument settings are saved in this register. The register could have been cleared with Special Function 251 (Clear Recall Registers) or because of a hardware error. This error E93 occurs simultaneously with hardware error H10.		
SEQ NOT SET...4 DIGITS	.E94	4094
Sequence was not set, 4 digits are required. Try the sequence setting again using two digits for both the start and stop sequence register numbers.		
ADRS VALID 0-30 ONLY	.E95	4095
HP-IB addresses are valid only between 0 and 30. Select an HP-IB address between 00 and 30, or select 31 for Listen Only capability.		
MASK VALID ONLY 0-255	.E96	4096
The RQS mask is valid only between decimal 0 and 255. Set the RQS mask between those values.		
HIT AMPTD=CLEAR RVS.PWR	.H1	7001
Press the AMPTD push button to reset the reverse-power-protect circuitry. A reverse-power condition has been sensed. After this condition is eliminated, select the AMPTD push button to reset the protection circuitry.		
HP-IB: Send AP after the condition is eliminated. Message H2 will always occur after the reverse-power-protect circuitry is reset in response to message H1.		
RVS.PWR PROTECT CLEARED .H2		7002
The reverse-power protect circuitry was previously tripped but is now reset.		

RECALL ERROR FOUND	.H10	7010
A recall error has been found. This message could be due to a hardware failure (for example, loss of RAM memory). The message means that a recall register that was recalled had no instrument settings saved in it. The register could have been cleared with Special Function 251 (Clear Recall Registers) or because of a hardware error. This error H10 occurs in conjunction with execution error E93.		
MSSG BUFFER OVERFLOWED	.H11	7011
The message buffer has overflowed. Some messages were lost.		
INSTRUMENT PRESET	.I1	
Instrument Preset is being executed. This message cannot be read via HP-IB using Output Display because it automatically clears from the display after execution completes.		
PARTIAL PRESET	.I2	
Partial Preset is being executed. This message cannot be read via HP-IB using Output Display because it automatically clears from the display after execution completes.		
YYMMDD = FIRMWARE CODE	.I3	
This message is an example of the Signal Generator's display of the current firmware version which is accessed with Special Function 249. In this example, YYMMDD represents the numbers that will appear in the display where YY is the last two digits of the year, MM is the number of the month, and DD is the day of the month. For example, 570218 would be February 18, 1957.		
KNOB INCR TURNED OFF	.I11	
Knob increment mode was turned off. Cursor positioning push buttons (HP-IB: KL or KR) turn off the Knob Increment mode.		
SETTINGS DISPLAY OFF	.I21	
Special Function 135 (Disable Display) was selected and the display of the instrument settings is disabled.		
Special Function 235 (Re-enable Display) re-enables the display of instrument settings.		
PHASE STEP DOWN 1 DEG	.I22	
PHASE STEP UP 1 DEG	.I23	
The RF signal's output phase was stepped down by 1 degree.		
The RF signal's output phase was stepped up by 1 degree.		
These messages are activated with Special Function 250.		
SPCL FUNC VERIFY OFF	.I24	
Special Function 111 (Special Function Verify Off) was selected and the automatic Special Function verification is disabled. A special function description will not be displayed automatically whenever a special function is selected. The display of special function descriptions can be re-enabled with Special Function 211.		
ENTERING SERVICE MODE	.I25	
Entering the Service Mode. Special Function 3 was just selected. Either refer to Section I, Remote Operation information about writing messages to the display. Select any function to exit this mode.		

SYS CONTROL DISABLED**.I31**

HP-IB system control capabilities were just disabled. The HP-IB address was just set which disables the Signal Generator's system control capabilities accessed with Special Function 3.

ADRS=LISTEN ONLY**.I32**

The instrument is configured as a listen-only device over HP-IB.

LISTEN ONLY DISABLED**.I33**

The instrument is no longer configured as a listen-only device. The instrument's HP-IB address setting was changed from 31 to a value between 00 and 30.

WAIT FOR FM LOOP LOCK**.I40**

Wait for the Signal Generator's internal FM circuitry to complete its setting. This message cannot be read via HP-IB using Output Display because it automatically clears from the display after execution completes. This message is displayed when switching from a dc-coupled FM source to a non-dc-coupled FM source. No additional external settling time allowance is necessary to settle within 100 Hz of the selected frequency.

RF.FREQ=DISPLAY -0.9 HZ	.I49
RF.FREQ=DISPLAY -0.8 HZ	.I48
RF.FREQ=DISPLAY -0.7 HZ	.I47
RF.FREQ=DISPLAY -0.6 HZ	.I46
RF.FREQ=DISPLAY -0.5 HZ	.I45
RF.FREQ=DISPLAY -0.4 HZ	.I44
RF.FREQ=DISPLAY -0.3 HZ	.I43
RF.FREQ=DISPLAY -0.2 HZ	.I42
RF.FREQ=DISPLAY -0.1 HZ	.I41
RF.FREQ=DISPLAY +0.1 HZ	.I51
RF.FREQ=DISPLAY +0.2 HZ	.I52
RF.FREQ=DISPLAY +0.3 HZ	.I53
RF.FREQ=DISPLAY +0.4 HZ	.I54
RF.FREQ=DISPLAY +0.5 HZ	.I55
RF.FREQ=DISPLAY +0.6 HZ	.I56
RF.FREQ=DISPLAY +0.7 HZ	.I57
RF.FREQ=DISPLAY +0.8 HZ	.I58
RF.FREQ=DISPLAY +0.9 HZ	.I59

The current RF output frequency is now summed with one of these 0.1 Hz steps listed in messages I41 through I49 and I51 through I59 that were accessed with either Special Function 240 (Decrement Frequency by 0.1 Hz) or Special Function 241 (Increment Frequency by 0.1 Hz). The RF frequency addition is automatically deleted with any specific frequency setting or change. These messages are queued up and can be displayed using MSSG.

HP-IB: Execute "MG" and read the display. Perform this entire process repeatedly to see the RF frequency addition message. Note that reading these messages over the bus (using MG) could cause transient hardware and service messages to be deleted from the message list.

CRUNCH CRUNCH MMMMMMM**.I60**

Amplitude sweep is possible and is currently being set. This message cannot be read via HP-IB using Output Display because it automatically clears from the display after execution completes.

SPCLS OFF. ENTER NUMBER .P0
All special functions are off. To select a special function, select its number.

HIT MSSG FOR EACH MSSG .P1
More than one message is in the message list, select MSSG (HP-IB CODE: MG) to see each message.

HP-IB: Note that when retrieving a message list using the "OH" command when more than one message exists, this is the first message you will receive in the list. Refer to the Output Messages discussion in paragraph 1-15.

OFF/ON SELECTS EMF ON .P2
The EMF mode is off. Select OFF ON (HP-IB: EMON) to select EMF on.

OFF/ON SELECTS EMF OFF .P3
The EMF mode is on. Select OFF ON (HP-IB: EMOF) to select EMF off.

HIT OFF/ON = HOLD FUNC .P4
Knob Hold is off, to hold the active function on the Knob, select OFF ON.

HP-IB: Send the HP-IB code of the desired active function followed by KHON.

HIT OFF/ON = HOLD OFF .P5
Knob Hold is on, to turn off the Knob Hold function, select OFF ON (HP-IB: KHOF).

USE KNOB/UP/DN/NUMBER .P11
The Help function allows you to view the descriptions and code numbers of special functions. Select either the Knob, Step push buttons, or a function's number.

RELEASE ALL KEYS .P91
Release all push buttons. At turn on, it appears that a push button is being held down. Release all push buttons to continue. If a push button is not being held down, your instrument may need servicing (refer to the Service Manual). This message cannot be read via HP-IB using Output Display because it automatically clears from the display after the push button is released. Also, HP-IB operation is halted when a push button is held down with this message displayed.

SPCL 3 ENTRY ERROR .V12
This message occurs if the characters entered were not valid.

ENTER SERVICE CMD .V16
This message occurs if the ASCII code entered was not recognized as valid.

MESSAGE 1 CLEARED .V90
This message occurs when 6 5 5 is selected.

MESSAGE 2 CLEARED .V91
This message occurs when 6 6 5 is selected.

MESSAGE 1 IS FULL .V92 21092
This message might occur after attempting to enter codes into an already full message. This message sets the Execution Error bit in the 8642 Status Byte.

MESSAGE 2 IS FULL .V93 21093
This message might occur after attempting to enter codes into an already full message. This message sets the Execution Error bit in the 8642 Status Byte.

MESSAGE 1 UNDEFINED**.V94****21094**

This message might occur when manipulating message 1. The message means that message 1 has not been initialized or RAM memory was lost. To initialize the message, select 6 5 5. This message sets the Hardware Error bit in the 8642 Status Byte.

MESSAGE 2 UNDEFINED**.V95****21095**

This message might occur when manipulating message 2. The message means that message 2 has not been initialized or RAM memory was lost. To initialize the message, select 6 6 5. This message sets the Hardware Error bit in the 8642 Status Byte.

Table 1-2. Out of Lock Messages

Message	Message Code Number	Solution	Comments
A19 OUT OF LOCK ERROR	.D0 3000	1, 2	Doubler ALC loop is out of lock.
A19 TRANSIENT FAILURE	.D1 3001	1, 2	Doubler ALC loop had been out of lock but now appears to be in lock.
A6A2 OUT OF LOCK ERROR	.F0 5000	3	Internal hardware cannot phase lock to the external reference.
A6A2 TRANSIENT FAILURE	.F1 5001	3	Internal hardware had not been able to phase lock to the external reference but now appears to be in lock.
A6A1 OUT OF LOCK ERROR	.F2 5002	2, 3	FM phase lock loop cannot track and lock to the time base.
A6A1 TRANSIENT FAILURE	.F3 5003	2, 3	FM phase lock loop had not been able to track and lock to the time base but now appears to be able to track and lock to the time base.
A13 OUT OF LOCK ERROR	.O0 14000	1, 2	Output Section ALC loop is out of lock.
A13 TRANSIENT FAILURE	.O1 14001	1, 2	Output Section ALC loop had been out of lock but now appears to be in lock.
A11 OUT OF LOCK ERROR	.R0 17000	2, 3	Reference phase lock loop is out of lock.
A11 TRANSIENT FAILURE	.R1 17001	2, 3	Reference phase lock loop had been out of lock but now appears to be in lock.
A12 OUT OF LOCK ERROR	.S0 18000	2, 3	Sum loop is out of lock.
A12 TRANSIENT FAILURE	.S1 18001	2, 3	Sum loop had been out of lock but now appears to be in lock.
A9 OUT OF LOCK ERROR	.T0 19000	3	IF phase lock loop is out of lock.
A9 TRANSIENT FAILURE	.T1 19001	3	IF phase lock loop had been out of lock but now appears to be in lock.
A14 OUT OF LOCK ERROR	.X0 23000	3	Heterodyne module SAW loop is out of lock.
A14 TRANSIENT FAILURE	.X1 23001	3	Heterodyne module SAW loop had been out of lock but now appears to be in lock.
A7 OUT OF LOCK ERROR	.Z0 25000	3	SAW loop is out of lock.
A7 TRANSIENT FAILURE	.Z1 25001	3	SAW loop had been out of lock but now appears to be in lock.

Out of Lock Solutions

1. Either reduce the amplitude level, reduce the AM depth, or reduce the external modulation input level.
2. Either reduce the FM or \emptyset M deviation, reduce the modulation frequency, change the external modulation rate, or change the external modulation level.
3. Either the external reference is not operating properly or connections are faulty at the rear-panel connector, EXT REF INPUT. (The internal hardware may still be faulty even though the message is gone; that is, the message would appear again if you connected another external reference to the instrument.)

1-8. OPERATING PROCEDURES.

Operation is broken down into the following functions:

SETTING INSTRUMENT FUNCTIONS (paragraph 1-9)

- RF Frequency
- Amplitude
- OFF ON
- Modulation
- Modulation Oscillator Output
- Simultaneous Modulation Source

MODIFYING SETTINGS (paragraph 1-10)

- Tune Knob
- Step, Increment Set
- Knob Increment
- Knob Hold
- Entry Off
- Display Editing

MAKING RELATIVE SETTINGS (paragraph 1-11)

- Amplitude Relative
- Frequency Relative

SELECTING SPECIAL FUNCTIONS (paragraph 1-12)

- Help Function
- Special Functions
- Detailed description of all Special Functions

SELECTING A SWEEP (paragraph 1-13)

- Stepped Frequency Sweep
- Phase Continuous Frequency Sweep
- Amplitude Sweep
- Sweep Time Calculations

RECALLING INSTRUMENT SETTINGS (paragraph 1-14)

- Save
- Recall
- Sequence, Set Sequence

HP-IB REMOTE OPERATION (paragraph 1-15)

- HP-IB Address
- HP-IB Capabilities
- Data Input
- Data Output
- Output Messages
- Clear
- Remote, Local
- Local Lockout, Set Local
- Status Byte
- System Controller
- Additional HP-IB Information

WRITING MESSAGES TO DISPLAY (paragraph 1-16)

1-9. SETTING INSTRUMENT FUNCTIONS

RF FREQUENCY

1. On Signal Generator, press SHIFT then INSTR PRESET push buttons.
2. Press **FREQ** push button.
Enter the desired RF frequency from 100KHz to 2GHz using the numeric push buttons.
Select GHz, MHz, KHz, or Hz.
3. Verify entered frequency is displayed along with cursor and **FREQ** annunciator.

AMPLITUDE

1. Press **AMPTD** push button.
Enter the desired level from -140 to +15dBm using the numeric push buttons.
Select dBm, V, mV, μ V, or dB μ V.
2. Verify entered amplitude is displayed along with cursor and **AMPTD** annunciator.
3. If EMF amplitude is required, proceed as follows:
Press **SHIFT**, **INCR SET**, then **OFF ON** push buttons to activate the EMF mode.

NOTE

Any previous amplitude setting will be automatically changed to reflect its equivalent EMF voltage setting.

Enter the desired level from -140 to +15dBm using the numeric push buttons.
Select V, mV, μ V, or dB μ V.

Verify entered EMF amplitude is displayed along with cursor and EMF annunciator.

To Exit EMF mode, press **SHIFT**, **INCR SET**, then **OFF ON** push buttons.

4. To turn off RF output amplitude and harmonics without adjusting the output attenuators, press **RF OFF ON** push button.
5. To turn on the amplitude to its previously selected value, press **RF OFF ON** push button.

OFF ON

1. If function is on, press function push button (AM,FM etc) then OFF ON push button to deactivate function without changing last stored value.
2. If function is off, press function push button (AM,FM etc) then OFF ON push button to activate function using last stored value.

MODULATION

1. Set AM as follows:
 - Press SHIFT, then INSTR PRESET push button.
 - If internal modulation oscillator is used,
Press AM then INT push button.
Press MOD FREQ push button and enter desired modulation frequency from 20Hz to 100KHz.
Press AM push button and enter desired depth from 0 to 99.9%.
Verify entered data is displayed along with cursor, AM, and INT annunciator.
 - If external modulation signal is used,
Connect 1 V_{peak} ±5% sinewave external input to AM connector.



Do not apply more than 15V peak to the AM input connector.

Select EXT AC or EXT DC push button as required.

Adjust external input frequency from DC to 100KHz for desired modulation rate.

Press AM push button and enter desired depth from 0 to 99.9%.

NOTE

When using external source, modulation depth setting sets the input sensitivity per volt and not actual depth. Any voltage change on the AM input connector will change AM depth.

Verify entered data is displayed along with cursor, AM, EXT, and AC/DC annunciator.

NOTE

AM can be used simultaneously with FM or (ØM) Phase Modulation. Combinations of internal and external modulation are possible using INT + function.

- To deactivate AM mode, press AM then OFF ON push buttons.

MODULATION—Continued

2. Set FM as follows:

- Press SHIFT, then INSTR PRESET push button.
- If internal modulation oscillator is used,
Press FM then INT push button.
Press MOD FREQ push button and enter desired modulation frequency from 20Hz to 100KHz.
Press FM push button and enter desired deviation from 300KHz to 1.5MHz.
Verify entered data is displayed along with cursor, FM, and INT annunciator.
- If external modulation signal is used,
Connect 1 V_{peak} ±5% sinewave external input to FM/ØM connector.

CAUTION

Do not apply more than 15V peak to the FM/ØM input connector.

Select EXT AC or EXT DC push button as required.

Adjust external input frequency from DC to 100KHz for desired modulation rate.

Press FM push button and enter desired deviation from 300KHz to 1.5MHz.

NOTE

When using external source, modulation deviation setting sets the input sensitivity per volt and not actual deviation. Any voltage change on the FM/ØM input connector will change FM deviation.

Verify entered data is displayed along with cursor, FM, EXT, and AC/DC annunciator.

NOTE

FM can be used simultaneously with AM or Pulse Modulation. Combinations of internal and external modulation are possible using INT + function.

- To deactivate FM mode, press FM then OFF ON push buttons.

MODULATION—Continued

3. Set ØM (Phase modulation) as follows:

- Press SHIFT, then INSTR PRESET push button.
- If internal modulation oscillator is used,
Press SHIFT , FM, then INT push buttons.
Press MOD FREQ push button and enter desired modulation frequency from 20Hz to 15KHz.
Press SHIFT then FM push buttons and enter desired deviation from 0 to 200 radians.
Verify entered data is displayed along with cursor, ØM, and INT annunciator.
- If external modulation signal is used,
Connect 1 Vpeak $\pm 5\%$ sinewave external input to FM/ØM connector.

CAUTION

Do not apply more than 15V peak to the FM/ØM input connector.

Select EXT AC or EXT DC push button as required.

Adjust external input frequency from DC to 15KHz for desired modulation rate.

Press SHIFT then FM push buttons and enter desired deviation from 0 to 200 radians.

NOTE

When using external source, modulation deviation setting sets the input sensitivity per volt and not actual deviation. Any voltage change on the FM/ØM input connector will change ØM deviation.

Verify entered data is displayed along with cursor, ØM, EXT, and AC/DC annunciator.

NOTE

ØM can be used simultaneously with AM or Pulse Modulation. Combinations of internal and external modulation are possible using INT + function.

- To deactivate ØM mode, press SHIFT, FM then OFF ON push buttons.

MODULATION—Continued

4. Set Pulse modulation as follows:

- Press SHIFT, then INSTR PRESET push button.
- If internal modulation oscillator is used,
Press SHIFT, AM, then INT push button.
Press MOD FREQ push button and enter desired modulation frequency from 10Hz to 50KHz.
Press SHIFT, AM, then OFF ON push buttons.
Verify entered data is displayed along with cursor, PULSE and INT annunciator.
- If external modulation signal is used,
Press SHIFT, AM, then EXT DC push buttons.
Connect ± 20 volt external input to Pulse connector (trigger voltage is $\pm 1.5V$).

CAUTION

Do not apply more than 20 volts to the Pulse input connector.

Adjust external input frequency from DC to 50KHz for desired modulation rate.

Press SHIFT, AM, then OFF ON push buttons.

Verify entered data is displayed along with cursor, PULSE, EXT, and DC annunciators.

NOTE

Pulse modulation can be used simultaneously with FM or $\emptyset M$ (Phase Modulation).

- To deactivate Pulse Modulation mode, press SHIFT, AM, then OFF ON push buttons.

MODULATION OSCILLATOR OUTPUT

1. Press SHIFT, then INSTR PRESET push button.
2. Press MOD FREQ push button and enter desired output frequency from 20Hz to 100KHz.
3. Verify MOD.FR and entered value is displayed.
4. Press SHIFT then MOD FREQ push buttons and enter desired output level from 0 to 3Vpeak.
5. Verify entered data is displayed along with cursor and MOD OUT. Signal is available for use at MOD connector.

SIMULTANEOUS MODULATION SOURCE

1. Select Internal+External AC as follows:
 - Set desired modulation mode (AM/FM/ØM) using internal oscillator as specified in setting MODULATION procedure.
 - Connect an external AC-coupled signal to the connector of the modulation mode selected in step 1. Set signal level to $1 V_{\text{peak}} \pm 5\%$. Set signal frequency to desired rate.
 - Press SHIFT then EXT AC push buttons.
 - Verify entered data is displayed along with INT, EXT, and AC annunciators.
2. Select Internal+External DC as follows:
 - Set desired modulation mode (AM/FM/ØM) using internal oscillator as specified in setting MODULATION procedure.
 - Connect an external DC-coupled signal to the connector of the modulation mode selected in previous step. Set signal level to $1 V_{\text{peak}} \pm 5\%$. Set signal frequency to desired rate.
 - Press SHIFT then EXT DC push buttons.
 - Verify entered data is displayed along with INT, EXT, and DC annunciators.

1-10. MODIFYING SETTINGS

TUNE KNOB

1. On Signal Generator, press SHIFT then INSTR PRESET push buttons.
2. Press \rightarrow or \leftarrow to position cursor in the display over digit to be changed.
3. Turn the Tune KNOB to change digit to desired value.

STEP, INCREMENT SET

1. Press desired function push button (FREQ, AMPTD, etc) then INCR SET push button and enter desired value.
2. Press STEP (UP/DOWN) push buttons to modify the displayed value with the cursor by the amount stored in step 1.

KNOB INCREMENT

1. On Signal Generator, press SHIFT then INSTR PRESET push buttons.
2. Press desired function push button (FREQ,AMPTD,etc) then INCR SET push button and enter desired value.
3. Press SHIFT then \rightarrow push buttons.
4. Turn the Tune KNOB to modify the displayed value with the cursor by the amount stored in step 2.

NOTE

When changing active functions, Knob Increment will continue to remain selected, which means that with any functions, the Knob will change the function's setting by the increment set value.

3. Press SHIFT then RF OFF ON push buttons to turn off Tune KNOB.

KNOB HOLD

1. Press desired function push button (FREQ,AMPTD,etc) then SHIFT, \leftarrow , then OFF ON push buttons.
2. Select any other desired function.

NOTE

Two cursors over the function value indicate Tune KNOB hold (step 1). Single cursor indicates active function (step 2).

3. Use Step, Data, and, the OFF ON push buttons to change the active function, and the Tune Knob to change the HOLD function.
4. Press SHIFT then \leftarrow push buttons to turn off Tune KNOB hold.

ENTRY OFF

1. Press SHIFT then RF OFF/ON to disable Knob Hold, Knob Increment, Tune Knob, Step, and Data push buttons until an active function is selected.

NOTE

All cursors will disappear from the display showing there is no active function.

DISPLAY EDITING

1. Press BACK SP push button to erase least significant digit.
2. Press SHIFT then SHIFT to resume normal operational display.

1-11. MAKING RELATIVE SETTINGS

AMPLITUDE RELATIVE

1. On Signal Generator, press SHIFT then INSTR PRESET push buttons.
2. If amplitude reference value is to be transferred from present amplitude output:
 - Verify displayed amplitude value is the desired reference value.
 - Press SHIFT then AMPTD push buttons.

NOTE

Amplitude that was present in display is now stored reference value. Displayed amplitude will be zero. All subsequent amplitude entries will now be offset from the reference setting stored.

- Verify AMPTD and REL annunciators are on.
3. If amplitude reference value is to be entered:
 - Press SHIFT then FREQ push buttons and enter the desired reference setting.

NOTE

Displayed amplitude and all subsequent amplitude entries will now be offset from the reference setting entered in previous step.

- Verify AMPTD and REL annunciators are on.
4. To deactivate Relative Mode, press SHIFT then OFF ON push buttons.

FREQUENCY RELATIVE

1. On Signal Generator, press SHIFT then INSTR PRESET push buttons.
2. If frequency reference value is to be transferred from present frequency output:
 - Verify displayed frequency value is the desired reference value.
 - Press SHIFT then AMPTD push buttons.

NOTE

Frequency that was present in display is now stored reference value. Displayed frequency will be zero. All subsequent frequency entries will now be offset from the reference setting stored.

- Verify FREQ and REL annunciators are on.
3. If frequency reference value is to be entered:
 - Press SHIFT then FREQ push buttons and enter the desired reference setting.

NOTE

Displayed frequency and all subsequent frequency entries will now be offset from the reference setting entered in previous step.

- Verify FREQ and REL annunciators are on.
4. To deactivate Relative Mode, press SHIFT then OFF ON push buttons.

1-12. SELECTING SPECIAL FUNCTIONS.

HELP FUNCTION

1. On Signal Generator, press SHIFT then STEP (UP) push buttons.
2. Select the desired mode of accessing special function descriptions 0 through 251,
 - Use Tune KNOB to scroll past special functions.
 - Use STEP (UP) push button to increment to the next special functions number and description.
 - Enter the number of the desired special function to be viewed.

NOTE

Help function only allows the operator to view numbers and descriptions of special functions and does not activate the special function mode.

3. Press SHIFT then STEP (DOWN) push buttons to deactivate Help mode.

SPECIAL FUNCTIONS

1. Press SHIFT then — push buttons and enter the number of the desired special function (activate or deactivate).
2. Press SHIFT then — push buttons to view the current special function modes active.

NOTE

Use Help function, Table 1-3, or see listing for information on special functions available.

DETAILED DESCRIPTIONS OF ALL SPECIAL FUNCTIONS

NO. DESCRIPTION

-
- | | |
|-----|--|
| 0 | <i>Special Functions 4 through 9 Off.</i> This special function turns off Special Functions 4 through 9. (Sometimes all these special functions will not be turned off if the instrument state is dependent on a special function. A message will be displayed to notify you if a special function remained on after you selected Special Function 0.) Special functions can also be turned off individually. |
| 3 | <i>Service Mode.</i> This special function causes the Signal Generator to enter its service mode. Refer to para 1-16 for information about writing messages to the display, or refer to Section III for information about servicing the instrument. Select any function to exit this mode if this push button was accidentally selected. |
| 4 | <i>ALC Off.</i> This special function opens the output leveling loop to provide (typically) a 5dB improvement in third order intermodulation at a 2kHz offset. Typical output level accuracy is ± 2 dB when ALC Off is selected. |
| 5 | <i>External Low Rate FM ON.</i> See number 112. |
| 6 | <i>FM Pre-emphasis On.</i> Special Function 6 can be selected to pre-emphasize internal or external FM modulating signals with a 750 μ s time constant. (Pre-emphasis boosts high frequencies in the modulating signal prior to modulating the carrier.) |
| 7 | <i>Low Distortion FM/\emptysetM On.</i> This special function switches shaper circuitry into the FM/ \emptyset M loop, reducing total harmonic distortion. |
| 9 | <i>Attenuator Range Hold On.</i> When Attenuator Range Hold is selected, the Signal Generator's output attenuators are fixed and the output ALC loop controls signal amplitude. This produces a 30dB range with monotonic, step-to-step amplitude increments. |
| 100 | <i>All Special Function Codes Less than 200 Off.</i> This special function turns off special functions 4 through 9, 111 through 119, 121 through 123, 134, and 135. (Sometimes all these special functions will not be turned off if the instrument state is dependent on a special function. A message will be displayed to notify you if a special function remained on after you selected Special Function 100.) Special functions can also be turned off individually. |

Table 1-3. Summary of Special Functions; Function to Code

Function	Special Function Description	Code	
		Select	Off
RF Frequency	Decrement Frequency by 0.1 Hz	240	
	Increment Frequency by 0.1 Hz	241	
	Phase Adjust by Knob or Step Keys	250	
	Phase Decrement 1°	242	
	Phase Increment 1°	243	
	Phase Decrement 5°	244	
	Phase Increment 5°	245	
Amplitude	ALC Off	4	204
	Attenuator Range Hold	9	209
	Disable Settling	119	219
FM	External Low Rate FM	5	205
	Internal + External Low Rate FM	112	212
	FM Pre-Emphasis	6	206
	Low Distortion FM/ΦM	7	207
	Negative FM Polarity	115	215
	DC FM Correction Off	116	216
	DC FM Update Mode	117	217
	AC-Coupled DC FM	118	218
	Prefer Heterodyne Band	8	208
	Disable Settling	119	219
ΦM	Low Distortion FM/ΦM	7	207
	Negative ΦM Polarity	114	214
	Disable Settling	119	219
Modulation Oscillator	Modulation Frequency Correction Off	113	213
	Calibrate Modulation Frequency Bands Again	248	
Sweep	Sweep Up and Down	121	221
	Linear Amplitude Sweep	122	222
	Phase Continuous Frequency Sweep	123	223
	Disable Settling	119	219
Miscellaneous	Special Functions 4-9 Off		0
	All Special Functions < 200 Off		100
	Special Function Verification Off	111	211
	Display Firmware Information	249	
	Disable Display	135	235
	Turn Off LCD Lighting	134	234
Clear Recall Registers	251		
Service	Service Mode	3	

DETAILED DESCRIPTIONS OF ALL SPECIAL FUNCTIONS—Continued

NO. DESCRIPTION

- 111 ***Disable the Automatic Special Function Verification Display.*** This special function disables the automatic display of the special function description that normally occurs after each special function is selected.
- 112 ***Internal + External Low Rate FM On.*** This special function and number 5 typically provide 0.4 Hz to 200 kHz external ac-coupled FM with the Signal Generator remaining in a phase locked state. Input coupling required for these functions makes the Signal Generator especially sensitive to dc voltage fluctuations. Therefore, relatively small dc voltage changes can cause the Signal Generator to lose phase lock, requiring one to two seconds to regain the locked condition. Special functions 112 or 5 is turned off when another FM modulation source is selected.
- 113 ***Modulation Frequency Correction Off.*** This special function disables the single-band calibration of the modulation frequency oscillator that normally occurs whenever the modulation oscillator frequency is set or the internal modulation oscillator is put into use. When this calibration is disabled, the typical modulation frequency switching time is decreased by approximately 200 ms.
- 114 ***Negative \emptyset M Polarity.*** This special function causes a positive voltage applied to the external FM/ \emptyset M INPUT to cause a phase lag and a negative voltage applied to cause a phase lead.
- 115 ***Negative FM Polarity.*** This special function causes a positive voltage applied to the external FM/ \emptyset M INPUT to cause a negative frequency shift and a negative voltage applied to cause a positive frequency shift.
- 116 ***DC FM Correction Off.*** This special function prevents the initial frequency correction that occurs when dc-coupled FM is selected. Normally, when dc-coupled FM is selected, the FM phase lock loop is open, causing an offset in the selected RF output frequency. To correct this initial offset, the dc-coupled signal is momentarily switched off, while an internal counter is used to determine the amount of RF frequency offset. The frequency offset is then corrected, and the dc-coupled signal is switched back on (DC FM Correction). Disabling this correction causes a decrease in switching time by approximately 200ms.
- 117 ***DC FM Update Mode On.*** With the FM loop unlocked, RF output frequency changes with a change in applied dc signal and with the normal drift of an unlocked VCO that occurs over time and temperature. In the DC FM Update Mode, the Signal Generator measures and displays these RF frequency changes.

DETAILED DESCRIPTIONS OF ALL SPECIAL FUNCTIONS—Continued

NO. DESCRIPTION

- 118 *AC-Coupled DC FM On*. When the Signal Generator is in the normal ac-coupled FM mode, the external signal is applied to the FM loop through circuitry that uses a phase lock loop to ensure the accuracy of the output signal. In dc-coupled FM (DC FM), the phase lock loop is unlocked and the external signal is applied directly to the unlocked VCO. With Special Function 118 selected, the input signal is ac-coupled to the unlocked FM VCO blocking any applied dc component. (Typical low-frequency corner frequency is 1 Hz.) Using DC FM avoids the phase shifts associated with ac-coupled FM circuitry and allows maximum stereo separation. An external dc-coupled FM source must be in use with Special Function 118 to get these benefits.
- 119 *Disable Settling*. This special function allows the Signal Generator's microprocessor to respond to new commands without waiting for the internal circuitry to settle, improving response time by up to 40 ms. When using this special function, it's possible to select a function before the previous function has finished settling. Also Special Function 119 disables out-of-lock messages.
- 121 *Sweep Up and Down On*. Sweep Up and Down is a type of sweep that causes the Signal Generator to sweep from the start end-point to the stop end-point and then from the stop end-point to the start end-point in the same amount of time (during auto or single sweep modes).
- 122 *Linear Amplitude Sweep*. This special function selects a linearly stepped output rather than the usual logarithmically stepped output. Use a sweep time greater than 900ms to obtain maximum sweep resolution.
- 123 *Phase Continuous Frequency Sweep*. Phase Continuous Frequency Sweep enables the Signal Generator to frequency sweep between two end-points in a linear, phase continuous manner.
- 134 *Turn Off LCD Lighting*. This special function turns off the LCD back-lighting in the display.
- 135 *Disable Display*. Special Function 135 causes the Signal Generator to execute commands without displaying the instrument state (useful in secure environments).
- 204 *Disable ALC Off*. This special function re-enables the output leveling loop that was disabled with Special Function 4.
- 205 *External Low Rate FM Off*. This special function turns off the FM modulation source selected with Special Function 5. When Special Function 5 is turned off in this way, the Signal Generator selects external, ac-coupled FM.
- 206 *FM Pre-Emphasis Off*. This special function turns off the pre-emphasis selected with Special Function 6.
- 207 *Low Distortion FM/ØM Off*. This special function switches out the shaper circuitry inserted with Special Function 7.

DETAILED DESCRIPTIONS OF ALL SPECIAL FUNCTIONS—Continued

NO.	DESCRIPTION
209	<i>Attenuator Range Hold Off.</i> This special function turns off Attenuator Range Hold selected with Special Function 9.
211	<i>Special Function Verify On.</i> This special function re-enables the automatic display of the special function description disabled with Special Function 111.
212	<i>Internal + External Low Rate FM Off.</i> This special function turns off the FM modulation source selected with Special Function 112. When Special Function 112 is turned off this way, the Signal Generator selects internal and external, ac-coupled FM summed together.
213	<i>Modulation Frequency Correction On.</i> This special function re-enables the single-band calibration that normally occurs whenever the modulation oscillator frequency is set or the internal modulation oscillator is put into use.
214	<i>Positive \emptysetM Polarity.</i> This special function disables Special Function 114 and re-enables the normally selected phase relationships. A positive voltage applied to the external FM/ \emptyset M INPUT causes a phase lead and a negative voltage applied causes a phase lag.
215	<i>Positive FM Polarity.</i> This special function disables Special Function 115 and re-enables the normally selected frequency-shift relationships. A positive voltage applied to the external FM/ \emptyset M INPUT causes a positive frequency shift and a negative voltage applied causes a negative frequency shift.
216	<i>DC FM Correction On.</i> This special function re-enables the correction disabled by Special Function 116.
217	<i>DC FM Update Mode Off.</i> This special function disables the DC FM update that occurs with Special Function 117.
218	<i>AC-Coupled DC FM Off.</i> This special function re-selects the dc coupling to the FM circuitry disabled with Special Function 118.
219	<i>Re-enable Settling.</i> This special function re-enables the settling disabled with Special Function 119.
221	<i>Sweep Up and Down Off.</i> This special function re-enables the normal sweep disabled with Special Function 121. Special Function 221 sets the Signal Generator to repeatedly sweep from the start end-point to the stop end-point (during auto or single sweep modes).
222	<i>Logarithmic Amplitude Sweep.</i> This special function selects the normally selected logarithmic stepped output disabled with Special Function 122.
223	<i>Phase Continuous Frequency Sweep Off.</i> This special function turns off the Phase Continuous Frequency Sweep selected with Special Function 123.
234	<i>Turn On LCD Lighting.</i> This special function turns on the LCD lighting disabled with Special Function 134.

DETAILED DESCRIPTIONS OF ALL SPECIAL FUNCTIONS—Continued

NO. DESCRIPTION

- 235 *Re-enable Display.* This special function re-enables the display of settings disabled with Special Function 135.
- 240 *Decrement Frequency by 0.1Hz.*
- 241 *Increment Frequency by 0.1Hz.*
- These special functions change the RF signal's output frequency in 0.1 Hz steps each time the special function is selected. Changing frequency in these ways cause a message to be queued up in the message list that provides the total increment or decrement.
242. *Phase Decrement 1 Degree.*
243. *Phase Increment 1 Degree.*
244. *Phase Decrement 5 Degrees.*
245. *Phase Increment 5 Degrees.*
- These functions change the RF signal's output phase by the indicated amount each time the special function is selected.
- 248 *Calibrate the Modulation Frequency Bands Again.* This special function enables you to initiate the calibration sequence that normally only occurs during instrument power up. This function can be used, for example, to recalibrate the modulation oscillator frequency bands if normal modulation frequency correction has been disabled with Special Function 113. Calibration typically takes one to two seconds.
- 249 *Display Firmware Information.* This special function displays the current firmware version with a message such as "YYMMDD = FIRMWARE CODE .13". In this example YYMMDD represents the numbers that will appear in the display where YY is the last two digits of the year, MM is the number of the month, and DD is the day of the month. For example, 841225 would be December 25, 1984.
- 250 *Phase Adjustment from Knob and Step Up and Step Down Keys.* This function enables control over the RF signal's output phase in one degree steps using either the Knob or Step Push buttons.
- 251 *Clear Recall Registers.* This special function clears all recall registers.

1-13. SELECTING A SWEEP

STEPPED FREQUENCY SWEEP

NOTE

Calculations for step size/number of steps to sweep time are provided under SWEEP TIME CALCULATIONS below.

1. On Signal Generator, press SHIFT then INSTR PRESET push buttons.
2. Press START FREQ push button and enter desired start frequency.
3. Press STOP FREQ push button and enter desired stop frequency.
4. Press SHIFT then START FREQ push buttons and enter desired sweep time.
5. Select desired sweep mode;
 - For AUTO sweep, press SHIFT then START AMPTD push button. Verify data entry is correct and START, FREQ, SWPNG and STOP Annunciators are on.
 - For Manual sweep, press SHIFT then STOP FREQ push button. Turn Tune KNOB for sweep.
 - For Single sweep, press SHIFT then STOP AMPTD push button.
5. To deactivate sweep mode, Press START FREQ, OFF ON, STOP FREQ, and then OFF ON push buttons.

PHASE CONTINUOUS FREQUENCY SWEEP

NOTE

Calculations for minimum sweep span, maximum sweep span, sweep time, and X-axis steps are provided under SWEEP TIME CALCULATIONS listed below.

1. On Signal Generator, verify not in stepped frequency sweep mode.
2. Press SHIFT then — push buttons and enter 1 2 3.
3. Press START FREQ push button and enter desired start frequency.
4. Press STOP FREQ push button and enter desired stop frequency.
5. Press SHIFT then START FREQ push buttons and enter desired sweep time.

PHASE CONTINUOUS FREQUENCY SWEEP—Continued

6. Select desired sweep mode;
 - For AUTO sweep, press SHIFT then START AMPTD push button. Verify data entry is correct and START, FREQ, SPCL, SWPNG and STOP Annunciators are on.
 - For Manual sweep, press SHIFT then STOP FREQ push button. Turn Tune KNOB for sweep.
 - For Single sweep, press SHIFT then STOP AMPTD push button.
7. To deactivate sweep mode, Press START FREQ, OFF ON, STOP FREQ, and then OFF ON push buttons. Press SHIFT then — push buttons and enter 2 2 3. Press SHIFT then SHIFT push buttons.

AMPLITUDE SWEEP

NOTE

Calculations for step size/number of steps to sweep time are provided under SWEEP TIME CALCULATIONS below.

1. On Signal Generator, press SHIFT then INSTR PRESET push buttons.
2. Press START AMPTD push button and enter desired start amplitude.
3. Press STOP AMPTD push button and enter desired stop amplitude.
4. Press SHIFT then START FREQ push buttons and enter desired sweep time.
5. Select desired sweep mode;
 - For AUTO sweep, press SHIFT then START AMPTD push button. Verify data entry is correct and FREQ, SWPNG, START, AMPTD, and STOP Annunciators are on.
 - For Manual sweep, press SHIFT then STOP FREQ push button. Turn Tune KNOB for sweep.
 - For Single sweep, press SHIFT then STOP AMPTD push button.
6. To deactivate sweep mode, Press START AMPTD, OFF ON, STOP AMPTD, and then OFF ON push buttons.

SWEEP TIME CALCULATIONS

1. Calculations for Stepped Frequency Sweep:

Calculate number of steps automatically selected as follows:

- The number of steps is the minimum of:

1023

or

$$\frac{| \text{Start Frequency (in Hz)} - \text{Stop Frequency (in Hz)} |}{1023}$$

or

$$\left[\text{INTEGER OF} \left(\frac{\text{Sweep Time (in ms)}}{\text{Min. Dwell Time (in ms)}} \right) - 1 \right]$$

Calculate sweep step size automatically selected as follows:

- The sweep size is the maximum of:

1 Hz

or

$$\frac{| \text{Start Frequency (in Hz)} - \text{Stop Frequency (in Hz)} |}{1023}$$

or

$$\frac{| \text{Start Frequency (in Hz)} - \text{Stop Frequency (in Hz)} |}{\left[\text{INTEGER OF} \left(\frac{\text{Sweep Time (in ms)}}{\text{Min. Dwell Time (in ms)}} \right) - 1 \right]}$$

Calculate sweep time to select desired number of steps as follows:

- Dwell Time =80msec when using special function 119
=135msec when not using special function 119.
- First, determine the desired number of steps is between the specified limits.
- The *maximum number* of frequency steps equals the minimum of:

1023

or

$$\frac{| \text{Start Frequency (in Hz)} - \text{Stop Frequency (in Hz)} |}{1\text{Hz}}$$

SWEEP TIME CALCULATIONS—Continued

- The *minimum number* of frequency steps equals the minimum of:

$$\left[\text{INTEGER OF} \left(\frac{275 \text{ ms}}{\text{Min. Dwell Time (in ms)}} - 1 \right) \right]$$

or

$$\frac{|\text{Start Frequency (in Hz)} - \text{Stop Frequency (in Hz)}|}{1\text{Hz}}$$

- If the desired number of steps is equal to the maximum, use a sweep time setting (in msec) equal to or greater than the result of the following equation:

$$(\text{Number of steps} + 1) \times \text{Min. Dwell Time (in msec)}$$

- If the desired number of steps is less than the maximum, use a sweep time setting (in msec) equal to or greater than the result of the above equation but less than the following equation:

$$(\text{Number of steps} + 2) \times \text{Min. Dwell Time (in msec)}$$

Calculate sweep time to select desired step size as follows:

- First, determine the desired step size is between the specified limits.
- The *maximum step size* equals the maximum of:

$$1 \text{ Hz}$$

or

$$\frac{|\text{Start Frequency (in Hz)} - \text{Stop Frequency (in Hz)}|}{\left[\text{INTEGER OF} \left(\frac{275 \text{ ms}}{\text{Min. Dwell Time (in ms)}} \right) - 1 \right]}$$

- The *minimum step size* is equal to the maximum of:

$$1\text{Hz}$$

or

$$\frac{|\text{Start Frequency (in Hz)} - \text{Stop Frequency (in Hz)}|}{1023}$$

- If the desired step size is equal to the minimum, use a sweep time setting (in msec) equal to or greater than the result of the following equation:

$$\left[\left(\frac{|\text{Start Frequency (in Hz)} - \text{Stop Frequency (in Hz)}|}{\text{Step Size (in Hz)}} \right) + 1 \right] \times \text{Min. Dwell Time (in ms)}$$

SWEEP TIME CALCULATIONS—Continued

- If the desired step size is greater than the minimum, use a sweep time setting (in msec) equal to or greater than the result of the above equation but less than the following equation:

$$\left[\left(\frac{|\text{Start Frequency (in Hz)} - \text{Stop Frequency (in Hz)}|}{\text{Step Size (in Hz)}} \right) + 2 \right] \times \text{Min. Dwell Time (in ms)}$$

2. Calculations for Phase Continuous Frequency Sweep:

- Divide Number*
- = 1 for frequencies up to 132.187500MHz
 - = 4 for frequencies from 132.1875001 to 264.375000MHz
 - = 2 for frequencies from 264.375001 to 528.750000MHz
 - = 1 for frequencies from 528.750001 to 1057.500000MHz
 - = 0.5 for frequencies from 1057.500001 to 2000MHz

Calculate the minimum possible (non-zero) frequency sweep span for a desired sweep time setting as follows:

- Minimum non-zero frequency sweep span (in Hz) equals the maximum of

1 Hz

or

$$\frac{0.2 \text{ Hz per second}}{\text{Divide Number}} \times \text{Sweep Time (in s)}$$

- If the result is not an integer, use the next highest integer.

Calculate the maximum frequency sweep span for a desired sweep time setting as follows:

- Maximum frequency span (in Hz) equals the minimum of

$$\frac{400,000 \text{ Hz}}{\text{Divide Number}}$$

or

$$\left[\text{INTEGER OF} \left(\frac{500 \text{ kHz per second}}{\text{Divide Number}} \times \text{Sweep Time (in ms)} \right) \right]$$

SWEEP TIME CALCULATIONS—Continued

Calculate the minimum (fastest) sweep time setting for a desired (non-zero) frequency span as follows:

- Minimum sweep time (in msec) equals the maximum of
5 msec
or
 $|\text{Start Frequency (in Hz)} - \text{Stop Frequency (in Hz)}| \times \text{Divide Number} \times 0.002\text{msec}$
- If the result is not an integer number of msec, use the next highest integer number of msec.

Calculate the -maximum (slowest) sweep time setting for a desired (non-zero) frequency span as follows:

- Maximum sweep time (in sec) equals the minimum of
999 sec
or
 $|\text{Start Frequency (in Hz)} - \text{Stop Frequency (in Hz)}| \times \text{Divide Number} \times 5\text{sec}$

Calculate the required sweep time to select a desired number of X-axis steps (1023 maximum) as follows:

$$\text{Desired Number of Steps} \times 1\text{msec}$$

3. Calculations for Amplitude Sweep:

Calculate number of steps automatically selected as follows:

- The number of steps is the minimum of:

$$\frac{|\text{Start Amplitude (in dBm)} - \text{Stop Amplitude (in dBm)}|}{0.1 \text{ dB}}$$

or

$$\left[\text{INTEGER OF} \left(\frac{\text{Sweep Time (in ms)}}{3 \text{ ms}} \right) - 1 \right]$$

Calculate sweep step size automatically selected as follows:

- The sweep size is the maximum of:

$$0.1 \text{ dB}$$

or

$$\frac{|\text{Start Amplitude (in dBm)} - \text{Stop Amplitude (in dBm)}|}{\left[\text{INTEGER OF} \left(\frac{\text{Sweep Time (in ms)}}{3 \text{ ms}} \right) - 1 \right]}$$

SWEEP TIME CALCULATIONS—Continued

Calculate sweep time to select desired number of steps as follows:

- First, determine the desired number of steps is between the specified limits.
- The *maximum number* of amplitude steps equals the minimum of:

$$\frac{|\text{Start Amplitude (in dBm)} - \text{Stop Amplitude (in dBm)}|}{0.1 \text{ dB}}$$

- The *minimum number* of amplitude steps equals the minimum of:

5

or

$$\frac{|\text{Start Amplitude (in dBm)} - \text{Stop Amplitude (in dBm)}|}{0.1 \text{ dB}}$$

- If the desired number of steps is equal to the maximum, use a sweep time setting (in msec) equal to or greater than the result of the following equation:

$$(\text{Number of steps} + 1) \times 3 \text{ msec}$$

- If the desired number of steps is less than the maximum, use a sweep time setting (in msec) equal to or greater than the result of the above equation but less than the following equation:

$$(\text{Number of steps} + 2) \times 3 \text{ msec}$$

Calculate sweep time to select desired step size as follows:

- First, determine the desired step size is between the specified limits.
- The *maximum step size* equals the maximum of:

0.1 dB

or

$$\frac{|\text{Start Amplitude (in dBm)} - \text{Stop Amplitude (in dBm)}|}{5}$$

- The *minimum step size* is equal to 0.1 dB.
- If the desired step size is equal to the minimum, use a sweep time setting (in msec) equal to or greater than the result of the following equation:

$$\left[\left(\frac{|\text{Start Amplitude (in dBm)} - \text{Stop Amplitude (in dBm)}|}{\text{Step Size (in dB)}} \right) + 1 \right] \times 3 \text{ ms}$$

- If the desired step size is greater than the minimum, use a sweep time setting (in msec) equal to or greater than the result of the above equation but less than the following equation:

$$\left[\left(\frac{|\text{Start Amplitude (in dBm)} - \text{Stop Amplitude (in dBm)}|}{\text{Step Size (in dB)}} \right) + 2 \right] \times 3 \text{ ms}$$

1-14. RECALLING INSTRUMENT SETTINGS

NOTE

The DN = 00 message shows the current register number, and (UP = 01) message shows the next register number (UP = 01).

SAVE

1. Press SAVE push button and,
 - Enter desired register from 00 to 50 for specific register.
 - Press STEP (UP) push button to save in next available register.
 - Press STEP (DOWN) push button to save in most recently accessed register.

RECALL

1. Press RECALL push button and,
 - Enter desired register from 00 to 50 for specific register.
 - Press STEP (UP) push button to recall instrument state stored in next available register.
 - Press STEP (DOWN) push button to recall most recently accessed register.

SEQUENCE, SETSEQUENCE

1. Press SHIFT then SEQ push buttons and enter the starting and ending registers.
2. Press SEQ push button to recall settings of next register.

NOTE

The NEXT message shows the next register to be called in sequence.

1-15. HP-IB REMOTE OPERATION.

The 8642 is fully programmable via the Hewlett-Packard Interface Bus (HP-IB) which can be operated with any Hewlett-Packard computing controller or computer for automatic system applications. For more information about HP-IB, refer to one or all of the following documents:

- IEEE Standard 488-1978,
- ANSI Standard MC1.1,
- "Improving Measurements in Engineering and Manufacturing" (HP part number 5952-0058) (the Hewlett-Packard catalog of Electronic Systems and Instruments), or
- "Tutorial Description of the Hewlett-Packard Interface Bus" (HP part number 5952-0156).

All front-panel functions are programmable over HP-IB except Knob rotation and switching the Power from Standby to On.

HP-IB ADDRESS

The Signal Generator's address is set to 19 at the factory both in RAM memory and on an internal switch located inside the instrument. You can change the address in RAM from the front panel.

The address stored in RAM remains valid through switching the Power from Standby to On and unplugging of the ac power cord. However, if the internal battery power is lost, RAM memory is lost and the Signal Generator reads the address on the internal switch. The internal switch address then becomes the address at turn on. At any time the instrument's HP-IB address can be displayed from the front panel.

Available Addresses. Any address from 00 to 30 can be assigned to the instrument.

Setting an address of 31 establishes the Signal Generator as a listen-only device. The listen-only mode causes the instrument to allow either HP-IB or local operation. However, any push buttons pressed while the Signal Generator is receiving HP-IB information could suspend the instrument in an unknown state. Also, with this address setting, the HP-IB control lines should be left open-circuited: IFC, ATN, REN, SRQ, and EOI.

1. To Display the current address from the front panel:
 - Press SHIFT then LOCAL push button.
2. To Change the current address from the front panel:
 - Press SHIFT then LOCAL push button and enter the new address from 00 to 31. Press Hz μ V push button.

NOTE

Setting the address from the front panel when the instrument is in its service mode will disable any activated HP-IB control capabilities.

HP-IB CAPABILITIES

The 8642 Signal Generator is designed to be compatible with a controller that interfaces in terms of the 12 bus messages summarized in the HP-IB Capability Reference Table. The bus functions are discussed in more detail in the following text. The Signal Generator's complete capability (as defined by IEEE Standard 488 and the identical ANSI Standard MC1.1) is described at the bottom of Table 1-4.

In remote mode, all front-panel controls are disabled except the Power switch and the Local push button (the Local push button can be disabled by configuring the instrument in Local Lockout). The Signal Generator will respond to each HP-IB message below according to its associated listen or talk address. (Each of these capabilities is described in more detail on the pages that follow.)

Input Data. When addressed to listen (with REN true), the Signal Generator stops talking and can respond to input data.

Output Data. When addressed to talk, the Signal Generator stops listening and can send output data.

Clear (Selected Device Clear SDC). When addressed to listen (with REN true), the Signal Generator stops talking and responds to SDC by clearing any uncompleted entries or messages.

Clear (Device Clear DCL). Regardless of the addressed state of the Signal Generator (whether addressed to listen or to talk), it stops talking and responds to DCL by clearing any uncompleted entries or messages.

Local. When addressed to listen (with REN true), the Signal Generator stops talking and responds to the Local command by returning from remote control to local control.

Local Lockout. Regardless of the addressed state of the Signal Generator (whether addressed to listen or to talk), it responds to the Local Lockout command by disabling the front-panel Local push button.

Clear Lockout and Set Local. Regardless of the addressed state of the Signal Generator (whether addressed to listen or to talk), it responds to the Clear Lockout and Set Local command by re-enabling the front-panel Local push button and returning from remote control to local control.

Require Service. Regardless of the addressed state of the Signal Generator (whether addressed to listen or to talk), it can send the Require Service message.

Status Byte. When addressed to talk, after receiving the Serial Poll Enable (SPE) bus command, the Signal Generator outputs the Status Byte.

Abort. Regardless of the addressed state of the Signal Generator (whether addressed to listen or to talk), it responds to the Abort command and stops listening or talking.

HP-IB Capabilities Local Mode. Besides having the above capabilities while remote, the following capabilities are also available from the local mode:

- Require Service
- Status Byte
- Data (Output)

Table 1-4. HP-IB Capability Reference Table

HP-IB Capability	Applicable	Response	Related Commands and Controls*	Interface Functions*
Data	Yes	All front-panel functions, special functions, and remote-only functions are programmable (except Knob Rotation). The Signal Generator can send status byte, message, and setting information. The front-panel LSTN and TLK annunciators turn on as appropriate when the instrument is addressed.	MLA MTA EOI	T6 L3 AH1 SH1
Trigger	No	The Signal Generator does not have a device trigger capability.	GET	DT0
Clear	Yes	The Signal Generator responds equally to DCL and SDC bus commands. The Clear capability does not reset instrument parameters.	DCL SDC	DC1
Remote	Yes	The Signal Generator's remote mode is enabled when the REN bus line is true. However, it remains in local (i.e., the keyboard is active) until it is first addressed to listen. The output signal is unchanged when the Signal Generator enters the remote mode. The front-panel RMT annunciator turns on when in remote mode.	REN MLA	RL1
Local	Yes	The Signal Generator returns to front-panel control when it enters the local mode. The output signal is unchanged. Responds either to the GTL bus command or the front-panel LOCAL key. The LOCAL key will not work if the instrument is in the Local Lockout State.	GTL	RL1
Local Lockout	Yes	Local Key is disabled during Local Lockout so only the controller or the POWER switch can return the Signal Generator to local.	LLO	RL1
Clear Lockout/ Set Local	Yes	Generator returns to local and Local Lockout is no longer true when the REN bus lines goes false.	REN	RL1
Pass Control/ Take Control	No	The Signal Generator cannot pass or take control of HP-IB. However it does have limited control capability that is intended for servicing the instrument. This control capability is accessed with Service Special Functions.	ATN IFC	C1 C2 C3 C28
Require Service	Yes	The Signal Generator sets the SRQ bus line true if one of the following conditions exists and it has been enabled by the RQS mask to send the message for that condition: Parameter Changed, Error, Ready, Local/Remote, Execution Error, Hardware Error, or End of Sweep.	SRQ	SR1
Status Byte	Yes	The Signal Generator responds to a Serial Poll Enable (SPE) bus command by sending an 8-bit byte when addressed to talk. Bit 6 (RQS bit) is true if Signal Generator had sent the Require Service Message. Each bit requires different conditions for clearing.	SPE SPD MTA	T6
Status Bit	No	The Signal Generator does not respond to a parallel poll.	ATN EOI	PP0
Abort	Yes	The Signal Generator stops talking or listening.	IFC	T6, L3

*Commands, Control lines and Interface Functions are defined in IEEE Std 488 (and the identical ANSI Standard MC1.1). Knowledge of these might not be necessary if your controller's manual describes programming in terms of the twelve HP-IB Messages shown in the left column.

Complete HP-IB capability as defined in IEEE Std 488 (and the identical ANSI Standard MC1.1) is: SH1, AH1, T6, TE0, L3, LE0, SR1, RL1, PP0, DC1, DT0, C1, C2, C3, C28, E2.

DATA INPUT

Data can be input to the Signal Generator using either front-panel keystrokes or via HP-IB.

To address the Signal Generator via HP-IB, the input data information usually contains the universal unlisten command, the Signal Generator's listen address, the controller's talk address, and a string of HP-IB program codes. As an example to set frequency to 123.4MHz (HP BASIC):

OUTPUT 719;"FR 123.4MZ"

Refer to your controller manual for command syntax and the controller's address.

Program Codes. The Signal Generator's functions can be accessed with specific program codes. These program codes are summarized in Signal Generator Function to HP-IB Code in Table 1-10, and Signal Generator HP-IB Code to Function in Table 1-11. In addition, most HP-IB codes are printed on the instrument's front panel, in light gray print, near the code's associated push button.

Input Syntax. Input data information consists of one or more bytes sent over the bus' eight data lines when the bus' attention control line (ATN) is false, and when the Signal Generator is remote and addressed to listen with the REN line true (low). The Signal Generator processes ASCII characters individually as they are received and performs the function specified as soon as a recognizable sequence of characters has been received.

Accessing the Signal Generator's front-panel key functions via HP-IB is equivalent to accessing them from the front-panel. Table 1-5 compares some local keystroke sequences and their corresponding HP-IB code sequences. (Direct access to the shift functions is possible from HP-IB so the Shift push button is not used in HP-IB coding.)

Table 1-5. Relationship Between Keystrokes and HP-IB Code Sequences

Function	Front-Panel Keystroke Sequence	HP-IB Sequence
To set a 1 MHz RF output frequency	FREQ 1 MHz V	FR 1 MZ
To set an RF frequency reference of 1 MHz	FREQ REF SET (SHIFT FREQ) 1 MHz V	FRRS 1 MZ
To select Special Function 111	SPCL (SHIFT -) 1 1 1	SP 111

DATA INPUT—Continued

Sequence Dependency. Some functions in the 8642 are coupled together because of internal circuit configuration limitations. This coupling can limit the execution of a setting when one function limits the setting of the other.

For example, amplitude and AM depth are coupled functions; An AM depth of 99.0% is possible only when the amplitude setting is between -140.0 and +14.0 dBm. Therefore,

changing this setting:	Amplitude = +14 dBm, AM depth = 99%
to this setting:	Amplitude = +15 dBm, AM depth = 75%

would not be possible if the amplitude entry was attempted before the AM setting. AM could be changed first to achieve the setting, but setting AM first would not always be successful. For example, if you were changing back to the first example (to an amplitude of +14 dBm and AM depth of 99%), setting the AM first would not set the requested AM setting. (To eliminate this sequence dependency problem when setting AM or amplitude, first turn off AM, then set the amplitude, then set the AM depth.)

How to Avoid Sequence Dependency Problems. The Operating Instructions describe the limitations of specific coupled functions and will help you avoid entering incorrect sequences. Also, when operating locally, displayed Execution Error messages direct you to your entry error. However, if operating via HP-IB, it might be inconvenient to rely either on the manual or on error messages for every combination of settings. Flowcharts of Sequence Dependency can assist in the development of driver subprograms to eliminate the consequences of sequence dependency. If you follow the flowcharts and still cannot obtain the requested setting, that setting is probably not possible.

When setting one or more of the following, use the appropriate flowchart:

Exceptions to Flowcharts. Not covered in those flowcharts is frequency sweep's dependence on entry sequence. Frequency sweeps are coupled to FM and ØM settings. When selecting either Digitally Stepped Frequency Sweep or Phase Continuous Frequency Sweep with either FM or ØM, use the following sequence:

1. Turn off frequency sweep (FAOF FBOF).
2. Select either Special Function 123 (Phase Continuous Frequency Sweep) or Special Function 223 (Phase Continuous Frequency Sweep Off which enables the selection of Digitally Stepped Frequency Sweep).
3. If FM is to be selected, use the FM flow chart (but don't set FM yet, nor FR).
4. If ØM is to be selected, use the ØM flowchart (but don't set PM yet, nor FR).
5. With Start Frequency (FA) or Stop Frequency (FB) active, select the sweep mode (FASA for auto, FASM for manual, or FASG for single).
6. Select the sweep time setting.
7. Select either the start or stop frequency setting. (Choose the frequency setting that is in the band that allows the desired FM or ØM setting.)
8. Select the desired FM or ØM deviation setting.
9. Select either the stop or start frequency setting (whichever of these that was not set in step 7).

When setting one or more of the following, use the appropriate flowchart:

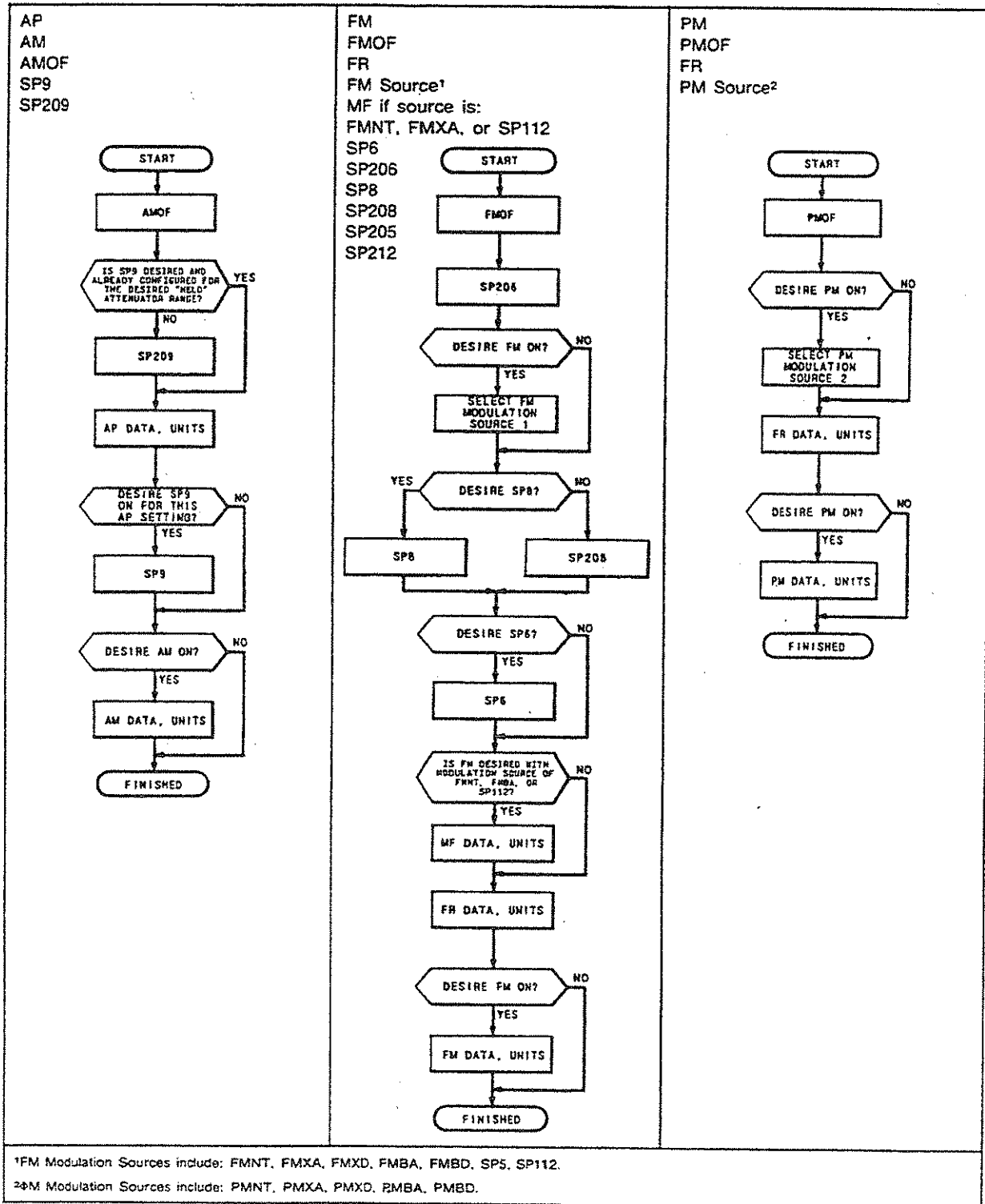

Figure 1-5. Flowcharts for Sequence Dependency

DATA INPUT—Continued

Valid Character Entry. When entering data over HP-IB, the data entry can take the form of:

Implicit point notation (for example, 100 MZ), or
Fixed Point notation (for example, 100.0 MZ), or
Exponential notation (for example, 1000E-1 MZ).

Each function has an HP-IB data-entry limit of 10 mantissa digits and 2 exponential digits (exponential notation is optional). For example, the following entries for 100 MHz will be accepted:

1000000000E-01 HZ
1000000000E-1 HZ
1000000000E-4 KZ

However, these entries for 100 MHz will not be accepted:

1000000000E-02 HZ (this entry will be accepted as 10 MHz)
100000000E-006 MZ (this entry won't be accepted and could cause problems in subsequent data entries)

Only the following data inputs are recognized over HP-IB by the Signal Generator; all other characters are ignored:

A-Z, a-z (lower-case letters are converted to upper case)
0-9
. + -

Leading zeros are treated as significant digits.

The space character, carriage return, and line feed are ignored.

DATA OUTPUT

The Signal Generator can send the following data messages when it is addressed to talk:

Status Byte (refer to Status Byte in this paragraph)
Messages (discussed below)
Display Information (discussed below)
Service Messages (refer to Section III specific Service Message information)

The Signal Generator can output the following messages and display information (normally viewed on the front-panel display) using HP-IB codes that do not have equivalent front-panel keys. The HP-IB codes are in parenthesis after each message listed below:

Output Messages
Hardware Errors (OH)
Execution Errors (OE)
Parameters Changed Messages (OC)
Output Active Function (OA)
Output HI, I.O Status (OL)
Output Display (Output Display is the default HP-IB output when nothing else is configured for data output; it does not require an HP-IB code to output data.)

Output Messages

Hardware Errors (OH). These messages signal the presence of either an internal circuit hardware problem or a firmware problem. (Refer to Operator Messages, in this section, for more information about these messages. Each message code is prefixed with the letter "H" in the listing in that section.)

The presence of one or more of these messages is signaled when bit 1 of the Status Byte is set. Some service-related messages can also cause this bit to be set.

Execution Errors (OE). These messages describe the Signal Generator's reason for not executing an attempted setting. (Refer to Operating Messages, in this Section, for more information about these messages. Each message code is prefixed with the letter "E" in that listing.)

The presence of one of these messages is signaled when bit 2 of the Status Byte is set. Some service-related messages can also cause this bit to be set.

Parameters Changed Messages (OC). These messages inform you that the Signal Generator has changed some other setting to allow a new setting. Some of the Signal Generator's functions cannot occur simultaneously with other functions, so the Signal Generator will automatically adjust or turn off the functions that are preventing the new setting. For example, AM is turned off when pulse modulation is selected; the Output Parameters Changed Message is "AM TURNED OFF .C11". (Refer to Operating Messages, in this Section, for more information about these messages. Each message code is prefixed with the letter "C" in that listing.)

The presence of this message is signaled when bit 7 of the Status Byte is set. Some service-related messages can also cause this bit to be set.

Examples

The Signal Generator can output either the message code number or the message string (the alphanumeric display) for any of the above messages. Table 1-8, Error Code and Message Recovery Example Program, provides some sample subprograms that detail a way to retrieve the Signal Generator's messages.

Execution Errors and Parameters Changed Messages. After it receives "OE" or "OC" and is addressed to talk the first time, the Signal Generator will output the message code number. The second time it is addressed to talk, the Signal Generator will output the message string.

You can read only the first Execution Error message if more than one of these has occurred since either the Status Byte was cleared or since the last time "OE" was executed. Then reading a message using "OE" will enable you to read out only the first Execution Error message.

You can read only the first Parameters Changed message if more than one of each of these has occurred since either the Status Byte was cleared or since the last time "OC" was executed. Then reading a message using "OC" will enable you to read out only the first Parameters Changed message.

Output Messages—Continued

Following is a programming example in BASIC for outputting an Execution Error (OE):

Output either an Execution Error code number or message string from the Signal Generator (address 19) and reset bit 2 of the Status Byte:

To output the message code number:

```
10 OUTPUT 719; "OE"  
20 ENTER 719; A
```

To output the message string:

```
10 OUTPUT 719; "OE"  
20 ENTER 719; A      ! Dummy read of the message code number  
30 ENTER 719; A$
```

The above examples can also be modified to apply to an Output Parameters Changed (OC) message if you send "OC" instead of "OE". Sending either "OE" or "OC" alone (program line 10 above) will reset the appropriate status bit (unless RQS is true, in which case the Status Byte must be read again to clear the status bit).

Note that you should not execute an instrument function between setting up the instrument for data output and reading the data from the Signal Generator. To illustrate this consideration, refer to the "OE" example above. If you were to insert a line 15 that set an instrument function such as AM, the data received from the Signal Generator will be the display data, not the Execution Error message code, because "AM" would have superceded the "OE" data output preparation.

Hardware Errors. Hardware Error messages are handled differently than Execution Error or Parameters Changed messages since more than one message can be present. These messages are stored as a queued up list with a maximum number of 22 messages. To properly retrieve all the queued up messages, follow the "OH" command with a software loop as shown in the sample program in Table 1-8.

Output Active Function (OA). Output Active Function enables the Signal Generator to output the setting of a selected active function over HP-IB. The Signal Generator outputs a string that can be directly read into a numeric variable or into a string variable which includes the HP-IB codes for both the function and its units specifier (maximum of 19 characters).

Following is a programming example in BASIC for outputting the active function (OA):

Output the RF frequency setting as either a numeric value or a string from the Signal Generator (address 19). ("OA" should be preceded by the function's HP-IB code.)

To output the numeric value:

```
10 OUTPUT 719; "FROA"  
20 ENTER 719; V      ! Value is output in Hz.
```

To output the alphanumeric character string:

```
10 OUTPUT 719; "FROA"  
20 ENTER 719; A$
```

Output Messages—Continued

The functions and values that can be output over HP-IB using "OA" are listed below along with some format parameters.

Meanings of Values That Could Be Output

- 200 indicates the function is off.
- 201 indicates RF OFF (for amplitude only).
- 202 indicates reverse power is tripped (for amplitude only).

A space character is placed before and after the numeric portion of the string.

Output String Formats. Table 1-6, Output Active Function String Formats (on the following page), lists the output format for each active function string.

The meanings of symbols in Table 1-6 are as follows:

- s = sign character, either "+" or "-"
- d = digit (Leading zero digits greater than the one's digit are suppressed.)

If a function's value is in relative units, the displayed, relative setting (not the absolute setting) will be output. You can output absolute units by converting from relative units to absolute units before outputting the active function.

"OA" can be sent without a function prefix. The first two characters in the output string will designate the active function. If the Signal Generator does not have an active function when it receives "OA" without a function prefix, it will output the display string (which is the default HP-IB output).

Table 1-6. Output Active Function String Formats

Function	String Format
Frequency (Value could be negative if Frequency is relative)	FR sddddddddd.0 HZ
Amplitude (in dBm)	AP sddd.d DM
(in dB relative, dB EMF relative, dB μ V, or dB EMF μ V)	AP sddd.d DB
(in volts or EMF volts)	AP +d.dddddddd VL
AM	AM +dd.d PC
FM	FM +ddddddd.0 HZ
Φ M	PM +ddd.ddddd RD
Modulation Frequency	MF +dddddd.d HZ
Modulation Output Level	ML +d.dddd VL
Start Frequency	FA +ddddddddd.0 HZ
Stop Frequency	FB +ddddddddd.0 HZ
Start Amplitude (in dBm)	AA sddd.d DM
(in volts or EMF volts)	AA +d.dddddddd VL
Stop Amplitude (in dBm)	AB sddd.d DM
(in volts or EMF volts)	AB +d.dddddddd VL
Sweep Time	ST +ddd.ddd SC

Leading zero digits greater than the one's digit are suppressed.

Output Messages—Continued

Output HI, LO Status (OL). Output HI, LO status enables an HP-IB Controller to monitor the level of the external modulation signal by configuring the Signal Generator to output the status of the HI, LO annunciators for AM, FM, or ØM. The status can be read as either a numeric value or as a string that represents the HI and LO annunciators.

Annunciator	Numeric Value Representation	String Representation
HI	+1	HI
LO	-1	LO
neither HI nor LO	0	OK

Following is a programming example in BASIC for outputting HI, LO status (OL):

Output from the Signal Generator (address 19) the status of its HI, LO annunciators for an external, ac-coupled AM signal.

To output the numeric value:

```
10 OUTPUT 719; "AMOL"  
20 ENTER 719; V
```

To output the string:

```
10 OUTPUT 719; "AMOL"  
20 ENTER 719; V ! Dummy read of the numeric value  
30 ENTER 719; A$
```

Output Display Information. The Signal Generator will output the display information when it is addressed to talk and is not configured to output any other data.

1. The first time the Signal Generator is addressed to talk, it will output the actual display in alphanumeric characters (maximum of 74 characters). (The string length of the alphanumeric display will always be greater than or equal to 25 characters.)
2. The second time the Signal Generator is addressed to talk, it will output a number, representing the displayed cursor positions, in a binary, weighted sum. (This string length will always be less than 25 characters.)
3. The third time the Signal Generator is addressed to talk, it will output a number, representing the displayed annunciators, in a binary, weighted sum. (This string length will also always be less than 25 characters.)

Each item in the sequence above will be output again in the same sequence when the Signal Generator is further addressed to talk.

Following is a programming example in BASIC for outputting display information:

Output the current display of the Signal Generator (address 19), including the cursor position and annunciators. (Assuming a function was executed to enable you to get the display you want.)

```
10 DIM A$[74] ! Define string big enough to handle  
! maximum display  
20 ENTER 719; A$ ! Display String  
30 ENTER 719; C ! Cursor Value  
40 ENTER 719; N ! Annunciator Value
```

Output Messages—Continued

The Signal Generator is initialized to output the alphanumeric display string first, whenever you execute an instrument function (for example, set AM or frequency). (When you are using Output Display to output messages, the actual front-panel display will be output, not the message code number that would be output if you used "OC", "OE", or "OH".)

The binary weight of the cursor positions are:

$2^1=2$ for the left most cursor, $2^2=4$ for the next cursor to the right, $2^3=8$ for the next cursor to the right, ..., 2_n for the nth cursor position from the left, ..., $2^{25}=33\ 554\ 432$ for the right most cursor.

The binary weight of the annunciators are provided in Table 1-7.

Example

With a display of:

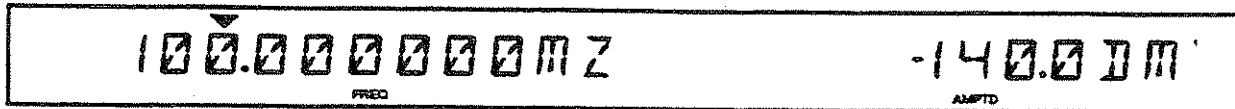

Alphanumeric characters output will be:

100.000000MZ -140.00DM

Cursor value output (4th cursor from the left) will be:

$$2^4 = 16$$

Annunciator value output for FREQ and AMPTD will be:

$$2^5 + 2^{20} = 32 + 1\ 048\ 576 = 1\ 048\ 608$$

Outputting the display could be used to output the currently selected special functions, or to output the annunciator value to determine the current modulation source.

CLEAR

The Signal Generator responds identically to Selected Device Clear (SDC) and Device Clear (DCL) bus commands by clearing any message or uncompleted entries. For example, a command of FR 100 would be cleared because no units terminator has been specified.

Also, with the Clear command, Clear Status Byte occurs, possibly clearing up to 6 status bits.

The Clear command does not affect instrument settings. However, selecting Instrument Preset (IP), Partial Preset (PP), or turning the Power from Standby to On, will reset instrument settings as described in the Operating Instruction, Instrument Preset, Partial Preset.

Table 1-7. Output Display; Binary Weight of Annunciators

Annunciator	Weighting	Decimal
RMT	2^0	1
LSTN	2^1	2
START (Frequency)	2^2	4
TLK	2^3	8
SRQ	2^4	16
FREQ	2^5	32
REL (Frequency)	2^6	64
EMF	2^7	128
SPCL	2^8	256
SWPNG	2^9	512
HI	2^{10}	1 024
LO	2^{11}	2 048
ΦM	2^{12}	4 096
FM	2^{13}	8 192
AM	2^{14}	16 384
START (Amplitude)	2^{15}	32 768
INT	2^{16}	65 536
EXT	2^{17}	131 072
AC	2^{18}	262 144
DC	2^{19}	524 288
AMPTD	2^{20}	1 048 576
REL (Amplitude)	2^{21}	2 097 152
STOP	2^{22}	4 194 304
MSSG	2^{23}	8 388 608

REMOTE, LOCAL

Local to Remote Transition. The Signal Generator goes remote when it receives the Remote message. The Remote message has two parts:

1. Remove Enable bus control line (REN) set true.
2. Device listen address received once (while REN is true).

The Signal Generator's output signal and all control settings remain unchanged with the local to remote transition, but any uncompleted messages (non-terminated partial entries) are cleared.

Remote to Local Transition. The Local message is the way the controller sends the Go To Local (GTL) bus command. The Signal Generator returns to local control when it receives the Local or Clear Lockout/Set Local message. The Signal Generator also returns to the local mode when the front-panel LOCAL push button is pressed (provided Local Lockout is not in effect). If the instrument is not in local lockout mode, pressing the front-panel LOCAL push button could interrupt a data transmission and suspend the Signal Generator in an unknown state.

Table 1-8. Error Code and Message Recovery Example Program

```

10 ! ERROR CODE AND MESSAGE RECOVERY EXAHPLE PROGRAM
20 ! JMT JULY 1984
30 ! EDIT DATE 23 AUG 1984
40 !
50 LET Gen=719 ! DEFINE 8642 ADDRESS
60 !
70 COM /Gen_addr/ Gen ! COMMON AREA TO STORE
80 ! GEN ADDRESS FOR SUB'S
90 !
100 DIM Mssg$(74) ! DIMENSION SPACE TO
110 ! ENTER IN MESSAGES
120 !
130 ENABLE INTR 7;2
140 ON INTR 7 CALL Get_message
150 OUTPUT Gen;"RM134HZ"
160 !
170 !
180 !
190 !
200 CALL User_program
210 !
220 !
230 !
240 !
250 !
260 END
270 !
280 ! SUB PROGRAMM TO POLL THE 8642
290 ! AND PRINT THE MESSAGE CODES
300 !
310 Get_message: SUB Get_message
320 COM /Gen_addr/ Gen
330 LET Byte=SPOLL(Gen) ! READ STATUS BYTE
340 IF BIT(Byte,2) THEN CALL Execution ! CHECK MESSAGE BIT
350 IF BIT(Byte,7) THEN CALL Change ! CHECK MESSAGE BIT
360 IF BIT(Byte,1) THEN CALL Hardware ! CHECK MESSAGE BIT
370 ENABLE INTR 7
380 SUBEND
390 !
400 !
410 Execution: SUB Execution
420 COM /Gen_addr/ Gen
430 OUTPUT Gen;"OE" ! OUTPUT"OE"COMMAND
440 ENTER Gen;Mssg_code ! READ MESSAGE CODE
450 PRINT USING 460;Mssg_code ! PRINT MESSAGE CODE
460 IMAGE "EXECUTION ERROR CODE =",K
470 ENTER Gen;Mssg$(1,74) ! READ MESSAGE
480 PRINT Mssg$(1,74) ! PRINT MESSAGE
490 SUBEND
500 !
510 Change: SUB Change
520 COM /Gen_addr/ Gen
530 OUTPUT Gen;"OC" ! OUTPUT"OC"COMMAND
540 ENTER Gen;Mssg_code ! READ MESSAGE CODE
550 PRINT USING 560;Mssg_code ! PRINT MESSAGE CODE
560 IMAGE "CHANGE CODE =",K
570 ENTER Gen;Mssg$(1,74) ! READ MESSAGE
580 PRINT Mssg$(1,74) ! PRINT MESSAGE
590 SUBEND
600 !
610 Hardware: SUB Hardware
620 COM /Gen_addr/ Gen
630 OUTPUT Gen;"OH" ! OUTPUT"OH"COMMAND
640 ENTER Gen;Mssg_code ! READ MESSAGE CODE
650 IF Mssg_code<>0 THEN 690 ! CHECK IF CODE =0
660 ENTER Gen;Mssg_code ! READ MESSAGE CODE
670 PRINT "NO HARDWARE MESSAGE FOUND" ! PRINT NO MESSAGES
680 GOTO 760
690 PRINT "MESSAGE CODE =",Mssg_code ! PRINT MESSAGE CODE
700 ENTER Gen;Mssg_code ! READ MESSAGE CODE
710 IF Mssg_code<>0 THEN 690 ! CHECK IF LAST
720 ENTER Gen;Mssg$(1,74) ! READ MESSAGE
730 PRINT Mssg$(1,74) ! PRINT MESSAGE
740 IF Mssg$(1,19)="END OF MESSAGE LIST" THEN 760 ! LAST MESSAGE ?
750 GOTO 720 ! GO FOR NEXT MSGE
760 SUBEND

```

LOCAL LOCKOUT, SET LOCAL

Local Lockout. The Local Lockout message is the way the controller sends the (LLO) bus command. The Signal Generator responds to the Local Lockout message by disabling the front-panel LOCAL push button.

Clear Lockout/Set Local. The Clear Lockout/Set Local message is the way the controller sets the Remote Enable (REN) bus control line false. The Signal Generator returns to local mode when it receives the Clear Lockout/Set Local message. No instrument settings are changed by the transition from remote to local.

When in local lockout, the Signal Generator can be returned to local only by the controller (using the Local or Clear Lockout/Set Local messages), or by setting the Power switch to Standby and back to on, or by removing the bus cable.

NOTE

Return-to-local while in local lockout can be accomplished by switching the POWER from STBY to ON. Returning to local control in this way has the following disadvantages:

- It defeats the purpose and advantages of local lockout (that is, the system controller will lose control of a system element).
- Instrument configuration is reset to the power-up conditions.

SERVICE REQUEST

The Signal Generator uses its internal Status Byte and a Request Service Mask Byte (RQS mask that you set) to issue a Service Request (SRQ bus line true).

RQS MASK. The RQS mask is an 8-bit byte that you can set to define which bits of the Status Byte will be allowed to cause a service request. (See Figure 1-6.) Bits 0 through 5 and 7 of the Status Byte are logically ANDed with bits 0 through 5 and 7 of the RQS mask byte. If the resultant value is not equal to zero, the Signal Generator sets bit 6 of the Status Byte true, which sends a Service Request (SRQ) message to the system controller (SRQ bus line true).

At turn-on or instrument preset, the RQS mask byte is set to zero, effectively disabling or masking all the status bits from causing a service request message.

Changing the 8-bit RQS Mask Byte

1. From the Remote Mode:

- Send RM, the decimal equivalent of the binary 8-bit byte (a number between 0 and 255), and the terminator, HZ.

SERVICE REQUEST—Continued

2. From the Local Mode:

- Select RQS MASK (SHIFT INT), the decimal equivalent of the binary 8-bit byte and any terminator (such as HZ μ V).

Example

Enable status bits 0 (End of Sweep), 1 (Hardware Error), and 7 (Parameters Changed) to cause a service request (SRQ bus line true) by unmasking those bits; that is, set the Signal Generator's RQS mask to binary 10000011 (decimal 131).

Set the mask value to: binary 10000011 = decimal 131

Local operation: Press RQS MASK (SHIFT INT) 1 3 1 HZ μ V

Remote operation: RM 131 HZ

A Service Request can be generated in either the local or remote mode. To determine which status bit caused the service request, refer to Table 1-9, HP-IB Status Byte Bit Definitions. The Status Byte can be read only by doing a serial poll via HP-IB.

Clearing the Service Request Message. The Service Request message can be cleared by masking the "set" bits in the Status Byte using the RQS mask. If the condition which caused SRQ to be pulled has been resolved, the Service Request message can be cleared with any of the following actions for clearing the Status Byte:

- Sending Clear Status (CS).
- Sending Instrument Preset (IP).
- Sending Device Clear or Selected Device Clear.
- Switching Power from Standby to On.
- Resetting the individual "set" bits. (Refer to Table 1-9.)

STATUS BYTE

The 8642 Status Byte consists of one 8-bit byte which reflects Signal Generator status. All 8 status bits are updated whether the Signal Generator is in local or remote mode.

Each bit of the Status Byte monitors a particular aspect of the Signal Generator's operation. Table 1-9, HP-IB Status Byte Bit Definitions, details the operating conditions which are monitored by the 8642 Status Byte.

The Status Byte can either be used to cause a Service Request or simply be read to monitor the Signal Generator's operating status.

Reading the Status Byte. To read the Signal Generator's Status Byte, the controller must send the Serial Poll Enable bus command and address the Signal Generator to talk. For example:

Program Statement (in BASIC)

```
10     S = SPOLL (719)
```

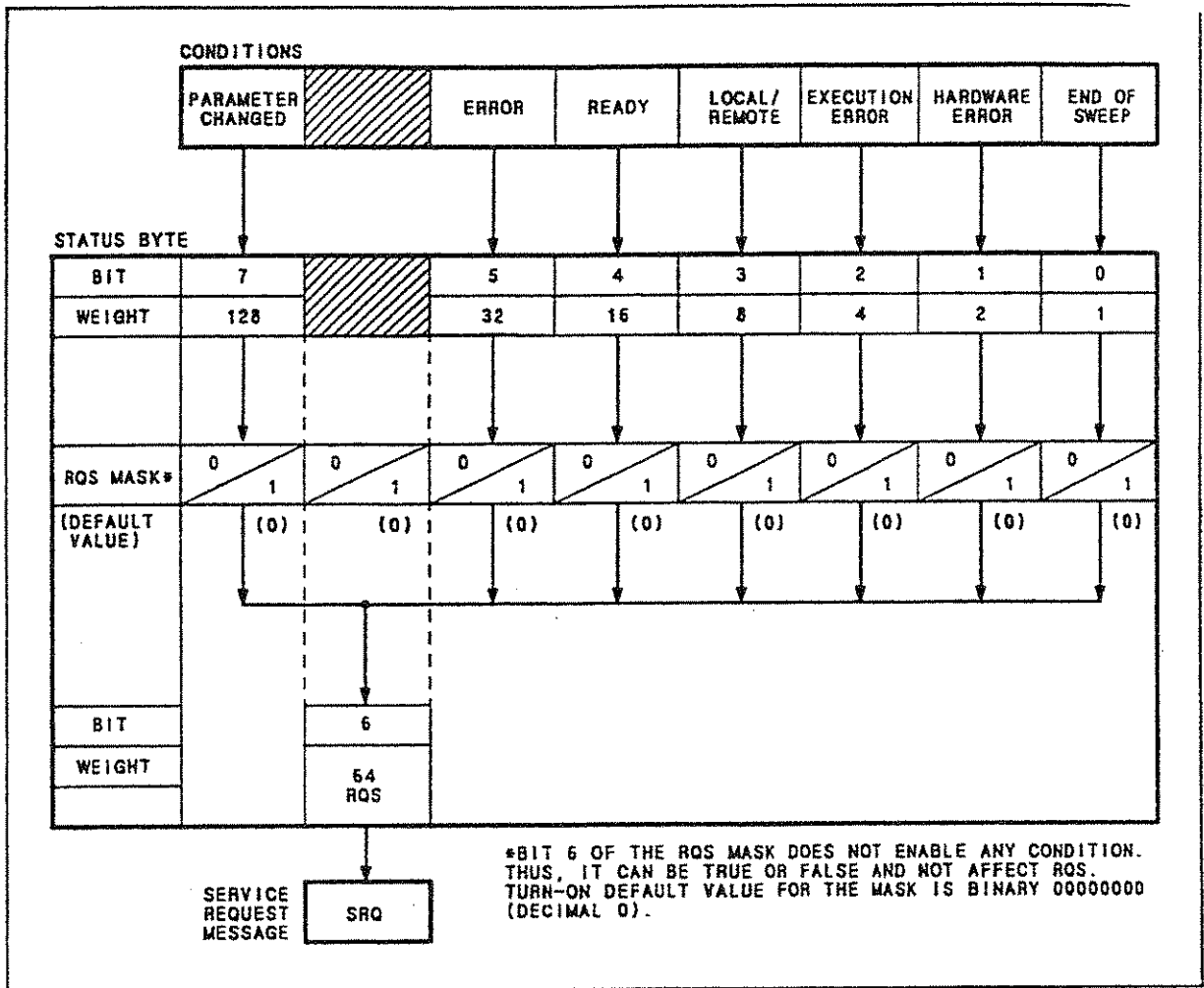

Figure 1-6. The Status Byte and RQS Mask.

If the RQS bit is not set, the Status Byte will reflect the current status of the instrument. If the RQS bit is set, the Status Byte will reflect the status of the instrument when the RQS bit was first set (or when the Status Byte was last read with RQS set). To actually get the current status of the instrument, the Status Byte should be read again. Note that the act of reading the Status Byte (alone) does not clear any status bits.

Clearing the Status Byte. If the instrument does not have an unresolved hardware error, the Status Byte will be "cleared" by executing any of the following:

- Sending Clear Status (CS).
- Sending Instrument Preset (IP).
- Sending Device Clear or Selected Device Clear.
- Switching the Power from Standby to On.

You can also clear the Status Byte by clearing the individual status bits. Refer to Table 1-9.

NOTE

Bits 3 (Local/Remote) and 4 (Ready) are not affected by "clearing" the Status Byte. They always output their actual values.

Table 1-9. HP-IB Status Byte Bit Definitions

Bit	HP-IB Operating Condition	Condition	Comments
0	END OF SWEEP	Single sweep finished.	Reset with auto, manual, or a new single sweep, or sweep mode off. ^{1,2}
1	HARDWARE ERROR	Instrument out-of-lock, reverse-power tripped, or instrument firmware malfunction.	Reset with an Output Hardware Error message to the 8642A/B (HP-IB program code "OH"). ^{1,2} More than one Hardware Error message may be present. After "OH" is executed, one error message code or string is output with each address to talk. (The Detailed Operating Instruction, Messages, lists the error codes with their respective messages.) To properly retrieve all Hardware Error information, refer to the example program in Data Output in this HP-IB information section.
2	EXECUTION ERROR	Syntax or function execution error.	Reset with an Output Execution error message to the 8642A/B (HP-IB program code "OE"). ^{1,2} Error code that caused bit to be set can be determined by reading the Output Execution Error code or string. Refer to the example program in Data Output in this HP-IB information section.
3	LOCAL/REMOTE	Instrument in local operation.	Reset when remote. Can be used to detect a front-panel SRQ (emulated by selecting the LOCAL key if not in Local Lockout). ²
4	READY	Typically always set.	The Status Byte must actually be read with this bit set for the instrument to have completed the processor delay time part of the setting change which might not include the analog settling time.
5	ERROR	Logical OR of bits 1 and 2.	Reset when bits 1 and 2 are reset. ¹
6	RQS (IEEE-488)	RQS mask is ANDed with the Status Byte and the result is not equal to 0 (refer to Service Request for more information).	Reset when the RQS mask ANDed with the Status Byte (ignoring bit 6) equals 0.
7	PARAMETER CHANGED	Previous setting has been automatically changed; for example, FM is turned off when ΦM becomes active.	Reset with an output Parameter Changed message (HP-IB program code "OC"). ^{1,2} Parameter that was changed can be determined by transmitting the Output Parameter Changed message code or string. Refer to the example program in Data Output in this HP-IB information section.

¹Also reset with IP, CS, Device Clear, Selected Device Clear, Power On. (Bit 1 is cleared only if all hardware errors are resolved.)
²If that bit was causing SRQ to be pulled, you must also read the Status Byte again to actually reset that bit. (This second reading will still show the error because the error is cleared only after the reading.)

SYSTEM CONTROLLER

The 8642 can be configured to perform as a system controller when in its service mode of operation. Perform the following steps to configure the 8642 to output test results to a printer connector to the HP-IB Interface connector:

1. Press SHIFT, —, then number 3 push buttons.
2. Press 8, 8, then Hz push buttons.
3. Press 3, 3, 0, then Hz push buttons.
4. System Controller is now activated.
5. Press 8, 9, then Hz push button to deactivate.

ADDITIONAL HP-IB INFORMATION

Abort. Abort abruptly terminates all listener/talker activity on the interface bus, using the Interface Clear (IFC) bus line, and prepares all instruments to receive a new command from the controller. Typically this is an initialization command used to place the bus in a known starting condition. The Signal Generator stops talking or listening when it receives the Abort message.

Trigger. The Signal Generator does not respond to the Trigger message.

Status Bit. The Signal Generator does not implement parallel poll operations and therefore cannot send a Status Bit message.

Controller Capabilities; Self Test and Calibration. The Signal Generator can be configured as a system controller to perform various self-test and self-calibration routines with a system voltmeter and the HP 8902A Measuring Receiver (and an optional printer).

Display Control Via HP-IB. Selecting the SHIFT key twice when in the local mode will display the instrument settings last selected. In the remote mode, you can send SHSH to achieve this same effect. (This may be useful when outputting display information.)

Remote Indicators. The Signal Generator displays HP-IB annunciators to indicate its current HP-IB status:

- RMT When remote operation is selected
- LSTN When addressed to listen
- TLK When addressed to talk
- SRQ When pulling the SRQ line (with the RQS bit set in the Status Byte)

Disabling the Listen Addressed State. The Signal Generator remains addressed to listen until:

- It is addressed to talk,
- It receives an abort message,
- It receives a universal unlisten command, or
- Until the Power is switched from Standby to On.

Disabling the Talk Addressed State. The Signal Generator remains addressed to talk until:

- It is addressed to listen,
- It receives an abort message,
- It receives some other device's talk address,
- It receives a universal untalk command, or
- Until the Power is switched from Standby to On.

Table 1-10. Signal Generator Function to HP-IB Code

Parameter	Code	Parameter	Code
Frequency		Units (Cont'd)	
Frequency	FR ¹	radian	RD
Start Frequency (Sweep)	FA ¹	second	SC
Stop Frequency (Sweep)	FB ¹	millisecond	MS
Amplitude		Sweep	
Amplitude	AP ¹	Sweep Time	ST ¹
Start Amplitude (Sweep)	AA ¹	Auto Sweep	SA ²
Stop Amplitude (Sweep)	AB ¹	Manual Sweep	SM ²
EMF Mode	EMON, EMOF	Single Sweep	SG ²
Modulation		Relative	
AM Depth	AM ¹	Reference Set	RS ²
FM Deviation	FM ¹	Relative Zero	RZ ²
φM Deviation	PM ¹	Relative Off	RF ²
Pulse	PLON, PLOF	Other	
Modulation Oscillator		Instrument Preset	IP
Modulation Frequency	MF ¹	Partial Preset	PP
Modulation Output Level	ML ¹	Special Function	SP
Modulation Source		Message	MG
Internal	NT ²	Output Hardware Error	OH
External AC	XA ²	Output Execution Error	OE
External DC	XD ²	Output Parameters	
Internal + External AC	BA ²	Changed	OC
Internal + External DC	BD ²	Output Active Function	OA ²
Data		Write Service Request Mask	RM
Numerals 0-9	0-9	Output HI,LO	
Decimal point		Annunciator Status	OL ²
Back Space	BS	Clear Status Byte	CS
Units		Step Up	UP ^{2,3}
dBm	DM or DB	Step Down	DN ^{2,3}
dB	DB or DM	Increment Set	IS ²
Volt	VL	Knob, cursor left	KL ²
mV	MV	Knob, cursor right	KR ²
μV	UV	Knob Hold	KHON ² ,
dBμV	DU		KHOF
GHz	GZ	Knob Increment	KI
MHz	MZ	Help	HP
kHz	KZ	Help Off	HO
Hz	HZ	RF Off/On	R0, R1
%	PC	Off, On	OF ² ,
			ON ²
		Entry Off	EO
		Sequence	SQ
		Set Sequence	SS
		Save	SV
		Recall	RC

¹Active function code.

²Function should be preceded by an active function code. For example, internal modulation source for AM is coded AMNT.

³These codes will sometimes not need to be preceded by an active function code; for example, when using UP or DN with SV, RC, HP, or SM.

Table 1-11. Signal Generator HP-IB Code to Function

Code	Parameter	Code	Parameter
AA ¹	Start Amplitude (Sweep)	NT ²	Internal
AB ¹	Stop Amplitude (Sweep)	OA ²	Output Active Function
AM ¹	AM Depth	OC	Output Parameters Changed
AP ¹	Amplitude	OE	Output Execution Error
BA ²	Internal + External AC	OF ²	
BD ²	Internal + External DC	ON ²	Off, On
BS	Back Space	OH	Output Hardware Error
CS	Clear Status Byte	OL ²	Output HI,LO Annunciator Status
DB	dB or dBm	PC	%
DM	dBm or dB	PLON,	
DN ^{2,3}	Step Down	PLOF	Pulse
DU	dB μ V	PM ¹	ϕ M Deviation
EMON,		PP	Partial Preset
EMOF	EMF Mode	R0,R1	RF Off/On
EO	Entry Off	RC	Recall
FA ¹	Start Frequency (Sweep)	RD	radian
FB ¹	Stop Frequency (Sweep)	RF ²	Relative Off
FM ¹	FM Deviation	RM	Write Service Request Mask
FR ¹	Frequency	RS ²	Reference Set
GZ	GHz	RZ ²	Relative Zero
HO	Help Off	SA ²	Auto Sweep
HP	Help	SC	second
HZ	Hz	SG ²	Single Sweep
IP	Instrument Preset	SM ²	Manual Sweep
IS ²	Increment Set	SP	Special Function
KHON ² ,		SQ	Sequence
KHOF	Knob Hold	SS	Set Sequence
KI	Knob Increment	ST ¹	Sweep Time
KL ²	Knob, cursor left	SV	Save
KR ²	Knob, cursor right	UP ^{2,3}	Step Up
KZ	kHz	UV	μ V
MF ¹	Modulation Frequency	VL	Volt
MG	Message	XA ²	External AC
ML ¹	Modulation Output Level	XD ²	External DC
MS	millisecond	0-9	Numerals 0-9
MV	mV		Decimal point
MZ	MHz		

¹Active function code.

²Function should be preceded by an active function code. For example, internal modulation source for AM is coded AMNT.

³These codes will sometimes not need to be preceded by an active function code; for example, when using UP or DN with SV, RC, HP, or SM.

1-16. WRITING MESSAGES TO DISPLAY.

You can write messages to the Signal Generator's display using service special functions and ASCII character codes. Two, separate, 49-character message strings can be easily displayed on the front panel or read via HP-IB. Messages such as these could be useful, for example, when keeping track of calibration times, or the owner of the instrument, or special calibration information. Also, when testing instruments, a message could be used as a system prompt. These messages are battery-backed up and can be stored through power off, to be read any time.

Service Special Functions 653 through 659 manipulate message 1; Special Function 663 through 669 manipulate message 2. Note that accessing service special functions is different than accessing the user special functions discussed previously in this manual.

To select user special functions, you key in SPCL (SHIFT -) and then the special function number.

To select service special functions locally, you need to follow two steps:

1. First select user Special Function 3, Service Mode, with keystrokes SPCL (SHIFT -) 3. Once you enter the service mode you can access the actual service special functions. However, you can only key in numbers and terminators; selecting any other key will cause the instrument to exit this special mode and display current instrument settings.
2. After you enter the service mode, you can select the service special function number. However, the instrument only knows that you have selected a special function when you key in the HZ μ V terminator. For example, to clear the current message in message 1, you would key in 6 5 5 HZ UV.

Table 1-12 lists the special functions that apply to both message 1 and message 2. Table 1-13 provides a list of valid ASCII character codes.

Example of entering a user defined message via front panel push buttons:

1. Press SHIFT, —, then 3 push buttons.
2. Press 6 5 5 then HZ μ V push buttons.
3. Press 6 5 6 7 3 then HZ μ V push buttons.
4. Press 6 5 6 7 6 then HZ μ V push buttons.
5. Press 6 5 6 8 5 then HZ μ V push buttons.
6. Press 6 5 6 8 6 then HZ μ V push buttons.
7. Press 6 5 6 3 2 then HZ μ V push buttons.
8. Press 6 5 6 7 2 then HZ μ V push buttons.
9. Press 6 5 6 8 0 then HZ μ V push buttons.
10. Press 6 5 4 then HZ μ V push buttons.
11. Verify the display reads ILUV HP

Example of entering a user defined message via HP-IB: You can use the following example BASIC program to enter a Message string of 49 characters into Message 1.

```

10 DIM C$(49)           ! DIMENSION 49 CHARACTER STRING
20 !
30 INPUT C$             ! INPUT CHARACTER STRING FOR MESSAGE 1
40 !
50 OUTPUT 719;"SP3655EN" ! CLEAR MESSAGE 1 IN THE 8642A/B
60 !
70 LET L=LEN(C$)       ! DETERMINE LENGTH OF MESSAGE 1
80 !
90 !
100 FOR I=1 TO L       ! CONVERT EACH CHARACTER IN C$ TO
110 LET A=NUM (C$(I,I)) ! ITS EQUIVALENT ASCII NUMERIC
120 OUTPUT 719 USING 130;A ! CODE
130 IMAGE "SP3656",K,"EN"
140 NEXT I
150 !
160 !
170 OUTPUT 719,"SP3657EN" ! DISPLAY THE MESSAGE
180 !
190 END

```

Example of Reading a User-Defined Message Via HP-IB. You can use the following example BASIC program to read the Message 1 string.

```

10 DIM C$(49)           ! DIMENSION 49 CHARACTER STRING
20 OUTPUT 719;"SP3657EN" ! DISPLAY MESSAGE 1
30 ENTER 719;C$        ! READ MESSAGE 1
40 END

```

Table 1-12. Special Functions that can be Used to Write to the Display

Special Functions		Description
Message 1	Message 2	
653	663	Underline the characters not yet defined in the message.
654	664	Take out the underlines from the characters not yet defined in the message.
655	665	Clear the stored message to enable writing another message.
656	666	Get ready to write the next sequential character in the message. This special function code is followed by the decimal equivalent of an ASCII character.
657	667	Output the message. This code is used to display the first half of the message. This code is also used to output the entire message via HP-IB.
658	668	Backspace to the previous character in the message.
659	669	Output message. This code is used to display the second half of the message.

Table 1-13. ACSII Character Codes

ASCII Character	Decimal Equivalent
space	32
!	33
"	34
#	35
\$	36
%	37
&	38
'	39
(40
)	41
*	42
+	43
,	44
-	45
.	46
/	47
0	48
1	49
2	50
3	51

ASCII Character	Decimal Equivalent
4	52
5	53
6	54
7	55
8	56
9	57
:	58
;	59
<	60
=	61
>	62
?	63
@	64
A	65
B	66
C	67
D	68
E	69
F	70
G	71

ASCII Character	Decimal Equivalent
H	72
I	73
J	74
K	75
L	76
M	77
N	78
O	79
P	80
Q	81
R	82
S	83
T	84
U	85
V	86
W	87
X	88
Y	89
Z	90