

HEWLETT  PACKARD

OPERATING AND SERVICE MANUAL

86222A/B RF PLUG-IN

(Including Options 002, 004, and 002/004)

SERIAL NUMBERS

This manual applies directly to HP Model 86222A with serial prefix 1725A and to HP Model 86222B with serial prefix 1722A.

With changes described in Section VII, this manual also applies to HP Model 86222A prefixes 1516A, 1549A, 1606A, and 1636A; and to HP Model 86222B prefixes 1522A, 1552A, 1601A, 1604A, and 1628A.

For additional information about serial numbers, see INSTRUMENTS COVERED BY MANUAL in Section I.

COPYRIGHT © HEWLETT-PACKARD COMPANY 1975, 1977
1400 FOUNTAIN GROVE PARKWAY, SANTA ROSA, CALIFORNIA, 95404 U.S.A.

MANUAL PART NO. 86222-90009

Microfiche Part No. 86222-90010

Printed: OCTOBER 1977

MANUAL CHANGES

MANUAL IDENTIFICATION

Model Number: 86222A/B

Date Printed: October 1977

Part Number: 86222-90009

This supplement contains important information for correcting manual errors and for adapting the manual to instruments containing improvements made after the printing of the manual.

To use this supplement:

Make all ERRATA corrections

Make all appropriate serial number related changes indicated in the tables below.

86222A	
Serial Prefix or Number	Make Manual Changes
1725A	1
1731A	1, 2
1832A, 1903A	1, 2, 5
1905A	1, 2, 5, 7
▶ 2035A	1,2,5,7,8

86222B	
Serial Prefix or Number	Make Manual Changes
1722A	1
1732A	1, 2
1741A	1, 2, 3
1815A	1, 2, 3, 4
1832A	1, 2, 3, 4, 5
1835A, 1902A	1, 2, 3, 4, 5, 6
1905A	1, 2, 3, 4, 5, 6, 7
▶ 2035A	1,2,3,4,5,6,7,8

▶ NEW ITEM

ERRATA

Title page:

Change first two paragraphs under SERIAL NUMBERS to read: This manual applies directly to HP Model 86222A with serial prefix 1636A and to HP Model 86222B with serial prefix 1628A.

With changes described in Section VII, this manual also applies to HP Model 86222A prefixes 1516A, 1529A, and 1606A; and to HP Model 86222B prefixes 1522A, 1552A, 1601A, and 1604A.

▶ Page 1-0, Figure 1-1:

Change the part number of the scale to: 86222-20029.

Page 1-4, Table 1-1:

Change footnote 4 to: Use HP Model 432A power meter, sweep duration >10 seconds.

Page 1-5, Table 1-2, under "Marker Output (Power Output +3 to +13 dBm)":

Change "Amplitude Mode: 0.5 dB" to "Amplitude Mode: >0.5 dB (internally adjustable)."

Page 1-6, Table 1-3:

Change U4 (for options 002 and 002/004) to HP Part No. 86222-60055.

NOTE

Manual change supplements are revised as often as necessary to keep manuals as current and accurate as possible. Hewlett-Packard recommends that you periodically request the latest edition of this supplement. Free copies are available from all HP offices. When requesting copies quote the manual identification information from your supplement, or the model number and print date from the title page of the manual.

20 AUGUST 1980

16 Pages

Printed in U.S.A.



HEWLETT
PACKARD

ERRATA (Cont'd)

Page 1-8, Table 1-4:

Change Power Meter and Power Sensor to Power Meter and Thermistor Mount and Model numbers to HP 432A/8478B.

Page 2-4, Table 2-2:

Change Power Meter and Power Sensor to Power Meter and Thermistor Mount and Model numbers to HP 432A/8478B.

Page 2-6, Paragraph 2-28:

In Figure 2-4, change Power Sensor to Thermistor Mount.

In EQUIPMENT list, change Power Meter model number to HP 432A, change Power Sensor to Thermistor Mount, and model number to HP 8478B.

Page 2-7, Paragraph 2-29:

In EQUIPMENT list, change Power Meter model number to HP 432A, change Power Sensor to Thermistor Mount, and model number to HP 8478B.

Page 3-7, Figure 3-3 (3 of 3)

Change step 3 to:

Depress LINE pushbutton switch 22 to turn on mainframe. With mainframe on, LINE 22, and FULL SWEEP/START MARKER 1 pushbutton should light.

Change step 6 to:

Set 8620C Markers switch 20 to INTEN position and 3 markers should appear on oscilloscope trace as intensified spots. Adjust oscilloscope intensity for best contrast. Set MARKER switch 20 to AMPL position and markers should appear on oscilloscope trace as a pip. Set MARKER switch 20 to OFF.

Page 3-13, Figure 3-5:

Change callouts to indicate a 10 MHz to 2.4 GHz range.

Page 3-13, Figure 3-6:

Change callout to 0.5 dB.

Page 3-14, Figure 3-8:

In equipment setup, change Power Sensor to Thermistor Mount.

In EQUIPMENT list, change Power Meter model number to HP 432A, change Power Sensor to Thermistor Mount, and model number to HP 8478B.

Page 3-15, Figure 3-8:

Change Model Number of BNC-To-Dual Banana Post adapter to read: "HP 10110A OR HP 10110B (2 places).

Page 3-17, Figure 3-9:

In equipment setup, change Power Sensor to Thermistor Mount.

In EQUIPMENT list, change Power Meter model number to HP 432A, change Power Sensor to Thermistor Mount, and model number to HP 8478B.

Page 4-2, Paragraph 4-8:

Change Frequency Stability Specification to:

Frequency Stability:

With Temperature: $\leq \pm 500$ kHz/ $^{\circ}$ C.

With 10% Line Voltage Change: $\leq \pm 20$ kHz.

With 3 : 1 Load SWR, All Phases: $\leq \pm 10$ kHz.

With 10 dB Power Level Change: $\leq \pm 100$ kHz.

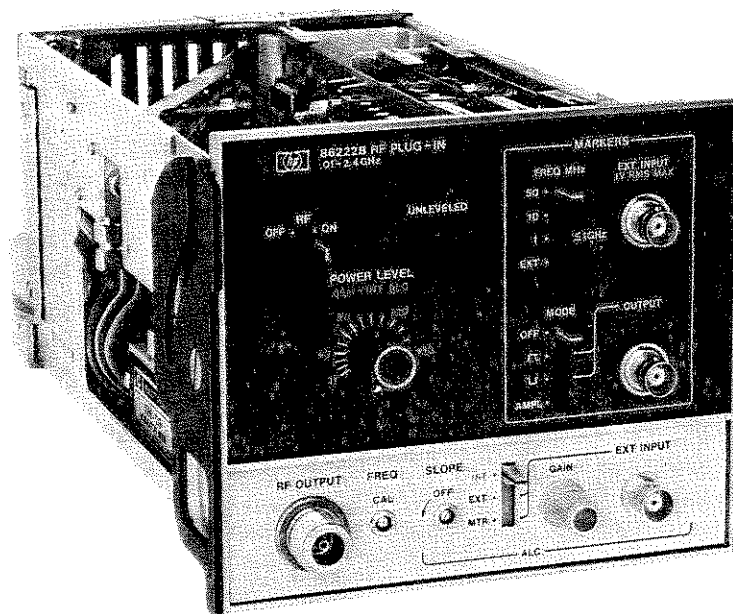

86222B RF PLUG-IN



SCALE FOR 8620A/C
86222-90029

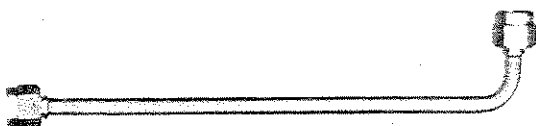

RF TEST CABLE
86290-20032



RESISTIVE BARREL
(86222B ONLY)
5061-1015

Figure 1-1. Model 86222B RF Plug-In with Accessories Supplied

SECTION I GENERAL INFORMATION

1-1. INTRODUCTION

1-2. This Operating and Service manual contains information required to install, operate, test, adjust, and service the Hewlett-Packard Model 86222A/B RF Plug-in. Figure 1-1 shows the instrument and accessories supplied. This section covers instrument identification, description, options, accessories, specifications, and other basic information.

1-3. Supplied with this manual is an Operating Information Supplement. The Supplement is a copy of the first three sections of the manual, and should be kept with the instrument for use by the operator.

1-4. Also listed on the title page of this manual is a Microfiche part number. This number can be used to order 4 x 6-inch microfiche transparencies of the manual. Each microfiche contains up to 60 photo-duplicates of the manual pages. The microfiche package also includes the latest Manual Changes supplement as well as all pertinent Service Notes.

1-5. SPECIFICATIONS

1-6. Instrument specifications are listed in Table 1-1. These specifications are the performance standards or limits against which the instrument is tested. Table 1-2 lists supplemental characteristics. Supplemental characteristics are not specifications but are typical characteristics included as additional information for the user.

1-7. SAFETY CONSIDERATIONS

1-8. General

1-9. This product and related documentation must be reviewed for familiarization with safety markings and instructions before operation. This product has been manufactured and tested in accordance with Hewlett-Packard standards.

1-10. Operation

1-11. BEFORE APPLYING POWER make sure the instrument's ac input is set for the available ac line voltage, that the correct fuse is installed, and that all normal safety precautions have been taken. (See Warnings below.)

1-12. Safety Symbols



Instruction manual symbol: The apparatus will be marked with this symbol when it is necessary for the user to refer to the instruction manual in order to protect the apparatus against damage.



Indicates dangerous voltages.



Earth Terminal

WARNING

The WARNING sign denotes a hazard. It calls attention to a procedure, practice, or the like, which, if not correctly performed or adhered to, could result in injury or loss of life. Do not proceed beyond a WARNING sign until the indicated conditions are fully understood and met.

CAUTION

The CAUTION sign denotes a hazard. It calls attention to an operating procedure, practice, or the like which, if not correctly performed or adhered to, could result in damage to or destruction of part or all of the equipment. Do not proceed beyond a CAUTION sign until the indicated conditions are fully understood and met.

1-13. Service

1-14. Although this instrument has been manufactured in accordance with international safety standards, this manual contains information, cautions, and warnings which must be followed to insure safe operation. Service should be performed only by qualified service personnel, and the following warnings should be observed.

WARNINGS

Any maintenance or repair of the opened instrument under voltage should be avoided as much as possible, but if necessary, should be carried out only by skilled persons who are aware of the hazard involved.

Capacitors inside the instrument may still be charged even if the instrument has been disconnected from its source of supply.

Ensure that only fuses with the required rated current and of the specified type (normal blow, time delay, etc.) are used for replacement. The use of repaired fuses and the short-circuiting of fuse-holders must be avoided.

If it is suspected that the protection has been impaired, the instrument must be made inoperative and be secured against any unintended operation.

If the mainframe is to be energized via an auto-transformer (for voltage reduction) make sure the common terminal is connected to the earthed pole of the power source.

BEFORE SWITCHING ON THE MAIN-FRAME, the protective earth terminals of the instrument must be connected to the protective conductor of the mains power cord. The mains plug shall only be inserted in a socket outlet provided with a protective earth contact. The protective action must not be negated by the use of an extension cord (power cord) without a protective conductor (grounding). Grounding one conductor of a two conductor outlet is not sufficient protection.

Any interruption of the protective (grounding) conductor (inside or outside the instrument) or disconnecting the protective earth terminal could make this instrument dangerous.

CAUTIONS

BEFORE SWITCHING ON THE MAIN-FRAME, ensure that mainframe's ac

CAUTIONS

(cont'd)

input is set to the voltage of the ac power source.

BEFORE SWITCHING ON THE MAIN-FRAME, ensure that the ac line fuse is of the required current rating and type (normal-blow, time delay, etc).

1-15. INSTRUMENTS COVERED BY MANUAL

1-16. Attached to the instrument is a serial number plate (Figure 1-2). The serial number is in two parts. The first four digits and the letter are the serial number prefix: the last five digits are the suffix. The prefix is the same for all identical instruments; it changes only when a change is made to the instrument. The suffix, however, is assigned sequentially and is different for each instrument. The contents of this manual apply to instruments with the serial number prefix(es) listed under SERIAL NUMBERS on the title page.

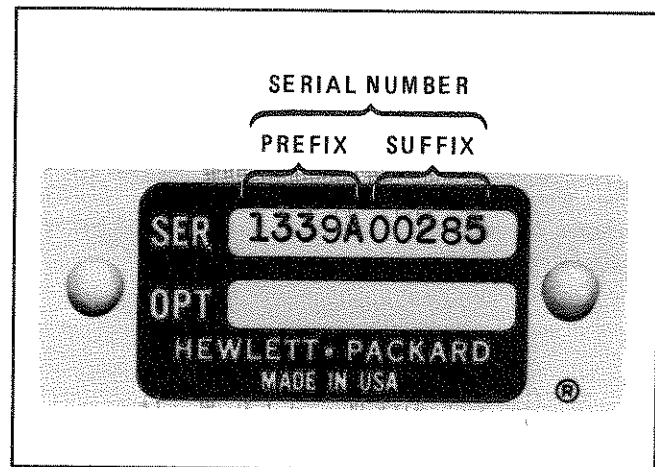

Figure 1-2. Typical Serial Number Plate

1-17. An instrument manufactured after the printing of this manual may have a serial number prefix that is not listed on the title page. This unlisted serial number prefix indicates the instrument is different from those described in this manual. The manual for this newer instrument is accompanied by a yellow Manual Changes supplement. This supplement contains "change information" that explains how to adapt the manual to the newer instrument.

1-18. In addition to change information, the supplement may contain information for correcting errors in the manual. To keep this manual as current and accurate as possible, Hewlett-Packard

recommends that you periodically request the latest Manual Changes supplement. The supplement for this manual is identified with this manual's print date and part number, both of which appear on the manual's title page. Complimentary copies of the supplement are available from Hewlett-Packard.

1-19. For information concerning a serial number prefix that is not listed on the title page or in the Manual Changes supplement, contact your nearest Hewlett-Packard office.

1-20. DESCRIPTION

1-21. The HP Model 86222A/B is designed as a plug-in for the Model 8620C mainframe. The mainframe and 86222A/B RF Plug-in make up a solid-state sweep signal source with a frequency range of 10 MHz to 2.4 GHz in one continuous sweep. The Model 86222B provides intensity or amplitude crystal markers at 1, 10, or 50 MHz intervals. Intensity markers are compatible with most CRT display units, including the HP Model 8755A Frequency Response Test Set and HP Model 8410B Network Analyzer. Front panel connector MARKER EXT INPUT provides the capability of generating markers using an external source.

1-22. The RF output of the instruments is controlled by the front panel POWER LEVEL control. Power can be leveled, externally or internally, across the band using a conventional power sampling and feedback technique. The automatic level control (ALC) switch selects the mode of leveling either internal (INT), external (EXT), or power meter (MTR). A front panel ALC EXT INPUT connector and ALC GAIN control are provided to use with an external leveling loop. When the UNLEVELED light is on, it indicates that the leveling loop is open over a portion of the swept band. BNC connectors on the rear panel allow for external FM signal inputs and a 1V/GHz FREQ REF output.

1-23. OPTIONS

1-24. Options for the Model 86222A/B RF Plug-in are available to (1) include a 70-dB built-in attenuator, (2) route the RF OUTPUT connector to the rear panel, (3) combine the 70 dB built-in attenuator and rear panel RF OUTPUT connector.

1-25. Option 002

1-26. Option 002 provides a front panel zero to 70 dB step attenuator in the RF signal line. Instal-

lation information is provided in Appendix A. See Table 1-3 for parts required to install Option 002.

1-27. Option 004

1-28. The 86222A/B Option 004 moves the RF OUTPUT connector from the front panel to the rear panel. Installation information is provided in Appendix B. Installation of the Option 004 requires the parts listed in Table 1-3.

1-29. Option 002/004

1-30. The 86222A/B Option 002/004 provides a rear panel RF OUTPUT connector with a zero to 70 dB step attenuator in the RF signal line. Installation information is provided in Appendix C. Installation of the Option 002/004 requires the parts listed in Table 1-3.

1-31. ACCESSORIES SUPPLIED

1-32. Figure 1-1 shows the HP Model 86222A/B RF Plug-in, the dial scale (HP Part No. 86222-20029) to be mounted in the 8620A/C mainframe, the RF Test cable (HP Part No. 86290-20032 for testing and troubleshooting the RF section, and a Resistive Barrel (HP Part No. 5061-1015) for simultaneous RF BLANKING and 86222B Intensity Marker operation (supplied with 86222B only).

1-33. EQUIPMENT REQUIRED BUT NOT SUPPLIED

1-34. To have a complete operating sweep oscillator unit, the Model 86222A/B RF Plug-in must be installed in an HP Model 8620C mainframe. HP Model 8620A mainframes with serial prefixes 1332A and below require a modification for HP Model 8410B Network Analyzer compatibility over multi-octave sweeps.

NOTE

All 86222A/B operation and maintenance procedures in this manual are set up using the HP Model 8620C mainframe. The procedures also apply to the 8620A mainframe, but the controls are different.

1-35. EQUIPMENT AVAILABLE

1-36. Service Accessories

1-37. Service Accessories for the 86222A/B RF Plug-in are available for convenience in aligning and

Table 1-1. Specifications for 86222A/B in 8620C

SPECIFICATIONS

FREQUENCY¹**Frequency Range:**

Calibrated: 10 MHz to 2.4 GHz.

Frequency Accuracy (25°C):²

CW Mode:³ $\leq \pm 10$ MHz.

All Sweep Modes (Sweep Time > 0.1 Sec):
 $\leq \pm 15$ MHz.

Frequency Stability:

With Temperature: $\leq \pm 500$ kHz/°C.

With 10% Line Voltage Change: $\leq \pm 20$ kHz.

With 3:1 Load SWR, All Phases: $\leq \pm 10$ kHz.

With 10 dB Power Level Change: $\leq \pm 100$ kHz.

Residual FM in 10 kHz Bandwidth (FM-NORM-PL

Switch in NORM position):

CW Mode: ≤ 5 kHz peak.

POWER OUTPUT¹**Power Level (For calibrated frequency range at 25°C):**

Maximum Leveled Power:² $\geq +13$ dBm (20 mW).

Power Level Accuracy (Internally Leveled):
 $\leq \pm 1$ dB (Includes Flatness)

Power Variation:

Internally Leveled:² $\leq \pm 0.25$ dB.

Externally Leveled:⁷

Crystal Detector: $\leq \pm 0.1$ dB.

Power Meter:⁴ $\leq \pm 0.1$ dB.

Option 002: ≤ 0.33 dB ± 0.016 dB/10 dB.

Spurious Signals (below fundamental at specified maximum leveled power, 25°C):²

Harmonics: ≥ 25 dB.

Non-Harmonics:

0.01–2.3 GHz: ≥ 30 dB.

2.3–2.4 GHz: ≥ 25 dB.

Residual AM (100 kHz Bandwidth): ≥ 50 dB below maximum power.

Equivalent Source SWR:

SWR: $\leq 1.5:1$.

Impedance: 50 ohms nominal.

MODULATION¹**External FM:**

Maximum Deviations for Modulation Frequencies:

DC to 100 Hz: ± 75 MHz.

100 Hz to 1 MHz: ± 5 MHz.

1 MHz to 2 MHz: ± 2 MHz.

External AM:^{2, 5}

ON/OFF Ratio: ≥ 30 dB.

Symmetry: 40/60 at $\geq +10$ dBm output power.

Attenuation for +6 volt input: ≥ 30 dB.

Internal AM (At Maximum Leveled Power):

1 kHz Square-wave ON/OFF Ratio: ≥ 30 dB.

RF Blanking ON/OFF Ratio: ≥ 30 dB.

MARKERS (86222B Only)^{1, 2, 6}**Marker Generator Accuracy (at 25°C with Power Output +3 to +13 dBm):**

Center Frequency Accuracy: $\pm 5 \times 10^{-6}$

Marker Frequency Range (Power Output +3 to +13 dBm):

50 and 10 MHz Markers: 10 MHz to 2.4 GHz.

1 MHz Marker: 10 MHz to 1 GHz.

¹ Unless otherwise noted, all specifications are at 0° to 55° C with plug-in installed in an 8620C mainframe.

² See also the Supplemental Characteristics, Table 1-2.

³ Approach desired frequency from low-frequency end of band.

⁴ Use HP Model 435A power meter. Sweep duration > 10 seconds.

⁵ Specific requirements for compatibility with HP 8755A, ± 6 V, 27.8 kHz square wave MODULATOR DRIVE output connected to external AM input.

⁶ 86222B markers will not operate when sweeping from a high frequency to a low frequency.

⁷ Excludes coupler and detector variation.

Table 1-2. Supplemental Characteristics for 86222A/B Installed in 8620C

SUPPLEMENTAL CHARACTERISTICS

NOTE: Values in this table are not specifications but are typical characteristics included for user information.

FREQUENCY

Frequency Accuracy in Remote Programmed Mode:Typically ± 6 MHz.**Linearity:**Correlation between frequency and SWEEP OUT voltage: ± 2 MHz.**Frequency Drift:**Drift ± 100 kHz per ten minutes after one hour warm-up.**Frequency Reference Output:**1 Volt/GHz ± 0.01 V.

POWER OUTPUT

Maximum Leveled Power:Typically $< +15$ dBm.**Power Variation (Across any 50 MHz portion between 30 MHz and 2.3 GHz):**Typically ± 0.05 dB.**Stability with Temperature Change:**Typically ± 0.02 dB/ $^{\circ}$ C.**Spurious Signals (dB below fundamental):**Harmonics: Typically ≥ 30 dB at +10 dBm.

Non-Harmonics:

10 MHz to 2.3 GHz at +10 dBm:

Typically ≥ 40 dB.

2.3 to 2.4 GHz at +10 dBm:

Typically ≥ 35 dB.**Broadband Noise (100 kHz Bandwidth):**Noise Level: ≤ -70 dBm.

MODULATION

Sensitivity:

FM Mode (FM-NORM-PL switch in FM position):

Typically -20 MHz/Volt.

Phase-Lock Mode (FM-NORM-PL switch in PL

position): Typically -6 MHz/Volt**External AM:**



Frequency Response:

Typically 150 kHz.

MARKERS (86222B Only)

External Marker Frequency Range:

(Power Output +3 to +13 dBm)

 -10 to 0 dBm External Input Power: 10 MHz to 1.0 GHz. -10 to $+10$ dBm External Input Power: 1.0 to 2.4 GHz (over limited power range).**Marker Width (around center frequency with Power Output +3 to +13 dBm):**50 MHz Marker: ± 300 kHz10 MHz Marker: ± 200 kHz1 MHz Marker: ± 75 kHzExternal Marker: ± 300 kHz**Temperature Stability (Power Output +3 to +13 dBm):**50 MHz Marker: ± 100 Hz/ $^{\circ}$ C.10 MHz Marker: ± 20 Hz/ $^{\circ}$ C.1 MHz Marker: ± 2 Hz/ $^{\circ}$ C.**Marker Output (Power Output +3 to +13 dBm):** Mode: +3 Volts. Mode: -3 to -8 Volts.

Amplitude Mode: 0.5 dB.

GENERAL

Crystal Input:Approximately -10 to -100 mV for specified leveling at maximum rated output; for use with negative polarity detectors such as HP Model 780-series Directional Detectors, and HP Model 423A Crystal Detector.**Net Weight:** 2.5 kg (5.5 pounds).**Shipping Weight:** 4 kg (9 pounds).**Dimensions:** Height 12.7 cm (5 inches); Width: 14.7 cm (5-13/16 inches); Depth 30.5 cm (12 inches).**Options:**

Option 002: Zero to 70 dB attenuator.

Option 004: Rear Panel RF OUTPUT.

Table 1-3. Parts Required for 86222A/B Options

Option	Reference Designator	HP Part No.	Description
002	A1 (86222A only)	86222-60029	Front Panel Board Assembly
	A1 (86222B only)	86222-60020	Front Panel Board Assembly
	(86222A only)	86222-00015	Panel: Front Upper
	(86222B only)	86222-00013	Panel: Front Upper
		86222-20026	Attenuator Bushing
	U4	08558-60003	70 dB Step Attenuator
		0370-1103	Knob, Pointer
	W8	86222-20021	RF Cable: Directional Detector to Attenuator
	W13	86222-20022	RF Cable: Attenuator to RF OUTPUT
004	W8	86222-20019	RF Cable: Directional Detector to Rear Panel RF OUTPUT
002/004	A1 (86222A only)	86222-60029	Front Panel Board Assembly
	A1 (86222B only)	86222-60020	Front Panel Board Assembly
	(86222A only)	86222-00015	Panel: Front Upper
	(86222B only)	86222-00013	Panel: Front Upper
		86222-20026	Attenuator Bushing
	U4	08558-60003	70 dB Step Attenuator
		0370-1103	Knob, Pointer
	W8	86222-20021	RF Cable: Directional Detector to Attenuator
	W13	86222-20023	RF Cable: Attenuator to Rear Panel RF OUTPUT

troubleshooting the mainframe and RF Plug-in. The service accessories kit contains a plug-in extender cable, extender boards, adjustment tool, and RF service cables (see Figure 1-3). The service accessories kit may be obtained from Hewlett-Packard by ordering Service Accessories Part No. 08620-60030.

1-38. Model 8755A/182C Swept Amplitude Analyzer and Oscilloscope

1-39. The Model 8620C/86222A/B Sweeper is compatible with the Hewlett-Packard Model 8755A Swept Amplitude Analyzer. For all swept amplitude measurements, the 27.8 kHz square-wave modulation is applied directly to the 8620C rear-panel EXT AM connector. This eliminates the need for an external modulator, thus providing maximum available power to a test setup. Section III contains techniques and instructions for using the 8755A for testing and measuring microwave devices.

1-40. Power Meters and Crystal Detectors

1-41. The Hewlett-Packard Model 435A Power Meter may be used for external leveling of the Model 86222A/B Plug-in. External leveled power is

also available using an HP 423A Crystal Detector. Section III contains detailed instructions for using the external power leveling systems.

1-42. Model 8410B/8411A Network Analyzer

1-43. The Model 8620C/86222A/B Sweeper provides multi-octave phase/gain measurement capability with the Hewlett-Packard Model 8410B Network Analyzer System. The combination of the Model 8410B Network Analyzer, the Model 8411A Frequency Converter, and an appropriate display plug-in forms a phasemeter and a ratiometer for direct phase and amplitude ratio measurement of RF voltages. These measurements can be made on single frequencies and on swept frequencies from 110 MHz to 2.4 GHz. The interfacing between the 8410B and the 8620C/86222A/B sweeper permits the 8410B to phase lock over the 110 MHz to 2.4 GHz range.

1-44. RECOMMENDED TEST EQUIPMENT

1-45. Equipment required to maintain the Model 86222A/B is listed in Table 1-4. Other equipment may be substituted if it meets or exceeds the critical specifications listed in the table.

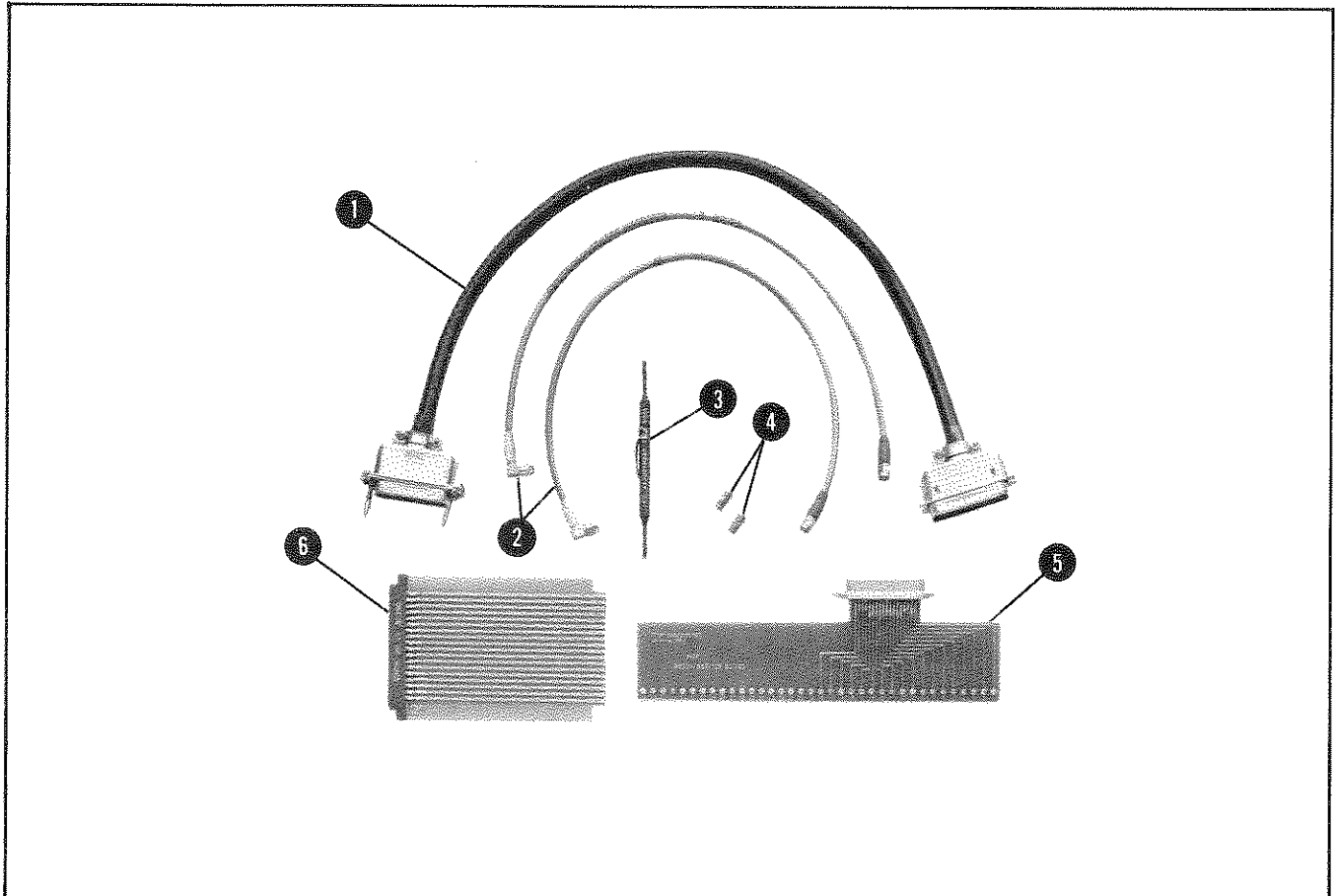

Item	Name	Part No.	Use
1	Extender Cable	08620-60032	Moves RF Plug-in outside mainframe for alignment or service
2	RF Service Cable (2 each)	8120-1578	Allows troubleshooting RF circuits
3	Adjustment Tool	8830-0024	Fits miniature adjustment slot on potentiometers
4	RF Connector, straight adapter, SMA jack to SMA jack (2 each)	1250-1158	Adapts RF Service cables from plug to jack
5	Service Board	08620-60037	Allows probing RF Section interface or programming connector during performance test or troubleshooting
6	18 Pin Extender Board	5060-2041	Extends mainframe boards for troubleshooting

Figure 1-3. Service Accessories Kit, HP Part No. 08620-60030

Table 1-4. Recommended Test Equipment (1 of 2)

Instrument	Critical Specifications	Recommended Model	Use*
Sweep Oscillator	8620A is only substitution.	HP 8620C	P, A, T
Spectrum Analyzer	Frequency Range: 10 MHz to 2.4 GHz	HP 8555A/8552B/ 141T	P
Oscilloscope with Dual-Trace Vertical Amplifier and 10:1 probes	Vertical Amplifier: Dual Trace with 10:1 probes. Bandwidth: 20 MHz minimum Vertical Sensitivity: 5 mV/Div Horizontal Sweep Rate: 1 μ s/Div minimum	HP 182C/1801A/ 1820C	P, A, T
DC Digital Voltmeter	Range: -50V to +50V Accuracy: $\pm 0.006\%$ Input Impedance: 10 megohms minimum	HP 3490A	P, A, T
Power Splitter	Frequency: 10 MHz to 2.4 GHz Attenuation in each arm: 6 dB	HP 11667A	P
Service Boards**	(See Figure 1-3)	HP 08620-60037	T
Extender Cable**	(See Figure 1-3)	HP 08620-60032	T
Adjustment Tool**	(See Figure 1-3)	HP 8830-0024	A
Crystal Detector	Frequency: 10 MHz to 2.4 GHz SWR: <1.2 to 2.4 GHz Polarity: Negative	HP 423A	P, A
Power Meter and Power Sensor	Frequency: 10 MHz to 2.4 GHz Range: +10 dBm to -20 dBm	HP 435A/8482A	P, A
3 dB Attenuator	Attenuation: 3 dB \pm 0.3 dB Frequency: Dc to 2.4 GHz	HP 8491A, Opt. 003	P
10 dB Attenuator	Attenuation: 10 dB \pm 0.5 dB Frequency: Dc to 2.4 GHz	HP 8491A, Opt. 010	P, A, T
20 dB Attenuator	Attenuation: 20 dB \pm 0.5 dB Frequency: Dc to 2.4 GHz	HP 8491A, Opt. 020	
BNC Tee	Connectors: 1 male and 2 female	HP 1250-0781	P, A, T
Swept Amplitude Analyzer and Oscilloscope Mainframe	Frequency Range: 15 MHz to 2.4 GHz	HP 8755A/182T	A
Detectors	Frequency Response: 15 MHz to 2.4 GHz Error: <1.3 dB Impedance: 50 ohms	HP 11664	A
<p>* P = Performance Test; A = Adjustments; T = Troubleshooting ** These parts are included in Service Accessories Kit No. 08620-60030</p>			

Table 1-4. Recommended Test Equipment (2 of 2)

Instrument	Critical Specifications	Recommended Model	Use*
RF Service Cable **	Impedance: 50 ohms Connectors: SMA to SMA (Figure 1-3)	HP 8120-1578	T
RF Connector Adapter**	SMA jack to SMA jack (Figure 1-3)	HP 1250-1158	T
18-Pin Extender Board**	(See Figure 1-3)	HP 5060-2041	T, A
Function Generator	Frequency: 10 Hz to 2.1 MHz Output: 12V peak-to-peak square-wave	HP 3310A	P, A
RMS Voltmeter	Scale: RMS volts Range: 0 to -70 dB Accuracy: $\pm 5\%$ Frequency Range: 10 Hz to 100 kHz	HP 3400A	P
DC Power Supply	Range: 0 to 10 Vdc Current: 0.1 Amp	HP 6213A	P
Adjustable AC Line Transformer	Output: 100 to 150 Vac Power: 150 watts	General Radio MT32	P
Directional Coupler	Coupling: 20 dB Directivity: >25 dB SWR all ports: <1.3	HP 778D	P, T
Frequency Counter	Range: 1 MHz to 2.4 GHz	HP 5340A	P, A, T
Cable	2-ft long, BNC connectors	HP 11086A	P
50 Ohm Load	Impedance: 50 Ohms BNC, Male Connector	HP 11593A	A
Adjustable Short	Type N, Male connector	Microlab FXR 50-6 MN	P
<p>* P = Performance Test; A = Adjustments; T = Troubleshooting</p> <p>** These parts are included in Service Accessories Kit No. 08620-60030.</p>			

SECTION II

INSTALLATION AND INCOMING INSPECTION TESTS

2-1. INSTALLATION

2-2. This section provides installation instructions for Model 86222A/B RF Plug-in and its accessories. It also includes information about initial inspection and damage claims, preparation for using the RF Plug-in and packaging, storage and shipment, and incoming inspection.

2-3. INITIAL INSPECTION

2-4. Inspect the shipping container for damage. If the shipping container or cushioning material is damaged, it should be kept until the contents of the shipment have been checked for completeness and the instrument has been checked mechanically and electrically. The contents of the shipment should be as shown in Figure 1-1, and procedures for checking electrical operation are given in Section IV. If the contents are incomplete, if there is mechanical damage or defect, or if the RF Plug-in does not pass the performance tests, notify the nearest Hewlett-Packard office. If the shipping container is damaged, or the cushioning material shows signs of stress, notify the carrier as well as the Hewlett-Packard office. Keep the shipping materials for carrier's inspection. The HP office will arrange for repair or replacement without waiting for claim settlement.

2-5. PREPARATION FOR USE

2-6. Power Requirements

2-7. When the Model 86222A/B RF Plug-in is properly installed, it obtains all power through the rear interface connector from the HP Model 8620A/C Sweep Oscillator mainframe.

2-8. Interconnections

2-9. For the Model 86222A/B RF Plug-in to operate, it must be plugged into an 8620A or 8620C mainframe. Connection is made by pushing the RF Plug-in into the mainframe so that the plug-in interface connector P1 mates with the mainframe connector.

2-10. Mating Connectors

2-11. The mating connectors for the HP Model 86222A/B RF Plug-in are shown in Table 2-1. This

table identifies the mating connector for each front and rear panel connector on the RF Plug-in and gives the HP Part No. and part numbers of alternate sources.

2-12. Operating Environment

2-13. **Temperature.** The instrument may be operated in temperatures from 0°C to +55°C.

2-14. **Humidity.** The instrument may be operated in environments with relative humidity up to 95%. However, the instrument should also be protected from temperature extremes which cause condensation within the instrument.

2-15. **Altitude.** The instrument may be operated at altitudes up to 4572 meters (15,000 feet).

2-16. Frequency Scale Installation

2-17. NOTE

If RF Plug-in is installed in mainframe, it must be removed to install frequency scale. See RF Plug-in removal instructions in Paragraph 2-20.

To install frequency scale, proceed as follows:

a. Disengage mainframe front-panel latch handle, shown in Figure 2-1, by pushing downward on handle while pushing inward lightly on top of front panel.

b. Swing front panel forward and down to position shown in Figure 2-2.

c. Depress mainframe front-panel BAND select lever, shown in Figure 2-1, to rotate frequency scale drum until desired scale position is accessible.

NOTE

The frequency scale for the 86222A/B RF Plug-in may be installed in any frequency scale drum position. If necessary to remove a frequency scale, exert a pressure OUTWARD, away from drum, on right-hand edge of scale.

d. Insert frequency scale so key (a 1/16-inch long, 1/2 inch wide protrusion) on left end of scale

Table 2-1. Model 86222A/B Mating Connectors

Connector on Instrument	Mating Connector		
	Industry Identification	HP Part No.	Alternate Sources
J1 MARKER EXT INPUT (86222B only)	Type BNC, male connector UG-88/U	1250-0256	Amphenol 31-202-1021 Bendix 12638-3 Specialty Connector 28P118-1
J2 MARKER OUTPUT (86222B only)			
J4 ALC EXT INPUT			
J5 FM			
J6 FREQ REF			
J3 RF OUTPUT	Type N, male connector UG-21G/U	1250-0882	Bendix 30481-2 Specialty Connector 25P117-2
J3 Rear RF OUT (Option 002/004)			

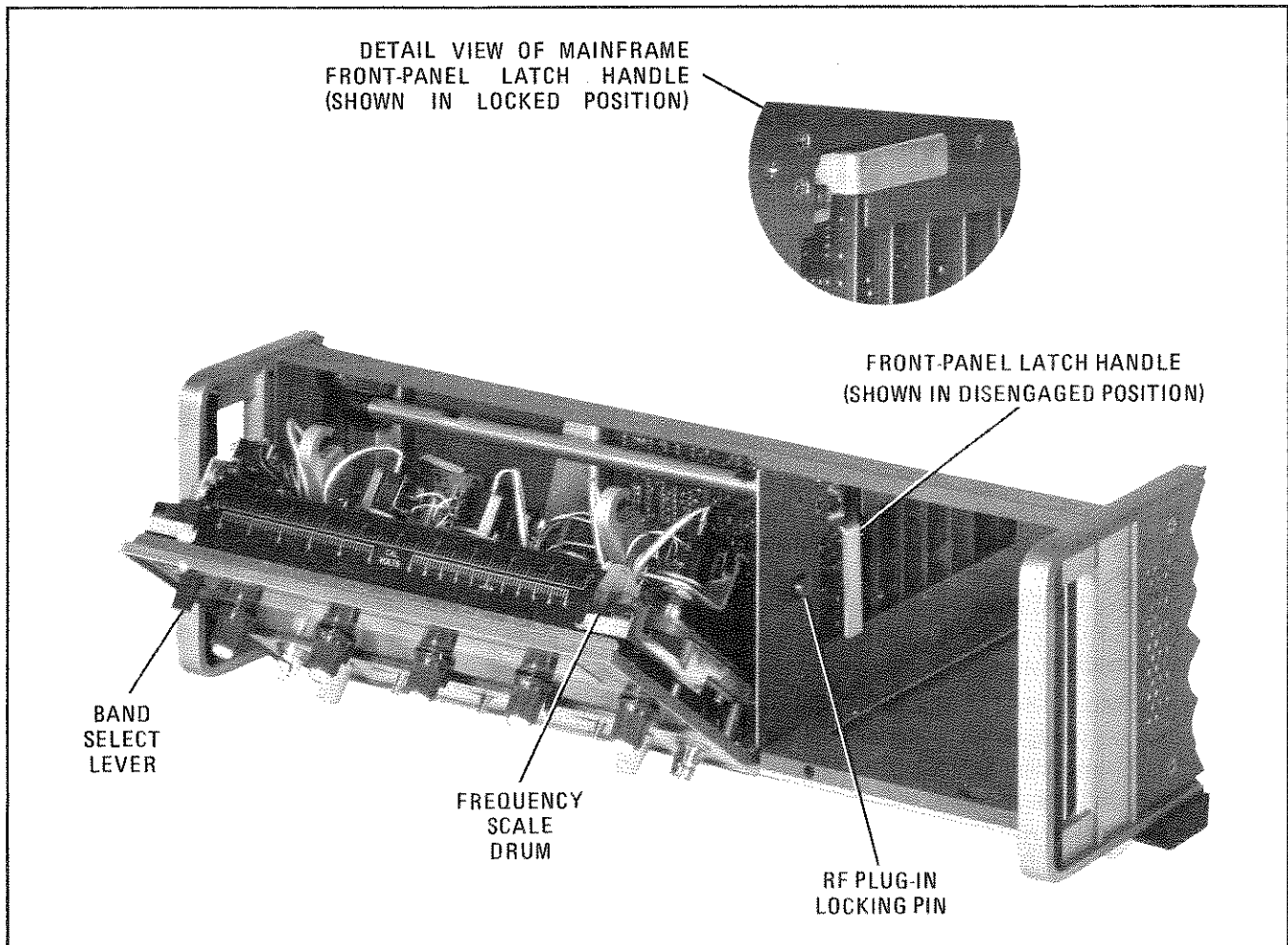

Figure 2-1. Installation of Frequency Scale and RF Plug-in

fits into notch in roller on left-hand edge of drum (see Figure 2-2).

e.

CAUTION

To prevent damage to frequency pointers when bandswitch drum is rotated, make certain that frequency scale is firmly in place and flush with band drum edges.

Push inward on right-hand edge of frequency scale to snap it into place on frequency scale drum.

f. Return front panel to upright (closed) position, and, while pushing inward lightly on top of front panel, re-engage front-panel latch handle by pushing it upward to lock positions as shown in Figure 2-1, inset view.

2-18. RF Plug-in Installation and Removal

2-19. Installation. To install RF Plug-in proceed as follows:

a. If mainframe power is ON, press mainframe LINE switch to OFF position.

b. Position latch handle located on left side of RF Plug-in so it is perpendicular to front panel. Portion of handle with rectangular cut-out should be facing forward and portion with notch should be facing rear of RF Plug-in.

c. Slide RF Plug-in into mainframe towards rear of compartment. RF Plug-in latch handle will engage a locking pin, shown in Figure 2-1, inside mainframe and exposed portion of latch handle will start to move downward.

d. Push latch handle downward, while still pushing inward on RF Plug-in, until latch handle is flush with front panel.

2-20. Removal. To remove RF Plug-in, proceed as follows:

a. Push inward on top of latch handle and pull forward and up on bottom of latch handle.

b. When exposed portion of latch handle is in a position perpendicular to RF Plug-in front panel, it is disengaged from locking pin (Figure 2-1) and RF Plug-in may be removed by pulling forward on latch handle.

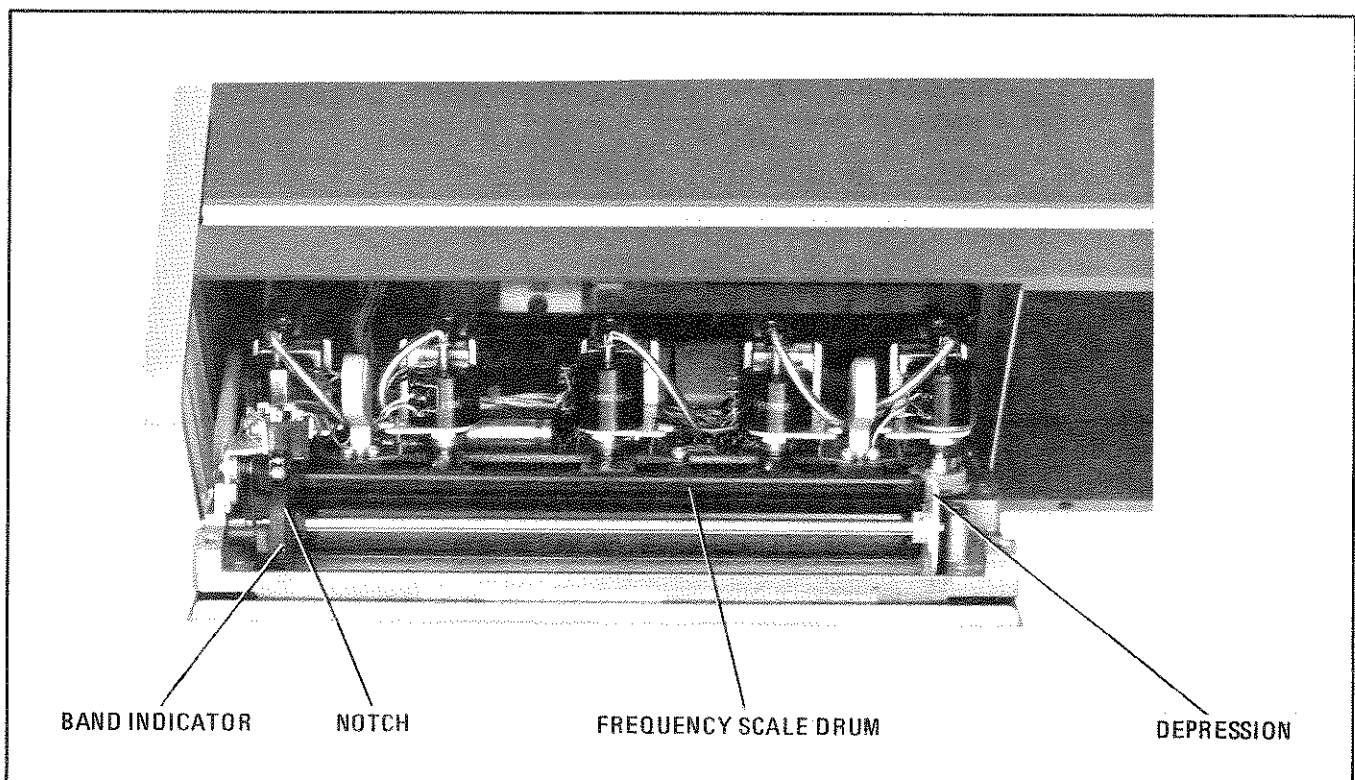

Figure 2-2. Mainframe Front Panel in Open Position

2-21. Installation of Options

2-22. To install or remove options, refer to the installation instructions in the appendixes for the applicable options.

2-23. MODIFICATIONS

2-24. Unmodified 8620A mainframes, which include prefixes 1332A and below, will not operate for continuous multi-octave frequency measurements with the HP Model 8410B Network Analyzer. To modify 8620A mainframes with serial

prefixes 1332A and below, order the 8620A Mainframe Modification Kit, HP Part Number 08620-60099. Service Note 8620A-6A explains the modification.

2-25. INCOMING INSPECTION TESTS

2-26. The following procedures test selected specifications to determine that the instrument is functioning properly for the requirements of incoming inspection. The recommended test equipment is listed in Table 2-2. Equipment that meets or exceeds the critical specifications may be substituted.

Table 2-2. Recommended Test Equipment for Incoming Inspection Tests

Instrument	Critical Specifications	Recommended Model
Sweep Oscillator	8620A is only substitution.	HP 8620C
Oscilloscope with Dual-Trace Vertical Amplifier and 10:1 probes	Vertical Amplifier: Dual trace with 10:1 probes Bandwidth: 20 MHz minimum Vertical Sensitivity: 5 mV/Div Horizontal Sweep Rate: 1 μ s/Div minimum	HP 182C/1801A/1820C
Frequency Counter	Range: 1 MHz to 2.4 GHz	HP 5340A
Power Meter and Power Sensor	Frequency: 10 MHz to 2.4 GHz Range: +10 dBm to -20 dBm	HP 435A/8482A
Crystal Detector	Frequency: 10 MHz to 2.4 GHz SWR: <1.2 to 2.4 GHz Polarity: Negative	HP 423A
Power Splitter	Frequency: 10 MHz to 2.4 GHz Attenuation in each arm: 6 dB	HP 11667A
10 dB Attenuator	Attenuation: 10 dB \pm 0.5 dB Frequency: Dc to 2.4 GHz	HP 8491A, Option 010
3 dB Attenuator	Attenuation: 3 dB \pm 0.3 dB Frequency: Dc to 2.4 GHz	HP 8491A, Option 003

2-27. Frequency Range and Accuracy

SPECIFICATION: Frequency range: 10 MHz to 2.4 GHz
 Frequency accuracy (at 25° C ambient):
 \pm 10 MHz CW mode. (Approach desired CW frequency from low-frequency end of band.)
 \pm 15 MHz All Sweep Modes (Sweep Time >0.1 sec.)

DESCRIPTION: The CW mode is checked at three frequencies across the band to determine if the RF signal is within frequency tolerance. Start-stop sweep is then selected and the frequency at each end-point is checked.

INCOMING INSPECTION TESTS

2-27. Frequency Range and Accuracy (Cont'd)

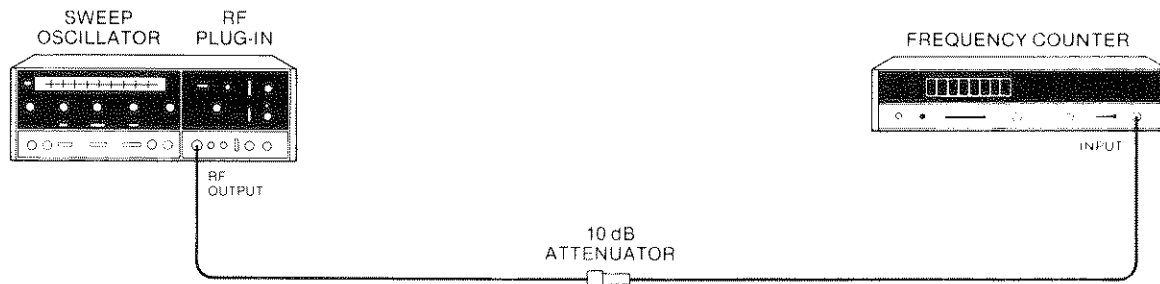

Figure 2-3. Frequency Range and Accuracy Test Setup

- EQUIPMENT:
- Sweep Oscillator HP 8620C
 - RF Plug-in HP 86222A/B
 - Frequency Counter HP 5340A
 - 10 dB Attenuator HP 8491A, Option 010

- PROCEDURE:
- a. Connect equipment as shown in Figure 2-3. Connect frequency counter through a 10 dB attenuator to the 86222A/B RF OUTPUT connector. Press 8620C LINE switch to the ON position.
 - b. Set controls as follows:
 - 8620C**
 - START MARKER Pointer 0.02 GHz
 - STOP MARKER Pointer 2.4 GHz
 - MODE MANUAL
 - 1 kHz SQ WV-OFF (Rear panel) OFF
 - 86222A/B**
 - RF ON
 - POWER LEVEL +13 dBm
 - ALC Switch INT
 - FM-NORM-PL NORM
 - c. Allow equipment to warm up for 30 minutes. Press 8620C CW pushbuttons. Set frequency counter to measure frequencies from .01 GHz to 2.4 GHz.
 - d. Set CW pointer to .01 GHz. Frequency counter should indicate 10 MHz ± 10 MHz.
 - e. Set CW pointer to 1.2 GHz. Frequency counter should indicate 1.2 GHz ± .01 GHz.
 - f. Set CW pointer to 2.4 GHz. Frequency counter should indicate 2.4 GHz ± .01 GHz.
 - g. Press FULL SWEEP pushbutton. Set MANUAL control fully counterclockwise. Frequency counter should indicate 20 MHz ± 15 MHz.
 - h. Set MANUAL control fully clockwise. Frequency counter should indicate 2.4 GHz ± .015 GHz.

INCOMING INSPECTION TESTS

2-28. Power Level and Variation Test

SPECIFICATION: Maximum Levelled Power (25°C): $\geq +13$ dBm.
 Power Variation (at maximum levelled power): Internally Levelled: ± 0.25 dB.

DESCRIPTION: Maximum levelled power is measured by a power meter. Power level variations with internal leveling are checked. The power variations are measured with a power meter.

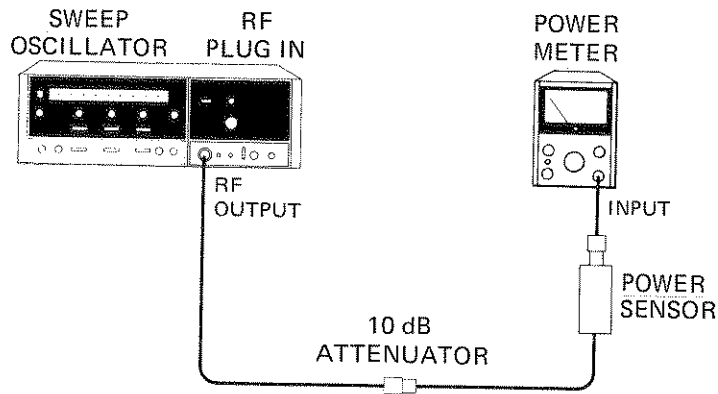

Figure 2-4. Internal Leveling Test Setup

EQUIPMENT:	Sweep Oscillator	HP 8620C
	RF Plug-in	HP 86222A/B
	Power Meter	HP 435A
	Power Sensor	HP 8482A
	10-dB Attenuator	HP 8491A, Option 010

PROCEDURE: a. Allow 30 minutes warm-up time. Set controls as follows:

8620C

- START MARKER Pointer 10 MHz
- STOP MARKER Pointer 2.4 GHz
- CW Pointer 1.2 GHz
- MODE MANUAL
- RF BLANKING—OFF (Rear panel). RF BLANKING

86222A/B

- RF ON
- ALC INT

- b. Connect equipment as shown in Figure 2-4.
- c. Set 86222A/B POWER LEVEL to maximum levelled power (UNLEVELED light out).
- d. Manually tune 8620C from full CCW to full CW, slowly enough for power meter to respond. Note maximum and minimum power readings.

INCOMING INSPECTION TESTS

2-28. Power Level and Variation Test (Cont'd)

- e. Difference between maximum and minimum power readings should be ≤ 0.5 dBm. Minimum reading should not be lower than +3 dBm.

2-29. Internal Amplitude Modulation Test

SPECIFICATION: All tests are referenced to the 86222A/B RF OUTPUT power set to the specified maximum power of +13 dBm.

Internal AM: RF Blanking (selected by 8620C RF BLANKING—OFF switch) ON/OFF ratio > 30 dB.

DESCRIPTION: Internal AM is checked for RF blanking on/off ratio. The on/off ratio is determined by power level measurement in the RF BLANKING and OFF conditions.

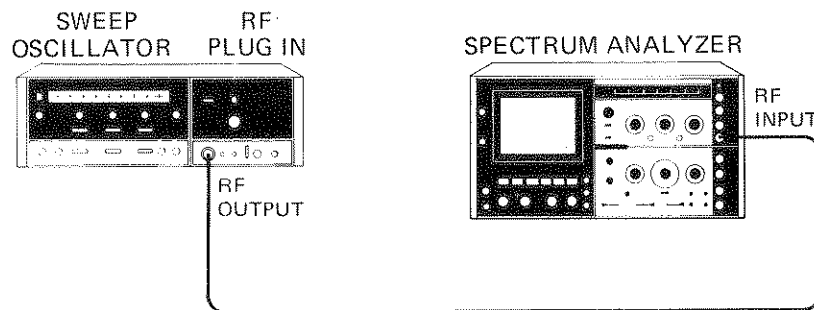

Figure 2-5. Internal Amplitude Modulation Test Setup

EQUIPMENT:	Sweep Oscillator	HP 8620C
	RF Plug-in	HP 86222A/B
	Power Meter	HP 435A
	Power Sensor	HP 8482A
	Spectrum Analyzer	HP 8555A/8552B/141T

PROCEDURE: a. Connect equipment as shown in Figure 2-5. Allow 30 minutes warm-up time.

b. Set controls as follows:

Sweep Oscillator:

START MARKER Pointer	1.2 GHz
MARKER SWEEP Pushbutton	Depressed (On)
RF BLANKING—OFF (Rear Panel)	OFF
MODE	AUTO
TRIGGER	EXT

RF Plug-in:

RF	ON
ALC	INT
FM-NORM-PL	NORM

Spectrum Analyzer:

BANDWIDTH	10 kHz
SCAN WIDTH	20 MHz/DIV
2 dB LOG—10 dB LOG—LINEAR	10 dB LOG

INCOMING INSPECTION TESTS

2-29. Internal Amplitude Modulation Test (cont'd)

- c. Adjust 86222A/B POWER LEVEL for maximum leveled power.
- d. Adjust spectrum analyzer to center RF carrier on display.
- e. Set LOG REF LEVEL on spectrum analyzer to top graticule line.
- f. Set 8620C RF BLANKING-OFF switch to RF BLANKING and note the difference in power level (ON/OFF ratio). The ON/OFF ratio should be greater than 30 dB.

2-30. Marker Range Test (86222B Only)

SPECIFICATION: Marker Frequency Range:
 10 and 50 MHz Markers: 10 MHz to 2.4 GHz
 1 MHz Marker: 10 MHz to 1 GHz.

DESCRIPTION: Marker frequency range is determined by using an oscilloscope and crystal detector to display the markers.

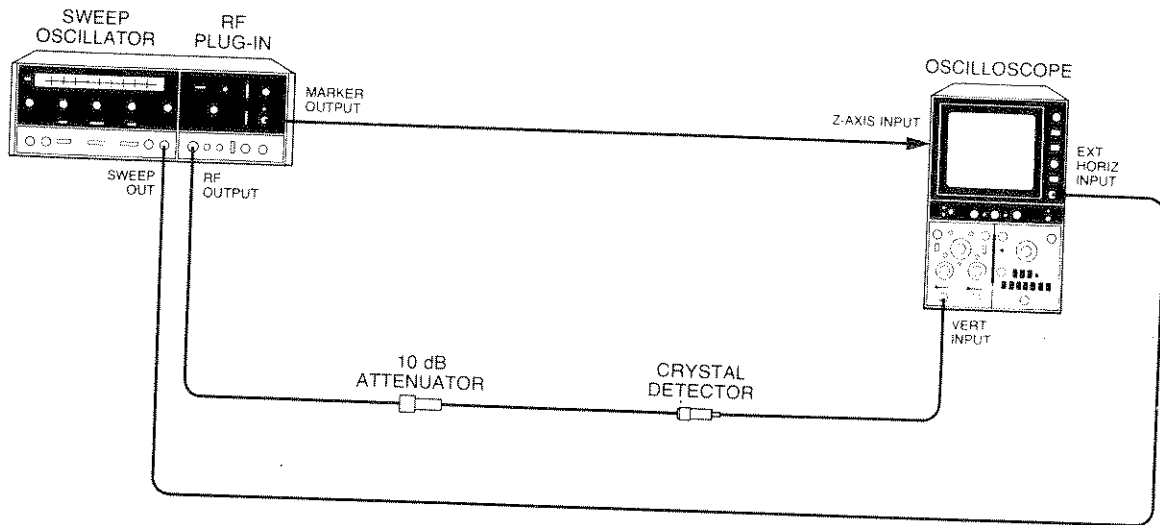

Figure 2-6. Marker Range Test Setup

EQUIPMENT:

Sweep Oscillator	HP 8620C
RF Plug-in	HP 86222B
Oscilloscope	HP 182C/1802A/1820C
Crystal Detector	HP 423A
10-dB Attenuator	HP 8491A, Option 010

- PROCEDURE:
- a. Connect equipment as shown in Figure 2-6. Set 8620C LINE switch to ON and allow 30 minutes warm-up time.
 - b. Set controls as follows:

INCOMING INSPECTION TESTS

2-30. Marker Range Test (86222B Only) (cont'd)

8620C

CW Pointer	100 MHz
ΔF Pointer	160 MHz
MODE	AUTO
TRIGGER	INT
TIME-SECONDS Switch	1 to .01
TIME-SECONDS Vernier	Fully Clockwise
RF BLANKING-OFF	RF BLANKING

86222B:

RF	ON
POWER LEVEL	+13 dBm
ALC	INT
MARKER FREQ MHz	50
MARKER MODE	
FM-NORM-PL	NORM

c.

NOTE

The oscilloscope display consists of the selected ΔF pointer frequency swept symmetrically around the selected CW point of frequency. For example, with the CW pointer at 100 MHz and a ΔF of 100 MHz, the display is from 50 MHz to 150 MHz. To determine the frequency range of the markers, the first and last good markers should each be centered on the oscilloscope display, and either the CW pointer frequency setting read directly, or the 8620C put in CW mode and the output frequency read with a frequency counter.

Press 8620C ΔF pushbutton and adjust ΔF to display from 2 to 8 markers on oscilloscope display. Adjust oscilloscope intensity for best marker contrast.

- d. Slowly adjust 8620C CW control to display from 10 MHz to 2.4 GHz and ensure 50 MHz markers are present and stable over the full calibrated frequency range.
- e. Set MARKER FREQ MHz switch to 10 and adjust ΔF to display between 2 and 8 markers on oscilloscope display.
- f. Slowly adjust 8620C CW control to display from 10 MHz to 2.4 GHz and ensure 10 MHz markers are present and stable over the full calibrated frequency range.
- g. Set MARKER FREQ MHz switch to 1 and adjust ΔF to display between 2 and 8 markers on oscilloscope display.
- h. Slowly adjust 8620C CW control to display from 10 MHz to 1 GHz and ensure 1 MHz markers are present and stable up to 1 GHz.

2-31. STORAGE AND SHIPMENT

2-32. Environment

2-33. The instrument may be stored or shipped in environments within the following limits:

Temperature -40°C to $+75^{\circ}\text{C}$
Humidity Up to 95% relative
Altitude 15240 meters (50,000 feet)

The instrument should also be protected from temperature extremes which cause condensation within the instrument.

2-34. Packaging

2-35. **Original Packaging.** Containers and materials identical to those used in factory packaging are available through Hewlett-Packard offices. If the instrument is being returned to Hewlett-Packard for servicing, attach a tag indicating the type of service required, return address, model number, and full serial number. Also, mark the container FRAGILE to assure careful handling. In any correspondence, refer to the instrument by model number and full serial number.

2-36. **Other Packaging.** The following general instructions should be used for re-packaging with commercially available materials:

a. Wrap instrument in heavy paper or plastic. (If shipping to Hewlett-Packard office or service center, attach tag indicating type of service required, return address, model number, and full serial number.)

b. Use strong shipping container. A double-wall carton made of 350-pound test material is adequate.

c. Use enough shock-absorbing material (3 to 4-inch layer) around all sides of instrument to provide firm cushion and prevent movement inside container. Protect control panel with cardboard.

d. Seal shipping container securely.

e. Mark shipping container FRAGILE to assure careful handling.

f. In any correspondence, refer to instrument by model number and full serial number.

SECTION III OPERATION

3-1. INTRODUCTION

3-2. This operating section explains the function of the controls and indicators of the Model 86222A/B RF Plug-in. It describes typical operating modes in a measurement system.

3-3. PANEL FEATURES

3-4. Front and rear panel features are described in Figures 3-1 and 3-2. Description numbers match the numbers on the illustration.

3-5. OPERATOR'S CHECKS

3-6. The Operator's Checks (Figure 3-3) allow the operator to make a quick evaluation of the instrument's main function prior to use. These checks assume that the 86222A/B RF Plug-in is installed in an 8620C Sweep Oscillator mainframe. The checks cover the RF Plug-in and mainframe; therefore, if the correct indications are not obtained, trouble may be in either of the units. If the RF Plug-in is suspected, follow the troubleshooting chart in Section VIII to isolate the problem.

3-7. OPERATING INSTRUCTIONS

3-8. General Operating Procedure

3-9. Figure 3-4 shows general operating procedures with the Model 8620C/86222A/B Sweep Oscillator connected in a typical measurement test setup. Many other applications are possible but are not shown because the general operating procedure is the same.

3-10. Internal Leveling

3-11. The most convenient method of RF output leveling is internal leveling. A portion of the RF output is coupled out of a direction detector, producing a dc voltage proportional to the RF output signal. This detected dc voltage is applied to the automatic leveling control circuit (ALC). The Operator's Checks in Figure 3-3 are performed in the internal leveling mode.

3-12. External Crystal Detector Leveling

3-13. Power may be leveled externally using a power splitting tee (or directional coupler) and crystal detector. This leveling system uses a power splitting tee to sample the RF output signal and a crystal detector to produce a dc voltage proportional to RF signal level. The detector voltage is compared with an internal reference voltage, and the difference voltage changes the output power level to keep it constant at the output. Instead of a power splitting tee, a directional coupler may be used to sample the RF signal for the leveling loop. Directional couplers are usually narrow band, whereas the power splitting tee is flat over a wide frequency range. The advantage of a directional coupler is that it does not have a 6-dB loss like the power splitting tee, therefore a higher maximum leveled power output may be obtained. To place the crystal detector leveling loop in operation, use the test setup and procedures in Figure 3-8.

3-14. External Power Meter Leveling

3-15. Power leveling can be obtained with a power meter and power splitting tee or directional coupler as shown in Figure 3-9. A sample of the RF output signal is routed to a power meter to produce a dc voltage proportional to the RF signal level. The dc voltage is applied to the 86222A/B ALC circuits and compared with an internal reference voltage. A difference voltage is produced and amplified by the ALC amplifier before being applied, as modulator drive, to the Modulator-Mixer U1. The modulator drive controls the output of the Modulator-Mixer to maintain a constant power level.

3-16. External FM

3-17. The 86222A/B RF output signal can be frequency modulated using an external modulating signal applied to the 86222A/B FM input connector. The external FM function provides a means of obtaining an output frequency that varies under the control of an external modulating signal. A positive going voltage causes output frequency to decrease while a negative going voltage causes output frequency to increase.

3-18. Phase Lock Operation

3-19. The 86222A/B RF output (CW) signal may be phase-locked using an external phase-lock signal applied to the 86222A/B FM input connector. The phase-lock function provides a means of obtaining a very stable CW frequency by transferring the frequency stability of the reference oscillator to the source. If the CW frequency starts to drift, the phase difference between the CW frequency and the reference frequency (reference oscillator) is

detected, producing a dc voltage. The dc voltage is a correction signal which restores the CW frequency to its previous point. Stability of this CW frequency is determined by the stability of the reference oscillator.

3-20. OPERATOR'S MAINTENANCE

3-21. Power circuits for the Model 86222A/B are fused in the mainframe. See the 8620C Operating and Service Manual for fuse replacement.

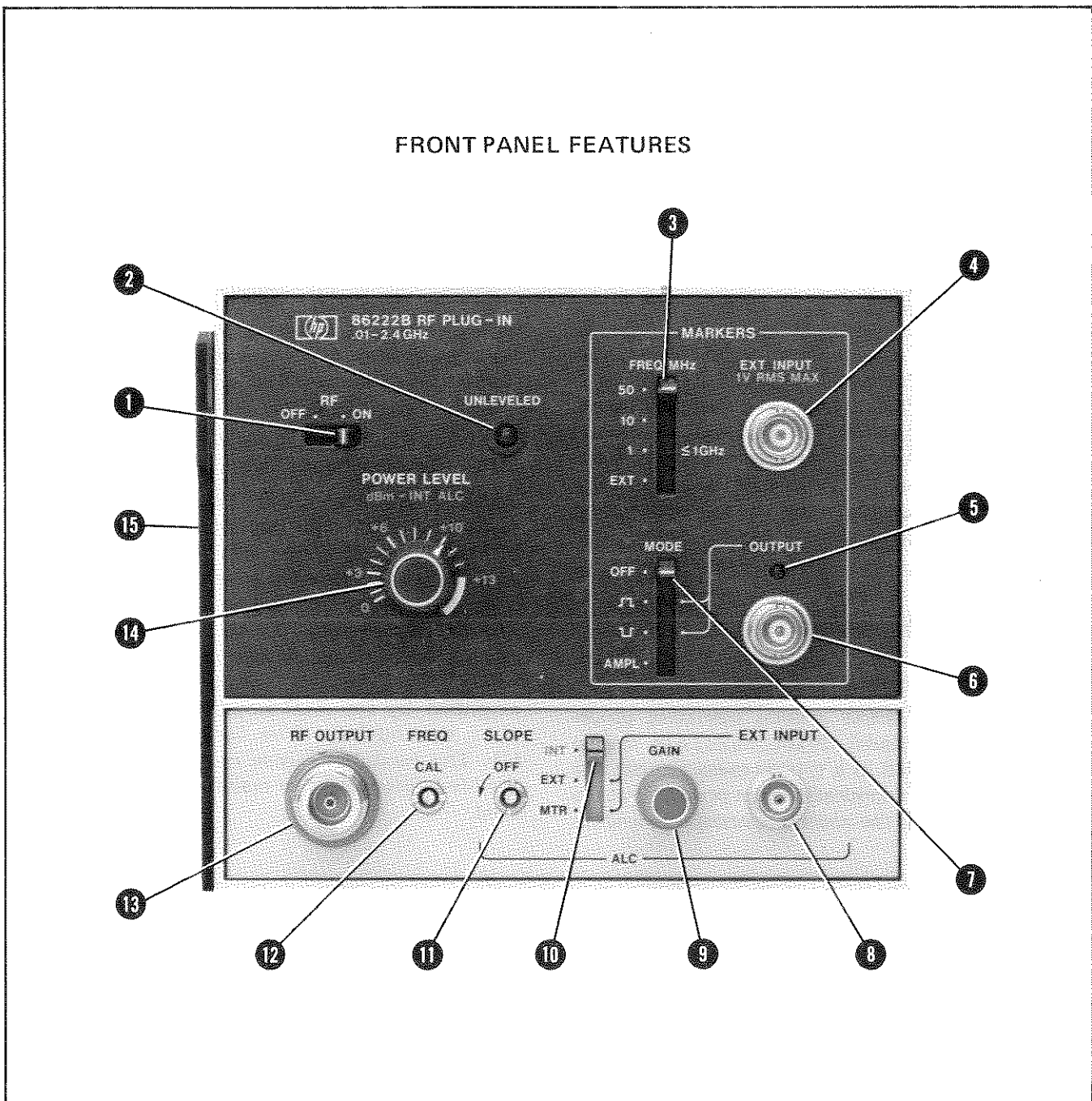

Figure 3-1. Front Panel Controls, Connectors and Indicators (1 of 2)

FRONT PANEL FEATURES

- ① **RF ON-OFF switch.** Turns RF power on and off. This is useful when zeroing power meter.
- ② **UNLEVELED lamp.** Lights if POWER LEVEL is set too high to permit leveling over sweep range selected.
- ③ **MARKER FREQ MHz² switch (86222B only).** Selects 50, 10 or 1 MHz internal crystal markers. EXT position selects markers generated from an external frequency source.
- ④ **MARKER EXT INPUT BNC connector (86222B only).** Input for external marker frequency source. Maximum signal input 1 volt RMS.
- ⑤ **MARKER OUTPUT lamp (86222B only).** Lights in \square MODE when marker is coincident with RF OUTPUT frequency. Enables accurate selection of CW frequency.
- ⑥ **MARKER OUTPUT BNC Connector (86222B only).** Output for intensity markers to Z-AXIS input of display unit.
- ⑦ **MARKER MODE switch (86222B only).** Selects amplitude (AMPL), negative intensity (\square), or positive intensity (\square) marker modes. Off position switches markers off.
- ⑧ **ALC EXT INPUT BNC connector.** Input for external leveling from power meter or crystal detector. Sensitivity -10 to -100 millivolts.
- ⑨ **ALC GAIN control.** Adjust ALC leveling amplifier gain when system is using an external leveling loop. Rotates clockwise to increase ALC loop gain.
- ⑩ **ALC switch.** Selects INT (internal), EXT (external), or MTR (power meter) power leveling modes.
- ⑪ **ALC SLOPE control.** Compensates for high frequency power losses in external RF cables by attenuating power at lower frequencies. This compensation provides a leveled RF signal output. The OFF position removes all compensation.
- ⑫ **FREQ CAL control.** provides fine frequency calibration for 86222A/B RF Plug-in.
- ⑬ **RF OUTPUT connector.** Type-N 50-ohm RF output connector.
- ⑭ **POWER LEVEL control.** Adjusts RF power output. Rotate clockwise to increase output power.
- ⑮ **Latch Handle.** Aids in installing and removing RF Plug-in. After installing, handle locks to hold RF Plug-in in place.

NOTE

The front panel changes when Option 002 or 004 is added. See Appendix A, B, or C for these front panel features.

Figure 3-1. Front Panel Controls, Connectors and Indicators (2 of 2)

REAR PANEL FEATURES

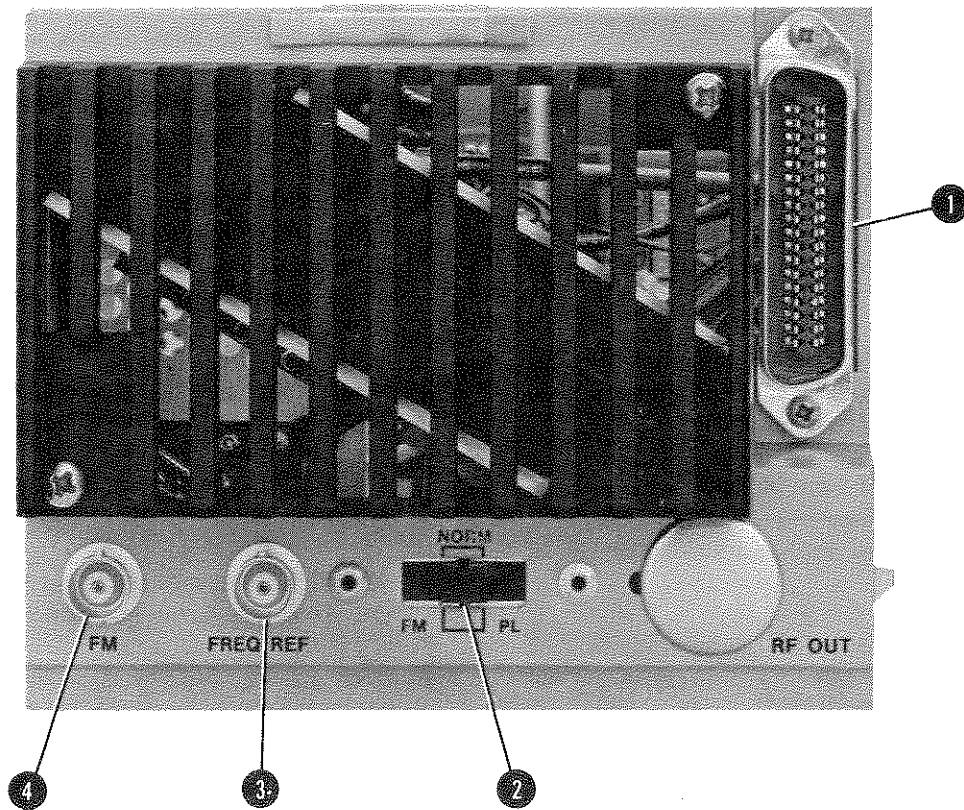

1 **Interface Connector.** Provides interconnection between 8620C mainframe and 86222A/B RF Plug-in.

2 **FM-NORM-PL switch.** Operates in conjunction with FM input connector to provide optimum performance for either normal sweep (NORM), frequency modulation (FM), or phase lock (PL) operation.

If FM or PL modes of operation are not being used, switch should be in NORM.

3 **FREQ REF BNC connector.** Provides approximately +1 volt/GHz frequency reference signal.

4 **FM BNC connector.** Input connector for FM modulation signal or phase locking error signal.

Figure 3-2. Rear Panel Controls and Connectors

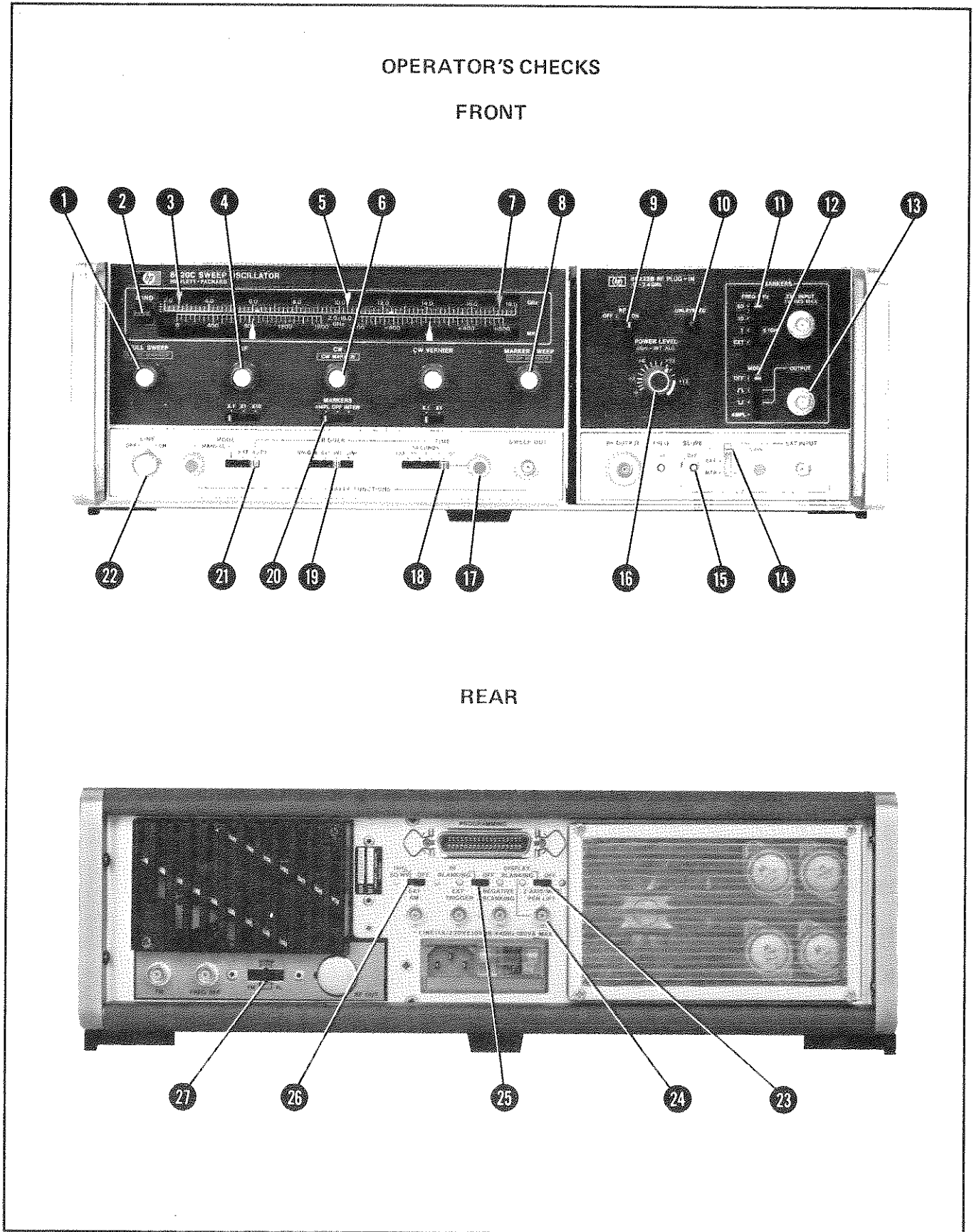
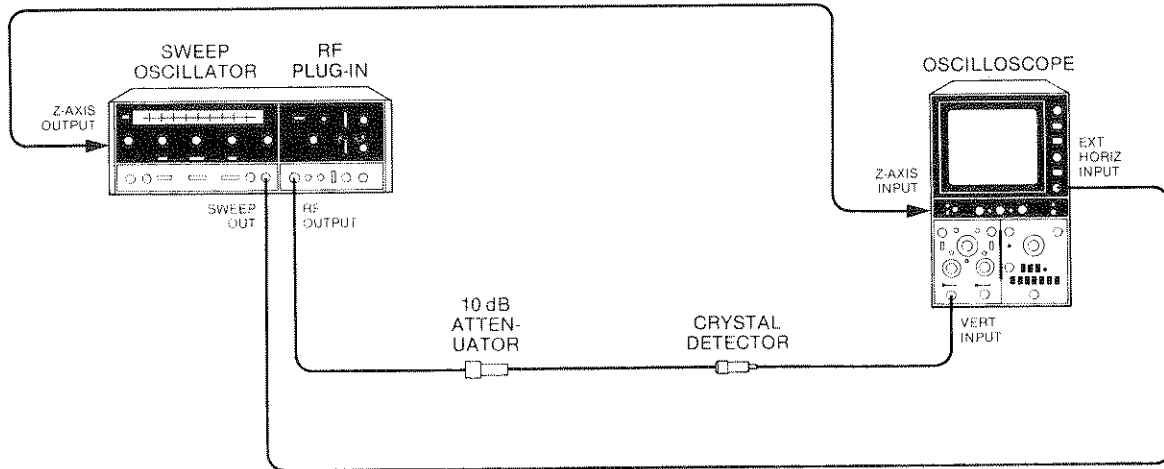

Figure 3-3. Operator's Checks (1 of 3)

OPERATOR'S CHECKS



EQUIPMENT:

Sweep Oscillator	HP 8620C
RF Plug-in	HP 86222A/B
Oscilloscope	HP 182C/1801A/1820C
Crystal Detector	HP 423A
10-dB Attenuator	HP 8491A, Option 010

NOTE

All procedures are written for the 8620C Sweep Oscillator. These same procedures will apply to the 8620A with proper attention to different switches.

PROCEDURE:

1. Connect equipment as shown in test setup.
2. Set controls as follows:

8620C:

BAND ②	0.01—2.4 GHz
START MARKER pointer ③ ..	Left-hand end mark on scale
CW MARKER pointer ⑤	Middle mark on scale
STOP MARKER pointer ⑦ ..	Right-hand end mark on scale
MARKERS ⑳	OFF
MODE ㉑	AUTO

Figure 3-3. Operator's Checks (2 of 3)

OPERATOR'S CHECKS

8620C (Cont'd):

TRIGGER 19	INT
TIME-SECONDS 18	0.1 to 0.01
TIME-SECONDS Vernier 17	Clockwise
Rear Panel 1 kHz SQ WV/OFF 26	OFF
Rear Panel DISPLAY BLANKING/OFF 23	..	DISPLAY BLANKING
Rear Panel RF BLANKING/OFF 25	OFF

86222A/B:

RF 9	ON
POWER LEVEL 16	Fully clockwise
ALC 14	INT
SLOPE 15	OFF
Rear Panel FM-NORM-PL 27	NORM
MARKERS MODE (86222B only) 12	OFF
MARKERS FREQ MHz (86222B only) 11	50

3. Depress LINE pushbutton switch 22 to turn on mainframe. With mainframe on, LINE 22, START MARKER 1, and STOP MARKER 8 pushbuttons should light.
4. Check that the instrument is sweeping correctly. This is indicated by continuous signal-level line below zero-volt dc level on oscilloscope.
5. UNLEVELED light 10 may be lit. If UNLEVELED light is lit, reduce output power by 86222A/B POWER LEVEL control 16 counterclockwise until UNLEVELED light goes out. This is adjustment point for maximum leveled power. Oscilloscope trace should be leveled. (Refer to Figures 3-5 and 3-6 for typical oscilloscope display of unleveled and leveled RF power output.
6. Set 8620C MARKERS Switch 20 to INTEN position and marker should appear on oscilloscope trace as intensity spot. Adjust oscilloscope intensity for best contrast. Set MARKER switch to AMPL position and marker should appear on oscilloscope trace as a pip. Set MARKER switch to OFF.

86222B ONLY:



7. Press 8620C ΔF pushbutton 4 and ΔF and CW 6 pushbuttons should light. Disconnect BNC cable from Z-AXIS OUTPUT 24 and connect it to MARKER OUTPUT connector 13. Set MARKERS MODE switch 12 to  and adjust ΔF control 4 for between 2 to 8 markers on oscilloscope display. Markers should appear on oscilloscope as intensity spots. Adjust oscilloscope intensity for best contrast. Set MARKERS MODE switch to  and markers should appear as dropouts on the oscilloscope trace. Set MARKERS MODE switch to AMPL and markers should appear as pulses. Changing MARKERS FREQ MHz switch 11 position should change marker frequency.

Figure 3-3. Operator's Checks 3 of 3)

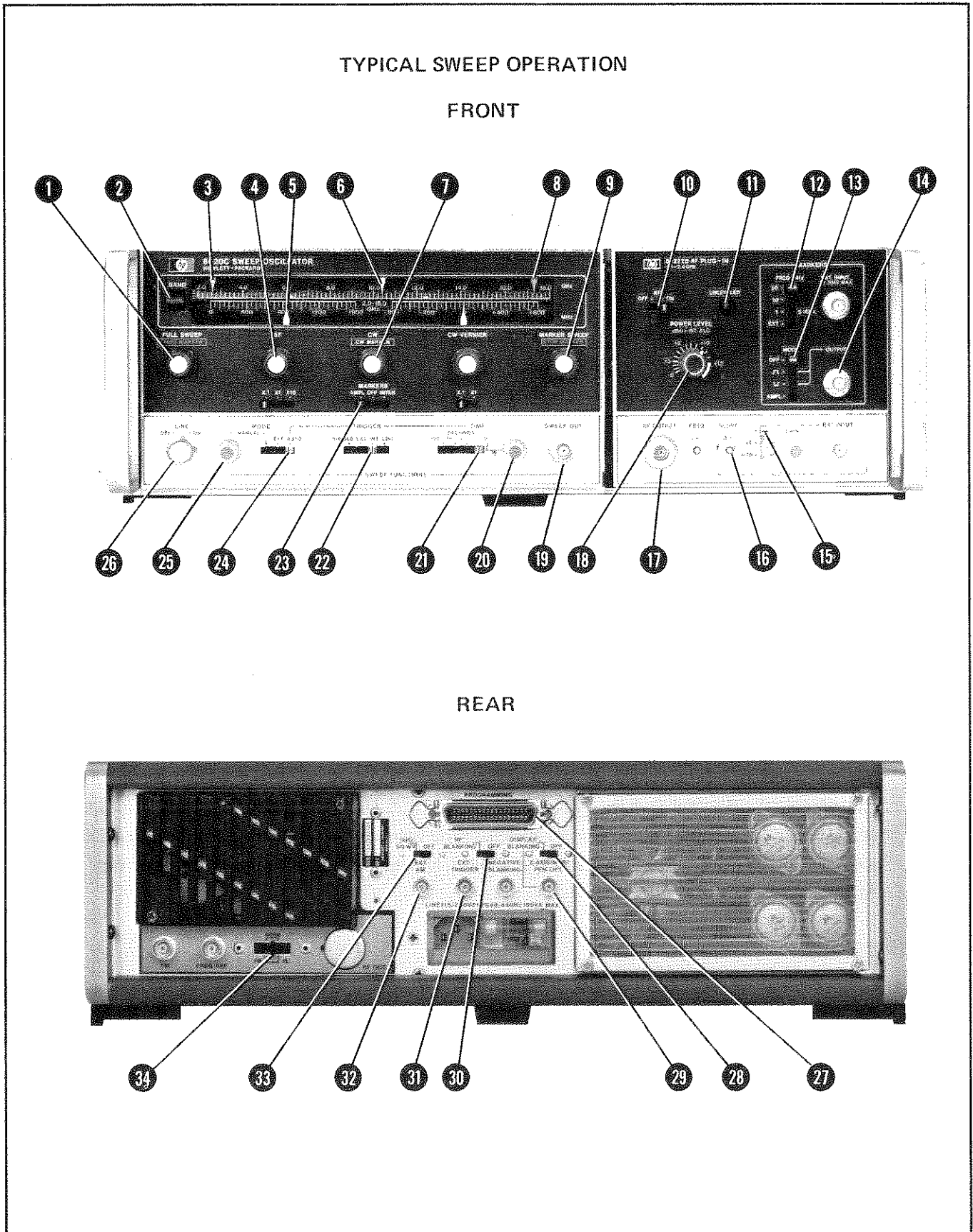
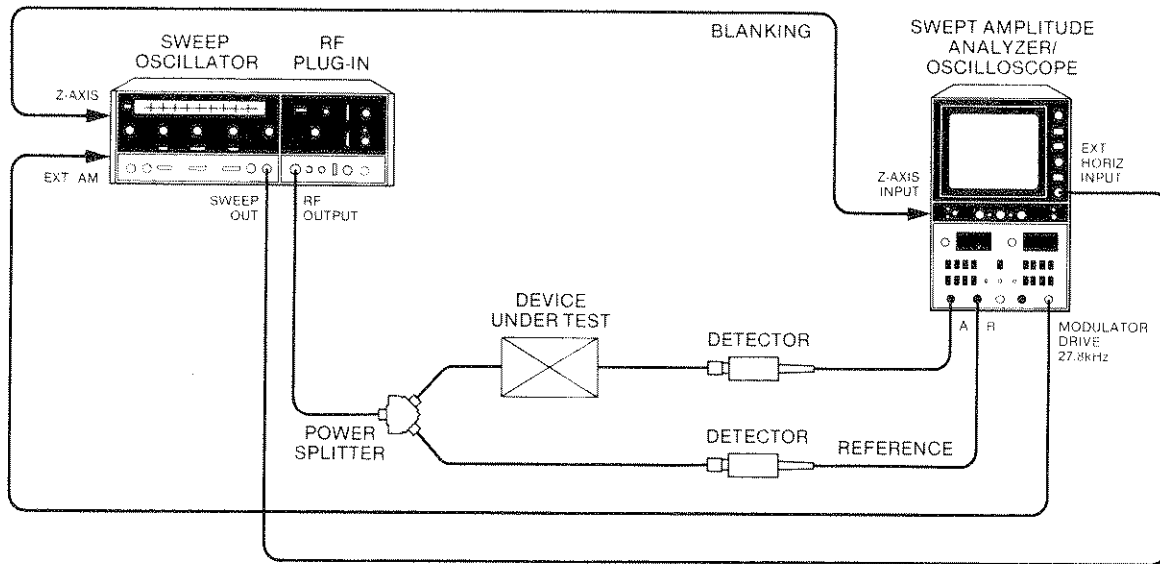

Figure 3-4. Typical Sweep Operation (1 of 5)

TYPICAL SWEEP OPERATION



NOTE

The device under test may be any microwave device such as an amplifier, a broadband or narrowband filter, or isolator. The following procedure describes generally how to set up the sweeper operation.

EQUIPMENT:

Sweep Oscillator	HP 8620C
RF Plug-in	HP 86222A/B
Swept Amplitude Analyzer/Oscilloscope	HP 8755A/182C
Detectors (2 required)	HP 11664A
Power Splitter	HP 11667A

PROCEDURE:

1. Connect equipment as shown in test setup.
2. Set controls as follows:

8620C:

BAND ②01 — 2.4 GHz
START MARKER pointer ③	Left-hand mark on scale
CW MARKER pointer ⑥	Middle mark on scale
STOP MARKER pointer ⑧	Right-hand end mark on scale

Figure 3-4. Typical Sweep Operation (2 of 5)

TYPICAL SWEEP OPERATION

8620C (cont'd)

MARKERS 23 OFF
 MODE 24 AUTO
 TRIGGER 22 INT
 TIME-SECONDS 21 0.1 to 0.01
 TIME-SECONDS Vernier 20 Clockwise
 DISPLAY BLANKING/OFF Rear Panel 28 .. DISPLAY BLANKING
 1 kHz SQ WV/OFF Rear Panel 33 OFF
 RF BLANKING/OFF Rear Panel 30 OFF

86222A/B:

RF 10 ON
 POWER LEVEL 18 Fully clockwise
 ALC 15 INT
 SLOPE-OFF 16 OFF
 FM-NORM-PL Rear Panel 34 FM
 MARKER MODE (86222B only) 13 OFF
 MARKER FREQ MHz (86222B only) 12 50

8755A CHANNEL A:

dB/DIV (Sensitivity) 10
 DISPLAY Press in R
 OFFSET dB +15
 OFFSET OFF

3. Depress LINE pushbutton switch 26 to turn on mainframe. The LINE switch and FULL SWEEP 1 pushbutton should light, indicating FULL SWEEP mode is selected. In sweep mode, a ramp sweep voltage is supplied through SWEEP OUT front panel connector 19 to display equipment.
4. Adjust 86222A/B POWER LEVEL control 18 for desired power level on oscilloscope. (For some measurements, such as flatness, POWER LEVEL is set so UNLEVELED lamp 11 is off.)

Figure 3-4. Typical Sweep Operation (3 of 5)

TYPICAL SWEEP OPERATION

NOTE

Normal operation requires a sweep from low frequency to high frequency. However, the Model 8620C will also sweep from high to low frequency by setting START MARKER pointer ③ to high-frequency side of sweep and setting STOP MARKER pointer at low-frequency side of sweep. This operation is possible only when 86222B markers are not used.

5. For normal sweep-mode operation, set 8620C MODE switch ②④ to AUTO and the sweep signal is obtained from internal sweep oscillator. This is the only position of the MODE switch that allows TRIGGER ②② and TIME ②① switches to operate. However, if an external sweep source is used, set MODE switch to EXT position. The EXT SWEEP is routed through rear-panel PROGRAMMING connector ②⑦ to MODE switch EXT position. If it is necessary to sweep band manually, set MODE to MANUAL position and adjust MANUAL control ②⑤. In MANUAL position, a tuning voltage is supplied through SWEEP OUT front-panel connector ①⑨ to display instrument.
6. For normal sweep operation, set 8620C TRIGGER switch ②② to INT position. This provides automatic repetitive sweep. If a single sweep is to be viewed, press TRIGGER switch to SINGLE position and release. Repeat this for each single sweep. TRIGGER EXT position connects trigger input circuit to rear-panel EXT TRIGGER connector ③①. LINE position allows sweep to be triggered by line frequency.
7. Set 8620C TIME-SECONDS switch ②① to desired range, and adjust vernier control ②⑩ to desired sweep time.
8. When operating with the HP 8755A, the 8620C rear-panel DISPLAY BLANKING/OFF switch ②⑧ is normally set to DISPLAY BLANKING and a blanking pulse is supplied through Z-AXIS/MKR/PEN LIFT output connector ②⑨ to the Swept Amplitude Analyzer Z-AXIS INPUT. For 86222B operation with the HP 8755A, MARKER OUTPUT connector ①④ is normally used to supply harmonic intensity markers to the swept Amplitude Analyzer Z-AXIS INPUT. Both display blanking and intensity marker operation may be used simultaneously if the equipment is connected as shown in the partial test setup below.

NOTE

The Resistive Barrel (5061-1015) is supplied with the 86222B.

Figure 3-4. Typical Sweep Operation (4 of 5)

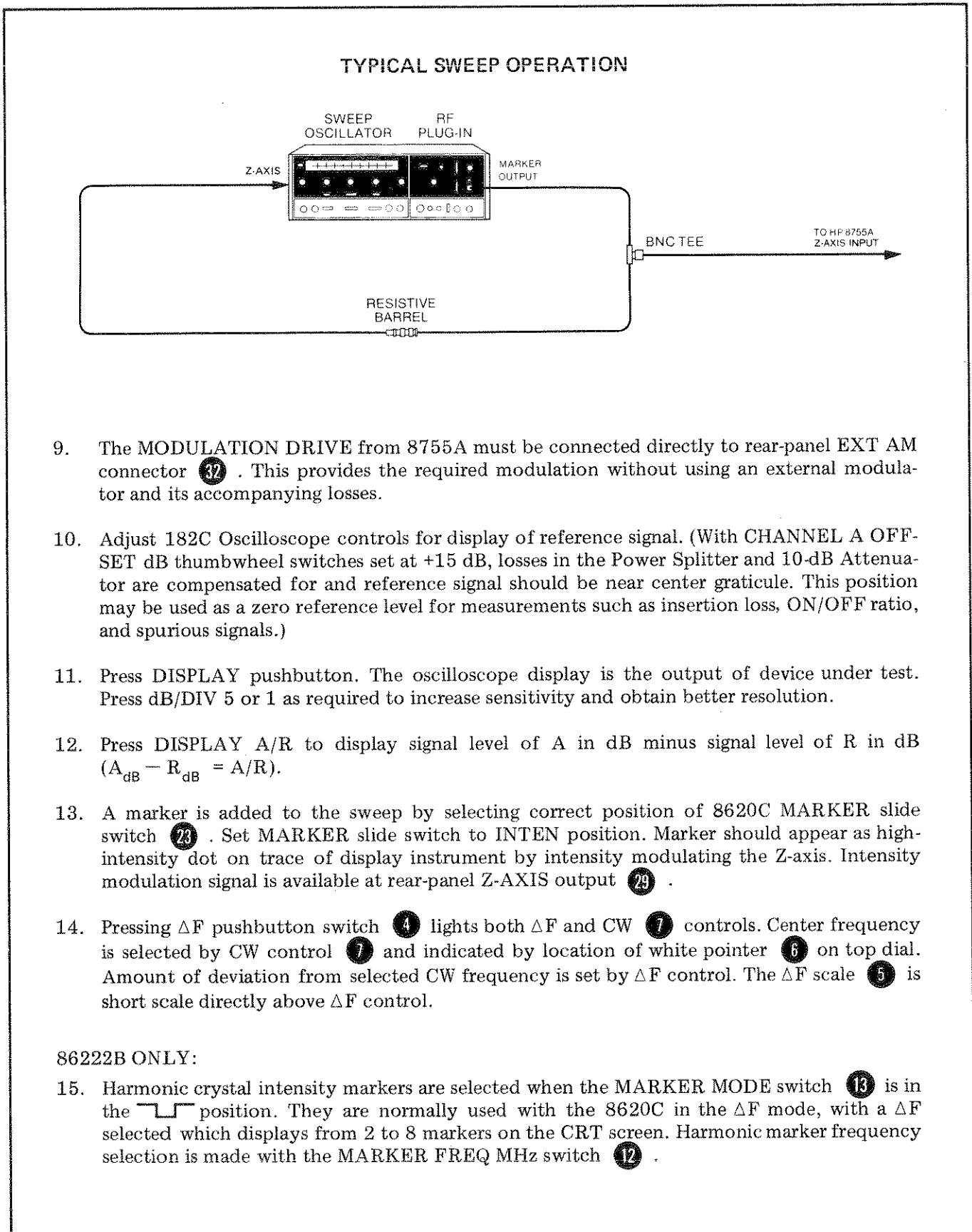

Figure 3-4. Typical Sweep Operation (5 of 5)

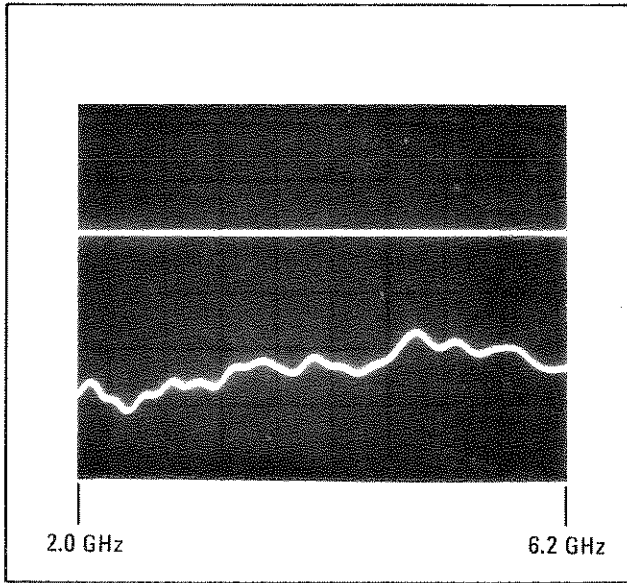

Figure 3-5. Unlevelled RF Power Output

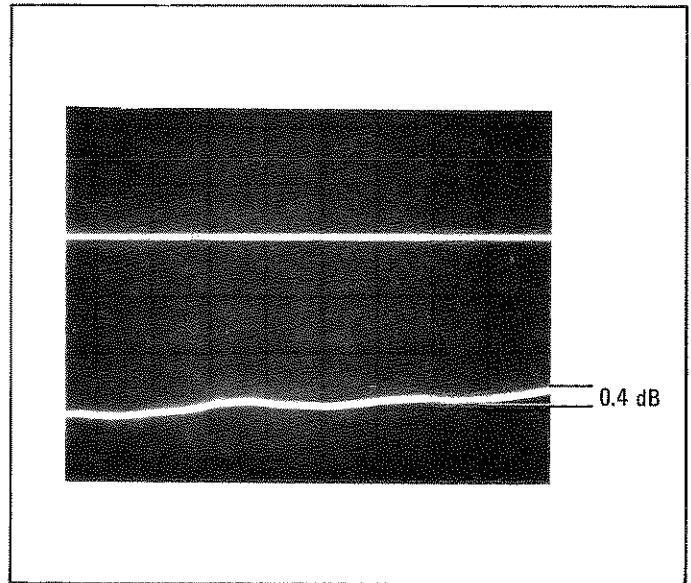

Figure 3-6. Levelled RF Power Output

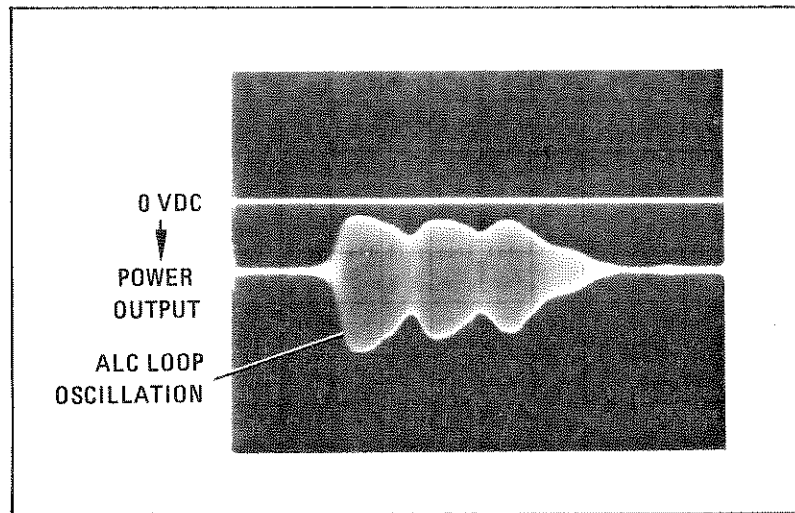
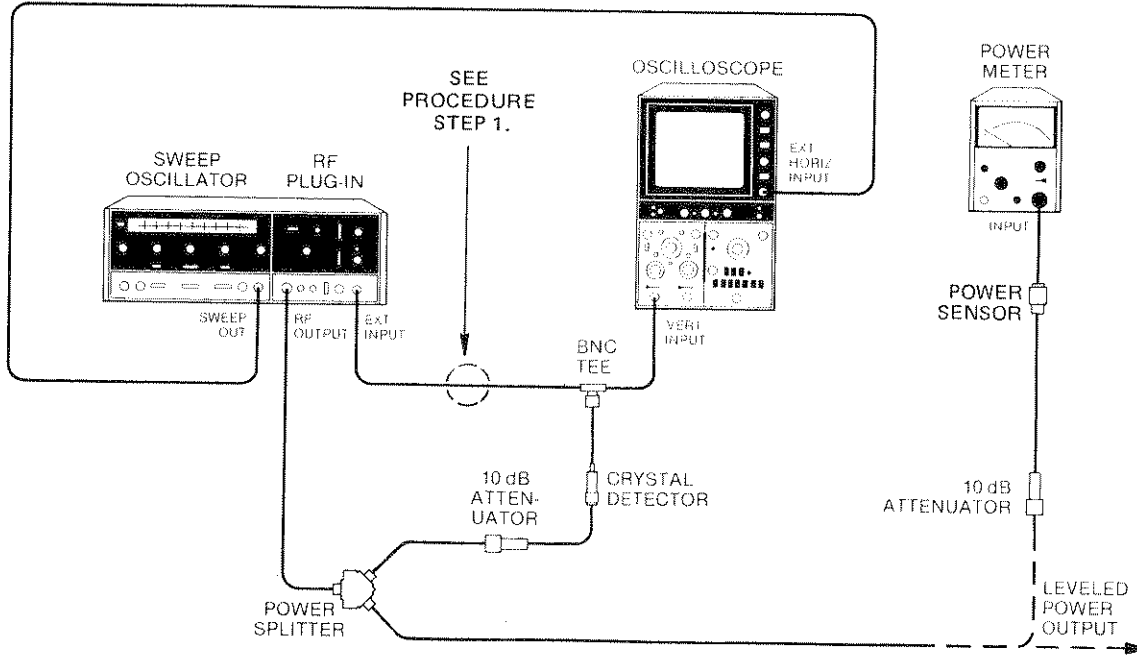

Figure 3-7. Oscillations with ALC Loop Gain Too High

EXTERNAL CRYSTAL DETECTOR LEVELING



EQUIPMENT:

Sweep Oscillator	HP 8620C
RF Plug-in	HP 86222A/B
Oscilloscope	HP 182C/1802A/1820C
Power Meter	HP 435A
Crystal Detector	HP 423A
Power Splitter	HP 11667A
10-dB Attenuator (2 required)	HP 8491A, Option 010
Power Sensor	HP 8482A
BNC TEE	HP 1250-0781

PROCEDURE:

1.

NOTE

Crystal output signal must be between -10 mVdc and -100 mVdc.

Connect equipment as shown in test setup.

Figure 3-8. External Crystal Detector Leveling (1 of 3)

EXTERNAL CRYSTAL DETECTOR LEVELING

NOTE

Between 10 MHz and 50 MHz there are resonant spikes that might be as high as 3 dB in the envelope of the RF feedthrough to the video output. These resonances are a function of the load impedance (including cable lengths) seen by the detector. During external leveling at 10 to 50 MHz, the resonant spikes may be damped out by insertion of the circuit shown below in the test setup. The circuit may be inserted in the line to the EXT INPUT of the RF Plug-in.

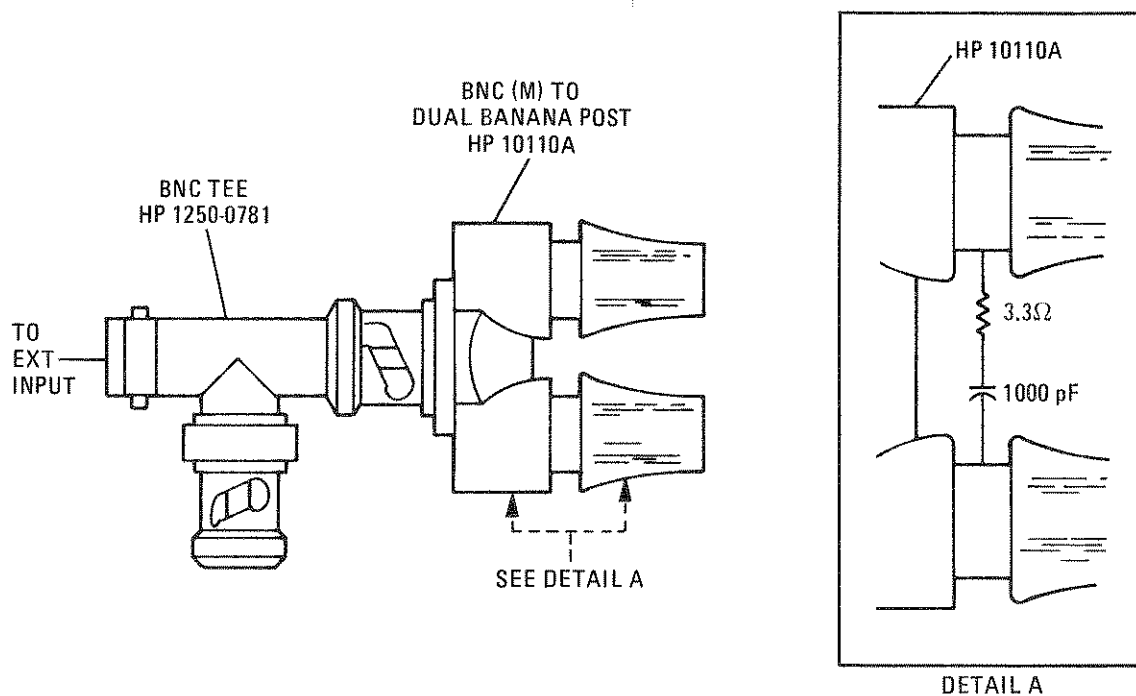

2. Set controls as follows:

8620C:

START MARKER Left-hand end frequency selected
 STOP MARKER Right-hand end frequency selected
 MARKERS OFF
 MODE AUTO
 TRIGGER INT
 TIME-SECONDS Vernier Fully clockwise
 1 kHz SQ WAVE/OFF Rear Panel OFF
 DISPLAY BLANKING/OFF Rear Panel DISPLAY BLANKING

Figure 3-8. External Crystal Detector Leveling (2 of 3)

EXTERNAL CRYSTAL DETECTOR LEVELING

86222A/B:

RF OUTPUT ON
POWER LEVEL Fully clockwise
ALC EXT
ALC GAIN Fully clockwise
FM-NORM-PL Rear Panel NORM (Normal)

3. Press 8620C LINE pushbutton switch to turn-on mainframe. The LINE switch and FULL SWEEP pushbutton should light, indicating FULL SWEEP mode is selected.
4. Adjust ALC GAIN and POWER LEVEL controls fully clockwise for maximum RF power OUTPUT and maximum ALC loop gain. One of the conditions shown in Figures 3-5 or 3-6 should be displayed on oscilloscope. If trace is unlevelled (or partially levelled) as shown in Figure 3-5 and UNLEVELED lamp is on, turn POWER LEVEL control counterclockwise until trace is level (see Figure 3-6). If ALC loop is too high, oscillations may occur as shown in Figure 3-7. To remove oscillations, reduce ALC loop gain by turning ALC GAIN control counterclockwise.
5. To use levelled RF power output for testing external equipment, make connection at point marked "Levelled Power Output".

Figure 3-8. External Crystal Detector Leveling (3 of 3)

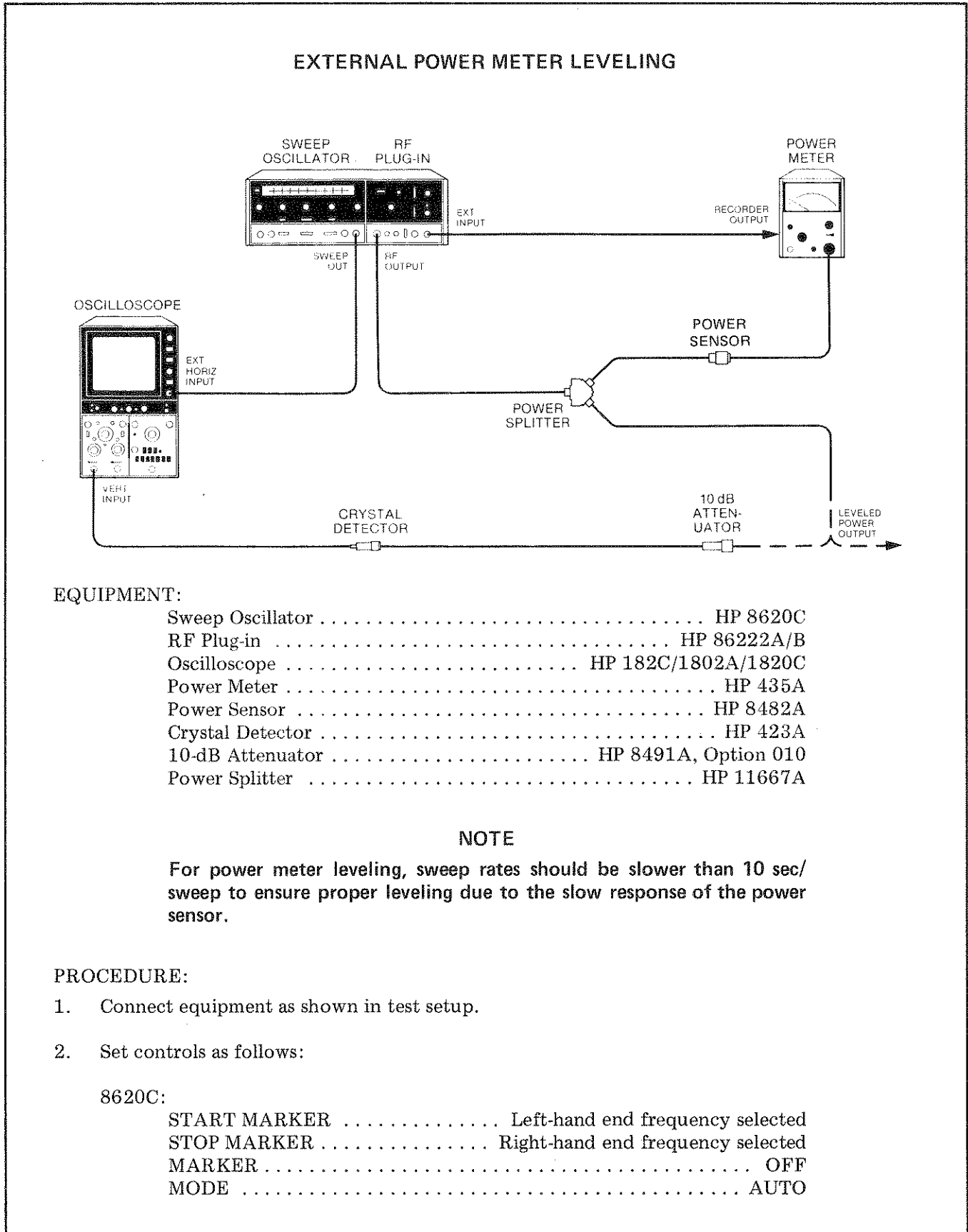

Figure 3-9. External Power Meter Leveling (1 of 2)

EXTERNAL POWER METER LEVELING

8620C (cont'd):

TRIGGER	INT
TIME-SECONDS	100 — 10
TIME-SECONDS Vernier	Fully clockwise
1 kHz SQ WAVE/OFF Rear Panel	OFF
DISPLAY BLANKING/OFF Rear Panel	DISPLAY BLANKING

86222A/B:

RF OUTPUT	ON
POWER LEVEL	Fully clockwise
ALC	MTR (Power Meter)
ALC-GAIN	Fully clockwise
FM-NORM-PL Rear Panel	NORM (Normal)

3. Press 8620C LINE pushbutton switch to turn-on mainframe. The LINE switch and FULL SWEEP pushbutton should light, indicating FULL SWEEP mode is selected.
4. Select range on power meter to obtain indication near top third of meter scale.
5. Adjust 86222A/B POWER LEVEL control counterclockwise until leveling across band occurs as shown in Figure 3-6. If oscillations appear on trace as shown in Figure 3-7, turn ALC GAIN control counterclockwise. With proper leveling across the band, the 86222A/B UNLEVELED light should be out.
6. To use leveled RF power output for testing external equipment, make connection at point marked "Leveled Power Output".

Figure 3-9. External Power Meter Leveling (2 of 2)

