

---

HP 8590 EM Series  
**User's Guide**

**EMC Analyzer**



HP Part No. 5963-2930  
Printed in UK August 1995

---

## **Notice**

The information contained in this document is subject to change without notice.

Hewlett-Packard makes no warranty of any kind with regard to this material, including but not limited to, the implied warranties of merchantability and fitness for a particular purpose. Hewlett-Packard shall not be liable for errors contained herein or for incidental or consequential damages in connection with the furnishing, performance, or use of this material.

## **Restricted Rights Legend**

Use, duplication, or disclosure by the U.S. Government is subject to restrictions as set forth in subparagraph (c) (1) (ii) of the Rights of Technical Data and Computer Software clause at DFARS 252.227-7013 for DOD agencies, and subparagraphs (c) (1) and (c) (2) of the Commercial Computer Software Restricted Rights clause at FAR 52.227-19 for other agencies.

© Copyright Hewlett-Packard Company 1995  
All Rights Reserved. Reproduction, adaptation, or translation without prior written permission is prohibited, except as allowed under the copyright laws.  
1400 Fountaingrove Parkway, Santa Rosa CA, 95403-1799, USA

---

## Certification

Hewlett-Packard Company certifies that this product met its published specifications at the time of shipment from the factory. Hewlett-Packard further certifies that its calibration measurements are traceable to the United States National Institute of Standards and Technology, to the extent allowed by the Institute's calibration facility, and to the calibration facilities of other International Standards Organization members.

## Regulatory Information

Regulatory information is located in the *HP 8590 EM Series EMC Analyzer Verification Guide*.

---

## Warranty

This Hewlett-Packard instrument product is warranted against defects in material and workmanship for a period of one year from date of shipment. During the warranty period, Hewlett-Packard Company will, at its option, either repair or replace products which prove to be defective.

For warranty service or repair, this product must be returned to a service facility designated by Hewlett-Packard. Buyer shall prepay shipping charges to Hewlett-Packard and Hewlett-Packard shall pay shipping charges to return the product to Buyer. However, Buyer shall pay all shipping charges, duties, and taxes for products returned to Hewlett-Packard from another country.

Hewlett-Packard warrants that its software and firmware designated by Hewlett-Packard for use with an instrument will execute its programming instructions when properly installed on that instrument. Hewlett-Packard does not warrant that the operation of the instrument, or software, or firmware will be uninterrupted or error-free.

### LIMITATION OF WARRANTY

The foregoing warranty shall not apply to defects resulting from improper or inadequate maintenance by Buyer, Buyer-supplied software or interfacing, unauthorized modification or misuse, operation outside of the environmental specifications for the product, or improper site preparation or maintenance.

NO OTHER WARRANTY IS EXPRESSED OR IMPLIED.  
HEWLETT-PACKARD SPECIFICALLY DISCLAIMS THE IMPLIED WARRANTIES OF MERCHANTABILITY AND FITNESS FOR A PARTICULAR PURPOSE.

### EXCLUSIVE REMEDIES

THE REMEDIES PROVIDED HEREIN ARE BUYER'S SOLE AND EXCLUSIVE REMEDIES. HEWLETT-PACKARD SHALL NOT BE LIABLE FOR ANY DIRECT, INDIRECT, SPECIAL, INCIDENTAL, OR CONSEQUENTIAL DAMAGES, WHETHER BASED ON CONTRACT, TORT, OR ANY OTHER LEGAL THEORY.

---

## Assistance

*Product maintenance agreements and other customer assistance agreements are available for Hewlett-Packard products. For any assistance, contact your nearest Hewlett-Packard Sales and Service Office.*

---

## Compliance

This instrument has been designed and tested in accordance with IEC Publication 348, Safety Requirements for Electronic Measuring Apparatus, and has been supplied in a safe condition. The instruction documentation contains information and warnings which must be followed by the user to ensure safe operation and to maintain the instrument in a safe condition.

---

## Safety Notes

The following safety notes are used throughout this manual. Familiarize yourself with each of the notes and its meaning before operating this instrument.

---

### WARNING

**Warning denotes a hazard. It calls attention to a procedure which, if not correctly performed or adhered to, could result in injury or loss of life. Do *not* proceed beyond a warning note until the indicated conditions are fully understood and met.**

---

### CAUTION

Caution denotes a hazard. It calls attention to a procedure that, if not correctly performed or adhered to, would result in damage to or destruction of the instrument. Do *not* proceed beyond a caution sign until the indicated conditions are fully understood and met.

---

---

## General Safety Considerations

### WARNING

- No operator serviceable parts inside. Refer servicing to qualified personnel. To prevent electrical shock, do not remove covers.
- If this instrument is not used as specified, the protection provided by the equipment may be impaired. This instrument must be used in a normal condition (in which all means for protection are intact) only.
- For continued protection against fire hazard, replace line fuse only with same type and rating ([F 5A/250V]). The use of other fuses or material is prohibited.

### CAUTION

- Before switching on this instrument, make sure that the line voltage selector switch is set to the voltage of the power supply and the correct fuse is installed.
- Always use the three-prong ac power cord supplied with this instrument. Failure to ensure adequate earth grounding by not using this cord may cause instrument damage.
- Only clean the instrument cabinet using a damp cloth.



The instruction documentation symbol. The product is marked with this symbol when it is necessary for the user to refer to the instructions in the documentation.

CE

The CE mark is a registered trademark of the European Community. (If accompanied by a year, it is when the design was proven.)

ISM1-A

This is a symbol of an Industrial Scientific and Medical Group 1 Class A product.

CSA

The CSA mark is a registered trademark of the Canadian Standards Association.

---

## Manual Conventions

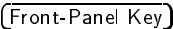
 Front-Panel Key

This represents a key physically located on the instrument.

 Softkey

This indicates a “softkey,” a key whose label is determined by the firmware of the instrument.

Screen Text

This indicates text displayed on the instrument’s screen.

---

## HP 8590 EM Series Documentation Description

The following documents are provided with the EMC analyzer.

- *User's Guide* describes installing your instrument, instrument features and how to make measurements, menu maps, error messages, and key descriptions.
- *Verification Guide* provides information for verifying instrument operation, specifications and characteristics, and customer support.
- *Quick Reference Guide* provides information on remote control instrument configuration, creating programs, and parameters for each of the programming commands available.

---

# HP 8590 EM Series EMC Analyzer Documentation Description

## Manuals Shipped with Your EMC Analyzer

### *HP 8590 EM Series EMC Analyzer User's Guide*

Describes how to prepare the analyzer for use.  
Describes analyzer features.  
Describes common applications.  
Tells how to make measurements with your EMC analyzer.  
Includes error messages.

### *HP 8590 EM Series EMC Analyzer Verification Guide*

Provides analyzer specifications and characteristics.  
Provides manual procedures to verify specifications.  
Indicates the test equipment required for verification.

### *HP 8590 EM Series EMC Analyzer Quick Reference Guide*

Describes how to make a simple measurement with your EMC analyzer.  
Briefly describes the EMC analyzer functions.  
Lists all the programming commands.

## Options

### **Option 910: Additional User's Documentation**

Provides an additional copy of the *HP 8590 EM Series EMC Analyzer User's Guide*, *HP 8590 EM Series EMC Analyzer Quick Reference Guide*, and the *HP 8590 EM Series EMC Analyzer Verification Guide*.

### **Option 915: Service Guide and Component-Level Information**

Describes troubleshooting and repair of the EMC analyzer.

Option 915 consists of two manuals:

*HP 8590 Series, and HP 8591C Cable TV Analyzer; Assembly-Level Repair Service Guide* describes adjustment and assembly level repair of the analyzer.

*HP 8590 Series, and HP 8591C Cable TV Analyzer; Component-Level Repair Service Guide* provides information for component-level repair of the analyzer.

## How to Order Manuals

Each of the manuals listed above can be ordered individually. To order, contact your local HP Sales and Service Office.





# Contents

---

<b>1. Preparing for Use</b>	
What you'll find in this chapter . . . . .	1-1
Introducing the EMC Analyzer . . . . .	1-2
HP 8590 EM Series EMC analyzer . . . . .	1-2
HP 8590 EM Series EMC analyzer/HP 85420E RF filter section . . . . .	1-3
Initial Inspection . . . . .	1-4
Accessories . . . . .	1-5
Preparing the EMC Analyzer Products for Use . . . . .	1-6
Preparing the EMC Analyzer . . . . .	1-7
Tracking generator self-calibration . . . . .	1-12
YTF self-calibration . . . . .	1-13
Preparing the RF Filter Section . . . . .	1-14
Power Cables . . . . .	1-20
Preparing a Static-Safe Work Station . . . . .	1-22
Reducing ESD damage . . . . .	1-23
Static-safe ESD accessories . . . . .	1-23
<b>2. Getting Acquainted with the EMC Analyzer</b>	
What you'll find in this chapter . . . . .	2-1
Front-Panel Features . . . . .	2-2
Rear-Panel Features . . . . .	2-6
Data controls . . . . .	2-9
Hold key . . . . .	2-9
Knob . . . . .	2-9
Number/units keypad . . . . .	2-9
Step keys . . . . .	2-10
Fine-focus control . . . . .	2-10
EMC Analyzer Screen Annotation . . . . .	2-11
Menu and Softkey Overview . . . . .	2-13
Making a Basic Measurement . . . . .	2-14
Spectrum Analyzer Mode Screen Annotation . . . . .	2-18
<b>3. Calibration</b>	
What you'll find in this chapter . . . . .	3-1
Improving Accuracy with Self-Calibration Routines . . . . .	3-1
Warm-up time . . . . .	3-1
Performing the tracking generator self-calibration routine (Option 010 only) . . . . .	3-3
Performing the YTF self-calibration routine . . . . .	3-4
When is self-calibration needed? . . . . .	3-4
Memory Card Insertion and Battery Replacement . . . . .	3-6
Changing the memory card battery . . . . .	3-7
Procedure to change the memory card battery . . . . .	3-8
Analyzer Battery Information . . . . .	3-9
Using the AutoCal function . . . . .	3-10

Setting the analyzer's clock . . . . .	3-10
Setting AutoCal time . . . . .	3-10
<b>4. Making Pre-compliance Measurements</b>	
What you'll find in this chapter . . . . .	4-1
Introducing the SETUP, TEST, and OUTPUT Keys . . . . .	4-2
Setting Up a Measurement Using the SETUP Key . . . . .	4-2
Using standard configurations . . . . .	4-2
Pre-compliance System Configurations . . . . .	4-3
Equipment list . . . . .	4-4
Configuring the system . . . . .	4-4
Loading pre-defined configurations from a card . . . . .	4-4
Customizing the standard configurations . . . . .	4-5
Modifying start and stop frequencies . . . . .	4-5
Modifying reference level and input attenuation . . . . .	4-5
Modifying IF and averaging bandwidths . . . . .	4-5
Selecting the active detector . . . . .	4-6
Selecting the measured detectors . . . . .	4-7
Measuring detector dwell times . . . . .	4-7
Controlling autoranging . . . . .	4-7
Using limit lines . . . . .	4-8
Loading a limit line from the card . . . . .	4-9
Using amplitude correction factors . . . . .	4-10
Loading an amplitude correction factor file from a card . . . . .	4-11
Activating the windows display format . . . . .	4-12
Making a Radiated Measurement . . . . .	4-14
Tuning the analyzer . . . . .	4-14
Using the marker to tune the analyzer . . . . .	4-15
Using the measure-at-marker function . . . . .	4-16
Using the auto-measure feature . . . . .	4-19
Creating a Report . . . . .	4-20
Configuring a printer . . . . .	4-20
Configuring and generating a report . . . . .	4-21
Making a Conducted Measurement . . . . .	4-23
Equipment list . . . . .	4-23
Configuring the system . . . . .	4-23
Loading pre-defined configurations from a card . . . . .	4-23
<b>5. List-Based Measurements</b>	
What you'll find in this chapter . . . . .	5-1
Adding signals to the list . . . . .	5-4
Viewing the signal list . . . . .	5-6
Sorting the signal list . . . . .	5-7
Deleting signals from the list . . . . .	5-8
Marking signals . . . . .	5-10
Remeasuring signals . . . . .	5-12
Saving signal lists . . . . .	5-12
Recalling signal lists . . . . .	5-13
Graphing signal lists . . . . .	5-13
Saving signal lists graphs . . . . .	5-14

<b>6. Stepped Measurements</b>	
What you'll find in this chapter . . . . .	6-1
Performing a stepped measurement . . . . .	6-1
Selecting a detector and setting a dwell time . . . . .	6-3
Using the marker . . . . .	6-4
Adding data to the signal list table . . . . .	6-5
Changing the frequency step . . . . .	6-5
Restarting and stopping the measurement . . . . .	6-5
Using logarithmic and linear steps . . . . .	6-7
<b>7. Making EMC Diagnostic Measurements</b>	
What you'll find in this chapter . . . . .	7-1
Making Diagnostic Measurements Using a Close-Field	
Probe . . . . .	7-2
Configuring systems for diagnostic emissions . . . . .	7-2
Setting up the test equipment . . . . .	7-2
Equipment list . . . . .	7-2
Making an automated diagnostic emission test . . . . .	7-3
Configuring the analyzer for testing . . . . .	7-3
Storing the data to internal memory . . . . .	7-5
Recalling the data from internal memory . . . . .	7-6
Making a field-strength measurement . . . . .	7-6
Characterizing the emissions . . . . .	7-6
Making a manual diagnostic emission test . . . . .	7-9
Other Diagnostic Techniques . . . . .	7-11
Resolving signals of equal amplitude . . . . .	7-11
Resolving small signals hidden by large signals . . . . .	7-14
Increasing the frequency readout resolution . . . . .	7-17
Decreasing the frequency span . . . . .	7-19
Peaking signal amplitude with preselector peak . . . . .	7-20
Tracking unstable signals . . . . .	7-22
Using the marker track function . . . . .	7-22
Using maximum-hold and minimum-hold . . . . .	7-24
Comparing signals using delta markers . . . . .	7-27
Measuring differences between two signals . . . . .	7-27
Measuring differences between signals on screen and off screen . . . . .	7-28
Measuring low-level signals . . . . .	7-30
Reducing input attenuation . . . . .	7-30
Reducing IF bandwidth . . . . .	7-33
Reducing averaging bandwidth . . . . .	7-34
Using video averaging . . . . .	7-35
Testing for distortion using the linearity check . . . . .	7-38
Measuring small signals in the presence of a large ambient signal . . . . .	7-38
Using linearity check . . . . .	7-41
Demodulating and listening to an AM or FM signal . . . . .	7-44
Using the analyzer in zero frequency span . . . . .	7-45
Measuring signals near band boundaries using harmonic lock . . . . .	7-48
Localized Susceptibility Testing . . . . .	7-51
Configuring systems for localized susceptibility testing . . . . .	7-51
Equipment list . . . . .	7-52
Making localized susceptibility measurements . . . . .	7-52
Setting up the tracking generator . . . . .	7-52

Tuning the tracking generator . . . . .	7-53
Turning the tracking generator on . . . . .	7-53
<b>8. Making Other Measurements</b>	
What you'll find in this section . . . . .	8-1
Stimulus-response measurements . . . . .	8-2
What are stimulus-response measurements? . . . . .	8-2
Using the EMC analyzer with the internal tracking generator . . . . .	8-2
Stepping through the measurement . . . . .	8-3
Tracking generator unlevelled condition . . . . .	8-8
Making reflection calibration measurements . . . . .	8-9
Reflection calibration . . . . .	8-9
Measuring the return loss . . . . .	8-10
Measuring amplitude modulation with the fast Fourier transform function . . . . .	8-12
Measuring the sidebands on a signal . . . . .	8-12
Repeating the test . . . . .	8-16
Measuring 3 dB and 6 dB bandwidth . . . . .	8-17
Measuring 99% power bandwidth . . . . .	8-18
Measuring percent AM modulation . . . . .	8-19
Measuring amplitude and frequency difference . . . . .	8-20
Making third order measurements . . . . .	8-22
Using the RF Filter Section <i>HP 85420E Option 1EM         only</i> . . . . .	8-24
Learning about the analog+ display mode (option 101 only) . . . . .	8-26
Triggering on a selected line of a video picture field . . . . .	8-28
<b>9. Limit Lines</b>	
What you'll find in this chapter . . . . .	9-1
Using EMC Limit Lines . . . . .	9-2
Creating, editing, or viewing a limit line . . . . .	9-2
Editing an existing limit line . . . . .	9-5
Defining a limit margin . . . . .	9-7
Activating limit-line testing . . . . .	9-7
Saving or recalling limit-line tables . . . . .	9-8
Saving a limit-line table . . . . .	9-8
Recalling a limit-line table . . . . .	9-9
Viewing the card catalog . . . . .	9-9
Using Spectrum Analyzer Limit Lines . . . . .	9-10
Creating, editing or viewing a limit line . . . . .	9-10
Selecting limit-line parameters . . . . .	9-11
Selecting the amplitude scale . . . . .	9-12
Selecting the limit-line table format . . . . .	9-14
Activating limit-line testing . . . . .	9-15

<b>10. Amplitude Correction Factors</b>	
What you'll find in this chapter . . . . .	10-1
Creating, editing, or viewing the amplitude-correction tables . . . . .	10-1
Activating amplitude correction . . . . .	10-6
Saving or recalling . . . . .	10-7
<b>11. Windows</b>	
What you'll find in this chapter . . . . .	11-1
<b>12. Saving, Recalling, and Outputting Data</b>	
What you'll find in this chapter . . . . .	12-1
Using a Card . . . . .	12-2
Formatting the card . . . . .	12-2
Filenames . . . . .	12-2
Available operations . . . . .	12-2
Entering a prefix . . . . .	12-3
Saving a trace . . . . .	12-4
Recalling a trace . . . . .	12-6
Saving and Recalling Data from Internal Memory . . . .	12-11
Saving a state . . . . .	12-11
Recalling a state . . . . .	12-11
Saving a trace . . . . .	12-12
Recalling a trace . . . . .	12-12
Protecting Internal Data from Being Overwritten . . . .	12-13
How to Output Data . . . . .	12-14
Configuring a printer . . . . .	12-14
Configuring and generating a report . . . . .	12-15
<b>13. Additional Features</b>	
What you'll find in this chapter . . . . .	13-1
Spectrum Analyzer Emulation . . . . .	13-1
Demodulator (all except option 703) . . . . .	13-2
Tracking Generator . . . . .	13-2
External Keyboard . . . . .	13-4
External keyboard features . . . . .	13-4
Installation . . . . .	13-7
Using the template . . . . .	13-7
Entering data using the external keyboard . . . . .	13-9
Entering annotation . . . . .	13-9
Entering programming commands . . . . .	13-10
Entering a screen title . . . . .	13-10
Entering a prefix . . . . .	13-11
<b>14. EMC Analyzer Error Messages</b>	
What you'll find in this chapter . . . . .	14-1
Nonrecoverable System Errors . . . . .	14-12

<b>15. Customer Support</b>	
What you'll find in this chapter . . . . .	15-1
If You Have a Problem . . . . .	15-1
Calling HP Sales and Service Offices . . . . .	15-1
Check the Basics . . . . .	15-2
If your EMC analyzer does not turn on . . . . .	15-2
If the HP 8590 EM series used with an HP 85420E option 1EM does not seem to be working <i>HP 85420E</i> <i>option 1EM only</i> . . . . .	15-2
If the EMC analyzer cannot communicate via HP-IB . . . . .	15-2
Verification of proper operation . . . . .	15-2
If the HP 8590 EM series used with an HP 85420E option 1EM does not power off <i>HP 85420E option</i> <i>1EM only</i> . . . . .	15-3
Error messages . . . . .	15-3
Additional Support Services . . . . .	15-3
CompuServe . . . . .	15-3
FAX support line . . . . .	15-4
Returning the EMC Analyzer for Service . . . . .	15-5
Package the EMC analyzer for shipment . . . . .	15-5
<b>16. Key Menus</b>	
What you'll find in this chapter . . . . .	16-1
<b>17. Key Dictionary</b>	
What you'll find in this chapter . . . . .	17-1
Service Functions . . . . .	17-2
Service calibration functions . . . . .	17-2
Service diagnostic functions . . . . .	17-2
Key Functions . . . . .	17-4
% AM . . . . .	17-4
$\phi$ LOCK ON OFF . . . . .	17-4
$\mu$ A/m . . . . .	17-4
$\mu$ V/m . . . . .	17-5
0-2.9 Gz BAND 0 . . . . .	17-5
2.75-6.5 BAND 1 . . . . .	17-6
2v REF DETECTOR . . . . .	17-6
3 dB POINTS . . . . .	17-6
3rd ORD MEAS . . . . .	17-6
6.0-12.8 BAND 2 . . . . .	17-7
6 dB POINTS . . . . .	17-7
9 kHz -150 kHz . . . . .	17-7
9 kHz EMI BW . . . . .	17-8
+10V REF DETECTOR . . . . .	17-8
-10V REF DETECTOR . . . . .	17-8
12.4-19 BAND 3 . . . . .	17-8
19.1-22 BAND 4 . . . . .	17-9
30 MHz -300 MHz . . . . .	17-9

99% PWR BW . . . . .	17-9
120 kHz EMI BW . . . . .	17-10
150 kHz -30 MHz . . . . .	17-10
200 Hz EMI BW . . . . .	17-10
200 MHz -1 GHz . . . . .	17-11
A <--> B . . . . .	17-11
A-B → A ON OFF . . . . .	17-12
A → C . . . . .	17-12
ABCDEF . . . . .	17-13
Abort . . . . .	17-13
ADD TO LIST . . . . .	17-13
ALC INT EXT . . . . .	17-14
ALC MTR INT XTAL . . . . .	17-14
ALC TEST . . . . .	17-14
ALL DLP → CARD . . . . .	17-15
Amp Cor . . . . .	17-15
AMP COR ON OFF . . . . .	17-15
AMPL SCL LOG LIN . . . . .	17-16
AMPLITUDE . . . . .	17-16
Amptd Units . . . . .	17-17
ANALOG+ ON OFF . . . . .	17-17
ANALYZER ADDRESS . . . . .	17-17
ANNOTATN ON OFF . . . . .	17-18
ANTENNA → CARD . . . . .	17-18
Antenna Factors . . . . .	17-19
ANTENNA ON OFF . . . . .	17-19
Antenna Units . . . . .	17-19
APND CAT ITEM . . . . .	17-20
ATTEN AUTO MAN . . . . .	17-20
AUTO ALL . . . . .	17-21
AUTO CAL ON OFF . . . . .	17-21
AUTO COUPLE . . . . .	17-22
AUTO-MEASURE . . . . .	17-22
AUTOEXEC ON OFF . . . . .	17-23
AUTORANG ON OFF . . . . .	17-23
AUX B . . . . .	17-23
Aux Conn Control . . . . .	17-24
AUX/USER . . . . .	17-24
AV DWELL TIME . . . . .	17-24
AVG BW AUTO MAN . . . . .	17-25
AVG ON OFF . . . . .	17-25

AV/IF BW RATIO . . . . .	17-26
B → C . . . . .	17-26
B <--> C . . . . .	17-26
B-DL → B . . . . .	17-27
Band Lock . . . . .	17-27
BAUD RATE . . . . .	17-28
BINARY SPAN . . . . .	17-28
BLANK A . . . . .	17-28
BLANK B . . . . .	17-29
BLANK C . . . . .	17-29
BLANK CARD . . . . .	17-29
BND LOCK ON OFF . . . . .	17-30
<b>BW</b> . . . . .	17-30
CABLE → CARD . . . . .	17-31
Cable Factors . . . . .	17-31
CABLE ON OFF . . . . .	17-31
<b>CAL</b> . . . . .	17-31
CAL AMPTD . . . . .	17-32
Cal At Time . . . . .	17-32
CAL CISPR BW . . . . .	17-32
CAL FETCH . . . . .	17-32
CAL FREQ . . . . .	17-33
CAL FREQ & AMPTD . . . . .	17-33
CAL MXR . . . . .	17-33
CAL STORE . . . . .	17-34
CAL TIMEBASE . . . . .	17-34
CAL TRK GEN . . . . .	17-34
CAL YTF . . . . .	17-35
Card Config . . . . .	17-35
CATALOG ALL . . . . .	17-35
CATALOG CARD . . . . .	17-36
Catalog Internal . . . . .	17-36
CATALOG PREFIX . . . . .	17-38
CATALOG REGISTER . . . . .	17-38
CATALOG VARIABLS . . . . .	17-39
CENTER FREQ . . . . .	17-39
CF STEP AUTO MAN . . . . .	17-40
Change Prefix . . . . .	17-41
Change Title . . . . .	17-42
CLEAR ANNOTATN . . . . .	17-42
CLEAR MARK . . . . .	17-43



CLEAR WRITE A	17-44
CLEAR WRITE B	17-45
CLEAR WRITE C	17-46
CLR ALL MARKS	17-46
CNTL A O 1	17-47
CNTL B O 1	17-47
CNTL C O 1	17-47
CNTL D O 1	17-48
CNT RES AUTO MAN	17-48
COARSE TUNE DAC	17-48
COMB GEN ON OFF	17-49
COMPLMNT MARKS	17-49
CONF TEST	17-49
CONFIG	17-50
COPY	17-51
COPY DEV PRNT PLT	17-55
COPY SCREEN	17-55
CORRECT ON OFF	17-55
Correctn Factors	17-56
CORRECTN ON OFF	17-56
COUPLE AC DC	17-56
CRT HORZ POSITION	17-57
CRT VERT POSITION	17-57
DACS	17-57
DATEMODE MDY DMY	17-57
dBm	17-58
dBmV	17-58
dB $\mu$ V	17-58
DEFAULT CAL DATA	17-59
DEFAULT CONFIG	17-59
DEFAULT SYNC	17-60
Define List	17-60
Define Report	17-60
DELETE ALL SIGS	17-61
DELETE FACTORS	17-61
DELETE FILE	17-61
DELETE LIMIT	17-63
DELETE MARKED	17-63
DELETE POINT	17-64
DELETE SEGMENT	17-64
DELETE SIGNAL	17-65

Delete Signals	17-65
DELTA MEAS	17-65
DEMOD	17-65
DEMOD AM FM	17-66
DEMOD ON OFF	17-66
DESKJET 310/550C	17-67
DESKJET 540	17-67
DET	17-67
DETECTOR PK QP AV	17-67
DETECTOR PK SP NG	17-68
DETECTOR SMP PK	17-68
DISPLAY	17-69
DISPLAY — CARD	17-69
DISPLAY CAL DATA	17-69
DISPLAY CNTL I	17-69
Dispose User Mem	17-70
DROOP	17-70
DSP LINE ON OFF	17-71
DWELL TIME	17-71
EDIT AMP COR	17-71
EDIT ANNOTATN	17-72
EDIT ANTENNA	17-72
EDIT CABLE	17-72
EDIT CAT ITEM	17-73
EDIT DONE	17-73
EDIT FLATNESS	17-74
EDIT LAST	17-75
Edit Limit	17-75
EDIT LIMIT	17-76
EDIT LIST	17-76
EDIT LOWER	17-77
EDIT MID/DELT	17-78
EDIT OTHER	17-78
EDIT UP/LOW	17-79
EDIT UPPER	17-79
EDIT UPR LWR	17-80
Editor	17-80
EMC ANALYZER	17-80
ENTER	17-82
EP LQ570 SML LRG	17-82
EP MX80 SML LRG	17-82

ERASE DLP MEM . . . . .	17-82
ERASE MEM CARD . . . . .	17-82
ERASE STATEALL . . . . .	17-83
ERASE TRACEALL . . . . .	17-83
EXECUTE TITLE . . . . .	17-83
EXIT . . . . .	17-83
EXIT CATALOG . . . . .	17-84
EXIT EDIT . . . . .	17-85
EXIT GRAPH . . . . .	17-86
EXIT MEASURE . . . . .	17-86
EXIT SHOW . . . . .	17-86
EXTERNAL . . . . .	17-87
EXTERNAL PREAMPG . . . . .	17-87
FAST STP ON OFF . . . . .	17-88
FFT MEAS . . . . .	17-88
FINE TUNE DAC . . . . .	17-88
FLAT . . . . .	17-89
Flatness Data . . . . .	17-89
FM COIL DRIVE . . . . .	17-89
FM GAIN . . . . .	17-90
FM OFFSET . . . . .	17-90
FM SPAN . . . . .	17-90
FORMAT CARD . . . . .	17-91
FREE RUN . . . . .	17-91
FREQ DIAG . . . . .	17-91
FREQ OFFSET . . . . .	17-92
FREQ SCL LOG LIN . . . . .	17-93
FREQ STEP . . . . .	17-94
FREQUENCY . . . . .	17-94
FRQ DISC NORM OFF . . . . .	17-94
FRQ SCAN ON OFF . . . . .	17-95
FULL SPAN . . . . .	17-95
Gauss . . . . .	17-95
GHIJKL . . . . .	17-96
GND REF DETECTOR . . . . .	17-96
GRAT ON OFF . . . . .	17-96
HOLD . . . . .	17-96
HP B&W PRINTER . . . . .	17-97
HP B&W DJ540 . . . . .	17-97
IDNUM . . . . .	17-97

IF BW AUTO MAN . . . . .	17-97
IF GAINS . . . . .	17-98
INIT FLT . . . . .	17-98
INPT LCK ON OFF . . . . .	17-98
Input . . . . .	17-99
INPUT 1 9k-50M . . . . .	17-99
INPUT 2 20M-2.9G . . . . .	17-99
INPUT 2 BYPASS . . . . .	17-100
INPUT Z 50Ω 75Ω . . . . .	17-100
INTERNAL — STATE . . . . .	17-100
Internal — Trace . . . . .	17-101
LAST SPAN . . . . .	17-101
Limit 1 . . . . .	17-102
LIMIT 1 ON OFF . . . . .	17-102
Limit 2 . . . . .	17-102
LIMIT 2 ON OFF . . . . .	17-103
Limit Lines . . . . .	17-103
LIMIT LINES . . . . .	17-104
LIMITS — CARD . . . . .	17-104
LIMITS FIX REL . . . . .	17-105
LIMITS FRQ TIME . . . . .	17-106
LIN CHCK ON OFF . . . . .	17-106
LIN ON OFF . . . . .	17-107
LINE . . . . .	17-107
LINE . . . . .	17-107
LIST — CARD . . . . .	17-107
LIST ON OFF . . . . .	17-108
LMT DISP Y N AUTO . . . . .	17-108
LMT TEST ON OFF . . . . .	17-109
LOAD FILE . . . . .	17-110
(LOCAL) . . . . .	17-111
LOG ON OFF . . . . .	17-111
LOGF SPD STD FAST . . . . .	17-112
MAIN COIL DR . . . . .	17-112
MAIN SPAN . . . . .	17-112
MAN TRK ADJUST . . . . .	17-113
MARGIN 1 ON OFF . . . . .	17-113
MARGIN 2 ON OFF . . . . .	17-114
MARK ALL DUPLICAT . . . . .	17-114
MARK ALL SIGNALS . . . . .	17-114
MARK LWR DUPLICAT . . . . .	17-115

MARK SIGNAL	17-115
MARK TO END	17-115
MARKER	17-116
MARKER # ON OFF	17-116
MARKER Δ	17-117
MARKER Δ SPAN	17-117
MARKER → CF	17-117
MARKER →CF STEP	17-118
MARKER → HIGH	17-118
MARKER →MINIMUM	17-118
MARKER →PK-PK	17-119
MARKER →REF LVL	17-119
MARKER → START	17-119
MARKER → STOP	17-120
MARKER ALL OFF	17-120
MARKER AMPTD	17-120
MARKER NORMAL	17-121
MARKER TUNE SPN	17-122
MAX HOLD A	17-123
MAX HOLD B	17-123
MAX/MIN ON OFF	17-123
MAX/MIN VIEW	17-124
MAX MXR LVL	17-124
MEAS SNG CONT	17-124
MEAS STEPPED	17-125
MEASURE AT MKR	17-125
Measure Detector	17-125
MEM LOCKED	17-126
MIN HOLD C	17-126
MIXER BIAS DAC	17-126
MK COUNT ON OFF	17-127
MK NOISE ON OFF	17-127
MK PAUSE ON OFF	17-128
MKR	17-128
MKR →	17-128
MK READ F T I P	17-129
MK TRACE AUTO ABC	17-129
MK TRACK ON OFF	17-130
MNOPQR	17-130
MODE	17-130
NEW EDIT	17-131

NEXT	17-131
NEXT PAGE	17-131
NEXT PEAK	17-132
NEXT PK LEFT	17-132
NEXT PK RIGHT	17-132
NO CONVERSN	17-133
No User Menus	17-133
NORM A/B ON OFF	17-133
NORMLIZE ON OFF	17-134
NORMLIZE POSITION	17-134
NTSC	17-134
WINDOWS ON	17-135
OTHER — CARD	17-136
Other Factors	17-136
OTHER ON OFF	17-136
OUTPUT	17-136
OUTPUT REPORT	17-137
OVLD ON OFF	17-137
PAINTJET PRINTER	17-137
PAL	17-137
PAL-M	17-138
PEAK EXCURSN	17-138
PK DWELL TIME	17-139
PK-PK MEAS	17-139
Plot Config	17-139
PLOTTER ADDRESS	17-139
PLT—LJT ON OFF	17-140
PLT_ _ LOC_ _	17-140
PLT MENU ON OFF	17-140
Plt Port Config	17-140
PLT PORT HPIB PAR	17-140
PLT PORT SER PAR	17-141
PLTS/PG 1 2 4	17-141
POINT	17-142
POWER ON IP LAST	17-143
PREAMP ON OFF	17-144
PRESEL DAC	17-144
PRESEL DEFAULT	17-144
PRESEL PEAK	17-145
PRESET	17-145
Print Config	17-148

PRINTER ADDRESS	17-148
PRINTER SETUP	17-148
Prn Port Config	17-148
PRN PORT HPIB PAR	17-149
PRN PORT SER PAR	17-149
PRT MENU ON OFF	17-149
pTesla	17-149
PURGE AMP COR	17-150
PURGE LIMITS	17-150
PWR SWP ON OFF	17-151
QP/AVG 10X OFF	17-152
QP DET ON OFF	17-152
QP DWELL TIME	17-152
QP GAIN ON OFF	17-153
QP ON OFF	17-153
QPD OFFSET	17-153
QPD RST ON OFF	17-154
RECALL AMP COR	17-154
RECALL ANTENNA	17-154
RECALL CABLE	17-155
Recall Card	17-155
RECALL DISPLAY	17-155
RECALL DLP	17-155
Recall Internal	17-156
RECALL LIMITS	17-156
RECALL LIST	17-156
RECALL OTHER	17-157
RECALL SETUP	17-157
RECALL STATE	17-157
RECALL TRACE	17-158
REF LVL	17-158
REF LVL OFFSET	17-159
REMEAS ALL SIGS	17-159
REMEAS MARKED	17-160
REMEAS SIGNAL	17-160
Re-measure	17-160
RESTART	17-161
RPG TITLE	17-161
SAVE AMP COR	17-161
SAVE ANTENNA	17-162

SAVE AUTOEXEC	17-162
SAVE CABLE	17-162
Save Card	17-163
SAVE EDIT	17-163
Save Internal	17-163
SAVE LIMITS	17-164
SAVE LIN GRAPH	17-164
SAVE LIST	17-165
SAVE LOG GRAPH	17-165
SAVE OTHER	17-166
Save/Rcl List	17-166
SAVE/RECALL	17-166
SAVE SETUP	17-167
SAV LOCK ON OFF	17-167
SCALE LOG LIN	17-168
SECAM-L	17-168
SELECT 1 2 3 4	17-168
SELECT AMPLITUD	17-169
Select Axis	17-170
SELECT DLT AMPL	17-170
SELECT FREQ	17-171
SELECT FRM LIST	17-172
SELECT LWR AMPL	17-173
SELECT MID AMPL	17-173
SELECT POINT	17-173
SELECT PREFIX	17-174
SELECT SEGMENT	17-176
SELECT TIME	17-177
Select Type	17-178
SELECT UPR AMPL	17-178
Selectv Mark	17-179
Service Cal	17-179
Service Diag	17-179
SET ATTN ERROR	17-179
Set B&W Printer	17-180
Set Colr Printer	17-180
SET DATE	17-180
SET TIME	17-180
SETTINGS ON OFF	17-181
SETUP	17-181
SETUP — CARD	17-181



SGL SWP	17-181
SHOW Δ 1 PK QP AV	17-182
SHOW Δ 2 PK QP AV	17-182
SHOW COR ON OFF	17-182
SHOW DET PK QP AV	17-183
SHOW MKR ON OFF	17-183
SHOW SETUP	17-183
SHW INST CONFIG	17-184
SIG LIST ON OFF	17-184
Signal Marking	17-184
SLOPE	17-185
SORT BY AVG AMP	17-185
SORT BY DLTA LIM	17-186
SORT BY FREQ	17-186
SORT BY PK AMP	17-186
SORT BY QP AMP	17-187
Sort Signals	17-187
SPAN or SPAN	17-187
SPAN ZOOM	17-188
SPEAKER ON OFF	17-188
SPECTRUM ANALYZER	17-188
SQUELCH	17-189
SRC ATN MAN AUTO	17-189
SRC PWR OFFSET	17-190
SRC PWR ON OFF	17-190
SRC PWR STP SIZE	17-190
START FREQ	17-191
STATE → CARD	17-191
STATE → INTRNL	17-191
STEP LOG LIN	17-192
STOP	17-192
STOP FREQ	17-192
STORE FLATNESS	17-192
STOR PWR ON UNITS	17-193
STP GAIN ZERO	17-193
STUVWX	17-193
SWEEP CONT SGL	17-194
SWEEP LOG LIN	17-194
SWEEP RAMP	17-194
SWEEP TIME DAC	17-195
SWEEP/TRIG	17-195

SWP CPLG SR SA . . . . .	17-195
SWP TIME AUTO MAN . . . . .	17-196
SYNC NRM NTSC . . . . .	17-196
SYNC NRM PAL . . . . .	17-197
TABLE ADDRESS . . . . .	17-197
TABLE CCW STOP . . . . .	17-197
TABLE CW STOP . . . . .	17-197
TEST . . . . .	17-198
THRESHLD ON OFF . . . . .	17-198
Time Date . . . . .	17-198
TIMEDATE ON OFF . . . . .	17-199
TOWER ADDRESS . . . . .	17-199
TOWER DN STOP . . . . .	17-199
Tower/ Turntbl . . . . .	17-199
TOWER UP STOP . . . . .	17-199
TOWER VERT HOR . . . . .	17-200
TRACE . . . . .	17-200
TRACE A B C . . . . .	17-200
TRACE A . . . . .	17-200
TRACE B . . . . .	17-201
TRACE B VW OFF . . . . .	17-201
TRACE C . . . . .	17-202
Trace — Card . . . . .	17-202
Trace — Intrnl . . . . .	17-203
Track Gen . . . . .	17-203
TRACKING PEAK . . . . .	17-204
Trigger . . . . .	17-204
TUNE SLO FAST . . . . .	17-204
TV LINE # . . . . .	17-205
TV Standard . . . . .	17-205
TV SYNC NEG POS . . . . .	17-205
TV TRIG . . . . .	17-206
TV TRIG EVEN FLD . . . . .	17-206
TV TRIG ODD FLD . . . . .	17-207
TV TRIG VERT INT . . . . .	17-207
User Menus . . . . .	17-207
VERIFY TIMEBASE . . . . .	17-208
VID AVG ON OFF . . . . .	17-208
VIDEO . . . . .	17-208
VIEW Δ OFF . . . . .	17-209
VIEW A . . . . .	17-209

VIEW B	17-210
VIEW C	17-210
VIEW CAL ON OFF	17-211
VIEW PK QP AV	17-211
Volts	17-211
Watts	17-212
WINDOWS OFF	17-212
X FINE TUNE DAC	17-212
YTF DRIVER	17-212
YTF SPAN	17-213
YTF TUNE COARSE	17-213
YTF TUNE FINE	17-213
YZ_# Spc Clear	17-213
ZERO SPAN	17-214
ZONE CENTER	17-214
ZONE PK LEFT	17-215
ZONE PK RIGHT	17-215
ZONE SPAN	17-216
ZOOM	17-216

**18. Options and Accessories**

What you'll find in this chapter	18-1
EMC analyzer	18-1
Options	18-1
Transducers and accessories	18-2

**A. SRQ**

Service Requests	A-1
Status byte definition	A-1
Service request activating commands	A-3

**B. EMC Setups, Limit Lines and Antenna Factors Card**

Auto-execute radiated emissions test setup sample	B-1
Radiated emissions test setup sample	B-2
Conducted emissions test setup sample	B-2
Diagnostic emissions test setup sample	B-3

**Index**

# Figures

---

1-1. HP 8590 EM Series EMC analyzer. . . . .	1-2
1-2. HP 8590 EM Series EMC analyzer with the HP 85420E RF filter section. . . . .	1-3
1-3. Static-safe work station. . . . .	1-22
2-1. Front-panel feature overview. . . . .	2-2
2-2. Rear-panel feature overview. . . . .	2-6
2-3. Adjusting the fine focus. . . . .	2-10
2-4. EMC analyzer screen annotation. . . . .	2-11
2-5. Placing the marker on a signal. . . . .	2-15
2-6. Displaying a list on the screen. . . . .	2-16
2-7. Displaying the list as a log graph. . . . .	2-17
2-8. Spectrum analyzer mode screen annotation. . . . .	2-18
3-1. Inserting the memory card. . . . .	3-6
3-2. Memory card battery date code location. . . . .	3-7
3-3. Memory card battery replacement. . . . .	3-8
3-4. Rear-panel battery information label. . . . .	3-9
4-1. Radiated EMC measurement test setup. . . . .	4-4
4-2. Active detector and measured detector messages. . . . .	4-6
4-3. Using the measure at marker function. . . . .	4-17
4-4. Conducted EMC measurement test setup. . . . .	4-23
4-5. Display using the log sweep mode. . . . .	4-24
5-1. 300 MHz calibrator signal. . . . .	5-2
5-2. 300 MHz calibrator signal with harmonics. . . . .	5-3
5-3. Peak, quasi-peak, and average detectors measurement results. . . . .	5-4
5-4. Signal added to signal list. . . . .	5-5
5-5. Signal list of 300 MHz calibrator signal and harmonics. 5-6. Signal list sorted by peak amplitude. . . . .	5-6
5-7. Last harmonic signal deleted. . . . .	5-7
5-8. Last harmonic signal remeasured and added to list. . . . .	5-8
5-9. Signal marking. . . . .	5-9
5-10. Marked signals deleted and list reordered. . . . .	5-10
5-11. Remaining signals in list remeasured. . . . .	5-11
5-12. Signals plotted on linear frequency scale. . . . .	5-12
5-13. Signals plotted on log frequency scale. . . . .	5-13
6-1. Stepped measurement display. . . . .	5-14
6-2. Stepped measurement using two detectors. . . . .	6-2
6-3. Using the marker. . . . .	6-3
6-4. Data added to the signal list table. . . . .	6-4
6-5. Stepped measurement stopped at 300.2 MHz. . . . .	6-5
6-6. Using a logarithmic step size. . . . .	6-6
6-7. Using a linear step size. . . . .	6-7
7-1. Diagnostic (close-field probe) test setup. . . . .	6-7
7-2. eSAMPLE_D selected. . . . .	7-2
7-3. Moving the marker to the highest response. . . . .	7-3
7-4. Reducing the span. . . . .	7-4

7-5. Saving the displayed response in view mode. . . . .	7-5
7-6. Reading the probe's output in dB $\mu$ A/m. . . . .	7-6
7-7. Signals viewed with MAX, MIN, VIEW. . . . .	7-7
7-8. Measuring the harmonic interval. . . . .	7-8
7-9. 30 MHz –300 MHz setup selected. . . . .	7-9
7-10. Adjusting the reference level and attenuation. . . . .	7-10
7-11. Setup for obtaining two signals. . . . .	7-12
7-12. Resolving signals of equal amplitude. . . . .	7-13
7-13. IF bandwidth for resolving small signals. . . . .	7-14
7-14. Signal resolution with a 30 kHz IF bandwidth. . . . .	7-15
7-15. Signal resolution with a 10 kHz IF bandwidth. . . . .	7-16
7-16. Using the marker counter. . . . .	7-18
7-17. After zooming in on the signal. . . . .	7-19
7-18. Peaking signal amplitude using preselector peak. . . . .	7-21
7-19. Using marker tracking to track an unstable signal. . . . .	7-23
7-20. Viewing an unstable signal using Max Hold A. . . . .	7-25
7-21. Viewing an unstable signal using Max and Min Hold. . . . .	7-26
7-22. Placing a marker on the CAL OUT signal. . . . .	7-27
7-23. Using the marker delta function. . . . .	7-28
7-24. Frequency and amplitude differences. . . . .	7-29
7-25. Low-level signal. . . . .	7-31
7-26. Using 0 dB attenuation. . . . .	7-32
7-27. Decreasing IF bandwidth. . . . .	7-33
7-28. Decreasing averaging bandwidth. . . . .	7-35
7-29. Using the video averaging function. . . . .	7-36
7-30. Set-up for obtaining two signals. . . . .	7-39
7-31. Using linearity check to detect compression. . . . .	7-40
7-32. Set-up for obtaining two signals. . . . .	7-41
7-33. Generating third order distortion products. . . . .	7-42
7-34. Using linearity check to identify distortion products. . . . .	7-43
7-35. Viewing an AM signal. . . . .	7-46
7-36. Measuring modulation in zero span. . . . .	7-47
7-37. Using harmonic lock. . . . .	7-49
7-38. Harmonic locking off. . . . .	7-50
7-39. Localized susceptibility measurements test setup. . . . .	7-51
7-40. Setting up the tracking generator. . . . .	7-52
7-41. Turning the tracking generator on. . . . .	7-53
8-1. EMC analyzer/tracking generator system block diagram. . . . .	8-2
8-2. Transmission measurement test setup. . . . .	8-3
8-3. Tracking-generator output power activated. . . . .	8-4
8-4. Normalized trace. . . . .	8-6
8-5. Measuring the rejection of the filter. . . . .	8-7
8-6. Reflection measurement short calibration test setup. . . . .	8-9
8-7. Measuring the return loss of the filter. . . . .	8-11
8-8. Maximum modulation frequency versus sweep time. . . . .	8-14
8-9. Using the FFT function. . . . .	8-15
8-10. Using the 6 dB points function. . . . .	8-17
8-11. Using the 99% pwr BW function. . . . .	8-18
8-12. Using the % AM function. . . . .	8-19
8-13. Using the Delta Meas function. . . . .	8-20
8-14. Using the Pk-Pk function. . . . .	8-21
8-15. Setup for making third order measurements. . . . .	8-22
8-16. Using 3rd Ord Meas function. . . . .	8-23
8-17. Viewing the calibrator signal through the RF filter section. . . . .	8-24

8-18. Turning the preamplifier on. . . . .	8-25
8-19. Analog+ display mode. . . . .	8-26
8-20. Triggering on an odd field of a video format. . . . .	8-28
8-21. Triggering on an even field of a video format. . . . .	8-29
9-1. Completed limit-line. . . . .	9-5
9-2. Editing an existing limit-line table. . . . .	9-6
9-3. Signal failing the limit line margin. . . . .	9-7
9-4. Signal exceeding the limit line. . . . .	9-13
10-1. Conversion factors defined with a log frequency scale. . . . .	10-4
10-2. Conversion factors defined with a linear frequency scale. . . . .	10-5
11-1. 300 MHz calibrator signal with harmonics. . . . .	11-2
11-2. Windows display mode on. . . . .	11-2
11-3. Zone markers moved to the right of the current span. . . . .	11-3
11-4. Zone span increased to include three signals. . . . .	11-4
11-5. Full-sized display of the applications window. . . . .	11-4
11-6. Full-sized display of the overview window. . . . .	11-5
11-7. Windows display mode off. . . . .	11-6
13-1. External keyboard template. . . . .	13-7
17-1. Internal memory catalog information. . . . .	17-36
17-2. Connecting a printer to the analyzer. . . . .	17-54

## Tables

---

1-1. EMC Analyzer Accessories . . . . .	1-5
1-2. RF Filter Section Accessories . . . . .	1-5
1-3. AC Power Cables Available . . . . .	1-21
1-4. Static-Safe ESD Accessories . . . . .	1-23
2-1. RF Output Frequency Range . . . . .	2-5
2-2. EMC Analyzer Screen Annotation . . . . .	2-12
2-3. Screen Annotation for Trace, Trigger, and Sweep Modes	2-12
2-4. Spectrum Analyzer Mode Screen Annotation . . . . .	2-19
2-5. Screen Annotation for Trace, Trigger, and Sweep Modes	2-19
4-1. Standard Configurations . . . . .	4-2
12-1. Internal Memory and Card Operations . . . . .	12-3
12-2. Save Functions Using a Card . . . . .	12-7
12-3. Recall Functions Using a Card . . . . .	12-9
12-4. Summary of Save and Recall Operations, Internal Memory . . . . .	12-13
13-8. External Keyboard Functions . . . . .	13-5
15-1. Hewlett-Packard Sales and Service Offices . . . . .	15-6
17-1. Center Frequency and Span Settings for Harmonic Bands . . . . .	17-27
17-2. Setting of HP ThinkJet Printer Mode Switches . . . . .	17-52
17-3. Default Configuration Values . . . . .	17-59
17-4. Preset EMC Analyzer Conditions . . . . .	17-81
17-5. Functions Which Exit The Windows Display Format . . . . .	17-135
17-6. Preset for EMC Analyzer Conditions . . . . .	17-146
17-7. Preset Spectrum Analyzer Conditions . . . . .	17-147
17-8. . . . .	17-151
A-1. Status Byte Definition . . . . .	A-2





# Preparing for Use

---

## What you'll find in this chapter

This chapter describes the process of getting the EMC analyzer ready to use when you have just received it. See “Preparing the EMC Analyzer” (in this chapter) for the process steps. The process includes steps for setting up the EMC analyzer as well as for setting up the EMC analyzer with the RF filter section. Information about static-safe handling procedures is also included in this chapter.

# Introducing the EMC Analyzer

## HP 8590 EM Series EMC analyzer

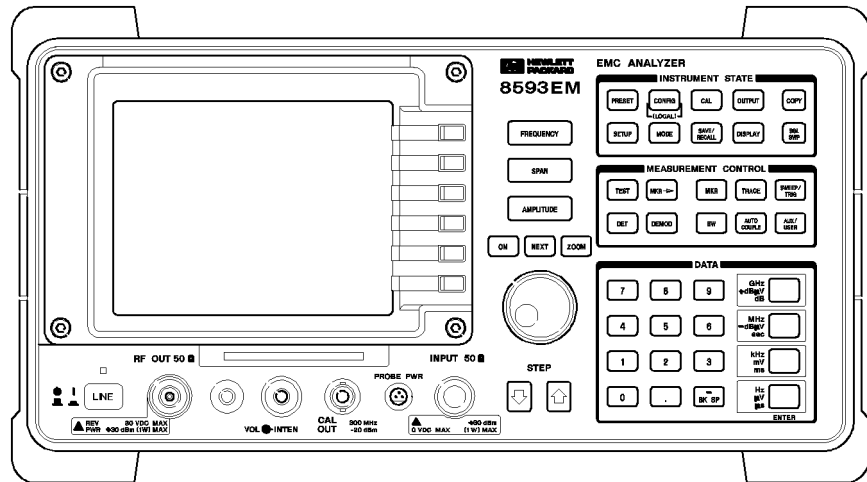

**Figure 1-1. HP 8590 EM Series EMC analyzer.**

The HP 8590 EM Series EMC analyzers are small, lightweight test instruments that cover the RF and microwave frequency ranges:

HP 8591EM, 9 kHz to 1.8 GHz

HP 8593EM, 9 kHz to 22 GHz (or 26.5 GHz)

HP 8594EM, 9 kHz to 2.9 GHz

HP 8595EM, 9 kHz to 6.5 GHz

HP 8596EM, 9 kHz to 12.8 GHz

## HP 8590 EM Series EMC analyzer/HP 85420E RF filter section

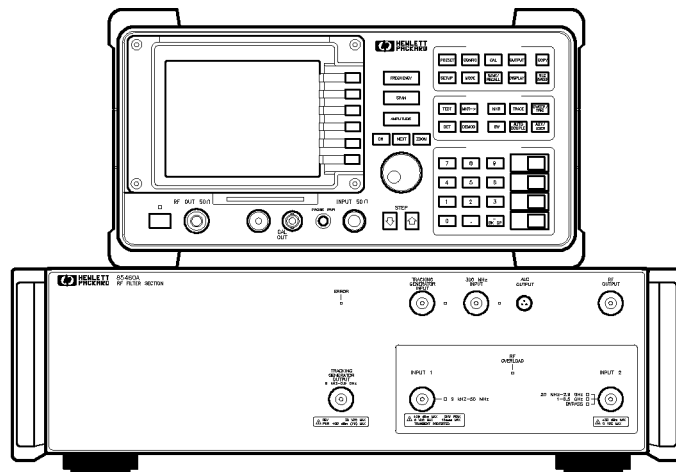

useemcrf

**Figure 1-2.**  
**HP 8590 EM Series EMC analyzer with the HP 85420E RF filter section.**

The HP 85420E RF filter section Option 1EM can be used with the HP 8591EM, HP 8594EM, HP 8595EM, or the HP 8596EM EMC analyzer to prevent RF overload at the input of the EMC analyzer. This is useful in geographical areas where ambient signals are abundant.

---

## Initial Inspection

Inspect the shipping container for damage. If the shipping container or cushioning material is damaged, keep it until you have verified that the contents are complete and you have tested the EMC analyzer mechanically and electrically.

“Accessories” contains the accessories shipped with the EMC analyzer and the RF filter section. If the contents are incomplete or if the EMC analyzer does not pass the operation verification tests in the verification manual, notify the nearest Hewlett-Packard office. If the shipping container is damaged or the cushioning material shows signs of stress, also notify the carrier. Keep the shipping materials for the carrier’s inspection. The HP office will arrange for repair or replacement without waiting for a claim settlement.

If the shipping materials are in good condition, retain them for possible future use. You may wish to ship the EMC analyzer to another location or return it to Hewlett-Packard for service.

## Accessories

The accessories shipped with the HP 8590 EM Series EMC analyzers are listed below:

**Table 1-1. EMC Analyzer Accessories**

Description	HP Part Number	Comments
Memory Card (RAM)	08591-10008	Blank RAM memory card
Memory Card (ROM)	08590-10027	ROM memory card with EMC setups, limit lines, and correction factors
Memory Card Holder	9222-1545	Two holders included
Adapter, Type N (m) to BNC (f)	1250-0780	One adapter is shipped with the EMC analyzer for the INPUT 50Ω connector (not shipped with Option 026 and Option 027). An additional adapter is shipped with Option 010, the tracking generator option.
Adapter BNC (m) to SMA (f)	1250-1700	Shipped with Option 026 and Option 027 only.
Connector, APC-3.5 mm (f) to (f)	5061-5311	Shipped with Option 026 only.
Connector, Type N (m) to SMA (f)	5061-5311	Shipped with Option 027 only.
Reference Connector	1250-1499	Shipped connected between the 10 MHz REF OUT and the EXT REF IN on the rear panel of the EMC analyzer.
Cable, 50Ω, BNC	8120-2682	Not shipped with Option 026 or Option 027.
Cable, SMA (m) to Type N (m)	8120-5148	Shipped with HP 8593EM and HP 8596EM. Not shipped with Option 026 or Option 027.
Cable, SMA (m) to SMA (m)	08592-60061	Shipped with Option 026 and 027 only.
Keyboard overlay	5182-1204	Overlay for external keyboard
Power cable	See Table 1-3	

The accessories shipped with the HP 85420E RF filter section are listed below:

**Table 1-2. RF Filter Section Accessories**

Description	HP Part Number	Comments
Flexible cable, Type N (m) to Type N (m), 260 mm (10.2 in)	8120-6479	RF OUTPUT to INPUT 50Ω cable
Flexible cable, Type N (m) to BNC (m), 250 mm (9.8 in)	8120-6480	CAL OUT to 300 MHz INPUT 50Ω cable
Flexible cable, Type N (m) to Type N (m), 350 mm (13.8 in)	8120-6482	RF OUT 50Ω to TRACKING GENERATOR INPUT cable (Option 010 only)
Auxiliary interface cable	8120-6481	9-pin interface bus cable
Flexible sweep cables, 505 mm (20 in)	8120-5049	2 cables, High Sweep and Sweep Ramp cables
Adapter, Type N (m) to BNC (f)	1250-0780	Two adapters
Cable BNC (m) to BNC (m), 30 cm (12 in)	8120-1838	Calibration cable
Front handles	5062-3989	
Power cable	See Table 1-3	

---

## Preparing the EMC Analyzer Products for Use

The EMC analyzer preparation procedures are straightforward and require minimal time to complete. There are two procedures for preparing the equipment for use. The first procedure, “Preparing the EMC Analyzer”, explains how to prepare the EMC analyzer for use. The second procedure, “Preparing the RF Filter Section”, explains how to prepare the RF filter section for use with the EMC analyzer. If you have the RF filter section and the EMC analyzer, first, follow the procedures in “Preparing the EMC Analyzer”, then follow the procedures in “Preparing the RF Filter Section”.

### **The EMC analyzer procedures include:**

- Installing the EMC analyzer.
- Performing frequency and amplitude self-calibration.
- Performing a tracking generator self-calibration (for models equipped with a tracking generator).
- Performing a filter self-calibration (for models equipped with a YIG-tuned filter).

### **The RF filter section procedures include:**

- Installing the RF filter section.
- Connecting the EMC analyzer to the RF filter section.
- Ensuring that the EMC analyzer is controlling the RF filter section.

## Preparing the EMC Analyzer

**1** Unpack and inspect the EMC analyzer to ensure that it is complete and that it was not damaged during shipment. Refer to “Initial Inspection” for specific instructions. Refer to Table 1-1 for a list of accessories shipped with the EMC analyzer.

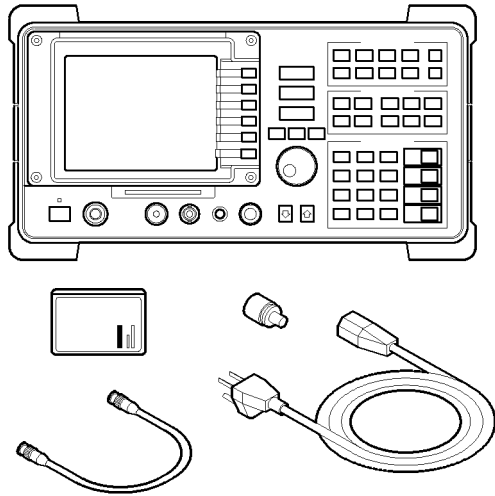

emcstp1

### CAUTION

*Do not* connect ac power until you have verified that the line voltage is correct, the proper fuse is installed, and the line voltage selector switch is properly positioned, as described in the following paragraphs. Damage to the equipment could result.

Before connecting the EMC analyzer to the power source, you must set the rear-panel voltage selector switch correctly to adapt the EMC analyzer to the power source. An improper selector switch setting can damage the EMC analyzer when it is turned on.

**2** Set the voltage selector switch on the EMC analyzer’s rear-panel to the line voltage range (115 V or 230 V). Use a small screwdriver to slide the switch so that the proper voltage label is visible.

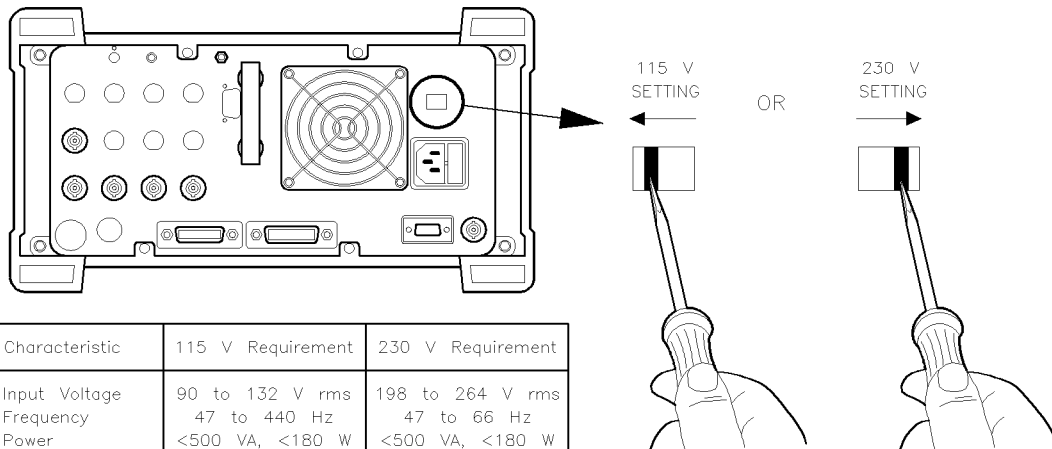

Characteristic	115 V Requirement	230 V Requirement
Input Voltage	90 to 132 V rms	198 to 264 V rms
Frequency	47 to 440 Hz	47 to 66 Hz
Power	<500 VA, <180 W	<500 VA, <180 W

emcstp2

**3** Check the line fuse housed in the container at the rear of the analyzer. Insert the tip of a screwdriver in the slot at the middle of the container and pry gently to extend the container. The fuse closest to the EMC analyzer is the fuse in use. The container also houses a spare fuse. If the fuse is defective or missing, install a new fuse in the proper position and reinsert the fuse container.

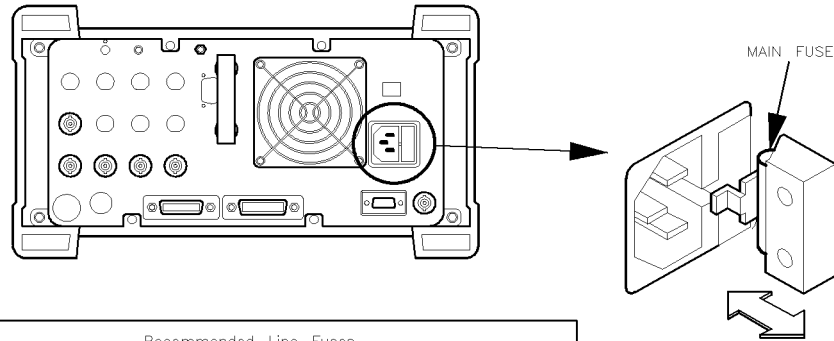

Recommended Line Fuses			
Size	Rating	Input Line Voltage	HP Part Number
5 by 20 mm	FSA, 250 V, 5 Amp (IEC approved)	115 V or 230 V	2110-0709

emcstp3

**WARNING**

The EMC analyzer is equipped with a three-wire power cable, in accordance with international safety standards. When connected to an appropriate power line outlet, this cable grounds the instrument cabinet.

Failure to ground the EMC analyzer properly can result in personal injury. Before turning on the EMC analyzer, you must connect its protective earth terminals to the protective conductor of the main power cable. Insert the main power cable plug only into a socket outlet that has a protective earth contact. **DO NOT** defeat the earth-grounding protection by using an extension cable, power cable, or autotransformer without a protective ground conductor.

If you are using an autotransformer, make sure its common terminal is connected to the protective earth contact of the power source outlet socket.

**4** Connect the power cord.

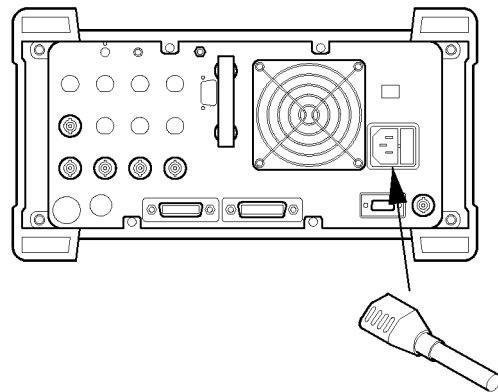

emcstp4



**5** Ensure the reference connector is connected between the 10 MHz OUTPUT and EXT REF IN rear-panel connectors. If you wish to use an external 10 MHz source as the reference frequency, remove the reference connector from the rear-panel and connect the external reference source to the EXT REF IN connector.

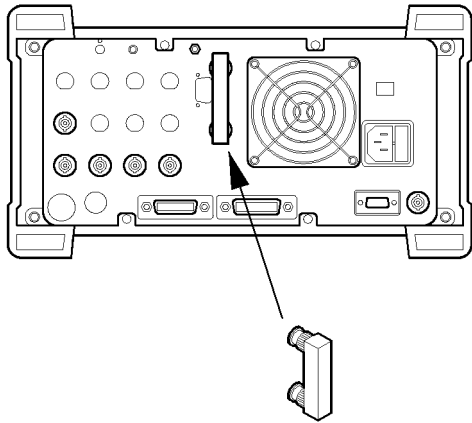

emcstp5

**6** Press **LINE**.

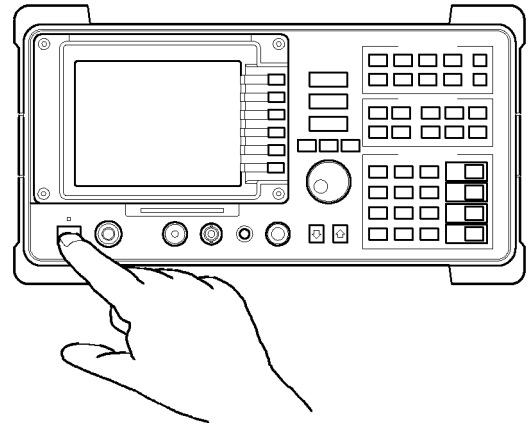

emcstp6

**7** Record the firmware date here and keep it for reference.

Firmware date: \_\_\_\_\_

After a few seconds, the screen displays the firmware date in the YYMMDD format. For example, 93.05.22 indicates May 22, 1993.

If you should need to call Hewlett-Packard for service or with any questions regarding your EMC analyzer, it will be helpful to have the firmware date readily available.

Allow the EMC analyzer to warm up at least 30 minutes before performing the self-calibration routines.

**8** Connect the type N (m) to BNC (f) connector (shipped with the EMC analyzer) to the INPUT 50Ω. Connect the 50Ω coaxial cable (also shipped with the EMC analyzer) between the front-panel CAL OUT and the INPUT 50Ω connector.

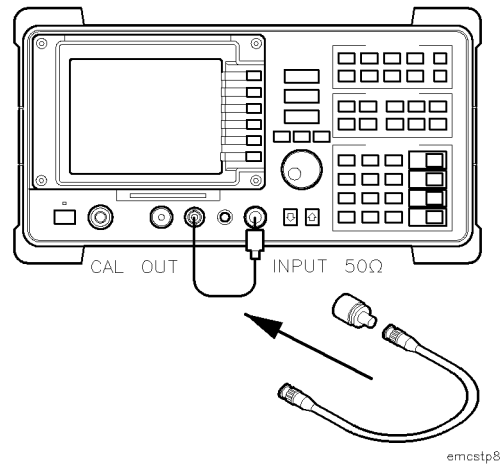

**9** Press **CAL** then **CAL FREQ & AMPTD**.

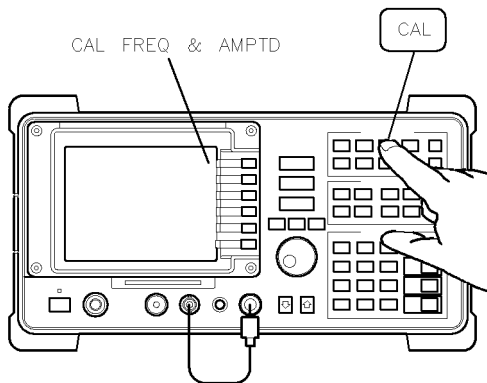

During the frequency routine, CAL: SWEEP, CAL: FREQ, and CAL: SPAN are displayed as the sequence progresses. *For an Option 102,* CAL: FM GAIN + OFFSET is also displayed.

During the amplitude routine, CAL; AMPTD, CAL: 3 dB BW, CAL: ATTEN, and CAL: LOGAMP are displayed as the sequence progresses. CAL: DONE appears when the routine is completed.

Any failures or discrepancies produce an error message on the screen.

**10** Press **CAL STORE** to store the correction factors when the frequency and amplitude self-calibration routines are complete.

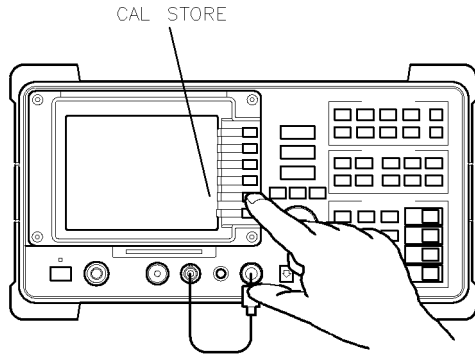

The self-calibration routines calibrate the EMC analyzer by generating correction factors. The softkey **CAL STORE** stores the correction factors in the area of EMC analyzer memory that is saved when the EMC analyzer is turned off; the EMC analyzer will automatically apply these factors in future measurements. If **CAL STORE** is not pressed, the correction factors remain in effect until the EMC analyzer is turned off.

- If your EMC analyzer is an option 010,  
Continue the calibration at “Tracking generator self-calibration”.
- If your EMC analyzer is not an option 010, but is an:
  - HP 8593EM, HP 8595EM, or HP 8596EM,  
Continue the calibration at “YTF self-calibration”.
  - HP 8591EM or HP 8594EM, and  
Came with the RF filter section, continue at “Preparing the RF Filter Section”.  
Did not come with the RF filter section, continue at Chapter 2. The instrument preparation is complete.

## Tracking generator self-calibration

For EMC analyzers with Option 010 only.

**1** Connect the tracking generator output (RF OUT 50 $\Omega$ ) to the INPUT 50 $\Omega$  connector using the BNC calibrator cable and a BNC-to-Type N adapter.

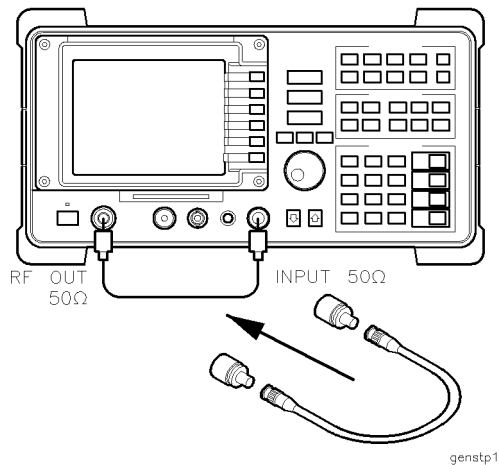

**2** Press **CAL** then **More 1 of 4**, **More 2 of 4**, and **CAL TRK GEN** to start the tracking generator self-calibration.

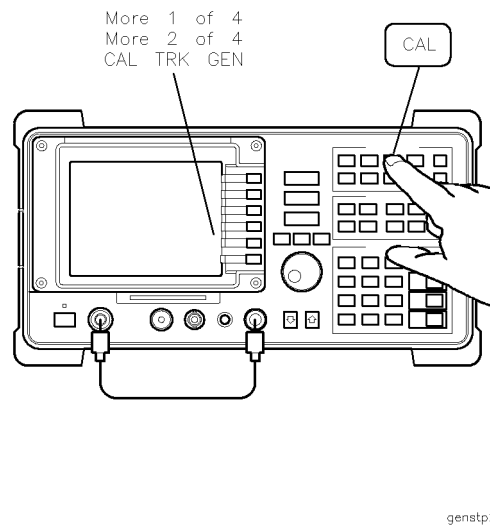

**3** After the test is complete, press **CAL STORE** to save the calibration data.

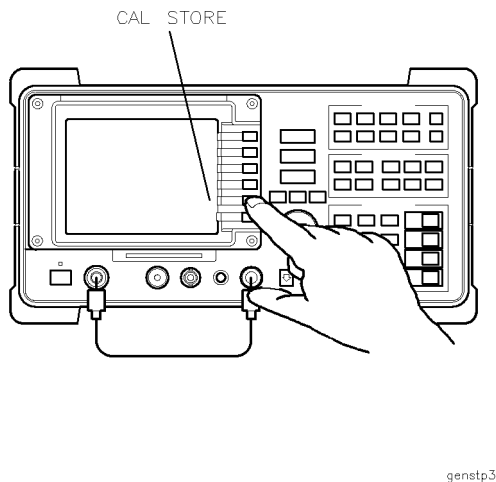

- If your EMC analyzer is an HP 8593EM, HP 8595EM, or HP 8596EM,

Continue the calibration at "YTF self-calibration".

- If your EMC analyzer is an HP 8591EM or HP 8594EM, and

Came with the RF filter section, continue at "Preparing the RF Filter Section".

Did not come with the RF filter section, continue at Chapter 2. The instrument preparation is complete.

**YTF self-calibration** For HP 8593EM, HP 8595EM, and HP 8596EM EMC analyzers only.

**1** Connect a low-loss cable from 100 MHz Comb OUT (the CAL OUT connector on the HP 8595EM) to the INPUT 50Ω connector.

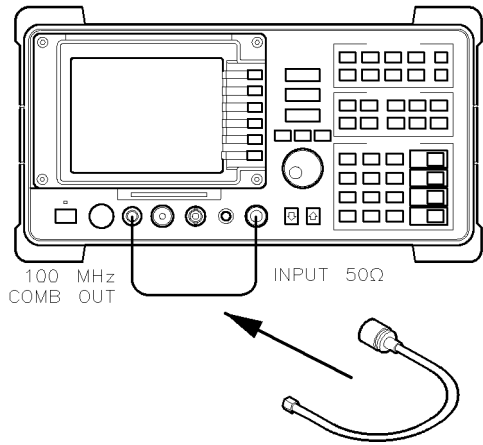

**2** Press **CAL** then More 1 of 4, More 2 of 4, More 3 of 4, and CAL YTF to start the YTF self-calibration.

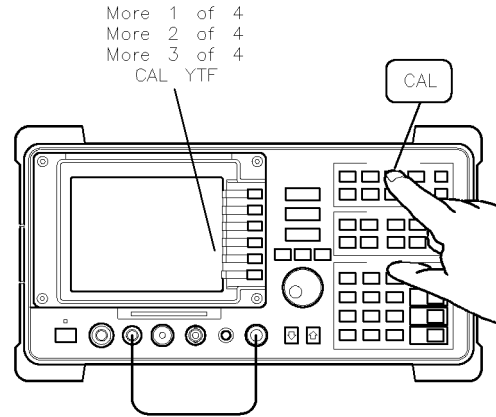

**3** After the YTF self-calibration routine is complete, press **CAL STORE** to save the calibration data. The calibration time varies between 3 and 7 minutes depending on the frequency range of the EMC analyzer.

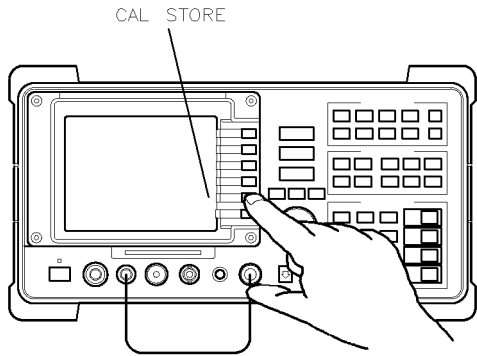

Model	Number	YTF CAL Time
HP	8593EM	7 minutes
HP	8595EM	3 minutes
HP	8596EM	5 minutes

- If your EMC analyzer came with the RF filter section, continue at “Preparing the RF Filter Section”.
- If your EMC analyzer did not come with the RF filter section, continue at Chapter 2. The instrument preparation is complete.

## Preparing the RF Filter Section

**1** Unpack and inspect the RF filter section to ensure that it is complete and that it was not damaged during shipment. Refer to “Initial Inspection” for specific instructions. Refer to Table 1-2 for a list of accessories shipped with the RF filter section.

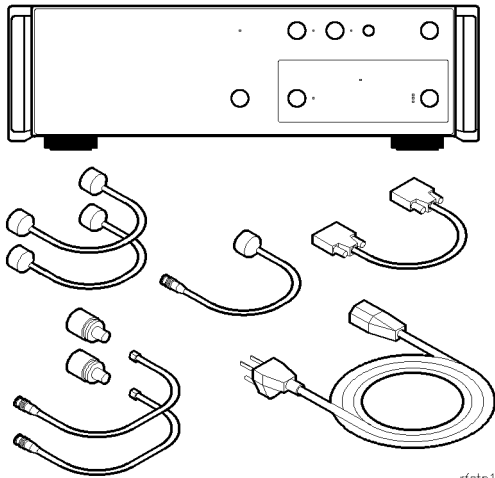

**2** Install the handles on the RF filter section according to the installation procedure shipped with the handles.

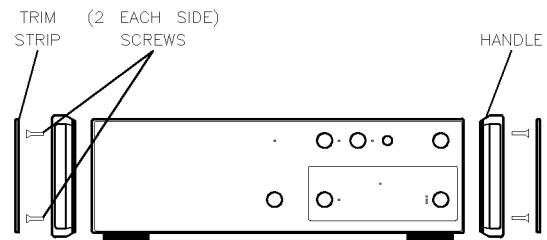

**3** Turn the EMC analyzer's line switch off.

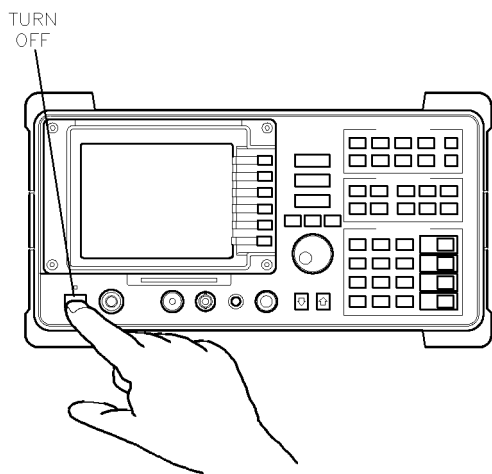

**4** Place the EMC analyzer on top of the RF filter section.

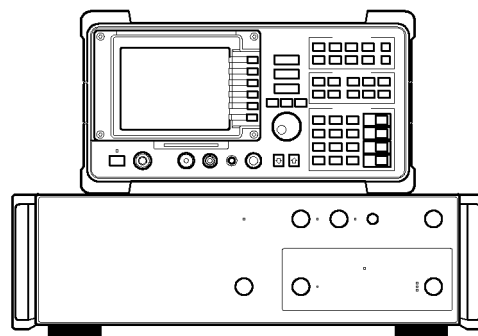

**5** Set the voltage selector switch on the RF filter section's rear-panel to the line voltage range (115 V or 230 V). Use a small screwdriver to slide the switch so that the proper voltage label is visible.

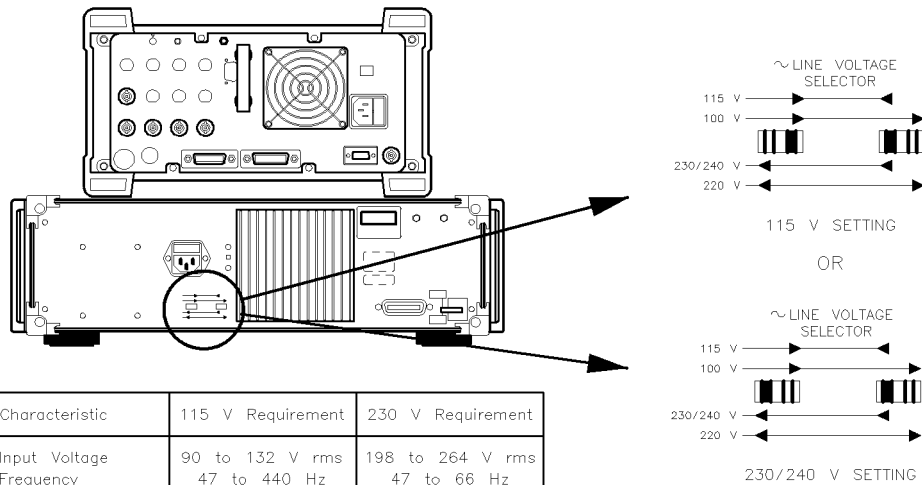

rfstp5

**6** Check the line fuse housed in the container at the rear of the RF filter section. If the fuse is defective or missing, install a new fuse.

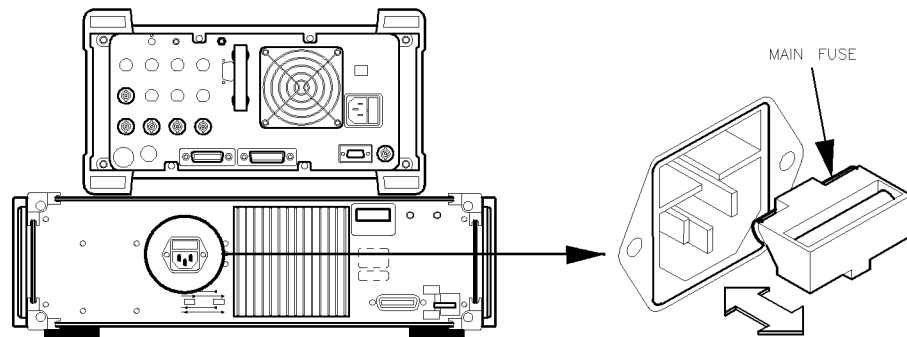

Recommended Line Fuses			
Size	Rating	Input Line Voltage	HP Part Number
5 by 20 mm	FSA, 250 V, .5 Amp (IEC approved)	115 V or 230 V	2110-0458
5 by 20 mm	FSA, 250 V, 1 Amp (UL/CSA approved)	115 V	2110-0782

rfstp6

### CAUTION

Before turning this instrument on, make sure that the line voltage selector switch is set to the voltage of the power supply and the correct fuse is installed. Ensure that the supply voltage is in the specified range.

Do not position this instrument where it is difficult to disconnect the power cord.

**7** Connect the power cord to the RF filter section.

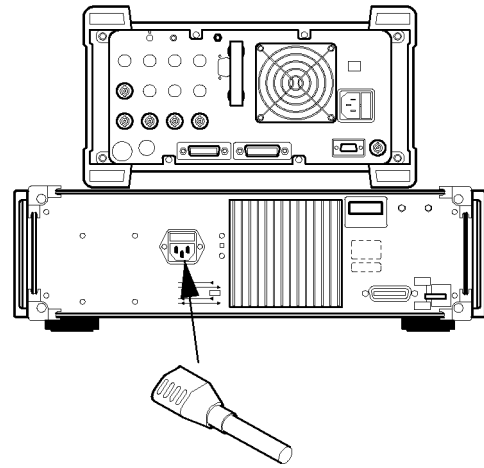

**8** Connect a cable from the RF filter section's HIGH SWEEP connector to the EMC analyzer's HIGH SWEEP IN/OUT (TTL) connector. Connect a cable from the RF filter section's SWEEP RAMP connector to the EMC analyzer's SWEEP OUTPUT connector.

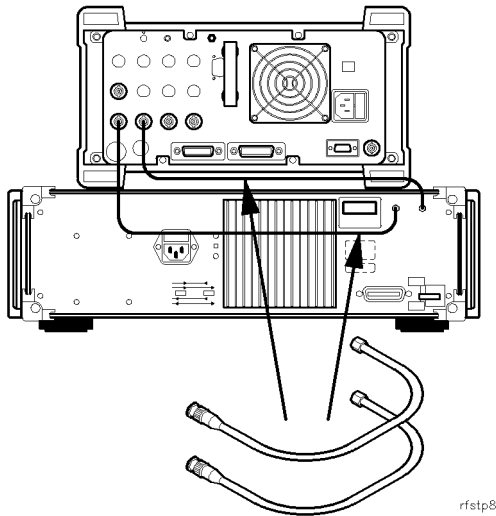

**9** Connect the AUX INTERFACE cable from the RF filter section's AUX INTERFACE connector to the EMC analyzer's AUX INTERFACE connector.

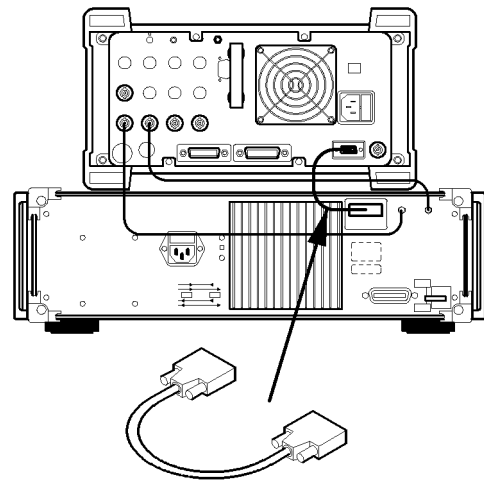



**10** Connect a cable from the RF filter section's 300 MHz INPUT 50Ω connector to the EMC analyzer's CAL OUT connector.

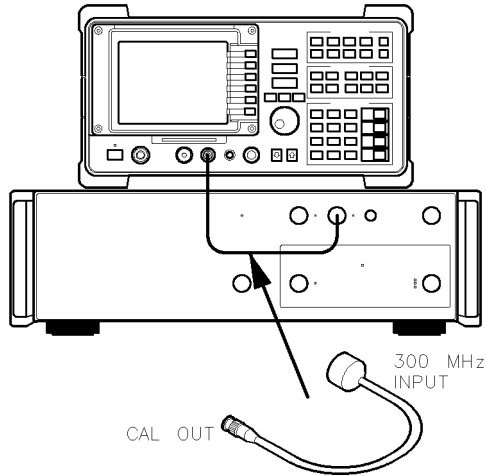

**11** Connect a cable from the RF filter section's RF OUT connector to the EMC analyzer's INPUT 50Ω connector.

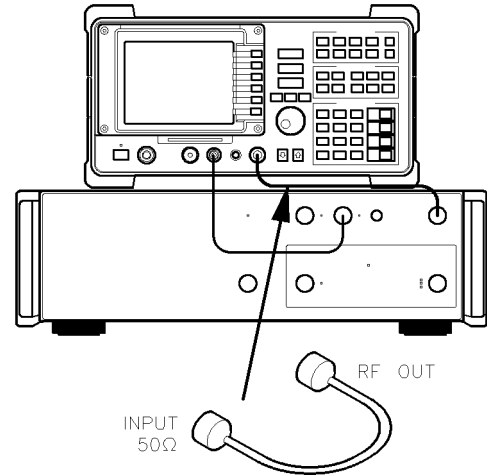

**12** For Option 010 models only, connect a cable from the RF filter section's TRACKING GENERATOR INPUT connector to the EMC analyzer's RF OUT 50Ω connector.

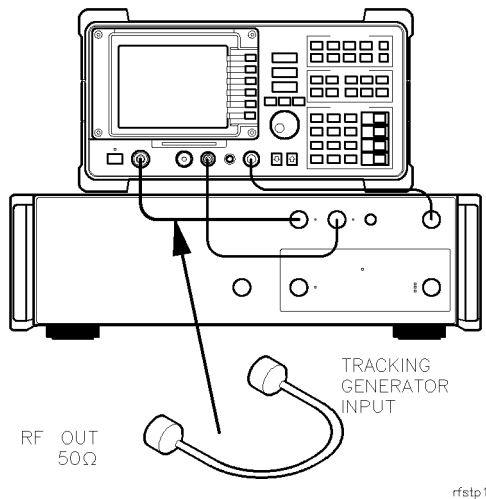

**13** Turn the EMC analyzer's line switch on.

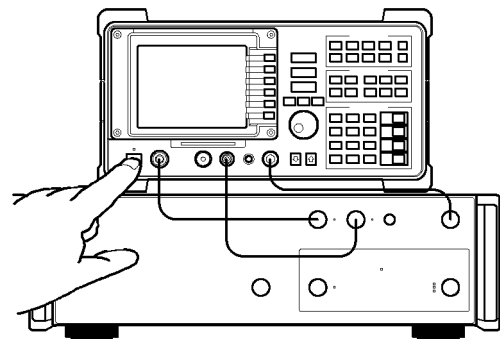

**14** Verify that the RF filter section turns on when the EMC analyzer's line switch is turned on.

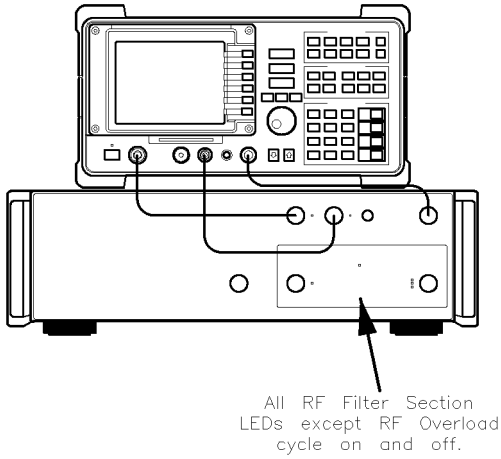

**15** Press **SETUP**.

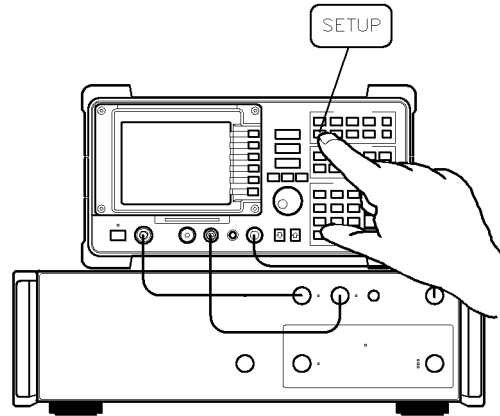

**16** Press the **9 kHz -150 kHz** softkey and verify that the RF filter section's **INPUT 1 LED** is on.

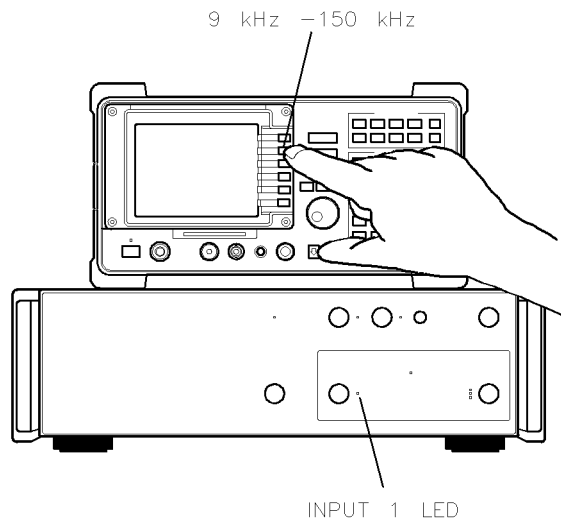

**17** Press the **200 MHz -1 GHz** softkey and verify that the RF filter section's INPUT 2 LED is on.

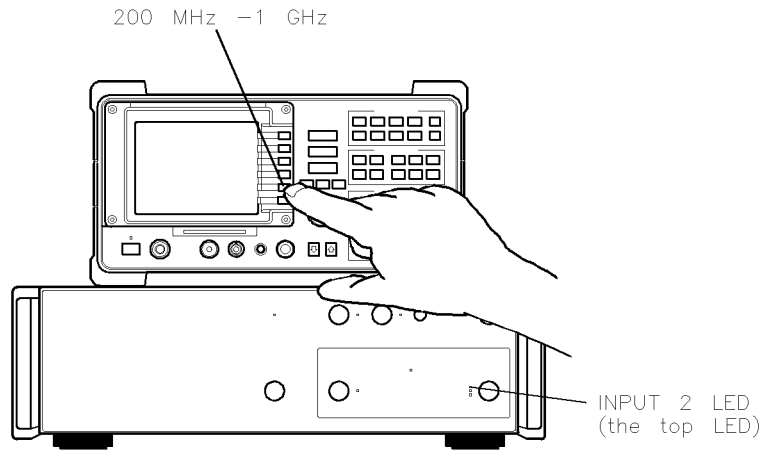

rfstp17

Continue at Chapter 2. The instrument preparation is complete.

---

## Power Cables

The EMC analyzer and the RF filter section are equipped with three-wire power cables, in accordance with international safety standards. When connected to an appropriate power line outlet, these cables ground the instrument cabinet.

### WARNING





---

**This is a Safety Class 1 Product provided with a protective earthing ground incorporated in the power cord. The mains plug shall only be inserted in a socket outlet provided with a protective earth contact. Any interruption of the protective conductor inside or outside of the instrument is likely to make the instrument dangerous. Intentional interruption is prohibited.**

---

Various power cables are available to connect the EMC analyzer to the types of ac power outlets unique to specific geographic areas. The cable appropriate for the area in which the EMC analyzer is originally shipped is included with the unit. You can order additional ac power cables for use in different areas. Table 1-3 lists the available ac power cables, illustrates the plug configurations, and identifies the geographic area in which each cable is appropriate.

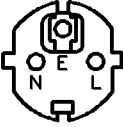
Table 1-3. AC Power Cables Available

PLUG TYPE **	CABLE HP PART NUMBER	PLUG DESCRIPTION	CABLE LENGTH CM (INCHES)	CABLE COLOR	FOR USE IN COUNTRY
<b>250V</b> 	8120-1351 8120-1703	Straight* BS1363A 90°	229 (90) 229 (90)	Mint Gray Mint Gray	Great Britain, Cyprus, Nigeria, Singapore, Zimbabwe
<b>250V</b> 	8120-1369 8120-0696	Straight* NZSS198/ASC112 90°	201 (79) 221 (87)	Gray Gray	Argentina, Australia, New Zealand, Mainland China
<b>250V</b> 	8120-1689 8120-1692	Straight* CEE7-Y11 90°	201 (79) 201 (79)	Mint Gray Mint Gray	East and West Europe, Central African Republic, United Arab Republic (unpolarized in many nations)
<b>125V</b> 	8120-1348 8120-1538	Straight* NEMA5-15P 90°	203 (80) 203 (80)	Black Black	United States Canada, Japan (100 V or 200 V), Brazil, Colombia, Mexico, Phillipines, Saudia Arabia, Taiwan
	8120-1378 8120-4753	Straight* NEMA5-15P Straight	203 (80) 230 (90)	Jade Gray Jade Gray	
	8120-1521 8120-4754	90° 90°	203 (80) 230 (90)	Jade Gray Jade Gray	
<b>250V</b> 	8120-5182 8120-5181	Straight* NEMA5-15P 90°	200 (78) 200 (78)	Jade Gray Jade Gray	Israel
<p>* Part number for plug is industry identifier for plug only. Number shown for cable is HP Part Number for complete cable, including plug.</p> <p>** E = Earth Ground; L = Line; N = Neutral.</p>					

FORMAT80

---

## Preparing a Static-Safe Work Station

Electrostatic discharge (ESD) can damage or destroy electronic components. Therefore, all work performed on assemblies consisting of electronic components should be done at a static-safe work station.

Figure 1-3 shows an example of a static-safe work station. Two types of ESD protection are shown:

- a conductive table mat and wrist strap combination
- a conductive floor mat and heel strap combination

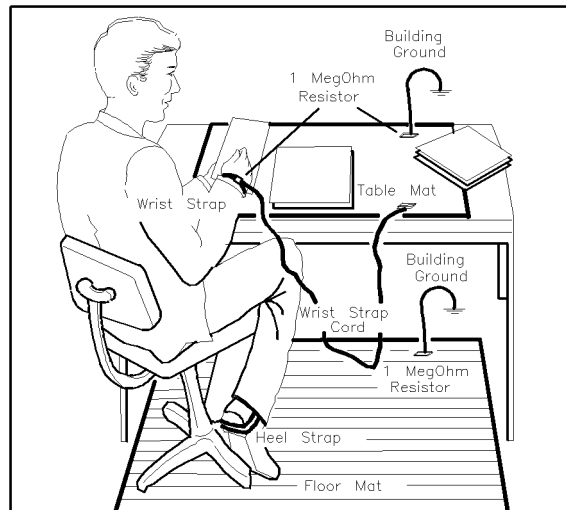

ESDPARTS

**Figure 1-3. Static-safe work station.**

These two types of ESD protection must be used together. Refer to Table 1-4 for a list of static-safe accessories and their HP part numbers.

### CAUTION

- Do not touch the edge-connector contacts or trace surfaces with bare hands. Always handle board assemblies by the edges.
  - Do not use erasers to clean the edge-connector contacts. Erasers generate static electricity and degrade the electrical quality of the contacts by removing the thin gold plating.
  - Do not use paper of any kind to clean the edge-connector contacts. Paper or lint particles left on the contact surface can cause intermittent electrical connections.
-

## Reducing ESD damage

To help reduce the amount of ESD damage that occurs during testing and servicing use the following guidelines:

- Be sure that all instruments are properly earth-grounded to prevent buildup of static charge.
- Personnel should be grounded with a resistor-isolated wrist strap before touching the center pin of any connector and before removing any assembly from the unit.
- Before connecting any coaxial cable to an instrument connector for the first time each day, *momentarily* short the center and outer conductors of the cable together.
- Handle all PC board assemblies and electronic components only at static-safe work stations.
- Store or transport PC board assemblies and electronic components in static-shielding containers.
- PC board assembly edge-connector contacts may be cleaned by using a lint-free cloth with a solution of 80% electronics-grade isopropyl alcohol and 20% deionized water. This procedure should be performed at a static-safe work station.

## Static-safe ESD accessories

**Table 1-4. Static-Safe ESD Accessories**

HP Part Number	Description
9300-0797	Set includes: 3M static control mat 0.6 m × 1.2 m (2 ft × 4 ft) and 4.6 m (15 ft) ground wire. (The wrist-strap and wrist-strap cord are not included. They must be ordered separately.)
9300-0865	Ground wire, 4.6 m (15 ft)
9300-0980	Wrist-strap cord 1.5 m (5 ft)
9300-1383	Wrist-strap, color black, stainless steel, without cord, has four adjustable links and a 7 mm post-type connection.
9300-1169	ESD heel-strap (reusable 6 to 12 months).
Order the following by calling HP DIRECT at (800) 538-8787 or through any Hewlett-Packard Sales and Service Office.	





## Getting Acquainted with the EMC Analyzer

---

### What you'll find in this chapter

This chapter provides an introduction to the EMC analyzer. The features included in this chapter are:

- front-panel features
- rear-panel features
- an explanation of screen annotation
- an overview of menus and softkeys
- the procedure for making a basic measurement

The EMC analyzer also supplies a spectrum analyzer operating mode, with screen annotation, described in “Spectrum Analyzer Mode Screen Annotation” at the end of this chapter.

## Front-Panel Features

The following section provides a brief description of front-panel features.

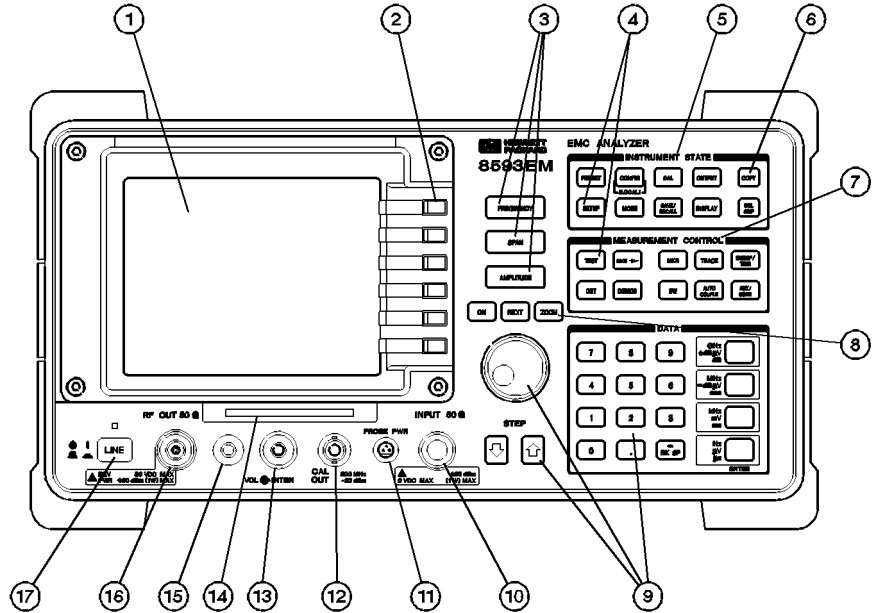

Figure 2-1. Front-panel feature overview.

- 1 **Front-Panel Display** is the area on the front-panel where information is provided to the user. That information includes the:
  - Active Function Block area. Functions appearing in this block include, for example, marker, span, center frequency, and reference level.
  - Message Block area. This block is where MEAS UNCAL and the asterisk (\*) appear. If one or more functions are manually set (uncoupled), and the amplitude or frequency becomes uncalibrated, MEAS UNCAL appears. (Press **AUTO COUPLE**, then **AUTO ALL**, to recouple functions.) The asterisk indicates that the display is not updated for new settings.
  - Softkey labels. Softkey labels are the annotation on the screen next to the unlabeled keys. Most of the labeled keys on the EMC analyzer's front panel (also called front-panel keys) access menus of related softkeys.
- 2 **Softkeys** are the unlabeled keys next to the screen.
- 3 **FREQUENCY**, **SPAN**, and **AMPLITUDE** are the three large dark-gray keys that activate the primary EMC analyzer tuning functions and access menus of related functions.
- 4 **SETUP** and **TEST** are the dark-gray keys that access menus of functions used to setup the instrument, then make fast and accurate EMC measurements.

- 5 **INSTRUMENT STATE** functions affect the state of the entire EMC analyzer. Self-calibration routines and special-function menus are accessed with these keys. The green **PRESET** key resets the entire EMC analyzer state and can be used as a “panic” button when you wish to return to a known state.

---

**Note**

If you wish to reset the EMC analyzer configuration to the state it was in when it was originally shipped from the factory, use **DEFAULT CONFIG**. Refer to the **DEFAULT CONFIG** softkey description in Chapter 17 for more information.

---

- 6 **COPY** key prints or plots screen data. Use **CONFIG**, **Plot Config** or **Print Config**, and **COPY DEV PRNT PLT** before pressing **COPY**.

- 7 **MEASUREMENT CONTROL** functions access menus that allow you to make manual or automated quasi-peak average measurements, adjust the IF bandwidth, adjust the sweep time, store and manipulate trace data, demodulate signals, control the markers, control the instrument display, and make measurements.
- 8 **WINDOWS** functions include **(ON)** to turn on the windows display mode, **(NEXT)** for switching between windows, and **(ZOOM)** for controlling the zone span and center frequency.
- 9 **DATA** keys, **STEP** keys, and **knob** allow you to change the numeric value of an active function.
- 10 **INPUT 50Ω** is the signal input for the spectrum analyzer.

---

**Caution**

Excessive signal input will damage the EMC analyzer input attenuator and the input mixer. The maximum power that the EMC analyzer can tolerate appears on the front panel.

---

**Note**

Excessive dc voltage can also damage the input attenuator. For your particular instrument, note the maximum dc voltage that should not be exceeded on the EMC analyzer front panel (under the INPUT 50Ω connector).

---

- 11 **PROBE PWR** provides the power for an active probe and other accessories.
- 12 **CAL OUT** provides a calibration signal of 300 MHz at 87 dB $\mu$ V.
- 13 **VOL-INTEN** changes the brightness of the screen display, and the volume of the speaker.
- 14 **Memory card reader** reads from a read-only (ROM) or random access (RAM) memory card. The memory card reader writes to a RAM card.
- 15 **100 MHz COMB OUT** is the output of the comb generator of the HP 8593EM and HP 8596EM EMC analyzers. The output is used to perform a **CAL YTF**.
- 16 **RF OUT 50 $\Omega$**  is the output for the built-in tracking generator. *Option 010 only.*
- 17 **LINE** turns the instrument on or off and performs an instrument check.

**Caution**

---

If the tracking generator output power is too high, it may damage the device under test. Do not exceed the maximum power that the device under test can tolerate.

---

**Table 2-1. RF Output Frequency Range**

<b>Model Number</b>	<b>Option 010 Frequency Range</b>
HP 8591EM	100 kHz to 1.8 GHz
HP 8593EM	9 kHz to 2.9 GHz
HP 8594EM	9 kHz to 2.9 GHz
HP 8595EM	9 kHz to 2.9 GHz
HP 8596EM	9 kHz to 2.9 GHz

**Note**

---

The instrument continues to draw power when it is plugged into the ac power source, even if the line power switch is off.

---

## Rear-Panel Features

The following section provides a brief description of rear-panel features.

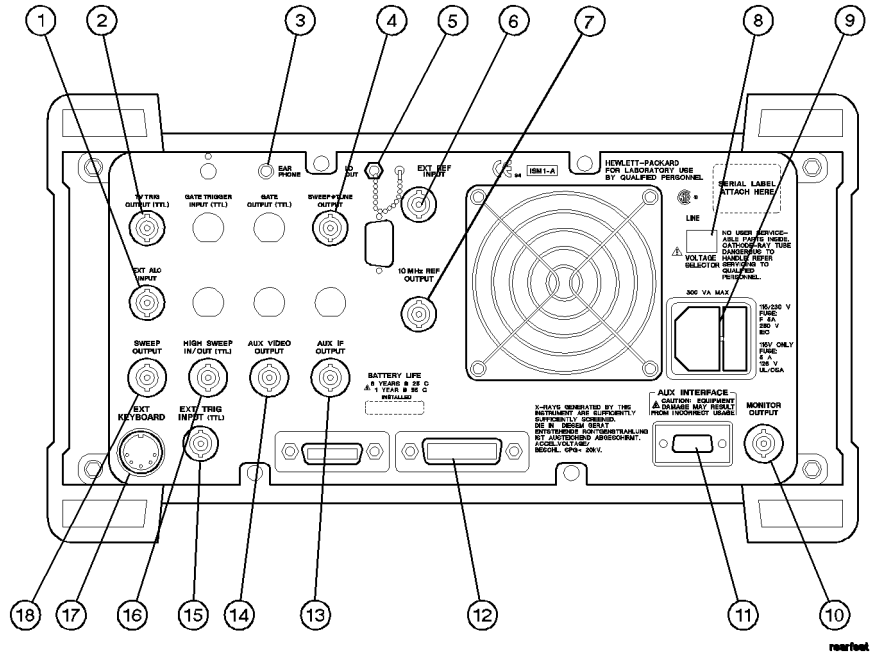

Figure 2-2. Rear-panel feature overview.

- 1 **EXT ALC INPUT** allows the use of an external detector or power meter for automatic leveling control of the tracking generator. Allows the use of an external detector *for an HP 8591EM, HP 8593EM, HP 8594EM, HP 8595EM, or HP 8596EM Option 010 only.*
- 2 **TV TRIG OUTPUT (TTL)** provides TV trigger output using TTL and negative-edge triggering. *For Options 101 and 102 combined or for Option 301.*
- 3 **EARPHONE** connector provides a connection for an earphone jack instead of using the internal speaker. *Not used in Option 703.*
- 4 **SWEEP + TUNE OUTPUT** provides a voltage ramp that is proportional to the EMC analyzer span (0 to 10 V) plus the tuning voltage of the LO. *For Option 009 only.*
- 5 **LO OUT** provides the output of the first LO, which is proportional to the frequency that the EMC analyzer is tuned to. *For Option 009 or 010 only.*

- 6 **EXT REF IN** accepts an external frequency source to provide the 10 MHz, -2 to +10 dBm frequency reference used by the EMC analyzer.
- 7 **10 MHz REF OUTPUT** provides a 10 MHz, 0 dBm minimum, time-based reference signal.
- 8 **VOLTAGE SELECTOR** adapts the unit to the power source: 115 V or 230 V.
- 9 **Power input** is the input for the line power source. Make sure that the line-power source outlet has a protective ground contact.
- 10 **MONITOR OUTPUT** drives an external monitor with a signal that has a 15.7 kHz horizontal synchronizing rate. It can also be switched to provide an NTSC format output which is compatible with VHS video recorders or a PAL format which is compatible with PAL/SECAM video recorders.
- 11 **AUX INTERFACE** provides a nine-pin "D" subminiature connector for control of external devices, such as the HP 85420E Option 1EM RF filter section. Refer to *HP 8590 EM Series EMC Analyzer Verification Guide* for a more detailed description.

---

**Caution**

Turn off the EMC analyzer before connecting the AUX INTERFACE connector to a device. Failure to do so may result in loss of factory-correction constants.

Do not exceed the current limits for the +5 V supply when using the AUX INTERFACE connector. Exceeding the current limits may result in loss of factory-correction constants.

Do not use the AUX INTERFACE as a video monitor interface. Damage to the video monitor will result.

---

- 12 **Interface connectors** are interfaces for HP-IB or RS-232 interface buses that support remote instrument operation and direct plotting or printing of screen data. Parallel interface supports parallel printing.
- 13 **AUX IF OUTPUT** is a 50 $\Omega$ , 21.4 MHz IF output that is the down-converted signal of the RF input of the EMC analyzer. Amplitude-correction factors are not applied to this signal.
- 14 **AUX VIDEO OUTPUT** provides detected video output (before the analog-to-digital conversion) proportional to vertical deflection of the trace. Output is from 0 V to 1 V. Amplitude-correction factors are not applied to this signal.
- 15 **EXT TRIG INPUT (TTL)** accepts the positive edge of an external voltage input that triggers the EMC analyzer internal sweep source.
- 16 **HIGH SWEEP IN/OUT (TTL)** indicates when the EMC analyzer is sweeping or can be grounded to stop sweeping.
- 17 **EXT KEYBOARD** connector is provided with the optional interface connector. The external keyboard is not included with the EMC analyzer. The external keyboard can be used to enter screen titles, prefixes, remote commands, and writing simple DLP's.

---

**Caution**

Turn off the EMC analyzer before connecting an external keyboard to the EMC analyzer.

---

- 18 **SWEEP OUTPUT** provides a voltage ramp proportional to the sweep and the EMC analyzer span (0 V to 10 V).



## Data controls

Data controls are used to change values for functions such as center frequency, start frequency, resolution bandwidth, and marker position.

The data controls will change the active function in a manner prescribed by that function. For example, you can change center frequency in fine steps with the knob, in discrete steps with the step keys, or to an exact value with the number/units keypad. For example, resolution bandwidth, which can be set to discrete values only, is changed to predetermined values with any of the data controls.

### Hold key

Deactivate functions with **HOLD** which is found under the **DISPLAY** key. The active function readout is blanked, indicating that no entry will be made inadvertently by using the knob, step keys, or keypad. (Pressing a function key re-enables the data controls.)

### Knob

The knob allows continuous change of functions, such as center frequency, reference level, and marker position. It also changes the values of many functions that change in increments only. Clockwise rotation of the knob increases values. For continuous changes, the extent of alteration is determined by the size of the measurement range; the speed at which the knob is turned does not affect the rate at which the values are changed.

The knob enables you to change the center frequency, start or stop frequency, or reference level in smooth scrolling action. The smooth scrolling feature is designed to move the trace display to the latest function value as the knob is turned. When either center frequency or reference level is adjusted, the signal will shift right or left or up or down with the rotation of the knob before a new sweep is actually taken. An asterisk is placed in the message block (the upper right-hand corner of the EMC analyzer display) to indicate that the data on-screen does not reflect data at the current setting.

### Note

---

When using the knob to change frequency or amplitude settings, the trace data is shifted. Therefore, when using **MAX HOLD A**, **MAX HOLD B**, or **MIN HOLD C**, moving the center frequency with the knob will not simulate a drifting signal.

---

### Number/units keypad

The number/units keypad allows entry of exact values for many of the EMC analyzer functions. You may include a decimal point in the number portion. If not, the decimal point is placed at the end of the number.

Numeric entries must be terminated with a units key. The units keys change the active function in a manner prescribed by that function. For example, the units keys for frequency span are **GHz**, **MHz**, **kHz**, and **Hz**, whereas the units for reference level are **+dBμV**, **-dBμV**, **mV**, and **μV**.

**Note**

---

If an entry from the number/units keypad does not coincide with an allowed function value (for example, that of a 12 MHz bandwidth), the EMC analyzer defaults to the nearest allowable value.

---

**Step keys**

The step keys allow discrete increases or decreases of the active function value. The step size depends upon the EMC analyzer measurement range or on a preset amount. Each press results in a single step change. For those parameters with fixed values, the next value in a sequence is selected each time a step key is pressed. Changes are predictable and can be set for some functions. Out-of-range values or out-of-sequence values will not occur using these keys.

**Fine-focus control**

The fine-focus control is located on the side of the EMC analyzer. Use the following procedure to adjust the fine-focus control:

1. Adjust the front-panel intensity control for a comfortable viewing intensity.
2. Use an adjustment tool or small screwdriver to access the fine-focus adjustment. Refer to Figure 2-3. Adjust for a focused display.

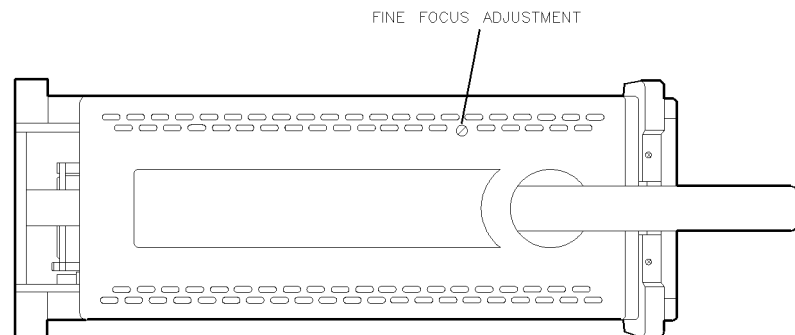

**Figure 2-3. Adjusting the fine focus.**

## EMC Analyzer Screen Annotation

Figure 2-4 shows an example of screen annotation as it appears on the screen of the EMC analyzer. Table 2-2 lists the screen annotation features numerically and refers to Figure 2-4.

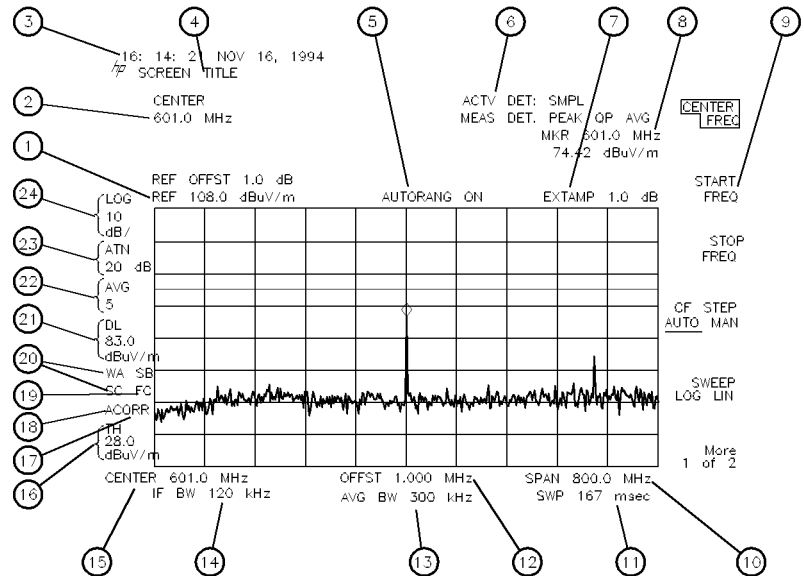

**Figure 2-4. EMC analyzer screen annotation.**

In Figure 2-4, item number 19 refers to the trigger and sweep modes of the EMC analyzer. The first letter (“F”) indicates the EMC analyzer is in free-run trigger mode. The second letter (“S”) indicates the EMC analyzer is in single-sweep mode. (“C”) indicates the EMC analyzer is in continuous-sweep mode.

Item number 20 refers to the trace modes of the EMC analyzer. The first letter (“W”) indicates the EMC analyzer is in clear-write mode. The second letter is “A,” representing trace A. The next two letters (“SB”) indicate the store-blank mode (“S”) for trace B (“B”). The trace mode annotation for trace C is displayed under the trace mode annotation of trace A. In Figure 2-4, the trace C trace mode is “SC,” indicating trace C (“C”) is in the store-blank mode (“S”).

The WINDOWS display mode splits the screen into two separate displays. Only one of these displays is active at a time. The active window will have a solid line around the graticule, rather than a broken line. The complete annotation is not available for each window because of space limitations.

**Table 2-2. EMC Analyzer Screen Annotation**

Item	Feature	Item	Feature
1	reference level	16	threshold
2	active function block	17	corrections factors on
3	time/date and command line	18	amplitude correction
4	screen title		factors on
5	autorange	19	trigger
6	active and measurement detector	20	trace mode
7	external preamp	21	display line
8	marker	22	video average
9	softkeys	23	attenuator setting
10	frequency span or stop frequency	24	amplitude scale
11	sweep time		
12	frequency offset		
13	AVG bandwidth		
14	IF bandwidth		
15	center or stop frequency		

Table 2-3 shows the different screen annotation codes for trace, trigger, and sweep modes.

**Table 2-3. Screen Annotation for Trace, Trigger, and Sweep Modes**

Trace Mode	Trigger Mode	Sweep Mode
W = clear-write (traces A/B/C)	F = free run	C = continuous
M = maximum hold (traces A/B)	L = line	S = single sweep
M = minimum hold (trace C)	V = video	
V = view (traces A/B/C)	E = external	
S = store-blank (traces A/B/C)	T = TV ( <i>Options 101 and 102 only</i> )	

---

## Menu and Softkey Overview

The keys labeled FREQUENCY, CAL, and MKR are all examples of front-panel keys. Pressing most front-panel keys accesses menus of functions that are displayed along the right side of the display. These menus are called softkey menus.

Softkey menus list functions other than those accessed directly by the front-panel keys. To activate a function on the softkey menu, press the unlabeled key immediately to the right of the annotation on the screen. The unlabeled keys next to the annotation on the display screen are called softkeys.

Front-panel keys are designated with a box around the key label, for example, **AMPLITUDE**; softkeys are designated by shading on the key label, for example, REF LVL. The softkeys that are displayed depend on which front-panel key is pressed and which menu level is enabled.

If a softkey function's value can be changed, it is called an active function. The function label of the active function appears in inverse video. For example, press **AMPLITUDE**. This calls up the softkey menu of related amplitude functions. Note the function labeled REF LVL appears in inverse video. REF LVL also appears in the active function block, indicating that it is the active amplitude function and can now be changed using any of the data entry controls.

A softkey with ON and OFF in its label can be used to turn the softkey's function on or off. To turn the function on, press the softkey so that ON is underlined. To turn the function off, press the softkey so that OFF is underlined. The following example demonstrates how an ON or OFF softkey function will be annotated:  
VID AVG ON OFF (ON).

A function with AUTO and MAN in the label can either be auto-coupled or have its value manually changed. The function's value can be changed manually by pressing the softkey until MAN is underlined, and then changing its value with the numeric keypad, knob, or step keys. To auto-couple a function, press the softkey so that AUTO is underlined. The following example demonstrates how an AUTO or MAN softkey function will be annotated:  
ATTEN AUTO MAN (AUTO).

A summary of all front-panel keys and their related softkeys can be found in Chapter 16, "Key Menus".

---

## Making a Basic Measurement

Basic measurements simply involve tuning the instrument to place a signal on the screen, then placing a marker on one or more signals, measuring those signals, and moving those signals to a list.

### Caution

---

Do not exceed the maximum input power that is printed on the front panel of the EMC analyzer.

---

Let's begin using the EMC analyzer by measuring an input signal. Since the 300 MHz calibration signal (CAL OUT) is readily available, we will use it as our input signal.

1. Turn the instrument on and press:

**PRESET**

2. Verify that the start frequency is set to 200 MHz and the stop frequency to 1.0 GHz. If not, the instrument has been configured as a spectrum analyzer. Press:

**MODE**

**EMC ANALYZER**

3. Connect CAL OUT to the EMC analyzer INPUT 50Ω connector (on the front panel) using an appropriate BNC cable and a BNC-to-Type N adapter.

*Option 026 only:* Connect the SMA (m) to SMA (m) cable to the EMC analyzer input with an APC-3.5 connector. Connect the cable to CAL OUT with the BNC-to-SMA adapter.

To access the marker, press:

**TEST**

MARKER is now displayed in the active function block, and the MARKER softkey label appears in inverse video to indicate that the marker is the active function. Place the marker on a signal by pressing:

**⇓**

Refer to Figure 2-5.

16: 23: 21 NOV 16, 1994

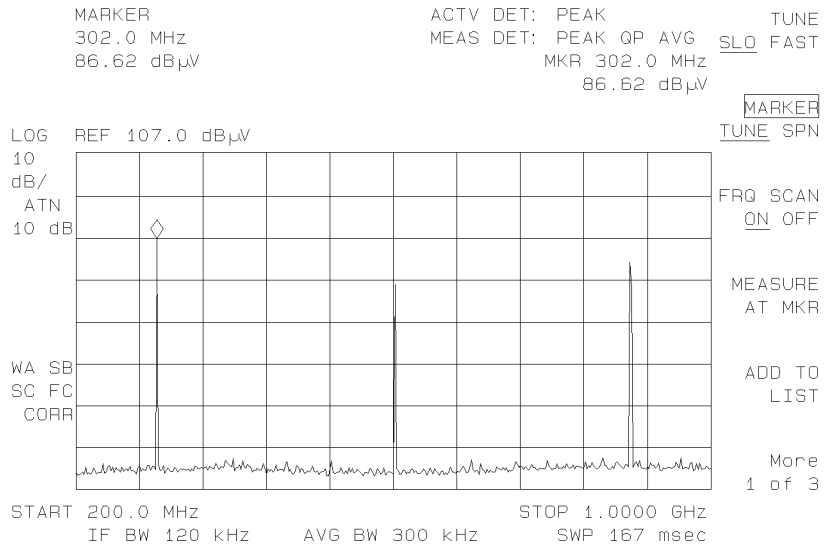

**Figure 2-5. Placing the marker on a signal.**

4. The measured marker values are displayed in the upper-right corner of the display after pressing:

**MEASURE AT MKR**

5. The measure-at-marker results are saved to an internal list by pressing:

**ADD TO LIST**

Signal Added is now displayed on the screen.

6. To place the marker on a second signal, press:

**↑** (one or more times)

7. To add the second signal to the internal list, press:

**MEASURE AT MKR**

**ADD TO LIST**

Repeat the process and place a third signal in the internal list.

8. To display the list on the screen, press:

More 1 of 3

SIG LIST ON OFF

The measure-at-marker results in the form of a list are displayed on the upper portion of the screen. Refer to Figure 2-6.

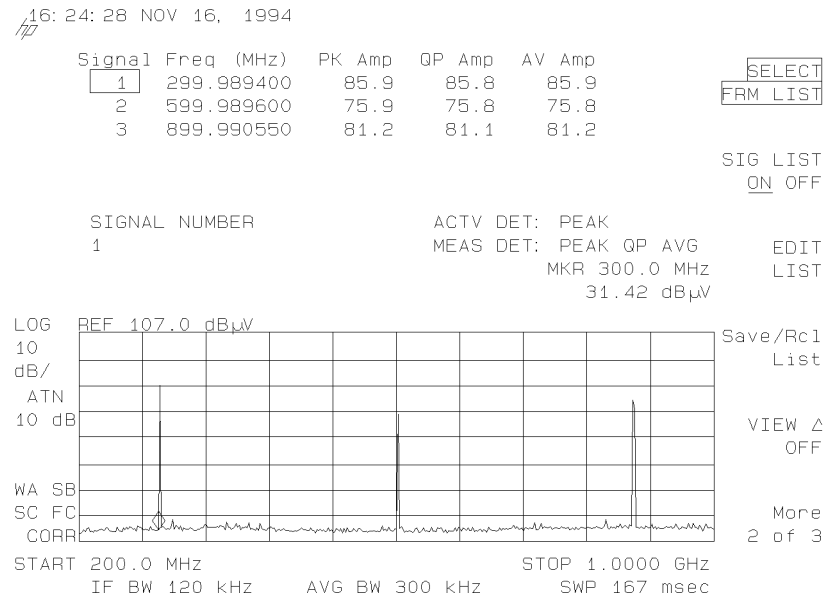

Figure 2-6. Displaying a list on the screen.



9. The list can be graphed on screen in either log or linear frequency scales by pressing:

**Save/Rcl List**

10. To view the signals in the list on a log graph, press:

**SAVE LOG GRAPH**

11. To clear the display's active function area, press:

**ENTER**

Refer to Figure 2-7.

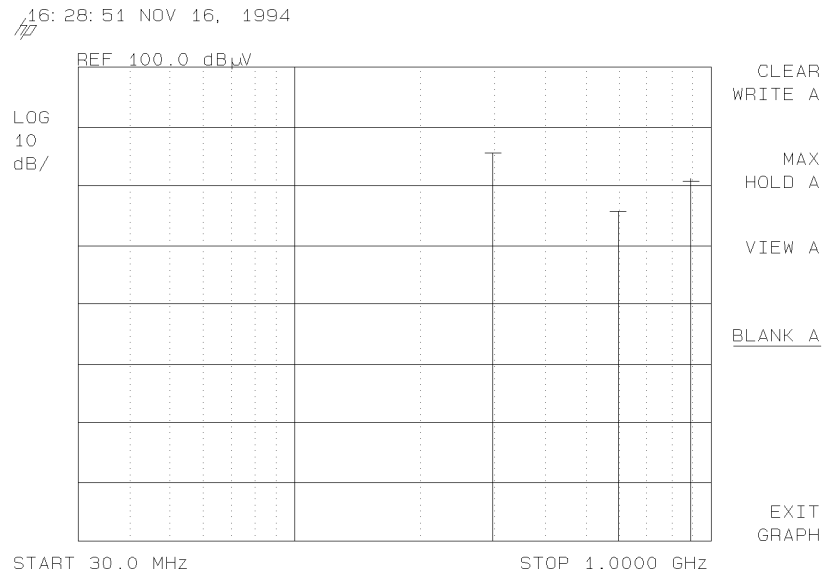

**Figure 2-7. Displaying the list as a log graph.**

**Note**

If the EMC analyzer is connected to either a printer or plotter:

- Press the **COPY** key to obtain a printed copy of the graph. Changing the configuration may be required, or
- Press the **OUTPUT** key to access the softkeys that will help you:
  - define a report.
  - define a list.
  - add up to two pages of text using a keyboard.

12. To return the instrument to a known state, press:

**PRESET**

## Spectrum Analyzer Mode Screen Annotation

Figure 2-8 shows an example of screen annotation as it appears on the screen of the EMC analyzer when in the **SPECTRUM ANALYZER** mode. Instrument modes are changed using the **(MODE)** front-panel key. Table 2-4 lists the screen annotation features numerically and refers to Figure 2-8.

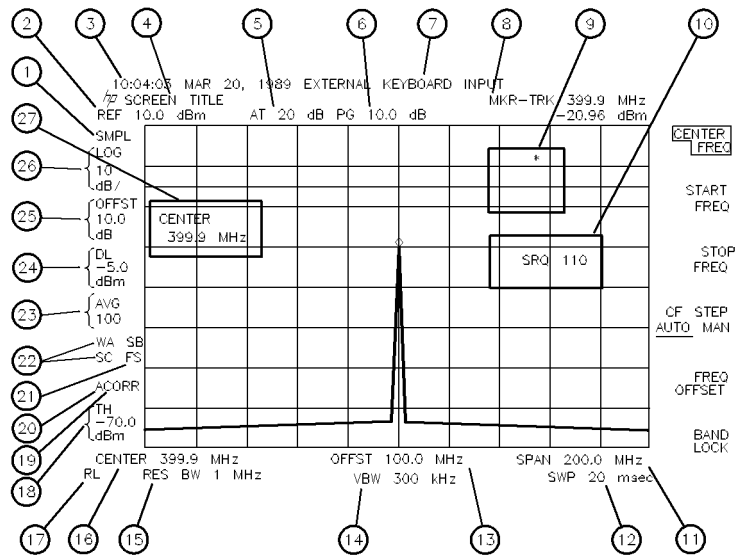

pu17de

**Figure 2-8. Spectrum analyzer mode screen annotation.**

In Figure 2-8, item number 21 refers to the trigger and sweep modes of the spectrum analyzer. The first letter (“F”) indicates the spectrum analyzer is in free-run trigger mode. The second letter (“S”) indicates the spectrum analyzer is in single-sweep mode.

Item number 22 refers to the trace modes of the spectrum analyzer mode. The first letter (“W”) indicates the spectrum analyzer is in clear-write mode. The second letter is “A,” representing trace A. The next two letters (“SB”) indicate the store-blank mode (“S”) for trace B (“B”). The trace mode annotation for trace C is displayed under the trace mode annotation of trace A. In Figure 2-8, the trace C trace mode is “SC,” indicating trace C (“C”) is in the store-blank mode (“S”).

The WINDOWS display mode splits the screen into two separate displays. Only one of these displays is active at a time. The active window will have a solid line around the graticule rather than a broken line. The complete annotation is not available for each window because of space limitations.

**Table 2-4.  
Spectrum Analyzer Mode Screen Annotation**

<b>Item</b>	<b>Feature</b>	<b>Item</b>	<b>Feature</b>
1	detector mode	14	video bandwidth
2	reference level	15	resolution bandwidth
3	time and date display	16	center frequency or start frequency
4	screen title	17	remote operation
5	RF attenuation	18	threshold
6	preamplifier gain	19	correction factors on amplitude correction
7	external keyboard entry	20	factors on
8	marker or signal track readout	21	trigger
9	measurement-uncalibrated or function-in-progress messages	22	trace mode
10	service request	23	video average
11	frequency span or stop	24	display line
12	frequency	25	amplitude offset
	sweep time	26	amplitude scale
13	frequency offset	27	active function block

Table 2-5 shows the different screen annotation codes for trace, trigger, and sweep modes.

**Table 2-5. Screen Annotation for Trace, Trigger, and Sweep Modes**

<b>Trace Mode</b>	<b>Trigger Mode</b>	<b>Sweep Mode</b>
W = clear-write (traces A/B/C)	F = free run	C = continuous
M = maximum hold (traces A/B)	L = line	S = single sweep
M = minimum hold (trace C)	V = video	
V = view (traces A/B/C)	E = external	
S = store-blank (traces A/B/C)	T = TV ( <i>Options 101 and 102 only</i> )	



# Calibration

---

## What you'll find in this chapter

This chapter describes procedures for calibrating the EMC analyzer. In this chapter you will:

- improve accuracy with self-calibration
- learn to use the memory card
- set the analyzer clock
- set the AutoCal time

---

## Improving Accuracy with Self-Calibration Routines

Data from the self-calibration routine is necessary for EMC analyzer operation. Executing the self-calibration routine regularly ensures that the EMC analyzer is using current calibration data that improves the EMC analyzer frequency and amplitude accuracy. Press the **CAL** key to view the self-calibration routine menus. The last softkey on this menu, labeled **More 1 of 4**, provides access to additional self-calibration functions. For more detailed information on the self-calibration softkeys, refer to Chapter 17, “Key Dictionary”.

The self-calibration routines add correction factors to internal circuitry. The addition of the correction factors is required to meet frequency and amplitude specifications.

When the correction factors are added to internal circuitry, CORR (corrected) appears on the left side of the screen.

### Warm-up time

In order for the EMC analyzer to meet its specifications, allow the EMC analyzer to warm up for 30 minutes, after being turned on, before attempting to make any calibrated measurements. Be sure to calibrate the EMC analyzer only *after* it has met operating temperature conditions.

The EMC analyzer frequency and amplitude self-calibration routines are initiated by the **CAL FREQ & AMPTD** softkey in the menu located under the **CAL** key.

1. To calibrate the instrument, connect the EMC analyzer CAL OUT to the INPUT 50Ω connector with an appropriate cable.

---

**Note**

A low-loss cable should be used for accurate calibration. Use the 50Ω cable shipped with the EMC analyzer.

---

2. On the EMC analyzer, press:

**CAL**

**CAL FREQ & AMPTD**

Cal signal not found will be displayed if CAL OUT is not connected to the EMC analyzer input. The frequency and amplitude self-calibration functions take approximately 5 minutes to finish, at which time the internal adjustment data is in working RAM.

3. To save this data in the area of EMC analyzer memory that is saved when the EMC analyzer is turned off, press:

**CAL STORE**

---

**Note**

To interrupt the calibration routines started by **CAL FREQ**, **CAL AMPTD**, or **CAL FREQ & AMPTD**, press **PRESET**, **CAL**, **More 1 of 4**, and **CAL FETCH**. **CAL FETCH** retrieves the previous correction factors. Improperly interrupting the self-calibration routines may result in corrupt correction factors. (If this occurs, press **CAL FREQ & AMPTD** to rerun the frequency and amplitude self-calibration routines.)

---

The frequency and amplitude self-calibration functions can be done separately by using the **CAL FREQ** or **CAL AMPTD** softkeys instead of **CAL FREQ & AMPTD**.

---

**Note**

If the frequency calibration **CAL FREQ** and the amplitude calibration **CAL AMPTD** self-calibration routines are used, the frequency calibration should be performed before the amplitude calibration, unless the frequency data is known to be accurate.

---

The **CAL FREQ** softkey starts the frequency self-calibration routine. This routine adjusts the frequency, sweep time, and span accuracy in approximately 2 minutes.

The **CAL AMPTD** softkey starts the amplitude calibration routine. This routine takes approximately 3 minutes to adjust the bandwidths, log and linear switching, IF gains, IF frequency centering, RF attenuation, and log amplifier. When the amplitude calibration routine has finished, the preset display returns and **CAL DONE** is displayed.

Although the EMC analyzer stores the correction factors in battery-backed RAM, the data will not be saved when the EMC analyzer power is turned off unless the data has been stored with **CAL STORE**. Using **CAL STORE** stores the correction factors in an area of EMC analyzer memory that is accessed when the EMC analyzer is turned on. After the frequency and amplitude self-calibration routines are complete, **CORR** (corrected) now appears

on the left side of the screen, indicating that the EMC analyzer is using its frequency and amplitude correction factors. Correction factors can be turned off by pressing **CORRECT ON OFF**. When OFF is underlined, most amplitude correction factors and some frequency correction factors are not used.

If the self-calibration routines cannot be performed, refer to “Check the Basics” in Chapter 15.

---

**Note**

When used with an *HP 85420E Option 1EM* RF filter section, the filter section must be disconnected from the analyzer prior to performing the self-calibration routines.

---

## Performing the tracking generator self-calibration routine (Option 010 only)

In order for the tracking generator to meet its specifications, allow the EMC analyzer to warm up for 30 minutes, after being turned on, before attempting to make any calibrated measurements. Be sure to calibrate the EMC analyzer and the tracking generator only *after* the EMC analyzer has met operating temperature conditions.

---

**Note**

Since the tracking-generator self-calibration routine uses the absolute amplitude level of the EMC analyzer, the EMC analyzer amplitude should be calibrated prior to using **CAL TRK GEN**.

---

1. To calibrate the tracking generator, connect the tracking generator output (RF OUT 50Ω) to the EMC analyzer INPUT 50Ω connector, using an appropriate cable and adapters.

---

**Note**

A low-loss cable should be used for accurate calibration. Use the 50Ω cable shipped with the EMC analyzer.

---

2. To calibrate the tracking generator, press:

```
CAL
More 1 of 4
More 2 of 4
CAL TRK GEN
```

TG SIGNAL NOT FOUND will be displayed if the tracking generator output is not connected to the EMC analyzer input.

3. To save this calibration data in the area of EMC analyzer memory that is saved when the EMC analyzer is turned off, press:

```
CAL
CAL STORE
```

## Performing the YTF self-calibration routine

*HP 8593EM, HP 8595EM, or HP 8596EM only*

For *HP 8593EM, HP 8595EM, and HP 8596EM* EMC analyzers only, the YTF self-calibration routine should be performed periodically. Refer to “When Is Self-Calibration Needed?” in the following section for some helpful guidelines on how often the self-calibration routines should be performed.

1. For the *HP 8593EM and HP 8596EM*, connect a low-loss cable (such as HP part number 8120-5148) from 100 MHz COMB OUT to the EMC analyzer input. For the *HP 8595EM*, connect the cable from the CAL OUT to the EMC analyzer input.
2. To calibrate, press:

```
CAL
More 1 of 4
More 2 of 4
More 3 of 4
CAL YTF
```

The YTF self-calibration routine completes in approximately:

<u>Model Number</u>	<u>Calibration Time</u>
HP 8593EM	7 minutes
HP 8595EM	3 minutes
HP 8596EM	5 minutes

3. To save the calibration factors in memory, press:

```
CAL
CAL STORE
```

4. To return to normal operation, press:

```
PRESET
```

## When is self-calibration needed?

While it is difficult to provide general advice for your specific measurement needs, the following suggestions may help you decide when to use the self-calibration features:

1. Perform the frequency and amplitude self-calibration routines whenever the instrument experiences significant environmental changes such as temperature ( $\pm 5$  °C), humidity, shock, or vibration (such as may occur during shipping or transport). This is especially important if the frequency and amplitude self-calibration routines were performed the last time in a different environment.
2. If the environment is relatively stable (for example, a lab environment), use `CAL FREQ & AMPTD` monthly. After being turned off overnight, the EMC analyzer will need to warm up, but should not require self-calibration.



3. To achieve optimal amplitude accuracy for relative measurements:
  - a. Keep the EMC analyzer in a stable environment.
  - b. Use **CAL FREQ & AMPTD** before beginning the first measurement.
  - c. Keep the EMC analyzer turned on between measurements.
  - d. Do not use **CAL FREQ & AMPTD** before subsequent measurements (the amplitude drift is normally smaller than the self-calibration uncertainty).
4. If you change the input signal for EXT REF IN, run the frequency and amplitude self-calibration routines using CAL OUT. Amplitude calibration is required to improve IF centering.
5. If preselector peaking (**PRESEL PEAK**) has more than a 2 dB effect on the signal amplitude when in BAND 1 or above, and in a single band sweep, then perform the YTF self-calibration routine and store the data with **CAL STORE**. The YTF self-calibration routine improves the preselector default values. (*HP 8593EM, HP 8595EM, or HP 8596EM only.*)
6. If accurate self-calibration is needed temporarily in a different environment, use **CAL FREQ & AMPTD**, but do not press **CAL STORE**. The temporary correction factors will be used until the EMC analyzer is turned off or until **CAL FETCH** is pressed.

---

## Memory Card Insertion and Battery Replacement

Use the following information to ensure that the memory card is inserted correctly. Improper insertion causes error messages to occur, but generally does not damage the card or instrument. Care must be taken, however, not to force the card into place. The cards are easy to insert when installed properly.

1. Locate the arrow printed on the card's label.
2. Insert the card with its arrow matching the raised arrow on the bezel around the card-insertion slot. Refer to Figure 3-1.

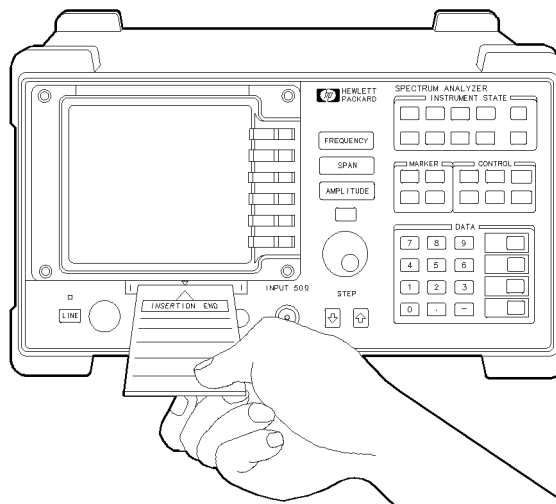

**Figure 3-1. Inserting the memory card.**

3. Press the card into the slot. When correctly inserted, about 19 mm (0.75 in) of the card is exposed from the slot.

## Changing the memory card battery

It is recommended that the memory card battery be changed every 2 years. The battery is a lithium commercial CMOS type battery, part number CR 2016.

---

### Note

The minimum lifetime of the battery (under ordinary conditions) is more than 2 years.

---

The date that the memory card battery was installed is either engraved on the side of the memory card or written on a label on the memory card.

If the memory card does not have a label with the date that the battery was installed, use the date code engraved on the side of the memory card. The date code engraved on the memory card consists of numbers and letters engraved in the black plastic on the side of the memory card. Refer to Figure 3-2. The first number indicates the year, the following two characters indicate the month, and the following number indicates the week in the month that the memory card battery was installed. For example, 80C3 indicates the battery was installed in the third week in October in 1988.

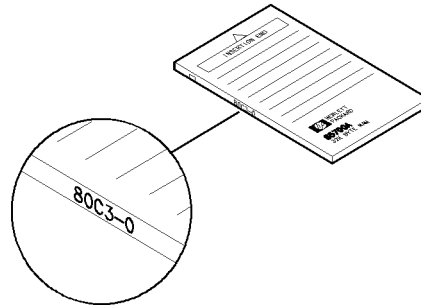

**Figure 3-2. Memory card battery date code location.**

### Procedure to change the memory card battery

The battery is located beside the card's write-protect switch on the end opposite the connector.

#### Caution

The battery power enables the memory card's memory to retain data. You can lose the data when the battery is removed. Replace the battery while the card is installed in a powered-up instrument.

1. Locate the groove along the edge of the battery clip. Refer to Figure 3-3.
2. Gently pry the battery clip out of the card. The battery fits within this clip.
3. Replace the battery, making sure the plus (+) sign on the battery is on the same side as the plus (+) sign on the clip.
4. Insert the battery clip into the memory card, holding the clip as oriented in Figure 3-3. (Face the "open" edge of the clip toward the write-protect switch on the memory card.)
5. Write the date that the battery was replaced on the memory card label. This will help you to remember when the battery should be replaced.

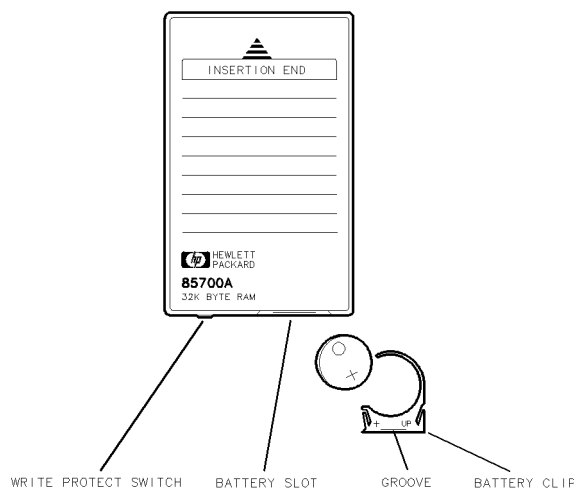

**Figure 3-3. Memory card battery replacement.**

---

## Analyzer Battery Information

The HP 8590 EM series EMC analyzers use a 3.6 V lithium battery to enable the EMC analyzer memory to retain data. The date when the battery was installed is on a label on the rear panel of the EMC analyzer. Refer to Figure 3-4.

The minimum life expectancy of the battery is 8 years at 25 °C, or 1 year at 55 °C. If you experience problems with the battery or the recommended time period for battery replacement has elapsed, refer to “Returning the EMC Analyzer for Service” in Chapter 15.

If you wish to replace the battery yourself, you can purchase the service documentation that provides all necessary test and maintenance information. The battery is soldered onto the EMC analyzer processor board.

You can order the service documentation for an HP 8590 EM series EMC analyzer through your HP Sales and Service office. The documentation is described under “Service Documentation (Option 915)” in Chapter 18 of this manual.

After replacing the EMC analyzer battery, write the date of battery replacement on the rear-panel label.



pu132e

**Figure 3-4. Rear-panel battery information label.**

## Using the AutoCal function

The AutoCal function enables you to select a time at which it would be convenient to have the calibration performed. If the Autocal function is ON when the analyzer's internal clock reaches the "AutoCal Time," a calibration will be performed.

### Setting the analyzer's clock

1. To set the clock, press:

**CONFIG**

Time Date

TIMEDATE ON OFF ON

**SET TIME** Use the numeric keys to enter the time in an HHMMSS format.

2. To terminate the entry, press:

**ENTER**

3. To set the date, press:

**SET DATE** Use the numeric keys to enter the date in an YYMMDD format.

4. To terminate the entry, press:

**ENTER**

### Setting AutoCal time

1. To set the time at which you wish to have the automatic calibration performed, press:

**CAL**

Cal At Time

**SET TIME** Use the numeric keys to enter the time in an HHMMSS format.

2. To terminate the entry, press:

**ENTER**

3. To initialize automatic calibration, press:

**AUTO CAL ON OFF ON**

### Note

---

When the automatic calibration function is ON, the calibration will be performed at the set time, even if the analyzer is in use. To successfully complete a calibration, the CAL OUT must be connected to the INPUT 50Ω.

---

## Making Pre-compliance Measurements

---

### What you'll find in this chapter

This chapter describes how to configure the EMC analyzer to make pre-compliance measurements, view and measure signals with the desired detectors, store these measurements to the internal list and create a report. The measurement examples presented in this chapter are:

- Setting Up a Measurement Using the SETUP Key
  - Using standard configurations
- Configuring Pre-compliance Systems for Radiated Emissions Testing
  - Using complete configurations from a memory card
  - Customizing the standard configurations
  - Loading user-defined configurations from a card
  - Loading a limit line from a card
  - Loading an amplitude correction factor file from a card
  - Activating the windows display format
  - Saving a setup to card
- Making a Radiated Measurement Using the TEST Key
  - Tuning the receiver
  - Using a marker to tune the analyzer and mark a signal
  - Making a measurement, saving the data in the list, and viewing the list
- Creating a Report Using the OUTPUT Key
  - Configuring a printer or plotter
  - Defining and producing a report
- Configuring Pre-compliance Systems for Conducted Emissions Testing
- Making a Conducted Measurement

---

## Introducing the SETUP, TEST, and OUTPUT Keys

The functions associated with the **SETUP**, **TEST**, and **OUTPUT** keys have been optimized to match the operations found in nearly all EMC measurements. These functions make it possible to gather and output data with a minimum number of keystrokes. The centralization of control provides a fast, easy way for you to configure the analyzer, gather data and generate reports. It also provides a base from which to learn the other powerful measurement and diagnostic features of the analyzer. The examples in this section describe the use of these functions to make radiated and conducted emissions measurements, and their interactions with other features of the instrument.

---

## Setting Up a Measurement Using the SETUP Key

To prepare the EMC analyzer to make pre-compliance measurements, the instrument settings must be appropriately configured. Optional procedures include displaying limit lines, activating amplitude-correction factors and opening the measurement windows.

The first level of menus, accessed by pressing the **SETUP** key, provide standard and user-defined configurations. The second, third, and fourth levels allow you to modify the standard configurations, and use limit lines and amplitude correction factors.

### Using standard configurations

The EMC analyzer provides four standard instrument configurations which simplify the process of preparing the analyzer to make measurements. The configurations are based on standard frequency ranges and are automatically selected by pressing the appropriate softkey. The settings unique to each configuration are shown in Table 4-1.

**Table 4-1. Standard Configurations**

<b>MENU LABEL Start/Stop Frequency</b>	<b>IF Bandwidth</b>	<b>Averaging Bandwidth</b>	<b>Reference Level</b>
9 kHz–150 kHz	200 Hz CISPR	300 Hz	70 dB $\mu$ V
150 kHz–30 MHz	9 kHz CISPR	30 kHz	75 dB $\mu$ V
30 MHz–300 MHz	120 kHz CISPR	300 kHz	80 dB $\mu$ V
200 MHz–1 GHz	120 kHz CISPR	300 kHz	80 dB $\mu$ V



The instrument preset values are:

- Peak detector displayed
- Peak, quasi-peak and average detectors available (for more information, refer to “Selecting the measured detectors” later in this chapter)
- Preamplifier off (when used with an RF filter section)
- RF and IF overload detection on (RF overload available with RF filter section)
- Autorange off

The settings common to all standard configurations are:

- 10 dB input attenuation
- Marker ON
- dB $\mu$ V units

---

## Pre-compliance System Configurations

The EMC analyzer comes with two memory cards:

EMC Setups, Limit Lines and Correction Factors.

Empty RAM card for storing user-defined setups, limit lines and correction factors

The memory card includes complete setups for, radiated, conducted, and diagnostic measurements and an auto-start program for radiated measurements. The empty card can be used to store user-defined settings. Refer to Chapter 12 and Appendix B for more information.

A typical radiated EMC measurement setup is shown in Figure 4-1. The setup shown uses the HP 84110EM Preproduction evaluation system.

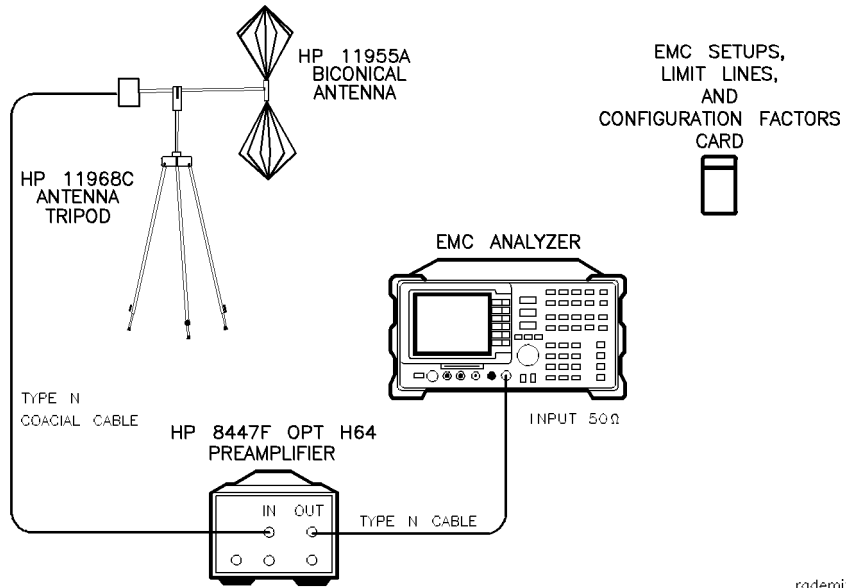

**Figure 4-1. Radiated EMC measurement test setup.**

**Equipment list**

EMC analyzer .....	HP 8591EM
	HP 8593EM
	HP 8594EM
	HP 8595EM
	HP 8596EM
EMC setup, limit lines, correction factors memory card .....	08590-10027
pre-amplifier .....	HP 8447F Option H64
biconical antenna .....	HP 11955A
antenna tripod .....	HP 11968C

**Configuring the system**

A complete setup can be read from the EMC setup, limit lines, correction factors memory card.

1. Insert memory card.
2. Connect CAL OUT to INPUT 50Ω.

**Loading pre-defined configurations from a card**

3. To select a pre-defined configuration from the card, insert the card into the card reader and press:

**SETUP**  
**RECALL SETUP**

The analyzer will catalog all setup files resident on the card. Use the keys or knob to highlight the file eSAMPLE\_R.

4. To load the highlighted file, press:

**LOAD FILE**

You can now continue the tutorial and complete the section, “Customizing the standard configurations” or proceed to the section, “Making a Radiated Measurement” later in this chapter.

## Customizing the standard configurations

The standard configurations can be modified to meet specific requirements. Frequency parameters (start, stop, and center span) are changed using the menus associated with the FREQUENCY key.

### Modifying start and stop frequencies

1. To change the start frequency, press:

**FREQUENCY**  
START FREQ ..... 150 **MHz**

2. To change the stop frequency, press:

STOP FREQ ..... 1100 **MHz**

### Modifying reference level and input attenuation

3. To set the reference level and input attenuation, press:

**AMPLITUDE**

4. To change the reference level, press:

REF LVL ..... 90 **+dB $\mu$ v**

5. To increase the input attenuation, press:

ATTEN AUTO MAN MAN ..... 20 **dB**

### Modifying IF and averaging bandwidths

The EMC analyzer offers measurement (CISPR) and diagnostic IF bandwidths as well as post-detection averaging bandwidths. The analyzer defaults to the measurement bandwidth appropriate for the current center frequency.

6. To select a different bandwidth, press:

**BW**

7. Each measurement bandwidth has its own softkey. To select a specific measurement bandwidth, press the appropriate key. To change to a diagnostic IF bandwidth, press:

IF BW AUTO MAN MAN ..... 100 **kHz**

8. Bandwidths may be selected by entering the desired value using the numeric keypad followed by the appropriate terminator, or by using the step keys or knob. To return the analyzer to the default setting, press:

IF BW AUTO MAN AUTO

9. The analyzer selects an averaging bandwidth appropriate for the selected IF bandwidth. To select a different averaging bandwidth, press:

AVG BW AUTO MAN MAN ..... 100 kHz

10. To set the analyzer to the default setting, press:

AVG BW AUTO MAN AUTO

### Selecting the active detector

The EMC analyzer can scan any one of the three available detectors. The currently active detector is indicated on the screen in the upper right-hand corner as the "ACTV DET." Refer to Figure 4-2. The default detector of the analyzer is the peak detector. The peak detector scans the measured spectrum faster than the other built-in detectors because of its short charge and discharge time constants.

11. To scan with the built-in quasi-peak or average detectors, press:

DET

QP ON OFF ON or AVG ON OFF ON

When using these detectors, the analyzer scans at a much slower rate due to longer time constants. Scan times are automatically selected to match the increased charge and discharge times. When making diagnostic measurements, it is possible to scan these slower detectors at a faster rate by reducing the sweep time. The analyzer will indicate this condition by displaying a "MEAS UNCAL" error message, as shown in Figure 4-2.

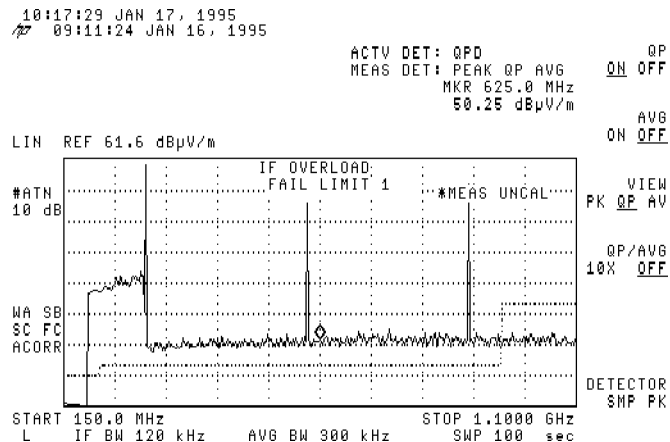

Figure 4-2. Active detector and measured detector messages.

12. Turn the scanning off by pressing:

QP ON OFF OFF

## Selecting the measured detectors

The **MEASURE AT MKR** softkey can be used to measure any of the three available detectors. The detectors selected to be measured are displayed in the upper right-hand corner of the screen labeled "MEAS DET". Refer to Figure 4-2. The default configuration makes all three detectors active. Selecting only the detectors you need reduces measurement time. The dwell time for each detector may be set independently.

13. To select the detectors to be measured and their dwell times, press:

```
SETUP
More 1 of 4
Measure Detector
```

14. Locate the **DETECTOR PK QP AV** softkey.

Notice each of the detector labels are underlined. This indicates they will all be measured.

Press the softkey. Notice some detectors are *not* underlined, and the detectors indicated next to MEAS DET onscreen have changed.

Continue pressing the softkey to observe the different possible combinations of detectors. When you are finished examining the combinations, make all three detectors active by pressing the following softkey until all three detectors are underlined.

```
DETECTOR PK QP AV PK QP AV
```

## Measuring detector dwell times

15. To modify the peak detector dwell time, press:

```
PK DWELL TIME ..... Enter the desired dwell time.
```

The current dwell time is indicated in the active function block.

16. To modify the dwell times for the quasi-peak and average detectors, press:

```
QP DWELL TIME ..... Enter the desired dwell time.
```

```
AV DWELL TIME ..... Enter the desired dwell time.
```

The current dwell time is indicated in the active function block.

### Note

---

The dwell times are added to the time required to obtain a valid detector reading, as dictated by the specific charge and discharge time constants. The total dwell time *cannot* be set below the required minimum value.

---

## Controlling autoranging

The autoranging feature allows the instrument to automatically change its sensitivity as needed to remove any RF or IF overloads that occur during operation.

**Note**

---

RF overload can only be detected when using an HP 85420E Option 1EM RF filter section.

---

The instrument will perform one autoranging activity per scan until the instrument is no longer in overload. To maximize sensitivity when the displayed frequencies are changed, the autoranging function will remove any corrective actions that were taken earlier, then autorange for the new conditions.

17. The following procedure can be used to activate autoranging:

```
SETUP
More 1 of 4
More 2 of 4
AUTORANG ON OFF ON
```

18. Autoranging can also be activated by pressing:

```
AMPLITUDE
AUTORANG ON OFF ON
```

**Using limit lines**

Two limit lines with margins can be displayed on the EMC analyzer. These limit lines can be used to visually determine whether displayed signals meet the appropriate limits. Margins are set relative to each of the limit lines, and are useful when taking into account any uncertainties that can exist in the entire measurement system.

If you wish to provide a margin of safety when testing to a limit, you may set a margin below the required limit. When the limit-test function is activated, the EMC analyzer automatically indicates onscreen whether or not a displayed signal passes or fails a displayed limit line or margin. When limit testing is activated, the analyzer automatically tests to either the limit line or the margin, whichever is lowest. Failures are indicated both onscreen and over the HP-IB bus. When performing limit testing with two limit lines and their associated margins, the analyzer automatically tests to the lowest of the four.

**Note**

---

When using the limit-test function, it is important to keep track of which detector output is being tested against which limit line. The peak detector is the default detector, however, most commercial limit lines indicate acceptable quasi-peak or average detector output levels. When viewing the peak detector output, it is possible to trigger a limit failure when testing against a quasi-peak limit line. This type of failure only indicates the need to remeasure the signal with the quasi-peak detector. It is quite possible for the peak value of an impulsive signal to exceed a quasi-peak limit, while the quasi-peak value of that same signal remains below the limit.

---

Refer to Chapter 9 for more information on entering and editing custom limit lines. Refer to Appendix B for a complete listing of the limit lines supplied on the memory card.

## Loading a limit line from the card

1. Set the analyzer to a known state by pressing:

```
PRESET
SETUP
200 MHz -1 GHz
AMPLITUDE
↑
```

2. Access the limit-line menu by pressing:

```
SETUP
More 1 of 4
Limit Lines
```

3. Insert the Setups, Limit Lines and Correction Factors card into the card reader. Load the IEN55022 Class A Radiated, 10 m limit file from the card by pressing:

```
RECALL LIMITS
```

Highlight 1EN022A10 using the step keys or knob.

4. To load the file, press:

```
LOAD FILE
```

The analyzer will automatically turn the limit lines on after it has finished loading the file.

5. Enter a -3 dB margin limit relative to limit line 1 by pressing:

```
Limit 1
MARGIN 1 ON OFF ON ..... 3 dB
```

The dotted margin line is displayed below the limit line. It can also be adjusted using the knob.

6. Turn limit testing on by pressing:

```
LMT TEST ON OFF ON
```

7. Test the functionality of limit-line testing by connecting CAL OUT to INPUT 50Ω.

The message "FAIL MARGIN 1" is displayed because the calibrator signal exceeds the margin line.

8. Turn the margin off by pressing:

```
SETUP
More 1 of 4
Limit Lines
Limit 1
MARGIN 1 ON OFF OFF
```

The message "FAIL LIMIT 1" is displayed because the calibrator signal now exceeds the limit line.

9. Disconnect the internal calibrator signal from INPUT 50Ω.

The message “PASS LIMIT” is displayed because no onscreen signals exceed the limit line.

## Using amplitude correction factors

The EMC analyzer can correct the displayed data to take into account the effects of any transducers, cables, preamps, or other two port devices used when making measurements. The corrections are made real-time, as the data is displayed onscreen. The EMC analyzer allows three types of amplitude-correction factors to be applied to the input signals.

### Correction factors

Conversion factors relating field strength to measured voltage.

Cable Factors Conversion factors to correct for cable insertion loss.

Other Factors Correction factors to account for the effects of any other two-port device placed between the antenna and the analyzer.

---

### Note

A total of 80 correction frequencies can be specified. They can be distributed among the three categories in any combination. A matrix of correction frequencies and amplitudes is entered for each category desired. The analyzer automatically sums the matrices and applies the net correction factor to the displayed data.

The amplitude-correction factor applied to the lowest selected frequency is also applied to all frequencies *below* the lowest selected frequency. The amplitude-correction factor applied to the highest selected frequency is also applied to all frequencies *above* the highest selected frequency. Refer to Chapter 10 and Appendix B for more detailed information.

---

### Note

A fourth type of amplitude-correction factor, called User Factors, is provided for backward capability with the A, B, C, D, E, and L-series. It is found under the **CAL** key. The methods described below also apply to User Factors.

---



## Loading an amplitude correction factor file from a card

Matrices can be loaded from a card or entered from the front panel. The following procedure describes how to load an antenna factor matrix from the Setups, Limit Lines, and Correction Factors card.

1. Set the analyzer to a known state by pressing:

PRESET  
SETUP  
200 MHz -1 GHz

2. Access the correction factors menu by pressing:

More 1 of 4  
Correctn Factors

3. Insert the EMC Setups, Limit Lines, Correction Factors card into the card reader.
4. Load the HP 11966D periodic antenna 200 MHz -1 GHz file from the card by pressing:

Antenna Factors  
RECALL ANTENNA

5. Highlight “nLOG\_PERD” using the step keys or knob.
6. To load the file, press:

LOAD FILE

The analyzer will automatically activate the correction factors after the file has been loaded. The noise floor will rise accordingly.

## Activating the windows display format

The windows display format can be used to provide a simultaneous display of both the entire frequency range of interest and a detailed subset of that range. This display format helps you keep track of all the signals in the entire spectrum while making measurements on a specific signal. When the windows display format is first activated, the initial trace is transferred into the upper overview window and a frequency span that is one-tenth the width of the current trace is actively scanned in the lower applications window. The span of the applications window is centered around either the center frequency of the overview window or the marker frequency that was active in the initial trace. All limit line and amplitude correction information that was active in the initial trace is automatically transferred to both the overview and applications window.

When using the windows display format, the information detailing the state of each window is simplified. Use the **ZOOM** key to expand the active display to full screen. A complete description of the window state is provided when in this full screen mode. Press the **ZOOM** key again to return to the windows display mode.

1. Before activating the windows display format, connect CAL OUT to INPUT 50Ω.
2. Set the analyzer to a known state by pressing:

```
PRESET
SETUP
200 MHz -1 GHz
More 1 of 4
More 2 of 4
AUTORANG ON OFF ON
MKR →
MARKER → HIGH
```

3. To activate the windows display format, press:

```
ON
```

Notice the initial trace has been moved to the overview window, and a ten percent span of that trace, centered around the marker, has been moved into the applications window.

4. To activate the overview window, press:

**NEXT**

The outline of the overview window is now highlighted, showing it to be the active window.

5. Activate the lower applications window again by pressing:

**NEXT**

The outline of the lower applications window is now highlighted.

By repeatedly pressing this softkey, the active trace control toggles between the upper overview window and the lower applications window.

6. To activate the zoom function, press:

**ZOOM**

Complete annotation of the active window state is provided when in the full-screen mode.

Press the **ZOOM** key again to return to the windows display mode.

7. To turn the windows mode off, press:

**ON**

**WINDOWS OFF**

---

## Making a Radiated Measurement

The main functions necessary for making pre-compliance measurements are located under the **TEST** key. These functions allow you to tune the analyzer, change the display of a signal by turning the scan on and off, point to the signal of interest with the marker, make a measurement of that signal, and enter that measurement into a data list.

### Tuning the analyzer

1. To access the measurement softkeys, press:

**TEST**

2. To tune to a new center frequency, press:

**TUNE SLO FAST**

and either,

- enter the desired value using the numeric keypad
- use the step keys
- rotate the knob to the desired center frequency

When entering a value with the numeric keys, the entry must be terminated by pressing one of the units keys, such as **MHz** or **GHz**. When adjusting the value using the step keys or knob, the units are entered automatically by the analyzer.

When the knob is used to enter the frequency, two tuning rates are available, slow and fast.

3. To change the rate at which the analyzer tunes when using the knob, press:

**TUNE SLO FAST FAST**

The slow rate is the default rate. It is calculated by the analyzer and is based on the scan width and the IF bandwidth. The fast rate is eight times greater than the slow rate.

You may toggle between the two rates by repeatedly pressing **TUNE SLO FAST**. The selected speed will be retained until it is changed, or an instrument preset is performed.

### Note

---

The frequency of the analyzer can also be changed by using the **CENTER**, **START**, and **STOP** functions. These functions are accessed by pressing the **FREQUENCY** key. The **SPAN** function, accessed by pressing the **SPAN** key, or the default user-softkey, can also be used to change the frequency of the analyzer.

---

## Using the marker to tune the analyzer

The marker function has two modes of operation. In tune mode, the analyzer retunes the center frequency while maintaining the current span when the marker is moved to either edge of the display. This is the default mode. In span mode, the analyzer will *not* retune the analyzer when the marker is moved to either the start or stop frequency of the current span.

1. To see how the tune and span modes work, set the analyzer to a known state by pressing:

**PRESET**

2. To use the internal calibrator as the test signal, connect CAL OUT to INPUT 50Ω.
3. Use the marker to point to the 300 MHz calibrator signal by pressing:

**TEST**

MARKER TUNE SPN ..... 300 MHz

4. Turn the windows display mode on by pressing:

**ON**

The 300 MHz calibrator signal is displayed in the center of the lower window.

The frequency span is 80 MHz.

5. Select the marker tune mode by pressing:

**TEST**

MARKER TUNE SPN TUNE

6. Rotate the knob clockwise until the marker reaches the right side of the window. As you continue to rotate the knob the analyzer changes frequencies. The zone marker is also moving in the upper overview window indicating the frequency range being displayed.
7. Continue rotating the knob until the 600 MHz calibrator signal is located in the center of the display.
8. Press the up-arrow (**↑**) step key. The analyzer retunes and the marker moves to the left edge of the display.
9. Press the up-arrow (**↑**) step key, again. The marker moves to the right edge of the display.
10. Continue pressing the up-arrow (**↑**) step key until the 900 MHz calibrator signal is displayed on the screen.
11. To change the marker mode to span, press:

MARKER TUNE SPN SPN

Note that when the knob is rotated counter-clockwise the analyzer does *not* retune when the marker reaches the edge of the display.

## Using the measure-at-marker function

The measure-at-marker function uses a built-in algorithm to simplify the process of taking data. Measurements are made by placing the marker on the signal of interest and then selecting the measure-at-marker function. The algorithm:

- locates the signal of interest
- turns the scan off at that signal
- optimizes the measurement dynamic range
- measures all detectors currently selected
- displays the results in the onscreen marker box

The marker box remains on the screen until the marker position or analyzer tuning is changed. The measure-at-marker results can be saved to the internal list by pressing **ADD TO LIST**. The contents of the internal list can be viewed and remeasured, as desired. Refer to Chapter 6 for more information.

The dwell time used for each detector can be adjusted using the dwell time function. Refer to the “Customizing Standard Settings” section earlier in this chapter for more information.

The following example shows how to:

- use the measure-at-marker function
- use the marker box
- store signals in the list
- view signals in the list

1. Set the analyzer to a known state by pressing:

**PRESET**

2. To use the internal calibrator signal as a test signal connect CAL OUT to INPUT 50Ω.

3. Activate the marker by pressing:

**TEST**

**MARKER TUNE SPN TUNE**

4. Rotate the knob until the marker is on the peak of the 300 MHz calibrator signal.

5. Measure the signal at the marker by pressing:

**MEASURE AT MKR**

The measured detector values are displayed on the screen in the marker box. Refer to Figure 4-3.

6. Save the measurement to the list by pressing:

**ADD TO LIST**

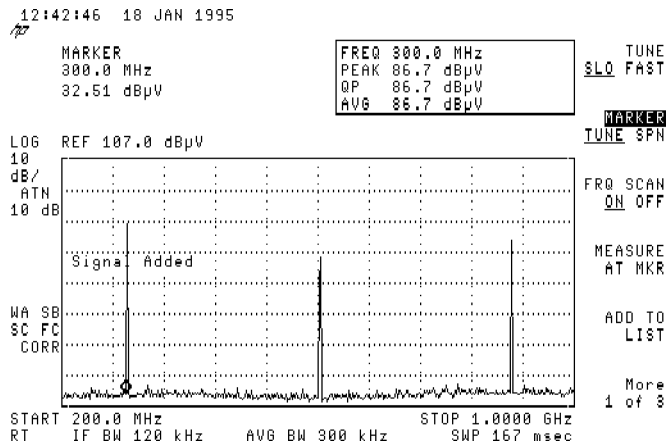

**Figure 4-3. Using the measure at marker function.**

7. Rotate the knob until the marker is on the peak of the 600 MHz calibrator signal, and then press:

**MEASURE AT MKR**

8. When the analyzer displays the measured values, press:

**ADD TO LIST**

9. Rotate the knob until the marker is on the peak of the 900 MHz calibrator signal, and then press:

**MEASURE AT MKR**

10. When the analyzer displays the measured values, press:

**ADD TO LIST**

11. Change the displayed span by pressing:

**SPAN** ..... 10 **MHz**

12. View the signals entered into the list by pressing:

**TEST**

**More 1 of 3**

**SIG LIST ON OFF ON**

Use the step keys to step through the list. The analyzer highlights the selection and automatically tunes to the indicated frequency. Refer to Chapter 6 for more information.

---

**Note**

- The measure-at-marker function uses an algorithm to sequentially reduce the frequency span until the peak of the signal of interest is displayed. After each span reduction, the marker moves to the largest signal present on the display. The analyzer indicates which signal it measured by leaving the marker at that signal. If you are measuring a small signal in the presence of a large signal, the algorithm may measure the larger signal. If this situation occurs, reduce the span until the larger signal is one major frequency division away from the smaller signal.
  - If using the measure-at-marker function to measure a pulsed signal with a repetition frequency of less than 5 Hz, set the sweep time to greater than or equal to the inverse of the pulse repetition frequency. (For example, to measure a 1 Hz CISPR pulse, set the sweep time to 1 second or greater prior to using the measure-at-marker function.)
  - Strong adjacent signals can affect measurement accuracy. The measure-at-marker algorithm detects when these signals may be interfering with the measurement and displays the message, “Strong adjacent signal”. The effects of strong signals can be reduced by increasing the input attenuation or, when making diagnostic measurements, by reducing the IF bandwidth.
-



## Using the auto-measure feature

Signals on the screen can be measured one at a time using measure-at-marker, or automatic measurements can be made using auto-measure.

1. Set the analyzer to a known state by pressing:

**PRESET**

2. Connect CAL OUT to INPUT 50Ω.

3. To measure the calibrator and all its on-screen harmonics, press:

**TEST**

More 1 of 3

More 2 of 3

**AUTO-MEASURE**

4. The three on-screen signals are measured as if individual measure-at-markers had been done and automatically added to the signal list.
5. To speed up the measurement, when a limit margin is on, only those signals above the limit margin are measured and added to the list. Refer to Chapter 9.

---

### Note

AUTO-MEASURE may measure the same signal multiple times in a wide span with multiple closely spaced signals. To prevent this from occurring, narrow the span until no more than 20-30 signals are on the screen. To remove duplicate signals from the list, refer to Chapter 5.

---

---

## Creating a Report

Data collected in the internal list can be printed in a report. The report can consist of any of the following elements:

- the user comments (annotations)
- a tabular list of the data
- a graph of the data in the list on either a linear or logarithmic frequency axis with the limit lines that are currently displayed
- a listing of the instrument setup parameters, including limit-line and amplitude-correction files

---

### Note

Only the graph can be sent to a plotter.

---

## Configuring a printer

The instrument supports a variety of printers. The analyzer must be configured correctly to operate with a specific printer type. Configuration options include:

- printer type
- HP-IB address of the printer
- menu printing enabled

The configuration information is used when printing with either the **(COPY)** key or the **OUTPUT REPORT** softkey (located on the **(OUTPUT)** key menu).

The following procedure configures the analyzer to print to an HP DeskJet printer.

1. Access the printer configuration menu by pressing:

**(CONFIG)**

2. To use a DeskJet 550C printer, press:

```
Print Config
Set Colr Printer
DESKJET 310/550C
```

---

### Note

The default printer is an HP black and white printer.

---

3. Set the HP-IB address of the printer. Enter the last two numbers of the address assigned to the printer. For example, if the printer address is 1, enter 01 by pressing:

```
Previous Menu
Prn Port Config
PRINTER ADDRESS ..... 01
```

4. Confirm the entry by pressing:

**(ENTER)**

## Configuring and generating a report

Use the list that was created in the section “Using the measure-at-marker function” earlier in this chapter for this procedure.

1. Access the report definition menu by pressing:

```
OUTPUT
Define Report
```

2. Verify that all report definitions are set to on (default mode), by selecting the following softkey settings:

```
ANNOTATN ON OFF ON
LOG ON OFF ON
LIN ON OFF ON
LIST ON OFF ON
SETTINGS ON OFF ON
```

3. To modify the list, press:

```
Previous Menu
Define List
```

The display of the data in the list can be tailored to meet your needs. You can:

- Select which of the measured detectors to print to the list.
- Display the differences between a data point and the limit lines, for any of the detectors.
- Elect to indicate which of the list entries have been “marked,” (refer to Chapter 5 for more information).
- Print the current correction factors used.

4. To modify which detector values are printed to the screen, press:

```
SHOW DET PK QP AV
```

The detectors that will be displayed are underlined (defaults are PK and QP).

Press the softkey repeatedly to view the detector combinations available.

5. When limit lines are active, the numerical difference between a specific detector reading and limit line 1 can be included in your report by pressing:

```
SHOW Δ 1 PK QP AV
```

The detectors that will be displayed are underlined. Press the softkey repeatedly to view the detector combinations available.

6. To include the numerical difference between a specific detector reading and limit line 2 in the report, press:

```
SHOW Δ 2 PK QP AV
```

The detectors that are currently detected are underlined. Press the softkey repeatedly to view the detector combinations available.

7. To include the total current correction factor used for the data point displayed in the report, press:

`SHOW COR ON OFF ON`

8. To include the “mark” in the report, press:

`SHOW MRK ON OFF ON`

## Note

---

When the maximum number of columns exceeds the maximum number of characters available across a page in portrait orientation, the analyzer will print the data in landscape orientation. The HP DeskJet and ThinkJet and the Epson MX80 and LQ570 do *not* support landscape orientation. The maximum number of columns that can be printed in portrait mode is nine.

---

9. To return to the top level OUTPUT menu, press:

`Previous Menu`

10. To add user notes to the report, press:

`EDIT ANNOTATN`

Annotation is entered with a keyboard. The maximum number of ASCII characters allowed in the annotation is 1024. For more information on connecting and using the keyboard, refer to Chapter 13.

11. To clear any existing annotation, press:

`CLEAR ANNOTATN`

`CLEAR ANNOTATN`

12. When you finish entering notes, press:

`EXIT EDIT`

13. Verify the printer is connected to the analyzer, then output the report by pressing:

`OUTPUT REPORT`

14. To halt the operation at any time during the output cycle, press:

`Abort`

The analyzer will finish any graphs currently in process before aborting the output cycle.

## Making a Conducted Measurement

A typical conducted EMC measurement setup is shown in Figure 4-4. The setup shown uses the HP 84110EM Preproduction evaluation system.

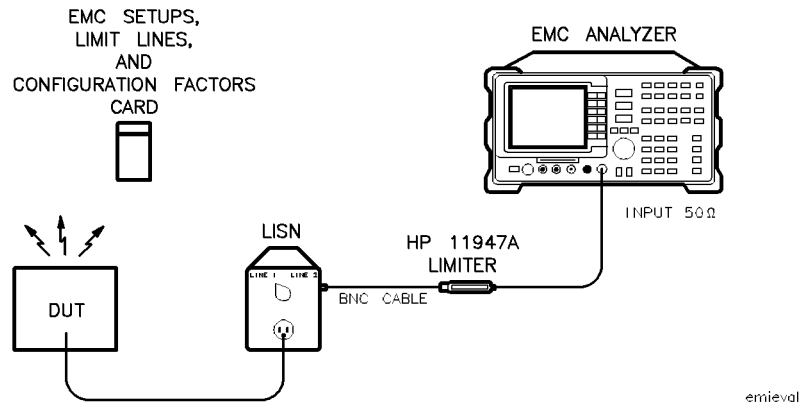

**Figure 4-4. Conducted EMC measurement test setup.**

### Caution

A transient limiter must be installed for all conducted measurements to protect the EMC analyzer's input from high-level transients. Such transients can exist on the power mains or result from cycling power to the device under test (DUT).

### Equipment list

EMC analyzer .....	HP 8591EM
	HP 8593EM
	HP 8594EM
	HP 8595EM
	HP 8596EM
EMC setup, limit lines, correction factors memory card	08590-10027
transient limiter .....	HP 11947A
line impedance stabilization network (LISN) .....	HP 11967D
	<i>or</i>
	HP 11967C

### Configuring the system

A complete setup can be read from the EMC setup, limit lines, correction factors memory card.

1. Connect CAL OUT to INPUT 50Ω.

#### Loading pre-defined configurations from a card

2. To select a pre-defined configuration from the card, insert the card into the card reader and press:

**SETUP**  
**RECALL SETUP**

The analyzer will catalog all setup files resident on the card. Use the keys or knob to highlight the file eSAMPLE\_C.

3. To load the highlighted file, press:

**LOAD FILE**

When this step is performed, the correction factors for the HP 11967D LISN is part of the setup information that is loaded.

4. If the HP 11967C LISN is being used, perform the following steps to load the LISN's correction factors:
  - a. Press:
 

**SAVE/RECALL** Recall Card **RECALL ANTENNA**
  - b. Use the step keys to highlight the "nLISN" file.
  - c. Press:

**LOAD FILE**

Once the "nLISN" file is loaded, future measurements are made using the typical correction factors associated with the HP 11967C LISN. However, the most accurate EMI measurements are achieved by entering in the individual correction factors supplied with the LISN. Refer to Chapter 10 for this procedure.

5. Measurements can now be made as described in the section, "Making Radiated Measurements", earlier in this chapter.
6. When making conducted measurements the data can be collected and displayed in Log Sweep mode. To use Log Sweep mode, press:

**FREQUENCY**

**SWEEP LOG LIN LOG**

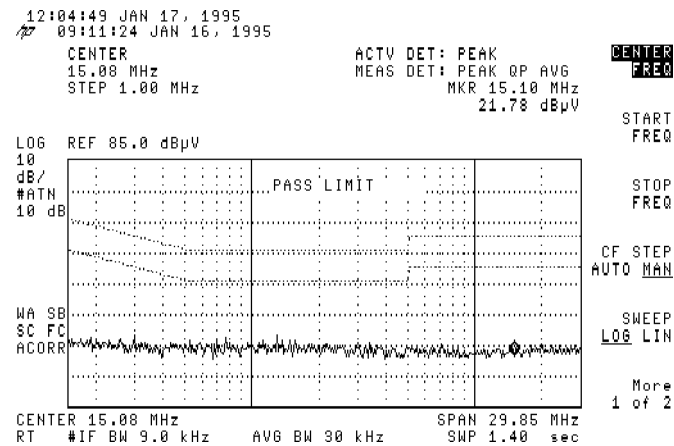

**Figure 4-5. Display using the log sweep mode.**

Data can also be collected and displayed using a stepped measurement approach. All three detectors can be measured as the analyzer steps across a frequency range. Refer to Chapter 6 for more information.

To copy, save or print the results, use the same procedures described earlier in this chapter.

## List-Based Measurements

---

### What you'll find in this chapter

Radiated emissions measurements revolve around signal lists. The key output of the testing process is a list of the highest amplitude signals from the equipment under test. It is this list of signals which regulatory agencies of the world are interested in.

The list-based measurement feature includes the following features:

- Add signals to the list.
- View the signal list table at any time.
- Sort the signal list.
- Delete signals from the list.
- Mark signals on the list.
- Remeasure signals on the list.
- Save the tabular list to card and recall it.
- Graph the signal list on a logarithmic or linear scale.
- Save the signal list graph to a card.

---

When viewing the signal list table, both list and trace information are viewed at the same time. The signal list is displayed in the upper half of the display screen; the lower half of the display screen is the active window with a live trace. Furthermore, as each signal in the list is selected, the frequency of the signal is used to tune the active window. If the frequency is already onscreen, just the marker is moved, otherwise the tune frequency is changed.

For the purpose of this measurement example, the 300 MHz calibrator signal and its harmonics will be used to build a signal list.

## Note

Before performing this measurement example, make sure the signal list is empty by pressing the following keys:

**TEST**

More 1 of 3

EDIT LIST (If table is empty, go to step 1 below.)

Delete Signals

DELETE ALL SIGS

DELETE ALL SIGS

1. Preset the instrument to a known state by pressing:

**PRESET**

2. Connect CAL OUT to INPUT 50 $\Omega$ .

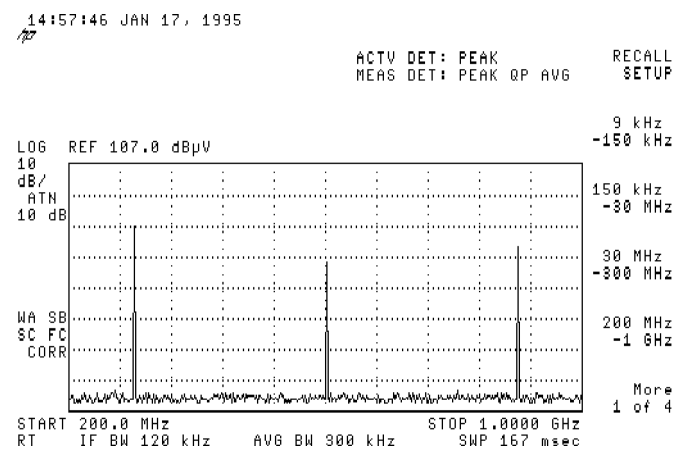
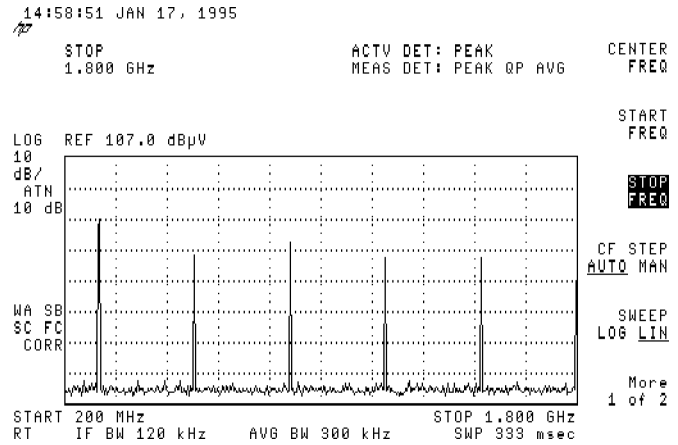

Figure 5-1. 300 MHz calibrator signal.



3. Set the analyzer stop frequency to 1.8 GHz in order to view additional harmonic signals by pressing:

**FREQUENCY**  
 STOP FREQ ..... 1.8 **GHz**



**Figure 5-2. 300 MHz calibrator signal with harmonics.**

4. Place a marker on the 300 MHz calibrator signal by pressing:

**MKR →**  
 MARKER → HIGH

## Adding signals to the list

5. Measure the peak, quasi-peak, and average detectors for this signal peak by pressing:

**TEST**

**MEASURE AT MKR** (wait for results to be displayed)

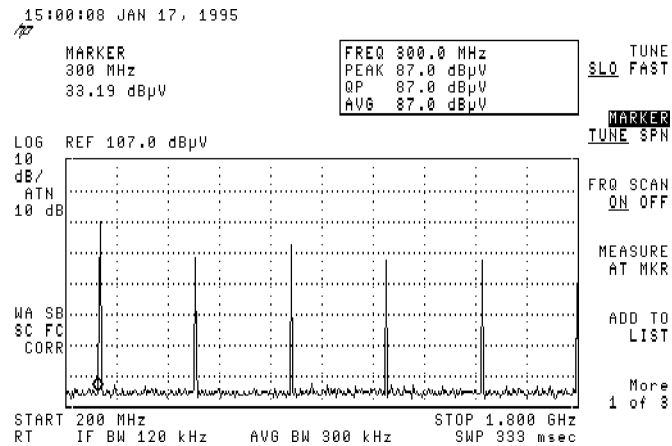

**Figure 5-3.**

**Peak, quasi-peak, and average detectors measurement results.**

6. After the measurement is complete, the results are displayed in the marker display area, and the signal can now be added to a signal list by pressing:

**ADD TO LIST**

7. Step to the first harmonic signal, take a measurement, and add this result to the signal list by using the following sequence:

**↑** (positions marker on first harmonic signal)

**MEASURE AT MKR** (wait for results to be displayed)

**ADD TO LIST**

### Note

You may need to press the **↑** (step up) key more than once to place the marker on the peak of the signal.

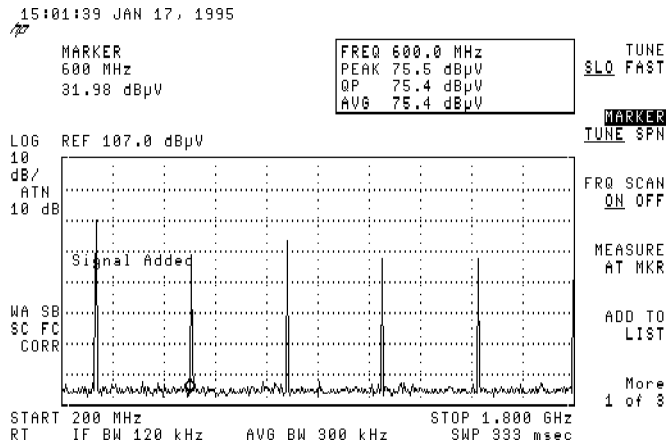

**Figure 5-4. Signal added to signal list.**

8. Repeat step 7 for the remaining harmonic signals until all signals have been measured and added to the signal list.

## Viewing the signal list

- Display the signal list that was created by the 300 MHz calibrator signal and its harmonics measured above by pressing:

More 1 of 3

SIG LIST ON OFF ON (displays the signal list)

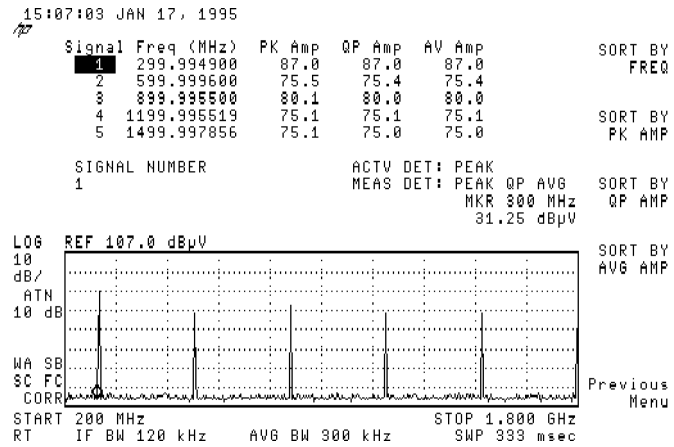

**Figure 5-5.**  
Signal list of 300 MHz calibrator signal and harmonics.

## Sorting the signal list

10. Sort the signal list by peak amplitude by pressing:

EDIT LIST

Sort Signals

SORT BY PK AMP

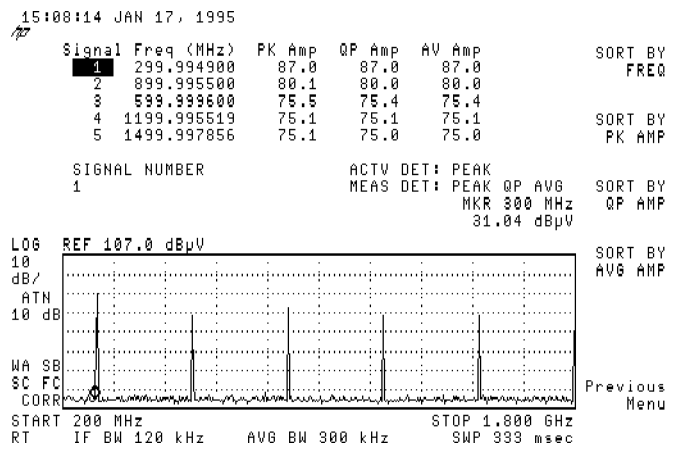

Figure 5-6. Signal list sorted by peak amplitude.

11. Resort the signal list by frequency by pressing:

SORT BY FREQ

## Deleting signals from the list

12. Delete the last harmonic signal from the signal list by using the following key sequence:

Previous Menu (returns to the editing menu)

Delete Signals (enters delete signals menu)

SELECT FRM LIST ..... 5 **ENTER**

DELETE SIGNAL , DELETE SIGNAL

### Note

After pressing **DELETE SIGNAL** once, the message "If you are sure, press key again to purge data" will appear. Pressing **DELETE SIGNAL** a second time deletes the data.

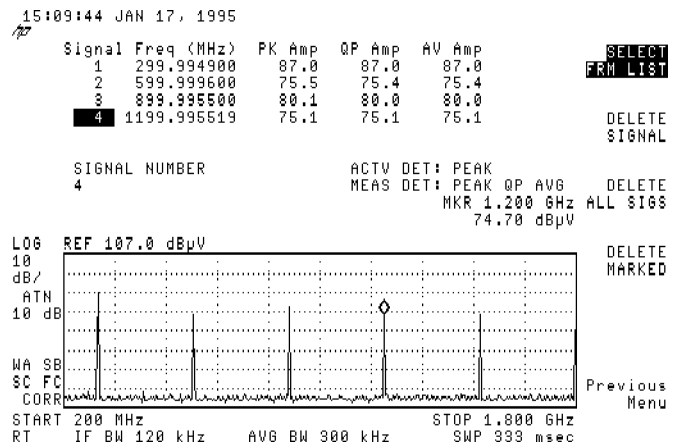

Figure 5-7. Last harmonic signal deleted.

13. Notice that after the signal has been deleted, the marker and signal number are decreased by one. In order to add the last harmonic signal back to the signal list, use the following key sequence:

**TEST**

**MARKER TUNE SPN TUNE** (activates marker)

**↑** (positions marker on last harmonic signal)

**MEASURE AT MKR** (wait for results)

**ADD TO LIST**

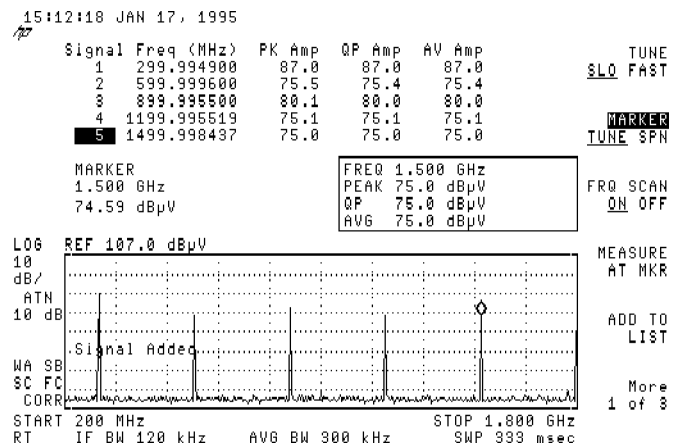

**Figure 5-8.**  
Last harmonic signal remeasured and added to list.

## Marking signals

14. Mark the 2nd harmonic signal for deletion by pressing:

More 1 of 3

EDIT LIST

Signal Marking ..... 2 **ENTER**

MARK SIGNAL

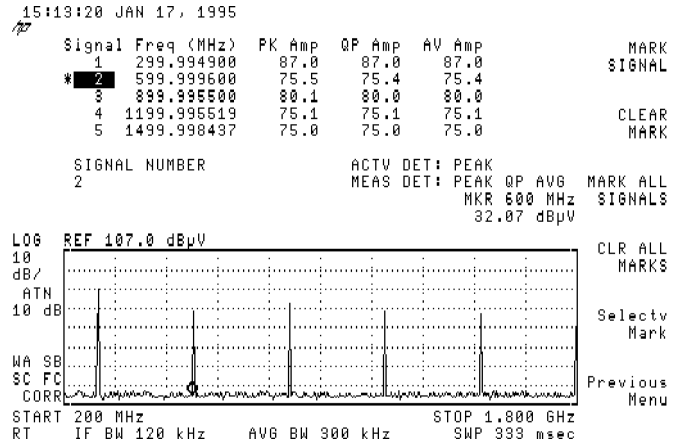

Figure 5-9. Signal marking.

Notice that signal 2 in the list is highlighted and marked with an asterisk.

15. Enter each of the 4th and 5th harmonic signal numbers and mark them by using the following sequence:

Previous Menu

Signal Marking ..... signal number **ENTER**

MARK SIGNAL



16. Delete the marked signals by pressing:

Previous Menu

Delete Signals

DELETE MARKED, DELETE MARKED

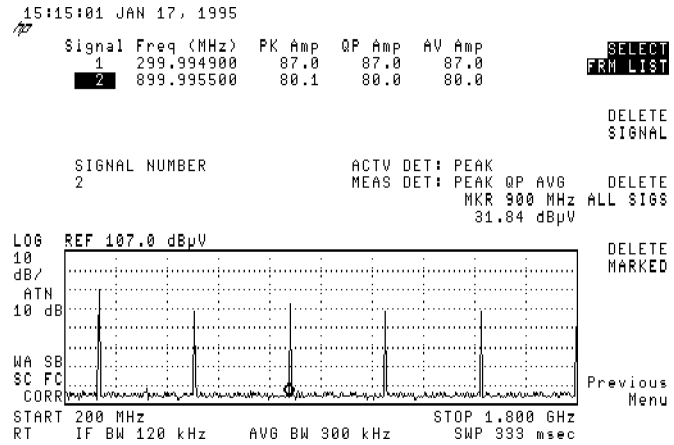

Figure 5-10. Marked signals deleted and list reordered.

Notice that remaining signals are renumbered sequentially.

## Remeasuring signals

17. Remeasure the remaining signals on the list by pressing:

Previous Menu

Re-measure

REMEAS ALL SIGS

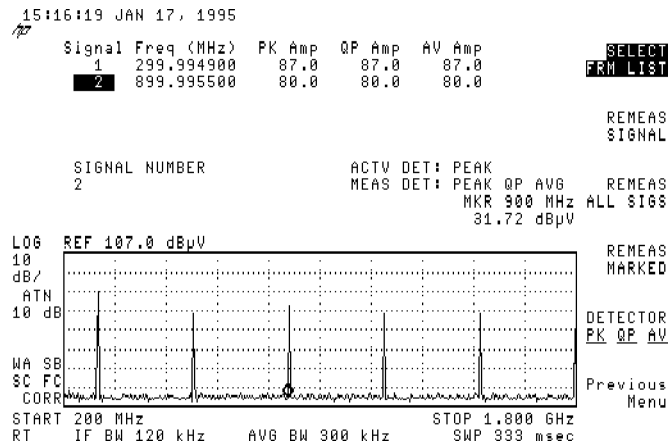

Figure 5-11. Remaining signals in list remeasured.

## Saving signal lists

### CAUTION

When saving internal data and signal lists are displayed, card warning messages do *not* appear. Therefore, it is recommended that you verify that a file has been saved before clearing the data from your display.

For example, before saving signal list data, make sure that your card is *not* write protected. To verify that the file was saved, press **RECALL LIST** to catalog signal lists that have been saved to the card, then check that the correct file was saved by inspecting the file name, date, and time stamp.

18. To save the current signal list, insert a memory card and press:

(TEST)

More 1 of 3

Save/Rcl List

SAVE LIST

Enter register number 5 and press (ENTER)

### Note

Signal lists and associated annotation can only be saved to a card. Refer to Chapter 12 for more information of saving and recalling. Refer to “Entering data using the external keyboard” in Chapter 13 for information on the annotation editor.

## Recalling signal lists

19. To recall the previously saved signal list from the card, press:

**RECALL LIST**

A catalog of the card fills the screen.

20. Select the filename corresponding to register number 5 using the knob or step keys, then press:

**LOAD FILE**

The signals in the file will be added to the end of the current signal list which remains unchanged. Any annotation for the signal list created using an external keyboard is also loaded from the file; any existing annotation is replaced.

## Graphing signal lists

21. To show a linear graphical representation of the signals in the signal list, press:

**SAVE LIN GRAPH**

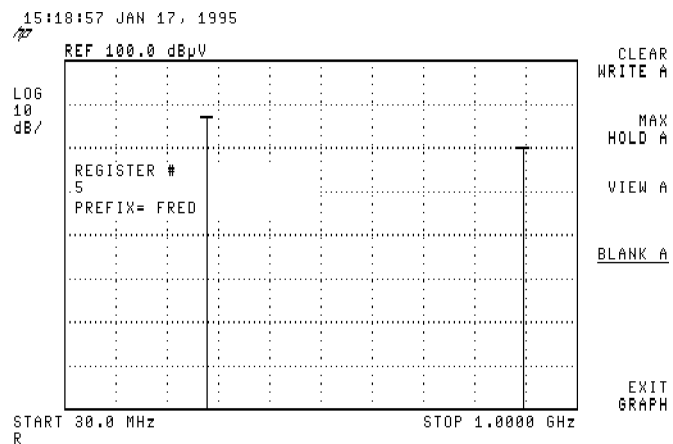

**Figure 5-12. Signals plotted on linear frequency scale.**

22. Press:

**EXIT GRAPH**

23. To show a logarithmic graphical representation of the signals in the signal list, press:

**SAVE LOG GRAPH**

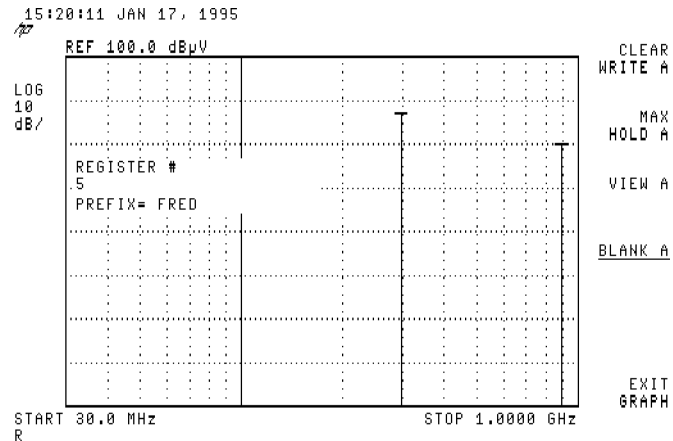

**Figure 5-13. Signals plotted on log frequency scale.**

## Saving signal lists graphs

---

**Note** Signal list graphs can only be saved to a card, not to internal memory.

---

24. To save the displayed log signal list graph to a card:

Enter the register number 8 and press **ENTER**

25. Once the process is saved, press:

**EXIT GRAPH**

---

**Note** The "Register #" message is not saved to the file.

---

## Stepped Measurements

---

### What you'll find in this chapter

Stepped measurements allow the analyzer to step across the frequency band in predefined frequency steps. When making the measurement, the analyzer steps to a given frequency in a fixed-tuned fashion. You can:

- Define the frequency step as either linear or logarithmic.
  - Specify the step size for each type of step.
  - Specify which detector(s) to measure.
  - Specify the dwell time for each detector.
- 

### Performing a stepped measurement

1. Preset the analyzer to a known state by pressing:

**PRESET**

2. Display the 300 MHz calibrator signal and its harmonics by connecting CAL OUT to INPUT 50Ω.
3. To perform a stepped measurement with a center frequency of 300 MHz and a span of 3 MHz, press:

**FREQUENCY**

CENTER FREQ ..... 300 **MHz**

**SPAN** ..... 3 **MHz**

**AMPLITUDE**

**↓** (moves the signal trace to the top of the display)

**TEST**

More 1 of 3

More 2 of 3

MEAS STEPPED

**Note**

To ensure all signals are captured and their amplitudes accurately displayed, the linear step size should be no more than one-half of a bandwidth.

When the analyzer completes the stepped measurement, three traces are displayed as shown below.

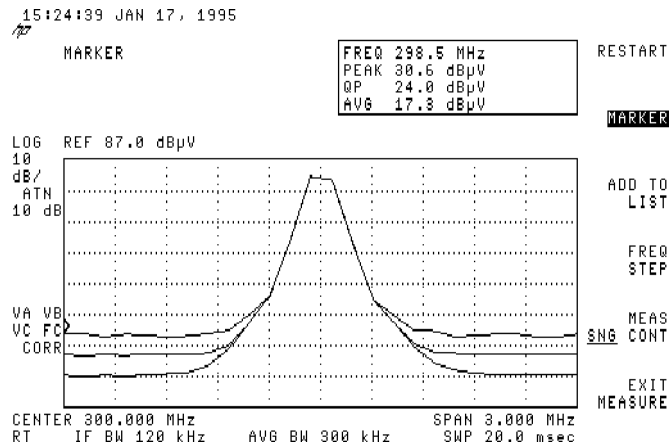

**Figure 6-1. Stepped measurement display.**

The traces are displayed as follows:

- |                   |                               |
|-------------------|-------------------------------|
| Highest amplitude | Peak detector amplitude       |
| Middle amplitude  | Quasi-peak detector amplitude |
| Lowest amplitude  | Average detector amplitude    |

**Note**

When EXIT MEASURE is pressed, the measurement is stopped and all data is lost. Be sure to save the data by adding it to the signal list table *prior* to pressing EXIT MEASURE .

- The measurement will be taken continuously, restarting automatically when the stop frequency is reached. To exit from the stepped measurement, press:

**EXIT MEASURE**

## Selecting a detector and setting a dwell time

At each frequency step, you can select a detector and a dwell time for the detector.

- To select the peak and quasi-peak detector and set a dwell time of two seconds, press:

```

(SETUP)
More 1 of 4
Measure Detector
DETECTOR PK QP AV PK
DETECTOR PK QP AV PK QP
QP DWELL TIME .....2 (sec)
  
```

- To view an onscreen display of the signal list and make a stepped measurement, press:

```

(TEST)
More 1 of 3
SIG LIST ON OFF ON
More 2 of 3
MEAS STEPPED
  
```

When the measurement is completed, the marker is positioned at the left edge of the screen. The marker box displays the information on the selected detectors.

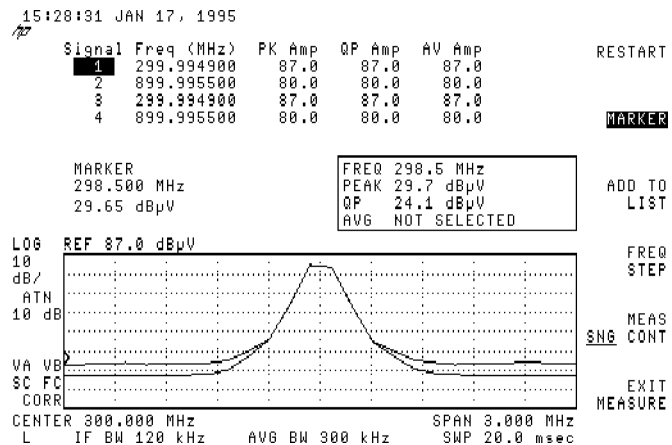

Figure 6-2. Stepped measurement using two detectors.

## Using the marker

The marker can be used to read the frequency and amplitude of two detectors, for example, peak and quasi-peak. When the measurement is complete, the marker function is the active function. Use the keypad, step keys or knob to move the marker along the trace. The frequency and amplitude values of the two traces at the marker are displayed in the marker box.

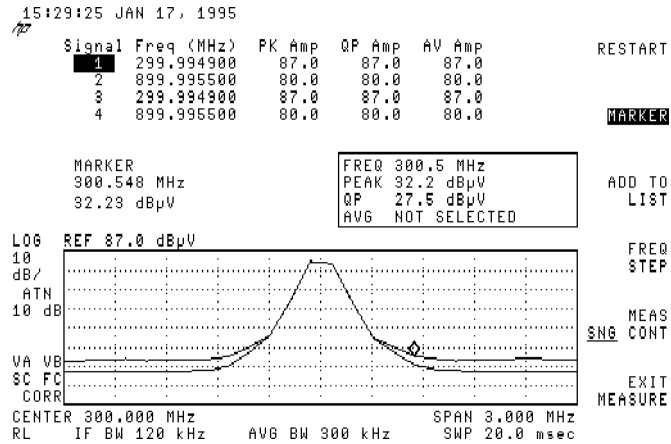

Figure 6-3. Using the marker.

The highest trace is the peak detector data and the lowest trace is the quasi-peak detector data.



## Adding data to the signal list table

The results of the stepped measurement can be added to the signal list table. Refer to Chapter 5 for more information on the signal list table.

If you wish to add the results of the stepped measurement to the signal list table, press:

**ADD TO LIST**

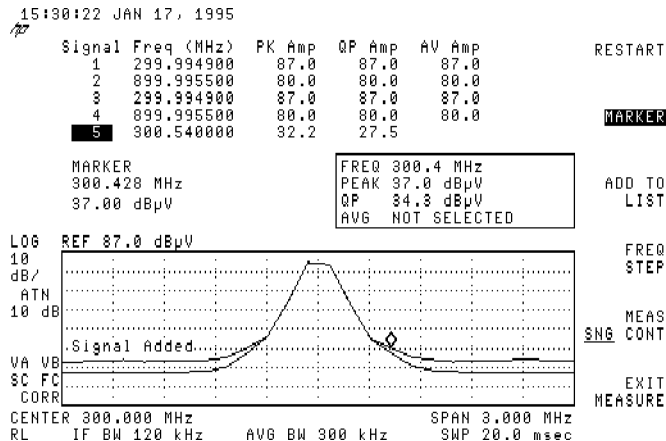

Figure 6-4. Data added to the signal list table.

The new data now appears in the signal list, press:

**EXIT MEASURE**

## Changing the frequency step

The default step size is equal to one IF bandwidth. To change the default step size, press:

**SETUP**

More 1 of 4

More 2 of 4

FREQ STEP ..... 0.5 **ENTER**

## Restarting and stopping the measurement

To start and stop a stepped measurement:

1. Start the measurement by pressing:

**TEST**

More 1 of 3

More 2 of 3

MEAS STEPPED

**Note**

If the measurement is stopped before the trace is completed, the marker may be used only on the portion of the trace recorded *before* the measurement was stopped.

2. When the measurement reaches 300.2 MHz, press:

**STOP**

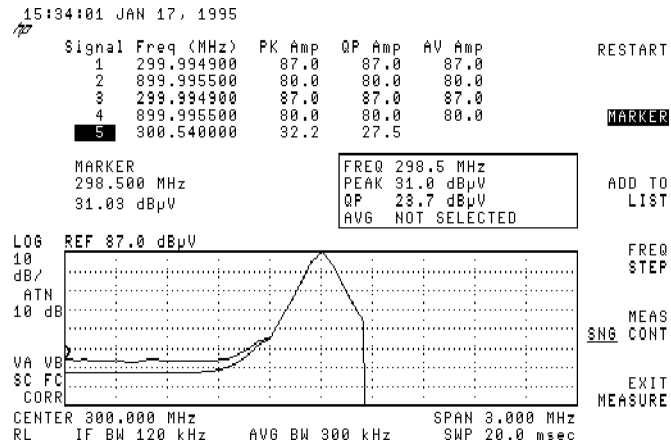

**Figure 6-5. Stepped measurement stopped at 300.2 MHz.**

3. Use the knob to move the marker along the trace. Observe the portion of the trace over which the marker is active.

**Note**

The MEAS SNG CONT function is always active. Executing the function during a measurement will not corrupt the measurement.

4. To select a continuous step mode, press:

**MEAS SNG CONT CONT**

5. To restart the measurement, press:

**RESTART**

**Note**

When EXIT MEASURE is pressed the measurement is stopped and all data is lost. Be sure to save the data by adding it to the signal list table *prior* to pressing EXIT MEASURE.

6. The measurement will be taken continuously, restarting automatically when the stop frequency is reached. To exit from the stepped measurement, press:

**EXIT MEASURE**

## Using logarithmic and linear steps

During conducted measurements (for example, CISPR bands A and B), the emissions are usually broadband in nature and you may wish to use the logarithmic frequency step function. This function can be used whenever a logarithmic display, spanning several decades, would be more informative than a linear display. The following figures show the two display options.

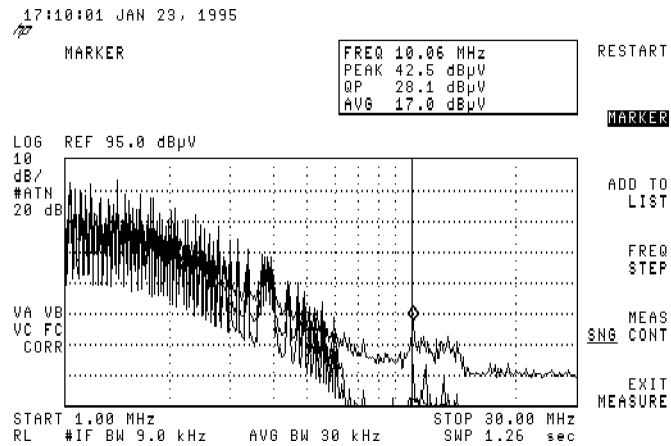

Figure 6-6. Using a logarithmic step size.

### Note

When using a logarithmic step size, the frequency step is specified as a percentage of frequency. The default step size equals three percent.

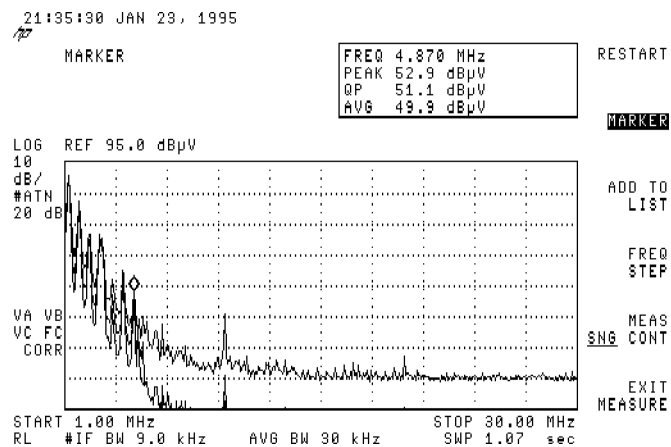

Figure 6-7. Using a linear step size.



## Making EMC Diagnostic Measurements

---

### What you'll find in this chapter

This chapter demonstrates how to make diagnostic measurements using the EMC analyzer. Each measurement focuses on different functions. The measurement procedures covered in this chapter are:

- Diagnostic emissions testing using a close-field probe
  - Configuring systems for diagnostic emissions testing.
  - Making automatic diagnostic emissions tests.
  - Making manual diagnostic emissions tests.
- Other diagnostic techniques
  - Resolving signals of equal amplitude using the IF bandwidth function.
  - Resolving small signals hidden by large signals using the IF bandwidth function.
  - Increasing the frequency readout resolution using the marker counter.
  - Decreasing the frequency span using the marker track function.
  - Peaking signal amplitude using the preselector peak function. (*HP 8593EM, HP 8595EM and HP 8596EM only.*)
  - Tracking unstable signals using marker track and the maximum hold and minimum hold functions.
  - Comparing signals using delta markers.
  - Measuring low-level signals using attenuation, averaging bandwidth, and video averaging.
  - Identifying distortion products using the RF attenuator and traces.
  - Measuring signals near band boundaries using harmonic lock.
- Localized susceptibility testing
  - Configuring Systems for Localized Susceptibility Testing
  - Making Localized Susceptibility Measurements

# Making Diagnostic Measurements Using a Close-Field Probe

This test uses a close-field probe to help locate problem emissions in the device under test (DUT) and to characterize those emissions.

**Note**

The trace information on the display screen presented in this procedure is only for example. It may not reflect what you see on your display.

## Configuring systems for diagnostic emissions

### Setting up the test equipment

**Equipment list.**

EMC Analyzer .....	HP 8591EM
	HP 8593EM
	HP 8594EM
	HP 8595EM
	HP 8596EM
EMC memory card .....	HP 08590-10027
HP 11945A close-field probe set .....	HP 11940A
	HP 11941A
Preamplifier .....	HP 8447F Option H64

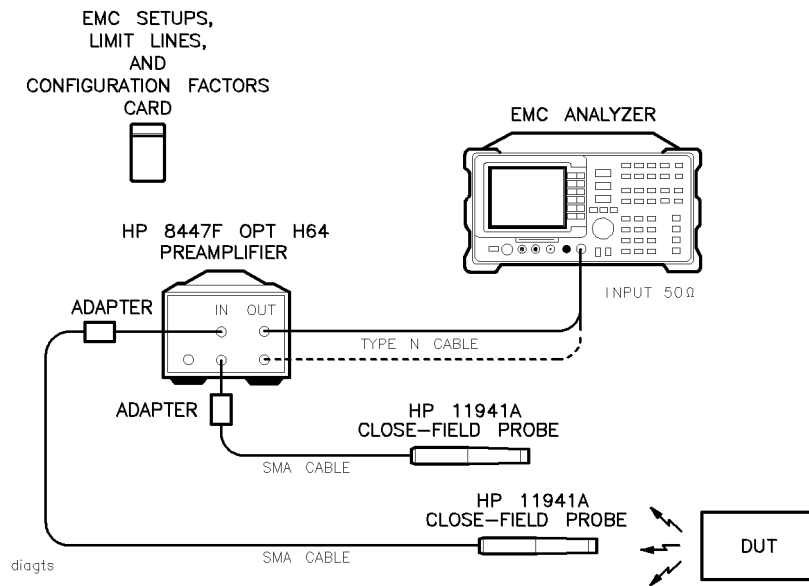

**Figure 7-1. Diagnostic (close-field probe) test setup.**

## Making an automated diagnostic emission test

### Note

For manual setup information, refer to "Making a manual diagnostic emission test" in this chapter.

### Configuring the analyzer for testing

1. Set the analyzer to a known state by pressing:

**PRESET**

2. Insert the card into the analyzer with the card's arrow matching the raised arrow on the bezel around the card-insertion slot.

3. To recall a setup, press:

**RECALL SETUP**

4. Use the step keys or knob to highlight the setup file "eSAMPLE\_D". Refer to Figure 7-2.

```
13:26:21  18 JAN 1995

859xEM  512
eAUTOEXEC ASCII 17  29 09:11:24  16 JAN 1995
eSAMPLE_R ASCII 46  18 09:11:24  16 JAN 1995
eSAMPLE_C ASCII 64  17 09:11:24  16 JAN 1995
eSAMPLE_D ASCII 81  18 09:11:24  16 JAN 1995

LOAD
FILE

DELETE
FILE

SELECT
PREFIX

EXIT
CATALOG

Previous
Menu

RT
```

Figure 7-2. eSAMPLE\_D selected.

5. To load the file, press:

**LOAD FILE**

6. Press:

**TEST**

- To move the marker to the response of interest and record that frequency, use the knob or step keys or press:

**(MKR →)**  
**MARKER → HIGH**

Refer to Figure 7-3.

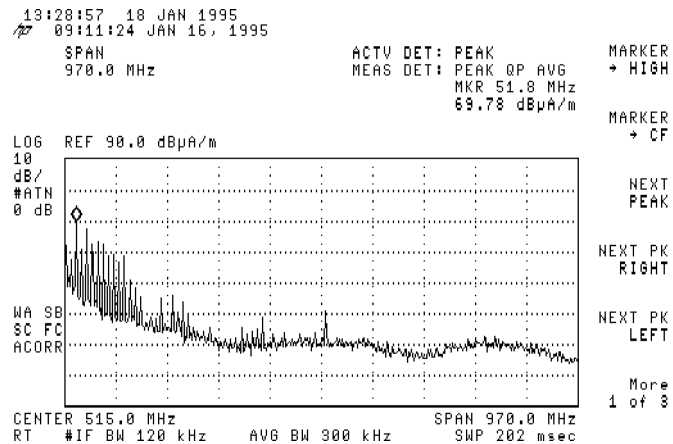

**Figure 7-3. Moving the marker to the highest response.**

- To move the marker to center frequency, press:

**(MKR →)**  
**MARKER → CF**

- To active the span, press:

**(SPAN)**

- To reduce the span, use the keypad to input the desired span, for example, 30 **(MHz)**. Refer to Figure 7-4.

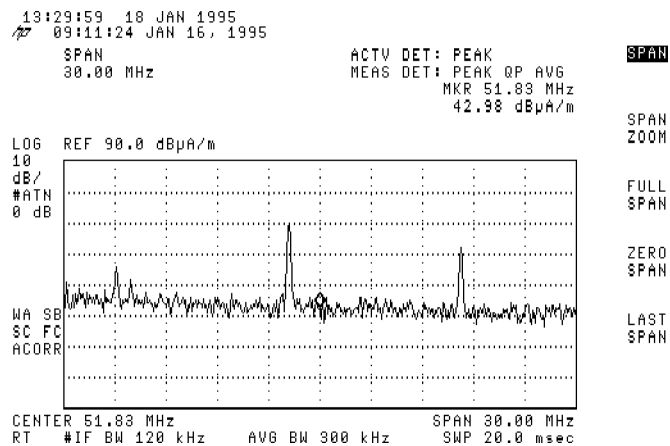

**Figure 7-4. Reducing the span.**



11. To record the emission level, press:

```
TRACE
TRACE A B C B
CLEAR WRITE B
TRACE A B C A
MAX HOLD A
```

12. Move the probe around the DUT to find the worst-case emission.  
Keep the probe tip close to the source of the emissions.

13. To save the displayed response, press:

```
VIEW A
```

Refer to Figure 7-5.

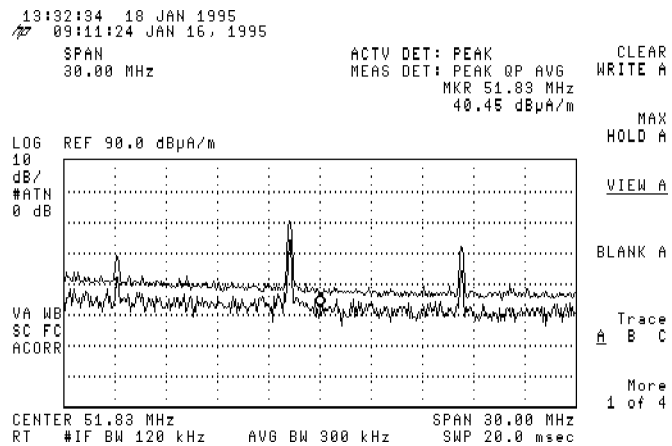

Figure 7-5. Saving the displayed response in view mode.

### Storing the data to internal memory

14. To store the data to internal memory, press:

```
SAVE/RECALL
Save Internal
Trace → Intrnl
```

15. To enter the trace A data into internal register 1, press:

```
TRACE A ..... 1 Hz
```

16. To clear-write trace A, press:

```
TRACE
CLEAR WRITE A
```

17. To turn off trace B, press:

```
TRACE A B C B
BLANK B
```

## Recalling the data from internal memory

18. To recall previous EMC data after modifying the device under test, press:

```
(SAVE/RECALL)
Recall Internal
Internal → Trace
```

19. To recall a previous trace, for comparison, from internal register 1, press:

```
TRACE A ..... 1 (Hz)
```

## Making a field-strength measurement

20. To make a field-strength measurement, press:

```
(MKR)
```

21. Position the marker on the desired signal. Read the field-strength value in dB $\mu$ A/m in the marker box. Refer to Figure 7-6.

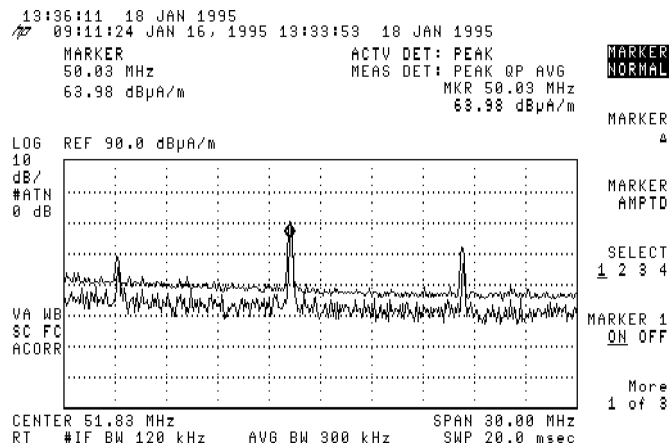

Figure 7-6. Reading the probe's output in dB $\mu$ A/m.

## Characterizing the emissions

22. To characterize the emissions, press:

```
(TRACE)
More 1 of 4
MAX/MIN ON OFF ON
MAX MIN VIEW (until MAX, MIN and VIEW are underlined)
```

23. Toggle **MAX/MIN VIEW** between MAX, MIN and VIEW to view max-held, min-held, and both signals on the display. Refer to Figure 7-7.

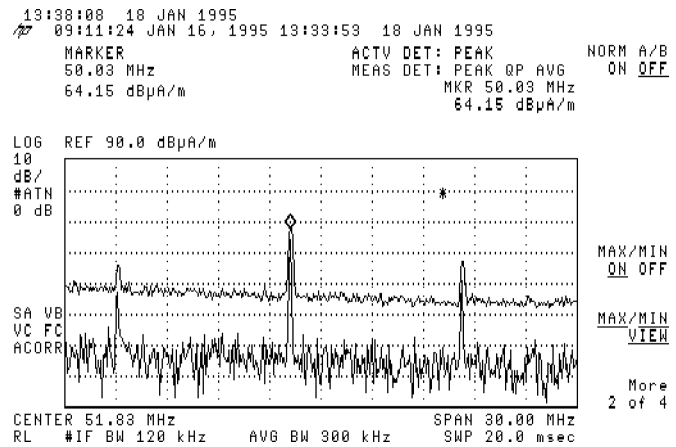

Figure 7-7. Signals viewed with MAX, MIN, VIEW.

24. To turn off the max/min measurements, press:

**MAX/MIN ON OFF OFF**

**Note**

The signals visible during **MIN VIEW** are continuous signals. The signals that appear during **MAX VIEW** and not **MIN VIEW** are pulsed or broadband signals.

25. To activate the delta marker, press:

**MKR**  
**MARKER Δ**

26. Measure the harmonic interval using the marker delta function and scroll to the next peak of interest. Record the interval. Refer to Figure 7-8.

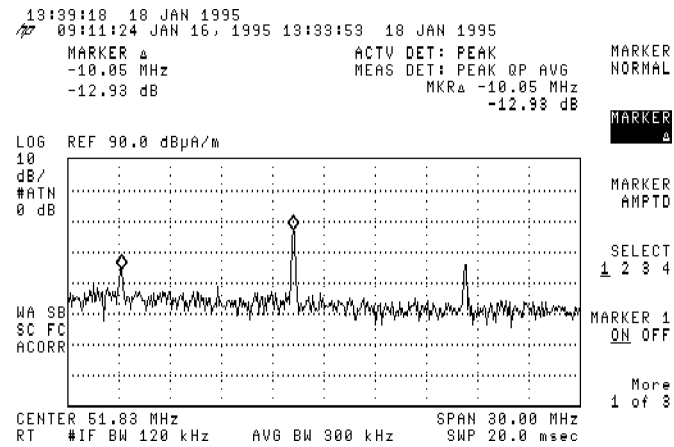

Figure 7-8. Measuring the harmonic interval.

27. To print the delta marker data in tubular form, connect the printer to the EMC analyzer (if it has not been previously connected) and press:

**COPY**

28. To clear the markers, press:

**MKR**

More 1 of 3

MARKER ALL OFF

## Making a manual diagnostic emission test

### Note

It is important to perform each step in the following procedures. To do otherwise will produce results that are different than expected.

1. To configure the EMC analyzer for testing, press:

**PRESET**

### Note

Measurements can be made outside the close-field probe's frequency range, but the probe will not be calibrated.

2. To set the analyzer's start and stop frequencies, when using the HP 11940A close-field probe, press:

**30 MHz -300 MHz**

Select **150 kHz -30 MHz** if using the HP 11941A close-field probe.

**More 1 of 4**

**Correctn Factors**

**Antenna Factors**

**RECALL ANTENNA**

Select nHP11940 if using the HP 11940A or nHP11941 if using the HP 11941A.

**LOAD FILE**

Refer to Figure 7-9.

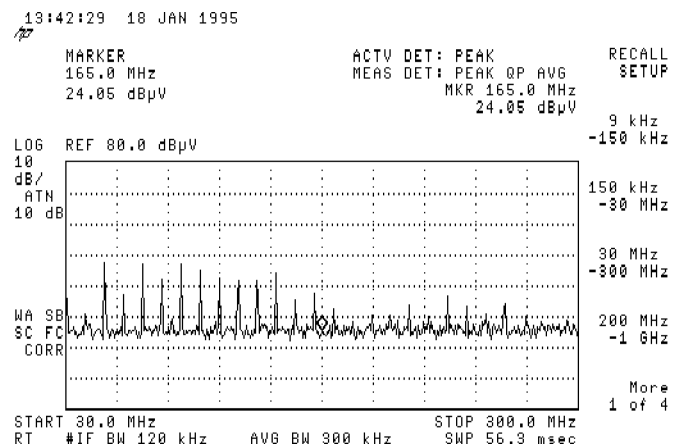

Figure 7-9. 30 MHz -300 MHz setup selected.

### Note

The entire 30 MHz to 300 MHz range can be viewed since close-field probes are not susceptible to troublesome ambient signals, such as commercial radio stations.

3. To factor in the preamplifier's gain, press:

Previous Menu

Other Factors

RECALL OTHER

Select o8447FHI if using the HP 11940A probe or o8447FLO if using the HP 11941A probe.

LOAD FILE

The correction factors for the probe and the amplifier are now applied to subsequent measurements.

Depending on the amplitude of the signals being measured, the reference level and attenuation may need adjusting.

4. To adjust the reference level and attenuation, press:

AMPLITUDE

ATTEN AUTO MAN MAN ..... 0 dB

Refer to Figure 7-10.

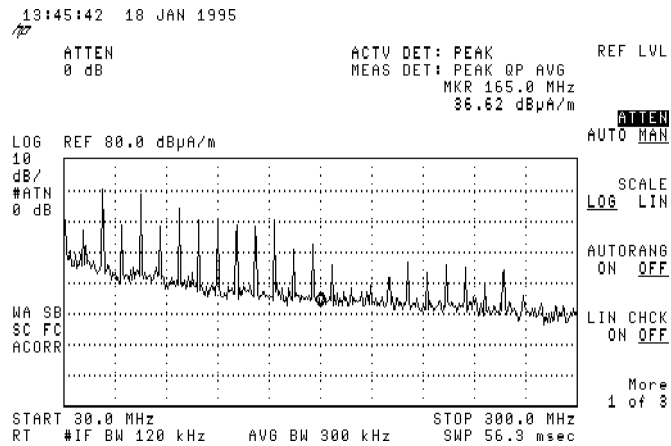

Figure 7-10. Adjusting the reference level and attenuation.

The marker and trace functions can be used as described earlier to characterize emissions in the selected frequency range.

---

## Other Diagnostic Techniques

### Resolving signals of equal amplitude

In responding to a continuous-wave signal, a scanning analyzer traces out the shape of its intermediate frequency (IF) filter. As we change the filter bandwidth, we change the width of the displayed response. If a wide filter is used and two equal-amplitude input signals are close enough in frequency, then the two signals appear as one. Thus, signal resolution is determined by the IF filters inside the analyzer.

For maximum flexibility, the analyzer allows you to select from the CISPR 200 Hz, 9 kHz and 120 kHz 6 dB measurement IF bandwidths, or from the 30 Hz to 3 MHz 3 dB diagnostic IF bandwidth in a 1, 3, 10 sequence, plus 5 MHz. The 1 MHz bandwidth is a 6 dB bandwidth. The bandwidths tell us how close together equal amplitude signals can be and still be distinguished from each other. The IFBW function selects the IF filter setting.

Generally, to resolve two signals of equal amplitude, the IF bandwidth must be less than or equal to the frequency separation of the two signals. If the bandwidth is equal to the separation, a dip of approximately 3 dB is seen between the peaks of the two equal signals, and it is clear that more than one signal is present. Refer to Figure 7-12.

In order to keep the analyzer calibrated, sweep time is automatically set to a value that is inversely proportional to the square of the IF bandwidth. So, if the IF bandwidth is reduced by a factor of 10, the sweep time is increased by a factor of 100 when sweep time and bandwidth settings are coupled. (Sweep time is proportional to  $1/BW^2$ .) For fastest measurement times, use the widest IF bandwidth that still permits discrimination of all desired signals.

In this example you will resolve two signals of equal amplitude with a frequency separation of 100 kHz.

1. Obtain two signals with a 100 kHz separation by connecting two signal sources to the analyzer input as shown in Figure 7-11.

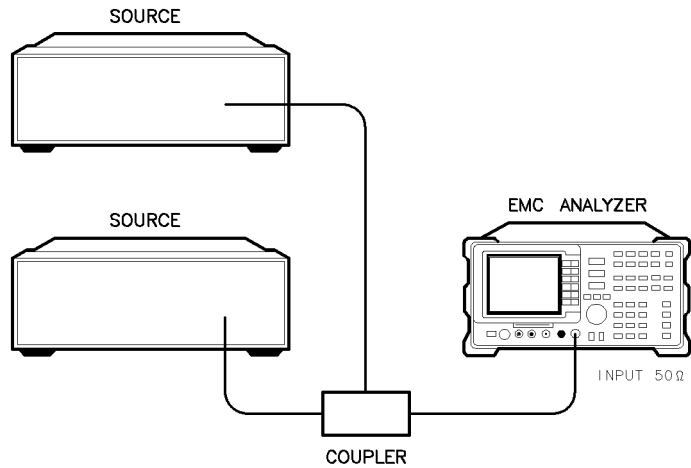

setfor2

**Figure 7-11. Setup for obtaining two signals.**

2. Set the frequencies of the two sources to be 100 kHz apart, for example, 300 MHz and 300.1 MHz. The amplitude of both signals should be approximately 87 dB $\mu$ V (-20 dBm).
3. Set the analyzer to a known state by pressing:

```

PRESET
FREQUENCY
CENTER FREQ ..... 300 (MHz)
SPAN ..... 2 (MHz)
AMPLITUDE
REF LVL ..... 82 (+dB $\mu$ V)
  
```

A single signal peak is visible.

4. Since the IF bandwidth must be less than or equal to the frequency separation of the two signals, an IF bandwidth of 30 kHz or less must be used to resolve the two input signals. Change the IF bandwidth to 10 kHz by pressing:

```

BW
IF BW AUTO MAN MAN ..... 10 (kHz)
  
```



The display should be similar to that shown in Figure 7-12. To resolve the signals further, use the knob or step keys to reduce the IF bandwidth.

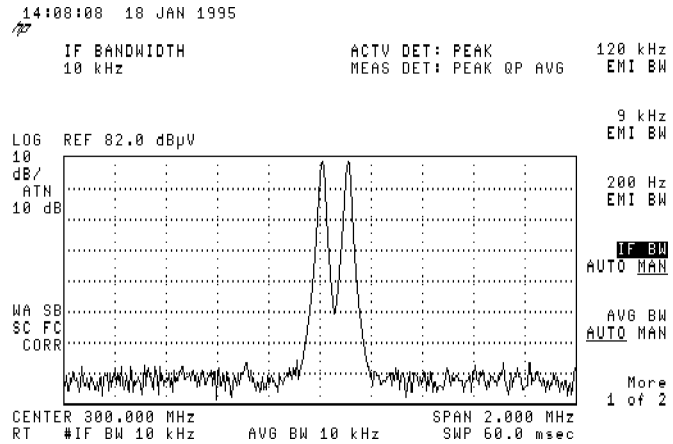

**Figure 7-12. Resolving signals of equal amplitude.**

As the IF bandwidth is decreased, resolution of the individual signals is improved and the sweep time is increased. For fastest measurement times, use the widest possible resolution bandwidth.

Since the IF bandwidth has been changed from the coupled value, a "#" mark appears next to "IF BW" in the lower-left corner of the screen, indicating that the IF bandwidth is uncoupled.

## Resolving small signals hidden by large signals

When attempting to resolve signals that are not equal in amplitude, you must consider the shape of the IF filter as well as its 3 dB or 6 dB bandwidth. The shape of the measurement filters is defined by CISPR 16. The shape of the diagnostic filter is defined by the shape factor, which is the ratio of the 60 dB bandwidth to the 3 dB bandwidth. (Generally, the IF filters in this analyzer have shape factors of 15:1 or less.) If a small signal is too close to a larger signal, the smaller signal can be hidden by the skirt of the larger signal. To view the smaller signal, you must select an IF bandwidth such that  $k$  is less than  $a$ . Refer to Figure 7-13.

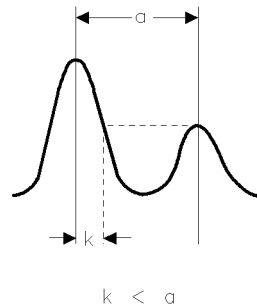

**Figure 7-13. IF bandwidth for resolving small signals.**

The separation between the two signals must be greater than half the filter width of the larger signal at the amplitude level of the smaller signal.

The following example resolves two input signals with a frequency separation of 100 kHz and an amplitude difference of 50 dB.

1. Obtain two signals with a 100 kHz separation by connecting the equipment as shown in the previous section, “Resolving signals of equal amplitude”.
2. Set the analyzer to a known state by pressing:

```
PRESET
FREQUENCY
CENTER FREQ ..... 300 MHz
SPAN ..... 2 MHz
```

3. Set the IF bandwidth to 30 kHz by pressing:

```
[BW]
IF BW AUTO MAN MAN ..... 30 [kHz]
```

4. Set one source to a frequency of 300 MHz and an amplitude of 87 dB $\mu$ V (-20 dBm).

5. Set the second source to a frequency of 300.1 MHz and an amplitude of 37 dB $\mu$ V (-70 dBm).

6. Set the 300 MHz signal to the reference level by pressing:

```
[MKR →]
More 1 of 3
MARKER → REF LVL
```

If a 30 kHz filter is used, the 60 dB bandwidth will be 450 kHz. Since the half-bandwidth (225 kHz) is wider than the frequency separation, the signals will not be resolved. Refer to Figure 7-14. (To determine resolution capability for intermediate values of amplitude level differences, consider the filter skirts between the 3 dB and 60 dB points to be approximately straight. In this case, we simply used the 60 dB value.)

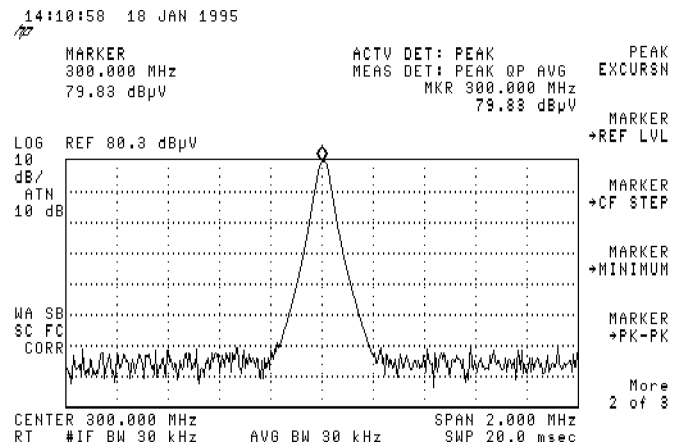

Figure 7-14. Signal resolution with a 30 kHz IF bandwidth.

7. To resolve the two signals reduce the IF bandwidth by pressing:

**BW**  
**IF BW AUTO MAN MAN** ..... 10 **kHz**

If a 10 kHz filter with a typical shape factor of 15:1 is used, the filter will have a bandwidth of 150 kHz at the 60 dB point. The half-bandwidth (75 kHz) is narrower than the frequency separation, so the input signals will be resolved. Refer to Figure 7-15.

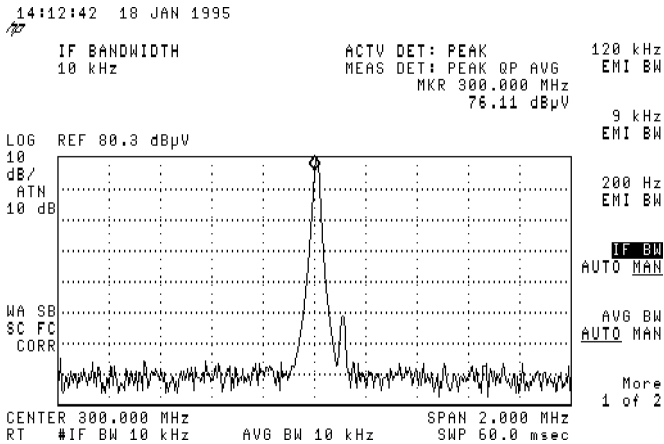

Figure 7-15. Signal resolution with a 10 kHz IF bandwidth.

## Increasing the frequency readout resolution

The marker counter increases the resolution and accuracy of frequency readout. When using the marker count function, if the bandwidth to span ratio is too small (less than 0.01), the Reduce Span message appears on the display. If there is another, larger signal (even off the display), the count will be for the larger signal.

The following example increases the resolution and accuracy of the frequency readout on the signal of interest.

1. Set the analyzer to a known state by connecting CAL OUT to INPUT 50 $\Omega$  and by pressing:

```
PRESET
FREQUENCY
CENTER FREQ ..... 300 MHz
SPAN ..... 3 MHz
```

2. Place a marker on the signal of interest by pressing:

```
MKR →
```

3. Turn the marker counter on by pressing:

```
MKR
More 1 of 3
MK COUNT ON OFF ON
```

The message COUNTER will be displayed as well as the frequency and amplitude of the marker.

4. Increase the counter resolution by pressing:

More 2 of 3

CNT RES AUTO MAN ..... 1 kHz

The marker counter readout is displayed in the upper-right corner of the screen. The resolution can be set from 1 Hz to 100 kHz.

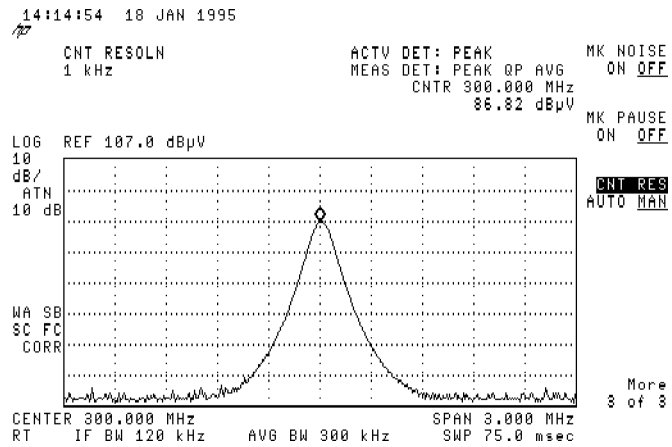

Figure 7-16. Using the marker counter.

5. The marker counter remains on until turned off. Turn off the marker counter by pressing:

MKR

More 1 of 3

MK COUNT ON OFF OFF

or

MKR

MKR 1 ON OFF OFF

## Decreasing the frequency span

Using the marker track function, you can quickly decrease the span while keeping the signal at center frequency.

This example examines a carrier signal in a 200 kHz span.

1. Set the analyzer to a known state by connecting CAL OUT to INPUT 50Ω and by pressing:

```

PRESET
FREQUENCY
STOP FREQ ..... 700 MHz
MKR→
MARKER → HIGH
  
```

2. Move the signal to the center of the screen by pressing:

```

MKR
More 1 of 3
MK TRACK ON OFF ON
  
```

Because the marker track function automatically maintains the signal at the center of the screen, you can reduce the span quickly for a closer look. If the signal drifts off of the screen as you decrease the span, use a wider frequency span.

3. Decrease the span by pressing:

```

SPAN ..... 2 MHz
  
```

The span decreases in steps as automatic zoom is completed. Refer to Figure 7-17. You can also use the knob or step keys to decrease the span.

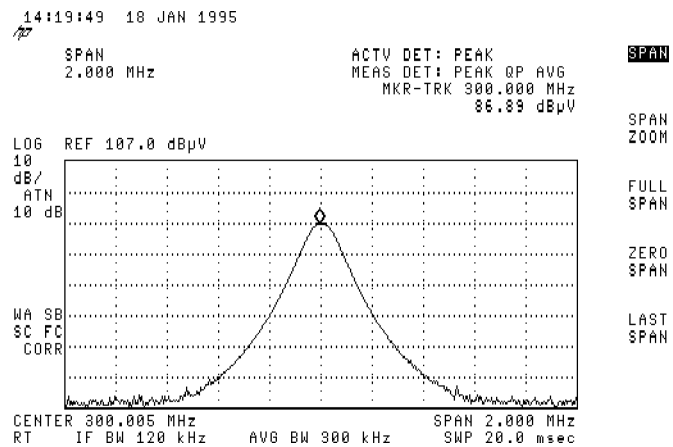

Figure 7-17. After zooming in on the signal.

4. Turn off the marker track function by pressing:

```
MKR
More 1 of 3
MK TRACK ON OFF OFF
```

## Peaking signal amplitude with preselector peak

### Note

PRESEL PEAK works only *above* 2.9 GHz, so it only applies to the HP 8593EM, HP 8595EM, and HP 8596EM.

The preselector peak function automatically adjusts the input filter tracking above 2.9 GHz to peak the signal at the active marker. Using preselector peak prior to measuring a signal yields the most accurate amplitude reading at the specified frequency.

1. To maximize the peak response of the high frequency input filter and adjust the tracking, tune the marker to a signal and press:

```
AMPLITUDE
More 1 of 3
PRESEL PEAK
```

### Note

PRESEL PEAK maximizes the peak response of the signal of interest, but may degrade the frequency response at other frequencies. Use PRESEL DEFAULT or PRESET to clear preselector-peak values before measuring a signal at another frequency.

PRESEL DEFAULT provides the best flatness for a full single-band and for viewing several signals simultaneously.

2. Set the analyzer to a known state by connecting CAL OUT to INPUT 50Ω and by pressing:

```
PRESET
FREQUENCY
START FREQ ..... 3.0 GHz
STOP FREQ ..... 3.5 GHz
MKR→
MARKER → HIGH
```



3. Peak the amplitude response by pressing:

AMPLITUDE

More 1 of 3

PRESEL PEAK

The message peaking is displayed while the routine is working.

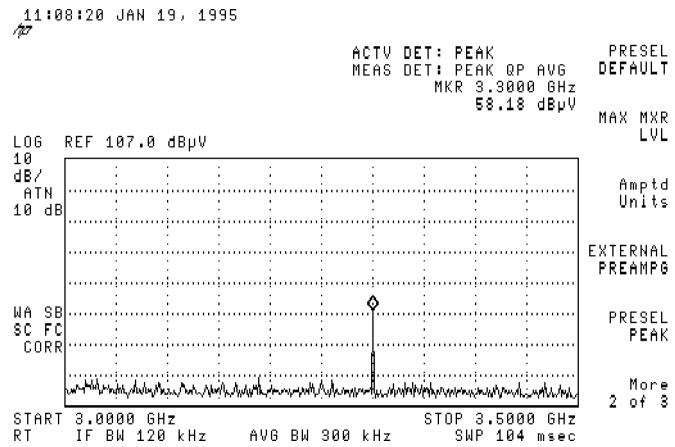

Figure 7-18. Peaking signal amplitude using preselector peak.

## Tracking unstable signals

The marker track function is useful for tracking unstable signals that drift with time. The maximum hold and minimum hold functions are useful for displaying modulated signals which appear unstable, but have an envelope that contains the information-bearing portion of the signal. **MK TRACK ON OFF** may be used to track these unstable signals. Use **(MKR→)**, **MARKER → HIGH** to place a marker on the highest signal on the display. Pressing **MK TRACK ON OFF ON** will bring that signal to the center frequency of the graticule and adjust the center frequency every sweep to bring the selected signal back to the center. **SPAN ZOOM** is a quick way to perform the **(MKR→)**, **MARKER → HIGH**, **(MKR)**, **MK TRACK ON OFF**, **(SPAN)** key sequence.

Note the primary function of the marker track function is to track unstable signals, not to track a signal as the center frequency of the analyzer is changed. If you choose to use the marker track function when changing center frequency, check to ensure the signal found by the tracking function is the correct signal.

### Using the marker track function

In this example you will use the marker track function to keep a drifting signal in the center of the display and monitor its change.

This example requires a modulated signal. An acceptable signal can be easily found by connecting an antenna to the analyzer input and tuning to the FM broadcast band (88 to 108 MHz).

1. Connect an antenna to the analyzer input.
2. Set the analyzer to a known state by pressing:

```
(PRESET)
(FREQUENCY)
CENTER FREQ ..... 104.9 (MHz)
(SPAN) ..... 20 (MHz)
(BW)
IF BW AUTO MAN MAN ..... 30 (kHz)
```

#### Note

Use a different signal frequency if no FM signal is available at 104.9 MHz in your area.

3. Adjust the reference level so the signal is within two divisions of the top of the display by pressing:

```
(AMPLITUDE)
REF LVL
```

Adjust the reference level so the signal is within two divisions of the top of the display.

4. Turn autoranging on by pressing:

```
AUTORANG ON OFF ON
```

5. Set the span by pressing:

```
(SPAN)
SPAN ZOOM .....500 (kHz)
```

Notice the signal has remained in the center of the display.

**Note**

If the signal you selected drifts too quickly for the analyzer to keep up with, increase the span.

6. The signal frequency drift can be read from the screen if both the marker track and marker delta functions are active. Press:

```
(MKR)
MARKER Δ
More 1 of 3
MK TRACK ON OFF ON
```

The marker readout indicates the change in frequency and amplitude as the signal drifts. Refer to Figure 7-19.

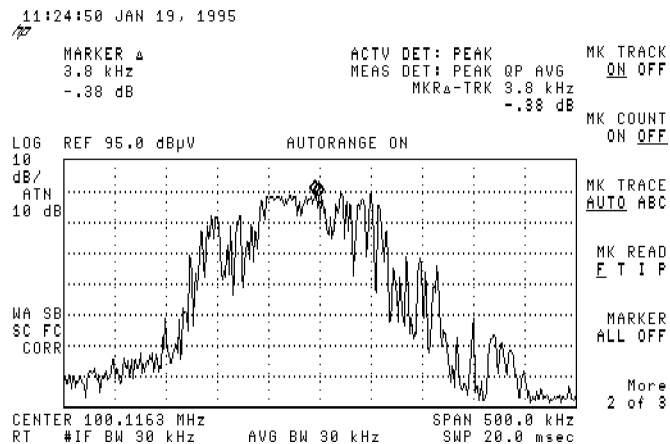

**Figure 7-19. Using marker tracking to track an unstable signal.**

The analyzer can measure the short-term and long-term stability of a source. The maximum amplitude level and the frequency drift of an input signal trace can be displayed and held by using the maximum-hold function. The minimum amplitude level can be displayed by using minimum hold (available for trace C only).

You can use the maximum-hold and minimum-hold functions if, for example, you want to determine how much of the frequency spectrum an FM signal occupies.

## Using maximum-hold and minimum-hold

In this example you will use the maximum-hold and minimum-hold functions to monitor the envelope of an FM signal.

1. Connect an antenna to the analyzer input.
2. Set the analyzer to a known state by pressing:

```
PRESET
FREQUENCY
  CENTER FREQ ..... 100 MHz
SPAN ..... 20 MHz
AMPLITUDE
  AUTORANG ON OFF ON (Toggles on and off.)
BW
  IF BW AUTO MAN MAN ..... 10 kHz
```

3. Determine the signal peak by pressing:

```
MKR→
  MARKER → HIGH
```

Adjust the reference level (under **AMPLITUDE**) so the signal is within two divisions of the top of the display.

4. Adjust the span by pressing:

```
SPAN
  SPAN ZOOM ..... 500 kHz
```

Notice the signal has remained in the center of the display.

5. Turn off the marker track function by pressing:

```
MKR
  More 1 of 3
  MK TRACK ON OFF OFF
```

6. Measure the excursion of the signal by pressing:

```
TRACE
MAX HOLD A
```

As the signal varies, maximum hold maintains the maximum responses of the input signal, as shown in Figure 7-20.

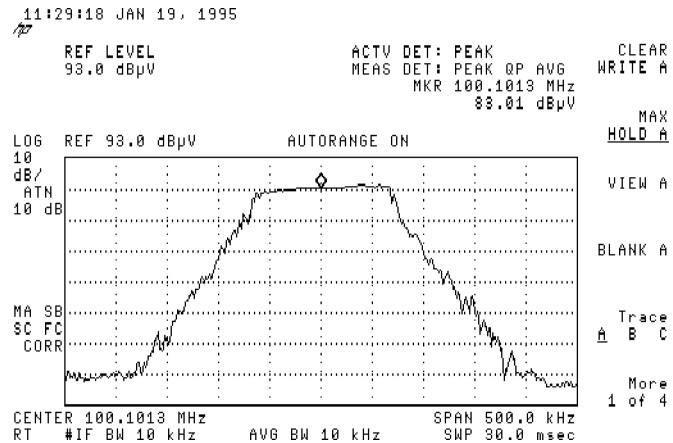

**Figure 7-20. Viewing an unstable signal using Max Hold A.**

Annotation on the left side of the screen indicates the trace mode. For example, MA SB SC indicates trace A is in maximum-hold mode, trace B and trace C are in store-blank mode.

7. Select trace B by pressing:

```
TRACE
TRACE A B C B
```

8. Place trace B in clear-write mode by pressing:

```
CLEAR WRITE B
```

Trace B displays the current measurement results as it sweeps. Trace A remains in maximum-hold mode, showing the frequency shift of the signal.

9. Select trace C by pressing:

```
TRACE A B C C
```

10. Display the minimum amplitude of the signal by pressing:

**MIN HOLD C**

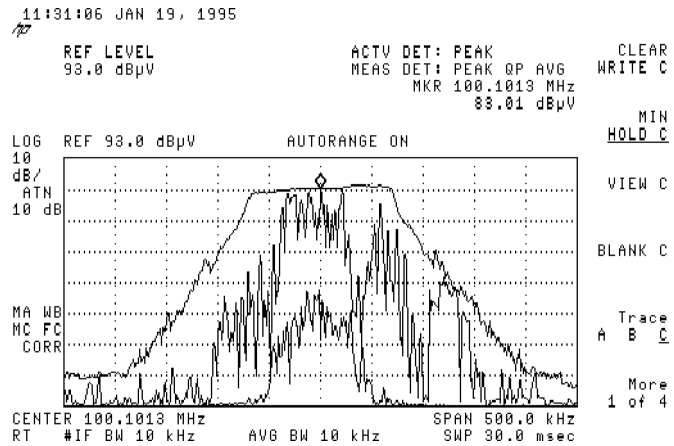

**Figure 7-21. Viewing an unstable signal using Max and Min Hold.**

## Comparing signals using delta markers

Using the analyzer, you can easily compare frequency and amplitude differences between signals, such as radio or television signal spectra. The delta marker function lets you compare two signals when both appear on the screen at one time or when only one appears on the screen.

### Measuring differences between two signals

In this example you will measure the differences between two signals on the same display screen.

1. Set the analyzer to a known state by connecting CAL OUT to INPUT 50 $\Omega$  and by pressing:

**PRESET**

The calibrator signal and its harmonics appear on the display.

2. Place a marker at the highest peak on the display by pressing:

**MKR** →

**MARKER** → **HIGH**

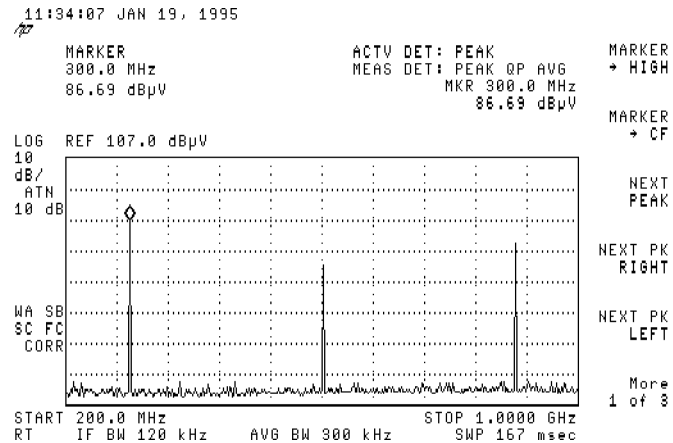

**Figure 7-22. Placing a marker on the CAL OUT signal.**

3. Activate a second marker at the position of the first marker by pressing:

**MKR**

**MARKER**  $\Delta$

4. Move the second marker to another signal peak using the step keys or the knob or by pressing:

**MKR** →

**NEXT PK RIGHT**

- The amplitude and frequency difference between the markers is displayed in the active function block and in the Marker Box. Refer to Figure 7-23.

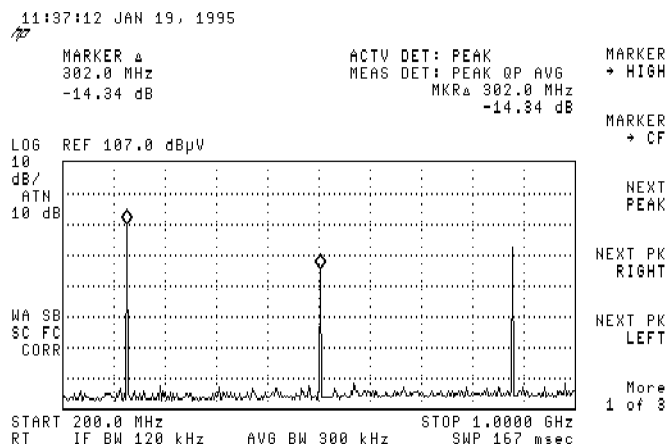

Figure 7-23. Using the marker delta function.

### Measuring differences between signals on screen and off screen

In this example you will measure the frequency and amplitude difference between two signals that do not appear on the screen at the same time. (This technique is useful for harmonic distortion tests when narrow span and narrow bandwidth are necessary to measure the low-level harmonics.)

- Set the analyzer to a known state by connecting CAL OUT to INPUT 50 $\Omega$  and by pressing:

PRESET  
FREQUENCY  
CENTER FREQ ..... 300 MHz  
SPAN ..... 10 MHz

- Place a marker on the peak by pressing:

MKR →  
MARKER → HIGH



3. Identify the position of the first marker by pressing:

**MKR**  
MARKER  $\Delta$

4. Set the center frequency by pressing:

**FREQUENCY**  
CENTER FREQ ..... 600 **MHz**

The first marker remains on the screen at the amplitude of the first signal peak.

**Note**

Changing the reference level changes the marker delta amplitude readout.

The annotation in the upper-right corner of the screen indicates the amplitude and frequency difference between the two markers. Refer to Figure 7-24.

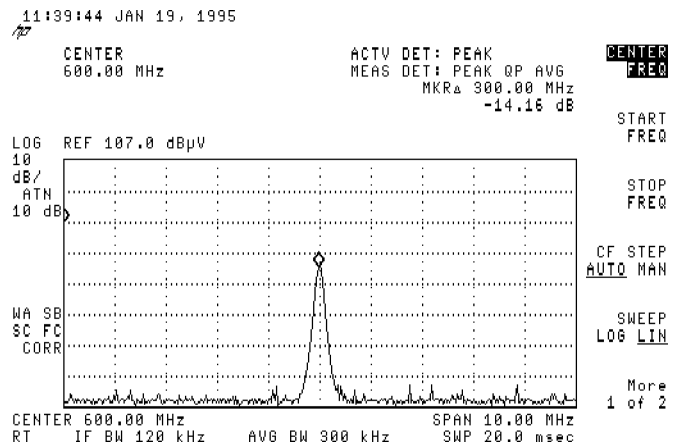

**Figure 7-24. Frequency and amplitude differences.**

## Measuring low-level signals

Analyzer sensitivity is the ability to measure low-level signals. It is limited by the noise generated inside the analyzer. The analyzer input attenuator and bandwidth settings affect the sensitivity by changing the signal-to-noise ratio. The attenuator affects the level of a signal passing through the instrument, whereas the bandwidth affects the level of internal noise without affecting the signal. In the first two examples in this section, the attenuator and bandwidth settings are adjusted to view low-level signals.

If, after adjusting the attenuation and IF bandwidth, a signal is still near the noise, visibility can be improved by using the averaging-bandwidth and video-averaging functions, as demonstrated in the following examples.

### Reducing input attenuation

If a signal is very close to the noise floor, reducing input attenuation brings the signal out of the noise. In this example, reducing the attenuation to 0 dB maximizes signal power in the analyzer.

#### Note

---

The total power of all input signals at the analyzer input must not exceed the maximum power level for the analyzer.

---

1. Connect an antenna to the analyzer input, then press:

**PRESET**

2. Reduce the frequency range to view a low-level signal of interest. For example, to reduce the frequency span to 20 MHz press:

**FREQUENCY**

START FREQ ..... 88 **MHz**

STOP FREQ ..... 108 **MHz**

**BW**

IF BW AUTO MAN MAN ..... 30 **kHz**

3. Place a marker on the low-level signal of interest by pressing:

**MKR**

Use the knob to position the marker at the signal's peak.

4. Place the signal at center frequency by pressing:

**MKR →**

MARKER → CF

5. Reduce the span to 1 MHz by pressing:

**SPAN**

Use the step-down key ( $\Downarrow$ ) to reduce the span. Refer to Figure 7-25.

6. Reduce the amplitude by pressing:

**AMPLITUDE**

$\Downarrow$ ,  $\Downarrow$

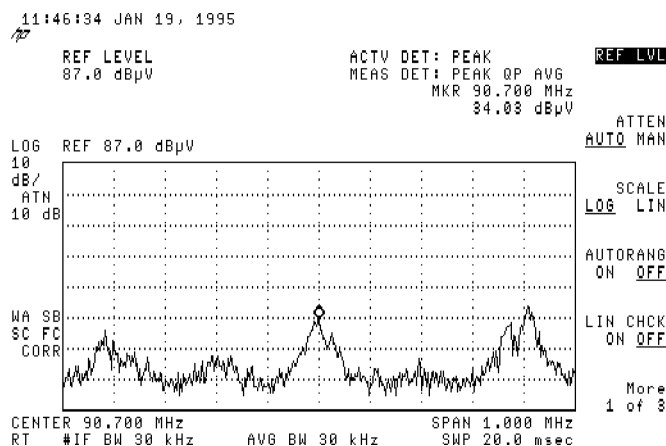

Figure 7-25. Low-level signal.

7. Press:

**ATTEN AUTO MAN**

Press the step-up key ( $\Uparrow$ ) twice to select 30 dB attenuation. Increasing the attenuation moves the noise floor closer to the signal.

A “#” mark appears next to the "ATN" annotation at the side of the display, indicating the attenuation is no longer coupled to other analyzer settings.

8. To see the signal more clearly, press:

0 **dB**

Zero attenuation makes the signal more visible. (To protect the input mixer, 0 dB RF attenuation can be selected only with the data keys.)

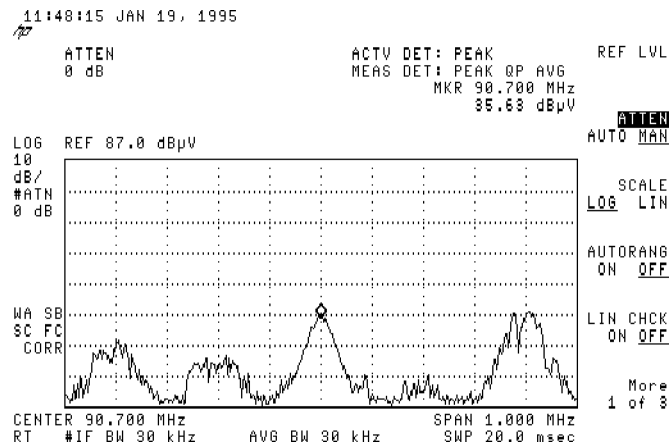

**Figure 7-26. Using 0 dB attenuation.**

**Note**

When using an *HP 85420E Option 1EM RF filter section*, the RF overload indicator may appear on screen if your ambient environment contains a large signal which falls within the bandwidth of the front-end filter section. If this occurs, increase the input attenuation as needed to turn off the indicator after you have completed this example.

9. Before connecting other signals to the analyzer input, increase the RF attenuation to protect the input mixer by pressing:

**ATTEN AUTO MAN** AUTO, or

**AUTO COUPLE**

**AUTO ALL**

## Reducing IF bandwidth

In this example the IF bandwidth will be reduced to view low-level signals.

1. As in the previous example, connect an antenna to the analyzer input. Set the analyzer to view a low-level signal.
2. Press:

**BW**  
IF BW AUTO MAN ..... 10 **kHz**

The low-level signal appears more clearly because the noise level is reduced. Refer to Figure 7-27.

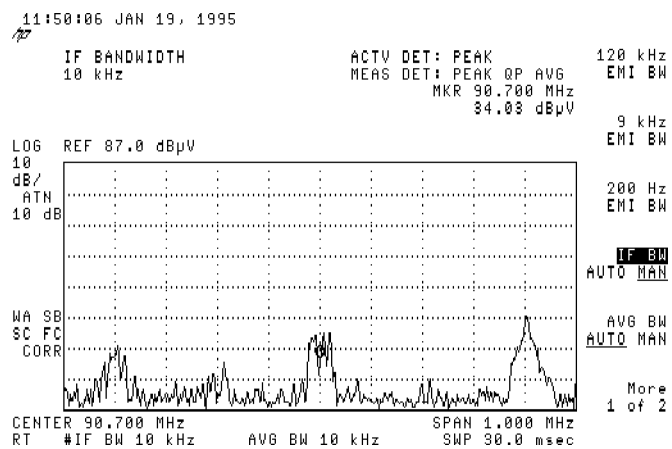

**Figure 7-27. Decreasing IF bandwidth.**

A “#” mark appears next to the “IF BW” annotation at the lower-left portion of the screen, indicating the resolution bandwidth is uncoupled.

As the IF bandwidth is reduced, the sweep time is increased to maintain analyzer calibration.

## Reducing averaging bandwidth

In this example you will use the averaging filter control to observe low-level narrow-band signals close to the noise floor. The averaging filter is a post-detection low-pass filter that smooths the displayed trace. When signal responses near the noise level of the analyzer are visually masked by the noise, the averaging filter can be narrowed to smooth this noise and improve the visibility of the signal. (Reducing averaging bandwidth requires a slower sweep time to keep the analyzer calibrated.)

Using the averaging-bandwidth function, measure the amplitude of a low-level signal.

1. As in the previous examples, connect an antenna to the analyzer input. Set the analyzer to view a low-level signal.
2. Reduce the IF bandwidth by pressing:

```
  (BW)
  IF BW AUTO MAN ..... 30 (kHz)
```

3. Reduce the averaging bandwidth by pressing:

```
  AVG BW AUTO MAN ..... 100 (Hz)
```

This improves the display of the signal by smoothing the noise, allowing better measurement of the signal amplitude.

A “#” mark also appears next to the "AVG BW" annotation at the left-bottom of the screen, indicating that the averaging bandwidth is not coupled to the IF bandwidth.

Instrument preset conditions couple the averaging bandwidth to the IF bandwidth so that the averaging bandwidth is equal to or wider than the IF bandwidth. If the averaging bandwidth is uncoupled when averaging bandwidth is the active function, pressing **AVG BW AUTO MAN** **AUTO** recouples the averaging bandwidth. Refer to Figure 7-28.

---

**Note**

Narrow averaging bandwidths mask pulse noise levels.

---

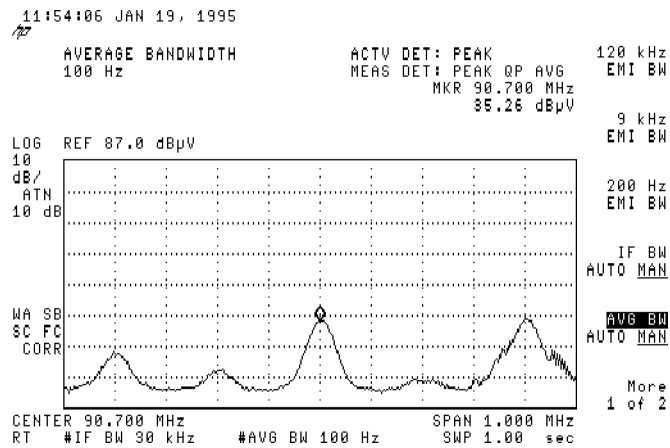

**Figure 7-28. Decreasing averaging bandwidth.**

### Using video averaging

In this example a signal level very close to the noise floor will be made more visible using video averaging.

Video averaging is a digital process in which each trace point is averaged with the previous trace-point average. Selecting video averaging changes the detection mode from peak to sample. The result is a sudden drop in the displayed noise level. The sample mode displays the instantaneous value of the signal at the end of the time or frequency interval represented by each display point, rather than the value of the peak during the interval. Sample mode is not used to measure signal amplitudes accurately because it may not find the true peak of the signal.

---

**Note**

The time required to construct a full trace that is averaged to the desired degree is approximately the same when using either the averaging-bandwidth or the video-averaging technique. The averaging-bandwidth technique completes the averaging as a slow sweep is taken, whereas the video-averaging technique takes many sweeps to complete the average. Characteristics of the signal being measured, such as drift and duty cycle, determine which technique is appropriate.

---

Video averaging improves the display of low-level signals in wide bandwidths by averaging the signal and the noise. As the analyzer takes sweeps, you can watch video averaging smooth the trace.

1. Set the analyzer to a known state by pressing:

```

(BW)
  AVG BW AUTO MAN AUTO
  
```

2. Connect an antenna to INPUT 50Ω of the analyzer and position a low-level signal on the screen.
3. Initiate the video averaging routine by pressing:

```

(TRACE)
  More 1 of 4
  More 2 of 4
  VID AVG ON OFF ON
  
```

As the averaging routine smooths the trace, low-level signals become more visible. "VIDEO AVG 100" appears in the active function block.

The number represents the number of samples (or sweeps) taken to complete the averaging routine.

4. Set the number of samples by pressing:

```

VID AVG ON OFF ..... 25 (ENTER)
  
```

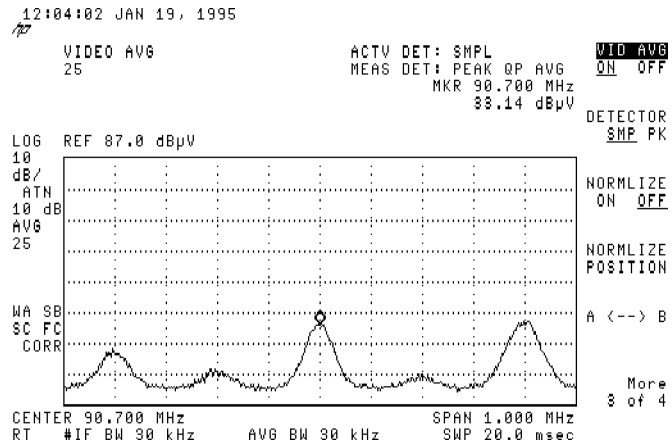

Figure 7-29. Using the video averaging function.



During averaging, the current sample appears at the left side of the graticule. Changes in active functions settings, such as the center frequency or reference level, will restart the sampling. The sampling will also restart if video averaging is turned off and then on again.

Once the set number of sweeps has been completed, the analyzer continues to provide a running average based on this set number.

5. Turn video averaging off and on again by pressing:

`VID AVG ON OFF OFF`

`VID AVG ON OFF ON`

The number of samples equals the number of sweeps in the averaging routine.

### **Testing for distortion using the linearity check**

The linearity check function can be used to test for compression of low-level signals or for the presence of internally-generated distortion due to high-level input signals. This function simplifies the process of determining if the displayed signals are suitable for measurement. Additional input attenuation is switched in while you monitor the value of the marker located on the signal in question. When using an RF filter section, this feature complements the RF overload function, which indicates when an overload *might* be present. It allows you to decide if the signal causing the overload is affecting the measurement of another signal.

### **Measuring small signals in the presence of a large ambient signal**

Analyzer overload due to large signals is one problem encountered when making measurements on an open site. When scanning over a frequency range which contains both a large ambient signal and a low-level DUT emission, the large signal may trigger the analyzer overload indicator when the analyzer sensitivity is set to view the small signal. While the analyzer *is* in overload as it scans through the large signal, it may *not* be in overload as it scans through the small signal. The presence or absence of the overload depends on the frequency spacing between the two signals relative to the analyzer input filter bandwidth. If the analyzer is not in overload as it scans through the small signal, the measured value of that signal will be correct even though the analyzer display indicates an overload has occurred. The Linearity Check function can be used to determine if the analyzer is in overload under these conditions.

1. Connect two signal generators to the input of the analyzer as shown in Figure 7-30. Set one signal to 300 MHz, 92 dB $\mu$ V (–15 dBm) and the other to 305 MHz, 27 dB $\mu$ V (–80 dBm). Increase the amplitude of the 305 MHz signal if it is masked by the noise level of the 300 MHz source.

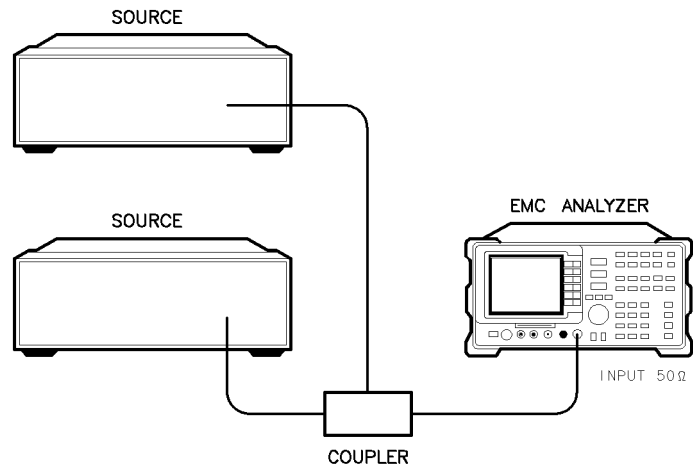

setfor2

**Figure 7-30. Set-up for obtaining two signals.**

2. Set the analyzer to a known state by pressing:

```

(PRESET)
(FREQUENCY)
  CENTER FREQ ..... 305 (MHz)
(SPAN) ..... 20 (MHz)
(AMPLITUDE)
  ATTEN AUTO MAN ..... 0 (dB)

```

Note the IF OVERLOAD message on the display due to the 300 MHz signal.

3. To view and mark the 305 MHz signal, press:

```

(SPAN) ..... 5 (MHz)
(MKR →)
  MARKER → HIGH
(MKR)
  MARKER Δ

```

Note the fluctuations in the delta marker amplitude displayed in the active function area. When the signal is near the noise floor, the noise contributions will cause fluctuation in the marker value. This could be interpreted as overload induced error when LINEARITY CHECK is activated.

4. To reduce the fluctuation, decrease the averaging bandwidth by pressing:

```

(BW)
  AVG BW AUTO MAN ..... 1 (kHz)

```

Note the absolute level of the marker delta readout and the reduced range of the fluctuation.

5. Activate linearity check by pressing:

AMPLITUDE

LIN CHCK ON OFF ON

If the delta marker amplitude and fluctuation changes by more than 1 dB, the analyzer is in compression. In this example, the delta marker readings remain the same and a valid measurement can be made because the 305 MHz signal is not being affected by the 300 MHz signal.

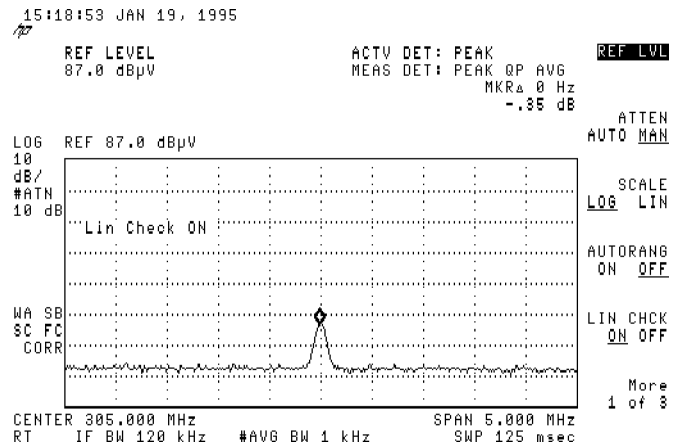

Figure 7-31. Using linearity check to detect compression.

**Using linearity check.** The Linearity Check function can be used to determine if a signal displayed in the presence of a high level ambient is an actual emission or an internally generated distortion product. When the Linearity Check function is activated, the level of the distortion product will change but the level of an actual input signal will not.

1. Connect two signal generators to the input of the analyzer as shown in Figure 7-32. Set one signal to 300 MHz, 107 dB $\mu$ V (0 dBm) and the other to 305 MHz, 65 dB $\mu$ V (-42 dBm). Increase the amplitude of the 305 MHz signal if it is masked by the noise level of the 300 MHz source.

**Note**

These levels were intentionally chosen to overdrive the analyzer and generate third order distortion products.

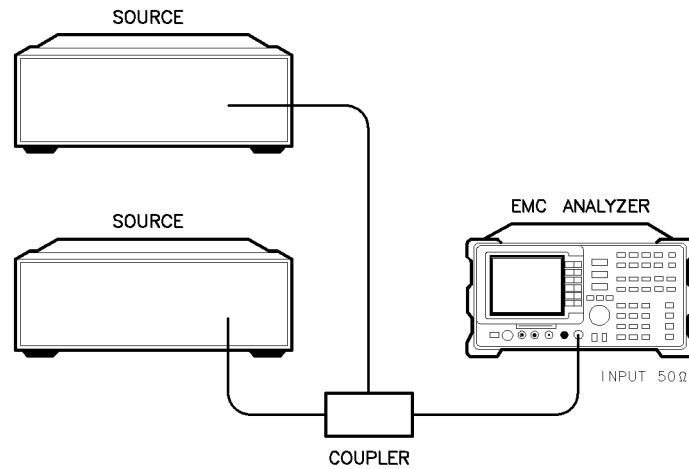

**Figure 7-32. Set-up for obtaining two signals.**

2. Set the analyzer to a known state by pressing:

```

(PRESET)
(FREQUENCY)
  CENTER FREQ ..... 300 (MHz)
  SPAN ..... 20 (MHz)
  (AMPLITUDE), (↓)
    ATTEN AUTO MAN ..... 0 (dB)
  
```

Note the IF OVERLOAD message.

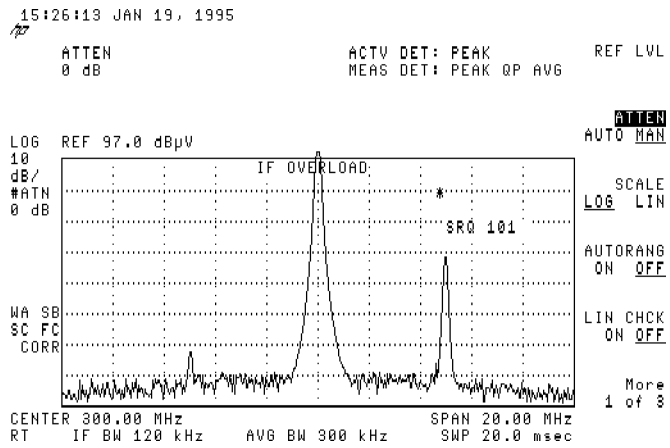

**Figure 7-33. Generating third order distortion products.**

- Use the knob to place the marker on the 295 MHz signal. Center the signal on the display and decrease the span by pressing:

**MKR** →  
 MARKER → CF  
**SPAN** ..... 5 **MHz**

- Reduce the noise induced fluctuations by pressing:

**BW**  
 AVG BW AUTO MAN ..... 1 **kHz**

- Observe the marker delta amplitude as you press:

**MKR**  
 MARKER Δ

- Active the Linearity Check function by pressing:

**AMPLITUDE**  
 LIN CHCK ON OFF ON

Observe the drop in the measured signal.

15:27:32 JAN 19, 1995

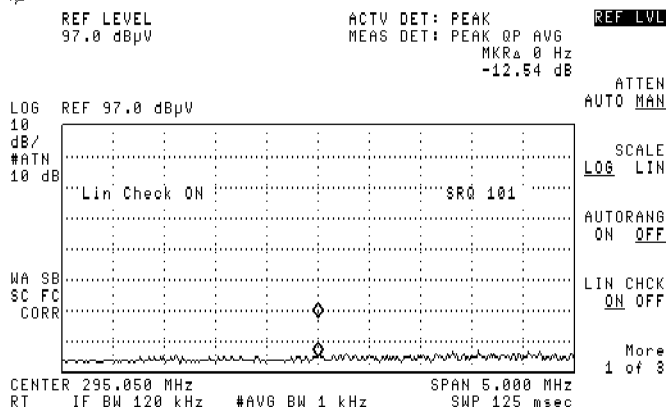

**Figure 7-34.**  
Using linearity check to identify distortion products.

## Demodulating and listening to an AM or FM signal

The functions available using the **DEMOD** key allow you to demodulate and hear signal information displayed on the EMC analyzer. Simply place a marker on a signal of interest, activate AM or FM demodulation, and then listen.

1. Connect an antenna to INPUT 50 $\Omega$  of the analyzer.
2. Select a frequency range on the analyzer, such as the range for FM radio broadcasts. For example, the frequency range for FM broadcasts in the United States is 88 MHz to 108 MHz. Press:

```
PRESET
FREQUENCY
START FREQ ..... 88 MHz
STOP FREQ ..... 108 MHz
```

3. Place a marker on the signal of interest by pressing:

```
MKR
```

Use the step keys or knob to moving the marker to a signal of interest.

4. Turn demodulation on by pressing:

```
DEMOD
DEMOD ON OFF ON
DEMOD AM FM FM
```

Use the front-panel volume control to control the speaker's volume.

5. The signal at the marker is demodulated for the duration of the dwell time. Use the step keys, knob, or data keys to change the dwell time. To change the dwell time to two seconds, press:

```
DWELL TIME, (↑), (↑)
```

6. The peak search functions can be used to move the marker to other signals of interest. Press **MKR →** to access **NEXT PEAK**, **NEXT PK RIGHT**, or **NEXT PK LEFT**.

7. The signal at the marker can be continuously demodulated when the frequency scan is turned off by pressing:

```
TEST
FRQ SCAN ON OFF OFF
```

8. To adjust FM sensitivity to better demodulate wideband or narrowband FM signals, adjust the FM Gain by pressing:

```
DEMOD
FM GAIN
```

The default value is 100 kHz per volt.



## Using the analyzer in zero frequency span

The EMC analyzer operates as a fixed-tuned analyzer in zero span. The zero span mode can be used to recover modulation on a carrier signal.

Center frequency in the swept-tuned mode becomes the tuned frequency in zero span. The horizontal axis of the screen becomes calibrated in time, rather than frequency. Markers display amplitude and time values.

The following functions establish a clear display of the video waveform.

- Trigger stabilizes the waveform trace on the display by triggering on the modulation envelope. If the signal's modulation is stable, video trigger synchronizes the sweep with the demodulated waveform.
- Linear mode should be used in amplitude modulation (AM) measurements to avoid distortion caused by the logarithmic amplifier when demodulating signals.
- Sweep time adjusts the full sweep time from 20 ms (20  $\mu$ s in zero span with Option 101), to 100 s. The sweep time readout refers to the full 10-division graticule. Divide this value by 10 to determine sweep time per division.
- Resolution and video bandwidth are selected according to the signal bandwidth.

Each of the coupled function values remains at its current value when zero span is activated. Video bandwidth is coupled to resolution bandwidth. Sweep time is not coupled to any other function.

### Note

---

Capability for measuring AM or FM demodulation is not available if your EMC analyzer has option 703. Refer to "Demodulating and Listening to an AM or FM Signal" in Chapter 8 for more information.

---

**Example:** View the modulation waveform of an AM signal in the time domain.

1. To obtain an AM signal, you can either connect an antenna to the EMC analyzer input and tune to a commercial AM broadcast station or you can connect a source to the EMC analyzer input and set the percent modulation of the source. (If a headset is used with the VIDEO OUT connector, the EMC analyzer will operate as a radio.)
2. First, center and zoom in on the signal in the frequency domain. Refer to "Decreasing the Frequency Span Using the Marker Track Function." Be sure to turn off the marker track function, since the marker track function must be off for zero span. Refer to Figure 7-35.



6. To select zero span, either press:

**SPAN** ..... 0 **Hz**

or press:

**ZERO SPAN**

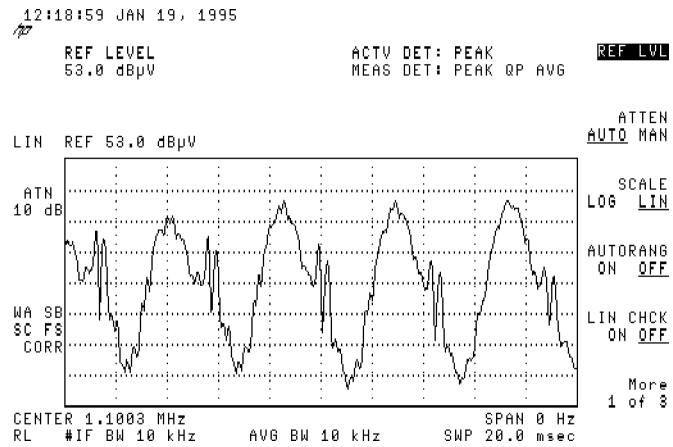

**Figure 7-36. Measuring modulation in zero span.**

If the modulation is a steady tone (for example, from a signal generator), use video trigger to trigger on the waveform and stabilize the display. Adjust the sweep time to change the horizontal scale.

Use markers and delta markers to measure time parameters of the waveform.

## Measuring signals near band boundaries using harmonic lock

### Note

This application should only be performed using an *HP 8593EM*, *HP 8595EM*, or *HP 8596EM*.

When measuring signals at or near a band crossing, use the lowest band having a specified upper frequency limit that will include the signal of interest. Refer to *HP 8590 EM Series EMC Analyzer Verification Guide* for your instrument for harmonic band specifications. Using harmonic lock, and choosing the lowest possible band to analyze a signal, ensures the best specified measurement accuracy.

To lock onto a specific harmonic, press:

```
(FREQUENCY)
More 1 of 2
Band Lock
BND LOCK ON OFF ON
```

or select a band (refer to *HP 8590 EM Series EMC Analyzer Verification Guide* for your instrument for band specifications).

After setting the harmonic lock, only center frequencies and spans within the frequency range of the harmonic band may be entered. The span is automatically reduced to accommodate a center frequency specified near the end of the band range.

### Example:

1. Connect 100 MHz COMB OUT to the EMC analyzer input. The HP 8595EM does not have a 100 MHz COMB OUT signal, so it cannot be used for this measurement example. (An external source must be substituted.)

2. Press (PRESET) and then the following keys:

```
(AUX/USER)
COMB GEN ON OFF ON
(SPAN) .....350 (MHz)
(FREQUENCY)
CENTER FREQ ..... 6.6 (GHz)
More 1 of 2
Band Lock
BND LOCK ON OFF ON
```

3. Place a marker on the farthest peak to the left by using the (MKR) key and the knob.

4. Press:

MARKER  $\Delta$

MKR  $\rightarrow$

NEXT PK RIGHT, NEXT PK RIGHT

to show the frequency and amplitude difference between the two comb teeth.

You will see three comb teeth on your display. The EMC analyzer is locked in band 2 and will not allow multiband sweeps. Refer to Figure 7-37.

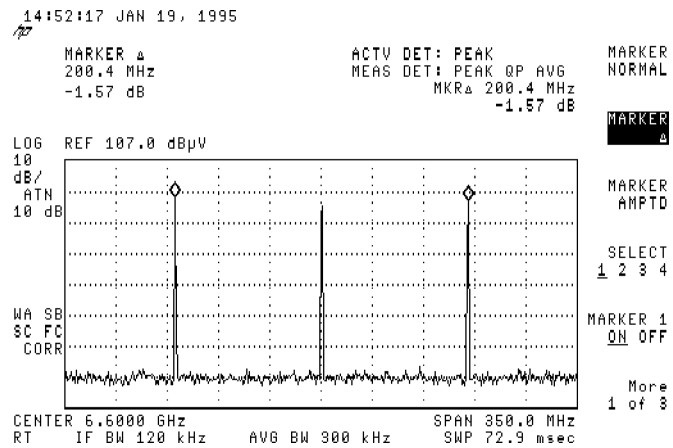

Figure 7-37. Using harmonic lock.

5. To see a multiband sweep, press the following keys:

MKR

More 1 of 3

MARKER ALL OFF

FREQUENCY

More 1 of 2

Band Lock

BND LOCK ON OFF OFF

- 6. Place a marker on the farthest peak to the left by pressing **(MKR)** and adjusting the knob.
- 7. Press:

**MARKER Δ**

**(MKR →)**

Use **NEXT PK RIGHT** to place a marker on the farthest peak to the right. The marker readout displays the frequency and amplitude difference between the two comb teeth. Refer to Figure 7-38.

**Note**

The comb frequencies have a 100 MHz spacing.

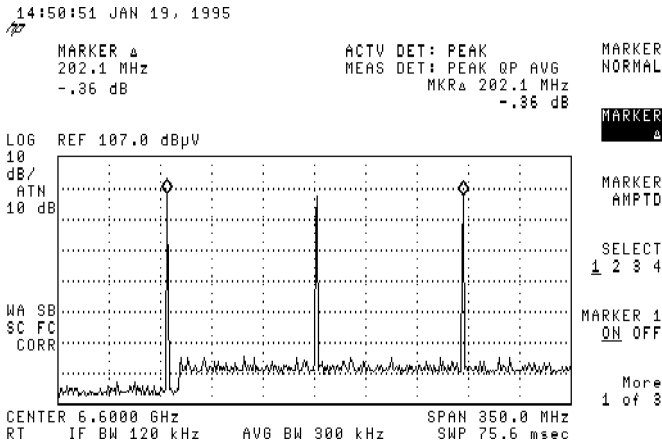

**Figure 7-38. Harmonic locking off.**

---

## Localized Susceptibility Testing

### Configuring systems for localized susceptibility testing

A typical setup for localized susceptibility testing is shown in Figure 7-39. The setup shown uses the HP 84100EM Preproduction Evaluation system.

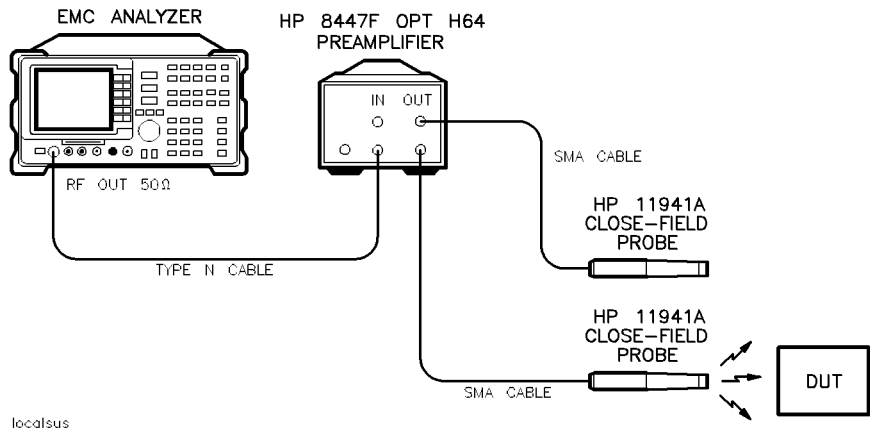

**Figure 7-39. Localized susceptibility measurements test setup.**

#### Caution

The HP 8447F preamplifier will only accept a 107 dB $\mu$ V input. The HP 8591EM's tracking generator can output 127 dB $\mu$ V, so be sure you know the output of the tracking generator *before* connecting it to the input of the HP 8447F. To prevent the amplifier from going into gain compression, the best, or safest input is approximately 92 dB $\mu$ V. A signal greater than this will not improve the amplifier's output and can cause gain compression.

#### Caution

When using an HP 8593EM, HP 8594EM, HP 8595EM, or HP 8596EM EMC analyzer, *delete the HP 8447F Option H64.*

The HP 8593EM, HP 8594EM, HP 8595EM, or HP 8596EM tracking generator can output 97 dB $\mu$ V, so be sure you know the output of the tracking generator *before* connecting it to the input of the HP 8447F. To prevent the amplifier from going into gain compression, the best, or safest input is approximately 92 dB $\mu$ V. A signal greater than this will not improve the amplifier's output and can cause gain compression.

When not using the preamplifier with the HP 8593EM, HP 8594EM, HP 8595EM, or HP 8596EM EMC analyzers, set **SCR PWR** (source power) to +2.75 dB.

## Equipment list

EMC analyzer .....	HP 8591EM Option 010
	HP 8593EM Option 010
	HP 8594EM Option 010
	HP 8595EM Option 010
	HP 8596EM Option 010
HP 11945A close-field test set .....	HP 11940A
	HP 11941A
preamplifier (use with HP 8591EM only) .....	HP 8447F Option H64

## Caution

The maximum safe input power to the HP 11940 and HP 11941 probes is +30 dB $\mu$ V (1 W).

## Making localized susceptibility measurements

The following steps set up the tracking generator portion of the EMC analyzer.

### Setting up the tracking generator

- To set the tracking generator to a known level without turning the it on, press:

```

PRESET
AUX/USER
Track Gen
SCR PWR ON OFF
  
```

The source power becomes the active function, SCR PWR is displayed in inverse video, but the source power has not been turned on. A typical display is shown in Figure 7-40.

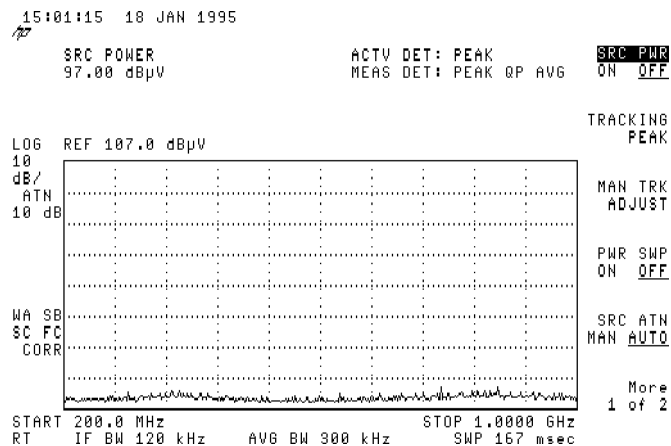

Figure 7-40. Setting up the tracking generator.



## Tuning the tracking generator

The next step requires tuning the tracking generator to the frequency of interest. The frequency must be within the frequency range of the probe being used. In the following steps an HP 11941A close-field probe with a frequency range of 9 kHz to 30 MHz is used to look at a narrow frequency range of about 10 MHz to 30 MHz.

2. To tune the analyzer for the desired range, press:

```

[SETUP]
  150 kHz -30 MHz
[FREQUENCY]
  START FREQ ..... 10 [MHz]

```

The tracking generator is now sweeping that range.

## Turning the tracking generator on

3. To set the source power, press:

```

[AUX/USER]
  Track Gen
  SCR PWR ON OFF ..... 92 [+dBμV]

```

The tracking generator is on. Notice the **SCR PWR** function has toggled to ON. A typical display is shown in Figure 7-41.

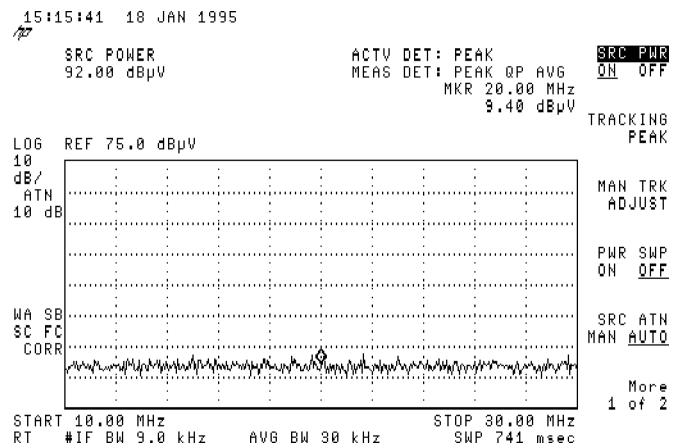

Figure 7-41. Turning the tracking generator on.

4. Use the probe to check the circuit under test for any disruptions in the DUT's normal operation.



## Making Other Measurements

---

### What you'll find in this section

This section demonstrates EMC analyzer measurement techniques with examples of typical applications; each application focuses on different features. The measurement procedures covered in this section are listed below.

- Stimulus-response measurements
- Making a reflection calibration and measurement
- Measuring amplitude modulation using FFT
- 3 dB and 6 dB bandwidth measurements
- 99% power bandwidth measurements
- Percent AM modulation measurements
- Amplitude and frequency difference measurements
- Third order measurements
- Using the HP 85420E Option 1EM RF filter section
- Learning about the analyzer's analog+ display mode
- Triggering on a selected line of a video picture field (Options 101 and 102, or Option 301 only).

To find descriptions of specific EMC analyzer functions refer to Chapter 17.

## Stimulus-response measurements

### What are stimulus-response measurements?

Stimulus-response measurements require a source to stimulate a device under test (DUT), an EMC analyzer to analyze the frequency-response characteristics of the DUT, and, for return-loss measurements, a directional coupler. Characterization of a DUT can be made in terms of its transmission or reflection parameters. Examples of transmission measurements include flatness and insertion loss. An example of a reflection measurement is return loss.

An EMC analyzer combined with a tracking generator forms a stimulus-response measurement system. Using the tracking generator as the swept source operation is analogous to a single-channel scalar network analyzer. A narrow-band system has a wide dynamic measurement range, but the tracking generator's output frequency must be made to precisely track the EMC analyzer's input frequency. This wide dynamic range will be illustrated in the following example. Figure 8-1 shows the block diagram of an EMC analyzer and tracking generator system.

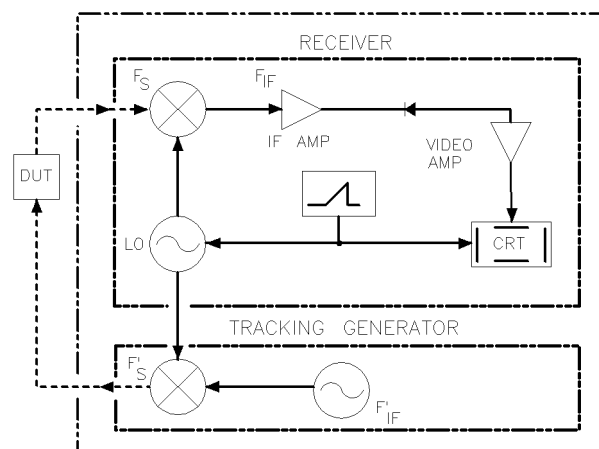

tgfig

**Figure 8-1.**  
**EMC analyzer/tracking generator system block diagram.**

### Using the EMC analyzer with the internal tracking generator

The procedure below describes how to use the built-in tracking generator system of the EMC analyzer to measure the rejection of a low-pass filter, which is a type of transmission measurement. Illustrated in this example are the functions in the tracking-generator menu, such as adjusting the tracking-generator output power, source calibration, and normalization.

## Stepping through the measurement

There are four basic steps in performing a stimulus-response measurement, whether it be a transmission or reflection measurement: set up the EMC analyzer settings, calibrate, normalize, and measure.

1. If necessary, perform the self-calibration routine for the tracking generator described in Chapter 2.
2. To measure the rejection of a bandpass filter, connect the equipment as shown in Figure 8-2. This example uses a bandpass filter with a center frequency of 145.4 MHz as the DUT.

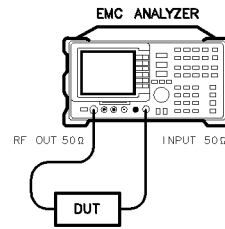

Figure 8-2. Transmission measurement test setup.

3. Set the EMC analyzer to a known state by pressing:

```
PRESET
FREQUENCY
START FREQ ..... 100 (MHz)
STOP FREQ ..... 250 (MHz)
AMPLITUDE ..... 102 (+dBμV)
```

4. Activate the tracking generator and turn the power on by pressing:

```
AUX/USER
Track Gen
SRC PWR ON OFF ON
```

### Caution

Excessive signal input may damage the DUT. Do not exceed the maximum power that the device under test can tolerate.

### Note

To reduce ripples caused by source return loss, use 10 dB or greater tracking generator output attenuation. Tracking generator output attenuation is normally a function of the source power selected. However, the output attenuation may be controlled by using

```
SRC ATN MAN AUTO .
```

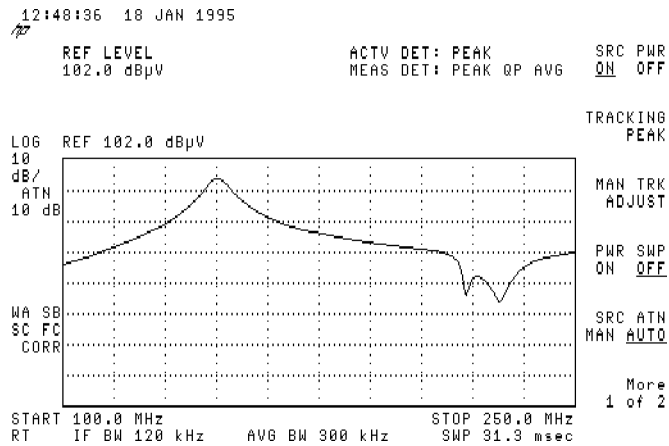

**Figure 8-3. Tracking-generator output power activated.**

- Put the sweep time of the EMC analyzer into stimulus-response auto-coupled mode by pressing:

More 1 of 2

SWP CPLG SR SA SR

Auto-coupled sweep times are usually much faster for swept-response measurements than for EMC analyzer measurements.

**Note**

In the stimulus-response mode, the Q (reactance versus resistance) of the DUT can determine the fastest rate at which the EMC analyzer can be swept. To determine whether the EMC analyzer is sweeping too fast, slow the sweep time and note whether there is a frequency or amplitude shift of the trace. Continue to slow the sweep time until there is no longer a frequency or amplitude shift.

- Decrease the resolution bandwidth to increase sensitivity, and narrow the averaging bandwidth to smooth the noise by pressing:

**BW**

IF BW AUTO MAN ..... 10 **kHz**

AVG BW AUTO MAN ..... 1 **kHz**

7. To make a transmission measurement accurately, the frequency response of the test system must be known. To measure the frequency response of the test system, connect the cable *but not the DUT* from the tracking generator output to the EMC analyzer input.

To store the frequency response of the test system in trace B, press:

```
TRACE
Trace A B C B
CLEAR WRITE B
BLANK B
```

8. To normalize, *reconnect the DUT* to the EMC analyzer and press:

```
TRACE
More 1 of 4
More 2 of 4
NORMLIZE ON OFF ON
```

Activate the display line by pressing:

```
NORMLIZE POSITION
```

The display line marks the normalized reference position, or the position where 0 dB insertion loss (transmission measurements) or 0 dB return loss (reflection measurements) will normally reside. Using the knob results in a change in the position of the normalized trace, within the range of the graticule. Set the level so it is one graticule below the top of the display.

Normalization eliminates the frequency response error of the test system. When normalization is on, trace math is being performed on the active trace. The trace math performed is trace A minus trace B plus the display line, with the result placed into trace A. Remember that trace A contained the measurement trace, trace B contained the stored calibration trace, and DL (display line) represents the normalized reference position. Note that the units of the reference level, dB, reflect this relative measurement.

- Measure the insertion loss of the filter at a given frequency (for example, 145.4 MHz) by pressing:

**(MKR)** ..... 145.4 **(MHz)**

The marker readout displays the rejection of the filter at 145.4 MHz (refer to Figure 8-4).

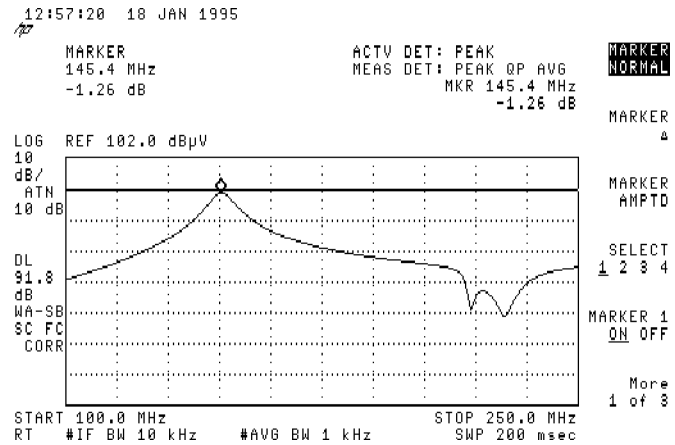

**Figure 8-4. Normalized trace.**

- Measure the rejection of the filter relative to the passband by pressing:

**(MKR)**  
MARKER Δ ..... 30 **(MHz)**



The Marker  $\Delta$  amplitude readout displays the rejection at a 30 MHz frequency offset refer to Figure 8-5.

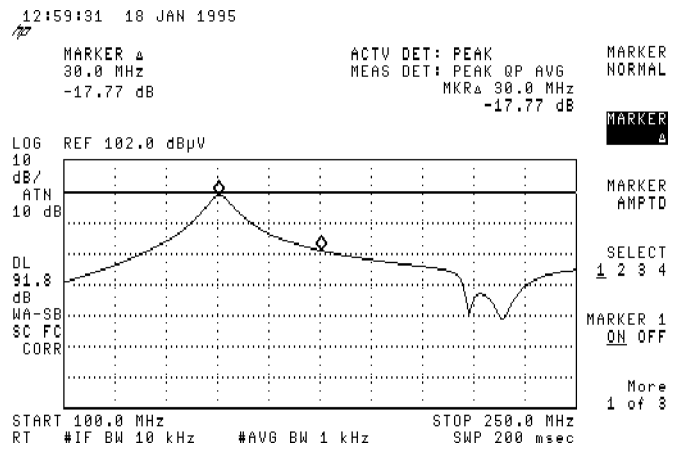

Figure 8-5. Measuring the rejection of the filter.

## Tracking generator unlevelled condition

When using the tracking generator, the message TG UNLVL may appear. The TG UNLVL message indicates that the tracking generator source power (SRC PWR ON OFF) could not be maintained at the user-selected level during some portion of the sweep. If the unlevelled condition exists at the beginning of the sweep, the message will be displayed immediately. If the unlevelled condition occurs after the sweep begins, the message will be displayed after the sweep is completed. A momentary unlevelled condition may not be detected when the sweep time is small. The message will be cleared after a sweep is completed with no unlevelled conditions.

The unlevelled condition may be caused by any of the following:

- Start frequency is too low or the stop frequency is too high. The unlevelled condition is likely to occur if the true frequency range exceeds the tracking generator frequency specification (especially the low frequency specification). The true frequency range being swept may be significantly different than the start or stop frequency annotations indicate, depending on other EMC analyzer settings, especially the span (refer to Chapter 17 for more instrument). For better frequency accuracy, use a narrower span.
- Tracking peak may be required (use TRACKING PEAK).
- Source attenuation may be set incorrectly (select SRC ATN MAN AUTO (AUTO) for optimum setting).
- The source power may be set too high or too low, use SRC PWR ON OFF to reset it.
- The source power sweep may be set too high, resulting in an unlevelled condition at the end of the sweep. Use PWR SWP ON OFF to decrease the amplitude.

## Making reflection calibration measurements

Typically, the calibration standard for reflection measurements is a short circuit connected at the reference plane (the point at which the test device will be connected). Refer to Figure 8-6. A short circuit has a reflection coefficient of 1 (0 dB return loss); it thus reflects all incident power and provides a convenient 0 dB reference.

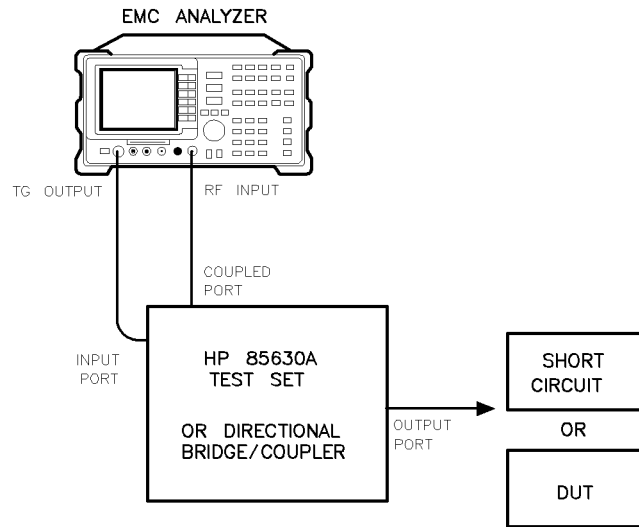

pu135e

**Figure 8-6. Reflection measurement short calibration test setup.**

**Example:** Measure the return loss of a filter.

The following procedure is written for making a reflection measurement using a coupler or directional bridge, instead of the test set.

### Reflection calibration

#### Note

The EMC analyzer center frequency and span for this measurement can easily be set up using the transmission measurement setup. Tune the EMC analyzer so that the passband of the filter comprises a majority of the display, then proceed with the steps outlined below.

1. Connect the DUT to the *output* port of a directional bridge or coupler. Terminate the unconnected port of the DUT.
2. Connect the tracking generator output of the EMC analyzer to the *input* port of a directional bridge or coupler.
3. Connect the EMC analyzer INPUT to the *coupled* port of a directional bridge or coupler.

4. Adjust the EMC analyzer for measurement conditions or settings. Turn on the tracking generator and set the amplitude level by pressing:

```
AUX/USER
Track Gen
SRC PWR ON OFF ON
```

Set center frequency, span, and other settings.

5. Replace the DUT with a short circuit.
6. Normalize the trace by performing the following functions:
  - a. To display the reference trace in B, press:

```
TRACE
TRACE A B C B
CLEAR WRITE B
```

- b. To store the reference trace in B, press:

```
BLANK B
```

- c. To activate the trace A minus trace B function, and display the results in trace A for each sweep, press:

```
More 1 of 4
More 2 of 4
NORMLIZE ON OFF ON
```

The normalized trace or flat line represents 0 dB return loss.

### Measuring the return loss

---

#### Note

If possible, use a coupler or bridge with the correct test port connector for both calibrating and measuring. Any adapter between the test port and DUT degrades coupler/bridge directivity and system source match. Ideally, you should use the same adapter for the calibration and the measurement. Be sure to terminate the second port of a two-port device.

---

7. After calibrating the system with the above procedure, reconnect the filter in place of the short circuit without changing any EMC analyzer settings.

8. Use the marker to read return loss. Press **(MKR)** and position the marker with the knob to read the return loss at that frequency. Refer to Figure 8-7.

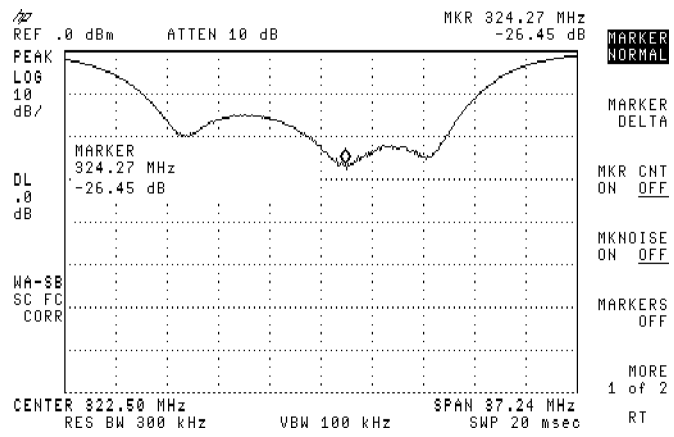

**Figure 8-7. Measuring the return loss of the filter.**

## Measuring amplitude modulation with the fast Fourier transform function

The fast Fourier transform (FFT) function of the EMC analyzer allows measurements of amplitude modulation (AM). The FFT function transforms demodulated AM data from the time domain (zero span) to the frequency domain. The FFT function calculates the magnitude of each frequency block of time-domain samples of the input signal. It is commonly used to measure AM at rates that cannot be measured in the normal frequency domain. The FFT is a post-detection fast Fourier transform function and cannot be used to resolve continuous wave or carrier signals.

The FFT function requires a specific EMC analyzer configuration. An AM signal is demodulated in the time domain by widening the resolution bandwidth to include the signal sidebands within the passband of the EMC analyzer. Then the scan is turned off so the tuning is centered on the AM carrier.

When **(AUX/USER)**, **More 1 of 3**, **FFT MEAS** is pressed, the function sets sample-detection mode and takes a sweep to obtain a sample of the input signal. Then the EMC analyzer executes a series of computations on the time data to produce the frequency-domain results.

### Note

After the FFT function is used, the markers are still in FFT mode for use in evaluating data. Turn off the markers before attempting to use the markers in the normal fashion.

## Measuring the sidebands on a signal

1. Connect a signal generator to the EMC analyzer input on the front panel. Adjust the signal generator to produce an AM signal at 10 MHz. (For example, set the modulation rate to 60 Hz with a 30% modulation level.)
2. Set the EMC analyzer to a known state by pressing:

```
(PRESET)
(FREQUENCY)
  CENTER FREQ ..... 10 (MHz)
  (SPAN) ..... 1 (MHz)
```

3. Set the IF bandwidth to 3 kHz by pressing:

```
(BW)
  IF BW AUTO MAN ..... 3 (kHz)
```

The IF bandwidth should be about 10 times greater than the highest modulation frequency of interest. (In this example, the fourth harmonic of 60 Hz is 240 Hz.)

4. Set the averaging bandwidth to 1 kHz by pressing:

AVG BW AUTO MAN ..... 1 **kHz**

The averaging bandwidth should be about twice that of the highest modulation frequency of interest. If the averaging bandwidth is too large, "alias" signals may appear in the FFT when signals greater than the highest modulation frequency of interest are present.

5. Change the amplitude scale to linear by pressing:

**AMPLITUDE**  
SCALE LOG LIN LIN

6. Change the reference level to place the signal peak within the top two divisions of the display by pressing:

REF LVL

Use the step keys or knob to adjust the signal. The signal must be below the reference level.

7. Turn frequency scan off by pressing:

**TEST**  
FRQ SCAN ON OFF OFF

8. Refer to Figure 8-8, which shows maximum modulation frequency ( $f_m$ ) in Hertz versus sweep time ( $T_s$ ) in seconds. Set the sweep time less than  $T_s(\text{man})$  for the maximum modulation frequency ( $f_m$ ) including the harmonics of the signal. The upper curve relates the sweep time to the maximum modulation frequency that can be observed (that is, the modulation frequency represented by the right edge of the graticule). The lower curve represents the modulation frequency one division from the left side of the graticule.

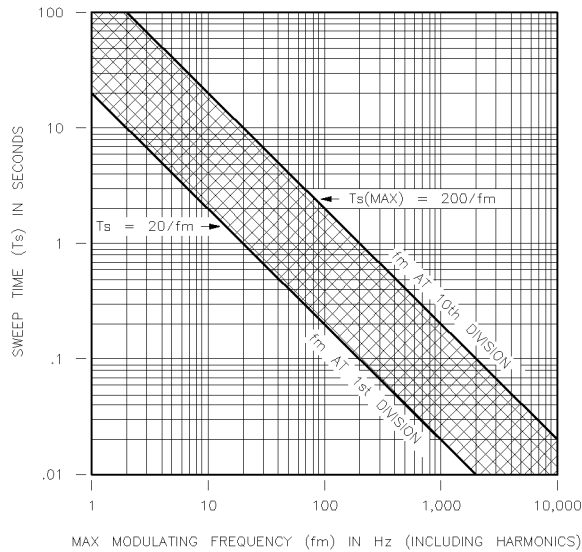

maxmod

**Figure 8-8.**  
**Maximum modulation frequency versus sweep time.**

Set the sweep time so it falls in the shaded area between the two lines. Refer to Figure 8-8. Set it closer to the bottom line to avoid the effects of aliasing. Note the upper line (marked *fm AT 10th DIVISION*) represents sampling at exactly the Nyquist rate. Some aliasing may be seen when a value for sweep time is close to the upper line. (Frequencies greater than the maximum modulation frequency for a specific sweep time will not be displayed accurately.)

For example, set the sweep time according to the figure (for a right edge graticule limit of 250 Hz, select 800 ms) by pressing:

**[SWEEP/TRIG]** ..... 800 **[ms]**

9. To save the current EMC analyzer settings in instrument state 2, press:

**[SAVE/RECALL]**  
 Save Internal  
 STATE → INTRNL ..... 2

If you wish to repeat the measurement retrieve the EMC analyzer settings by pressing:

**[SAVE/RECALL]**  
 Recall Internal  
 INTERNAL → STATE ..... 2

**Note**

If you want to prevent the EMC analyzer from taking a sweep before executing the FFT function, place trace A in the view mode.



10. To perform a fast Fourier transform, press:

**AUX/USER**

More 1 of 3

**FFT MEAS**

When the transform is complete the frequency-domain data is displayed.

11. A marker is placed on the carrier at the 0 Hz reference (at the left edge of the display). To determine the frequency and amplitude difference from the carrier, press:

**MKR**

**MARKER Δ**

Use the knob to move the marker to the modulation.

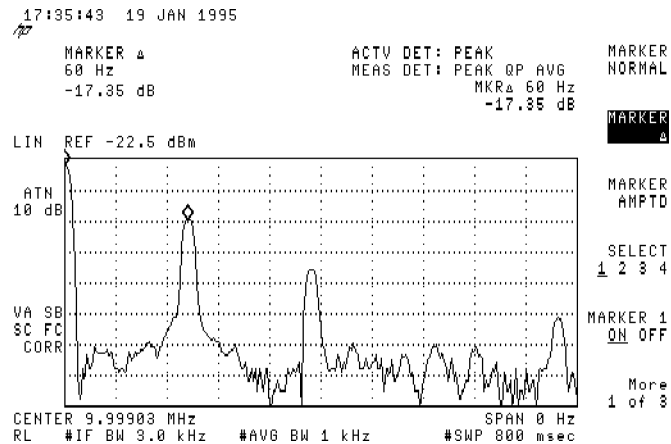

**Figure 8-9. Using the FFT function.**

The results of the FFT function are displayed on the EMC analyzer screen. The carrier is displayed at the left edge of the screen. The modulation sidebands and any distortion is displayed along the horizontal axis. The left edge of the graticule represents 0 Hz relative to the carrier. The right edge of the graticule represents the maximum FFT frequency calculated. In Figure 8-9 the maximum FFT frequency is 200 divided by the sweep time (250 Hz). The amplitude relationships between the carrier, sidebands, and distortion components are the same as they would be if displayed using swept-tuned operation in log mode at 10 dB per division.

**Note**

The annotation describes the settings before the FFT (linear mode, center frequency 300 MHz, span 0 Hz), and the marker annotation describes the settings after the FFT (log mode, signal at 60 Hz, maximum frequency is 250 Hz).

12. Turn off the markers by pressing:

**(MKR)**  
MARKER 1 ON OFF OFF

**Note**

If the markers are not turned off after using the FFT function they will not work correctly when used with other settings.

**Repeating the test.**

13. To repeat the test, clear the screen data by pressing:

**(TRACE)**  
CLEAR WRITE A

14. Recall the instrument state by pressing:

**(SAVE/RECALL)**  
Recall Internal  
INTERNAL → STATE ..... 2

15. Continue the measurement from list item 10.

## Measuring 3 dB and 6 dB bandwidth

The EMC analyzer allows you to measure the 3 dB or 6 dB bandwidth of a filter by pressing a single button. A delta marker measurement is performed on the largest on screen signal and the bandwidth is displayed in the active function area.

1. Set the EMC analyzer to a known state by pressing:

**PRESET**

2. Connect CAL OUT to INPUT 50Ω.

3. Set the frequency and span by pressing:

**FREQUENCY**

CENTER FREQ ..... 300 **MHz**

**SPAN** .....

2 **MHz**

4. Perform a 3 dB bandwidth measurement by pressing:

**AUX/USER**

More 1 of 3

**3 dB POINTS**

5. Perform a 6 dB bandwidth measurement by pressing:

**6 dB POINTS**

The value is displayed in the active function block.

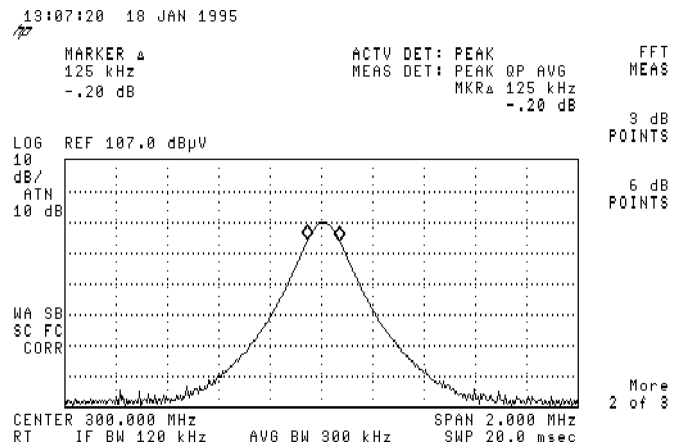

Figure 8-10. Using the 6 dB points function.

## Measuring 99% power bandwidth

The EMC analyzer allows you to measure the power bandwidth of a signal by pressing a single button. The result is displayed in the active function area.

1. Tune the EMC analyzer so only the signal of interest is displayed.
2. Set the EMC analyzer to a known state by pressing:

**PRESET**

3. Connect CAL OUT to INPUT 50Ω.

4. Set the frequency and span by pressing:

**FREQUENCY**

**CENTER FREQ** ..... 300 **MHz**

**SPAN** ..... 2 **MHz**

5. Measure the 99% power bandwidth by pressing:

**AUX/USER**

More 1 of 3

More 2 of 3

99% PWR BW

The value is given in the active function block.

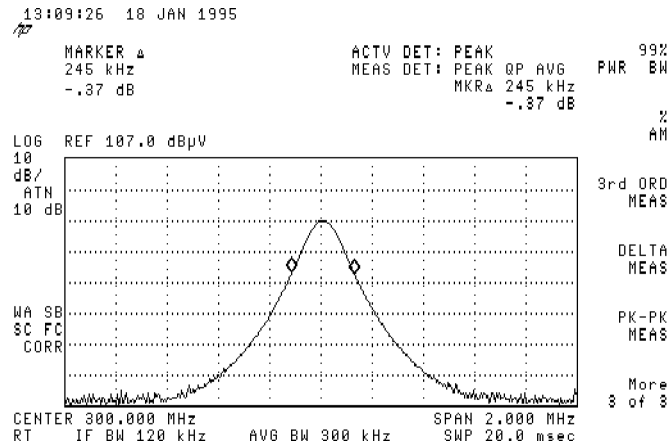

Figure 8-11. Using the 99% pwr BW function.

## Measuring percent AM modulation

Percent amplitude measurement can be measured quickly and easily by pressing a single key.

1. Connect a source capable of amplitude modulation to the EMC analyzer. Tune the source to 10 MHz and 80 dB $\mu$ V (-27 dBm). Set the modulation frequency to 10 kHz with a 30% modulation level.
2. Set the EMC analyzer to a known state by pressing:

```

(PRESET)
(FREQUENCY)
  CENTER FREQ ..... 10 (MHz)
(SPAN) ..... 100 (kHz)
(BW)
  IF BW AUTO MAN ..... 3 (kHz)
  
```

Note the corner signal and the sidebands.

3. Measure the percent amplitude modulation by pressing:

```

(AUX/USER)
  More 1 of 3
  More 2 of 3
  % AM
  
```

The percent of amplitude modulation is displayed in the active function block.

### Note

The IF bandwidth must be set so the sidebands are displayed and the maximum amplitude excursion between displayed signals must be greater than the value set under Peak Excursion (default 6 dB). The sidebands are assumed to be entirely from amplitude modulation. At least one sideband must be displayed; if not, the measurement stops and 0% AM is displayed in the active area.

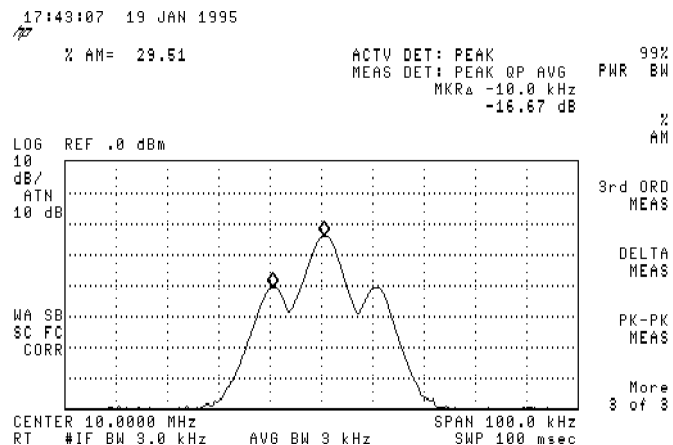

Figure 8-12. Using the % AM function.

## Measuring amplitude and frequency difference

Amplitude and frequency difference measurements between two signals can be made using the one-button Delta Meas and Pk-Pk functions. The Delta Meas function compares the two largest on screen signals and displays the difference in the active function area. The Pk-Pk function compares the largest and smallest on screen signal (or noise) and displays the difference in the active function area. A single measurement is made each time a button is pressed. The markers may be turned off after a measurement is made by pressing:

**MKR**  
 MARKER 1 ON OFF OFF

1. Set the EMC analyzer to a known state by pressing:

**PRESET**

2. Connect CAL OUT to INPUT 50Ω.
3. Set the stop frequency by pressing:

**FREQUENCY**  
 STOP FREQ ..... 700 **MHz**

4. Measure the difference between the two highest peaks by pressing:

**AUX/USER**  
 More 1 of 3  
 More 2 of 3  
 DELTA MEAS

The value is displayed in the active function block.

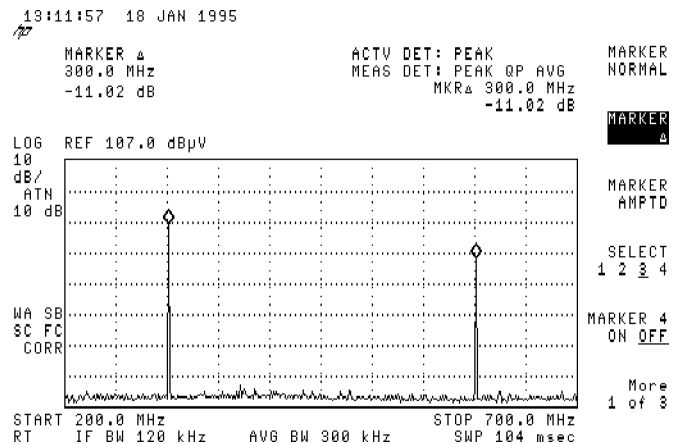

Figure 8-13. Using the Delta Meas function.

5. To measure the difference between the highest peak and the noise floor, press:

AUX/USER

More 1 of 3

More 2 of 3

PK-PK MEAS

The value is displayed in the active function block.

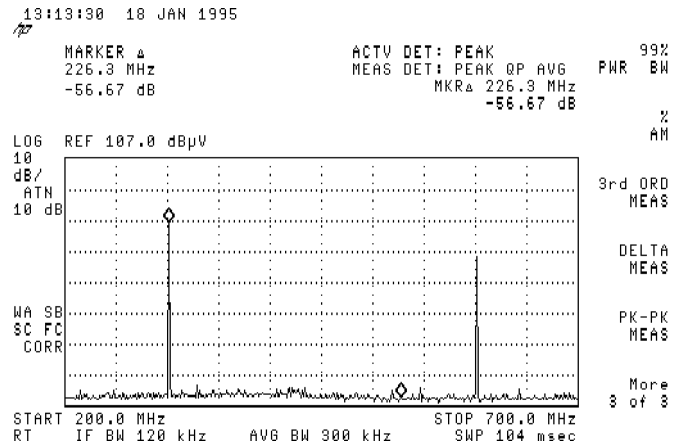
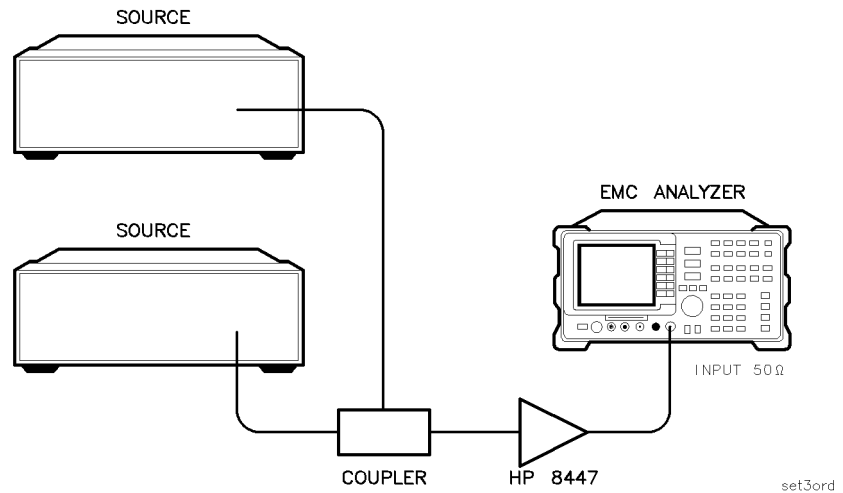

Figure 8-14. Using the Pk-Pk function.

## Making third order measurements

Two-tone, third order intermodulation distortion is a common problem in many electronic systems. When two signals are present in a system, they can mix with any generated second harmonics and create third order intermodulation distortion products. Third order product frequency and amplitude differences can be easily measured using the one-button 3rd Ord Meas function.



**Figure 8-15. Setup for making third order measurements.**

1. Connect two sources to the EMC analyzer through an amplifier with the appropriate frequency range. Refer to Figure 8-15. Set one source to 300 MHz and 80 dB $\mu$ V (-27 dBm) and the other source to 301 MHz and 80 dB $\mu$ V (-27 dBm).

### Caution

You may need to vary the source powers and/or frequencies, depending on the available test amplifier. Use sufficient input attenuation or sufficiently small signals to prevent damage to the input of the EMC analyzer.

2. Set the EMC analyzer to a known state by pressing:

**PRESET**

3. Set the frequency and span by pressing:

**FREQUENCY**

**CENTER FREQ** ..... 300 **MHz**

**SPAN** ..... 5 **MHz**

4. Adjust the EMC analyzer so at least one of the fundamental signals and a third-order product is displayed.



5. Measure the amplitude and frequency differences by pressing:

AUX/USER

More 1 of 3

More 2 of 3

3rd ORD MEAS

The value is displayed in the active function block.

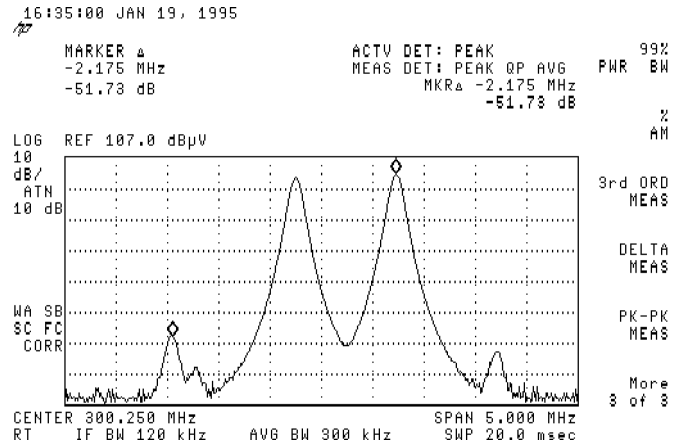

Figure 8-16. Using 3rd Ord Meas function.

## Using the RF Filter Section

HP 85420E Option 1EM only

Set up the analyzer as described in “Preparing the EMC Analyzer” in Chapter 1 and “Preparing the RF Filter Section” in Chapter 1.

The RF section provides filters to prevent RF overload in the presence of high ambient radiated emissions and some conducted measurements. The RF filter section automatically switches filter paths and tracks changes in center frequency and span. It also provides a built-in preamplifier, an RF overload indicator, and additional autoranging capabilities.

The RF filter section has two RF inputs:

- Input 1            used for low frequency conducted measurements
- Input 2            provides filtering up to 2.9 Ghz for radiated emissions measurements. It also has a bypass path which provides no preselection up to 12.8 Ghz

### Note

All calibrations must be performed with the RF filter section *disconnected*.

1. Verify there is no input to the RF filter section and press:

**PRESET**

2. View the calibrator signal by pressing:

More 1 of 5

More 2 of 5

More 3 of 5

More 4 of 5

INPUT

VIEW CAL ON OFF ON

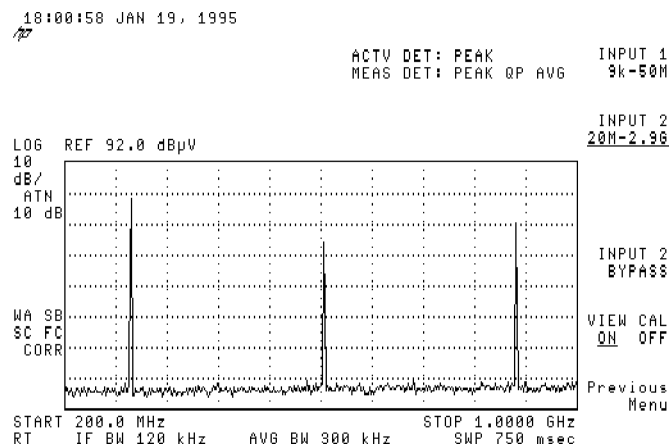

Figure 8-17. Viewing the calibrator signal through the RF filter section.

**Note**

From this menu, the preselected input and bypass input are available.

3. Add 12 dB of amplification to the signal by turning the preamplifier on by pressing:

Previous Menu

PREAMP ON OFF ON

Note the change in the signal level.

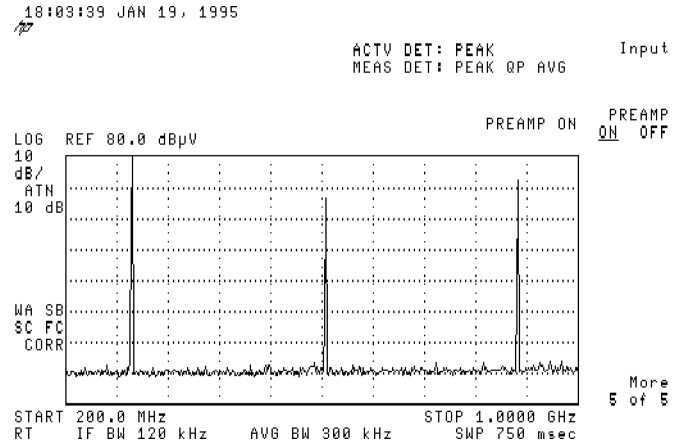

**Figure 8-18. Turning the preamplifier on.**

4. To sweep outside the range of the selected input, press:

FREQUENCY

More 1 of 2

INPT LCK ON OFF OFF

## Learning about the analog + display mode (option 101 only)

The analog+ display mode combines traditional analog display performance with digital display benefits. Analog+ display mode gives the EMC analyzer the look and feel of older analog displays, such as the HP 8558B, but it has the added benefit of features common to digital displays. Display features include:

- Hard-copy output directly to a printer
- Complete marker functionality such as noise readout
- Screen annotation functions such as title, linear and log scales, and graticule
- Negative peak detector (included with Option 101)

The analog+ display mode is only available on EMC analyzers with Option 101. (It is also available with Option 301 which is a combination of Options 101 and 102.) Option 101 also includes a negative peak detector, useful for video modulator balance adjustments and intermodulation distortion measurements.

The analog+ display mode can be used to view interfering intermodulation products on a live television channel. It can be used to set the residual carrier level and check the linearity of a video modulator. Refer to Product Note 8590-3, HP part number 5091-2480, for more information about these measurements.

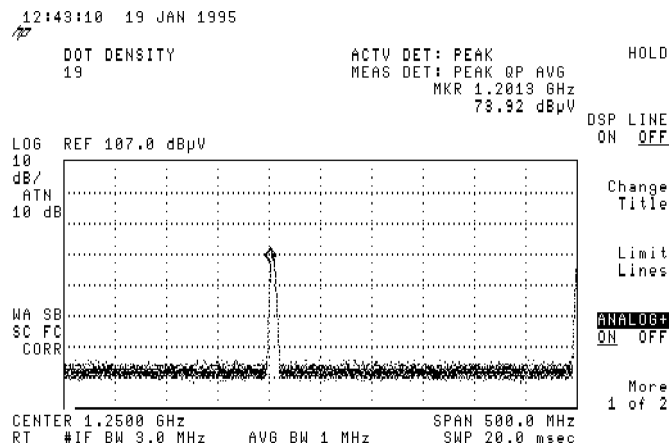

Figure 8-19. Analog+ display mode.

**Example:** Use the analog+ display mode to look at the calibrator signal.

1. Connect the CAL OUT signal to the EMC analyzer INPUT 50Ω.  
Press:

```
PRESET
FREQUENCY
START FREQ ..... 1 GHz
STOP FREQ ..... 1.5 GHz
```

2. Press **DISPLAY** and **ANALOG+ ON OFF** (ON) to turn on the analog+ display mode. Use the knob, step keys, or the data entry keys to change the DOT DENSITY.
3. Press **MKR** to activate a marker and use the knob to move it.
4. Press **DISPLAY**. Then press **ANALOG+ ON OFF** to underline OFF to turn the analog+ display off.

---

**Note**

Limit lines can be used to test data on an analog+ display, but they cannot be displayed.

---

## Triggering on a selected line of a video picture field

### Note

This application should only be performed using an *HP 8591EM*, *HP 8593EM*, *HP 8594EM*, *HP 8595EM*, or *HP 8596EM with Option 301 (Options 101 and 102 combined)*.

With Option 301, you can trigger on a TV picture carrier signal. This example enables you to view a test signal transmitted during vertical retrace when the TV screen is blanked.

1. Press **PRESET**.
2. Set the frequency of a picture carrier signal to center frequency.
3. Press **SWEEP/TRIG**, **Trigger** and **TV TRIG**. If the EMC analyzer is in a nonzero span, **TV TRIG** sets the amplitude scale to linear, places a marker on the signal peak, moves the marker to the reference level, changes the detector to sample, sets the sweep time to 100  $\mu$ s, sets the resolution bandwidth to 1 MHz, and sets the span to 0 Hz. The TV line number is the active function. The preset function sets the EMC analyzer to trigger on an odd field of a video format and TV line number 17.

The sweep time of 100  $\mu$ s allows you to view two TV lines, line 17 and part of line 18. The multiburst is on TV line number 17, and the composite is on TV line number 18.

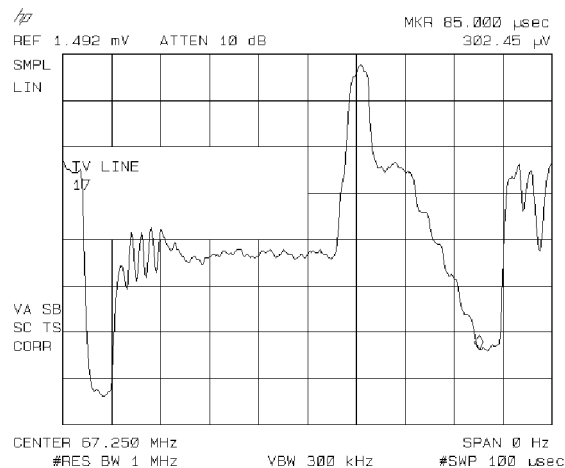

**Figure 8-20. Triggering on an odd field of a video format.**

4. Press **TV TRIG EVEN FLD** to trigger on an even field of a video format.

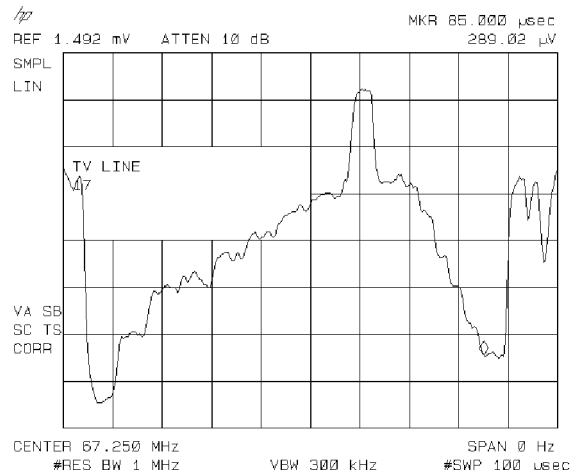

**Figure 8-21. Triggering on an even field of a video format.**

The default video format is NTSC. Press **TV Standard**, then **PAL-M**, **PAL**, or **SECAM-L** to select a different video format. For non-interlaced video formats, press **TV TRIG VERT INT**.

**Note**

---

The video format selection (**NTSC**, **PAL-M**, **PAL**, or **SECAM-L**) automatically selects the video modulation (negative or positive).

---





## Limit Lines

---

### What you'll find in this chapter

This chapter contains procedures for creating, editing, viewing, saving, and recalling a limit line.

---

Limit lines provide an easy way to compare trace data to a set of amplitude and frequency parameters while the analyzer is sweeping the measurement range.

Two limit lines with margins can be displayed on the EMC analyzer. These limit lines can be used to visually determine whether displayed signals meet the appropriate limits. Margins are set relative to each of the limit lines, and are useful when taking into account any uncertainties that can exist in the entire measurement system.

If you wish to provide a margin of safety when testing to a limit, you may set a margin below the required limit. When the limit-test function is activated, the EMC analyzer automatically indicates onscreen whether or not a displayed signal passes or fails a displayed limit line or margin.

When limit testing is activated, the analyzer automatically tests to either the limit-line or the margin, whichever is lowest. Failures are indicated both onscreen and over the HP-IB bus. When performing limit testing with two limit lines and their associated margins, the analyzer automatically tests to the lowest of the four.

Limit lines are constructed from a table of frequency and amplitude coordinate pairs. Limit-line segments are created by connecting these points. Everything except the segment length is defined by the entry for its beginning point. There are several ways of entering the frequency/amplitude pairs. These are described in the following section.

#### Note

---

Limit lines can be created and edited from the front panel or remotely via HP-IB or RS-232. Limit lines in a trace format can only be created using remote commands or a downloadable program. Refer to the LIMHI and LIMLO commands in the *HP 8590 EM Series EMC Analyzer Quick Reference Guide* for more information.

---

**Note**

The Setups, Limit Lines, and Correction Factors card provides several predetermined limit lines. Refer to Appendix B for a complete listing.

---

## Using EMC Limit Lines

### Creating, editing, or viewing a limit line

This example shows how to create and activate an upper limit line for the 300 MHz OUTPUT signal.

1. Set the instrument to a known state by pressing:

**PRESET**

2. Select EMC analyzer mode by pressing:

**MODE**

EMC ANALYZER

3. Connect INPUT 50Ω to CAL OUT to display the 300 MHz calibrator signal and its harmonics.

4. Set the center frequency and span by pressing:

**FREQUENCY**

CENTER FREQ ..... 300 **MHz**

**SPAN** ..... 500 **MHz**

**ENTER** (to disable the active function area)

5. To access the limit-line menus, press:

**SETUP**

More 1 of 4

Limit Lines

---

**Note**

Limit line structure in EMC analyzer mode is different than spectrum analyzer mode and are not interchangeable. When an attempt is made to use a limit line that was created in spectrum-analyzer mode, the message, SA Limits not allowed in RCVR mode., will be displayed.

---

6. To remove the limit lines, press:

```
Limit 1
DELETE LIMIT, DELETE LIMIT
Previous Menu
Limit 2
DELETE LIMIT, DELETE LIMIT
Previous Menu
```

After pressing DELETE LIMIT once, the message:

“If you are sure, press key again to purge data”

will appear. Pressing DELETE LIMITS a second time purges the limit-line table. The **PRESET** key turns limit-line testing off (if it is on), but does not clear an existing limit-line table.

---

**Note**

You can create limit lines using either logarithmic or linear frequency and amplitude scales. The choice depends upon the limit line that you want to create.

---

7. To select the linear frequency and logarithmic amplitude scales, press:

```
Limit 1
EDIT LIMIT
Select Type
Select Axis
FREQ SCL LOG LIN LIN
AMPL SCL LOG LIN LOG
Previous Menu, Previous Menu
```

---

**Note**

When the frequency is entered, amplitude selection automatically becomes the active function. When the amplitude is entered, the type selection automatically becomes the active function. When the type is entered, frequency selection automatically becomes the active function. This speeds up data entry when you want to enter several coordinates.

---

8. To enter the first coordinate, press:

```
SELECT FREQ ..... 75 (MHz)
SELECT AMPLITUD ..... 47 (+dBμV)
POINT
```

**Note**

- The segment type determines how the coordinate point of the current line segment is connected to the coordinate point of the next line segment. The segment type determines whether the line segment is horizontal, sloped, or a single point.

To specify the segment type, press:

```
Select Type
SLOPE, FLAT, or POINT
Previous Menu
```

- The coordinates for the second point must be entered before the first limit-line segment is displayed.

When entering coordinates, the frequency, amplitude and type fields will be listed with asterisks (\*\*\*) until new values are entered. The new coordinate will be listed last until the frequency, amplitude, and type selections have been entered. Once a frequency, amplitude, and type selection have been entered, the coordinate will be sorted into the limit-line table according to its frequency.

9. To enter the second coordinate, press:

```
SELECT FREQ ..... 100 (MHz)
SELECT AMPLITUD ..... 47 (+dBµV)
FLAT
```

10. Set remaining limit-line coordinates of 250 MHz with a slope of 47 dBµV/m, 400 MHz with a slope of 87 dBµV/m, and 500 MHz with a slope of 97 dBµV/m, by pressing:

```
SELECT FREQ ..... 250 (MHz)
SELECT AMPLITUD ..... 47 (+dBµV)
SLOPE
SELECT FREQ ..... 400 (MHz)
SELECT AMPLITUD ..... 87 (+dBµV)
SLOPE
SELECT FREQ ..... 500 (MHz)
SELECT AMPLITUD ..... 97 (+dBµV)
SLOPE
```

**Note**

A total of thirty points can be specified for each limit line. The onscreen indicator displays the number of remaining memory locations.

11. When all coordinates are entered, press:

```
EDIT DONE
```

12. To turn limit testing on, press:

```
LIMIT 1 ON OFF ON
LMT TEST ON OFF ON
```

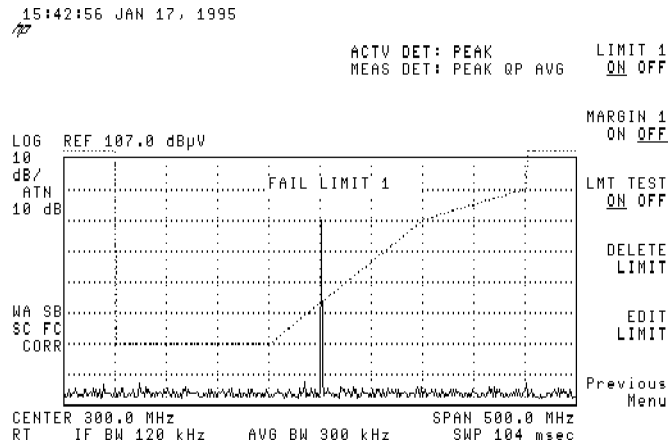

Figure 9-1. Completed limit-line.

13. Disconnect CAL OUT from INPUT 50Ω.

The message "PASS LIMIT" is displayed because no signal exceeds the limit line.

14. Reconnect CAL OUT to INPUT 50Ω.

### Editing an existing limit line

1. If you wish to add or modify segments in an existing table, press:

```
(SETUP)
More 1 of 4
Limit Lines
Limit 1
EDIT LIMIT
SELECT FREQ ..... 250 (MHz)
SELECT AMPLITUD ..... 57 (+dBµV)
SLOPE
SELECT FREQ ..... 400 (MHz)
SELECT AMPLITUD ..... 57 (+dBµV)
SLOPE
```

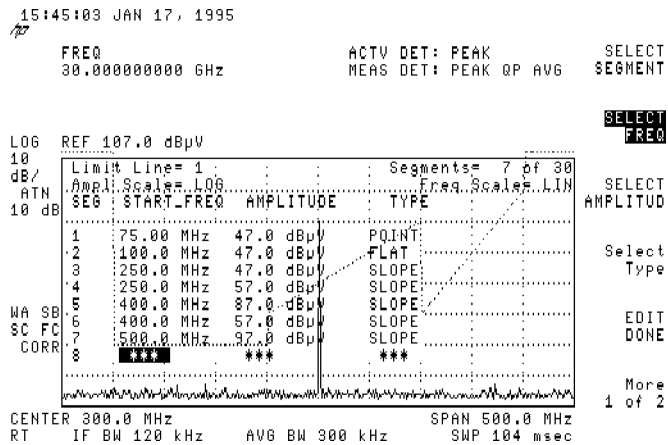

Figure 9-2. Editing an existing limit-line table.

- To change the amplitude of segment number six from 57 dB $\mu$ V/m to 102 dB $\mu$ V/m, select the segment to be edited by pressing:

SELECT SEGMENT

- Use the step keys, number keys, or the knob to select row number six. Enter the new value by pressing:

SELECT AMPLITUDE ..... 102 (+dB $\mu$ V)

- To delete segment number six, press:

Previous Menu

More 1 of 2

SELECT SEGMENT

- Use the step keys, number keys, or the knob to select segment number six and then, press:

DELETE SEGMENT

- When you finish editing the limit-line table, press:

More 2 of 2

EDIT DONE

## Defining a limit margin

To set a  $-3$  dB limit-line margin, press:

MARGIN 1 ON OFF ON ..... 3 **dB**

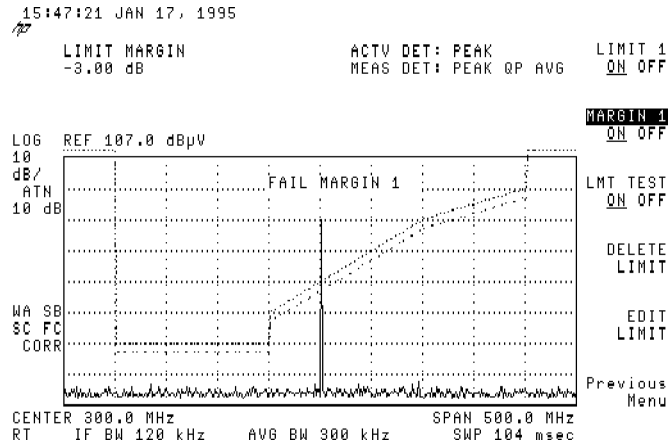

**Figure 9-3. Signal failing the limit line margin.**

### Note

- If the margin is displayed, limit-line testing is *applied to the margin* not the actual limit line. The limit and margin displays are independent. Limit-line testing must have either, or both, limit or margin displays ON.
- In linear amplitude displays, limit margins cannot be displayed for limit lines positioned more than 12 dB above the current reference level.

## Activating limit-line testing

When you are done editing, on/off functions of the limit test become available.

To turn limit-line testing on, press:

LMT TEST ON OFF ON

The analyzer can perform limit-line testing only if a limit is displayed. When limit-line testing is activated, the analyzer automatically tests to either the limit-line or the margin, whichever is lowest. Failures are indicated both onscreen and over the HP-IB bus. When limit-line testing using two limit lines and their associated margins, the analyzer automatically tests to either the limit-lines or the margins, whichever of the four is lowest.

## Saving or recalling limit-line tables

### Saving a limit-line table

1. Insert a card in the card reader.
2. To save the current limit-line table, press:

`(SAVE/RECALL)`

3. To enter a prefix, press:

`Change Prefix`

4. To clear an existing prefix, press:

`YZ_# Spc Clear`

`Clear`

5. Enter the prefix "DEMO" by pressing:

`ABCDEF , D`

`ABCDEF , E`

`MNOPQR , M`

`MNOPQR , 0`

The message "PREFIX=DEMO" is displayed on the screen.

6. To save the current limit-line table to the card, press:

`More 1 of 2`

`EDIT DONE`

`Save Card`

`LIMITS → CARD`

7. The register number is the active function. Enter register number one by pressing:

`1 (ENTER)`

The limit-line data is saved to a card.

### Note

The `SAVE LIMITS` function, located under the `(SETUP)` key, can also be used to save limit-line data. It is accessed by pressing:

`(SETUP)`

`More 1 of 4`

`Limit Lines`

`SAVE LIMITS`

The desired mass storage device and the prefix cannot be changed. They must be preset to the desired state before using this function. Only the register number can be entered.



## Recalling a limit-line table

1. To recall limit-line tables from the card, press:

**SAVE/RECALL**

**Recall Card**

**RECALL LIMITS**

2. Use the step keys or knob to scroll through the displayed menu. When the desired file is highlighted, press:

**LOAD FILE**

### Note

---

When a limit line is saved, the following information is stored:

- Limit 1 data, including the limit-line and margin information
  - Limit 2 data, including the limit-line and margin information
  - LIMIT 1 ON OFF status
  - LIMIT 2 ON OFF status
  - MARGIN 1 ON OFF status
  - MARGIN 2 ON OFF status
  - LIMIT TEST 1 ON OFF status
  - LIMIT TEST 2 ON OFF status
- 

## Viewing the card catalog

If you wish to see a list of the files on a card you may use the catalog card function.

1. Insert a card into the card reader.
2. To view the catalog of limit-line files on the card, press:

**CATALOG CARD**

Note the name of the desired file. The name will be “lprefix\_register number”.) The limit-line information you saved earlier will be displayed as, “1DEMO\_1”. Refer to Chapter 12 for more information on saving and recalling, and outputting data.

3. When you are finished viewing the catalog, press:

**EXIT CATALOG**

---

## Using Spectrum Analyzer Limit Lines

### Creating, editing or viewing a limit line

This example shows how to create an upper limit line for the 300 MHz OUTPUT signal and activate testing.

1. Set the instrument to a known state by pressing:

**PRESET**

2. Verify the mode selected is spectrum analyzer by pressing:

**MODE**

SPECTRUM ANALYZER

3. Connect INPUT 50Ω to CAL OUT to display the 300 MHz calibrator signal and its harmonics.

4. Set the center frequency and span by pressing:

**FREQUENCY**

CENTER FREQ ..... 300 **MHz**

**SPAN** ..... 500 **MHz**

**ENTER** (to disable the active function area)

5. To access the limit-line menus, press:

**SETUP**

More 1 of 4

Limit Lines

Edit Limit

## Selecting limit-line parameters

1. The limits, frequency or time, function requires the limit-line parameters be entered as either frequency or time. Though coordinates of frequency and amplitude are used most often, limit-line data can also be entered in terms of time and amplitude. Frequency is the default selection. If TIME is selected, START TIME will replace START FREQ in the edit limit menus.

Clear existing limits and select frequency by pressing:

```
LIMITS FRQ TIME , TIME (Clears existing limits.)  
LIMITS FRQ TIME FRQ
```

2. To edit or create an upper limit line, press:

```
EDIT UPPER
```

---

### Note

Limit line structure in spectrum analyzer mode is different than EMC analyzer mode and are not interchangeable. When an attempt is made to use a limit line that was created in spectrum-analysis mode, the message, RCVR Limits not allowed in SA mode. will be displayed.

---

3. To remove this limit line, press:

```
More 1 of 2  
PURGE LIMITS , PURGE LIMITS  
EDIT UPPER
```

After pressing PURGE LIMITS once, the message

“If you are sure, press key again to purge data”

will appear. Pressing PURGE LIMITS a second time purges the limit-line table. (PRESET) turns limit-line testing off (if it is on), but does not clear an existing limit-line table.

4. To remove the error message, press:

```
(ENTER)
```

---

### Note

The table defaults to fixed parameters. The middle of the table displayed onscreen should be labeled Limits=FIXED. If it is labeled Limits=RELATIVE, press:

```
More 1 of 2  
LIMITS FIX REL FIX
```

The limits, fixed or relative, function determines whether or not the limit line is set relative to the analyzer's center frequency and reference-level settings.

When time parameters are used, the relative format only affects the amplitude part of the coordinate pairs. The time parameters are always fixed, beginning at the left edge of the graticule.

---

## Selecting the amplitude scale

1. To select the amplitude scale, press:

```
More 2 of 2
Select Type
Select Axis
FREQ SCL LOG LIN LIN
AMPL SCL LOG LIN LOG
Previous Menu , Previous Menu
```

### Note

When entering coordinates, frequency, amplitude, and type fields will be listed with asterisks (\*\*\*) until new values are entered. The new coordinate will be listed last until the frequency, amplitude, and type selections have been entered. Once a frequency, amplitude, and type selection have been entered, the coordinate will be sorted into the limit-line table according to its frequency.

2. Set the beginning or the first limit-line segment to 50 MHz, with an amplitude of 47 dB $\mu$ V/m by pressing:

```
SELECT FREQ ..... 50 (MHz)
SELECT AMPLITUD ..... 47 (+dB $\mu$ V)
FLAT
```

### Note

The coordinates for the second point must be entered before the first limit-line segment will be displayed.

3. Set the beginning of the second limit-line segment to 250 MHz with a slope of 47 dB $\mu$ V/m by pressing:

```
SELECT FREQ ..... 250 (MHz)
SELECT AMPLITUD ..... 47 (+dB $\mu$ V)
SLOPE
```

### Note

Table entries can be edited if you make a mistake. To edit an existing segment, select the segment. Select the frequency, or amplitude of the column to be edited.

4. Set the third limit-line segment to 400 MHz with an amplitude of 92 dB $\mu$ V/m by pressing:

```
SELECT FREQ ..... 400 (MHz)
SELECT AMPLITUD ..... 92 (+dB $\mu$ V)
SLOPE
```

- Set the fourth limit-line segment to 600 MHz with an amplitude of 92 dB $\mu$ V/m by pressing:

```

SELECT FREQ ..... 600 (MHz)
SELECT AMPLITUD ..... 92 (+dB $\mu$ V)
SLOPE

```

**Note**

Segments can be defined even if they are out of the display range.

- After all the segments have been entered, press:

```

More 1 of 2
EDIT DONE

```

- To turn limit testing on, press:

```
LMT TEST ON OFF ON
```

The message “FAIL UPPER” is displayed because the calibration signal exceeds the limit line.

**Note**

When on, the limit-test function tests to the defined limits, even if they are not displayed.

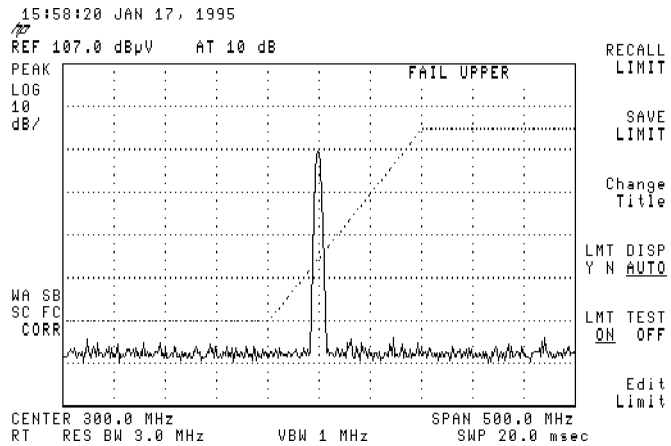

**Figure 9-4. Signal exceeding the limit line.**

- Disconnect CAL OUT from INPUT 50 $\Omega$ .

The message “PASS LIMIT” is displayed because no signal exceeds the limit line.

## Selecting the limit-line table format

You can use any of the following keys to create or edit a limit-line table:

EDIT UPPER

EDIT LOWER

EDIT UP/LOW

EDIT MID/DELT

Each of the edit softkeys represents a different kind of limit-line table format. The choice depends on whether you want only an upper limit line, only a lower limit line, or both an upper and a lower limit line. If both an upper and a lower limit line are desired, the characteristics of the desired limit lines will determine whether you select the EDIT UP/LOW or EDIT MID/DELT function.

The four limit-line table formats are described below:

EDIT UPPER

Accesses the upper limit-line table format. One amplitude component (representing an upper limit-line segment) is specified for each frequency (or time) component.

EDIT LOWER

Accesses the lower limit-line table. One amplitude component (representing a lower limit-line segment) is specified for each frequency (or time) component.

EDIT UP/LOW

Accesses the upper/lower limit-line table format. Two amplitude components (one each for the upper and lower limit-line segments) can be specified for each frequency or time component.

EDIT MID/DELT

Accesses the mid/delta limit-line table format. Two amplitude components (one representing a mid-amplitude value, one representing a deviation or delta (positive and negative values) from either side of this value) is specified for frequency component. If no deviation is entered, the deviation defaults to zero.

---

### Note

- When editing a limit line table you may use a format different than the one used when creating it.
  - Frequency or amplitude values that are not within the analyzer's maximum range will be modified.
-

## Activating limit-line testing

When **EDIT DONE** is pressed, the **LMT TEST ON OFF** and **LMT DISP Y N AUTO** functions become available.

To turn limit-line testing on, press:

**LMT TEST ON OFF ON**

---

### Note

If **LMT DISP Y N AUTO N**, the limit line is not displayed. If **LMT DISP Y N AUTO Y**, the limit line is displayed.

Pressing **LMT DISP Y N AUTO AUTO** sets the limit line display to match the limit-line test function. When **AUTO** is selected, the limit lines are only displayed when **LMT TEST ON OFF ON** is selected.

---

For information on selecting segment types and saving or recalling limit-line tables, refer to the appropriate sections earlier in this chapter.





## Amplitude Correction Factors

---

### What you'll find in this chapter

The EMC analyzer allows three types of amplitude-correction factors to be applied to the input signals.

Antenna Factors    Conversion factors relating field strength to measured voltage.

Cable Factors      Conversion factors to correct for cable insertion loss.

Other Factors      Correction factors to account for the effects of any other two-port device placed between the antenna and the analyzer.

---

**Note**                    A fourth type of amplitude-correction factor, called User Factors, is provided for backward capability with the A, B, C, D, E, and L-series. It is found under the **(CAL)** key. The methods described below also apply to User Factors.

---

**Note**                    Several typical amplitude correction factor files are supplied on the Setups, Limit Lines, and Correction Factors card. Refer to Appendix B for a complete listing.

---



---

### Creating, editing, or viewing the amplitude-correction tables

In this example, an antenna amplitude-correction factor will be created.

1. Preset the analyzer to a known state by pressing:

```

(PRESET)
(SETUP)
  200 MHz -1 GHz
(FREQUENCY)
  START FREQ ..... 300 (MHz)
  STOP FREQ ..... 1 (GHz)
  
```

---

**Note** The EMC analyzer must be calibrated in order to use amplitude correction. If “CORR” is not displayed on the screen, you should perform a calibration. Refer to Chapter 3 for more information.

---

2. To create, edit, or view the amplitude-correction factors for antennas, press:

```
SETUP
More 1 of 4
Correctn Factors
Antenna Factors
```

---

**Note** Creating, editing, and viewing the antenna, cable and other amplitude-correction tables follow identical procedures. If you wish to create a cable or other amplitude-correction table, select Cable Factors or Other Factors instead of Antenna Factors.

---

To delete any existing antenna amplitude-correction factors, press:

```
EDIT ANTENNA
More 1 of 2
DELETE FACTORS, DELETE FACTORS
(Press only once if the table is empty.)
More 2 of 2
```

- 
- Note**
- After pressing `DELETE FACTORS` once, the message “If you are sure, press key again to purge data” will appear. Pressing `DELETE FACTORS` a second time deletes the antenna amplitude-correction factors.
  - When the frequency is entered, amplitude selection automatically becomes the active function. When the amplitude is entered, the correction point is incremented, and the frequency selection automatically becomes the active function. This speeds up data entry when you want to enter several coordinates.
- 

3. To select an antenna amplitude-correction factor of 0 dB at 300 MHz, press:

```
SELECT FREQ ..... 300 (MHz)
SELECT AMPLITUD ..... 0 (dB)
```

4. Continue to add correction factors of 20 dB at 400 MHz and 0 dB at 5 GHz by using the following key sequence:

```
SELECT FREQ ..... 400 (MHz)
SELECT AMPLITUD ..... 20 (dB)
SELECT FREQ ..... 5 (GHz)
SELECT AMPLITUD ..... 0 (dB)
```

## Note

---

A total of 80 correction points can be specified for each data set. They can be distributed among the three categories in any combination, however, the data sets can contain no more than a total of 80 unique frequency values.

When antenna, cable, and other points are specified at the same frequency, the data is stored as one point. For example, if you specify:

- an antenna point at 300 MHz, 19 dB
- a cable point at 300 MHz, -3 dB
- an other point at 300 MHz, -10 dB

then:

$$19 \text{ dB} + (-3 \text{ dB}) + (-10 \text{ dB}) = 6 \text{ dB}$$

and the final correction factor of 6 dB is stored in a single memory location. In this case, it would be possible for the total number of actual points to exceed eighty. The onscreen indicator displays the number of remaining memory locations.

The amplitude-correction factor applied to the lowest selected frequency is also applied to all frequencies *below* the lowest selected frequency. The amplitude-correction factor applied to the highest selected frequency is also applied to all frequencies *above* the highest selected frequency.

---

5. To convert the amplitude values to antenna field-strength units, press:

```
More 1 of 2
Antenna Units
μV/m
```

The analyzer will now display amplitude units as  $\mu\text{V}/\text{m}$  antenna field-strength units.

6. To select a correction based on a logarithmic frequency scale, press:

```

Previous Menu
FREQ SCL LOG LIN LOG
More 2 of 2
EDIT DONE

```

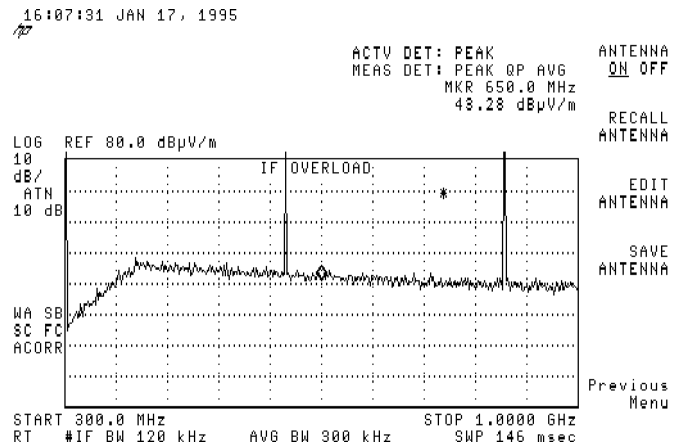

**Figure 10-1.**  
**Conversion factors defined with a log frequency scale.**

**Note**

Logarithmic frequency scale corrections are linearly interpolated between correction points with respect to the logarithm of the frequency. These correction points become straight lines on a log-frequency scale. The interpolation is computed as:

$$y(f) = \frac{y_{i+1} - y_i}{f_{i+1} - f_i} \log(f - f_i) + y_i$$

Linear frequency scale corrections are interpolated along straight lines, connecting adjacent points on a linear-frequency scale. The interpolation is computed as:

$$y(f) = \frac{y_{i+1} - y_i}{f_{i+1} - f_i} (f - f_i) + y_i$$

7. To select a correction based on a linear frequency scale, press:

```

EDIT ANTENNA
More 1 of 2
FREQ SCL LOG LIN LIN
More 2 of 2
EDIT DONE
  
```

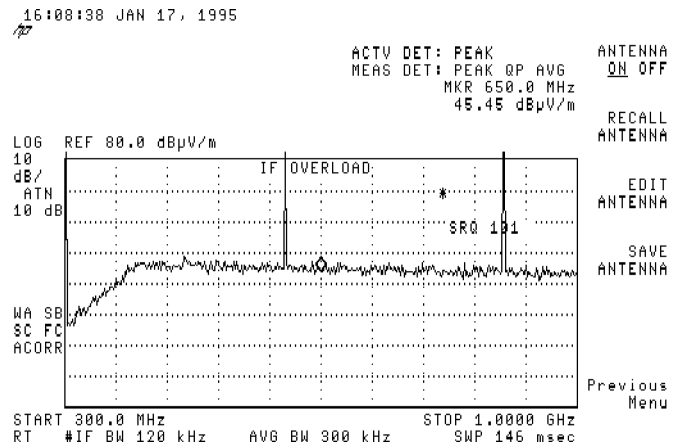

**Figure 10-2.**  
**Conversion factors defined with a linear frequency scale.**

8. To add an additional frequency coordinate at 500 MHz and 0 dB, press:

```

EDIT ANTENNA
SELECT FREQ ..... 500 (MHz)
SELECT AMPLITUD ..... 0 (dB)
  
```

**Note**

When entering coordinates, the frequency and amplitude fields will be listed with asterisks (\*\*\*) until new values are entered. The new coordinate will be listed last until both the frequency and amplitude values have been entered. Once a frequency and an amplitude value have been entered, the coordinate will be sorted into the amplitude-correction table according to its frequency.

9. To edit the third row of antenna amplitude-correction factors, press:

SELECT POINT

Use the arrow keys or the knob to select point three.

10. To change the amplitude coordinate to -18 dB, press:

SELECT AMPLITUD ..... 18

EDIT DONE

11. The amplitude-correction information can be stored to a memory card by pressing:

SAVE ANTENNA 2 .....

The antenna amplitude-correction data has been saved on a card.

**Activating amplitude correction**

To turn amplitude corrections on, press:

More 1 of 4

Correctn Factors

CORRECTN ON OFF ON

**Note**

When amplitude correction is turned off, all of the three possible correction factors (antenna, cable and other) are disabled. When amplitude-correction factors are turned on, only the correction factors you turned on will be enabled. For example, if you have selected:

ANTENNA ON OFF ON

CABLE ON OFF ON

OTHER ON OFF OFF

then all amplitude-correction factors will be disabled when the amplitude correction is turned off. When amplitude correction is turned on, only the antenna and cable amplitude-correction factors will be enabled.

## Saving or recalling

1. To save or recall the amplitude-correction factors, press:

**SETUP**

More 1 of 4

Correctn Factors

Antenna Factors , Cable Factors , or Other Factors

SAVE ANTENNA or RECALL ANTENNA

or

SAVE CABLE or RECALL CABLE

or

SAVE OTHER or RECALL OTHER

---

### Note

The SAVE softkeys save the current amplitude-correction factors to a card. The amplitude-correction factors can only be saved to a card, not internal memory.

---

2. To save the correction factors, press:

SAVE ANTENNA , SAVE CABLE , or SAVE OTHER

3. To save the information, press:

A register number **ENTER**

The data has been saved to a card as nDEMO\_X, for antenna correction factors, cDEMO\_X for cable correction factors, and oDEMO\_X for other correction factors.

4. To recall amplitude-correction factors from the card, press:

RECALL ANTENNA , RECALL CABLE , or RECALL OTHER

5. Use the step keys to highlight the desired file, and then press:

LOAD FILE





# Windows

---

## What you'll find in this chapter

Windows display mode splits the instrument display into two frequency or time displays.

When windows is first turned on, the top (overview) window contains an inactive copy of the normal display. The lower (applications) window is active and displays a subset of the frequency span of the overview window. The span of the applications window is indicated on the overview window by a pair of vertical lines called zone markers. The zone markers indicate the portion of the overview window that is displayed in the applications window. To look at different portions of the overview window, move the zone markers using the **ZONE CENTER** and **ZONE SPAN** softkeys.

The instrument state of the active window can be changed without affecting the state of the inactive window. The state of the active window will be used as the state of the instrument for sweeping and updating trace data.

---

For the purpose of this example, use the windows display mode to view the 300 MHz calibrator signal.

1. Preset the instrument to a known state by pressing:

**PRESET**

2. Connect CAL OUT to INPUT 50Ω.

- To view additional harmonic signals set the analyzer stop frequency to 1.8 GHz by pressing:

**FREQUENCY**  
**STOP FREQ** ..... 1.8 **GHz**

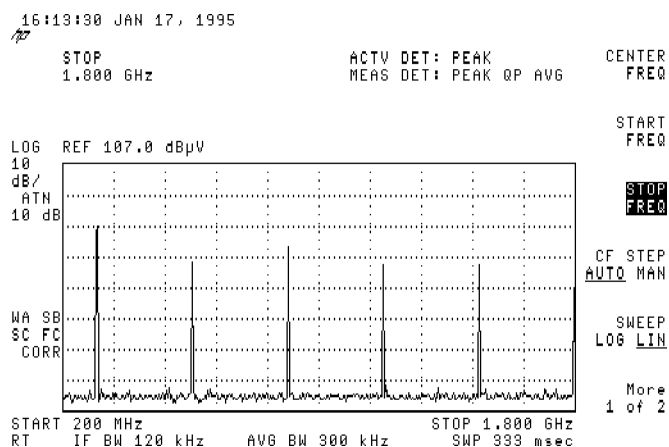
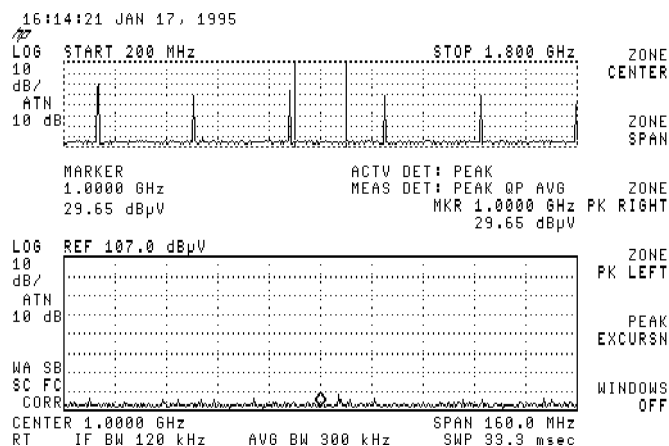

**Figure 11-1. 300 MHz calibrator signal with harmonics.**

- Activate the windows function by pressing:

**ON**

The active window is outlined with a bold line.

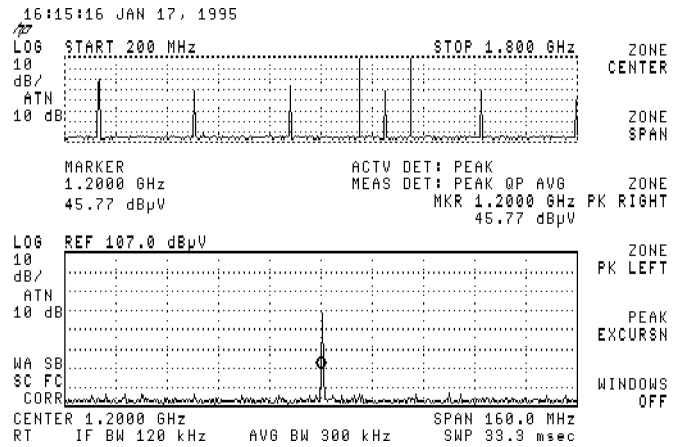

**Figure 11-2. Windows display mode on.**

5. Move the zone markers to the first signal to the right of the current zone by pressing:

**ZONE PK RIGHT**

The zone is centered around the new signal.



**Figure 11-3.**  
**Zone markers moved to the right of the current span.**

6. Move the zone markers to the first signal to the left of the zone by pressing:

**ZONE PK LEFT**

The zone is centered around the new signal.

7. Increase the zone span to include three signals by pressing:

**ZONE SPAN**  

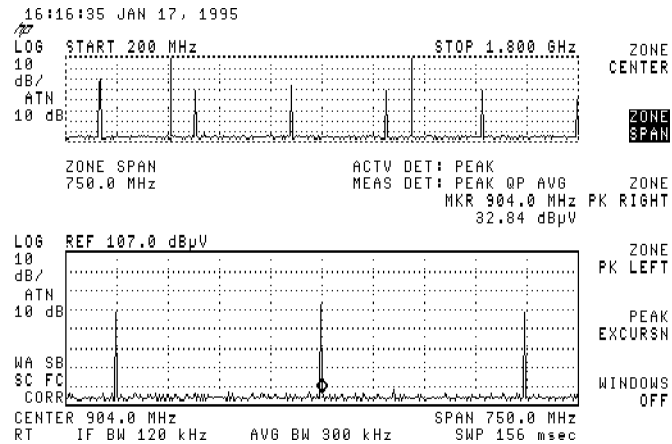

Figure 11-4. Zone span increased to include three signals.

8. View a full-sized display of the applications window by pressing:

**ZOOM**

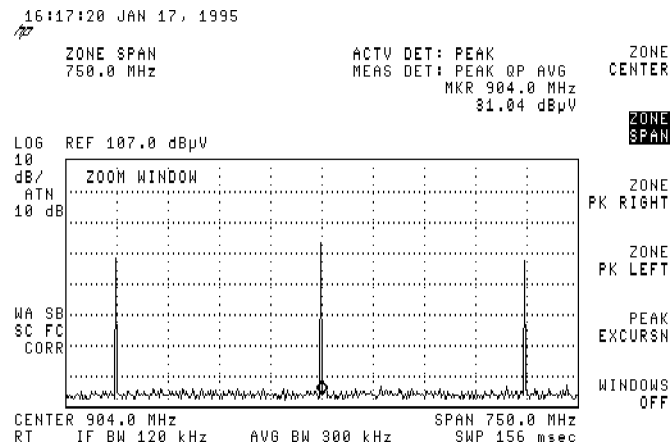
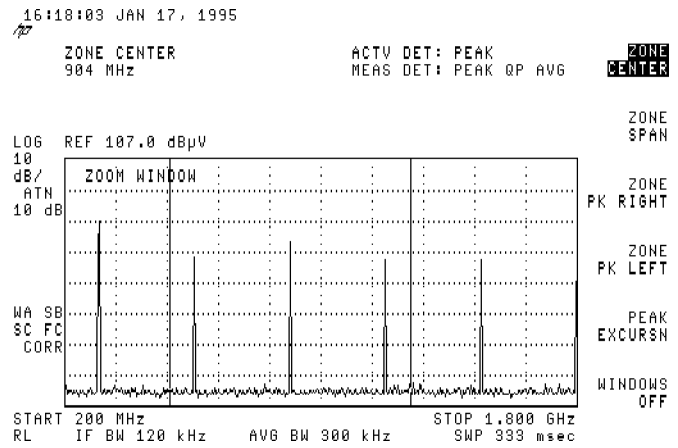

Figure 11-5. Full-sized display of the applications window.

9. View and activate a full-sized display of the overview window by pressing:

**NEXT**

The applications window is now active.



**Figure 11-6. Full-sized display of the overview window.**

10. Return to the windows display mode by pressing:

**ZOOM**

11. Return to normal display mode of operation by pressing:

**WINDOWS OFF**

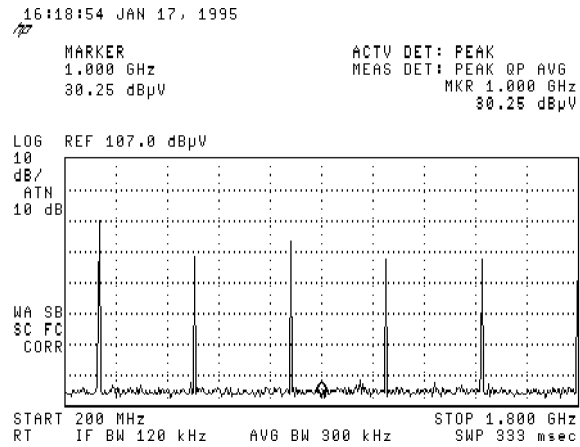

**Figure 11-7. Windows display mode off.**

12. To turn on the windows format again with the current display as the new overview window, press:

**ON**

A new applications window will be generated based on the zone in the overview window.

**Note**

Markers can be used in both windows, but they must be turned on in each window. The current limit lines and amplitude-correction factors are common to both windows.

## Saving, Recalling, and Outputting Data

---

### What you'll find in this chapter

This chapter describes how to save and recall instrument setups, signal lists, states, traces, display images, limit-line tables, and amplitude-correction factors using both cards and the internal instrument memory.

A card provides additional memory for saving instrument setup, signal lists, traces, display images, limit-lines tables, amplitude-correction factors, states, and download personalities (DLPs). The data is easily retrievable without the need for an external controller.

The process of saving and recalling data from the card is similar to saving and recalling data from the internal memory. There are some important differences. For example, data is stored in internal memory as an item; on the card, data is stored as a logical interchange file (LIF).

---

## Using a Card

### Formatting the card

Use an Epson 40-pin RAM card, such as the 08591-10008, supplied with the instrument. If this is a new card, it must be formatted before use. The card can be formatted on the EMC analyzer, using the following procedure.

### Note

Before formatting your card, make sure that the card does *not* contain any valuable data by pressing the following keys to catalog the card.

```
CONFIG
```

```
More 1 of 3
```

```
Card Config
```

```
CATALOG CARD
```

Existing data on the card will be displayed if the card has been formatted. If the card has *not* been formatted, the following message will be displayed:

```
INVALID CARD:DIRECTORY
```

Insert the card with its arrow facing the card-insertion slot and format the card by pressing:

```
CONFIG
```

```
More 1 of 3
```

```
Card Config
```

```
FORMAT CARD
```

The message, If you are sure, press key again to purge data appears on the screen. Continue by pressing:

```
FORMAT CARD
```

### Filenames

A filename consists of a:

- file type descriptor (automatically supplied)
- prefix (optional)
- register number (required)

A filename is defined as:

file type descriptor + prefix register\_number for example, "tPREFIX\_3"

The filename cannot exceed eight characters. The file type descriptor is a single character preceding the prefix such as, "t", for a trace.

### Available operations

Table 12-1 lists the save and recall operations available using internal memory or the card.

Refer to Table 12-4, at the end of this section, for a summary of functions that can be saved to and recalled from internal memory.



**Table 12-1. Internal Memory and Card Operations**

Mass Storage Device	Data Stored As	Stored with a Prefix?	Restriction on Register Number	Types of Data That Can Be Stored <sup>1</sup>	Catalog Functions Available
Internal Memory	Item	No	1 to 8 for states, 0 to MAX REG # for traces and limit lines	States Traces Limit-line tables	CATALOG ALL CATALOG REGISTER CATALOG VARIABLES CATALOG PREFIX DELETE FILE LOAD FILE <sup>2</sup>
Card	File	Yes	Prefix + register # ≤ 8 character	Setups Lists State Trace Limit-line tables Antenna correction Cable correction Other correction User correction Downloadable program Display images	CATALOG CARD SETUP → CARD LIMITS → CARD LIST → CARD ANTENNA → CARD CABLE → CARD OTHER → CARD DISPLAY → CARD Trace → Card ALL DLP → CARD DELETE FILE LOAD FILE

1 Specifies types of data that can be stored by using normal front-panel operation.

2 When cataloging internal memory, **LOAD FILE** is available for **CATALOG REGISTER** only.

**Entering a prefix**

Card data can be stored and recalled using a prefix. A prefix allows you to give a custom name to your file. The prefix can be from one to seven characters long. The longer the prefix, the shorter the register number must be. The total length of the prefix and register number cannot exceed eight characters. The prefix can be any character; however, the underscore must not be the first character of the prefix.

1. Enter the prefix "TEST", by using the following key sequences:

```
(SAVE/RECALL)
Change Prefix
STUVWX , T
ABCDEF , E
STUVWX , S
STUVWX , T
```

or

```
(CONFIG)
Change Prefix
STUVWX , T
ABCDEF , E
STUVWX , S
STUVWX , T
```

---

**Note**

If you make a mistake, press (BK SP) to erase the incorrect character.

---

2. To change a prefix, clear the existing prefix and then enter a new prefix. Clear an existing prefix by pressing:

```
(CONFIG)
Change Prefix
YZ_# Spc Clr
Clear
```

or

Use (BK SP) to erase the existing prefix.

**Saving a trace**

3. Preset the instrument to a known state by pressing:

```
(PRESET)
```

4. Connect CAL OUT to INPUT 50Ω.

5. Enter a screen title by pressing:

```
DISPLAY
Change Title
STUVWX , S
ABCDEF , A
STUVWX , V
ABCDEF , E
YZ_# Spc Clr
Space
STUVWX , T
ABCDEF , E
STUVWX , S
STUVWX , T
```

6. Enter the prefix "TRACE", by using the following key sequences:

```
SAVE/RECALL
Change Prefix
STUVWX , T
MNOPQR , R
ABCDEF , A
ABCDEF , C
ABCDEF , E
```

---

**Note**

If you do not specify a prefix, the trace will be saved with the file name "t\_(register #)".

---

7. Save the trace to card by pressing:

```
SAVE/RECALL
Save Card
More 1 of 3
Trace → CARD
TRACE A
```

8. REGISTER # and PREFIX= are displayed on the screen. Use the numeric keypad to enter register number 5 by pressing:

```
5 ENTER
```

The trace data has now been saved to the card.

## Recalling a trace

9. Recall the trace by pressing:

SAVE/RECALL

Recall Card

More 1 of 3

RECALL TRACE

Use the step keys or knob to highlight "tTRACE\_5",  
and then press:

LOAD FILE

The recalled trace data is displayed as trace B.

10. Reset the display by pressing:

SPAN ..... 3 MHz

### Note

---

Recalled trace data includes the instrument state.

---

The following items can be saved and recalled:

	Save	Recall
Setup	yes	yes
List	yes	yes
Limits	yes	yes
Antenna	yes	yes
Cable	yes	yes
Other	yes	yes
User	yes	yes
Display	yes	yes
Trace	yes	yes
State	yes	yes
DLP	yes	yes

Table 12-2 and Table 12-3 list the operations, their filenames, register ranges and key sequences for saving and recalling data with the HP 8590 EM series.

**Table 12-2. Save Functions Using a Card**

Operation	Screen Title Available?	File Name	Register Range	Key Sequence
save antenna	No	[n (current prefix)_(register #)]	Prefix + register # ≤8 characters	<b>SAVE/RECALL</b> Save Card ANTENNA → CARD (register #) <b>ENTER</b>
save cable	No	[c (current prefix)_(register #)]	Prefix + register # ≤8 characters	<b>SAVE/RECALL</b> Save Card More 1 of 3 CABLE → CARD (register #) <b>ENTER</b>
save display image	Yes <sup>1</sup>	[i (current prefix)_(register #)]	Prefix + register # ≤8 characters	<b>SAVE/RECALL</b> Save Card More 1 of 3 DISPLAY → CARD (register #) <b>ENTER</b>
save downloadable program	No	[d (current prefix)_(register #)]	Prefix + register # ≤8 characters	<b>SAVE/RECALL</b> Save Card More 1 of 3 ALL DLP → CARD
save limits	No	[l (current prefix)_(register #)]	Prefix + register # ≤8 characters	<b>SAVE/RECALL</b> Save Card LIMITS → CARD (register #) <b>ENTER</b>
save list	No	[g (current prefix)_(register #)]	Prefix + register # ≤8 characters	<b>SAVE/RECALL</b> Save Card LIST → CARD (register #) <b>ENTER</b>
save other	No	[o (current prefix)_(register #)]	Prefix + register # ≤8 characters	<b>SAVE/RECALL</b> Save Card More 1 of 3 OTHER → CARD (register #) <b>ENTER</b>
save setup	Yes	[e (current prefix)_(register #)]	Prefix + register # ≤8 characters	<b>SAVE/RECALL</b> Save Card SETUP → CARD (register #) <b>ENTER</b>

<sup>1</sup> The screen title is part of the display image, but is an image only. It is not recalled as a title.

**Table 12-2. Save Functions Using a Card (continued)**

Operation	Screen Title Available?	File Name	Register Range	Key Sequence
save state	No	[s (current prefix)_(register #)]	Prefix + register # ≤8 characters	<b>SAVE/RECALL</b> Save Card More 1 of 3 More 2 of 3 STATE → CARD (register #) <b>ENTER</b>
save trace	Yes	[t (current prefix)_(register #)]	Prefix + register # ≤8 characters	<b>SAVE/RECALL</b> Save Card More 1 of 3 Trace → CARD TRACE A, TRACE B, TRACE C, or LIMIT LINES (register #) <b>ENTER</b>
save user ampcor	No	[a (current prefix)_(register #)]	Prefix + register # ≤8 characters	<b>CAL</b> More 1 of 4 More 2 of 4 More 3 of 4 Amp Cor SAVE AMP COR (register #) <b>ENTER</b>

**Table 12-3. Recall Functions Using a Card**

Operation	Screen Title Available?	File Name	Key Sequence
recall antenna	No	[n (desired filename)]	<b>SAVE/RECALL</b> Recall Card RECALL ANTENNA Highlight desired filename. LOAD FILE
recall cable	No	[c (desired filename)]	<b>SAVE/RECALL</b> Recall Card More 1 of 3 RECALL CABLE Highlight desired filename. LOAD FILE
recall display	Yes <sup>1</sup>	[i (desired filename)]	<b>SAVE/RECALL</b> Recall Card More 1 of 3 RECALL DISPLAY Highlight desired filename. LOAD FILE
recall downloadable program (DLP)	No	[d (desired filename)]	<b>SAVE/RECALL</b> Recall Card More 1 of 3 RECALL DLP Highlight desired filename. LOAD FILE
recall limits	No	[l (desired filename)]	<b>SAVE/RECALL</b> Recall Card RECALL LIMITS Highlight desired filename. LOAD FILE
recall list	No	[g (desired filename)]	<b>SAVE/RECALL</b> Recall Card RECALL LIST Highlight desired filename. LOAD FILE

<sup>1</sup> The screen title is part of the display image, but is an image only. It is not recalled as a title.

**Table 12-3.  
Recall Functions Using a Card (continued)**

Operation	Screen Title Available?	File Name	Key Sequence
recall other	No	[o (desired filename)]	(SAVE/RECALL) Recall Card More 1 of 3 RECALL OTHER Highlight desired filename. LOAD FILE
recall setup	Yes	[e (desired filename)]	(SAVE/RECALL) Recall Card RECALL SETUP Highlight desired filename. LOAD FILE
recall state	No	[s (desired filename)]	(SAVE/RECALL) Recall Card More 1 of 3 More 2 of 3 RECALL STATE Highlight desired filename. LOAD FILE
recall trace	Yes	[t (desired filename)]	(SAVE/RECALL) Recall Card More 1 of 3 RECALL TRACE Highlight desired filename. LOAD FILE
recall user ampcor	No	[a (desired filename)]	(CAL) More 1 of 4 More 2 of 4 More 3 of 4 Amp Cor RECALL AMP COR



---

## Saving and Recalling Data from Internal Memory

This section explains how to save and recall state, trace, and limit line data to and from internal memory. The Save/Recall menu can be used to store up to eight states, several traces and limit-line tables in internal memory.

Saving state data saves the instrument settings, but not the trace data. Saving trace data saves the trace data and the state data. Limit-line data is stored in trace registers, but state and trace data are not recalled with the limit-line data. States, traces, and limit-line tables are saved in internal memory even if the instrument is turned off or **PRESET** is pressed.

Refer to Table 12-4 for a summary of saving and recalling data to and from internal memory.

### Saving a state

1. Preset the instrument to a known state by pressing:

**PRESET**

2. Connect CAL OUT to INPUT 50Ω.

3. View the 300 MHz calibrator signal by pressing:

**FREQUENCY**

CENTER FREQ ..... 300 **MHz**

**SPAN**

SPAN ..... 10 **MHz**

4. Save this instrument state by pressing:

**SAVE/RECALL**

5. Select internal memory as the mass storage device by pressing:

Save Internal

6. Save data in register 5 by pressing:

STATE → INTRNL ..... 5 **ENTER**

The message “State saved” is displayed.

### Recalling a state

1. Preset the instrument to a known state by pressing:

**PRESET**

2. Recall the 300 MHz calibrator signal from internal memory by pressing:

**SAVE/RECALL**

Recall Internal (to select internal)

INTERNAL → STATE ..... 5 **ENTER**

The message “State recalled” is displayed.

**Note**

Register 9 is a special register which can aid in recovering from inadvertent loss of line power (power failure). Pressing:

```
(SAVE/RECALL)
Recall Internal
INTERNAL → STATE .....9 (ENTER)
```

This places the instrument in the state that existed just prior to the loss of power. The POWER ON LAST function (under the (CONFIG) key) can be set to do this automatically.

**Saving a trace**

Saving trace data is very similar to saving state data. Saving trace data saves both the trace data and the state data.

- 1. Set the analyzer to a known state by pressing:

```
(PRESET)
```

- 2. Set up the trace data to be stored and press:

```
(SAVE/RECALL)
Save Internal
Trace → Intrnl
TRACE A .....5 (ENTER)
```

REGISTER # and MAX REG # = are displayed on the screen. The Number after MAX REG # = indicates the maximum register number that can be entered for trace storage in internal memory.

**Recalling a trace**

- 1. Recall data from a trace by pressing:

```
(SAVE/RECALL)
Recall Internal
Internal → Trace
TRACE A .....5 (ENTER)
```

The recalled trace is placed in the view mode and the instrument state changed to the state that was recalled.

## Protecting Internal Data from Being Overwritten

Protect all the internal state, trace, and limit line data from being overwritten by pressing:

**SAVE/RECALL**

Save Internal

SAV LOCK ON OFF ON

Table 12-4 summarizes the functions when saving and recalling data to and from internal memory.

**Table 12-4.**  
**Summary of Save and Recall Operations, Internal Memory**

Operation	Screen Title Available?	Register Range	Key Sequence
save state	No	1 to 8 <sup>1</sup>	<b>SAVE/RECALL</b> Save → Internal STATE → INTRNL (register number) <b>ENTER</b>
recall state	No	1 to 8 <sup>1</sup>	<b>SAVE/RECALL</b> Recall → Internal INTERNAL → STATE (register number) <b>ENTER</b>
save trace	Yes	0 to MAX REG #	<b>SAVE/RECALL</b> Save → Internal Trace → Intrnl TRACE A , TRACE B , or TRACE C (register number) <b>ENTER</b>
recall trace	Yes	0 to MAX REG #	<b>SAVE/RECALL</b> Recall → Internal Internal → Trace TRACE A , TRACE B , or TRACE C (register number) <b>ENTER</b>
save limit-line table	Yes <sup>2</sup>	0 to MAX REG #	<b>SAVE/RECALL</b> Save → Internal Trace → Intrnl LIMIT LINES (register number) <b>ENTER</b>
recall limit-line table	No	0 to MAX REG #	<b>SAVE/RECALL</b> Recall → Internal Internal → Trace LIMIT LINES (register number) <b>ENTER</b>

<sup>1</sup> Registers 1 through 8 are available for the user to save a state. State register 0 contains the current state of the instrument, register 9 contains the previous state of the instrument.

<sup>2</sup> The screen title is displayed when cataloging the trace registers with **CATALOG REGISTER**. The screen title is not recalled with the limit-line tables.

---

## How to Output Data

At any time, the screen information can be sent to a printer or plotter by pressing **(COPY)**.

Data collected in the signal list can also be printed or plotted in a report. The report can consist of any of the following elements:

- the user comments (annotations)
- a tabular list of the data
- a plot of the data in the list, on either a linear or logarithmic frequency axis with the limit lines that are currently displayed
- a listing of the instrument setup parameters, including limit-line and amplitude-correction files

The report may be configured using any, or all, of the elements listed above. The graph can also be saved to a card.

### Note

---

Only the graph can be sent to a plotter.

---

## Configuring a printer

The EMC analyzer supports a variety of printers. The analyzer must be configured correctly to operate with a specific printer type. Configuration options include:

- printer type
- address of the printer
- menu printing enabled

The configuration information is used when printing with either the **(COPY)** key or the **OUTPUT REPORT** softkey (located on the **(OUTPUT)** key menu).

The following procedure configures the receiver to print to an HP ThinkJet printer.

1. Access the printer configuration menu by pressing:

**(CONFIG)**

2. Configure the analyzer for the type of printer you wish to use. For example, to use an HP ThinkJet printer, press:

```
Print Config
Set B&W Printer
HP B&W Printer
```

3. Set the HP-IB address of the printer. Enter the last two numbers of the address assigned to the printer. For example, if the printer address is 1, enter 01 by pressing:

```
Print Config
Prn Port Config
PRINTER ADDRESS .....01 (ENTER)
```

## Configuring and generating a report

Use a list similar to the one created in the “Using the measure-at-marker function” in Chapter 4 for this procedure.

1. Access the report definition menu by pressing:

```
OUTPUT
Define Report
```

2. Verify that all report definitions are set to ON by selecting the following softkey settings:

```
ANNOTATN ON OFF ON
LOG ON OFF ON
LIN ON OFF ON
LIST ON OFF ON
SETTINGS ON OFF ON
```

---

### Note

The ANNOTATN ON OFF function in the Display menu does *not* turn user annotation on and off. It is used to turn onscreen annotation, such as the instrument settings, marker box, title line, softkeys, on and off.

---

3. To modify the list, press:

```
Previous Menu
Define List
```

The display of the data in the list can be tailored to meet your needs. You can:

- Select which of the measured detectors to print to the list.
- Display the differences between a data point and the limit lines for any of the detectors.
- Elect to indicate which of the list entries have been “marked” (for more information, refer to Chapter 2).
- Print the current correction factors used.

4. To modify which detector values are printed to the screen, press:

`SHOW DET PK QP AV`

The detectors that will be displayed are underlined (defaults are PK and QP). Press the softkey repeatedly to view the detector combinations available.

5. To display the numerical difference between a specific detector reading and limit line 1, press:

`SHOW Δ 1 PK QP AV`

The detectors that will be displayed are underlined. Press the softkey repeatedly to view the detector combinations available.

6. To display the numerical difference between a specific detector reading and limit line 2, press:

`SHOW Δ 2 PK QP AV`

The detectors that are currently detected are underlined. Press the softkey repeatedly to view the detector combinations available.

7. To display the total current correction factor used for the data point displayed, press:

`SHOW COR ON OFF ON`

8. To display the “mark” in the report, press:

`SHOW MRK ON OFF ON`

## Note

---

When the maximum number of columns exceeds the maximum number of characters available across a page in portrait orientation, the analyzer will print the data in landscape orientation. Some printers, including the HP ThinkJet, HP DeskJet, Epson MX80 and Epson LQ570 do not support landscape orientation. Check your printer documentation for information. The maximum number of columns that can be printed in portrait mode is nine.

---

9. To return to the top level OUTPUT menu, press:

`Previous Menu`

10. To add user notes to the report, press:

`EDIT ANNOTATN`

Annotation is entered using the HP 1405B, option ABA external keyboard. The maximum number of ASCII characters allowed in the annotation is 1024. For more information on connecting and using the keyboard, refer to Chapter 13.

11. To clear any existing annotation, press:

`CLEAR ANNOTATN`

`CLEAR ANNOTATN`

12. When you finish entering notes, press:

`EXIT EDIT`

13. Verify the printer is connected to the analyzer, then output the report by pressing:

`OUTPUT REPORT`

14. To halt the operation at any time during the output cycle, press:

`Abort`

The analyzer will finish any graphs currently in process before aborting the output cycle.





## Additional Features

---

### What you'll find in this chapter

This chapter describes additional capabilities of the analyzer, including the:

- Spectrum analyzer emulation
- Demodulator
- Tracking generator

You will also learn:

- How to install and use an external keyboard
- How to enter annotation, programming command and screen titles

---

### Spectrum Analyzer Emulation

The EMC analyzer can be configured to emulate spectrum analyzer operation. When in spectrum analysis mode:

- IF bandwidths are coupled to span. (In analyzer mode, the IF bandwidth is selected based on center frequency.)
- The default marker operation is MARKER SPAN, not MARKER TUNE.
- Limit lines operate differently. Refer to Chapter 9 for more information.
- The screen is annotated differently.
- Many automated EMC functions are not available.

To select spectrum analyzer mode, press:

```
MODE
SPECTRUM ANALYZER
```

---

## Demodulator (all except option 703)

Demodulator control includes:

DEMOM	Directly accesses the softkey menus that include AM and FM demodulation, FM gain, dwell time, and squelch level.
VOLUME	Adjusts the audio level of the internal speaker.
REAR PANEL PHONEJACK	Provides an audio output for using headphones.

The following list describes each of the menu selections on the Demodulator menu.

DEMOM ON OFF	Turns the demodulator on and off (default is off).
DEMOM AM FM	Selects the demodulator mode (default is AM).
SPEAKER ON OFF	Turns the internal speaker on and off.
SQUELCH	Sets the level of signal required to activate the audio amplifier.
FM GAIN	Changes the sensitivity of the FM discriminator. The sensitivity can be modified to attain sufficient audio output for a specific voltage setting when demodulating narrowband and broadband FM signals.
DWELL TIME	Sets the length of time the demodulator is on at the marker when scanning a frequency range greater than 0 Hz.

---

## Tracking Generator

The tracking generator is a frequency source that automatically tracks the analyzer's tuned input frequency. This source is useful when characterizing two-port devices, such as filters, amplifiers, and cables.

To access the tracking generator menus, press:

**AUX/USER**  
Track Gen

When **SCR PWR ON OFF** is first pressed, the current setting of the output power level is indicated in the active function block, however power is not turned on. To activate the tracking generator, press **SCR PWR ON OFF** a second time or change the output power level using the numeric keypad, step keys, or knob. (A terminator key is required when using the keypad.)

## Note

---

The `PWR SWP ON OFF` and `SRC ATN MAN AUTO` functions operate the same way as the `SCR PWR ON OFF` function.

---

The following list describes each of the menu selections on the Tracking Generator menu.

<code>SCR PWR ON OFF</code>	Turns the source power on and off and sets the source power level (default is 97 dB $\mu$ V). Use the numeric keys, step keys or knob to set the desired source power level.
<code>TRACKING PEAK</code>	Aligns the tracking generator output frequency to the tuned frequency of the analyzer. The alignment is most critical when using narrow IF bandwidths ( $\leq 30$ kHz). This operation should be performed the first time the tracking generator is used with narrow IF bandwidths each day or when changing the IF bandwidths.
<code>MAN TRK ADJUST</code>	Enables manual alignment of the tracking generator output frequency to the tuned frequency of the analyzer. The alignment is most critical when using narrow IF bandwidths ( $\leq 30$ kHz). Use the numeric keys, step keys or knob to adjust the alignment.
<code>PWR SWP ON OFF</code>	Varies the output power of the tracking generator over the span (default is off (0 dB), maximum is 15 dB). This feature is useful when measuring the compression of an amplifier. The source power sweep amplitude deviation can be adjusted using the numeric keys, step keys, or knob.
<code>SRC ATN MAN AUTO</code>	The built-in attenuator is used to optimize the power level of the tracking generator output. In the automatic (default) mode the attenuator is auto-coupled to the output. In the manual mode the power level can be adjusted using the numeric keys, step keys, or knob (maximum is 56 dB).
<code>More 1 of 2</code>	Accesses the second Tracking Generator menu level.

SCR PWR STP SIZE	Sets the step size value for the step keys (default is 10 dB).
SCR PWR OFFSET	Offsets the value of the displayed source power level (default is 0 dB). This function can be used to account for the gain or loss of a DUT.
ALC INT EXT	The tracking generator is leveled internally (default). When done manually an external signal can be connected to the ALC INPUT.
ALC MTR EXT XTAL	<i>HP 8591EM only.</i> The tracking generator is leveled internally (default). When done manually an external signal can be connected to the ALC INPUT.
SWP CPLG SR SA	Changes sweep time (default is “no delay”) in stimulus-response mode to account for the response time of a DUT. This is useful when testing devices such as filters.
Previous Menu	Accesses the <b>AUX/USER</b> menu.
More 2 of 2	Accesses the first Tracking Generator menu level.

---

## External Keyboard

### External keyboard features

The HP C1405B keyboard is an IBM AT compatible keyboard that can be connected to the external keyboard connector on the rear panel of the EMC analyzer. The external keyboard allows a convenient way to enter screen titles and remote programming commands directly into the EMC analyzer or to access the softkey functions.

The function keys of the external keyboard control the EMC analyzer as follows:

**Table 13-8. External Keyboard Functions**

<b>Key</b>	<b>Description</b>
F1—F6	Softkeys 1 through 6 (respectively) of the current EMC analyzer menu.
F7	Enter prefix mode.
F8	Enter remote commands mode.
F9	Accesses the <b>FREQUENCY</b> menu.
F10	Accesses the <b>SPAN</b> menu.
F11	Accesses the <b>AMPLITUDE</b> menu.
F12	Retrieves the present screen title for editing.
<b>ESC</b>	Accesses the enter title mode.
<b>PRINT SCREEN</b>	Copies the EMC analyzer screen display to the active copy device.
<b>PAUSE</b>	Accesses the DLP Editor and redefines F7—F12.

**Table 13-8. External Keyboard Functions (continued)**

Key	Description
<b>DELETE</b>	Deletes the character over the cursor.
<b>INSERT</b>	Toggles between the insert and replace mode at the cursor.
<b>BACKSPACE</b>	Erases the previous character to the left of the cursor.
<b>ALT-DELETE</b> *	Clears the keyboard line.
<b>CTRL-DELETE</b> *	Clears to end of line.
<b>←</b>	Moves the cursor to the left.
<b>→</b>	Moves the cursor to the right.
<b>▼</b>	Moves from later items to earlier items in the recall buffer.
<b>▲</b>	Moves from earlier items to later items in the recall buffer.
<b>CTRL-C</b> *	End-of-text.
<b>CTRL-J</b> *	Line feed.
<b>CTRL-M</b> *	Carriage return.
<b>CTRL-N</b> *	Turns on inverse video.
<b>CTRL-O</b> *	Turns enhancements (inverse video, underlining) off.
<b>CTRL-P</b> *	Turns on underlining.
<b>CTRL-<span style="border: 1px solid black; padding: 0 2px;"> </span></b> *	Escape.
*The dash between keys indicates that both keys should be pressed at the same time.	

The external keyboard operation with the EMC analyzer is similar to its operation with a computer except for the following:

SCROLL LOCK and NUM LOCK are fixed and cannot be changed. Pressing **NUM LOCK** displays the keyboard mode on the EMC analyzer screen. The EMC analyzer will not recognize the control characters or function keys.

The keyboard supports a 244 character recall buffer. The longest single item is limited to 243 characters; subsequent characters are ignored. Using the **↑** or **↓** keys of the external keyboard to recall an item does not change the buffer contents. Recalling an item and then pressing the **ENTER** key does not store a new copy of the item in the recall buffer. If an item is recalled and then modified, a new copy will be made in the recall buffer. Adding new data into the keyboard line deletes the oldest data automatically.

When in command mode, the active line will append a semicolon to the keyboard entry if the line does not end with a semicolon and it is fewer than 243 characters long.

**Installation** To install the external keyboard (HP 1405B option ABA):

1. Press **LINE** to turn off power to the analyzer.

**CAUTION**

- Turn off the analyzer before connecting an external keyboard to the analyzer. Failure to do so may result in loss of factory calibration data.
- Static discharges of greater than 3 kV to metallic portions of the connector housing on the keyboard during operation may cause the instrument to reset.

- Plug the keyboard into the EXT KEYBOARD input located on the rear panel of the EMC analyzer.
- Press **LINE** to turn on power to the EMC analyzer.

The external keyboard is now ready to be used.

**Using the template**

The External Keyboard Template (HP part number 5182-1204), displays the functions available when using the external keyboard. The external keyboard has two modes of operation:

Annotation Editor                      This mode is used to enter or edit annotation.

Keyboard Entry                         This mode is used to enter or edit the command line, title line, or prefix.

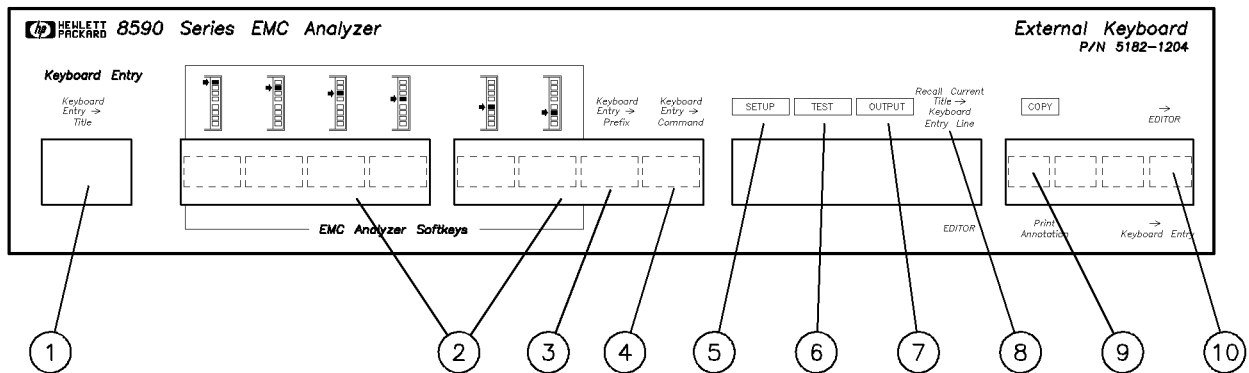

template

**Figure 13-1. External keyboard template.**

This section provides a brief description of the template features. Refer to Figure 13-1.

- 1 EDITOR (**Esc**) is used to select the keyboard entry destination to be the title.
- 2 The onscreen softkeys can be accessed by pressing the appropriate function key (**F1**) through (**F6**).
- 3 (**F7**) is used to select the keyboard entry destination to be the prefix.
- 4 (**F8**) is used to select the keyboard entry destination to be the command line.
- 5 SETUP (**F9**) duplicates the front-panel (**SETUP**) key.
- 6 TEST (**F10**) duplicates the front-panel (**TEST**) key.
- 7 OUTPUT (**F11**) duplicates the front-panel (**OUTPUT**) key.
- 8 Recall Current Title → Keyboard Entry Line (**F12**) moves the currently displayed title to the keyboard entry line so it can be edited.
- 9 The function of the (**Print Screen**) key is determined by the current operating mode. In keyboard entry mode it duplicates the front-panel (**COPY**) key. In editor mode it prints the annotation.
- 10 The Exit → EDITOR/Exit → Keyboard Entry (**Pause**) toggles between the two operating modes.



## Entering data using the external keyboard

### Entering annotation

The external keyboard can be used to enter explanatory text. Annotation can be:

- displayed on the analyzer screen to provide additional information
- printed separately, or as part of a report
- stored with the signal list and recalled for future reference

1. Select the Annotation Editor by pressing:

Exit → EDITOR, ((Pause))

#### Note

When the Annotation Editor is selected using the external keyboard, annotation is automatically turned on.

Annotation editing can also be turned on from the front panel by pressing:

OUTPUT  
EDIT ANNOTATN

2. To clear any existing annotation:

On the front panel, press:

OUTPUT

On the external keyboard, press:

EDIT ANNOTATN ((F5))

CLEAR ANNOTATN ((F1))

EXIT EDIT ((F6))

3. Use the external keyboard to enter the following message:

This is an annotation editor. It can be used to record information about the measurement.

#### Note

The Home, End, Insert, Delete, and arrow keys are available. The backspace ((←)) key can also be used.

4. To print the annotation, press:

Print Annotation ((Print Screen))

For information on saving a signal list and its annotation, refer to Chapter 5, List-Based Measurements.

5. When you are finished with the annotation, press

Exit → Keyboard Entry ((Pause)).

## Entering programming commands

Remote programming commands can be entered using the external keyboard. Refer to *HP 8590 EM Series EMC Analyzer Quick Reference Guide* for a complete list of the remote programming commands.

1. Select the Command function by pressing:

**(F8)**

The on-screen message, “Keyboard Entry → Command” flashes on the screen.

2. Set the center frequency to 300 MHz and the span to 2 MHz by using the external keyboard to enter:

CF300MZ; **(Enter)**

SP2MZ; **(Enter)**

### Note

---

When editing the keyboard entry line the down-arrow key (**(↓)**) can be used to recall previously entered lines.

---

## Entering a screen title

1. Select the Title function by pressing:

**(Esc)**

The on-screen message Keyboard Entry → Title flashes on the screen.

2. Use the external keyboard to enter:

This is a title.

When you are finished entering the prefix, press **(Enter)**. The new title will move from the Keyboard Entry line to the Title line.

3. To edit an existing Title line move the current title to the Keyboard Entry line by pressing:

Recall Current Title → Keyboard Entry Line **(F12)**

4. Use the external keyboard to change the title to read:

This Is a New Title

When you are finished entering the title, press **(Enter)**. The title will move from the Keyboard Entry line to the Title line.

## Entering a prefix

1. Select the Prefix function by pressing:

**F7**

The on-screen message Keyboard Entry → Prefix flashes on the screen.

2. Use the external keyboard to enter:

J0Y

When you are finished entering the prefix, press **Enter**.

To view the new prefix, press:

**SAVE/RECALL**

Change Prefix

The message “Prefix = J0Y” is displayed in the active function area of the screen.

3. When you are finished viewing the prefix, press:

More 1 of 2

EDIT DONE



## EMC Analyzer Error Messages

---

### What you'll find in this chapter

The EMC analyzer can generate various messages that appear on its screen during operation to indicate a problem.

There are three types of messages: hardware error messages (H), user-created error messages (U), and informational messages (M).

- Hardware error messages indicate the EMC analyzer hardware is probably broken.
- User-created error messages appear when the EMC analyzer is used incorrectly. They are usually generated during remote operation (entering programming commands using either a controller or the external keyboard).
- Informational messages provide information indicating the EMC analyzer's progress within a specific procedure.

The messages are listed in alphabetical order on the following pages; each message is defined, and its type is indicated by an (H), (U), or (M).

#### **ϕ LOCK OFF**

Indicates slow YTO tuning. This message may appear if the EMC analyzer is using default correction factors. If this message appears constantly, perform the CAL FREQ routine to try to eliminate this message. ϕ LOCK OFF appears briefly during the CAL FREQ routine, during instrument preset, or when the frequency value is changed; this is normal and does not indicate a problem. (U) and (H)

#### **ADC-2V FAIL**

Indicates a hardware failure. (H)

#### **ADC-GND FAIL**

Indicates a hardware failure. (H)

#### **ADC-TIME FAIL**

Indicates a hardware failure. (H) and (U)

#### **CAL: \_ \_ \_**

During the self-calibration routine, messages may appear on the display to indicate how the calibration routines are progressing. For example, sweep, freq, span, MC delay, FM coil, and atten can appear on the EMC analyzer display. ϕ LOCK OFF appears briefly during the CAL FREQ self-calibration routine; this is normal and does not indicate a problem. (M)

**CAL: \_ \_ \_ : done Press CAL STORE to save**

Indicates that the self-calibration routine is finished and that you should press **CAL STORE**. (M)

**CAL: cannot execute CALAMP enter: 0 dB PREAMP GAIN**

The preamplifier gain should be set to 0 dB before the CAL AMPTD routine is performed. The preamplifier gain is set by using **EXTERNAL PREAMPG**. This message also sets SRQ 110. (U)

**CAL: DATA NOT STORED CAL AMP NEEDED**

The correction factors are corrupt and cannot be stored. You need to perform the CAL AMPTD or the CAL FREQ & AMPTD routine before trying to store the correction factors. This message also sets SRQ 110. (U)

**CAL: FM SPAN SENS FAIL**

The EMC analyzer could not set up span sensitivity of the FM coil. (H)

**CAL: GAIN FAIL**

Indicates the signal amplitude is too low during the CAL AMPTD routine. This message also sets SRQ 110. (H)

**Cal harmonic > = 5.7 GHz NOT found**

Indicates that the CAL YTF routine for an HP 8595EM cannot find a harmonic of the 300 MHz calibration signal. If this happens, ensure that the CAL OUT connector is connected to the EMC analyzer input, perform the CAL FREQ & AMPTD routine, and then perform the CAL YTF routine again. (U) and (H)

**CAL: MAIN COIL SENSE FAIL**

The EMC analyzer could not set up span sensitivity of the main coil. If this message appears, press **FREQUENCY**, **-37**, **Hz**, **CAL**, **More 1 of 4**, **More 2 of 4**, **DEFAULT CAL DATA**, and perform the CAL FREQ routine again. (H)

**CAL: NBW 200 Hz notch amp failed**

Indicates that the 200 Hz resolution bandwidth is not the correct shape for the calibration routine. (H)

**CAL: NBW 200 Hz notch failed**

Indicates that the 200 Hz resolution bandwidth is not the correct shape for the calibration routine. (H)

**CAL: NBW 200 Hz width failed**

Indicates that the 200 Hz resolution bandwidth is not the correct bandwidth for the calibration routine. (H)

**CAL: NBW gain failed**

Indicates that one of the resolution bandwidths is not the correct amplitude for the calibration routine. (H)

**CAL: NBW width failed**

Indicates that one of the resolution bandwidths is not the correct width for the calibration routine. (H)

**CAL: PASSCODE NEEDED**

Indicates that the function cannot be accessed without the pass code. For the DEFAULT CAL DATA function, enter the passcode by pressing **FREQUENCY**, **-37**, **Hz**. (M)

**CAL: RES BW AMPL FAIL**

The relative insertion loss of the resolution bandwidth is incorrect. This message also sets SRQ 110. (H)

**CAL SIGNAL NOT FOUND**

Indicates the calibration signal (CAL OUT) cannot be found. Check that the CAL OUT and the EMC analyzer input connectors are connected with an appropriate cable. If the calibration signal is connected to the EMC analyzer input but cannot be found, press **(FREQUENCY)**, **-37**, **(Hz)**, **(CAL)**, **More 1 of 4**, **More 2 of 4**, **DEFAULT CAL DATA**. If the calibration signal still cannot be found, press **(FREQUENCY)**, **-37**, **(Hz)** and perform the CAL FREQ or CAL FREQ & AMP TD self-calibration routines. This message also sets SRQ 110. (U) and (H)

**CAL: SPAN SENS FAIL**

The self-calibration span sensitivity routine failed. This message also sets SRQ 110. (H)

**CAL: USING DEFAULT DATA**

Indicates that the calibration data is corrupt and the default correction factors are being used. Interruption of the self-calibration routines or an error can cause this problem. (M)

**CAL YTF FAILED**

Indicates that the CAL YTF routine could not be successfully completed. If this message appears, ensure that the CAL OUT connector (for the HP 8595EM) or 100 MHz COMB OUT connector (for the HP 8593EM or HP 8596EM) is connected to the EMC analyzer input, then perform the CAL YTF routine again. (U) and (H)

**CAL: ZERO FAIL**

The EMC analyzer could not set up the tuning sensitivity of the main coil. If this message appears, press **(FREQUENCY)**, **-37**, **(Hz)**, **(CAL)**, **More 1 of 4**, **More 2 of 4**, **DEFAULT CAL DATA**, and perform the CAL FREQ routine again. (H)

**Cannot BYPASS Input 1**

An attempt was made to execute the BYPASS command while the signal path is routed through INPUT 1 of the RF filter section. Only INPUT 2 of the RF filter section can be bypassed. *Requires the HP 85420E Option 1EM RF Filter section.*

**Cannot engage phase lock with current CAL FREQ data**

Indicates that the CAL FREQ routine needs to be performed before phase locking can be turned on. (U)

**Comb harmonic at \_ \_ \_ GHz NOT found**

Indicates that the CAL YTF routine for the EMC analyzer cannot find a harmonic of the comb generator at frequency displayed. If this happens, ensure that the 100 MHz COMB OUT connector (for an HP 8593EM or HP 8596EM) or the CAL OUT connector (for an HP 8595EM) is connected to the EMC analyzer input with a low-loss, short cable before the CAL YTF routine is performed. (U) and (H)

**COMB SIGNAL NOT FOUND**

The comb signal cannot be found. Check that 100 MHz COMB OUT is connected to the EMC analyzer input. The comb generator is available with the HP 8593EM or HP 8596EM only. (U) and (H)

**CMD ERR: \_ \_ \_**

The specified programming command is not recognized by the EMC analyzer. Press **ANNOTATN ON OFF** to clear. (U)

**CONF TEST FAIL**

Indicates that the confidence test failed. If this happens, ensure that the CAL OUT connector is connected to the EMC analyzer input, perform the CAL FREQ & AMPTD routine, and then perform the confidence test again. This message also sets SRQ 110. (H) and (U)

**EMPTY DLP MEM**

Indicates that the user-defined items (user-defined functions, user-defined variables, user-defined traces, user-defined softkeys) and any personalities (for example, the HP 85712B EMC measurement Personality) in the EMC analyzer's memory have been deleted. If the message is continuously displayed at power up, it may indicate a hardware failure. See the EMC analyzer's Service Guide for more information. (U)

**FAIL: \_ \_ \_**

An error was discovered during the power-up check. The 4-digit by 10-digit code indicates the type of error. Error codes are described in the EMC analyzer's service guide. (H)

**File type incompatible**

Indicates that the selected file is not a display image file. The file name for a display image file is always preceded by an "i." (U)

**FREQ UNCAL**

If the FREQ UNCAL message appears constantly, it indicates a YTO-tuning error. If this message appears constantly, perform the CAL FREQ routine. FREQ UNCAL appears briefly during the CAL FREQ routine; this is normal and does not indicate a problem. (U) and (H) (U) and (H)

**Function not available in current Mode**

Indicates that the function that you have selected can only be used with the EMC analyzer or spectrum analyzer mode. You can use the **(MODE)** key to select the EMC analyzer or spectrum analyzer mode. (U)

**Function not available with analog display**

Indicates that the function that you have selected is not compatible with the Analog+ display mode. To use the function, you must first turn off the Analog+ display mode with **ANALOG+ ON OFF**. (U)

**INTERNAL LOCKED**

The EMC analyzer's internal trace and state registers have been locked. To unlock the trace or state registers, press **SAV LOCK ON OFF** so that OFF is underlined. For remote operation, use PSTATE OFF. (U)



**INVALID ACTDEF: \_ \_ \_**

The specified ACTDEF name is not valid. See the ACTDEF programming command. (U)

**INVALID AMPCOR: FREQ**

For the AMPCOR command, the frequency data must be entered in increasing order. See the description for the AMPCOR programming command for more information. (U)

**INVALID BLOCK FORMAT: IF STATEMENT**

An invalid block format appeared within the IF statement. See the description for the IF THEN ELSE ENDIF programming command for more information. (U)

**INVALID CARD**

Indicates one of the following conditions: the memory card is write-protected (check the position of the switch on the memory card), the memory card is a read-only memory (ROM) card, or a memory card has not been inserted. (U)

**INVALID CARD: BAD MEDIA**

Indicates the formatting routine (**FORMAT CARD**) for the memory card could not be completed. See the description for INVALID CARD above for more information about the possible causes of this message. (U) and (H)

**INVALID CARD: DATA ERROR**

Indicates the data could not be retrieved from the memory card. (U) and (H)

**INVALID CARD: DIRECTORY**

Indicates the memory card has not been formatted. (U)

**INVALID CARD: NO CARD**

Indicates a memory card has not been inserted. (U)

**INVALID CARD: TYPE**

Indicates one of the following conditions: the memory card is write-protected (check the position of the switch on the memory card), the memory card is a read-only memory (ROM) card, or a memory card has not been inserted. (U)

**INVALID CHECKSUM: USTATE**

The user-defined state does not follow the expected format. (U)

**INVALID COMPARE OPERATOR**

An IF/THEN or REPEAT/UNTIL routine is improperly constructed. Specifically, the IF or UNTIL operands are incorrect. (U)

**INVALID DET: FM or TV option only**

Indicates that the selected detector cannot be used until the appropriate option is installed in the EMC analyzer. (U)

**INVALID ENTER FORMAT**

The enter format is not valid. See the appropriate programming command description to determine the correct format. (U)

**INVALID <file name> NOT FOUND**

Indicates that the specified file could not be loaded into EMC analyzer memory or purged from memory because the file name cannot be found. (U)

**INVALID FILENAME \_ \_ \_**

Indicates the specified file name is invalid. A file name is invalid if there is no file name specified, if the first letter of the file name is not alphabetic, or if the specified file type does not match the type of file. See the description SAVRCLW or STOR programming command for more information. (U)

**INVALID FILE: NO ROOM**

Indicates that there is insufficient space available on the memory card to store the data. (U)

**INVALID HP-IB ADRS/OPERATION**

An HP-IB operation was aborted due to an incorrect address or invalid operation. Check that there is only one controller (the EMC analyzer) connected to the printer or plotter. (U)

**INVALID HP-IB OPERATION REN TRUE**

The HP-IB operation is not allowed. (This is usually caused by trying to print or plot when a controller is on the interface bus with the EMC analyzer.) To use the EMC analyzer print or plot functions, you must disconnect any other controllers on the HP-IB. If you are using programming commands to print or plot, you can use an HP BASIC command instead of disconnecting the controller. (U)

**INVALID ITEM:\_ \_ \_**

Indicates an invalid parameter has been used in a programming command. (U)

**INVALID KEYLBL: \_ \_ \_**

Indicates that the specified key label contains too many characters. A key label is limited to 8 printable characters per label line. (U)

**INVALID KEYNAME:\_ \_ \_**

The specified key name is not allowed. (The key name may have conflicted with a EMC analyzer programming command.) To avoid this problem, use an underscore as the second character in the key name, or avoid beginning the key name with the following pairs of letters: LB, OA, OL, TA, TB, TR, MA, MF, TS, OT, and DR. (U)

**INVALID OUTPUT FORMAT**

The output format is not valid. See the appropriate programming command description to determine the correct format. (U)

**INVALID RANGE: Stop < Start**

Indicates that the first trace element specified for a range of trace elements is larger than ending trace element. When specifying a trace range the starting element must be less than the ending element. For example, TRA[2,300] is legal but TRA[300,2] is not. (U)

**INVALID REGISTER NUMBER**

The specified trace register number is invalid. (U)

**INVALID REPEAT MEM OVFL**

Memory overflow occurred due to a REPEAT routine. This can occur if there is not enough EMC analyzer memory for the REPEAT UNTIL declaration, or if the REPEAT UNTIL declaration exceeds 2047 characters. (U)

**INVALID REPEAT NEST LEVEL**

The nesting level in the REPEAT routine is improperly constructed. This can occur if too many REPEAT routines are nested. When used within a downloadable program (DLP), the maximum number of REPEAT UNTIL statements that can be nested is 20. (U)

**INVALID RS-232 ADRS/OPERATION**

An RS-232 operation was aborted due to an invalid operation. (U)

**INVALID SAVE REG**

Data has not been saved in the specified state or trace register, or the data is corrupt. (U)

**INVALID SCRMOVE**

Indicates the EMC analyzer may have a hardware failure. See the EMC analyzer's service guide (option 915) for more information. (H)

**INVALID START INDEX**

Indicates that the first trace element specified for a range of trace elements is not within the trace range of the specified trace. (U)

**INVALID STOP INDEX**

Indicates that the ending trace element specified for a range of trace elements is not within the trace range of the specified trace. (U)

**INVALID STORE DEST: \_ \_ \_**

The specified destination field is invalid. (U)

**INVALID TRACE: \_ \_ \_**

The specified trace is invalid. (U)

**INVALID TRACENAME: \_ \_ \_**

Indicates the specified trace could not be saved because the trace name is not allowed. To avoid this problem, use an underscore as the second character in the trace name, or avoid beginning the trace name with the following pairs of letters: LB, OA, OL, TA, TB, TR, MA, MF, TS, OT, and DR. (U)

**INVALID VALUE PARAMETER: \_ \_ \_**

The specified value parameter is invalid. (U)

**INVALID VARDEF: \_ \_ \_**

The specified variable name is not allowed. To avoid this problem, use an underscore as the second character in the variable label, or avoid beginning the variable label with the following pairs of letters: LB, OA, OL, TA, TB, TR, MA, MF, TS, OT, and DR. (U)

**INVALID WINDOW TYPE: \_ \_ \_**

The specified window is invalid. See the description for the TWINDOW programming command. (U)

**LOST SIGNAL**

For the HP 8593EM or HP 8596EM, this message indicates that the cable from the 100 MHz COMB OUT connector to the EMC analyzer input is defective or has become disconnected during the CAL YTF routine. For the HP 8595EM, this message indicates that the cable from the CAL OUT connector is defective or has been disconnected during the CAL YTF routine. Be sure to use a short, low-loss cable to connect the signal to the EMC analyzer input when performing the CAL YTF routine. (U)

**LO UNLVL**

Indicates that the EMC analyzer's local oscillator distribution amplifier is not functioning properly. (H)

**Marker Count Reduce SPAN**

Indicates the resolution bandwidth to span ratio is too small to use the marker count function. Check the span and resolution bandwidth settings. (U)

**Marker Count Widen RES BW**

Indicates that the current resolution bandwidth setting is too narrow to use with the marker counter function. The marker counter function can be in narrow resolution bandwidths (bandwidths that are less than 1 kHz) with the following procedure:

1. Place the marker on the desired signal.
2. Increase the resolution bandwidth to 1 kHz and verify the marker is on the signal peak.
3. If the marker is on the signal peak, the marker count function can be used in either the 1 kHz resolution bandwidth or the original narrow resolution bandwidth setting. If the marker is not on the signal peak, it should be moved to the signal peak and the marker counter function should not be used with a resolution bandwidth setting of less than 1 kHz. (U)

**MEAS UNCAL**

The measurement is uncalibrated. Check the sweep time, span, and bandwidth settings, or press **AUTO COUPLE**, **AUTO ALL**. (U)

**MEMORY OVERFLOW:ERASE DLP MEM and reload**

This message indicates that too many user-defined items (functions, variables, key definitions), or downloadable programs have been loaded into EMC analyzer memory. If this message appears, use **ERASE DLP MEM** and then load the user-defined item or downloadable program into EMC analyzer memory. (U)

**No card found**

Indicates that the memory card is not inserted. (U)

**No points defined**

Indicates the specified limit line or amplitude correction function cannot be performed because no limit line segments or amplitude correction factors have been defined. (U)

**OVEN COLD**

Indicates that the EMC analyzer has been powered up for less than 5 minutes. (The actual temperature of the precision frequency oven is not measured.) (Option 004 only.) (M)

**PARAMETER ERROR: \_ \_ \_**

The specified parameter is not recognized by the EMC analyzer. See the appropriate programming command description to determine the correct parameters. (U)

**PASSCODE NEEDED**

Indicates that the function cannot be accessed without the pass code. (U)

**POS-PK FAIL**

Indicates the positive-peak detector has failed. (H)

**RCVR Limits not allowed in SA mode**

This error is encountered when an attempt is made to enable limit-line display, limit-margin display, or limit testing of limits defined in EMC analyzer mode when the instrument is operating in Signal Analysis mode. To correct the problem, either purge the limits or switch to Receiver mode. (U)

**REF UNLOCK**

Indicates that the frequency reference is not locked to the external reference input. Check that the 10 MHz REF OUT connector is connected to the EXT REF IN connector, or, when using an external reference, that an external 10 MHz reference source of sufficient amplitude is connect to the EXT REF IN connector. (U) and (H)

**Required option not installed**

Some EMC analyzer functions require that an option be installed in the EMC analyzer. See the description for the function in the *HP 8590 EM Series EMC Analyzer User's Guide* for more information about which option is required. (U)

**RES-BW NOISE FAIL**

Indicates the noise floor level is incorrect at the indicated bandwidth. (H)

**RES-BW SHAPE FAIL**

Indicates the 3 dB bandwidth is not within specifications. (H)

**RF Filter Section Absent**

This message is displayed if the bypass command is executed when the RF filter section is not connected to, or is not communicating with, the EMC analyzer. (U) and (H)

**RFFS Error: COMMAND**

The RF filter section has received a command that it does not recognize. Assure that there is no cable connected to the RF filter section Service Bus interface. If the condition persists, and there is no cable connected to the RF filter section Service Bus interface, contact your HP representative. *Requires the HP 85420E Option 1EM RF Filter section.* (U)

**RFFS Error: HARDWARE**

The RF filter section has experienced a hardware failure. If the condition persists after presetting the instrument or cycling power, contact your HP representative. *Requires the HP 85420E Option 1EM RF Filter section.* (H)

**RFFS Error: TIMEOUT**

Communication failure between the EMC analyzer; and the RF filter section. Check power to the RF filter section and check that the AUX interface cable is properly connected between both instruments. *Requires the HP 85420E Option 1EM RF Filter section.* (U) (H)

**RFFS Service Bus Active**

This message appears in the active function area of the EMC analyzer; display when an external controller communicates with the RF filter section via the RF filter section Service Bus interface. *Requires the HP 85420E Option 1EM RF Filter section.* (H)

**RF PRESEL ERROR**

Indicates that the preselector peak routine cannot be performed.  
*Requires the HP 85420E Option 1EM RF Filter section.* (H)

**RF PRESEL TIMEOUT**

Indicates that the preselector peak routine cannot be performed.  
*Requires the HP 85420E Option 1EM RF Filter section.*(H)

**SA Limits not allowed in RCVR mode**

This error is encountered when an attempt is made to enable limit-line display, limit-margin display, or limit testing of limits defined in Spectrum Analyzer mode when the instrument is operating in EMC Analyzer mode. To correct the problem, either delete the limits or switch to Spectrum Analyzer mode. (U)

**SAMPLE FAIL**

Indicates the sample detector has failed. (H)

**SETUP ERROR**

Indicates that the span, channel bandwidth, or channel spacing are not set correctly for the adjacent channel power or channel power measurement. (U)

**Signal Not Found**

Indicates the PEAK ZOOM routine did not find a valid signal. (U)

**SMPLR UNLCK**

Indicates that the sampling oscillator circuitry is not functioning properly. If this message appears, check that the external frequency reference is correctly connected to the EXT REF INPUT. (U) and (H)

**SOFTKEY OVFL**

Softkey nesting exceeds the maximum number of levels. (U)

**SRQ - - -**

The specified service request is active. Service requests are a form of informational message and are explained in Appendix A of the *HP 8590 EM Series EMC Analyzer User's Guide*. (M)

**STEP GAIN/ATTN FAIL**

Indicates the step gain has failed. (H)

**Stop at marker not available with negative detection**

Indicates that the marker counter cannot be used when negative peak detection is selected. To use the marker counter, turn off negative peak detection with `DETECTOR PK SP NG`. (U)

**TABLE FULL**

Indicates the upper or lower table of limit lines contains the maximum number of entries allowed. Additional entries to the table are ignored. (U)

**TG SIGNAL NOT FOUND**

Indicates the tracking generator output signal cannot be found. Check that the tracking generator output (RF OUT 50Ω or RF OUT 75Ω) is connected to the EMC analyzer input connector with an appropriate cable. (U)

**TG UNLVL**

This message can indicate the following: that the source power is set higher or lower than the EMC analyzer can provide, that the

frequency span extends beyond the specified frequency range of the tracking generator, or that the calibration data for the tracking generator is incorrect. See “Stimulus-Response Measurements”, in Chapter 8, for more information. (U)

**Trace A is not available**

Indicates that trace A is in the store-blank mode and cannot be used for limit-line testing. Use **CLEAR WRITE A** or **VIEW A** to change trace A from the store-blank mode to the clear write mode, and then turn on limit-line testing. (U)

**UNDF KEY**

The softkey number is not recognized by the EMC analyzer. (U)

**USING DEFAULTS self cal needed**

Indicates that the current correction factors are the default correction factors and that the CAL FREQ & AMPTD routine needs to be performed. For the HP 8593EM, HP 8595EM, or HP 8596EM, CAL YTF routine needs to be performed also. (U)

**VID-BW FAIL**

Indicates the video bandwidths have failed. (H)

**YTF is not available**

The YTF is only available for the HP 8593EM, HP 8595EM, and HP 8596EM. (U)

---

## Nonrecoverable System Errors

Certain situations can create error conditions from which the main processor cannot recover. In the event that the processor detects a nonrecoverable error, the instrument will be initialized, the display will be blanked, and special error messages will be written to the display.

The following is a sample nonrecoverable system error message display.

```
System Error 4, HP 859XEM, SN 4
09:15:20 FEB 8, 1995, Rev: 950208
  SR: 0000      PC: 00FFB370      00FF6F1E:    00009300
D0: 00000000   A0: 00FFB238      00FF6F22:    00000000
D1: 00000000   A1: 00FF803E      00FF6F26:    00000000
D2: 00FFB238   A2: 00FF803C      00FF6F2A:    00FF803E
D3: 00FF803E   A3: 00FFB2FE      00FF6F2E:    000031B1
D4: 00008E7D   A4: 00FFB2F4      00FF6F32:    0004065E
D5: 00FF80E8   A5: 00FC6948      00FF6F36:    0004EDE8
D6: 00FFB39A   A6: FFFFFFFE      00FF6F3A:    00FF8000
D7: 00FFB392   A7: 00FF6F1E      00FF6F3E:    00FF88AE
                                00FF6F42:    00FF87E0
                                00FF6F46:    00FFB03C
                                00FF6F4A:    000C9AEA
                                00FF6F4E:    00FF8890
                                00FF6F52:    040800FF
                                00FF6F56:    000900FF
                                00FF6F5A:    B23A0000

WARNING: Config Settings Defaulted
        Press COPY to print error report and
        advise your local HP representative
Press PRESET to resume operation
```

When a nonrecoverable error message is displayed, the instrument will only respond to the front-panel COPY and PRESET keys. If you have a printer configured and connected to the instrument, and if no remote controller is currently connected to the I/O port through which the printer is connected, you can generate a hardcopy of the diagnostic part of the error message by pressing the front-panel COPY key.

In order to resume instrument operation following a nonrecoverable system error, press the front-panel PRESET key. The instrument will resume operation from its preset state.



Among the conditions which can contribute to the occurrence of a nonrecoverable system error are:

- Hardware failure of the main processor
- Hardware failure of system memory available to the main processor
- Errors in the primary system control program
- Attempted execution of unsupported system commands

Nonrecoverable system errors may occur when attempting to load an improper file type into the machine. For example, loading a file with an incorrect format into a limit line or amplitude correction table may generate this error.

If nonrecoverable system errors occur regularly, contact your HP representative.



## Customer Support

---

### What you'll find in this chapter

Your EMC analyzer is built to provide dependable service. It is unlikely that you will experience a problem. However, Hewlett-Packard's worldwide sales and service organization is ready to provide the support you need.

---

### If You Have a Problem

Before calling Hewlett-Packard or returning the EMC analyzer for service, please make the checks listed in "Check the Basics" later in this chapter. If you still have a problem, please read the warranty printed at the front of this manual. If your EMC analyzer is covered by a separate maintenance agreement, please be familiar with its terms.

Hewlett-Packard offers several maintenance plans to service your EMC analyzer after warranty expiration. Call your HP Sales and Service Office for full details.

If you want to service the EMC analyzer yourself after warranty expiration, contact your HP Sales and Service Office to obtain the most current test and maintenance information.

---

### Calling HP Sales and Service Offices

Sales and service offices are located around the world to provide complete support for your EMC analyzer. To obtain servicing information or to order replacement parts, contact the nearest Hewlett-Packard Sales and Service office listed in Table 15-1. In any correspondence or telephone conversations, refer to the EMC analyzer by its model number and full serial number. With this information, the HP representative can quickly determine whether your unit is still within its warranty period.

---

## Check the Basics

In general, a problem can be caused by a hardware failure, a software error, or a user error. Often problems may be solved by repeating what was being done when the problem occurred. A few minutes spent in performing these simple checks may eliminate time spent waiting for instrument repair.

### If your EMC analyzer does not turn on

- Verify the EMC analyzer is plugged into the proper ac power source.
- Verify the line socket has power.
- Verify the rear-panel voltage selector switches are set correctly.
- Verify the line fuses are good.
- Verify the EMC analyzer is turned on.

### If the HP 8590 EM series used with an HP 85420E option 1EM does not seem to be working

*HP 85420E option 1EM only*

- Verify the ac power to the EMC analyzer as described above.
- Verify the rear-panel auxiliary interface cable is properly connected.
- Verify the rear-panel sweep ramp and high sweep cables are properly connected.

### If the EMC analyzer cannot communicate via HP-IB

- Verify the proper HP-IB address has been set.
- Verify there are no equipment address conflicts.
- Verify the other equipment and cables are connected properly and operating correctly.
- Verify the HP-IB cable is connected to the EMC analyzer.

### Verification of proper operation

- Verify the test being performed and the expected results are within the specifications and capabilities of the EMC analyzer.
- Check operation by performing the operation verification procedures in the *HP 8590 EM Series EMC Analyzer Verification Guide*. Record all results in the operation verification test record.

## If the HP 8590 EM series used with an HP 85420E option 1EM does not power off

*HP 85420E option 1EM only*

- Verify the service power switch on the HP 8590 EM series used with an HP 85420E option 1EM is set to normal mode.

- Error messages**
- Check the EMC analyzer display for error messages. Refer to Chapter 14 of this manual.

---

## Additional Support Services

### CompuServe

CompuServe, the worldwide electronic information utility, provides technical information and support for EMC instrumentation and communication with other EMC users.

With a CompuServe account and a modem-equipped computer, simply type G0 HPSYS and select the EMC system section to get information on documentation, application notes, product notes, service notes, software, firmware revision listings, data sheets, and more.

If you are not a member of CompuServe and would like to join, call CompuServe and take advantage of the Free Introductory Membership. The membership includes the following:

- An introductory usage credit to CompuServe.
- A private User ID and Password.
- A complimentary subscription to CompuServe's monthly computing publication, *CompuServe Magazine*.

To take advantage of the CompuServe Free Introductory Membership offer, call one of the telephone numbers below and ask for Representative Number 999.

Country	Toll-Free	Direct
Argentina	—	(+ 54) 01-372-7883
Australia	008-023-158	(+ 61) 2-410-4555
Canada	—	(+ 1) 614-457-8650
Chile	—	(+ 56) 2-696-8807
Germany	0130 86 4643	(+ 49) (+ 89) 66 55 0-222
Hong Kong	—	(+ 852) 867-0102
Israel	—	(+ 972) 3-290466
Japan	0120-22-1200	(+ 81) 3-5471-5806
Korea	080-022-7400	(+ 82) 2-569-5400
New Zealand	0800-441-082	—
South Africa	—	(+ 27) 12-841-2530
Switzerland	155 31 79	—
Taiwan	—	(+ 886) 2-515-7035
United Kingdom	0800 289458	(+ 44) (+ 272) 255111
United States	800-848-8990	(+ 1) 614-457-8650
Venezuela	—	(+ 58) 2-793-2984
Elsewhere	—	(+ 1) 614-457-8650

### FAX support line

A fax sheet is provided at the end of this chapter as a method in which to directly contact the HP EMC support team in the event of a problem. The fax cover sheet provides the EMC support team with information about your company, the product, and a detailed description about the problem.

### Note

---

**All** items on the fax cover sheet *must* be completed in order to expedite your response. Any incomplete item may delay your response.

---

Simply copy the fax cover sheet, fill out the requested information, include any additional information sheets, and fax the sheet(s) to HP EMC Support at (707) 577-4200. Depending on the complexity of the problem, you should receive a response back within a few days.

---

## Returning the EMC Analyzer for Service

Use the information in this section if it is necessary to return the EMC analyzer to Hewlett-Packard.

### Package the EMC analyzer for shipment

Use the following steps to package the HP 8590 EM series for shipment to Hewlett-Packard for service:

1. Fill in a service tag (available at the end of this chapter) and attach it to the instrument. Please be as specific as possible about the nature of the problem. Send a copy of any or all of the following information:
  - Any error messages that appeared on the EMC analyzer display.
  - A completed operation verification test record located at the end of Chapter 2 in this manual.
  - Any other specific data on the performance of the EMC analyzer.

### CAUTION

---

Damage to the EMC analyzer can result from using packaging materials other than those specified. Never use styrene pellets in any shape as packaging materials. They do not adequately cushion the instrument or prevent it from shifting in the carton. Styrene pellets cause equipment damage by generating static electricity and by lodging in the fan.

---

2. Use the original packaging materials or strong shipping containers that are made of double-walled, corrugated cardboard with 159 kg (350 lb) bursting strength. The cartons must be both large enough and strong enough and allow at least 3 to 4 inches on all sides of the instrument for packing material.
3. Protect the front panel with cardboard.
4. Surround the instrument with at least 3 to 4 inches of packing material, or enough to prevent the instrument from moving in the carton. If packing foam is not available, the best alternative is SD-240 Air Cap™ from Sealed Air Corporation (Commerce, CA 90001). Air Cap looks like a plastic sheet covered with 1-1/4 inch air-filled bubbles. Use the pink Air Cap to reduce static electricity. Wrap the instrument several times in the material to both protect the instrument and prevent it from moving in the carton.
5. Seal the shipping container securely with strong nylon adhesive tape.
6. Mark the shipping container "FRAGILE, HANDLE WITH CARE" to ensure careful handling.
7. Retain copies of all shipping papers.

**Table 15-1. Hewlett-Packard Sales and Service Offices**

US FIELD OPERATIONS		
<p><b>Customer Information</b> Hewlett-Packard Company 19320 Pruneridge Avenue Cupertino, CA 95014, USA (800) 752-0900</p>	<p><b>California, Northern</b> Hewlett-Packard Co. 301 E. Evelyn Mountain View, CA 94041 (415) 694-2000</p>	<p><b>California, Southern</b> Hewlett-Packard Co. 1421 South Manhattan Ave. Fullerton, CA 92631 (714) 999-6700</p>
<p><b>Colorado</b> Hewlett-Packard Co. 24 Inverness Place, East Englewood, CO 80112 (303) 649-5000</p>	<p><b>Georgia</b> Hewlett-Packard Co. 2000 South Park Place Atlanta, GA 30339 (404) 955-1500</p>	<p><b>Illinois</b> Hewlett-Packard Co. 5201 Tollview Drive Rolling Meadows, IL 60008 (708) 255-9800</p>
<p><b>New Jersey</b> 120 W. Century Road Paramus, NJ 07653 (201)599-5000</p>	<p><b>Texas</b> 930 E. Campbell Rd. Richardson, TX 75081 (214) 231-6101</p>	
EUROPEAN FIELD OPERATIONS		
<p><b>Headquarters</b> Hewlett-Packard S.A. 150, Route du Nant-d'Avril 1217 Meyrin 2/Geneva Switzerland (41 22) 780.8111</p>	<p><b>France</b> Hewlett-Packard France 1 Avenue Du Canada Zone D'Activite De Courtaboeuf F-91947 Les Ulis Cedex France (33 1) 69 82 60 60</p>	<p><b>Germany</b> Hewlett-Packard GmbH Bernner Strasse 117 6000 Frankfurt 56 West Germany (49 69) 500006-0</p>
<p><b>Great Britain</b> Hewlett-Packard Ltd Eskdale Road, Winnersh Triangle Wokingham, Berkshire RF11 5DZ England (44 734) 696622</p>		
INTERCON FIELD OPERATIONS		
<p><b>Headquarters</b> Hewlett-Packard Company 3495 Deer Creek Rd. Palo Alto, California 94304-1316 (415) 857-5027</p>	<p><b>Australia</b> Hewlett-Packard Australia Ltd. 31-41 Joseph Street Blackburn, Victoria 3130 (61 3) 895-2895</p>	<p><b>Canada</b> Hewlett-Packard (Canada) Ltd. 17500 South Service Road Trans-Canada Highway Kirkland, Quebec H9J 2X8 Canada (514) 697-4232</p>
<p><b>China</b> China Hewlett-Packard Co. 38 Bei San Huan X1 Road Shuang Yu Shu Hai Dian District Beijing, China (86 1) 256-6888</p>	<p><b>Japan</b> Yokogawa-Hewlett-Packard Ltd. 1-27-15 Yabe, Sagamihara Kanagawa 229, Japan (81 427) 59-1311</p>	<p><b>Singapore</b> Hewlett-Packard Singapore (Pte.) Ltd 1150 Depot Road Singapore 0410 (65) 273-7388</p>
<p><b>Taiwan</b> Hewlett-Packard Taiwan 8th Floor, H-P Building 337 Fu Hsing North Road Taipei, Taiwan (886 2) 712-0404</p>		





**Fax Cover Sheet**

To: **HP EMC Support**                      **FAX Number: (707) 577-4200**                      Page \_\_\_\_ of \_\_\_\_

Date Transmitted: \_\_\_\_\_ Time Transmitted: \_\_\_\_\_

**From:**

Company: \_\_\_\_\_

Last Name: \_\_\_\_\_ First Name: \_\_\_\_\_

Address: \_\_\_\_\_

City: \_\_\_\_\_ State: \_\_\_\_\_

Country: \_\_\_\_\_ Postal Code: \_\_\_\_\_ Mail Stop: \_\_\_\_\_

Telephone Number (include Country Code): \_\_\_\_\_

Fax Number (required): \_\_\_\_\_

**Product:**

- HP 8591EM                       HP 8594EM                       HP 8596EM
- HP 8593EM                       HP 8595EM                      Option(s): \_\_\_\_\_

EMC Analyzer

RF Filter Section

**Serial Number(s):**                      \_\_\_\_\_                      \_\_\_\_\_

**Firmware Revision:**                      \_\_\_\_\_                      \_\_\_\_\_

**Is the problem reproducible?**                       **Yes**                       **No**

**Detailed Problem Description:** (include all setup information and any additional pages)

---



---



---



---



---



## Key Menus

### What you'll find in this chapter

This chapter contains the key menu diagrams for the HP 8590 EM series. Each diagram is arranged alphabetically according to the front-panel key name.

Some of the softkeys in the key menus are model or option specific and may not appear on your EMC analyzer.

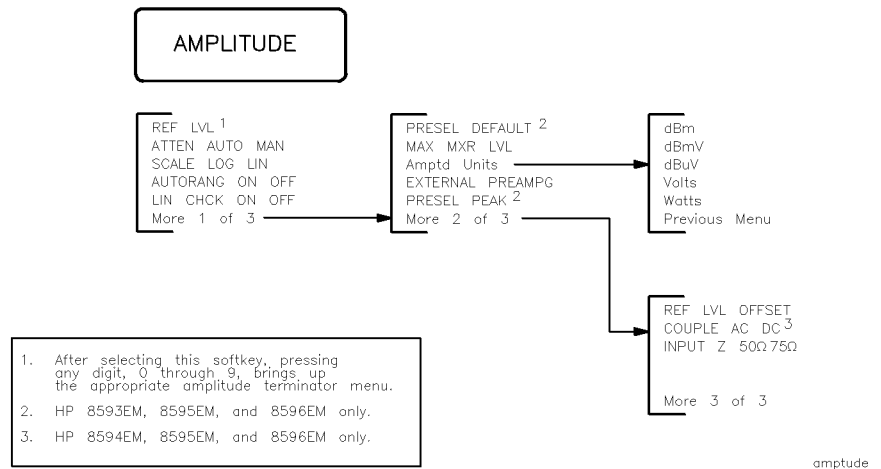

**AUTO  
COUPLE**

AUTO ALL  
IF BW AUTO MAN  
AVG BW AUTO MAN  
ATTEN AUTO MAN  
SWP TIME AUTO MAN  
CF STEP AUTO MAN

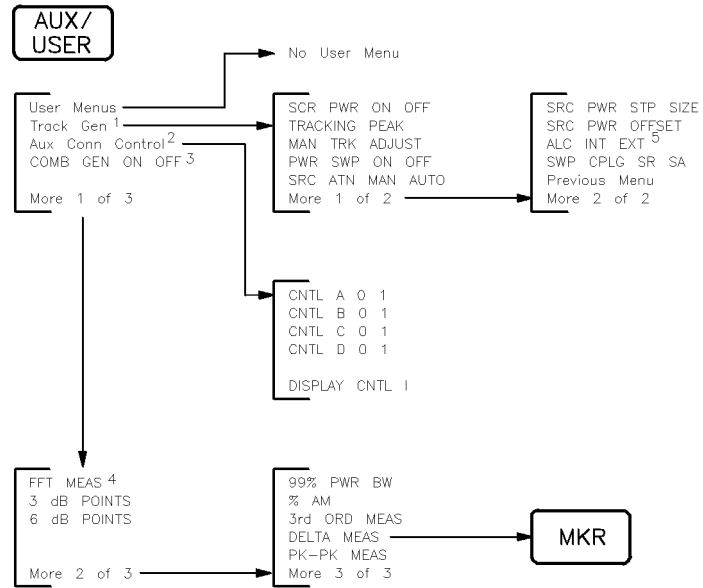

1. Option 010 only.
2. Not available when used with HP 85420E, Option 1EM, RF Filter Section.
3. HP 8593EM or HP 8596EM only.
4. Available only when LIN is selected for the SWEEP LOG LIN softkey.
5. ALC MTR INT XTAL for HP 8591EM only.

auxuser

## BW

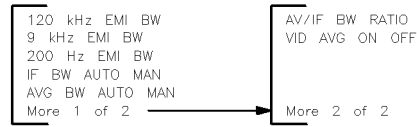

bw

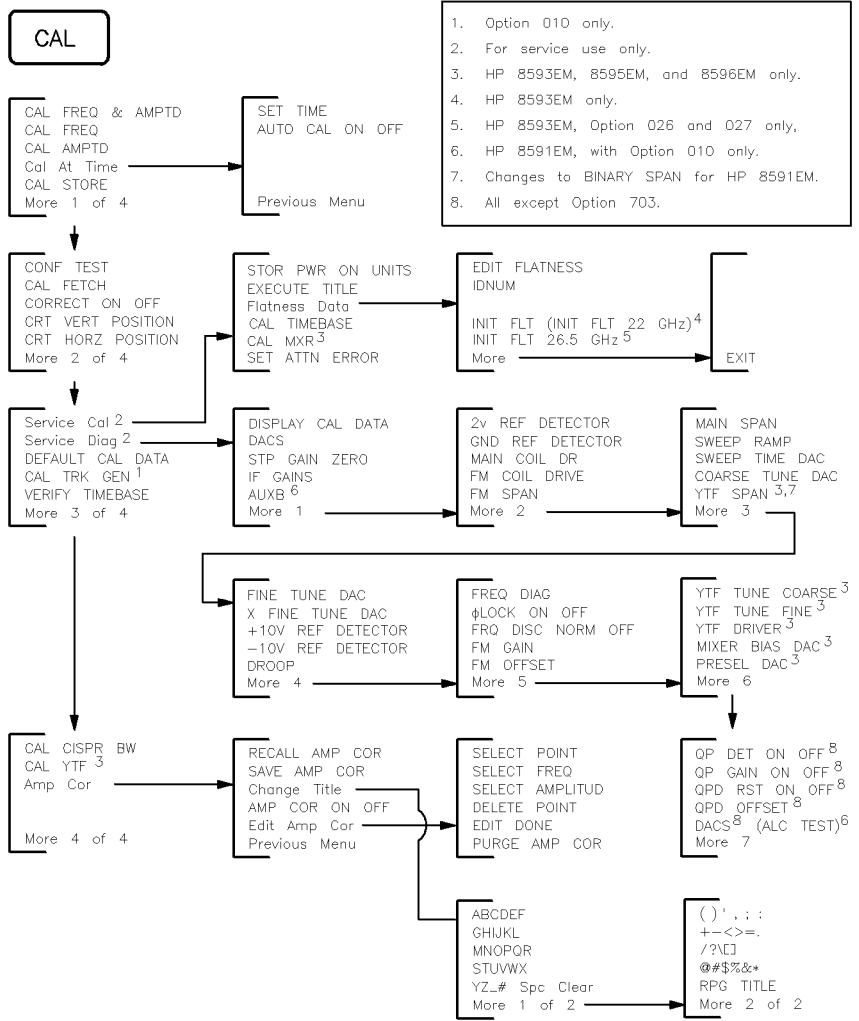

calmenu

**CONFIG**

COPY DEV PRNT PLT  
 Plot Config  
 Print Config  
 Time Date  
 Change Prefix  
 More 1 of 3

PLTS/PG 1 2 4  
 PLT\_ \_ LOC\_ \_ 1  
 PLT->LJT ON OFF  
 Plt Port/Config  
 PLT MENU ON OFF  
 Previous Menu

PRN PORT HPIB PAR<sup>5</sup>  
 PLT PORT HPIB PAR<sup>6</sup>  
 PRINTER ADDRESS<sup>2</sup>  
 PLOTTER ADDRESS<sup>7</sup>

Previous Menu

HP B&W PRINTER  
 HP B&W DJ540  
 EP MX80 SML LRG  
 EP LQ570 SML LRG

Previous Menu

Set B&W Printer  
 Set Colr Printer  
 Plt Port/Config  
 PRT MENU ON OFF  
 PRINTER SETUP  
 Previous Menu

PAINTJET PRINTER  
 DESKJET 310/550C  
 DESKJET 540

Previous Menu

TIMEDATE ON OFF  
 DATEMODE MDY DMY  
 SET TIME  
 SET DATE  
 Previous Menu

():::  
 +-<>=,  
 /?LJ  
 @#\$%&\*  
 EDIT DONE  
 More 2 of 2

ABCDEF  
 GHIJKL  
 MNOPQR  
 STUVWX  
 YZ\_# Spc Clear  
 More 1 of 2

CATALOG CARD  
 FORMAT CARD  
 BLANK CARD  
 Previous Menu

Card Config  
 Dispose User Mem  
 ANALYZER ADDRESS<sup>2</sup>  
 DEFAULT CONFIG  
 SHW INST CONFIG<sup>3</sup>  
 More 2 of 3

ERASE MEM CARD  
 ERASE DLP MEM  
 ERASE STATEALL<sup>4</sup>  
 ERASE TRACEALL<sup>4</sup>

Previous Menu

POWER ON IP LAST  
 SYNC NRM NTSC  
 DEFAULT SYNC  
 SYNC NRM PAL

More 3 of 3

1. Appears only when PLTS/PG 2 or 4 is selected.
2. Changes to BAUD RATE for Option 043.
3. Changes to EXIT SHOW when selected.
4. Changes to MEM LOCKED when SAVE LOCK is on.
5. Changes to PRN PORT SER PAR for Option 043.
6. Changes to PLN PORT SER PAR for Option 043.
7. Except option 043.

config

**COPY**

copymenu

DEMOD <sup>1</sup>

DEMOD ON OFF  
DEMOD AM FM  
SPEAKER ON OFF  
SQUELCH  
FM GAIN  
DWEELL TIME

1. All except Option 703.

demod

DET

QP ON OFF <sup>1</sup>  
AVG ON OFF <sup>1</sup>  
VIEW PK QP AV <sup>1</sup>  
QP/AVG 10X OFF <sup>1</sup>  
DETECTOR SMP PK <sup>2</sup>

1. All except Option 703.  
2. Changes to DETECTOR PK SP NG when Option 101 or 301 is installed.

det

### DISPLAY hardkey—in EMC ANALYZER mode only

The DISPLAY hardkey has different Limit Lines softkey menus between the EMC analyzer and spectrum analyzer modes.

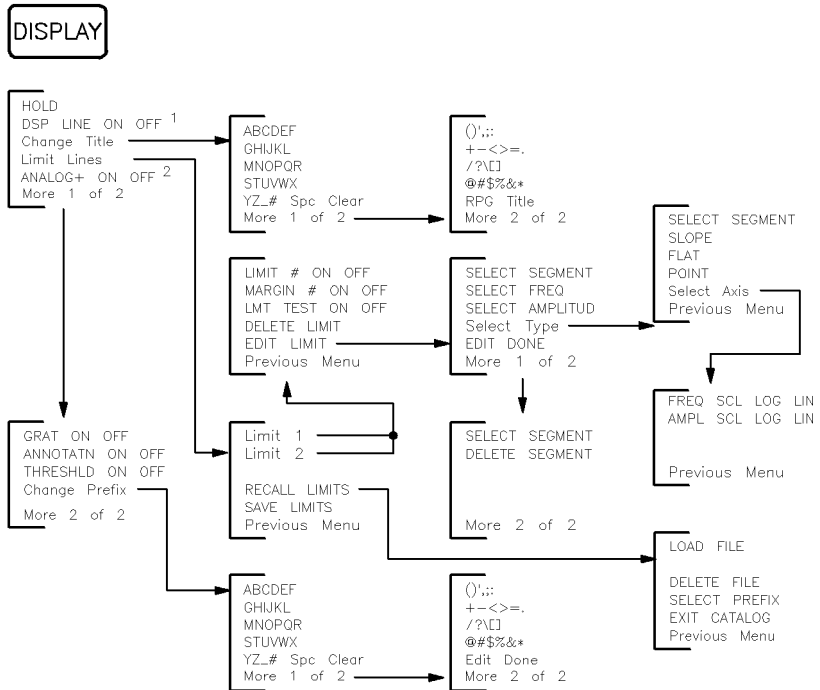

1. After selecting this softkey, pressing any digit, 0 through 9, brings up the appropriate amplitude terminator menu.
2. Does not operate if SWEEP LOG is selected. Requires Option 101 or 301.

displayr



## DISPLAY hardkey—in SPECTRUM ANALYZER mode only

The DISPLAY hardkey has different Limit Lines softkey menus between the EMC analyzer and spectrum analyzer modes.

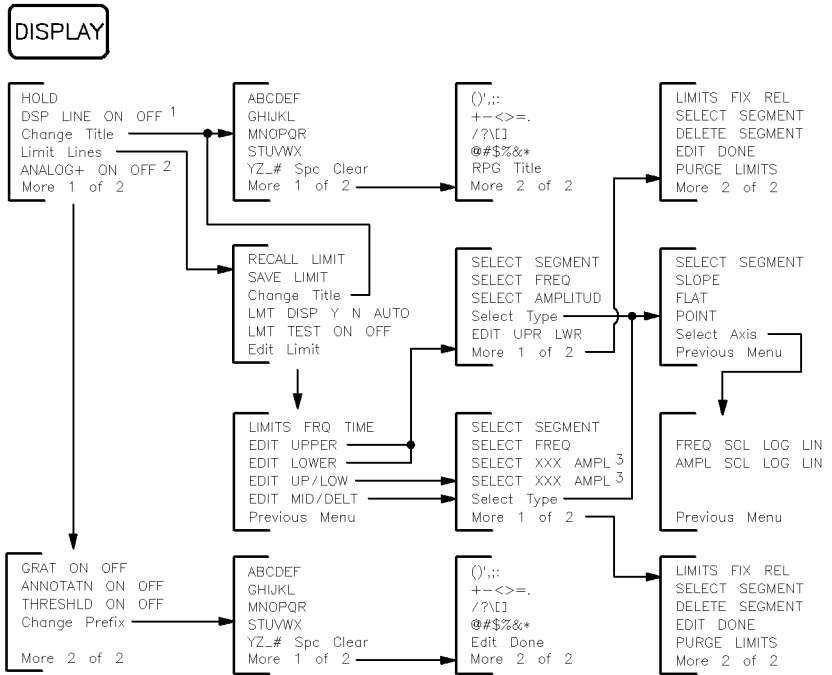

1. After selecting this softkey, pressing any digit, 0 through 9, brings up the appropriate amplitude terminator menu.
2. Does not operate if SWEEP LOG is selected. Requires Option 101 or 301.
3. Specifies amplitude for UPR LWR or MID DLT limit lines, respectively.

displays

## FREQUENCY

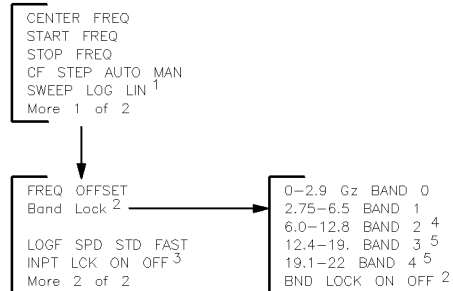

1. Does not operate if ANALOG + on.
2. Available only for HP 8593EM, HP 8595EM, or an HP 8596EM.
3. Available only for an HP 85420E, Option 1EM, RF Filter Section.
4. HP 8595EM or 8596EM.
5. HP 8593EM only.

frequenc

**MKR**

MARKER NORMAL  
MARKER Δ  
MARKER AMPTD 1  
SELECT 1 2 3 4  
MARKER # ON OFF  
More 1 of 3

MK TRACK ON OFF  
MK COUNT ON OFF  
MK TRACE AUTO ABC  
MK READ F T I P  
MARKER ALL OFF  
More 2 of 3

MK NOISE ON OFF  
MK PAUSE ON OFF  
CNT RES AUTO MAN  
More 3 of 3

1. After selecting this softkey, pressing any digit, 0 through 9, brings up the appropriate amplitude terminator menu.

mkr

**MKR->**

MARKER -> HIGH  
MARKER -> CF  
NEXT PEAK  
NEXT PK RIGHT  
NEXT PK LEFT  
More 1 of 3

PEAK EXCURSN  
MARKER -> REF LVL  
MARKER -> CF STEP  
MARKER -> MINIMUM  
MARKER -> PK-PK  
More 2 of 3

MARKER -> START  
MARKER -> STOP  
MARKER Δ  
MARKER Δ SPAN  
DSP LINE ON OFF  
More 3 of 3

mkrright

**MODE**

EMC ANALYZER  
SPECTRUM ANALYZER

modemenu

**OUTPUT**

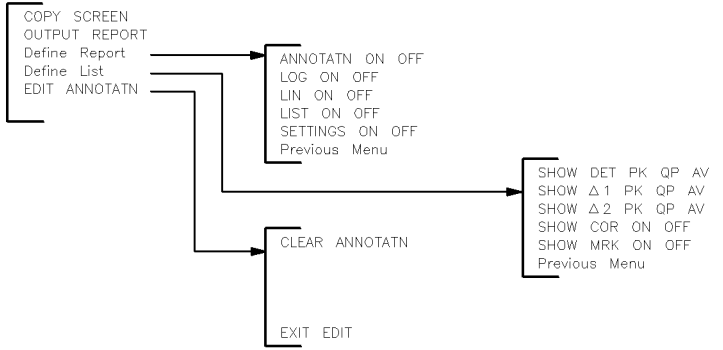

output



**SETUP hardkey—in EMC ANALYZER mode only**

The SETUP hardkey has different Limit Lines softkey menus between the EMC analyzer and spectrum analyzer modes.

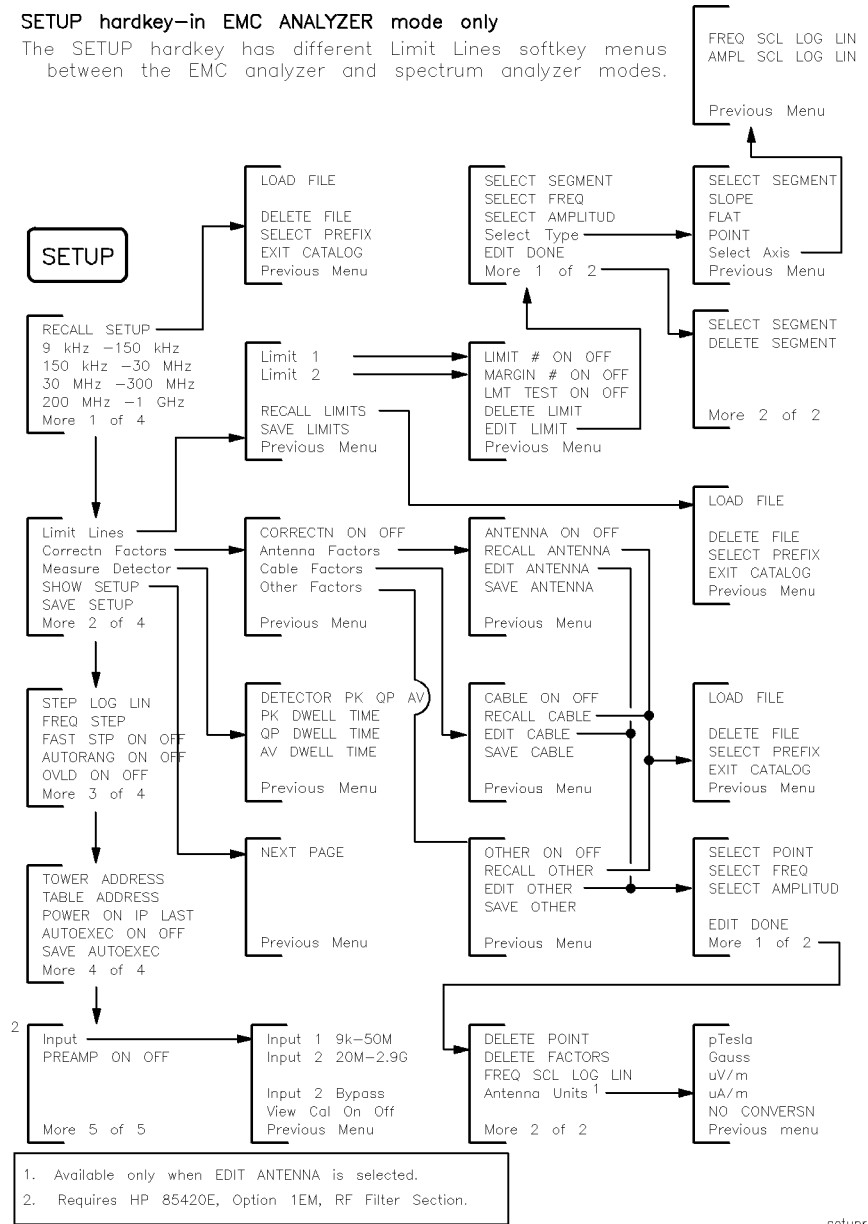

setuppr



SGL  
SWP

sglswp

SPAN

SPAN  
SPAN ZOOM  
FULL SPAN  
ZERO SPAN  
LAST SPAN

spanmenu

SWEEP/  
TRIG

SWP TIME AUTO MAN  
SWEEP CONT SGL  
  
Trigger  
SWEEP LOG LIN  
LOGF SPD STD FAST<sup>1</sup>

SWEEP CONT SGL  
FREE RUN  
VIDEO  
LINE  
EXTERNAL  
TV TRIG<sup>2</sup>

TV LINE #  
TV TRIG ODD FLD  
TV TRIG EVEN FLD  
TV TRIG VERT INT  
TV SYNC NEG POS  
TV Standard

NTSC  
PAL-M  
PAL  
SECAM-L  
  
Previous Menu

1. Available only when LOG is selected on the SWEEP LOG LIN softkey.
2. Only when Option 101 and 102 or Option 301 is installed.

swptrig

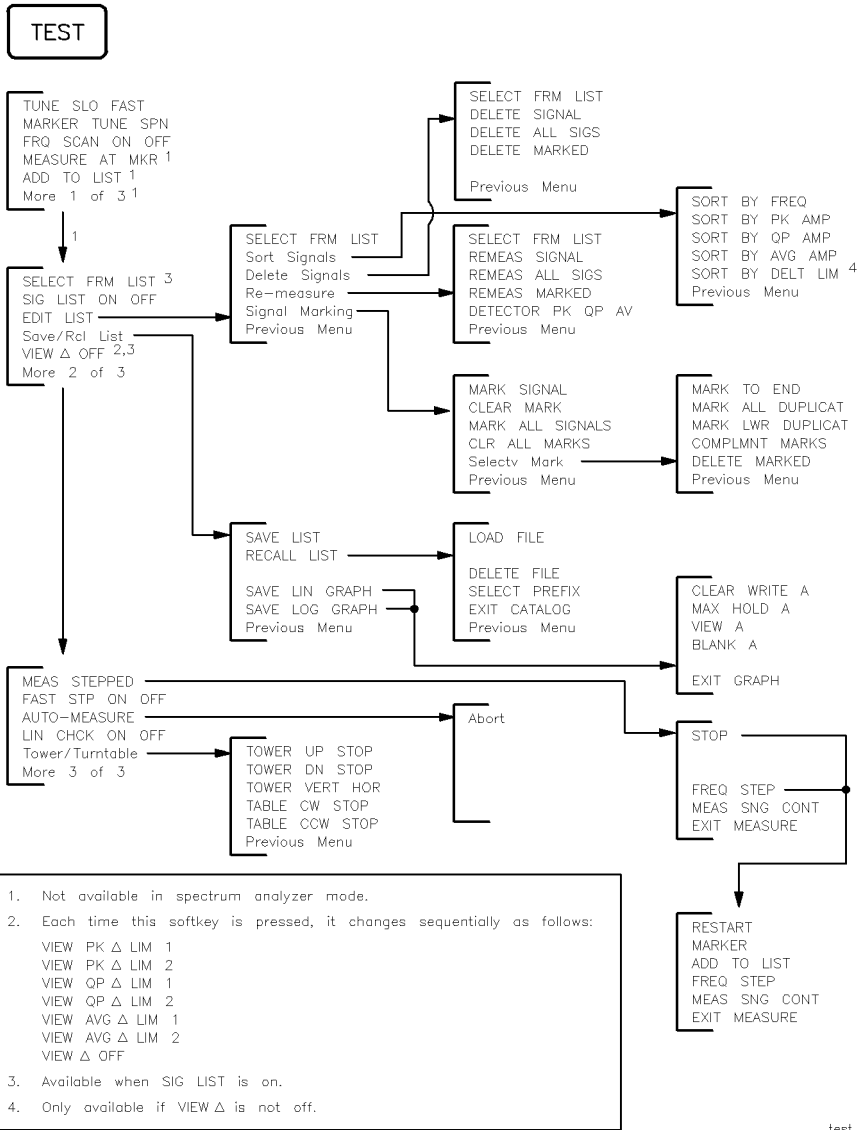

test



## TRACE

CLEAR WRITE A<sup>1</sup>  
 MAX HOLD A<sup>2</sup>  
 VIEW A<sup>1</sup>  
 BLANK A<sup>1</sup>  
 TRACE A B C  
 More 1 of 4

NORM A/B ON OFF  
 TRACE B VW OFF<sup>3</sup>  
 MAX/MIN ON OFF  
 MAX/MIN VIEW<sup>4</sup>  
 More 2 of 4

VID AVG ON OFF  
 DETECTOR SMP PK<sup>5</sup>  
 NORMLIZE ON OFF  
 NORMLIZE POSITION  
 A <--> B  
 More 3 of 4

A-B --> A ON OFF  
 B-DL --> B  
 B <--> C  
 A --> C  
 B --> C  
 More 4 of 4

1. Change to B or C when TRACE B or C is selected, respectively.
2. Changes to MAX HOLD B when trace B is selected and to MIN HOLD C when trace C is selected.
3. Only available when NORM A/B ON.
4. Only available when MAX/MIN ON.
5. Changes to DETECTOR PK SP NG for Option 101 or 301 only.

tracem

## WINDOWS

### ON

ZONE CENTER  
 ZONE SPAN  
 ZONE PK RIGHT  
 ZONE PK LEFT  
 PEAK EXCURSN  
 WINDOWS OFF

### NEXT

(If windows are on,  
 activates alternate  
 windows.)

### ZOOM

(Toggles between  
 split-screen and  
 full-size display,  
 if windows are on.)

windows



## Key Dictionary

---

### What you'll find in this chapter

This chapter describes functions and controls of the instrument. The front-panel keys and softkey functions are listed alphabetically, followed by a complete and detailed description.

Brief descriptions for service functions have also been included in this chapter. However, for more detailed descriptions and information about the use of each function, refer to the respective service guide for your instrument. A listing of all service calibration and service diagnostic functions has been provided in the following “Service Functions” section.

All softkeys and their relationship to the front-panel keys are shown in Chapter 16, “Key Menus”.

---

## Service Functions

Two types of functions are available for service use only:

- Service calibration functions.
- Service diagnostic functions.

These service functions are designed for service use only. However, brief descriptions for each function are provided in this chapter.

### Service calibration functions

Service Cal accesses the following service calibration softkeys:

```
CAL MXR
CAL TIMEBASE
EDIT FLATNESS
EDIT PA FLATNESS
EXECUTE TITLE
EXIT
Flatness Data
IDNUM
INIT FLT
SET ATTN ERROR
STOR PWR ON UNITS
STORE FLATNESS
```

### Service diagnostic functions

Service Diag accesses the following diagnostic softkeys:

```
φ LOCK ON OFF
+10V REF DETECTOR
-10V REF DETECTOR
2v REF DETECTOR
COARSE TUNE DAC
DACS
DISPLAY CAL DATA
Display Sys Data
DROOP
FINE TUNE DAC
FM COIL DRIVE
FM GAIN
FM OFFSET
FM SPAN
FREQ DIAG
FRQ DISC NORM OFF
GND REF DETECTOR
IF GAINS
MAIN COIL DR
MAIN SPAN
MIXER BIAS DAC
```

PRESEL DAC  
QP DET ON OFF  
QP GAIN ON OFF  
QPD OFFSET  
QPD RST ON OFF  
STP GAIN ZERO  
SWEEP RAMP  
SWEEP TIME DAC  
X FINE TUNE DAC  
YTF DRIVER  
YTF SPAN  
YTF TUNE COARSE  
YTF TUNE FINE

---

## Key Functions

**% AM**

Softkey that determines the percent of amplitude modulation of the largest displayed signal and its two sidebands. The sidebands are assumed to be entirely from amplitude modulation. If there are differences in the sideband amplitude, the larger value is used. The measurement runs continuously, reexecuting at the end of each sweep.

All three signal must be displayed. The frequency spacing of the sideband signals must be the same within the span accuracy of the measurement. All of the signals must be greater than the peak excursion above the threshold. The amplitude scale may be either linear or logarithmic.

### Key Path

**(AUX\USER)** More More  
1 of 3 2 of 3 % AM

---

**φLOCK  
ON OFF**

Softkey that turns off phase locking on the instrument. The counter is turned off so frequency correction is no longer done at the start of each sweep. Turning the phase locking off increases measurement speed, but it decreases frequency accuracy. This is a service diagnostic function and is for service use.

### Key Path

More More Service  
**(CAL)** 1 of 4 2 of 4 Diag More 1 ... More 4 φLOCK  
ON OFF

---

**μA/m**

Softkey that selects μA/m as the transducer conversion units for the antenna amplitude-correction factors.

### Key Path

More Correctn Antenna EDIT More  
**(SETUP)** 1 of 4 Factors Factors ANTENNA 1 of 2  
Antenna  
Units μA/m

### Related Programming Command

XUNITS

---

$\mu\text{V}/\text{m}$

Softkey that selects  $\mu\text{V}/\text{m}$  as the transducer conversion units for the antenna amplitude-correction factors.

### Key Path

More Correctn Antenna EDIT More  
SETUP 1 of 4 Factors Factors ANTENNA 1 of 2  
Antenna  
Units  $\mu\text{V}/\text{m}$

### Related Programming Command

XUNITS

---

0-2.9 Gz  
BAND 0

*HP 8593EM, 8595EM, or 8596EM only.*

Softkey that locks onto harmonic Band 0. Once 0-2.9 Gz BAND 0 has been pressed, only frequencies and spans that fall within this frequency band may be entered. The span is reduced automatically to accommodate a center frequency specified near the end of the band range.

If a start frequency is entered that is outside of the current band boundaries, it will be set to the nearest band edge instead. If a start frequency that is greater than the current stop frequency is entered, the (possibly modified) start frequency is used for both the start and the stop frequency; therefore, the span will be set to zero. If the start and stop frequencies specify too large a span, they will be modified.

If a stop frequency is entered that is outside of the current band boundaries, it will be set to the nearest band edge instead. If a stop frequency that is less than the current start frequency is entered, the (possibly modified) stop frequency will be used for both the start and stop frequency; therefore, the span will be set to zero.

The span will be modified if necessary to get the center frequency specified without crossing the band edges. The span will be limited as necessary to keep the start and stop frequencies within the band edges without changing the center frequency. The maximum span allowed is 2.904 GHz.

### Key Path

More Band 0-2.9 Gz  
FREQUENCY 1 of 2 Lock BAND 0

### Related Programming Command

HNLOCK

---

2.75-6.5  
BAND 1

HP 8593EM, 8595EM, or 8596EM only.

Softkey that locks onto harmonic band 1. Harmonic band 1 is preselected and has a specified tuning range of 2.75 GHz to 6.5 GHz.

**Key Path**

More Band 2.75-6.5  
(FREQUENCY) 1 of 2 Lock BAND 1

**Related Programming Command**

HNLOCK

---

2v REF  
DETECTOR

Softkey that displays the output of the 2 V reference produced on the A16 processor/video assembly as a horizontal line at the top graticule. This is a service diagnostic function and is for service use only.

**Key Path**

More More Service 2v REF  
(CAL) 1 of 4 2 of 4 Diag More 1 DETECTOR

3 dB  
POINTS

Softkey that initiates an automatic 3 dB bandwidth measurement on the highest peak displayed on screen.

**Key Path**

More 3 dB  
(AUX/USER) 1 of 3 POINTS

3rd ORD  
MEAS

Softkey that initiates an automatic frequency and amplitude measurement on a third-order product. At least one of the fundamental tones and the third-order product must be displayed on the screen.

**Key Path**

More More 3rd ORD  
(AUX/USER) 1 of 3 2 of 3 MEAS



6.0-12.8  
BAND 2

*HP 8593EM or 8596EM only.*

Softkey that locks onto harmonic band 2. Harmonic band 2 is preselected and has a specified tuning range of 6.0 to 12.8 GHz.

### Key Path

(FREQUENCY) More Band 6.0-12.8  
1 of 2 Lock BAND 2

### Related Programming Command

HNLOCK

---

6 dB  
POINTS

Softkey that initiates an automatic 6 dB bandwidth measurement on the highest peak displayed on the screen.

### Key Path

(AUX/USER) More 6 dB  
1 of 3 POINTS

---

9 kHz  
-150 kHz

Softkey that presets the instrument to the predefined settings:

Start frequency:	9 kHz
Stop frequency:	150 kHz
I.F. bandwidth:	200 Hz
Reference level:	70 dB $\mu$ V
Attenuation:	10 dB

### Key Path

(SETUP) 9 kHz  
-150 kHz

---

9 kHz  
EMI BW

Softkey that allows a 6 dB intermediate frequency bandwidth of 9 kHz. This bandwidth is useful when performing electromagnetic interference (EMI) measurements.

#### Key Path

9 kHz  
(BW) EMI BW

#### Related Programming Command

IFBW, RB

---

+10V REF  
DETECTOR

Softkey that displays the output of the +10 V reference from the analog interface circuit board as a horizontal line at the top of the graticule. This is a service diagnostic function and is for service use only.

#### Key Path

More More Service +10V REF  
(CAL) 1 of 4 2 of 4 Diag More 1 ... More 3 DETECTOR

---

-10V REF  
DETECTOR

Softkey that displays the output of the -10 V reference from the analog circuit board as a horizontal line at the bottom graticule. This is a service diagnostic function and is for service use only.

#### Key Path

More More Service -10V REF  
(CAL) 1 of 4 2 of 4 Diag More 1 ... More 3 DETECTOR

---

12.4-19  
BAND 3

*HP 8593EM only.*

Softkey that locks onto harmonic band 3. Harmonic band 3 is preselected and has a specified tuning range of 12.4 to 19 GHz.

#### Key Path

More Band 12.4-19  
(FREQUENCY) 1 of 2 Lock BAND 31

#### Related Programming Command

HNLOCK

---

19.1-22  
BAND 4

*HP 8593EM only.*

Softkey that locks onto harmonic band 4. Harmonic band 4 is preselected and has a specified tuning range of 19.1 to 22 GHz.

### Key Path

(FREQUENCY) More Band 19.1-22  
1 of 2 Lock BAND 4

### Related Programming Command

HNLOCK

---

30 MHz  
-300 MHz

Softkey that presets the EMC analyzer to the predefined settings:

Start frequency:	30 MHz
Stop frequency:	300 MHz
I.F. bandwidth:	120 kHz
Reference level:	80 dB $\mu$ V
Attenuation:	10 dB

### Key Path

(SETUP) 30 MHz  
-300 MHz

---

99% PWR  
BW

Softkey that initiates an automatic measurement of the 99% power bandwidth of the largest signal displayed on the screen.

### Key Path

(AUX/USER) More More 99% PWR  
1 of 3 2 of 3 BW

### Related Programming Command

PWRBW

---

120 kHz  
EMI BW

Softkey that allows a 6 dB intermeditate frequency bandwidth of 120 kHz. This bandwidth is useful when performing electromagnetic interference (EMI) measurements.

#### Key Path

120 kHz  
(BW) EMI BW

#### Related Programming Command

IFBW, RB

---

150 kHz  
-30 MHz

Softkey that presets the instrument to the predefined settings:

Start frequency:	150 kHz
Stop frequency:	30 MHz
I.F. bandwidth:	9 kHz
Reference level:	75 dB $\mu$ V
Attenuation:	10 dB

#### Key Path

150 kHz  
(SETUP) -30 MHz

---

200 Hz  
EMI BW

Softkey that allows a 6 dB intermeditate frequency bandwidth of 200 Hz. This bandwidth is useful when performing electromagnetic interference (EMI) measurements.

#### Key Path

200 Hz  
(BW) EMI BW

#### Related Programming Command

IFBW, RB

---

200 MHz  
-1 GHz

Softkey that presets the instrument to the predefined settings:

Start frequency:	200 MHz
Stop frequency:	1 GHz
I.F. bandwidth:	120 kHz
Reference level:	80 dB $\mu$ V
Attenuation:	10 dB

#### Key Path

(SETUP) 200 MHz  
-1 GHz

---

A <--> B

Softkey that exchanges the contents of the trace A register with the trace B register and puts trace A in view mode.

#### Key Path

(TRACE) More More  
1 of 4 2 of 4 A <--> B

#### Related Programming Command

AXB

---

A - B → A  
ON OFF

Softkey that when ON is underlined, subtracts the data in trace B from the measured data in trace A. A minus sign (-) appears between the trace A status and the trace B status in the screen annotation while the function is active.

To deactivate this function, press A - B → A ON OFF so that OFF is underlined. The A-B → A and B-DL → B functions are math functions. Unlike operations on dBm units, math functions operate on measurement units. Measurement units are used to format trace data for data within the graticule limits. The displayed amplitude of each element falls on one of 8000 vertical points with the value of 8000 being equal to the reference level. For log scale data, each point is equal to 0.01 dB. The peak of a signal equal to -10 dBm, or one division below the reference level, is equal to 7000 measurement units (8000 - 1000 = 7000). In linear mode, each point has a resolution of [reference level in volts/8000].

For example, if trace A contains amplitude values of -10 dBm and trace B contains amplitude values of -40 dBm, the result of the A - B → A function would be -10.004 dBm if dBm units were used. Since measurement units are used for the A - B → A function, the result of A - B → A is -50 dBm (-10 dBm = 7000 measurement units, -40 dBm = 4000 measurement units; the result is 3000 measurement units, which is equal to -50 dBm).

#### Key Path

More More More A - B → A  
TRACE 1 of 4 2 of 4 3 of 4 ON OFF

#### Related Programming Command

AMB

---

A → C

Softkey that copies trace A into trace C.

#### Key Path

More More More  
TRACE 1 of 4 2 of 4 3 of 4 A → C

---

**ABCDEF**

Softkey that accesses the softkey menu for selecting screen title or prefix characters A through F.

**Key Access**

**CAL**, **CONFIG**, **DISPLAY**, **SAVE/RECALL**, or **SETUP**

**Related Programming Command**

TITLE, PREFIX

---

**Abort**

Softkey that exits the Auto Measure function or discontinues output.

**Key Path**

**TEST** More 1 of 3 More 2 of 3 AUTO-MEASURE Abort  
**OUTPUT** OUTPUT REPORT Abort

---

**ADD TO LIST**

*Not available in Spectrum Analyzer mode.*

Softkey that adds a signal to the internal signal list. The signal added is either for the last **MEASURE AT MKR** result or the measurement at the marker position after a stepped measurement.

**Key Path**

*EMC Analyzer mode only.*

**TEST** ADD TO LIST  
**TEST** More 1 of 3 More 2 of 3 MEAS STEPPED STOP ADD TO LIST  
**TEST** More 1 of 3 More 2 of 3 MEAS STEPPED FREQ STEP ADD TO LIST

**Related Programming Command**

SIGADD

---

ALC  
INT EXT

HP 8593EM, 8594EM, 8595EM, or 8596EM with Option 010 only.

Softkey that activates internal (INT) leveling or external (EXT) leveling.

### Key Path

(AUX/USER) Track Gen 1 of 2 More ALC INT EXT

### Related Programming Command

SRCALC

---

ALC MTR  
INT XTAL

HP 8591EM with Option 010 only.

Softkey that activates the automatic leveling control (ALC) function for internal (INT) leveling or external (XTAL or MTR) leveling. The external leveling input (located on the rear panel of the spectrum analyzer) can be used with a power meter or crystal that has a positive or negative voltage output. See *HP 8590 EM Series EMC Analyzer Verification Guide* for the leveling input characteristics. External leveling increases the amplitude accuracy by improving the effective source match. The meter (MTR) position narrows ALC loop bandwidth so a power meter can be used.

### Key Path

(AUX/USER) Track Gen 1 of 2 More ALC MTR INT XTAL

---

ALC  
TEST

HP 8591EM with Option 010 only.

Softkey that breaks the leveling loop of the automatic leveling control in the tracking generator. This is a service diagnostic function and is for service use only.

### Key Path

(CAL) 1 of 4 More 2 of 4 More Service Diag DACS

---



ALL DLP  
→ CARD

Softkey that saves all downloadable programs and key definitions that are in analyzer memory onto the memory card.

**Key Path**

SAVE/RECALL Save More ALL DLP  
Card 1 of 3 → CARD

---

Amp Cor

Softkey that stores or recalls the current user amplitude-correction factors on the memory card and allows editing.

**Key Path**

CAL More More More  
1 of 4 2 of 4 3 of 4 Amp Cor

**Related Programming Command**

AMPCOR

---

AMP COR  
ON OFF

Softkey that turns the current amplitude-correction factors on or off.

**Key Path**

CAL More More More AMP COR  
1 of 4 2 of 4 3 of 4 Amp Cor ON OFF

**Related Programming Command**

AMPCOR

---

AMPL SCL  
LOG LIN

Softkey that specifies whether the limit line is derived from a logarithmic or linear amplitude axis. Underline LIN to set the amplitude axis to linear or LOG to set the amplitude axis to logarithmic.

### Key Path

*EMC Analyzer mode.*

<b>DISPLAY</b>	Limit	EDIT	Select	Select	AMPL SCL
	Lines ... *	LIMIT	Type	Axis	LOG LIN
<b>SETUP</b>	More	Limit	EDIT	Select	Select
	1 of 4	Lines ... *	LIMIT	Type	Axis
	AMPL SCL				
	LOG LIN				

*Spectrum Analyzer mode.*

<b>DISPLAY</b>	Limit	Edit	Select	Select	AMPL SCL
	Lines	Limit ... †	Type	Axis	LOG LIN
<b>SETUP</b>	More	Limit	Edit	Select	Select
	1 of 4	Lines	Limit ... †	Type	Axis
	AMPL SCL				
	LOG LIN				

\* Either **Limit 1** or **Limit 2** can be used to complete the key path.

† Any of the following can be used to complete the key path:  
**EDIT UPPER**, **EDIT LOWER**, **EDIT UP/LOW**, or **EDIT MID/DELT**.

### Related Programming Command

LIMIAMPSCCL

**AMPLITUDE**

Hardkey that activates the reference level function and accesses the amplitude menu. The softkeys accessed when you press **AMPLITUDE** change reference level, input attenuation, vertical scale, mixer level, amplitude units, input impedance, and amplitude offset. Pressing **AMPLITUDE** accesses the preselector peaking and preselector default functions also.

## Amptd Units

Softkey that accesses a menu to select the desired amplitude units. Amplitude units can be selected by pressing, dBm, dBmV, dB $\mu$ V, Volts, or Watts.

### Key Path

More Amptd  
(AMPLITUDE) 1 of 3 Units

### Related Programming Command

AUNITS

---

## ANALOG+ ON OFF

*Does not operate if SWEEP LOG is selected. Requires Option 101 or 301.*

Softkey that turns on the analog+ display mode.

### Key Path

ANALOG+  
(DISPLAY) ON OFF

### Related Programming Command

ANLGPLUS

---

## ANALYZER ADDRESS

*Softkey changes to BAUD RATE for Option 043.*

Softkey that allows you to set the HP-IB address of the instrument. The address is set to 18 by pressing DEFAULT CONFIG.

### Key Path

More ANALYZER  
(CONFIG) 1 of 3 ADDRESS

---

**ANNOTATN  
ON OFF**

As accessed from **DISPLAY**.

Softkey that turns the screen annotation on or off. However, softkey annotation will remain on the screen. The screen annotation may not be required for prints or plots, or during remote operation. Refer to the **HOLD** softkey description regarding softkey annotation.

As accessed from **OUTPUT**.

Softkey that turns on or off the generation of a tabular listing of the screen annotation. The listing will be sent to the printer when **OUTPUT REPORT** is executed.

**Key Path**

**DISPLAY** More ANNOTATN  
1 of 2 ON OFF

**OUTPUT** Define ANNOTATN  
Report ON OFF

**Related Programming Command**

ANNOT (Display version)

---

**ANTENNA  
→ CARD**

Softkey that saves the current antenna amplitude-correction factors to a card. To save antenna data press, **ANTENNA → CARD . REGISTER #** and **PREFIX=** are displayed on the screen. Use the data keys to enter the desired register number then press **ENTER**. The message **Saving to :FILENAME** is displayed. The antenna data has now been saved to a card.

**Key Path**

**SAVE/RECALL** Save ANTENNA  
Card → CARD

**Related Programming Command**

STOR

---

## Antenna Factors

Softkey that accesses a menu to turn on, recall, edit, or save antenna amplitude-correction factors. Antenna factors are conversion factors relating field strength to measured voltage.

### Key Path

(SETUP) More Correctn Antenna  
1 of 4 Factors Factors

### Related Programming Command

AMPCOR

---

## ANTENNA ON OFF

Softkey that turns on or off antenna amplitude-correction factors.

### Key Path

(SETUP) More Correctn Antenna ANTENNA  
1 of 4 Factors Factors ON OFF

### Related Programming Command

AMPCOR

---

## Antenna Units

*Available only when EDIT ANTENNA is selected.*

Softkey that accesses a menu of the transducer conversion units for the antenna-correction factors. This specifies the units of the physical attribute to which an antenna actually responds and which will be indicated on the display for reference level, display line level, threshold level, and marker readouts.

### Key Path

(SETUP) More Correctn Antenna EDIT More  
1 of 4 Factors Factors ANTENNA 1 of 2  
Antenna  
Units

### Related Programming Command

XUNITS

---

APND  
CAT ITEM

Softkey that starts the DLP editor function and allows the highlighted item from the catalog of instrument memory to be added to the end of the item that is currently in the DLP editor memory of the instrument. If the item to be added will not fit in the available memory space, it will not be appended.

#### Key Path

(SAVE/RECALL)	Save Internal	Catalog Internal	... *	Editor	APND CAT ITEM
(SAVE/RECALL)	Recall Internal	Catalog Internal	... *	Editor	APND CAT ITEM

\* Any of the following can be used to complete the key path:  
CATALOG ALL , CATALOG PREFIX , or CATALOG VARIABLES .

ATTEN  
AUTO MAN

Softkey that sets the input attenuation in 10 dB increments. The instrument input attenuator, which is normally coupled (linked) to the reference level control, reduces the power level of the input signal at the input mixer. The attenuator is recoupled when AUTO is underlined.

#### Key Path

(AMPLITUDE)	ATTEN AUTO MAN
(AUTO COUPLE)	ATTEN AUTO MAN

#### CAUTION

- To prevent damage to the input mixer, the power level at the input mixer must not exceed +30 dBm. To prevent signal compression, power at the input to the input mixer must be kept below -10 dBm.
- To protect the mixer from possible damage, 0 dB RF attenuation (no input power reduction to the mixer) can be selected only from the data keys.

#### Related Programming Command

AT

AUTO  
ALL

Softkey that couples the following functions:

- intermeditate frequency bandwidth
- average video bandwidth
- attenuation
- sweep time
- center-frequency step
- average video bandwidth
- average-video-bandwidth to intermediate-frequency-bandwidth ratio.

**Key Path**

(AUTO COUPLE) AUTO  
ALL

**Related Programming Command**

AUTO

---

AUTO CAL  
ON OFF

Softkey that turns the automatic calibration feature of the EMC analyzer on or off.

**Key Path**

(CAL) Cal At AUTO CAL  
Time ON OFF

**Related Programming Command**

AUTOCAL

---

## AUTO COUPLE

Hardkey that accesses the softkey menu of functions that can be coupled. (Coupled functions are functions that are linked: if one function is changed, the other function is changed.) The functions that can be auto-coupled are listed below:

- Intermediate frequency bandwidth couples to span center frequency in EMC analyzer mode and to span in spectrum analyzer mode.
- Average video bandwidth couples to intermediate frequency bandwidth when the instrument has a average-video-bandwidth to intermediate-frequency-bandwidth ratio of 0.3.
- Sweep time couples to span, intermediate frequency bandwidth, and average video bandwidth.
- RF attenuation couples to reference level.
- Center frequency step size couples to 10% of span.

During normal operation, the sweep time, intermediate frequency bandwidth, and average video bandwidth are coupled to yield optimum performance. If any of these functions becomes uncoupled (that is, is manually set), a “#” will appear next to the screen annotation representing the function on the screen.

If one or more function(s) is manually set so that the amplitude or frequency becomes uncalibrated, MEAS UNCAL appears on the top right-side of the graticule.

Recouple a single function by pressing the function label (to activate the function), and pressing the function again so that AUTO is underlined.

Pressing **AUTO COUPLE**, **AUTO ALL** couples all coupled functions listed.

---

## AUTO-MEASURE

Softkey that finds all signals on the display and makes an EMI measurement using specified detectors. Each signal is tuned to in sequence, the span is reduced in steps to zero span, and a maximum of three detectors are measured. The detectors used are selected using **DETECTOR PK QP AV**. Measurement time is determined by selecting **AV DWELL TIME**, **PK DWELL TIME**, or **QP DWELL TIME**. After each signal is measured it is added to the signal list. If a limit margin is on, only signals above the margin are measured and added to the list.

### Key Path

**TEST** **More** **More** **AUTO-**  
1 of 3 2 of 3 MEASURE

### Related Programming Command

MEASALLSIGS

---



AUTOEXEC  
ON OFF

Softkey that enables and disables the automatic loading and execution of the file "eAUTOEXEC". When enabled, the instrument, upon a power-up sequence, will search the card for an "eAUTOEXEC" file and if found will load and execute it.

#### Key Path

(SETUP) More More More AUTOEXEC  
1 of 4 2 of 4 3 of 4 ON OFF

#### Related Programming Command

AUTOEXEC

---

AUTORANG  
ON OFF

Softkey that turns the current state of the auto-range function on or off. When on, the auto-range function automatically adjusts RF attenuation or reference level (IF step-gain) in response to either an IF or RF overload condition detected during the previous sweep.

Auto range requires overload detection capability. IF overload detection is standard in the HP 8590 EM Series (except Option 703). For RF overload detection, an HP 85420E Option 1EM RF filter section is required. The filter section can *not* be set to bypass.

When on, auto range automatically enables overload detection. When disabled, auto range does *not* disable over load detection.

#### Key Path

(AMPLITUDE) AUTORANG  
ON OFF

(SETUP) More More AUTORANG  
1 of 4 2 of 4 ON OFF

#### Related Programming Command

ARNG

---

AUX B

*HP 8591EM with Option 010 only.*

Softkey that displays the voltage level present at an unused input to the test point MUX circuitry located on the A7 analog interface assembly. This is a service diagnostic function and is for service use only.

#### Key Path

(CAL) More More Service  
1 of 4 2 of 4 Diag AUX B

---

## Aux Conn Control

*Not available when used with HP 85420E Option 1EM RF filter section.*

Softkey that accesses the menu used to control the auxiliary outputs and input. The auxiliary outputs are controlled by pressing `CNTL A 0 1`, `CNTL B 0 1`, `CNTL C 0 1`, and `CNTL D 0 1`. The status of the auxiliary input (control line I), can be displayed on the screen with `DISPLAY CNTL I`.

### Key Path

`AUX/USER` `Aux Conn Control`

---

## `AUX/USER`

Hardkey that accesses the User Menu and the menu containing `FFT MEAS`, `3 dB POINTS`, `6 dB POINTS`, `99% PWR PW`, `% AM`, `3rd ORD MEAS`, `DELTA MEAS`, and `PK-PK MEAS`. If no keys have been defined in the user menu, `No User Menu` is displayed.

---

## AV DWELL TIME

Softkey that sets the measurement time when the average detector is measured. This key is used in conjunction with `MEASURE AT MKR`, `Re-measure`, `AUTO-MEASURE`, and `MEAS STEPPED`.

### Key Path

`More Measure AV DWELL`  
`(SETUP) 1 of 4 Detector TIME`

### Related Programming Command

MEASTIMEAVG

---

AVG BW  
AUTO MAN

Softkey that specifies the averaging bandwidth, which is a post-detection, low-pass filter. The average video bandwidth is normally coupled to the intermediate frequency bandwidth. Selecting MAN uncouples the average video bandwidth from intermediate frequency bandwidth (it does nothing to the sweeptime and span coupling). Selecting AUTO recouples average video bandwidth to the intermediate frequency bandwidth.

Frequency values other than the values in the 1, 3, 10 sequence are rounded to the nearest permissible value.

#### Key Path

(AUTO COUPLE) AVG BW  
AUTO MAN

(BW) AVG BW  
AUTO MAN

#### Related Programming Command

AVBW, VB

---

AVG  
ON OFF

*Not available with Option 703.*

Softkey that toggles the average detector on and off. When on, the instrument is placed in linear amplitude detection, the average detector is turned on, and the system settings are optimized to accurately measure average amplitude.

#### Key Path

(DET) AVG  
ON OFF

#### Related Programming Command

SWITCHAVG, SWITCHQPD

---

AV/IF  
BW RATIO

Softkey that determines the automatic setting of average video bandwidth by multiplying the parameter by the intermediate frequency bandwidth. Ratio values other than the values in the 1, 3, 10 sequence are rounded to the nearest permissible value.

#### Key Path

More AV/IF  
(BW) 1 of 2 BW RATIO

#### Related Programming Command

VBR

---

B → C

Softkey that moves trace B into trace C, then stops updating trace C by placing it in the view mode. Trace B is unchanged by BTC. Trace B must contain a complete sweep of measurement information.

#### Key Path

More More More  
(TRACE) 1 of 4 2 of 4 3 of 4 B → C

#### Related Programming Command

BTC

---

B <--> C

Softkey that exchanges the contents of trace B with trace C and puts trace B in view mode.

#### Key Path

More More More  
(TRACE) 1 of 4 2 of 4 3 of 4 B <--> C

#### Related Programming Command

BXC

---

**B-DL → B**

Softkey that subtracts the display line from trace B and places the result in trace B. The B-DL → B function is a math operation. Refer to the **A-B → A ON OFF** softkey description for information about math operations.

**Key Path**

**TRACE** **More** **More** **More**  
1 of 4 2 of 4 3 of 4 **B-DL → B**

**Related Programming Command**

BML

**Band Lock**

*HP 8593EM, 8595EM, or 9596EM only.*

Softkey that accesses the harmonic band menu and the band lock function. Selecting a harmonic band causes the instrument to lock onto the specified harmonic band and automatically select the settings shown in Table 17-1.

**Table 17-1.**  
**Center Frequency and Span Settings for Harmonic Bands**

Softkey	Center Frequency	Span	Description
0-2.9 Gz BAND 0	1.45 GHz	2.865 GHz	Low-pass filtered, first harmonic mixing.
2.75-6.5 BAND 1	4.638 GHz	3.6 GHz	Preselected, first harmonic mixing.
6.0-12.8 BAND 2 *	9.4 GHz	6.8 GHz	Preselected, second harmonic mixing.
12.4-19.4 BAND 3 †	15.9 GHz	7 GHz	Preselected, third harmonic mixing.
19.1-22 BAND 4 †	20.55 GHz	2.9 GHz	Preselected, fourth harmonic mixing.
* Not available with the HP 8595EM. † Not available with the HP 8595EM or HP 8596EM.			

**BND LOCK ON OFF** locks the instrument onto a selected frequency band (local oscillator harmonic number). When only one frequency band is being swept the corresponding softkey will be underlined, even if band lock is off.

**Key Path**

**FREQUENCY** **More** **Band**  
1 of 2 **Lock**

**Related Programming Command**

HNLOCK

**BAUD  
RATE**

Softkey that allows you to set the data transmission speed.

**Note**

The RS-232 interface is only available with Option 043.

**Key Path**

More BAUD  
(CONFIG) 1 of 3 RATE

**Related Programming Command**

BAUDRATE

**BINARY  
SPAN**

*HP 8591EM only.*

Softkey that displays the output of the span DAC that is located on the A7 analog interface assembly. This is a service diagnostic function and is for service use only.

**Key Path**

More More Service  
(CAL) 1 of 4 2 of 4 Diag More 1 More 2 BINARY  
SPAN

**BLANK A**

*Changes to B or C when TRACE B or C is selected, respectively.*

Softkey that stores the amplitude data for trace A and removes it from the screen. The trace A register will not be updated as the instrument sweeps.

**Key Path**

(TRACE) BLANK A

More Save/Rcl SAVE  
(TEST) 1 of 3 List LIN GRAPH BLANK A

More Save/Rcl SAVE  
(TEST) 1 of 3 List LOG GRAPH BLANK A

**Related Programming Command**

BLANK

## BLANK B

Softkey that stores the amplitude data for trace B and removes it from the screen. The trace B register will not be updated as the instrument sweeps.

### Key Path

(TRACE) TRACE  
A B C B BLANK B

### Related Programming Command

BLANK

---

## BLANK C

Softkey that stores the amplitude data for trace C and removes it from the screen. The trace C register will not be updated as the instrument sweeps.

### Key Path

(TRACE) TRACE  
A B C C BLANK C

### Related Programming Command

BLANK

---

## BLANK CARD

Softkey that deletes all the files from the memory card.

### Key Path

(CONFIG) More Card BLANK  
1 of 3 Config CARD

### Related Programming Command

FORMAT

---

**BND LOCK**  
**ON OFF**

*HP 8593EM, 8595EM, or 8596EM only.*

Softkey that when ON is underlined, the instrument is locked to the lowest frequency band (local oscillator harmonic number) containing the correct center frequency. Start and stop frequencies will be changed if necessary. Executing a band lock limits the tuning range to the selected harmonic number. Selecting the softkeys for either band 0 or band 1 turns on the band lock function automatically.

If the start frequency is well within a lower band, turning band lock off will result in a multiband sweep. If a specific band had been selected prior to changing to a multiband sweep, the softkey label of the selected band will no longer be underlined indicating that it is not selected. Sweep of a single band is indicated if the softkey label of the selected band is underlined.

**Note**

Before changing the frequency range to another harmonic band, unlock the band by pressing **BND LOCK ON OFF** so that OFF is underlined.

**Key Path**

	More	Band	BND LOCK
<b>FREQUENCY</b>	1 of 2	Lock	ON OFF

**Related Programming Command**

HNLOCK, HNUNLK

**BW**

Hardkey that activates the intermediate frequency bandwidth function and accesses the softkeys that control the bandwidth functions: **120 kHz EMI BW**, **9 kHz EMI BW**, **200 Hz EMI BW**, **IF BW AUTO MAN**, **AVG BW AUTO MAN**, **AV/IF BW RATIO**, and **VID AVG ON OFF**. (Also refer to the **IF BW AUTO MAN** softkey description.)



CABLE  
→ CARD

Softkey that saves cable amplitude-correction data to a card. To save cable data press, CABLE → CARD. REGISTER # and PREFIX= are displayed on the screen. Use the data keys to enter the desired register number then press **ENTER**. The message Saving to :FILENAME is displayed. The cable data has now been saved to a card.

#### Key Path

**SAVE/RECALL** Save Card More 1 of 3 CABLE → CARD

#### Related Programming Command

STOR

---

Cable  
Factors

Softkey that accesses a menu to turn on, recall, edit, or save cable amplitude-correction factors. Cable factors are conversion factors used to correct for cable insertion loss.

#### Key Path

**SETUP** More 1 of 4 Correctn Factors Cable Factors

#### Related Programming Command

AMPCOR

---

CABLE  
ON OFF

Softkey that turns on or off cable amplitude correction factors.

#### Key Path

**SETUP** More 1 of 4 Correctn Factors Cable Factors CABLE ON OFF

#### Related Programming Command

AMPCOR

---

**CAL**

Hardkey that accesses menus used for the self-calibration, service-diagnostics, and service-calibration functions.

---

CAL  
AMPTD

Softkey that initiates the amplitude correction routine.

**Key Path**

CAL  
(CAL) AMPTD

**Related Programming Command**

CAL

---

Cal  
At Time

Softkey that accesses a menu to set the time of an automatic calibration.

**Key Path**

Cal  
(CAL) At Time

**Related Programming Command**

CAL

---

CAL  
CISPR BW

Softkey that performs the portion of the amplitude calibration where the CISPR 6 dB bandwidths are calibrated.

**Key Path**

More More More CAL  
(CAL) 1 of 4 2 of 4 3 of 4 CISPR BW

**Related Programming Command**

CAL

---

CAL  
FETCH

Softkey that retrieves stored self-calibration correction factors from the last calibration saved using CAL STORE.

**Key Path**

More CAL  
(CAL) 1 of 4 FETCH

**Related Programming Command**

CAL

---

CAL  
FREQ

Softkey that initiates the frequency correction routine.

**Key Path**

CAL  
(CAL) FREQ

**Related Programming Command**

CAL

---

CAL FREQ  
& AMPTD

Softkey that initiates frequency and amplitude correction routines.

**Key Path**

CAL FREQ  
(CAL) & AMPTD

**Related Programming Command**

CAL

---

CAL  
MXR

*HP 8593M, 8595EM, or 8596EM only.*

Softkey that adjusts the bias-current DAC setting for the optimum displayed-signal amplitude using the 300 MHz CAL OUT signal. This is a service calibration function and is for service use only.

**Key Path**

More More Service CAL  
(CAL) 1 of 4 2 of 4 Cal MXR

**Related Programming Command**

CAL

---

## CAL STORE

Softkey that stores the correction factors from the last calibration. The stored correction factors are automatically retrieved when the instrument is turned on. If correction factors are not stored, they will be retained only until the instrument is turned off. Refer to the description for the CAL FETCH softkey.

### Key Path

CAL  
CAL STORE

### Related Programming Command

CAL

---

## CAL TIMEBASE

Softkey that changes the setting of the 10 MHz reference (standard timebase) DAC that is located on the A25 counter lock assembly. This is a service calibration function and is for service use only.

### Key Path

More More Service CAL  
CAL 1 of 4 2 of 4 Cal TIMEBASE

## CAL TRK GEN

*Option 010 only.*

Softkey that performs absolute amplitude, and vernier self-calibration routines. The instrument should be amplitude calibrated by pressing CAL AMPTD prior to using the CAL TRK GEN function. Connect the tracking generator output to the instrument input before pressing CAL TRK GEN.

### Key Path

More More CAL  
CAL 1 of 4 2 of 4 TRK GEN

### Related Programming Command

CAL

---

**CAL  
YTF**

*HP 8593EM, 8595EM, or 8596EM only.*

Softkey that generates the best slope and offset adjustment to calibrate the YIG-tuned filter (YTF) for each harmonic band. The self-calibration routine, **CAL ALL** should be performed before running the CAL YTF routine.

For the HP 8593EM and HP 8596EM, connect the COMB OUT to INPUT 50Ω prior to pressing **CAL YTF** . For the HP 8595EM, connect CAL OUT to INPUT 50Ω prior to pressing **CAL YTF** .

**Key Path**

**CAL** **More** **More** **More** **CAL**  
1 of 4 2 of 4 3 of 4 YTF

**Related Programming Command**

CAL

---

**Card  
Config**

Softkey that accesses a menu to format a card in LIF format. **Card Config** also accesses the Catalog Card and Protect functions.

**Key Path**

**CONFIG** **More** **Card**  
1 of 3 Config

**CATALOG  
ALL**

Softkey that catalogs all the programs and variables stored in instrument memory. Press **CATALOG REGISTER** to catalog states, traces, and limit-line tables, saved in instrument memory.

**Key Path**

**SAVE/RECALL** **Save** **Catalog** **CATALOG**  
Internal Internal ALL  
**SAVE/RECALL** **Recall** **Catalog** **CATALOG**  
Internal Internal ALL

**Related Programming Command**

CAT

---

## CATALOG CARD

Softkey that catalogs the card. Existing data on the card will be displayed if the card has been formatted. If the card has not been formatted, the following message will be displayed:

When cataloging a card, you can specify the type of information to be cataloged.

### Key Path

```
More Card CATALOG
(CONFIG) 1 of 3 Config CARD

Save CATALOG
(SAVE/RECALL) Card CARD

Recall CATALOG
(SAVE/RECALL) Card CARD
```

### Related Programming Command

CAT

---

## Catalog Internal

Softkey that accesses a menu of cataloging functions for instrument memory: CATALOG ALL , CATALOG REGISTER , CATALOG VARIABLES , and CATALOG PREFIX . Each catalog function displays catalog information. The catalog contains information about the data stored in internal memory. Refer to Figure 17-1.

14:05:46 JAN 20, 1995

```
INTERNAL: 294 73734
P_RINT      59
KEY#2      13
KEY#1      13
R_RESULT   35
T_EST      33
$.HIFT     34
H_SPAN     34
V_ARB      33
V_ARA      33

Editor
DELETE
FILE

SELECT
PREFIX

EXIT
CATALOG

Previous
Menu
```

RT

**Figure 17-1. Internal memory catalog information.**

The screen includes the following information:

- Name of the catalog source.
- Bytes of internal memory used.
- Total bytes of internal memory available.
- Bytes used by item.
- Name of item.

Unlike saving to the card, data is saved as an item in internal memory.

Use the step keys or knob to view different sections of the directory, then press **LOAD FILE** to select a file. The selected file is highlighted in inverse video.

Each of the catalog softkey functions access the menu that has the **DELETE FILE** function. Use **DELETE FILE** to delete the item from internal memory.

Pressing **CATALOG REGISTER** allows access to the **LOAD FILE** function. Use **LOAD FILE** to load a state or trace from internal memory. Do not use **LOAD FILE** to load limit-line table and amplitude-correction factor items.

Also refer to the **CATALOG ALL** and **CATALOG VARIABLES** softkey descriptions.

### Key Path

<b>SAVE/RECALL</b>	Save	Catalog
	Internal	Internal
<b>SAVE/RECALL</b>	Recall	Catalog
	Internal	Internal

### Related Programming Command

CAT

---

## CATALOG PREFIX

Softkey that catalogs all of the saved data, that has the specified prefix, that is either on the card or in internal memory. The entire prefix does not have to be specified. For example, if you want to catalog all the files beginning with the prefix S, specify S as the prefix, using the change prefix function, then select **CATALOG PREFIX**. Prefixed items can be saved in internal memory by either loading in from a card or using remote programming commands to define them.

### Key Path

	Save	Catalog	CATALOG
<b>SAVE/RECALL</b>	Internal	Internal	PREFIX

	Recall	Catalog	CATALOG
<b>SAVE/RECALL</b>	Internal	Internal	PREFIX

	Save	More	More	CATALOG
<b>SAVE/RECALL</b>	Card	1 of 3	2 of 3	PREFIX

	Recall	More	More	CATALOG
<b>SAVE/RECALL</b>	Card	1 of 3	2 of 3	PREFIX

---

## CATALOG REGISTER

Softkey that displays the status of state and trace registers in internal memory. States 1 through 8 are displayed with the center frequency (denoted by CF) and span (denoted by SP). The status of trace registers 0 to the maximum number of traces is displayed also. If a trace, limit-line table, or amplitude correction factors have been saved in the trace register, the screen title (denoted by "TR:") is displayed, otherwise UNUSED is displayed. If the screen title length allows, or if no title is saved with the trace, the time and date are displayed. To load the contents of the state or trace register into internal memory, use the knob or step keys to select the register and press **LOAD FILE**. The **DELETE FILE** key can be used to delete a state or trace register from internal memory.

### Note

Do not use **LOAD FILE** to load the contents of a trace register containing limit-line tables or amplitude-correction factors.

---

### Key Path

	Save	Catalog	CATALOG
<b>SAVE/RECALL</b>	Internal	Internal	REGISTER

	Recall	Catalog	CATALOG
<b>SAVE/RECALL</b>	Internal	Internal	REGISTER

### Related Programming Commands

CAT

---



## CATALOG VARIABLES

Softkey that catalogs all of the variables saved in internal memory. Variables can be saved in internal memory by loading in a downloadable program from the card or defining a function using remote programming commands (VARDEF or TRDEF).

### Note

Variables beginning with an underscore are used by the instrument firmware. Modifying these is not recommended and may give unexpected results.

### Key Path

SAVE/RECALL	Save	Catalog	CATALOG
	Internal	Internal	VARIABLES
SAVE/RECALL	Recall	Catalog	CATALOG
	Internal	Internal	VARIABLES

### Related Programming Command

CAT

## CENTER FREQ

Softkey that activates the center-frequency function to allow the selection of frequency that will be at the center of the screen.

### Key Path

FREQUENCY	CENTER
	FREQ

### Related Programming Command

CF

CF STEP  
AUTO MAN

Softkey that changes the step size for the center frequency function. Once a step size has been selected and the center frequency function is activated, the step keys change center frequency by the step-size value. The step size function is useful for finding harmonics and sidebands beyond the current frequency span of the instrument. When auto-coupled, the center frequency step size is set to one graticule (10 percent of the span).

### Key Path

(AUTO COUPLE) CF STEP  
AUTO MAN

(FREQUENCY) CF STEP  
AUTO MAN

### Related Programming Command

SS

---

## Change Prefix

Softkey that allows you to enter a prefix that can be used for saving and recalling data to and from the card, and for cataloging by the prefix. The prefix can be from one to seven characters long. The longer the prefix, the shorter the register number must be. The total length of the prefix and register number cannot exceed eight characters. The prefix can be any character; however, the underscore should not be the first character of the prefix. Pressing **Change Prefix** accesses a menu containing the letters of the alphabet, the underscore symbol ( ), the number symbol (#), a space, and the clear function. To select a character, press the softkey that displays the group of characters that contains the desired character. The softkey menu changes to allow you to select an individual character. If you make a mistake, press **(BK SP)** to space back over the incorrect character. Additional characters are available by pressing **More 1 of 2**. Numbers may be selected with the data keys.

A prefix can be cleared with the clear function. Press or **(DISPLAY)**, **More 1 of 2** or **(CONFIG)**, **Change Prefix**, **YZ\_# Spc Clear**, **Clear** to clear the current prefix. The current prefix is blanked by pressing **DEFAULT CONFIG**.

### Key Path

**(CONFIG)** **Change Prefix**

**(DISPLAY)** **More 1 of 2** **Change Prefix**

**(SAVE/RECALL)** **Change Prefix**

**(SAVE/RECALL)** **Save Internal** **Catalog Internal** **Change Prefix**

**(SAVE/RECALL)** **Recall Internal** **Catalog Internal** **Change Prefix**

### Related Programming Command

PREFIX

---

## Change Title

Softkey that allows you to write a 53-character screen title across the top of the screen. Pressing **Change Title** accesses the softkey menus that contain the available characters and symbols. A programming command can be entered in the screen title area. It can then be executed from the front panel by pressing **EXECUTE TITLE**.

The screen title will remain on the screen until either

**Change Title** is pressed again or a trace is recalled that was saved with a screen title. A screen title can also be cleared by using the clear function. Press **(DISPLAY)**, **Change Title**, **YZ\_# Spc Clear**, **Clear** to clear the current screen title.

Pressing **Change Title** accesses a menu containing the letters of the alphabet, the underscore symbol (\_), the number symbol (#), a space, and the **Clear** softkey. To select a character, press the softkey that displays the group of characters that contains the desired character. The softkey menu changes to allow you to select an individual character. If you make a mistake, press **(BK SP)** to space back over the incorrect character. Additional characters are available by pressing **More 1 of 2**. Numbers may be selected by using the data keys.

### Key Path

**(CAL)** **More** 1 of 4 **More** 2 of 4 **More** 3 of 4 **Amp Cor** **Change Title**

**(DISPLAY)** **Change Title**

*Spectrum Analyzer mode.*

**(DISPLAY)** **Limit Lines** **Change Title**

**(SETUP)** **More** 1 of 4 **Limit Lines** **Change Title**

### Related Programming Command

TITLE

---

## CLEAR ANNOTATN

Softkey that clears the annotation editor of all text.

### Key Path

**(OUTPUT)** **EDIT ANNOTATN** **CLEAR ANNOTATN**

---

**CLEAR  
MARK**

Softkey that clears the mark from a signal on the signal list.

**Key Path**

**(TEST)** More 1 of 3 EDIT LIST Signal Marking CLEAR MARK

**Related Programming Command**

SIGUNMARK

---

**CLEAR  
WRITE A**

Softkey that erases any data previously stored in trace A and continuously displays any signals during the sweep of the instrument. This function is activated at power on and by pressing **PRESET**.

Changing the trace mode of trace C to clear write or minimum hold can change the trace mode of trace A. If trace A is in clear-write mode or maximum-hold mode when trace C is changed to clear write or minimum hold, the trace mode of trace A is changed to store blank. The following table shows the trace mode of trace A before and after changing trace C to clear-write or minimum-hold trace mode.

Trace Mode of Trace A Before	Trace Mode of Trace A After
Clear write	Store blank
Maximum hold	Store blank
View	View

Changing the trace mode of trace A to clear write or maximum hold can change the trace mode of trace C. If trace C is in clear-write mode when trace A is changed to clear write or minimum hold, the trace mode of trace C is changed to minimum hold.

Trace Mode of Trace C Before	Trace Mode of Trace C After
Clear write	Minimum hold
Minimum hold	Minimum hold
View	View

**Key Path**

**CLEAR**  
**WRITE A**

**TRACE**

**More** **Save/Rcl** **SAVE** **CLEAR**  
**TEST** 1 of 3 **List** **LIN GRAPH** **WRITE A**

**More** **Save/Rcl** **SAVE** **CLEAR**  
**TEST** 1 of 3 **List** **LOG GRAPH** **WRITE A**

**Related Programming Command**

CLRW

---

**CLEAR  
WRITE B**

Softkey that erases any data previously stored in trace B and continuously displays any signals during the sweep of the instrument. This function is activated at power on and by pressing **(PRESET)**.

Changing the trace mode of trace C to clear write or minimum hold can change the trace mode of trace B. If trace B is in clear-write mode or maximum-hold mode when trace C is changed to clear write or minimum hold, the trace mode of trace B is changed to store blank.

The following table shows the trace mode of trace B before and after changing trace C to clear-write or minimum-hold trace mode.

Trace Mode of Trace B Before	Trace Mode of Trace B After
Clear write	Store blank
Maximum hold	Store blank
View	View

Changing the trace mode of trace B to clear write or maximum hold can change the trace mode of trace C. If trace C is in clear-write mode when trace B is changed to clear write or minimum hold, the trace mode of trace C is changed to minimum hold.

Trace Mode of Trace C Before	Trace Mode of Trace C After
Clear write	Minimum hold
Minimum hold	Minimum hold
View	View

**Key Path**

**(TRACE)** TRACE CLEAR  
A B C B WRITE B

**Related Programming Command**

CLRW

**CLEAR  
WRITE C**

Softkey that erases any data previously stored in trace C and continuously displays any signals during the sweep of the instrument. This function is activated at power on and by pressing **PRESET**.

Changing the trace mode of trace C to clear write or minimum hold can change the trace mode of trace A or trace B. If trace A or trace B is in clear-write mode or maximum-hold mode when trace C is changed to clear write or minimum hold, the trace mode of trace A or trace B is changed to store blank.

The following table shows the trace mode of trace A or trace B before and after changing trace C to clear-write or minimum-hold trace mode.

Trace Mode of Trace A or B Before	Trace Mode of Trace A or B After
Clear write	Store blank
Maximum hold	Store blank
View	View

If you want to use trace A or trace B in the clear write or maximum hold mode and do not want trace C to blank it, use minimum hold or view trace mode for trace C.

**Key Path**

**TRACE** **CLEAR**  
**TRACE** A B C C **WRITE C**

**Related Programming Command**

CLRW

---

**CLR ALL  
MARKS**

Softkey that clears all signals in the signal list.

**Key Path**

**More** **EDIT** **Signal** **CLR ALL**  
**TEST** 1 of 3 **LIST** **Marking** **MARKS**

**Related Programming Command**

SIGUNMARK

---



CNTL A  
0 1

*Not available when used with an HP 85420E Option 1EM RF filter section.*

Softkey that makes the auxiliary-interface control line A output high or low (TTL). This line can be used to control any external drive that takes a TTL input.

#### Key Path

	Aux Conn	CNTL A
(AUX/USER)	Control	0 1

#### Related Programming Command

CNTLA

---

CNTL B  
0 1

*Not available when used with an HP 85420E Option 1EM RF filter section.*

Softkey that makes the auxiliary-interface control line B output high or low (TTL). This line can be used to control any external drive that takes a TTL input.

#### Key Path

	Aux Conn	CNTL B
(AUX/USER)	Control	0 1

#### Related Programming Command

CNTLB

---

CNTL C  
0 1

*Not available when used with an HP 85420E Option 1EM RF filter section.*

Softkey that makes the auxiliary-interface control line C output high or low (TTL). This line can be used to control any external drive that takes a TTL input.

#### Key Path

	Aux Conn	CNTL C
(AUX/USER)	Control	0 1

#### Related Programming Command

CNTLC

---

CNTL D  
0 1

*Not available when used with an HP 85420E Option 1EM RF filter section.*

Softkey that makes the auxiliary-interface control line D output high or low (TTL). This line can be used to control any external drive that takes a TTL input.

### Key Path

Aux Conn CNTL D  
Control 0 1  
(AUX/USER)

### Related Programming Command

CNTLD

---

CNT RES  
AUTO MAN

Softkey that sets the resolution of the marker frequency counter. When AUTO is underlined, the marker counter resolution is set to 6 kHz. When MAN is underlined, the marker counter resolution can be set manually from 1 Hz to 100 kHz.

### Key Path

More More CNT RES  
(MKR) 1 of 3 2 of 3 AUTO MAN

### Related Programming Command

MKFCR

---

COARSE  
TUNE DAC

Softkey that displays the analog output of the YTO coarse-tune DAC located on the A7 analog interface assembly. This is a service diagnostic function and is for service use only.

### Key Path

More More Service  
(CAL) 1 of 4 2 of 4 Diag More 1 More 2 COARSE  
TUNE DAC

---

COMB GEN  
ON OFF

*HP 8593EM or HP 8596EM only.*

Softkey that turns the internal comb generator on or off.

#### Key Path

(AUX/USER) COMB GEN  
ON OFF

#### Related Programming Command

COMB

---

COMPLMNT  
MARKS

Softkey that complements all marked signals in the signal list. For example, if all the even numbered signals in the signal list are marked, pressing **COMPLMNT MARKS**, with mark all odd numbered signals instead.

#### Key Path

(TEST) More 1 of 3 EDIT LIST Signal Marking Selectv Mark COMPLMNT MARKS

#### Related Programming Command

SIGMARK

---

CONF TEST

Softkey that initiates a variety of tests to check the major functions of the analyzer. The confidence test function checks that the video bandwidths change, the noise floor level decreases as the resolution bandwidth narrows, the step gains switch, and the 3 dB bandwidths of the resolution bandwidths are correctly set.

#### Key Path

(CAL) More 1 of 4 CONF TEST

---

**CONFIG**

Hardkey that accesses the menu used for printer and plotter configurations, time and date display functions, changing the current prefix, card configuration functions, disposing of user-defined variables and programs from internal memory, changing the instrument address or the baud rate, displaying the installed options on screen, and changing the format of the MONITOR output. Pressing **CONFIG** after the instrument has been placed in the remote mode places the instrument in the local mode and enables front-panel control. During remote operation, an R appears in the lower-left corner of the screen indicating remote mode. Pressing **CONFIG** removes the R annotation from the lower-left corner.

---

**COPY**

Hardkey that initiates an output of the screen data, without an external controller, to a previously specified graphics printer or plotter.

The printer or plotter must have already been selected using **CONFIG** and either **Plot Config** (for a plotter) or **Print Config** (for a printer).

1. To obtain a print, press:

**CONFIG**

**COPY DEV PRNT PLT PRNT**

**Print Config**

**Prn Port Config**

For HP-IB, use **PRINTER ADDRESS** to change the HP-IB address of the printer, if necessary. Press:

**CONFIG**

**Print Config**

**Prn Port Config**

**PRN PORT HP-IB PAR HP-IB**

**PRINTER ADDRESS**

For RS-232, use **BAUD RATE** to change the baud rate of the analyzer, if necessary. Press:

**CONFIG**

**Print Config**

**Prn Port Config**

**PRN PORT SER PAR SER**

**BAUD RATE**

2. If the analyzer is connected to an HP PaintJet printer and you want a color printout, press:

**Set Colr Printer**

**PAINTJET PRINTER**

3. If the analyzer is connected to an HP PaintJet printer and you want a black and white printout, press:

**Set B&W Printer**

**HP B&W PRINTER**

**Table 17-2.  
Setting of HP ThinkJet Printer Mode Switches**

Switch Number	Setting	Comments
1	down	Printer performs a carriage return only.
2	down	Printer performs a line feed only.
3	up	Sets the printer to skip paper perforations
4	down	Sets the printer for a paper length of 11 inches.
5	down	Sets the printer to HP MODE.
6	up	Sets the printer to USASCII.
7	down	
8	down	

4. If you want the softkey labels to be printed with the analyzer display printout when using **(COPY)**, press:

PRT MENU ON OFF ON

5. To begin the process, press:

**(COPY)**

6. The process will begin. The screen remains frozen (no further sweeps taken) until the data transfer to the printer is complete. The analyzer works with many Hewlett-Packard printers.

1. The plotting process is similar to the printing process. To begin a plot, press:

```
(CONFIG)
Plot Config
```

2. To obtain a plot, press:

```
(CONFIG)
COPY DEV PRNT PLT PLT
Plot Config
Plt Port Config
```

For HP-IB, use PLOTTER ADDRESS to change the HP-IB address for the plotter, if necessary. Press:

```
(CONFIG)
Plot Config
Plt Port Config
PLT PORT HP-IB PAR HP-IB
PLOTTER ADDRESS
```

For RS-232, use BAUD RATE to change the baud rate of the analyzer, if necessary. Press:

```
(CONFIG)
Plot Config
Plt Port Config
PLT PORT SER PAR SER
BAUD RATE
```

With PLTS/PG 1 2 4, you can choose a full-page, half-page, or quarter-page plot. Press PLTS/PG 1 2 4 to underline the number of plots per page desired. If two or four plots per page are chosen, a softkey function is displayed that allows you to select the location of the plotter output on the paper. If two plots per page are selected, PLT \_ \_LOC \_ \_ is displayed. If four plots per page are selected, PLT \_ \_LOC \_ \_ is displayed. Press the softkey until the rectangular marker is in the desired section of the softkey label. The upper and lower sections of the softkey label graphically represent the position of the page where the plotter output will be located.

---

**Note**

The HP 7470A Plotter does not support two plots per page output. If you use an HP 7470A Plotter with an HP 8590 EM Series EMC analyzer, you can select one or four plots per page, but not two plots per page.

---

For a multipen plotter, the pens of the plotter draw the different components of the screen as follows:

Pen Number	Description
1	Draws the annotation and graticule.
2	Draws trace A.
3	Draws trace B.
4	Draws trace C and the display line.
5	Draws user-generated graphics and the lower limit line.
6	Draws the upper limit line.

3. To plot, press:

Previous Menu

COPY DEV PRNT PLT PLT

**COPY**

Printing is usually faster than plotting, but plotting provides higher resolution output. The analyzer works with plotters such as the HP 7440A.

Figure 17-2 shows the rear view of a typical printer/analyzer configuration.

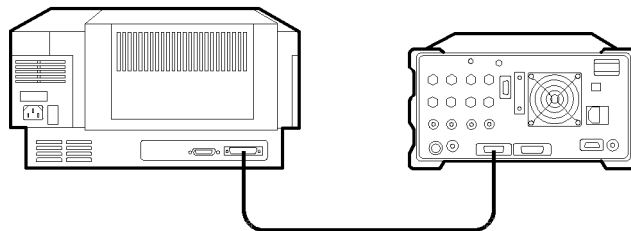

**Figure 17-2. Connecting a printer to the analyzer.**

**Note**

Printing and plotting require an optional interface. Generally, analyzers with an HP-IB interface set the plotter address to 5 and the printer address to 1. Analyzers with an RS-232 interface must have the baud rate set to match the baud rate of the printer or plotter being used.

**Related Programming Commands**

PLOT, PRINT



COPY DEV  
PRNT PLT

Softkey that changes between a printer and plotter. For example, if you have been printing and want to do a plot, press COPY DEV PRNT PLT to underline PLT before pressing (COPY).

#### Key Path

(CONFIG) COPY DEV  
PRNT PLT

---

COPY  
SCREEN

Softkey that sends a copy of the current display to the printer specified by Printer Type . This is the same as the (COPY) key.

#### Key Path

(OUTPUT) COPY  
SCREEN

#### Related Programming Command

PLOT, PRINT

---

CORRECT  
ON OFF

Softkey that controls use of some correction factors. When ON is underlined, correction factors are used and CORR appears on the left hand-side of the display. When OFF is underlined, correction factors are not used. Turning the correction factors off degrades amplitude accuracy.

#### Note

Correction factors must be on for the instrument to meet its specified performance.

---

#### Key Path

(CAL) More 1 of 4 CORRECT  
ON OFF

#### Related Programming Command

CAL

---

**Correctn  
Factors**

Softkey that accesses a menu of correction factors used to create, edit, and view antenna, cable, and other amplitude-correction factors.

**Key Path**

More Correctn  
(SETUP) 1 of 4 Factors

**Related Programming Command**

AMPCOR

---

**CORRECTN  
ON OFF**

Softkey that turns antenna, cable, or other amplitude-correction factors on or off.

**Key Path**

More Correctn CORRECTN  
(SETUP) 1 of 4 Factors ON OFF

**Related Programming Command**

CORREK

---

**COUPLE  
AC DC**

*HP 8594EM, 8595EM or 8596EM only.*

Softkey that specifies alternating-current (AC) or direct-current (DC) coupling at the instrument input. Selecting ac coupling blocks any dc voltage at the instrument input; however, the ac coupling also decreases the frequency range of the instrument. The input coupling is set to ac by an instrument preset.

Amplitude specifications apply only when coupling is set to DC.

---

**CAUTION**

Do not use dc coupling if there is any dc voltage at the instrument input.

---

**Key Path**

More More COUPLE  
(AMPLITUDE) 1 of 3 2 of 3 AC DC

**Related Programming Command**

COUPLE

---

**CRT HORZ  
POSITION**

Softkey that changes the horizontal position of the signal. Press **CAL STORE** if you want to use this position permanently, so that it is not lost when the power is turned off.

**Key Path**

**(CAL)** **More** **CRT HORZ**  
**1 or 4** **POSITION**

---

**CRT VERT  
POSITION**

Softkey that changes the vertical position of the signal. Press **CAL STORE** if you want to use this position permanently, so that it is not lost when the power is turned off.

**Key Path**

**(CAL)** **More** **CRT VERT**  
**1 or 4** **POSITION**

---

**DACS**

*Not available with Option 703.*

Softkey that changes the DAC numbers of the span, DAC YTO coarse-tune, DAC YTO fine-tune, and YTO FM tune DAC located on the A7 analog interface assembly. This is a service diagnostic function and is for service use only.

**Key Path**

**(CAL)** **More** **More** **Service**  
**1 of 4** **2 of 4** **Diag** **DACS**

---

**DATEMODE  
MDY DMY**

Softkey that changes the display of the date from a month-day-year format to a day-month-year format. It is set to a month-day-year format by pressing **DEFAULT CONFIG**.

**Key Path**

**(CONFIG)** **Time** **DATEMODE**  
**Date** **MDY DMY**

**Related Programming Command**

DATEMODE

---

**dBm**

Softkey that changes the amplitude units to dBm for the current setting (logarithmic or linear).

**Key Path**

More Amptd  
AMPLITUDE 1 of 3 Units dBm

**Related Programming Command**

AUNITS

---

**dBmV**

Softkey that changes the amplitude units to dBmV for the current setting (logarithmic or linear).

**Key Path**

More Amptd  
AMPLITUDE 1 of 3 Units dBmV

**Related Programming Command**

AUNITS

---

**dB $\mu$ V**

Softkey that changes the amplitude units to dB $\mu$ V for the current setting (logarithmic or linear).

**Key Path**

More Amptd  
AMPLITUDE 1 of 3 Units dB $\mu$ V

**Related Programming Command**

AUNITS

---

**DEFAULT  
CAL DATA**

Softkey that accesses the factory-default correction factors. A special pass code is required for use. If the message Self cal needed appears when **DEFAULT CAL DATA** is pressed, the **CAL FREQ** and **CAL AMP** routines need to be run. **CAL ALL** must be run to ensure specifications. (If the maximum frequency of interest is higher than 3 GHz, the **CAL YTF** routine must also be run.) The calibration results must then be saved by pressing **CAL STORE**.

**Key Path**

**CAL** **More** **More** **DEFAULT**  
1 of 4 2 of 4 **CAL DATA**

**Related Programming Command**

CAL

---

**DEFAULT  
CONFIG**

Softkey that resets the instrument configuration to the state it was in when it was originally shipped from the factory then performs an instrument preset. Refer to Table 17-3 for the default user-configuration values set by pressing **DEFAULT CONFIG**.

**Table 17-3. Default Configuration Values**

Configuration	Default Value
Analyzer address	18
Copy device	printer
CRT position (Horizontal and Vertical)	10, 48
Printer address	1
Plotter address	5
Baud rate	1200
External preamp	0 dB
Save lock (internal states or traces)	Off
Printer	black and white printer
Print menu	on
Plots per page	1
Time/date display	on
Date mode	month-day-year format
Prefix	(blank)
Analyzer state at power on	instrument preset

**Key Path**

**CONFIG** **More** **DEFAULT**  
1 of 3 **CONFIG**

---

## DEFAULT SYNC

Softkey that restores the factory default values of the horizontal and vertical synchronization constants for the rear panel MONITOR output.

### Key Path

**CONFIG** **More** **More** **DEFAULT**  
1 of 3 2 of 3 SYNC

### Related Programming Command

SYNCMODE

---

## Define List

Softkey that accesses a menu that specifies what elements of a table are output to the printer when **OUTPUT REPORT** is executed. If any of the elements are set to on, they will be included as part of the list portion of the report.

### Key Path

**OUTPUT** **Define**  
List

### Related Programming Command

TBLDEF

---

## Define Report

Softkey that accesses a menu which specifies what elements of a report are output to the printer or the plotter. If any of the elements are set to on, they will be sent to the printer followed by a form feed. Only **LOG ON OFF** and **LIN ON OFF** can be used when outputting to a plotter. The report is generated by **OUTPUT REPORT**.

### Key Path

**OUTPUT** **Define**  
Report

### Related Programming Command

RPTDEF

---

**DELETE  
ALL SIGS**

Softkey that deletes all signals from the signal list.

**Key Path**

**(TEST)** More 1 of 3 EDIT LIST Delete Signals DELETE ALL SIGS

**Related Programming Command**

SIGDEL

---

**DELETE  
FACTORS**

Softkey that deletes all antenna, cable, or other amplitude-correction factors.

**Key Path**

**(SETUP)** More 1 of 4 Correctn Factors Antenna Factors EDIT ANTENNA More 1 of 2 DELETE FACTORS

**(SETUP)** More 1 of 4 Correctn Factors Cable Factors EDIT CABLE More 1 of 2 DELETE FACTORS

**(SETUP)** More 1 of 4 Correctn Factors Other Factors EDIT OTHER More 1 of 2 DELETE FACTORS

**Related Programming Command**

AMPCOR

---

**DELETE  
FILE**

Softkey that deletes an item from internal memory or a file from the card. Use the step keys to view different sections of the directory and use the knob to select the file or item to delete. Pressing **DELETE FILE** causes a message to appear on the screen: If you are sure, press key again to purge data. Press **DELETE FILE** again if you want to delete the memory item.

**Note**

Deleting items beginning with an underscore from the instrument is not recommended and may have unexpected results. Items beginning with an underscore are used by the instrument.

---

**Key Path**

**(SAVE/RECALL)** Save or Recall Card ... \* DELETE FILE

**(SAVE/RECALL)** Save or Recall Card More 1 of 3 ... † DELETE FILE

	Save/Recall	Catalog		DELETE
(SAVE/RECALL)	Internal	Internal	... §	FILE

	RECALL	DELETE
(SETUP)	SETUP	FILE

	More	Correctn		DELETE
(SETUP)	1 of 4	Factors	...	FILE

	More	Limit	RECALL	DELETE
(SETUP)	1 of 4	Lines	LIMITS	FILE

	More	Save/Rcl	RECALL	DELETE
(TEST)	1 of 3	List	LIST	FILE

*EMC Analyzer mode only.*

	Limit	RECALL	DELETE
(DISPLAY)	Lines	LIMITS	FILE

\* Any of the following can be used to complete the key path:

Recall: CATALOG CARD, RECALL SETUP, RECALL LIST, RECALL LIMITS, or RECALL ANTENNA, or  
 Save: CATALOG CARD, SETUP → CARD LIST → CARD, LIMITS → CARD, ANTENNA → CARD.

† Any of the following can be used to complete the key path:

Recall: RECALL CABLE, RECALL OTHER, RECALL DISPLAY, RECALL DLP, RECALL TRACE or  
 Save: CABLE → CARD, OTHER → CARD, DISPLAY → CARD, Trace → CARD, ALL DLP → CARD

§ Any of the following can be used to complete the key path:

CATALOG ALL, CATALOG REGISTER, CATALOG VARIABLES, or CATALOG PREFIX.

|| Any of the following groups of softkeys can be used to complete the key path:

Antenna Factors EDIT ANTENNA, or Cable Factors EDIT CABLE, or Other Factors EDIT OTHER.

## Related Programming Command

PURGE

---



**DELETE  
LIMIT**

*EMC Analyzer mode only.*

Softkey that deletes the selected limit-line table.

**Key Path**

**DISPLAY** Limit Lines ... \* DELETE LIMIT

**SETUP** More Limit Lines ... \* DELETE LIMIT

\* Either **Limit 1** or **Limit 2** can be used to complete the key path.

**Related Programming Command**

LIMIDEL

---

**DELETE  
MARKED**

Softkey that deletes all marked signals from the signal list. Signals can be marked using **MARK ALL SIGNALS**, **MARK SIGNAL**, and **Selectv Mark**.

**Key Path**

**TEST** More EDIT Delete DELETE  
1 of 3 LIST Signals MARKED

**TEST** More Signal Selectv DELETE  
1 of 3 Marking Mark MARKED

**Related Programming Command**

SIGDEL, SIGMARK

---

## DELETE POINT

Softkey that deletes an amplitude-correction factor that was previously selected by **SELECT POINT**.

### Key Path

	More	More	More	Amp	EDIT	DELETE
<b>(CAL)</b>	1 of 4	2 of 4	3 of 4	Cor	AMP COR	POINT
	More	Correctn	Antenna	EDIT	More	DELETE
<b>(SETUP)</b>	1 of 4	Factors	Factors	ANTENNA	1 of 2	POINT
	More	Correctn	Cable	EDIT	More	DELETE
<b>(SETUP)</b>	1 of 4	Factors	Factors	CABLE	1 of 2	POINT
	More	Correctn	Other	EDIT	More	DELETE
<b>(SETUP)</b>	1 of 4	Factors	Factors	OTHER	1 of 2	POINT

---

## DELETE SEGMENT

Softkey that deletes the limit-line entry for the selected segment number. Use the knob or step keys to highlight the segment number to be deleted, then press **DELETE SEGMENT**.

### Key Path

*EMC Analyzer mode.*

	Limit		EDIT	More	DELETE
<b>(DISPLAY)</b>	Lines	... *	LIMIT	1 of 2	SEGMENT
	More	Limit	EDIT	More	DELETE
<b>(SETUP)</b>	1 of 4	Lines	LIMIT	1 of 2	SEGMENT

\* Either **Limit 1** or **Limit 2** can be used to complete the key path.

*Spectrum Analyzer mode.*

	Limit	Edit		More	DELETE
<b>(DISPLAY)</b>	Lines	Limit	... *	1 of 2	SEGMENT
	More	Limit	Edit	More	DELETE
<b>(SETUP)</b>	1 of 4	Lines	Limit	1 of 2	SEGMENT

\* Any of the following can be used to complete the key path:  
**EDIT UPPER**, **EDIT LOWER**, **EDIT UP/LOW**, or **EDIT MID/DELT**.

### Related Programming Command

SEGDEL

---

**DELETE  
SIGNAL**

Softkey that deletes the signal located at the cursor from the signal list.

**Key Path**

**(TEST)** More 1 of 3 EDIT LIST Delete Signals DELETE SIGNAL

**Related Programming Command**

SIGDEL, SIGPOS

---

**Delete  
Signals**

Softkey that accesses a menu which deletes one or more signals from the signal list.

**Key Path**

**(TEST)** More 1 of 3 EDIT LIST Delete Signals

**Related Programming Command**

SIGDEL

---

**DELTA  
MEAS**

Softkey that accesses the **(MKR)** menu. Refer to **(MKR)** for more information.

**Key Path**

**(AUX/USER)** More 1 of 3 More 2 of 3 DELTA MEAS

**(DEMOM)**

*Not available with Option 703.*

Hardkey that directly accesses the menu that selects AM or FM demodulation, FM gain, dwell time, and squelch levels.

---

DEM  
AM FM

Softkey that allows selection of amplitude (AM) or frequency (FM) demodulation.

Activating AM detection turns off FM demodulation (if it is on). When the frequency span is greater than 0 Hz, a 30 kHz intermediate frequency bandwidth is used during demodulation, regardless of the screen annotation.

Turning FM demodulation on turns off AM demodulation (if it is on). When the frequency span is greater than 0 Hz, a 100 kHz bandwidth is used during the demodulation, regardless of the screen annotation. When the span is equal to 0 Hz, the displayed bandwidth is used.

### Key Path

DEM  
AM FM

### Related Programming Command

DEM

---

DEM  
ON OFF

Softkey that turns the AM or FM demodulation on and off. If the instrument is in a nonzero span, a marker is placed at center screen if an onscreen marker is not already present. The marker pause is changed to equal the current dwell time value. Demodulation takes place on any signal that is indicated by the marker position during the marker pause. There is no change to the display during marker pause, but the demodulation signal is present on the AUX VIDEO OUT. Also refer to the **SPEAKER ON OFF** softkey description.

Pressing **DEM ON OFF** selects the sample peak detector for AM demodulation, the FMV detector for FM demodulation. If the instrument is in zero span, demodulation is done continuously, with or without an onscreen marker.

### Key Path

DEM  
ON OFF

### Related Programming Command

DEM

---

DESKJET  
310/550C

Softkey that selects the HP DeskJet 310 or 550C for color printing.

**Key Path**

	Print	Set Colr	DESKJET
(CONFIG)	Config	Printer	310/550C

---

DESKJET  
540

Softkey that selects the HP DeskJet 540 for color printing.

**Key Path**

	Print	Set Colr	DESKJET
(CONFIG)	Config	Printer	540

---

(DET)

Hardkey that accesses a menu for selecting the quasi-peak, average, peak, sample and negative detection.

---

DETECTOR  
PK QP AV

Softkey that turns automatic measuring on or off for the peak, quasi-peak, and average detectors. Underline the desired detector or detectors by pressing DETECTOR PK QP AV.

**Key Path**

	More	Measure	DETECTOR
(SETUP)	1 of 4	Detector	PK QP AV

	More	EDIT	Re-	DETECTOR
(TEST)	1 of 3	LIST	measure	PK QP AV

**Related Programming Command**

AUTOAVG, AUTOQPD

---

DETECTOR  
PK SP NG

*Option 101 and 103 only.*

Softkey that selects either positive peak detection or sample detection. When sample detection is selected, "SMPL" appears in the upper-right corner of the screen. In sample mode, the instantaneous signal value at the present display point is placed in memory. Sample detection is activated automatically for noise level markers, during video averaging, and for FFT measurements.

When positive peak detection is selected, "PEAK" appears in the upper-right corner of the screen. Positive peak detection obtains the maximum video signal between the last display point and the present display point and stores this value in the trace memory address. Positive peak detection is selected at power on and by pressing **PRESET**.

### Key Path

**TRACE** More 1 of 4 More 2 of 4 DETECTOR  
PK SP NG

**DET** DETECTOR  
PK SP NG

### Related Programming Command

DET

---

DETECTOR  
SMP PK

Softkey that selects between positive peak detection and sample detection. When sample detection is selected, "SMPL" appears in the upper-left corner of the screen. In sample mode, the instantaneous signal value at the present display point is placed in memory. Sample detection is activated automatically for noise level markers, during video averaging, and for FFT measurements.

When positive peak detection is selected, "PEAK" appears in the upper-left corner of the screen. Positive peak detection obtains the maximum video signal between the last display point and the present display point and stores this value in the trace memory address. Positive peak detection is selected at power on and by pressing **PRESET**.

### Key Path

**DET** DETECTOR  
SMP PK

**TRACE** More 1 of 4 More 2 of 4 DETECTOR  
SMP PK

### Related Programming Command

DET

---

**DISPLAY**

Hardkey that activates the display line, hold, and threshold functions. It controls the display of the graticule and screen annotation, and provides for title and prefix entries.

---

**DISPLAY**  
→ **CARD**

Softkey that saves display images to a card. To save display images press, **DISPLAY** → **CARD**. **REGISTER #** and **PREFIX=** are displayed on the screen. Use the data keys to enter the desired register number then press **(ENTER)**. The display image is saved to a card.

**Key Path**

**(SAVE/RECALL)** Save More **DISPLAY**  
Card 1 of 3 — **CARD**

**Related Programming Command**

STOR

---

**DISPLAY**  
**CAL DATA**

Softkey that displays the current correction-factor data generated by the frequency and amplitude self-calibration routines. This is a service diagnostic function and is for service use only.

**Key Path**

**(CAL)** More More Service **DISPLAY**  
1 of 4 2 of 4 Diag **CAL DATA**

**DISPLAY**  
**CNTL I**

*Not available when used with an HP 85420E Option 1EM RF filter section.*

Softkey that displays the status of the auxiliary connector input (control line I) onscreen (high = 1 or low = 0, in TTL).

**Key Path**

**(AUX/USER)** Aux Conn **DISPLAY**  
Control **CNTL I**

**Related Programming Command**

CNTLI

---

## Dispose User Mem

Softkey that accesses a menu to dispose of all the user programs and variables that are in internal memory.

---

### Note

Use **DELETE FILE** to selectively delete stored programs or variables from internal memory.

---

Using **DISPOSE USER MEM** may change the printer or plotter configuration. Pressing **DISPOSE USER MEM** sets the printer output to print a black and white print by selecting **COLOR MONOCHRM**, sets the copy device to print when **COPY DEV PRNT PLT** has PRNT underlined, and sets the print menu to on when **PRT MENU ON OFF** has ON underlined. Use **Print Config** to change any of these functions.

### Key Path

More    Dispose  
**(CONFIG)** 1 of 3    User Mem

### Related Programming Command

DISPOSE

---

## DROOP

Softkey that disables the reset of the peak detector on the A16 processor/video assembly after each analog-to-digital conversion. This is a service diagnostic function and is for service use only.

### Key Path

More    More    Service  
**(CAL)** 1 of 4    2 of 4    Diag    More 1 ...    More 3    DROOP

---



DSP LINE  
ON OFF

After selecting this softkey, pressing any digit, 0 through 9, brings up the appropriate amplitude terminator menu.

Softkey that activates an adjustable horizontal line that is used as a visual reference line. The line, which can be used for trace arithmetic, has amplitude values that correspond to its vertical position when compared to the reference level. The value of the display line appears in the active function block and on the left side of the screen. The display line can be adjusted using the step keys, knob, or data keys. To deactivate the display line, press **DSP LINE ON OFF** so that OFF is underlined. (Also refer to the **VIDEO** softkey description.)

### Key Path

**(DISPLAY)** DSP LINE  
ON OFF

**(MKR →)** More 1 of 3 More 2 of 3 DSP LINE  
ON OFF

### Related Programming Command

DL

---

DWELL  
TIME

Softkey that sets the dwell time for marker pause, during which demodulation can take place in nonzero span sweeps. The dwell time can be set from 2 milliseconds to 100 seconds.

### Key Path

**(DEMOD)** DWELL  
TIME

### Related Programming Command

MKPAUSE

---

EDIT  
AMP COR

Softkey that allows you to edit the current amplitude-correction factors table.

### Key Path

**(CAL)** More 1 of 4 More 2 of 4 More 3 of 4 Amp EDIT  
Cor AMP COR

### Related Programming Command

AMPCOR

---

**EDIT**  
**ANNOTATN**

Softkey that accesses the annotation editor. The annotation editor allows entry of up to 1500 characters of text using an external keyboard. The annotation text can be stored to a card or printed using **OUTPUT REPORT**.

**Key Path**

**EDIT**  
**ANNOTATN**

**Related Programming Command**

EDITANNOT

---

**EDIT**  
**ANTENNA**

Softkey that accesses a menu used to edit antenna amplitude-correction factors.

**Key Path**

**More** **Correctn** **Antenna** **EDIT**  
**1 of 4** **Factors** **Factors** **ANTENNA**

**Related Programming Command**

AMPCOR

---

**EDIT**  
**CABLE**

Softkey that accesses a menu used to edit cable amplitude-correction factors.

**Key Path**

**More** **Correctn** **Cable** **EDIT**  
**1 of 4** **Factors** **Factors** **CABLE**

**Related Programming Command**

AMPCOR

---

**EDIT  
CAT ITEM**

Softkey that starts the DLP editor function and loads the highlighted item from the catalog of instrument memory to be displayed and edited. It copies the item into the instruments internal DLP editor memory which is a 2500 byte memory buffer. If an item is edited, the new edited version will not be overwritten in the internal memory until it is processed by the **SAVE EDIT** softkey.

**Key Path**

<b>SAVE/RECALL</b>	Save Internal	Catalog Internal	... *	Editor	<b>EDIT CAT ITEM</b>
<b>SAVE/RECALL</b>	Recall Internal	Catalog Internal	... *	Editor	<b>EDIT CAT ITEM</b>

\* Any of the following can be used to complete the key path:  
**CATALOG ALL** , **CATALOG VARIABLES** , or **CATALOG PREFIX** .

**EDIT  
DONE**

Softkey that can be accessed through the amplitude-correction, menu the limit-line menu, and the change prefix menu. When accessed from the amplitude-correction menu, the amplitude-correction factors table is erased from the screen and the amplitude-correction menu is restored onscreen. When accessed from the limit-line menu, the limit-line table is erased from the screen and the limit-line menu is restored onscreen. Use **EDIT DONE** when all the amplitude-correction factors have been entered.

When accessed from the change prefix menu, **EDIT DONE** erases the prefix from the screen and restores the previous menu. Use **EDIT DONE** when prefix characters have all been entered.

**Key Path**

<b>CAL</b>	More 1 of 4	More 2 of 4	More 3 of 4	Amp Cor	<b>EDIT AMP COR</b>	<b>EDIT DONE</b>
<b>CONFIG</b>	Change Prefix	More 1 of 2	<b>EDIT DONE</b>			
<b>DISPLAY</b>	More 1 of 2	Change Prefix	More 1 of 2	<b>EDIT DONE</b>		
<b>SAVE/RECALL</b>	Save Internal	Catalog Internal	Change Prefix	More 1 of 2	<b>EDIT DONE</b>	
<b>SAVE/RECALL</b>	Recall Internal	Catalog Internal	Change Prefix	More 1 of 2	<b>EDIT DONE</b>	
<b>SAVE/RECALL</b>	Change Prefix	More 1 of 2	<b>EDIT DONE</b>			

*EMC Analyzer mode.*

	Limit		EDIT	EDIT
(DISPLAY)	Lines	... *	LIMIT	DONE
	More	Change	More	EDIT
(DISPLAY)	1 of 2	Prefix	1 of 2	DONE
	More	Limit		EDIT
(SETUP)	1 of 4	Lines	... *	LIMIT
	More	Correctn		EDIT
(SETUP)	1 of 4	Factors	... †	DONE

*Spectrum Analyzer mode.*

	Limit	Edit		More	EDIT
(DISPLAY)	Lines	Limit	... §	1 of 2	DONE
	More	Limit	Edit		More
(SETUP)	1 of 4	Lines	Limit	... §	1 of 2
					EDIT
					DONE

\* Either **Limit 1** or **Limit 2** can be used to complete the key path.

† Any of the following groups of softkeys can be used to complete the key path:  
**Antenna Factors** **EDIT ANTENNA**, or **Cable Factors** **EDIT CABLE**,  
or **Other Factors** **EDIT OTHER**.

§ Any of the following can be used to complete the key path:  
**EDIT UPPER**, **EDIT LOWER**, **EDIT UP/LOW**, or **EDIT MID/DELT**.

---

**EDIT  
FLATNESS**

Softkey that allows flatness-correction constants to be viewed or modified. This is a service calibration function and is for service use only.

**Key Path**

	More	More	Service	Flatness	EDIT
(CAL)	1 of 4	2 of 4	Cal	Data	FLATNESS

---

EDIT  
LAST

Softkey that starts the DLP editor function and allows the most recent item that was being edited, in the DLP editor buffer, to be accessed again. The item will not be in the user memory of the instrument until it is processed by the **SAVE EDIT** softkey. The DLP editor memory remains intact when the instrument is preset and when it is powered off.

### Key Path

<b>(SAVE/RECALL)</b>	Save Internal	Catalog Internal	... *	Editor	EDIT LAST
<b>(SAVE/RECALL)</b>	Recall Internal	Catalog Internal	... *	Editor	EDIT LAST

\* Any of the following can be used to complete the key path:  
**CATALOG ALL**, **CATALOG VARIABLES**, or **CATALOG PREFIX**.

Edit  
Limit

*Spectrum Analyzer mode only.*

Softkey that allows you to edit the current limit-line tables by accessing **Edit Upper**, **Edit Lower**, **Edit Up/Low**, and **Edit Mid/Delt**. Use **PURGE LIMITS** under any of the above edit menus to dispose of the current limit-line table.

### Key Path

<b>(DISPLAY)</b>	Limit Lines	Edit Limit	
<b>(SETUP)</b>	More 1 of 4	Limit Lines	Edit Limit

**EDIT  
LIMIT**

*EMC Analyzer mode only.*

Softkey that allows you to edit the current limit-line tables for limit line 1 or limit line 2. Use **DELETE LIMITS** under this menu to dispose of the current limit-line table.

**Key Path**

**(DISPLAY)** **Limit**  
**Lines ... \*** **EDIT**  
**LIMIT**

**(SETUP)** **More** **Limit** **EDIT**  
**1 of 4** **Lines ... \*** **LIMIT**

\* Either **Limit 1** or **Limit 2** can be used to complete the key path.

---

**EDIT  
LIST**

Softkey that accesses a menu to edit signal list functions for marking, remeasuring and deleting signals.

**Key Path**

**(TEST)** **More** **EDIT**  
**1 of 3** **LIST**

**Related Programming Command**

SIGLIST

---

**EDIT**  
**LOWER**

*Spectrum Analyzer mode only.*

Softkey that allows you to view or edit the lower limit-line table. Up to 30 entries are allowed for the lower limit-line table. With the lower limit-line table format, the coordinates for the lower limit-line are specified, but none are specified for the upper limit line. Even if upper limit-line values exist or the values had been entered as an upper and lower limit-line table, the lower limit-line values are treated as a separate table from the upper limit-line values. The lower limit-line entries can have independent frequency (or time) and amplitude coordinates from upper limit-line table entries.

### Key Path

**(DISPLAY)** Limit Edit EDIT  
Lines Limit LOWER

**(SETUP)** More Limit Edit EDIT  
1 of 4 Lines Limit LOWER

### Related Programming Command

LIMIMODE

---

**EDIT  
MID/DELT**

*Spectrum Analyzer mode only.*

Softkey that allows you to view or edit the upper and lower limit-line tables simultaneously. These tables are edited by entering a middle amplitude value and an amplitude deviation. Up to 30 entries are allowed for the upper and lower limit-line tables. Like the upper and lower limit-line table format, the mid/delta limit-line table format provides a means of specifying the upper and lower limit lines at the same time. Unlike the upper and lower table format, the amplitude values are specified as a middle amplitude value with a delta (the upper and lower limit lines are drawn equal positive and negative distance from the middle amplitude).

With the mid/delta format the frequency (or time), and the middle amplitude plus the delta comprise the upper limit line; the frequency (or time), and the middle amplitude minus the delta comprise the lower limit line. The difference between the mid/delta and the upper/lower format is the way the amplitude values are entered; the frequency (time) coordinate begins a segment regardless of the format chosen. The mid/delta format can be used if the upper and lower limit lines are symmetrical with respect to the amplitude axis. An upper and lower amplitude component are specified for every frequency (or time) component.

**Key Path**

**DISPLAY** Limit Edit EDIT  
Lines Limit MID/DELT

**SETUP** More Limit Edit EDIT  
1 of 4 Lines Limit MID/DELT

**Related Programming Command**

LIMIMODE

---

**EDIT  
OTHER**

Softkey that accesses the ampcor editor to edit correction factors for devices other than antennas and cables.

**Key Path**

**SETUP** More Correctn Other EDIT  
1 of 4 Factors Factors OTHER

**Related Programming Command**

AMPCOR

---



EDIT  
UP/LOW

*Spectrum Analyzer mode only.*

Softkey that allows you to view or edit the upper and lower limit-line tables simultaneously. Up to 30 entries are allowed for the upper and lower limit-line tables. With the upper and lower limit-line table format, the upper and lower limit-lines can be entered at the same time.

With the upper and lower limit-line format, the frequency (or time), upper amplitude, and lower amplitude are specified. The frequency (or time) and upper amplitude value comprise the coordinate point for the upper limit line, the frequency (or time) and lower amplitude value comprise the coordinate point for the lower limit line. It is not necessary to specify both an upper and lower amplitude component for every frequency (or time) component.

### Key Path

Limit Edit EDIT  
Lines Limit UP/LOW  
(DISPLAY)

More Limit Edit EDIT  
1 of 4 Lines Limit UP/LOW  
(SETUP)

### Related Programming Command

LIMIMODE

---

EDIT  
UPPER

*Spectrum Analyzer mode only.*

Softkey that allows you to view or edit the upper limit-line table. Up to 30 entries are allowed for the upper limit-line table. With the upper limit-line table format, the coordinates of the upper limit line are specified, but none are specified for the lower limit line. Even if lower limit-line values exist or the values had been entered as an upper and lower limit-line table, the upper limit-line values are treated as a separate table from the lower limit-line values. The upper limit-line entries can have independent frequency (or time) and amplitude coordinates from lower limit-line table entries.

### Key Path

Limit Edit EDIT  
Lines Limit UPPER  
(DISPLAY)

More Limit Edit EDIT  
1 of 4 Lines Limit UPPPER  
(SETUP)

### Related Programming Command

LIMIMODE

---

**EDIT**  
**UPR LWR**

*Spectrum Analyzer mode only.*

Softkey that selects upper or lower limit-line tables. It switches to the limit-line table that is not currently being edited.

### Key Path

**DISPLAY** Limit Edit EDIT  
Lines Limit ... \* UPR LWR

**SETUP** More Limit Edit EDIT  
1 of 4 Lines Limit ... \* UPR LWR

\* Either **EDIT UPPER** or **EDIT LOWER** can be used to complete the key path.

### Related Programming Command

LIMIMODE

---

**Editor**

Softkey that accesses the menu of downloadable program (DLP) editor softkeys. Programming commands can be used to write a program to control the instrument. The built-in DLP editor uses the instrument rather than an external computer to create, view, or edit programs. These programs can then be sent to the command parser of the instrument, which is similar to outputting them to the instrument from an external computer.

### Key Path

**SAVE/RECALL** Recall Catalog  
Internal Internal ... \* Editor

**SAVE/RECALL** Save/Recall Catalog  
Internal Internal ... \* Editor

\* Any of the following can be used to complete the key path.

**CATALOG ALL**, **CATALOG VARIABLES**, or **CATALOG PREFIX**.

---

**EMC**  
**ANALYZER**

Softkey that allows the EMC analyzer mode only to be preset. Table 17-4 lists the conditions affected by the preset EMC analyzer function.

**Table 17-4. Preset EMC Analyzer Conditions**

A – B → A	off
Annotation and graticule	on
Attenuation	coupled
Average video bandwidth	300 kHz (coupled)
AV/IFBW ratio	0.3
Center frequency	600 MHz
Center frequency step size	100 MHz
Coupled functions	all set to AUTO
Coupling	AC
Detector	positive peak
Display line	off
Frequency offset	0 Hz
Harmonic lock	off
IF Bandwidth	120 kHz (coupled)
Limit-line testing	off
Marker counter	off
Marker counter resolution	6 kHz (auto-coupled)
Markers	off
Reference level	92 dB $\mu$ V in power-on units
Reference level offset	0 dB
Reference level position	top (8th graticule)
Scale	log 10dB/div
Span	800 MHz
Start Frequency	200 MHz
Stop Frequency	1.0 GHz
State registers 1–8	unaffected
Sweep	continuous
Sweep time	2.70 s (auto-coupled)
Threshold	off
Trace A	clear write
Trace B	store-blank
Trace C	store-blank
Trace math	cleared
Trace registers	unaffected
Trigger	free
Video averaging	off

**Key Path**

MODE
EMC  
ANALYZER

**Related Programming Command**

INSTTYPE

---

**ENTER**

Hardkey that enters a numerical value that has been entered from the front panel using the keypad, knob, or step up/down keys.

---

**EP LQ570**  
**SML LRG**

Softkey that specifies EPSON LQ570 as the printer connected to the output port.

**Key Path**

**Print** **Set B&W** **EP LQ570**  
**CONFIG** **Config** **Printer** **SML LRG**

---

**EP MX80**  
**SML LRG**

Softkey that specifies EPSON MX80 as the printer connected to the output port.

**Key Path**

**Print** **Set B&W** **EP MX80**  
**CONFIG** **Config** **Printer** **SML LRG**

---

**ERASE**  
**DLP MEM**

Softkey that allows you to dispose of the DLPs, all traces defined by TRDEF, and all VARDEF variables in memory.

**Key Path**

**More** **Dispose** **ERASE**  
**CONFIG** **1 of 3** **User Mem** **DLP MEM**

**Related Programming Command**

DISPOSE

---

**ERASE**  
**MEM CARD**

Softkey that allows you to dispose of any data or programs stored on the memory card by formatting it. This is the same as **FORMAT CARD**.

**Key Path**

**More** **Dispose** **ERASE**  
**CONFIG** **1 of 3** **User Mem** **MEM CARD**

**Related Programming Command**

FORMAT

---

**ERASE  
STATEALL**

*Changes to MEM LOCKED when SAVE LOCK is on.*

Softkey that allows you to purge all the user state registers 1 through 9.

**Key Path**

**(CONFIG)** More 1 of 3 Dispose User Mem ERASE STATEALL

---

**ERASE  
TRACEALL**

*Changes to MEM LOCKED when SAVE LOCK is on.*

Softkey that disposes of any or all user-defined traces.

**Key Path**

**(CONFIG)** More 1 of 3 Dispose User Mem ERASE TRACEALL

---

**EXECUTE  
TITLE**

Softkey that executes a programming command displayed in the screen title area of the instrument. The **Change Title** function can be used to print programming commands in the screen title area of the display. The commands can then be executed from the front panel of the instrument, without an external computer, by pressing the **EXECUTE TITLE** softkey.

**Key Path**

**(CAL)** More 1 of 4 More 2 of 4 Service Cal EXECUTE TITLE

---

**EXIT**

Softkey that exits the **EDIT FLATNESS** menu. This is a service calibration function and is designed for service use only.

**Key Path**

**(CAL)** More 1 of 4 More 2 of 4 Service Cal Flatness Data More EXIT

---

**EXIT  
CATALOG**

Softkey that returns the instrument to the state it was in before the current catalog function was invoked. It clears the catalog display and returns to a normal display.

**Key Path**

<b>SAVE/RECALL</b>	Recall Card	...	*	EXIT CATALOG
<b>SAVE/RECALL</b>	Save Card	...	*	EXIT CATALOG
<b>SAVE/RECALL</b>	Recall Card	More 1 of 3	... †	EXIT CATALOG
<b>SAVE/RECALL</b>	Recall Internal	Catalog Internal	§	EXIT CATALOG
<b>SAVE/RECALL</b>	Save Card	CATALOG CARD		EXIT CATALOG
<b>SAVE/RECALL</b>	Recall/Recall Card	CATALOG CARD		EXIT CATALOG
<b>SAVE/RECALL</b>	Save Internal	Catalog Internal	... §	EXIT CATALOG
<b>SAVE/RECALL</b>	Recall Internal	Catalog Internal	... §	EXIT CATALOG

*EMC Analyzer mode.*

	Limit	RECALL	EXIT
(DISPLAY)	Lines	LIMITS	CATALOG

	More	Limit	RECALL	EXIT
(SETUP)	1 of 4	Lines	LIMITS	CATALOG

*Spectrum Analyzer mode.*

	RECALL	EXIT
(SETUP)	SETUP	CATALOG

	More	Save/Rcl	RECALL	EXIT
(TEST)	1 of 3	List	LIST	CATALOG

\* Any of the following can be used to complete the key path.

CATALOG CARD, RECALL SETUP, RECALL LIST, RECALL LIMITS  
or RECALL ANTENNA.

† Any of the following can be used to complete the key path.

RECALL CABLE, RECALL OTHER, or RECALL TRACE.

§ Any of the following can be used to complete the key path.

CATALOG ALL, CATALOG VARIABLES, CATALOG PREFIX, or  
CATALOG REGISTER.

---

EXIT  
EDIT

Softkey that exits the annotation editor.

**Key Path**

	EDIT	EXIT
(OUTPUT)	ANNOTATN	EDIT

**Related Programming Command**

EXITANNOT

---

**EXIT  
GRAPH**

Softkey that exits the **SAVE LIN GRAPH** or **SAVE LOG GRAPH** report graph functions.

**Key Path**

	More	Save/Rcl	SAVE	EXIT
(TEST)	1 of 3	List	LIN GRAPH	GRAPH

	More	Save/Rcl	SAVE	EXIT
(TEST)	1 of 3	List	LOG GRAPH	GRAPH

**Related Programming Command**

SIGGRAPH

---

**EXIT  
MEASURE**

Softkey that exits the **MEAS STEPPED** menu.

**Key Path**

	More	More	MEAS	EXIT
(TEST)	1 of 3	2 of 3	STEPPED	MEASURE

	More	More	MEAS	EXIT	
(TEST)	1 of 3	2 of 3	STEPPED	STOP	MEASURE

	More	More	MEAS	FREQ	EXIT
(TEST)	1 of 3	2 of 3	STEPPED	STEP	MEASURE

**EXIT  
SHOW**

Softkey that exits the **SHW INST CONFIG** function.

**Key Path**

	More	SHW INST	EXIT
(CONFIG)	1 of 3	CONFIG	SHOW

**Related Programming Command**

HAVE, ID, REF, SER

---



## EXTERNAL

Softkey that activates the trigger condition that allows the next sweep to start when an external voltage (connected to EXT TRIG INPUT on the rear panel) passes through approximately 1.5 volts. The external trigger signal must be a 0 V to +5 V TTL signal.

### Key Path

(SWEEP/TRIG) Trigger EXTERNAL

### Related Programming Command

TM

---

## EXTERNAL PREAMPG

Softkey that adds a positive or negative preamplifier gain value, which is subtracted from the displayed signal. EXTERNAL PREAMPG is similar to the REF LVL OFFSET; however, with the EXTERNAL PREAMPG, the attenuation may be changed depending on the preamplifier gain entered. A preamplifier gain offset is used for measurements that require an external preamplifier or long cables. The offset is subtracted from the amplitude readout so that the displayed signal level represents the signal level at the input of the preamplifier. The preamplifier gain offset is displayed at the top right hand-side of the screen and is removed by entering zero. The preamplifier gain offset is entered using the data keys. Press CAL STORE if you want the instrument to use the current preamplifier gain offset when power is turned on. Preamplifier gain offset is set to zero when DEFAULT CONFIG is pressed. The preamplifier gain value is not affected by an instrument preset.

### Key Path

(AMPLITUDE) 1 of 3 More EXTERNAL  
PREAMPG

### Related Programming Command

PREAMPG

---

**FAST STP  
ON OFF**

Softkey that determines how stepped measurements are made. When OFF is selected, the MEAS STEPPED softkey performs a stepped measurement between the specified start and stop frequencies in increments set by the FREQ STEP softkey measuring all the selected detectors to the full accuracy of the instrument. When ON is selected and a limit margin is on (MARGIN # ON OFF), only the steps where the peak amplitude exceeds the limit margin are measured using the selected detectors. Using this softkey under normal conditions results in faster measurements due to the limited number of signals being measured.

**Key Path**

More More FAST STP  
(TEST) 1 of 3 2 of 3 ON OFF

More More FAST STP  
(SETUP) 1 of 4 2 of 4 ON OFF

**Related Programming Command**

LOGSWPSPEED

---

**FFT MEAS**

*This softkey is only available when LIN is selected for the SWEEP LOG LIN softkey.*

Softkey that activates a discrete fast Fourier transform based on the current setup. For additional information refer to Chapter 8.

**Key Path**

More  
(AUX/USER) 1 of 3 FFT MEAS

**Related Programming Command**

FFT

---

**FINE  
TUNE DAC**

Softkey that displays the output of the YTO fine-tune DAC, which is produced on the A7 analog interface assembly. This is a service diagnostic function and is for service use only.

**Key Path**

More More Service FINE  
(CAL) 1 of 4 2 of 4 Diag More 1 ... More 3 TUNE DAC

---

## FLAT

Softkey that draws a zero-slope line between the coordinate point of the current segment and the coordinate point of the next segment, producing limit-line values equal in amplitude for all frequencies between the two points. If the amplitude values of the two segments differ, the limit line “steps” to the frequency value of the second segment.

### Key Path

*EMC Analyzer mode.*

```
Limit      EDIT  Select  
Lines     LIMIT Type  FLAT  
(DISPLAY) ... *
```

```
More  Limit      EDIT  Select  
1 of 4 Lines     LIMIT Type  FLAT  
(SETUP)
```

*Spectrum Analyzer mode.*

```
Limit  Edit      Select  
Lines Limit     Type  FLAT  
(DISPLAY) ... †
```

```
More  Limit  Edit      Select  
1 of 4 Lines Limit     Type  FLAT  
(SETUP)
```

\* Either `Limit 1` or `Limit 2` can be used to complete the key path.

† Any of the following can be used to complete the key path:

`EDIT UPPER`, `EDIT LOWER`, `EDIT UP/LOW`, or `EDIT MID/DELT`.

---

## Flatness Data

Softkey that accesses a menu used to view or edit the flatness-correction constants. This is a service calibration function and is for service use only.

### Key Path

```
More  More  Service  Flatness  
1 of 4 2 of 4 Cal     Data  
(CAL)
```

---

## FM COIL DRIVE

Softkey that displays the output of the FM coil driver produced on the A7 analog interface assembly. This is a service diagnostic function and is for service use only.

### Key Path

```
More  More  Service  FM COIL  
1 of 4 2 of 4 Diag     More 1  DRIVE  
(CAL)
```

## FM GAIN

Softkey that adjusts the FM deviation display. The center graticule represents zero deviation. The top graticule is the positive deviation set by FM GAIN. The bottom graticule is the negative deviation set by FM GAIN. The range for FM gain is from 3 kHz to 1.175 MHz. The default value is 100 kHz. This is a service calibration function and is for service use only.

### Key Path

(CAL) More 1 of 4 More 2 of 4 Service Diag More 1 ... More 4 FM GAIN

(DEM) FM GAIN

### Related Programming Command

FMGAIN

---

## FM OFFSET

Softkey that adjusts the horizontal trace for center-screen with no modulation on the carrier. This is a service diagnostic function and is for service use only.

### Key Path

(CAL) More 1 of 4 More 2 of 4 Service Diag More 1 ... More 4 FM OFFSET

---

## FM SPAN

Softkey that displays the FM SPAN signal from the span dividers on the A7 Analog Interface assembly. This is a service diagnostic function and is for service use only.

### Key Path

(CAL) More 1 of 4 More 2 of 4 Service Diag More 1 FM SPAN

---

**FORMAT  
CARD**

Softkey that formats a card in logical interchange (LIF) format. This is the same as **ERASE MEM CARD**. The memory card is formatted with the volume label "HP859X".

**Key Path**

**(CONFIG)** More Card **FORMAT**  
1 of 3 Config **CARD**

**Related Programming Command**

FORMAT

---

**FREE RUN**

Softkey that activates the trigger condition to start the next sweep as soon as possible after the last sweep.

**Key Path**

**(SWEEP/TRIG)** Trigger **FREE RUN**

**Related Programming Command**

TM

---

**FREQ  
DIAG**

Softkey that displays, in real-time, frequency diagnostic information for the local oscillator section. This is a service diagnostic function and is for service use only.

**Key Path**

More More Service **FREQ**  
**(CAL)** 1 of 4 2 of 4 Diag More 1 ... More 4 **DIAG**

---

## FREQ OFFSET

Softkey that inputs a frequency offset value that is added to the frequency readout, to account for frequency conversions external to the instrument. Offset entries are added to all frequency readouts including marker, start frequency, and stop frequency. Entering an offset does not affect the trace. Offsets are not added to the span. Frequency offsets are entered using the data keys.

When a frequency offset is entered, its value is displayed on the top left side of the screen. To eliminate an offset, press **FREQ OFFSET** and 0 **ENTER**. Pressing **PRESET** also sets the offset to zero.

### Key Path

**FREQUENCY** **More** **FREQ**  
1 of 2 **OFFSET**

### Related Programming Command

FOFFSET

---

FREQ SCL  
LOG LIN

Softkey that specifies whether the limit line is derived from a logarithmic or linear frequency axis. Underline LIN to set the frequency axis to linear or LOG to set the frequency axis to logarithmic.

### Key Path

More Correctn Antenna EDIT More  
(SETUP) 1 of 4 Factors Factors ANTENNA 1 of 2  
FREQ SCL  
LOG LIN

More Correctn Cable EDIT More FREQ SCL  
(SETUP) 1 of 4 Factors Factors CABLE 1 of 2 LOG LIN

More Correctn Other EDIT More FREQ SCL  
(SETUP) 1 of 4 Factors Factors OTHER 1 of 2 LOG LIN

#### EMC Analyzer mode.

Limit EDIT Select Select FREQ SCL  
(DISPLAY) Lines ... \* LIMIT Type Axis LOG LIN

More Limit EDIT Select Select  
(SETUP) 1 of 4 Lines ... \* LIMIT Type Axis  
FREQ SCL  
LOG LIN

#### Spectrum Analyzer mode.

Limit Edit Select Select FREQ SCL  
(DISPLAY) Lines Limit ... † Type Axis LOG LIN

More Limit Edit Select Select  
(SETUP) 1 of 4 Lines Limit ... † Type Axis  
FREQ SCL  
LOG LIN

\* Either Limit 1 or Limit 2 can be used to complete the key path.

† Any of the following can be used to complete the key path:

EDIT UPPER, EDIT LOWER, EDIT UP/LOW, or EDIT MID/DELT.

### Related Programming Command

LIMIFRQSC

**FREQ  
STEP**

Softkey that sets the size of the frequency step for stepped measurements.

**Key Path**

**(SETUP)** More 1 of 4 More 2 of 4 FREQ STEP

**(TEST)** More 1 of 3 More 2 of 3 MEAS STEPPED FREQ STEP

**(TEST)** More 1 of 3 More 2 of 3 MEAS STEPPED STOP FREQ STEP

---

**FREQUENCY**

Hardkey that activates the center-frequency or start-frequency function and accesses a menu of other frequency functions. The center frequency or start frequency value appears below the graticule on the screen.

Although the instrument allows entry of frequencies greater than the specified frequency range, using frequencies greater than the frequency span of the instrument is not recommended.

**Note**

When changing both the center frequency and the span, change the frequency first since the span can be limited by the frequency value.

---

**FRQ DISC  
NORM OFF**

Softkey that indicates the status of the frequency discriminator as a function of LO span. This is a service diagnostic function and is for service use only.

**Key Path**

**(CAL)** More 1 of 4 More 2 of 4 Service Diag More 1 ... More 4 FRQ DISC NORM OFF

---



FRQ SCAN  
ON OFF

Softkey that reduces the signal span at the marker to zero span by performing an automatic zoom. When **FREQ SCAN ON OFF** is off, the instrument is restored to its previous setting with the exception of the marker which is placed at the same frequency as the zero scan (span) frequency.

**Key Path**

FRQ SCAN  
(TEST) ON OFF

**Related Programming Command**

RECZOOM

---

FULL  
SPAN

Softkey that changes the instrument span to full span. The span can be limited if harmonic band lock (**BND LOCK ON OFF**) is set to ON.

**Key Path**

FULL  
(SPAN) SPAN

**Related Programming Command**

FS

---

Gauss

Softkey that selects gauss as the transducer conversion units for the antenna amplitude-correction factors.

**Key Path**

More Correctn Antenna RECALL More  
(SETUP) 1 of 4 Factors Factors ANTENNA 1 of 2  
Antenna  
Units Gauss

**Related Programming Command**

XUNITS

---

## GHIJKL

Softkey that accesses the menu used for selecting screen title or prefix characters G through L.

### Key Access

**CAL**, **CONFIG**, **DISPLAY**, **SAVE/RECALL**, or **SETUP**

### Related Programming Command

TITLE, PREFX

---

## GND REF DETECTOR

Softkey that displays the output of the analog-ground reference produced on the A16 processor/video assembly. This is a service diagnostic function and is for service use only.

### Key Path

**CAL** More 1 of 4 More 2 of 4 Service Diag More 1 GND REF DETECTOR

---

## GRAT ON OFF

Softkey that turns the screen graticule on and off. This is helpful when alternative graphics are drawn on the screen through a remote controller and during plotting, when a graticule is not required.

### Key Path

**DISPLAY** More 1 of 2 GRAT ON OFF

### Related Programming Command

GRAT

---

## HOLD

Softkey that deactivates the active function and blanks the active function text from the display. No data can be accidentally entered using the knob, step keys, or data keys. Activating another function will turn off the hold function.

### Key Path

**DISPLAY** HOLD

### Related Programming Command

HD

---

HP B&W  
PRINTER

Softkey that selects a black and white printer. Use this function if you have a black and white HP printer, or if you are using a color printer, but want to print in black and white.

**Key Path**

(CONFIG) Print Set B&W HP B&W  
Config Printer PRINTER

---

HP B&W  
DJ540

Softkey that selects a black and white printer. Use this function if you have a black and white HP DeskJet 540 printer.

**Key Path**

(CONFIG) Print Set B&W HP B&W  
Config Printer DJ540

---

IDNUM

Softkey that is used when the instrument is powered on the first time. It inputs the instrument model number and option information. This is a service calibration function and is for service use only.

**Key Path**

(CAL) More More Service Flatness  
1 of 4 2 of 4 Cal Data IDNUM

---

IF BW  
AUTO MAN

Softkey that specifies the intermediate frequency bandwidth. When MAN is underlined, the coupling between center frequency (EMC analyzer mode) or span (spectrum analyzer mode) and intermediate frequency bandwidth is disabled. When AUTO is underlined, coupling is reestablished.

**Key Path**

(AUTO COUPLE) IF BW  
AUTO MAN  
(BW) IF BW  
AUTO MAN

**Related Programming Command**

IFBW, RB

---

## IF GAINS

Softkey that displays the gain setting of the following: RF Atten, 3rd Conv DAC, 21.4 Gain, Cal Atten, Lin Gain, and NBW Sgain. This is a service calibration function and is for service use only.

### Key Path

**(CAL)** More More Service  
1 of 4 2 of 4 Diag IF GAINS

---

## INIT FLT

*INIT FLT 22 GHz: HP 8593EM only.*

*INIT FLT 26.5 GHz: HP 8593EM Option 026 and 027 only.*

Softkey that is used when the instrument is powered on the first time. It sets the defaults for instrument flatness including the start and stop frequencies and the step size. All of the correction values are set to zero. This is a service calibration function and is for service use only.

### Key Path

**(CAL)** More More Service Flatness INIT  
1 of 4 2 of 4 Cal Data FLT

---

## INPT LCK ON OFF

*Only available when used with an HP 85420E Option 1EM RF filter section.*

Softkey that limits tuning to values within the currently selected input path. For example, when input lock is on, and a stop frequency is selected out of the range of the currently selected input path, the actual stop frequency used will be the highest possible value allowed by the selected input path.

### Key Path

**(FREQUENCY)** More INPT LCK  
1 of 2 ON OFF

### Related Programming Command

RFLINK

---

## Input

*Only available when used with an HP 85420E Option 1EM RF filter section.*

Softkey that accesses a menu that allows switching Input 1, Input 2, Input 2 (bypass) or the 300 MHz calibrator signal so that it is routed to the RF input of the instrument.

### Key Path

**(SETUP)** **More** **More** **More** **More** **Input**  
1 of 5 2 of 5 3 of 5 4 of 5

---

## INPUT 1 9k-50M

*Only available when used with an HP 85420E Option 1EM RF filter section.*

Softkey that specifies the 9 kHz to 50 MHz input path (INPUT 1) as the signal routing path of the HP 8590 EM series used with an HP 85420E Option 1EM.

### Key Path

**(SETUP)** **More** **More** **More** **More** **Input** **INPUT 1**  
1 of 5 2 of 5 3 of 5 4 of 5 9k-50M

### Related Programming Command

RFIN

---

## INPUT 2 20M-2.9G

*Only available when used with an HP 85420E Option 1EM RF filter section.*

Softkey that specifies the 20 MHz to 2.9 GHz input path (INPUT 2) as the signal routing path of the HP 8590 EM series used with an HP 85420E Option 1EM.

### Key Path

**(SETUP)** **More** **More** **More** **More** **Input** **INPUT 2**  
1 of 5 2 of 5 3 of 5 4 of 5 20M-2.9G

### Related Programming Command

RFIN

---

## INPUT 2 BYPASS

*Only available when used with an HP 85420E Option 1EM RF filter section.*

Softkey that specifies the bypass input path (INPUT 2) as the signal routing path of the HP 8590 EM series used with an HP 85420E Option 1EM.

### Key Path

**(SETUP)** More More More More INPUT 2  
1 of 5 2 of 5 3 of 5 4 of 5 Input BYPASS

### Related Programming Command

BYPASS, RFIN

---

## INPUT Z 50Ω 75Ω

Softkey that sets the input impedance for voltage-to-power conversions. The impedance you select is for computational purposes only, since the actual impedance of 50Ω is set by internal hardware. The preset value can be changed by using a service function. Select the computational input impedance by pressing **INPUT Z 50Ω 75Ω** or by entering 50 or 75 using the data keys.

### Key Path

**(AMPLITUDE)** More More INPUT Z  
1 of 3 2 of 3 50Ω 75Ω

### Related Programming Command

INZ

---

## INTERNAL → STATE

Softkey that recalls the saved instrument state from the selected state register. To recall a state, press **INTERNAL → STATE** and use the data keys to enter a state register number (valid state register numbers are 1 through 9). State register 9 contains a previous state; state register 0 contains the current state. If windows are being used, the instrument state can only be recalled into the active window.

### Key Path

**(SAVE/RECALL)** Recall INTERNAL  
Internal → STATE

### Related Programming Command

RCLS

---

**Internal**  
→ **Trace**

Softkey that accesses a menu that allows you to either; select the trace in which the trace data is to be recalled (trace A, trace B, or trace C), or recall the current limit-line tables. When recalling a trace, select the trace in which the trace data is to be recalled, enter the trace register number, and press **(ENTER)**. If windows are being used, only the trace of the active window can be recalled.

When recalling a limit-line table, press **LIMIT LINES**, enter the trace register number, and press **(ENTER)**. Valid trace register numbers are 0 through the maximum register number. The maximum register number is the number displayed after **MAX REG # =** during a save or recall operation. If a screen title is present, it is recalled with the trace data (but not with the limit-line table). If the screen title does not exceed 34 characters, the time and date when the data was stored will also be displayed. **INVALID SAVEREG** is displayed if data has not been stored in the trace register.

**Key Path**

**(SAVE/RECALL)** **Recall** **Internal**  
**Internal** → **Trace**

**Related Programming Command**

RCLT

---

**LAST**  
**SPAN**

Softkey that changes the frequency span of the instrument to the previous span setting.

**Key Path**

**(SPAN)** **LAST**  
**SPAN**

**Related Programming Command**

LSPAN

---

## Limit 1

*EMC Analyzer mode only.*

Softkey that accesses the menu for displaying, testing, deleting, and editing of limit 1 and its corresponding margin.

### Key Path

Limit  
(DISPLAY) Lines Limit 1

More Limit  
(SETUP) 1 of 4 Lines Limit 1

### Related Programming Command

LIMINUM

---

## LIMIT 1 ON OFF

*EMC Analyzer mode only.*

Softkey that displays limit line 1 when ON is underlined.

### Key Path

Limit LIMIT 1  
(DISPLAY) Lines Limit 1 ON OFF

More Limit LIMIT 1  
(SETUP) 1 of 4 Lines Limit 1 ON OFF

### Related Programming Command

LIMILINESTA

---

## Limit 2

*EMC Analyzer mode only.*

Softkey that accesses a menu for displaying, testing, deleting, and editing of limit 2 and its corresponding margin.

### Key Path

Limit  
(DISPLAY) Lines Limit 2

More Limit  
(SETUP) 1 of 4 Lines Limit 2

### Related Programming Command

LIMINUM

---



LIMIT 2  
ON OFF

*EMC Analyzer mode only.*

Softkey that displays limit line 2 when ON is underlined.

### Key Path

Limit  
(DISPLAY) Lines Limit 2 ON OFF

More Limit LIMIT 2  
(SETUP) 1 of 4 Lines Limit 2 ON OFF

### Related Programming Command

LIMILINESTA

---

Limit  
Lines

Softkey that accesses the limit-line menus.

### Key Path

Limit  
(DISPLAY) Lines

More Limit  
(SETUP) 1 of 4 Lines

---

## LIMIT LINES

Softkey that saves or recalls limit-line tables in a trace register to or from a card or internal memory.

When accessed by **(SAVE/RECALL)**, the current limit-line table is stored to a trace register in internal memory or on a card. To save a limit-line table press, **LIMIT LINES . REGISTER #** and **PREFIX=** are displayed on the screen. Use the data keys to enter the desired register number then press **(ENTER)**. The limit-line table is then saved to a card.

When accessed by **(SAVE/RECALL)**, the limit-line table will be recalled from a trace register in internal memory. To recall a limit-line table press, **LIMIT LINES**, use the step keys or knob to highlight the desired file then press **LOAD FILE**.

### Key Path

<b>(SAVE/RECALL)</b>	Recall	Internal	LIMIT
	Internal	→ Trace	LINES
<b>(SAVE/RECALL)</b>	Save	Trace	LIMIT
	Internal	→ Intrnl	LINES
<b>(SAVE/RECALL)</b>	Save More	Trace	LIMIT
	Card 1 of 3	→CARD	LINES

---

## LIMITS → CARD

Softkey that saves the current limit-line data to a card. To save a limit line press, **LIMITS → CARD**. **REGISTER #** and **PREFIX=** are displayed on the screen. Use the data keys to enter the desired register number then press **(ENTER)**. The limit line is then saved to a card.

### Key Path

<b>(SAVE/RECALL)</b>	Save	LIMITS
	Card	→ CARD

### Related Programming Command

STOR

---

## LIMITS FIX REL

*Spectrum Analyzer mode only.*

Softkey that allows you to choose fixed or relative type of limit lines. The fixed (FIX) type uses the current limit line as a reference with fixed frequency and amplitude values. The relative (REL) setting causes the current limit-line value to be relative to the displayed center frequency and reference-level amplitude values. When limit lines are specified with time, rather than frequency, the relative setting only affects the amplitude values. The current amplitude values will be relative to the displayed reference-level amplitude, but the time values will always start at the left edge of the graticule.

As an example, assume you have a frequency limit line. If the limit line is specified as fixed, entering a limit-line segment with a frequency coordinate of 300 MHz displays the limit-line segment at 300 MHz. If the same limit-line table is specified as relative, it is displayed relative to the center frequency and reference level of the instrument. If the center frequency is at 1.2 GHz, a relative limit-line segment with a frequency coordinate of 300 MHz will display the limit-line segment at 1.5 GHz. If the amplitude component of the relative limit-line segment is -10 dB, then -10 dB is added to the reference level value to obtain the amplitude of the given component (reference level offset included).

RELATIVE is displayed in the limit-line table when the limit-line type is relative; FIXED is displayed when limit-line type is fixed.

A limit line entered as fixed may be changed to relative, and one entered as relative may be changed to fixed. When changing between fixed and relative limit-lines, the frequency and amplitude values in the limit-line table change so that the limit line remains in the same position for the current frequency and amplitude settings of the instrument. If a time and amplitude limit line is used, the amplitude values change but the time values remain the same.

### Key Path

```
Limit Edit More LIMITS
(DISPLAY) Lines Limit ... * 1 of 2 FIX REL

More Limit Edit More LIMITS
(SETUP) 1 of 4 Lines Limit ... * 1 of 2 FIX REL
```

\* Any of the following can be used to complete the key path:

EDIT UPPER, EDIT LOWER, EDIT UP/LOW, or EDIT MID/DELT.

### Related Programming Command

LIMIREL

LIMITS  
FRQ TIME

*Spectrum Analyzer mode only.*

Softkey that selects whether limit lines will be entered using frequency or sweep time to define the segments. Limit lines can be created by the user to test trace data. They can be specified as a table of limit-line segments of amplitude versus frequency, or of amplitude versus time. Time values are evaluated with respect to the EMC analyzer sweep time. A time value of zero corresponds to the start of the sweep, which is the left edge of the graticule.

Switching the limit line definition between frequency and time will erase the current limit-line table. The message If you are sure, press key again to purge data will appear. Press LIMITS FRQ TIME again to purge the limit-line table and switch between frequency and time.

**Key Path**

	Limit	Edit	LIMITS	
(DISPLAY)	Lines	Limit	FRQ TIME	
	More	Limit	Edit	LIMITS
(SETUP)	1 of 4	Lines	Limit	FRQ TIME

**Related Programming Command**

LIMIFT

---

LIN CHCK  
ON OFF

Softkey that determines whether a given signal is undergoing compression by adding (ON) or removing (OFF) additional RF attenuation.

**Key Path**

	LIN CHCK		
(AMPLITUDE)	ON OFF		
	More	More	LIN CHCK
(TEST)	1 of 3	2 of 3	ON OFF

**Related Programming Command**

LINCHK

---

LIN  
ON OFF

Softkey that turns on or off the generation of a linear graph of the signal list. The linear graph is sent to the printer or plotter when **OUTPUT REPORT** is executed.

#### Key Path

Define LIN  
**OUTPUT** Report ON OFF

#### Related Programming Command

RPTDEF

---

**LINE**

Hardkey that powers up the instrument.

---

LIN

Softkey that activates the trigger condition that allows the next sweep to be synchronized with the next cycle of the line voltage.

#### Key Path

**SWEEP/TRIG** Trigger LIN

#### Related Programming Command

TM

---

LIST  
→ CARD

Softkey that saves the current signal list to a card. To save a signal list press, **LIST → CARD**. REGISTER # and PREFIX= are displayed on the screen. Use the data keys to enter the desired register number then press **ENTER**. The signal list is then saved to a card.

#### Key Path

Save LIST  
**SAVE/RECALL** Card → CARD

#### Related Programming Command

STOR

---

LIST  
ON OFF

Softkey that enables or disables the generation of a tabular listing of a signal list. The listing is sent to a printer when **OUTPUT REPORT** is executed.

#### Key Path

**OUTPUT** Define LIST  
Report ON OFF

#### Related Programming Command

RPTDEF

---

LMT DISP  
Y N AUTO

*Spectrum Analyzer mode only.*

Softkey that displays any portion of the limit lines that are currently within the display boundary of the EMC analyzer. If Y (yes) is underlined the limit lines are displayed. If N (no) is underlined they are not displayed. If AUTO is underlined, the display of the limit lines is dependent on the limit test function. The limit lines will be displayed while the limit test function is turned on, otherwise they will be turned off.

#### Key Path

**DISPLAY** Limit LMT DISP  
Lines Y N AUTO

**SETUP** More Limit LMT DISP  
1 of 4 Lines Y N AUTO

#### Related Programming Command

LIMIDISP

---

LMT TEST  
ON OFF

Softkey that turns the limit-line testing and (if LMT DISP AUTO is selected) turns the display of the limit lines on and off. When limit-line testing is enabled, every measurement sweep of trace A is compared to the limit lines.

### Key Path

*EMC Analyzer mode.*

(DISPLAY)	Limit Lines	...	*	LMT TEST ON OFF
(SETUP)	More 1 of 4	Limit Lines	...	LMT TEST ON OFF

\* Either Limit 1 or Limit 2 can be used to complete the key path.

*Spectrum Analyzer mode.*

(DISPLAY)	Limit Lines	LMT TEST ON OFF	
(SETUP)	More 1 of 4	Limit Lines	LMT TEST ON OFF

### Related Programming Command

LIMIFAIL, LIMITEST

**LOAD  
FILE**

Softkey that loads a file from the card or a register into instrument memory.

Use the step keys or knob to view sections of the directory, then press **LOAD FILE** to select the highlighted file or register.

**Note**

Use of the **LOAD FILE** softkey is not recommended for recalling limit-line tables or amplitude-correction factors stored in internal memory.

**Key Path**

**SAVE/RECALL** Save Card CATALOG CARD LOAD FILE

**SAVE/RECALL** Recall Card CATALOG CARD LOAD FILE

**SAVE/RECALL** Save Internal Catalog Internal CATALOG REGISTER LOAD FILE

**SAVE/RECALL** Recall Internal Catalog Internal CATALOG REGISTER LOAD FILE

**SETUP** RECALL SETUP LOAD FILE

**SETUP** More 1 of 4 Correctn Factor ... § LOAD FILE

**TEST** More 1 of 3 Save/Rcl List RECALL LIST LOAD FILE

\* Any of the following can be used to complete the key path:  
**CATALOG CARD**, **RECALL SETUP**, **RECALL LIST**, **RECALL LIMITS**,  
or **RECALL ANTENNA**.

† Any of the following can be used to complete the key path:  
**RECALL CABLE**, **RECALL OTHER**, or **RECALL TRACE**.

§ Any of the following groups of softkeys can be used to complete the key path:  
**Antenna Factors RECALL ANTENNA**, or **Cable Factors RECALL CABLE**,  
or **Other Factors RECALL OTHER**.



*EMC Analyzer mode.*

	Limit	RECALL	LOAD
(DISPLAY)	Lines	LIMITS	FILE

	More	Limit	RECALL	LOAD
(SETUP)	1 of 4	Lines	LIMITS	FILE

### Related Programming Command

LOAD

---

**(LOCAL)** Pressing (CONFIG) (LOCAL) after the instrument has been placed in the remote mode places the instrument in the local mode and enables front-panel control. During remote operation, “R” appears in the lower-left corner of the screen indicating remote and talk. A “T” or “L” may appear during remote operation, indicating talk or listen. Pressing the (CONFIG) key removes the “R” symbol in the lower-left corner.

---

LOG
ON OFF

Softkey that turns on or off the generation of a logarithmic graph of the signal list. The logarithmic graph is sent to the printer or plotter when OUTPUT REPORT is executed.

### Key Path

	Define	LOG
(OUTPUT)	Report	ON OFF

### Related Programming Command

RPTDEF

---

LOGF SPD  
STD FAST

*This softkey is only available when LOG is selected for the SWEEP LOG LIN softkey.*

Softkey that selects between optimizing the frequency accuracy or minimizing the scan time. When “STD” is selected the frequency accuracy of the sweep is optimized. When “FAST” is selected the scan time of the sweep is minimized.

**Note**

Selecting the LOGF SPD STD FAST function has an effect on the minimum sweep time selected by the SWP TIME AUTO MAN function. The minimum sweep time is less than or equal to the minimum sweep time when SWP TIME AUTO MAN (AUTO) is selected.

**Key Path**

More LOGF SPD  
(FREQUENCY) 1 of 2 STD FAST

LOGF SPD  
(SWEEP/TRIG) STD FAST

**Related Programming Command**

LOGSWEEPSPD

MAIN  
COIL DR

Softkey that displays the output produced by the main-coil driver on the A7 analog interface assembly. This is a service diagnostic function and is for service use only.

**Key Path**

More More Service MAIN  
(CAL) 1 of 4 2 of 4 Diag More 1 COIL DR

MAIN  
SPAN

Softkey that displays the main-coil-span signal, MC\_SPAN, from the span dividers on the A7 analog interface assembly. This is a service diagnostic function and is for service use only.

**Key Path**

More More Service MAIN  
(CAL) 1 of 4 2 of 4 Diag More 1 More 2 SPAN

MAN TRK  
ADJUST

Softkey that allows the user to adjust the frequency of the tracking-generator oscillator manually using the step keys or knob. The tracking adjust is tuned to maximize the amplitude of the trace.

Tracking error occurs when the output frequency of the tracking generator is not exactly matched to the input frequency of the instrument. The resulting mixing product from the instrument input mixer is not at the center of the IF bandwidth. Any tracking errors may be compensated for by manually adjusting the oscillator of the tracking generator, or by performing an automatic tracking routine, which is initiated by pressing TRACKING PEAK .

### Key Path

(AUX/USER) Track Gen MAN TRK  
ADJUST

### Related Programming Command

SRCTK

---

MARGIN 1  
ON OFF

Softkey that sets the amplitude (in negative decibels) and display state for limit margin 1. The limit margin is a fixed amplitude relative to the limit line.

### Key Path

*EMC Analyzer mode only.*

(DISPLAY) Limit Lines Limit 1 MARGIN 1  
ON OFF

(SETUP) More Limit Lines Limit 1 MARGIN 1  
1 of 4 ON OFF

### Related Programming Command

LIMIMARGAMP, LIMIMARGSTA

---

MARGIN 2  
ON OFF

Softkey that sets the amplitude (in negative decibels) and display state for limit margin 2. The limit margin is a fixed amplitude relative to the limit line.

### Key Path

*EMC Analyzer mode only.*

Limit MARGIN 2  
Lines Limit 2 ON OFF  
(DISPLAY)

More Limit MARGIN 2  
1 of 4 Lines Limit 2 ON OFF  
(SETUP)

### Related Programming Command

LIMIMARGAMP, LIMIMARGSTA

---

MARK ALL  
DUPLICAT

Softkey that marks all identical signals in the signal list. Duplicate signals are those whose frequencies are too close to each other to be resolved as distinct signals.

### Key Path

More EDIT Signal Selectv MARK ALL  
1 of 3 LIST Marking Mark DUPLICAT  
(TEST)

### Related Programming Command

SIGMARK

---

MARK ALL  
SIGNALS

Softkey that marks all signals in the signal list.

### Key Path

More EDIT Signal MARK ALL  
1 of 3 LIST Marking SIGNALS  
(TEST)

### Related Programming Command

SIGMARK

---

MARK LWR  
DUPLICAT

Softkey that marks all duplicate signals in the list that are lower in peak amplitude. Duplicate signals are those whose frequencies are too close to each other to be resolved as distinct signals.

**Key Path**

More EDIT Signal Selectv MARK LWR  
(TEST) 1 of 3 LIST Marking Mark DUPLICAT

**Related Programming Command**

SIGMARK

---

MARK  
SIGNAL

Softkey that marks the highlighted signal in the signal list.

**Key Path**

More EDIT Signal MARK  
(TEST) 1 of 3 LIST Marking SIGNAL

**Related Programming Command**

SIGMARK

---

MARK TO  
END

Softkey that marks all signals, after the highlighted signal, to the end of the list.

**Key Path**

More EDIT Signal Selectv MARK TO  
(TEST) 1 of 3 LIST Marking Mark END

**Related Programming Command**

SIGMARK

---

## MARKER

Softkey that activates a single marker on the result of a stepped measurement. Use the knob, step keys and data keys to position the marker. When a measurement point is selected with the marker, the frequency and the selected detectors (peak, quasi-peak, and average detectors) are displayed in the marker box.

### Key Path

(TEST) More More MEAS  
1 of 3 2 of 3 STEPPED STOP MARKER

More More MEAS FREQ  
(TEST) 1 of 3 2 of 3 STEPPED STEP MARKER

### Related Programming Command

MKN

---

## MARKER # ON OFF

Softkey that turns the selected marker on or off. One of the four markers must first be selected by the SELECT 1 2 3 4 key, otherwise marker 1, or the last selected marker, will be turned on or off. When a new marker is turned on by pressing MARKER # ON OFF, the MK TRACE AUTO ABC function always switches to AUTO and the marker is put on the trace that is selected by the AUTO mode.

### Key Path

MARKER 1  
(MKR) ON OFF

### Related Programming Command

MKACTV

---

## MARKER $\Delta$

Softkey that activates a second marker at the position of the first marker. (If no marker is present, two markers appear at the center of the display.) The amplitude and frequency of the first marker is fixed, and the second marker is under your control. Annotation in the active function block and in the upper-right corner of the screen indicates the frequency and amplitude differences between the two markers. The display mode must not be changed between log and linear while using a delta marker.

### Note

If there are already four markers when **MARKER  $\Delta$**  is pressed, a nonactive marker disappears, the active marker becomes a reference marker, and the delta marker becomes the active marker.

---

### Key Path

(MKR) MARKER  $\Delta$

More More  
(MKR  $\rightarrow$ ) 1 of 3 2 of 3 MARKER  $\Delta$

### Related Programming Command

MKD

---

## MARKER $\Delta$ SPAN

Softkey that sets the start and stop frequencies to the values of the delta markers. The start and stop frequencies will not be set if the delta marker is off.

### Key Path

More More MARKER  
(MKR  $\rightarrow$ ) 1 of 3 2 of 3  $\Delta$  SPAN

### Related Programming Command

MKSP

---

## MARKER $\rightarrow$ CF

Softkey that changes the instrument settings so that the frequency at the marker becomes the center frequency.

### Key Path

MARKER  
(MKR  $\rightarrow$ )  $\rightarrow$  CF

### Related Programming Command

MKCF

---

MARKER  
→CF STEP

Softkey that changes the center-frequency step size to match the value of the active marker. Press (FREQUENCY) then CF STEP AUTO MAN to view the step size. If marker delta is active, the step size will be set to the frequency difference between the markers.

#### Key Path

More MARKER  
(MKR →) 1 of 3 →CF STEP

#### Related Programming Command

MKSS

---

MARKER  
→ HIGH

Softkey that automatically places a marker on the highest amplitude of a trace and displays the marker's amplitude and frequency.

#### Key Path

MARKER  
(MKR →) → HIGH

#### Related Programming Command

MKPK

---

MARKER  
→MINIMUM

Softkey that moves the active marker to the minimum detected amplitude value.

#### Key Path

More MARKER  
(MKR →) 1 of 3 →MINIMUM

#### Related Programming Command

MKMIN

---



MARKER  
→PK-PK

Softkey that finds and displays the frequency and amplitude differences between the highest and lowest trace points. Pressing MARKER →PK-PK performs the routine similar to pressing the following keys: MKR →, More 1 of 3, and MARKER→MINIMUM.

#### Key Path

MKR → More 1 of 3 MARKER →PK-PK

#### Related Programming Command

MKPK

---

MARKER  
→REF LVL

Softkey that changes the instrument settings so that the amplitude at the active marker becomes the reference level.

#### Key Path

MKR → More 1 of 3 MARKER →REF LVL

#### Related Programming Command

MKRL

---

MARKER  
→ START

Softkey that changes the start frequency so that it is equal to the frequency of the active marker. This moves the active marker to the left edge of the display.

#### Key Path

MKR → More 1 of 3 More 2 of 3 MARKER → START

---

MARKER  
→ STOP

Softkey that changes the stop frequency so that it is equal to the frequency of the active marker. This moves the active marker to the right edge of the display.

#### Key Path

More More MARKER  
MRK → 1 of 3 2 of 3 → STOP

#### Related Programming Command

MKSTOP

---

MARKER  
ALL OFF

Softkey that turns off all of the markers, including markers used for marker track and demodulation. Marker annotation is also removed.

#### Key Path

More MARKER  
MKR 1 of 3 ALL OFF

#### Related Programming Command

MKOFF

---

MARKER  
AMPTD

Softkey that keeps the active marker at the requested amplitude on the screen. Once activated, the marker remains at the amplitude selected by the step keys, knob, or data keys, even if the signal frequency is changed. The marker will be placed on the signal furthest left at that amplitude. If no signal exists at that amplitude, it will be placed above the highest signal amplitude (or below the lowest trace element if it is below all trace elements). When marker delta is active in addition to marker amplitude, the behavior of the active marker is useful for measuring signal bandwidths. For example, place a marker 20 dB below the peak of a signal, press **MARKER AMPTD**. The marker readout shows the 20 dB bandwidth.

After selecting this softkey, pressing any digit, 0 through 9, brings up the appropriate amplitude terminator menu.

#### Key Path

MARKER  
MKR AMPTD

#### Related Programming Command

MKA, MKTYPE

---

## MARKER NORMAL

Softkey that activates a single frequency marker at the center frequency on the active trace if an onscreen marker is not already displayed. If there is an onscreen marker before the MARKER NORMAL function is enabled, a frequency marker is enabled at the position of the first marker. Use the data controls to position the marker. Annotation in the active function block and in the upper-right corner indicates the frequency and amplitude of the marker. The marker stays on the trace at the horizontal screen position where it was left unless **MK TRACK ON OFF**, **MARKER AMPTD**, or a “marker to” softkey function (such as **MARKER → CF**, **MARKER →REF LVL**, **MARKER →CF STEP**, **MARKER Δ SPAN**, or **MARKER →MINIMUM**) is selected. Pressing **MARKER NORMAL** turns off the marker-delta function.

### Key Path

**MARKER**  
**(MKR) NORMAL**

### Related Programming Command

MKN

---

## MARKER TUNE SPN

Softkey that modifies the behavior of the marker positioning functionality of the instrument when accessed through the data keys, knob, or stepkeys.

When **MARKER TUNE SPN** is activated and TUNE is underlined:

- Data key input, positions frequency and time markers at the specified numeric frequency input, tuning the instrument to the specified frequency if necessary. Numeric key-pad input terminators are “Hz, kHz, MHz, or GHz”.
- Knob input, repositions the marker position as a function of frequency, tuning the instrument to its specified frequency if the knob input places the marker position beyond the limits of the current span.
- Step-key input:
  - Zero-span, steps the marker to the edge of the display and retunes the instrument on succeeding step-key presses.
  - Non-zero span, positions the marker at the next peak left (⏪) or next peak right (⏩) by one half of the intermediate frequency bandwidth. If no signals exist, the marker is positioned at the left edge (⏪) or the right edge (⏩) of the display. If the marker is already at the edge of the display, subsequent steps retune the instrument by a step equal to the size of the current span.

### Key Path

MARKER  
(TEST) TUNE SPN

### Related Programming Command

RCVRRMRKR

---

MAX  
HOLD A

Softkey that maintains the maximum level for each trace point of trace A and updates each trace point if a new maximum level is detected in successive sweeps.

#### Key Path

			MAX	
(TRACE)			HOLD A	
	More	Save/Rcl	SAVE LIN	MAX
(TEST)	1 of 3	List	GRAPH	HOLD A
	More	Save/Rcl	SAVE LOG	MAX
(TEST)	1 of 3	List	GRAPH	HOLD A

#### Related Programming Command

MXMH

---

MAX  
HOLD B

Softkey that maintains the maximum level for each trace point of trace B and updates each trace point if a new maximum level is detected in successive sweeps.

#### Key Path

		MAX
(TRACE)		HOLD B

#### Related Programming Command

MXMH

---

MAX/MIN  
ON OFF

Softkey causes the analyzer to put trace B into max-hold mode and trace C into min-hold (trace A is active). When used with **MAX/MIN VIEW**, this function lets you discriminate between narrowband and broadband signals. Turning on this function turns off **NORM A/B ON OFF**.

#### Key Path

	More	MAX/MIN
(TRACE)	1 of 4	ON OFF

#### Related Programming Command

MAXMIN

---

**MAX/MIN  
VIEW**

*Only available when MAX/MIN is on.*

Softkey that allows the user to view **MAX/MIN ON OFF** function. All traces stop sweeping and the maximum and the minimum signals are displayed on the CRT.

**Key Path**

**TRACE** **More** **MAX/MIN**  
1 of 4 **VIEW**

**Related Programming Command**

MAXMIN

---

**MAX MXR  
LVL**

Softkey that lets you change the maximum input mixer level in 10 dB steps from -10 dBm to -100 dBm. The mixer level is equal to the reference level minus the attenuator setting. As the reference level changes, the input attenuator setting is changed to keep the power levels less than the selected level at the input mixer. Pressing **PRESET** resets the maximum input mixer level to -10 dBm.

**Key Path**

**AMPLITUDE** **More** **MAX MXR**  
1 of 3 **LVL**

**Related Programming Command**

ML

---

**MEAS  
SNG CONT**

Softkey that sets the stepped measurements for either single or continuous sweep mode.

**Key Path**

**TEST** **More** **More** **MEAS** **MEAS**  
1 of 3 2 of 3 **STEPPED** **SNG CONT**

**TEST** **More** **More** **MEAS** **MEAS**  
1 of 3 2 of 3 **STEPPED** **STOP** **SNG CONT**

**TEST** **More** **More** **MEAS** **FREQ** **MEAS**  
1 of 3 2 of 3 **STEPPED** **STEP** **SNG CONT**

**Related Programming Command**

SNGLS, CONTS

---

**MEAS  
STEPPED**

Softkey that initiates a stepped measurement. The stepped measurement is taken between the specified start and stop frequencies in conjunction with the selected step size (**FREQ STEP**), step type (**STEP LOG LIN**), and step mode (**MEAS SNG CONT**).

**Key Path**

**(TEST)** **More** **More** **MEAS**  
1 of 3 2 of 3 STEPPED

---

**MEASURE  
AT MKR**

*EMC Analyzer only.*

Softkey that makes a measurement, using specified detectors, with the marker position as the measurement frequency.

**Note**

When the selected bandwidth is a non-CISPR bandwidth the message, Non-CISPR bandwidth being used, press CONTINUE to resume or press USE CISPR to change, is displayed.

---

**Key Path**

*EMC Analyzer mode only.*

**(TEST)** **MEASURE**  
AT MKR

**Related Programming Command**

MEASSIG

---

**Measure  
Detector**

Softkey that accesses a menu to select automatic measuring or the measurement time of the specified detectors.

**Key Path**

**(SETUP)** **More** **Measure**  
1 of 4 Detector

---

MEM  
LOCKED

Softkey available only when **SAV LOCK ON OFF** is on.

Softkey that locks all the current internal state and trace registers against further data storage. With the state and trace memory locked, the **STATE → INTRNL** and **Trace → Intrnl** softkey functions are no longer accessible; **MEM LOCKED** is displayed instead. Pressing **DEFAULT CONFIG** or **(PRESET)** sets **SAV LOCK ON OFF** to OFF.

**Note**

When **SAVE LOCK ON OFF** is set to ON, none of the state registers can be overwritten, including state register nine. The instrument automatically updates state register nine with the last state unless the save lock function is on.

**Key Path**

	More	Dispose	MEM
<b>(CONFIG)</b>	1 of 3	User Mem	LOCKED
		Save/Recall	MEM
<b>(SAVE/RECALL)</b>		Internal	LOCKED

**Related Programming Command**

PSTATE

MIN  
HOLD C

Softkey that updates trace C with the minimum level detected.

**Key Path**

	MIN
<b>(TRACE)</b>	HOLD C

**Related Programming Command**

MINH

MIXER  
BIAS DAC

*HP 8593EM, 8595EM, or 8596EM only.*

Softkey that displays the output of the mixer-bias DAC from the first-converter driver on the A7 analog interface assembly. This is a service diagnostic function and is for service use only.

**Key Path**

	More	More	Service				MIXER
<b>(CAL)</b>	1 of 4	2 of 4	Diag	More 1 ...	More 5		BIAS DAC



MK COUNT  
ON OFF

Softkey that turns on the marker counter when ON is underlined. If no marker is active before MK COUNT ON OFF is pressed, a marker is activated at center screen. Press MK COUNT ON OFF (so that OFF is underlined), to turn the marker counter off. Press CNT RES AUTO MAN to change the marker counter resolution to an uncoupled value.

An asterick (\*) may appear in the upper right of the display along with the message Marker Count. The ratio of the intermeditate frequency bandwidth to span must be greater than 0.01 for the marker count function to work properly. Reduce Span appears on screen if the bandwidth to span ratio is less than 0.01. The function will count the largest signal in a 300 Hz bandwidth even if a narrower bandwidth setting is used.

### Key Path

More MK COUNT  
(MKR) 1 of 3 ON OFF

### Related Programming Command

MKFC

---

MK NOISE  
ON OFF

Softkey that reads out the average noise level, referenced to a 1 Hz noise power bandwidth, at the marker position. If no marker is present, a marker appears at the center of the screen. The root-mean-square noise level, normalized to a 1 Hz noise power bandwidth, is read out. The sample detector is activated.

### Key Path

More More MK NOISE  
(MKR) 1 of 3 2 of 3 ON OFF

### Related Programming Command

MKNOISE

---

MK PAUSE  
ON OFF

Softkey that stops the instrument sweep at the marker position for the duration of the dwell time. The dwell time can be set from 2 milliseconds to 100 seconds.

### Key Path

More More MK PAUSE  
(MKR) 1 of 3 2 of 3 ON OFF

### Related Programming Command

MKPAUSE

---

(MKR)

Hardkey that accesses the marker control softkeys which select the type and number of markers and turn them on and off. Markers are diamond-shaped characters that identify points of traces and allow the traces to be manipulated and controlled on the screen. During manual operation, four markers may appear on the display simultaneously; only one can be controlled at a time. The marker that is controlled is called the “active” marker. Pressing (MKR) activates the MARKER NORMAL softkey.

---

(MKR →)

Hardkey that accesses a menu of marker-to-functions such as:

- MARKER → HIGH
  - MARKER → CF
  - MARKER → REF LVL
  - MARKER → CF STEP
  - MARKER → MINIMUM
  - MARKER → START
  - MARKER → STOP
  - MARKER → PK-PK
  - MARKER Δ
  - MARKER Δ SPAN
  - NEXT PEAK
  - NEXT PK LEFT
  - NEXT PK RIGHT
-

MK READ  
F T I P

Softkey that selects the marker readout to be displayed in signal frequency, sweep time, the inverse of the sweep time, or the period which is the inverse of the frequency. When the instrument is in zero span the frequency type readout cannot be selected.

### Key Path

More MK READ  
(MKR) 1 of 3 F T I P

### Related Programming Command

MKREAD

---

MK TRACE  
AUTO ABC

Softkey that assigns a marker to a trace. Pressing MK TRACE AUTO ABC will activate a marker on trace A if there are no markers turned on. If a marker is currently active, press MK TRACE AUTO ABC until A, B, or C are underlined. The active marker will be moved to the selected trace.

Selecting the auto mode will move the marker to the trace that is automatically selected. The selection order is to first look for a trace in the clear-write mode, in trace A, then trace B, then trace C. If no traces are currently being written, it will select a trace in the view-store mode, again in the order of trace A, B, then C.

### Key Path

More MK TRACE  
(MKR) 1 of 3 AUTO ABC

### Related Programming Command

MKTRACE

---

MK TRACK  
ON OFF

Softkey that moves the signal that is nearest to the active marker to the center of the screen and keeps the signal there. MKR-TRK or CNTR-TRK appears in the upper-right corner of the display. An asterick (\*) may appear in the upper-right corner of the display while the instrument is verifying that it has the correct signal.

Pressing MK TRACK ON OFF, (PRESET), MARKER NORMAL, or MARKER ALL OFF turns off the marker-track function.

When marker track is on and the span is reduced, an automatic zoom is performed: the span is reduced in steps so that the signal remains at the center of the screen. If the span is zero, marker track cannot be activated.

### Key Path

More MK TRACK  
(MKR) 1 of 3 ON OFF

### Related Programming Command

MKTRACK

---

MNOPQR

Softkey that accesses a menu for selecting screen title or prefix characters M through R.

### Key Access

(CAL), (CONFIG), (DISPLAY), (SAVE/RECALL), or (SETUP)

### Related Programming Command

TITLE, PREFX

---

(MODE)

Hardkey that accesses the menu for selecting EMC ANALYZER or SPECTRUM ANALYZER modes of operation.

### Related Programming Command

MODE, INSTTYPE

---

**NEW  
EDIT**

Softkey that starts the DLP editor function, clearing the DLP editor memory to create a new item in the 2500 byte DLP editor memory. The item will not be in the user memory of the instrument until it is processed by the **SAVE EDIT** softkey. The DLP editor memory buffer remains intact when the instrument is preset and when it is powered off.

**Key Path**

<b>(SAVE/RECALL)</b>	Save Internal	Catalog Internal	... *	Editor	<b>NEW EDIT</b>
<b>(SAVE/RECALL)</b>	Recall Internal	Catalog Internal	... *	Editor	<b>NEW EDIT</b>

\* Any of the following can be used to complete the key path:  
**CATALOG ALL** , **CATALOG VARIABLES** , or **CATALOG PREFIX** .

**(NEXT)**

Hardkey that selects the upper or lower window as the active window. When the windows display mode is activated, there will be two windows displayed on the screen. Only one of the windows is active (the active window will have a highlighted line around the graticule). Pressing **(NEXT)** consecutively, will toggle between the two windows.

**Related Programming Command**

WINNEXT

**NEXT  
PAGE**

Softkey that displays the next page of the instrument setup. For example, if you are currently viewing page 2 of the instrument setup pressing **NEXT PAGE** will display page 3 of the instrument setup.

**Key Path**

<b>(SETUP)</b>	More 1 of 4	<b>SHOW SETUP</b>	<b>NEXT PAGE</b>
----------------	----------------	-----------------------	----------------------

**Related Programming Command**

SHOWSETUP

NEXT  
PEAK

Softkey that moves the active marker to the next signal peak of higher amplitude. The signal peak must exceed the threshold value. (Also refer to the PEAK EXCURSN and THRESHLD ON OFF softkey descriptions.)

#### Key Path

(MKR →) NEXT  
PEAK

#### Related Programming Command

MKPK

---

NEXT PK  
LEFT

Softkey that moves the marker to the next peak left of the current marker. The signal peak must exceed the threshold value. If there is no peak to the left, the marker will not move. (Also refer to the THRESHLD ON OFF softkey description.)

#### Key Path

(MKR →) NEXT PK  
LEFT

#### Related Programming Command

MKPK

---

NEXT PK  
RIGHT

Softkey that moves the marker to the next peak right of the current marker. The signal peak must exceed the threshold value. If there is no peak to the right, the marker will not move. (Also refer to the THRESHLD ON OFF softkey description.)

#### Key Path

(MKR →) NEXT PK  
RIGHT

#### Related Programming Command

MKPK

---

**NO  
CONVERSN**

Softkey that specifies that no conversion units are used for the antenna amplitude-correction factors.

### Key Path

	More	Correctn	Antenna	EDIT	More
(SETUP)	1 of 4	Factors	Factors	ANTENNA	1 of 2
Antenna	NO				
Units	CONVERSN				

### Related Programming Command

XUNITS

---

**No User  
Menus**

Softkey that is displayed if no user menus have been defined by the user.

### Key Path

	User	No User
(AUX/USER)	Menus	Menus

---

**NORM A/B  
ON OFF**

Softkey that subtracts trace B from trace A and adds the result to the display line. The result is displayed in trace A. The trace data is normalized with respect to the display line even if the value of the display line is changed. This function is executed on all subsequent sweeps until it is turned off. A minus sign (–) appears between the trace A status and the trace B status in the screen annotation while the function is active. To turn off the normalize function, press **NORM A/B ON OFF** so that OFF is underlined.

The normalize function is useful for applying correction data to a trace. For example, store a measurement sweep of the response of a system in trace B. Trace A can be used to measure the response of the system after a device is added. Set **NORM A/B ON OFF** to ON to subtract the system response from the response of the device under test, to characterize the response of a device under test.

### Key Path

	More	NORM A/B
(TRACE)	1 of 4	ON OFF

### Related Programming Command

AMBPL

---

NORMLIZE  
ON OFF

Softkey that subtracts trace B from trace A and adds the result to the display line. The result is displayed in trace A. The trace data is normalized with respect to the display line even if the value of the display line is changed. This function is executed on all subsequent sweeps until it is turned off. A minus sign (–) appears between the trace A status and the trace B status in the screen annotation while the function is active. To turn off the normalize function, press

NORMLIZE ON OFF so that OFF is underlined.

The normalize function is useful for applying correction data to a trace. For example, store a measurement sweep of the response of a system in trace B. Trace A can be used to measure the response of the system after a device is added. Set NORMLIZE ON OFF to ON to subtract the system response from the response of the device under test, to characterize the response of a device under test.

#### Key Path

More More NORMLIZE  
TRACE 1 of 4 2 of 4 ON OFF

#### Related Programming Command

AMBPL

---

NORMLIZE  
POSITION

Softkey that displays the display line and makes the display line function active. The trace data is normalized with respect to the display line even if the value of the display line is changed.

#### Key Path

More More NORMLIZE  
TRACE 1 of 4 2 of 4 POSITION

#### Related Programming Command

DL

---

NTSC

Softkey that allows you to trigger on the NTSC video format. Pressing this softkey alters the TV line number that the instrument triggers on internally.

#### Key Path

TV  
SWEEP/TRIG Trigger TV TRIG Standard NTSC

---



## WINDOWS **(ON)**

Hardkey that activates the windows display mode and accesses the menu of window zone functions. The windows display function splits the screen into two separate displays. Only one of these displays is active at a time. The currently active window will have a highlighted line around the graticule. The WINDOWS **(NEXT)** key will switch the active display between the upper and lower windows. The instrument state of the active window can be changed without affecting the state of the inactive window. The complete annotation is not displayed for each window because of space limitations.

When the windows display mode is first turned on, the top window will contain an inactive copy of the previous full display. The lower window will be active and will display a subset of the frequency span of the upper window. The displayed span, or zone, of the lower window will be indicated on the upper window by two vertical lines called zone markers. The zone can be moved and changed using the zone keys which are accessed by pressing the WINDOWS **(ON)** key. Changing the span or center frequency of the lower window will change the corresponding zone markers on the upper window.

Most functions can be used from within the windows display mode. Some functions, like editing limit lines and showing the options, require a full-sized display. They will temporarily exit the windows display format. When the function is finished the instrument will return to a windows display. Other functions will permanently exit the windows display and it will be necessary to restart the windows display mode by pressing WINDOWS **(ON)**. Refer to Table 17-5.

Limit lines can be displayed and tested within the windows display mode. Viewing and testing must be turned on independently in each window. The current limit lines will be common to both windows.

**(SAVE/RECALL)** does not save the windows display mode. If the windows display mode is being used, the save state function saves the state of the currently active window. The recall state function recalls the stored state into the currently active window. Refer to the **STATE → INTRNL** softkey description for more information about saving the display.

**Table 17-5.**  
**Functions Which Exit The Windows Display Format**

Function	Description
Calibration Functions	self-calibration routines
Dispose User Memory	deletes user's items from instrument memory
Instrument Preset	returns instrument to preset state

### Related Programming Command

WINON

**OTHER**  
→ **CARD**

Softkey that saves *other* two-port amplitude-correction factors to a card. To save *other* amplitude-correction factors press, **OTHER** → **CARD**. **REGISTER #** and **PREFIX=** are displayed on the screen. Use the data keys to enter the desired register number then press **(ENTER)**. The *other* two-port amplitude-correction data is then saved to a card.

#### Key Path

**(SAVE/RECALL)** **Save** **More** **OTHER**  
**Card** **1 of 3** → **CARD**

#### Related Programming Command

STOR

---

**Other**  
**Factors**

Softkey that accesses a menu to turn on, recall, edit, or save *other* amplitude-correction factors for any two-port device, excluding antenna and cable factors, placed between the antenna and the instrument.

#### Key Path

**(SETUP)** **More** **Correctn** **Other**  
**1 of 4** **Factors** **Factors**

#### Related Programming Command

AMPCOR

---

**OTHER**  
**ON OFF**

Softkey that turns on or off *other* two-port amplitude-correction factors, excluding antenna and cable factors, placed between the antenna and the instrument.

#### Key Path

**(SETUP)** **More** **Correctn** **Other** **OTHER**  
**1 of 4** **Factors** **Factors** **ON OFF**

#### Related Programming Command

AMPCOR

---

**(OUTPUT)**

Hardkey that accesses a menu to output reports to a plotter or a printer, or send a copy of the current display to the printer.

---

**OUTPUT  
REPORT**

Softkey that outputs a report to the specified printer, or graphs to a plotter.

**Key Path**

**OUTPUT**  
**REPORT**

---

**OVLD  
ON OFF**

Softkey that enables or disables RF and IF overload status.

**Key Path**

**More** **More** **OVLD**  
**SETUP** 1 of 4 2 of 4 **ON OFF**

**Related Programming Command**

OVLD

---

**PAINTJET  
PRINTER**

Softkey that selects a color print. For use with an HP PaintJet printer only.

**Key Path**

**Print** **Set Colr** **PAINTJET**  
**CONFIG** **Config** **Printer** **PRINTER**

---

**PAL**

Softkey that allows you to trigger on the PAL video format. Pressing this softkey alters the TV line number that the instrument triggers on internally.

**Key Path**

**TV**  
**SWEEP/TRIG** **Trigger** **TV TRIG** **Standard** **PAL**

---

## PAL-M

Softkey that allows you to trigger on the PAL-M video format. Pressing this softkey alters the TV line number that the instrument triggers on internally.

### Key Path

[SWEEP/TRIG] Trigger TV TRIG TV Standard PAL-M

---

## PEAK EXCURSN

Softkey that sets the minimum amplitude variation of signals that the marker can identify as a peak. If a value of 10 dB is selected, the marker moves only to peaks that rise and fall more than 10 dB above the threshold line (or the noise floor of the display). Pressing [PRESET] or turning on power resets the excursion to 6 dB, and the threshold to 70 dB below the reference level.

---

### Note

When a peak has a lump on its skirt that is the peak-excursion value above the threshold, the lump is considered a peak in its own right only if it has a peak excursion drop on both sides. Two peaks that are so close that only a valley divides them are not differentiated if the valley is not the peak-excursion value deep.

---

When the peak excursion value is less than 6 dB, the marker-peaking functions may not recognize signals less than 6 dB above the noise floor. To correct this, when measuring signals near the noise floor, the excursion value can be reduced even further. To prevent the marker from identifying noise as signals, reduce the noise floor variance to a value less than the peak-excursion value by reducing the averaging (video) bandwidth or by using video averaging.

### Key Path

[MKR →] More 1 of 3 PEAK EXCURSN  
[ON] PEAK EXCURSN

### Related Programming Command

MKPX

---

## PK DWELL TIME

Softkey that sets the measurement time when the peak detector is measured. This key is used in conjunction with MEASURE AT MKR , Re-measure , AUTO-MEASURE , and MEAS STEPPED .

### Key Path

More Measure PK DWELL  
(SETUP) 1 of 4 Detector TIME

### Related Programming Command

MEASTIMEPK

---

## PK-PK MEAS

Softkey that initiates an automatic measurement of the frequency and amplitude differences of the highest and lowest signals displayed on the screen. Pressing PK-PK MEAS performs a routine that is similar to MARKER  $\Delta$  and then moving the second marker to the lowest detected signal.

### Key Path

More More PK-PK  
(AUX/USER) 1 of 3 2 of 3 MEAS

## Plot Config

Softkey that accesses the menu used to address the plotter and to select plotter options. Refer to the (COPY) key for more information.

### Key Path

Plot  
(CONFIG) Config

---

## PLOTTER ADDRESS

*Not available with Option 043.*

Softkey that changes the HP-IB address of the plotter. The plotter address is set to 5 when DEFAULT CONFIG is pressed.

### Key Path

Plot Plt Port PLOTTER  
(CONFIG) Config Config ADDRESS

### Related Programming Command

PLOTADRS

---

PLT→LJT  
ON OFF

Softkey that allows you to plot a full-page, half-page, or quarter-page output to an HP LaserJet printer.

#### Key Path

Plot      PLT→LJT  
Config    ON OFF  
**CONFIG**

---

PLT\_ \_  
LOC\_ \_

*Only active when PLTS/PG 2 or 4 is selected.*

Softkey that selects the position of the plotter output.

#### Key Path

Plot      PLT\_ \_  
Config    LOC\_ \_  
**CONFIG**

---

PLT MENU  
ON OFF

Softkey that allows the softkey labels to be plotted along with the display. This function operates when the **COPY** key is used in a plot configuration. The plot menu function is set to on when **DEFAULT CONFIG** is pressed.

#### Key Path

Plot      PLT MENU  
Config    ON OFF  
**CONFIG**

---

Plt Port  
Config

Softkey that accesses the menus used to select plotter options. See the **COPY** key for more information.

#### Key Path

Plot      Plt Port  
Config    Config  
**CONFIG**

---

PLT PORT  
HPIB PAR

*Not available with Option 043.*

Softkey that allows you to select between HP-IB and parallel plotter ports.

#### Key Path

Plot      Plt Port    PLT PORT  
Config    Config      HPIB PAR  
**CONFIG**

---

PLT PORT  
SER PAR

*Not available with Option 043.*

Softkey that allows you to select between serial and parallel plotter ports. The BAUD RATE softkey appears in this menu only when serial is selected.

#### Key Path

(CONFIG) Plot Plt Port PLT PORT  
Config Config SER PAR

---

PLTS/PG  
1 2 4

Softkey that allows you to choose a full-page, half-page, or quarter-page plot. Press PLTS/PG 1 2 4 to underline the number of plots per page desired. If two or four plots per page are chosen, a softkey function is displayed that allows you to select the location of the plotter output on the paper. If two plots per page are selected, [ ] LOC \_ \_ is displayed. If four plots per page are selected, [ ] \_LOC \_ \_ is displayed. Press the softkey until the rectangular marker is in the desired section of the softkey label. The upper and lower sections of the softkey label graphically represent the position of the page where the plotter output will be located.

#### Note

The HP 7470A plotter does not support two plots per page output, you can select one or four plots per page.

---

#### Key Path

(CONFIG) Plot PLTS/PG  
Config 1 2 4

---

## POINT

Softkey that specifies a limit value for one coordinate point, so that a point segment specifies a limit value for a single frequency. (For spectrum analyzer mode only, the point segment can specify a limit value for time also.) The point segment type is generally used as the last segment in the limit-line table. However, if the last segment in the table is not of the point segment type, an implicit point is automatically added at the right-hand side of the screen.

### Key Path

*EMC Analyzer mode.*

```
Limit      EDIT  Select  
Lines ... * LIMIT Type POINT
```

```
More  Limit      EDIT  Select  
1 of 4 Lines ... * LIMIT Type POINT
```

*Spectrum Analyzer mode.*

```
Limit  Edit      Select  
Lines Limit ... † Type POINT
```

```
More  Limit  Edit      Select  
1 of 4 Lines Limit ... † Type POINT
```

\* Either `Limit 1` or `Limit 2` can be used to complete the key path.

† Any of the following can be used to complete the key path:  
`EDIT UPPER`, `EDIT LOWER`, `EDIT UP/LOW`, or `EDIT MID/DELT`.



## POWER ON IP LAST

Softkey that determines the state of the instrument when the instrument is powered on. If the POWER ON function is set to IP, the state of the instrument is the same as it is after (PRESET) is pressed, when the instrument is powered on. If the POWER ON function is set to LAST, then the state that the instrument was left in when it was powered off is recalled.

The setting (IP or LAST) of the POWER ON function is not changed by pressing (PRESET). Use the POWER ON IP LAST softkey function to change the setting of the instrument state which is recalled at power on. Limit lines are not recalled when the instrument is powered up.

### Note

If you have a downloadable program or “personality” installed in internal memory, the following changes apply to the operation of the POWER ON function: When using a downloadable program or personality, the last state of the personality is not recalled. We recommend that if you are using a downloadable program or personality, you set POWER ON IP LAST to IP. If POWER ON IP LAST is set to LAST, you must press (PRESET) whenever you power on the instrument.

### Key Path

(CONFIG) More More POWER ON  
1 of 3 2 of 3 IP LAST

(SETUP) More More More POWER ON  
1 of 4 2 of 4 3 of 4 IP LAST

### Related Programming Command

POWERON

PREAMP  
ON OFF

*Only available when used with an HP 85420E Option 1EM RF filter section.*

Softkey that switches the system preamplifier in and out of the input path.

When the preamplifier is on:

The HP 8590 EM series used with an HP 85420E Option 1EM adds 12 dB of gain to the path of either INPUT 1 (9 kHz to 50 MHz) or INPUT 2 (20 MHz to 2.9 GHz).

When the HP 85420E Option 1EM is present in the system, the following input path selections set the preamplifier as follows:

- INPUT 1 (9 kHz to 50 Mhz): PREAMP ON
- INPUT 2 (20 MHz to 2.9 GHz): PREAMP OFF
- INPUT 2 bypass: PREAMP OFF

### Key Path

(SETUP) More More More More PREAMP  
1 of 5 2 of 5 3 of 5 4 of 5 Input ON OFF

### Related Programming Command

PREAMP

---

PRESEL  
DAC

*HP 8593EM, 8595EM, or 8596EM only.*

Softkey that peaks the YTF preselector by allowing the user to manually adjust the YTF fine-tune DAC. This is a service diagnostic function and is for service use only.

### Key Path

(CAL) More More Service PRESEL  
1 of 4 2 of 4 Diag More 1 ... More 5 DAC

PRESEL  
DEFAULT

*HP 8593EM, 8595EM, or 8596EM only.*

Softkey that enables default preselector data to allow maximum frequency response without peaking the preselector. The CAL YTF routine should be performed before pressing PRESEL DEFAULT.

### Key Path

(AMPLITUDE) More PRESEL  
1 of 3 DEFAULT

---

**PRESEL  
PEAK**

*HP 8593EM, 8595EM, or 8596EM only.*

Softkey that optimally centers the preselector on a given signal for the most accurate measurement of amplitude. The maximum response found for the frequency at the marker determines the future adjustment values that will be provided to the preselector.

**Key Path**

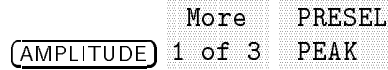

**Related Programming Command**

PP

---

**(PRESET)**

Hardkey that provides a convenient starting point for making most measurements. When in spectrum analyzer mode, pressing (PRESET) displays softkeys used for accessing the operating modes available for your instrument. Refer to Table 17-6 and Table 17-7 for the conditions established by pressing (PRESET).

The instrument preset function performs a processor test, but does not affect CAL data. Pressing (PRESET) clears both the input and output buffers, but does not clear trace B. The amplitude values of trace C are set to the reference level. Amplitude-correction factors are turned off. Limit-line testing is turned off, but the limit-line tables remain in internal memory. The status byte is set to 0. Instrument preset affects all operating modes. (Refer to the key description for (MODE) for more information about other operating modes.)

---

**Note**

Turning the instrument on performs an instrument preset. Turning on the instrument also fetches CAL data; completes a processor test; clears trace B, trace C, and both the input and output buffers; turns off amplitude correction factors; turns off limit-line testing; and sets the status byte to 0. The last state of the instrument (before it was switched off) is recalled, unless instrument preset has been set by the power on function.

---

**Related Programming Command**

IP

**Table 17-6. Preset for EMC Analyzer Conditions**

A – B → A	off
Amplitude correction factors	off
Amplitude units	default values
Annotation and graticule display	on
Attenuation	10 dB (auto-coupled)
Average bandwidth	1 MHz (auto-coupled)
AV/IFBW ratio	0.3
Center frequency	600 MHz
CF step size	100 MHz
Coupled functions	all set to AUTO
Coupling	AC
Detector	positive peak
Display line level	2.5 graticule divisions below reference level, display off
Frequency offset	0 Hz
Intermediate frequency bandwidth	120 kHz (auto-coupled)
Limit-line testing	off
Log scale	10 dB/division
Marker counter	off
Marker counter resolution	auto-coupled
Markers	off
Mixer level	– 10 dBm
Operating mode	EMC analyzer
Preselector peak	reset
Reference level	107 dB $\mu$ V in power-on units
Reference level offset	0 dB
Reference level position	top (8th) graticule
Span	800 MHz
SRQ mask	octal 50
Start Frequency	200 MHz
Stop Frequency	1 GHz.
State registers 1–8	unaffected
Sweep	continuous
Threshold level	at baseline, display off
Title	cleared
Trace A	clear-write
Trace B	store-blank
Trace C	store-blank, at reference level
Trace registers	unaffected
Trigger	free run
Video averaging	off

**Table 17-7. Preset Spectrum Analyzer Conditions**

A – B → A	off
Amplitude correction factors	off
Amplitude units	default values
Annotation and graticule display	on
Attenuation	10 dB (auto-coupled)
Average bandwidth	1 MHz (auto-coupled)
AV/IFBW ratio	0.3
Bandwidth	3 MHz
Center frequency	900 MHz for 8591EM, 12.38 GHz for 8593EM, 1.45 GHz for 8594EM, 3.25 GHz for 8595EM, 6.4 GHz for 8596EM
CF step size	100 MHz
Coupled functions	all set to AUTO
Coupling	AC
Detector	positive peak
Display line level	2.5 graticule divisions below reference level, display off
Frequency offset	0 Hz
Limit-line testing	off
LIMIHI and LIMILO	cleared
Log scale	10 dB/division
Marker counter	off
Marker counter resolution	auto-coupled
Markers	off
Mixer level	–10 dBm
Operating mode	spectrum analyzer
Preselector peak	reset
Reference level	107 dB $\mu$ V in power-on units
Reference level offset	0 dB
Reference level position	top (8th) graticule
Resolution bandwidth	3 MHz (auto coupled)
Span	1.8 GHz for 8591EM, 19.25 GHz for 8593EM, 2.9 GHz for 8594EM, 6.5 GHz for 8595EM, 12.8 GHz for 8596EM
SRQ mask	octal 50
Start Frequency	0 Hz (except 2.75 GHz for 8593EM)
Stop Frequency	1.86 GHz for 8591EM, 22 GHz for 8593EM, 2.9 GHz for 8594EM, 6.5 GHz for 8595EM, 12.8 GHz for 8596EM
State registers 1–8	unaffected
Sweep	continuous
Threshold level	one graticule above baseline, display off
Title	cleared
Trace A	clear-write
Trace B	store-blank
Trace C	store-blank, at reference level
Trace registers	unaffected
Trigger	free run
Video averaging	off
Video bandwidth	3 MHz

---

**Print  
Config**

Softkey that accesses a menu used to address the printer, select a black and white print or a color print (a color print requires either an HP PaintJet, HP DeskJet 500C, HP DeskJet 540C, or HP DeskJet 550C printer), and reset the printer. Refer to the **(COPY)** key for more information.

**Key Path**

**(CONFIG)** **Print  
Config**

---

**PRINTER  
ADDRESS**

*Not available with Option 043.*

Softkey that changes the HP-IB address of the printer. The printer address is set to 1 by pressing **DEFAULT CONFIG**.

**Key Path**

**(CONFIG)** **Print  
Config** **Prn Port  
Config** **PRINTER  
ADDRESS**

---

**Related Programming Command**

PRNTADRS

---

**PRINTER  
SETUP**

Softkey that resets the printer, sets the printer to 60 lines per page, and skips line perforations. This function enables you to obtain up to two printouts per page. The printer paper should be at the top of the form before using this function.

**Key Path**

**(CONFIG)** **Print  
Config** **PRINTER  
SETUP**

---

**Prn Port  
Config**

Softkey that accesses the menus used to select printer options. See the **(COPY)** key for more information.

**Key Path**

**(CONFIG)** **Print  
Config** **Prn Port  
Config**

---

PRN PORT  
HPIB PAR

*Not available for Option 043.*

Softkey that allows you to select between HP-IB and parallel printer ports.

**Key Path**

**CONFIG** Print Prn Port PRN PORT  
Config Config HPIB PAR

---

PRN PORT  
SER PAR

*Option 043 only.*

Softkey that allows you to select between serial and parallel printer ports. The **BAUD RATE** softkey appears in this menu only when serial is selected.

**Key Path**

**CONFIG** Print Prn Port PRN PORT  
Config Config SER PAR

---

PRT MENU  
ON OFF

Softkey that allows the softkey labels to be printed along with the display. This function operates when the **COPY** key is used in a print configuration. The print menu function is set to ON when **DEFAULT CONFIG** is pressed.

**Key Path**

**CONFIG** Print PRT MENU  
Config ON OFF

---

pTesla

Softkey that selects pTesla as the transducer conversion units for the antenna amplitude-correction factors.

**Key Path**

**SETUP** More Correctn Antenna EDIT More  
1 of 4 Factors Factors ANTENNA 1 of 2  
Antenna  
Units pTesla

**Related Programming Command**

XUNITS

---

PURGE  
AMP COR

Softkey that clears the current user amplitude-correction factors table.

### Key Path

(CAL) More More More Amp EDIT PURGE  
1 of 4 2 of 4 3 of 4 Cor AMP COR AMP COR

---

PURGE  
LIMITS

*Spectrum Analyzer mode only.*

Softkey that clears the current limit-line table from internal memory. Pressing PURGE LIMITS displays the message: If you are sure, press key again to purge data. Press PURGE LIMITS again if you wish to clear the current limit-line table. Press SAVE LIMIT to save the current limit-line table, and then press PURGE LIMITS to clear the current limit-line table.

### Key Path

(DISPLAY) Limit Edit More PURGE  
Lines Limit ... \* 1 of 2 LIMITS

(SETUP) More Limit Edit More PURGE  
1 of 4 Lines Limit ... \* 1 of 2 LIMITS

\* Any of the following can be used to complete the key path:  
EDIT UPPER, EDIT LOWER, EDIT UP/LOW, or EDIT MID/DELT.

### Related Programming Command

LIMIDEL

---



PWR SWP  
ON OFF

*This softkey is only available when LIN is selected for the SWEEP LOG LIN softkey.*

Softkey that activates (ON) or deactivates (OFF) the power-sweep function, which sweeps the output power of the tracking generator over the selected power-sweep range. The value of the power-sweep range is displayed in the active-function block when PWR SWP ON OFF is turned on. The available power-sweep range is a function of the source attenuator setting: For power sweeps, press SRC ATN MAN AUTO until (MAN) is underlined so the instrument source attenuator is manually set (decoupled).

For a given source attenuation setting, the maximum specified power-sweep range is shown in Table 17-8.

**Table 17-8.**

Tracking Generator Power Sweep Range Attenuator Setting	Power Sweep Range
0 dB	-1 to -10
8 dB	-10.1 to -18
16 dB	-18.1 to -26
24 dB	-26.1 to -34
32 dB	-34.1 to -42
40 dB	-42.1 to -50
48 dB	-50.1 to -58
56 dB	-58.1 to -66

The output power of the tracking generator is swept with the sweep voltage of the instrument. The output power is always swept from the source power setting to a higher power setting (negative source power sweep values are not allowed). Refer to the calibration guide for your instrument for more information regarding source power and source attenuation relationships.

Power-sweep measurements are particularly useful in making gain compression measurements or output power versus frequency measurements.

### Key Path

(AUX/USER) Track Gen PWR SWP  
ON OFF

### Related Programming Command

SRCPSWP

QP/AVG  
10X OFF

*Not available with Option 703.*

Softkey that turns off the linear 10X gain stage in the quasi-peak and average detector signal path. Either the average or quasi-peak detector must be the active detector.

### Key Path

QP/AVG  
(DET) 10X OFF

### Related Programming Command

QPGAIN

---

QP DET  
ON OFF

*Not available with Option 703.*

Softkey that turns the quasi-peak detector on and off. This is a service diagnostic function and is for service use only.

### Key Path

More More Service QP DET  
(CAL) 1 of 4 2 of 4 Diag More 1 ... More 6 ON OFF

---

QP DWELL  
TIME

Softkey that sets the measurement time when the quasi-peak detector is measured. This key is used in conjunction with MEASURE AT MKR, Re-measure, AUTO-MEASURE, and MEAS STEPPED.

### Key Path

More Measure QP DWELL  
(SETUP) 1 of 4 Detector TIME

### Related Programming Command

MEASTIMEQPD

---

QP GAIN  
ON OFF

*Not available with Option 703.*

Softkey that amplifies the video signal ten times (20 dB). This is a service diagnostic function and is for service use only.

#### Key Path

(CAL) More 1 of 4 More 2 of 4 Service Diag More 1 ... More 6 QP GAIN ON OFF

#### Related Programming Command

QPGAIN

---

QP  
ON OFF

*Not available with Option 703.*

Softkey that turns on and off the quasi-peak detector as the active detector. Because of the slow charge and discharge time constants of the quasi-peak detector, it is best to use in fixed-tuned (zero span) or narrow spans.

#### Key Path

(DET) QP ON OFF

#### Related Programming Command

SWITCHQPD, SWITCHAVG

---

QPD  
OFFSET

*Not available with Option 703.*

Softkey that sets the offset of the quasi-peak detector. This is a service diagnostic function and is for service use only.

#### Key Path

(CAL) More 1 of 4 More 2 of 4 Service Diag More 1 ... More 6 QPD OFFSET

---

QPD RST  
ON OFF

*Not available with Option 703.*

Softkey that discharges and resets the quasi-peak detector. This is a service diagnostic function and is for service use only.

### Key Path

(CAL) More 1 of 4 More 2 of 4 Service Diag More 1 ... More 6 QPD RST ON OFF

---

RECALL  
AMP COR

Softkey that recalls a user amplitude-correction factors table from the memory card.

### Key Path

(CAL) More 1 of 4 More 2 of 4 More 3 of 4 Amp Cor RECALL AMP COR

### Related Programming Command

AMPCOR, LOAD

---

RECALL  
ANTENNA

Softkey that recalls antenna-correction factors from a card. To recall antenna-correction data press, **RECALL ANTENNA** use the step keys or knob to highlight the desired file, then press **LOAD FILE**.

### Key Path

(SAVE/RECALL) Recall Card RECALL ANTENNA

(SETUP) More 1 of 4 Correctn Factors Antenna Factors RECALL ANTENNA

### Related Programming Command

AMPCOR, LOAD

---

## RECALL CABLE

Softkey that recalls cable-correction factors from a card. To recall cable factors press, **RECALL CABLE** use the step keys or knob to highlight the desired file, then press **LOAD FILE**.

### Key Path

**SAVE/RECALL** Recall Card More 1 of 3 **RECALL CABLE**  
**SETUP** More 1 of 4 Correctn Factors Cable Factors **RECALL CABLE**

### Related Programming Command

AMPCOR, LOAD

---

## Recall Card

Softkey that accesses a menu to recall instrument setups, signals lists, states, traces, display images, limit-line tables, and amplitude-correction factors from a card.

### Key Path

**SAVE/RECALL** Recall Card

---

## RECALL DISPLAY

Softkey that recalls display images from a card.

### Key Path

**SAVE/RECALL** Recall Card More 1 of 3 **RECALL DISPLAY**

### Related Programming Command

LOAD

---

## RECALL DLP

Softkey that recalls a downloadable program (DLP) from a card.

### Key Path

**SAVE/RECALL** Recall Card More 1 of 3 **RECALL DLP**

### Related Programming Command

LOAD

---

**Recall  
Internal**

Softkey that accesses a menu to recall states, traces, and limit-line tables from internal memory.

**Key Path**

**SAVE/RECALL** Recall  
Internal

---

**RECALL  
LIMITS**

Softkey that recalls limit-line tables from a card. To recall a limit-line table press, **RECALL LIMITS** use the step keys or knob to highlight the desired file, then press **LOAD FILE**.

**Key Path**

**DISPLAY** Limit RECALL  
Lines LIMITS

**SAVE/RECALL** Recall RECALL  
Card LIMITS

**SETUP** More Limit RECALL  
1 of 4 Lines LIMITS

---

**RECALL  
LIST**

Softkey that recalls signal lists from a card. To recall a signal list press, **RECALL LIST** use the step keys or knob to highlight the desired file, then press **LOAD FILE**.

**Key Path**

**SAVE/RECALL** Recall RECALL  
Card LIST

**TEST** More Save/Rcl RECALL  
1 of 3 List LIST

**Related Programming Command**

LOAD

---

**RECALL  
OTHER**

Softkey that recalls *other* two-port device factors from a card. To recall *other* data press, **RECALL OTHER** use the step keys or knob to highlight the desired file, then press **LOAD FILE**.

**Key Path**

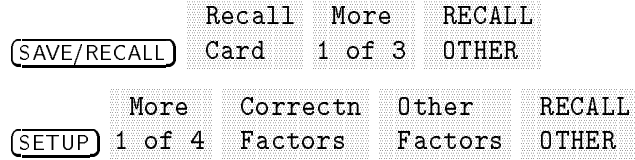

**Related Programming Command**

AMPCOR, LOAD

---

**RECALL  
SETUP**

Softkey that recalls instrument setups from a card. To recall an instrument setup press, **RECALL SETUP** use the step keys or knob to highlight the desired file, then press **LOAD FILE**.

Instrument setups consist of instrument states, window states, limit line definitions, and amplitude-correction definitions.

**Key Path**

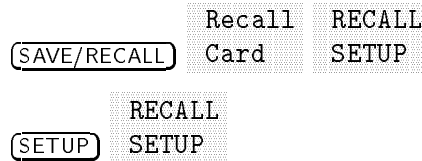

**Related Programming Command**

LOAD

---

**RECALL  
STATE**

Softkey that recalls, into analyzer memory, a state saved on the memory card.

**Key Path**

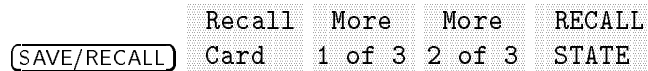

**Related Programming Command**

LOAD

---

## RECALL TRACE

Softkey that recalls traces from a card. To recall a trace press, **RECALL TRACE** use the step keys or knob to highlight the desired file, then press **LOAD FILE**.

### Key Path

**SAVE/RECALL** Recall Card More 1 of 3 **RECALL TRACE**

### Related Programming Command

LOAD

---

## REF LVL

Softkey that allows the reference level to be changed. This function is activated when **AMPLITUDE** is pressed. The reference level is the amplitude power or voltage represented by the top graticule line on the screen. Changing the value of the reference level changes the absolute amplitude level (in dB $\mu$ V) of the top graticule line. The reference level can be changed using the data keys, knob, or step keys.

After selecting this softkey, pressing any digit, 0 through 9, brings up the appropriate amplitude terminator menu.

### Key Path

**AMPLITUDE** REF LVL

### Related Programming Command

RL

---



## REF LVL OFFSET

Softkey that adds an offset value to the displayed reference level. Offsets are entered by using the data keys. Entering an offset does not affect the trace or the attenuation value. Reference-level offsets are used when gain or loss occurs between a device under test and the instrument input. Thus, the signal level measured by the instrument is the level at the input of an external amplitude-conversion device. When an amplitude offset is entered, its value is displayed on the top left-side of the screen. To eliminate an offset, press REF LVL OFFSET, 0 **(-dBm)** or **(+dBm)**. Pressing **(PRESET)** also sets the offset to zero. Refer to also the **EXTERNAL PREAMPG** softkey description.

### Key Path

**(AMPLITUDE)** More 1 of 3 More 2 of 3 REF LVL OFFSET

### Related Programming Command

ROFFSET

---

## REMEAS ALL SIGS

Softkey that remeasures all signals in the signal list. To remeasure each signal the algorithm spans down on the signal using the initial frequency listed in the table. When zero span is reached, up to three detectors can be used to measure the signal. These detectors are selected using **DETECTOR PK QP AV**.

### Key Path

**(TEST)** More 1 of 3 EDIT LIST Re-measure REMEAS ALL SIGS

### Related Programming Command

REMEASSIG

---

## REMEAS MARKED

Softkey that remeasures marked signals in the signal list. To remeasure each signal the algorithm spans down on the signal using the initial frequency listed in the table. When zero span is reached, up to three detectors can be used to measure the signal. These detectors are selected using `DETECTOR PK QP AV`.

### Key Path

`(TEST)` `More` `1 of 3` `EDIT LIST` `Re-` `measure` `REMEAS MARKED`

### Related Programming Command

REMEASSIG

---

## REMEAS SIGNAL

Softkey that remeasures the signal specified in the signal list. To remeasure each signal, the algorithm spans down on the signal using the initial frequency listed in the table. When zero span is reached, up to three detectors can be used to measure the signal. These detectors are selected using `DETECTOR PK QP AV`.

### Key Path

`(TEST)` `More` `1 of 3` `EDIT LIST` `Re-` `measure` `REMEAS SIGNAL`

### Related Programming Command

REMEASSIG

---

## Re- measure

Softkey that accesses a menu that remeasures one or more signals in the signal list.

### Key Path

`(TEST)` `More` `1 of 3` `EDIT LIST` `Re-` `measure`

### Related Programming Command

REMEASSIG

---

## RESTART

Softkey that restarts a stepped measurement. The stepped measurement is taken between the specified start and stop frequencies in conjunction with the selected step size (FREQ STEP), step type (STEP LOG LIN) and step mode (MEAS SNG CONT).

### Key Path

	More	More	MEAS		
(TEST)	1 of 3	2 of 3	STEPPED	STOP	RESTART
	More	More	MEAS	FREQ	
(TEST)	1 of 3	2 of 3	STEPPED	STEP	RESTART

---

## RPG TITLE

Softkey that provides additional characters for the Change Title function.

### Key Path

	More	More	More	Amp	Change	More	RPG
(CAL)	1 of 4	2 of 4	3 of 4	Cor	Title	1 of 2	TITLE
		Change	More	RPG			
(DISPLAY)		Title	1 of 2	TITLE			

---

## SAVE AMP COR

Softkey that saves the current user amplitude-correction factors table to the current mass-storage device (memory or memory card).

### Key Path

	More	More	More	Amp	SAVE
(CAL)	1 of 4	2 of 4	3 of 4	Cor	AMP COR

### Related Programming Command

STOR, AMPCOR

---

**SAVE  
ANTENNA**

Softkey that saves antenna amplitude-correction data to a card. To save antenna data press, **SAVE ANTENNA**. REGISTER # and PREFIX= are displayed on the screen. Use the data keys to enter the desired register number then press **(ENTER)**. The antenna data is then saved to a card.

**Key Path**

**(SETUP)** More Correctn Antenna SAVE  
1 of 4 Factors Factors ANTENNA

**Related Programming Command**

STOR, AMPCOR

---

**SAVE  
AUTOEXEC**

Softkey that stores the current instrument setup to the memory card under the name "AUTOEXEC". When "AUTOEXEC ON" is enabled, and the instrument is powered on with the card installed, that setting is restored. The setup includes all traces, limit lines, correction factors and window states.

**Key Path**

**(SETUP)** More More More SAVE  
1 of 4 2 of 4 3 of 4 AUTOEXEC

**Related Programming Command**

STOR

---

**SAVE  
CABLE**

Softkey that saves cable amplitude-correction data to a card. To save cable data press, **SAVE CABLE**. REGISTER # and PREFIX= are displayed on the screen. Use the data keys to enter the desired register number then press **(ENTER)**. The cable data is then saved to a card.

**Key Path**

**(SETUP)** More Correctn Cable SAVE  
1 of 4 Factors Factors CABLE

**Related Programming Command**

STOR, AMPCOR

---

Save  
Card

Softkey that accesses a menu to save instrument setups, signals lists, states, traces, display images, limit-line tables, and amplitude-correction factors to a card.

**Key Path**

(SAVE/RECALL) Save  
Card

**Related Programming Command**

MSI

---

SAVE  
EDIT

Softkey that passes the text from the DLP editor memory through the parser to execute as instrument commands. If the text (commands) is a valid user-defined function, it passes through the parser and into the instrument user memory. It will replace an existing user defined function of the same name.

**Key Path**

(SAVE/RECALL) Save Catalog Internal ... \* Editor SAVE  
EDIT

(SAVE/RECALL) Recall Catalog Internal ... \* Editor SAVE  
EDIT

\* Any of the following can be used to complete the key path:  
CATALOG ALL , CATALOG VARIABLES , or CATALOG PREFIX .

---

Save  
Internal

Softkey that accesses a menu to save states, traces, and limit-line tables to internal instrument memory.

**Key Path**

(SAVE/RECALL) Save  
Internal

**Related Programming Command**

MSI

---

## SAVE LIMITS

Softkey that saves the current limit-line table to a card. To save a limit-line table press, **SAVE LIMITS**. REGISTER # and PREFIX= are displayed on the screen. Use the data keys to enter the desired register number then press **(ENTER)**. The limit-line table is then saved to a card.

### Key Path

**(DISPLAY)** Limit Lines SAVE LIMITS

**(SETUP)** More 1 of 4 Limit Lines SAVE LIMITS

### Related Programming Command

STOR

---

## SAVE LIN GRAPH

Softkey that draws an EMI report graph on the display.

**SAVE LIN GRAPH** draws a full-screen graticule, linear frequency-axis with limited annotation. Drop lines for peak amplitude signals with cross-bars for quasi-peak and average amplitude readings are drawn on the graticule. The quasi-peak cross-bar and the average cross-bar are equal to or lower than the top of the drop line. The start and stop frequencies are defined based on the frequencies in the signal list.

### Key Path

**(TEST)** More 1 of 3 Save/Rcl List SAVE LIN GRAPH

### Related Programming Command

SIGGRAPH, STOR

---

## SAVE LIST

Softkey that saves the current signal list to a card. To save a signal list press, **SAVE LIST**. REGISTER # and PREFIX= are displayed on the screen. Use the data keys to enter the desired register number then press **ENTER**. The signal list is then saved to a card.

### CAUTION

When saving internal data and signal lists are displayed, card warning messages do *not* appear. Therefore it is recommended that you verify that a file has been saved before clearing the data from your display.

For example, before saving signal list data, make sure that your card is *not* write protected. To verify that the file was saved, press **RECALL LIST** to catalog signal lists that have been saved to the card, then check that the correct file was saved by inspecting the file name, date, and time stamp.

### Key Path

	More	Save/Rcl	SAVE
<b>TEST</b>	1 of 3	List	LIST

### Related Programming Command

STOR

## SAVE LOG GRAPH

Softkey that draws an EMI report graph on the display. **SAVE LOG GRAPH** draws a full-screen graticule, logarithmic frequency-axis with limited annotation. Drop lines for peak amplitude signals with cross-bars for quasi-peak and average amplitude readings are drawn on the graticule. The quasi-peak cross-bar and the average cross-bar are equal to or lower than the top of the drop line. The start and stop frequencies are defined based on the frequencies in the signal list.

### Key Path

	More	Save/Rcl	SAVE LOG
<b>TEST</b>	1 of 3	List	GRAPH

### Related Programming Command

SIGGRAPH, STOR

SAVE  
OTHER

Softkey that saves *other* two-port amplitude-correction factors to a card. To save *other* amplitude-correction factors press, SAVE OTHER. REGISTER # and PREFIX= are displayed on the screen. Use the data keys to enter the desired register number then press **ENTER**. *Other* two-port amplitude-correction data is then saved to a card.

#### Key Path

**SETUP** More Correctn Other SAVE  
1 of 4 Factors Factors OTHER

#### Related Programming Command

AMPCOR, STOR

---

Save/Rcl  
List

Softkey that accesses a menu used to save and recall signal lists. Save/Rcl List also draws report graphs on the display.

#### Key Path

**TEST** More Save/Rcl  
1 of 3 List

**SAVE/RECALL**

Hardkey that accesses menus that allow you to store state data, trace data, and limit-line tables in internal memory. The SAVE/RECALL function also allows you to save or recall instrument setups, state data, trace data, limit-line tables, amplitude-correction factors, signal lists, and display images on the card. In addition, pressing **SAVE/RECALL** accesses the menus used to catalog the saved or recalled data in internal memory or on the card.

Saving state data saves the instrument settings, but not the trace data. Saving trace data saves both the trace data and the state data. Display images can only be saved to or recalled from the card.

States and traces are saved in internal memory even if the instrument is turned off or **PRESET** is pressed. Eight internal state registers and many trace and limit-line registers are available for the user. The **Catalog Internal** softkey is used to access the catalog functions.

#### Related Programming Command

SAVRCLF, MSI

---



## SAVE SETUP

Softkey that saves the current setup to a card. To save a setup press, **SAVE SETUP**. REGISTER # and PREFIX= are displayed on the screen. Use the data keys to enter the desired register number then press **ENTER**. The setup is then saved to a card.

### Key Path

**SETUP** **More** **SAVE**  
1 of 4 **SETUP**

### Related Programming Command

STOR

---

## SAV LOCK ON OFF

Softkey that locks all the current internal state and trace registers against further data storage, when ON is underlined. With the state and trace memory locked, the **STATE → INTRNL** and **Trace → Intrnl** softkey functions are no longer accessible; the **MEM LOCKED** softkey function is displayed instead. Pressing **DEFAULT CONFIG** or **PRESET** sets **SAV LOCK ON OFF** to OFF.

### Note

When **SAV LOCK ON OFF** is set to ON, none of the state registers can be overwritten, including state register nine. The instrument automatically updates state register nine with the last state unless the save lock function is on.

---

### Key Path

**SAVE/RECALL** **Save** **SAV LOCK**  
**Internal** **ON OFF**

### Related Programming Command

PSTATE

---

SCALE  
LOG LIN

Softkey that scales the vertical graticule divisions in logarithmic units when LOG is underlined. When LOG is the active function, the logarithmic units per division can be changed. Values may range from 0.1 to 20 dB per division. When LIN is underlined, the vertical scale is in linear mode which has a range of 1 kW to 1 pW. The reference-level value is set to the top of the screen and the bottom graticule becomes zero volts. (Each division of the graticule is one-eighth of the reference level in volts.)

Pressing SCALE LOG LIN always sets the units specified for the current amplitude scale. Pressing PRESET or powering on the instrument sets the default units.

### Key Path

SCALE  
AMPLITUDE LOG LIN

### Related Programming Command

LG, LN

---

SECAM-L

*Available with Option 101 and 102 or Option 301 only.*

Softkey that allows you to trigger on the SECAM-L video format. Pressing this softkey alters the TV line number that the instrument triggers on internally.

### Key Path

SWEEP/TRIG Trigger TV TRIG TV Standard SECAM-L

---

SELECT  
1 2 3 4

Softkey that selects one of the four possible markers. A marker can be turned on once it is selected. A marker that has already been turned on will become active when it is selected. If a marker has already been turned on and assigned to a specific trace it will become active on that trace and the MK TRACE AUTO ABC softkey will have the appropriate trace letter underlined.

### Key Path

SELECT  
MKR 1 2 3 4

### Related Programming Command

MKACT

---

## SELECT AMPLITUD

Softkey that enters either the amplitude value for the displayed (upper or lower) limit-line segment or the amplitude value for the current amplitude-correction point. Enter the amplitude value for the selected frequency (or time, for spectrum analyzer mode only) by using the data keys. Change an amplitude value by using the step keys or the knob. Press **[BK SP]** to correct errors.

### Key Path

**[CAL]** More 1 of 4 More 2 of 4 More 3 of 4 Amp Cor EDIT AMP COR SELECT AMPLITUD

**[SETUP]** More 1 of 4 Correctn Factors ... \* SELECT AMPLITUD

*EMC Analyzer mode.*

**[DISPLAY]** Limit Lines ... † EDIT LIMIT SELECT AMPLITUD

**[SETUP]** More 1 of 4 Limit Lines ... † EDIT LIMIT SELECT AMPLITUD

*Spectrum Analyzer mode.*

**[DISPLAY]** Limit Lines Edit Limit ... § SELECT AMPLITUD

**[SETUP]** More 1 of 4 Limit Lines Edit Limit ... § SELECT AMPLITUD

\* Any of the following group of softkeys can be used to complete the key path:  
**Antenna Factors**, **EDIT ANTENNA**, or **Cable Factors**, **EDIT CABLE**  
or **Other Factors**, **EDIT OTHER**.

† Either **Limit 1** or **Limit 2** can be used to complete the key path.

§ Either **EDIT UPPER**, or **EDIT LOWER** can be used to complete the key path.

### Related Programming Command

AMPCOR, LIMSEG

---

## Select Axis

Softkey that accesses a menu which allows the selection of the frequency and the amplitude scales for the limit line to be either logarithmic or linear.

### Key Path

	Limit	EDIT	Select	Select	
(DISPLAY)	Lines	... *	LIMIT	Type Axis	
	More	Limit	EDIT	Select	Select
(SETUP)	1 of 4	Lines	... *	LIMIT	Type Axis

\* Either Limit 1 or Limit 2 can be used to complete the key path.

---

## SELECT DLT AMPL

Softkey that allows you to enter the delta amplitude value. The middle amplitude value and the delta amplitude value create an upper and lower limit-line segment. Enter the delta amplitude value for the selected frequency or time by using the knob or data keys.

### Key Path

	Limit	Edit	EDIT	SELECT	
(DISPLAY)	Lines	Limit	UP/LOW	DLT AMPL	
	More	Limit	Edit	EDIT	SELECT
(SETUP)	1 of 4	Lines	Limit	UP/LOW	DLT AMPL

---

**SELECT  
FREQ**

Softkey that enters the frequency value for a limit-line segment or for an amplitude-correction point. Enter the frequency value for the frequency by using the data keys. Change the frequency value by using the step keys or the knob. Press **(BK SP)** to correct errors.

A frequency coordinate must always be specified for either limit lines or amplitude-correction factors.

**Note**

Limit-line data is sorted in frequency order in the limit-line table. The sorting occurs after you have entered the frequency and at least one amplitude value.

For amplitude-correction factors, only two entries with the same frequency are valid. Only the first and last points of a series with the same frequency values are used; the middle points are ignored.

Amplitude-correction data is sorted in the table by frequency. The sorting occurs immediately after you have entered the frequency value via the front panel.

**Key Path**

**(CAL)** **More** 1 of 4 **More** 2 of 4 **More** 3 of 4 **Amp** Cor **EDIT** AMP COR **SELECT** FREQ

**(SETUP)** **More** 1 of 4 **Correctn** Factors ... \* **SELECT** FREQ

*EMC Analyzer mode.*

**(DISPLAY)** **Limit** Lines ... † **EDIT** LIMIT **SELECT** FREQ

**(SETUP)** **More** 1 of 4 **Limit** Lines ... † **EDIT** LIMIT **SELECT** FREQ

*Spectrum Analyzer mode.*

	Limit	Edit		SELECT
(DISPLAY)	Lines	Limit	... §	FREQ

	More	Limit	Edit		SELECT
(SETUP)	1 of 4	Lines	Limit	... §	FREQ

\* Any of the following group of softkeys can be used to complete the key path:

Antenna Factors , EDIT ANTENNA , or Cable Factors , EDIT CABLE  
or Other Factors , EDIT OTHER .

† Either Limit 1 or Limit 2 can be used to complete the key path.

§ Any of the following keys can be used to complete the key path:

EDIT UPPER , EDIT LOWER , EDIT UP/LOW or EDIT MID/DELT .

### Related Programming Command

AMPCOR, LIMISEG

---

SELECT  
FRM LIST

*Only available when SIG LIST is on.*

Softkey that controls the cursor position in the signal list.

### Key Path

	More	SELECT
(TEST)	1 of 3	FRM LIST

	More	EDIT	SELECT
(TEST)	1 of 3	LIST	FRM LIST

	More	EDIT	Delete	SELECT
(TEST)	1 of 3	LIST	Signals	FRM LIST

	More	EDIT	Re-	SELECT
(TEST)	1 of 3	LIST	Measure	FRM LIST

### Related Programming Command

SIGPOS

---

**SELECT  
LWR AMPL**

*Spectrum Analyzer mode only.*

Softkey that enters the amplitude value for the lower limit-line segment. Enter the amplitude value for the selected frequency or time by using the knob or data keys. Press **(BK SP)** to correct errors.

**Key Path**

	Limit	Edit	EDIT	SELECT
<b>(DISPLAY)</b>	Lines	Limit	UP/LOW	LWR AMPL

	More	Limit	Edit	EDIT	SELECT
<b>(SETUP)</b>	1 of 4	Lines	Limit	UP/LOW	LWR AMPL

---

**SELECT  
MID AMPL**

*Spectrum Analyzer mode only.*

Softkey that enters the amplitude value for the middle of the limit-line segment. Enter the amplitude value for the selected frequency or time by using the knob or data keys. Press **(BK SP)** to correct errors.

**Key Path**

	Limit	Edit	EDIT	SELECT
<b>(DISPLAY)</b>	Lines	Limit	MID/DELT	MID AMPL

	More	Limit	Edit	EDIT	SELECT
<b>(SETUP)</b>	1 of 4	Lines	Limit	MID/DELT	MID AMPL

---

**SELECT  
POINT**

Softkey that creates or edits an amplitude-correction factor data point. Enter the point number to be created or edited by using the data keys, then press **(ENTER)**. Press **(BK SP)** to correct errors.

**Key Path**

	More	More	More	Amp	EDIT	SELECT
<b>(CAL)</b>	1 of 4	2 of 4	3 of 4	Cor	AMP COR	POINT

	More	Correctn	Antenna	EDIT	SELECT
<b>(SETUP)</b>	1 of 4	Factors	Factors	ANTENNA	POINT

	More	Correctn	Cable	EDIT	SELECT
<b>(SETUP)</b>	1 of 4	Factors	Factors	CABLE	POINT

	More	Correctn	Other	EDIT	SELECT
<b>(SETUP)</b>	1 of 4	Factors	Factors	OTHER	POINT

**Related Programming Command**

AMPCOR

---

## SELECT PREFIX

Softkey that allows you to select an already existing prefix of a cataloged file and changes the current prefix to this selected prefix. This provides a convenient method for saving and recalling data to and from the card and for cataloging by the prefix. Use either the knob or step keys to select the file.

### Key Path

<b>SAVE/RECALL</b>	Save Card	...	†	SELECT PREFIX	
<b>SAVE/RECALL</b>	Recall Card	...	*	SELECT PREFIX	
<b>SAVE/RECALL</b>	Save Internal	Catalog Internal	...	§	SELECT PREFIX
<b>SAVE/RECALL</b>	Recall Internal	Catalog Internal	...	§	SELECT PREFIX
<b>SETUP</b>	RECALL SETUP	SELECT PREFIX			
<b>SETUP</b>	More 1 of 4	Correctn Factors	...		SELECT PREFIX
<b>SETUP</b>	More 1 of 4	Limit Lines	RECALL LIMITS	SELECT PREFIX	
<b>TEST</b>	More 1 of 3	Save/Rcl List	RECALL LIST	SELECT PREFIX	



*EMC Analyzer mode.*

<b>DISPLAY</b>	Limit	RECALL	SELECT
	Lines	LIMITS	PREFIX

\* Any of the following keys can be used to complete the key path:  
CATALOG CARD, RECALL SETUP, RECALL LIST, RECALL LIMITS,  
or RECALL ANTENNA.

† Any of the following keys can be used to complete the key path:  
CATALOG CARD, SETUP→CARD, LIST→CARD, LIMITS→CARD, or  
ANTENNA→CARD.

§ Any of the following keys can be used to complete the key path:  
CATALOG ALL, CATALOG REGISTER, CATALOG VARIABLES, or  
CATALOG PREFIX.

|| Any of the following group of softkeys can be used to complete the key path:  
Antenna Factors, EDIT ANTENNA, or Cable Factors, EDIT CABLE, or  
Other Factors, EDIT OTHER.

---

## SELECT SEGMENT

Softkey that creates or edits a limit-line segment. Limit lines are created by entering frequency (or time) and amplitude values into a limit-line table. The frequency (or time, for spectrum analyzer mode only) and amplitude values specify a coordinate point from which a limit-line segment is drawn. The coordinate point is the lowest frequency or time point of the line segment. Limit lines are constructed from left to right. To select a segment, press **SELECT SEGMENT**, enter the segment number you wish to specify, then press a units key.

Up to 30 segments can be specified per limit-line table.

### Key Path

*EMC Analyzer mode.*

	Limit			EDIT	SELECT
<b>DISPLAY</b>	Lines	...	*	LIMIT	SEGMENT

	Limit			EDIT	More	SELECT
<b>DISPLAY</b>	Lines	...	*	LIMIT	1 of 2	SEGMENT

	Limit			EDIT	Select	SELECT
<b>DISPLAY</b>	Lines	...	*	LIMIT	Type	SEGMENT

	More	Limit		EDIT	SELECT
<b>SETUP</b>	1 of 4	Lines	...	LIMIT	SEGMENT

	More	Limit		EDIT	More	SELECT
<b>SETUP</b>	1 of 4	Lines	...	LIMIT	1 of 2	SEGMENT

	More	Limit		EDIT	Select	SELECT
<b>SETUP</b>	1 of 4	Lines	...	LIMIT	Type	SEGMENT

*Spectrum Analyzer mode.*

<b>DISPLAY</b>	Limit Lines	Edit Limit	...	†	SELECT SEGMENT		
<b>DISPLAY</b>	Limit Lines	Edit Limit	...	†	More 1 of 2	SELECT SEGMENT	
<b>SETUP</b>	More 1 of 4	Limit Lines	Edit Limit	...	†	SELECT SEGMENT	
<b>SETUP</b>	More 1 of 4	Limit Lines	Edit Limit	...	†	More 1 of 2	SELECT SEGMENT
<b>SETUP</b>	More 1 of 4	Limit Lines	Edit Limit	...	†	Select Type	SELECT SEGMENT

\* Either **Limit 1** or **Limit 2** can be used to complete the key path.

† Any of the following can be used to complete the key path:

**EDIT UPPER**, **EDIT LOWER**, **EDIT UP/LOW**, or **EDIT MID/DELT**.

**SELECT  
TIME**

*Spectrum Analyzer mode only.*

Softkey that allows you to enter the time value for a limit-line segment. The time value is with respect to the sweep time. A time value of zero is the start of the sweep, which is the left edge of the graticule. Enter the time value by using the data keys. Change the time value by using the step keys or the knob.

**Note**

Limit-line data is sorted in time order in the limit-line table. The sorting occurs after you have entered the time and at least one amplitude value.

**Key Path**

<b>SETUP</b>	More 1 of 4	Limit Lines	Edit Limit	...	*	SELECT TIME
--------------	----------------	----------------	---------------	-----	---	----------------

\* Either **EDIT UP/LOW** or **EDIT MID/DELT** can be used to complete the key path.

## Select Type

Softkey that accesses the menu used to select the limit-line type of line. Press **FLAT** to select a flat line, press **SLOPE** to select a sloped line, or press **POINT** to select a point.

### Key Path

*EMC Analyzer mode.*

**DISPLAY** Limit Lines ... \* **EDIT** **Select**  
LIMIT Type

**SETUP** More Limit Lines ... \* **EDIT** **Select**  
1 of 4 LIMIT Type

*Spectrum Analyzer mode.*

**DISPLAY** Limit Edit Lines Limit ... † **Select**  
Type

**SETUP** More Limit Edit Lines Limit ... † **Select**  
1 of 4 Type

\* Either **Limit 1** or **Limit 2** can be used to complete the key path.

† Any of the following can be used to complete the key path:  
**EDIT UPPER**, **EDIT LOWER**, **EDIT UP/LOW**, or **EDIT MID/DELT**.

## SELECT UPR AMPL

*Spectrum Analyzer mode only.*

Softkey that enters the amplitude value for the upper limit-line segment. Enter the amplitude value for the selected frequency or time by using the knob or data keys. Press **(BK SP)** to correct errors.

### Key Path

**DISPLAY** Limit Edit Lines Limit UP/LOW **EDIT** **SELECT**  
UPR AMPL

**SETUP** More Limit Edit Lines Limit UP/LOW **EDIT** **SELECT**  
1 of 4 UPR AMPL

Selectv  
Mark

Softkey that accesses a menu that marks one or more signals on the signal list.

**Key Path**

More EDIT Signal Selectv  
(TEST) 1 of 3 LIST Marking Mark

**Related Programming Command**

SIGMARK

---

Service  
Cal

Softkey that accesses several service calibration functions. The service calibration functions are designed for service use only.

**Key Path**

More More Service  
(CAL) 1 of 4 2 of 4 Cal

Service  
Diag

Softkey that accesses several service diagnostic functions. The service diagnostic functions are designed for service use only.

**Key Path**

More More Service  
(CAL) 1 of 4 2 of 4 Diag

SET ATTN  
ERROR

Softkey that sets the calibration attenuator-error factors (this is not the same as the input attenuator). This is a service calibration function and is for service use only.

**Key Path**

More More Service SET ATTN  
(CAL) 1 of 4 2 of 4 Cal ERROR

## Set B&W Printer

Softkey that accesses the softkeys for setting up black and white HP and Epson compatible printers.

### Key Path

**CONFIG** Print Set B&W  
Config Printer

---

## Set Colr Printer

Softkey that accesses the softkey for setting up the HP PaintJet and HP DeskJet printers.

### Key Path

**CONFIG** Print Set Colr  
Config Printer

---

## SET DATE

Softkey that allows you to set the date of the real-time clock. To enter the date in the YYMMDD format use the data keys then press **ENTER**. Valid year (YY) values are 00 through 99. Valid month (MM) values are from 01 to 12, and valid day values are from 01 to 31.

### Key Path

**CONFIG** Time SET  
Date DATE

### Related Programming Command

SETDATE

---

## SET TIME

Softkey that allows you to set the time of the real-time clock. To enter the time in 24 hour, HHMMSS format, use the data keys then press **ENTER**. Valid hour (HH) values are from 00 to 23. Valid minute (MM) and second (SS) values are from 00 to 59.

### Key Path

**CONFIG** Time SET  
Date TIME

**CAL** Cal At SET  
Time TIME

### Related Programming Command

CALTIME, SETTIME

---

SETTINGS  
ON OFF

Softkey that turns on or off the generation of a tabular listing of current instrument settings. The listing will be sent to the printer when **OUTPUT REPORT** is executed.

#### Key Path

**OUTPUT** Define SETTINGS  
Report ON OFF

#### Related Programming Command

RPTDEF

---

**SETUP**

Hardkey that accesses softkey functions that control the EMC analyzer or spectrum analyzer settings to be used in a measurement, such as frequency range, antenna correction factors, and limit lines.

---

SETUP  
→ CARD

Softkey that stores the settings of the instrument to the card. This includes: windows and the states associated with them, limit lines, correction factors, and other settings.

#### Key Path

**SAVE/RECALL** Save SETUP  
Card → CARD

#### Related Programming Command

STOR

---

**SGL SWP**

Hardkey that initiates a sweep when in single-sweep mode.

#### Related Programming Command

TS

---

SHOW Δ 1  
PK QP AV

Softkey that specifies that any or all of the following are included in the list portion of the report: peak detector delta from limit 1, quasi-peak detector delta from limit 1, or average detector delta from limit 1.

#### Key Path

	Define	SHOW Δ 1
(OUTPUT)	List	PK QP AV

#### Related Programming Command

TBLDEF

---

SHOW Δ 2  
PK QP AV

Softkey that specifies that any or all of the following are included in the list portion of the report: peak detector delta from limit 2, quasi-peak detector delta from limit 2, or average detector delta from limit 2.

#### Key Path

	Define	SHOW Δ 2
(OUTPUT)	List	PK QP AV

#### Related Programming Command

TBLDEF

---

SHOW COR  
ON OFF

Softkey that specifies the total correction factors are included as part of the list portion of the report. The listing is sent to the printer upon receipt of an `OUTPUT REPORT`.

#### Key Path

	Define	SHOW COR
(OUTPUT)	List	ON OFF

#### Related Programming Command

TBLDEF

---



SHOW DET  
PK QP AV

Softkey that specifies that any or all of the following are included in the list portion of the report: the peak detector, quasi-peak detector, and the average detector. The listing is sent to the printer upon receipt of an `OUTPUT REPORT`.

#### Key Path

	Define	SHOW DET
<code>OUTPUT</code>	List	PK QP AV

#### Related Programming Command

TBLDEF

---

SHOW MKR  
ON OFF

Softkey that specifies signals that are marked in the signal list will be included as part of the list portion of the report.

#### Key Path

	Define	SHOW MKR
<code>OUTPUT</code>	List	ON OFF

#### Related Programming Command

TBLDEF

---

SHOW  
SETUP

Softkey that shows current settings of the instrument on the display. `SHOW SETUP` consists of four pages of information, including existing filenames, correction-factor data, limit-line data, frequency settings, trace data, and so on. To access each succeeding page of information press `NEXT PAGE`. To exit, press `Previous Menu`.

#### Key Path

	More	SHOW
<code>SETUP</code>	1 of 4	SETUP

#### Related Programming Command

SHOWSETUP

---

SHW INST  
CONFIG

*Softkey changes to EXIT SHOW when selected.*

Softkey that displays information about the configuration of the instrument including; model number, serial number, and the firmware revision date. Also included are the specific devices installed; HP-IB interface, RS-232 interface, tracking generator (TG), quasi-peak detector (QPD), FM demodulator (Demod), precision frequency reference (oven), narrow bandwidths (NBW), and additional information about the analyzer.

**Key Path**

More SHW INST  
CONFIG 1 of 3 CONFIG

**Related Programming Command**

HAVE, ID, REF, SER

---

SIG LIST  
ON OFF

Softkey that turns on or off the signal list viewing and editing functions.

**Key Path**

More SIG LIST  
TEST 1 of 3 ON OFF

**Related Programming Command**

SIGLIST

---

Signal  
Marking

Softkey that accesses a menu to mark one or more signal on the signal list.

**Key Path**

More EDIT Signal  
TEST 1 of 3 LIST Marking

**Related Programming Command**

SIGMARK

---

## SLOPE

Softkey that draws a straight line between the coordinate point of the current segment and the coordinate point of the next segment, producing limit-line values for all frequencies between the two points.

### Key Path

*EMC Analyzer mode.*

[DISPLAY] Limit Lines ... \* EDIT LIMIT Select Type SLOPE

[SETUP] More 1 of 4 Limit Lines ... \* EDIT LIMIT Select Type SLOPE

*Spectrum Analyzer mode.*

[DISPLAY] Limit Lines Edit Limit ... † Select Type SLOPE

[SETUP] More 1 of 4 Limit Lines Edit Limit ... † Select Type SLOPE

\* Either Limit 1 or Limit 2 can be used to complete the key path.

† Any of the following can be used to complete the key path:  
EDIT UPPER, EDIT LOWER, EDIT UP/LOW, or EDIT MID/DELT.

---

## SORT BY AVG AMP

Softkey that sorts the internal signal list by average amplitude. This list is sorted in descending order.

### Key Path

[TEST] More 1 of 3 EDIT LIST Sort Signals SORT BY AVG AMP

### Related Programming Command

SIGSORT

---

**SORT BY  
DLTA LIM**

*This key is only active when **VIEW Δ OFF** is pressed first.*

Softkey that sorts the internal signal list by delta limits. The list will be sorted in descending order.

**Key Path**

More EDIT Sort SORT BY  
**(TEST)** 1 of 3 LIST Signals DLTA LIM

**Related Programming Command**

SIGSORT

---

**SORT BY  
FREQ**

Softkey that sorts the internal signal list by the frequency of the signals. The list will be sorted in ascending order.

**Key Path**

More EDIT Sort SORT BY  
**(TEST)** 1 of 3 LIST Signals FREQ

**Related Programming Command**

SIGSORT

---

**SORT BY  
PK AMP**

Softkey that sorts the internal signal list by peak amplitude. The list will be sorted by descending order.

**Key Path**

More EDIT Sort SORT BY  
**(TEST)** 1 of 3 LIST Signals PK AMP

**Related Programming Command**

SIGSORT

---

**SORT BY  
QP AMP**

Softkey that sorts the internal signal list by quasi-peak amplitude. The list will be sorted by descending order.

#### Key Path

More EDIT Sort SORT BY  
(TEST) 1 of 3 LIST Signals QP AMP

#### Related Programming Command

SIGSORT

---

**Sort  
Signals**

Softkey that accesses a menu to sort the internal signal list based on the softkey selected. Softkeys available are:

- SORT BY FREQ
- SORT BY PK AMP
- SORT BY QP AMP
- SORT BY AVG AMP
- SORT BY DLTA LIM

SORT BY DLTA LIM is only available when VIEW Δ OFF is pressed.

#### Key Path

More EDIT Sort  
(TEST) 1 of 3 LIST Signals

#### Related Programming Command

SIGSORT

---

**(SPAN) or SPAN**

Hardkey and softkey that activates the SPAN function and accesses the frequency-span functions. Pressing SPAN allows the user to change the frequency range symmetrically about the center frequency. The frequency-span readout describes the total displayed frequency range; to determine frequency span per horizontal graticule division for linear sweeps, divide the frequency span by 10.

#### Key Path

(SPAN) SPAN

#### Related Programming Command

SP

---

SPAN  
ZOOM

Softkey that finds the highest signal peak onscreen. If a marker is not already on the peak, it places a marker on it, turns on the marker-track function, and activates the span function.

#### Key Path

SPAN  
(SPAN) ZOOM

#### Related Programming Command

SPZOOM

---

SPEAKER  
ON OFF

Softkey that turns the internal speaker on and off. The volume from the speaker is controlled by the front-panel volume control knob and FM GAIN (when using FM demodulation). There is no output from the speaker unless demodulation is turned on. Pressing (PRESET) sets SPEAKER ON OFF to ON.

#### Key Path

SPEAKER  
(DEMODO) ON OFF

#### Related Programming Command

SPEAKER

---

SPECTRUM  
ANALYZER

Softkey that allows the spectrum analyzer mode only to be preset. Refer to Table 17-7 for the preset signal analyzer conditions. Other operating modes will not be affected.

#### Key Path

(MODE) SPECTRUM ANALYZER, *when the instrument mode of operation is EMC analyzer.*

#### Related Programming Command

MODE, INSTTYPE

---

## SQUELCH

Softkey that adjusts the squelch level. The squelch level mutes weak signals and passes strong signals. The squelch level affects the audio output only. If the internal speaker is on, audio signals are not output unless the signal strength exceeds the squelch threshold. The squelch level does not affect the rear-panel AUX VIDEO OUT signal. Squelch level is indicated onscreen by the unitless numbers 0 to 100, with 0 being minimum squelch threshold (all signals are passed), and 100 being maximum squelch threshold (no signals are passed). The default squelch value is 0.

### Key Path

DEMOD SQUELCH

### Related Programming Command

SQLCH

---

## SRC ATN MAN AUTO

Softkey that allows you to select between automatic and manual adjustment of the tracking generator's switching attenuator. It can be manually adjusted from 0 to 56 dB in 8 dB steps. When auto-coupled, the SRC ATN function automatically adjusts the attenuator to yield the source amplitude level specified by the SRC PWR ON OFF softkey function. Set SRC ATN MAN AUTO so that MAN is underlined (decoupled) for power sweeps greater than 8 dB.

### Key Path

AUX/USER Track Gen SRC ATN  
MAN AUTO

### Related Programming Command

SRCAT

---

SRC PWR  
OFFSET

Softkey that offsets the displayed power of the tracking generator (SRC). Offset values may range from  $-327$  dB to  $+327$  dB.

Using the source-power-offset capability of the tracking generator allows you to take system losses or gains into account, thereby displaying the actual power delivered to the device under test.

#### Key Path

(AUX/USER) Track Gen 1 of 2 More SRC PWR  
OFFSET

#### Related Programming Command

SRCPOFS

---

SRC PWR  
ON OFF

Softkey that activates (ON) or deactivates (OFF) the output power of the tracking generator (SRC). The power level can then be adjusted using the data keys, step keys, or knob.

#### Key Path

(AUX/USER) Track Gen SRC PWR  
ON OFF

#### Related Programming Command

SRCPWR

---

SRC PWR  
STP SIZE

Softkey that sets the step size of the source-power level, source-power offset, and power-sweep range functions. The step size may be values from  $-327$  dB to  $327$  dB. The default setting is one vertical scale division.

#### Key Path

(AUX/USER) Track Gen 1 of 2 More SRC PWR  
STP SIZE

#### Related Programming Command

SRCPSTP

---



START  
FREQ

Softkey that sets the frequency at the left side of the graticule. The left and right sides of the graticule correspond to the start and stop frequencies. When these frequencies are activated, their values are displayed below the graticule in place of center frequency and span.

#### Key Path

(FREQUENCY) START  
FREQ

#### Related Programming Command

FA

---

STATE  
→ CARD

Softkey that saves the current analyzer state on the memory card.

#### Key Path

(SAVE/RECALL) Save More More STATE  
Card 1 of 3 2 of 3 → CARD

#### Related Programming Command

STOR

---

STATE  
→ INTRNL

*Softkey changes to MEM LOCKED when SAV LOCK ON.*

Softkey that saves the current instrument state in the selected state register. To save the current state, press **STATE → INTRNL**, and use the data keys to enter a state register number (valid state register numbers are 1 through 8). If windows are being used, only the state of the active window will be saved.

#### Key Path

(SAVE/RECALL) Save STATE  
Internal → INTRNL

#### Related Programming Command

SAVES

---

STEP  
LOG LIN

Softkey that initiates a logarithmic or linear stepped measurement. The stepped measurement is taken between the specified start and stop frequencies in conjunction with the selected step size (FREQ STEP), and step mode (MEAS SNG CONT). The parameter specified is multiplied by the intermediate frequency (resolution) bandwidth to determine the actual step size.

#### Key Path

(SETUP) More More STEP  
1 of 4 2 of 4 LOG LIN

---

STOP

Softkey that stops a stepped measurement.

#### Key Path

(TEST) More More MEAS  
1 of 3 2 of 3 STEPPED STOP

---

STOP  
FREQ

Softkey that sets the frequency at the right side of the graticule. The left and right sides of the graticule correspond to the start and stop frequencies. When these frequencies are activated, their values are displayed below the graticule in place of center frequency and span.

#### Key Path

(FREQUENCY) STOP  
FREQ

---

#### Related Programming Command

FB

---

STORE  
FLATNESS

*This key is only active when EDIT FLATNESS is pressed first.*

Softkey that stores amplitude versus frequency calibration factors. This is a service calibration function and is for service use only.

#### Key Path

(CAL) More More Service Flatness EDIT  
1 of 4 2 of 4 Cal Data FLATNESS  
STORE  
FLATNESS

---

## STOR PWR ON UNITS

Softkey that sets the default settings for the units used in the linear and the logarithmic modes when the instrument is powered on. The settings for the units can be changed during normal instrument operation but they will return to the default settings when the instrument is powered on again. This is a service calibration function.

### Key Path

	More	More	Service	STOR PWR
(CAL)	1 of 4	2 of 4	Cal	ON UNITS

---

## STP GAIN ZERO

Softkey that disables the two 20 dB step-gain amplifiers on the A12 amplitude control assembly. This is a service diagnostic function and is for service use only.

### Key Path

	More	More	Service	STP GAIN
(CAL)	1 of 4	2 of 4	Diag	ZERO

---

## STUVWX

Softkey that accesses the menu used for selecting screen title or prefix characters S through X.

### Key Access

(CAL), (CONFIG), (DISPLAY), (SAVE/RECALL), or (SETUP)

### Related Programming Command

TITLE, PREFX

---

SWEEP  
CONT SGL

Softkey that switches the instrument between continuous-sweep mode and single-sweep mode. If the instrument is in single-sweep mode, SGL is underlined. Press **(SINGLE)** to enable a sweep when in single-sweep mode. When continuous-sweep mode is in use, one sweep follows another as soon as it is triggered. Pressing **(PRESET)** and turning the power on, selects continuous sweep.

**Key Path**

**(SWEEP/TRIG)** SWEEP  
CONT SGL

**(SWEEP/TRIG)** Trigger SWEEP  
CONT SGL

**Related Programming Command**

CONTS, SNGLS

---

SWEEP  
LOG LIN

*Does not operate if ANALOG + is on.*

Softkey that selects between a logarithmic and linear frequency axis.

**Key Path**

**(FREQUENCY)** SWEEP  
LOG LIN

**(SWEEP/TRIG)** SWEEP  
LOG LIN

**Related Programming Commands**

SWEEPTYPE

---

SWEEP  
RAMP

Softkey that displays the RAMP signal from the sweep-ramp generator that is located on the A7 analog interface assembly. This is a service diagnostic function and is for service use only.

**Key Path**

**(CAL)** More 1 of 4 More 2 of 4 Service Diag More 1 More 2 SWEEP  
RAMP

---

SWEEP  
TIME DAC

Softkey that displays the output of the sweep-time DAC (SWP\_DAC) from the sweep-ramp generator that is on the A7 analog interface assembly. This is a service diagnostic function and is for service use only.

#### Key Path

(CAL) More 1 of 4 More 2 of 4 Service Diag More 1 More 2 SWEEP TIME DAC

---

SWEEP/TRIG

Hardkey that accesses the sweep-time menu and the sweep-time softkey functions SWP TIME AUTO MAN and SWEEP CONT SGL. It also accesses the trigger mode functions.

#### Related Programming Command

SNGLS, CONTS, TM

---

SWP CPLG  
SR SA

Softkey that selects stimulus-response (SR) or EMC analyzer auto-coupled sweep time. In stimulus-response mode, auto-coupled sweep times are usually much faster for swept-response measurements. Stimulus-response auto-coupled sweep times are typically valid in stimulus-response measurements when the frequency span of the instrument is less than 20 times the bandwidth of the device under test.

#### Key Path

(AUX/USER) Track Gen More 1 of 2 SWP CPLG SR SA

#### Related Programming Command

MEASURE, SWPCPL

---

SWP TIME  
AUTO MAN

Softkey that selects the length of time in which the instrument sweeps the displayed frequency span. In all non-zero frequency spans, the sweep time varies from 20 milliseconds to 100 seconds. In zero frequency span, the fastest sweep time is 15 milliseconds. Reducing the sweep time increases the rate of sweeps. The sweep time can be changed using the step keys, the knob, or the data keys.

For Option 101 or Option 301 only: Option 101 provides sweep times from 20  $\mu$ s to 20 ms in zero span.

#### Key Path

SWP TIME  
AUTO COUPLE AUTO MAN

SWP TIME  
SWEEP/TRIG AUTO MAN

#### Related Programming Command

ST

---

SYNC NRM  
NTSC

Softkey that changes the rear panel MONITOR output between normal internal monitor horizontal and vertical synchronization constants or the NTSC video compatible format. In the NTSC mode, the monitor output is compatible with NTSC video cassette recorders.

The display will be compressed slightly when using the NTSC format instead of the normal format. The NTSC format has less vertical resolution than the display. The top and bottom of the display are compressed slightly so that all of the information can be fit into the vertical resolution available with the NTSC format.

#### Key Path

More More SYNC NRM  
CONFIG 1 of 2 2 of 3 NTSC

#### Related Programming Command

SYNCMODE

---

SYNC NRM  
PAL

Softkey that changes the rear panel MONITOR output between normal internal monitor horizontal and vertical synchronization constants or the PAL video compatible format. In the PAL mode, the monitor output is compatible with PAL video cassette recorders.

The display will be compressed slightly when using the PAL format instead of the normal format. The PAL format has less vertical resolution than the display. The top of the display is compressed slightly so that all of the information can be fit into the vertical resolution available with the PAL format.

#### Key Path

(CONFIG) More More SYNC NRM  
1 of 2 2 of 3 PAL

#### Related Programming Command

SYNCMODE

---

TABLE  
ADDRESS

Softkey that sets the HP-IB address of an EMCO-compatible automatic turntable.

#### Key Path

(SETUP) More More More TABLE  
1 of 4 2 of 4 3 of 4 ADDRESS

TABLE  
CCW STOP

Softkey that starts or stops an EMCO-compatible turntable's rotation in the counterclockwise direction.

#### Key Path

(TEST) More More Tower/  
1 of 3 2 of 3 Turntbl TABLE  
CCW STOP

TABLE  
CW STOP

Softkey that starts or stops an EMCO-compatible turntable's rotation in the clockwise direction.

#### Key Path

(TEST) More More Tower/  
1 of 3 2 of 3 Turntbl TABLE  
CW STOP

---

**TEST**

Hardkey that provides control for measuring signals and manipulating lists of measured signals.

---

**THRESHLD  
ON OFF**

Softkey that sets a lower boundary to the active trace. The threshold line “clips” signals that appear below the line when this function is on. The boundary is defined in amplitude units that correspond to its vertical position when compared to the reference level.

The value of the threshold appears in the active-function block and on the lower-left side of the screen. The threshold level does not influence the trace memory or marker position. The peaks found by the markers must be at least the peak-excursion value above the threshold level. The value of the threshold level can be changed using the step keys, the knob, or the data keys. If a threshold is active, press **THRESHLD ON OFF** until OFF is selected to turn the threshold display off. The threshold value affects peak searching even when the THRESHLD function is set to off.

#### Key Path

**More** **THRESHLD**  
**DISPLAY** 1 of 2 **ON OFF**

#### Related Programming Command

TH

---

**Time  
Date**

Softkey that accesses the menu used to set and display the real-time clock.

#### Key Path

**Time**  
**CONFIG** **Date**

#### Related Programming Command

TIMEDATE

---



TIMEDATE  
ON OFF

Softkey that turns the display of the real-time clock on or off.  
Pressing **DEFAULT CONFIG** sets **TIMEDATE ON OFF** to ON.

#### Key Path

**CONFIG** Time TIMEDATE  
Date ON OFF

#### Related Programming Command

TIMEDSP

---

TOWER  
ADDRESS

Softkey that sets the HP-IB address of an EMCO-compatible automated antenna position (tower).

#### Key Path

**SETUP** More More More TOWER  
1 of 4 2 of 4 3 of 4 ADDRESS

TOWER  
DN STOP

Softkey that sends an EMCO-compatible automated tower down or steps its descent.

#### Key Path

**TEST** More More Tower/  
1 of 3 2 of 3 Turntbl TOWER  
DN STOP

Tower/  
Turntbl

Softkey that accesses a menu of functions for controlling EMCO-compatible towers and turntables.

#### Key Path

**TEST** More More Tower/  
1 of 3 2 of 3 Turntbl

TOWER  
UP STOP

Softkey that sends an EMCO-compatible automated tower up or steps its ascent.

#### Key Path

**TEST** More More Tower/  
1 of 3 2 of 3 Turntbl TOWER  
UP STOP

---

TOWER  
VERT HOR

Softkey that sets the antenna polarity to either verticle or horizontal, using an EMCO-compatible automated tower. This function may require multiple presses to calibrate.

#### Key Path

(TEST) More More Tower/ TOWER  
1 of 3 2 of 3 Turntbl VERT HOR

---

(TRACE)

Hardkey that accesses the trace softkeys that store and manipulate trace information. Each trace is comprised of a series of data points that form a register where amplitude information is stored. The instrument updates the information for any active trace with each sweep. If two traces are being written to, they are updated on alternating sweeps.

---

TRACE  
A B C

Softkey that selects the menu used for trace A, trace B, or trace C functions. Press TRACE A B C until the letter of the desired trace is underlined.

#### Key Path

(TRACE) TRACE  
A B C

---

TRACE A

Softkey that saves trace A data to a card. To save trace A data press, Trace → Card, TRACE A. REGISTER # and PREFIX= are displayed on the screen. Use the data keys to enter the desired register number. Trace A data is then saved to a card.

#### Key Path

(SAVE/RECALL) Recall Internal  
Internal → Trace TRACE A

(SAVE/RECALL) Save More Trace  
Card 1 of 3 → CARD TRACE A

(SAVE/RECALL) Save Trace  
Internal → Intrnl TRACE A

---

#### Related Programming Command

SETC

---

## TRACE B

Softkey that saves trace B data to a card. To save trace B data press, Trace → Card, TRACE B. REGISTER # and PREFIX= are displayed on the screen. Use the data keys to enter the desired register number. Trace B data is then saved to a card.

### Key Path

Recall Internal  
(SAVE/RECALL) Internal → Trace TRACE B

Save More Trace  
(SAVE/RECALL) Card 1 of 3 → CARD TRACE B

Save Trace  
(SAVE/RECALL) Internal → Intrnl TRACE B

### Related Programming Command

SETC

---

## TRACE B VW OFF

Softkey that allows viewing, (VW) or blanking, (OFF) trace B. This softkey only appears when NORM A/B ON OFF is set to ON.

### Key Path

More TRACE B  
(TRACE) 1 of 4 VW OFF

### Related Programming Command

BLANK, VIEW

---

## TRACE C

Softkey that saves trace C data to a card. To save trace C data press, Trace → Card, press, Trace → Card, TRACE C. REGISTER # and PREFIX= are displayed on the screen. Use the data keys to enter the desired register number. Trace C data is then saved to a card.

### Key Path

SAVE/RECALL Recall Internal  
Internal → Trace TRACE C

SAVE/RECALL Save More Trace  
Card 1 of 3 → CARD TRACE C

SAVE/RECALL Save Trace  
Internal → Intrnl TRACE C

### Related Programming Command

SETC

---

## Trace → Card

Softkey that accesses a menu to select the item to be stored on a card: the trace to be saved (trace A, trace B, or trace C), or a limit-line table.

### Key Path

SAVE/RECALL Save More Trace  
Card 1 of 3 → CARD

### Related Programming Command

STOR

---

**Trace**  
→ **Intrnl**

*Softkey changes to MEM LOCKED when SAV LOCK ON.*

Softkey that accesses a menu to select the item to be stored in internal memory: the trace to be saved (trace A, trace B, or trace C), or a limit-line table. To save a trace, select the trace to be saved, enter the trace-register number, and press **(ENTER)**. To save a limit-line table press, **LIMIT LINES**, enter the trace-register number, then press **(ENTER)**. Valid trace-register numbers are 0 through the maximum register number. The maximum register number is the number *x* displayed after **MAX REG # = x** during a save or recall operation. If a screen title is present, it is saved with the trace data. The time and date that the trace was stored is appended to the screen title. If windows are being used, only the trace of the active window will be saved.

### Key Path

**(SAVE/RECALL)** **Save** **Trace**  
**Internal** → **Intrnl**

### Related Programming Command

SAVET

---

**Track Gen**

*Available with Option 010 only.*

Softkey that accesses a menu that controls the built-in tracking generator.

### Key Path

**(AUX/USER)** **Track Gen**

---

## TRACKING PEAK

Softkey that activates a routine to adjust the tracking adjustment for the peak response of the tracking generator.

### Note

For tracking peak to function properly, the tracking generator must be connected to the instrument.

Before making a stimulus-response measurement, care must be taken to maximize the tracking adjustment of the tracking generator to ensure maximum available dynamic range.

### Key Path

**(AUX/USER)** Track Gen TRACKING PEAK

### Related Programming Command

SRCTKPK

## Trigger

Softkey that accesses a menu for setting the trigger mode of the EMC analyzer.

### Key Path

**(SWEEP/TRIG)** Trigger

### Related Programming Command

TM

## TUNE SLO FAST

Softkey that makes center frequency the active function and, when FAST is underlined, increases the speed of the marker positioning and center frequency tuning functionality of the knob and step keys.

For marker positioning, the knob changes the marker position by four times the normal rate (FAST).

For center frequency, the knob tuning is eight times the normal rate. (FAST)

### Key Path

**(TEST)** TUNE SLO FAST

### Related Programming Command

FASTMRKR

TV  
LINE #

*Available with Option 101 and 102 or 301 only.*

Softkey that selects the line number of the video picture field. The values allowed are 1 to 1012.

**Key Path**

(SWEEP/TRIG) Trigger TV TRIG TV LINE #

**Related Programming Command**

TVLINE

---

TV  
Standard

*Available with Option 101 and 102 or 301 only.*

Softkey that allows the instrument to trigger on the standard video formats; NTSC, PAL, PAL-M, or SECAM-L.

**Key Path**

(SWEEP/TRIG) Trigger TV TRIG TV Standard

**Related Programming Command**

TVSTND

---

TV SYNC  
NEG POS

*Available with Option 101 and 102 or 301 only.*

Softkey that selects the polarity of the modulation of the video format. NTSC uses the negative or positive modulation video format. NTSC, PAL, PAL-M use negative modulation. SECAM-L uses positive modulation.

**Key Path**

(SWEEP/TRIG) Trigger TV TRIG TV SYNC NEG POS

**Related Programming Command**

TVSYNC

---

TV  
TRIG

*Available with Option 101 and 102 or 301 only.*

Softkey that provides sweep triggering on the selected line of a video picture field and accesses the softkey menu used to select the line number of the video picture field and the type of video picture frame.

When TV TRIG is pressed, the trigger mode is changed to TV trigger, TV LINE # becomes the active function, and the softkey menu for changing the TV line numbers and video field trigger is accessed.

If the instrument is in non-zero span, the resolution bandwidth is changed to 1 MHz, the frequency span is set to 0 Hz, the detector mode is changed to sample, the sweep time is changed to 100  $\mu$ s, the amplitude scale is changed to linear, a sweep is taken, and a marker is placed on the signal peak.

#### Key Path

(SWEEP/TRIG) Trigger TV  
TRIG

#### Related Programming Command

TM

---

TV TRIG  
EVEN FLD

*Available with Option 101 and 102 or 301 only.*

Softkey that selects an even video field of an interlaced video format to trigger on.

#### Key Path

(SWEEP/TRIG) Trigger TV TV TRIG  
TRIG EVEN FLD

#### Related Programming Command

TVSFRM

---



TV TRIG  
ODD FLD

*Available with Option 101 and 102 or 301 only.*

Softkey that selects an odd video field of an interlaced video format to trigger on.

**Key Path**

(SWEEP/TRIG) Trigger TV TRIG  
TRIG ODD FLD

**Related Programming Command**

TVSFRM

---

TV TRIG  
VERT INT

*Available with Option 101 and 102 or 301 only.*

Softkey that selects a vertical interval to trigger on. Triggering occurs on the next pulse edge. If it triggers on an even field, triggering will not alternate between odd and even fields. If it triggers on an odd field, triggering will alternate between odd and even fields. The vertical interval is used for non-interlaced video formats.

**Key Path**

(SWEEP/TRIG) Trigger TV TRIG  
TRIG VERT INT

**Related Programming Command**

TVSFRM

---

User  
Menus

Softkey that accesses a menu available for your use for user-defined programs and key functions.

**Key Path**

(AUX/USER) User  
Menus

---

## VERIFY TIMEBASE

Softkey that allows the time base digital-to-analog converter to be changed to verify that the 10 MHz reference time base performs to specification. Pressing **PRESET** resets the time base to its original value. A pass code is required to access this function.

### Key Path

**CAL** More More VERIFY  
1 of 4 2 of 4 TIMEBASE

---

## VID AVG ON OFF

Softkey that initiates a digital averaging routine that averages displayed signals and noise. This function does not affect the sweep time, bandwidth, or other analog characteristics of the instrument. Annotation on the left side of the screen indicates the current number of sweeps averaged. The default number of sweeps is 100. Increasing the number of sweeps smooths the trace. To turn off the video averaging function, press **VID AVG ON OFF** so that OFF is underlined. The number of sweeps can be entered using the data keys.

### Key Path

**BW** More VID AVG  
1 of 2 ON OFF

**TRACE** More More VID AVG  
1 of 4 2 or 4 ON OFF

### Related Programming Command

VAVG, CLRAVG

---

## VIDEO

Softkey that activates the trigger condition that allows the next sweep to start if the detected RF envelope voltage rises to a level set by the display line. When **VIDEO** is pressed, the display line appears on the screen. For example, connect the CAL OUT signal to the instrument input, change the trigger mode to video, and lower the display line. The instrument triggers when the display line reaches the noise floor.

### Key Path

**SWEEP/TRIG** Trigger VIDEO

### Related Programming Command

TM

---

VIEW Δ  
OFF

*Only available when SIG LIST is on.*

Softkey that accesses a menu to select which delta from the limit-line table is viewed by the display signal list. Each time this softkey is pressed, it changes sequentially as follows:

- VIEW PK Δ LIM 1
- VIEW PK Δ LIM 2
- VIEW QP Δ LIM 1
- VIEW QP Δ LIM 2
- VIEW AVG Δ LIM 1
- VIEW AVG Δ LIM 2
- VIEW Δ OFF

### Key Path

More VIEW Δ  
(TEST) 1 of 3 OFF

### Related Programming Command

SIGDLTAVIEW

---

VIEW A

Softkey that holds and displays the amplitude data that is in the trace A register. The trace A register is not updated as the instrument sweeps. If trace A is deactivated by pressing STORE BLANK A, the stored data can be retrieved by pressing VIEW A.

### Key Path

(TRACE) VIEW A

More Save/Rcl SAVE  
(TEST) 1 of 3 List LIN GRAPH VIEW A

More Save/Rcl SAVE  
(TEST) 1 of 3 List LOG GRAPH VIEW A

### Related Programming Command

VIEW

---

## VIEW B

Softkey that holds and displays the amplitude data that is in the trace B register. The trace B register is not updated as the instrument sweeps. If trace B is deactivated by pressing **STORE BLANK B**, the stored data can be retrieved by pressing **VIEW B**.

### Key Path

<b>TRACE</b>	<b>VIEW B</b>			
	<b>More</b>	<b>Save/Rcl</b>	<b>SAVE</b>	
<b>TEST</b>	<b>1 of 3</b>	<b>List</b>	<b>LIN GRAPH</b>	<b>VIEW B</b>
	<b>More</b>	<b>Save/Rcl</b>	<b>SAVE</b>	
<b>TEST</b>	<b>1 of 3</b>	<b>List</b>	<b>LOG GRAPH</b>	<b>VIEW B</b>

### Related Programming Command

VIEW

---

## VIEW C

Softkey that holds and displays the amplitude data that is in the trace C register. The trace C register is not updated as the instrument sweeps. If trace C is deactivated by pressing **STORE BLANK C**, the stored data can be retrieved by pressing **VIEW C**.

### Key Path

<b>TRACE</b>	<b>VIEW C</b>			
	<b>More</b>	<b>Save/Rcl</b>	<b>SAVE</b>	
<b>TEST</b>	<b>1 of 3</b>	<b>List</b>	<b>LIN GRAPH</b>	<b>VIEW C</b>
	<b>More</b>	<b>Save/Rcl</b>	<b>SAVE</b>	
<b>TEST</b>	<b>1 of 3</b>	<b>List</b>	<b>LOG GRAPH</b>	<b>VIEW C</b>

### Related Programming Command

VIEW

---

VIEW CAL  
ON OFF

*Only available when used with an HP 85420E Option 1EM RF filter section.*

Softkey that switches the 300 MHz calibrator signal so that it is routed internally to the input of the instrument or externally to the 300 MHz output of the instrument.

#### Key Path

(SETUP) More More More More Input VIEW CAL  
1 of 5 2 of 5 3 of 5 4 of 5 ON OFF

#### Related Programming Command

CALSW

---

VIEW  
PK QP AV

*Not available with Option 703.*

Softkey that toggles between the different detection modes, peak (PK), quasi-peak (QP), and average (AV). This function is accessed through the VIEW Δ OFF key when SIG LIST is ON.

#### Key Path

(DET) VIEW  
PK QP AV

(TEST) More VIEW Δ VIEW  
1 of 3 OFF PK QP AV

#### Related Programming Command

DET

---

Volts

Softkey that changes the amplitude units to volts.

#### Key Path

(AMPLITUDE) More Amptd  
1 of 3 Units Volts

#### Related Programming Command

AUNITS

---

Watts

Softkey that changes the amplitude units to watts.

### Key Path

More Amptd  
(AMPLITUDE) 1 of 3 Units Watts

### Related Programming Command

AUNITS

---

WINDOWS  
OFF

Softkey that turns off the windows display mode and returns to the normal full-sized display. The state of the last active window will become the instrument state when the windows display is turned off.

### Key Path

(ON) WINDOWS OFF

### Related Programming Command

WINOFF

---

X FINE  
TUNE DAC

Softkey that displays the output of the YTO extra-fine-tune DAC (FM\_TUNE) that is on the A7 analog interface assembly. This is a service diagnostic function and is for service use only.

### Key Path

More More Service X FINE  
(CAL) 1 of 4 2 of 4 Diag More 1 ... More 3 TUNE DAC

YTF  
DRIVER

*HP 8593EM, 8595EM, or 8596EM only.*

Softkey that displays the output of the sample-and-hold circuit in the YTF span divider and driver located on the A7 analog interface assembly. This is a service diagnostic function and is for service use only.

### Key Path

More More Service YTF  
(CAL) 1 of 4 2 of 4 Diag More 1 ... More 5 DRIVER

---

**YTF  
SPAN**

HP 8593EM, 8595EM, or 8596EM only. This softkey changes to *BINARY SPAN* for HP 8591EM.

Softkey that displays a trace of the voltage driving the YTF as it sweeps through the displayed span. This is a service diagnostic function and is for service use only.

**Key Path**

**(CAL)** More 1 of 4 More 2 of 4 Service Diag More 1 More 2 YTF SPAN

---

**YTF TUNE  
COARSE**

HP 8593EM, 8595EM, or 8596EM only.

Softkey that displays the output produced by the YTF coarse-tune DAC located on the A7 analog interface assembly. This is a service diagnostic function and is for service use only.

**Key Path**

**(CAL)** More 1 of 4 More 2 of 4 Service Diag More 1 ... More 5 YTF TUNE COARSE

---

**YTF TUNE  
FINE**

HP 8593EM, 8595EM, or 8596EM only.

Softkey that displays the output produced by the YTF fine-tune DAC located on the A7 analog interface assembly. This is a service diagnostic function and is for service use only.

**Key Path**

**(CAL)** More 1 of 4 More 2 of 4 Service Diag More 1 ... More 5 YTF TUNE FINE

---

**YZ\_# Spc  
Clear**

Softkey that accesses the menu used for selecting the characters Y, Z, underscore (\_), #, space, or for clearing the screen title.

**Key Access**

**(CAL)**, **(CONFIG)**, **(DISPLAY)**, **(SAVE/RECALL)**, or **(SETUP)**

**Related Programming Command**

TITLE, PREFX

---

ZERO  
SPAN

Softkey that changes the frequency span to zero and turns off marker track if it is on.

#### Key Path

ZERO  
(SPAN) SPAN

#### Related Programming Command

SP

---

ZONE  
CENTER

Softkey that moves the zone markers in frequency without changing the zone span. The zone markers are vertical lines marking the zone on the upper window. They correspond with the frequency range displayed in the lower window. As the zone markers are moved the center frequency of the lower window is changed but the lower window will not be updated unless it is active.

The zone can be moved beyond the frequency range that is being displayed in the upper window. Its movement is limited to the frequency range of the instrument. The zone markers will be displayed at the edges of the upper window when the zone is moved beyond the displayed frequency range.

#### Key Path

ZONE  
(ON) CENTER

#### Related Programming Command

ZMKNTR

---



**ZONE  
PK LEFT**

Softkey that searches for the next frequency peak outside and to the left of the zone markers on the upper window trace and then moves the zone so that it is centered around the new peak. The zone span is not changed. The center frequency of the lower window changes to reflect the new zone center frequency. The lower window will not be updated until it is made active. If no peak is found the zone will not be moved. A signal must have a 6 dB peak excursion to be identified as a peak signal. The definition of a peak excursion can be changed by selecting **PEAK EXCURSN** while the upper window is active.

Pressing **ZONE PK LEFT** will have no effect if the upper window is in zero span.

#### **Key Path**

**ZONE**  
**(ON) PK LEFT**

#### **Related Programming Command**

ZMKPKNL

---

**ZONE  
PK RIGHT**

Softkey that searches for the next frequency peak outside and to the right of the zone markers on the upper window trace and then moves the zone so that it is centered around the new peak. The zone span is not changed. The center frequency of the lower window changes to reflect the new zone center frequency. The lower window will not be updated until it is made active. If no peak is found the zone will not be moved. A signal must have a 6 dB peak excursion to be identified as a peak signal. The definition of a peak excursion can be changing by selecting **PEAK EXCURSN** while the upper window is active.

Pressing **ZONE PK RIGHT** will have no effect if the upper window is in zero span.

#### **Key Path**

**ZONE**  
**(ON) PK RIGHT**

#### **Related Programming Command**

ZMKPKNR

---

**ZONE  
SPAN**

Softkey that changes the span of the zone markers without changing the center frequency. The zone markers are vertical lines marking the zone on the upper window. They correspond with the frequency range displayed in the lower window. As the zone markers are moved the span of the lower window is changed but the lower window will not be updated unless it is active.

The zone can be expanded beyond the frequency range that is being displayed in the upper window. Its movement is limited to the frequency range of the instrument. The zone markers will be displayed at the edges of the upper window when the zone is moved beyond the displayed frequency range.

**Key Path**

**ZONE**  
**SPAN**

**Related Programming Command**

ZMKSPAN

---

**ZOOM**

Hardkey that switches between the split-screen windows display and a full size display of the window that is currently active. Once the ZOOM function is active the **NEXT** key can be used to switch between the two windows while remaining zoomed (full sized).

**Related Programming Command**

WINZOOM

---

## Options and Accessories

---

### What you'll find in this chapter

This chapter lists the instruments, options and accessories available for the HP 8590 EM series EMC analyzers.

---

<b>EMC analyzer</b>	HP 8591EM	9 kHz to 1.8 GHz
	HP 8593EM	9 kHz to 22 GHz (or 26.5 GHz)
	HP 8594EM	9 kHz to 2.9 GHz
	HP 8595EM	9 kHz to 6.5 GHz
	HP 8596EM	9 kHz to 12.8 GHz
<b>Options</b>	004	Precision frequency reference
	009	LO output (except HP 8591EM)
	010	Tracking generator (9 kHz to 2.9 GHz) (100 kHz to 1.8 GHz on HP 8591EM)
	026	26 GHz frequency range (HP 8593EM only)
	027	26 GHz frequency range, type N (HP 8593EM only)
	040	Front panel cover
	042	Soft case
	043	RS-232 and parallel port
	101	Fast time domain sweeps
	102	AM/FM demod, TV sync
	301	Combination of Options 101 and 102
	703	Delete quasi-peak detector
	908	Rack mount without handles
	909	Rack mount with handles
	910	Additional operating manuals
915	Support manuals	

W30	Two year service contract
W32	Two year calibration service

### Transducers and accessories

HP 11945A Opt E51	Probe kit (9 kHz to 1 GHz)
HP 11947A	Transient limiter
HP 11955A	Biconical antenna (typical cal data)
HP 11956A	Log periodic antenna (typical cal data)
HP 11966C	Biconical antenna (typical cal data)
HP 11966D	Log periodic antenna (.2 to 1 GHz)
HP 11966E	Ridged horn (1 to 18 GHz)
HP 11966L	10 meter N cable
HP 11966P	Broadband antenna (30 MHz to 1 GHz)
HP 11967C	Line impedance stabilization network (25 amp)
HP 11967D	LISN (10 amp)
HP 11968C	Tripod
HP 85420E Opt. 1EM	RF filter section (except HP 8593EM)

## **SRQ**

---

### **Service Requests**

This appendix describes the receiver service request (SRQ) capability. A service request is an instrument output that tells the operator or computer that a specific event has taken place in the instrument.

When writing programs, service requests can be used to interrupt the computer program sequence, causing the program to branch to a subroutine. For example, by using service requests, the computer can perform other operations while the receiver is sweeping. When the sweep is completed, the computer can service the receiver by changing the receiver state or reading data from the memory.

---

#### **Note**

Service requests do not work with computers that have an RS-232 interface. Not all service requests are available with some HP-IB computers. Refer to the manuals supplied by your computer's manufacturer.

---

When making a service request, the receiver places the I/O interface SRQ line true and the receiver displays SRQ with an octal coded number. Setting the SRQ line true announces to the computer that the receiver requires attention. The computer can then command the receiver to send its "status byte." The status byte indicates the type of service request. The status byte is the binary equivalent of the octal SRQ number.

---

#### **Note**

If the instrument display annotation has been blanked, the service request notation will not appear.

A serial polling technique must be used by the computer to test for service requests. The receiver does not respond to parallel polling.

---

A service request can be cleared from the display by doing an instrument preset.

### **Status byte definition**

The status byte sent by the receiver determines the nature of the service request. The meaning of each bit of the status byte is explained in Table A-1.

**Table A-1. Status Byte Definition**

Bit	Message	Display Message
0 (LSB)	Overload Detected	SRQ 101
1	Unit Key Pressed	SRQ 102
2	End of sweep	SRQ 104
3	Hardware broken	SRQ 110
4	Command complete	SRQ 120
5	Illegal command	SRQ 140
6	Universal HP-IB service request HP-IB RQS bit	-
7	Unused	-

The display message is an octal number based on the binary value of the status byte. This octal number always begins with a "1" since this is translated from bit 6, the universal service request bit. The status byte for an illegal receiver command (SRQ 140) is as follows:

<b>bit number</b>	<b>7 6</b>	<b>5 4 3</b>	<b>2 1 0</b>
status byte	0 1	1 0 0	0 0 0

This displays the octal equivalent of the status byte binary number:  
SRQ 140

The octal equivalent is based on the whole binary number: 01100000  
(binary) = 140 (octal)

One simple way to determine the octal equivalent of the binary number is to partition the binary number three bits at a time from the least significant bit, and treat each part as a single binary number:

<b>binary</b>	<b>0 1</b>	<b>1 0 0</b>	<b>0 0 0</b>
octal	1	4	0

The decimal equivalent of the octal number is determined as follows:

$$140 \text{ (octal)} = 1 \times (8) + 4 \times (8) + 0 \times (8) = 96 \text{ (decimal)}$$

More than one service request can be sent at the same time. For example, if an illegal receiver command (SRQ 140) and the end of a sweep (SRQ 104) occurred at the same time, SRQ 144 appears on the receiver display, because both bit 5 and bit 2 are set as shown below:

<b>bit number</b>	<b>7 6</b>	<b>5 4 3</b>	<b>2 1 0</b>	
status byte	0 1	1 0 0	1 0 0	
octal value	1	4	4	= SRQ 144

## **Service request activating commands**

With the exceptions of SRQ 101, SRQ 140, and SRQ 110, service requests can only be activated from a computer. (SRQ 101, SRQ 140, and SRQ 110 are activated at instrument preset.) Your programmer's guide describes service request activating commands under RQS and SRQ.





## EMC Setups, Limit Lines and Antenna Factors Card

---

This appendix describes the files on the EMC Setups, Limit Lines and Antenna Factors Card, HP part number 08590-10027.

---

### Auto-execute radiated emissions test setup sample

**Equipment:**

HP 11966P Broadband Antenna  
HP 8447F Option H64 Dual Preamp

**Instrument Settings:**

IF Bandwidth 120 kHz  
Averaging Bandwidth 300 kHz  
RF Attenuation + 10 dB  
Reference Level + 70 dB $\mu$ V/m  
08447FH Correction Factors  
nHP11966P Correction Factors

**Auto-Execute Radiated Emissions Test Setup Sample**

Filename	Test	Frequency Range	Limit Lines
eAUTOEXEC	Sample AUTOEXEC Radiated Setup	30 to 1000 MHz	FCC15B3M

## Radiated emissions test setup sample

### Equipment:

HP 11966C Broadband Antenna  
HP 8447F Option H64 Dual Preamp

### Instrument Settings:

IF Bandwidth 120 kHz  
Averaging Bandwidth 300 kHz  
RF Attenuation +10 dB  
Reference Level +70 dB $\mu$ V/m  
nHP11966C Correction Factors  
o8447FHI Correction Factor

### Radiated Emissions Test Setup Sample

Filename	Test	Frequency Range	Limit Lines
eSAMPLE_R	Sample Radiated Setup	30 to 300 MHz	FCC15B3M

## Conducted emissions test setup sample

### Equipment:

HP 11967C LISN  
HP 11947A Transient Limiter (-10 dB)

### Instrument Settings:

IF Bandwidth 9 kHz  
Averaging Bandwidth 30 kHz  
RF Attenuation +10 dB  
Reference Level +85 dB $\mu$ V/m  
nLISN Correction Factors  
nHP11947A Correction Factors

### Conducted Emissions Test Setup Sample

Filename	Test	Frequency Range	Limit Lines
eSAMPLE_C	Sample Conducted Setup	150 kHz to 30 MHz	EN022_BC

## Diagnostic emissions test setup sample

### Equipment:

HP 11940A Close Field Probe  
HP 8447F Option H64 Dual Preamp

### Instrument Settings:

IF Bandwidth 120 kHz  
Averaging Bandwidth 300 kHz  
RF Attenuation 0 dB  
Reference Level +90 dB $\mu$ V/m  
HP 11940A Correction Factors

### Diagnostic Emissions Test Setup Sample

Filename	Test	Frequency Range	Limit Lines
eSAMPLE_D	Sample Diagnostic Setup	30 to 1000 MHz	OFF

## Setups

Filename	Description
eAUTOEXEC	Auto-execute radiated emissions setup
eSAMPLE_R	Radiated emissions test setup
eSAMPLE_C	Conducted emissions test setup
eSAMPLE_D	Diagnostic setup

## Antenna Correction Factors

Filename	Description
nBICONICAL	Antenna Factors for HP 11966C Biconical Antenna (30 MHz to 300 MHz) at 3m spacing
nHF_LOG	Antenna Factors for HP 11966N HF Log Periodic Antenna (200 MHz to 5 GHz) at 3m spacing
nHORN	Antenna Factors for HP 11966E Double-Rigid Waveguide Horn Antenna (1 GHz to 18 GHz) at 3m spacing
nHP11940	Typical Antenna Factors for HP 11940A Probe
nHP11941	Typical Antenna Factors for HP 11941A Probe
nHP11966P	Typical Antenna Factors for HP 11996P Broadband Antenna (30 MHz to 1 GHz)
nLISN	Transducer Factors for HP 11967C Line Impedance Stabilization Network (10 kHz to 105 MHz)
nLISN10A	Transducer Factors for HP 11967D Line Impedance Stabilization Network (9 kHz to 30 MHz)
nLOG_PERD	Antenna Factors for HP 11966D Periodic Antenna (200 MHz to 1 GHz) at 3m spacing
nMAG_LOOP	Transducer factors for the HP 11966A Active Loop H-Field Antenna

## Cable Correction Factors

Filename	Description
cCABLE	Correction factors for the HP 11966L 10m cable, type-N

## Other Correction Factors

Filename	Description
oHP11947A	Correction factors for the HP 11947A Transient Limiter
o8447FLO	Correction factors for the low frequency amplifier of the HP 8447F option H64
o8447FHI	Correction factors for the high frequency amplifier of the HP 8447F option H64

## Limit Lines

Filename	Description
1EN011_A1	EN55011 Class A, Group 1 Conducted Limits <sup>1</sup>
1EN011_A2	EN55011 Class A, Group 2 Conducted Limits <sup>1</sup>
1EN011_BC	EN55011 Class B, Groups 1 and 2 Conducted Limits <sup>1</sup>
1EN011A1R	EN55011 Test Site Radiated, 30m distance, Class A
1EN011A2R	EN55011 Test Site Radiated, 30m distance, Class A, Group 2
1EN011B1R	EN55011 Test Site Radiated, 10m distance, Class B, Group 1
1EN011B2R	EN55011 Test Site Radiated, 10m distance, Class B, Group 2
1EN014_HH	EN55014 Interference Limits household (30 MHz to 300 MHz)
1EN014_HL	EN55014 Interference Limits household (150 kHz to 30 MHz)
1EN014_P1	EN55014 Interference Portable tools 700W (150 kHz to 30 MHz)
1EN014_P2	EN55014 Interference Portable tools 700 to 1000W (150 kHz to 30 MHz)
1EN014_P3	EN55014 Interference Portable tools 1000 to 2000W (150 kHz to 30 MHz)
1EN014_P4	EN55014 Interference Portable tools 700W (30 MHz to 300 MHz)
1EN014_P5	EN55014 Interference Portable tools 700 to 1000W (30 MHz to 300 MHz)
1EN014_P6	EN55014 Interference Portable tools 1000 to 2000W (30 MHz to 300 MHz)
1EN022_AC	EN55022 Class A Conducted Limits <sup>1</sup>
1EN022_BC	EN55022 Class B Conducted Limits <sup>1</sup>
1EN022A10	EN55022 Class A Radiated, 10m limit
1EN022A30	EN55022 Class A Radiated, 30m limit
1EN022B10	EN55022 Class B Radiated, 10m limit
1FCC15_AC	FCC Part 15, Class A Conducted Limits
1FCC15_BC	FCC Part 15, Class B Conducted Limits
1FCC15A10	FCC Part 15, Class A Radiated, 10m limit
1FCC15B3M	FCC Part 15, Class B Radiate, 3m limit
1VCCI_1C	VCCI, Class 1 Conducted Limits <sup>1</sup>
1VCCI_2C	VCCI, Class 2 Conducted Limits <sup>1</sup>
1VCCI1_10	VCCI, Class 1 Radiated, 10m limit
1VCCI1_3M	VCCI, Class 1 Radiated, 3m limit
1VCCI2_10	VCCI, Class 2 Radiated, 10m limit
1VCCI2_3M	VCCI, Class 2 Radiated, 3m limit
1VDE71_1A	VDE 0871 Part 11; Group 1, Class A Radiated 30m limit
1VDE71_1B	VDE 0871 Part 11; Group 1, Class B Radiated 10m limit
1VDE71_2A	VDE 0871 Part 11; Group 2, Class A Radiated 30m limit
1VDE71_2B	VDE 0871 Part 11; Group 2, Class B Radiated 10m limit
1VFG43_10	VFG 243/1991 (electric field, 10m)
1VFG43_3M	VFG 243/1991 (magnetic field, 3m)
1VFG43_CP	VFG 243/1991 (conducted: power lines) <sup>1</sup>
1VFG43_CS	VFG 243/1991 (conducted: signal and control lines) <sup>1</sup>

1 Limit Line 1 contains the quasi peak limit value. Limit Line 2 contains the average limit value.



# Index

---

- 0** 0-2.9 Gz BAND 0, 17-5, 17-27
  
- 1** 10 MHz reference DAC setting, 17-34  
10 MHz REF OUTPUT, 2-7  
+10V REF DETECTOR, 17-2, 17-8  
-10V REF DETECTOR, 17-8  
120 kHz EMI BW, 17-10  
12.4-19 BAND 3, 17-8  
150 kHz –30 MHz, 17-10  
19.1-22 BAND 4, 17-9
  
- 2** 200 Hz EMI BW, 17-10  
200 MHz –1 GHZ, 17-11  
2.75-6.5 BAND 1, 17-6, 17-27  
2v REF DETECTOR, 17-2, 17-6
  
- 3** 30 MHz –300 MHz, 17-9  
3 dB POINTS, 17-6  
3rd ORD MEAS, 17-6
  
- 6** 6.0-12.8 BAND 2, 17-7  
6 dB POINTS, 17-7
  
- 9** 99% PWR BW, 17-9  
9 kHz EMI BW, 17-8  
9 kHz –150 kHz, 17-7
  
- A** ABCDEF, 17-13  
Abort, 17-13  
accessories, 18-2  
ac coupling, 17-56  
activating
  - amplitude correction, 10-6
  - analyzer limit-line testing, 9-7, 9-15
  - overview mode, 11-5
  - windows display mode, 11-2active function, 2-13  
active function clearing, 17-96  
adding
  - data to signal list, 5-4, 6-5addressing plotter, 17-139  
addressing printer, 17-148  
ADD TO LIST, 17-13

- A <-> B, 17-11
- ALC INT EXT, 17-14
- ALC MTR INT XTAL, 17-14
- ALC TEST, 17-14
- ALL DLP → CARD, 17-15
- alpha characters, 17-13, 17-96, 17-193, 17-213
- % AM, 17-4
- A-B → A ON OFF, 17-12
- Amp Cor, 17-15
- AMP COR ON OFF, 17-15
- AMPLITUDE, 2-2, 17-16
- amplitude accuracy, 17-55
- amplitude and frequency difference, measuring, 8-20
- amplitude correction
  - activating, 10-6
  - saving and recalling, 10-7
  - tables, creating, 10-1
  - tables, editing, 10-6
- amplitude correction factors
  - edit done, 17-73
  - select amplitude, 17-169
  - select frequency, 17-171
  - select point, 17-173
- amplitude demodulation, 17-66
- amplitude menus, 17-16
- amplitude modulation, 17-4
  - measuring with the FFT function, 8-12
- amplitude scale, 17-168
- amplitude units, 17-17
  - dBm, 17-58
  - dB $\mu$ V, 17-58
  - dBmV, 17-58
  - Volts, 17-211
  - Watts, 17-212
- AMPL SCL LOG LIN, 17-16
- Amptd Units, 17-17
- analog+ display
  - using, 8-25-27
- ANALOG+ ON OFF, 17-17
- analyzer
  - battery, 3-9
  - clock, 3-10
  - limit line format , 9-14
  - limit lines, activating, 9-15
  - limit lines, creating, 9-10
  - limit lines, editing, 9-12
- ANALYZER ADDRESS, 17-17
- ANNOTATN ON OFF, 17-18
- Antenna Factors, 17-19
- ANTENNA ON OFF, 17-19
- ANTENNA → CARD, 17-18
- Antenna Units, 17-19
- APND CAT ITEM, 17-20
- A → C, 17-12
- ATTEN AUTO MAN, 17-20



- attenuation coupling, 17-21
- attenuator-error factors, 17-179
- AUTO ALL, 17-21
- autocal, 3-10
- AUTO CAL ON OFF, 17-21
- AUTO COUPLE, 17-22
- AUTOEXEC ON OFF, 17-23
- automated diagnostic emission test, 7-3
- auto-measure, 4-19
- AUTO-MEASURE, 17-22
- autoranging, 4-7
- AUTORANG ON OFF, 17-23
- AUX B, 17-23
- Aux Conn Control, 17-24
- AUX IF OUTPUT, 2-8
- auxiliary connector input, 17-69
- auxiliary interface
  - control line A, 17-47
  - control line B, 17-47
  - control line C, 17-47
  - control line D, 17-48
- AUX INTERFACE, 2-7
- AUX/USER, 17-24
- AUX VIDEO OUTPUT, 2-8
- available memory, 17-36
- AV DWELL TIME, 17-24
- average bandwidth
  - modifying, 4-5
  - reducing, 7-34
- average video bandwidth coupling, 17-21
- AVG BW AUTO MAN, 17-25
- AVG ON OFF, 17-25
- AV/IF BW RATIO, 17-26

**B**

- band boundaries, measuring signals near, 7-48
- band lock
  - band selection, 17-6-9
- Band Lock, 17-27
- BAND LOCK, 7-48
- band locking, 17-30
- bandwidth
  - functions, 17-30
  - measuring 3 dB and 6 dB, 8-17
  - measuring 99% power, 8-18
  - modifying, 4-5
- battery
  - changing the battery, 3-7
- BAUD RATE, 17-28
- B  $\leftrightarrow$  C, 17-26
- bias-current DAC adjustment, 17-33
- binary, A-2
- BINARY SPAN, 17-28
- BLANK A, 17-28
- BLANK B, 17-29

BLANK C, 17-29  
BLANK CARD, 17-29  
B-DL → B, 17-27  
BND LOCK ON OFF, 7-48, 17-30  
B → C, 17-26  
BW, 17-30

**C** Cable Factors, 17-31  
CABLE ON OFF, 17-31  
CABLE → CARD, 17-31  
CAL, 3-1, 17-31  
CAL AMP, 17-32  
CAL AMPTD, 3-2  
Cal At Time, 17-32  
CAL CISPR BW, 17-32  
CAL FETCH, 3-2, 17-32  
CAL FREQ, 3-2, 17-33  
CAL FREQ & AMPTD, 1-10, 3-1, 17-33  
calibration  
    attenuator-error factors, 17-179  
    self-calibration routines, 3-1  
CAL MXR, 17-2, 17-33  
CAL OUT, 2-5  
cal output, 2-5  
CAL STORE, 1-11, 3-2, 17-34  
CAL TIMEBASE, 17-2, 17-34  
CAL TRK GEN, 3-3, 17-34  
CAL YTF, 3-4, 17-35  
card  
    catalog, viewing, 9-9  
    changing the battery, 3-7  
    delete file, 17-61  
    formatting, 12-2  
    inserting a memory card, 3-6  
    loading amplitude correction factors from, 4-11  
    loading limit lines, 4-9  
    loading pre-defined configurations, 4-4, 4-23  
Card Config, 17-35  
CATALOG ALL, 17-35  
CATALOG CARD, 17-36  
Catalog Internal, 17-36  
CATALOG PREFIX, 17-38  
CATALOG REGISTER, 17-38  
CATALOG VARIABLES, 17-39  
CENTER FREQ, 17-39  
center frequency, 17-39  
    step size, 17-40  
    window zone, 17-214  
CF STEP AUTO MAN, 17-40  
change function values, 2-9  
change prefix  
    edit done, 17-73  
Change Prefix, 17-41  
Change Title, 17-42

- changing the frequency step, 6-5
- characters, 17-13, 17-96, 17-193, 17-213
- CLEAR ANNOTATN, 17-42
- clear display
  - active function area, 2-9
- clearing a service request, A-1
- clearing the active function, 17-96
- CLEAR MARK, 17-43
- CLEAR WRITE A, 17-44
- CLEAR WRITE B, 17-45
- CLEAR WRITE C, 17-46
- clock, 3-10
- close-field probe, 7-2-10
- CLR ALL MARKS, 17-46
- CNTL A 0 1, 17-47
- CNTL B 0 1, 17-47
- CNTL C 0 1, 17-47
- CNTL D 0 1, 17-48
- CNT RES AUTO MAN, 7-17, 17-48
- COARSE TUNE DAC, 17-2, 17-48
- COMB GEN ON OFF, 7-48, 17-49
- command complete, A-1
- commands
  - front panel execution, 17-83
- comparing signals, 7-27
- compliance measurements
  - configuring a printer, 12-14
  - generating a report, 12-15
- COMPLMNT MARKS, 17-49
- CompuServe, 15-3
- conducted emissions, B-2
- confidence test, 17-49
- CONFIG, 17-50
- configuration
  - plotter, 17-139
  - printer, 17-148
- configuring a printer, 4-20, 12-14
- configuring pre-compliance system, 4-3
- configuring systems for diagnostic emissions, 7-2
- CONF TEST, 17-49
- connector
  - 10 MHz ref output, 2-7
  - aux IF output, 2-8
  - aux video output, 2-8
  - earphone, 2-6
  - ext alc input, 2-6
  - external keyboard, 2-8
  - ext ref in, 2-7
  - ext trig input, 2-8
  - hi sweep in/out, 2-8
  - HP-IB interface, 2-8
  - LO output, 2-6
  - monitor output, 2-7
  - sweep output, 2-8
  - sweep + tune output, 2-6

- TV trig output, 2-6
- continuous sweep, 17-194
- control functions, 2-4
- control line A
  - auxiliary interface, 17-47
- control line B
  - auxiliary interface, 17-47
- control line C
  - auxiliary interface, 17-47
- control line D
  - auxiliary interface, 17-48
- COPY, 2-3, 17-51
- COPY DEV PRNT PLT, 17-55
- COPY SCREEN, 17-55
- correction factors, 3-1, 3-3, 17-55
  - data display, 17-69
  - default, 17-59
  - self-calibration, 17-32
  - storing, 17-34
- Correctn Factors, 17-56
- CORRECTN ON OFF, 17-56
- CORRECT ON OFF, 3-3, 17-55
- COUPLE AC DC, 17-56
- coupled functions menu, 17-22
- coupled sweep time, 17-196
- coupling
  - ac or dc, 17-56
  - all functions, 17-21
- creating
  - amplitude correction tables, 10-1
  - analyzer limit lines, 9-2, 9-10
  - new programs, 17-131
  - reports, 4-20, 12-14
  - signal lists, 5-2
- CRT HORZ POSITION, 17-57
- CRT VERT POSITION, 17-57
- customizing standard configurations, 4-5

## **D** DAC

- bias current adjustment, 17-33
- extra fine-tune, 17-212
- fine tune, 17-88
- mixer bias, 17-126
- sweep time, 17-195
- YTF coarse tune, 17-213
- YTF fine-tune, 17-213
- DACS, 17-2, 17-57
- data
  - controls, 2-9
  - entry using external keyboard, 13-9
  - keys, 2-9
  - output, 12-14
  - protection, 12-13
- DATEMODE MDY DMY, 17-57

- dBm, 17-58
- dB $\mu$ V, 17-58
- dBmV, 17-58
- dc coupling, 17-56
- deactivate function, 2-9
- deactivating the active function, 17-96
- DEFAULT CAL DATA, 17-59
- DEFAULT CONFIG, 17-59
- DEFAULT SYNC, 17-60
- Define List, 17-60
- Define Report, 17-60
- defining a analyzer limit margin, 9-7
- DELETE ALL SIGS, 17-61
- DELETE FACTORS, 17-61
- DELETE FILE, 17-61
- DELETE LIMIT, 17-63
- DELETE MARKED, 17-63
- DELETE POINT, 17-64
- DELETE SEGMENT, 17-64
- DELETE SIGNAL, 17-65
- Delete Signals, 17-65
- deleting, limit lines in analyzer mode, 9-2
- deleting signals from signal list, 5-8
- delta marker, 7-27, 17-117
- DELTA MEAS, 17-65
- DEMODO, 17-65
- DEMODO AM FM, 17-66
- DEMODO ON OFF, 17-66
- demodulating an AM or FM signal, 7-44
- demodulation
  - AM, 17-66
  - dwell time, 17-71
  - FM, 17-66
  - FM gain, 17-90
  - FM offset, 17-90
  - FM span, 17-90
  - on and off, 17-66
  - speaker on off, 17-188
  - squelch, 17-189
- demodulator, 13-2
- DESKJET 310/550C, 17-67
- DESKJET 540, 17-67
- DET, 17-67
- detection mode
  - positive peak, 17-68
  - sample, 17-68
- detector
  - quasi peak, 17-152
- DETECTOR PK QP AV, 17-67
- DETECTOR PK SP NG, 17-68
- detectors, 4-6, 6-3
- DETECTOR SMP PK, 17-68
- diagnostic emission
  - configuring system, 7-2
  - testing, 7-2-8

- diagnostic emissions, B-3
  - automated test, 7-3
  - manual test, 7-9ff
- diagnostic emission test
  - manual, 7-10
- diagnostic measurements, 7-1-53
  - resolving signals of equal amplitude, 7-11
  - resolving small signals hidden by large signals, 7-14
- disable peak detector reset, 17-70
- DISPLAY, 17-69
- DISPLAY CAL DATA, 17-2, 17-69
- DISPLAY CNTL I, 17-69
- display line, 17-71
- DISPLAY → CARD, 17-69
- Display Sys Data, 17-2
- display, two windows, 17-135
- display zone
  - change span, 17-216
  - find left peak, 17-215
  - find right peak, 17-215
  - move center, 17-214
- Dispose User Mem, 17-70
- distortion, testing, 7-38
- DLP editor, 17-80
  - function appending, 17-20
- double display, 17-135
- DROOP, 17-2, 17-70
- DSP LINE ON OFF, 17-71
- DUT emissions, 7-2
- DWELL TIME, 17-71
- dwel times, 4-7, 6-3
  - modifying, 4-7

**E**

- earphone connector, 2-6
- EDIT AMP COR, 17-71
- EDIT ANNOTATN, 17-72
- EDIT ANTENNA, 17-72
- EDIT CABLE, 17-72
- EDIT CAT ITEM, 17-73
- EDIT DONE, 17-73
- EDIT FLATNESS, 17-2, 17-74
- editing
  - amplitude correction tables, 10-6
  - analyzer limit lines, 9-2, 9-5, 9-10, 9-12
  - DLPs, 17-80
- EDIT LAST, 17-75
- Edit Limit, 17-75
- EDIT LIMIT, 17-76
- EDIT LIST, 17-76
- EDIT LOWER, 17-77
- EDIT MID/DELT, 17-78
- Editor, 17-80
- EDIT OTHER, 17-78
- EDIT PA FLATNESS, 17-2

- EDIT UP/LOW, 17-79
- EDIT UPPER, 17-79
- EDIT UPR LWR, 17-80
- electrostatic discharge (ESD), 1-22
- EMC ANALYZER, 17-80
- EMC analyzer auto-coupled sweep time, 17-195
- EMC analyzer configuration
  - default, 17-59
- EMC analyzer error messages, 14-1
- EMC analyzer state recalled, 17-143
- EMI bandwidth
  - 120 kHz, 17-10
  - 200 Hz, 17-10
  - 9 kHz, 17-8
- emissions
  - conducted, B-2
  - diagnostic, B-3
  - radiated, B-1-2
- emission testing
  - diagnostic, 7-2-8
- emulation, spectrum analyzer, 13-1
- end of sweep, A-1
- ENTER, 17-82
- entering a prefix, 12-3
- EPSON LQ, 17-82
- EPSON MX80, 17-82
- ERASE DLP MEM, 17-82
- ERASE MEM CARD, 17-82
- ERASE STATEALL, 17-83
- ERASE TRACEALL, 17-83
- erase user programs and variables, 17-70
- error messages, 14-1
- errors, non recoverable, 14-12
- ESD (electrostatic discharge), 1-22, 1-23
- exchange trace A and B, 17-11
- exchange trace B and C, 17-26
- execute a command
  - front panel, 17-83
- EXECUTE TITLE, 17-2, 17-83
- EXIT, 17-83
- EXIT CATALOG, 17-84
- EXIT EDIT, 17-85
- EXIT GRAPH, 17-86
- EXIT MEASURE, 17-86
- EXIT SHOW, 17-86
- expanding a window, 17-216
- EXT ALC INPUT, 2-6
- EXTERNAL, 17-87
- external/internal leveling, 17-14
- external keyboard, 13-4
  - connector, 2-8
- EXTERNAL PREAMPG, 17-87
- EXT KEYBOARD, 2-8
- EXT REF IN, 2-7
- EXT TRIG INPUT, 2-8

**F** fast Fourier transform, 17-88  
fast Fourier transform function, 8-12  
  measuring sidebands, 8-12  
fatal errors, 14-12  
FAX  
  form, 15-7  
  support, 15-4  
FFT MEAS, 17-88  
filenames, 12-2  
fine-focus control, 2-10  
FINE TUNE DAC, 17-2, 17-88, 17-212  
firmware date, 1-9  
fixed, limit line type, 17-105  
fix-tuned analyzer, 7-45  
FLAT, 17-89  
flatness  
  factory defaults, 17-98  
flatness correction constants, 17-74, 17-89  
Flatness Data, 17-2, 17-89  
FM COIL DRIVE, 17-2, 17-89  
FM GAIN, 17-2, 17-90  
FM OFFSET, 17-2, 17-90  
FM SPAN, 17-2, 17-90  
FORMAT CARD, 17-91  
format date, 17-57  
formatting a card, 12-2  
FREE RUN, 17-91  
FREQ DIAG, 17-2, 17-91  
FREQ OFFSET, 17-92  
FREQ SCL LOG LIN, 17-93  
FREQ STEP, 17-94  
frequency  
  changing the step, 6-5  
  decreasing the span, 7-19  
  modifying, 4-5  
  stop, 17-192  
FREQUENCY, 2-2, 17-94  
frequency demodulation, 17-66  
frequency, improving accuracy, 17-112  
frequency offset, 17-92  
frequency span, 17-187  
  changing to full span, 17-95  
front panel execution of programming commands, 17-83  
front-panel features, 2-2-5  
FRQ DISC NORM OFF, 17-2, 17-94  
FRQ SCAN ON OFF, 17-95  
FULL SPAN, 17-95  
function coupling, 17-21  
fuse holder, 2-7



- G**
  - Gauss, 17-95
  - generating a report, 4-21, 12-15
  - GHIJKL, 17-96
  - GND REF DETECTOR, 17-2, 17-96
  - graphing signal lists, 5-13
  - GRAT ON OFF, 17-96
  
- H**
  - hardware broken, A-1
  - hardware error messages, 14-1
  - harmonic band
    - menu, 17-27
    - slope and offset adjust, 17-35
  - harmonic band 1, 17-6
  - harmonic band 2, 17-7
  - harmonic band 3, 17-8
  - harmonic band 4, 17-9
  - harmonic lock, 7-48, 17-30
  - highest peak
    - finding next, 17-132
  - highest signal peak, 17-188
  - HIGH SWEEP IN/OUT, 2-8
  - HOLD, 2-9, 17-96
  - HP 85420E option 1EM
    - using, 8-23-25
  - HP B&W DJ540, 17-97
  - HP B&W PRINTER, 17-97
  - HP-IB interface connector, 2-8
  
- I**
  - IDNUM, 17-2, 17-97
  - IF bandwidth
    - function, 7-11
    - modifying, 4-5
    - reducing, 7-33
  - IF BW AUTO MAN, 17-97
  - IF GAINS, 17-2, 17-98
  - illegal command, A-1
  - impulse noise measurement, 7-35
  - increase frequency readout resolution, 7-17
  - informational screen messages, 14-1
  - INIT FLT, 17-2, 17-98
  - initial inspection, 1-4
  - INPT LOCK ON OFF, 17-98
  - Input, 17-99
  - INPUT 1 9k-50M, 17-99
  - INPUT 2 20M-2.9G, 17-99
  - INPUT 2 BYPASS, 17-100
  - INPUT 50 $\Omega$ , 2-4
  - INPUT 75 $\Omega$ , 2-4
  - input and output
    - auxiliary control, 17-24
  - input attenuation
    - control, 17-20
    - modifying, 4-5
    - reducing, 7-30

- input impedance, 17-100
- INPUT Z 50Ω 75Ω, 17-100
- inserting a memory card, 3-6
- instrument preset, 17-145
- instrument state, 2-3
- intensity control, 2-5
- interface connectors, 2-8
- intermediate frequency bandwidth coupling, 17-21
- intermodulation distortion, measuring, 8-22
- internal data protection, 12-13
- internal/external leveling, 17-14
- internal memory, 17-36
  - cataloging functions, 17-36
  - catalog variables, 17-39
  - delete file, 17-61
  - erase user programs and variables, 17-70
  - program and variable cataloging, 17-35
  - saving to, 17-203
  - state and trace register status, 17-38
- INTERNAL → STATE, 17-100
- Internal → Trace, 17-101

**K** keyboard

- entering data, 13-9
- external keyboard functions, 13-4
- template, 13-7

key menus, 16-1-15

knob, 2-9

**L** LAST SPAN, 17-101

LIF filenames, 12-2

Limit 1, 17-102

LIMIT 1 ON OFF, 17-102

Limit 2, 17-102

LIMIT 2 ON OFF, 17-103

limit lines

- activating analyzer, 9-15
- analyzer, 9-10
- analyzer, activating testing, 9-7
- analyzer, editing, 9-12
- analyzer, format, 9-14
- analyzer, saving, 9-8
- delete point, 17-64
- delete segment, 17-64
- deleting in analyzer mode, 9-2
- displaying, 17-108
- edit lower table, 17-77
- edit mid/delta amplitude, 17-78
- edit table, 17-75-76
- edit upper and lower tables, 17-79-80
- fixed and relative, 17-105
- flat type, 17-89
- point, 17-142
- purge, 17-150

- purging in signal analysis mode, 9-11
- recalling, 9-9
- recall table, 17-156
- save table, 17-164
- select amplitude, 17-169
- select frequency, 17-171
- select frequency or time, 17-106
- select lower amplitude, 17-173
- select middle amplitude, 17-173
- select segment, 17-176
- select type, 17-178
- select upper amplitude, 17-178
- slope type, 17-185
- testing, 17-109
- using, 9-2
- Limit Lines, 17-103
- LIMIT LINES, 17-104
- limit margin, analyzer, 9-7
- LIMITS FIX REL, 17-105
- LIMITS FRQ TIME, 17-106
- LIMITS → CARD, 17-104
- LIN CHCK ON OFF, 17-106
- LINE, 17-107
- linear
  - scale, 17-168
  - step, 6-7
  - sweep, 17-194
- linearity check, using, 7-38, 7-41
- LINE front-panel key, 2-5
- LIN ON OFF, 17-107
- listening to an AM or FM signal, 7-44
- LIST ON OFF, 17-108
- LIST → CARD, 17-107
- LMT DISP Y N AUTO, 17-108
- LMT TEST ON OFF, 17-109
- LOAD FILE, 17-110
- loading
  - amplitude correction factors from a card, 4-11
  - pre-defined configurations from a card, 4-4, 4-23
- (LOCAL), 17-50, 17-111
- localized susceptibility testing, 7-51-53
- local operation, 17-50, 17-111
- lock harmonic band, 17-30
- lock internal state and trace registers, 17-167
- logarithmic
  - step, 6-7
  - sweep, 17-194
- LOGF SPD, 17-112
- LOG ON OFF, 17-111
- log scale, 17-168
- LO OUTPUT, 2-6
- lower limit line
  - editing, 17-77
- low-level signals
  - reducing attenuation, 7-30

- reducing averaging bandwidth, 7-34
- reducing IF bandwidth, 7-33
- video averaging, 7-35

**M**

- MAIN COIL DR, 17-2, 17-112
- MAIN SPAN, 17-2, 17-112
- MAN TRK ADJUST, 17-113
- manual diagnostic emission test, 7-9-10
- manual tracking adjustment, 17-113
- MARGIN 1 ON OFF, 17-113
- MARGIN 2 ON OFF, 17-114
- MARK ALL DUPLICAT, 17-114
- MARK ALL SIGNALS, 17-114
- marker, 2-4, 6-4
  - counter, 7-17, 17-127
  - delta, 7-27
  - menu of controls, 17-128
  - noise, 17-127
  - pause, 17-128
  - pause, dwell time, 17-71
  - readout modes, 17-129
  - selection, 17-168
  - trace selection, 17-129
  - tracking, 7-19, 17-130
- MARKER, 17-116
- MARKER ALL OFF, 17-120
- MARKER AMPTD, 17-120
- MARKER NORMAL, 17-121
- MARKER # ON OFF, 17-116
- MARKER → CF, 17-117
- MARKER →CF STEP, 17-118
- MARKER → HIGH, 17-118
- MARKER →MINIMUM, 17-118
- MARKER →PK-PK, 17-119
- MARKER →REF LVL, 17-119
- MARKER → START, 17-119
- MARKER → STOP, 17-120
- MARKER TUNE SPN, 17-122
- MARKER  $\Delta$ , 17-117
- MARKER  $\Delta$  SPAN, 17-117
- marking signals, 5-10
- MARK LWR DUPLICAT, 17-115
- MARK SIGNAL, 17-115
- MARK TO END, 17-115
- MAX HOLD A, 7-25, 17-123
- MAX HOLD B, 17-123
- maximum
  - hold, 7-24
  - mixer level, 17-124
- MAX/MIN ON OFF, 17-123
- MAX/MIN VIEW, 17-124
- MAX MXR LVL, 17-124
- MEAS SNG CONT, 17-124
- MEAS STEPPED, 17-125

- measure-at-marker, 4-16
- Measure at Marker, 4-7
- MEASURE AT MKR, 17-125
- Measure Detector, 17-125
- measurement
  - restarting, 6-5
  - stopping, 6-5
- measuring
  - 3 dB and 6 dB bandwidth, 8-17
  - 99% power bandwidth, 8-18
  - amplitude and frequency difference, 8-20
  - low-level signals, 7-30
  - percent AM modulation, 8-19
  - return loss, 8-10
  - signals near band boundaries, 7-48
  - third order products, 8-22
- MEM LOCKED, 17-126, 17-167
- memory, amount available, 17-36
- memory card, B-1
  - battery, 3-7
  - changing the battery, 3-7
  - inserting a memory card, 3-6
  - reader, 2-5
  - write-protect switch, 3-8
- memory card reader, 2-5
- menu and softkey overview, 2-13
- menus, 16-1
- $\mu\text{A}/\text{m}$ , 17-4
- $\mu\text{V}/\text{m}$ , 17-5
- mid/delta limit line
  - editing amplitude, 17-78
- MIN HOLD C, 7-25, 17-126
- minimizing scan time, 17-112
- minimum hold, 7-24
- minimum to marker, 17-118
- 10V REF DETECTOR, 17-2
- MIXER BIAS DAC, 17-2, 17-126
- mixer input level maximum, 17-124
- MK COUNT ON OFF, 7-17, 17-127
- MK NOISE ON OFF, 17-127
- MK PAUSE ON OFF, 17-128
- MKR, 17-128
- MK READ F T I P, 17-129
- MKR  $\rightarrow$ , 17-128
- MK TRACE AUTO ABC, 17-129
- MK TRACK ON OFF, 7-22, 17-130
- MNOPQR, 17-130
- MODE, 17-130
- modifying standard configurations, 4-5
- MONITOR OUTPUT, 2-7
- move trace A into C, 17-12
- moving zone markers, 11-3
- multipen plotter, 17-53

- N**
  - NEW EDIT, 17-131
  - NEXT, 17-131
  - NEXT PAGE, 17-131
  - NEXT PEAK, 17-132
  - NEXT PK LEFT, 17-132
  - NEXT PK RIGHT, 17-132
  - NO CONVERSN, 17-133
  - non recoverable errors, 14-12
  - NORM A/B ON OFF, 17-133
  - normalization, 8-5
  - normal marker, 17-121
  - NORMLIZE ON OFF, 17-134
  - NORMLIZE POSITION, 17-134
  - No User Menus, 17-133
  - NTSC, 17-134
  - number/units keypad, 2-9
  
- O**
  - octal to binary, A-2
  - ON, 17-135
  - on/off switch, 2-5
  - operation, local, 17-111
  - optimizing frequency accuracy, 17-112
  - options, 18-1
  - Other Factors, 17-136
  - OTHER ON OFF, 17-136
  - OTHER → CARD, 17-136
  - output
    - data, 12-14
    - power, 17-190
    - screen data, 17-51
  - OUTPUT, 17-136
  - OUTPUT front-panel key, 4-1
  - OUTPUT REPORT, 17-137
  - overview
    - menus and softkeys, 2-13
    - mode, activating, 11-5
  - overwrite protection, 12-13
  - OVLN ON OFF, 17-137
  
- P**
  - packing material, 15-5
  - PAINTJET PRINTER, 17-137
  - PAL, 17-137
  - PAL-M, 17-138
  - parallel
    - interface connector, 2-8
    - polling, A-1
  - pass code, 17-59
  - PC board connector cleaning, 1-22
  - peak
    - next, 17-132
    - next left, 17-132
    - next right, 17-132
  - peak detection mode
    - positive/negative, 17-68

- PEAK EXCURSN, 17-138
- peaking signal amplitude, 7-20
- peak response routine, 17-204
- peak search
  - outside of the zone, 17-215
- peak to peak measurement, 17-119
- percent AM modulation
  - measuring, 8-19
- percent amplitude modulation, 17-4
- phase lock on/off, 17-4
- $\phi$  LOCK ON OFF, 17-2
- $\phi$ LOCK ON OFF, 17-4
- PK DWELL TIME, 17-139
- PK-PK MEAS, 8-20, 17-139
- Plot Config, 17-139
- PLOTTER ADDRESS, 17-139
- plotter configuration, 17-50
- plotting, 17-51, 17-55
- PLT\_ \_\LOC\_ \_ , 17-140
- PLT MENU ON OFF, 17-140
- Plt Port Config, 17-140
- PLT PORT HPIB PAR, 17-140
- PLT PORT SER PAR, 17-141
- PLT—LJT ON OFF, 17-140
- PLTS/PG 1 2 4, 17-141
- POINT, 17-142
- point deletion, 17-64
- positive peak detection mode, 17-68
- power bandwidth, measuring, 8-18
- power cable, 1-20
- power input, 2-7
- POWER ON IP LAST, 17-143
- power-on state of EMC analyzer, 17-143
- preamplifier gain, 17-87
- PREAMP ON OFF, 17-144
- pre-compliance measurements
  - analyzer tuning, 4-14
  - analyzer tuning using marker, 4-15
  - autoranging, using, 4-7
  - bandwidths, modifying, 4-5
  - configuring, 4-3
  - configuring a printer, 4-20
  - creating a report, 4-20
  - customizing standard configurations, 4-5
  - detector, selection, 4-6
  - dwel time, modifying, 4-7
  - frequencies, modifying, 4-5
  - generating a report, 4-21
  - loading amplitude correction factors from a card, 4-11
  - loading configurations from a card, 4-4, 4-23
  - measure at marker, 4-7
  - radiated, 4-14
  - reference level, modifying, 4-5
  - setting up, 4-1
  - standard configurations, 4-2

- using limit lines, 4-8
- using measure-at-marker, 4-16
- predetermined correction factors, 17-59
- prefix
  - catalog of, 17-38
  - editing, 12-4
  - entering, 12-3
  - entry, 17-41
  - selection, 17-174
- PRESEL DAC, 17-2, 17-144
- PRESEL DEFAULT, 7-20, 17-144
- preselector
  - default, 17-144
  - peak, 7-20, 17-145
- preselector peak, 7-20
- PRESEL PEAK, 17-145
- PRESET, 17-145
- preset conditions
  - EMC analyzer, 17-145
  - spectrum analyzer, 17-146
- Print Config, 17-148
- printer
  - configuration, 17-50
  - configuring, 4-20, 12-14
  - HP Paintjet, 17-51
- PRINTER ADDRESS, 17-148
- PRINTER SETUP, 17-148
- printing, 17-51, 17-55
- print menu, 17-149
- Prn Port Config, 17-148
- PRN PORT HPIB PAR, 17-149
- PRN PORT SER PAR, 17-149
- probe, close-field, 7-2-10
- PROBE PWR, 2-5
- problems, how to solve, 15-2
- program cataloging, 17-35
- program (DLP) editor, 17-80
- program editing and creating, 17-80
- programming command
  - front panel execution, 17-83
- PRT MENU ON OFF, 17-149
- pTesla, 17-149
- PURGE AMP COR, 17-150
- PURGE LIMITS, 17-150
- purging, limit lines in signal analysis mode, 9-11
- PWR SWP ON OFF, 17-151



- Q**
  - QP/AVG 10X OFF, 17-152
  - QP DET ON OFF, 17-3, 17-152
  - QPD OFFSET, 17-3, 17-153
  - QPD RST ON OFF, 17-3, 17-154
  - QP DWELL TIME, 17-152
  - QP GAIN ON OFF, 17-3, 17-153
  - QP ON OFF, 17-153
  - quasi-peak, detector, 17-152
  
- R**
  - radiated emissions, B-1, B-2
  - real-time clock, 17-198
    - set date, 17-180
    - set time, 17-180
    - time and date display, 17-198
  - rear-panel battery information label, 3-9
  - rear-panel features, 2-6-8
  - RECALL AMP COR, 17-154
  - RECALL ANTENNA, 17-154
  - RECALL CABLE, 17-155
  - Recall Card, 17-155
  - RECALL DISPLAY, 17-155
  - RECALL DLP, 17-155
  - recalling
    - amplitude correction, 10-7
    - a trace from internal memory, 17-101
    - limit-line table, 9-9
    - signal lists, 5-13
    - state, internal, 12-11
    - trace, 12-6
      - trace, internal, 12-12
  - Recall Internal, 17-156
  - RECALL LIMITS, 17-156
  - RECALL LIST, 17-156
  - RECALL OTHER, 17-157
  - RECALL SETUP, 17-157
  - RECALL STATE, 17-157
  - RECALL TRACE, 17-158
  - reference connector, 1-9
  - reference detector
    - 2V, 17-6
    - ground, 17-96
  - reference level, 17-158
    - modifying, 4-5
    - offset, 17-159
  - reflection calibration measurements, 8-9
  - REF LVL, 17-158
  - REF LVL OFFSET, 17-159
  - relative, limit line type, 17-105
  - REMEAS ALL SIGS, 17-159
  - REMEAS MARKED, 17-160
  - REMEAS SIGNAL, 17-160
  - Re-measure, 17-160
  - remeasuring signals, 5-12
  - remote command

- front panel execution, 17-83
- remote operation, 17-50
- report
  - configuring, 4-21, 12-15
  - creating, 4-20, 12-14
  - generating, 4-21, 12-15
- resolving signals, 7-14
- RESTART, 17-161
- return loss, measuring, 8-10
- RF filter section, using, 8-23-25
- RPG knob, 2-9
- RPG TITLE, 17-161
- RS-232 interface connector, 2-8

**S**

- sales and service offices, 15-6
- sample detection mode, 17-68
- SAVE AMP COR, 17-161
- SAVE ANTENNA, 17-162
- SAVE AUTOEXEC, 17-162
- SAVE CABLE, 17-162
- Save Card, 17-163
- save current state
  - state register, 17-191
- saved analyzer state, 17-100
- SAVE EDIT, 17-163
- Save Internal, 17-163
- SAVE LIMITS, 17-164
- SAVE LIN GRAPH, 17-164
- SAVE LIST, 17-165
- SAVE LOG GRAPH, 17-165
- SAVE OTHER, 17-166
- Save/Rec\ List, 17-166
- SAVE/RECALL, 17-166
- SAVE SETUP, 17-167
- saving
  - amplitude correction, 10-7
  - analyzer limit-line table, 9-8
  - signal lists, 5-12
  - state, internal, 12-11
  - to internal memory, 17-203
  - trace, 12-4
    - trace, internal, 12-12
- SAV LOCK ON OFF, 17-167
- SCALE LOG LIN, 17-168
- scan time, minimizing, 17-112
- screen annotation, 2-11-12, 2-18-19
  - on or off, 17-18
- screen characters, 17-96, 17-130, 17-193, 17-213
- screen data output, 17-51
- screen graticule, 17-96
- screen title, 17-42
  - characters, 17-13
- SECAM-L, 17-168
- segment deletion, 17-64

- SELECT 1 2 3 4, 17-168
- SELECT AMPLITUD, 17-169
- Select Axis, 17-170
- SELECT DLT AMPL, 17-170
- SELECT FREQ, 17-171
- SELECT FRM LIST, 17-172
- selecting detectors, 4-6, 6-3
- SELECT LWR AMPL, 17-173
- SELECT MID AMPL, 17-173
- SELECT POINT, 17-173
- SELECT PREFIX, 17-174
- SELECT SEGMENT, 17-176
- SELECT TIME, 17-177
- SELECT TYPE, 17-178
- SELECT UPR AMPL, 17-178
- Selectv Mark, 17-179
- self-calibration routines, 3-1-4
  - correction factors, 17-32
  - tracking generator, 17-34
- sensitivity, analyzer, 7-30
- serial polling, A-1
- Service Cal, 17-2, 17-179
- Service Diag, 17-2, 17-179
- service functions, 17-2
  - Service Cal, 17-2
  - Service Diag, 17-2
- service request, A-1
- service, returning for, 15-5
- SET ATTN ERROR, 17-2, 17-179
- Set B&W Printer, 17-180
- Set Colr Printer, 17-180
- SET DATE, 17-180
- SET TIME, 17-180
- SETTINGS ON OFF, 17-181
- SETUP, 17-181
- SETUP front-panel key, 4-1
- setup, printer, 17-148
- SETUP → CARD, 17-181
- SGL SWP, 17-181
- SHOW COR ON OFF, 17-182
- SHOW DET PK QP AV, 17-183
- SHOW MKR ON OFF, 17-183
- SHOW SETUP, 17-183
- SHOW Δ 1\ PK QP AV, 17-182
- SHOW Δ 2\ PK QP AV, 17-182
- SHW INST CONFIG, 17-184
- sidebands, measuring, 8-12
- SIG LIST ON OFF, 17-184
- signal
  - comparison, 7-27
  - difference on and off screen, 7-28
  - differences, 7-27
  - separation, 7-14
  - tracking, 7-19
- signal list

- adding signals, 5-4
- creating, 5-2
- deleting signals, 5-8
- graphing, 5-13
- marking, 5-10
- remeasuring, 5-12
- saving and recalling, 5-12
- sorting, 5-7
- table, 6-5
- viewing, 5-6
- Signal Marking, 17-184
- signal peak, highest, 17-188
- single sweep, 17-194
- SLOPE, 17-185
- small signals, measuring in presence of large ambient, 7-38
- softkeys, 2-2
  - location, 16-1
  - overview, 2-13
- SORT BY AVG AMP, 17-185
- SORT BY DLTA LIM, 17-186
- SORT BY FREQ, 17-186
- SORT BY QP AMP, 17-187
- SORT BY\ PK AMP, 17-186
- sorting signal lists, 5-7
- Sort Signals, 17-187
- source power, 17-190
- space character, 17-213
- span
  - 0 Hz, 17-214
  - LAST SPAN, 17-101
  - window zone, 17-216
- SPAN, 2-2, 17-187
- SPAN ZOOM, 7-22, 17-188
- SPEAKER ON OFF, 17-188
- SPECTRUM ANALYZER, 17-188
- spectrum analyzer emulation, 13-1
- split screen, 17-135
- SQUELCH, 17-189
- SRC ATN MAN AUTO, 17-189
- SRC PWR OFFSET, 17-190
- SRC PWR ON OFF, 17-190
- SRC PWR ON OFF softkey, 8-3
- SRC PWR STP SIZE, 17-190
- SRQ, A-1
- standard configurations, 4-2
  - customizing, 4-5
- standard timebase, 17-34
- start and stop frequencies, 17-117
  - modifying, 4-5
- START FREQ, 17-191
- state of EMC analyzer at power on, 17-143
- state registers, locking, 17-167
- STATE → CARD, 17-191
- STATE → INTRNL, 17-191
- static-safe work station, 1-22

- static-shielding containers, 1-23
- status byte, A-1
- step
  - frequency, 6-5
  - keys, 2-10
  - linear, 6-7
  - logarithmic, 6-7
- STEP KEYS, 2-4
- STEP LOG LIN, 17-192
- stepped measurements, 6-1
- step size
  - center frequency, 17-40
  - coupling, 17-21
- stimulus-response
  - measurements, 8-2
  - mode, 8-4, 17-195
- STOP, 17-192
- STOP FREQ, 17-192
- store correction factors, 17-34
- STORE FLATNESS, 17-2, 17-192
- storing the correction factors
  - CAL STORE, 1-11
- STOR PWR ON UNITS, 17-2, 17-193
- STP GAIN ZERO, 17-3, 17-193
- STUVWX, 17-193
- subtract display line from trace B, 17-27
- subtract trace B from A, 17-12
- support, FAX, 15-4
- susceptability testing, 7-51-53
- sweep control
  - continuous, 17-194
  - single, 17-194
- SWEEP CONT SGL, 17-194
- SWEEP LOG LIN, 17-194
- sweep modes, 2-11, 2-18
- SWEEP OUTPUT, 2-8
- SWEEP RAMP, 17-3, 17-194
- sweep time, 7-11, 17-196
  - coupling, 17-21
- SWEEP TIME DAC, 17-3, 17-195
- SWEEP/TRIG, 17-195
- SWEEP+TUNE OUTPUT, 2-6
- switch trace A and B, 17-11
- SWP CPLG SR RECV, 17-195
- SWP TIME AUTO MAN, 17-196
- SYNC NRM NTSC, 17-196
- SYNC NRM PAL, 17-197

**T** TABLE ADDRESS, 17-197  
 TABLE CCW STOP, 17-197  
 TABLE CW STOP, 17-197  
 tables  
     amplitude correction, activating, 10-6  
     amplitude correction, creating, 10-1  
     amplitude correction, editing, 10-6  
     amplitude correction, saving and recalling, 10-7  
     analyzer limit line, saving, 9-8  
     limit line, format of analyzer, 9-14  
     limit line, recalling, 9-9  
 TEST, 17-198  
 TEST front-panel key, 4-1  
 testing  
     diagnostic emission, 7-2-8  
     localized susceptibility, 7-51-53  
 TG UNLVL message, 8-8  
 ThinkJet Printer mode switch settings, 17-51  
 third order measurements, 8-22  
 THRESHLD ON OFF, 17-198  
 threshold line, 17-198  
 Time Date, 17-198  
 TIMEDATE ON OFF, 17-199  
 TOWER ADDRESS, 17-199  
 TOWER DN STOP, 17-199  
 Tower Turntable, 17-199  
 TOWER UP STOP, 17-199  
 TOWER VERT HOR, 17-200  
 trace  
     A <—> B, 17-11  
     A—B → A, 17-12  
     A → C, 17-12  
     blank trace A, 17-28  
     blank trace B, 17-29  
     blank trace C, 17-29  
     B—DL → B, 17-27  
     clear write trace A, 17-44  
     clear write trace B, 17-45  
     clear write trace C, 17-46  
     move trace B into C, 17-26  
     view mode, 17-209-210  
 TRACE, 17-200  
 trace A  
     maximum hold, 17-123  
 TRACE A, 17-200  
 TRACE A B C, 17-200  
 trace B  
     maximum hold, 17-123  
 TRACE B, 17-201  
 TRACE B VW OFF, 17-201  
 TRACE C, 17-202  
 trace modes, 2-11, 2-18  
 trace registers, locking, 17-167  
 Trace → Card, 17-202  
 Trace → Intrnl, 17-203

- Track Gen, 17-203
- TRACK GEN front-panel key, 8-3
- tracking generator, 13-2
  - external leveling input, 2-6
  - frequency adjustment, 17-113
  - internal/external leveling, 17-14
  - normalization, 8-5
  - output power, 17-190
  - peak response, 17-204
  - power sweep, 17-151
  - power sweep range, 17-190
  - self-calibration, 17-34
  - self-calibration routine, 3-3
  - source attenuator, 17-189
  - source power offset, 17-190
  - source power step size, 17-190
  - stimulus-response, 8-2
  - unleveled condition, 8-8
  - warm-up time, 3-3
- TRACKING PEAK, 17-204
- tracking unstable signals, 7-22
- transducers, 18-2
- trigger
  - external, 17-87
  - free run, 17-91
  - line, 17-107
  - video, 17-208
- Trigger, 17-204
- triggering on a selected line, video picture field, 8-28
- trigger modes, 2-11, 2-18
- troubleshooting, 15-2
- TUNE SLO FAST, 17-204
- turning off markers, 17-120
- turning off windows display, 17-212
- turn off active function, 2-9
- TV LINE #, 17-205
- TV Standard, 17-205
- TVSTND, 8-29
- TV SYNC NEG POS, 17-205
- TV TRIG, 8-28, 17-206
- TV TRIG EVEN FLD, 8-29, 17-206
- TV triggering, 8-28
- TV TRIG ODD FLD, 17-207
- TV TRIG OUTPUT, 2-6
- TV TRIG VERT INT, 17-207
- two display windows, 17-135
- type of limit line, 17-178

- U**
  - underscore character, 17-213
  - unit key pressed, A-1
  - units, amplitude, 17-17
  - universal HP-IB service request, A-1
  - unleveled condition, tracking generator, 8-8
  - upper and lower limit lines, editing, 17-79
  - user-created error messages, 14-1
  - User Menus, 17-207
  
- V**
  - variable cataloging, 17-35
  - VERIFY TIMEBASE, 17-208
  - VID AVG ON OFF, 17-208
  - VIDEO, 17-208
  - video averaging, 7-35, 17-208
  - video picture field
    - triggering on a selected line, 8-28
  - VIEW A, 17-209
  - VIEW B, 17-210
  - VIEW C, 17-210
  - VIEW CAL ON OFF, 17-211
  - viewing
    - analyzer limit lines, 9-2, 9-10
    - card catalog, 9-9
    - signal list, 5-6
  - VIEW PK QP AV, 17-211
  - VIEW  $\Delta$  OFF, 17-209
  - VOL-INTEN, 2-5
  - VOLTAGE SELECTOR, 2-7
  - Volts, 17-211
  - volume control, 2-5
  
- W**
  - warm-up time, 3-1
  - Watts, 17-212
  - when self-calibration is needed, 3-4
  - windows
    - ON, 17-135
    - ZOOM, 17-216
  - windows display mode
    - activating, 4-12, 11-2
    - activating overview mode, 11-5
    - moving zone markers, 11-3
    - turning off, 11-6
  - WINDOWS OFF, 17-212
  - write protection, 12-13
  - write-protect switch, 3-8



- X** X FINE TUNE DAC, 17-3
  
- Y** YTF DRIVER, 17-3, 17-212  
YTF self-calibration routine, 3-4  
YTF slope and offset adjustment, 17-35  
YTF SPAN, 17-3, 17-213  
YTF TUNE COARSE, 17-3, 17-213  
YTF TUNE FINE, 17-3, 17-213  
YZ\_# Spc Clear, 17-213
  
- Z** ZERO SPAN, 7-20, 17-214  
ZONE CENTER, 17-214  
zone markers, 11-3  
ZONE PK LEFT, 17-215  
ZONE PK RIGHT, 17-215  
ZONE SPAN, 17-216  
ZOOM, 17-216  
zooming a window, 17-216

